

On the Limitations of Ideological Critique

Wei-Kai Liao

Department of Politics
Faculty of Social Sciences, University of Sheffield

A thesis submitted in partial fulfilment of the requirements for the
Degree of Doctor of Philosophy

May 2015

In Memory of My Father

Abstract

This thesis investigates whether humans possess the capacity to resist ideology via two dimensions: empirical analysis and philosophical discourse. For the empirical analysis, academic ideology-specialists and their publications (articles related to ideological analysis or critique (IAC)) are selected as research subjects. Through analysing ideology-specialists' IAC works, this thesis attempts to examine their immunity against (their own or social) ideology and humans' limitation of undertaking (ideological) critique. Inspired by the Frankfurt School's argument of standardisation in cultural creations, this thesis has analysed 33 IAC articles to determine whether these IAC works are composed in the same way and lead to an academic industry (as with the culture industry critiqued by Adorno and Horkheimer). Based on the commonalities between the 33 IAC articles, it has been found that standard writing procedures (SWPs) when writing IAC articles do indeed exist. Accordingly, through an empirical analysis, this thesis argues that ideology critics are incapable of exempting from either their own or from the social ideology in which they are embedded. Humans' capacity to undertake a neutrally and objectively ideological critique is limited.

In the philosophical discourse, Adorno's works are selected since many of his ideas seem to guide a way out of ideology's dungeon; yet, Adorno only succeeds in a theoretical dimension. His discourses have conveyed certain significations that represent his personal ideology resulting from his life experience. His defeat reveals the limitation of undertaking (ideological) critique: criticising one subject, even through an ideological angle, involves an ideology itself. Finally, in order to solve this dilemma of fatalism, this thesis suggests the concept of *humbleness* and the action of *self-critique*. The former asks readers to realise humans' limitation of undertaking a neutral and objective (ideological) critique, so that humans have to minimise their egocentricity. The latter indicates a possible way to escape from ideology.

Keywords: Ideology, Intellectual, Critique, Frankfurt School, Marxism, Adorno, Humble

Contents

Chapter 1

Introduction	1
1.1 Motivation, Research Question, and Debate.....	1
1.2 Framing the Subject	2
1.3 Thesis Outline	4
1.4 Clarification and Redefinition of Terminologies	10
1.5 Definition of Ideology in this Thesis	15

Chapter 2

Framing the Subject and the Object —Intellectuals and the Ideological Critiques	17
2.1. Introduction.....	17
2.2. History of Intellectuals.....	18
Intellectuals in Early History	18
Intelligentsia in Russia.....	19
Intellectuals in France and Contemporary Society	21
Summary and Discussion.....	23
2.3. History of Critique and Ideological Critique	24
What is Critique?	24
Evolution of Critique—From Scepticism to Modern Critique.....	26
Evolution of Critique—Epoch of Ideological Critique	27
The Difference between General Critique and Ideological Critique.....	30
Summary	33
2.4. Academic Intellectuals and Ideological Critique	34
From Jesters to Modern (General) Critics.....	34
When General Critics Encounter Ideology	36
Academic Intellectuals of Ideological Critique.....	38
2.5. Conclusion	41

Chapter 3

Theoretical Inspiration: Standardisation

—From Culture Industry to Academic Industry	43
3.1 Introduction	43
3.2 The Frankfurt School.....	44
Its History and Critique on Ideology-Life Complex	44
Concept: Dialectic of Enlightenment	47
Concept: Instrumental Rationality.....	48
Concept: Identity and Totality	51
3.3 Culture Industry and Academic Industry.....	54
Culture Industry.....	55
Academic Industry.....	58
Seriously, Has Standardisation Occurred in Academic Publications?.....	61
3.4 Conclusion.....	62

Chapter 4

Methodology	65
4.1 Introduction	65
4.2 Data Collection and Research Objectives	65
Data Collection.....	65
Research Objectives of Empirical Analysis.....	68
4.3 Methods of Empirical Analysis: Literature and Discourse Analysis.....	68
Literature Analysis.....	68
Discourse Analysis	70
4.4 Presentation in Empirical Analysis Chapters (5-8).....	73
Framework.....	73
Examples	74
SWPs Codes and How they are Presented in IAC Articles.	75
How to Match SWPs Codes Within IAC Articles (How to Use the Disk)	78
4.5 Conclusion.....	79

Section of Empirical Analysis (Chapters 5-8)

—Introduction: Standard Writing Procedures of Ideological Critique81

Chapter 5

Procedure 1: Identifying Essential Elements —The Nature of Ideology85

5.1. Introduction..... 85

 Marx’s Fundamental Concepts for Understanding Ideology 85

5.2 Finding the Classes 90

 Theoretical Review and Extension 90

 Empirical Analysis 97

5.3 Involving Power..... 100

 Theoretical Review 101

 Empirical Analysis 105

5.4 Class and Power—Discussion of Dominant Ideology 109

 Theoretical Review 109

 Empirical Analysis 112

5.5 Presenting the Reality 114

 Theoretical Review—Whether Ideology is a False Consciousness115

 Empirical Analysis 123

5.6 Reality and Power 128

5.7 Class and Reality—Discussion of Class Consciousness..... 131

 Theoretical Review 131

 Empirical Analysis 134

5.8 The Characteristic of Ideology..... 135

5.9 Class, Power and Reality—Hegemony Theory 140

5.10 Conclusion: Unfinished Business between de Tracy and Napoleon 142

Chapter 6

Procedure 2: Applying Theoretical Foundations — The Making of Ideology.....145

6.1 Introduction..... 145

6.2 Marx’s Analytical Pathway 146

 Theoretical Review 146

Empirical Analysis	149
Application of Marx’s Analytical Pathway	151
6.3 Althusser’s Analytical Pathway	152
Theoretical Review.....	152
Empirical Analysis	155
Application of Althusser’s Analytical Pathway	157
6.4 Gramscian Analytical Pathway.....	158
Theoretical Review.....	158
Empirical Analysis	159
Examples of Articulation.....	160
Application of Gramscian Analytical Pathway	162
6.5 Examples of Application of Diverse Pathways	163
6.6 Pathway of Historical Description.....	164
6.7 Semiotic Analytical Pathway.....	167
Theoretical Review.....	168
Empirical Analysis	171
Application of the Semiotic Analytical Pathway.....	176
6.8 Conclusion and Discussion.....	177

Chapter 7

Procedure 3: Connoting Certain Meanings & Procedure 4: Illustration

— Ideology Concealed in Texts	179
Procedure 3: Connoting Certain Meanings	180
7.1 Introduction	180
7.2 Connoting Certain Meanings.....	182
Theoretical Review—Barthes’s Mythology	183
Empirical Analysis	188
Application of Barthes’s Mythology	194
7.3 Conclusion.....	195
Procedure 4: Illustration (Articulation and Interpellation)	196
7.4 Introduction	196
Theoretical Discussion—The Meaning of Illustration	196
7.5 Illustration—Via Understanding of the Research Subjects’ History	198

Finding Similarities (and Making Comparison)	199
Using References	202
7.6 Illustration—Through Specific Presenting Techniques	206
Transferring (Rhetorics of Persuasion)	206
Using Inarguable Values	210
Writing Skills	213
Explaining	220
7.7 Conclusion and Discussion	222
Conclusion	222
Discussion	223

Chapter 8

Procedure 5: Selecting Expression Styles & Procedure 6: Revealing Personal Viewpoints	
— Ideology Embedded in Analysts	225
Procedure 5: Selecting (IAC) Expression Styles	225
8.1 Introduction.....	225
8.2 Selecting Expression Styles	226
Purely Descriptive Style	226
Interpretative Style.....	227
Articles Categorised Between the Purely Descriptive and Interpretative Styles .	228
Defensive and Corrective Style.....	229
8.3 Discussion and Application.....	230
Discussion: Which Style is the Best?.....	230
Application of Three IAC Expression Styles.....	231
8.4 Conclusion	232
Procedure 6: Revealing Personal Viewpoints	234
8.5 Introduction.....	234
8.6 Subjectivities Revealed— via Declaring a Standpoint	234
Declaring a Standpoint: Pessimistically.....	234
Declaring a Standpoint: Optimistically.....	236
8.7 Subjectivities Revealed—due to IAC Analysts’ Narrating Traits	238
Narrating Traits: IAC Analysts’ Title Selection.	238
Narrating Traits: IAC Analysts’ Asking Questions	241

Narrating Traits: IAC Analysts' Personal Background.....	243
Narrating Traits: IAC Analysts' Assertive Declaration	245
8.8 Conclusion.....	247
Section of Empirical Analysis (Chapters 5-8)	
—Conclusion and Discussion.....	249
Conclusion.....	249
Does A Certain Way of Writing IAC Articles Exist?.....	255
Discussion	259
Chapter 9	
Adorno's Way Out of Ideology	261
9.1 Introduction: A Permanent Dialectic	261
9.2 Ways out of Ideology's Cage: Diverse Perspectives	261
Theory and Practice.....	264
9.3 Adorno's Escape Routes.....	267
Ontological Dimension.....	268
Epistemological Angle.....	274
Methodological Angle	278
9.4 The Real Practice: Arts.....	279
9.5 Conclusion.....	283
9.6 Discussion	284
Chapter 10	
Conclusion and Suggestion —Humbleness and Self-Critique	287
10.1 Conclusion.....	287
10.2 Suggestion: Way Out of Ideology.....	290
Humbleness	292
Meaning of Critique and the Way to Escape Ideology: Self-Critique	296
Bibliography	299
Appendices	320

Chapter 1

Introduction

1.1 Motivation, Research Question, and Debate

Discourse and semiotic analyses were adopted in my MA dissertation to illustrate American hegemony in Hollywood superhero films. Yet, the more I criticised the films, the more I found myself involved and identifying with the American hegemony. Although I have often watched the scene in which Superman saves an airplane, I still feel excited and nervous whenever I watch it. Such reaction has confused me. If people, like me, consider themselves critics, how might they acknowledge the ideology that they are arguing? If so-called critics cannot avoid the influences from their own or the social total ideology, how could they obtain authority to claim the validity of their critique?

Of course, Sahin (1980) was correct in saying that researchers do not have to despise a subject in order to analyse the hidden hegemony. However, in my opinion, since researchers have learned or developed various theories and are considered people who can lead others to see social injustice or unbalanced power relationships, for example, they should respond differently from the public, to be responsible for the arguments resulting from their critique and analysis, and to be the vanguard of the critical response.

What is it that makes analysts or critics, like me, on the one hand, think they have understood/discovered/criticised the ideology of their research, yet, simultaneously surrender to their research subjects on the other? Are analysts/critics really capable of delineating the ideology of their research? Or, is the unacceptable fact that the ideology they describe always and already influenced/determined by another more obscure, unidentifiable, insensible but powerful ideology embedded in their consciousness, abounding in the social condition in which they live? Accordingly, my prime question is:

Are analysts or critics capable of exempting from the influences of their own and social ideology, even if they are experts in ideology studies?

If so, then another question is: By what given authority, can one state that one's analysis/critique is valid, without any personal opinions? In fact, any humans' discussions (even those not related to ideology) are all the products of ideology, without exception, because every discussion is based on ones' personal ideology to examine/argue against another's ideology which, eventually, will fall into an endless loop of 'critique of critique of critique...'. Research on *ideology* will always face the curse of circular reasoning. Criticising one subject involves an ideology itself (McLellan, 1995; Larrain, 1994; Thompson, 1990; Žižek, 1989). Just as people cannot use the word *labour* to describe Marx's notion of labour, criticizing a system of human consciousness, by using another system of human consciousness, is similar to Escher's drawings: the 'paradox... of two hands drawing each other' (Žižek, 1989, p. 47). In short, if one claims that he/she is able to criticise/analyse one ideology neutrally and objectively, the question is: how can they avoid involving their own ideology to do so?

On the contrary, if the answer is *not*, then what is the meaning/purpose of critique/analysis (of ideology)? Alternatively, why do people continue to criticise/analyse if all discussions, *ab ovo*, are the products of discussants' own ideology? If humans' conscious actions always refer to certain guiding ideology, the reason for humans' existence becomes even harder to understand.

Whether critics/analysts are capable of neutrally and objectively undertaking their analysis/critique which is exempt from the influences of their own and social ideology, or whether the results of their analyses are the conscious products determined by their own or social ideology? These questions, which attempt to examine humans' limitation during their analysis, will be answered through this thesis.

1.2 Framing the Subject

Based on above discussion, three subjects revealing the kernel of this thesis are: humans, (ideological) critique/analysis, and ideology. To investigate these three subjects' inter-relationships, this thesis focuses on *academics'* conscious activities, examining academic publications which specifically refer to the type of *ideological critique/analysis*. This is to observe how they present their works as well as seeing if they are able to impart

their critique/analysis neutrally and objectively, without involving personal opinions. Further explanation is provided below.

1) Humans: In this study, I specifically refer to ideology-specialists. By these I mean scholars who are familiar with ideology-related theories. Ideological-specialists have been promoted to a higher position as the few people who are able to carry the role of real-intellectuals. They are, or might be, the most capable people who can escape from the intervention of ideology.

2) Critique/analysis: Critique and analysis are actions resulting from humans' conscious activities. This thesis focuses on academics' publications (e.g., journals, books, or chapters) which claim to be written from the angle of ideological analysis or critique (IAC). The reason for selecting the 'ideological' angle is: what other angle of critique/analysis is capable of avoiding the interference of ideology if those which adopt the 'ideological' angle cannot.

The two points above establish this thesis' task: to investigate how academics compose/present their works of critique/analysis especially when they claim to undertake their analysis/critique through the perspective of ideology. In so doing, this thesis seeks to answer the research question: Are analysts or critics capable of escaping from the influences of social and indeed their own ideology, even if they are experts in ideology studies? In other words, it is also a work to determine the limitation of ideological critique.

Another subject of this thesis is 3) ideology. In this thesis, ideology refers to a strength which influences how analysts undertake their conscious works. It not only means the academics' own ideology, which directs how they present their works, but also means the social total ideology which invisibly determines/influences the making of their personal ideology.

People's recognition of ideology's power has changed through time. A famous description originally from Marx is that "they do not know it, but they do it" (Marx & Dragstedt, 1976, p. 36, also see Žižek, 1989, p.29). To some elucidators, this indicated Marx's concept of *false consciousness*. Sloterdijk (cited in Žižek, 1989) reinterpreted the capacity of ideology as "they know very well what they are doing, but still, they are doing it" (p. 29). Sloterdijk was right about the capability of ideology; yet, the significance/reference of his sentence seems too general and imprecise.

First, the ‘they’ should be classified carefully while reading this sentence. Who might be the ‘they’ able to recognize ideology is a critical question with which this thesis begins its research in Chapter 2. Moreover, was Sloterdijk too optimistic in his statement, ‘they know very well what they are doing’? Do they *really* know very well? Whether Sloterdijk’s statement is true or false, or as this thesis asks—are *they* (e.g., analysts or critics) capable of exempting from the influences of their own and social ideology—is another question to be answered at the end of this study.

1.3 Thesis Outline

Chapter 2: Accordingly, this thesis, in Chapter 2, starts with explaining the first subject, *the human subject*, finding out who are ‘they’. A brief history of intellectuals is reviewed to determine the common characteristics intellectuals in history shared together with the responsibilities they shouldered that have helped humans’ spiritual and physical development. After, this thesis investigates the second subject, *critique*. A history of critique is examined to illustrate the nature, purposes, and functions of critique which have helped to improve humans’ rationality through time.

After the investigation of human (intellectuals) and critique with consideration of scholars’ gradual awareness of the capacity of ideology in contemporary academia, this thesis argues that the ‘they’ should only refer to those people¹ (including academic scholars, students, literary critics) who are aware of the capacity of ideology, who have learned the basic theories or understood the characteristic of ideology, and who adopt the angle of ideology to analyse/criticise in their original research fields. Namely, ‘they’ refers to the ideological critics/analysts. This thesis argues that in contemporary society, they (ideological critics) are the few humans who might be able to shoulder the role of intellectuals to discover

¹ This does not mean to support elitism. The fact is that ideology is not an open subject, about which all persons are able to talk. Many scholars have shared the same perspective, such as Bourdieu (Bourdieu & Eagleton, 1994) who commented that “you [mankind] have a conscious agent who is the scholar, the learned person, and the others who don’t have access to consciousness” (p. 267). Another example is from Larrain (1994). He provided a clear explanation to answer why the masses are unaware of the operation of ideology. He explained that in psychotherapy, patients realize their problems and are willing to accept suggestions from psychiatrists—in short, patients know. Yet, in social analysis, the oppressed class are unaware of their social condition. It is hard for them to believe that their inner consciousness is composed of something that the ‘Critical Theorist’ has called ‘ideology’. That is to say, the masses are not aware of so-called ideological things.

the social problem (via their critique/analysis) especially in the epoch of ideology. Their works of critique/analysis 'might' be able to lead people to discover ideology. Based on the discussion in Chapter 2, it will be demonstrated that it is possible to escape from the cage of ideology through ideological-specialists' critique/analysis.

Yet, while the current dominant idea of capitalism, which intrudes into academic creation, is brought into consideration, what has been suggested in Chapter 2 is questionable. Macherey (1978) argued that a writer is merely a producer who composes words into an article, which is no different from assembling a vehicle. In addition, Eagleton (1976) proposed, "Literature [...] is also an *industry*. Books are not just structures of meaning, they are also commodities produced by publishers and sold on the market at a profit" (p. 59, emphasise original). The two scholars share a notion that the process of creating literature is no different from producing commercial goods. It is especially Eagleton's words which indicate a similar manufacturing logic with commodities' production: things are massively fabricated in a production line which goes through a model of compulsion (invisible controls), commodification, and standardisation (Adorno & Horkheimer, 1997). This logic explains exactly the concept of *culture industry* offered by the Frankfurt School.

Chapter 3: Accordingly, in Chapter 3, this thesis will first introduce some Frankfurt School thinkers' concepts, such as *dialectic of enlightenment*, *instrumental rationality*, and *identity and totality*. These concepts may seem not relevant to the main stream of this thesis; but they are the foundational and background concepts to many theoretical discussion of this thesis. The second half of Chapter 3 will discuss whether scholars' publications contribute to an 'academic industry', which reveals the same phenomena as the culture industry displays, including phenomena of compulsion, commodification, and standardisation in academic works. Based on the Frankfurt School's notions, this thesis specifically places the spotlight on the phenomenon of standardisation in the academic industry (while for the other two phenomena discussions could readily be found, e.g., Radder, 2010). It argues that if the phenomenon of standardisation indeed intrudes into academic creations, then scholars are able to produce any academic works just by following certain writing rules, even articles related to ideological critique/analysis. Hence, based on the discourse in Chapter 3 that the ideological critics/analysts' academic works indeed are generated on the production line of

academic industry, this thesis argues that escaping the cage of ideology is impossible (opposite to the argument in Chapter 2).

The statement made in Chapter 3, about the phenomenon of standardisation in academic works, is unlikely to be accepted/admitted by academics since most scholars believe their academic works are the outcome of their free will, which is unique. How could commonalities exist between their works and others? How could it be possible to have a standard writing discipline to follow when writing articles? This thesis argues that there, especially in social science, indeed exist standard writing procedures in academic publications, even for articles which claim to adopt the angle of ideology to analyse/criticise the research subjects. Thus, determining the 'standard writing procedures', hidden in articles related to ideological analysis/critique, is the mission of the subsequent empirical analysis chapters (5 to 8).

Chapter 4: Therefore, Chapter 4 will explain the research method specific to the empirical analysis of this thesis. Contents include how the research data were collected and analysed as well as how this thesis presents the research results.

As mentioned above, Chapters 5 to 8 offer the empirical analysis of this study, the purpose of which is to discover the commonalities between diverse articles related to ideological analysis/critique (IAC), that is, to find evidence of what this thesis calls the standardized procedures for writing academic IAC articles. This thesis has induced six standard writing procedures (SWPs). On the one hand, if standard writing procedures exist, it means that there is a rule guiding analysts to write their IAC articles. It further implies that in spite of every effort that the IAC analysts have made to break through the cage of ideology, eventually they are still prisoners of ideology (their own or the social total). On the other hand, those induced commonalities (or SWPs) between diverse IAC articles have another role: to establish a methodology of ideological analysis or critique. That is to say, by following this method, analysts could easily analyse or criticise their research subjects *ideologically*. These six standard procedures for writing IAC articles are briefly introduced as follows.

Chapter 5 introduces the first of the six procedures, *Identifying Essential Elements*, which is a procedure to understand the nature of ideology. This thesis argues that ideology is

a word about *relations* which contains three elements: Class², power, and reality. These three elements form the initial motivation of analysts and, most importantly, their presumed standpoints which have affected the conclusion of their analysis. The interactive relation of these three elements also responds to many topics while discussing ideology, such as concepts of false consciousness, class consciousness, dominant ideology, characteristics of ideology (e.g., negative or neutral), formation of ideology (e.g., visible or invisible).

If Procedure 1 (identifying essential elements) is to study the nature of one researched phenomenon (i.e., the researched ideology), then the following five procedures could be seen as ways to practically investigate how and why such a phenomenon conveys a certain ideology or can be considered as an ideology. These are procedures to comprehend the making of ideology.

Chapter 6: Procedure 2 illustrated in Chapter 6 is to *Apply Theoretical Foundations*. Understanding the theoretical foundations adopted by IAC analysts in their articles will help to comprehend the ideology of the researched phenomenon that they have tried to present/construct, or convince us to believe. This thesis has categorized theories that IAC analysts frequently apply into five categories (or analytical pathways). They are: analytical pathways of Marx, Althusser, and Gramscian as well as a historical description pathway and a semiotic pathway. The application of theoretical foundations could influence the structure, writing trend, argument, or even the conclusion of an IAC article.

Chapter 7 deals with two procedures including 3 *Connoting Certain Meanings* and 4 *Illustrating*. These two procedures focus on examining how 'IAC articles' (i.e., the texts) are presented through which certain (ideological) connotations are indicated. Procedure 3 introduces Barthes's notion of mythology to solve the shortcoming which people usually violate: that is, randomly or arbitrarily labelling one phenomenon as an ideology without providing reasonable argumentation. Barthes's notion helps to explain why the meaning of one sign transforms to another meaning, or how a phenomenon implies/carries a certain ideology. This is an important foundation to comprehend the making of ideology, and provides analysis/critique related to ideology with a theoretical basis instead of hollow arguments.

² The term *Class* has been redefined/ reinterpreted by this thesis and will be explained in Chapter 5.

If Procedure 3 is a theory-based perspective to examine how ideology functions/operates, then procedure 4 explains ideology's practical applications. Procedure 4, *Illustrating*, explains the techniques (i.e., illustrating techniques) that IAC analysts frequently use in which their writings display the same function as the concept of myth suggests. By applying these illustrating techniques, ordinary signs start their journey to carry connotations. These illustrating techniques include *finding similarities*, *using references*, *transferring*, *using inarguable values*, *special writing skills*, and *explaining* which are all terminologies created by this thesis.

Chapter 8: While Procedures 3 and 4 (Chapter 7) focus on the texts, the remaining procedures, 5 *Selecting Expression Styles* and 6 *Revealing Personal Viewpoints*, are introduced in Chapter 8, turning the angle to investigate how IAC analysts' 'consciousness' intrudes into their works. Procedure 5, *selecting expression styles*, indicates the diverse degrees in which IAC analysts involve themselves (e.g., attitudes, positions, judgements, preferences, etc.) within their writings. These diverse degrees of engagement result in their different expressive styles, which could be categorised as: the purely descriptive style, the interpretative style, and defensive/corrective style. These diverse styles correspondingly affect the extent to which the validity of an IAC article is recognised and accepted by the readers.

If Procedure 5 is a holistic view to see how IAC analysts' expressive styles influence the making of an IAC article, then Procedure 6, also presented in Chapter 8, focuses on IAC analysts' practical writing techniques to determine how they intentionally/accidentally expose their stance (e.g., pessimistically or optimistically). These writing techniques which reveal their personal viewpoints include their *title selection*, *asking questions*, *personal background*, and their *assertive declaration*. These created terminologies will be explained in Procedure 6.

In the empirical chapters (5-8), this thesis has concluded the commonalities between diverse IAC articles to testify that there indeed exists standard procedures for writing IAC articles. If such statement is acceptable, then it is reasonable to prove again that no one is able to escape from the influence of ideology, even the ideology-specialists.

Chapter 9: Results from the empirical analysis show that ideology-specialists are unable to break through the cage of ideology. For this reason, in Chapter 9, this thesis returns to review related literatures, specifically focusing on Adorno's philosophy, to ascertain whether early scholars had provided escape routes from the dungeon of ideology. Selecting Adorno is not only to draw a correspondence with the literature discussed in Chapter 3 from which this thesis' argument (e.g., SWP in IAC articles) was inspired; it is also because Adorno's concepts, such as *the preponderance of the object*, *the pursuit of non-identify-thinking*, *immanent critique*, *constellation*, etc., seem to guide a way out of the cage of ideology. Yet, this thesis argues that Adorno only *theoretically* established the brave new world where people might find ways out of ideology's intervention. In fact, Adorno's discourses, to a great degree, were inevitably influenced by his personal judgement (see discussion in Chapter 9).

Chapter 10: Both the empirical analysis (Chapters 5-8) and the philosophical discussion (Ch. 9) show that humans, to a great degree, are inevitably limited to their own ideology while undertaking the analysis and critique. In short, humans' consciousnesses per se has influenced the arguments of one conscious critique/analysis. Faced with such an inevitable limitation, in Chapter 10, *Conclusion and Suggestion*, this thesis suggests that human beings have to humble themselves to minimize their self-considered-righteous as much as possible. This is to prevent humans from adopting their own ideology to judge others' ideology, which turns out to fall into the endless loop of ideology-critique of ideology-critique. Moreover, the only work of critique that humans are able to undertake is limited to the regime of 'self-critique'. This argument is undoubtedly a moral perspective, yet, it is what this thesis considers the way out of ideology. Arguments will be provided in the main discussion.

In summary, the content and argument of each chapter are set out as Table 1-1.

Table 1-1: Thesis Outline

Chapter 2: Framing the Subjects —Intellectuals and Ideological Critique	
Contents	1. Concepts of intellectuals. 2. Concepts of (ideological) critique. 3. The role of ideological critics in the contemporary society
Argument	Ideological critics/analysts are the few people who can lead others to escape from the cage of ideology.
Chapter 3: Theoretical Inspiration —From the Notion of the Frankfurt School to Standardisation of Academic Publications	
Contents	1. The Frankfurt School thinkers' theories. 2. Academic industry and standardisation in academic publications
Argument	None is able to escape from the influences of ideology because of the phenomenon of standardisation in academic publications
Chapter 4: Methodology for the Empirical Analysis Chapters	
Chapter 5-8: Standard Writing Procedures of Ideological Analysis/Critique —A Theoretical Review and Empirical Analysis	
Contents	1. Ideology-related literature. 2. Empirical analysis results (6 SWPs findings). 3. Suggestions for writing IAC articles (methodology). Six standard procedures for writing IAC articles (SWPs): identifying essential elements, applying theoretical foundations, connoting certain meanings, illustrating, selecting expression styles, and revealing personal viewpoints.
Argument	Due to the standardized phenomenon in academic publications, there is a guiding rule for writing articles related to ideological analysis/critique. Accordingly, no one is able to escape from the influence of ideology.
Chapter 9: Way Out: Rethinking the Possibility of (a Critique of) Ideological Critique —On Notions of Adorno	
Contents	1. Adorno's philosophies. 2. Limitation of Adorno's perspectives.
Argument	Adorno only theoretically established the brave new world out of ideology's intervention. No one is capable of escaping from the influences of ideology, even philosophers.
Chapter 10: Conclusion and Suggestion	
Content	1. Conclusion of chapters. 2. Suggestion: Out of fatalism and determinism.
Argument	The importance of humbleness and self-critique.

1.4 Clarification and Redefinition of Terminologies

Before advancing to the main chapters, a few specific usages of terminologies in this thesis should be classified or redefined.

A. Differences between critique/analysis of ideology (of X) and ideological critique/analysis (of X): This thesis will first distinguish their differences, and then explain why they are considered identical in the rest of this thesis.

'Critique/analysis of ideology (of X)' usually considers their research subjects to carry a (false/bad) ideology, so that it should be analysed (and then criticised). Yet, analysts/critics of this type are inevitably influenced by their own perspectives (e.g., considering that this

ideology of X *is...*) before they start their analysis/critique. In other words, although analysts will try to be neutral (or consider themselves capable of being neutral), the arguments they are able to present are always already embedded in their innermost consciousness, that is, their own ideology.

Take ideology of natural science for example. In Galilei's era, scientists criticised the church as, for example, corrupt and closed units while the church tarnished scientists as pagans. Both held their own 'truth' to criticise others' 'belief'. In fact, both truth and belief are all ideologies. One side's ideology decided 'why the other's ideology is wrong', and, not always but usually, whoever controls the power controls the rights of definition.

Hence, since rightness is defined by the power-have, it means that any 'critique/analysis of ideology (of X)' is consequentially the conscious product of certain people at a particular time. As time goes, one ideology (i.e., C) which is considered to be 'right' might be deemed to be 'wrong' by another ideology (e.g. D) in other time; yet, this new ideology D might be argued to be wrong again by ideology E in the future. That is to say, if the 'critique/analysis of ideology' is based on humans' consciousness (i.e., their ideology), the analysis/critique will never end, in which case the action of analysis/critique falls into the loop—ideology critique of ideology critique of ideology critique....

On the contrary, analysts who carry the 'ideological critique/analysis (of X)' do not know (or attempt to claim) 'what ideology it is' before they start their analysing or criticising. They will not claim 'research subject X carries a (false/bad) ideology' in advance before starting their research; instead, they will explain what factors (e.g., power, organised interests) influence the birth of one phenomenon within X which might carry certain ideology, or they will illustrate how a simple sign carries a certain connotation in X.

Accordingly, three characteristics of the angle of ideological critique/analysis (of X) could be found. First, research related to 'ideological analysis/critique' requires a long process of argumentation in which its arguments are built on analysable and visible elements. In this sense, the second characteristic reveals: the ideology that the analysts/critics finally report to their readers is nothing to do with right or wrong in nature. The second characteristic also brings out the third: although power is still the critical factor for analyses in social science, it is no longer the main factor in the angle of 'ideological analysis/critique'.

The latter places the spotlight on how and why X reveals a certain ideology where power is one factor but not the sole one. For example, some sentences might carry certain ideology without its authors' purpose written; that is why we call it 'ideology'.

According to the discussion above, the angle of 'ideological critique/analysis' would be much suitable if seen as a methodology. 'Ideological critique/analysis' as a methodology contains many analytical methods, including semiotics, context, discourse analysis and those methods which can help determine ideological operations and their further influences within the research cases. This methodology focuses more on how ideology works in X or how X reveals a certain ideology rather than directly claiming that X contains/is an (bad/wrong, true/false) ideology. Considering 'ideological critique/analysis' as a methodology is also the mission which this thesis expects to contribute via the empirical analysis chapters.

Yet, despite distinguishing the differences between these two terms being possible, most predecessors who applied these terms, to a great degree, did not make a clear distinction as this thesis' collected IAC articles have shown. The main reason might be because the term *ideology per se* is an abstract concept, especially when ideology's *characteristic* is misunderstood, analysts' position of seeing the concept, *ideology*, will vary (this is detailed/explained in Chapter 5). Accordingly, the damage of mixing up these two terms is that the concept *ideology* will continue to stay at an obscure status where it becomes more like a cosmetic vocabulary. By applying the word, *ideology*, within either articles' titles or sentences of context, analysts are able to specialize and strengthen their argument (even though the article might have little discussion regarding the concept of ideology). As a result, to them, what angle of the characteristic of ideology that one analyst possesses, whether they consider ideology as a researched target or regard ideology as an analytical angle, is no longer a necessary question to be asked before a study of ideology.

Although the differences between the two terms are distinguishable, this thesis is forced to regard these as the same concept. For, first, aforementioned confusion still exists in ideology-related research. Second, it is also due to the lack of IAC articles which meet the requirement that this thesis needs in its empirical analysis (to be further explained in methodology chapter).

Thus, this thesis presumes that both critique/analysis of ideology (of X) and ideological critique/analysis (of X), broadly speaking, are sorts of ideology-studies which focus on a certain research object/phenomenon/occurrence (of X). Accordingly, later writing in this thesis will adopt the term *ideological critique/analysis* to refer to both terms, but it will be presented as *critique/analysis of ideology* occasionally depending on the needs of context or identification.

B. Relationship between Analysis and Critique: The presentation of *critique/analysis* (critique **slash** analysis) as used above, honestly speaking, is annoying, which not only made the description redundant but also confused the meanings of sentences. To most people, *critique* and *analysis* are two different concepts. Yet, for this thesis, there is no difference between these two concepts, especially with respect to research related to ideology.

To the public cognition, the word *analysis* makes readers feel more neutral and objective while the word *critique* usually makes readers deem that critics think they understand the research subjects better than others might. To the public, critics are those people who consider themselves located at a higher knowledge level arguing with everything for the sake of argument. Thus, the only difference is from the feeling that the two words (i.e., analysis and critique) bring to the readers, but not from the nature of each word. Accordingly, the usage of the word *analysis* in the article title of ideology-related research will create a relatively neutral and objective expression to its readers compared to the same article title adopting the word *critique*. For example, compare the title ‘An ideological *Analysis* of Teenage Culture in the U.K.’ with ‘An Ideological *Critique* of...’. The latter will not be seen as a neutral presentation but rather as aggressive, especially if such a title is written by foreigners and read by U.K. citizens.

Not only the public’s cognition but also in other research fields, such as natural science, can the concepts *analysis* and *critique* be clearly distinguished. Yet, this thesis argues that once a research topic is engaged in ideology, there will be no difference between the characteristic/function of *analysis* and *critique*—in short, to analyse *is* to criticise and vice versa.

From the epistemology angle, critique needs to be carried out through analysis. Even though most analysts try to express their objectivity by adopting a comparatively neutral phrase (i.e., by claiming that this is an ideological ‘analysis’ instead of ‘critique’), it is still inevitable that they will unintentionally reveal their disagreements, arguments, personal interests, and attitudes during the process of their ‘analysis.’ This is because the enemy which all analysts encounter while writing articles related to ideological analysis (or critique) is ideology. Actions of analysis in the ideology realm always represent their authors’ ideology judging another ideology. Namely, the action of analysis is done via an invisible process which has always engaged with personal opinion representing an action of critique.

On the other hand, critique can only be achieved via analysing. While analysts attempt to criticise one thing, for example, a social problem, they have to prove that such problem indeed exists in society. Analysts cannot randomly or arbitrarily label one phenomenon as a social problem without providing reasonable argumentation. Thus, the action of critique is done via a visible process which is composed of reasonable argumentation resulting from thorough analysis.

In short, when the purpose or dimension of research studies engages with ideology-related subjects, the terms *analysis* and *critique* become each other’s alter ego. Accordingly, later writing in this thesis will adopt the word *critique* to signify meanings of critique as well as analysis. This is for two reasons: to reduce redundant phrases and, most importantly, to proclaim the position of this thesis—analysis indeed is critique in neutral and objective clothing.

To conclude, based on the classification and redefinition of ideology-related terminologies illustrated above, as well as trying to avoid confusion when words such as ideological, critique, analysis, articles, authors, and analysts come together, an explanation regarding the specific usage of terminologies in this thesis is provided below.

First, ‘ideological analysis or critique’ is a combination of ideological analysis and ideological critique which is the main research subject in this thesis so that, wherever it is used in this thesis, it should be seen as an individual phrase. This term is usually abbreviated as capitalized IAC. Accordingly, an equation could be drawn as:

Ideological analysis or critique = ideological analysis/critique
 = ideological critique
 = analysis or critique of ideology
 = analysis/critique of ideology
 = critique of ideology

Second, 33 articles focusing on ideological analysis or critique have been collected as this thesis' research data. These 33 articles are presented as 'article(s) of IAC' or 'IAC article(s)'.

Similarly, third, people who wrote those collected 33 IAC articles are presented in this thesis as 'analyst(s) of IAC' or 'IAC analyst(s)'. The word *analysts* in the thesis mostly refer to the writers of these 33 IAC articles.

Finally, SWPs stands for 'standard writing procedures' which is a guiding discipline that this thesis presumes and wishes to discover. Such a discipline conveys standard procedures for writing articles related ideological analysis or critique.

Other terminologies, which relate more to the usages specifically in empirical analysis chapters, will be introduced in Chapter 4: Methodology.

1.5 Definition of Ideology in this Thesis

The discussion of ideology-theories will be systematically illustrated in later chapters. This short section is to explain my own perspective regarding the term, ideology, which also illustrates what influenced me or the position I adopted to undertake the empirical analysis. I argue, people have to realise the two parts of ideology before they enter into the discussion of ideology. Humans might well know the 1) 'analyzable' or 'visible' part of ideology; but they will never detect any piece of the 2) 'invisible' or 'ontological' part of ideology; that is why we call the latter *ideology*.

What analysts can analyse, speak about, and understand is always the visible, analyzable part of ideology of one subject, such as my research findings in later chapters. On the other hand, **what** influenced me to generate my argument is **something** that belongs to the invisible or ontological part of ideology that I will never determine by myself because I am already living in that ideology. My invisible part of ideology could be analysed by other

analysts just as I can analyse the ideology of my research data (others' ideology). Based on the above explanation, ideological analysis/critique is possible via A's analysis/critique on B's ideology.

Accordingly, my definition of ideology in the visible, analyzable realm is: Ideology is a set of beliefs which **reflects** or **influences** humans' conscious activities (which also turns back to contribute to the matrix of such a set of beliefs to reflect or influence future humans' conscious activities). By defining its capacity as 'reflect' and 'influence', first, the positive and neutral as well as the negative and critical characteristics of ideology are considered; second, the circular and accumulative feature of ideology is also taken into account³. Hence, ideological analysis/critique is possible in the visible, analyzable realm. To analyse or to criticise one ideology is to investigate how a set of beliefs reflects or influences humans' conscious activities.

It seems possible, reasonable, and acceptable to criticise/analyse one's ideology based on our own opinions (i.e., ideology) in the visible, analyzable realm of ideology. Yet, it is still arguable because, as previously questioned: by what given authority, can we state that our analysis/critique is valid without our personal judgment? Thus, for this thesis, a proper ideological analysis/critique should be the one in which its analysts must avoid involving personal opinion/judgement in their discussion as far as possible. This is why the neutrality and objectivity are set as one of the angles to examine whether the IAC analysts are capable of escaping from the influence of (their own) ideology. This thesis argues, an ideological analysis/critique is valid only when the analysis is undertaken neutrally and objectively.

³ I.e., X ideology reflects/influences human activity, becoming Y ideology to reflect/influence another human activity, which generates Z ideology to reflect/influence another human activity...

Chapter 2

Framing the Subject and the Object —Intellectuals and the Ideological Critiques

2.1. Introduction

Human subjects and the critiques they propose are two crucial topics central to this thesis. The former are the executors while the latter are what they do. When the angle of ideology⁴ is taken into consideration the main research question of this thesis becomes: could human beings be immune to the influence of ideology, even if they specialize in analysing and criticising ideology? The aims of this chapter are to consider intellectuals (2.2), critique (2.3), their interrelationship (2.4), and most importantly, their relationship with ideology (2.3 & 2.4).

In section 2.2, this thesis investigates the concepts of intellectuals through an angle of historical evolution, which tries to identify the basic characteristic of intellectuals and their roles in society. The aim of this section is to establish foundational concepts for later discussion in section 2.4: to assure why ideological critics are the few humans who can shoulder the role of intellectuals to discover the social problem especially in the epoch of ideology. In section 2.3, this thesis frames the other subject—critique. Section 2.3 starts with classifying that professed critique is not opposition for the sake of opposition, which reflects a contemporary misrecognition toward the meaning of critique. The discussion illustrates the philosophical evolution (from specialism via idealism to material critique) to see how critics justify and undertake the works of critique and that of ideological critique. Also in this section, the difference between (general) critique and ideological critique is discussed.

⁴ All ideology-related notions will be illustrated in Chapters 5 to 8 accompanying with the empirical analysis. The position of this thesis regarding ideology is briefly provided here. According to Abercrombie (2006), there are three types of dimension which consider the concept of ideology as, first, specific kinds of beliefs, e.g., communism, capitalism, socialism, etc.; second, as a distorted or false belief; and third, as a set of beliefs which has nothing to do with true or false. The position of this thesis massively adopts the dimension of the third type, especially in cooperation with the notion of power relation. Regarding the first and second types, both of them will be interpreted in related chapters showing what position they play in the standard writing procedure of ideological critique.

Finally, in section 2.4, this thesis first expounds how humans undertake their critique, and then continues to discuss to what extent critics can be seen as intellectuals especially when the influence of personal ideology is taken into consideration. Based on all the discussions above, this study distinguishes ideological critics from general critics. By further explaining the differences in functions and characters between the two, it has concluded that academics, who are familiar with ideology-related theories, are few in terms of 'real' intellectuals in contemporary society.

2.2. History of Intellectuals

This section will start by depicting the general characteristics considered for intellectuals through historical development in western academic circles, from ancient times via seventeenth century France and eighteenth century Russia to present day. In so doing, a basic definition of intellectuals is provided. It says: the basic characteristics of intellectuals are to propagate new ideas and to criticise the wrongness of society. Sometimes, characteristics such as being well-educated and other specific personal attributes (e.g., courageousness, feeling obligated, radicalism, and being a revolutionary or even being famous) are reasons to be considered as intellectuals too.

Intellectuals in Early History

First, ancient times sages could be seen as intellectuals. They included speakers, poets, and teachers, essentially people who engaged in enlightening the public's thinking. Yet, they were described negatively by Socrates as people who were burned by knowledge, helping to create tyranny through their ideas (Lilla, 2001). Although there was no such word as *intellectual* to refer to the above people at that time, people who possessed the skills of propagating ideas were considered capable of illuminating the masses.

Jesters in the royal, medieval courts, as described in Shakespeare's *King Lear*, revealed one of the intellectuals' functions—critique. Most jesters were of lowly class with mental or physical problems (Otto, 2001). Due to their disability, their funny imitation of nobilities' speech and behaviours all became entertainment. Yet, since 'what really happened in the court' was usually the story material for jesters, their innocent imitation invisibly mocked the noblemen. Although what the jesters did was innocent simulation, displaying what they had

seen in the palace shares the same role/function of intellectuals, that is, to tell the truth—which could be considered as an early mode of critique

According to Coser (1965), it was not until the seventeenth century that people in Europe, including clerics, diviners, and clerks of courts, started to consider themselves as leaders who proclaimed that they could guide society. Although the term *intellectual* had not been coined at this time, it was the first time that the group-consciousness of intellectual-like emerged. In this epoch, they possessed the role of propagators to lead the public and maintain social order.

In the eighteenth century, the decreasing power of theocracy bred sceptics, deists, and atheists, who were confident people prompting and leading the public in criticising ordered disciplines, especially the religious variety (Johnson, 1988). Different to early history, intellectual-like people in this epoch empowered themselves and this extended to having a critical perspective observing society. Different from jesters, whose role of being seen as critics resulted from their innocent mimicry of royal life, intellectual-like people in this epoch directly commented on society's problems from their critical perspective (Johnson, 1988).

Overall, the shift of intellectuals' characteristics in a diachronic perspective began from 1) propagating new ideas to the public to 2) mocking (criticising) royal life. Later, the characteristic of intellectuals returned to 3) the function of propagation focusing more on maintaining the vested social order, and, eventually, arrived at the characteristic with which modern people are much more familiar, that is, 4) critically criticising society. Namely, the simplest definition of intellectual could be drawn as those people who possess functions of **propagation** and **critique**.

Intelligentsia in Russia

The development of the Russian concept of intellectuals⁵ could be distinguished by three stages: before the 1890s (especially from 1838), the 1890s-1917, and after 1917 (Berlin, 1979).

⁵ Although, in Russia, the term *Intelligentsia* was used instead of *intellectual*, for the convenience of discussion, this thesis will use the term *intellectual* to describe the general meaning of such a specific group of people. *Intelligentsia* will be used only when its particular historical meaning is being discussed.

During the “Remarkable Decade”, 1838 to 1948⁶, the vanguard intellectuals, specifically new university graduates, tried to introduce diverse knowledge from other nations. This knowledge impact led group members to carry out social critique, especially criticising citizens’ views and values of life, which, to a great extent, is considered to have caused the Russian 1917 revolution (Acton, 1997; Berlin, 1979; Confino, 1972). Although these vanguard intellectuals⁷ were criticised in respect of confusing life values with their learned literature and ideas, what they did was to introduce a new dimension of seeing or valuing things.

In the 1860s, the word *intelligentsia* was created, referring to the stratum of educated critics (Acton, 1997). Nevertheless, just as Napoléon stigmatized Tracy and his fellows as *metaphysicians*, Nicholas II of Russia once likened the roles of these educated Russians to *syphilis* (Acton, 1997). These two emperors both had sensed a threat from the knowledgeable people, whose critical power might impact their legitimacy, so that they demonized and stigmatized the intelligentsia. This is the birth of the second stage, the 1890s-1917. What should be noted is the identification of a people who were ‘educated’ was no longer the essential requirement of being part of the intelligentsia during the 1890s-1917. According to Pipes (1974), Jacoby (2000), and Bobbio (1993 in Bellamy, 1997), even those people who were in working or peasant classes were considered as intelligentsia provided they kept their distance from Nicholas II’s regime, held a definitely opposite position, and possessed a **radical** and **revolutionary** attitude against this old political and economic system.

The characteristic of Russian intellectuals changed again after the Soviets took power (Acton, 1997). Membership of the intelligentsia, which originally referred to the radical and revolutionary stratum, had been extended to encompass a broader category “including all non-manual strata of the working population” (p. 150). Intelligentsia no longer held an “establishment” attitude (p. 150) or argued against the new government as the revolution had done. Instead, they turned their shellfire to life-based subjects, such as environmental or

⁶ Berlin (1979) quoted the title “A Remarkable Decade” from Pavel Annenkov, a Russian critic whom Karl Marx admired, to describe the beginnings of Russian intellectual history in a general point of view. Yet, to himself, the time that Russian students went abroad to pursue new knowledge could be traced back to Peter the Great.

⁷ Due to the severe publication censorship, vanguard members of intellectual circles could not directly criticize the contemporary political condition. For this reason, they conveyed their critical ideas within their art or literary critique (Berlin, 1979).

religious issues (Acton, 1997). They returned to the original characteristics of intellectuals, propagation and critique (on life⁸).

Despite the Russian concept of intellectuals having changed through time, attitudes of being **radical** and **revolutionary** to overthrow an outdated system are what they contributed to the understanding of intellectuals' roles.

Intellectuals in France and Contemporary Society

The self-consciousness of being intellectuals in France referred to *l'Affaire Dreyfus*⁹ in 1895 (Derfler, 2002) in which a group of people led by Émile Zola, who wrote *J'accuse*, jointly signed a letter to accuse the government's abuse of power and requiring a fair application of justice. They were diverse, socially prominent people (actors, writers, scientists), and eventually denominated by journalist Georges Clemenceau as *intellectuals*.

In France, the courage of practically entering into public debate to stand up for beliefs of 'what is right' is a key characteristic of intellectuals, that is, taking Jennings' (1997) words, beliefs of "Truth, Justice, Reason and Universality" (p. 70). These French intellectuals believed that it was an obligation to be a "purveyor" and to shoulder social responsibility (Berlin, 1979, p. 39).

The contribution that French intellectuals made to enrich the concept of intellectuals is: the requirement of being intellectuals is that they have to deem themselves as 'saviours' with strong **courage** and **obligation** devoted to a better society, which shoulders a sense of commitment: If not me, then who? This French belief was inherited and directed the later movements such as anti-fascism, anti-colonialism, and the Algerian War wherein self-intellectualized persons such as students and academic scholars played a great part in the history of French intellectuals (Jennings, 1997).

In contemporary society, what intellectuals are is massively based on media representation. According to Jennings and Kemp-Welch (1997), the function of the

⁸ In fact, to a great extent, this change should have considered the political conditions under Soviet governance.

⁹ The fountainhead of this affair can be traced back to 1517, when Martin Luther criticized the Holy See that opened the religious tumult in Europe. In 1888, the economy of France was deeply influenced due to the excavation of the Suez Canal, which unveiled the malady of collusion between Jewish middlemen. Being the scapegoat of the epoch, the French artillery officer Alfred Dreyfus, who was Jewish, was convicted of treason and of collaborating with the enemy, Germany (Derfler, 2002).

intellectual, with a traditional definition (i.e., propagation and critique), was replaced by famous television celebrities after the 1960s, a period in which the media started to grow. The impact was that real-intellectuals (based on previously discussed characteristics) had to discard their beliefs, ideals, and ambitions to obtain the right of voice, which is controlled by media owners or journalists, and were forced to yield to commercial interests. As a result, media celebrities are much more ‘believed’ than the above-described intellectuals. They are significant to the public and they have a great impact on the public’s consciousness (Boon & Lomore, 2001; Marshall, 1997).

Undoubtedly, some genres of celebrities, such as political commentators, are able to criticise society and possess the basic function of intellectuals—propagation and critique¹⁰. However, since some celebrities are a media creation (a field wherein true voice has to yield to diverse power) and since they are composed of diverse people (who achieve fame for various reasons¹¹), from an academic perspective it is difficult to consider them so-called intellectuals (even though the public are willing to think so). It is reasonable to claim that being **famous** can make people ‘intellectuals’ in the age of media communication.

¹⁰ What we have to notice is that this thesis here only explains that celebrities possess such capacities; this thesis does not argue or criticize the rightness/wrongness of these capacities. For example, whether the ideas that they propagate benefit society; whether their judgements about society are fair and objective, or whether their judgements are just used to convey their subjective opinion, which might be believed due to their fame. These arguments will be left to section 2.4 *Academic Intellectuals and Ideological Critique*, because such arguments have already entered into the regime of ideology.

¹¹ According to Rojek (2001), three forms of generating celebrities are ascribed, achieved, and attributed (p. 17). The first, ascribed, is unchangeable: Being famous is based on blood relationship. One is born famous. A royal family is an example. On the contrary, the second and third forms are acquired through competition or attributed by mass media. Rojek proposed two terminologies: celetoid and celector (p. 24), to subdivide the celebrity phenomena, especially referring to the one attributed to mass media. Celetoids have a short-lived appearance usually resulting from one-hit wonders. They come and go quickly. People who become famous (and disappear) swiftly due to their appearance on TV show, for example, *Britain’s Got Talent* is a good example. In terms of Celeactors, it is a subcategory of Celetoids which mainly refers to fictional characters. They have no real self and the public face is entirely imaginary. Lara Croft created by video game and later film *Tomb Raider* and Mr. Bean are classic examples. In spite of how celebrities are ascribed, achieved, or attributed as a member of the royal family, or professor, politician, sport-stars with specific achievements, or short-lived *Britain’s Got Talent* stars, or made up characters, the point is: the ways of becoming famous are various and, most importantly, it is undeniable that, to a great degree, they possess capacities to influence the society. Even though they might not consider themselves as intellectuals, to the public, what they say, how they act, and even their philosophies all function as disciplines of intellectuals.

Summary and Discussion

Based on historical investigation, the western intellectuals' characteristic is found to contain: propagation, critique (through mocking), radical and revolutionary critique, possessing courage and obligation, and being famous, which are listed in Table 2-1. These characteristics represent the role of intellectuals in particular times. Yet when the influence of (personal) ideology is considered, traits that make them admirable in their time make them problematic from the angle of ideology. This argument will be discussed throughout this chapter.

Table 2-1: Characteristics of Intellectuals in Human History

Time	Characteristics of Intellectuals	Representatives/ Specific Features
Ancient Times	Propagation	Speakers, poets, and teachers / who were able to enlighten the public's thinking.
Medieval times	Critique (through mocking)	Royal court jesters / through adopting royal court life as stories and performing also displayed what this world really was like.
17 th Century	Propagation	Clerics, diviners, and clerks of courts / 1. who started to shape intellectual-like group-consciousness; 2. function was to maintain social order.
18 th Century	Critique	Sceptics, deists, and atheists / 1. who resulted from decreasing power of theocracy; and 2. focused on criticising ordered disciplines, especially religion.
18 th Cen. in Russia	Propagation	Before 1890s: Overseas, educated students. / Russia intelligentsia especially referred to stratum of educated critics who propagated new knowledge to society.
	Radical and Revolutionary Critique	1890s-1917: Intelligentsia were no longer limited to educated stratum. People in working or peasant classes were considered intelligentsia only if they held a radical and revolutionary attitude to argue for the old political and economic system.
	Propagation, Critique	After 1917: All non manual strata were intelligentsia / who turned the angle to focus (criticise) on a single subject such as environmental and religious issues except politics.
19 th Cen. in France	Courage, Obligation	The brave people / The term intellectual specifically referred to <i>l'Affaire Dreyfus</i> .
Modern Society	Famous	Television celebrities. / Definition of intellectuals returns to vagueness.

2.3. History of Critique and Ideological Critique

The concept of intellectuals was introduced in the previous section. This section will frame the second subject of this thesis—(ideological) critique—by examining its definition and developing history. Finally a comparison between (general) critique and ideological critique will be offered.

What is Critique?

The broad meaning of criticism in earlier times was limited to literature and art examination (Jay, 1996). It focused on textual criticism, in which connoisseurs were usually equal to critics. For example, the *Homeric Hymns* were examined by astronomers (e.g., the solar eclipse when Odysseus returned home) and geographers (e.g., discovery of Mycenae and evacuation of the site of Troy) to prove the authenticity of the texts in history (Hernadi, 1981). The capacity for criticism, at this stage, was limited to specific groups, meaning that only people who had recognized knowledge of the subject were deemed able to undertake criticism. These professed critics were considered to understand the intention and the purpose of compositions better than the original authors (Cazamian, 1929), as Brownell (1914) explained the “judge of the tiller is not the carpenter but the helmsman” (p. 13).

Another trend, different from the above, is known as ‘critique’, which is the kernel of this thesis. Critique, in a broad meaning, means to indicate the troublesome matters, focusing on particular phenomena in human society such as cultural, political, and economic issues. Nevertheless, application and recognition of critique today, whether (general) critique or ideological critique, seems to face confusion regarding the purposes of undertaking it. Hence, instead of directly claiming a definition of critique, this research suggests that classifying the misunderstandings critique has been facing is a better way to understand critique’s essence.

First, critique is not to oppose one thing for the sake of opposition. Possessing critical thinking is important especially to educated people. But, the problem is that—by adopting the logic of *Dialect of Enlightenment*—this ‘we all need critical thinking to unveil the myth surrounding us’ has become another new myth which veils human thinking again¹². As a

¹² This ‘we all need critical thinking’ also echoes Marcuse’s (1991) idea of ‘Instrumental Rationality’. That ‘if I want to be rational, I must possess a critical thinking’ has become an instrumental rationality which creates a new myth that ‘because I think critically (due to I oppose things), I am rational so I must be right’. This new myth not only is based on self-granted rationality but also distinguishes us

result, most people, even educated persons, suppose that critique means to take an opposite position to comment, argue, and object to all issues; in so doing, they are distinguished from the irrational others.

Nevertheless, Kant claimed that human rationality is limited so that critique cannot be exaggerated (in Russell, 1946). Critique is not reasonless judgements or accusations, nor to proffer unlimited complaints or disagree with others. It is not to oppose one thing for the sake of opposition. Once oppositions and objections are misrepresented as equalling the characteristics of critique, the real discourse sphere will gradually disappear. Whilst this sphere is occupied by irrational arguments and disagreements, so-called critique will become a scapegoat, eventually losing its power to balance unrighteousness.

The reason for explaining 'what critique is not' is because the definition of it is so simple: looking for the truth. Without such understanding of what critique is not, this simple definition can be easily appropriated, and people will self-righteously think that all their actions (i.e., always taking an opposite position to comment, judge, and object to all issues) stand alongside the truth.

Hence, to criticise is to look for truth. Heidegger (1997) claimed that truth results from the discovering and revealing processes. Critics discover abnormal phenomena, then reveal or question these phenomena instead of judging and proclaiming their wrongness. What these critics have done could be seen as critique. For example, economists may perceive a negative market trend after a government policy decision so that they provide a warning to prevent future economic problems. Or socialists note the gap between urban and rural communities and ask their government for a balanced countryside development. Thus, people who query and argue, in conjunction with offering warnings or suggestions, could be seen as undertaking critique.

However, the above examples can only be seen as a 'general' critique because once the influence of (subjects') ideology is considered, whether the critics truly discover the 'truth' is arguable. Thus, the following section will, through historical and philosophical investigation, examine the characteristic of critique to answer why ideological critique emerges in contemporary society.

from other irrationals. The concept of instrumental rationality will be introduced in next chapter.

Evolvement of Critique—From Scepticism to Modern Critique

From the philosophical perspective, according to Popper (1996), early critique could be tracked back to the “sceptical school” (p. 192), which began, from Xenophanes’ search for truth. Xenophanes, considered as one of the earliest critics in human history, believed that being suspicious of everything is a way to approach the objective truth (Popper, 1996), claiming that “there is nowhere anything but guessing” (in Russell, 1946, p. 40). His scepticism was expressed through his attitude toward God. Xenophanes was a student of Homer, but he disagreed with and criticised Homer’s perspective, which personalized God as mortal (Popper, 1996). Xenophanes argued, for example, if oxen had ability, like humans, to draw gods, then an image of a god who looks like them (oxen) would be painted. (This argument has implied the influence of ideology.) Consequently, by looking for the relationship between objective truth and humans’ fallibility, Xenophanes founded the philosophical branch of the sceptical school (Popper, 1996). Popper (1996) explained that although such a sceptical way of thinking is usually negatively misunderstood, the significance of being sceptical is “to look out, to inquire, to reflect, [and] to search” (p. 192) which is the way to seek the truth.

Popper (1996) claimed that philosophers who followed this sceptical tradition, (including Socrates, Erasmus, Locke, Hume) emphasised the “human ignorance¹³” (p. 192). Socrates stated that he knew nothing which influenced his students to remain as sceptics of their days (in Russell, 1946); Plato’s writing style¹⁴ often did not arrive at a clear conclusion implying an attitude of scepticism. Although scepticism was no longer the dominant thought train after the third century¹⁵ (Popper, 1996), the spirit of scepticism can be seen as one of critique’s foundations.

It is not until Hume’s work, which also influenced Kant’s series of writings on critique, that the evolution of critical thinking transformed from scepticism to critique (Russell, 1946). From a general perspective, scepticism and critique share the same position—negativity;

¹³ As Popper (1996) said “What all the members of this sceptical tradition have in common ...and what I also share with this tradition is that we stress our human ignorance.” (p. 192)

¹⁴ Modern scholars, such as Nietzsche, Adorno, Horkheimer, and Marcuse, also considered ‘writing style’ as a way of pursuing the truth. But, differently, instead of leaving conclusion aside as Plato did, they usually made their arguments and works as short fragments, or, as aphorism. Please refer to Chapter 9. For more discussion of their writing style, please refer to Rose (1978) and Jay (1996).

¹⁵ In the third century, thought of scepticism was argued as only capable of inciting people against their nation or religion, but incapable of leading to practical solutions (Russell, 1946).

however, there is a slight difference between the two. The concept of negativity in scepticism is close to the meaning of ‘opposition’ in modern usage. By contrast, the meaning of negativity in critique possesses a similar meaning as Kantians’ ‘affirmation’ (Žižek, 1993). Kant’s three major critiques tried to explain the possibilities of humanity through rejecting the notion of a godsend morality; he tried to determine how humans establish the codes of conduct (i.e., morality). To Kant, critique entails not opposing everything; instead, it is an affirmative establishing process, namely, through the process of critique, to establish a possibility (Kant, 2009; Russell, 1946; Žižek, 1993).

According to Jay (1996), modern critique started from Hegel. One of Hegel’s crucial concepts of critique is to consider society as a totality, such that every social phenomenon could only be analysed by examining the whole social context (Horkheimer, 1972). The purpose of critique is to destroy the matrix of totality, given that it is in a limited condition. This closed totality implies an internal injury of human society, covered by a specific social consciousness, which might cause extreme disorder if not dealt with seamlessly (Wu, 2008). Based on the dimension of totality, Hegel (in Jay, 1996; Žižek, 1993) connected philosophical cerebration to social and political phenomena, such that the angle of critique starts to evaluate the construction of things, especially to indicate problems hidden in social and political phenomena.

Marx agreed with Hegel’s logic of critique, i.e., dialects, including the important notion of totality, except for one aspect: the way of doing critique. To Hegel, the development of human history results from thinking; to Marx, it stems from human daily political and economic material-practices. This difference has distinguished Marx’s material dialectics from Hegel’s ideal dialectics as well as ideological critique from general critique, which will be discussed in the next section.

Evolvement of Critique—Epoch of Ideological Critique

A better understanding of the term *ideological critique* should return to the time when the power of ideology was noticed while undertaking critique. Marx’s critique on capitalist society could be seen as the early human masterpiece which took ideology and its influences into consideration.

According to Marx (1971), human productive force determines the relation of production which reflects the economic formation of that time. Directly upon this economic base-structure is another corresponding political super-structure; forms of the latter represent a consequential determined relationship which is varying, together with the development of the relation of production. The point is that this political super-structure, which goes through ideological forms including legal, political, religious, artistic, or philosophic ones, will eventually, and inevitably, influence human consciousness.

Ideology is capable of pouring particular value and meaning into culture which is an act that rationalizes the special relation of power in society. Some groups control these power relations while others do not, which could be described as a dominant and subordinate relationship. Ideology, on the surface, claims to stand for the truth for it seems so natural and optimum. In fact, ideology helps to maintain rationality for the vested dominants which answers why dominant groups are able to consolidate and enlarge their advantages over subordinate groups in this relationship of power competition.

Accordingly, since ideology has such a great impact, criticizing these diverse ideologies becomes a possible method to understand how human (false-) consciousness is moulded by relations of power controlled by certain dominant groups. Ultimately, such critique is hoped to deconstruct this unbalanced power relationship (Oakley, 1983). In short, ideological critique is a dimension to analyse how a certain ideology involves the making of human consciousness.

Nevertheless, such a simple definition has significant implications for the meaning of critique. Marx's contribution to critique is that, by detecting the relationship between base and superstructure, he not only bridged the analytical angle of critique to the ideological realm, but also implied one important point: any demonstration of critique must possess a material basis which establishes its difference from Hegel's idealism.

All critiques, in a broad meaning, are ideological critiques as they are all based on personal ideology against another ideology. This view might help to understand why Marx disagreed with Hegel's idealism. To Marx, Hegel's critique regarding social phenomena was based on an obscure mental/spiritual dimension, which is unable to achieve the action of critique, only helping to maintain the vested social reality (Parekh, 1982). According to

Parekh (1982, p.1), Marx generally called Hegel and the Young Hegelians (another term, the Holy Family) *ideologists*; for they did nothing but create idealism. To Marx, the reason why the Holy Family created idealism is that they wanted to seek the internal logic of things, but failed. This is because, in spite of how the Holy Family considered things, essentially they had already been influenced by their own educational background and living environment¹⁶ (Parekh, 1982). Marx argued that there is nothing which could be called ‘things as such’; instead, the concept of ‘things as such’ is an “empty phase” (in Parekh, p. 4). With this empty characteristic of the things as such, philosophers like the Holy Family can define the things as willingly as they wanted. As a result, what they had defined was nothing to do with things ‘as such’; what they had established was, as per Parekh’s (1982) explanation, “a general theory of property, but not a theory of property in general” (p. 4).

With Hegelian-created idealism when they thought they were looking for things ‘as such’, they had created and defined what so-called rightness, goodness, morality, and justice really are, eventually, self-believing that they were standing next to the truth.

To escape from this problem, Marx appropriated Hegel’s notion of dialectic and confirmed his own method for analysing society, that is, the materialist dialectics, which were demonstrated when Marx began his critique of political economy. In his study, he did not directly claim that ideology has great power on human consciousness. Instead, he first acknowledged that the order of materiality of social development is prior to human ideal subjectivity, which could find testimony from his historical economic studies. In so doing, he, eventually, found how relations of production determined a certain social formation and the corresponding ideology¹⁷. All told, instead of providing direct and ideal statements, Marx’s critiques require strict demonstrations with a material basis.

Accordingly, since Marx considered ideology as a crucial element which influences human consciousness, and explained its emergence through his strict demonstration of identifying the material relationship within research subjects, it could be said that he turned

¹⁶ Of course, Marx himself did not escape the same problem. His critique on Hegel was also based on his own educational background and living environment. Yet, such a way of argument (a critique on a critique...) will never end. That is why this thesis suggests considering Marx’s ideas as a method, please refer to discussion in Chapter 5.

¹⁷ That echoes to Marx’s and Engels (1970) famous claim that “The ideas of the ruling class are in every epoch the ruling ideas [...] is at the same time its ruling intellectual force” (p. 64).

the dimension of critique from daily matters to humans' thoughts, i.e., critique of ideology or ideological critique. Works of critique applied through an ideology-dimension are based on a demonstration: the phenomenon of social inequality results from an unbalanced dominant relationship where the dominant groups possess more interests (e.g., economic or political power) to develop certain ideologies to maintain and strengthen their advantages¹⁸. In short, after Marx, investigating humans' ideology and its influences became an angle of critique to seek the truth.

However, what kind of critique could be seen as critique of ideology (ideological critique) is still ambiguous. Based on Marx's foundation, this thesis attempts to establish a methodology for ideological critique. Commonalities among academic articles related to ideology-critique will be delineated (in Chapters 5 to 8) to see how such ideology-dimension critique is undertaken to examine/criticise social phenomenon. In so doing, this thesis seeks to establish a methodology for ideological critique and if such a methodology might be delineated, it will help answer the research question of this thesis: whether humans are able to escape from the influence of their own ideology or social total ideology, or to find out humans' limitation while undertaking the works of ideological critique.

The Difference between General Critique and Ideological Critique

The previous section explained Marx's contributions to works of critique where concept of ideological critique and general/ideal critique is distinguished. He took the angle of critique away from idealism to emphasize the importance of critique based on material dialect perspectives.

Regardless of the type of critique, all predecessors' efforts are the same: looking for the truth and establishing a better world. Yet, there are still several diverse characteristics between general and ideological critiques. This study will go further to illustrate their differences (which will also help to realize the speciality of ideological critiques). These

¹⁸ This demonstration is closer to the angle of 'critique of ideology' where ideology is negatively seen, or say, discussion of ideology is related more to power operation. Yet, according to the distinction of 'critique of ideology' and 'ideological critique' explained in section 1.4, *Chapter 1*, angle of 'ideological critique' is situated much on a neutral position where the dimension of ideology is seen as a method to examine subjects. However, before the findings in the empirical analysis chapters are explained, this thesis here has to (is forced to) consider these two terms as containing the same meanings for reading convenience.

differences include their epistemology, whether they recognize the power relation, and the angle from which they define the truth.

First, by quoting Aron's (1957) classification of three levels of critique, their epistemological difference is revealed. Aron's first level focuses on technical critique which takes a position against the rulers. The purpose of such critique is to correct the mistakes of systems and to improve human society. For example, people highlight the unreasonable laws to improve legislation. The second level is the critique on morality, endeavouring to detect what humans have been doing wrong; for instance, those which impinge on humanity such as colonialism, slavery, and alienation in a capitalist society. The third is the critique of ideology. It takes the viewpoint of a possible future society to criticise modern ones to unveil pernicious social regulations (e.g., capitalism), which are influenced by invisible power and controlled by specific groups.

What this thesis has been calling the general critique echoes Aron's first level which focuses on visible facts, or trends, to claim what is wrong. In terms of Aron's second level, moral critique, this can also be considered as ideological critique (based on a broad definition). It is a critique which criticises the ideology that one society gestates. Such a moral critique is close to an ideal critique. Finally, Aron's third level corresponds to the ideological critique that this thesis suggests. It is a non-idealism critique, and one that requires a material demonstration. That is, a critique which investigates what sort of power relations are controlled by specific groups that give birth to a certain ideology which then influences human consciousness.

The second difference between general and ideological critiques reflects on the extent to which the angle of power relation is investigated. General critique focuses on visible facts, or trends, to claim what is wrong. Critics who undertake general critique possess specialized knowledge in their particular areas to determine whether issues follow the regulations together with warning the public of potential risks if mistakes are detected. All results of general critiques are based on critics' professional specialty. They detect and criticise what is wrong to protect society.

Conversely, ideological critique concentrates on the innermost, invisible, and qualitative segments of the research subjects to unveil how one specific idea functions

purposely or innocently and examines why social orders become the way they are now, which might help the dominant groups maintain their advantages. Thus, ideological critique focuses on exploring whether particular ideas (which represent certain groups' ideology) are influenced by visible or invisible power or other factors leading to a specific way of thinking that influences social development.

Take studies in the communication field as an example. General critique would examine how harmful policies influence society (e.g., determine how media policy relaxes restrictions on foreign films which might lead to a decline in the production of local films). Differently, ideological critique will show how foreign films influence local culture and lead to problems of national identity.

Third, although the final difference seems simple, it explores the greatest distinction between general and ideological critiques, namely, how they detect the problem of the research object and how they approach the truth.

Regarding how they detect a problem, for general critique, there will always be a certain answer (right versus wrong) to a question; such critique usually directly claims what is wrong so that it can be corrected. Such judgements are beyond approach because their data, findings, statistics (which no doubt are based on critics' ideologies) direct them to make such a judgement. Namely, general critique detects a wrongness or risk and provides a warning or suggests a solution. Different from general critique, ideological critique will never declare the wrongness of one research phenomenon; if it has to do so, it only identifies what is inappropriate within this phenomenon. Actually, the real mission of ideological critique is to discover a phenomenon, which, on the surface, seems right but, in fact, conceals something which is inappropriate which also helps to create a consensus of apparent 'rightness' for the public. Thus, ideological critique is to ferret out the wolf in sheep's clothing.

Regarding the ways of seeking the truth, for general critique, truth is the opposite of wrongness. When general critics state what is wrong based on the visible facts or data findings, simultaneously, they also imply what is right. Once humans solve the wrongness, they reach the so-called truth. Differently, ideological critique will never claim what truth or rightness is (Foucault, 1991; Hernadi, 1981); in fact, it is incapable of doing so (otherwise, it will fall into endless ideological critique on the previous critiques). Ideological critique is to

probe seemingly inappropriate phenomena resulting from certain social common sense to explore how its “truth of regime” (Foucault’s term) or rightness-construction was established (Hernadi, 1981).

Although the following paragraph is a digressive discussion in this section, it is central to this thesis. Any claim of reaching/discovering the truth is always arguable because no one can ignore that a claim regarding the so-called ‘truth’ has resulted from discussants’ ideologies, which shares a similar question to this thesis: are humans capable of escaping from ideology. As mentioned in section 2.3, Heidegger (1997) claimed that truth results from the discovering and revealing processes; yet, he also argued that such processes do not mean to uncover the relationship between a concept and the discussed object *per se*.

Accordingly, truth is not generated from the relationship between subjects and objects, because such truth only shows *subjects’ certain ideology*. Annoyingly, this does not mean that truth comes from the relationship between subjects and subjects either, given that if the so-called truth could be intersubjectively found, it would inevitably become a *dominant ideology*. To escape from ideology (resulting from subjects’ personally interpreting objects) and dominant ideology (stemming from intersubjective agreement), critiques, which take the angle of ideology, seem to be a way to reach the truth. Yet, is not ideological critique undertaken based on critics’ own ideology? The troublesome loop emerges, which is what this thesis tries to resolve through the following chapters.

Although this thesis examines humans’ capacity to escape ideology, it is also the examination of whether humans are able to reach the truth. It seeks to answer whether all truth claims are ideological? If not, how might ideology be removed to reach the truth? If so, is ideology the best humans can do and can we never accept the truth people claim? If so, might some ideologies be better than others? This question will be answered gradually through discussion of each chapter.

Summary

This section started by arguing that critique is not to oppose one thing for the sake of opposition. This is for a simple reason: the definition of critique is to seek out the truth. To understand the emergence of ideological critique, this thesis investigates the historical evolution of critique. The path begins with Xenophanes (i.e., sceptical school) via Socrates,

Hume, Kant (i.e., interrogative attitude) and Hegel (i.e., idealism critique), and finally arrives at Marx (i.e., material-based critique). Marx's critique of political economy bridged works of critique to the realm of ideology where ideal critique was discarded.

After reviewing the philosophical history of critique, this section discussed the differences between general and ideological critique. The former is usually to indicate what is wrong based on visible facts or data of findings. Providing problems are resolved, humans might reach the truth. The latter concentrates on the innermost, invisible, and qualitative segments of research subjects to unveil what on the surface seems right but indeed conveys something inappropriate which helps certain groups to create a dominant ideology. Yet, whether ideological critique is able to reach the truth, for this thesis, is still arguable.

2.4. Academic Intellectuals and Ideological Critique

The previous two sections have illustrated the meanings/characteristics of intellectuals and of critiques. This section will first discuss the relationship between intellectuals and critique to answer why intellectuals could shoulder the work of critique. Yet, when the angle of ideology is measured (which indicates that all critiques are the products of discussants' ideologies) together with the new recognition of intellectuals in modern society (e.g., being famous), then whether intellectuals are still capable of carrying critique becomes debatable. Who else can shoulder the mission of critique? This thesis suggests that academic critics, especially those who focus on phenomena or the theory of ideology, are the few people who are able to shoulder the role of real intellectuals. They are potentially the most capable people who might escape from the intervention of ideology.

From Jesters to Modern (General) Critics

The relationship between critics and their critiques has similarities in the evolution of court jesters and their functions. The ancient times fools, who could be seen as the precursors of jesters, were mainly the mentally or physically impaired. They imitated nobilities' speech and actions, which unintentionally revealed 'what really happened at court'. Due to their disabilities, they were much tolerated, known as 'licensed fools' and exempt from punishment even if they offended the nobility.

The function of the jesters (fools) can be explained by its parallel role, the clowns. While the fools (jesters) improvised to entertain nobilities, clowns performed their entertainment following a script—i.e., the clowns were trained. Clowns usually wear heavy make-up with a big smile concealing the actors' real facial expressions. This make-up creates a role of the 'Other' with this outside mask, not the real face of the actors, entertaining (and simultaneously criticising) audiences.

The function of the clowns being the Others (or outsiders) is also demonstrated by the game of cards (Gaarder, 1996). In poker, for example, the joker (crowns) card is unnumbered, implying its subversive role in this ordered game. In Tarot, the Fool is the first card of the system, usually assigned to zero or even unnumbered. It is listed before the Sun card or the World card. To a great degree, the Fool may be considered more important in modern human consciousness, implying the fools' (clowns') unconventional role out of the world. In short, clowns are well-trained, made-up entertainers, outsiders who subvert the vested order.

Jesters could be considered as the combination of licensed fools and well-trained outsider clowns. The first point is, had there been no such fools' 'licenses' exempting from punishments, these jesters would definitely have been risking their lives for their innocent imitation. Second, if there had been no such clowns' well-trained characteristics standing outside the ordered society, jesters' performance would never have been so funny yet so real to the general public. Under the guise of entertainment, they tell the truth.

Modern critics, inadvertently, share many characteristics with jesters, being exempted from what they have argued and well-trained outsiders. First, modern critics, of course, do not have to entertain the public. That they are exempted from punishment thanks to nobility's acquiescence to the fools' deficiencies is no longer the case, rather it might be human rights, freedom of speech, or simple respect from the public to intelligent people in modern society. Second, training is required for the ability to critique, which brings to mind the training of clowns for the ability to entertain. A real critic, as argued in section 2.3, will never oppose one thing for the sake of opposition. Their criticising of society should be based on rationality which is learned and trained (this point will be further discussed later). Most modern critics, it is argued¹⁹, endeavored to take a position outside a system, such as

¹⁹ Some scholars suggested that critics should engage within the society to undertake critiques, such

concepts of Mannheim's (1936) 'free-floating intellectuals', Said's (1994) 'outsider, amateur', and Benda's (2006) 'universal intellectuals'. In short, exempting from what they have argued and being well-trained outsiders are two common characteristics for modern critics.

When General Critics Encounter Ideology

The following question can be considered. Do modern critics count as intellectuals? The answer is complex. In terms of the definition of intellectuals—people who propagate new ideas and criticise what is wrong, sometimes feeling obligated to do it, and, occasionally, doing it with a brave, radical, and revolutionary sense of calling—modern critics are intellectuals. In terms of their fiery-spirited intention, to improve society, they are intellectuals.

However, living in a 'relaxed' advanced society (compared to times of trouble in human history or countries currently suffering diverse challenges), hailing modern critics as intellectuals could render the meaning of intellectuals valueless. In fact, the question of 'what are intellectuals?' has been asked regularly, and much literature has already offered various arguments. Some focused on distinguishing types of intellectuals and suggested their ideal model of intellectuals²⁰ while others criticised and investigated why/how intellectuals lost their power and function²¹. All show that the meaning of real intellectuals is important for the development of society.

When the angle of ideology is considered, the requirement of becoming real intellectuals is of a superior grade. This is because even those elements such as courage,

as Gramsci's (1971) concept of 'organic intellectuals'. This thesis has listed a figure, attached as Appendix 2, to show above scholars' preference regarding the roles of intellectuals. Although it is not the subject of this thesis, it is still worth mentioning.

²⁰ For example, Gramsci (1971) distinguished intellectuals as traditional v.s. organic; Foucault (1991) did as specific v.s. universal; Bauman's (1989) classification was legislators v.s. interpreters; and Mannheim (1936) defined as particular v.s. free-floating. Said (1994) suggested that the ideal intellectual should be an unengaged outsider while Benda (1955; 2006) argued that it should be non-praxis universal ones.

²¹ For example, Lilla (2001) explained the famous sarcasm "Back from Syracuse" (p. 194) which refers to Martin Heidegger's returning to university after war. Moreover, Foucault's argument that there are professionals everywhere, but intellectuals have disappeared. Benda (1955; 2006) and Hazareesingh (1994) pointed out the phenomenon of losing intellectuals. These are all example to explain why intellectuals lose their function and roles in contemporary society. As for other systematically relevant arguments, please refer to Jacoby (2000), Johnson (1988), Benda (2006), Posner (2002), and Furedi (2004).

feeling obligation, radicalism, and revolution (which people used to admire and consider as ways to reach real intellectuals) are a high risk, and could ultimately be the holy pretexts which, on the surface, are noble spirits to be appreciated; but in fact, these elements become gangways to rationalize so-called intellectuals' actions to reach their own purpose, which no doubt is the reflection of their ideologies.

Take the Russian revolution as an example. To Russian intelligentsia's opinions, Nicholas II's regime of an old style political and economic system was bad and wrong; nevertheless, to what extent, was such a critique based on their own value, position, and opinion, that is, ideologies? If later Russian history, under communist Soviet governance, is also considered, would such a revolution have been as welcome as those intelligentsias had previously desired? (Of course, this is my own judgement.) Take the 1960s French debates on the Algerian War as another example. In that period, two groups of so-called intellectuals, with opposing opinions, claimed their rightness of perspective regarding whether to support the war or to conscientiously object. The actions, spirits, and attitudes of both groups could be considered as intellectual because both indeed wanted to make France better. This is a competition for ideological hegemony and it is impossible to judge which side is correct and who shoulders the role of intellectuals.

Based on these examples, it shows that when critics' own ideologies are concerned, the question of 'what are intellectuals?' becomes complicated and cannot simply rely on their possessing brave, courageous, radical, or revolutionary attitudes to propagate a new idea or criticise the so-called wrongness of society.

As a result, this thesis argues that, in the age of ideology, especially for a 'relaxed' advanced society, the meaning of intellectuals should be redefined or, say, the roles of intellectuals should be re-distinguished. This thesis suggests classifying intellectuals' roles as the 'general' (i.e., all the features of modern critics discussed above) and 'ideological' intellectuals. The definition of ideological intellectuals and why nowadays they are limited to academia together with the problem academic intellectuals of ideological critique have faced will be discussed later. Before that, a definition for general intellectuals (modern critics) is provided here as conclusion to this section

General intellectuals are usually well trained within a specific knowledge field; they propagate new ideas and criticise social deviating phenomena. Most of the time, they could be exempted from what they have criticised. Their critiques often focus on visible data or facts; as a result, to them, the truth is the opposite side of wrongness. Pointing out and solving these faulty phenomena are the methods to reach the truth.

Academic Intellectuals of Ideological Critique

A definition of intellectuals (modern critics) who work on general critique has been provided above; a definition of intellectuals who work on ideological critique, however, is difficult to set out. When the executor of critiques (i.e., humans) and their so-called free will (or their ideology) are taken into consideration simultaneously, who is able to shoulder the role of intellectuals to undertake ideological critique requires thorough inspection. A failed inspection might lead to a failed ideological critique, causing an endless loop of personal consciousness criticising another consciousness, thereby contributing to nothing but creating another ideal-critique.

However, there is no evidence to determine who is capable or incapable of undertaking ideological critique, since any judgement is all ideological estimation. As a result, this thesis can only explain who may be best placed to conduct ideological critique. It argues that works of ideological critique, to a great degree, are limited to academic circles, especially those academic critics who focus on dealing with phenomena or theories of ideology, i.e., the academic ideology theorists. Reasons are provided as follows.

First, the ability of undertaking ideological critique is limited to specific academics if the following question is taken seriously: Do critics fully understand the nature/characteristic of ideology? Have they explained *how* and *why* one ideology emerges while conducting ideological critique?

All people with specialization in certain areas are capable of doing critiques to point out the wrongness and to offer suggestions. This is what general critics do. General critics are sometimes involved in a discussion of ideology too. However, unlike their highlighting social problems which at least are based on visible data or evidence, they usually link one social problem directly to ideology without explaining *why* and *how* such an ideology relates to this social problem. This is merely an idealism-style critique on one ideology, but not a real ideological critique.

Differently, critics of ideological critiques are required to explain *why* (and under what conditions) this ideology is created, and with what sorts of operation of power that this ideology is linked to such a social problem. That is to say, only when general critics possess abilities to explain *how* and *why* such ideology emerges, do they become ideological critics. To possess such abilities, critics must be familiar with theories of ideologies (regardless of the diverse theoretical dimensions they hold) and the relative discussion (e.g., ideas of consciousness, power, hegemony, etc.). Only by thoroughly understanding to what the nature of ideology refers, are people able to talk about ideology.

Second, since not every one learns/understands the basic discussion/theory of ideology before they talk about/apply the term of ideology, and since works of ideological critique are usually obscure and often conflict with people's 'normal' thinking, ideological critics' arguments are not easily accepted/supported; their arguments can only circulate and be understood, even agreed, within academia.

Different from the general critics who focus on the visible faults, ideological critics attempt to discover invisible social phenomena which seem so right on the surface, yet, in fact are inappropriate. Ideological critics' argumentations often overly refer to human consciousness, which is beyond the general public's comprehension. If ideological critics' words are easily accepted, then such words only reveal the public's common thoughts instead of the humans' inner part of concealed 'ideology'. As a result, while fools are laughed at for their clumsy demeanours, ideological critics are also deemed to be unrealistic because their critiques on invisible human consciousness *per se*, to the public, are highly absurd.

Inadvertently, ideological critics are also seen as over-nervous and taking everything too seriously (e.g., always linking terms like power, hegemony, ideology to every phenomenon) so that their arguments are usually regarded as a foolish perspective. Eventually, ideological critics re-shoulder the role of entertainer, echoed in Shakespeare's (2008) description of the jester as "wise enough to play the fool" (p. 87). Accordingly, academia becomes the only channel where such unusual social observation can communicate.

Finally, people who work on ideological critique possess a special inner feeling of personal responsibility toward society; this feeling usually accompanies an indignant and helpless sense.

Ennis (1987) suggested that works of critique include three essentials: skills, abilities, and dispositions. While the terms *skills* and *abilities* correspond to the previous discussion of why ideological critique is limited to academics, disposition can be seen as the foundation of any style of critique. Dispositions means whether general or ideological critics, there must be a sense of calling leading them to shoulder social responsibilities. Yet, there are slight differences between them. While general critics see the wrongness of one certain social phenomenon, they warn, criticise, and suggest solutions; by so doing, they (think they) accomplish their social responsibilities.

Differently, what ideological critics have observed is not the wrongness on the surface; instead, it is inappropriateness in rightness' clothing. Although they try to discover these ideological phenomena, the problem is that since these phenomena are seen as so right and normal to the public, no one will consider these phenomena as serious problems as these critics do. Consequently, their critiques are usually treated with contempt; they are re-criticised by the public as scholars in ivory towers who sense trouble in the air because, to the public, there is nothing to worry about. As a result, the calling of social responsibility seems impossible to accomplish which eventually reflects on ideological critics' indignant and helpless feelings. For inappropriateness is in rightness' clothing, they are indignant; for the public's ignorance (even if it is bliss), they feel helpless. Some critics retreat through frustration; others endure which becomes the crucial reason making them the real intellectuals. This is the characteristic of the intellectual to which this thesis refers and which might be well explained by Adorno's words.

Adorno (1990) argued that although the world is awful and identity-thinking²² is terrible, it does not mean that real intellectuals have to surrender. "For it is a feature of truth that it will last, along with its temporal core" (p. 371). Even though they are seen as idiots in this reification world, real intellectuals still have to fight,

armored against every tangible, imaginatively unimaginative assertion of transcendence.... And yet philosophy cannot abdicate if stupidity is not to triumph in realized unreason. Aux sots je préfère les fous. (p. 404)

²² Concept of identity-thinking will be introduced in Chapter 3.

Adorno's words help to distinguish the decisive difference between ideological and general critics. The former are intellectuals who possess a special inner feeling of personal responsibility toward society; they keep criticising ideological phenomena, fighting the unjust in just clothing. Although the public do not need them, see them, or believe them, and no one is there to understand. To create a better world and for truth to triumph, they prefer to be *sots* instead of *fous*.

2.5. Conclusion

This chapter started by illustrating the historical evolution of two subjects of this thesis—intellectuals and the critiques they offer. In terms of the definition of intellectuals, propagating new ideas and criticising the wrongness of society are usually considered as intellectuals' basic characteristics. Sometimes, characteristics such as being educated and other specific personal attitudes (e.g., bravery, feeling obligated, being radical, revolutionary or just famous) are also reasons for being considered intellectuals.

In terms of critique, the definition is simple, to seek the truth. This thesis investigates the historical evolution of critique to understand the emergence of ideological critique. The path begins with Xenophanes (sceptical school) via Socrates, Hume, Kant (interrogative attitude) and Hegel (idealism critique), finally reaching Marx (material-based critique). Marx's critique on political economy bridged works of critique to the realm of ideology where ideal critique was discarded.

After reviewing the philosophical history of critique, this chapter discussed the differences between general and ideological critique. The former is usually to point out what is wrong with the research subjects based on the visible facts or data of findings. As long as problems are resolved, humans might reach the truth. Differently, ideological critique concentrates on the innermost, invisible, and qualitative segments of research subjects to unveil what, on the surface, seems right but indeed conveys something inappropriate which helps certain groups to create a common dominant ideology.

The final section of this chapter focused on the relationship between intellectuals and their work of critiques and explained the situation when ideology is considered. This thesis argues that in the epoch of ideology, ideological critics are limited to academia and they are

the few humans who might be able to shoulder the role of intellectuals especially in contemporary society. Three factors are explained. First, the ability to analyse and criticise ideology is limited to specific academics, especially to those familiar with ideology-related notions. As a result, second, ideological critiques are usually obscure and critics' arguments are perceived as strange, and not readily accepted by the public. The third factor, making academic ideological critics intellectuals, is that ideological critiques require a special inner feeling of personal responsibility towards society. Ideological critics unveil the inappropriate when clothed as rightness. Yet, their arguments are uneasily accepted by the public and often ridiculed as unrealistic; while some critics cave, others have more tenacity and this makes them the intellectuals.

The argument of this chapter concludes that academic ideological critics are the few people who can be seen as real intellectuals in contemporary society. Based on this, it seems that ideological critics are able to lead the public to escape from the influence of ideology. However, questions remain. While this thesis highlighted the limitation of general (modern) critics when they encounter ideology, the same shortcoming applies to ideological critics who also have to overcome their own or social ideology, such as the influence of capitalism. Accordingly, whether capitalism influences academic publications and how/if ideological critics' own ideologies influence their works are the missions in the following chapters. Only after these questions are considered, might the answer to whether humans can escape from an ideology dungeon be provided.

Chapter 3

Theoretical Inspiration: Standardisation —From Culture Industry to Academic Industry

3.1 Introduction

In the previous chapter, this thesis framed two subjects, *intellectual* and *critique*, focusing on their characteristic and definitional evolution through historical and philosophical perspectives respectively. Meanwhile, how the strength of ideology influences the way of recognizing these two terms is also considered throughout the discussion. Based on these investigations, ideological critics are distinguished from general ones.

This thesis also argues that ideological critics are limited to academia particularly those who specialize in ideology-related studies. Ideology-specialists are the few people who are able to discover inappropriateness when disguised as rightness in contemporary society. Nevertheless, such expectation remains doubtful. Although Chapter 2 endowed ideological critics with the function of real intellectuals, they still have to tackle being influenced by their inner or social total ideologies. In fact, ideological critics' works are still conscious products of their own ideology, despite those works being meant to criticise ideology. Humans are unable to run from ideology's dungeon.

Yet, such claim cannot be suggested simply based on my 'idealism' argument because it is my personal ideology against those ideological critics' ideology, which is similar to their works being based on their ideology to fight against the ideology of their research subjects. Arguments like that will inevitably fall into the endless loop of idealism critique. Thus, to provide validated argumentations, which testify above statement, this thesis turns to examine ideological critics' works (e.g., articles, papers, books) to see if they and their works might be immune from the influences of ideology.

According to Adorno (1973), "identity is the primal form of ideology" (p. 148). Based on his notion, finding the 'commonalities' between diverse IAC works is one reasonable way

to examine ideological critics' immunity against ideology. Exploring the commonalities, or what Adorno despised the most—identity-thinking, between diverse IAC articles has a theoretical foundation inspired by the Frankfurt School's critiques on the 'culture industry', which discovered the phenomenon of making artistic products in a model of compulsion (invisible controls), commodification, and standardisation.

Hence, this chapter will briefly introduce some critical concepts of the Frankfurt School. Although considerable detail is needed to explain their notions which may seem irrelevant to this work's train of thought at this stage, their ideas indeed are the foundational concepts that not only help to understand notions of the culture industry, but also help to delineate this thesis' argument of 'academic industry' in the following discussion. Academic industry is nothing new; in fact, it has been discussed²³. Yet, re-stating it here is to specifically highlight the standardisation in academic publications (resulting from commonalities), or what this thesis calls the phenomenon of Standard Writing Procedures (SWPs) in IAC articles, which is the main presumption that this thesis will consider in Chapters 5-8.

Essentially, this chapter is an introspection of Chapter 2, re-thinking the ideological critics' capacity to escape the influence of ideology. Concepts of the Frankfurt School will be introduced first, to be followed by an explanation of the birth of academic industry, which led to the phenomenon of standardisation in academic publications. If ideological critics' IAC articles were found to be standardised, following standard writing procedures, it will prove that no one is capable of escaping the power of ideology (i.e., mission of Chapters 5-8).

3.2 The Frankfurt School

Its History and Critique on Ideology-Life Complex

People are much more familiar with the Frankfurt School and Max Horkheimer than with the School's birthplace, the *Institute for Social Research*, and Carl Grunberg, the first director of

²³ For example, Macherey (1978) argued that a writer is merely a producer who composes words into an article, which is no different from assembling a vehicle. In addition, Eagleton (1976) proposed, "Literature [...] is also an *industry*. Books are not just structures of meaning, they are also commodities produced by publishers and sold on the market at a profit" (p. 59, emphasise original). The two scholars share a notion that the process of creating literature is no different from producing commercial goods.

this Institute. Originally, the objective of the Institute was to research and strengthen Marxism; such an objective was followed by many of its previous leaders until Horkheimer (Jay, 1996). Under Horkheimer's directorship, the Institute did not simply focus on economic dimensions, others such as cultural and psychological dimensions were also considered as analytical angles to understand society²⁴ (Jay, 1984). The reasons that these dimensions, beyond economics, were emphasised were also related to the specialist background of the Institute (Rose, 1978; Held, 1980; Jay, 1996). For example, Marcuse and Fromm possessed backgrounds in psychoanalysis while Adorno focused on musical and aesthetic perspectives.

Eventually, they came to be known as the *Frankfurt School*. Although members of the Frankfurt School possess diverse backgrounds, their arguments shared the same considerations: attempting to determine what had gone wrong within society and to debate what was ordinarily not discussed (Horkheimer, 1972). Their thoughts on analysing and criticising society have been described succinctly as 'Critical Theory'²⁵. Critical theory is more like a collective noun or a concept. The purpose of its existence is to position itself to tell the truth (Jay, 1996), which, to a great degree, shares the same characteristic as ideological critique.

²⁴ That whether Horkheimer was a Marxist has been questioned a lot. It is said that there was no opportunity for Horkheimer to be appointed as professor in the department of philosophy at that time; therefore, if he could become the director of the Institute for Social Research, he could be promoted as professor (because the director is a vacancy for professor level). Since the goal of such an institute is Marxism-oriented, it seems that adopting a position close to Marxism would help him obtain the position. This interesting suspicion might also provide an answer to the question of why the Frankfurt School is criticized extensively for abandoning the economic angle (Wiggershaus, 1994).

²⁵ Critical Theory is different from other theories. Other theories focus on specific notions or offer a complete system of discourse. Although Critical Theory or, say, the Frankfurt School theorists, to a great degree, inherited from Marx's ideas, it still showed a certain diversity, especially to orthodox Marxism which hinges on the viewpoint of class consciousness (Jay, 1996). As discussed above, Critical Theory is composed of diverse research angles such as culture, society, psychoanalysis, music, and aesthetic. In his article "Traditional and Critical Theory", Horkheimer (1972) had explained the difference between these two terminologies. Traditional theory (i.e., other theories mentioned above) excessively praises objectivity to avoid prejudice and conflicts of interests. It wishes to depart from value judgement via intelligent determination in order to pursue an agreeable theory without any contradictions. With traditional theory, the research objects are positioned outside theories. On the contrary, Critical Theory subsumes the study objects into the analysed structure, such that it claims itself as an indispensable link to change the world. The purpose of Critical Theory is not to reach absolute knowledge. This is because even though Critical Theory helps to change reality, it varies itself simultaneously during the whole process. In other words, traditional theory tries to place itself outside of the research object in order to provide the abstract concept with a concrete system; however, in Critical Theory, the concrete system is represented as various ideologies which serve certain interest groups. If traditional theory supports the "existing reality" (p. 217), then Critical Theory lifts this veil which, to a great degree, shares the same function as ideological critique.

One of the Frankfurt School's central argumentative points is that ideology and daily life are indeed and unquestionably integrated in the age of capitalist society. Simply put, an ideology-life complex has been created. Encountering this phenomenon, several Institute theorists have provided their perspectives. Horkheimer and Adorno (2002) in their book *Dialectic of Enlightenment* explained that the pursuit of rationality (which, in fact, is the representation of certain ideologies) has led human beings to make progress ever since the age of enlightenment. These rational disciplines were originally established only to eliminate barbaric and illiterate human manners; however, they replaced the very social guiding logics, which they used to criticise most, becoming themselves a new myth. Inside this myth, the ideology, which promotes the sublime of rationality, was involved with human life becoming the only discipline.

Moreover, Marcuse (1991) provided this new myth a terminology, that is, *Instrumental Rationality*. To him, advanced society *per se* indeed possesses the characteristics of ideology which help to reproduce dominant thought. This thought is that rationality is important. With the assistance of ideology, such thought is repeatedly reproduced where so-called scientific knowledge and technology (i.e., instrumental rationality) are blindly pursued and identified. Eventually, a world that lives with one-dimensional man is created. The impact of such a one-dimensional society could find further theoretical explanation in Adorno's (1990) notion of *identity* where he discussed how this ideology-life complex led to human irrationality on the scale of the Holocaust.

If the phenomenon of the ideology-life complex is the starting point of the Frankfurt School—i.e., the presentation of society now is opposite to its reality— then what this School continues to do is to begin their critiques (see section 3.3) and look for solutions (see Chapter 9). As mentioned above, it is better to understand some critical concepts of the Frankfurt School to ascertain how they diagnose society before investigating how they criticise it as well as guiding ways out of it. Concepts that the following section will review include notions of *Dialectic of Enlightenment*, *Instrumental Rationality*, and *Identity(-thinking)* and *Totality*.

Concept: Dialectic of Enlightenment

To the Frankfurt School²⁶, the purpose of enlightenment is to release humans from fears of barbarism via the guidance of rationality. Enlightenment thus claims to establish knowledge based on neutral mathematical disciplines and objective logic to eliminate illusion and myth. In other words, the idea of enlightenment upholds the logical form and highly praises the mathematical disciplines. This is to eradicate the sensitive characteristics of everything, simplifying everything into countable quantities. In so doing, all things in the world, even human feelings, could be equally calculated and exchanged (Horkheimer & Adorno, 2002).

Yet, Horkheimer and Adorno (2002) in their book, *The Dialectic of Enlightenment*, questioned “why humanity, instead of entering a truly human state, is sinking into a new kind of barbarism” (2002, p. xiv). They answered that although the world has become more civilized since the age of enlightenment, a blind fetish of enlightenment-correct has become another new dominant myth and ideology with a better disguised appearance. The enlightenment rejected myth, but ultimately it became a new myth itself. This myth was borne out of human belief in rationality, science, technology, and knowledge where they were forced to abandon individuality of thinking. The characteristics of their thoughts can only be shown through material formation becoming a new form of thinking, which is based on an instrumental and technological rationality.

What should be clarified is that it is not the instruments, technologies, and knowledge *per se* which the Frankfurt School criticised, but rather the thinking logic, or the ideology, that upholds rationality, (blindly) believing in the correctness of instruments, technologies, and knowledge.

In short, the Frankfurt School argues that while the spirit of enlightenment shepherds humans from being savage to being civil, humanity itself has retreated back to the barbarian stage due to the new myths it has created. The difference is that the reasons that have provoked this relapse into barbarism are no longer factors such as the economy, but rather

²⁶ What must be explained here is that, to a certain extent, this thesis has simply and irresponsibly generalized thoughts of the Frankfurt School’s theorists into an angle of totality, and collectively presented this as “the Frankfurt School.” (Ironically, seeing all incidents, even though they are close, as a totality is to a certain extent agreed with by Lukacs, but rejected by Adorno). The reasons for presenting it this way are not only that this is not a thesis on the Frankfurt School, but also that the thoughts of the Frankfurt School’s members are mutually demonstrated and complementary to each other. Frankly speaking, there is a certain difficulty in distinguishing their individual thoughts across such a limited number of pages.

rationality. With the sword of rationality, enlightenment was able to criticise old ideologies; this rational sword, however, has become another form of violence that itself should be argued against.

Drawing on Horkheimer & Adorno (2002), if the humans' enlightenment initially involved the pursuit of rationality to escape from barbarism, then what the Frankfurt School wishes is to ask us to undertake the second enlightenment, that is, to criticise the irrationality of rationality derived from the first enlightenment.

The reason why the first enlightenment was veiled in itself or why rational reason became violent reason could be explained by Marcuse's and Adorno's other ideas, which is the task of the following discussion. To Marcuse (1991), the first enlightenment has encouraged people to follow the discipline of scientific technology (i.e., instrumental rationality), which becomes the only way for the public to prove their rationality. To Adorno (1990), the impact that the first enlightenment, or the instrumental rationality, has created is that human beings have begun to pursue identity to create a dreamed totality.

Concept: Instrumental Rationality

How scientific technology, as a formation of ideology, influences society could be traced back to Marx's (1971) relative discourses where he demonstrated how productive forces and the relations of production together determine the social formation of an age²⁷. Marx's demonstrative logic is: scientific technology is part of the productive forces—the diverse labour instruments (and its users) determine the expression of the productive forces (and its corresponding relations of production, i.e., the means of production), which will determine the whole formation of social development (and its corresponding relationships of dominance). Essentially, this reflects an ideology of a time. As Marx (1955) said,

The same men who establish their social relations in conformity with their material productivity, produce also principles, ideas, and categories, in conformity with their social relations. (p. 119)

²⁷ The productive forces refer to what type(s) of labourers are in demand and the instruments they adopt to create products. Although it is human beings as labourers who create their own instruments, it is the certain social economic conditions at the time which determine what sort of labourers these humans become and what type of instruments they are able to (invent and) use. Handiwork in the feudal manor, the steam engine machine in an industrial capital society, and Internet business in the era of information all show that the means of production, to a certain degree, reflect the corresponding formation of society.

If Marx pointed out the veiled relationship between the productive forces (especially the corresponding instruments) and one ideology of a time, then arguments claimed by the Frankfurt School are to demonstrate how scientific technology, which was nourished in the era of enlightenment, became the dominant ideology of their time (and, of course, our present-day), or, has become the only standard to achieve rationality. Although members of the Frankfurt School, e.g., Horkheimer and Adorno, more or less, entered into the discussion on how scientific technology influences human consciousness, Marcuse should be considered as the one who actually offered a complete analysis and critique on the influence of scientific technology.

Marcuse's (1991) foci were mainly on the relationship between the political content of scientific/technological rationality and the characteristic of ideologies. His findings were that scientific technologies *per se* are a new kind of ideology. To Marcuse, mechanization (i.e., the result of scientific technology development) has redefined the meaning of labour²⁸ because technological progress promotes the productive forces that also have improved human lives, including those of the bourgeoisie and proletariat. In other words, the improvement of instruments has brought about a better working environment, which in turn has changed the proletariat's attitude regarding their labouring, and eventually makes them feel that the gap between the two classes has been reduced.

However, using an iPhone 4, as Steve Jobs did, does not mean that the class difference between him and us is removed. As Marcuse (1991) argued,

this assimilation indicates not the disappearance of classes, but the extent to which the needs and satisfactions that serve the preservation of the Establishment are shared by the underlying population. (p. 8)

In fact, to Marcuse (1991), exploitation does still exist because the very truth of exploitation is now veiled by the development of scientific technology (e.g., the operation of instruments becomes more convenient). To him, "The slaves of developed industrial civilization are sublimated slaves, but they are slaves" (p. 32). The definition of slaves does not refer to the difficulty of performing labour but to workers' conditions of playing disposable yet instrumental roles.

²⁸ For concept of labour, please refer to Chapter 5.

Marcuse (1991) stated that technology eliminated the original form, which serves a single purpose and created a new general form, which can serve several major purposes. The scientific technologies quantify the abstract natural world, transforming it into one with countable materials offering humans an efficient, reasonable, and comprehensive sensibility to reach objectivity. The scientific technologies meet not only the material but also the spiritual needs of humans, creating an illusion where humans neglect the false and deceitful characteristic of scientific technology and forget the real freedom. The worship of and reliance on scientific technology becomes a key part of humans' living discipline, and further creeps into their daily life. Marcuse described these phenomena as the pursuit of "technological rationality" (i.e., instrumental reason²⁹).

The characteristics of technological rationality are composed of logical, mathematical, and instrumental formations, including both the application of visible scientific instruments and invisible derivative/constructed knowledge. Under the guidance of technological rationality, humans stand on quantified data and formalised, standardised procedures to evaluate things in the world; in so doing, they think that they are able to objectively and neutrally establish a principle for all things. Thus, such positive thinking of technological rationality, to the public, is the principles guiding humans' social practices.

However, to Marcuse (1991), the technological rationality *per se* possesses the characteristic of ideology, which is the leading logic of social control. Since technological rationality possesses the characteristic of ideology, the application of visible technologies and invisible derivative knowledge could never be neutral. On the contrary, it is unidirectional and interest-oriented, and it is destined to construct a systematic and cultural totality by eliminating other differences of things. It transpires that the application of scientific technology, whether through visible instruments or invisible knowledge, is a method to maintain a certain ideology. This phenomenon is what Marcuse described as the rationality of irrationality, or an alienated rationality.

²⁹ Although Marcuse's terminology of instrumental rationality was inherited from Weber's notion of rationality (including value-rational and instrumental-rational action), Marcuse often adopted *technological rationality* instead of Weber's term *instrumental-rational action* or *instrumental reason* as termed by his other colleagues, such as Horkheimer and Adorno. Generally speaking, these terms share the same concept.

To Marcuse (1991), when alienated rationality reaches a certain degree, the foreseeable impacts will be “the closing of the political universe” (p. 19), “the conquest of the unhappy consciousness: repressive desublimation” (p. 56), and “the closing of the universe of discourse” (p. 84). In other words, because such social consciousness (i.e., technological rationality) created by the advanced industrial society controls and dominates political and social thinking, the goal of social development gradually becomes identical to governments’ goals, where all sorts of social problems are subsumed into the governance of states. Society could be extremely rich and so could be unusually poor; it could be a welfare state and also could be one that initiates wars. In terms of politics, oppositional parties are becoming identical; in terms of economics, unions and firms in fact are run by the same guiding logics. These notions are summarised by Marcuse (1991) as the one-dimension society—“the paralysis of criticism: society without opposition” (p. xli).

Concept: Identity and Totality

Marcuse’s (1991) argumentation on technological rationality explained not only how a one-dimension society is created but also how people living in such a society lose their negative thinking when facing the “triumph of positive thinking” (p. 170). By pointing out the concepts of *identity* and *totality*, Adorno (1990) also shared Marcuse’s concern regarding the changing society.

To Adorno (1990), the characteristic of *identity*—or identity-thinking³⁰—is to categorize, connect, and simultaneously simplify concepts of various terms or humans’ cognitions in order to forge a particular way of thinking. In so doing, the contents of a term, which seemingly contains diverse and abundant meanings, become inwardly narrow and singular due to the operation of *identity*.

For example, the term *freedom* originally contained diverse concepts, e.g., including its conditions and legal limitations; but, under the function of *identity*, humans easily and lazily recognize this term as ‘being free’. *Freedom* has lost its original intention (with required

³⁰ Gillian Rose (1978) concluded that identity-thinking, non-identity thinking, and rational identity thinking are three elements which constructed Adorno’s notion of identity(-thinking). Due to the limitation of page length, this thesis will only introduce the notion of identity-thinking in this chapter and non-identity thinking in Chapter 9. For a complete treatment of rational identity thinking, please refer to Rose’s (1978) book *The Melancholy Science: An Introduction to the Thought of Theodor W. Adorno*, Chapter 3.

conditions); instead, it is seen simply as the protection of personal interests in which people take ‘self-interests’ or ‘being free’ as the only way of thinking regarding freedom. While freedom is simplified to a particular way of thinking (i.e., identity-thinking), it testifies Adorno’s concern that the function of identify helps to create a certain ideology. Adorno (1973) stated that “identity is the primal form of ideology” (p. 148). Similarly, the identity-thinking of ‘being free’ is the ‘primal form’ that constructs the ideology of seeing freedom.

The operating model of identity, according to Adorno (1990), is to pursue the quantitative singularity instead of the qualitative diversity which is the reason why Adorno was disgusted at identity(-thinking). The tragedy of Auschwitz is the example through which Adorno demonstrated the threat of Nazis looking for identity. Under the discipline of instrumental reason—evaluating things based on quantifiable matters, Jewish people were presented as the countable Others. Consequently, death in the Holocaust is not an individual matter but that of a quantifiable “specimen”³¹. (Schweppenhäuser, 2009, p. 67; Adorno, 1990, p. 362). Once the subjects could be degraded to quantitative examples (i.e., quantifiable others or non-identical, non-historical gestated individuals), even humans could be dumped freely.

Auschwitz testified to the threat of identity-thinking (i.e., the pursuit of sameness or totality) which could find theoretical support from Marx’s concept of commodity exchange as Adorno (1990) explained,

The barter principle, the reduction of human labor to the abstract universal concept of average working hours, is fundamentally akin to the principle of identification. Barter is the social model of the principle, and without the principle there would be no barter. (p. 146)

Adorno (1990) agreed with Marx that the capitalist society mechanism is built on the discipline of commodity exchange. This mechanism is an alienated social operating logic where the nature of humans is degraded like that of materials, helping to pursue identity and homophily. During the process of exchange, the non-identifiable labouring outcomes

³¹ The Holocaust museum in Jerusalem has one of its key principles that they do not teach people about the Holocaust in terms of numbers, their pedagogy is based on telling personal stories because to talk in numbers and statistics is to perpetuate what the Nazis did. Their pedagogical principles echo Adorno’s aspect.

become commensurable and identifiable, eventually reaching their final destination: the totality. Totality (i.e., seeking identity) is a foreseeable destructive consequence which is what primarily concerned Adorno. He claimed,

It is through barter that nonidentical individuals and performances become commensurable and identical. The spread of the principle imposes on the whole world an obligation to become identical, to become total. (1990, p. 146)

Totality, the destination of identity-thinking, is what Adorno (1990) opposed the most. To understand Adorno's attitude regarding totality, Marx's and Lukacs' perspectives should be reviewed. According to Marx (in Held, 1980), demand is the critical factor that causes human development through daily labouring. The process of humans' labouring determines the social construction; it is also a way to understand the nature of humans such as the pursuit of rationality and freedom. Humans' labouring is not only an economic material practice but also a way to prove their material existence.

However, at a certain stage of their labouring, the division of labour is an inevitable phenomenon. The simplest division is that of material and spiritual labour (Marx & Engels, 1970; Wolff, 2002). From such division, spiritual labour is able to break away from material labour to establish pure discourses such as theology and philosophy—that is, the battlefield wherein ideology works. To Marx (1971), humans' consciousness is the products of their social practice/labouring. Only when consciousness eliminates material labour does it start to gain the characteristic of ideology functioning as ideology. It is also because of the division of material and spiritual labour that the division of subject and object starts to be seen as a way to recognize the world (Jay, 1984).

Lukacs's (1971) demonstration on totality is indeed based on recognizing the division of material and spiritual labour and that of subject and object (which, yet, is what Adorno (1990) was most against). To Lukacs (1971), the proletariat have to recognize that their social consciousness is a reified (alienated) consciousness, which disengages from their daily labouring, and also have to identify their situation of being the object of the dominant class if they want to end this oppressed condition. Thus, he suggested we recognize the society as a totality where every social phenomenon should be investigated within the whole social context. In so doing, people are able to investigate the interaction between subjects and objects completely to reach their unity. Once the proletariat realizes their own proletarian consciousness, breaking through the dominance of capitalist ideology becomes possible.

Lukacs (1971) attempted to recreate the totality of the world via the dialectic of subject-object, i.e., to clearly identify object from subject and vice versa. This is to distinguish the ideology of the proletariat from that of the bourgeoisie and to transform the proletarian consciousness from being object to subject. Nevertheless, to Adorno, Lukacs's logic of totality is not an objective dialectic. It still goes with the angle of subject-centred or human-centred. The subjects, eventually, engulf the objects; in other words, objects are the compelled and subdued targets under the subjects' superiority. The triumph of subject will consequentially lead to the establishment of the sameness, which reflects a certain subject's totality instead of totality of subject-object.

The serious impact of identity and totality is that objects are incapable of realizing their predicament. They, as the objects of social development, misrecognized themselves as subjects. Such misrecognition of being the subject echoes Adorno and Horkheimer's (1997) critique on the culture industry where they explained how customers suffer from the misunderstanding of choosing what they want; in fact, what they can consume is all the identical products representing nothing special but sameness.

3.3 Culture Industry and Academic Industry

In the previous section, this thesis briefly explained the Frankfurt School's findings regarding problems of contemporary society. Their foundational concepts including *dialectic of enlightenment*, *instrumental rationality*, and *identity and totality* were introduced as well. These concepts echo their argumentations on the phenomenon of the culture industry.

The notion of dialectic of enlightenment asks people to introspect ideas, which are taken for granted. While it is applied to explain the phenomenon of the culture industry, Horkheimer and Adorno wished to expose the real nature of contemporary artistic creations which had lost their original aura and were covered by sameness. (Works of ideological critique also share the same logic, i.e., to discover inappropriateness in rightness' clothing.)

The reason that cultural creations sink into the culture industry's model of production is because of the development of instruments and technologies (Horkheimer & Adorno, 2002; Marcuse, 1991). The instruments and technologies change the way of presenting artistic works which gradually undermine the nature of cultural creation, eventually, result in a

problem: instrumental rationalities have expelled ‘value-rational actions’ (Weber’s term) that cultural creations originally possessed. (This thesis will examine whether works of ideological critique suffer from such instrumental rationality, especially the curse of standardisation, in the empirical analysis chapters.)

In discussion about the culture industry, modern artistic creations, on the surface, are seemingly various, but, in fact, conceal sameness, which results from the culture industry’s characteristics of compulsion, commodification, and standardisation. This is why Adorno (2002) warned us off identity-thinking and its subsequent totality which will wipe away the diversities of things and let human consciousness become what he called the “social cement” (p. 459; also see Adorno & Horkheimer, 1997). (This thesis will also discuss whether works of ideological critique reach nothing but sameness due to the impact of standardisation in the empirical analysis chapters.)

This section will first introduce characteristics of the culture industry then investigate whether publications in academia gradually become the academic industry due to similar characteristics. It will question to what extent the works of ideological critiques become involved with these characteristics, especially the phenomenon of standardisation.

Culture Industry

Frankfurt School thinkers have argued that culture (i.e., the traditional elite culture, or the culture prior to capitalism) should take a position against society (Adorno & Horkheimer, 1992). The function of artistic creation is not to parade society’s achievements but to reflect society’s contradictions. It is a function of “negative truth” (p. 37; Adorno, 1991, p. 26)—i.e., ‘negativity’. Nevertheless, since the emergence of capitalism in the eighteenth century, the function of negativity has been lost. Thus, artistic creation (which should now be called cultural product) starts to confirm the logic of capitalism, which eventually generates a ‘mass culture’ peculiar to modern industrial society, contributing to what Adorno and Horkheimer named the *culture industry*³².

Three features of the culture industry can be concluded with regard to the methods which produce cultural creations. First, a method of production is gradually combined with

³² Why Adorno (and Horkheimer) switched the term from *mass culture*, used before 1974, to *culture industry* is explained in Adorno’s (1991) book *The Culture Industry*, Chapter 3.

scientific technology; second, this method begins representing the mercantile demands rather than presenting its creators' ideas; and third, this method is progressively similar to the process of commodity production (Adorno & Horkheimer, 1992; 1997). The above three points correspond to the three characteristics of the culture industry respectively, that is, the compulsion (invisible controls), commodification, and standardisation.

In terms of compulsion, it echoes what Marcuse (1991) argued: how the instrumental reason compulsively influences humans' life principles in the advanced industrial society, making people think simply (one-dimensional thought). When cultural creations are compulsively produced through scientific technologies, scientific and instrumental rationalities will invisibly influence the human way of thinking which becomes the only scale to judge all things around; as a result, humans' own thinking, comparatively speaking, seems redundant. Adorno (2002) answered why such a phenomenon occurred. It is because the compulsive characteristic of the culture industry is similar to the capacity of concrete which impedes humans from recognizing their real needs and interests. Under this condition, the culture industry is able to control public thought and psyche and further cultivate the obedient ideology that supports authority and maintains the status quo (Horkheimer & Adorno, 2002; Adorno, 1991). Adorno (2002) stated that the culture industry indeed is the "social cement" (p. 459) wherein, "The customer is not king, as the culture industry would have us believe, not its subject but its object" (Adorno, 1991, p. 99).

Regarding the commercialized phenomenon, this means that humans' perception of cultural creations is no longer different from that of consumer goods because human attitudes regarding cultural creations are governed by disciplines of value. This is to say, regardless of whether from the angle of artists (who produce), merchants (who price), or customers (who purchase), cultural products become nothing but one type of consumer good in the market depending on profits and exchange-value. Adorno (2002) considered jazz as an example. He explained the influences of commodification are that musical composition became market, sale, profit, and popularity-oriented which has fertilized what he called "musical fetishism" (p. 295). Namely, cultural creations in the age of commodification are valued by economic discipline instead of psychological or spiritual needs.

On the matter of standardisation, Horkheimer and Adorno (2002) argued that the way of producing artistic creations becomes increasingly similar to the standard way of producing commodities. Standardisation means to revise, even to remove, the original and peculiar characteristics of cultural materials, making them as simple as formalized components on a production line. This line represents a standard production procedure wherein materials selected to produce diverse types of cultural products might be different, but the producing logic remains the same. As a result, cultural products are able to be massively produced (or reproduced, duplicated) which not only reduces costs but also increases efficiency to gain maximum benefits.

From such a standard procedure, the production process will be simplified. For this reason, a tiny modification in the production process could furnish commodities with many different styles seeming to be multiple and customized, thereby meeting all individual demands. This echoes what Strinati (2004) has argued: “The more cultural products are actually standardized, the more they appear to be individualized³³” (p. 57). A critical impact of standardisation is that it conveys the value of capitalists and eliminates the specialities of cultural creations. (Horkheimer & Adorno, 2002; Adorno, 1991). All these seemingly individualized cultural creations are in fact conveying a kind of pseudo-individuality and false-need, of which customers are never aware and which could be seen as the ideological function of the culture industry.

In summary, to the Frankfurt School, culture should essentially possess the function of negativity against society. Yet, such a function has disappeared since the invasion of capitalism has made creations of culture industrialized, which is the result of three characteristics: compulsion, commodification, and standardisation. ‘Culture industry’ is used to explain this phenomenon happening in cultural creations. Suffering from the power of the culture industry, cultural products compulsorily limit human thinking and impede people

³³ The film *The Island* (Bay, 2005) illustrates the same logic: that even a complicated production like human consciousness can easily be evolved into diverse personalities if a slight alteration to the standard procedure is set up. In this film, the main character, Jordan Two Delta (played by Scarlett Johansson), keeps defending her claim that she does have memories from before the catastrophe portrayed in the film, such as memories of her childhood, mother, grandmother, pets, farm, and especially her bicycle. While she is remembering, Steve Buscemi, the technician of this island, has no choice but to interrupt her by saying, “No. Memory imprints. There's only, like, 12 stories. They change around little details. But they're all pretty much the same” (Bay, 2005).

from recognizing their real needs and interests. Simultaneously, the culture industry also reshapes human attitudes regarding the value of cultural creations, which is scaled by the criteria of market, sale, profit, and popularity. Characteristics of compulsion and commodification result from and in another characteristic of the culture industry, standardisation, which puts cultural materials into the standard production procedure in order to massively produce products of culture. Standardisation not only eliminates the culture's specialities but also creates pseudo-individuality and false-needs for the public.

Academic Industry

If the Frankfurt School's critique on the impact of the culture industry is to discover social phenomenon of their time, and in turn to express their diverse perspectives toward social reality (e.g., dialectic of enlightenment, instrumental reason, identity-thinking, and totality), then the characteristics and production logics of the culture industry (i.e., compulsion, commodification, and standardisation) are also applicable to academic publications. In this thesis, academic publications can be classified as a genre of cultural creations since, to a great degree, they have been influenced by the same characteristics and production logics discussed above.

The first similarity is the compulsive nature of academic publications. The compulsive phenomenon in academia refers to the fact that people who want to work in academia are forced to adopt, even accept, those reputed scholars' ideas or acknowledged concepts. Just as iOS and Android dominate the mobile operating systems market, some famous scholars and ideas encompassing biblical zeal have dominated certain research fields. Not all masterpieces can be acknowledged at the time they are written³⁴, yet today's famous scholars' opinions and citations of particular literature have become the standard for judging new and emerging academics' works.

This compulsive phenomenon also testifies Althusser's (1971) idea: the reproduction of the relation of production. The value of one academic publication is easily sublimed based on its authors' reputation (e.g., written by a renowned scholar); simultaneously, once the

³⁴ The Italian scholar Giovanni Vico is a good example. His thought was neglected in his time but was rediscovered by Jules Michelet a hundred years later, which opened the way to the development of communist thought (Wilson, 1972).

value of such a publication is granted, it helps to build this scholar's reputation again. This phenomenon also echoes Foucault's (1980) notion of knowledge-power.

The academic consent of a time/field is the conscious representation of the leading scholars who control the research direction of their time/field. These leading scholars also keep reproducing their reputation in one field through cooperation between their vested fames and new works. Great-masters and acknowledged ideas or jargon become a compulsive strength in the age of academic industry, which invisibly shapes variety into identity (-thinking) leading to 'academic cement'.

The second similarity is the commercialized trend growing in academia wherein academic publications have lost their 'aura'³⁵, becoming the real commodities governed by disciplines of exchange-value. In contemporary academia, people have to pay to download an academic article from, for example, Sage Publications, just as they do to download music from iTunes. This phenomenon may seem ironic if the purchased article is one criticising the greed of capitalism from a communist perspective³⁶. This ironic contradiction is much more serious when the electronic format of an academic publication has saved the major traditional printing cost. People have ignored what Marx (Marx & Engels, 1982) argued that "once the product is produced, its price is determined by the costs necessarily incurred in *reproducing* it" (p. 424, emphasis original). Unquestionably, the action of selling an academic article (that criticises capitalism) *per se* is the triumph of capitalism, let alone selling an electronic edition.

³⁵ This thesis adopts Benjamin's (2003a) term *aura* to describe the exclusive characteristic which belongs to individual artistic creations only. Yet, this does not mean that Benjamin himself possessed the same perspective as Adorno and Horkheimer did regarding the 'loss' of such individual specialty of arts. While Adorno and Horkheimer (1992) considered the artistic creation in the age of capitalism as 'culture industry', Benjamin held a different perspective. In the article *The Work of Art in the Age of Mechanical Reproduction*, he argued that cultural creations are widely available and being massively reproduced due to the technological developments, but it is not that bad. To Benjamin, although the 'aura' of a cultural creation disappears, intimacy between compositions and audiences is created. In the past, only the rich were able to access particular cultural masterpieces; but, nowadays, everyone can do so. Mechanical reproduction helps to tear down the fence between groups which is a good thing for reducing class differences.

³⁶ This thesis here especially refers to the research fields of the social sciences. Most academic findings in the applied sciences, such as mechanical engineering, pertain to business inventions and innovations in modern society (e.g., the application of motor engines), so it is senseless to argue that these academic publications have reading costs. Nevertheless, the purpose of social science, to a great degree, is to pursue a better development of human society. In terms of this thesis' position, they should be ashamed if socialists are looking for profits from what they have written.

Moreover, another commercialized phenomenon is that academic publications are market-oriented and can be put on shelves if they have commercial potential, as per the following example: Anthony Giddens visited the president of Taiwan, Shui-Bian Chen, in 2002, to advocate his notion of ‘the third way’. Before he went, few of his books had been published in Taiwan’s book market. However, more than five were published right after his visit. The publishers simply purchased the copyrights from mainland China and translated the Simple Chinese to Traditional Chinese. His books were published not because of how great his theory was but because he was President Chen’s spiritual mentor³⁷. Giddens and his books are commodities. Taiwanese consumers purchased Giddens’s books not to read (maybe this was the original intention), but rather for fashion, to collect, or to testify the moment of hope. Academic works, to publishers, are no different from mystery novels, as they are all essentially commodities to generate profits.

It should be noted that the above critiques on commercialized and compulsive phenomena within academia are not to argue how much financial benefit reputed scholars could obtain since academic publications could never compete with general publications. Rather, it is because academic publications should be different from mass commercial publications. Academic publications, as a way of representing culture, should maintain what the Frankfurt School theorists had insisted—the negativity of cultural creations.

So far, this section has explained the compulsive and commercialized phenomenon in academia and now turns to the phenomena of standardisation. In general publication (e.g., novels, magazines) standardisation is a common feature in which although books’ titles seem varied, the vaunted special contents (e.g., secrets of succeeding in the stock market) are no different from one book to another. Under the standardized production logic, the content of general publications is like consumer goods which are random combinations of similar and common ingredients wherein a tiny variation could result in a large number of varieties down the line. Standardisation in general publication is an inarguable fact; yet, has standardisation occurred in academic publications?

³⁷ Chen said that he was inspired by Giddens’s ‘the third way’ to achieve a political solution between two conflicting opinions in Taiwan—maintaining independence versus uniting with China. People in Taiwan suddenly found this a great idea, one that might be useful in dealing with their difficulties.

Seriously, Has Standardisation Occurred in Academic Publications?

There will be huge critique if this thesis claims that academic publications also follow the same standardized production logic. Generally speaking, most people believe that academic publications are different from general publications because every scholar possesses their ‘free will’ to present their unique academic ideas.

Nevertheless, while discussing the abilities of general critics in Chapter 2, this thesis has argued:

1. If the truth results from the relationship between **subject** and **object**, it shows nothing but a **certain ideology**.
2. If the truth comes from the relationship between **subject** and **subject**, so-called intersubjective agreement will contribute to nothing but a **dominant ideology**.

Accordingly, a question should be asked: to what extent does scholars’ so-called ‘free will’ represent their ideology (of what they think ‘not ideology’) as well as contribute to a certain dominant ideology (of their own understanding of seeking the truth)?

This thesis argues that believing in such rationality of ‘I have free will’—taking the logic of dialectic of enlightenment—is irrational. ‘I have free will’ *per se* is an ideology. No one is capable of escaping from the influence of ideology. Yet, such argument cannot be suggested from nothing. To test this argument, this thesis attempts to investigate if standardisation occurred in academic publications.

This chapter has investigated how standardisation has contributed to the birth of culture industry. Its characteristic is to create a normal model, via reducing the diversities, to maximise efficiency and profits of production, and finally to establish identity-thinking. Similarly, if such a phenomenon of standardisation also happens to academic publications, it means that there is a rule guiding scholars to compose their academic works despite the rule resulting from individuals’ ideologies or the social (total) ideology surrounding individuals. If such standardisation really impacts academic publications, it indicates that works of ideological critiques are limited, which is not as freely expressing critics’ thoughts as people used to think.

This thesis states that standardisation has indeed happened to academic publications. It plays an ideological guiding discipline which emerges in the form of standard writing

procedures (SWPs). Different research fields have their own SWPs to discuss specific subjects in their field. The foreseeable influences are: because academic publications are standardized, a tiny change (e.g., permutation combination of contents or ideas) could make every publication (e.g., books, papers) seem unique even though they are composed of similar concepts. Therefore, academic publications could be easily and massively (re-)produced³⁸ since they are gradually tending towards identical thinking and eventually total discourse.

To determine/prove this standardized phenomenon or so-called standard writing procedures, in the empirical analysis chapters (5 to 8), this thesis will focus on articles whose authors claim undertake investigations via the angle of ideological critique/analysis. The rationale for selecting such types of academic publications (i.e., IAC articles) is based on the discussion in Chapter 2. This thesis, in Chapter 2, has promoted ideological critics to a higher position as the few people who are able to carry the role of real-intellectuals. They are, or might be, the most capable people who can escape from the intervention of ideology. Hence, their works —ideological critiques— are the most suitable research data to examine their immunity against (their or social) ideology. By examining academic critics' works of ideological critique/analysis, this thesis wishes to answer whether standard procedures (SWPs) for writing IAC articles exist, and further to investigate IAC analysts' capacity against (their or social) ideology as well as their limitation of undertaking ideological critique.

3.4 Conclusion

This chapter is an introspection of Chapter 2 examining whether academic publications of ideological critics could avoid the influence of capitalism with an inspiration from what has happened to cultural creations. The Frankfurt School theorists detected the phenomenon of the ideology-life complex and explained it with notions of dialectics of enlightenment, instrumental rationality, and identity-thinking and totality. These notions are their theoretical basis to criticise the problem of industrialized artistic creations. They determined three

³⁸ Massive production here does not mean quantitative amounts of visible printing; instead, it refers to publishing output of reputed scholars who massively reproduce and duplicate their (old) ideas, that is, new context for an old idea.

characteristics of the culture industry: compulsion, commodification, and standardisation.

This chapter adopts these three characteristics to examine whether academic publications have been industrialized, especially focusing on the phenomenon of standardisation. The reason for doing so is that standardisation is an ideological guiding discipline that emerged in the form of standard writing procedures. In short, standardisation is an ideology. To justify this argument, this thesis concentrates on ideological critics who work on ideological critique/analysis, since they are, or might be, the most likely people to escape from the intervention of ideology. Before advancing to the chapters on findings, this thesis will explain the methodology of the empirical analysis in the next chapter.

Chapter 4

Methodology

4.1 Introduction

In Chapter 3, this thesis stated that standardisation has indeed happened to academic publications. It is an ideological guiding discipline which emerges in the form of standard writing procedures (SWPs). Whether this presumption is valid is the mission of the empirical analysis chapters (5 to 8). Before advancing to the empirical analysis, this chapter will explain how this thesis undertakes the analytical mission, including how research data are collected, how the analytical methods are applied, and how the analytical outcomes are presented.

4.2 Data Collection and Research Objectives

Data Collection

The research objects examined in this thesis are all academic publications such as journal articles or book chapters, but only if the articles claim to be written from the angle of ideological analysis or critique. The keywords *ideological critique*, *ideological analysis*, *ideological criticism*, *critique of ideology*, and *analysis of ideology* have been used to search the archives of academic publishing companies (e.g., Sage, Routledge, SwetsWise), the catalogue of the University of Sheffield Library, as well as Google Books and Google Scholar to collect related articles for this study. 37 articles whose 'title' precisely matched the above-listed keywords have been collected. From these potential samples, only 33 articles, whose content displayed the application of ideology-related concepts, were selected as the main analytical data.

Although there should be more scholars who deal with this topic without directly and clearly titling their articles with the keywords mentioned above, the decision was made for this thesis to only focus on these 33 pieces of data. This is because, as discussed in Chapter 2,

the research object of this thesis is academic scholars who decide to adopt the angle of ideological critique/analysis to investigate their research, or who display their research interests in ideology (as their articles' titles have revealed). In so doing, it will meet the mission of this thesis: studying those who are the most likely persons to escape from the intervention of ideology (since ideology, to them, could be seen as a research object³⁹).

These 33 articles related to ideological critique/analysis are listed in Table 4-1. In this table, RA is the abbreviation for *Research Articles*, which are all followed with numbers to refer to certain articles, e.g., RA07, RA33. These 'RA+number' codes are applied to substitute for the original title of articles in later writing. Lastly, all 33 collected articles are stored on a disk attached as Appendix 1.

Table 4-1: List of Collected Research Articles and Their Reference

Research Articles	Reference
RA01	Moss, G. & O'Loughlin, B. (2005) New Labour's Information Age Policy Programme: An Ideology Analysis, <i>Journal of Political Ideologies</i> , 10(2): 165-183.
RA02	Abbas, T. (2001). Media Capital and the Representation of South Asian Muslims in the British Press: An Ideological Analysis, <i>Journal of Muslim Minority Affairs</i> , 21(2): 245-257.
RA03	Sakamoto, R. (2001). Dream of a Modern Subject: Maruyama Masao, Fukuzawa Yukichi, and 'Asia' as the Limit of Ideology Critique, <i>Japanese Studies</i> , 21(2): 137-153.
RA04	Bishop, R. (2001). Old Dogs, New Tricks? An Ideological Analysis of Thematic Shifts in Television Advertising for Diet Products, 1990-2000, <i>Journal of Communication Inquiry</i> , 25: 334-352.
RA05	Brennen, B. & Duffy, M. (2003). "If A Problem Cannot Be Solved, Enlarge It": An Ideological Critique of the "Other" in Pearl Harbor and September 11 New York Times Coverage, <i>Journalism Studies</i> , 4(1): 3-14.
RA06	Bishop, R. (2005). The Wayward Child: An Ideological Analysis of Sports Contract Holdout Coverage, <i>Journalism Studies</i> , 6(4): 445-459.
RA07	Hazelton, M. (1990). Medical Discourse on Contemporary Nurse Education: An Ideological Analysis, <i>Journal of Sociology</i> , 26(1): 107-125.
RA08	Crawford, K. (1998). The Construction of the National Curriculum: An Ideological and Political Analysis, <i>Research Papers in Education</i> , 13(3): 261-276.
RA09	Medvic, S. K. (2007). Old Democrats in New Clothing?: An Ideological Analysis of a Democratic Party Faction, <i>Party Politics</i> , 13(5):587-609.
RA10	Goss, B. M. (2005). "Jeffersonian Poetry": An Ideological Analysis of George F. Will's Editorials (2002–2004), <i>Journalism Studies</i> , 6(4):417-429.
RA11	Kerr, M. (1960). Rashid Rida and Islamic Legal Reform: An Ideological Analysis, <i>The Muslim World</i> , 50(2): 99-108.

³⁹ Focusing on articles related to ideological critique, for this thesis, has a philosophical significance. Any analysis or critique on X's ideology is not to answer what exactly this X is. Instead, it is to understand how X's definition is transformed through time, or how X's interpretation-right is being competed under a certain relationship of power. That is to say, studying the ideology of a certain field could be considered as the study of such research's origin as well as destination. Studying ideology per se could be seen as the foundation of any research.

RA12	Ewick, P. & Silbey, S. S. (1999). Common Knowledge and Ideological Critique: The Significance of Knowing that the 'Haves' Come out Ahead, <i>Law and Society Review</i> 33(4): 1025-1044.
RA13	Garrison, J. L. (1978), Public Assistance in Egypt: An Ideological Analysis , <i>Middle East Journal</i> , 32(3): 279-290.
RA14	Palermo, J. (1977). Reading Asante's Myth of Afrocentricity: An Ideological Critique, <i>Philosophy of Education</i> , 1997: 100-111.
RA15	Apple, Michael W. (1985). Teaching and "Women's Work": A Comparative Historical and Ideological Analysis, <i>Teachers College Record</i> , 86(3): 455-473.
RA16	Ferreira, S. Morais, A. M. & Neves, I. P. (2011). Science Curricula Design: Analysis of Authors' Ideological and Pedagogical Principles, <i>International Studies in Sociology of Education</i> , 21(2): 137-159.
RA17	Weltman, D. (2003). The Pragmatics of Peremptory Assertion: An Ideological Analysis of Word 'Just' in Local Politicians' Denials of Politics, <i>Discourse Society</i> , 14: 349-373.
RA18	Hansen, J. T. (2006). Is the Best Practices Movement Consistent With the Values of the Counseling Profession? A Critical Analysis of Best Practices Ideology, <i>Counseling and Values</i> , 50: 165-160.
RA19	Downes, D. (2010). Harry Potter and the Deathly Hollowness: A Narratological and Ideological Critique of J. K. Rowling's Magical System, <i>International Research in Children's Literature</i> 3(2): 162-175.
RA20	Smith, D. E. (1975). An Analysis of Ideological Structures and how Women are Excluded: Considerations for Academic Women, <i>Canadian Review of Sociology</i> , 12(4): 353-369.
RA21	Weintraub, A. N. (2006). Dangdut Soul: Who are 'the People' in Indonesian Popular Music?, <i>Asian Journal of Communication</i> , 16(4):411-431.
RA22	Haslanger, S. (2007). "But Mom, Crop-Tops Are Cute!" Social Knowledge, Social Structure and Ideology Critique, <i>Philosophical Issues</i> , 17(1): 70-91.
RA23	Barker, P. J., Reynolds, W. & Ward, T. (1995). The Proper Focus of Nursing: A Critique of the Caring Ideology, <i>International Journal of Nursing Studies</i> , 32(4): 386-397.
RA24	Lu, X. (1990). An Ideological/Cultural Analysis of Political Slogans in Communist China. <i>Discourse Society</i> , 10:487-508.
RA25	DeFoster, R. (2010). American Gun Culture, School Shootings, and a "Frontier Mentality": An Ideological Analysis of British Editorial Pages in the Decade After Columbine, <i>Communication, Culture & Critique</i> , 3(4): 466-484.
RA26	Rooney, E. (1984). From Republican Movement to Workers' Party: An Ideological Analysis, In C. Curtin, M. Kelly, & L. O'Dowd, <i>Culture and Ideology in Ireland</i> , pp. 79-98. Galway: Galway University Press.
RA27	Jones, B. G. (2008). The Global Political Economy of Social Crisis: Towards a Critique of the 'Failed State' Ideology. <i>Review of International Political Economy</i> , 15(2): 180-205.
RA28	Talshir, G. (2003). A Threefold Ideological Analysis of Die Grünen: From Ecologized Socialism to Political Liberalism?, <i>Journal of Political Ideologies</i> , 8(2):157-184.
RA29	Ewing, S. (1991). The Russian Social Insurance Movement, 1912-1914: An Ideological Analysis, <i>Slavic Review</i> , 50(4): 914-926.
RA30	Harvey, D. L. & Reed, M. H. (1996). The Culture of Poverty: An Ideological Analysis. <i>Sociological Perspectives</i> , 39(4): 465-495.
RA31	Dilevko, J. (2001). An Ideological Analysis of Digital Reference Service Models. <i>Library Trends</i> , 50(2): 218-244.
RA32	Johnston, K. (1983). A Discourse for All Seasons? An Ideological Analysis of the Schools Commission Reports, 1973 to 1981, <i>The Australian Journal of Education</i> , 27(1): 17-32.
RA33	Gillespie, J. (2002). Transplanted Company Law: An Ideological and Cultural Analysis of Market-Entry in Vietnam, <i>International and Comparative Law Quarterly</i> . 51(3): 641-672.

Research Objectives of Empirical Analysis

In the following four chapters of empirical analysis, two major research objectives are undertaken. Based on the inspiration of the concept, *standardisation*, offered by the Frankfurt School, the first research objective is to examine whether standard procedures (SWPs) for writing academic articles related to ideological analysis/critique exist. If SWPs do exist, it means that there is indeed a rule guiding analysts to write their IAC articles. It further implies that in spite of every effort IAC analysts have made to break through the cage of ideology, eventually they are still prisoners of (their own or social total) ideology. Through such investigation, this thesis might be able to test if humans, even critics specialising in ideology, can be immune from the power of ideology, or to find out what limitation IAC critics have faced.

Of course, showing SWPs does not necessarily show that ideological critique is paradoxical. In fact, those induced commonalities (i.e., SWPs) between diverse IAC articles, from another perspective, also contribute to the second objective of this empirical analysis: to establish a methodology specifically for research studies which adopt an angle of ideological analysis/critique for their analyses. By following such an IAC method, an effective critique on social issues is expectable. Analysts could easily analyse or criticise their research subjects *ideologically*, which might help to generate emancipation in diverse research fields. This methodology focuses more on how ideology works in X or how X reveals a certain ideology rather than directly claiming that X contains/is a (bad/wrong) ideology. This methodology of ideological critique is based on a rigorous theoretical foundation, which will be explained through discussion.

4.3 Methods of Empirical Analysis: Literature and Discourse Analysis

In order to examine whether standard procedures exist for writing IAC articles, two methodologies—literature analysis and discourse analysis—will be adopted.

Literature Analysis

To begin with, literature analysis (or documentary analysis) is a method which begins with collecting literature data, continuing to identify data, and finally to classify and induce findings to achieve an understanding of one research subject (Carey, 2012). The collection

step was introduced in the previous section 4.2. The classified/induced findings (i.e., 6 SWPs) will be explained gradually through the following 4 chapters. The key step, especially to this thesis, is how to *identify* the similarities within the collected literature in order to claim/induce them as procedures of SWPs.

Content analysis in quantitative research calculates data based on accurate key-words. For example, to calculate how many words of ‘articulation’ are used in one article in order to display its reference to, for example, the contribution of ideological hegemony. Gathering statistics from collected IAC articles is also the key method applied in this thesis. Yet, since IAC analysts are from diverse research fields, in adopting different methods to carry out (what they themselves think) the so-called ideological analysis/critique, it is difficult to obtain reliable statistics to reveal the significance of findings. In fact, this thesis has found that many analysts described concepts related to ideology in their discourse without applying those specific terminologies, which are well known/developed in ideology research⁴⁰. This feature implies that if the statistics, which this thesis calculates to reveal the prominent concepts of ideology, are only based on specific ideology-related key-words, then the findings would be questionable.

Hence, what statistics this thesis attempts to gather, to identify the notions applied in the collected IAC articles, are based on three types of qualitative-oriented ‘concepts’: first, the precise usage of terminologies (e.g., articulation), second, the related ideas (e.g., applying a concept analogous to the concept of articulation), and third, the ways of description (e.g., a description which reveals a phenomenon of articulation).

⁴⁰ Research article 01 is a good example that explains how the notion of *articulation* is revealed in the article without using the word articulation or related vocabularies. The authors, Moss and O’Loughlin (2005), analyse how New Labour uses “opinion polls, focus groups, consultations and other social scientific techniques” to articulate concepts of science and establish a public-orientation to establish an epistemological foundation for its information age policy (p. 167). Moss and O’Loughlin argue that New Labour also connects concepts of “globalisation, reflexive modernity, and the information age” to rationalize its policy ideology (pp. 167-168). Moreover, by claiming equality and justice, New Labour is able to link “welfare” to “life politics”, which means that people have to help themselves before asking for government assistance (p. 169). Other examples of dis/re-articulation can be easily found in their writing. All in all, the core argument of this article (which goes through a dis/re-articulation perspective) is that New Labour’s information age policy (the main subject) articulates everything (e.g., knowledge, skills, usage ability), which supports its importance in the information age; at the same time, the government’s social responsibility and duty are disarticulated from the old ideology.

Once a concept (based on the above three types) is repeatedly identified among diverse IAC articles, accumulating to a certain noticeable degree, it will be pre-considered as part of the SWPs. Finally, after a categorising/classifying process based on the similarity between these identified concepts, this thesis finally induces six SWPs.

Discourse Analysis

Although IAC analysts' diverse research backgrounds might lead them to adopt different methods to undertake (what they think) the so-called ideological analysis/critique, all writing is discursive. Analysing their diverse discourses is a way to explore what specific significance is concealed within their writings.

Fairclough (1992a) suggested that a good discourse analysis should comprise three levels: *textual*, *discursive*, and *social practice*. Firstly, the level of textual practice emphasizes the linguistic structure of sentences to examine the most basic and simplest usage of words in the whole context. This is to see the various cognitions and feelings that a different usage of words might bring to readers (Fairclough, 1992a). Textual practice can be seen as the foundation work of making ideology. In this regard, in order to obtain or establish a referencing basis for later practical analysis, this research has reviewed related literature including *semiotic*, *textual*, and *multimodal analysis* which are all notions explaining why the most basic signs, words, structures, icons, colour, and typography are capable of signifying certain connotations (Machin, 2007).

Semiotic concepts will be introduced in Chapter 6, which is considered one of the sub-SWPs. In this thesis, semiotics is more related to an epistemological foundation of understanding how meanings of things are generated instead of being a practical analytical method. In terms of textual analysis, it is to practically examine the usages of verb, tense, punctuation, modal form, etc. in texts to see how meanings change with diverse usages. This thesis has summarised the basic notions of textual analysis as listed in Appendix 4-1 which is the referencing basis of this thesis to analyse IAC articles. The multimodal analysis is less related to this thesis, as all collected IAC articles are words instead of images (except for RA04). Yet, this thesis has summarized its basic notions in Appendix 4-2, which benefits other types of ideological analysis/critique, such as analysing the connotations of images (e.g., newspapers' printed adverts or TVs' dynamic adverts). For that, it is worth involving

every angle of ideological analysis/critique as this thesis attempts to establish a methodology of ideological analysis/critique.

Fairclough's (1992a) second level—discursive practice—is to investigate how texts are written by the author (and understood by readers) to ascertain which particular meanings are signified. To Fairclough (1995), discursive practice is always within a dominating, competing, reconstructing, or re-recognising process between diverse discourses (e.g., other texts read before). That is what he claimed as the process of 'intertextual analysis' suggested to argue against Foucault's notion of discourse (Fairclough, 1992b). He stated that Foucault simplified discourse analysis which focused on the text only. Fairclough argued a good discourse analysis should not only focus on the analysed text *per se*, other discourses outside this text should be considered as well (ibid).

Accordingly, the significance that Fairclough's concept of 'discursive practice' brought to this thesis is that the authority/validation of claiming SWPs cannot be determined based on the finding of single text (IAC article). That is to say, although particular terms, concepts, or ways of description might imply certain connotation in one IAC article, they might refer to nothing in other IAC articles. Therefore, what this thesis should find is the commonalities across most IAC articles which reveal similar logic, carrying certain ideology.

The third level of Fairclough's (1992a) discourse analysis is *social practice*. Although connotation of texts could be detected via diverse research methods such as semiotic or textual analysis (his first level—textual practice), written texts also carry their authors' personal ideology. For this reason, it is important to simultaneously examine how social factors work on texts while undertaking the 'textual practice'. This is the mission of the second level, *discursive practice*, which plays the role of "link" (1998, p. 144) between *textual practice* and *social practice*. To Fairclough, these three levels do not practice independently but interdependently.

This thesis argues that Fairclough's concept *social practice* in fact refers to the concept of ideology. The analysis of 'social practice' is to investigate how the IAC analysts' ideology, as well as social total ideology, influences their written works. For example, in procedure 6, *revealing personal viewpoints*, this thesis investigates IAC analysts' personal background (i.e., social practice) to see how it influences their writings (i.e., textual practice). This mission could be undertaken through the *discourse practice*.

To conclude, literature analysis and discourse analysis are two guiding methods for the coming empirical analysis. The former explains how this thesis induces SWPs (i.e., from collecting literature data, continuing to identify it, and finally to classify and induce findings). In discourse analysis, its first level, *textual practice*, could be seen as the practical method to determine how signs (words) have certain connotation. Yet, the role of *social practice* cannot be ignored because it always influences the making of text from outside. In order to see what certain meanings (textual and social meanings) are signified in texts, *discursive practice* is the mission to be done.

Lastly, as mentioned above, since it is difficult to extract common characteristics and consider them as SWPs just from first time analysis and since one new-found feature in an article does not mean that it necessarily applies to all, for this reason, unceasing re-examination of all collected IAC articles to test one new finding are required in order to obtain a fair final induction. In other words, this thesis could claim a feature as one of the SWPs ONLY after repeated 'finding and proving' processes are done. The mission of this thesis might be achieved only by continually looking for common features and simultaneously unceasingly verifying these new-found-features in all IAC articles. All of which are based on the discipline of literature analysis and the practice of discourse analysis.

For example, not until the examination of research article No. 24 (RA24), did this thesis find the causality of how IAC analysts' background (i.e., Chinese) might influence the way they present (i.e., revealing disgust at the China Communist Party). Due to this new finding, this thesis has had to re-investigate all analysed articles to see if this finding applied to most of the IAC articles, or if such phenomena were applied to RA 24 only. There will always be new features found during analysis, even in repeatedly examined articles. For this reason, unceasingly re-verifying these new found features in all collected IAC articles is important and is the authority that this thesis could claim as one feature (part) of the SWPs.

4.4 Presentation in Empirical Analysis Chapters (5-8)

Framework

This is a study focusing on the entangled relationship between humans and ideology, specifically concentrating on academic critics who work on ideological analysis or critique. Regarding the concept of humans (i.e., intellectuals or ideological critics) and the critiques, this thesis has offered literature reviews of both terms in Chapter 2. With regard to the discussion of ideology theory, this has not been addressed yet. In fact, this thesis will not offer a literature review of ideology in a single chapter. Instead, specific literature reviews of ideology will be presented together with related empirical analysis reports in the same discussion block. That is, although the following chapters 5-8 mainly focus on explaining what SWPs this thesis has found, the corresponding ideology theories will be introduced before explaining these SWPs.

For example, Chapter 6 explains the analytical pathways of ideological critique/analysis (Procedure 2), including Marx's, Althusser's, Gramscian, Semiotic and Historical Descriptive analytical pathways. As shown in Figure 4-1, in each discussion topic (see green box), this thesis first introduces the related ideology theories (see red box), and then provides the empirical reports regarding analysis of 33 IAC articles (see blue box). By such a framework arrangement, this thesis wishes to create a resonance between theoretical understandings and empirical practices.

Figure 4-1: Presentation of Literature and Empirical Analysis

Chapter 6	
Procedure 2: Applying Theoretical Foundation—The Making of Ideology.....	
6.1 Introduction.....	
6.2 Marx's Analytical Pathway.....	→ Discussion Topic
Theoretical Review.....	→ Ideology Literatures Review
Empirical Analysis.....	→ Analysis of IAC Articles
Application of Marx's Analytical Pathway.....	
6.3 Althusser's Analytical Pathway.....	
Theoretical Review.....	
Empirical Analysis.....	
Application of Althusser's Analytical Pathway.....	
6.4 Gramscian Analytical Pathway.....	
Theoretical Review.....	
Empirical Analysis.....	
Examples of Articulation.....	

Examples

Regarding the presentation of the empirical analysis, this thesis will only provide 2 or 3 examples found in IAC articles to explain each procedure (or sub-procedure) of SWPs. This is not only because of the limitation of pages but also to provide unhindered reading. Despite this, all other examples of the same SWPs in all IAC articles will be collated and listed in a reference-table attached at the end of each discussion. Take one reference-table (Table 6-1) from the empirical analysis chapter as an example (see Figure 4-2). This table collects all references/examples regarding all 33 IAC articles which apply concepts of Marx (i.e., Marx's Analytical Pathway in SWPs) to analyse their research. For instance, in Research Article 02, readers can find the application of Marx's concepts on pages 247, 248, 249, and 253 as the blue box in Figure 4-2.

Figure 4-2: How other SWPs Examples can be found in the Reference Table

SWPs Code: P2-M (Marx's Analytical Pathway)	
Articles	Found References/Examples
RA01	p.166(2); p.172(8)
RA02	p.247(3)c; p.248(4)a,b; p.249(5)a,b; p.253(9)c;
RA03	p.143(7);
RA05	p.3(1); p.4(2); p.12(10); p.13(11);
RA06	p.445(1)a,b; p.446(2); p.448(4)a,b; p.450(6)a,b,c; p.456(12); p.457(13)a,b;
RA07	p.107(1); p.108(2)c; p.109(3); p.110(4)c; p.113(7); p.114(8); p.116(10);
RA08	p.261(1)a,b; p.264(4)b,c;
RA10	p.419(3); p.424(8); p.427(11)c;
RA11	p.101(3); p.105(7); p.107(9); p.108(10);
RA12	p.1025(1)a,b; p.1026(2)c; p.1029(5);
RA13	p.287(9)c;
RA14	p.100(1)c,d; p.101(2)c,d; p.102(3)c; p.103(4)a,b,c; p.105(6)c,d; p.106(7);
RA33	p.650(10)b; p.652(12); p.653(13); p.655(15)a,b; p.656(16); p.658(18)b,c; p.661(21)c,d; p.662(22)d; p.670(30)b,c;
Concepts a: Base-structure; b: Super-structure; c: (False)-Consciousness; d: Alienation.	

To further explain the design and function of the reference-table.

- SWPs Code: will be explained in next section.
- Research Articles: are abbreviated as RA, which are followed with numbers to refer to certain articles, e.g., RA07. References of each article are in Table 4-1.
- Found References/Examples: display all other examples related to the SWPs procedure of current discussion. Take RA13 in Figure 4-2 as an example (see red box). 'p.287' refers

to the original journal's/book's page. '(9)' means the document page, which is provided for readers to quickly find the reference in the original IAC articles. All collected IAC articles are sorted in the disk attached as the Appendix 1. 'c' refers to specific concept-code of the discussion topic; it varies from one topic to another. For instance, in this example (Marx's Pathway case), 'c' refers to Marx's concept of 'false consciousness'. In Althusser's pathway case (see Chapter 6, Table 6-3), 'c' refers to the concept of 'interpellation'. Differences in each concept-code are provided at the bottom of each reference-table (see green box in Figure 4-2).

SWPs Codes and How they are Presented in IAC Articles.

In order to accurately record analysis findings, as well as to create a clear referencing system, this thesis has generated what it refers to as 'SWPs Codes' to undertake this task. Every SWPs Code refers to a particular (sub-)procedure of SWPs, (or say, each (sub-)procedure possesses its own SWPs Code). These codes are simply the abbreviation of the SWPs' name. For example, in the previous Figure 4-2, the SWPs Code is 'P2-M' which is the abbreviation of 'Procedure 2: Applying Theoretical Foundations—Marx's Analytical Pathway'.

During the process of analysis, once any part (e.g., words, sentences, or, paragraphs) of writings in 33 IAC articles are considered as referring to a specific (sub-)procedure of SWPs, a corresponding 'SWPs Code' will be marked alongside the detected parts of writing in that IAC article, as per the blue box in Figure 4-3.

Figure 4-3: SWPs Codes Marked in IAC Articles

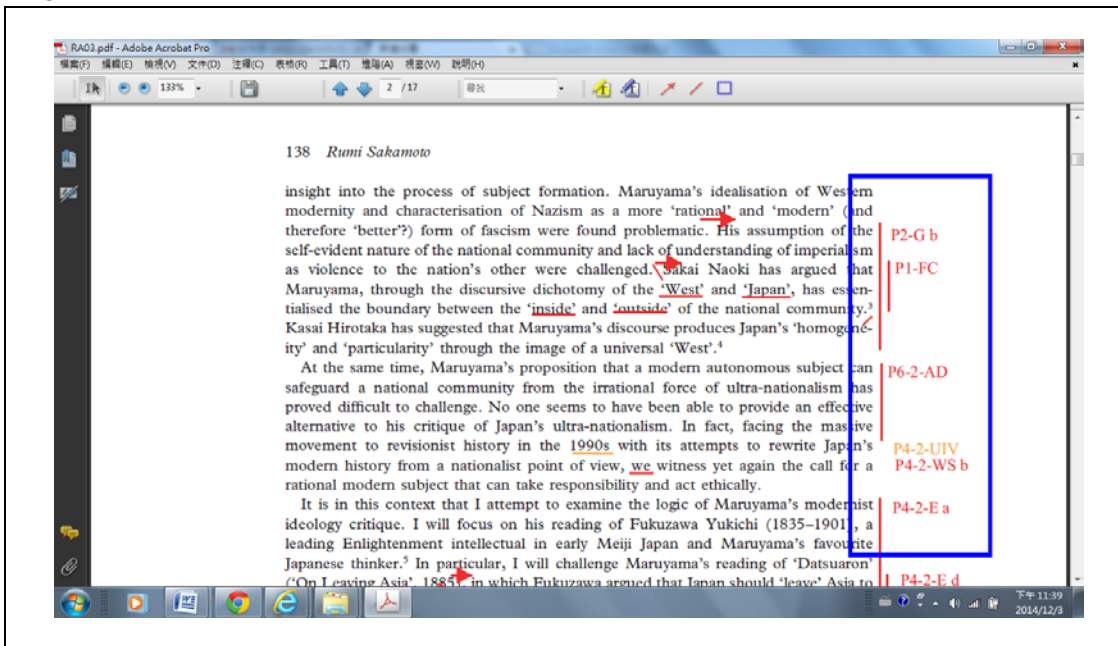

Additionally, all SWPs Codes created for this thesis are listed as the following Table 4-2. This table provides a map of all found/induced/established procedures of SWPs thus far. In this table, 'Content Index' is added, which indicates the part, section, and chapter to which the discussion refers.

Table 4-2: SWPs Codes and Content Index of SWPs

Procedure of		Key Points/Sub-steps		SWPs Codes	Index	
1	Identifying Essential Elements	Finding the Classes		P1-FC	5.2	
		Involving Power		P1-PR	5.3	
		Presenting the Reality		P1-IP	5.5	
2	Appropriating a Theoretical Foundation	Marx's Analytical Pathway		P2-M	6.2	
		Althusser's Analytical Pathway		P2-A	6.3	
		Gramscian Analytical Pathway		P2-G	6.4	
		Pathway of Historical Description		P2-HD	6.6	
		Semiotic Analytical Pathway		P2-S	6.7	
3	Connoting Certain Meanings			P3-C	7.2	
4	Illustrating (Articulating and Interpellating)	1 via Thoroughly Understanding the History or Literature		Finding the Similarities	P4-1-FS	7.5
				Using References	P4-1-UR	7.5
		2 through Specific Presenting Techniques		Transferring	P4-2-T	7.6
				Direct Statement	P4-2-DS	7.6
				Writing Skills	P4-2-WS	7.6
				Explaining	P4-2-E	7.6
5	Selecting Expression Styles	Purely Descriptive Style		P5-PDS	8.2	
		Interpretative Style		P5-IS	8.2	
		Defensive and Corrective Style		P5-DCS	8.2	
6	Revealing Personal Viewpoints	1 via Declaring a Standpoint		Optimism	P6-1-P	8.6
				Pessimism	P6-1-O	8.6
		2 through the Narrating Traits		Title Selection	P6-2-TS	8.7
				Asking Questions	P6-2-AQ	8.7
				Personal Background	P6-2-PB	8.7
				Assertive Declaration	P6-2-AD	8.7

How to Match SWPs Codes Within IAC Articles (How to Use the Disk)

This thesis usually offers 2 to 3 examples in each discussion of SWPs. Other related examples/references are collated and listed in the ‘reference tables’ which are the channels to find further examples in all IAC articles stored in the disk (Appendix 1). All analysis tracks of each IAC article were recorded by using ‘SWPs Codes’.

Supposed readers wish to see how RA05 applies Marx’s analytical pathway (SWPs Code is P2-M) aside from the example that this thesis has displayed in the main text. RA05 can be found on the disk (Appendix 1).

The following Figure 4-4 shows the connection between the reference table, *P2-M*, and IAC article, *RA05* (see red box). The reference table of *P2-M* shows that readers can find the application of Marx’s concepts (see green box) on page 4 (see blue box). ‘(2)’ means the document page (see yellow box).

Figure 4-4: Connection Between Reference Table and IAC Articles

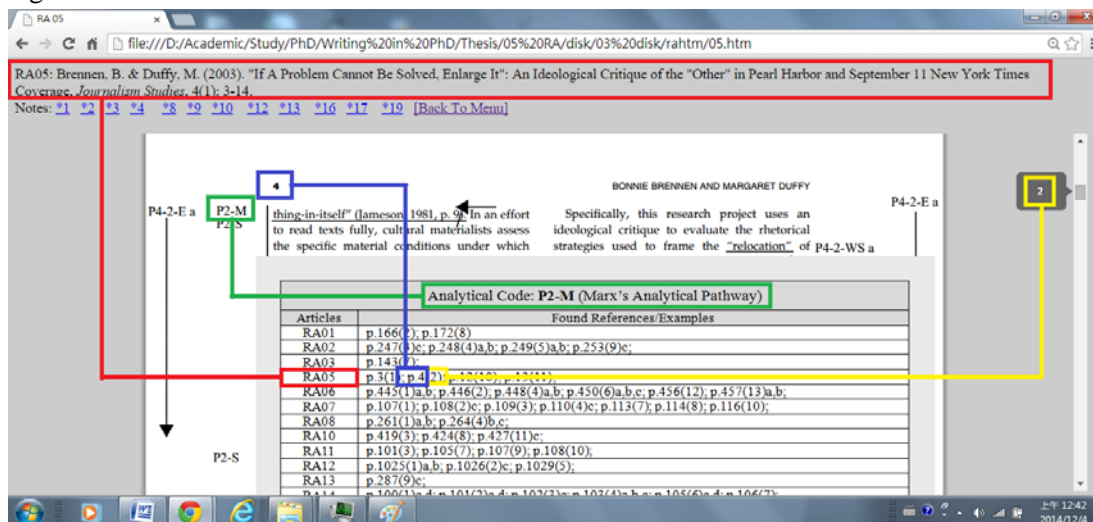

Moreover, the ‘arrowhead sign’ marked in IAC articles means the beginning of one SWP (see Figure 4-5). For example, in Figure 4-5, the arrowhead sign in the blue box means that procedure *P2-S* of the SWPs begins from this line. Similarly, in the green box, procedure *P4-1-FS(MC)*, starts from the line where the arrowhead sign is.

Where an asterisk is combined with a number, such as *1 in the red box on the right means that this thesis also provides extra explanation for the reasons why this sentence/paragraph is considered to possess such a characteristic. Only by clicking the

hyperlinked asterisk (the red box on the top left), will a note box with an explanation appear (middle red box), as in Figure 4-5.

Figure 4-5: Reference of Arrowhead and Asterisk Signs (Note Box)

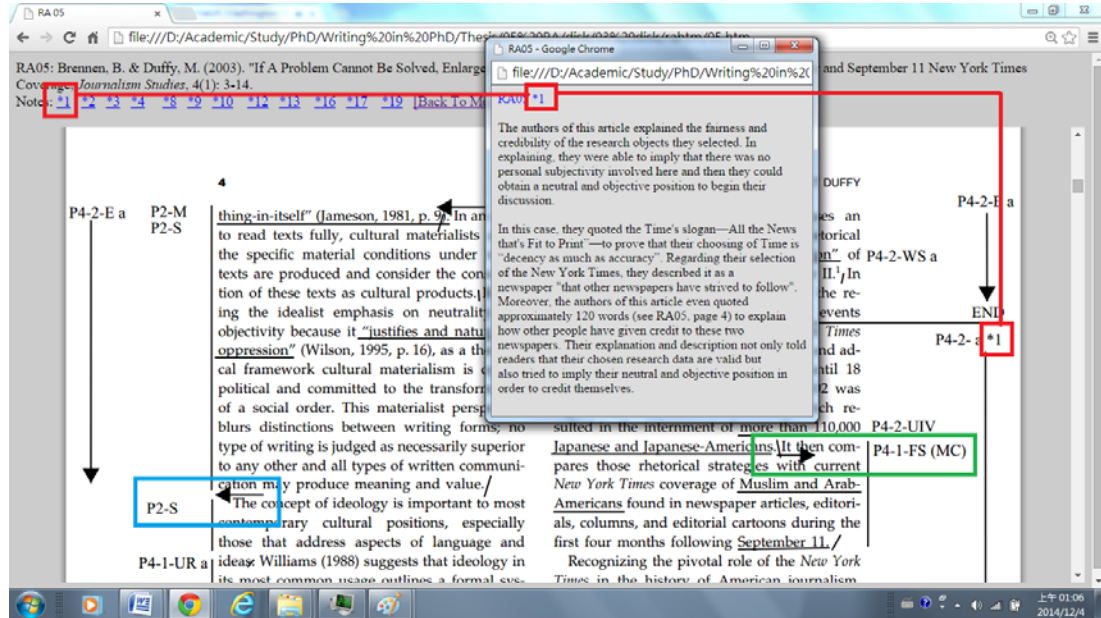

4.5 Conclusion

This chapter introduces the methodology specifically for later empirical analysis chapters (5-8). It has explained how research data (i.e., 33 IAC articles) were collected and the two research objectives of empirical analysis (i.e., examining the existence of SWPs and establishing a methodology for ideological critique). Literature and discourse analysis are two methods underpinning the empirical analysis. The former explains how this thesis induces SWPs (i.e., from collecting literature data, continuing to identify it, and finally to classify and induce findings). The latter adopts Fairclough's three dimensions of discourse analysis (i.e., textual, discursive, social practice) guiding this thesis to examine the relationship among IAC analysts, their works, and outside social ideology. Finally, how this thesis presents research outcomes was also introduced in this chapter.

Section of Empirical Analysis (Chapters 5-8)

Introduction

—Standard Writing Procedures of Ideological Critique

In Chapter 2, this thesis introduced two subjects—*intellectual* and *ideological critique*. It argues that intellectuals are the few people who are capable of working on ideological critique. Whilst, in Chapter 3, this thesis adopted three arguments in relation to the culture industry—the phenomenon of compulsion (invisible controls), commodification, and standardisation as offered by the Frankfurt School—to examine whether scholars' works (particularly ideology-critics') are being industrialized (especially focusing on the standardisation of their IAC works).

Yet, this argument does not mean that standardisation is bad. Showing standard procedures for writing IAC articles does not necessarily show that ideological critique is paradoxical. In fact, if the standard procedure for writing IAC articles exist, effective critiques could be made easily which might also help to generate emancipation in diverse research fields. What concerns this thesis is that if standardisation indeed happens to academic publications, especially works related to ideology, it means there is a guiding principle for scholars to follow; the undeniable fact is that such a principle inevitably results from either their own or social total ideology. Since an analysis or critique is based on ones' ideology to argue against others', from where might critics acquire the authority to claim that 'my argument is right'?

In order to verify this assumed academic phenomenon of standardisation and investigate the capacity of ideological critics to escape the shackles of ideology, the following empirical analysis (chapters 5-8) will test whether a similar formation of discourse (i.e., the *standard writing procedure*) exists for analysts from different fields to write articles related to ideological critique/analysis. To determine or to establish/conclude such *standard*

writing procedures is to demonstrate the question discussed in later chapters: Can ideology-specialists (human beings) be immune from the influence of ideology? Or, what factors limit ideological critics' capacity to undertake ideological critiques?

Although this thesis has distinguished the concept of ideological critique from general critique in Chapter 2, such discussion is based on a broad meaning of ideology. A clear and systematic discussion of ideology theories is still missing. Hence, findings of empirical analysis and its related ideology theories will be presented together in the following chapters. In so doing, the aim is not only to provide a link between *theory* and *practice*, but more importantly, the aspiration to classify the current predicament of ideology research.

According to Abercrombie *et al.* (2006), there are three types of dimension to the concept of ideology: first, specific kinds of beliefs, e.g., communism, capitalism, socialism; second, a distorted or false belief; and third, a set of beliefs (which has nothing to do with true or false) which is in cooperation with the construction of consciousness under the manipulation of power in a certain social condition (e.g., humans' belief in one social movement).

However, not everyone is aware of the above distinctions applying the term *ideology*. In fact, the problem of understanding ideology is the problem of epistemology. People usually neglect what they indeed refer to when they talk about ideology. Do they refer to the essence of the term ideology? Do they refer to the process of making an ideology? Do they mean the influence of ideology? Do they simply indicate 'specific kinds of beliefs', such as capitalism (i.e., the first type)? Do they try to reveal the false ideology that certain groups force people to believe (i.e., the second type)? Or, do they try to illustrate 'a set of beliefs' such as the belief in a student movement (i.e., the third type)?

Since people remain lost in diverse epistemology regarding ideology perspectives, the term ideology is lost in the process of definition and recognition. Words like 'ideology' and 'ideological' often only retain the negative or obscure meanings (Purvis & Hunt, 1993). Ideology-related words all become 'adjectives' for purposes of emphasis; they are merely part of the vocabularies that users or readers mention or read without paying any attention⁴¹.

⁴¹ Of course, here, it mainly refers to those academicians who are not specialized in ideology study. To them, the word *ideology* is applied for the purpose of 'emphasis' which usually goes with the negative characteristic of ideology. Please refer to later discussion in this Chapter.

In brief, words related to ideology are used as ornamentation. Most readers, even academic scholars, care little about how ideology works or how it affects other matters; they have no thought for the significance of ideology. Yet, surprisingly, terminologies, such as alienation, dominant ideology, material existence, articulation, interpellation, relation of production, RSAs/ISAs, hegemony, false consciousness, reification or labour, have been applied through discussions related to topics of ideology. These terms resulted from diverse epistemological angles regarding ideology's characteristics, but they have become entangled in diverse ideology discourses.

For this predicament of ideology research, a new map of understanding ideology will be suggested. This is also the reason why the literature of ideology theory has not yet been introduced. The related literature of ideology will be introduced and discussed together with corresponding empirical analysis results in order to map a clear structure of ideology. Accordingly, this thesis distinguishes the question 'what is ideology?' into two perspectives: the nature of ideology and the making of ideology. Understanding the nature of ideology is the first procedure of the six SWPs for writing IAC articles. Regarding the making of ideology, this will be explained throughout the discussion in the other five procedures. It is further divided into two dimensions: Ideology concealed in texts and ideology embedded in analysts. These six standard writing procedures are listed below. A map showing detailed concepts of these procedures is drawn as Figure 5-1.

Procedure 1: identifying essential elements—the nature of ideology (Chapter 5);

Procedure 2: applying theoretical foundations—the making of ideology (Chapter 6);

Procedure 3: connoting certain meanings—ideology concealed in texts (Chapter 7);

Procedure 4: illustrating—ideology concealed in texts (Chapter 7);

Procedure 5: selecting expression styles—ideology embedded in analysts (Chapter 8);

Procedure 6: revealing personal viewpoints—ideology embedded in analysts (Chapter 8).

Figure 5-1: Standard Writing Procedures

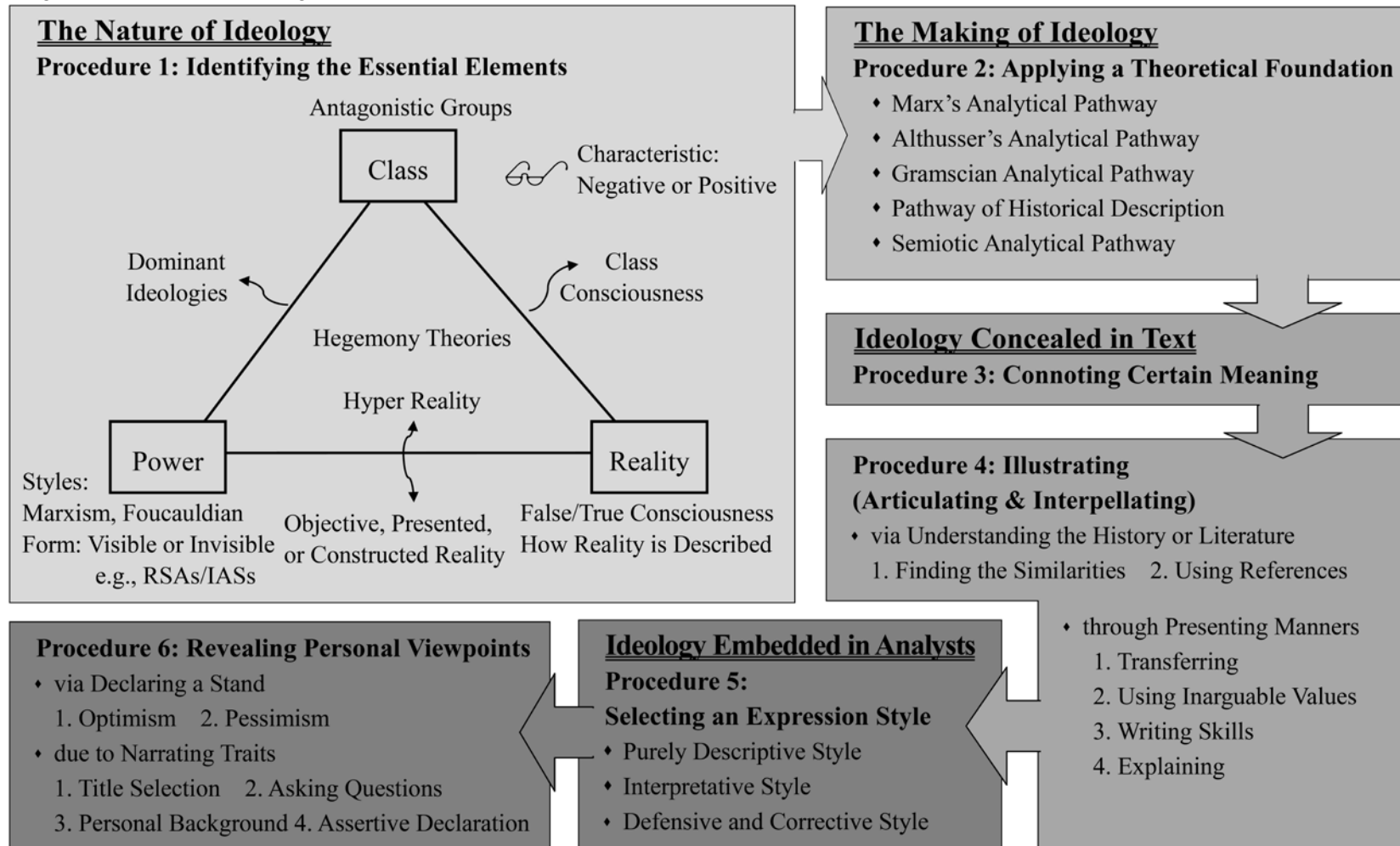

Chapter 5

Procedure 1: Identifying Essential Elements

—The Nature of Ideology

5.1. Introduction

The first of the six procedures is to *identify essential elements*, or the procedure to understand the nature of ideology. This thesis argues that ideology is a term about relations which contains three elements: Class, power, and reality. Here, the term *Class* has been redefined/reinterpreted by this thesis and will be explained in a later section. Simply put, the first procedure (identifying essential elements) is to confirm 1) which research subjects IAC analysts are concerned with (i.e., Class); 2) what the presumed phenomenon is which invites the analysts' motivation (i.e., Reality); and 3) how this phenomenon is presented/constructed (i.e., Power). These three elements form the initial motivation of analysts and, most importantly, determine their presumed standpoints which have affected their eventual conclusion, even though the analysts might reach that through different analysis/critique methods.

The relationship between Class, reality, and power as well as their interaction, resulting in creating various terminologies, are displayed as Figure 5-2. Individual elements and the relationships between them will be theoretically discussed and accompanied with the empirical analysis results. However, before this thesis advances to the first procedure, some of Marx's fundamental concepts should be introduced for a better understanding of ideology in later discussion, especially to explain why this thesis redefines the term *Class* to replace *class* (which is argued not to suit all ideology-related discussions), thereby considering Class as the essential element of ideology.

Marx's Fundamental Concepts for Understanding Ideology

Labour has been a critical factor in the making of humans' history. Lukacs (1971) argued that the construction of social existence is not about evolution but labour, which also

distinguishes the difference between mankind and animals. Labour refers to the way people arrange their activities for maintaining their lives in human society. It also refers to how people transform their efforts so that they might exchange these for other necessities. To Marx (1976), whenever humans enter into exchanges with the world, they try to remain independent and subjective, but not subject to others. Marx defined the labouring process as a process of objectification through which humans can manifest their real abilities and demonstrate their free will. In other words, labour is an extension of the existence of the human species' being (Suchting, 1983).

Figure 5-2: The Nature of Ideology

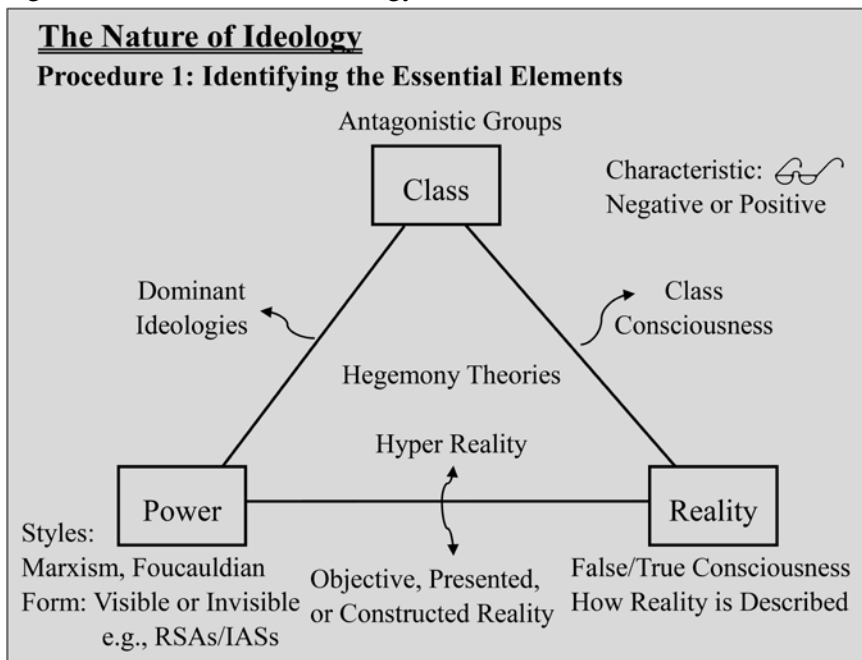

Nevertheless, since the invasion of the logic of capitalism, humans no longer work for the sake of accomplishing their own volition. The logic of capitalism implies an important notion: the division of labour. In order to maximise the efficiency of production and profits, capitalists divide the production process into several specific units. Marx quoted from Ferguson to describe this phenomenon: “Manufacturers, accordingly, prosper most where the mind is least consulted, and where the workshop may ... be considered as an engine, the parts of which are men” (1976, p. 397). That is to say, professional skills needed in the past are no longer required under the logic of capitalism, meaning that workers are replaceable and, as Marx explained, workers are paid by capitalists not for their labour but their labour-power.

Accordingly, labour means that humans develop natural materials from one form to another (e.g., from wood to chairs). This can be defined as including two types of labour practice. In the first, workers use tools to create what they need. It is a process of objectification in which humans are able to distinguish themselves from their creations. It also means that nature is something humans could appropriate and transform to the form of what they need. In so doing, humans display their ability and free will.

Yet, the key point is the second type. In the second, capitalists use workers' labour-power to produce products; thus, workers themselves become tools and are alienated. Simply put, humans not only materialize/reify the nature; they are also alienated by themselves, as Marx and Engels (1970) said,

As long, therefore, as activity is not voluntarily, but naturally, divided, man's own deed becomes an alien power opposed to him, which enslaves him instead of being controlled by him. (p.53)

Hence, when the 'relation of production' of capitalism impacts on humans' free will, people are alienated. Originally, the products (results of labour) that humans make should be part of their will; a product should be identified with the person who produces it. However, under the logic of the division of labour, the relationship between products and producers changed. As Eagleton (1991) pointed out, "In certain social conditions, Marx argues, human powers, products and processes escape from the control of human subjects and come to assume an apparently autonomous existence"(p. 70). That is, the condition of alienation occurs because the link between humans' will and their work has disappeared. There are four types of alienation that humankind suffers: People are alienated from 1) themselves,⁴² 2) the results of their labour,⁴³ 3) the production process,⁴⁴ and 4) other people⁴⁵ (Marx, 1970).

Thus, the result of the division of labour is that "the *devaluation* of the world of men is in direct proportion to the *increasing value* of the world of things" (Marx, 1970, p107; emphasis original). This asymmetric and paradoxical subject-object relationship produces

⁴² Being replaceable workers, their personal values are neglected, let alone their being able to pursue the honour of achievement.

⁴³ The results (products) of a person's labour belong to capitalists; whereas, for example, people might hope to accumulate the fruits of their labour for themselves by old age.

⁴⁴ Workers are no longer important to capitalists because they are only a single part of the whole production process. They are replaceable.

⁴⁵ Due to the division of labour, the relationship among workers is never again cooperative but competitive.

alienated, estranged human beings who switch their position from the subject to the object as they are objectified by capitalism.

Another critical logic of capitalism is the means of production. This comprises two interrelated notions: the material forces of production and the relations of production (Marx, 1971). The former refers to visible equipment (e.g., machines) and invisible technology (e.g., 'know-how') of production; the latter comprises the necessary rules during the process of production. For instance, a workplace may have a rule directing workers to work twelve hours a day and six days a week if they want to retain their job; there may also be a rule requiring a salary deduction if workers request an absence. These rules, which imply the invisible power to maintain the relationship between the dominant and the dominated groups in order to make everything run smoothly, are the relations of production.

However, to Marx (1971), the condition of the means of production is not stable. This is because when time elapses, the development of the material force of production will eventually influence the change in the relations of production. The key point is that, to Marx, the relations of production representing the "economic structure of society, the real foundation" (p. 21) will influence the political structure, at a conscious level. That is to say, the unstable conditions within the means of production, together with the economic determination to political structure (existence of conditions), causes an inevitable struggle and revolution. Marx continued: "At a certain stage of development, the material productive forces of society come into conflict with the existing relations of production" (p. 22).

Namely, from explaining why humans need labour (via discovering the phenomena of division of labour and alienation) to demonstrating the dominant logic of the relations of production, Marx's analysis of the political economy has not only explained the operation of capitalism, but, most importantly, also explored the fact that human consciousness could be influenced by a certain group who possess the means of production. All the aforementioned notions unintentionally contribute to Marx's concept of ideology. Simultaneously, the concept of ideology in turn also testifies the rationality of his political economic findings.

Marx's notions, discussed above, are the foundational concepts to understand his ideological perspective. These concepts could also be explained through this thesis's

angle—Class/class⁴⁶, power, and reality.

First, Marx's concept of ideology contains an implication: the existence of diverse classes. In *The Eighteenth Brumaire of Louis Bonaparte*, Marx (1963) said,

Upon the different forms of property, upon the social conditions of existence, rises an entire superstructure of distinct and peculiarly formed sentiments, illusions, modes of thought and views of life (p. 47).

This quotation indicates that different means of production and diverse social conditions of existence will construct various material conditions of people resulting in different groups of thought. Accordingly, classes' (groups') distinction is a component concept to understanding ideology.

Second, Marx's discussion of objectification, the division of labour, and alienation also display his position regarding the characteristic of ideology, that is, whether it is a false consciousness. This point explains that ideology is a term about the representation of reality—humans' consciousness toward their existence and not just their existence⁴⁷.

Finally, although there is no particular writing in Marx's works which describes the concept of power as other scholars, like Foucault, did, the notion of power indeed suffuses Marx's works. His discussions, for example, of how capitalists exploited workers, how the economic structure influenced the upper political and conscious structure, and how workers were alienated due to capitalism, have all shown the track of power manipulation.

The above discussion explains Marx's concepts through this thesis own dimension. A more detailed explanation will be provided in this chapter, with the aim of explaining why identifying these three elements (Class, reality, and power) and their relationship are the primary works that have to be undertaken before IAC analysts start their analysis. In the empirical analysis chapters, ideology-related literature will be discussed first. Following the above theoretical reviews are the empirical analysis results which are based on an analysis of

⁴⁶ What has to be explained is that the angle of class so far still remains Marx's regime. Even if the statement—ideology is composed of three elements (class, power, and reality)—suggested by this thesis could be accepted, it could only explain Marx's ideology concept. In order to establish a concept which could be applied to any discussion related to ideology, the concept of class should be redefined (which is the task of the next section). Thus, an uppercase Class is adopted to distinguish this thesis' definition of Class from Marx's notion of class.

⁴⁷ This thesis in the conclusion Chapter 11 argues, Humans are only able to recognise the 'analyzable' or 'visible' part of ideology; but they will never ever detect any peace of the 'invisible' as well as the 'ontological' part of ideology. Hence, there is always some other social existence that humans can never perceive.

33 IAC articles. In so doing, this thesis wishes to create a resonance between theoretical understandings and empirical practices.

5.2 Finding the Classes

Finding the class/Class is the first mission of the procedure *Identifying Essential Elements* in understanding the nature of ideology. To begin, this section will introduce Marx's notion of class (due to the term *class per se* representing many basic concepts of ideology), and then continue to explain why this thesis has to revise and reinterpret the understanding of (Marx's) *class* as (this thesis's uppercased) *Class* in order to establish a new dimension which could be applied to all ideology discussions.

Theoretical Review and Extension

In *The Communist Manifesto*, Marx and Engels (2009) declared, "The history of all hitherto existing society is the history of class struggles" (p. 5). They explained that diverse classes are divided across every period of human life, such that classes replace, compete, and struggle against other classes. It is a historical regulation. The following emergence of the bourgeoisie did not solve the tendency to struggle among classes but only simplified it and categorized mankind into two classes: the bourgeoisie and the proletariat (Marx & Engels, 2009). Although the concept of class has a great importance in his works, Marx did not offer class with a systematic notion. Why bourgeoisie and proletariat? What was the relationship between the two that Marx wanted to tell us⁴⁸? Hence, the following discussion will be based on a few perspectives as it attempts to answer Marx's notion of class as well as explaining why this thesis retains the term Class.

First, class refers to the ways in which people make their living. When Marx (2009) described the construction of society in capitalism, he distinguished six groups: landlords, capitalist, wage labourers, petty bourgeoisie, the professional classes and the *lumpenproletariat* (see also Parekh, 1982). The relationship between each group is flexible,

⁴⁸ Discussion began from explaining Marx's concept of class does not mean that all ideological critique are following Marxist in form, even though this thesis keeps the usage of the term 'Class' which might cause readers to think so. This is what this thesis will suggest later: to take Marx's ideas, e.g., class, as a method. Marx's class is an angle to understand the characteristic of ideology. That is why this thesis has to revise the term class as uppercased Class in order to apply to all perspectives of ideological critique which will be discussed right away.

so that sometimes they share common interests, identify with other groups, and occasionally even change from one group to another. It is also possible that one group may vanish entirely. Besides, Marx also adopted another investigative angle separating people simply into bourgeoisie and proletarian classes. This angle is based on the ‘economic conditions of existence’. Marx emphasized that the classification has nothing to do with the “‘identity’ of the ‘source’ of income” but with the way people make their living⁴⁹ (Parekh, 1982, p. 22). Namely, simply adopting the economic angle to distinguish classes is problematic because location of classes is easily shifted, and Marx knew this very well. To Marx, the standard of distinguishing classes has to consider the ways that people make their living, which is also the most distinct difference between the bourgeoisie and proletarian (instead of the economic determinism that the *Second International* misled; Lukacs, 1971).

Second, class distinction results from the division of labour. In the *Economic and Philosophical Manuscripts of 1844*, Marx (1970) sorted people into property owners and property-less workers which investigated the phenomenon of estranged labour. As discussed above, the condition of alienation is cursed by the division of labour in which workers lose the link between the outcomes of their labour, themselves, production process, and others. Since workers sell their calculable labour-power to capitalists, they are depreciated as the cheapest products. Workers (their labour-power) can be traded between capitalists while the latter accumulate their capital, which benefits from the surplus value of products, by exploiting the former (Marx, 1970). Moreover, Marx and Engels (1970), in the *German Ideology*, also used a similar description. They wrote,

[...] the classes, already determined by the division of labour, which in every such mass of men separate out, and of which one dominates all the others. (p. 53-4)

In short, the division of labour, which results from the logic of capitalism, results in the division of classes. It is more because after the division of labour, humans’ labour-power became tradable, which also caused the division of classes: the class to buy and the class to sell.

⁴⁹ The economic conditions of existence means the way people obtain their social status and carry out relationships with others—how they should perform, act and respond. This is an angle to decide which class they belong to. For example, the income of office secretaries differs extensively from that of university professors, but they are categorized into the same class. It is the labouring style that decides their class status but not their income.

The third perspective is the possession of private property. In the *German Ideology*, Marx and Engels (1970) clearly discussed how diverse forms of division of labour influenced the possession of private property in different epochs. In the age before capitalism (including the primitive age, slavery, and feudal social system), the division of labour was inaccurate and the development of the material forces of production lagged behind the development of the ownership of property. At that time, the ownership of property belongs to tribal (primitive), ancient communal and state (slavery), and feudal or estate (feudal). The distinction of classes during these epochs was still unclear (Marx & Engels, 1970).

Although it was possible to see capitalists in feudal society, their social role was still dominated by the nobility (Marx & Engels, 2009). Yet, as the material force of production developed and evolved, capitalists (who occupied the means of production) accumulated capital by exploiting the workers (who were not only alienated by division of labour but also excluded from ownership of means of production and private property). That is, capital accumulation helped capitalists to increasingly possess more private property (which also invisibly promoted their political influence⁵⁰) to distinguish themselves from those who had less private property. Although Marx (Marx & Engels, 1970) also admitted the existence of the petty bourgeoisie and a small peasant class, in his view, the private property of these negligible classes would eventually be exterminated through the industrial development. These classes would eventually be subsumed into the proletariat.

Marx was considered to simplify diverse classes into two, the bourgeoisie and proletariat, which has been widely criticised (Lukacs, 1971; Gramsci, 1971). Critics argue that his (ideology) study only focused on the angle of class thus rendering it inadequate for analysing other topics in complex contemporary societies (Freedman, 2006). For instance, feminists argue that the class perspective is unable to explain the social position of gender⁵¹.

⁵⁰ In early capitalism society (manufacturing period), they are the pillars of states. In modern capitalism society, Marx named them the committee of a country to describe their power within the political region (Marx & Engels, 2009).

⁵¹ But, this criticism is unfair to Marx and perhaps not useful for understanding the notion of ideology. First, critics usually reverse cause and effect. It is agreed that Marx stood firm on the position of classes, especially the proletariat's point of view, to criticise capitalism (Parekh, 1982). Critics ignore that Marx agreed the capability of proletariat *after* he investigated the political economy of his epoch. He started from studying the origins of commodities in order to analyse its value/surplus-value. With an understanding of the alienation phenomenon, which is generated from a division of labour, he

Nevertheless, as this thesis has tried to delineate Marx's notion regarding class (through his discussion of the economic conditions of existence, the division of labour, and private property), it seems that Marx's discourses on class have implied a demonstrative logic: whenever Marx talked about class, his logic always tries to convince us that there exists **an invisible competing and unbalanced relationship between groups** (despite talking about six classes, roles of division of labour, or ownership of private property).

Drawing on Marx's discussion of class, it is possible to claim that Marx never tried to distinguish classes. This thesis argues that what Marx wanted to suggest regarding the social diverse classes is the competing relationship for interests between the 'haves' and 'have-nots'.

In fact, in the *Eighteenth Brumaire of Louis Bonaparte*, Marx (1963) did try to define what he meant by *proletarian class*. His words implied what this thesis has proposed—the concept of class refers to a competing relationship. He said,

Insofar as millions of families live under conditions of existence that separate their mode of life, their interests, and their culture from those of the other classes, and put them in hostile opposition to the latter, they form a class (p. 124).

To Marx (1963), the same conditions of existence, interests, and culture identity of a group (which thus holds a different position from another group) could shape a class. In other words, it cannot be a class if there is “no community, no national bond, and no political organisation among them” (p. 124). To a great extent, to Marx, recognizing the ‘difference’ and even holding ‘a hostile opposition’ to the other groups are necessary reasons in concretizing a class. His words also implied that what people should focus on is the

provided an analysis of commodity fetishism to explain the irrational human activities in capitalism. Namely, he did not first set up a presupposition of a class angle and then receive a conclusion of alienated condition of workers. Instead, he detected the alienated condition among human beings (e.g., workers) first, and then tracked back to find out that such a condition resulted from the unbalanced power relationship between two groups of people. Second, critics usually neglect historical factors. Marx's (1971) explanation or contribution of ideology is based on his study of political economy in which he focused on questions of “capital, landed property, wage-labour, the State, foreign trade, world market” (p.20). As a result, the angle of class—classified by the bourgeoisie and the proletariat—is what Marx *concluded after* his extensive studies as well as the notion of class struggle being the possible solution that he found. The historical background determines his focus on dimension of class instead of gender and racial issues, which, frankly speaking, were not the main social issues in his epoch. Nevertheless, critics usually possess a narrow eyesight on recognition of class (e.g., capitalists/workers), gender (male/female), or race (e.g., white/black). They neglected that all these subjects share the same characteristic in any ideology discussion. This is the major work of this chapter which will be left to the main context.

relationship (of political struggle) between two classes, rather than simply asking those sluggish definitional questions⁵².

One more argument requires discussion before concluding why Marx's concept of class has led this thesis to claim that 'Class' is one of three critical components of ideology. That is, to consider Marx's ideas as a method.

Lukacs (1971) defended what is real Marxism, or in his words, the Orthodox Marxism.

He explained,

Orthodox Marxism, therefore, does not imply the uncritical acceptance of the results of Marx's investigations. It is not the 'belief' in this or that thesis, nor the exegesis of a 'sacred' book. On the contrary, orthodox refers exclusively to method. It is the scientific conviction that dialectical materialism is the road to truth and that its methods can be developed, expanded and deepened only along the lines laid down by its founders. (p. 1)

Lukacs' words suggest that the real contribution of Marx's ideas should be seen as a method. If Marx's concept of class could be considered as an angle to observe society (instead of being limited to his political economic study), then this 'class concept' should never simply be understood as a term which is distinguished by the economic differences or by the ownership of means of production. Instead, the concept of class should lead analysts to detect the constant argumentative logic that Marx revealed in his different writings, that is, a (competing) relationship between diverse groups (which is what exactly this thesis stands for regarding Marx's concept of class).

Accordingly, there is a need to redefine and reinterpret the concept of class. In order to distinguish this thesis' angle from Marx's angle, uppercased Class is used. The difference between class and Class is: while the lowercased class signifies a distinction between bourgeoisie/capitalists and proletarian/workers (usually criticised as inadequate for analysing other social topics, e.g., gender differences, regarding ideology research), the uppercased *Class* is suggested to refer to a **competing relationship between diverse groups** (which is expected to apply to any discussion related to ideology).

⁵² Questions such as: What is the bourgeoisie? How do we define the proletarian class? And, to which class does the petty-bourgeois belong?

How and why this notion of Class could be applied to all ideology research? An explanation of its characteristic is needed. This thesis argues:

1. Any analysis regarding ideology contains a set of inter-definitional Classes. They are the *Primary Class* and the *Secondary Class*. Such a distinction (i.e., primary and secondary) is based on the semiotic notion of ‘binary opposition’ which will be introduced in Chapter 6. Simply put, how humans recognize a thing is never from the thing *per se* but from the *meaning of the thing*. What a thing means could only be understood through what this thing does *not* mean. For example, the meaning of justice could only be understood through what is *not* justice.
2. Primary Class here refers to the *main research subject* while Secondary Class means its *opposite/compared subject*. Yet, the latter might not always appear (or cannot be discovered); it depends on the angle of power (see discussion in section 5.4 *Class & Power*) or the ‘expression styles’ of IAC analysts (see discussion in Chapter 8).
3. The perspective of power which the analysts of ideology research adopt will determine how they present the relationship between Primary and Secondary Class.
 - 3-1. The relationship between the Primary and Secondary Class could be to compete for power, interests, or interpretation rights. The equation could be presented as:

$$\text{The Primary Class} \left\{ \begin{array}{l} \text{dominates} \\ \text{resists} \\ \text{negotiates with} \end{array} \right. \text{the Secondary Class.}$$

Not all the Primary Class in any researched phenomena are on the powerful side, some are described as the powerless image. Thus, the resistant and negotiating condition exists.

- 3-2. While the perspective of power plays a marginal role in an analysis, this kind of analysis usually *purely describes* the Primary Class wherein the Secondary Class seems to be absent. Yet, according to semiotics, the way of

understanding the Primary Class still relies on concepts of the ‘non-Primary’ Class—that is, the invisible and opposite Secondary Class⁵³.

It could be argued that, according to the concept of Class described above, adopting words such as ‘subject’ or ‘group’ instead of ‘Class’ could still have exactly the same meaning (e.g., the Primary Group instead of the Primary Class). The word *Class* could be easily confused with Marx’s *class*. The reasons for retaining this term are: first, it is Marx who uncovered and *conceptualized* the injustice relationship in human societies. Since Marx’s concepts of ideology were developed from the investigation of the unbalanced relationship between dominant and dominated classes, there is no need to create additional terminology which might lose the original motive of investigating ideology—that is, to investigate the political struggle between classes.

Second, the word class itself contains a critical meaning that incorporates discriminating and fighting characteristics—i.e., competing—which could be seen as the cause of the birth of ideology. Hence, as with explanation offered above, there is a fourth reinterpretation to the concept of Class:

4. The term Class in this thesis refers to diverse, competing relationships, including dominating, negotiating, compromising, and resisting relationships. Only when the concept of Class is seen as a relationship between diverse groups (instead of simply referring to the capitalists/labour or the bourgeoisie/proletarian), could it apply to any ideology discussion. For example, while it is in the feminist discussion, the Class relationship refers to the female Class and the male Class. While the discussion goes further to investigate the racial ideology within one gender, for example, female, the Class means the ideological competition between the white female Class and other different ethnic backgrounds female Class. As a result, all research regarding ideology could be analysed through the angle of Class only if a (competing) relationship within such research could be discovered.

⁵³ For example, RA28 explains how the ideology of Die Grünen (The German Green Party) shifts from ecologized socialism to political liberalism. Die Grünen is the Primary Class in this case. Even this article does not compare Die Grünen with other parties, the invisible concept of ‘what Die Grünen is not’ is still embedded in the analyst’s (or readers’) cognition. This is why the ‘shift from ecologized socialism to political liberalism’ means significance to this analyst.

Empirical Analysis

In the previous part of the literature review, Marx’s notion of class has been extended as (competing) relationships between two groups (e.g., male/female, eastern/western, white/black, party 1/party 2, etc.). Such a (competing) relationship has been found in this thesis’ research data (i.e., 33 IAC articles) listed as Table 5-1. Again, the Primary Class means the main research subject while the Secondary Class refers to the opposite/compared subject in the 33 IAC articles (whether the Secondary Class appears/is described depends on the degree of power that the IAC analysts apply). Discourse battlefield means the topic of articles wherein the Primary (and Secondary) Class acts to fight or construct their ideological leadership

Table 5-1: Classes and their Discourse Battlefield

RA	Classes Relationship		Discourse Battlefield
	Primary Class	Secondary Class	
01	New Labour Party’s technology policy	Definition of citizen’s responsibility toward society (concealed Secondary Class)	New Labour Party’s technology policy
02	Otherized South Asian Muslims	Western World, British	Media, British press
03	Maruyama Masao’s ideas (of Japanese Fascism, Asia)	Fukuzawa Yukichi’s ideas (of Japanese Fascism, Asia), authors’ own ideas	Masao’s and Yukichi’s Articles
04	Ideology of Modern dieting	Fad dieting	Media, TV Advertisements
05	Otherized Japanese-Americans and Muslim and Arab-Americans	The definition of a(n) (real) American Citizen	Media, U.S. press: New York Times & Times
06	A sport player/worker	Professional sport team/owner	Media, Seattle sports writers
07	Nursing education system	Hospital education system	Medical discourse in: 1. Formal government inquiry: Submission; 2. Informal print media.
08	New Right ideology: fears of a 'sense of loss'	The fundamental principle of conservatism	1. Documentation (e.g., The National Curriculum 5-16); 2. Interview 17 people serving in HMI, NCC.
	Traditional subject-based curriculum	Academic curriculum	
09	New Democrat ideology	Democrat Party philosophy	ADA, National Journal & DW-NOMINATE Scores (p. 588)
10	George F. Will’s right-wing meta-ideology	The <i>reality</i> that an IAC Article’s author suggests (concealed Secondary Class)	196 of Will’s editorials
11	Idea of reformer, Rashid Rida	Idea of conservative (concealed Secondary Class)	Islamic Legal Reform,
12	The “Haves” People who understand law	The “Have nots” People who don’t understand law	Whether the “Haves” come out ahead

Procedure 1: Identifying Essential Elements

13	Public Assistance Law under New Regime	Public Assistance Law under Old Regime	Meaning of Public Assistant
14	Concept of Afrocentricity in Curriculum	Non- Afrocentricity concept (concealed Secondary Class)	Educational Curriculum Model
15	Female teachers	Male teachers	School curricula
16	Four Authors' Ideologies on Science Curricula Design		Trend and Ideology of Science Curricular Contexts
	Personal ideological principle	Social pedagogical principle	
17	Usage of the word 'Just' on Denials	Without Using (conceal Secondary Class)	Social Impression toward Local Politicians' Denials of Politics
18	Ideology of Holding Value of 'Best Practice'	Value of Traditional Practice	Value of the Counselling Profession
19	Rowling's Magical System	Absurd Narrative	Logic of Narrative
20	Female Scholars	Male Scholars	Right and Position in Academia
21	What real Dangdut music means	What Dangdut music represents in contemporary	Meaning of "the people" in Dangdut music
22	The diverse perspectives of seeing crop-top between daughters' viewpoints		How meaning of a thing is defined.
		Parents' viewpoints	
23	Ideology of "new caring" created by medical discourse	Original meaning of "caring"	Meaning of "caring"
24	The Chinese Communist Party's diverse political slogans at different times.	Compared with Author's attitude toward these slogans (concealed Secondary Class)	People's ideology shift
25	How British see American Gun Culture	Usually compared to author's ideology of American Gun Culture (concealed)	British Editorial Pages and author's own opinions
26	Ireland Republican Movement	Corresponding historical background (concealed Secondary Class)	The ideology shift (e.g., from a physical force organisation to a socialist party)
27	Perspective suggested by the western country and academic	Perspective regarding related (post-)colonial, cold war history	The definition of failed state. (take Somalia as example)
28	The political ideology shift within Die Grünen Party.		based on investigation of their Basic Programme in 1980 and 2002
	Old/new ideology	New/old ideology	
29	Bolshevik/Menshevik's faction policy position	Menshevik /Bolshevik's faction policy position	Russian Social Insurances Movement
30	Other scholars' (mis-)understanding of "Subculture of Poverty"	Author's (correct) understanding of such a notion	Oscar Lewis' notion of "Subculture of Poverty"
31	Digital reference service models, e.g., de-professionalization	(Traditional) reference service, e.g., professionalization	What is good to reference work
32	Official discourse about education in every report	Reports in other years (as comparison)	Schools Commission Reports, especially on educational equality and participation topics
33	Borrowed company law, Vietnam elites legislator, government	Application of law Vietnam executor, local council	Theory and practice of company law

Table 5-1 offers a holistic view of the Primary and Secondary Class in 33 IAC articles. Other texts/references which display related discussion of (sub-)Primary (and Secondary) Class are listed in Table 5-2.

Table 5-2: Finding the Classes

SWPs Code: PI-FC (Finding the Class)	
Articles	Found References/Examples
RA02	p.246(2); p.248(4); p.249(5); p.250(6); p.251(7); p.254(10);
RA03	p.138(2); p.140(4); p.142(6); p.143(7); p.144(8); p.145(9); p.146(10); p.147(11); p.148(12); p.149(13); p.150(14); p.151(15);
RA04	p.338(5); p.350(17);
RA05	p.6(4); p.12(10);
RA06	p.446(2); p.450(6); p.456(12); p.457(13);
RA07	p.107(1); p.109(3); p.110(4); p.111(5); p.112(6); p.113(7); p.114(8); p.115(9); p.116(10); p.119(13);
RA08	p.261(1); p.263(3); p.264(4); p.265(5); p.270(10); p.271(11); p.272(12);
RA09	p.588(2); p.592(6); p.593(7);
RA10	p.418(2); p.420(4); p.421(5); p.423(7); p.424(8); p.425(9); p.427(11);
RA11	p.99(1); p.100(2); p.105(7);
RA12	p.1025(1); p.1026(2); p.1029(5); p.1039(15);
RA14	p.104(5);
RA15	p.455(1); p.456(2); p.457(3); p.464(10); p.466(12); p.467(13); p.469(15);
RA16	p.138(2); p.145(9); p.147(11); p.151(15);
RA20	p.355(3); p.356(4); p.362(10); p.363(11); p.364(12); p.365(13); p.367(15);
RA21	p.413(3); p.414(4); p.415(5); p.416(6); p.417(7); p.422(12); p.423(13); p.425(15); p.426(16);
RA22	p.70(1); p.72(3); p.73(4); p.74(5); p.75(6); p.88(19);
RA23	p.387(2); p.390(5); p.395(10);
RA24	p.488(2); p.494(8); p.495(9); p.496(10); p.497(11); p.498(12);
RA25	p.468(3); p.472(7); p.474(9);
RA26	p.89(11); p.91(13); p.94(16); p.95(17);
RA27	p.182(3); p.190(11); p.191(12); p.192(13); p.193(14); p.194(15); p.195(16); p.197(18);
RA28	p.161(5); p.162(6); p.169(13); p.180(24);
RA29	p.921(8);
RA30	p.468(4); p.469(5); p.474(10); p.478(14); p.488(24); p.489(25);
RA31	p.219(2); p.223(6); p.230(13); p.231(14); p.232(15); p.234(17);
RA32	p.17(1); p.21(5); p.24(8);
RA33	p.643(3); p.644(4); p.648(8); p.650(10); p.653(13); p.654(14); p.655(15);

To conclude, finding the Classes is one of three tasks to be done in the procedure of identifying essential elements. It is to distinguish the research’s main subject (i.e., the Primary Class) and its corresponding opposite identifiable or unidentifiable subjects (i.e., the Secondary Classes) as well as recognizing the competing relationship (including dominating, negotiating, compromising, and resisting styles) between these two subjects before analysts start their analysis. This is similar to the necessity film directors have in confirming their main actor/actress and other supporting roles (e.g., actress/actor, villains, etc.) before filming begins.

5.3 Involving Power

In the previous section, this thesis re-defines Class (with uppercase capital letter) as a concept which refers to competing relationships between two (or more) groups that hold diverse opinions to strive for limited interests/resources. Such re-definition shares a logical similarity with Adam Schaff's (1976) perspective. Schaff's logic is that modern society is constructed of two classes, the "revolutionary" class and the "conservative" class (Schaff, 1976, p. 246). The former refers to a class which is in a 'rising' trend, fighting for its rights; while the latter is the class, which is in a 'falling' trend, trying to maintain its dominant advantages. This rising and falling status of classes echoes this thesis's perspective of Class, that is, a competing relationship.

People used to think that this 'rising' and 'falling' relationship was only present in modern capitalist societies, regarding it as a positional shift of class due to economic factors. However, such a way of thinking may be doubtful, with the line from the film *Enemy at the Gate* (Annaud, 2001) stimulating a reflection. It says,

Man will always be a man. There is no new man. We tried so hard to create a society that was equal, where there'd be nothing to envy your neighbour. But there's always something to envy. A smile, a friendship, something you don't have and want to appropriate. In this world, even a Soviet one, there will always be rich and poor. Rich in gifts, poor in gifts. Rich in love, poor in love.

This story line explains that even in a society without class distinction (i.e., Marx's angle), there always exist the differences of Classes (i.e., the angle of this thesis) such as innate gifts or love relationships. Human activities inevitably lead to the categories of the 'haves' and 'have-nots'. Whether to agree with Marx's angle of (economically differentiated) classes⁵⁴ or accepting this thesis' angle of (competing) Classes, it is always the factor of power which creates the differences between the haves and the have-nots everywhere. The term *Class* refers to nothing if there is no *power* working inside. Similarly, the existence of *power* is founded on the interaction of *Classes*. Power cannot be found, analysed, and criticised if there are no Classes competing against one another.

⁵⁴ Of course, this thesis here simply presents how most people think about Marx's angle of class. In fact, Marx's distinction of class is more focusing on the ownership of the means of production.

Theoretical Review

Perspective of Power Study

Hay (2002) noted that researchers are usually confused with whether the discussion of power *per se* is related to an analytical perspective or a critical one. In the North American and British academies, scholars adopt qualitative methods, trying to measure the existence of power. A simple equation could be drawn: If X is influenced by Y or Y directly controls X and this can be shown, then there is evidence of power. Based on the complexity of the design, the degree of power could even be measured as well. Researchers have tried many ways to analyse power: its existence, its function, or its influence. This could be seen as studying power from an analytical perspective.

The contradiction is: even if all criteria show that Y indeed directly influences X, does X really suffer from Y's power *as the analysts discover/think?* For example, people in North Korea believe that they are the happiest human beings in the world (Demick, 2010), yet people who live elsewhere and examine this country, might consider North Koreans to be suffering under a dictatorship. This example shows: the process of analysing a case is simultaneously the process whereby analysts are making a judgement. As Lukes (1974, 2005) argues, to measure power or to claim one has power over others is a judgement made by personal value. Such a judgement reveals the analysts' critical perspective while analysts consider themselves as possessing an analytical perspective to analyse their research subjects. Simply put, the discussion of power is always displayed within a process of seemingly neutral analysis which, conversely, will inevitably convey a personal critical judgement.⁵⁵

How Does Power Operate?

Facing this entanglement of 'analytical' and 'critical' perspectives, pretending to possess a neutral and objective position to analyse power is nonsense. It is the same as if this thesis

⁵⁵ The mixed analytical and critical perspectives usually cause the word, power, to be recognized as a derogatory term, becoming an ethical evaluation. Hay (2002) tries to redefine power, attempting to establish an angle of power analysis without personal judgement. He argues that an angle of "context-shaping" (p. 185) is the kernel of the power discussion which shares the same demonstrative logic when he adopts the strategic-relational approach to deal with the structure-agency debate. The discussion of power not only focuses on how A influences B; but, how B reacts and what change to the context where A and B together situate are important as well. He simply defines power as 'the ability of actors to "have an effect" upon the context which defines the range of possibilities of others' (p. 186). For more discussion of power, please refer to Hay (2002) Chapter 5 or Lukes (1974, 2005).

were to claim to offer a neutral and objective discussion on ideological critique which indeed would be hypocritical. In fact, to Lukes (1974, 2005), being able to identify the power operation *per se* is the mission of critique, even if revealing analysts' subjectivity is unavoidable.

The study of power mainly focuses on power's nature, how power operation is identified, or how power operates. Regarding discussion on the nature of power, this can be found in Lukes' (1974, 2005) works and several of Foucault's (1980, 1991b, 1998) publications, although it is not this section's topic. This section focuses on how the operation of power is identified (how power operates) in the dimension of making ideology. The angles of Marxism (especially Marx, Gramsci, and Althusser) and Foucauldians will be offered.

The operation of power is unidirectional and straightforward in Marx's and Althusser's concepts of ideology. From their perspectives, to explain the operation of power is to illustrate how one class dominates another class. Thus, power is repressively possessed by a class named 'bourgeoisie' which is incapable of anything but exploiting the 'proletarian' class. Although Gramsci did not emphasize the capacity of resistance as much as Foucault did, the power relation, in his perspective, is fluctuating which is reflected in his hegemony theory. If Marx's and Althusser's notion of power is inflexible and monopolized by a certain group, then, drawing on Gramsci's (1971) hegemony theory, power does not only belong to a single group; instead, it is something that all groups could fight for the leadership in order to create their own hegemony.

Yet, if to compare Gramsci with Foucault further, the latter contains an even more flexible attitude regarding the concept of power. Foucault held a notion of power opposite to that found in Marxism⁵⁶ (Hunt & Wickham, 1994). To Foucault (1990), power is a "multiplicity of force relations" (p. 92). It is a process comprised of continuing negotiation, competition, and transformation, a support in which diverse power forces link together, and a strategy that is the reflection of social hegemony. Power cannot be possessed by specific groups because it is not a zero-sum game; instead, it is exercised immediately and anywhere (Foucault, 1980, 1991a, 2002). Hence, to Foucault, power is not only generated from the

⁵⁶ Foucault's opposite position to that of Marxism, despite using the word 'ideology', should be considered with the social background Foucault himself lived in, where Marxism was part of the mainstream ideas of the time.

centre to the periphery, from the dominant to the oppressed class; in fact, the reverse is possible as well.

Although traditional Marxists and Foucauldians hold different perspectives of power, there are still some similarities regarding the concept of power in their discussions. First, both groups believe that power is a critical element that influences the way people sense society. Next and more importantly, both groups have explained how power functions. Power possesses a capacity to help the dominant groups maintain their vested interests by forcing people to obey certain rules or influencing people's way of thinking. The more power operates, the more the vested social order is confirmed which could generally be categorized into two modes: the visible and the invisible.

Althusser (1971) divided society into two steering states units, the "Repressive State Apparatus" (RSAs) and the "Ideological State Apparatus" (ISAs). The former includes not only "the police, the courts, the prison; but also the army" (p. 137); namely, it contains control units that "function by violence" (p. 143). The latter is comprised of the media, religious organisations, family, the educational system, etc.; namely, it controls society via peaceful methods, through daily activities. That is to say, the former represents a *visible* armed strength to keep human society in order; while the latter changes and influences people's minds unobtrusively and imperceptibly. Altogether, these components constitute a society's value system. Compared to Althusser, Gramsci (1971) divided society into two levels: "political society" and "civil society" (p. 12). The former is similar to Althusser's RSAs, meaning a visible and violent power; the latter comes close to ISAs, that is, an invisible ideological power. Accordingly, it is reasonable to say that RSAs operate in the political society while ISAs work on the civil society.

As discussed above, Althusser's notion of power is unidirectional and straightforward. Whether ISA or RSA, to Althusser, they are all operated from the dominant to the oppressed side. On the contrary, Gramsci's notion of power is much more flexible and negotiable (albeit not as much as Foucault's). To Gramsci, although violent power is required for controlling a state, it is not enough. A government cannot always force people to accept policies by using armed force; instead, Gramsci (1971) suggested that the ruling class must develop "consent" (or, to use another term, the "intellectual and moral leadership", p. 57),

which is identified by the majority of citizens⁵⁷.

The differences between the visible and invisible styles could also be found in Foucault's discussion. By using a diachronic perspective, Foucault (1980) separated the types of power into 'juridico-discursive' power and modern power. The former is executed in political bodies, by states with a repressive position; while the latter is performed in societies with a productive perspective. Although Foucault's division here was not as subtle as Althusser's or Gramsci's, his complete theory of power, in fact, is a theory about how visible power transfers to invisible power⁵⁸. For example, as Foucault (1991a) quoted from Servan: "A stupid despot may constrain his slaves with iron chains; but a true politician binds them even more strongly by the chain of their own ideas" (pp.102-103).

Of course, Gramsci's notion of power is not as flexible as Foucault's. It could even be claimed that Foucault's discussion of power simultaneously admits the existence of resistance. Foucault (1978) argues, "Where there is power, there is resistance" (p. 95). He argued,

Resistances do not derive from a few heterogeneous principles; but neither are they a lure or a promise that is of necessity betrayed. They are the odd term in relations of power; they are inscribed in the latter as an irreducible opposite. (p. 96)

Drawing on Foucault, it could be said that power and resistance share the same logic of

⁵⁷ Gramsci (1971) goes further in that he distinguishes between organic ideology and arbitrary ideology within the whole of power ideology. Organic ideology represents the material interests for vested, systemic groups (e.g., his example, the religious group); arbitrary ideology, meanwhile, is the unconscious power exerted in daily life, which will combine the former's material interests, and finally contribute to the formation of structuralized, systematized mechanisms such as educational systems.

⁵⁸ It is no doubt that Foucault's efforts focused on the discussion of 'power' rather than ideology. This thesis here simply includes his basic concepts of power to explain how ideology might operate (in Foucault's dimension). Although Foucault rejected using the term *ideology*, it seems that there is no cognitive difference to understanding his argumentation on 'power' even if the term *power* embedded in his articles were to be replaced by the term *ideology*. For example, his discussion of discipline and punishment which began from the visible style of power, e.g., ways of physical punishment, to his focuses on features of invisible power (e.g., concepts of juridico-discursive power or capillary movement) indeed is an explanation of how ideology disciplines the behaviour and cognition of prisoners. Although the term *ideology* was not invented by Marx, the discussion of ideology was greatly associated with Marx's related concepts. As a result, the term *ideology* was usually understood through the angle of determined, dominated relation, or false consciousness. At least, such ways of understanding the concept of ideology could be seen as the 'dominated ideology' in Foucault's time. Accordingly, it is reasonable to argue that, to a great degree, Foucault's rejecting the term *ideology* might simply because that he did not want to follow the common customs to use the term *ideology*. Foucault adopted the term *discourse* instead of *ideology* while discussing concepts of power and it has been argued that there is no difference between the two terms, *discourse* and *ideology* (e.g., Eagleton, 1991, or Purvis and Hunt, 1993)

expressing/demonstrating their strength. What makes them different depends on *who* applies it: the dominant or the oppressed sides. That is to say, power means that one side attempts to dominate, control, or influence the other side. When the same strength reacts reversely, it is named *resistance* (even though it is still the demonstration of power—the oppressed group's power). If Gramsci claims that the oppressed side still possesses the possibility of fighting for power (or in his words: the 'consent'), then Foucault would say that the power of all competitors is equal.

Hence, all of Althusser's, Gramsci's and Foucault's notions share the same logic: that influence on the human mind is as efficient as torture of the human body (even though Foucault expressed this argumentation without involving the term *ideology*). Their ideas all described the history of humans' appropriating power to maintain dominance as a transformation from visible to invisible power; that is, from armed force to ideological strength, from force to surveillance, or from punishment to self-disciplining.

To conclude, power, as one of three essential elements of ideology, plays the key role to influence how other elements (i.e., Class and reality) and, eventually, how such ideology is seen. The discussion of power is always displayed within a process of seemingly neutral analysis, which will inevitably convey a personal critical judgement. Finally, it is agreed that the invisible operation of power works with much more efficiency on the human mind than applying a visible style.

Empirical Analysis

In the literature section, this thesis has pointed out that the investigation of power is always through a critical perspective (i.e., analysts' own standard) which is covered by an analytical perspective (i.e., analysts think so). There is no denying that this thesis's following analysis (on the power operation regarding 33 IAC articles) is inevitably to be a reflection of my personal judgement. This is an unavoidable dilemma. Yet, identifying the power relationship, although it results from analysts' ideology, is still a way to understand how power operates (as Lukes might agree).

From the 33 IAC articles, this thesis has concluded four styles of power operation/presentation. They are:

Style I: The visible or invisible power possessed by a certain group which directly constructs a reality for the other groups (in order to serve the former group's interests).

This is an angle of power close to Marx's and Althusser's perspective.

Example 5-1: RA06 explains how news media (impeded by a sport team's invisible threat to their future news resources) constructs/presents an image of Joey Galloway as a wayward child, greedy and disloyal by their sport news (in which so-called power works). Such an image demonizing Galloway is to sustain the authority of the sport's team, its coach, and its vested authority.

Example 5-2: RA21, by reviewing history, explains how the definition of Dangdut music has been appropriated by diverse groups to pursue their group interests (e.g., political or economic interests) in which the spirit of Dangdut music—originally representing the real life of people—is reinterpreted by invisible power to serve ideologies of certain groups.

Other examples related to Style I can be found in RA02, RA04, RA05, RA06, RA07, RA10, RA12, RA15, RA18, RA20, RA21, RA23, RA24, and RA25. For a detailed explanation, please refer to Appendix 5-1.

Style II: The operation of power is displayed in a negotiating process between the dominant and oppressed groups. This is a power competition close to Gramsci's angle.

Example 5-3: In RA08, the author suggests that the 1998 National Curriculum is a product of conscious competition and negotiation fought by diverse interest groups. The operation of power is reflected in how individuals and interest groups, who all possess different historical, social, and cultural backgrounds, together participate in the discussion and finally construct the legitimate curriculum knowledge (i.e., The 1998 National Curriculum).

Example 5-4: In RA14, if Asante's notion of *Afrocentricity* tried to evoke black people to fight the interpretation-rights for themselves, then what this article (RA14) tries to argue is that such action of competition for the interpretation-rights is unsuccessful. The author of this article explains more about how power operates in a negotiating mode.

Other examples related to Style II can be found in RA03, RA08, RA13, RA14, RA17, RA26, RA29, and RA32. For a detailed explanation, please refer to Appendix 5-1.

Style III: The oppressed group clarifies the misunderstanding, resists the installed viewpoints, or fights for their interpretation-rights. This is a style of power operation which is close to Foucault's notion of resistance.

Example 5-5: RA11 discusses how Islamic intellectuals internally fight for the interpretation-rights of the reform of Islamic Law. Nevertheless, due to the involvement of religion, these intellectuals' arguments usually become a reform plan influenced by their particular thoughts. This is an article explaining how reformers, the intellectuals, attempt to fight for the interpretation-rights to rethink Islamic Law which is against the original vested ideas (even though they usually fail).

Yet, this thesis discovered there was only one IAC article (RA11) which particularly focuses on the angle of resistance. In fact, most articles which display the angle of resistance usually combine discussion with other styles (e.g., I or II). RA30 is an example which simultaneously adopts Styles I (dominant) and III (resistant).

Example 5-6: RA30 claims that Oscar Lewis' notion of 'subculture of poverty', in the past thirty years, has been misunderstood as a critique on victims of poverty. The author of this article attempts to clarify how such power operates in (or is dominated by) the mainstream academic discourses of the past thirty years. (Style I) By distinguishing the dominated phenomenon, this author also tries to defend and redress such a misunderstanding of Lewis' notion. (Style III)

Other examples related to Style III can be found in RA11, RA27, RA30, RA31, and RA33. For a detailed explanation, please refer to Appendix 5-1.

Style IV: The operation of power does not obviously reveal or apply in IAC articles.

Example 5-7: RA09 does not talk about how power operates or how power constructs reality. The analyst of this article adopts quantitative data (e.g., voting statistics) to show where in the spectrum of political ideology (i.e., liberal, centrist, or conservative) these diverse factions of the Democrats party (i.e., Traditional Democrats, New Democrats, Blue Dogs) are located.

Example 5-8: RA22 devotes pages on *theoretically* discussing the relationship between power and reality, to explain how power constructs reality. Nevertheless, while the author of

this article brings an example into her discussion, she *does not clearly* explain how her research objects—parents and daughters—apply their power or resistance to construct or defend their own value (i.e., whether crop-tops are cute or dorky). Hence, this article only discusses the notion of power theoretically; but, in its provided example, how power works is not explained.

RA09 seems only to discuss the position of political ideologies while RA22 did not explain how power worked. Does this Style IV, where ‘operation of power’ seems not to exist, qualify to be included in what this thesis has termed the ideological critique/analysis? Indeed, **it is** if the **neutral characteristic** of ideology’s nature is considered. Also, as explained in the methodology, Chapter 4, if a methodology of ideological critique/analysis were established, power should only be seen as one of its analysis angles but not all. Section 5.4 will provide further discussion.

Other examples related to Style IV can be found in RA01, RA09, RA16, RA19, RA22, and RA28. For a detailed explanation, please refer to Appendix 5-1.

Appendix 5-1 shows a holistic view to explain what angle of power is applied in 33 IAC articles. Table 5-3 provides the references which show how the notion of power was revealed within IAC analysts’ writings (texts).

Table 5-3: Involving Power

SWPs Code: P1-IP (Involving Power)	
Articles	Found References/Examples
RA01	p.166(2)
RA02	p.245(1); p.248(4); p.249(5); p.250(6); p.251(7); p.253(9); p.254(10);
RA05	p.3(1); p.4(2); p.5(3); p.6(4); p.13(11);
RA06	p.445(1); p.446(2); p.447(3); p.448(4); p.449(5); p.450(6); p.451(7); p.456(12); p.457(13);
RA07	p.107(1); p.108(2); p.109(3); p.110(4); p.111(5); p.114(8); p.115(9); p.116(10); p.117(11); p.118(12); p.119(13); p.122(16);
RA08	p.261(1); p.262(2); p.263(3); p.264(4); p.265(5); p.267(7); p.270(10); p.273(13);
RA10	p.418(2); p.419(3); p.426(10);
RA11	p.100(2); p.102(4); p.103(5); p.104(6);
RA12	p.1025(1); p.1026(2); p.1031(7); p.1032(8); p.1034(10); p.1035(11); p.1036(12); p.1037(13); p.1039(15);
RA13	p.283(5);
RA14	p.100(1); p.101(2); p.103(4); p.106(7);
RA15	p.455(1); p.456(2); p.457(3); p.462(8); p.467(13); p.469(15);
RA16	p.138(2); p.139(3); p.140(4); p.147(11); p.152(16); p.154(18);
RA17	p.353(5); p.358(10);
RA18	p.157(4); p.159(6);
RA20	p.354(2); p.355(3); p.356(4); p.357(5); p.358(6); p.359(7); p.360(8); p.361(9); p.362(10); p.364(12); p.364(12); p.365(13);
RA21	p.412(2); p.413(3); p.415(5); p.416(6); p.417(7); p.418(8); p.421(11); p.423(13); p.426(16); p.427(17);
RA22	p.70(1); p.71(2); p.73(4); p.75(6); p.77(8); p.81(12); p.84(15); p.85(16); p.87(18);
RA23	p.387(2); p.388(3); p.389(4); p.390(5); p.395(10); p.396(11);
RA24	p.487(1); p.488(2); p.489(3); p.490(4); p.492(6); p.493(7); p.494(8); p.497(11); p.503(17); p.504(18);
RA25	p.467(2); p.468(3); p.470(5); p.470-1(5-6); p.471(6); p.474(9); p.478(13); p.480(15);
RA26	p.79(1); p.89-90(11-12); p.91(13); p.92(14); p.93(15); p.94(16);
RA27	p.181(2); p.182(3); p.183(4); p.184(5); p.186(7); p.191(12); p.192(13); p.193(14); p.194(15);

	p.195(16); p.197(18); p.198(19); p.199(20);
RA28	p.161(5); p.171(15); p.179(23);
RA29	p.915(2); p.918(5); p.921(8); p.922(9); p.923(10); p.925(12);
RA30	p.466(2); p.470(6); p.488(24); p.489(25); p.490(26);
RA31	p.232(15); p.240(23);
RA32	p.17(1); p.18(2); p.19(3); p.21(5); p.22(6); p.28(12); p.30(14);
RA33	p.643(3); p.646(6); p.649(9); p.650(10); p.651(11); p.653(13); p.654(14); p.655(15); p.656(16); p.658(18); p.660(20); p.661(21); p.662(22);

5.4 Class and Power—Discussion of Dominant Ideology

Theoretical Review

In *The German Ideology*, Marx (Marx & Engels, 1970) wrote,

The ideas of the ruling class are in every epoch the ruling ideas, i.e. the class which is the ruling material force of society, is at the same time its ruling intellectual force.... The ruling ideas are nothing more than the ideal expression of the dominant material relationships....[T]hey rule as a class and determine the extent and compass of an epoch....[T]hey do this in its whole range... among other things rule also as thinkers, as producers of ideas, and regulate the production and distribution of the ideas of their age. (p. 64)

This quotation presents Marx’s standard statement on capitalist society: what it would be when factors of power and Class are considered simultaneously in the analysis of ideology (i.e., the phenomenon when certain Class applies power to define things). Marx (1957) provided the example of the phenomenon of diverse groups, such as the bourgeoisie, the aristocracy, and the monarchy, competing for power after the collapse of the feudal system—i.e. whoever controls the material relations of production controls the power of interpretation (ideological strength); and, whoever controls the latter controls all. Of course, the proletarian class can generate ideology as well (i.e., Gramsci’s or Foucault’s viewpoint); but, the difference is that the proletarian’s ideological strength is powerless or lacking in relative power. Hence, the history of how the bourgeoisie defeated the feudal system via the logic of capitalism (e.g., division of labour, private property) is the history of how the bourgeoisie increased its ideological strength and created its dominant ideology⁵⁹.

⁵⁹ Dominant ideology here has little to do with Gramsci’s notion of hegemony. Gramsci’s hegemony is considered as a battlefield in which all ideas, voices, and forces are fighting for the power of leadership in order to create consent. Yet, the discussion of dominant ideology is much a concept which follows Marx’s thread of thought. It is a unidirectional power operation which explains more about how certain groups create a common sense to the public. Please also refer to the previous section 5.3 *Power* for more explanation regarding the difference between the concept of dominant ideology and that of hegemony theory.

In addition, Lenin (in Bottomore, 1983) and Lukacs (1971) also shared the same notion: that ideology is the result of the interaction between diverse classes and power (e.g., political expression, pursuit of interests). Lenin held a neutral meaning in respect of the interactive results between power and classes which indicates his neutral attitude regarding the meaning of ideology⁶⁰. He argued that even the proletarian class can have power to create its own ideology (Bottomore, 1983). The difference is that the bourgeoisie has more resources and opportunities to expand its ideology, preferably to create a certain (dominant) ideology which benefits their interests (Larrain, 1988). To Lukacs (1971), the unbalanced ownership of relations of production between two classes creates the reified proletarian class. This reification influences the proletariat's condition of existence and its consciousness (Lukacs (1971). Hence, the dominant ideology is not defined by a villainous scheme from the bourgeoisie, but by the logic of capitalism, in which one is reified while the other benefits from it.⁶¹

The discussion of 'dominant ideology', so far, seems to carry a negative meaning, being displayed as an absolute power (i.e., one side dominates the other). Nevertheless, such recognition of the concept of dominant ideology is controversial. Eagleton's (1991) explanation of how dominant ideology is created might show the reason why.

First, an ideology has to state its system of values and beliefs, meaning that it has to distinguish its basic territory of ideas from others. Secondly, this ideology has to naturalize and universalize its basic ideas, and then this ideology could enlarge its capacity for interpretation. Next, this ideology has to eliminate and exclude other thoughts which are against it. Finally, this ideology has to obscure social reality to create an appropriate environment for itself. Eagleton's suggestion involves several notions, such as mythology, interpellation and articulation, which will be discussed in the following chapters. His

⁶⁰ In ideology literature, there is a discussion which focuses on the characteristic of ideology: whether ideology per se conveys a positive and neutral or a negative and critical characteristic. This discussion will be left to section 5.6 *Reality and Power*.

⁶¹ A dominant ideology could result in diverse effects due to the class/Class/group differences. To the group whose group's interests and consciousness are the same as the dominant ideology of the time, this dominant ideology will help them to carry out what Althusser called "reproduction the relation of production" in order to maintain their dominance (Althusser's notion will be explained in Chapter 6). On the other hand, to those groups whose interests and consciousness collide with this dominant ideology, then the latter become the reason why members of these groups are alienated (in Marx's term) or reified (in Lukacs' term). For the notion of alienation or reification, please refer to section 5.2 *Class*.

suggested process implies two points: dominant ideology is seen to contain a negative meaning, and ideology itself possesses an absolute power.

Yet, in some sense, the above two points are inappropriate. First, not all dominant ideologies are negative. Plamenatz (1970) argued that dominant ideology involves two forms: instruction and indoctrination. Both of these involve transferring ideas from one class to another via communication channels (e.g., teaching, to maintain the social order). The difference is that the latter (i.e., indoctrination) additionally tries to make one class think and act as the other class (usually the dominant one) wants it to do. It causes relations of exploitation or distortion, which are done on purpose. This could be referred to as the negative meaning of dominant ideology. Differently, 'instruction' only guides people to follow the rules which are perceived normally (e.g. following the traffic rules).

Second, because the concept of dominant ideology is usually misrecognised, people tend to consider that ideology itself possesses an absolute power. In other words, people always link ideology to a dominant power when they think of ideology negatively. However, this is not entirely so: not every ideology is related to the dominant power. For example, racialism and feminism are both ideologies, but they are not in a dominant position compared to other ideologies. In fact, different ideologies are not comparable, as Eagleton (1991) described that "*all* ideologies are politically oppositional" (p. 6; emphasis original). Some ideologies, such as capitalism and communism, represent political views; while others, such as the hegemony of Hollywood, refer to a culturally dominant viewpoint; others, such as racialism and feminism, are generated by diverging dimensions of seeing human practice. Thus, not all ideologies possess the dominant power because 'ideology' is a word representing a set of ideas which does not necessarily mean being involved with power competition in order to fight for dominance over others⁶².

⁶² Although this note is not quite relevant to the discussion of this section, the viewpoint of Abercrombie et al. (1978, 1990) regarding the topic of the dominant ideology is worth discussing. The concept of dominant ideology, to them, is more likely to carry a negative characteristic (even though, in many of the cases they studied, they did not discuss the nature of ideology: whether ideology possesses a positive or negative characteristic). Abercrombie et al. (1978, 1990) in their series of "the Dominant Ideologies" claimed that the ruling class suffers the dominant ideology more than the oppressed class. Take their study as an example. In the feudal age, the dominant class was more confined by the rule of the church than the dominated class. Privileged ideas of the church are usually linked within the discourse of intellectuals; the peasants did not fall under this influence because they were "unchurched" (1978, p. 157). Yet, their findings are arguable if the characteristics of one dominant ideology (i.e., positive or negative) is also put into consideration. Of course, the dominant

Not all dominant ideologies have absolute power or possess negative purposes (e.g., control, exploitation, distortion), nor are they created to dominate other groups. For example, the neutral dominant ideology (such as ‘obeying the law is the obligation of citizens’) does not display a negative image to the public (even though, to some extent, such an ideology still invisibly helps certain groups to maintain their interests and dominant status). Hence, in any study on dominant ideologies, whether an ideology is a neutral dominant ideology or one with a negative meaning depends on the specific context in which an ideology is situated.

To conclude, when factors of power and Class are considered simultaneously, diverse ideologies will be evoked, some of which will become the dominant ideology. Not every ideology holds the power to create dominance; and not every dominant ideology possesses a negative meaning. The condition to establish dominance, even one with a negative characteristic, depends on how the elements of ideology—power and Class—interact.

Empirical Analysis

The theoretical review part discussed the concept *dominant ideology* which results from the interaction between Class and power. In this empirical analysis part, findings have shown that some of the 33 IAC articles also reveal evidence of the concept of dominant ideology. Based on the previous theoretical discussion, this thesis will exhibit the critical/negative and neutral/positive examples of dominant ideology respectively.

ideology affects the dominant class more than the oppressed one. One ideology could become the dominant one only when it cooperates with power manipulation. While the dominant class is usually the one who controls the power, the ideology by which they use power to maintain is the ideology that they first believe in. People always use power to maintain what they have already had first, and then to ask for more if possible. If such an ideology makes them dominant, of course, they believe in this ideology more than others. However, as this thesis has explored a neutral characteristic of the concept of dominant ideology, based on this viewpoint, it is reasonable to answer why Abercrombie et al were so surprised at their findings. Their surprise implied that they possessed a negative characteristic viewpoint regarding the concept of dominant ideology. To them, the dominant ideology is a tool controlled by the dominant class; or, the dominant ideology refers to false consciousness which is designed for a purpose. In short, Abercrombie et al. presupposed a negative meaning regarding the concept of ideology which is created by a ruling class for the purposes of dominating another. For this reason, they think the oppressed class should be the one that is influenced the most. In fact, most of the cases they discussed are merely the dominant ideology with a neutral characteristic but not the one which is created on purpose in order to maintain the certain interests of the dominant class. They rarely discussed how power was applied to serve a certain class and their consciousness. Offering discussions of dominant ideology without considering its characteristic and the power operation, they indeed lost in contradictory argumentation.

Style I: dominant ideology with a negative characteristic

Example 5-9: RA04 points out that diet companies, through advertisements, continually construct a certain ideology to their customers. Despite in different periods the purposes of advertisements are diverse (e.g., from fad dieting to healthy dieting adverts), the diet companies constantly imbue the same ideology—dieting is important—which is indeed a dominant ideology to the customers. The diet companies apply visible signs or slogans to spread the invisible unidirectional power to customers. To the author of RA04, customers’ recognition of ‘dieting is important’ carried by the TV advertisements is a negative dominant ideology because it neither sincerely meets customers’ real need nor offers them benefits. Instead, it only contributes to the diet companies’ interests.

Example 5-10: RA27 explains how the West defines a type of country, such as Somalia, as a ‘failed state’ which reveals the dominant ideology of the West. This dominant ideology has resulted from the academic argumentations, news reports as well as imperial and post-colonialism. That is to say, the definition of a failed state is usually the imagination of the West which is often negatively presented. Nevertheless, such an imagination is still the only angle—i.e., the dominant ideology— for the world to evaluate the status of a country.

Other IAC articles which reveal a dominant ideology with a negative characteristic are RA02, RA04, RA06, RA15, and RA27. Please refer to Appendix 5-1.

Style II: dominant ideology with a neutral characteristic

Example 5-11: The author of RA03 argued that because Maruyama Masao was “the most prominent and influential political theorist of postwar Japan”, his illustration toward Fukuzawa Yukichi has become the only way of thinking for the Japanese to understand Fukuzawa Yukichi’s political thought. In short, Masao’s way of understanding Yukichi is the dominant ideology for those who want to study Yukichi. Although the author of RA03 criticised that Masao misunderstood Yukichi’s thoughts, this does not affect the fact that Masao’s way of understanding Yukichi is the dominant ideology for Japanese which has nothing to do with its truth or falsity (it is a misunderstanding only to the author of RA03).

Example 5-12: RA12 adopts an interview method to investigate people who have legal experience in order to answer why people agree with such a (dominant) ideology that ‘the Haves come out ahead’. The interviewees include lawyers, the people who possess legal

knowledge, someone who is capable of hiring lawyers, and the one who is not. Based on their experiences, the author of RA12 answered why ‘the Haves come out ahead’ is the dominant ideology when people think of legal activities.

Other IAC articles which reveal a dominant ideology with a neutral characteristic are RA03, RA07, RA11, RA12, RA18, RA30, and RA31. For a detailed explanation, please refer to Appendix 5-1.

5.5 Presenting the Reality

The reason why human beings work is not only that daily labouring provides a way to demonstrate their free will (or to complete what Marx called the process of objectification⁶³), but also because it is a way to obtain the daily needs that they require for maintaining their lives. If the necessities for everyday life were not necessary, then the daily labouring would also be unnecessary (Parekh, 1982). To Marx, the search for truth does not come about because of the human desire for truth or knowledge, but because, as Parekh (1982) explained, “they are needy beings who must engage in successful material and political praxis in order to satisfy their needs” (pp. 188-189). Namely, demanding their needs is the reason why humans look for truth, even for freedom.

Nevertheless, the way humans sense the truth is varied, or how humans recognize reality is different due to humans’ diverse consciousness. It is humans’ interactions and social practices (including both material and political praxis, i.e., manual or mental labour) as well as the specific backgrounds of an epoch where people are situated that together influence the making of their consciousness. It is individuals’ own consciousness that determines how they consider what is real, the truth, or the reality which also results in constructing (/or is revealed as) different ideologies. Of course, these ideologies in turn will influence humans’ practices and knowledge of a time (i.e., their consciousness), which is the foundation of how they recognize the reality. It is a perpetually circulating movement. As such, to this thesis, the reality is the representation of ideology while ideology simultaneously influences how people recognize the reality.

⁶³ For the concept of objectification, please refer to section 5.1 *Introduction*.

The problem is that humans are unable to determine what their consciousnesses or ideology really is (no one would rationally admit that they possess a false consciousness or are influenced by ideology), not to mention the fact the reality they consider as the truth is always the reflection of a certain ideology. Although the statement of why reality is the representation of ideology *per se* is as obscure and complex as the concept *ideology*, this thesis argues that once the reality of research phenomena *is described*, it is still able to discover one's consciousnesses or ideology. In other words, how humans describe reality is how they invisibly expose their consciousness or ideology. Through the process of understanding how people *describe* reality, humans become able to comprehend how an ideology is created or what ideology it is.

Accordingly, how 33 IAC articles describe the reality of their research will be described in this section. Yet, regarding the topic of reality, a critical debate in the ideology realm must not be overlooked, that is, whether ideology, by nature, is a false consciousness (does ideology *per se* represent a false reality?). Although scholars nowadays tend to agree that ideology has nothing to do with true or false but is just a channel to represent humans' diverse consciousness (McLellan, 1995; Freeden, 2003; Eagleton, 1991; Thompson, 1984; Plamenatz, 1970), it is still worth discussing this 'false consciousness debate' since it is a critical point to understanding the essence of ideology.

Hence, in the theoretical discussion part, this thesis will first focus on the question: is ideology a false consciousness (does ideology represent a false reality)? Following the theoretical discussion, the empirical analysis reports will be provided. Then, how reality is described in IAC articles will be explained.

Theoretical Review—Whether Ideology is a False Consciousness (Does Ideology Represent a False Reality?)

Marx's perspective is usually the kernel of the discussion when arguing whether ideology is a false consciousness. Although later scholars such as McLellan (1995) argued strongly that "Marx never used the expression 'false consciousness'" (p. 16), early discussion of Marx's attitude toward ideology is often equated with false consciousness, for example, Plamenatz (1970) wrote that "Marx often called ideology 'false consciousness'" (p. 23). Why Marx's concept of ideology has been referred to as false consciousness could be explained as having two factors and one catalyst.

Marx's example of correlating humans' living circumstances with a *camera obscura*, which presents an upturned image on the human retina, could be the first factor. This correlation is based on Marx's other concept, the division of labour⁶⁴, in which the humans' labour process is alienated.⁶⁵ When the links between humans' labour and the results of labour disappear, people forget that they are the sovereign of the results of their labour; on the contrary, they are subjected to their creations. The relation is reversed, just like the world seen through the mechanism of the *camera obscura*. Marx's explanations of the commodities fetishism and religion are good examples of the way humans confuse their relationships with what they create. The created products obtain increasingly dominant power and finally surpass their producers.

To Marx, "all thought is socially determined" (cited in Eagleton, 1991, p.89) which could be seen as the second factor. After he investigated civil society via the angle of political economy, Marx (1971) explained how the economic level determines the ideological level, claiming that "it is not the consciousness of men that determines their existence, but their social existence that determines their consciousness" (p. 21). If the economic level can determine the ideological level, as Marx suggested, then whoever controls property at the economic level controls the making of human consciousness. Hence, when property owners look to accumulate their maximum interests, to some extent, information (all idea systems) cannot be truly presented but will work to maintain vested interests—in short, misinterpretations may occur. When the ideological level is determined by the economic level, thoughts will also be determined.

The above two factors might explain why some scholars consider Marx to link ideology with false consciousness. Nevertheless, it is Engels, the catalyst, who was acknowledged as Marx's interpreter after his death, who identified ideology with false consciousness. Engels wrote (in a letter to Franz Mehring),

Ideology is a process accomplished by the so-called thinker consciously, it is true, but with a false consciousness. The real motive forces impelling him unknown to him; otherwise, it simply would not be an ideological process. (Marx & Engels, 1934, p. 511)

⁶⁴ For the concept of the division of labour, please refer to previous section 5.1 *Introduction*.

⁶⁵ Marx pointed out four types of alienation. Please refer to Marx's (1977) *Economic & Philosophical Manuscripts of 1844*. Or section 5.1 *Introduction*.

To Engels, ‘motive forces’ are an invisible power conducting subjects to an unknown condition where false-consciousness occurs. Although humans are involved with manipulating ideas, they do not purposely define an idea with a specific preferred meaning; in fact, they are also unaware of the motive forces. To Engels, the characteristic of false consciousness of ideology refers to two main effects that help to distort and shape reality as well as to sustain the contemporary social order (Festenstein & Kenny, 2005). Marx’s attitude toward reality in the notion of ideology is associated with Engels because the latter somehow compelled readers to understand Marx through his point of view after Marx’s death. If Engels’ innocent misleading⁶⁶ is forgivable, then what Marx’s attitude of ideology was and whether Marx *did* equal ideology with false consciousness or not should be discussed.

First, how Marx related ideology to consciousness is important. In the Preface of *A Contribution of the Critique of Political Economy*, by explaining the transformation and relationship between the economic level (the material relation of production) and the ideological level (including “the legal, political, religious, artistic or philosophic,” Marx, 1971, p. 21), Marx stated the function of the ideological level, “in which men become conscious of this conflict and fight it out” (p. 21). Hence, consciousness is the subject with which the ideological level is concerned, which is influenced by material economic relations. Thus far, the discussion has been about how ideology refers to consciousness, but not to false or true consciousness.

Second, as McLellan (1995) pointed out, Marx’s notion of ideology is so ambiguous that Marx explained it in diverse writings; moreover, Marx did not deal with the ‘true/false dichotomy’ while he was discussing ideology. If Marx once thought that ideology was an

⁶⁶ In fact, such an accusation against Engels is not fair. There is a fact: later scholars usually misquote and misunderstand the original authors. Some scholars quoted from Engels’ letter to Mehring and claimed that Engels considered ideology as false consciousness. Yet, to Larrain (1983), Engels’ whole letter to Mehring, in fact, had described the concept of ideology in a general way. This innocent mistake applies to lots of scholars’ understanding of Marx, without exception. Parekh (1982) argued that Marx’s notion of ideology mainly comes from *The German Ideology* and is mostly quoted from Marx’s careless remarks in that book, from which scholars usually only picked up words and created slogans and so often neglected the whole context that Marx referred to. It happened to Lukacs as well. Larrain (1983, 1988) pointed out that many researchers (e.g., Jones, Poulantzas, Adlam, McDonough and Seliger) who considered Lukacs as holding to the notion that ‘ideology is false-consciousness’, usually bypassed a critical point: They only quoted words from one part of Lukacs’ article and neglected the most important thing: the whole context. Obviously, that later scholar’s words appropriated from others are usually the reason for this false consciousness debate.

illusion, a false-consciousness, it could only be found in his early writing, *The German Ideology*. In Marx's later works, *Capital*, ideology is seen as a result of daily life. Hence, McLellan (1995) concluded that what Marx really cared about was the process of misleading and what specific reasons made people think the way the ruling class wanted them to think. McLellan suggested that, to Marx, ideology might display a distorted consciousness—or ideology is a channel to carry both true and false consciousness—but, its characteristic has nothing to do with true or false.

Third, by investigating how Marx described/used the word 'ideologist', whether he equated ideology to false consciousness becomes clear. To Marx, Hegel and the Young Hegelians, or to use another term 'the Holy Family', are all ideologists (Parekh, 1982). If ideology refers to false consciousness, then ideologists could be seen as the people who create false consciousness. However, the above statement neither conforms to Marx's starting position nor explains why he criticised Hegel and the Young Hegelians. Marx criticised them because they did nothing except create idealism⁶⁷. That is why the sub-title of his book *The Holy Family* (Marx, 1957) is "Critique of Critical Critique". Marx criticised them (the holy family) because their critiques were based on their own thoughts. To Marx, people who create or define things *as such* based on their own thoughts are ideologists, and the things ideologists have created or defined are ideologies. Most importantly, Marx **did not mean** that these ideologists (or their critiques) created a false consciousness (ideology)⁶⁸.

Based on the above three dimensions—first, ideology is a level based upon economics which displays human consciousness; second, ideology is only a channel to carry both true and false consciousness; third, the logical relation with which Marx explained the word ideologist—it is reasonable to claim that, to Marx, ideology has nothing to do with false consciousness.

Other later scholars also provided abundant demonstrations regarding this false consciousness debate. Yet, due to limited pages, this thesis can only offer a brief introduction

⁶⁷ A detailed explanation of Marx's critique on Hegelian idealism, please refer to Chapter 2 (Section 2.3).

⁶⁸ Another way to explain why, to Marx, ideology is not false consciousness may be found in Marx's explanation of the word 'apologist'. Please refer to Parekh's (1982), p. 11ff.

to their ideas. First, according to McLellan (1995), Lukacs usually put the terms of morals, ideology, religion and false consciousness together⁶⁹ (as well as his partial writings⁷⁰) which might imply from his position that ideology is equal to false consciousness. However, Lukacs' heavy focus on the proletariat's serious condition should be taken into consideration. In fact, to Lukacs (1971), not all ideologies are false consciousness. It is not one ideology which places a class consciousness into a false position, but the class condition in which people have already been situated; namely, it is the specific circumstance of classes which leads people to possess a false consciousness, but not ideology⁷¹. As a result, Lukacs (1971) wished to clearly distinguish between true and false consciousness for the proletariat. He believed that the proletariat's false consciousness results from the reification of class consciousness, which is generated from the logic of relations of production, so that capitalism possesses a political and economic advantage over other ideas.

To Lukacs (1971), since proletarians' class consciousness is likely composed of the logic of capitalism, the only thing that matters is: if the proletariat only partly perceives capitalism's logic, then false consciousness occurs. Thus, it is reasonable to say that, to Lukacs, false consciousness is a result of human consciousness when humans face the reification power of capitalism, which has nothing to do with ideology *per se* at all.⁷²

Second, Mannheim (1936) suggested that ideology is presented in both social and psychological forms. His attitude to reality in the notion of ideology can be found in his discussion of the psychological mode, which also refers to his other term, the 'particular

⁶⁹ As Lukacs wrote, "in the class struggle of the past the most varied ideologies, religions, moral and other forms of false consciousness were decisive" (cited in McLellan, 1995, p. 23).

⁷⁰ For example, as Lukacs (1971) wrote "[Consciousness] appears...as something which is *subjectively* justified in the social and historical situation, as something which can and should be understood, i.e. as 'right'. At the same time, *objectively*, it by-passes the essence of the evolution of society and fails to pinpoint it and express it adequately. That is to say, objectively, it appears as a 'false consciousness'" (p. 50).

⁷¹ From this point of view, it is understandable why his concept of *totality* attempts to identify the subject with the object. Please refer to Chapter 9 where this thesis has discussed and compared his and Adorno's concept of *totality*.

⁷² In order to escape from such false consciousness, Lukacs (1971) strongly pointed out the importance of 'totality'. To him, connecting the consciousness with the whole society is the only way to figure out human beings' real feelings and thoughts and to understand in what circumstance these feelings and thoughts are generated. Consequently, perceiving the reified condition and embedded false consciousness is the only way for the proletariat to restore the ownership over its consciousness. Only when the proletariat realises its condition of class-in-itself and conceive the condition of class-for-itself will the revolution and emancipation become possible (the concept of totality will be left to Chapter 9 while dealing with Adorno's concept of totality).

conception of ideology'. In the psychological mode (or in the particular conception), ideology is seen as "conscious distortions, calculated lies, or forms of self-deception" (Freeden, 2003, p. 14)—in short, it is the result of misinterpretation. However, to Mannheim (1936), these distorted ideas are just thought which is created by diverse thinkers who stand for specific positions. The trap of seeing ideology as false consciousness arises from humans' lacking a holistic perspective. Accordingly, why reality is described as false consciousness is not the problem of the discussed issue itself; instead, it is due to interpreters' diverse stances as well as the different epochs in which they are situated. Mannheim concluded the above phenomenon as humans' possessing the dimension of 'relativism'.

Conversely, Mannheim (1936) suggested another notion, 'relationism', to substitute for 'relativism' in order to understand society. To him, what really matters in sensing reality is the 'relation' between interpreter and interpreted objects. From the angle of relationism, researchers will adjust their personal notions within the contemporary social values where evaluating reality is based on the relation between them (interpreters), their position, their research objects, and the "condition of existence and modes of thought" of that time (p. 70). In so doing, the angle of the 'total conception of ideology' will be taken where reality (ideology) will not simply be seen as false consciousness.

Third, Gramsci (1971) disagreed with identifying ideology as false consciousness. His logic of disagreement is closer to Mannheim's than Lukacs' or Marx's. To Gramsci (1971), false consciousness is a political or historical result which only applies to a particular condition and event. A false consciousness is claimed because the observer investigates the situation with his/her fixed thoughts. On the contrary, those people who are being observed might not think the same as the observers do. That is to say, Marx can never explicitly illustrate the consciousness of the proletariat because he was not situated in the same circumstances as the real proletariat class were. The false consciousness of the proletariat class could be just an imaginary figment of these observers' minds, as they come from the bourgeoisie.

Fourth, Althusser (1971) disputed the concept of false consciousness. His attitude of reality in the notion of ideology is that ideology represents humans' imagination of social existence. Drawing on Althusser, reality, as an element of ideology, has nothing to do with

truth or falsehood, but is concerned with the ways of thinking to which people are accustomed. To Althusser (1971), ideology is a ‘system of representations’ or is an intermediary sphere into which subjects pour their consciousness and receive revised consciousness in return, which might be represented as unconscious. The phenomenon of the unconscious should be answered by a concept of imaginary. To Althusser (1971), ideology involves both ‘real lived relation’ and ‘imaginary lived relation’. The former refers to the ‘relation’ between humans and the world in which they act; while the latter focuses on the way such relation is represented. Usually, the former is subsumed by the latter. Namely, the function of ideology is to represent the imaginary relationship of individuals to their real conditions of existence. Although the imaginary relationship seems to refer to the argument of making true or false consciousness, to Althusser, it is not. What Althusser really focused on was never the question of whether ideology is false consciousness or whether humans are able to truly recognize reality, but the question of how people understand the world through the system of ideological representation in which an imaginary relationship is created⁷³ (Althusser, 1971; Eagleton, 1991; Montag, 2003).

Finally, to other ideology discussants, Plamenatz (1970) argued that all consciousness is determined by the process of social construction, so that each consciousness refers to a different ideology separately. False consciousness is simply a part of all kinds of consciousness, which is generated from a specific social condition. Hence, ideology cannot dogmatically be seen as false consciousness. In addition, Žižek’s (1989) argument is similar to Gramsci’s position: false consciousness is a result of the judgement that contemporary people maintain their own points of view as they review past events. Žižek claims that if ideology is illusion, it will be displayed through humans’ social practice but not through their consciousness (e.g., people keep doing something, say, irrationally, and they do not even know why they do it). Ideology is not an expression of illusion, but embedded in the unusual condition which leads people to perform without thinking (Žižek, 1989).

Larrain (1991) asserted that although the negative concept of ideology was expressed within Marx’s works, it does not mean that ideology refers to false consciousness. It could

⁷³ How such imaginary relationship is created is answered in his discussion of ISA/RSA and concept of interpellation.

only mean that ideology possesses the function of distortion, which cannot be referred to as false consciousness. To Larrain (1991), the notion of false consciousness *per se* is as obscure as ideology in that it never tells what fake sensation that ideology involves. False consciousness is seen to involve results of error or mistake; but, some ideologies fail to refer to error or mistake. False consciousness is usually considered as being created by the ruling class to mislead the working class, which is not accurate. In fact, it is the logic of the relations of production that deceive workers' consciousness. Moreover, Parekh's (1982) disagreement is that ideology possesses the function of distortion as Larrain suggested, but not every distorted event that is caused by a false consciousness can be seen as ideological. As his example describes, the 'sun goes around the earth' is a distorted idea (a false consciousness), but it is not an ideology at all. Parekh argued that the difference between ideology and false consciousness is that the former combines a system of ideas but does not refer to a single idea (e.g., the sun goes around the earth).

Summary and Discussion

According to the discussion above, this section concludes that ideology is not false consciousness, given that false consciousness is not the nature/essence of ideology. Ideologies can survive dominance without having false consciousness. False consciousness is only a possible result/effect of reality. Reality, being an element of ideology, has nothing to do with falsehood or truth.

The platform of ideology for reality and for false-consciousness is different. The former is the host, while the latter is the parasite. An ideology could display with either a true or false perspective. The birth of a false consciousness requires two points: first, the operation of power indeed exists in the researched phenomenon; and, second, there are innocent subjects (Classes), who will not find out at all. False consciousness is defined only when the veiled groups are unaware of anything. That is to say, if subjects discover the truth, they no longer participate in false consciousness, even if they still suffer from its influence. This is because understanding is one thing, but to remove it is quite another.

Moreover, the reason why ideology is an abstract concept is because the early elaborators, particularly Marx and Engels, did not clearly state what they were referring to when they adopted the notion of false consciousness to describe ideology. Did they refer to

false consciousness as the ‘possible results/effects’ of ideology, or did they consider false consciousness as the nature/essence of ideology? It seems that this false consciousness debate indeed has lost philosophical recognition.

This thesis argues that the question of whether ideology is false consciousness is a question of epistemology from a theoretical dimension. In the practical dimension, when one false consciousness is invisibly and undoubtedly accepted, it is no longer the false consciousness but an ‘ideology’ which locates on an ontological level. In other words, the epistemology (e.g., false or neutral perspectives) scholars adopt when entering into debate is based on their personal educational background and life experiences, that is, their ideology. Accordingly, a statement such as “ideology is a false consciousness” *per se* is an ideology, which belongs to the angle of ontology.

The ontology, like ideology, is located in the human subconscious domain with people being incapable of recognizing what it really is, and therefore, has determined what epistemology scholars adopt to evaluate all things in the world⁷⁴. What people can ascertain is that their epistemology has shifted (e.g., from adopting a negative to a natural angle of ideology). However, they are unable to understand why and how their epistemology shifts because “why and how” is the work of ontology. Ontology is the alter ego of ideology and vice versa. People always innocently think that they are able to perceive both, but what they have perceived is never the ontology and ideology. Ontology determines what epistemology a person possesses just as ideology determines the way people act.

Empirical Analysis

Although there is only one among the 33 IAC articles, the RA25, which theoretically and particularly discusses the false consciousness debate, there are still a few articles whose analyses indeed refer to such a debate. These IAC analysts mainly argue that their researched subject has constructed (/is suffering from) a false consciousness; or they explained that the ideology they had found is represented/constructed as a false consciousness. Two examples (Example 5-13 and 5-14) will be given later. Yet, what has to be emphasized here is that none of the 33 IAC articles directly claim that the essence of ideology *per se* is a false

⁷⁴ This is why Hay (2002, 2007) states that ontology is prior to epistemology (cf. Bates & Jenkins, 2007).

consciousness. This might imply that, after decades of debating, researchers of ideology today would agree that ideology is only a channel or tool to convey/represent a diverse reality (whether it is objective or constructed); it has nothing to do with true or false.

Example 5-13: The author of RA04 argues that although diet companies continually revise the advertising of their products to create a fresh image of ‘we understand customers’ demands’, the purposes are all for their business. Namely, advertising varies periodically, but the goal of diet companies remains the same. Drawing on the view from RA04’s author, these various advertisings have created a false demand, i.e., the false consciousness, for the audiences. Thus, this author tries to explore the conversion of reality from a diachronic angle, and explains what reality (or false demand/consciousness) these advertisings really represent.

Example 5-14: RA13 argues that Egypt’s social welfare plans were originally designed to manage the poverty problem in order to reach modernity. However, social welfare plans, such as ‘public assistance law’ and ‘social insurance’, have provided Egyptians with nothing but the false consciousnesses which is always just an imagination of social welfare. This is because those diverse welfare plans are more like rhetoric tools which helped diverse political regimes to maintain social order and their authority. The purpose of social welfare plans is not to help people; instead, it is to create a (false) consciousness that the ‘government is helping people’.

Other articles which refer to the discussion of false consciousness include RA02, RA04, RA10, RA13, RA17, RA21, RA22, RA23, RA24, RA25, RA27, RA28, RA30, and RA31. For a detailed explanation, please refer to Appendix 5-2.

How Reality Is Described

This thesis has argued that although the term reality is obscure, once the reality *is described*, it is able to reveal people’s consciousnesses or say, their ideologies. The moment when humans *describe* the reality they assume is simultaneously the moment when they invisibly expose their consciousness or ideology. Through the process of understanding how people describe reality, it is possible to discover how an ideology is created and what ideology it is as well. After the investigation of 33 IAC articles, this thesis has determined four ways of describing reality.

Way I: The IAC analysts show what the constructed reality is. This generally includes two dimensions of analysis: how W constructs a reality to maintain its interests (to dominate D), or how D is suffering from a constructed reality (created by W).

Example 5-15: RA07 explains how medical discourse continually constructs a traditional image for the public. This constructed image (i.e., reality) is that nursing is subject to the medical profession.

Example 5-16: the author of RA05 explains that, by using specific words and descriptions, the U.S. media has constructed Muslim and Arab-Americans as the ‘Other’ after 9/11. When Americans accepted the distinction of the Other (from us), to the author of RA05, they accepted a given consciousness. Hence, what Americans think after 9/11 (e.g., Muslim is the Other) is an ideology which represents a constructed reality.

Example 5-17: RA24 points out how the Chinese Communist Party applies diverse visible political slogans to change people’s invisible consciousness, which reflects people’s thinking (i.e., diverse realities) through times (e.g., in the early era: to be loyal to leaders; in later eras: to rationalize the policy of economic development). The reality which represents people’s value here is constructed by the dominant group.

Other IAC articles which describe the reality from a constructed angle include RA01, RA02, RA03, RA04, RA05, RA06, RA07, RA10, RA12, RA15, RA18, RA20, RA21, RA23, RA24, RA25, RA27, RA30, and RA31. For a detailed explanation, please refer to Appendix 5-2.

Way II: The IAC analysts simply illustrate the reality of their research; or objectively describe how a reality is presented which is based on a process of competition, negotiations, and compromise by diverse positions.

Example 5-18: The author of RA09 employs quantitative data (e.g., voting statistics) to show readers where in the spectrum of political ideology (i.e., liberal, centrist, or conservative) these diverse factions (i.e., Traditional Democrats, New Democrats, Blue Dogs) of the Democrats party are located. The author simply presents what reality one faction holds without involving a discussion of power operation or whether such a reality is true or false.

Example 5-19: The analyst of RA26 explains the conversion of the Ireland Republican Movement. Such a conversion shifts “from a physical force organisation to a socialist party

that emphasises economic rather than national issues.” He does not judge whether the reality, which represented the social condition of a time (e.g., in the ‘force’ or ‘party’ style stage), is influenced by power or is presented truthfully or falsely. The analyst just (objectively) presents the reality of certain times diachronically.

The context of other IAC articles which simply or objectively illustrate the reality of the research includes RA08, RA09, RA17, RA22, RA26, RA32, and RA33. For a detailed explanation, please refer to Appendix 5-2.

Way III: The IAC analysts arbitrarily or subjectively claim: the reality that their analyses have found is misrepresented (by a certain group); instead, the truth is X. In this theme, IAC analysts’ own opinion regarding ‘what the real reality should be’ is revealed overtly.

Example 5-20: RA28 mainly discusses the ideology shift in Die Grünen (The German Green Party) from 1980 to 2002 which is based on an investigation of official documents. The author of this article thinks that Die Grünen nowadays possesses the liberalism ideology (i.e., the reality that the author himself considers) instead of the ideology of ecologized socialism that most people suppose. Namely, the IAC analyst denies one current ideology and reasserts another.

Example 5-21: RA19 belongs to an analysis of cultural creation which analyses the narrative structure of Rowling’s *Harry Potter*. By pointing out the contradictory narrative embedded in this novel, the analyst of this article argues that Rowling has mixed up the first (i.e., real) and the second (i.e., magical) worlds. Namely, the reality that this novel presents to us (i.e., mixed world) is not the same as what Rowling and her readers thought (i.e., magical world). This analyst tells us what reality it is, to argue against what we used to think it is (It is A not B).

Other IAC articles which show analysts’ arbitrary or subjective judgement include RA03, RA04, RA13, RA14, RA18, RA19, RA21, RA27, RA28, RA29, RA30, and RA31. For detailed explanation, please refer to Appendix 5-2.

Way IV: That how reality is described is not clearly explained by the IAC analysts (Discussion of reality is hardly found). Although discussion of ideology, more or less, has to illustrate the figure of such ideology, there are still some articles which do not draw the

shape of their research. These articles either focused on ‘how power acts’ in their research object (e.g., RA11) or simply introduce/present their research object⁷⁵.

Example 5-22: RA16 mainly explains the difference between the authors’ (i.e., people who designed curriculum for Portuguese middle school) personal ideological and the pedagogical principle of their works. This article does not clearly discuss what reality it is.

Examples of this way of describing reality include RA11 and RA16. For a detailed explanation, please refer to Appendix 5-2.

Appendix 5-2 shows a holistic view to explain what angle of reality is applied in 33 IAC articles. Table 5-4 provides the references which displays how the notion of reality was revealed within IAC analysts’ writings (texts).

Table 5-4: Presenting the Reality

SWPs Code: P1-PR (Presenting the Reality)	
Articles	Found References/Examples
RA01	p.165(1); p.166(2); p.172(8); p.174-5(10-11); p.176(12); p.177(13); p.177-8(13-4); p.178(14);
RA02	p.246(2); p.249(5); p.250(6); p.252(8); p.253(9); p.254(10);
RA03	p.144(8); p.147(11);
RA04	p.335(2); p.338(5);
RA05	p.3(1); p.6(4); p.7(5); p.8(6); p.9(7); p.10(8); p.11(9); p.12(10);
RA06	p.446(2); p.448(4); p.452(8); p.456(12);
RA07	p.113(7); p.114(8); p.115(9); p.116(10); p.117(11); p.118(12); p.119(13); p.122(16);
RA08	p.263(3); p.264(4); p.269(9); p.272(12);
RA09	p.588(2);
RA10	p.418(2); p.426(10);
RA11	p.99(1); p.103(5); p.104(6);
RA12	p.1034(10); p.1036(12);
RA13	p.284(6); p.285(7); p.287(9); p.288(10); p.289(11);
RA14	p.100(1); p.101(2)a; p.109-10(10-1);
RA15	p.455(1); p.456(2); p.457(3); p.462(8); p.466(12);
RA16	p.138(2); p.152(16);
RA17	p.352(4); p.354(6);
RA18	p.157(4);
RA20	p.354(2); p.356(4); p.357(5); p.359(7);
RA21	p.411(1); p.412(2); p.413(3); p.417(7); p.420(10); p.421(11); p.424(14); p.427(17);
RA22	p.70(1); p.71(2); p.81(12);
RA23	p.387(2); p.389(4); p.390(5);
RA24	p.492(6); p.494(8); p.497(11); p.498(12); p.499(13); p.501(15);
RA25	p.467(2); p.478(13); p.480(15);
RA26	p.79(1); p.87(9); p.88(10); p.90(12); p.92(14);
RA27	p.181(2); p.183(4); p.191(12); p.198(19);
RA28	p.168(12);
RA29	p.914(1); p.915(2);
RA30	p.466(2); p.485(21); p.489(25); p.490(26);
RA31	p.219(2);
RA32	p.21(5); p.24(8);
RA33	p.641-2(1-2); p.664-5(24-5)b; p.666-7(26-7)b; p.667-9(27-9)b; p.670-1(30-1);

⁷⁵ These IAC articles can be considered as papers which fall outside of the above categories. Although the analysts did not clearly draw the reality (what ideology it is) in their paper, their description still represents certain reality in which their interpretation of ‘what reality it is’ has led readers’ thinking.

5.6 Reality and Power

In the previous section, this thesis has argued that through the process of *describing* the reality of researched phenomenon, the making of one ideology is revealed. Yet, the above statement neglects a critical point: it is only through the *viewpoint of analysts* that ideology could be recognized via such way (i.e., describing the researched phenomenon). On the contrary, to *the public*, everything in daily life represents the reality. To the public, so called reality indeed is the reality—or their consent or understanding of their life—which has nothing to do with the above statement: reality is the representation of ideology that guides their life and action. To the public, if ideology exists, whoever suffers from it or holds it without knowing will always be the ‘other’ instead of ‘us’. Namely, analysts sense the diverse styles of reality which contributes to the making of ideology while, to the public, reality is just the reality.

The reason for pointing out the difference between analysts and the public here is to emphasize: only through the viewpoint of analysts can the reality, which contributes to the diverse representation of ideology, be described. Analysts are capable of distinguishing diverse realities because they have brought the concept of *power* into their analysis. Although reality, as one of three essential elements of ideology in this thesis’ presumption, is considered as being located in an objective position, intervention of power cannot be ignored when dealing with the topic of ideology.

In the previous section, this thesis strived to *purely* and *neutrally* explain how reality is described in IAC articles; yet, the categorized four ways are still inevitably involved with power manipulation. Hence, this section will highlight the role of power to see how it influences the making of reality. Four types of reality resulting from the degree of power intervention are categorized. From low to strong intervention, they are: 1) objective, 2) presented, 3) constructed, and 4) hyper reality.

Type I: The Objective Reality means that the factor of power does not become involved with the birth of reality at all. It could only be seen as a *conceptual* reality or a *spiritual* or *real* reality because it, essentially, cannot be presented by humans’ system of signification (e.g., oral languages, signs, gestures, etc.). It is an *absolute reality* that human beings can never recognize.

Type II: The Presented Reality. In this thesis, it means the one which is close to the objective reality (but still unable to reach the realm). Even though some analysts of IAC articles seemingly objectively and purely describe their research, it is still impossible for them to analyse things without any intervention of their personal ideology. This is because even the apparently innocent words or structures of sentences, as well as the quotations or cited examples, all signify a certain angle of interpretation which is influenced by the invisible power intervention. Accordingly, the ways of describing the reality *II*⁷⁶ and *IV*⁷⁷, introduced in the previous section, belong to this category. IAC analysts who adopt Way II and Way IV try to stay in a neutral position to describe the reality of their research phenomenon. To compare, the degree of power intervention in Way II is more than that in Way IV.

Type III: The Constructed Reality. Power here indeed works on the process of describing the reality. First, regarding the texts of articles only (and regardless of the subjectivities of analysts), IAC articles of this category usually attempt to tell readers ‘how power works on constructing humans consciousness’. Accordingly, Way I⁷⁸ belongs to this category. Second, while the IAC analysts’ subjectivities directly show in their writings, they attempt to construct a reality to their readers. Way III⁷⁹ is in this category. Analysts who adopt Way III often claim that the reality is not X but Y; in so doing, a new reality is constructed. Both Way I and Way III explain how power works on constructing a reality, whether it reflects the texts of IAC articles or reveals the IAC analysts’ subjectivities.

Although the above three types of reality are displayed diversely, they are all the representation of ideology which is similar to the fact that even though steam, water, and ice have different formations, their chemical formula is the same, H₂O. The degree of heat explains the diverse formation of H₂O (i.e., steam, water, or ice) which is just like the degree of power influencing the representation of ideology (i.e., an objective, presented, or constructed reality).

⁷⁶ Way II: The IAC analysts simply illustrate the reality of their research; or objectively describe how a reality is presented.

⁷⁷ Way IV: How reality is described is not clearly explained by the IAC analysts.

⁷⁸ Way I: The IAC articles show what the constructed reality is.

⁷⁹ Way III: The IAC analysts arbitrarily or subjectively claim: the reality that their analyses have found is misrepresented; instead, the truth is...

Yet, what should be addressed here is that the different types of reality resulting from the degree of power intervention can only be distinguished through the viewpoint of analysts; this is because the factor of power is considered. In contrast, the public, to a great degree, are incapable of doing this. They do not have the ability, skill, or knowledge regarding ideology (e.g., aware of power factor) in order to distinguish the above diverse types of reality. To them, reality is the reality, or their consent, instead of ideology guiding their life and action. If ideology exists, the one who suffers from it or holds it without knowing will always be the 'other' instead of 'us'. Since the public is a group of people incapable of identifying the power of ideology, the influence is: the reality that they sense is much more 'real' than the reality *per se*.

Accordingly, the fourth type of reality (based on the degree of power) is **the Hyper Reality (Type IV)** which is terminology appropriated from Baudrillard (1994). The hyper-reality particularly here refers to people who are incapable of perceiving power manipulation. To the public, the concept of power does not even exist in the way of their recognizing the reality; in their thought, there is no such specific group (i.e., Class notion) trying to maintain their hegemony either. While the power factor is considered to be *inexistent* by the public (even though it indeed exists and works), the reality they recognise becomes more 'real' than the reality *per se*.

From the analysts' perspective, this is a hyper-reality which indeed is what ideology-specialists called 'the ideology' that guides the public. Yet, ideology-specialists themselves also suffer from certain hyper-reality because there is always something that they do not know 'they do not know'. That is why we call ideology, 'ideology'. In short, to the public (in fact, even to ideology-specialists), the hyper-reality is *the* reality, their consent, or their way of understanding their life.

To conclude, this section has focused on the role of power to see how it influences the making of reality. Four types of reality resulting from the degree of power intervention have been categorized. From low to strong intervention, they are: 1) objective, 2) presented, 3) constructed, and 4) hyper-reality. The first three are the reality that IAC analysts might discover while the last answers why ideology controls human beings without showing its existence.

5.7 Class and Reality—Discussion of Class Consciousness

Theoretical Review

When ideological analysis/critique examines the interaction between the elements of Class and reality, the discussion usually focuses on the topic of ‘class consciousness’. From a neutral and objective perspective, the concept of class consciousness simply represents the ‘common thought’ of a group of people. However, while class consciousness is considered negatively, it means that the common thought that a group of people believe is falsely and purposely constructed by others. This group of people is incapable of perceiving their real condition, or their real class consciousness (cf. Lukacs, 1971). The problem is: once this group of people operate within such a false group consciousness, then what they have done is not for their own group interest; instead, all their efforts are to assist the other group of people, who possess more power than them, to maintain the other groups’ interests and dominance, or as Geuss (1981) described, the “functional and genetic properties” (p. 24).

It could be said that almost all scholars who deal with the concept of class consciousness were particularly referring to a class consciousness which is veiled by another (false) consciousness, especially Marx and Lukacs.

Marx thought that philosophers in the seventeenth century, on the surface, had developed their own philosophy, which finally contributed to knowledge bodies such as liberalism, utilitarianism and constructivism (Parekh, 1982). In reality, to Marx, the knowledge they established was all constructed through the same logic which is based on certain social conditions of existence, so that the development of their philosophies was limited. The inner concept of knowledge has expressed nothing but the consciousness of the dominant class—the bourgeoisie—in their time, considering that all scholars are socially influenced yet fail to know their prejudices (Parekh, 1982).

Marx and Engels (1970) claimed that “the ideas of the ruling class are in every epoch the ruling ideas” (p. 64). In fact, intellectuals and their ideas are the representatives of the ruling class. They might not be the ruling class, but they are part of it (Boudon, 1989). This is also evidenced in Foucault’s (1991a) study of the prison, where he shared the same notion that intellectuals are the underclass of a ruling class. Diverse sets of knowledge such as liberalism and utilitarianism are products of the ruling class, and even criticism from

scholars, who are seen as helping people recognize injustices, is all made from the same ground. Hence, Marx took the angle of the proletariat to solve this dilemma⁸⁰. It is from the proletariat viewpoint (but not by proletarians themselves) that injustice and truth can clearly be seen (Boudon, 1989).

Following Marx, Lenin's (in Parekh, 1982) notion of class is the basic and critical detector to understand social reality. Compared to (petty-)bourgeois classes, who have to maintain their vested interests and are afraid of destabilising conflicts, the proletariat class has nothing to lose. To Lenin, the proletarians' conditions of existence will eventually direct them to fight for the truth—seek their real interests, which so far have been exploited. Yet, Marx only called upon the proletariat to fight against those who possessed the means of production while Lenin reasserted the importance of being in a class struggle. It was not until Lukacs suggested the proletariat recognize their class consciousness, or awaken from the false class consciousness, that the possibility of reaching proletarians' real interests became possible.

To Lukacs (1971), the reality which represents each class' consciousness is recognized differently. The bourgeoisie does not have to discover the truth because they (their class consciousness) represent the truth. On the contrary, to the proletariat, they must uncover the evil because the problem is not as Lenin envisioned—the proletariat class has nothing to lose—but a matter of vital importance. Although Lenin and Lukacs adopt different angles to see the situation of the proletariat, both believe that the proletarians' viewpoint is the way to uncover the essence of capitalism which still follows Marx and Engels' track.

Moreover, Lukacs (1971) suggested, in order for the proletariat to awaken their class consciousness, they have to realize that they are situated in the condition of 'class in itself'. This concept was originated from Kant's notion 'thing-in-itself'⁸¹. Lukacs (1971) named Kant's notion of thing-in-itself as the 'first nature' which signifies invisible concepts that

⁸⁰ As this thesis has discussed in the previous section 5.2 *Class*, Marx started his investigation from the position of political economy and concluded that the viewpoint of the proletariat is the best angle to understand capitalism. This angle could be seen as Marx's (and Engels) standpoint of epistemology regarding roles of the proletarians.

⁸¹ In Kant (in Jones, 1977), there is a compass line to limit humans' capacity of understanding the world, meaning that there are always some concepts which human beings are unable to make sense of for any sake. Kant named this field, which takes over the unperceivable concepts, "thing-in-itself" (p.14). By so doing, the concepts of object and subject are created. Conceptions will be classified to the field of 'thing-in-itself' as an object if humans cannot understand them.

humans do not understand and never will. Based on Kant's notion, Lukacs (1971) elaborated to demonstrate that, in a reified world, humans cannot understand their visible creations because the identical relation between humans and their creations is split into a new relationship of *subject* and *object*. Lukacs defined this phenomenon as the 'second nature' in parallel to Kant's notion of thing-in-itself (i.e., the first nature). Lukacs (1971) insisted that the subject and object should be in an identical relation and, can be identified. The thing-in-itself (the first nature) and the phenomenon of reification (the second nature) are just an unavoidable historical process at a certain point in human development. To him, objects are always understandable. Hence, the way to solve this problem is to create an identical subject-object or to reach the realm of totality⁸² (Lukacs, 1971).

Lukacs (1971) believed that the identical relationship would be approached only when proletarians realize their circumstances and turn their class position from 'in themselves' to 'for themselves', through which class revolution will become possible. To Kant, the identical subject-object can be revealed through art; to Hegel, it is not through art but history. Lukacs found the limitation of Hegel's notion and extended the notion of history to class consciousness of the proletariat as discussed above (Lukacs, 1971, p. 142; Jones, 1977, p. 15; Eagleton, 2007, p. 98). That is to say, realizing that their class consciousness is a reified consciousness in the historical development, or veiled by a false (or other class') consciousness, is the way for proletarians to escape the dominant ideology to recognize their real interests, ignoring that such a reified condition happens in the value or material dimension.

To conclude, when the examining angle turns to Class and reality, the discussion in ideology theory mainly focuses on the debate of class consciousness. The concept of class consciousness could simply refer to the 'common thought' of a group when such a concept is viewed from a neutral dimension. Nevertheless, the concept of class consciousness is often seen to convey a negative meaning in ideology discussion. It implies that the sensible class consciousness which the oppressed class possess is a constructed one which is veiled by other (false) consciousness, so that the oppressed class is incapable of realizing their real class consciousness. Accordingly, what Lukacs meant by saying proletarians have to be aware

⁸² For Lukacs' subject and object' and 'totality', please refer to Chapter 9.

of their class consciousness is to realize their condition, which is veiled by a certain false consciousness offered by others. In so doing, they could retrieve their real class consciousness. Once they have done this, revolution becomes possible.

Empirical Analysis

The following empirical analysis reports will display both neutral and negative angles regarding the discussion of class consciousness in 33 IAC articles. What should be noted is that the following concept of ‘class’ refers to this thesis’ notion of Class not Marx’s class. For example, the ‘Class’ of RA15 refers to a ‘female teacher Class’ which is opposite to the ‘male management Class’; or in RA19, it refers to a ‘readers Class’ which is formed by readers who love Rowling’s *Harry Potter*.

First, the concept of Class consciousness maintains a neutral dimension which refers to the ‘common thought’ of a group of people.

Example 5-23: The author of RA09 uses quantitative data (e.g., voting statistics) to show us where in the spectrum of political ideology (i.e., liberal, centrist, or conservative) these diverse factions (i.e., Traditional Democrats, New Democrats, Blue Dogs) of the Democrats party are located. The author simply presents what consciousness one faction holds without discussing the power operation or whether such a consciousness is right or wrong, good or bad for the people. Accordingly, the discussion of Class (faction) consciousness maintains a neutral dimension.

Other IAC articles which reflect a neutral dimension of the concept of Class consciousness include RA09, RA16, RA26, and RA28.

Second, the concept of Class consciousness refers to a consent which is (falsely) constructed by others’ consciousness. People in this group have to be aware of their condition to retrieve their real Class consciousness and interests.

Example 5-24: RA15 applies history and quantitative data to explain how the value of man (and middle class) constructs the image (or the social roles) of female teachers (and working class). Such an image influences the public expectation of female teachers’ roles, their teaching contents, their wages as well as their Class (status) location. Thus, the Class consciousness which these female teachers have perceived, to the analyst of RA15, is not their real Class consciousness.

Other IAC articles which display a negative dimension of the concept of Class consciousness include RA15, RA19, RA20, RA21, RA24, and RA27. Uncategorized articles, which do not clearly involve the discussion of Class consciousness, are RA01 to RA08, RA10 to RA17, RA18, RA22, RA23, RA25, and RA29 to RA33.

5.8 The Characteristic of Ideology

This thesis argues that any discussion regarding the nature of ideology could be explained through the investigation of three essential elements of ideology—Class, power, and reality. So far, each element and their inter-relationship have been discussed. Related empirical analysis reports have also been provided. Nevertheless, it could be found that this thesis is unable to directly claim ‘what this concept means’ while dealing with concepts of *dominant ideology* and *class consciousness*. Instead, this thesis always has to consider the different dimension in which these concepts are discussed—i.e., whether it is through a neutral/positive or a negative dimension. This is because another topic in the ideology realm has not been dealt with yet, that is, the characteristic of ideology.

The main argument regarding the characteristic of ideology rests on whether ideology *per se*, by nature, refers to a negative and critical, or a positive and neutral characteristic. McLellan (1995) suggests two trends to show the transformation of the characteristic. One trend originated in France while the other has German roots.

In the French trend, Destutt de Tracy (followed by Durkheim, structuralist and empiricist) gave birth to the subject, *idea-logy*. He argued that “truth is correspondence with reality” (in McLellan, 1995, p. 8), in which humans are considered capable of recognizing the nature of science. Thus, to de Tracy, ways of looking for the truth is based on the physical sciences⁸³. Ideology, from de Tracy’s perspective, is ‘positive and progressive’ and retains a neutral characteristic here.

Yet, due to the unfinished business between Napoleon Bonaparte and de Tracy (to be discussed later), Napoleon started to label de Tracy and his followers as *ideologues*;

⁸³ To de Tracy, the concept of ‘idea-logy’ involved two characters, materialism and evolutionism. The former means that idea-logy is stimulated by human’s material activities, such as oral language, written language, personal gesture et cetera. Ideology is not created by invisible spirits or mystery. The evolutionism depicts a world: by studying in idea-logy, humans could improve their social and political condition in order to perfect the living environment (Baradat, 1997).

condemning that their 'idea-logy' study only focused on the 'first causes' and neglected the law and religious matters. Napoleon claimed that "this cloudy metaphysics [...] attribute all the misfortunes of our fair France" (Barth, 1977, p.27 in McLellan, 1995, p.5). It is agreed that since Napoleon's power intervened in academia, the way of seeing ideology has changed. The characteristic of ideology is now seen negatively.

In the German trend, Hegel and Marx (via Mannheim and Habermas) started to focus rather on the "making of truth than on empirical observation" (in McLellan, 1995, p. 8). While de Tracy's 'physical science' method is to empirically observe things to seek for truth, to Marx, truth is defined by specific social groups which are not the neutral expression of ideas but ideology. Ideology, to Marx, is seen as "illusory ideas, false ideas [...] class-conditioned thought, unfounded ideas [...], and a body of justificatory beliefs" (in Parekh, 1982, Introduction).

Usually, Marx was considered to have a negative meaning of ideology. McLellan (1995) concluded two reasons. First, Marx adopted the angle of materialism to criticise and replace idealism (applied by Hegelians) in which ideology is the result associated with idealism. Second, Marx often described ideology as an "uneven distribution of resources and power" (ibid., p. 9). These two reasons have invisibly led later scholars to consider Marx as possessing a negative perspective of ideology.

In fact, Marx described ideology in a neutral way as well. In the Preface to *A Contribution of the Critique of Political Economy*, Marx (1971) explained that ideological forms are the result (reflection) of economic conditions of production, in which ideology did not refer to power, but only described a parallel relationship at the economic level.

It is reasonable to say that such diverse angles regarding the characteristic of ideology resulted from the different historical background or relation of power that de Tracy, Napoleon, or Marx situated. There is not much contest to disagree that the characteristic of ideology could be neutral. Yet, since Marx is seen to identify ideology with a negative characteristic (even though he described ideology positively, too) and since his words always felt so wrong as well as so right, as a result, an expeditionary army regarding the characteristic of ideology allied and started their exploration.

Both Lenin and Lukacs despised the negative meaning/characteristic of ideology (Bottomore, 1983). To Lenin, ideology often referred to a specific consciousness of the dominant class, given that its members usually possess more power than the members of the dominated class; this current dominant consciousness might also be criticised/replaced by other consciousness (different political positions) somewhere in time. So, to Lenin, ideology is the expression of particular political ideas of diverse classes (Bottomore, 1983; Larrain, 1988). Lukacs shared the same idea with Lenin: that both the bourgeoisie and proletariat classes have their own ideologies. Yet, different from Lenin, he suggested that it is not because the former possess more power than the latter but because the latter is reified (Bottomore, 1983). Namely, to Lenin and Lukacs, ideology itself has nothing to do with negative meanings; rather it is the expression of class consciousness.

To Gramsci, the negative meaning of ideology is also possible while it is under certain social structures. If people consider that ideology only contains a negative meaning, to Gramsci, they simplify the way to recognize ideologies (McLellan, 1995). Habermas (in Geuss, 1981) suggested that ideology is a term about describing a thing. To answer 'what this ideology is' is to ask what this ideology refers to. If it refers to religion, for example, then it is a religious ideology. Ideology is the description of the things that people try to understand. From Habermas' stance, ideology possesses a neutral characteristic.

Later scholars such as Geuss (1981) and Thompson (1990), separately, provided their own system to explain the diverse characteristics of ideology. Geuss (1981) concluded on the descriptive, pejorative and positive senses of ideology. Ideology in the descriptive sense refers to a broad and pure anthropological perspective, from which ideology is understood to contain both discursive (concepts, ideas, beliefs) and non-discursive (gestures, rituals, attitudes) elements. That is to say, ideology is the description of concepts, beliefs, gestures or attitudes.⁸⁴ Next, a pejorative (or critical) meaning of ideology implies that some people in a society are deceived, in that they cannot truly see the condition and power relations where they are situated.⁸⁵ The final meaning of ideology is with a positive sense that contains an

⁸⁴ Geuss (1981) claimed the classification of discursive and non-discursive elements here has nothing to do with explicit or implicit, but is related to the extent of sophistication in describing a thing.

⁸⁵ Geuss (1981) explained this pejorative meaning at length through three angles. First, it has an epistemic purpose. Its purpose is to make people think the way this ideology wants them to think, or to transform a particular belief into a general belief to all citizens. Second, it has a functional purpose. Its

active meaning. Ideology here does not refer to something to be discovered, but something to be pursued or created, that people are able to use to “satisfy their wants and needs and further their interests” (p. 22).

Moreover, Thompson (1990) simply concluded that the characteristics of ideology belong to either a descriptive definition or a prescriptive definition. The former is a delineation of reality without power intervening; while the latter is the product of power. A descriptive definition of ideology contains a neutral conception in which ideology is seen as “‘systems of thought’, ‘systems of belief’ or ‘symbolic systems’” (p.5); in fact, it may be seen as all sorts of “x-isms”. Thus, this conception is made without any judgement, misleading or illusory—it represents the reality or knowledge of a certain social life.⁸⁶ When a descriptive meaning of ideology is evaluated by power, it becomes a prescriptive definition in which the reality of ideology is abused depending on how one camp appropriates a specific intention to serve its interests. The prescriptive meaning of ideology is often presented as negative, pejorative, critical and one-sided, such that the word ‘ideological’ from this angle is usually linked with conspiratorial purposes or painted as supporting a specific dominant power (Thompson, 1990).

Table 5-5: Diverse Distinction of the Characteristic of Ideology

Main Char. & Representatives	Positive or Neutral		Negative or Critical	
	de Tracy, Lenin Lukacs (rejects negative meaning) Marx (neutral meaning)		Napoleon, Marx Gramsci (Negative is possible)	
Similar Ideas & Advocators	Descriptive		Prescriptive	
	Habermas, Thompson		Thompson	
	Positive	Descriptive	Pejorative	
	Geuss	Geuss	Geuss	

To conclude, Table 5-5 shows the diverse perspectives of seeing the characteristic of ideology. As discussion and classification continues, today most scholars agree that the

purpose is to support and stabilize the vested institutions, and to mask and hinder social controversy. Third, it creates a genetic reason, in that it tells the history of this consciousness (ideology) to make people accept the truth.

⁸⁶ However, frankly speaking, although ‘x-isms’, which are also defined as ideologies, seem to present a neutral description, some ‘x-isms’ are typically characterized by one camp as having a threatening meaning in order to demonize the other camp, e.g., capitalism versus communism during the Cold War (Freeden, 2003).

nature of ideology possesses a neutral characteristic. However, why does ideology, in many cases of research, seem to represent a negative meaning? The answer is power, that is, what angle of power analysts adopt. How do they describe the power operation? The factor of power makes a discussion of ideology be seen negatively. In the 33 IAC articles, although there are no analysts who are found to regard ideology with a negative characteristic, the angle of power these analysts adopted indeed has influenced their analyses, whereby the way they describe relative phenomena (e.g., dominant ideology of a regime) might be felt negatively. What has to be noticed is that the characteristic of ideology by nature is not negative. Instead, ideology is a channel where its characteristic might be seen negatively only when it is presented to be so which is also based on the dimension of power that the analysts possess.

The following Table 5-6 shows the abstract of the three essential emblems—Class, reality, and power—and their relationship with a consideration of both neutral and negative dimensions.

Table 5-6: Discussions with the Consideration of Characteristic of Ideology

	The Characteristic of Ideology the Analysts Possess	
	Positive or Neutral	Negative or Critical
Class	Two Classes with a negotiating, compromising relationship.	With a competing, oppositional relationship.
Power	To purely describe how power works between A and B, e.g., dominant, negotiating, compromising, or resistant.	Power operation is shown as a tool to construct a certain idea from A to B on purpose.
Reality	To purely present the reality of the researched phenomenon.	To emphasize that reality is a constructed one which does not present the truth.
Class & power	Simply refers to a prevailing ideology in a society. E.g., “Obeying the law is the obligation of citizens”.	By applying power, a constructed dominant ideology could help a certain group to maintain its interests which might damage others. E.g., the dominant ideology of “obeying the law is the obligation of citizens” helps to maintain social order which mostly benefits those vested groups and their interests.
Class & reality	Refers to a ‘common thought’ of a group of people. E.g., Worldview of people who live in North Korea.	Discussion usually attempts to claim that an oppressed group has to be aware of their (false) Class consciousness to reach their real interests. E.g., People of North Korea have to realize their condition to retrieve their real Class consciousness and interests.

Power & reality	When power works on reality, it is always hard to maintain a positive or neutral result.	Instead, it usually refers to a false consciousness which is constructed for a purpose. E.g., People who live in North Korea believe that their leader was born with God's will to guide them.
-----------------	--	--

5.9 Class, Power and Reality—Hegemony Theory

In the previous section, this thesis discussed the diverse angles of classifying the characteristic of ideology, and suggested that the angle of power that the analysts adopt (and the way they describe it) is the key reason to generate such a debate. Since power plays such a critical role in recognizing ideology, then a flexible concept of power is important, especially when all three elements are simultaneously considered in order to ultimately outline ideology.

Gramsci's hegemony theory is a suitable concept to delineate the relationship between the three essential elements (i.e., Class, power, and reality) of ideology. His attitude regarding power, compared to others such as Marx and Althusser, seems to stay in a relatively flexible and neutral position (yet, inferior to Foucault).

When most people think of Gramsci's hegemony theory, they read this theory with an understanding close to the concept of 'dominant ideology'. Such an understanding reflects a stronger entanglement with power which is unidirectional and arbitrary. Nevertheless, drawing on Gramsci, the term hegemony should be more about "a process of struggle" (Ransome, 1992, p. 132). The concept of power in his world is not fixed and controlled; instead, it contains flexible and various dimensions such as dominant, negotiable, resistant, and compromising angles. Accordingly, his concept of hegemony grants ideology theory the possibility of alternation.⁸⁷

Gramsci was influenced by Lenin. Yet, in contrast to Lenin, who saw "political hegemony" as the only way of controlling a country, Gramsci thought that having only

⁸⁷ Nevertheless, the shortfall is that his notion was, as Salamini (1974) claimed, "elaborated in a specific Italian intellectual climate" (p. 360). Namely, the meaning of hegemony that people recognize today was, as Durham and Kellner suggested (2001), a demonstration of Gramsci's prison letters in which he described why and how fascism could replace the "liberal bourgeois regime" in Italy (p. 33). Although the theory is unavoidably limited, it is Gramsci who defined the word 'hegemony' and provided "new ways of thinking about revolutionary politics and specifies a whole set of priorities" (Boggs, 1976, p. 20).

“domination” power does not guarantee a permanent regime. He offered the concept of “ideological hegemony” (Salamini, 1974, p. 368). Gramsci (1971) specified the notion of ‘civil society’, which comes close to Althusser’s notion of ISAs, to explain how ideological power influences people. To Gramsci, although violent power is required to control a state, it is not enough. A government cannot always force people to accept policies by using armed force. Instead, he suggested that the ruling class must develop “consent,” identified by the majority of citizens (Ransome, 1992, p. 135; Femia, 1981, p. 42).

Yet, achieving this ‘consent’ by the ruling class does not mean that the society will be stable and without struggle. Gramsci’s (1971) most important notion was that consensus is not controlled by a specific group; on the contrary, every social group has opportunities to compete for it. Any group can offer a totally different idea, even if the idea runs counter to the current dominant consensus. To Gramsci, ideology should be a battlefield in which all ideas, voices, and forces fight for their own territories and leadership in order to compete for consent (Gramsci, 1971)—in Gramsci’s own words, to fight for the “intellectual and moral leadership” (p. 57).

That is to say, a dominant ideology is not born with and given to a ruling class; rather, a dominant ideology is the winner of that negotiation and competition. Again, his hegemony theory implies his position of possessing a flexible notion of power; it could be a dominant, negotiable, resistant, or compromising style of power operation. Based on such a viewpoint of power, his hegemony perspective provides the notion of ideology with a new analytical angle in which ideology is always within “a process of struggle” (Ransome, 1992, p. 132).

Consequently, by adopting three essential elements of ideology (Class, power and reality) to delineate Gramsci’s hegemony theory, it could be briefly described as: diverse groups (Classes) are fighting for leadership (via diverse style of power operation) to create their particular ideological hegemony (i.e., consent, diverse types of reality). Once one group creates a hegemony (Class and reality relations), they have to maintain it (Class and power relations). This process of maintaining simultaneously (re)produces the relations of production (power and reality relations) that empower the dominance of this hegemony.

5.10 Conclusion: Unfinished Business between de Tracy and Napoleon

This thesis has investigated 33 IAC articles to testify whether standard writing procedures exist. Six procedures are concluded. This chapter has mainly focused on the first procedure, which is to identify essential elements of ideology (i.e., the researched phenomenon), including three essential elements, Class, power, and reality. These three elements and their interaction together delineate one ideology. In other words, investigating these three essential elements and their relationship explains what the nature of ideology it is.

This chapter has introduced the related ideology literature through the dimensions of Class, power, reality, and their relationship. Relative examples found in 33 IAC articles have also been provided. Applying the ‘Class, power, reality’ dimension to explain the nature of ideology is not new, as this dimension existed in de Tracy’s time when the term *ideology* was coined.

Thus, this section will tell a story about the unfinished business between Napoleon and de Tracy to test the ‘Class, power, reality’ dimension (i.e., procedure 1: identifying essential elements) in understanding ideology. It is this chapter’s conclusion yet, could also be seen as its introduction. Not surprisingly, any discussion of ideology *per se* is a loop; the introduction is the conclusion, the conclusion, the introduction.

Unfinished Business between de Tracy and Napoleon

Although John Plamenatz (1970) offered the term *ideology* a different origination, most ideology researchers consider that this terminology was created by Destutt de Tracy. He named it “idea-logy” (McLellan, 1995, p.5). De Tracy, a French philosopher, had a complicated, unfinished business with the famous emperor, Napoleon Bonaparte. Despite the varying meanings of ideology pointed out by researchers from one generation to another, it can be confidently claimed that, if we return to examine the relationship between de Tracy and Napoleon, all questions regarding discussions of ideology can be found.

With Napoleon’s help, de Tracy created a science subject, *idea-logy*, which focused on the ground, the origin, the nature and the essence of humans’ ideas (McLellan, 1995; Freedden, 2003; Eagleton, 2007). To de Tracy, ideas can be found empirically (Freedden, 2003) through the “physical sensations” (McLellan, 1995, p.5). He wished that researchers could dismiss their own stereotype and short-sighted views to deal with a rigorous analysis of human ideas.

It is reasonable to say that idea-logy possessed an energetic meaning at this moment, that is, ideology maintained a positive, or at least, a neutral position.

As previously set out, these French men had unfinished business. De Tracy received his sponsorship from Napoleon, but Napoleon was also the one who kicked away the ladder. A strong empire requires many elements to maintain its power; in Napoleon's case, it was mainly a religious element. Nevertheless, his close relationship with religion received much critique from de Tracy and his followers. Based on an unbalanced relationship of power, the latter was defeated by Napoleon easily. Napoleon claimed that "this cloudy metaphysics [will...] attribute all the misfortunes of our fair France" (Barth, 1977, p.27 in McLellan, 1995, p.5). Napoleon also promoted law and history to a higher position which, to him, could maintain France's honour (McLellan, 1995). The winner rules, while the loser is ruled. Napoleon demonstrated the notion of ideological hegemony. Most researchers reported that the notion of ideology started to convey a negative meaning from then on.

Applying to the statement of this thesis, the concepts of ideology such as 'dominant ideology' (e.g., here, religion) and 'dominant Class' (e.g., Napoleon and his courtiers) surpassing the oppressed Class (e.g., de Tracy and his fellows) and their opinions (e.g., new subject idea-logy) are revealed here. With Napoleon's dominant position he could twist an idea easily, which refers to the notion of power operation. With Napoleon's (unbalanced) relationship with de Tracy displays the concept of 'competing Classes'. Moreover, his words of 'cloudy metaphysics' and 'misfortunes of our *fair* France (emphasis added)' also indirectly implied the discussion about whether ideology is 'false consciousness'. This true or false consciousness also points to the origin of such a discussion, that is, how reality is described.

To conclude, this thesis applies the story of de Tracy and Napoleon to demonstrate that identifying ideology's three composing elements, Class, power, reality, and their relationship (i.e., the first procedure of SWP) is a means to understanding the structure, feature, and even the nature of the researched phenomenon. While identifying these essential elements of research phenomenon, it is able to reveal the nature of such ideology (phenomenon) which is also the foundation work to analyse or criticise this ideology (phenomenon).

Procedure 1: Identifying Essential Elements

Chapter 6

Procedure 2: Applying Theoretical Foundations — The Making of Ideology

6.1 Introduction

The first procedure of SWPs introduced in the previous chapter is to identify essential elements of a researched phenomenon. This is a procedure to understand the nature of the researched phenomenon which is composed of three essential elements: Class, power, and reality. These three elements and their interaction together delineate an ideology, which forms analysts' initial motivation and their presumed standpoints that might have affected the conclusion drawn through the analysis.

It might be argued that although the nature of researched phenomenon might be similar, ideological analysis/critique should be unique from one case to another once their practical and detailed writing texts are considered. Yet, this thesis argues there are still some common features among these seemingly diverse ideological analyses. Even the apparently unique writings still reveal certain commonalities, which are the foundation that this thesis inducted to SWPs.

If the first procedure (identifying essential elements) is to study the nature of the researched phenomenon, then the following five procedures could be seen as ways to investigate how/why such a phenomenon conveys a certain ideology or can be seen as an ideology, that is, to understand the making of ideology. These procedures will be introduced in the following chapters, including procedures of 2) applying theoretical foundations, 3) connoting certain meanings, 4) illustrating (incl. articulating and interpellating), 5) selecting expression styles, and 6) revealing personal viewpoints.

Procedure 2: Applying Theoretical Foundations

Although the IAC analysts' academic background is different and the subjects they investigate are diverse, many similarities among these 33 IAC articles can be found, including the application of theories which, to a great degree, could influence the structure, writing trend, argument, or even the conclusion of an IAC article.

Therefore, understanding the theoretical foundation adopted by IAC analysts in their articles will help to comprehend the ideology of the researched phenomenon that they have tried to present/construct, or convince us to believe. This thesis has inducted 33 IAC analysts' common application of ideology theories into five theoretical foundations (or analytical pathways). They are: 1) Marx's, 2) Althusser's, 3) Gramscian, 4) historical descriptive, and 5) semiotic analytical pathways.

Whilst five pathways have been inducted, this does not mean that IAC analysts only adopt one pathway to analyse their research, nor does it mean that methods of analysing ideology are limited to these five dimensions. Works of ideological analysis or critique are various and abundant. The following discussion will gradually introduce these five analytical pathways. Related theoretical review will be provided first, and followed by offering the results from empirical analysis. Moreover, since establishing a methodology for ideological analysis/critique is also an aim of this thesis, how to apply these theoretical foundations (or analytical pathways) will be suggested as well.

6.2 Marx's Analytical Pathway

Theoretical Review

Although de Tracy set up the term *idea-logy*, the initial discussion of ideology stemmed from Marx's related discourses. To understand Marx's perspective on ideology, or to understand how he explained the relationship between humans' activity and their corresponding consciousness, all discussions have to return to his critique on political economy. Marx (1971) wrote,

In the social production of their existence, men inevitably enter into definite relations, which are independent of their will, namely relations of production appropriate to a given stage in the development of their material forces of production. The totality of these relations of production constitutes the economic structure of society, the real foundation, on which arises a legal and political superstructure and to which correspond definite forms of social consciousness. The mode of production of material life conditions the general process of social, political and intellectual life. (pp. 20-21)

By studying political economy, Marx explained the concepts of material productive forces, means of production, and the relations of production together with how capital defines economic activities. These conceptual discussions together comprise what he claimed to be the economic base-structure. Another concept based on this base-structure is what Marx named the political superstructure. Regarding the relationship between these two structures, Marx argued that following the development of capitalism, an inevitable clash between the productive forces and the relations of production would lead to the alteration of the base-structure, which, simultaneously, would also induce the adjustment of the superstructure. In other words, the superstructure is an inevitable corollary of the base-structure; or say, the economic base-structure directly determines the superstructure. Marx's demonstrative logic is reflected in his words, "It is not the consciousness of men that determines their existence, but their social existence that determines their consciousness" (p. 21).

What should be noted here is that Marx's attitude regarding this gradually conceptualizing notion of ideology so far has not referred to a concept with negative meaning or capability (e.g., distortion). Marx just simply explained how economic factors determine humans' thoughts without judgement.

To Marx, the alteration which happens in the economic base-structure is observable and which could be found through natural science evidence. Differently, the form of alteration that most concerned him was "the legal, political, religious, artistic or philosophic — in short, ideological forms in which men become conscious of this conflict and fight it out" (p. 21).

That is to say, what human beings should be most worried about are those ideological forms which attempt to pretend that everything is going well. Accordingly, the question arises of how to appraise whether these ideological forms are beneficial or harmful to people, and most importantly, who can determine this? Capitalists, the governors, educators, or...?

Marx (1971) answered,

Just as one does not judge an individual by what he thinks about himself, so one cannot judge such a period of transformation by its consciousness,

but, on the contrary, this consciousness must be explained from the contradictions of material life, from the conflict existing between the social forces of production and the relations of production. (p. 21)

The first quotation implies his critique on the idealism which is demonstrated in his books *The Holy Family* and *The Germany Ideology*⁸⁸. The second quotation refers to his methodology of dialectical materialism. Drawing on Marx (1971), whether those ideological forms are beneficial or harmful is impossible to examine through idealism since it would be adopting one side's consciousness to judge/evaluate consciousness of the other side. Instead, the alteration in the economic base-structure is the pivot to be scrutinized which echoes Marx's perspective: humans' social existence determines their consciousness.

As a result, if the economic base-structure plays such an important role, then a new question emerges: who controls the base-structure? Or, who controls those ideological forms which indeed results from the alteration of the base-structure? Above questions or the question of how and why ideology is created, could find answers in Marx and Engels' (1970) book *The German Ideology* where Marx described the function of ideology, albeit through abstract concepts, as

The ideas of the ruling class are in every epoch the ruling ideas, i.e. the class which is the ruling *material* force of society, is at the same time its ruling *intellectual* force. (p. 64, emphasis original)

These words reveal his concern about who controls the relations of production, or, who are dominated. This concern initiated his investigation into the inequality which resulted from unbalanced power relations. As the notion of power is considered, the study of (false) consciousness which is offered/constructed by certain groups to influence/control other groups become one of the key points to understand Marx's ideology concepts. Marx's contribution conceptualizing the notion of ideology is that he has found a competing relationship between diverse classes (i.e., the bourgeoisie and the proletariat). This also resulted in other discussions of social phenomenon such as alienation and fetishism.

⁸⁸ For his critique on Holy Family's idealism, please refer to Chapter 5.

Marx's concept of ideology derived from his investigation on the unbalanced power relation between two classes. The ingredients of his ideology theory included concepts such as division of labour, relation of production, base/superstructure, false-consciousness, alienation, class struggle, which were all introduced in the previous chapter. While an IAC article adopts these concepts to explain its researched phenomenon, it could be said that such an article applies to Marx's analytical pathway (or the Marxist form of ideological analysis/critique) which could be abstracted as follows:

Ma→Whoever controls the relation of production (base-structure)

Mb→controls the power of interpretation (superstructure).

Mc→This "who" is capable of creating (false) consciousness (to Marx, the 'who' is the dominant class).

Md→While the dominated group lives under this (false) consciousness,

Me→it also suffers from four types of alienated condition.

Mf→As a result, they are unable to freely perform their free will to reach the destination of being objectification.

Mg→In order to remove the (false) consciousness, the dominated group has to sense this oppressed condition, to jump from class-in-itself to class-for-itself.

Empirical Analysis

The previous section first explained the birth of Marx's concept of ideology, then revealed Marx's consistent argument—the competing relationship between diverse classes. His concepts have been utilized to establish what this thesis calls *Marx's analytical pathway*. Of course, this pathway could be extended. Here, RA02 is taken as an example to explain how Marx's pathway was applied in practical analysis.

Example 6-1: RA02 considers how the UK media misrepresents Islam where Islam is stigmatized through a violent, irrational, and radical image. The application of Marx's analytical pathway in RA02 could be drawn as follows:

Ma→The access right of media (newspapers) in the UK is mainly controlled by white English people.

Mb→Hence, they also control the power to define Islam and Muslims.

Mc→They created a stigmatized image of Islam and Muslims

Me→such that the Islamic immigrants who live in the UK cannot determine who they are and they have become alienated from themselves.

Most IAC articles which were examined in this thesis did not simply adopt a particular set of ideology concepts (e.g., only Marx's) to demonstrate their arguments. Due to the diverse research cases, the concepts adopted by IAC analysts depend on the arguments that IAC analysts make. Thus, Example 6-1 only shows how Marx's pathway was applied to RA02 with a holistic perspective. It does not mean that RA02 only adopts Marx's concept of ideology to compose its discourse; other analytical pathways (e.g., Althusser's, Gramscian, etc.) could also be found in RA02.

To provide a better understanding of how Marx's analytical pathway was applied, Table 6-1 is a reference list showing the application of Marx's analytical pathway in the 33 IAC articles. The original IAC articles could be found in the disk attached in Appendix 1.

Table 6-1: Reference of IAC Articles Which Apply Marx's Analytical Pathway

SWPs Code: P2-M (Marx's Analytical Pathway)	
Articles	Found References/Examples
RA01	p.166(2); p.172(8)
RA02	p.247(3)c; p.248(4)a,b; p.249(5)a,b; p.253(9)c;
RA03	p.143(7);
RA05	p.3(1); p.4(2); p.12(10); p.13(11);
RA06	p.445(1)a,b; p.446(2); p.448(4)a,b; p.450(6)a,b,c; p.456(12); p.457(13)a,b;
RA07	p.107(1); p.108(2)c; p.109(3); p.110(4)c; p.113(7); p.114(8); p.116(10);
RA08	p.261(1)a,b; p.264(4)b,c;
RA10	p.419(3); p.424(8); p.427(11)c;
RA11	p.101(3); p.105(7); p.107(9); p.108(10);
RA12	p.1025(1)a,b; p.1026(2)c; p.1029(5);
RA13	p.287(9)c;
RA14	p.100(1)c,d; p.101(2)c,d; p.102(3)c; p.103(4)a,b,c; p.105(6)c,d; p.106(7);
RA15	p.455(1); p.456(2); p.457(3); p.462(8); p.465(11); p.467(13); p.468(14); p.469(15);
RA16	p.138(2)a,b; p.139(3);
RA20	p.354(2)a,b,c; p.355(3)a,b; p.356(4); p.357(5)a,b; p.358(6)a,b; p.361(9)a,b; p.362(10); p.364(12); p.366(14)c; p.367(15)f;
RA21	p.412(2)c; p.413(3)c; p.415(5); p.416(6); p.421(11); p.423(13)c; p.425(15); p.427(17)c;
RA22	p.70(1)c,f; p.71(2); p.73(4)c; p.74(5)c; p.75(6)c; p.76(7)b; p.77(8); p.78(9); p.79(10); p.80(11);
RA23	p.387(2); p.388(3); p.390(5)c; p.394(9); p.395(10)c; p.396(11)a,b,c;
RA24	p.487(1)c; p.489(3); p.490(4); p.491(5); p.494(8)a,b; p.495(9); p.496(10); p.498(12)c;
RA25	p.470-1(5-6); p.478(13)a,b;
RA27	p.181(2)a,b; p.182(3)a,b,c; p.186(7)a,b,c; p.187(8)c; p.190(11); p.191(12)c; p.192(13); p.197(18)c; p.198(19)a,b; p.198(19); p.199(20)c;
RA28	p.161(5); p.163(7); p.164(8); p.170(14)c; p.171(15); p.172(16); p.173(17); p.179(23);
RA29	p.915(2); p.918(5); p.919(6); p.920(7); p.925-6(12-13);
RA30	p.466(2); p.467(3); p.469(5)c; p.471(7); p.472(8); p.473(9); p.479(15)c; p.480(16)c; p.481(17); p.482(18)c; p.483(19)c; p.485(21); p.486(22); p.488(24); p.489(25)a,b,c; p.490(26)a,b;
RA31	p.219(2)c; p.223(6); p.226(9)c; p.228(11)c; p.229(12)c; p.230(13); p.231(14)c; p.232(15); p.233(16); p.240(23); p.241(24);
RA32	p.18(2); p.20(4); p.24(8); p.26(10)d;
RA33	p.650(10)b; p.652(12); p.653(13); p.655(15)a,b; p.656(16); p.658(18)b,c; p.661(21)c,d; p.662(22)d; p.670(30)b,c;
Concepts a: Base-structure); b: super-structure; c: (false)-consciousness; d: alienation.	

Application of Marx’s Analytical Pathway

The above discussion has just described how Marx’s concepts of ideology were applied in IAC articles. The following Table 6-2 is a suggestion for future IAC analysts to apply Marx’s way of analysing ideology. It explains that if the methodology of ideological analysis/critique could be established, as suggested in Chapter 4, then this table (6-2) explains how future IAC analysts, and under what conditions, might apply Marx’s concepts in their writings. Establishing a set of procedures (i.e., methodology) for ideological analysis/critique is an ambition of this thesis although not its primary focus. Thus, the following table can only provide a brief explanation based on the concepts mentioned above. It does not refer to Marx’s entire concept of ideology.

Table 6-2: Application of Marx’s Analytical Pathway

Concept of Ideology	The Applicable Condition
Class Struggle*	When the primary research subjects and other subjects are within a mutually competitive relationship (i.e., competition for power, rights and interests, authority to interpret, rights to control...etc.), the concept of Class Struggle can be adopted to describe the opposing relation between the two.
Base/ Superstructure	When the research topic implies how a vested group takes advantage of its economic predominance (here, it does not merely refer to money but also to the relation of production) by utilizing the mechanism of superstructure (e.g., education, religion) to gain the authority to define something, analysts could apply notions of base-structure and super-structure to acquire a theoretical support.
Alienation	When analysts try to describe how human beings lose their identification of themselves or their relationships and linkage to their achievements, the concepts of alienation can be applied, e.g., when they feel no connection with their own identity, their co-workers, their work results and the working environment.
Class-in-itself/ Class-for-itself*	This concept is often adopted to provide utopian advice about what research subjects should do in order to remove the bondage, namely that the oppressed group needs to realize their living condition as jumping from class-in-itself to class-for-itself.
*The term Class here refers to this thesis’ extended concept of a competing relationship between diverse groups.	

6.3 Althusser's Analytical Pathway

Althusser's contribution to ideology is that his notions make the ideology visible and *analysable* which is what Marx lacks. The notion of ideology in Marx is an abstract concept that simply exists; no one can answer why it exists. Conversely, Althusser tells people how and why ideology comes into existence. His notion provides an analytical dimension to concretize the process of ideological analysis instead of simply referring one phenomenon to an ideology. In short, his focus is on how ideology is formed.

Althusser argued that "ideology has a material existence" (1971, p. 165) which is the foundational concept to understand how ideology is formed. His other interpretations regarding ideology include "the individual is interpellated [by ideology] as a subject" (p. 182), "ideology represents the imaginary relationship of individuals to their real conditions of existence" (p. 162), and ideology is to "[reproduce] the relations of production" (p. 148). All concepts help to establish his viewpoint of ideology.

Theoretical Review

The concept of "ideology has a material existence" indicates that ideology is no longer an abstract concept. It is born neither from nothing nor from a simple spirit or thought. Instead, it lives in human beings' daily practice. People usually consider 'thought' as abstract nothingness; yet, even the 'thinking process' in humans' brain has a material existence (Freeden, 2003). Mankind cannot generate anything without referring to the concepts which they have already known, as Wittgenstein (2003) claimed, "whereof one cannot speak thereof one must be silent" (p. 3). Hence, visible written works, images, human gestures, invisible thoughts, and oral language all possess materiality, which is the framework of ideology. Similarly, whether to criticise/analyse an ideology or to write IAC articles, analysts cannot avoid using the signs (i.e., written language) because all phenomena, which analysts are capable of perceiving, recognising, understanding and further presenting to readers, can only be expressed via material semiotic elements.

Besides, if the concept, 'ideology has a material existence', means *what* constructs ideology, then Althusser's other concept, *interpellation*, refers to *how* such ideology prevails or maintains itself. To Althusser (1971), the making of an ideology does not generate from nothing but requires a process of what he called *interpellation*, which is operated by the

Ideological State Apparatus (ISAs⁸⁹). The task of the ISAs is to “interpellate individuals as subjects” (p. 182). Interpellation is a process to connect external signs and logic of the world with internal signs and logic of an individual. In other words, the process of interpellation is to let individuals realize the same signs and logic both in this ideology and in their daily activities and, most importantly, to create a connection. In so doing, it could be said that this ideology interpellates individuals of the world as subjects of itself (i.e., the subjects which are subjected to this ideology).

However, a man proposing to a woman does not mean that the latter has to accept the proposal. This situation suggests that in an interpellation process, *responses* from individuals are a critical requirement. “[A]nswering the call”, as Althusser (1971, p. 170) described, is the way to undertake the making of an ideology, meaning that only when the woman says “yes”, is this proposal (referring to: a marriage, a serious relationship, a responsibility—in sum, *all thoughts* when people consider the action of *proposal*) a success. Otherwise, the proposal fails to interpellate this women as its subject (i.e., the marriage). Similarly, only when readers accept the arguments that IAC analysts suggest, then it could be said that IAC analysts successfully interpellate readers as subjects of their articles.

Foucault’s (1991a) notion of discipline shares the same function with Althusser’s interpellation. While interpellation only succeeds in receiving responses from individuals, discipline adopts an active mode to direct individuals into its rules. To Althusser, ideology interpellates individuals as subjects; to Foucault, the mechanism of discipline⁹⁰ trains

⁸⁹ For the concept of ISA, please refer to Chapter 5.

⁹⁰ In *Discipline and Punishment*, Foucault (1991) suggested that discipline is a mechanism that distinguishes humans’ activities via a binary opposition system, especially focusing on the operation of power. The effect of discipline is accomplished not only by assigning individuals to the place where they belong but also by prohibiting and eliminating individuals from other opposite ideas. Likewise, the mechanism of discipline is similar to Shakespeare’s (2004) famous line in Hamlet that “To be, or not to be—that is the question” (p. 164); but, the critical point is that the mechanism of discipline makes the decision not the oppressed individuals. Foucault (1991) depicted several concepts of how the mechanism of discipline works. Firstly, a closed space is required. For the purpose of this thesis, the closed spaces not only refers to concreate constructions such as schools, hospitals and prisons as Foucault’s research objects but also indicate a closed information receiving mode, e.g. watching the same News channel every day (from the viewpoint of this thesis, reading the same demonstrative style of IAC articles). Secondly, a normalized timetable designed to monitor and command individuals step by step is required. Individuals are similar to machines, controlled by a time-tabled schedule to execute the ordered missions. In a word, individuals are objected (from the viewpoint of this thesis, if SWP exists, it echoes this second point). Thirdly, repetition of commanded activities is required for individuals (Foucault, 1991). Mechanism of repetition in Foucault’s angle is to train individuals to perform requested orders instinctively, e.g. training of soldiers. From the perspective of making an ideology, it refers to the function that by sensing the signs and logic of this

individuals as subjects of it. Both of them successfully explain how an ideology (or the discipline) is identified by individuals.

Moreover, when one ideology, which is based on material foundations, successfully interpellates individuals as subjects of itself, this ideology “represents’ the imaginary relation of individuals to these social relations” (Althusser, 1971, p. 162). When a woman accepts the proposal (i.e., the interpellation is completed), the ideology of marriage comes to her mind as she automatically links material existence (e.g., a ring, a ritual of proposal) to her future life (whether happy or tragic) via her imagination of stories about marriages that she projects for herself. Similarly, as readers read the arguments (i.e., displayed by writing texts—material components) suggested by the IAC analysts, once they accept (i.e., interpellation completed), they will automatically link these arguments to all the concepts and theories they already know providing credits and validity to those arguments. That is to say, because of a material component and interpellation process, human beings obtain an invisible consent, an imagination of the social relations that this ideology presents or constructs.

Finally, to Althusser, if the process of interpellation works and finally creates a specific ideology or makes individuals identify with the vested ideology, then what this ideology should do in order to maintain or enlarge its dominance is to “[reproduce] the relations of production” (Althusser, 1971, p. 148).

This notion originated from Marx’s concept *the relations of production*⁹¹ which explains the operational model of capitalism, e.g. Marx’s discussion of surplus value and capital accumulation. However, to Althusser, such a mechanism (e.g., the operation of capitalism) does not always guarantee success. He found out that ‘reproduction’ is the key that helps the vested mechanism to establish and maintain its dominance. To reproduce

ideology repeatedly, individuals will easily be disciplined. Finally, evaluation observation, punishment and compensation (award) are required. Foucault described that individuals will be classified into diverse sections based on evaluation of their performance and disciplined degree followed by punishment or compensation. This classified system is designed to establish an observation system in which individuals are monitored by each other. In so doing, the cost of supervision and control is also reduced.

⁹¹ The relations of production means, from Marx’s stance, the mechanism of how workers produce products based on the forces and means of production, and this mechanism changes across different time periods. It is an invisible rule/mechanism—e.g., working time schedule, boss’s superiority, reward and punishment, or annual profits being divided based on shareholding ratio—that makes people (e.g., workers) of an epoch obey without questioning.

means to repeat the past successful mechanism. For example, to strictly execute the punishment disciplines in order to make sure that no exceptions exist. Once the rule is repeatedly identified, the vested relations of production continue to prevail. Because of this function of ideology, society maintains its running model, the ruling class retains its advantage, and individuals are satisfied with the way things are, namely that the function of 'reproduction' is to maintain social order.

According to Althusser's basic concepts of ideology introduced above, an analytical pathway based on these could be drawn as follows:

Aa→ Ideologies have a material existence.

Ab→ Hence, when a group controls the Ideological State Apparatus (ISAs),

Ac→ it is able to appropriate those material elements to interpellate individuals.

Ad→ Ideology represents the imaginary relation of individuals to those social relations.

Ae→ When individuals are hailed by ideology, they become the subject of it.

Af→ After accomplishing the interpellation, the ideology has to reproduce the relation of production in order to ensure its existence.

Empirical Analysis

Example 6-2: RA20 is taken as an example. It explains how academia is dominated by males and excludes females from interpretation-rights via forms of thought, images, and symbols.

Althusser's analytical pathway applied to RA20 could be drawn as follows:

Ab→ "Universities, schools, broadcasting and publishing corporations, and the like are the ideological institutions of the society" (Smith, 1975, p. 354), which are controlled by men.

Aa→ Based on the application of academic production (e.g., forms of thought, images, and symbols, p. 353),

Ac→ women unconsciously accept (agree with) the academic rules which are dominated by men.

Ad→ Under this circumstance, women even "throw the control to others [men]" (p. 364) possessing an imagination relation where men are superior to them whereby women are excluded.

Ae→ As a result, they become the subjects of men's academic regime. (p. 365)

Procedure 2: Applying Theoretical Foundation

To provide a better understanding of how Althusser's analytical pathway was applied, Table 6-3 is a reference list providing guidance to determine the application of his analytical pathway in the collected 33 IAC articles. The original IAC articles could be found in the disk attached in Appendix 1.

Table 6-3: Reference of IAC Articles Which Apply Althusser's Analytical Pathway

SWPs Code: P2-A (Althusser's Analytical Pathway)	
Articles	Found References/Examples
RA01	p.166(2); p.173(9);
RA02	p.245(1)b; p.248(4)b; p.249(5)b,c,e;
RA04	p.335(2); p.338(5)d; p.339(6);
RA05	p.3(1); p.5(3); p.6(4);
RA06	p.457(13)b,e;
RA07	p.108(2); p.109(3)e; p.110(4)e; p.113(7)d;
RA08	p.264(4)b,e;
RA10	p.419(3)a,d; p.420(4)b;
RA11	p.100(2)b; p.101(3)e; p.105(7);
RA12	p.1025(1)e; p.1027(3)a; p.1028(4)d; p.1037(13); p.1038(14); p.1039(15);
RA13	p.279(1)c;
RA14	p.100(1)b,d; p.101(2); p.102(3)d; p.103(4)a,b,c,d; p.106(7);
RA15	p.456(2)e; p.458(4)b; p.462(8)e; p.466(12)e; p.467(13)e; p.469(15);
RA16	p.138(2)a,e; p.139(3)b,e;
RA20	p.354(2)a,b,e; p.356(4)a,b; p.358(6)b; p.359(7)a,b,e; p.361(9)b,e; p.362(10)b; p.363(11)b;
RA21	p.413(3)e; p.417(7)e; p.418(8)b; p.422(12); p.423(13)b; p.427(17)a,e;
RA22	p.71(2)a; p.72(3)d; p.73(4)e; p.75(6)a,d,e; p.76(7)a,d; p.77(8); p.78(9)a,e; p.79(10)a,c; p.80(11); p.85(16); p.88(19);
RA24	p.488(2); p.490(4)a; p.491(5)a; p.494(8);
RA25	p.469(4)a; p.470(5)b,d,e; p.480(15);
RA26	p.91(13)c;
RA27	p.181(2)b,e,f; p.182(3)c,f; p.184(5)a,c; p.185(6)b; p.186(7)e; p.188(9)b,e; p.192(13)d; p.197(18); p.198(19)b,e; p.199(20)e;
RA28	p.164(8)a; p.177(21)a;
RA29	p.914(1); p.917(4); p.918(5);
RA30	p.466(2)b; p.479(15)e; p.480(16)e; p.482(18); p.485(21); p.487(23)e; p.490(26);
RA32	p.17(1)b; p.18(2)a,b; p.27(11)e; p.28(12);
RA33	p.650(10)b; p.661(21)b; p.670(30)b; p.672(32)d;
Concepts a: Materiality; b: ISA; c:Interpellation; d: Imagination of social existence; e: Reproduction of the relation of production.	

Application of Althusser’s Analytical Pathway

The following Table 6-4 is a suggestion for future IAC analysts to apply Althusser’s pathway to analyse ideology.

Table 6-4: Application of Althusser’s Analytical Pathway

Concept of Ideology	The Applicable Discourse Condition
ISA	When the research topic focuses on the institutions, which usually provide a neutral expression to the public (e.g. schools), the notion of ISA can be adopted to theoretically link the institution and ideologically invisible power together.
Materiality	This notion is mostly considered as the presumed basis which is applied to analyse ‘what’ constructs one ideology. By explaining the characteristics of ideology, it responds to why those abstract, pure, and spiritual concepts could be analysed.
Interpellation	This notion can be employed to describe how individuals are convinced by specific ideology, that is, the process of interpellation. This is the theoretical basis that can be adopted to demonstrate the active capacity of ideology.
Imaginary Relation	The meaning of imaginary relation here does not refer to a fantasy, but recognition of one’s own conscious position, that is, the analysts can adopt this concept to describe how research subjects deem their own situation as being normal. This is because that “ideology ‘represents’ the imaginary relation of individuals to these social relations”.
To Reproduce the Relation of Production	Analysts can take this notion to illustrate how ideology maintains its existence.

6.4 Gramscian Analytical Pathway

If Althusser's pathway offered a channel to analyse how ideology is formed, then Gramscian concepts help to illustrate the competing phenomenon between diverse ideologies and explain how one vested ideology maintains or enlarges its dominance. Furthermore, if Gramsci's concept of hegemony explains how one ideology maintains its dominance, then Laclau and Mouffe's (2001) notion of (dis/re-)articulation provides a clear map illustrating how hegemony is established, revised, and strengthened. Gramsci's hegemony theory was introduced in the previous chapter⁹²; the following discussion will mainly focus on the aspect of articulation.

Theoretical Review

The notion of (dis/re-)articulation was addressed by Laclau and Mouffe which was applied by Hall (in Grossberg, 1996, Interview) in his cultural studies. The former invented the idea to investigate the allied relationship between political groups while the latter appropriated this idea to explain the question of identity. To Laclau and Mouffe (2001), all social groups can form political associations with their particular political purposes; yet, no one can just perform self-importantly and independently. One association has to cooperate with another (i.e., *articulate*) in a specific agenda in which they share common interests in a particular social condition. These allied associations can *disarticulate* their united relationship once they face disagreement of opinions or interests and they can *rearticulate* if needed. The process of (dis/re-)articulation never ends because, as Laclau and Mouffe (2001) claim, "this articulation should be constantly re-created and renegotiated, and there is no final point at which a balance will be definitively achieved" (p. 188).

Hall (in Grossberg, 1996; interview) explained that the concept of articulation is similar to a tractor-trailer in which the tractor can link to many trailers. Hall described that,

An articulation is thus the form of the connection that can make a unity of two different elements, under certain conditions. It is a linkage which is not necessary, determined, absolute and essential for all time. (p. 141)

⁹² Simply put, hegemony should be seen as a battlefield in which all ideas, voices, and forces are fighting for their own territories in order to compete for consent—in Gramsci's (1971) words, to fight for the "intellectual and moral leadership" (p. 57). Once a hegemony/ideology is created, it has to maintain its power because there is no guarantee that such hegemony/ideology can last forever. The making of hegemony is always within a process of struggle.

Hence, a hegemony, or a dominant ideology, has to articulate or rearticulate other voices and opinions (in short, everything that benefits its dominant ideology), and it also must disarticulate anything which is injurious in order to spread its hegemony.

Based on Gramsci's hegemony theory together with his other notions (e.g., civil society, leadership), and Laclau and Mouffe's supplementary concept, *articulation*, a Gramscian analytical pathway could be drawn as follows:

Ga→ Ideology is a battlefield that exists in civil society

Gb→ in which various voices and opinions are allowed to negotiate, to compete for consent, that is, the "intellectual and moral leadership" (Gramsci, 1971, p. 57.).

Gc→ In order to achieve hegemony, methods of war of position,

Gd→(re)articulation,

Ge→and disarticulation are often adopted to gain the leadership.

(Thus far, the notion of hegemony refers to a 'process' of fighting for consent.)

Gf→When one of the competing groups obtains hegemony,

Gg→it has to maintain and enlarge its dominance to ensure the safety of its ideological hegemony, which has to go through the same strategies of

Gd→ (re)articulation (i.e., to absorb everything that benefits its dominant ideology),

Ge→ and disarticulation (i.e., to obviate anything which is injurious to its hegemony).

Empirical Analysis

Gramsci's notion illustrates how certain ideological hegemony is established and how it further maintains its dominance. This notion is broadly applied in IAC articles.

Example 6-3: RA06 explains how news media constructs/presents Joey Galloway as an image of wayward child, greedy, and disloyal through their sport news. Such an image of demonizing Galloway is to sustain the authority of the sports team, its coach, and their vested authority.

Gb→ The professional sports team, the Seattle Seahawks, and the all-star player, Joey Galloway, are fighting for interpretation rights over a salary issue

Ga→ in Seattle newspapers.

Ma→ However, the sports team not only has taken advantage of access to media space
(Mb→ because the team controls who can interview its players),

Gc→ but also appropriated a strategy of relationship, which begins from quoting the coach's
fairness of speeches, then the teammates' complaints, and finally the family's
admonition, step by step.

Gf→The sports team eventually creates its hegemony of authority over this event.

Gd→ To accomplish this hegemony, the sports team has articulated that it is offering a fair
salary and being open-hearted, and has articulated negative adjectives such as *wayward*,
greedy, *selfish*, *modern racism*, and *lacking in team spirit* in relation to the player,
Galloway.

Gg→ Finally, the player compromised, and the sports team again enlarges its
unchallengeable hegemony.

Examples of Articulation

Due to the importance of *articulation* in the process of ideological analysis or critique, this thesis provides an additional example to explain how the notion of articulation functions. RA01 is an example that testifies to this notion without using terminologies like 'articulation' or related vocabularies.

Example 6-4: The authors, Moss and O'Loughlin (2005), analyse how New Labour uses 'opinion polls', 'focus groups', 'consultations', and other social 'scientific techniques' to link concepts of science and public-orientation together to establish an epistemological foundation for the party's information age policy (p. 167). The authors argued that New Labour also connects concepts of 'globalisation', 'reflexive modernity', and the 'information age' with humans' daily experiences to rationalize the emerging ideology of this policy (pp. 167-168). Moreover, by claiming equality and justice, New Labour is able to connect 'welfare' to 'life politics', which means people have to help themselves before asking for government assistance (p. 169); as a result, government's responsibilities and duties are forgotten.

Other tracks of application of dis/re-articulation can be found in RA01. The core argument of this article is that New Labour's information age policy (the main subject, or the Primary Class) articulates everything (e.g., knowledge, skills, users' abilities), which

supports its importance in the information age. At the same time, the government’s social responsibility and duty are disarticulated from the old ideology. As a result, authors of this article claim New Labour has shown the party’s ideological shift.

To provide a better understanding of how the Gramscian analytical pathway was applied, Table 6-5 is a reference showing the application of a Gramscian analytical pathway in the collected 33 IAC articles. The original IAC articles could be found in the disk attached in Appendix 1.

Table 6-5: Reference of IAC Articles Which Apply Gramscian Analytical Pathway

SWPs Code: P2-G (Gramscian Analytical Pathway)	
Articles	Found References/Examples
RA01	p.167(3); p.168-70(4-6); p.172(8); p.172-3(8-9); p.179(15);
RA02	p.247(3)d; p.251(7)b; p.253(9)b; p.140(4)b;
RA03	p.137(1)d; p.138(2)b; p.141(5)b; p.143(7)d; p.144(8)d; p.145(9)b; p.149(13)b; p.152(16)d;
RA04	p.334(1)d; p.335(2)d; p.336(3)b; p.337(4)f; p.338(5); p.339(6)d; p.340(7)b; p.349(16)d; p.350(17)d,f;
RA05	p.3(1); p.5(3); p.6(4); p.8(6); p.11(9);
RA06	p.445(1); p.446(2); p.447(3)d; p.449(5); p.450(6); p.451(7)d; p.452(8)d; p.453(9)d; p.454(10)d; p.456(12)d;
RA07	p.108(2)c,d; p.109(3); p.110(4); p.111(5)b; p.112(6); p.113(7)d; p.114(8); p.115(9)d; p.116(10); p.119(13)d; p.122(16)d;
RA08	p.261(1)b; p.262(2)e; p.263(3)b,c; p.264(4)b; p.265(5)b,e; p.266(6)b,d; p.267(7)b; p.267-8(7-8); p.269(9)b; p.270(10)b; p.271(11)b; p.272(12)b; p.273(13)b; p.274(14)e,f;
RA09	p.588(2)b; p.589(3)b,d; p.592(6)b;
RA10	p.419(3)d; p.424(8)d; p.425(9)d; p.427(11);
RA11	p.99(1)b; p.100(2); p.101(3)b; p.103(5)b; p.104(6); p.105(7); p.106(8); p.107(9); p.108(10)b;
RA12	p.1026(2)e; p.1026(2); p.1031(7)b; p.1035(11); p.1036(12)b; p.1037(13); p.1039(15)d;
RA13	p.279(1)f; p.281(3)d; pp.283-4(5-6)b; p.290(12)d,f;
RA14	p.104(5)b; p.106(7)d;
RA15	p.455(1); p.456(2); p.457(3); p.460(6); p.462(8); p.465(11)b,d; p.467(13)d; p.468(14)b; p.469(15)b; p.469(15);
RA16	p.139(3); p.140(4); p.145(9); p.147(11)b; p.148(12)e; p.150(14); p.151(15); p.152(16)b; p.153(17); p.154(18)d; p.155(19)e;
RA17	p.350(2)b; p.354(6); p.364(16)d; p.369(21);
RA18	p.155(2); p.158(5); p.159(6);
RA20	p.354(2); p.356(4); p.357(5)d; p.358(6); p.366(14); p.367(15);
RA21	p.412(2); p.413(3)d; p.414(4)d; p.415(5)d; p.417(7); p.419(9); p.420(10)d; p.421(11)b,d; p.424(14)d; p.425(15)b; p.426(16)b; p.427(17)b;
RA22	p.71(2); p.72(3)b; p.73(4)b; p.74(5)b; p.81(12); p.85(16); p.87(18)f;
RA23	p.388(3)b; p.389(4); p.392(7); p.395(10); p.396(11)d;
RA24	p.488(2); p.492-3(6-7)d; p.493(7)d; p.494(8); p.495(9)b,d; p.499(13)b; p.500(14)b; p.503(17);
RA25	p.466-8(1-3)b; p.467(2); p.468-9(3-4)d; p.469(4)d; p.470(5)b,e; p.473(8)b; p.473-4(8-9)b; p.474(9)b; p.475(10)d; p.476(11)b; p.478(13)b,e,f; p.480(15)b;
RA26	p.79(1)b; p.80(2)d,e; p.83(5)d; p.85(7); p.87(9)d,f; p.88(10)b; p.89(11)b; p.91(13)b; p.92(14)b; p.94(16)b,d; p.95(17)d; p.96(18)d;
RA27	p.181(2)b,e; p.183(4)b,d; p.184(5)d; p.186(7)b,e; p.191(12); p.192(13)b; p.193(14); p.194(15); p.195(16); p.196(17); p.197(18); p.198(19);
RA28	p.158(2)d; p.162(6)c,d; p.163(7)c,d; p.164(8)d; p.165(9)b; p.166(10)b; p.168(12); p.169(13); p.171(15)c; p.172(16); p.173(17)d; p.174(18)f; p.180(24);
RA29	p.914(1); p.915(2); p.917(4); p.918(5); p.919(6); p.920(7); p.921(8); p.922(9); p.923(10); p.924(11); p.925(12);
RA30	p.467(3)b; p.468(4); p.469(5); p.470(6); p.471(7)d; p.472(8)d; p.473(9); p.474(10); p.476(12)b; p.477(13)b; p.481(17)d; p.482(18); p.485(21)d; p.486(22); p.487(23); p.489(25)d; p.490(26);
RA31	p.221(4)d; p.222(5)d; p.225(8)d; p.228(11)d; p.233(16)b; p.234(17)b; p.240(23)d; p.241(24)b,d;
RA32	p.17(1)d; p.18(2)b,d; p.21(5)b,c,d; p.22(6)c,d,e,f; p.24(8)d; p.26(10); p.28(12)d; p.30(14)d;
RA33	p.643(3)f; p.646(6)b; p.648(8)b; p.649(9)b; p.650(10)b,e; p.651(11)b; p.652(12); p.654(14)b; p.655(15)b,d,f; p.656(16)b; p.658(18)b,e; p.658-9(18-9)d; p.662(22)b; p.664(24)b; p.666(26)b; p.669(29)b; p.670(30)d,f; p.671(31)b; p.672(32)b;
Concepts a: Civil society; b: Intellectual and moral leadership; c: War of position d: (Dis/re)-Articulation; e: Consent; f: Hegemony	

Application of Gramscian Analytical Pathway

The following Table 6-6 is a suggestion for future IAC analysts who might wish to adopt Gramscian analytical pathway to compose their analysis.

Table 6-6: Application of Gramscian Analytical Pathway

Concept of Ideology	The Applicable Discourse Condition
Battlefield	When the analysts try to analyse the mutual competition between two concepts, they could introduce the concept of the battlefield of ideology to describe where these two powers will compete. The most familiar battlefields will be the authority to use the media and the prerogatives to speak and occupy channels to expound a phenomenon.
Civil Society	This concept is the same as ISA.
Intellectual and Moral Leadership	This notion provides researchers with an exposition about what the diverse voices fight for in the battlefield of ideology (whether it is fighting for the prerogative to access the media or the authority to expound a phenomenon). It is a lexicon to represent what diverse voices contend.
War of Position	This is a battle strategy. If the analysts try to illustrate that the discovered hegemony in their research is constructed gradually they can employ this notion.
Articulation/ Disarticulation	When the analysts try to explain the process of how their research subjects eliminate some concepts which are originally unfavourable to them and also increase others that are beneficial instead, this notion offers a theoretical response to illustrate how a fixed hegemony operates to hold its dominance.
Hegemony	This notion can be applied from two perspectives. First, the analysts can illustrate the advantage of a vested dominant ideology. Second, this notion can also be employed to describe how the oppressed group is capable of competing for consent to change the living conditions where they are situated. Analysts of such type of writing usually possess an optimistic and hopeful position.

6.5 Examples of Application of Diverse Pathways

As previously mentioned, this thesis has summed up three analytical pathways which offer a clear map to explain how common concepts of ideology are applied; yet, how concepts of ideology in practice are applied (e.g., to adopt Marx's or Althusser's notions) depends on IAC analysts' viewpoints and the arguments they try to make. RA04 can be considered as an example to show how Althusser's and Gramscian pathways are applied together.

Example 6-5: RA04 discusses how diet companies continually revise the advertising appeal of their products (which, to the author, creates a false image) to maintain their customers' demands. Since the 1980s, the diet industry has been criticised for selling unsubstantiated diet products which have usually claimed to possess the effect of fad dieting.

In order to maintain business⁹³,

Ab→diet companies use TV advertising

Aa→to transmit the texts, images, speeches, and body gestures which convey diet companies' new sales strategy.

Ac→Through advertising, diet companies hope to capture audiences' attention and desires.

These TV advertisements show that

Ge→diet companies themselves disagreed with the old diet method—fad dieting—which they used to promote;

Gd→instead, they suggest a new way of thinking—healthy dieting.

Ad→These advertising signs are designed to create a (an imaginary) relationship between customers and the demand for diet products.

Ae→Once audiences accept the message from TV advertisements, the new concept—healthy dieting— will be connected to people's consciousness.

Gf→It also upholds the hegemony of the importance of dieting.

Af→These TV adverts, again, reproduce the relation of 'thin is good and fat is bad'.

Gc→To successfully reproduce the hegemony of diet, a long-term, and gradual revision of TV advertising strategy is required.

⁹³ References of each step are briefly listed here. For a detail explanation, please refer to previous sections. Ab: ISAs. Aa: material existence. Ac: start to interpellate audiences. Ge: disarticulation. Gd: articulation. Ad: imaginary relationship. Ae: interpellation completed. Gf: hegemony. Af: reproduction the relation of production. Gc: strategy of war of position.

In the previous sections, this thesis has introduced three analytical pathways, including Marx's, Althusser's, and Gramscian. It could be concluded as the Marxism analytical pathways. The following sections will introduce two other analytical angles that are frequently applied in IAC articles or which are the guiding rule to conduct analysts' writings. They are historical description and semiotic analytical pathways.

6.6 Pathway of Historical Description

The analytical pathway of historical description, which is termed by this thesis, is usually applied to illustrate the researched objects' ideology shift through time. Frankly speaking, this historical descriptive pathway does not have theoretical foundations; in other words, this thesis is incapable of finding clear literatures to delineate this pathway. It cannot be categorized as textual analysis, nor can it be seen as discourse analysis. This is because those IAC articles, which applied 'historical descriptive' pathway, do not focus on the specific text or power-operation (which is what textual analysis and discourse analysis often do). Instead, IAC analysts who adopted this pathway were more likely to tell 'stories' without any intension. This thesis specifically identified this pathway because it indicates two points: first, the special characteristic of ideological analysis; second, the dilemma of that.

First, regarding the special characteristic of ideological analysis, it means that the process of describing history *per se* is the process of undertaking ideological critique/analysis as well as the process of constructing ideology, forcing readers to believe what they should believe. The purpose of describing history is to interpellate readers as subjects of the analysts' arguments. This logic is similar to the relationship between the terms *analysis* and *critique*, which is explained in the Chapter 1 (Section 1.4). While the terms *describing*, *analysing*, and *constructing* are interdependent and refer to the same action, the pathway of the historical description indicates that the IAC analysts undertake their ideological analysis simply by telling histories of their research objects; the process whereby they describe history *per se*, simultaneously, is also the process of analysing or constructing ideology.

Moreover, the IAC articles, which applied this pathway, 'do not intend' to tell readers what to believe. The word 'intend' here means that readers could clearly perceive what IAC

analysts try to emphasise (e.g., telling readers what are the power relation, the dominant relation, and the false consciousness of the researched phenomenon, which the former three pathways usually do). On the contrary, the words ‘do not intend’ means that the IAC articles almost objectively and neutrally present the ideology shift of their research phenomenon through historical development (e.g., simply and purely telling what happened in history).

The more IAC analysts simply and purely describe the research, the more readers will be interpellated. This is because, in the application of the historical descriptive pathway, the appearance of the article’s authors is hidden. As a result, a neutral and objective image of such article is created.

In this pathway, citing from literature is a common manner. Right after a simple and pure description, IAC analysts usually provide ‘quotations’ to support/echo/prove what they just wrote. These citations play the function of constructing ideology that tries to interpellate readers in order to promote the validity and reliability of their writings. These selected quotations, the cited extent, and its order of presentation, to a great degree, have not only proven the argument that IAC analysts wish to make but also guided the direction the analysts wanted their readers to follow. Edward P. Thompson’s (1991) *The Making of the English Working Class* could be seen as the model of applying what this thesis called the pathway of historical description.

Namely, the application of the historical descriptive pathway will help to create a seemingly neutral and objective ideological analysis. While this pathway is applied together with other pathways (which is commonplace in 33 collected IAC articles), the historical description part of the context will help the whole article to gain more validity and reliability.

The pathway of historical description cannot simply be abstracted as examples here because it is a style based on the whole context, which can only be detected through a holistic angle. Thus, this thesis can only provide a reference list to show the location in 33 IAC articles that applied what this thesis termed the analytical pathway of historical description, as Table 6-7 shows. The original IAC articles could be found in the disk attached in Appendix 1.

Table 6-7: Reference of IAC Articles Which Apply Pathway of Historical Description

SWPs Code: P2-HD (Analytical Pathway of Historical Description)	
Articles	Found References/Examples
RA02	p.246(2); p.247(3); p.250(6); p.254(10);
RA03	p.141(5); p.142(6);
RA04	p.335(2); p.336(3);
RA05	pp.5-6(3-4); pp.6-7(4-5); pp.7-9(5-7); pp.9-11(7-9)
RA07	p.111(5); p.112(6);
RA08	p.263(3);
RA09	p.590(4); p.591(5); p.604(18);
RA13	p.279-82(1-4); pp.283-90(5-12)
RA15	p.458(4); p.459(5); p.460(6); p.461(7); p.462(8); p.464(10); p.466(12); p.467(13); p.468(14);
RA17	p.353(5);
RA21	p.413(3); p.414(4); p.415(5); p.416(6); p.417(7); p.418(8); p.420(10); p.423(13);
RA24	p.488(2); p.492(6); p.493(7); p.494-5(8-9); p.495(9); p.496(10); p.497(11); p.499-502(13-16);
RA25	p.468-9(3-4); p.471-2(6-7);
RA26	Entirecontext
RA27	p.182(3); p.187(8); p.188(9); p.189(10); p.190(11); p.193(14); p.194(15); p.195(16); p.196(17);
RA28	p.160(4); p.161(5); p.162(6); p.167(11);
RA29	Entirecontext
RA30	p.467(3); p.468(4); p.469(5); p.470(6);
RA32	p.19(3); p.19-22(3-6); p.25(9);
RA33	p.641(1); p.642-3(2-3); p.646-9(6-9); p.651-2(11-2); p.655(15); p.658(18); p.660(20); p.661(21); p.666(26); p.667(27);

As mentioned in the first point, while IAC articles are simply and purely described, the track of IAC analysts' subjectivities will be easily forgotten so that a neutral and objective image of such an article can be created. The more an IAC articles looks objective, the more readers will be interpellated. Yet, the above statement ignores a point. While this thesis claims that the pathway of historical description could help to create a neutral or objective image of IAC articles, does it mean that their IAC analysts *really* purely describe their researches without involving their subjectivity? Or does it just mean that the readers (like me) lose their ability to criticise due to their being unfamiliar with such a research topic, especially the history part? Here comes the second point: the dilemma of ideological analysis—IAC analysts' capacity to comprehend the researched phenomenon (e.g., contexts).

Take my own experience of analysing (reading) these 33 IAC articles for example. While the IAC articles refer to specific subjects, events, or phenomena that are based on a synchronic dimension, it is not difficult to comprehend or analyse such articles. However, while the IAC articles are based on a historical dimension to investigate how ideology shifts over time, the mission of analysis becomes tough, which is simply due to my unfamiliarity of the researched topic's history. In short, if it is difficult for readers to comprehend the history of the IAC articles' topics or the lack of relative concepts of such a topic, it will be inefficient to detect the connotation of the IAC articles or to detect whether these articles convey certain ideology. Take RA25 and RA24 for examples.

Example 6-6: RA25 deals with the Ireland's Republican Movement. To me, without an understanding of Ireland's history, analysis could only rely on the printed texts. As a result, unless the author of RA25 adopts a particular way to present this article (e.g., Marx's pathway), use specific vocabularies (e.g., alienation), or obviously make judgements (e.g., A is right, B is wrong), the descriptions in this article will be seen neutrally and accurately to those readers who are unfamiliar with Ireland (e.g., myself). On the contrary, if RA25 is passed to readers from, for example, Republic of Ireland, Northern Ireland, England, etc., their understanding of this article will be different (even if they are academic scholars who specialise in this topic). To them, even an unremarkable description (e.g., an angle of history) could make a difference, implying their diverse historical viewpoints.

Example 6-7: RA24 is an ideological and cultural analysis of political slogans in communist China. As a Taiwanese, my understanding of the personages, historical transference, and slogans (which are translated from Chinese to English) will be much deeper than those of other readers, such as British students. To British students who major in politics, RA24 might be seen as a neutral and normal article, while it is comparatively easier for me to dig out the personal ideology of the author. Of course, it is also inevitable that I might understand this article through my personal ideology, such as my understanding of Chinese history from the angle of being Taiwanese.

To conclude, the description of history is a pathway to analyse as well as construct ideology. Through the manner of telling histories, this pathway could create a neutral and objective image for ideological analysis/critique, where the articles' authors are ignored. This pathway even functions efficiently in interpellating readers, especially when these readers are unfamiliar with the history of the researched topic.

6.7 Semiotic Analytical Pathway

Except for those IAC articles which deal with media presentation (e.g., RA02, RA04, RA06, RA10, RA25), it is hard to find obvious applications of semiotic concepts in IAC articles. Yet, many semiotic concepts are indeed the invisible guiding rule which influences the making of IAC articles, even though those analysts were probably unaware of their following the semiotic disciplines. It cannot be said that IAC articles obviously apply

semiotics to analyse their research. It can only be said that IAC analysts imperceptibly followed the semiotic rules to conduct their analysis. Hence, this section is more about theoretically explaining how IAC analysts unintentionally followed the rule of semiotics to undertake their analysis instead of explaining how they practicably adopt semiotics.

This section still first introduced the concept of semiotics and then provides examples related to empirical analysis. Although the theoretical review may seem long-winded, these semiotic concepts are the foundation of Procedure 3, *connoting certain meanings*, which needs to be explained at this stage. Moreover, since this thesis has the ambition to establish the methodology for ideological analysis/critique, semiotics is an indispensable method to analyse/criticise ideology.

Theoretical Review

In section 6.3, this thesis has discussed Althusser's concept of ideology as having a "material existence" (1971, p. 165), which is a key point to making ideology analysable. In order to further understand why ideology has a material existence, an easy way is to investigate humans' signification systems (such as gestures, facial expressions, languages, etc.) that construct ideology. Ideology, to a great extent, is the outcome of a specific language. Understanding the construction of language is a way to discover how an ideology is made.

Saussure (as cited in Sturrock, 2003), divided language into "parole" and "langue" (p. 30). The former is a platform for language to demonstrate/perform itself, while the latter is the set of rules or, in Saussure's term, "the grammar of the language" (p. 30). For instance, this English article (a style of displaying language) can be finished only if, first, I understand English grammar and vocabularies (langue—the rules of English writing), and, second, I write (parole—performance) it down.

The rules, grammar, and structure of language not only make the use of a language possible but also dictate how language should be used. Langue is composed of three elements: signs, syntagms, and paradigms (Fiske, 1990). Concepts of syntagms and paradigms will be discussed later. What Saussure is truly interested in is nothing but signs.

Saussure (as cited in Fiske, 1990) declared that signs are composed of two parts: a "signifier" and a "signified" (see Figure 6-1). The former is a sign's "sound" or "image" (Berger, 2000, p. 37), which is the form or the figure of an object without any meaning. The

latter (signified) refers to the “concept” or the meaning of an object that is embedded inside people’s minds when they think of such an object. In short, ‘signified’ means that people can recognise the meaning of one object without even practically seeing this object (Berger, 2000; Fiske, 1990).

Figure 6-1: Saussure’s Concept of Sign

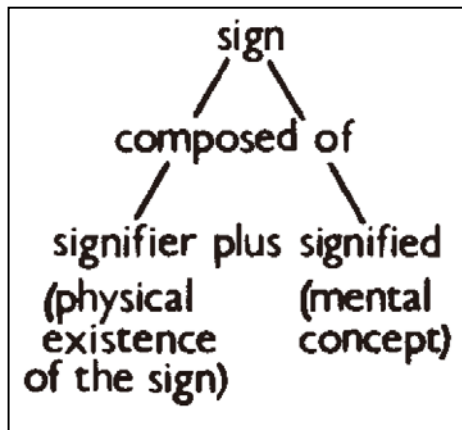

Source: Fiske, J. (1990, p. 44)

To Saussure (in Fiske, 1990), the relationship between signifier and signified is arbitrary. It means that there is no absolute cause to link the word, such as ‘justice’ (signifier) to the ‘meaning’ of justice (signified). One thing’s meaning must receive the answer from what this thing does not mean—why A is A is because A is **not B**. The meaning of ‘justice’ is not generated by itself; differently, justice receives its meaning from what is *not justice*. In other words, it is the positional difference of a thing (e.g., one concept) within the system of language that determines its meaning, but not the natural existence of such a thing (e.g., the ‘word’ justice *per se*).

Thus, the question ‘what does this sign mean?’ can only be answered with ‘what does this sign **not mean**?’ This special relation between signs, which generates the meaning of signs, is what Levi-Strauss (as cited in Fiske, 1990) called “binary oppositions” (p. 116). Levi-Strauss argued, “A binary opposition is a system of two related categories that [...] comprises the universe” (in Fiske, p. 116). Fiske (1990) described that when a binary opposition functions perfectly, one thing that does not belong to category A must belong to category B. Although binary oppositions are not the best way to define everything humans experience, people understand the world most easily through them (p. 118).

Accordingly, the making of ideology is *not* to pick up one phenomenon referring it to a specific meaning, and then claim ‘this is an ideology I found’. Instead, it is through the notion of binary opposition that the meaning of a thing is defined by what it is not.

The concept of binary opposition helps to understand the meaning of a sign (of course, by what the sign does not mean); yet to understand the meaning of the whole context (i.e., to understand the ideology of such a context), it has to reply on the other two aforementioned semiotic concepts, that is, the syntagms and paradigms.

Syntagm refers to a combination of diverse signs in which the meaning of language (e.g., an oral or written sentence) is generated (Fiske, 1990; Robert & Kress, 1988). As Figure 6-2 shows, the sentence is composed of diverse signs (e.g., the subject *I*, the noun *suit*, and the location *school*). Through this way, meaning of this sentence can be confirmed. Most importantly, the composing of signs in this syntagm structure has to obey the grammar—that is, what Saussure called the ‘langue’; in this way, readers are able to make sense of this sentence.

In addition, paradigm is a selection pool where a sign (e.g., *suit*) can be substituted for another similar set of signs (e.g., set of clothing; Fiske, 1990; Robert & Kress, 1988). As Figure 6-2 shows, sign *I* (representing the subject) could be replaced with *you*, *he*, or even a name, like Tom or Mary. According to the notion of binary opposition, a diverse selection of sets of signs (e.g., *I* instead of *he*; *school* instead of *church*) will create different meanings of the sentence. For example, the meaning of ‘I wear a coat’ to school is different from that of wearing a ‘T-shirt’, which implies seasonal differences.

Figure 6-2: Relation of Signs, the Syntagmatic Structure, and the Paradigmatic Choices

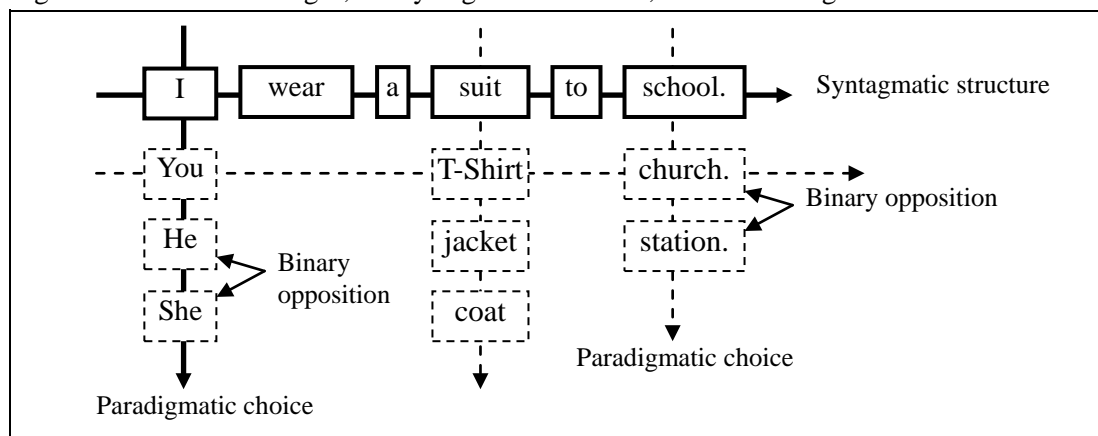

In Chapter 5, this thesis claimed that it is able to identify the Primary Class and its corresponding Secondary Class in all IAC articles (of course, in some cases, the Secondary Class is not obvious). They are in a binary oppositional relationship. They define each other. It is reasonable to say that any ideologies are all constructed by many signs. Except the Primary Class (sign), there must exist many subordinate signs that stand for the same position with the Primary Class. Together they all contribute to the making of one ideology. This thesis simply named these signs as Sub-Primary Classes (henceforth, Sub-PCs). Surely, the corresponding Sub-Secondary Classes (henceforth, Sub-SCs) do exist as well.

Thus, based on semiotic concepts—signs (with a binary oppositional relationship, i.e., the Primary Class v.s. Secondary Class, the Sub-PCs v.s. Sub-SCs), syntagmatic structure, and paradigmatic choices—the map of how one ideology is recognised could be drawn as in Figure 6-3 (How Reality is Constructed). (Of course, the making of ideology is very complex, which will be detailed in *Procedure 3: Connoting Certain Meanings*, displayed as Figure 7-3.)

Figure 6-3: How Reality is Constructed (from the Semiotic Perspective)

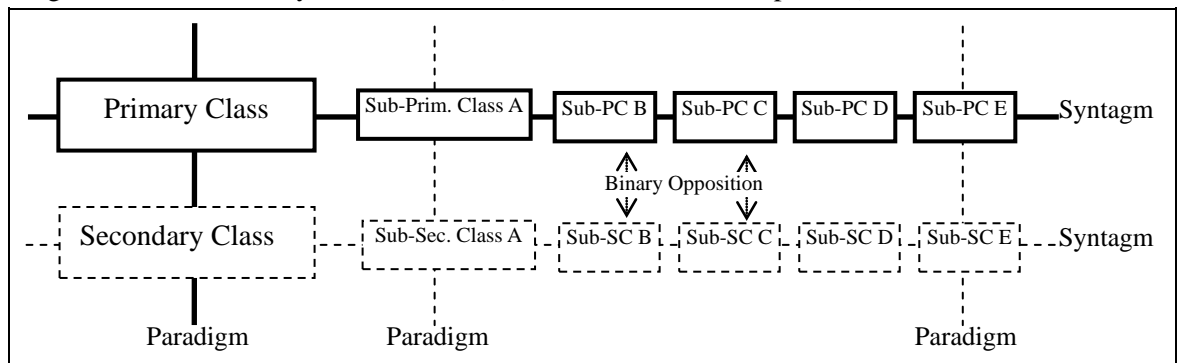

The following discussion will provide two examples. The first one theoretically explains how the basic semiotic notions can be applied to illustrate the making of ideology which is based on the model of Figure 6-3. Another example practically shows how IAC analyst, Bishop, undertook his research via the dimension of semiotics.

Empirical Analysis

Example 6-8 (theoretical dimension): The quotations below cited from RA02 (Abbas, 2001) have explained how the IAC analyst, Abbas, described (presented/created) the reality of his

research, which can be analysed through the semiotic analytical pathway. This quotation says:

This paper is a theoretical attempt to explain the ideological nature of anti-Muslim discourse found in the British press. It is argued that dominant media capital, that is held in ever fewer hands, seeks to subvert South Asian Muslims by endeavouring to define an explicitly negative view of Islam. (p. 245)

From the first sentence, *British press* can be seen as the Primary Class. This shows that the analyst of RA02 tried to show how the British press describes *Muslims*⁹⁴. The second sentence reveals several of the Sub-Primary Classes, such as the terms *dominant media capital*, *subvert*, *South Asian Muslims*, *endeavouring to define*, etc. Based on these two sentences, a reality,⁹⁵ represented ideologically, which the analyst of RA02 tried to present/create, can be simply drawn as in Figure 6-4 (see syntagmatic structure 1).

⁹⁴ Of course, *Muslims* could be the Primary Class as well; if so, the discourse becomes how Muslims *are described* by the British press. The selection of an ‘active’ or ‘passive voice’ could influence the feeling when people read (which will be further discussed in the next chapter). The former style could create a dominant and arbitrary image to the British press while the latter (passive) expresses a suffering image to Muslims. Based on this thesis’s analysis of this article, the author of RA02 is closer to arguing how the British press actively constructs a negative image on Islam. Thus, in this example, the British press is seen as the Primary Class.

⁹⁵ Whether it is a presented-reality or a constructed-reality depends on how readers, i.e., you and me, interpret it. Please refer to discussion in the previous chapter.

Figure 6-4: How the British Press Describes Muslims from the Semiotics Perspective

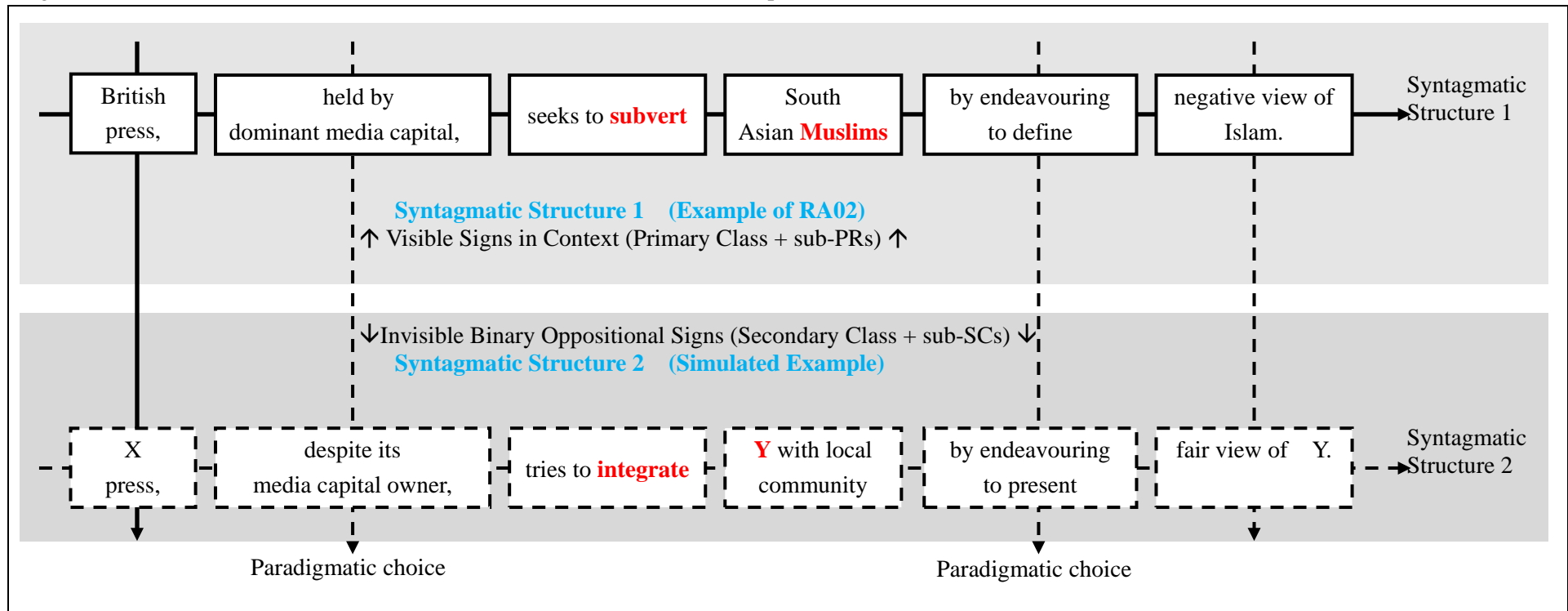

Although it is difficult to exactly detect the corresponding Secondary Class (and the Sub-SCs), the binary oppositional relationship between the Primary and the Secondary Classes does exist. Let us consider some word switches, as shown in Figure 6-4 (see simulated example of syntagmatic structure 2). In the syntagmatic structure 2, the word/sign *integrate* replaces *subvert* (from syntagmatic structure 1). Y (i.e., other paradigmatic choices: religions like *Buddhism* or *Hinduism*) replaces the term *Muslims*. In short, all signs (e.g., *subvert* or *Muslims*) in the structure of language are changeable; once any sign in a sentence is changed, the meaning of such sentence will be different. As the syntagmatic structure 2 in Figure 6-4 indicates: media X is described to adopt a 'positive' or at least a 'neutral' position to present its object Y, in which media X helps society's integration instead of distinction.

Namely, what semiotic analysis does is to determine what signs the analysts use (e.g., British press, *subvert*, *Muslims*) and compare with other possible signs that the analysts do not use (e.g., X press, *integrate*, Y religion). In so analysing, the meaning of one sentence emerges. A sentence is composed of signs; a paragraph is composed of sentences; an article is composed of paragraphs. While this relationship is recognised, how (the analyst's) reality⁹⁶ of such an article is presented/created and what it is could be delineated.

Figure 6-4 theoretically shows how this thesis analysed RA02 in terms of semiotics, which revealed how the analyst of RA02 unintentionally followed the semiotic rules to conduct his IAC work. The following example takes RA04 to ascertain how analyst, Ronald Bishop, undertook his analysis via semiotics.

Example 6-9 (practical dimension): Bishop in RA04 explained how a diet company's product, Ultra Slim-Fast, conveys a professional and scientific image. His application of semiotics was revealed in his analysis in relation to a TV commercial. He wrote:

In 1996, the company introduced the "Slim-Fast Institute." One Institute commercial began with **white-coated characters** scurrying around behind a pair of imposing **glass doors**, which **open**, allowing the viewer to **pass through**. Would-be **scientists** are shown **eyeing test tubes** and convening to discuss **complex figures** on a **wall chart**. (p. 343; emphasis added)

Boldface is added to reveal the track of semiotic analysis. In this example, the diet company's

⁹⁶ The discussion of semiotics so far can only explain how reality is constructed. Of course, the term reality, to a great degree, could refer to ideology, as the previous chapter has discussed how reality represents ideology. Yet, regarding the making of ideology, the notion of connotation should be considered in order to provide a complete explanation which will be explained in *Procedure 3: Connoting certain meanings*.

‘Slim-Fast Institute’ is the Primary Class, which is what the commercial tries to highlight. Through Bishop’s description, several Sub-Primary Classes could be identified (as shown in boldface) which are applied to promote reliability of the Slim-Fast Institute. Based on semiotic analysis, Bishop revealed how the TV commercial applied specific signs to create certain meanings. (This example will be further explained later)

Yet, what meanings (i.e., connotation) the signs bring to readers (explaining why ideology emerges) is impossible to detect simply by the basic semiotic notions suggested above. It requires extra analytical work, which will be explained in the next SWPs procedure (*procedure 3: connoting certain meanings*). The purpose of suggesting semiotics as an analytical pathway is not only to echo Althusser’s concept of ideology as having a “material existence” (1971, p. 165). It is also that since all IAC articles employ signs, there is no reason to ignore the most basic elements, which always carry the possibility to create ideologies.

Again, in order to provide a better understanding of how the semiotic analytical pathway was applied, Table 6-8 is a reference showing the application of semiotics in the collected 33 IAC articles. The original IAC articles could be found in the disk attached in Appendix 1.

Table 6-8. Reference of IAC Articles Which Apply Semiotic Analytical Pathway

SWPs Code: P2-S (Semiotic Analytical Pathway)	
Articles	Found References/Examples
RA02	p.249(5);
RA03	p.143(7); p.149(13); p.150(14);
RA04	p.341(8); p.342(9); p.343(10); p.344(11); p.345(12); p.346(13); p.347(14); p.348(15); p.350(17);
RA05	p.3(1); p.4(2); pp.6-7(4-5); pp.7-9(5-7); pp.9-11(7-9);
RA06	p.446(2); p.447(3); p.448(4); p.449(5); p.450(6); p.451(7); p.452(8); p.453(9); p.454(10);
RA07	p.108(2); p.110(4); p.113(7); p.115(9); p.118(12); p.119(13);
RA08	p.262(2); p.263(3); p.272(12); p.273(13);
RA09	p.591(5); p.592(6);
RA10	p.418(2); p.419(3); p.420(4); p.421(5); p.422(6); p.423(7); p.425(9); p.427(11);
RA11	p.102(4);
RA12	p.1032(8); p.1034(10); p.1036(12); p.1037(13);
RA14	p.100(1);
RA16	p.145(9); p.146(10); p.147(11);
RA17	p.355(7); p.356(8); p.359(11); p.360(12); p.361(13); p.364(16); p.365(17); p.367(19); p.368(20);
RA18	p.159(6);
RA19	p.167(6);
RA20	p.356(4); p.362(10); p.364(12); p.367(15);
RA21	p.414(4); p.415(5); p.419(9); p.420(10); p.421(11); p.422(12); p.425(15); p.427(17);
RA22	p.72(3); p.73(4); p.75(6); p.76(7); p.79(10); p.82(13); p.83(14);
RA23	p.391(6); p.392(7);
RA24	p.489(3); p.490(4); p.491(5); p.496(10); p.497(11); p.499(13);
RA25	p.469(4); p.472(7); p.474(9); p.477(12); p.480(15); p.480-1(15-6);
RA27	p.180(1); p.181(2); p.184(5); p.197(18); p.198(19);
RA28	p.167(11); p.170(14); p.171(15); p.174(18);
RA29	p.919(6);
RA30	p.466(2); p.468(4); p.470(6); p.471(7); p.473(9);
RA31	p.222(5); p.224(7); p.226(9); p.229(12); p.231(14); p.233(16); p.235(18); p.236(19); p.240(23);
RA32	p.18(2);
RA33	p.657(17); p.662(22);

Application of the Semiotic Analytical Pathway

The following Table 6-9 provides guidance for future IAC analysts to analyse/criticise ideology if they plan to adopt a semiotic analytical pathway. Yet many semiotic notions, such as language, parole, langue, signifier, signified, etc., are simply the theoretical concepts. There are only a few concepts (such as signs with binary oppositional relationships, syntagmatic structures, and paradigmatic choices) that can be applied to practical analysis. Thus, the following Table 6-9 only displays the application of these concepts.

Table 6-9. Application of Semiotic Analytical Pathway

Concept of Ideology	The Applicable Discourse Condition
<p>Signs (Binary Opposition)</p>	<p>First, future IAC analysts have to find out the main subject of their research, i.e., the Primary Class (sign) and its other subordinate signs. This is a basic and essential step for ideological analysis. Then, although it is not always detectable, analysts have to detect the secondary sign and its companies based on the notion of binary opposition. The meaning of the Primary Class emerges from its binary oppositional relationship with the Secondary Class. Hence, the more signs of contexts are recognised, the better the analysts can obtain the skeleton of such contexts.</p>
<p>Syntagmatic Structure</p>	<p>In this axis of the syntagmatic structure, diverse signs join together to create meaning. Thus, analysts have to investigate how signs are applied as well as to detect what extra specific signs are included in this axis. One more or one less sign in the axis changes the meaning. The more the analysts can realise the <i>structure</i> of a sentence, a paragraph, a section (a chapter), or a whole context, the better they understand the meaning of texts.</p>
<p>Paradigmatic Choices</p>	<p>Paradigmatic choices mean the different selections within a set of similar signs. Thus, analysts have to detect <i>what sign is selected</i> in the similar sets of signs, because whenever a single composed sign on this axis changes, the meaning of reference changes (e.g., like and dislike). The more analysts understand what sign is selected, the better they can detect the differences of signification.</p>

6.8 Conclusion and Discussion

What concerns analysts the most determines the invisible guiding mechanism, which influences how they undertake their analysis. The theoretical perspectives that IAC analysts apply to analyse their research, of course, are diverse, and depend on the theoretical concepts with which the IAC analysts are familiar as well as according to their education background. Yet, among these seemingly diverse styles, which composed the 33 IAC articles, there are still some common theoretical applications revealed in analysts' analysis. This chapter has introduced five analytical pathways, including Marx's, Althusser's, Gramscian, historical descriptive, and semiotic analytical pathways.

Yet, undeniably, the above five pathways, to a very great extent, represent my own ideology regarding ideological analysis/critique. What theories I have read influence (in fact, determine) what pathways I am able to discover. People can only understand/find out what they have already known. That is to say, even though the collected IAC articles are from diverse research fields, the analytical pathways that this thesis has introduced are limited to my own ideology. Such limitation also evokes this thesis's research question again: whether humans are capable of escaping from the influence of ideology.

Procedure 2: Applying Theoretical Foundation

Chapter 7

Procedure 3: Connoting Certain Meanings & Procedure 4: Illustration — Ideology Concealed in Texts

In *Procedure 1*, this thesis suggests IAC analysts to *identify essential elements* of their research phenomenon, recognising the significance of these three elements, Class, power, and reality as well as their interrelationship. This is a procedure to identify the nature of ideology. In *Procedure 2: selecting theoretical foundations*, IAC analysts apply the theories to explain and verify the phenomena they have found in their research. Five analytical pathways are inducted by this thesis, including Marx's, Althusser's, Gramscian, historical description, and semiotic pathways. Procedure 2 is to examine the making of ideology.

This chapter deals with procedure 3 and 4. *Procedure 3* provides a theoretical basis for explaining why and how one phenomenon becomes (is considered as) an ideology. In this chapter, Barthes' mythology is introduced. His notion helps to explain why the meaning of one sign transforms to another meaning, or how a phenomenon implies a certain ideology. This procedure is a bridge to connect the readers' original simple consciousness to the land of ideology.

If Barthes explained how diverse simple signs convey specific connotations, which together construct a certain ideology or preferred reading through a theoretical perspective, then what *Procedure 4, Illustration*, does is to detect the techniques (i.e., illustrating techniques) that IAC analysts usually use in which their writings demonstrate the same tracks/logics of operation as in the theory of mythology.

Procedure 3: Connoting Certain Meanings

7.1 Introduction

In Procedure 2 (Chapter 5), this thesis offered Figure 6-3 to explain how reality is constructed (i.e., revealing certain ideology) through the application of basic semiotic notions. However, strictly speaking, Figure 6-3 can only be seen as a basic model because this figure simply regards ‘signs’ as an integer (the whole) of meaning, which ignores that signs in fact are composed of the *signified* and *signifier* as Saussure’s semiotics suggested. Accordingly, a better structure of reality should be drawn as Figure 7-1 (How Reality is Constructed with the Notion of the Sign). Figure 7-1 is the advanced edition of Figure 6-3. They share the same logic to explain how reality (or ideology) is constructed. Understanding that sign is composed of *signifier* and *signified* is the key to understanding Barthes’ mythology which is also the bridge to understanding why/how a simple sign is able to carry certain connotation/ideology. Ideology was not born out of nothing.

Figure 7-1: How Reality is Constructed based on the Notion of Sign (Signified & Signifier)

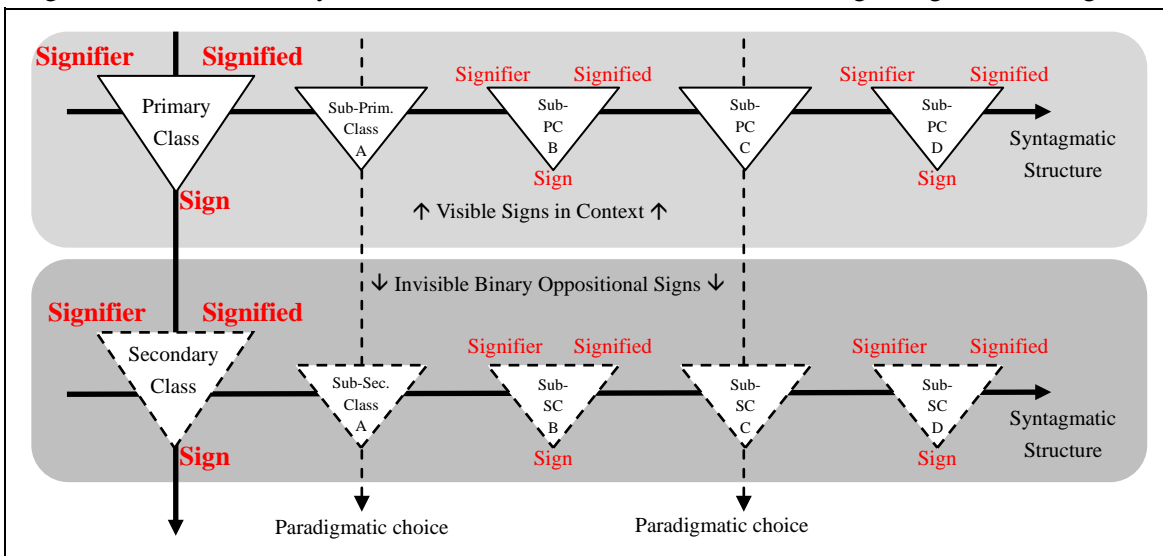

Compare Figure 6-3: How Reality is Constructed (from the Semiotic Perspective)

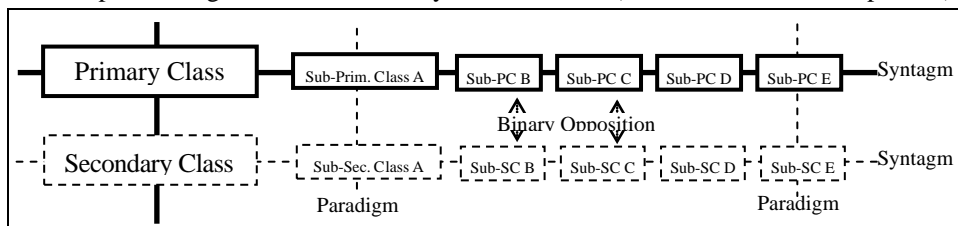

As discussed in Chapter 5, the concept *ideology* possesses two characteristics—negative and positive meaning/function. From a positive or neutral angle of the characteristic of ideology, claiming that Figure 6-3 (or Figure 7-1) can explain how a reality (or ideology) is presented should be acceptable. The reality (ideology) is constructed by diverse signs in the syntagmatic structure axis. These diverse signs are all selected from their own paradigmatic choice pools.

However, it is undeniable that ideology is mostly seen to convey ‘a distorted or false belief’, thereby having a negative meaning/function. Here comes a question: What is the basis for analysts to assert that Y (e.g., a film or context) conveys an ideology (e.g., an American hegemony)? What is the authority for analysts to refer to one phenomenon as ideology with *a negative characteristic*? Accordingly, when an ideology is negatively presented, simply adopting Figure 7-1 (or Figure 6-3) to explain how reality (ideology) is constructed is problematic. (A new Figure 7-3 will be provided to amend this problem in a later discussion.)

In fact, this problem has been discovered in 33 collected IAC articles, which shows that almost none of the IAC analysts are capable of *clearly explaining why* their research phenomenon carries/represents a certain ideology, or *how* one ideology is constructed. Instead, they just directly state one thing as an ideology. Such kind of statement is barely enough to be accepted when the characteristic of ideology refers to a positive or neutral dimension; yet, when it refers to a negative characteristic of ideology, directly stating that X signifies an ideology is debatable.

This is also the common critique of ideological analysis/critique: by whose authority are you so confident in claiming this is an ideology? Why this ideology *is the ideology* cannot be validated by random or arbitrary allegation after all. It always needs a theoretical foundation, especially when the researched phenomenon is referring to a negative characteristic of ideology.

Therefore, this section (*Procedure 3: Connoting Certain Meanings*) will introduce Barthes’s notion of mythology to solve the shortcoming of randomly or arbitrarily labelling one phenomenon as an ideology. Barthes’s notion helps to explain why the meaning of one sign transforms to another meaning, how a phenomenon implies a certain ideology, or *how*

such an ideology comes to exist. This is an important foundation to comprehend the making of ideology which is also a bridge to connect the readers' original simple consciousness to the land of ideology.

7.2 Connoting Certain Meanings

Drawing on Barthes's (1993) mythology, it can be said that the difference between a neutral characteristic (e.g., specific kinds of beliefs) and a negative characteristic of ideology (e.g., a distorted or false belief) is the connotation. The reason why one ideology is negatively recognised (or why one ideology is deemed to convey a negative image) is that the meaning of the signs which construct one ideology no longer refers to its original meaning; instead, these signs signify a new meaning, i.e., a connotation, resulting from certain power and cultural influences.

In his other work, *Elements of Semiology*, Barthes (1968) reinterpreted semiotics. He suggested two levels, *denotation* and *connotation*, to understand the meaning of signs, or the system of signification. The first level, denotation, refers to Saussure's semiotic concepts. In terms of the second level⁹⁷ (i.e., connotation), his concept of *myth* has explained how signs start to carry certain meanings.

⁹⁷ Regarding the second level (i.e., connotation), Barthes in his life has suggested three dimensions to explain how connotation emerges, including the concepts of connotation (1968), myth (1993), and symbol (1977 in Fiske, 1990). In respect of the concept *symbol*, in fact, Barthes did not provide a systematic explanation of how the connotation of symbol emerges (Fiske, 1990). According to Fiske (1990), *symbol* can be explained as an object that will become a symbol when the original meaning of this object is adopted to describe another thing (Fiske, 1990). For example, when people distinguish the gender for a toilet, they usually use a pipe to refer to male while using high heels to signify female. In terms of the concept of connotation (method angle), this thesis argues, to a great degree, Barthes's notion of connotation (method angle) shares the same operational logic with his aspect of myth. Using Barthes's own example to explain this similarity: a man sends a bunch of roses to a woman; based on the meaning of the sign, roses refer to a type of flower (compare to Barthes's first order system). Only when they are sent from one person to another, do roses start to signify love (compare to Barthes's second order system). Barthes explained that the sign of the rose has shifted its meaning from material meaning (a flower) to a cultural meaning (love). Regarding Barthes' concept of myth, comparatively speaking, this concept was well expounded. Thus, this thesis will adopt his concept of myth to explain how the meaning of signs change.

Theoretical Review—Barthes’s Mythology

Barthes wrote (1993),

Myth is a system of communication [...] a message [...] a mode of signification, a form [...] a type of speech [...] Myth is not defined by the object of its message, but by the way in which it utters this message. [Myth is] a type of social *usage* which is added to pure matter. (p. 109, emphasis original)

Barthes’s own words simply provided his definition of myth, which explained two features of his mythology. First, the function of myth refers to a *process*; and second, *power operation* is embedded in this process.

To Barthes (1993), myth is a two-dimensional (or two steps, two orders) operation on the sign. He provided a pattern displaying the relationship between myth and sign as well as how myth functions, as Figure 7-2 shows.

Figure 7-2: Barthes’s Myth Model

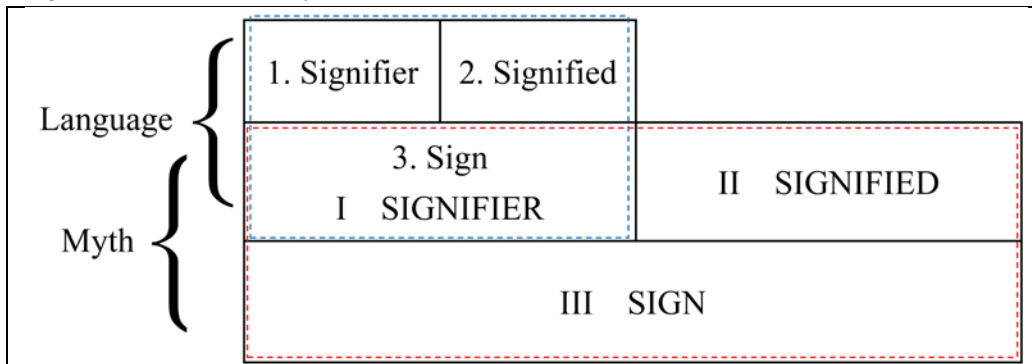

Source: Barthes, R. (1993, p. 113; colour boxes added)

As elucidated in section 6.7 (semiotic analytical pathway), a sign is composed of the *signified* and *signifier*; meaning of one sign is confirmed according to the binary oppositional relationship between this sign and others. To Barthes, this is the basis of semiotics (i.e., the ‘language’ part in Figure 7-2, see blue dotted box), which only shows the meaning of denotation, referring to the first level of the signification system (i.e., Saussure’s semiotic concepts). Barthes (1993) argued that Saussure only focussed on the relationship between *signifier* and *signified* and, as Fiske (1990) explained, ignored the “external meaning” of the signs (p. 44). Despite the fact that the ‘paradigmatic choices’ or the ‘syntagmatic structure’ of those signs remains unchanged, these same signs can still convey diverse meaning within a specific cultural or social background. It could be said that Barthes emphasised more the ‘hidden meaning’ of the structure of signs than the ‘structure’ of signs *per se* (the latter is Saussure’s work).

To Barthes (1993), the ‘hidden’ meaning of signs could be found in what he named the “second-order semiological system” (Barthes, 1993, p. 114), as the ‘myth’ part in Figure 7-2 shows (see red dotted box), where the myth helps to create connotations⁹⁸. Based on this two-order semiological system, it is understandable that myth is a concept that relies on the first-order system and exercises on the second-order system where connotation emerges.

How does myth work in Barthes’s semiological system? To Barthes, a sign in the first-order system has its original meaning, history, and story. So, the first step that myth operates is to hollow out the original meaning of the *sign* (i.e., the ‘3. Sign’ in Figure 7-2) of the first-order system. In so doing, this sign will only maintain its ‘form’ without any ‘concept’ inside, which, according to the semiotic concept, becomes a new signifier—a signifier of the second-order system (i.e., the I SIGNIFIER in Figure 7-2).

While the meaning of a sign (3. Sign) in the first-order system is hollowed out and becomes the new signifier (I SIGNIFIER) of the second-order system, the next step that myth operates is to immediately introduce a new meaning, a new history, or a new story which myth prefers (i.e., a new signified, II SIGNIFIED in Figure 7-2) and to link this new meaning with the new signifier (i.e., I SIGNIFIER or the hollowed sign ‘3. Sign’). The reason a myth can do so is due to the *arbitrary* relationship between the *signifier* and *signified*. As a result, the connotation (i.e., III SIGN, invisible) of the original sign (i.e., 3. Sign, visible) comes to exist.

Namely, how myth works is to make the first-order system’s ‘3. Sign’ become the second-order system’s “I SIGNIFIER”. As Barthes (1993) explained, the sign “in the first system [...] becomes a mere signifier in the second” (p. 114). Simultaneously, the new II SIGNIFIED, which myth prefers, will be arbitrarily linked to this I SIGNIFIER. In so doing, this original sign (i.e., “3. Sign”) will be displayed with a totally different meaning (i.e., connotation, the invisible III SIGN) to readers.

⁹⁸ What has to be noted first is that, to Barthes, the connotation here does not simply refer to a ‘false’ concept; instead, it means what meaning of signs is recognized within a certain cultural background. While the meaning of signs that people perceive damages the interests of one group of people, the discovery of what meaning (connotation) such signs signify becomes very important. Barthes argues, the more people that take the meaning of signs for granted, the more dangerous the signs are. In order to discover how this ‘common sense’ (i.e., connotation) works, it has to go through mythological analysis.

What one has to notice is that the ‘new meaning (connotation, i.e., III SIGN)’ that myth reinstalls into the hollowed sign (i.e., 3. Sign) is not the myth of what people used to think when reading this term itself. Myth does not refer to any meaning. Myth, as Barthes claims, is the “signification” that is a *process*—transforming signs of the first-order system into a new signifier (hollowed form) in the second order, and then arbitrarily linking with a new signified (myth’s preferred concept)—assisting a sign to start to signify certain connotations (p. 121).

Nevertheless, the reason a myth is able to function is not simply because of the above process. Another point that makes myth special is that myth always has an ‘excuse’ whenever one interrogates its (sneaky) influence and efficiency. This excuse is what Barthes (1993) called myth’s “alibi” (p. 123). Barthes further explains:

The essential point in all this is that the form does not suppress the meaning, it only impoverishes it, it puts it at a distance ... [Its meaning] is a death with reprieve; the meaning loses its value, but keeps its life. The meaning will be for the form like an instantaneous reserve of history, a tamed richness, which it is possible to call and dismiss in a sort of rapid alternation. (p. 118)

What Barthes tried to say is that although the meaning of the sign in/of the first-order system is hollowed by myth, the original meaning of this sign never disappears. It will show up again when the intention of myth is detected. When one argues that myth changes the meaning of a sign, myth can always confidently offer its ‘alibi’ to refute criticisms by claiming that ‘nothing has changed’ because it is ‘still the same sign’ (i.e., 3. Sign), which represents the same meaning (instead of the new reinstalled meaning). When readers are again negligent, myth will immediately connect readers to the connotations that myth actually wants to convey imperceptibly.

That is to say, myth’s functioning process always needs a citadel where it can pretend to be innocent and guiltless; but myth will stealthily take over the authority of interpretation when people do not pay attention to what they read/see. Barthes (1993) concluded, “It is this constant game of hide-and-seek between the meaning [i.e., 3. Sign] and the form [i.e., I SIGNIFIER] which defines myth” (p. 118).

To conclude, the two levels of the semiological system are the key points as to why myth can display its strength to transform the meaning of signs. Myth will hollow the original meaning of sign (i.e., 3. Sign) of the first-order system and make it the new signifier

(i.e., I SIGNIFIER) of the second-order system. Simultaneously, a new meaning (i.e., II SIGNIFIED), which myth prefers, will be arbitrarily linked to the I SIGNIFIER. As a result, when readers see this sign, they do not read the original meaning (i.e., '3. Sign'); instead, what they perceive is the connotation of such sign (i.e., the invisible III SIGN). Of course, when one argues myth's intervention in signs, myth will defend that nothing has changed because the sign is still the same sign, which also represents the same meaning (original meaning). This is myth's alibi. Myth always enjoys playing hide-and-seek.

This section theoretically discusses how simple signs, once having the aid of myth, start to convey certain connotations. How myth functions could refer to the previous Figure 7-2. In the latter Example 7-1, this thesis will take RA17 to explain how myth works on a single sign (i.e., the word 'just') to convey a connotation.

Yet in most cases, the connotation of an ideology is usually generated from the cooperation of several signs. That is to say: in the process of making an ideology, not all signs can individually reveal its connotation; sometimes, a sign can display a connotation only when it teams up with other signs⁹⁹. Accordingly, a map to explain how and why signs together signify other connotations (i.e., the making of ideology) can be drawn as Figure 7-3¹⁰⁰, which is a combination of Figure 7-2 (explaining how myth functions) and Figure 6-3 (referring to basic semiotic notions). It again testifies that the basic semiotic notion, such as syntagmatic structure, and paradigmatic choices should not be ignored while analysing ideology.

⁹⁹ Take Barthes's (1993) own example of the black soldier who salutes to a French flag. Saluting, as a single sign, refers to the gesture of a hand (the signifier) and the meaning of respect (the signified). While this sign cooperates with other signs, such as 'black people' and the 'French flag', a new meaning, or say, a connotation—France's generousness—comes to exist.

¹⁰⁰ In this figure, the oppositional part only displays the structure of sign (i.e., sign = signifier + signified) instead of the Barthes's myth model (two-order system). This is because the (second-order) connotations result from the (first-order) primary signs; the (first-order) primary signs are defined by their binary oppositional relationship with the secondary signs. The secondary signs have nothing to do with the operation of myth. The Secondary Classes play the comparison roles.

Figure 7-3: How Reality is Constructed from the Myth Operation (Barthes's Concept)

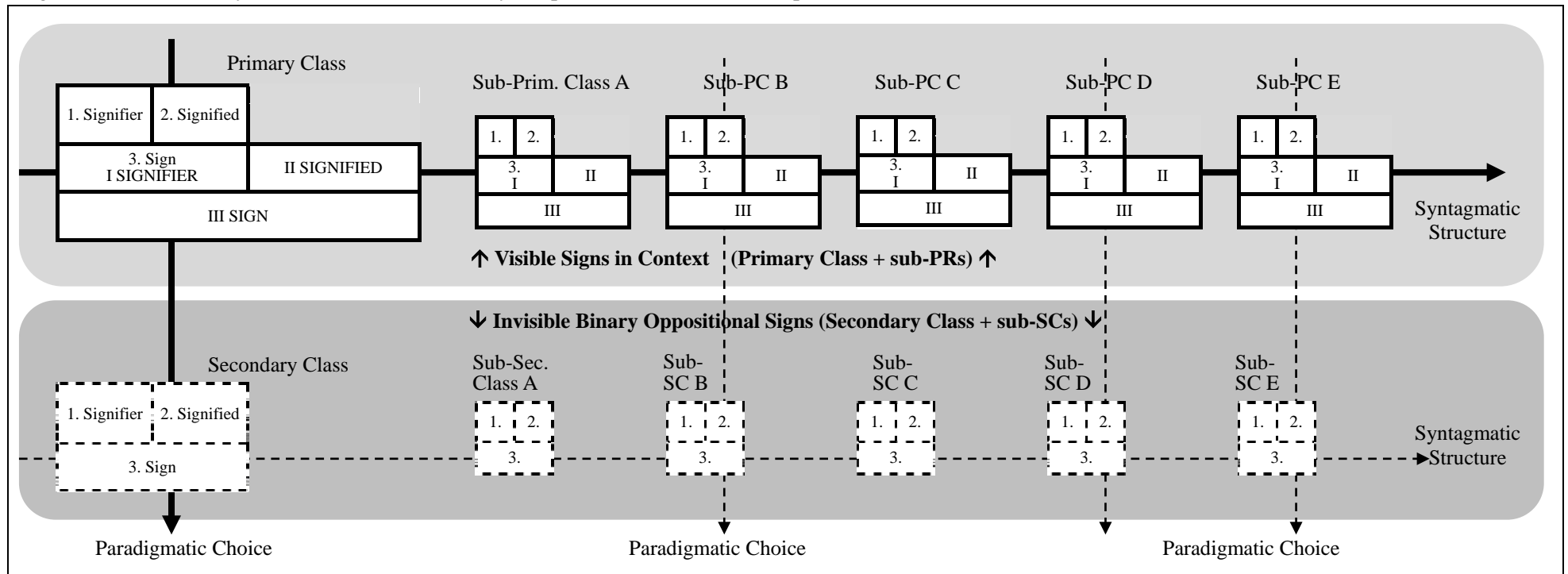

The following examples will explain how a single sign (Example 7-1) signifies a connotation as well as how diverse signs work together (Example 7-2) to convey a connotation.

Empirical Analysis

Example 7-1: How a single sign reveals a connotation. In RA17, the IAC analyst, David Weltman, analysed how the single word, *just*, was appropriated for political intention (to deny things). Weltman pointed out that usage of *just* was able to create comparability between speeches: as he explained, “speakers appear to argue for an ideologically preferred version, and so at the same time against an alternative, or dispreferred one” (2003, p. 350). His explanation, to a great extent, echoes the function of myth in generating connotations. To simply adopt one extract provided in Weltman’s article, where one of his interviewees answers the question of why he joins the Labour Party:

And that is I want to help people. And the reason why I’m in the Labour Party is that I **just** see that the people who need the help the most are more likely to be helped through Labour policies than they are through Conservative policies. It’s really **just** as simple as that. But I didn’t learn my politics through university. If you like I learnt it in the university of life. (p. 358; layout is revised; emphasis original)

In this example, the first-order system is: this politician is definitely a member of the Labour Party. How myth works in this case? The myth first decreases the importance of the politician’s party-background (i.e., to empty the original meaning) and then to implant a neutral role for this politician which works on the second-order system. Because the politician “**just** [sees] that the people [...] are more likely to be helped through Labour policies”, he joined the Labour Party. The word *just* offers a space for this politician to maintain a neutral political position: It is to help people that he joins the Labour Party.

Similarly, when the critics argue that this politician, by using the word *just*, tries to de-emphasise his identity as a Labour Party member and guides the spotlight to focus on ‘he wants to help people’, the myth will respond, ‘No, he did not deny his identity as a Labour Party member. He just thinks that this Party is a good place to help people’. Namely, in this example, the politician adopts the word *just* to create a neutral political position, preventing him from appearing to have a closer relationship with a specific political party. *Just* is the gangplank of the mythical process of ideology.

How a single sign starts to carry its connotation was explained in the above example 7-1. How diverse signs together construct a certain connotation (i.e., ideology) will be illustrated below.

Example 7-2: In RA04, IAC analyst, Ronald Bishop, explained how a diet company's product, Ultra Slim-Fast, conveys a professional and scientific image. He wrote:

In 1996, the company introduced the "Slim-Fast Institute." One Institute commercial began with **white-coated characters** scurrying around behind a pair of imposing **glass doors**, which **open**, allowing the viewer to **pass through**. Would-be **scientists** are shown **eyeing test tubes** and convening to discuss **complex figures** on a **wall chart**. (2001, p. 343; emphasis added)

In this example, the diet company's 'Slim-Fast Institute' is the Primary Class, which is what this commercial tries to promote. Several Sub-Primary Classes could be identified as well (as shown in boldface). They are all signs which are able to signify specific connotations to promote reliability of the Slim-Fast Institute. This thesis has indicated their common connotations, which are revealed according Barthes's mythology, as Figure 7-4 shows.

How might their connotations emerge? Take *Sub-PC A* as an example (see Figure 7-4, red words). At the first-order system, the sign from the TV (or IAC article) is 'white coat', which is composed of the 1.Signifier: a white coat (image), and the 2.Signified: a coat is a type of clothing (concept); accordingly, the 3.Sign here refers to 'white coat is a type of clothing'.

At the second-order system, the meaning of the 3.Sign is hollowed, becoming a form without any concept (i.e., I SIGNIFIER: white coat ~~is a type of clothing~~). At the same time, the myth will reinstall a new concept (i.e., the II SIGNIFIED: a professional sense¹⁰¹) to connect with this hollowed I SIGNIFIER. As a result, the connotation of *Sub-PC A* emerges, that is, III SIGN: white coat signifies a professional sense. Myth works in other Sub-Primary Classes (B-G) through the same logic as well, as Figure 7-4 shows.

¹⁰¹ Why 'professional sense'? It has to consider the colour 'white' mean to us as well as the place that 'white coat' is shown. This point will be further explained later

Figure 7-4: The Reality that the TV Frame Constructs Through the Operation of Myth

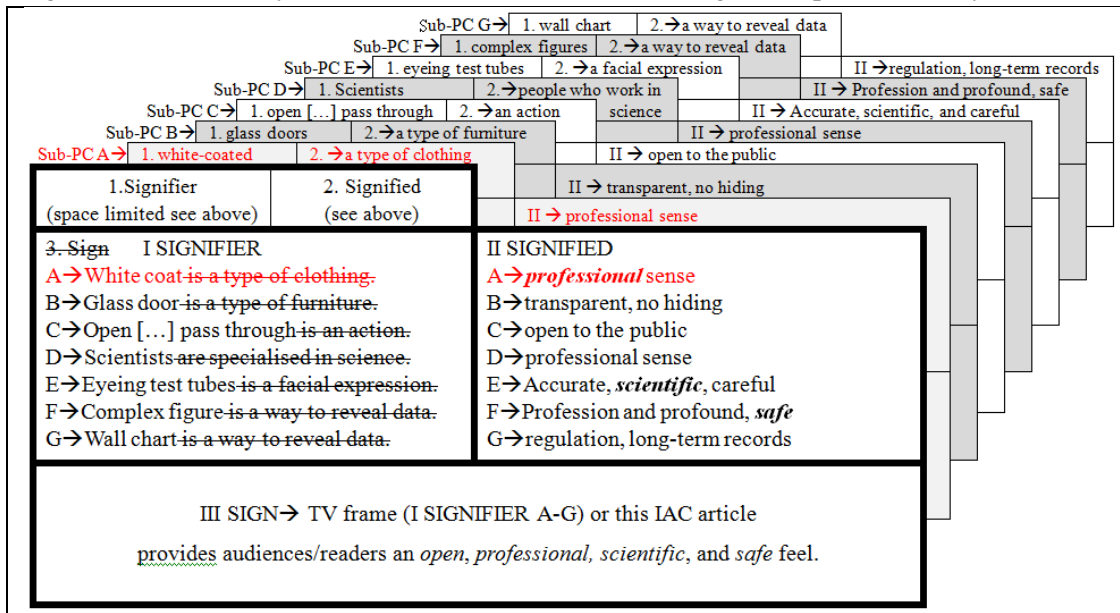

So far, the Primary Class still refers to the ‘Slim-Fast Institute’. It is not until Bishop wrote down the following sentence (as the TV advert continues), the real Primary Class (to which the Slim-Fast Institute in fact serves) as well as the connotation it carries—Ultra Slim-Fast is safe and professional—reveals. Bishop (2001) wrote:

The activity continues as we are told that Ultra Slim-Fast is nutritionally beneficial and that using the product is part of a healthy lifestyle. (p. 343)

That is to say, right after the appearance of the above sentence, the original meaning of Ultra Slim-Fast—as being a product—has been emptied to become a pure ‘form’ without any ‘concept’ inside. Simultaneously, myth immediately replaces a new meaning—a professional, scientific, and safe concept—which results from Bishop’s earlier description (i.e., the previous quotation: Sub-Primary Classes A–G). The entire mythological process can be drawn as Figure 7-5 (please refer to theoretical Figure 7-3 and the previous Figure 7-4).

As explained before, myth always has excuses. When it faces critiques—such as: this advertising utilises professional and scientific frames (signs) to provide credits to the product Ultra Slim-Fast— myth will retreat back to the original fort and reply, ‘No. This is just a frame picturing a laboratory, something necessary for any product’s development’; or ‘We simply adopt the condition of laboratory as the background of our advertisement’. This is the process of explaining how ideology plays the game of hide-and-seek as it inserts specific meanings in ordinary signs.

Figure 7-5: Why the Diet Product Ultra Slim-Fast Conveys a 'Professional, Scientific and Safe' Connotation (Mythological Process)

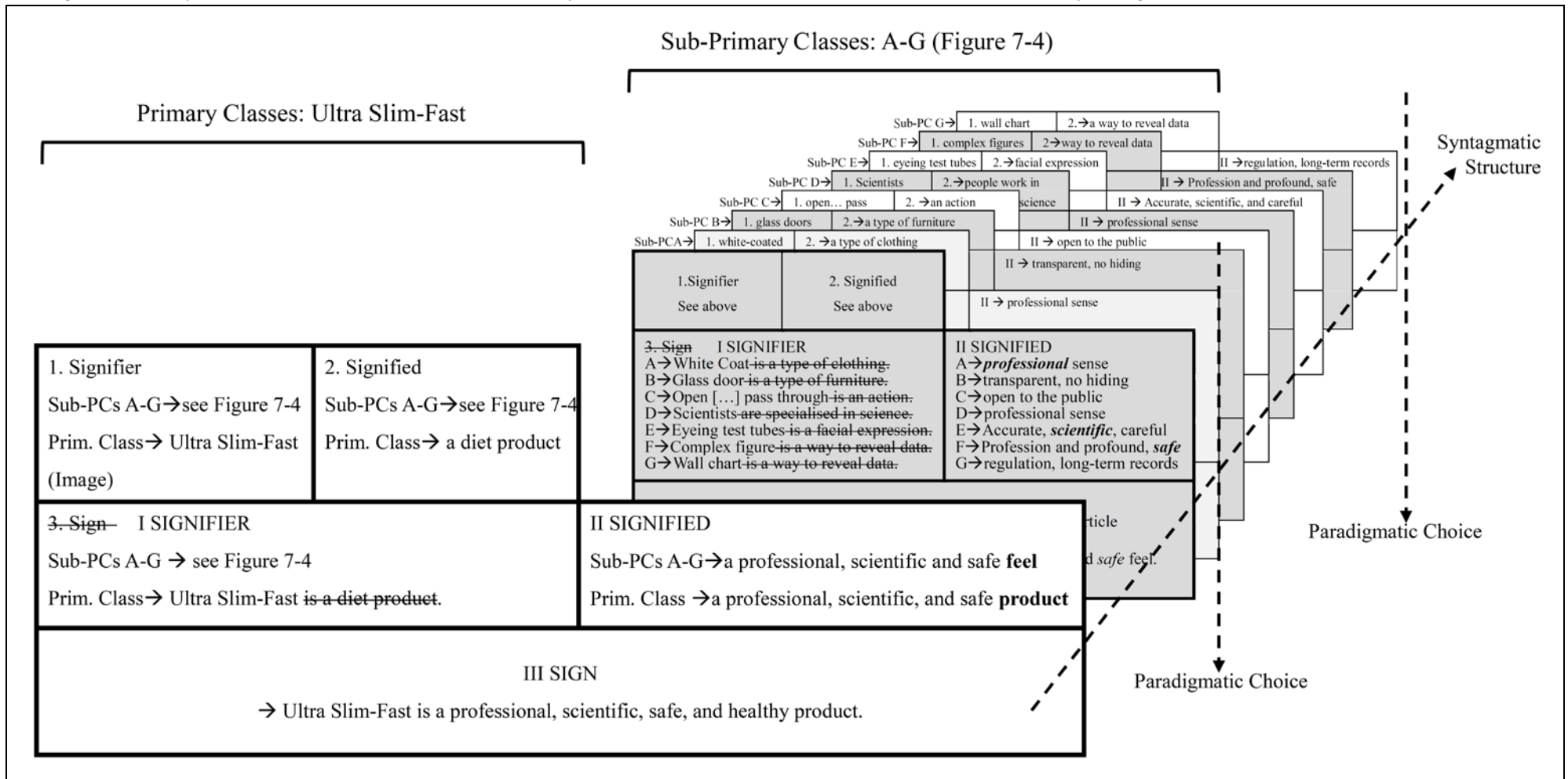

The above two examples are provided to explain how myth functions, or, in other words, to prove how Barthes's notion of myth delineates the making of ideology. Yet, as mentioned earlier, most IAC articles usually directly state one thing as an ideology instead of systematically and clearly explaining why such a phenomenon signifies an ideology or how one ideology is constructed. This is also the reason why this thesis suggests *Procedure 3: Connoting Certain Significances* that is expected to be the bridge to mend their demonstrative shortcoming.

The following example shows what the concept of myth can do to intensify the demonstration that IAC analysts usually ignore.

Example 7-3: In RA07, the IAC analyst, Michael Hazelton, quoted a paragraph from his research data, an official report named *Submission*. The *Submission* says:

The shift from hospital-based to college-based training had been a disaster for the public hospital system. The nurses came out of college with a degree but no practical experience. Some of them cannot even put on a bandage. (1990, p. 119)

His citing these words from the *Submission* shows that he himself has discovered the connotation of this paragraph—that is, *Submission's* words attempt to slander college-based nurse training and to define such training with images of incompetency. Yet, Hazelton failed to tell his readers *why* and *how* these words possess such a negative connotation. This is why this thesis suggests Barthes's mythology to redeem such kinds of demonstrative shortcoming, which happens a lot in most of the IAC articles that this thesis has investigated.

In this example, the critical factor that connects the college-based nurses to images of incompetency and inexperience (or, as the quotation says, 'a disaster for the public hospital system') is from the *Submission's* description: they "cannot even put on a bandage" (p. 119). To the public's traditional recognition, bandaging is a necessary skill that all nurses should be equipped with.

The myth functions first by emptying the original meaning/value of college-based nurses—i.e., their efforts to obtain degrees—and second by replacing it with the traditional public consciousness—i.e., nurses must be skilled in bandaging. In other words, myth will wipe away the necessity and importance of college-trained nurses, who possess other medical knowledge and skills, and displace them with the connotation that traditional skills (e.g., bandaging) are much more important. As a result, after the operation of myth in creating connotation, images of incompetency have been connected to college-trained

nurses.

Again, while the critics argue that the ideology of this report, *Submission*, expresses disdain for the college-trained nurses, the myth will retreat to the literal meaning of words and reply, ‘No, the report only points out their inexperience with bandaging compared to hospital-trained nurses. This report does not mean college-trained nurses are incompetent’. Consequently, this operation of myth, by playing the game of hide-and-seek, helps certain group to maintain or intensify their certain ideology (i.e., the orthodoxy of hospital-based nurse training).

To conclude, in this section, this thesis has provided examples to explain how myth operates based on a single sign as well as a set of signs to convey a certain connotation in which one ideology is established. Moreover, this thesis also explained why and how Barthes’s mythology could be a bridge to redeem the demonstrative shortcoming where IAC analysts usually neglect.

Table 7-1 is a reference list guiding identification of how IAC analysts’ writings pointed out the connotation that their research subjects convey, even though, in most cases, they did not provide adequate demonstrations to support their findings. Yet, Barthes’ mythology could mend such shortcoming. The original IAC articles could be found in the disk attached in Appendix 1.

Table 7-1: Reference of IAC Articles Which Imply the Existence of Connotation

SWPs Code: P3-C (Connoting Certain Significances)	
Articles	Found References/Examples
RA01	p.173(9); p.178(14); 180(16);
RA03	p.139(3); p.140(4); p.141(5); p.143(7); p.144(8); p.146(10); p.148(12); p.149(13); p.151(15);
RA04	p.338(5); p.339(6); p.341(8); p.342(9); p.343(10); p.344(11); p.345(12); p.346(13); p.347(14); p.348(15); p.351(18);
RA06	p.447(3); p.448(4); p.450(6); p.451(7); p.453(9); p.454(10); p.455(11); p.456(12); p.457(13);
RA07	p.118(12); p.119(13); p.122(16);
RA08	p.271(11);
RA10	p.419(3); p.422(6); p.425(9);
RA12	p.1031(7); p.1032(8); p.1036(12); p.1040(16);
RA15	p.465(11); p.467(13); p.468(14);
RA16	p.139(3); p.140(4); p.145(9); p.147(11); p.148(12); p.150(14); p.152(16);
RA17	p.351(3); p.355(7); p.356(8); p.359(11); p.360(12); p.361(13); p.363(15); p.364(16); p.365(17); p.366(18); p.368(20); p.369(21);
RA18	p.159(6);
RA20	p.362(10); p.363(11);
RA21	p.419(9); p.420(10); p.421(11); p.423(13); p.425(15); p.426(16);
RA23	p.387(2); p.390(5)a; p.391(6); p.393(8);
RA24	p.500(14); p.501(15);
RA28	p.167(11); p.175(19); p.176(20)a; p.180(24);
RA29	p.923(10)a;
RA30	p.466(2)a; p.471(7); p.472(8); p.473(9); p.474(10); p.484(20); p.490(26);
RA31	p.223(6); p.224(7); p.225(8); p.228(11); p.229(12);
RA32	p.22(6); p.24(8); p.25(9);

Application of Barthes's Mythology

Concepts of mythology are much easier to apply in visual analysis, such as advertising, TV programmes, and films because the basic elements (e.g., colours, gestures) of their signs are much more recognisable. Yet, mythology can still be applied to text, as the above three examples have shown. Hence, this part will suggest two points for future analysts who apply Barthes's mythology to illustrate the making of ideology.

First, as mentioned previously, the process of describing phenomena *per se* is the process of analysing and constructing an ideology. For this reason, analysts are required to possess the capacity of *describing phenomena* before they are able to examine how *others* describe their research studies. In order to obtain such ability, analysts have to understand well the describing methods they can apply (to describe their research). After realising how self might describe phenomena, then it is possible to understand what describing methods others might apply to do the same.

Second, in order to realise what elements they can apply, future analysts are required to comprehend the meaning of elements—i.e., signs, including the birth of its meaning, as well as its different meaning in diverse cultural backgrounds, which is what Barthes emphasised the most. This is also to answer why the 'white coat' in example 7-2 refers to a 'professional sense'.

For instance, the gesture of people lifting their hats means a greeting that originated in medieval times when knights took off their helmets in order to prove their goodwill. This movement of lifting a hand to the head also explains the meaning of salute. A salute refers to the respect that is based on the meaning of taking off a helmet to show no hostility in the past (Machin, 2007; Panofsky, 1955; Van Leeuwen, 2001). As IAC analysts, they have to understand the (original) meaning of helmet (that is, people are armed to fight) before they can detect the connotation of the image, in Barthes' own example, showing a black soldier's salute to a French flag.

Regarding the meaning of the same signs in different cultures, for example, yellow can mean sunny, but in some cultures it refers to sickness, as when people have a liver disease (Kress & Van Leeuwen, 2002). Japanese people dress in white clothing at weddings, while such dress refers to funeral affairs in Taiwanese culture. Similarly, being IAC analysts, the more they can comprehend the meaning of the same elements/signs in different cultures, the

better they can accurately determine the connotation their research subjects carry.

In short, future IAC analysts should possess the ability to *describe* their research phenomena before they are able to examine how **others'** texts conceal particular connotation. To thoroughly understand the meaning of signs, including their origins and diversity in different backgrounds, is a way to undertake their analysis/critique.

7.3 Conclusion

It is reasonable to say that the most common critique on ideological analysis or critique should be: By whose authority are you so confident in claiming this *is an ideology*? It points out that why ideology is considered as ideology cannot be validated by random or arbitrary allegation. It always needs a theoretical basis, especially when the researched phenomenon is referring to a negative characteristic of ideology. Simply claiming that 'one phenomenon represents an ideology' without explaining why and how is irresponsible and incomplete, which, unfortunately, is the common argumentative shortcoming that this thesis has found in most of our 33 IAC articles.

Thus, this thesis introduces Barthes's concept of mythology to mend this argumentative shortcoming. Of course, Barthes's concept of mythology is one of many ways to discover connotations that are based on Saussure's semiotic concepts. The process of operation of myth relies on a two-order semiological system where connotation results from the transformation between the first-order system's sign and the second-order system's signifier. Because of this process, why and how a simple sign is able to convey a connotation is answered. Barthes's notion not only helps to mend the argumentative shortcoming; it also helps ideological analysis to obtain more reliability and validity.

Procedure 4: Illustration (Articulation and Interpellation)

7.4 Introduction

In *Procedure 2, selecting theoretical foundations*, this thesis introduced the basic semiotic concepts which help to explain how reality (or a neutral characteristic of ideology) is presented. By introducing the notion of mythology in *Procedure 3 connoting certain meanings*, how ideology, especially one with a negative meaning, is constructed becomes clear. The concept of mythology helps us to comprehend how simple signs are able to carry certain connotations.

If *Procedure 3*, based on a theoretical perspective (i.e., mythology), explains how diverse signs convey specific connotations, which might further reveal a certain ideology, then *Procedure 4, Illustration*, determines practically the same function as the concept of myth suggests, enabling ordinary signs to start their journey and carry connotations. In short, *Procedure 4* attempts to discover the kinds of illustrating techniques that IAC analysts frequently apply. By using these techniques, IAC analysts' written words start to carry certain connotation.

Accordingly, this section will first explain why the term *illustration* is used in this thesis as well as its relationship with other terms, *articulation* and *interpellation*. Next, two *illustrating techniques* will be introduced, including the depiction of research subjects via a thorough understanding of their history and literature, and through specific presenting techniques.

Theoretical Discussion—The Meaning of Illustration

Whether analysing or criticizing an ideology (or the IAC works) or whether purely presenting or constructing IAC articles/reports, analysts' illustrations (i.e., their words) always play an influential role in determining readers' understanding. From a semiotic perspective, illustrations are the product of signs which echoes Althusser's notion: ideology has a material existence. The basis of material existence permits the possibility of whether to analyse or criticise, to purely present or construct ideologies, all of which are embraced in the same way, illustrating.

This thesis suggests that every process of illustrating anything in any context contains two major means, that is, interpellation and (dis/re-)articulation. The former's concept is generated from Althusser while the latter is from Gramscian (specifically in Laclau & Mouffe, 2001). A specific ideology interpellates individuals as its subjects as well as dis/re-articulating elements to empower its hegemony; this refers to the process of 'making' (i.e., purely presenting or constructing) ideologies. Similarly, it is through *telling* people how individuals are interpellated and what elements are dis/re-articulated that analysts unveil the connotation of ideologies, which refers to the process of 'analysing or criticising' ideologies¹⁰².

Whether to make (purely present or construct) or to tell (analyse or criticise), they are all based on analysts' illustrating actions. Thus, in this thesis, the term *illustration* is adopted to refer to both concepts of *articulation* and *interpellation*. In other words, ideology is presented or constructed as well as analysed or criticised through the illustrating process, which could be seen as comprising the consecutive actions of articulation and interpellation.

Although notions of articulation and interpellation possess their own theoretical origin, this study states that each term is indeed the alter ego of the other. They are complementary. Both notions are a batch of terminologies which interact with and depend upon the other. A bolder perspective might be that they are merely two different terminologies which refer to the same characteristic dealing with the same mission in the realm of ideology. This is because a successful action of interpellation results from a long term process of (dis/re-)articulation which reflects the individuals' life experience. On the other hand, whether the work of (dis/re-)articulation is valid can only be attested to when individuals are successfully interpellated to accept the points of (dis/re-)articulating.

Why has the term *illustration* been introduced here? Although interpellation and articulation are concepts agreed to be capable of explaining 'how ideology is formed or revealed', these two terms are considered to possess an *active, aggressive, or attempted*

¹⁰² Additionally, how IAC analysts make their readers believe what they have argued is also through their illustration of arguments. That is still the process of interpellation and articulation. What has to be noted is that whether they purely present their findings or not, they inevitably and unintentionally create a new ideology. Again, it is back to the process of constructing ideology. This is what this thesis stated in Chapter 4, that understanding the making of ideology is to analyse it, and the process of analysing an ideology is also that of making a new ideology. This is surely a permanent loop in any ideology-related research which will be discussed in later chapters.

implication while probing ideologies. In fact, not every (IAC) analysts intends to embed connotations in contexts during their writing process, even though their works might indeed construct an ideology. If the terms interpellation and articulation are used to explain how they compose their writings, it seems that they analyse/criticise *for purpose* which contains deliberate intentions. Hence, the reason why the term *illustration* is introduced here is simple: first, to create a term, which holds a *pure* and *neutral* characteristic, in order to avoid the *active* or *attempted* characteristic of both *interpellation* and *articulation*. Second, since this thesis argues that *interpellation* and *articulation* are in fact the alter ego of the other carrying the same mission in making ideology, a simplified and neutral term *illustrating/illustration* to replace them seems reasonable.

Thus, based on an investigation of 33 IAC articles, how IAC analysts illustrate their research—i.e., how they interpellate their readers to accept their argument and how they (dis/re-)articulate concepts needed to complete their argument— in order to undertake their ideological analysis/critique has been induced as two dimensions, first, via a thoroughly understanding of the research subjects' history and literature, and second, through specific describing/presenting techniques.

7.5 Illustration—Via A Thoroughly Understanding of the Research Subjects' History or Literature

In the previous discussion of myth, this study pointed out that all signs possess certain meanings whose origin could be retrospectively traced (e.g., the meaning of saluting). Once these signs are appropriated within a new context, intentionally or accidentally, connotations might emerge (e.g., black soldier salutes to a French flag). Accordingly, this thesis argues that analysts are required to comprehend the meaning of signs (including its original meaning and its different meaning in diverse cultural backgrounds) to reach a comprehensive analysed result.

Since any ideology is shaped through a long-term historical process in which all elements of it interact with and influence one another, thoroughly understanding the researched subjects' history or literature becomes the critical point to detect such a shaping process. This is similar to the importance of historical statistics in sports since these data

could help to analyse opponents' performance and habits in order to defeat them. The more analysts can comprehend the history and literature, the better they might detect the ideological track of their research subjects, and, the more efficiently they can apply the history/literature to construct a certain ideology.

Two IAC analysts' common illustrating (i.e., interpellating and articulating.) techniques based on their thoroughly understanding the history or literature are: first, *finding similarities* (and further to make comparison) and, second, *using references*.

Finding Similarities (and Making Comparison)

Finding similarities here means to uncover the similarities of texts, concepts, and history (events) between researched subjects and certain history or literature. Regarding texts in particular, it refers to the similarity of texts' figure, pronunciation, or implied meaning between the researched texts and texts in literature.

The birth of connotation here is based on this logic: if the texts/concepts/history in a certain history or literature refer to a specific meaning, then the similar texts/concepts/history found in the researched subjects will easily be linked to signify the same meaning.

Example 7-4: Regarding the similarities of texts, take RA19 for example. In RA19, the IAC analyst, Daragh Downes (2010), utilized the illustrating aspect of finding similarities in his research in order to explain why some parts of J. K. Rowling's writings were based on a projection of Nazi history. As Downes wrote,

We hear **Grindelwald**; we think of a certain other **Teutonic dark wizard**. We hear **pure-blood** philosophy; we think of **Aryan supremacy**. We hear **Nurmengard**; we think of **Nuremberg**. We hear **reign of terror**; we think of **Lebensraum, ghettos and camps**. We hear **mainland Europe**; we think of – **mainland Europe**. We hear **1945**; we think of – **1945**. (p. 167; emphasis added)

The pair of Nurmengard and Nuremberg refers to similar words, especially in its figure. Other pairs of terms (e.g., pure-blood vs. Aryan or reign of terror vs. Lebensraum) emphasized above apply to the similarities of implied meaning or history. All these pairs of terms together create the similarities between the *Harry Potter* story and Nazi history. Further discussion of this point is provided in the conclusion.

Example 7-5: In terms of finding similarities of concepts, take RA22 and RA25 as examples. In RA22, the author, Haslanger (2007), argued how gender stereotype leads to

gender identity. She found the similarity of stereotypical thinking that girls are usually bad at mathematics in order to support and equate her argument that “highly gender coded clothing has been found to be one such thing” (p. 76). She attempted to argue that girls were not born with bad mathematical skills as well as not being supposed to wear certain styles of clothing (to be girls), which are both gender stereotypes. In addition, in RA25, the IAC analyst, DeFoster (2010), argued how the media presented the news of the Columbine school shooting as having “marked a watershed in coverage of these kinds of tragedies” (p. 466). She pointed out the similarity of news coverage in the Gulf War—“the exhaustive, cyclical, round-the-clock news coverage” (p. 466) —to show how and why such media reports influenced audiences’ attitude and public discourse in the coverage of Columbine.

In the above cases, these analysts attempted to use specific concepts with which people are already familiar to help readers understand their arguments. Of course, if readers are unfamiliar with these similar concepts offered—e.g., mathematical gender stereotyping and the style of news report from the Gulf War—or readers do not even consider that any similarities exist (i.e., readers did not ‘answer the call’, Althusser’s term), then these analysts fail to interpellate their readers. Yet, if readers are familiar with these compared concepts and agree with the similarities drawn, then the process of interpellation (to accept analysts’ arguments) will be easier and more efficient.

Accordingly, the ideological function of *finding similarities* is that the IAC analysts, on the surface, seem to merely suggest a comparison for readers (and readers have free will to agree or disagree). In fact, claiming the similarities between the researched subjects and the related history/literature, is an efficient way of allowing analysts to infer or directly claim that their research subjects possess the same concept/ideology (because the history/literature has already demonstrated it). In other words, finding similarities is about shaping the vantage point from which something is viewed which echoes to Hall’s (2004) notion of ‘preferred reading’ (explained in Chapter 9).

Example 7-6: In regard to finding similarities of history, RA05 can be used as an example. In RA05, the IAC analysts, Brennen and Duffy (2003), explained how media represented Arab-Americans in the 9/11 events through a comparison with the *Pearl Harbor* incident. In both situations American territory was attacked. The authors found several

similarities such as, “civil liberties [were] curtailed” (p. 6); government asked people to “return to normalcy” (p. 7); Japanese and Arab-Americans were presented as “targets of harassment” (p. 9), “oppositional voices [were] muted” (p. 11). According to them, these similarities were drawn in news coverage of both events. They found that both Japanese and Arab-Americans were tagged with an image of the Others.

It is interesting that, although RA05 claimed to examine both events, most discussions and citation of news-texts were placed on the *Pearl Harbor* side. For example, after a long discussion of how government asked people to ‘return to normalcy’, the authors only had one sentence¹⁰³ to claim that *it is the same* as in the news coverage of 9/11. It seems that, on the surface, Brennen and Duffy attempted to create a reasonable comparison between two events. In fact, it is through highlighting events’ similarities that they transferred and connected what people understood about an old event to a current one. As a result, authors do not have to address much about 9/11. Whatever points they took to explain Pearl Harbor, readers will automatically connect to their 9/11 argument based on the ideological illustrating aspect of *finding similarities*.

To conclude, whether J. K. Rowling was conscious/unconscious to create such similarities in her novel, once her texts became influential, they require examination. Finding similarities (based on a thorough understanding of history and literature) could be seen as the basic technique in which to proceed with an ideological analysis/critique, through which it should be possible to predict and prevent the possible influences from, for instance, Rowling’s concealed fascist ideology embedded in the Harry Potter series. Of course, whether the similarities exist between researched contexts and history depends on the readers. Once readers agree with the similarities suggested by the authors, it becomes the easier and more efficient way to pass the recognition regarding history/literature to current researched contexts. Once the connection of similarities is created, whatever arguments the analysts suggest, readers will automatically connect these arguments to the analysts’ research subject.

Reference of *finding similarities* (and *making comparison*) which were frequently applied in 33 IAC articles is listed as Table 7-2.

¹⁰³ The sentence is: As will be shown, this is also a powerful theme seen in the coverage following 9/11.

Table 7-2: Reference of Finding Similarities

SWPs Code: P4-1-FS(MC) (Finding the Similarities and Making Comparison)	
Articles	Found References/Examples
RA01	p.178(14)b; 179(15)b;
RA03	p.142(6)b;
RA05	p.3(1)b; p.4(2)b; p.7(5)a; p.8(6)a; p.10(8)b; pp.10-11(8-9)a; p.11(9)a;
RA06	p.447(3)a; p.457(13)b;
RA07	p.110(4)a;
RA08	p.269(9)b;
RA09	p.603(17)b;
RA10	p.422(6)a; p.426(10)b;
RA12	p.1030(6)b; p.1038(14)a;
RA14	p.101(2)a;
RA17	p.357(9)a; p.362(14)a; p.365(17)a;
RA18	p.159(6)b;
RA19	p.164(3)a; p.165(4)a; p.167(6)a,b; p.168(7)b; p.169(8)b; p.170(9)b;
RA20	p.357(5)a; p.366(14)a;
RA22	p.73(4)a; p.76(7); p.85(16);
RA23	p.388(3)b; p.389(4)a; p.390(5)a; p.394(9)a; p.395(10)a;
RA24	p.488(2)b; p.488-9(2-3)b; p.490(4)b; p.497(11)a,b; p.498(12)b; p.504(18)b;
RA25	p.466(1)a; p.477(12)b; p.478(13)a;
RA26	p.83(5)b; p.84(6)b; p.95(17)b;
RA27	p.199(20)b;
RA28	p.164(8)a,b; p.171(15)a; p.179(23)a;
RA30	p.471(7)a; p.476(12)b; p.488(24)b;
RA31	p.222(5)a; p.226(9)a; p.227(10)b; p.228(11)a; p.229(12)a; p.230(13)b; p.232(15)b;
RA32	p.18(2)b; p.19(3)b;
RA33	p.663-4(23-4)a; p.665(25)b;
Concepts a: Finding the Similarities; b: Making comparison.	

Using References

Using references means that analysts cite certain terminologies, sentences, or data to echo, testify, or prove their arguments. Any selected quotation or terminology in ideological works, in fact, is applied to articulate with analysts' own opinions in order to interpellate readers to accept what they argue. The more analysts thoroughly understand the history or literature of their research subjects, the more they can skilfully apply words, terminology or famous quotations, and the more reliability and validity of their argument they can claim.

First, in respect of encoding, the action of selecting certain references is the result of ideological operations which represent the analysts' own ideology. These selected quotations, the cited extent, and order of presentation, to a great degree, have not only demonstrated the argument IAC analysts wish to make but have also indicated the direction the analysts want their readers to follow. These cited references help to rationalize the *analysts' own words* instead of displaying its own original meaning, which, on the one hand, echoes Barthes' notion 'the death of the author' whilst on the other these selected quotations are able to generate an entirely different meaning. Take IAC article RA25 for example.

Example 7-7: RA25 is a twelve thousand word article in which 275 quotations¹⁰⁴ from literature or newspapers (its research subjects) are cited. These 275 quotations contain about 2800 words. Take one paragraph in page 454 of RA25 as an example.

Throughout the coverage, money was cited as Galloway's sole motivation for holding out. **"The Seahawks thought they had given Joey Galloway 35 million reasons to end his holdout,"** Farnsworth wrote in the Post-Intelligencer after Galloway rejected the Seahawks' offer (1999c, p. 1). **"In a business supported primarily by fans who can't afford decent furniture, he mocks the \$5 million a year on the table,"** columnist Ron Judd wrote. **"He laughs off a \$7 million signing bonus he's never earned. Give me \$10 million, he says. Then we'll talk about my loyalty"** (1999, p. 3; emphasis added).

The *cited references* might help to rationalize the *analysts' own intention* instead of displaying its own meaning; or, in this case, it could be said that the analysts *help* readers to examine/conclude how newspapers talked about Galloway. Either dimension of thinking is possible depending on readers' recognition. The point is that *using references* indeed is a way to reveal analysts' personal opinion, or, at least, representing what the analysts consider as important (otherwise, they *would not have* cited such words to generate an argument).

Next, in terms of decoding, readers never perceive meanings of contexts from quotations and meanings of the analysts' own words separately. Quotations and analysts' own words usually are seen as a 'whole'. In most cases, quotations are not read with the original meaning, but are served as a foil to complete the analysts' own words which together construct a certain meaning (or ideology). Take RA12 for example.

Example 7-8: In RA12, Ewick and Silbey (1999) quoted (first sentence cited below) and wrote (the second sentence),

So I thought what I would do, in a magnanimous gesture, is I would file an appeal for everybody in my poker game. Just do them all at the same time.

Thus, to Alan Fox the law is a gift he can bestow upon others. [...] In fact, Alan Fox plays law as he plays poker. He said, "Because people who are really my friends, I couldn't do enough for them." Besides, Alan Fox told us, "It's fun."

Although Alan Fox indeed links his appeal to a 'poker game', his words (the first sentence, cited by Ewick and Silbey) became the evidence/resource for Ewick and Silbey to manipulate support for what they attempt to argue. As a result, they created a crafty image of Alan Fox. Although Ewick and Silbey seem to positively describe Fox's faith to his friends,

¹⁰⁴ It was counted by this thesis.

their words (“In fact, Alan Fox plays law as he plays poker”) and the term they cited (“It's fun”) still subverts readers' cognition regarding Fox's attitude toward law.

Finally, the most critical power of *using reference* is to create an 'alibi' for the analysts where the analysts' tracks disappear. By quoting from others' words, the analysts are able to place themselves outside the debated issues to avoid being criticised as 'over subjectivity'. In short, the technique of *using references* usually displays a faith: let the truth speak for itself in which the subjectivity of analysts has been reduced. It seems that it is the quotation speaking rather than the analysts. Take RA08 for example.

Example 7-9: The following quotations are the final sentences in the conclusion section of RA08. The IAC analyst, Crawford (1998, p. 274), cited and wrote,

Hatcher and Troyna (1994, p.156) have asked, 'Which actor dominated in the relationship among those two shape and implement government policies?', and (p. 165), 'The crucial question is, in the struggle over the curriculum, which element is dominant? We would argue that state control has the upper hand...'. Within the contexts of influence and text production, the construction of the National Curriculum supports this conclusion.

In this final paragraph, Crawford quoted other scholars' argument instead of writing his own interrogating sentences. In so doing, he kept himself away from personal judgement. While some may argue that this conclusion is too arbitrary, these citations will provide him an alibi where he (his subjectivity) is absent, which provides himself with a neutral and objective image. Simultaneously, while readers are neglected, his personal ideology (which leads to his selection of these quotations) is cleverly revealed through these quotations.

To conclude, cited words or famous quotations never speak for themselves. Analysts' actions of selecting a certain reference are the results of ideological operation which represent their own ideology. Mostly, when analysts cite, they hardly wish to display the original meaning of such quotations. Instead, they appropriate the selected quotations to support their own arguments and sometimes the meaning of such a quotation deviates. Last, the most critical power of *using reference* is to create an alibi for the analysts where their tracks disappear, which could offer them a neutral and objective image. Hence, by thoroughly understanding the research subjects' history or literature, analysts are able to select suitable references which not only help to echo, testify, or prove their arguments, but also convey their intentions. *References* are used to be articulated with the analysts' own ideas in order to interpellate readers to accept their arguments.

Other examples of *using references* which were frequently applied in 33 IAC articles is listed as Table 7-3.

Table 7-3: Examples of Using References

SWPs Code: P4-1-UR (Using References)	
Articles	Found References/Examples
RA01	p.165(1); p.167(3); p.168(4); p.169(5); p.170(6); p.171(7); p.172(8); p.173(9); p.174(10); p.175(11); p.176(12); 177(13); p.178(14); 179(15); 180(16);
RA02	p.247(3); p.248(4); p.249(5); p.250(6); p.251(7); p.252(8); p.253(9); p.254(10);
RA03	p.137(1); p.139(3); p.140(4); p.141(5); p.142(6); p.143(7)a,b; p.144(8); p.145(9); p.146(10); p.147(11)a,b; p.148(12); p.149(13); p.150(14); p.151(15); p.152(16); p.153(17);
RA04	p.336(3); p.337(4); p.338(5); p.339(6)a,b; p.340(7); p.343(10); p.345(12); p.347(14); p.348(15); p.349(16); p.350(17); p.351(18);
RA05	p.3(1); p.4(2); p.5(3); p.6(4); p.7(5); p.8(6); p.9(7); p.10(8); p.11(9); p.12(10); p.13(11);
RA06	p.446(2)a,b; p.447(3); p.448(4); p.449(5); p.450(6); p.451(7); p.452(8); p.453(9); p.454(10); p.455(11); p.456(12);
RA07	p.108(2)a,b; p.109(3)b; p.110(4); p.111(5); p.115(9); p.116(10); p.117(11)b; p.118(12); p.119(13);
RA08	p.262(2); p.263(3); p.264(4); p.265(5); p.266(6); p.267(7); p.268(8); p.269(9); p.270(10); p.271(11); p.272(12); p.273(13); p.274(14);
RA09	p.588(2); p.589(3); p.589-90(3-4); p.590(4); p.591(5); p.592(6); p.593(7); p.593-4(7-8); p.594(8); p.598(12); p.603(17);
RA10	p.417(1); p.418(2); p.419(3); p.420(4); p.421(5); p.422(6); p.423(7); p.424(8); p.425(9); p.426(10);
RA11	p.104(6); p.105(7); p.106(8); p.107(9);
RA12	p.1025(1); p.1028(4); p.1029(5); p.1030(6); p.1031(7); p.1032(8); p.1033(9); p.1034(10); p.1035(11); p.1037(13)a,b; p.1038(14); p.1040(16);
RA13	p.279(1); p.280(2); p.281(3); p.282(4); p.283(5); p.284(6); p.285(7); p.290(12);
RA14	p.100(1)a,b; p.101(2)a,b; p.102(3); p.103(4)a,b; p.104(5)a,b; p.105(6); p.106(7); p.107(8); p.107-8(8-9)b; p.108(9)a,b; p.109(10);
RA15	p.455-6(1-2); p.457(3); p.458(4); p.461(7); p.462(8); p.463(9); p.464(10); p.465(11); p.466(12); p.468(14);
RA16	p.137(1); p.138(2); p.141(5); p.145(9); p.146(10); p.147(11); p.148(12); p.149(13); p.150(14);
RA17	p.351(3)a,b; p.352(4); p.353(5); p.355(7); p.356(8); p.357(9); p.362(14)a,b; p.366(18)b;
RA18	p.154(1); p.155(2); p.157(4);
RA19	p.162(1); p.163(2); p.164(3); p.165(4); p.166(5); p.167(6); p.168(7); p.169(8); p.170(9); p.171(10)a,b; p.172(11); p.173(12);
RA20	p.355(3); p.357(5); p.358(6); p.362(10); p.363(11); p.364(12); p.365(13); p.366(14);
RA21	p.412(2); p.414(4); p.416(6); p.417(7); p.418(8); p.419(9); p.420(10); p.421(11); p.422(12); p.423(13); p.424(14); p.425(15); p.426(16);
RA22	p.70(1); p.71(2); p.75(6); p.76(7); p.77(8); p.78(9); p.82(13); p.83-4(14-5); p.86(17);
RA23	p.386(1); p.387(2); p.388(3); p.389(4); p.390(5); p.391(6); p.392(7); p.393(8); p.394(9); p.395(10);
RA24	p.487(1); p.488(2); p.489(3)a,b; p.490(4); p.491(5); p.492(6); p.494(8); p.495(9)a,b; p.496(10); p.497(11); p.498(12); p.499(13); p.500(14); p.501(15); p.503(17); p.504(18);
RA25	p.466(1); p.467(2); p.468(3); p.469(4); p.470(5); p.472(7)a,b; p.473(8); p.474(9); p.475(10); p.476(11); p.477(12); p.479(14); p.480(15); p.481(16);
RA26	p.79(1); p.81(3); p.82(4); p.83(5); p.84(6); p.86(8); p.87(9); p.88(10); p.92(14); p.93(15); p.94(16); p.95(17);
RA27	p.181(2); p.182(3); p.183(4); p.184(5); p.185(6); p.186(7); p.188(9); p.193(14); p.194(15); p.195(16); p.196(17); p.199(20);
RA28	p.158(2); p.160(4); p.162(6); p.163(7); p.164-5(8-9); p.167(11); p.168-9(12-3); p.169(13); p.170(14); p.171(15); p.172(16); p.173(17); p.174(18); p.175(19); p.176(20); p.177(21);
RA29	p.914(1); p.915(2); p.916(3); p.917(4); p.918(5); p.919(6); p.922(9); p.923(10); p.924(11); p.925(12);
RA30	p.470(6); p.471(7); p.472(8); p.473(9); p.474(10); p.475(11); p.476(12); p.477(13); p.478(14); p.479(15); p.480(16)b; p.481(17); p.482(18); p.483-4(19-20); p.486(22)b; p.487(23)b; p.488(24);
RA31	p.218(1); p.219(2); p.220(3); p.221(4); p.222(5); p.223(6); p.224(7); p.225(8); p.226(9)a,b; p.227(10); p.228(11); p.229(12); p.230(13); p.231(14); p.232(15); p.233(16); p.234(17); p.235(18); p.236(19); p.237(20); p.238(21); p.239(22)a,b; p.240(23); p.241(24)a,b; p.242(25);
RA32	p.20(4); p.22(6); p.23(7); p.24(8); p.25(9); p.26(10); p.27(11); p.28(12); p.29(13);
RA33	p.642(2); p.644(4)a,b; p.645(5)a,b; p.646(6); p.650(10)b; p.652(12); p.653(13); p.654(14); p.655(15); p.656(16); p.657(17); p.659(19); p.660(20); p.664(24);

Concepts a: General referencing; b: references from reputed people of the research field.

7.6 Illustration—Through Specific Presenting Techniques

The preceding sections on *finding similarities* and *using references* have explained how analysts articulate certain concepts of their arguments to interpellate readers as subjects of their research (or their ideology). These two techniques are based on a requirement: thorough understanding of the research subjects' history or literature. Yet, if analysts are not familiar with, for instance, Nazi history, they are unable to recognise the fascist ideology embedded in Rowling's *Harry Potter*, not to mention to apply related references to support or convey their argument.

Indeed tracks of ideological manipulation (by IAC analysts) are revealed throughout IAC articles. The following discussion will focus on how simple words, due to analysts' specific presenting techniques, start to display specific meanings or help to undertake ideological manipulation to influence readers. In other words, it is to examine those specific presenting techniques that analysts unconsciously but frequently apply, which are shown to contain the actions of articulation and interpellation. Four presenting techniques are found, including techniques of *transferring*, *using inarguable data*, *writing*, and last, *explaining*.

Transferring (Rhetorics of Persuasion)

There is a special presenting technique found in 33 IAC articles, which is termed as the process of *transferring*. By applying it, IAC analysts could easily rationalise their argument without even providing systematic argumentation. This presenting technique of *transferring* is like creating a channel, through which analysts' written words will become neutral, objective, and reasonable which also helps to create analysts' credibility and assists them to interpellate readers to accept their argument. Three transferring styles were found: a) giving confession, b) giving a compliment first, then criticising, and c) self-criticising first, then defending.

Style a) Giving Confession.

By admitting that 'I am not sure', 'It is unclear', 'My argument might be wrong' as well as stating 'there is no right or wrong'—in short, an uncertainty, analysts could achieve a humble and objective image. They are sincere about doing their research (otherwise they would not make the confession which might challenge their argument). Style a is based on this logic: How can readers judge analysts' arguments since the latter are not arrogant and do

not boast of their rightness; they are even brave enough to admit their shortcoming? As a result, their written words are seen as credible and honest which eventually will help IAC analysts to interpellate readers to their later arguments. This style is especially useful to ideological analysis/critique because once analysts confess that ‘I might be wrong’, it is hard to judge their suffering from their own ideology.

Example 7-10 (all emphasis added):

I do not want to claim that the interviews necessarily provided ‘**true**’ accounts of events. (RA08, p. 263)

This second ‘should,’ **it might be argued**, is a pragmatic or moral ‘should’. (RA22, pp. 73-4)

“Caring”, therefore, may—**or may not**—distinguish nurses from others; (RA23, 1995, p. 387)

In RA08, the analyst claimed that he was unable to tell the truth. Such statement tried to create a neutral and objective image for him, making his readers believe that his analysis was not involved with his personal opinion. Although uncertain demonstration is unacceptable in academic writing, it cannot be denied that, to a great degree, *uncertainty* could help analysts to avoid being criticised as overly subjective.

Style b) Giving Compliment first (to built a fair image), and then Criticise.

Analysts compliment their analysing/interrogating research subjects first. In so doing, a fair image of ‘they are **not** the picky people who **only criticise others**’ could be created; they know how to ‘appreciate’ others. Once the image of being an impartial analyst is shaped, analysts’ later critiques will be much more acceptable. This is similar to academic supervising where tutors usually praise students’ work first and then point out their problems. With this process, tutors’ comments will be more appreciated instead of either having students lose their confidence or thinking that their tutor is too fastidious. Take RA24 for example.

Example 7-11: In RA24, the IAC analyst, Lu, almost introduced and explained every Chinese Communist Party’s (CCP) political slogans and their political influences *negatively* through her article. She also pointed out how her family suffered from the CCP’s tyranny. Yet, she started to *positively* illustrate slogans’ meaning that when her discussion dealt with slogans from Deng Xiaoping's period, she also praised the contribution of Deng’s slogans.

As she wrote,

This presentation of ‘facts’¹⁰⁵ also served to restore national pride and return the country to traditional Chinese values, such as Maoist’s utilitarianism. (p. 500; emphasis added)

Nevertheless, there was no reason for her to praise Deng Xiaoping's leadership and start to agree with these new slogans, as her invisible political position exposed her disgust at the CCP almost in her whole context (e.g., her family’s experiences of suffering). As expected, while she commended the CCP's new slogan of returning to traditional values, she immediately added a comment, which followed the previous quotation, saying,

However, at the same time, what the government failed to explain or deliberately avoided explaining, was the building of ‘socialism with Chinese characteristics’. It is not clear whether this was because the Chinese leadership feared that the adoption of capitalism on a large scale would create chaos, or because they feared losing face on a global scale by directly admitting their interest in and pursuit of capitalism. (p. 500)

In the above quotation, Lu started to tell us that the CCP did not explain the meaning of such a slogan and she continued by commenting on why the CCP was afraid to do so. Her words again put the CCP into a distrusted position, which has remained attached to her political stance. Namely, she praised the CCP first to establish an image of ‘her being a fair/neutral analyst’, indicating that she is not only criticising without rationality. After giving a compliment, her following critiques were more acceptable and credible/convincing.

Style c) Self-criticise first, and then defend.

Analysts using this style are usually first to criticise themselves or their supporting/defending subjects, or to admit that their or their defending subjects’ condition is not as bad as compared to the past. This implies that *they know* they should not complain too much. In so doing, they create an impression to readers: they understand the importance of introspection and appreciation. After such a self-examining image is built, they can start to proclaim their points or to argue what is still unfair to them. Since they initially self-criticise, their subsequent words will easily be seen as being honest, which ultimately will help IAC analysts to interpellate readers to their later arguments. Take RA20 for example.

¹⁰⁵ Footnote added. The term ‘fact’, according to Lu (1999), is “defined as what is present in the text and its medium” (p. 492). “Its medium” refers to the CCP’s political magazine in her discussion.

Example 7-12: In RA20, the analyst, Smith (1975), wrote,

Women have of course had access to and used the limited and largely domestic zone of women's magazines, television programs, women's novels, poetry, soap operas, etc. **But**, this is a limited zone. It follows the contours of their restricted role in the society. (pp. 354-355; emphasis added)

In this case, Smith first admitted that women nowadays have obtained something that they did not have in the past (and they indeed appreciate). Yet, what Smith attempted to argue was the argument shown from the word ‘but’ in the above quotation. Thus, through this transferring process, Smith could avoid criticism such as ‘the role of women is much better nowadays, why are you still unsatisfied and asking for more?’ Analysts’ self-questioning first before defending will offer the impression to readers that they have thoroughly investigated every viewpoint including their own challenges. After such impression is created, analysts are able to proclaim their argument, which will be more readily accepted.

To conclude, using the presenting techniques of *transferring* could be compared to building a region of money laundering, through which analysts are able to give their written words a neutral and objective image. *Transferring* contains three styles: a. giving a confession; b. giving a compliment first, then criticising; and c. self-criticising first, then defending. Through the process of transferring, IAC analysts’ arguments become objective, neutral, and rational so that their words will be easier and more efficient to articulate certain ideas and debates, thereby interpellating readers to agree.

Other example of *transferring* applied in 33 IAC articles are listed in Table 7-4.

Table 7-4: References of Transferring

SWPs Code: P4-2-T (Transferring)	
Articles	Found References/Examples
RA01	p.165-6(1-2),p.167(3); p.168(4); p.173(9); p.175(11); p.177(12); 179(15); 180(16);
RA02	p.246(2)e; p.247(3)e; p.252(8)a; p.254(10)e;
RA03	p.138(2)c; p.147(11)e;
RA04	p.338(5)e; p.350(17)b;
RA05	p.5(3); p.6(4); p.7(5); p.8(6); p.9(7); p.10(8); p.11(9);
RA06	p.447(3)a; p.457(13)b; p.458(14)a,d;
RA07	p.107(1)b; p.109(3)e; p.119(13)a;
RA08	p.263(3)b,c; p.264(4)a; p.265(5)a; p.266(6)a; p.269(9)d; p.274(14)b,c;
RA09	p.589(3)a; p.591(5)c; p.599-600(13-14)b; p.600(14)b,c; p.601(15)c;
RA10	p.418(2)c,d; p.419(3)b; p.422(6)a; p.425(9)c; p.426(10)d; p.427(11)d;
RA12	p.1026(2)e; p.1034(10)a;
RA13	pp.280-1(2-3)a; p.281(3)a,e; p.284(6)d; p.285(7)a; p.288(10)b,c; p.290(12)d;
RA14	p.101(2)c; p.103(4)d; p.107(8)a; p.109(10)a;
RA15	p.455(1)a; p.456(2)b; p.465(11)d; p.467(13)b;
RA16	p.140(4)d; p.144(8)b; p.154(18)b;
RA17	p.357(9)b,c; p.366(18)a; p.367(19)b; p.369(21)e;
RA18	p.154(1); p.155(2); p.156(3); p.157(4); p.158(5); p.159(6);
RA19	p.162(1)a; p.163(2)e; p.164(3)c,e; p.166(5)d; p.167(6)a,d; p.168(7)a,c,d; p.171(10)a; p.173(12)a,c; p.174(13)a;
RA20	p.354-5(2-3)c; p.355(3)a,b; p.357(5)b; p.358(6)b; p.360(8)b; p.362(10)b;
RA21	p.424(14)c; p.427(17)b;

Procedure 4: Illustration (Articulation & Interpellation)

RA22	p.71(2)e; p.72(3)d; p.73(4)b; p.75(6)b; p.76(7)a,c; p.80(11)b; p.87(18)b; p.88(19)c;
RA23	p.387(2)b; p.388(3)a; p.389(4)c,d; p.390(5)d; p.391(6)a; p.392(7)c; p.393(8)a,d; p.394(9)d; p.395(10)d;
RA24	p.487(1)a; p.488(2)a; p.489(3)a; p.491(5)a,b; p.492(6)b; p.498(12)a,b,e; p.499(13)a; p.500(14)d;
RA25	p.466(1)c; p.468(3)a; p.469(4)a; p.471(6)a;
RA26	p.80(2)d; p.81(3)a; p.82(4)a; p.85(7)b; p.86(8)c; p.91(13)e; p.94(16)c; p.95(17)d;
RA27	p.181(2)d; p.182(3)a,e; p.184(5)c,d; p.186(7)c;
RA28	p.158(2)a,d; p.162(6)a; p.168(12)e; p.169(13)a; p.174(18)d; p.180(24)e;
RA29	p.919(6);
RA30	p.466(2)a; p.470(6)a; p.478(14)d; p.487(23)c;
RA31	p.219(2)d; p.220(3)d; p.222(5)d; p.226(9)d; p.233(16)a; p.241(24)c;
RA32	p.17(1)b; p.19(3)b; p.20(4)c; p.28(12)d;
RA33	p.644(4)c; p.647(7)a; p.653(13)c; p.654(14)d; p.656(16)d; p.658(18)a; p.662(22)a; p.664(24)c; p.666(26)e; p.667(27)a,e; p.669(29)d; p.671(31)b;
Concepts a: Giving confession; b: giving compliment first (to build a fair image), and then criticise; c: self-criticise first, and then defend.	

Using Inarguable Values

The presenting technique of *using inarguable values* means that analysts adopt certain beliefs or data, which are considered to be unchallengeable, to build the authority of their arguments. Once this is created, their arguments will become accredited which will facilitate the ideology (e.g., analysts' opinions) to interpellate readers as well as to (dis/re-)articulate viewpoints of the argument to lead readers to specific perceptions. This thesis has concluded two common inarguable values found in 33 IAC articles, including the *unchallengeable social beliefs* and the *inarguable information/evidence*.

Unchallengeable Social Beliefs

There are always some social beliefs which guide people's cognition of recognising society. These beliefs are unchallengeable, otherwise they would infringe on the discipline that people believe (e.g., equalitarianism, humanism, or feminism). This thesis has found in 33 IAC articles that caring for the inviolable groups like children, elders, and the disadvantaged are the common unchallengeable beliefs that the IAC analysts applied to support their arguments. Take RA01 as example.

Example 7-13: In RA01, the IAC analysts, Moss and O'Loughlin (2005), discussed the ideology shift in New Labour. The presenting technique of using inarguable values was applied in this article. They wrote,

A clear embodiment of 'futurity' pinpointed by Ruth Lister is New Labour's concept of the 'child-citizen becoming worker'. The 'citizen-worker' [means] that social rights are earned through work. [Although] 'Children are 100 per cent of the nation's future' [...], [w]ith the concept of spending replaced by social investment, children are to be invested in as the citizen-workers of the future. The implication is that children are now not valued intrinsically, but instrumentally, as a means to economic growth, lower crime, and a healthier population of future adults. (p. 172)

In their article's section III (pages 171 to 174), Moss and O'Loughlin explained how the ideas of 'futuraity', 'social order', 'duty', and 'network' together determined the ideology shift in New Labour. In the 'futuraity' part, they took the role of children in New Labour's new policies as their example. This helped to explain New Labour's new idea that social rights are earned through work. Yet, it also demonized New Labour due to the inviolable social beliefs assigned to children. Protecting children is important.

New Labour attempted to introduce childcare policies based on a *management* perspective to demonstrate their ideal of scientific governance. However, from the two authors' perspective, 'suffering children' are the key point, which enabled them to undertake the articulating manipulation; as a result, a heartless wrongdoers image was attached to New Labour. Hence, if Moss and O'Loughlin were successful in interpellating readers by applying *unchallengeable social beliefs* (i.e., taking care of children is important), it would become easier for them to obtain readers' agreements in other discussions.

Inarguable Information/Evidence

In RA08, the IAC analyst, Crawford (1998), interviewed 17 people in his study. If the number of interviewees he mentioned was 5 instead of 17, then the reliability and validity of his research could be disputed. This example shows that some information, such as statistics, certain dates, names, and allusions, all possess the capacity to influence readers' cognition. The information, especially when they are presented as an exact historical date or a clear statistic, under certain conditions, will be seen as evidence which will simultaneously make these information inarguable. Thus, by using certain information, not only are IAC analysts able to create a sense of reality to readers, it could also help to build the analysts' credibility which is another efficient way to obtain readers' trust. Take RA28 for example.

Example7-14: In RA28, the IAC analyst, Gayil Talshir (2003), explained how the concept of ecology was illustrated in the Green Party's official document, the *Grun2020*. She wrote,

Tellingly, ecology [...] was conspicuously absent from the draft *Grun2020* programme **until page 65**. Ecology was subordinated to the concepts of freedom and justice [...], acquiring only a derivative role in the new fundamental programme of the Greens. Ecological issues were discussed **in 12 of the 156 pages** of the draft programme. (p. 176, emphasis added)

Procedure 4: Illustration (Articulation & Interpellation)

Talshir explained that concepts of sustainability and ecological policies do not only belong to the Green Party, as people used to think. On the contrary, she demonstrated that even the Green Party itself did not talk much about ecological policies. Of course, such an argument is hard for readers to accept. As a result, she offered numbers (e.g., page quantities) as evidence, as the above quotation showed. Even if readers had not wanted to believe these figures, they are/became inarguable information/evidence because Talshir personally found/calculated them from the party's official document.

To conclude, the presenting technique of *using inarguable values* means that analysts adopt a certain social beliefs or information/evidence, which is considered to be unchallengeable, to build their arguments' authenticity. Having created this offers their arguments increased credibility which in turn facilitates the certain ideology to interpellate readers. In addition, the stance within the argument can be (dis/re) articulated thereby leading readers to a particular perception.

Other references of *using inarguable values* which were applied in 33 IAC articles are listed in Table 7-5.

Table 7-5: References of Using Inarguable Values

SWPs Code: P4-2-UIV (Using Inarguable Values)	
Articles	Found References/Examples
RA01	p.172(8); p.174(10); p.177(13); p.178(14);
RA02	p.245(1); p.246(2); p.248(4); p.250(6); p.251(7); p.252(8); p.253(9);
RA03	p.137(1); p.138(2); p.143(7); p.147(11); p.149(13); p.150(14);
RA04	p.334(1); p.335(2); p.336(3); p.337(4); p.349(16); p.350(17);
RA05	p.4(2); p.5(3); p.6(4); p.7(5); p.8(6); p.11(9); p.12(10);
RA06	p.448(4); p.449(5); p.450(6); p.451(7);
RA07	p.107(1); p.118(12); p.119(13);
RA08	p.262(2); p.263(3); p.265(5); p.266(6); p.267(7); p.268(8); p.269(9); p.271(11);
RA09	p.588(2); p.589(3); p.590(4); p.591(5); p.592(6); p.593(7); p.594(8); p.596(10); p.597(11); p.598(12); p.599(13); p.600(14); p.601(15); p.602(16);
RA10	p.418(2); p.421(5); p.424(8); p.427(11);
RA11	p.99(1); p.101(3);
RA12	p.1027(3); p.1028(4); p.1035(11);
RA13	p.279(1); p.280(2); p.281(3); p.282(4); p.283(5); p.284(6); p.285(7); p.286(8); p.287(9); p.288(10); p.289(11); p.290(12);
RA14	p.100(1);
RA15	p.455(1); p.456(2); p.457(3); p.458(4); p.459(5); p.460(6); p.465(11); p.466(12); p.467(13); p.468(14);
RA16	p.137(1); p.140(4);
RA17	p.353(5); p.354(6);
RA18	p.156(3);
RA19	p.163(2); p.171(10);
RA20	p.357(5); p.358(6); p.359(7); p.360(8); p.361(9);
RA21	p.411(1); p.412(2); p.413(3); p.414(4); p.415(5); p.416(6); p.417(7); p.418(8); p.420(10); p.421(11); p.422(12); p.424(14); p.425(15); p.426(16);
RA23	p.390(5); p.393(8); p.396(11);
RA24	p.487(1); p.488(2); p.492(6); p.493(7); p.495(9); p.496(10); p.500(14); p.501(15);
RA25	p.467(2); p.471(6); p.472(7); p.473(8); p.474(9); p.475(10); p.476(11); p.477(12); p.478(13); p.479(14);
RA26	p.79(1); p.80(2); p.81(3); p.82(4); p.83(5); p.85(7); p.87(9); p.88(10); p.91(13); p.92(14);

Procedure 4: Illustration (Articulation & Interpellation)

RA27	p.181(2); p.182(3); p.184(5); p.185(6); p.188(9); p.189(10); p.192(13); p.194(15); p.195(16); p.196(17); p.197(18);
RA28	p.158(2); p.159(3); p.160(4); p.167(11); p.168(12); p.169(13); p.170(14); p.173(17); p.174(18); p.176(20); p.177(21); p.178(22); p.180(24);
RA29	p.916(3); p.921(8); p.923(10); p.924(11);
RA30	p.468(4); p.469(5);
RA31	p.221(4); p.223(6); p.224(7); p.225(8); p.227(10); p.229(12); p.230(13); p.231(14); p.232(15);
RA32	p.19(3); p.20(4); p.21(5); p.25(9); p.28(12); p.29(13);
RA33	p.641(1); p.644(4); p.646(6); p.647(7); p.648(8); p.649(9); p.653(13); p.654(14); p.655(15); p.659(19); p.661(21); p.664(24); p.665(25); p.666(26); p.667(27); p.669(29);

Writing Skills

Another specific presenting technique frequently applied in 33 IAC articles, which helps to display analysts’ specific attitudes together with influencing readers’ cognition, is the analysts’ inconspicuous or unremarkable *writing skills/habits*. These *writing skills/habits* help to undertake the interpellating and the articulating manipulation. Three *writing skills/habits* that IAC analysts frequently applied were: skills of using a) punctuation marks, b) personal pronouns, and c) specific phrases.

Skill a) Using Punctuation Marks

The uses of specific punctuation marks in academic articles, such as italics, boldface, quotation marks, parentheses as well as colon and dash, are to emphasise the importance of the marked terms or to highlight aspects. Yet, for ideological operation, punctuation marks not only expose analysts’ intentions, but also help to undertake the operations of articulation and interpellation.

Using specific punctuation marks is similar to seeing the ‘Try your brakes’ traffic sign, in this case asking readers to decrease their driving speed whilst on the motorway of words. That split second could be the moment that hails readers to surrender, just as drivers are told to be vigilant, provided neither ignores the warning sign nor the emphasised words. Whilst there is no guarantee that drivers’ or readers’ attention will be attracted every time, if it happens there comes the possibility of articulation and interpellation where analysts’ ideas will likely be delivered to readers.

Example 7-15: In RA09, the IAC analyst, Medvic (2007, p. 600), adopts quantitative data (voting statistics) to show where in the spectrum of political ideology (i.e., liberal, centrist, or conservative) these diverse factions of the Democrats party (i.e., Traditional Democrats, New Democrats, Blue Dogs) are located. To explain the difference between

Traditional and New Democrats, he wrote,

- a. Traditional Democrats = -0.466 (differs significantly from b, c and d).
- b. New Democrats = -0.348 (differs significantly from a, c and d).
- c. New Democrats/Blue Dogs = -0.200 (differs significantly from a and b).
- d. Blue Dogs = -0.130 (differs significantly from a and b).

In this case, parentheses (or brackets) were applied. Parentheses, according to the Oxford Online Dictionary, are “placed around extra information in a piece of writing”. On the surface, it is to add information or explanation. From an ideological operation perspective, it is to lead readers to read and comprehend a sentence *in the way the analysts wish* which assist the latter to interpellate the former as the subject of their arguments. This is especially because that words inside parentheses are usually seen as less important than the main text, which contains a function of what Barthes called the ‘alibi’¹⁰⁶; this is the reason why myth works successfully and efficiently.

In this example, the words that Medvic put in parentheses such as ‘(differs significantly from...)’ have already determined the direction to read the quantitative data¹⁰⁷. It is also because these are words in parenthesis, that readers might easily underestimate the extra information from Medvic, so that they are easily interpellated as subjects of the analysts.

Other explanation of the ideological function of punctuation marks is attached in Appendix 4-1: Basic Concepts of Textual Analysis.

Skill b) Using Personal Pronouns

Scholars in academia, especially young scholars, often use terms like *this study*, *this survey*, and *this research*, instead of *I* or *we* in their writing to appear to be coming from a neutral and objective position. Yet, the use of personal pronouns, on some occasions, could help analysts to interpellate their readers. Moss and O’Loughlin (2005), the analysts of RA05, implied and applied this function. They wrote,

¹⁰⁶ For the concept of ‘alibi’, please refer to Procedure 3 in this chapter.

¹⁰⁷ In this example, the words inside the parentheses show that the analyst wishes to create a relationship of a vs. b vs. (c+d). However, there is no reason to simply claim that c and d together differ from a and b just because the difference between them is less (-0.070). The analyst, by using additional words inside parentheses, has stressed his method of calculation being the only method readers should follow. On the surface, the parentheses signify an illusion of decreased importance whereas they are definitely there for the purpose of interpellation

The ubiquity of new interactive and networked technologies is heralding a new ‘information age’, or ‘*Our* Information Age’ in New Labour’s inclusive terms. (p. 170; emphasis original)

They italicized the word ‘our’, which implies that they also realised the power of using personal pronouns, helping them to encourage readers to stand with them (the use of italics also echoes the function of using punctuation marks as discussed in the previous section).

The concealed ideological function of using personal pronouns reflects in its two purposes, first, to increase the intimacy with readers and second, to create the same enemy hatred with their readers. First, regarding the increase of intimacy, RA04 can be used as an example.

Example 7-16 (all emphasis added): In RA04, Bishop (2001) wrote,

Instead, **we** are more obsessed with losing weight—and with using these “quick-fix” methods—than ever. (p. 335)

We spend \$ 6 billion a year on fraudulent diet products. (p. 335)

In case of RA04, by using the term *we*, Bishop has created an imaginary community. The ‘we’ he applied does not refer to any real persons. Instead, it refers to our social consciousness. *We* is seen here as a social totality, so that everyone, even if they are not a product user, has to face this problem since this is a community issue. Thus, by using *we*, Bishop raised the problem from a personal level to a social one. When readers agree with the seriousness, they will easily accept Bishop’s other arguments since we are implied to be as the whole.

Second, by using personal pronouns, analysts are able to forge an alliance where they and readers share a common hostility toward the same enemy.

Example 7-17: In RA04, after describing how diet companies persuade people to purchase their products by claiming the importance of being ‘thin’, the analyst immediately became his readers’ representative by asking a question,

But are companies having any success in reshaping **our relationship** to weight loss? (p. 338, emphasis added).

In another place, he wrote,

The full range of **our desires** was placed in the service of advertising’s basic purpose—to provide effective mass distribution of products. (p. 340, emphasis added)

When the terms *our relationship* or *our desires* come to readers' views, Bishop has created the impression that he is standing alongside readers and in so doing, readers feel that Bishop represents them to interrogate and fight against those diet companies. Once readers identify with Bishop, his other arguments opposing such organisations will also easily be accepted.

Sometimes, the use of personal pronouns could help emphasising the distinction among competing Classes in the research. Take RA20 for example.

Example 7-18: The analyst, Smith (1975), wrote,

From this circle women have been to a large extent excluded. **They** have been admitted to it only by special licence and as individuals, not as representative of their sex. **They** can share in it only by receiving its terms and relevances and these are the terms and relevances of a discourse among men. (p. 354)

What should be noted is that before this quotation, Smith used the word 'men' to describe males. Nevertheless, while describing women (as the above quotation shows), the word 'they' was adopted instead of the term 'women' (which was only used once at the beginning). In this way, Smith created a sharp comparison. While she criticised men, the word 'men' was visible to readers which helped them to recognize who the enemy really is. When she discussed the situation of females, the word 'they' was applied instead of 'women', to help to create a female's image of being *excluded* with no right to ask for their social position and role or even the female term—women.

Skill c) Using Specific Phrases

There are specific words or phrases which, on the surface, might be seen as ordinary as it can be from the readers' viewpoint; in fact, these words or phrases quietly and stealthily perform the functions of interpellation and articulation.

After investigating 33 IAC articles, this thesis has found three frequently applied types of phrases which possess great capacity to interpellate readers or articulate ideas to the analysts' argument. They are, first, the phrases which could hide the analysts' tracks; second, ordinal phrases/numbers; third, those phrases which claim to give evidence.

First, IAC analysts usually adopt specific words or phrases to conceal their own subjectivities. In so doing, they could create a neutral and objective image for themselves which would help them to hail readers to accept their opinions. In terms of specific words, for example, the words 'proponents' in RA14, 'one' in RA29 (e.g., One could say, p. 917),

and ‘informant’ in RA33 are applied to create the effect of being the ‘third person’ to hide the tracks of analysts. Regarding how specific phrases convey such a function, RA12 will be used as an example.

Example 7-19: In RA12, the way of using specific phrases helps Ewick and Silbey (1999) to hide their roles, as authors, here. They wrote,

Thus, being without resources, **Ms. Sherman understood** that she had little or no choice but to [...]. **Finding themselves** in such a position of powerlessness, people often [...]. **Recognizing themselves** as the "have nots" facing some [...]. (p. 1034; emphasis added)

Ewick and Silbey did not write ‘It is reasonable to say that Ms. Sherman believes’; instead they directly wrote ‘Ms. Sherman understood’ which is an affirmative sentence. By using such a description, they created the impression that Ms. Sherman is right here speaking or that they knew her well. They hide themselves with this specific phrase. This is their analysing by ideology criteria. Other novel-like writing styles, such as ‘finding themselves’ and ‘recognizing themselves’, also created a situation where the analysts hailed readers to be novel fans to accept their given ‘story’ instead of ‘analysis’. These phrases all convey the interpellation function to make readers believe.

By using such specific phrases, all analysts are able to obtain the alibi for their engagement. Through hiding their tracks from their articles, analysts are able to establish neutral and objective images for themselves. Once this is established, it becomes easier to convince readers.

Second, when analysts present their arguments by using ordinal phrases/numbers such as first, second, third, or, (1), (2), (3), on some occasions it will help to discipline readers. By using this, analysts create a clear map of their discussion for readers that can be easily followed. The more that readers follow these ordinals, the better able they are to understand analysts’ arguments; the more they realize what analysts try to argue, so they will be prisoners of the analysts’ arguments. Besides, through displaying arguments accompanied by these ordinal phrases/numbers, analysts are able to create a (false) impression that ‘my argument is systematic and clear’ which is also a reason to interpellate readers to approve the analysts’ efforts/credibility (not their argument). This phenomenon could easily be found by examining students’ reports, for example. While students seem to present their arguments by

using ordinal numbers, it will create a systematic image to examiners, even if their arguments are nonsense.

Third, it is common to see phrases such as ‘for example’ in many writing genres. When examples are linked well to analysts’ arguments, it is an efficient way to show support or evidence to readers and to persuade them, the opposite also applies. Yet, specifically in academic writing, weak examples, in fact, do not affect how academic readers value the analysts’ whole discourses as much as people used to think¹⁰⁸. This is thanks to the phrases (proclaiming to give examples) such as ‘for example’, which contains an ideological function. When the phrase ‘for example’ comes into readers’ view, they automatically switch their reading attitude whereby the given examples are unknowingly taken less seriously. Most academic scholars realize that exceptions can be found in every example. Weak examples can be replaced by more suitable ones only if the main arguments are reasonable. *Examples* are given to support the logic of analysts’ arguments; they play a subordinate role to the main argument. Take RA17 (Weltman, 2003) for example.

Example 7-20: After arguing that his interviewee, a politician who used to be a teacher, is “politically opinionated and [...] even politically engaged at a practical level”, the analyst, Weltman, continued to prove his argument by offering an example. He wrote,

She represents, for example, her own efforts as a teacher—especially working with underprivileged pupils—by reference to her self-proclaimed socialist beliefs. (p. 365)

In this case, by saying ‘for example’, Weltman did not have to explain all his interviewee’s beliefs related to being a teacher. Instead, he only had to select the particular part of his interviewee’s beliefs—the part which best suited his own argument¹⁰⁹. The term ‘for example’ diminishes readers’ watchfulness to ask Weltman for a systematic discussion. Since

¹⁰⁸ The argument of this thesis here should be compared to the general public’s writing activities. In academic writing, analysts’ arguments are given prior to their examples. Yet, to the public’s writings such as daily informal debates, a weak example will destroy the whole argument. This is because most of the public apply examples to explain what they are trying to argue. Most of them are incapable of establishing a systematic argument. As a result, giving examples become the primary way to describe their arguments which also simultaneously reveals their weakness.

¹⁰⁹ Of course, there is also a sense that this is good academic practice; to do otherwise would be to waste space. Yet, any selection of examples per se is already the conscious product of its analysts. The problem is that such personal conscious is concealed by the term ‘for example’ which provides analysts with more flexibility to demonstrate/defend their argument. This is also the argument why phrases like ‘for example’ possess ideological function.

such phrases (proclaiming to give examples, e.g., for example) possesses the function of lowering readers' alertness, readers will easily agree with his main argument as well as the invisible embedded personal ideology while they are reading the *examples*.

Other references of the technique, *Writing Skills*, which were applied in 33 IAC articles are listed in Table 7-6.

Table 7-6: References of Writing Skills

SWPs Code: P4-2-WS (Writing Skills)	
Articles	Found References/Examples
RA01	p.165(1); p.167(3); p.168(4); p.170(6); p.171(7); p.173(9); p.174(10); p.175(11); 176(12); p.177(13); p.178(14); 179(15);
RA02	p.245(1)d,g; p.246(2)a,e,g; p.247(3)a,e,g; p.248(4)a; p.249(5)a,g; p.250(6)a; p.251(7)a,d,g; p.252(8)d,e; p.253(9)g; p.254(10)d;
RA03	p.137(1)a; p.138(2)a,b; p.139(3)a,g; p.140(4)a; p.141(5)a,e,g; p.142(6)a,e; p.143(7)a,b; p.144(8)a,b,d,g; p.146(10)a,b,g; p.147(11)e; p.149(13)a,e; p.150(14)a; p.151(15)a,b; p.153(17)a,b,c;
RA04	p.334(1)a; p.335(2)a,b; p.336(3)g; p.337(4)a,b,e; p.338(5)a,b,c; p.339(6)a,b; p.340(7)b,e,g; p.341(8)g; p.342(9)b; p.343(10)b,g; p.344(11)a,b; p.345(12)a,b; p.346(13)a,b; p.347(14)a,g; p.348(15)a,b; p.349(16)a,b; p.350(17)a,b; p.351(18)a,b;
RA05	p.3(1); p.4(2); p.5(3); p.6(4); p.7(5); p.10(8); p.12(10);
RA06	p.445(1)a; p.446(2)a,b,g; p.447(3)a,b,g; p.448(4)a,b,g; p.449(5)a,g; p.450(6)a,d; p.451(7)a,g; p.453(9)a; p.454(10)a,g; p.455(11)a,b; p.456(12)a; p.457(13)a,b,e;
RA07	p.108(2)a,g; p.111(5)a,g; p.112(6)a,f; p.113(7)a; p.114(8)a,b,e,g; p.115(9)a,e,g; p.116(10)e; p.117(11)a,g; p.118(12)a; p.119(13)a; p.122(16)a;
RA08	p.262(2)e; p.263(3)g; p.264(4)d,e,g; p.265(5)e; p.266(6)g; p.268(8)g; p.269(9)e; p.270(10)b,f,g; p.273(13)e; p.274(14)b;
RA09	p.588(2)a,b,c,g; p.589(3)a; p.591(5)a,b,c,e,f,g; p.592(6)d; p.593(7)a,c,e; p.594(8)a,b; p.595(9)a,g; p.596(10)a,e,g; p.597(11)a; p.598(12)a; p.599(13)a,b,f; p.600(14)a,b; p.602(16)a; p.603(17)a,b,c; p.604(18)a,b,g;
RA10	p.417(1)a; p.418(2)a; p.419(3)a,g; p.420(4)a,c; p.421(5)a,g; p.422(6)a,g; p.423(7)a,g; p.424(8)a,e; p.425(9)a,g; p.426(10)a;
RA11	p.99(1)a,c,d; p.100(2)a; p.101(3)a,b,e,f; p.102(4)a; p.103(5)a; p.105(7)a,b; p.107(9)a;
RA12	p.1025(1)a; p.1026(2)a,c,e; p.1027(3)a,e,g; p.1028(4)a,g; p.1029(5)a; p.1030(6)a,b; p.1031(7)a,g; p.1033(9)a,b; p.1034(10)a,e,g; p.1035(11)a,b,e,g; p.1036(12)a,b,c,e; p.1037(13)a; p.1038(14)a,b; p.1039(15)a,b; p.1040(16)a,b;
RA13	p.279(1)e,g; p.282(4)a; p.283(5)a,e,g; p.284(6)e,g; p.285(7)a; p.286(8)g; p.287(9)e; p.288(10)a; p.289(11)a; p.290(12)a;
RA14	p.100(1)b,c,e,g; p.101(2)a,b,e; p.102(3)a,g; p.103(4)a,g; p.104(5)a,e,g; p.105(6)a; p.106(7)e,g; p.107(8)a,c,e,g; p.108(9)a,e,g; p.109(10)a,e,f; p.110(11)d;
RA15	p.455(1)a,b; p.456(2)a,b,g; p.457(3)a,b; p.458(4)b,g; p.459(5)b; p.460(6)b; p.461(7)a,g; p.462(8)a; p.463(9)c; p.464(10)a,b,g; p.465(11)b; p.466(12)a; p.467(13)a; p.468(14)a,e; p.469(15)a,b; p.470(16)a;
RA16	p.137(1)a; p.138(2)a; p.139(3)a,e; p.140(4)a; p.141(5)a; p.142(6)a; p.143(7)a,e; p.144(8)a; p.145(9)a,e; p.146(10)a,g; p.147(11)a; p.148(12)a; p.149(13)a; p.151(15)a,e; p.152(16)a,e; p.153(17)a,e; p.154(18)a,e;
RA17	p.349(1)a,e; p.350(2)a,g; p.351(3)a,b,g; p.352(4)a; p.353(5)a,g; p.354(6)a,g; p.355(7)a,g; p.356(8)a,b; p.357(9)a,b,g; p.358(10)b; p.359(11)a,b; p.360(12)a; p.361(13)a,b,d; p.362(14)e; p.363(15)a,b,e,g; p.364(16)a; p.365(17)a,b,e; p.366(18)a,b; p.367(19)a,g; p.368(20)a,b; p.369(21)a,b; p.370(22)b;
RA18	p.154(1); p.155(2); p.156(3); p.157(4); p.158(5); p.159(6);
RA19	p.162(1)b; p.163(2)b; p.164(3)b; p.165(4)a,b,c; p.166(5)a,c; p.167(6)a; p.168(7)a,b; p.169(8)a,b; p.170(9)a,b; p.171(10)a; p.172(11)a,b; p.173(12)a,e; p.174(13)a;
RA20	p.354(2)a,b,e; p.355(3)a,b,e,g; p.356(4)a,b; p.357(5)b; p.358(6)a,c,d,g; p.359(7)a,b; p.360(8)a,b,e; p.361(9)a,b; p.362(10)a,b,g; p.363(11)a,b; p.364(12)a,b,e; p.365(13)a,b,e,f; p.366(14)b; p.367(15)a,b;
RA21	p.412(2)a; p.414(4)a,g; p.415(5)e,g; p.416(6)a; p.417(7)a,g; p.418(8)a,g; p.420(10)a,g; p.421(11)a; p.422(12)a,e; p.423(13)c; p.424(14)c,g; p.425(15)c; p.426(16)a; p.427(17)a,b;
RA22	p.71(2)a,d; p.72(3)a,c; p.73(4)a,b,g; p.74(5)a,e,g; p.75(6)a,b,c,g; p.76(7)a,c,g; p.77(8)a,b; p.78(9)a,b,c; p.79(10)a,c,d; p.80(11)b,c; p.81(12)a,b,c,e,g; p.82(13)a,b; p.83(14)a,b; p.84(15)a,b,c,g; p.85(16)a,b,c,g; p.86(17)b; p.87(18)c; p.88(19)a,b,g;
RA23	p.387(2)a,b,e,g; p.388(3)a,c,e,g; p.389(4)a,g; p.390(5)a,g; p.391(6)g; p.392(7)b,c,d,e,g; p.393(8)b,c,g; p.394(9)c,g; p.395(10)b;
RA24	p.488(2)e; p.490(4)a,g; p.491(5)a; p.492(6)g; p.493(7)e,g; p.494(8)a,e; p.495(9)e,g; p.497(11)e,g; p.498(12)a,e; p.499(13)g; p.503(17)e; p.504(18)e;
RA25	p.467(2)d; p.467(2)a; p.468(3)g; p.469(4)g; p.470(5)a; p.471(6)a,g; p.472(7)a,g; p.473(8)a,g; p.474(9)a,g; p.475(10)a,e,g; p.476(11)a,e; p.477(12)a,e; p.478(13)a,e; p.479(14)a,e; p.480(15)a; p.481(16)a;

Procedure 4: Illustration (Articulation & Interpellation)

RA26	p.79(1)a,e; p.80(2)a,d,g; p.82(4)a,e; p.83(5)a,e; p.88(10)a,g; p.90(12)a; p.91(13)a; p.92(14)e; p.95(17)a; p.96(18)a;
RA27	p.180(1)a,e; p.182(3)a; p.183(4)a,e; p.184(5)a,e,g; p.185(6)a,e; p.186(7)a; p.187(8)a; p.188(9)a; p.189(10)a,e; p.191(12)a,e,g; p.193(14)a; p.197(18)a,e; p.198(19)a,e; p.199(20)a;
RA28	p.158(2)a,e; p.159(3)a,g; p.160(4)a; p.161(5)a,c; p.162(6)a,e,g; p.163(7)a; p.164(8)a; p.165(9)a,g; p.166(10)a; p.167(11)a; p.168(12)a,g; p.169(13)a,c,e,g; p.170(14)a,e,g; p.171(15)a; p.172(16)a,g; p.173(17)a,e; p.174(18)a; p.175(19)a,c; p.176(20)a,g; p.177(21)a,g; p.178(22)a; p.179(23)a,c; p.180(24)a; p.181(25)a;
RA29	p.915(2); p.916(3); p.917(4); p.919(6); p.922(9); p.925(12); p.926(13);
RA30	p.465(1)b; p.466(2)a,b; p.467(3)a,b,g; p.468(4)b; p.470(6)b,c; p.471(7)a; p.472(8)e; p.473(9)e; p.474(10)e; p.477(13)a,b,f; p.478(14)b,c; p.480(16)g; p.482(18)a; p.484(20)a; p.485(21)a,g; p.486(22)a,c; p.488(24)a,b; p.489(25)a,b; p.490(26)a;
RA31	p.219(2)a; p.220(3)a,c,e; p.221(4)a; p.222(5)a,c; p.223(6)a,c,e; p.224(7)a,e; p.225(8)a,e; p.226(9)c,e,g; p.227(10)a,e; p.228(11)a,e; p.229(12)a; p.231(14)a; p.233(16)a,g; p.234(17)c; p.235(18)a; p.236(19)a,c; p.237(20)a; p.238(21)a; p.239(22)a; p.240(23)a; p.241(24)a;
RA32	p.17(1)c; p.18(2)a,b,c,e; p.19(3)b,g; p.20(4)a; p.21(5)e; p.22(6)g; p.23(7)b; p.24(8)b; p.26(10)a,b; p.28(12)b,c; p.29(13)b;
RA33	p.641(1)f; p.642(2)d,g; p.643(3)a; p.644(4)a; p.645(5)e; p.646(6)a,e,g; p.647(7)a; p.648(8)a,e,g; p.649(9)a; p.650(10)a,e,g; p.651(11)a,g; p.652(12)e,g; p.654(14)g; p.657(17)a,e,g; p.658(18)a,b,e,g; p.659(19)g; p.660(20)b,g; p.661(21)a; p.662(22)a,g; p.663(23)a,g; p.664(24)a,g,e; p.665(25)e,g; p.667(27)b,g; p.669(29)a,b; p.670(30)a,b,e,g; p.671(31)a,b,g,f; p.672(32)a;
Concepts a: Using punctuation marks; b: using personal pronouns; c: using specific phrases; d: please refer to P6-2-AD;e: please refer to P6-2-AQ; f: sentence structure; g: please refer to P6-2-TS	

Explaining

Another common presenting technique found in 33 IAC articles is termed as analysts’ (seemingly redundant) *explaining* action. *Explaining* here simply means that analysts especially spend spaces to explain the basic information of their research, such as the methodology they adopt, how they collect the research data and related theories or concepts.

Reasons for *explaining* the research methodology are not only to clarify how the analysts undertake their research but also to create the impression to readers that ‘this research is systematically guided by clear direction’. The purpose of *explaining* the related theories and concepts of research is to claim: ‘this research has its theoretical basis’ which simultaneously strengthen the preciseness and reliability of such research. Whether explaining the methodology or related research theories, both are frequently applied in IAC articles to help readers better understand the research (on the other hand, they also help analysts to interpellate readers).

How the ideological function of *explaining* operates is based on this belief: if the research data are imprudently collected, the conclusions are very likely to be unreliable. Because of this belief, when analysts especially take time to explain how they collect/select research data, their (seemingly redundant) explanation will help to convince readers or lead them to believe that their arguments and conclusion are valid. Take RA05 for example.

Example 7-21: In RA05, the analysts, Brennen and Duffy (2003), used two pages to explain that the research data (i.e., news from the *New York Times*) they selected was reliable and impartial. In this case, they quoted the *Time's* slogan—All the News that's Fit to Print” (p. 4)—to prove that *New York Times* offers “decency as much as accuracy” (p. 4) which is a newspaper “that other newspapers have strived to follow” (p. 4). Moreover, they quoted approximately 120 words (on page 4) to explain how other people had given credit to the *New York Times*. Their explanations helped to tell readers that their chosen research data was valid which helped to transfer the credit to their subsequent argument and conclusion. The presenting technique of *explaining* is to strive for readers’ trust in order to infuse analysts’ argument (i.e., ideology) into them.

In short, analysts’ *explaining* the basic information of their research, on the surface, is to let their readers clearly understand the methodology or related theories. In fact, the process of giving explanations is to direct readers to believe the importance, indispensability, and reliability of their studies as well as to lead readers to a certain way of thinking. In so doing, they are able to create a neutral and objective image for themselves whereby their arguments (i.e, their own ideology) will unknowingly influence the readers.

Other references of the technique, explaining, which were applied in 33 IAC articles are listed as Table 7-7.

Table 7-7: References of Explaining

SWPs Code: P4-2-E (Explaining)	
Articles	Found References/Examples
RA01	p.166(2); p.167(3); p.168(4);
RA02	p.245(1)a; p.245-6(1-2)d; p.250(6)d; p.251-2(7-8)d;
RA03	p.137(1)d; p.138(2)a,d; p.139(3)a,d; p.140(4)d; p.141(5)a; p.142(6)d; p.143(7)d; p.144(8)a; p.145(9)d; p.146(10)d; p.147(11)d; p.148(12)d; p.149(13)d;
RA04	p.338(5)a,d; p.340(7)a,d; p.349(16)d;
RA05	p.3(1); p.4(2); p.5(3); p.12(10);
RA06	p.445(1)c; p.446(2)a,d; p.447(3)a,d; p.448(4)a,d; p.449(5)a,d; p.452(8)d;
RA07	p.108(2)a,d; p.109(3)a,d; p.110(4)d; p.111(5)a,d; p.112(6)d; p.114(8); p.117(11)d; p.118(12)a,d; p.119(13)c;
RA08	p.261(1)d; p.262(2)a,b,d; p.264(4)d; p.265(5)a,d; p.272(12)d;
RA09	p.588(2)a; p.589(3)d; p.590(4)d; p.595(9)a; p.596(10)a; p.597(11)a; p.599(13)a; p.601(15)a;
RA10	p.417(1)d; p.418(2)a,d; p.419(3)a,d; p.420(4)d;
RA11	p.101(3)a,d; p.102(4)d; p.103(5)d; p.105(7)d; p.106(8)d; p.107(9);
RA12	p.1026(2)d; p.1027(3)a; p.1028(4)c,d; p.1029(5)c; p.1030(6)c; p.1031(7)d; p.1032(8)c; p.1036(12)d; p.1037(13)d; p.1038(14)d; p.1040(16)c;
RA13	p.282(4)d; p.284(6)d;
RA14	p.100(1)a,d; p.101(2)a; p.102(3)a,d; p.103(4)a,d; p.104(5)a,d; p.105(6)c,d; p.106(7)d; p.107(8)d; p.108(9)d;
RA15	p.456(2)a; p.457(3)a; p.458(4)a; p.468(14)a;
RA16	p.138(2); p.139(3)a,d; p.140(4)a; p.141(5)a,d; p.142(6)a; p.143(7)a; p.144(8)a; p.145(9)a; p.146(10)a; p.151(15)a; p.154(18)d;
RA17	p.350(2)a,b,d; p.351(3)a,d; p.352(4)a,d; p.353(5)a; p.354(6)a; p.355(7)a; p.356(8)d; p.357(9)a,d; p.358(10)a; p.362(14)d; p.366(18)d;
RA18	p.154(1); p.155(2); p.156(3); p.157(4); p.158(5); p.159(6);
RA19	p.162(1)c,d; p.163(2)c,d; p.164(3)c,d; p.166(5)c,d; p.167(6)c,d; p.169(8)c,d; p.173(12)c,d;

Procedure 4: Illustration (Articulation & Interpellation)

RA20	p.355(3)a,d; p.356(4)a,d; p.359(7)a; p.361(9)d; p.363(11)c; p.365(13)c; p.366(14)c;
RA21	p.411(1)d; p.412(2)d; p.413(3)a,d; p.414(4)d; p.415(5)d; p.416(6)d;
RA22	p.74(5)a; p.75(6)a,d; p.76(7)d; p.77(8)d; p.78(9)d; p.79(10)c,d; p.80(11)c; p.83(14)d; p.85(16)c;
RA23	p.387(2)a,d; p.388(3)d; p.389(4)d; p.390(5)a; p.392(7)d; p.395(10)c,d;
RA24	p.488(2)d; p.489(3)a,d; p.490(4)d; p.491(5)a,d; p.492(6)a,d; p.493(7)a,d; p.495(9)d; p.496(10)d; p.498(12)d; p.504(18)d;
RA25	p.469(4)a,d; p.470-1(5-6)d; p.471(6)a,b; p.480(15)d;
RA27	p.180(1)d; p.181(2); p.182(3)a; p.183(4)d; p.186(7)d; p.187(8)d; p.188(9)d;
RA28	p.159(3)a; p.162(6)d; p.163(7)d; p.164(8)d; p.165(9)d; p.170(14)a; p.175(19)d; p.176(20)d;
RA29	p.915(2); p.919(6);
RA30	p.465(1)c; p.466(2)a,c,d; p.467(3)a,d; p.468(4)d; p.471(7)a; p.474(10)d; p.479(15)d; p.482(18)d; p.483(19)a; p.485(21)d; p.486(22)d; p.487(23)d;
RA31	p.220(3)a; p.223(6)d; p.226(9)d; p.227(10)c; p.230(13)d; p.233(16)d; p.234(17)d; p.235(18)d; p.236(19)a; p.238(21)a; p.239(22)d; p.240(23)d;
RA32	p.17(1)a; p.18(2)a,d; p.19(3)b; p.23(7)d; p.24(8)d;
RA33	p.642(2)a,d; p.643(3)d; p.644(4)d; p.645(5)d; p.646(6)d; p.647(7)d; p.648(8)d; p.649(9)d; p.651(11)d; p.652(12)d; p.655(15)d; p.657(17)d; p.665(25)d; p.666(26)d;
Concepts a: Explain the methodology and limitation; b: explaining how data is collected; c: explaining personal experience; d: explaining specific theories;	

7.7 Conclusion and Discussion

In spite of how IAC analysts write their articles, the most likely purpose is to persuade readers to accept what they argue. When a reader accepts one article’s argument, it could say that such article successfully interpellates this reader as subject of its argument. This article succeeds in ideology competition.

In order to successfully obtain readers’ acknowledgment, providing professional, conscientious, systematic, and theoretical aspects, of course, are essential. Yet, there are still some unobtrusive ‘illustrating/presenting techniques’ which carry the capacity to undertake the ideological operation of interpellation and articulation. They could be the last push. Accordingly, the mission of Procedure 4 *Illustration* is to detect: what presenting techniques that IAC analysts apply are able to carry the operation of interpellation and articulation.

Conclusion

This section first stated that interpellation and articulation are alter egos of each other, which are all based on analysts’ illustrations. Two illustrating aspects are, first, via a thorough understanding of the research subjects’ history or literature, and second, through specific presenting techniques.

In terms of the former, when IAC analysts have a good understanding of the history or literature of their research subjects, they are able to utilize similar concepts from the past to justify their argument of the current research subjects. Through thoroughly understanding the history/literature, this becomes a treasury where analysts can find suitable references to attest their arguments. *Finding similarities* (and *Making Comparison*) to refer to certain arguments

or *using references* to justify the validity of the arguments are all part of the ideological operation which is hidden in the clothing of normal writing.

In terms of analysts' illustration via specific presenting techniques, this thesis suggests four ways. The first is *transferring*, creating a channel, through which an analyst's written words will become neutral, objective, and reasonable, helping to interpellate readers to accept the argument. Second, there are certain social beliefs that people cannot discard (for fear that their belief system might collapse) or scientific evidence they cannot challenge. When IAC analysts use these *inarguable values*, it helps to curb readers' floating thoughts in order to finally ask them to accept the provided arguments.

Third, there are functions of interpellation or articulation which have resulted from IAC analysts' *writing skills/habits*, including the usage of punctuation marks, personal pronouns, and specific phrases. These skills could create diverse implications which expose analysts' particular attitudes as well as influencing readers' cognition. Finally, when IAC analysts *explain* the basic information of their studies (such as how they collect/select research data), on the surface, they help readers to understand their research better; in fact, they help themselves to interpellate readers since their explanations lead (or limit) readers to a certain way of thinking.

Discussion

Whether this procedure, *illustration* (via understanding the history and through presenting techniques), possesses the ideological function of articulation and interpellation as this thesis states above is arguable. Although this thesis has theoretically explained the validity of these suggested concepts, they do refer to the invisible effects upon *readers' cognition* which cannot be examined from IAC articles. Yet, it is because no one can absolutely deny these techniques' ideological function and because these suggested techniques look absurd, that is why these techniques convey the invisible ideological function of articulation and interpellation. If their functions were recognisable and approvable, they would have become the 'ideology' (a fixed system of ideas) instead of the invisible 'ideological function'.

Illustrating techniques of the Procedure 4, which are frequently applied by IAC analysts, should be seen as a 'possible way' to interpellate readers as subjects of the analysts as well as to articulate certain concepts of the analysts' arguments, which are not guaranteed. In fact,

Procedure 4: Illustration (Articulation & Interpellation)

the process of interpellation and articulation (i.e., illustration) will never see immediate effects; instead, it is a long-term effectuation. The only guarantee to successfully influencing readers is through repetition including *continuation* and *accumulation*.

Continuation, from the analysts' position, means to keep interpellating readers and articulating ideas to intensify arguments through diverse presenting techniques. Accumulation means that readers will eventually 'answer the call' (Althusser's term) once they receive and are saturated with enough messages from analysts' contexts. This is similar to the process of chasing a person you admire by writing billets-doux, for example. It does not matter if you write hundreds of letters that receive no positive responses, because it would be worth it if one of the letters, or even one sentence, touched the intended's heart and moved him/her to realize your genuineness somewhere in time.

Triggering the making of an ideology always happens so silently that no one is able to detect when, where, and how this ideology started to exist, which has similarities with people not usually being able to verbalise why they have fallen in love with someone, as the feeling takes people by surprise. Yet, one thing that is guaranteed to succeed whether in interpellating readers or chasing a would-be love interest is repetition—continuation and accumulation.

Chapter 8

Procedure 5: Selecting Expression Styles & Procedure 6: Revealing Personal Viewpoints — Ideology Embedded in Analysts

The previous chapter specifically focused on ideological operation, which is concealed in IAC articles' texts. This chapter turns the dimension to investigate ideological operation embedded in IAC analysts' consciousness to ascertain what commonality they share while writing their IAC articles. This chapter contains the final two procedures of SWPs, *procedure 5: selecting expression styles* and *procedure 6: revealing personal viewpoints*.

Procedure 5 discusses the extent/degree to which IAC analysts involve their own viewpoints within their writings, which will correspondingly affect the extent to which the validation of an IAC article is recognised and accepted by the readers. Three styles have been classified which are, from lower participation to high involvement, the *purely descriptive*, *interpretative*, and *defensive and corrective styles*. In the final procedure 6, this thesis will focus on how IAC analysts intentionally/accidentally reveal their personal viewpoints (subjectivities) through their writing in two ways, first, via *declaring a standpoint* and, second, through their *narrating traits*.

This chapter will introduce these two procedures, then a conclusion for the all six procedures (Chapters 5-8) and further discussion will be provided.

Procedure 5: Selecting (IAC) Expression Styles

8.1 Introduction

Diverse IAC analysts, from different backgrounds, compose various types of IAC articles. Some of them try to be neutral and objective to describe social phenomena while others

place themselves into the discussion to defend or argue against certain ideology. Accordingly, procedure 5 will categorise the expression styles that IAC analysts frequently apply based on the extent/degree that they involve their own viewpoints (including their attitudes, positions, judgements, preferences) within their writings.

This thesis adopts a holistic dimension to categorise the 33 collected IAC articles, in which three expression styles have been generalised. They are 1) the purely descriptive style, 2) the interpretative style, and 3) the defensive and corrective style.

8.2 Selecting Expression Styles

Purely Descriptive Style

The first style means that IAC analysts simply and purely describe the research phenomenon they have discovered without involving themselves with any personal subjectivity. With respect to this style, the most common research method that IAC analysts adopted includes literature review, interview surveys, or quantitative statistics. For example:

Example 8-1: RA09 does not talk about how power operates or how power constructs reality. The analyst of this article adopts quantitative data (e.g., voting statistics) to show us where in the spectrum of political ideology (i.e., liberal, centrist, or conservative) these diverse factions (i.e., Traditional Democrats, New Democrats, Blue Dogs) of the Democratic party are located. The analyst simply and purely describes what consciousness one faction holds without involving a discussion of power operation or whether this faction consciousness is true or false. The discussion maintains a neutral dimension.

Example 8-2: RA11 discusses how Islamic intellectuals internally fight for the interpretation-rights of the reform of Islamic law. The analyst of this article did not reveal much of his subjectivity; instead, his discussion is mainly based on historical explanation and quotation. As a result, this article is categorised as a purely descriptive style of ideological analysis¹¹⁰.

¹¹⁰ It is imaginable that readers might argue whether this style (purely descriptive) be claimed as 'ideological' critique/analysis, or is not 'purely descriptive' terms which contradict 'ideological' analysis/critique? Two points could answer this argument. First, in the introduction chapter, this thesis suggested that the term 'critique' and 'analysis' are alter ego of each other. Second, in Chapter 5, this thesis has discussed the nature of ideology whereby it is possible for the term ideology to possess a positive/neutral characteristic. Based on these two points, a critique/analysis on ideology could be one

Other cases regarding IAC articles, which are written via a purely descriptive style, include RA09, RA11, RA29, and RA33. For a detailed explanation, please refer to Appendix 6-1.

In short, the IAC analysts who adopted the purely descriptive style mostly tried to stand in a position outside of personal judgement. They were likely to recall history, cite relative quotation, or adopt quantitative statistics; that is, they let visible evidence speak for itself. It could say that this *purely descriptive style* usually responds to the IAC articles, which are based on the analytical pathway of *historical description* introduced in Procedure 2.

Yet, it is precisely because the research subject they tried to figure out was *ideology* itself that these IAC analysts, more or less, were likely to infuse their own subjective evaluations into their articles. Therefore, strictly speaking, this purely descriptive style can only be seen as an ideological analysis style that *attempts* to stay in a relatively neutral or positive position to undertake their analysis.

Interpretative Style

Another commonly applied IAC expression style is the *interpretative style*. Different from the first style where IAC analysts purely describe/present the (new) ideology they discovered, in the second style, they start to argue or judge their research subjects. In other words, after describing what ideology it is (the first style), IAC analysts continue to illustrate why this certain ideology is formed, to clarify the differentiation amongst diverse ideologies, or to explain how (and under what conditions) these ideologies are transformed (e.g., from old ones to new ones). Namely, the more one IAC analyst tries to interpret, the more their personal subjectivity is revealed. The track of their subjective intervention could be found throughout their words regardless of their doing so purposely or unconsciously. For example:

Example 8-3: RA22 *theoretically* discussed how reality is constructed, e.g., by different social structures, such as school vs. real society. The analyst designed an example (not a real-life example) to discuss how parents and daughters react to the question of whether a crop-top is cute or dorky. Although this analyst tried to examine what reasons (e.g., relative truth, social truth relativism) influence parents' and daughters' thoughts, the way he

in which its analysts neutrally and purely present their findings without displaying (much) of their personal opinions (ideology).

described it was obviously close to the parents' position (even though he tried to present the argument neutrally and equally). Since this analyst involved his attitude in his discussion (e.g., he clearly determined that parents' opinion is right), this article was categorised as an interpretative style of ideological analysis.

Example 8-4: RA14 is an article that obviously showed the analyst's personal subjectivities. This article explained that Asante's notion of Afrocentricity did not work out as Asante expected—to lead black people or Africans to escape from the dominance of the West. To the analyst of RA14, Asante's demonstration still relies on the vested Western logic; the world is not changed due to Asante's suggestion, and that black people are still alienated. The analyst's subjectivity is found through his writing. He confirmedly argued that things are not going the way that Asante wished. This is an evaluation made from his point of view.

Other cases regarding IAC articles that are written via an interpretative style include RA01, RA05, RA08, RA14, RA15, RA17, RA22, RA24, RA28, and RA32. For a detailed explanation, please refer to Appendix 8-1.

In short, the interpretative ideological analysis style can be seen as an analytical extension of the first style. The difference is that the IAC articles are categorised into the interpretative style only when their IAC analysts involve personal subjectivities in their writings, regardless of whether it was done intentionally or unknowingly.

Articles Categorised Between the Purely Descriptive and Interpretative Styles

Although this thesis tries to distinguish diverse expression styles based on the degree to which IAC analysts involve themselves in their writing, there are still some cases that cannot be categorised into either purely descriptive or interpretative styles. In spite of how hard IAC analysts tried to purely describe their research objects, on some occasions, they still inevitably revealed their subjectivity due to, for example, the vocabularies they used or the unintentional judgements they made. Take RA12 and RA13 as examples.

Example 8-5: The first half of the RA12 was written via a purely descriptive style in which analysts simply presented stories of their interviewees and quoted these interviewees' own words to show what they thought about the law. Yet in the second half of this article, the analysts started to bring their opinions to demonstrate how and why the 'Haves come out ahead.' For example, they wrote sentences such as "In answering these questions, we suggest

precisely the opposite [...]” (p. 1036) and “We reiterate, however, that law’s power is only in part derived from its status as transcendent and ideal” (p. 1040). This thesis does not mean to find fault with the way they presented articles. These sentences indeed exposed the analysts’ position and attitude, which turned its expression angle from purely descriptive to an interpretative style. Thus, it should say that both purely descriptive and interpretive styles coexist in this article.

Example 8-6: RA13 adopted methods of historical narration and offered quantitative data to explain that Egypt’s social welfare plans (e.g., public assistance law and social insurance) indeed are the rhetoric tools that helped diverse political regimes to maintain social order and their authority. Regarding the analytical methods this article applied, it could be categorised as a purely descriptive style. Nevertheless, some of the analyst’s writings, such as “This sudden concern” (p. 280), “it is thus not surprising” (p. 281, 288, 290), “It no doubt seemed”, “would (of necessity?) be added” (p. 283), and “Ironically, . . .” (p. 290), to a great extent, have revealed her own preference and subjectivity. Although these subjective descriptions might be innocent writings due to the analyst’s writing behaviour, in a holistic view of this article, a fair categorising is to admit the existence of both styles in this article.

Other cases regarding IAC articles that are categorised between the purely descriptive and interpretative styles include RA12, RA13, RA16, RA25, and RA26. For a detailed explanation, please refer to Appendix 8-1.

Defensive and Corrective Style

The third one is the defensive and corrective style of ideological analysis. If the IAC analysts intentionally or unconsciously display their subjectivities in the interpretative style, then one could say that, in the defensive and corrective style, they directly and obviously expose their attitudes and even their emotions.

IAC analysts who adopt this style usually involved their opinions within the discussion, even though they may not have been aware of their involvement. Because of this, these IAC analysts are usually considered to be prejudiced, and the arguments they put forth in the articles seem as if they just want to refute or remonstrate something they consider justified. Although this expression style obviously reveals the analysts’ subjectivity, it does not mean that such ideological analysis is wrong or fails, which will be explained later.

IAC analysts who write their articles via the defensive and corrective style usually share this common feature: they begin with (sometimes strongly) declaring how W is subjectively, intentionally, and mistakenly represented by an ideology (which is constructed by a certain group)—that is, the truth is not like what such ideology has averred. After defending, sometimes, they continue to explain what the genuine truth of W should be.

Namely, through the demonstrative process of ‘it is not . . . but . . .’, the IAC analysts explain what ideology they oppose, how this ideology is formed, what influences it might cause, and how the genuine reality is now treated negatively. Simply put, they defend and correct the misunderstood parts as well as tell readers what is right. Take RA07 for example.

Example 8-7: RA07 explained how the medical profession, which is continually superior in power to nursing, adopts its medical discourses to construct a traditional value: nursing is subject to the medical profession. Because of such discourses, when nursing tries to fight for its independent character, simultaneously, nursing is articulated to the images of crisis, militancy, radicalism, and incompetency. The analyst of this article criticised such false images of nursing and, by defending and redressing, he offered readers a real image of nursing.

In addition, IAC analysts who deployed the defensive and corrective style of ideological analysis, to a great extent, evinced a close connection with their backgrounds, such as education, ethnicity, nationality, and history. This finding will be mainly discussed in Procedure 6.

Other cases regarding IAC articles that were written via a defensive and corrective style include RA02, RA03, RA04, RA06, RA07, RA10, RA18, RA19, RA20, RA21, RA23, RA27, RA30, and RA31. For a detailed explanation, please refer to Appendix 8-1.

8.3 Discussion and Application

Discussion: Which Style is the Best?

The procedure of selecting expression styles is distinguished by the degree that IAC analysts involve their own viewpoints (including their attitudes, positions, judgements, preferences, etc.) within their writings, which will correspondingly affect the extent to which the validation of an IAC article is recognised and accepted by readers. However, since it is

incapable of recognising who the readers are and what experiences they possess, no one is able to claim which expression styles are the best. In fact, any style that could interpellate readers as the subject of its argument is a suitable one, which, of course, depends on the subjects, readers' backgrounds, and the media through which arguments are presented.

Theoretically speaking, IAC analysts who adopt the purely descriptive style can provide the article with an neutral and objective image, while analysts who write through the interpretative or defensive/corrective styles might incur criticisms such as 'possessing too much of their personal ideology and standpoint.' Yet, on some occasion, articles whose authors highly reveal their personal feelings/opinions on their analyses (i.e., the interpretative or defensive and corrective styles) could easily touch readers' heart compared to articles written neutrally or objectively. Take RA02 as a practical example.

Example 8-8: The analyst of RA02, Tahir Abbas, explained how the British press misrepresents South Asian Muslims, all the while evincing a high degree of personal judgement. On the one hand, Western white people may deem this article as one full of complaints and querulousness, while a purely descriptive style of ideological analysis might more easily attract their attention to the media's misrepresentation phenomenon. On the other hand, although the defensive and corrective styles obviously disclose the analysts' high degree of subjectivity, this expression style could receive identification from a particular group of readers, especially those who agree with the same argument (i.e., the logic of "X press misrepresents Y") or who have ever experienced the same situation (e.g., people who feel that they are misrepresented by the media, such as women, members of a subculture, or underprivileged and oppressed groups).

Accordingly, among these three expression styles, there is no best one for all ideological analysis/critique. It all depends on a case-by-case basis. This is all because no one knows who the readers are exactly, as well as when, where, and under what conditions the articles could interpellate readers as subjects of their arguments.

Application of Three IAC Expression Styles

The purpose of analysing one ideology (or say, writing IAC articles) is to tell readers what has been found and, most importantly, ask them to accept the argument. There is no right expression style to apply in all cases. The style that can influence the most readers is the best

(even though some styles might be purposely applied for certain reasons). Thus, the purpose of this section is to suggest to the future analysts some conditions of applying these expression styles.

Simply put, all IAC analysts have to observe in advance who their potential readers will be and where they hope their articles will be published (e.g., readers of ordinary newspapers/magazines, readers of general interest academic journals, or readers of journals in specific areas, e.g., gender, religion). Then they can decide whether they themselves should employ the purely descriptive, the interpretative, or the defensive and corrective styles that reveal the degrees of their subjective participation.

Table 8-1 shows the strategy to apply these expression styles. What one has to notice is that this table only concentrates on specific conditions, i.e., the potential readers and platform of publication. In fact, in practice, how IAC analysts express their articles is, no doubt, quite complicated.

Table 8-1: Application of Three IAC Expression Styles

Expected Readers/ Expected Publishing Platform	Position of Imaginary Readers	Suggested Styles
General public/ Informal media (e.g., local newspaper)	Insiders	DCS*
	Unclear or neutral position	IS/PDS>DCS
	Outsider or opposite opinion	PDS>IS
Specialists/ Professional media (e.g., journals)	The same character	PDS>IS>DCS
	Different character	PDS>IS
* PDS: The Purely Descriptive Style. IS: The Interpretative Style. DCS: The Defensive and Corrective Style.		

8.4 Conclusion

To summarise this section (Procedure 5), this thesis has categorised three expression styles that IAC analysts usually adopt while writing their IAC articles. They are the purely descriptive, the interpretative, and the defensive and corrective styles, which are distinguished based on the degree to which IAC analysts involve their own viewpoints within their writings. Correspondingly, the diverse application of expression styles will affect the extent to which the validation of an IAC article is recognised and accepted by the readers. Yet this thesis cannot judge which styles are the best nor argue whether IAC analysts should involve subjectivity in their writing. Since no one can exactly predict who their readers

might be or when these readers could be interpellated as the subjects of their articles, the style that can influence the most readers is the suitable one. Moreover, these three expression styles of ideological analysis can be seen as references for future analysts. After recognising what characteristics their potential readers possess, as well as where they hope their articles will be published, these future analysts could select the appropriate expression styles to compose the most influential IAC articles.

Procedure 6: Revealing Personal Viewpoints

8.5 Introduction

Procedures 5 and 6 investigate the ideological operation embedded in IAC analysts' consciousness to ascertain what commonality they share while writing their articles related to ideological critique. In *Procedure 5, Selecting Expression Styles*, this thesis has discussed the diverse extent to which IAC analysts involve personal subjectivities within their writing.

In this final *Procedure 6, Exposing Personal Viewpoints*, two sections of discussion are included. This thesis first explains how IAC analysts declare their standpoints which reflect their attitude regarding ideology, including its power, its capacity, and the possibility of resistance. In the second section, this thesis will focus on IAC analysts' writings to investigate how unremarkable narrating traits that IAC analysts casually apply have invisibly exposed their subjectivities. Four narrating traits of IAC analysts are inducted: 1) title selection, 2) asking questions, 3) personal background, and 4) assertive declaration.

8.6 Subjectivities Revealed— via Declaring a Standpoint

In its analysis of the 33 IAC Articles, this thesis discovers how IAC analysts see the power of ideology as well as how they infer the final outcome of their research. Two standpoints could be drawn, the pessimistic or the optimistic attitudes.

Declaring a Standpoint: Pessimistically

A pessimistic attitude is usually revealed in IAC analysts' writings in their encounter with the power of ideology. Their pessimistic discourses usually refer to a sense of powerlessness: in spite of the oppressed groups' efforts to change, eventually they are incapable of escaping from the power of ideology (controlled by superior groups). The IAC articles' discourses or conclusions, which adhere to such a pessimistic position, usually build on the concepts similar to notions of Gramsci's 'dominant hegemony' or Althusser's 'reproduction of the relations of production'. These two notions share the same argumentative logic: the dominant groups will utilize their resources and power to continuously reproduce the relations of production, which can maintain their dominance over the subordinate classes, in order to sustain their hegemony. Take RA06 and RA14 as examples.

Example 8-9: The IAC analyst of RA06, Ronald Bishop (2005), expressed his pessimistic attitude of resistance regarding the influences of ideology constructed by certain groups. He wrote,

Resistance is often reshaped so that it cannot offer a substantial challenge to the dominant ideology. Opponents are even given the “rhetorical tools” needed to mount a challenge, but their efforts only bring limited challenge to the dominant ideology. (p. 447)

Example 8-10: The analyst of RA14, James Palermo (1977), illustrated how one ideology constantly reproduces its rationality, which drives the younger generation to keep identifying with it.

The school then, reproduces the relations of the exploited to exploiters repeating the capitalist relations of production, and inculcating within the child the ideology of the ruling class wrapped up in an apprenticeship with a variety of know-how knowledge. (p. 105)

The first example echoes Gramsci’s demonstrative logic of dominant ideology while the second example responds to Althusser’s notion, even though the names of these two contributors of the ideology concepts were not mentioned.

There are plenty of reasons that can lead IAC analysts to espouse a pessimistic attitude toward ideologies: reasons such as the existence of ‘unbalanced power’ and ‘false consciousness’, ‘alienated subjects’, or the phenomenon of ‘otherization’. For example, in RA02 and RA06, the IAC analysts expounded that the interpretation-rights are possessed by a certain group due to the existence of an unbalanced power relationship. In RA04, RA14, RA18, these analysts adopted the concept of *false consciousness* to describe how a certain dominant ideology is maintained. In RA02, RA05, and RA10, the IAC analysts mainly discussed how subordinate groups are ‘otherized’ by the dominant groups and, as a result, lose their rights of speech and interpretation in the competition for ideological hegemony.

Based on the above discussion and examples, the discourse logic of the IAC analysts who possess a pessimistic attitude can be drawn as:

- a) Since the power between two Classes is unbalanced (or reasons such as the influence of the false consciousness, or the subordinate groups’ being otherized),
- b) and under this inescapable circumstance, the dominant Class is able to continually reproduce the necessary elements (relations of production) to sustain its hegemony.

c) As a result, the oppressed Class lose their interpretation rights in the competition of ideological hegemony. The dominance in the relationship remains.

References of IAC articles whose analysts possess a pessimistic attitude are listed as Table 8-2.

Table 8-2: References of Pessimistic Standpoint

SWPs Code: P6-1-P (Pessimistic Attitude)	
Articles	Found References/Examples
RA01	p.166(2); p.178(14); 179(15);
RA06	p.447(3)
RA14	p.105(6)
RA30	p.466(2);
RA31	p.226(9);

Declaring a Standpoint: Optimistically

By contrast, IAC analysts who possess an optimistic attitude (which, of course, does not mean they neglect the power of ideology) will usually offer suggestions to escape from the cage of ideology after explaining how the power of ideology works in their research subject. On other occasions, IAC also offer their arguments which are close to another dimension of understanding Gramsci’s hegemony theory. The concept of the hegemony theory they employed focuses on the *process of hegemonic struggle*, implying that the hegemony (i.e., dominant ideology) is not immobile because the disadvantaged groups are still able to fight for ‘intellectual and moral leadership’ (Gramsci’s term). Take RA07 for example.

Example 8-11: In RA07, the analyst, Hazelton, (1990), explained that there is an unequal power relationship between independent nurse education and the nurse education which pertains to the medical profession. He also explained how the medical profession maintains its hegemony through discourses. Nevertheless, Hazelton also emphasized the existence of an “ideological struggle” (p. 108) while offering the concept of hegemony. He wrote that “hegemonic dominance is not akin to ‘a piece of heavy machinery’ which relentlessly guarantees the continued existence of a dominant class” (p. 109). This responds to the situation where he devoted a lengthy portion of his article to argue that the medical profession maintains its hegemony through discourses but, unexpectedly, came to the following irrelevant conclusion in the final sentence of the article. He concluded,

to this end nurses should not be daunted by the task ahead, indeed, the very fact that nurse education is now situated firmly in the higher education sector represents a considerable success (p. 123).

It is reasonable to say that the reason why IAC analysts like Hazelton possess an optimistic attitude about escaping from the power of ideology is because they believe the ideological hegemony is able to be snatched, is changeable, and is not absolute.

The other optimistic view discovered in IAC articles focuses on the discussion of class consciousness. This adopts discourses spanning from Marx to Lukacs, stating that if class-in-itself could be transformed to class-for-itself (that is, the awakening of class consciousness), it is possible to break through the shackles of ideology. Take RA20 for example.

Example 8-12: The analyst, Smith (1975), expounded first that female academics are excluded because of manipulation derived from male language, judgement, signs, powers, and established knowledge. As a result, she accentuated that women are incapable of throwing off this yoke until awakening to their female self-consciousness. As she wrote,

We cannot be content with working as academics in the box created by the male monopoly of artistic, ideological, and other symbolic resources so that we do in relation to women and arising out of our interests and experience. [...] We must [...] begin an examination and critique of how women are constituted as other in the ideological formations which establish the hegemony of male consciousness. [...] This means, for example, claiming the right to examine literature from the perspective of women [...] constructing a sociology for women rather than of women. (p. 367)

Accordingly, the reason why IAC analysts like Smith possess an optimistic attitude is because they believe they can recognize the unfairness and the oppressed predicament they are situated in, as long as their consciousness is awakened, which conforms to what Adorno (1973) said: “things should be different” (p. 203).

Based on the above discussion and examples, the discourse logic of IAC analysts who possess an optimistic attitude could be drawn as:

- a) Although unbalanced power, false consciousness, alienation, and otherization indeed exist and seem unavoidable,
- b) every voice is still able to strive for the ‘intellectual and moral leadership’ or rights of interpretation. Ideological hegemony is not immobile.
- c) Things might be different only based on one condition: the oppressed Class has to awaken to their Class consciousness, their interests, to become the ‘class-for-itself’ instead of ‘class-in-itself’.

References of IAC articles whose analysts possess an optimistic attitude are listed as Table 8-3.

Table 8-3: References of Optimistic Standpoint

SWPs Code: P6-1-O (Optimistic Attitude)	
Articles	Found References/Examples
RA07	p.109(3); p.123(17);
RA12	p.1026(2);
RA15	p.469-70(15-6);
RA20	p.367(15);
RA22	p.86(17); p.87(18);
RA27	p.187(8);

8.7 Subjectivities Revealed—due to IAC Analysts’ Narrating Traits

The previous section showed how IAC analysts see the power of ideology as well as how they infer the final outcome of their research subjects. Two standpoints could be drawn, the pessimistic or the optimistic attitudes. If declaring a standpoint reflects IAC analysts’ attitude regarding ideology, then the following discussion, which focuses on analysts’ narrating traits, can be seen as another way to examine how they reveal their subjectivities. Four traits have been concluded. They are IAC analysts’ 1) title selection, 2) asking questions, 3) personal background, and 4) assertive declaration.

Narrating Traits: IAC Analysts’ Title Selection.

In journalism, if news is seen as a commodity, then the headline of this news is the advertisement of this commodity. How titles are selected, just like in the case of advertisements, determines whether readers read them or what angle they adopt when reading them.

Title selection in academic articles follows the same mechanism. Analysts could utilize titles or sub-titles to attract readers in order to force or influence them to agree or adopt their viewpoints. In other words, title/sub-title selection, a seemingly common and insignificant action, could reveal analysts’ (unintentional) subjectivities as well as influence readers’ cognition. The function of this trait is to lead readers to a certain way of thinking and making readers self-fulfil the argument that the title stated.

Title selection is found to be a frequently applied narrating trait in 33 IAC articles. Take a few IAC articles as examples.

Example 8-13 (Sub-title Selection): In RA06, the analyst, Bishop (2005), denominated the section headings as ‘Making Concessions’ (p. 449) and ‘Hurting the Team’ (p. 451), in RA31, Dilevko (2001) named one heading ‘The Danger of Deskilling in Call Centers’ (p. 222), and in RA23, Barker et al. (1995) subtitled a section as ‘The retreat from skills’ (p. 392). Although these section headings reveal the main ideas of each section in advance, it is still a contention, which is over-determined by its analysts to the extent that it has already set up a reading angle for its readers. The reason why these headings reveal analysts’ subjectivities or lead readers to a certain way of thinking is because the vocabulary within the sub-title has already and originally carried specific judgemental meanings, such as *concessions*, *hurting*, *danger*, and *retreat*. IAC analysts’ sub-titles selection (unintentionally) reveals their attitude regarding their research.

In some situations, IAC analysts’ subjectivities are even more conspicuous when the title/subtitle is presented with punctuation which, to a great degree, has guided readers to accept a certain position. Take RA28 and RA21 for example.

Example 8-14: The article title of RA28 is:

A threefold ideological analysis of Die Grünen: From Ecologized socialism to political liberalism? (p. 157)

There is a question mark at the end. The analyst, Talshir (2003), claimed that the Green Party has switched its political ideology from ‘ecologized socialism’ to ‘political liberalism’. However, such a strong affirmative statement/finding can be criticised for excessive subjectivity. By using a question mark, Talshir’s title could establish an impression of standing in a neutral position. It seems Talshir is saying, ‘I am not that sure whether the ideology changed; I just offer a phenomenon that I have found; you, readers, should have your own perspectives’. Cunningly, it is this question mark, which on the surface offers Talshir’s statement a neutral position, which in fact intensifies readers’ consciousness to accept, confirm, and believe his statement—the Green Party indeed has switched their political ideology.

Other IAC articles whose titles were presented with question marks are listed below:

Title of RA04,

Old Dogs, New Tricks? An Ideological Analysis of Thematic Shifts in Television Advertising for Diet Products, 1990-2000

Title of RA09,

Old Democrats in New Clothing?: An Ideological Analysis of a Democratic Party Faction

Title of RA32,

A Discourse for All Seasons? An Ideological Analysis of the Schools Commission reports, 1973 to 1981

Although these titles were presented with question marks, they all reveal the analysts’ subjectivities (answer). A question mark here is a smoke-screen which helps analysts to create a neutral and objective image. As Barthes (1993) might claim, these question marks are the ‘alibi’ (p. 123) of IAC analysts’ subjectivities.

To conclude, most of the time, the title of an article will influence whether this article is attractive enough to read. Yet, from a perspective of ideological analysis, the selected titles/subtitles not only revealed the analyst’s attitude, but also had influenced the readers’ way of thinking. Sometimes, with the assistance of punctuation, the article title will help its author to create a neutral and objective image; but, it simultaneously and inevitably reveals the article’s (the analyst’s) preference, position, and subjectivities.

Other references which expose IAC analysts’ subjectivities due to their title selection are listed as Table 8-4.

Table 8-4: References of Title Selection

SWPs Code: P6-2-TS (Title Selection)	
Articles	Found References/Examples
RA02	p.250(6); p.252(8);
RA04	p.334(1); p.335(2);
RA05	p.6(4); p.11(9);
RA08	p.264(4);
RA09	p.587(1);
RA15	p.456(2); p.468(14);
RA18	p.154(1);
RA20	p.357(5);
RA21	p.411(1);
RA22	p.71(2);
RA23	p.392(7); p.393(8);
RA24	p.494(8);
RA25	p.476(11)
RA27	p.187(8);
RA28	p.157(1); p.167(11); p.173(17);
RA30	p.476(12); p.483(19);
RA31	p.220(3); p.222(5); p.230(13); p.236(19);
RA32	p.17(1);
RA33	p.655(15); p.657(17);

Narrating Traits: IAC Analysts' Asking Questions

Peculiarly, when academics ask questions in their articles, they are never sincerely inviting answers or allowing readers to think. Asking questions is a way to persuade or force readers to accept the author's opinions. It happens to IAC analysts as well and their purpose of persuasion is even more apparent. Whenever the IAC analysts suggest questions, to a certain degree, they are (consciously/unconsciously) pretending to remain in a neutral position, when in fact, it is the most obvious way to divulge their personal attitude.

Example 8-15: Some questions directly reveal the IAC analysts' subjectivity, such as the example in RA30 (Harvey & Reed, 1996):

There is also the suggestion that Lewis carefully delimited the culture of poverty concept to a "foreign country." But did he? (p. 478)

This sentence displays the analysts' personal attitude without the need for any analysis to prove them, as the use of 'But did he?' has shown their answer. Yet, most questions which carry IAC analysts' subjectivity are concealed. Take RA09 as example.

Example 8-16: The question asked in RA09 (Medvic, 2007):

How different, in the end, is the Third Way from traditional Democratic liberalism? (p. 593)

This sentence shows that the IAC analyst, Stephen K. Medvic, wished to imply: 'there is no difference'. Readers can find implication (i.e., Medvic's answer) from the above sentence especially when they read the term *in the end*. This term *in the end* not only imports to readers an indication—do not think too much, or no need to think—it also conveys a helpless logic (in spite of ..., eventually...), which leads readers to give up thinking of the possible differences. Because of these factors, even though the terminology 'the Third way' might have its own original meaning in other discussions, in this sentence, it is connected to 'traditional Democratic Liberalism'.

In fact, how IAC analysts' questions reveal their subjectivities and the answer they want readers to accept could be examined through a mathematic principle. In this equation, the question mark refers to a minus, a dubious intention (i.e., -). Therefore, when a sentence is described positively (i.e., +), then the IAC analysts hold a negative position (i.e., that minus times plus receives a minus). On the other hand, when a sentence is presented negatively (i.e., -), the IAC analysts hold a positive attitude (i.e., that minus times minus gets

a plus). To test the equation, we can observe two examples from RA22.

Example 8-17: In RA22, the analyst, Haslanger (2007), asked,

Are Crop-Tops Cute? (p. 71)

and

Under the circumstances it seems that there is something right about the Daughter's reply to her Parents, and their reply is not enough. And yet, aren't the parents right? (p. 72)

According to the mathematic equation, it is possible to unveil Haslanger's personal attitude—that is, Crop-Tops are not cute and parents are right.

Haslanger's own writings in later pages confirmed this analysis. He suggested an answer after he asked a question. He writes,

Is it possible to evaluate the epistemic practices of a milieu by standards that are not themselves milieu-relative? If not, ... (p. 87).

According to the equation, that a positive sentence (+) finishes with a question mark (-) shows the IAC analysts' negative attitude. If Haslanger provides both sides of the answer, 'If yes' and 'If not', then the above questions (and his attitude) can remain in a neutral position. Yet, he only answered 'If not', which not only displays his negative position but also confirms the equation that this thesis suggests. What has to be noticed is that this equation applies to real question sentences or text in content only. As for the titles of articles, the question mark there is simply a smoke-screen to create a neutral and objective position for its analysts.

To conclude, whenever the IAC analysts suggest questions, they are (consciously/unconsciously) pretending to stay in a neutral position, when in fact, it is the most obvious way to divulge their personal attitude.

Other references which expose IAC analysts' subjectivities due to their asking questions are listed as Table 8-5.

Table 8-5: References of Asking Questions

SWPs Code: P6-2-AQ (Asking Questions)	
Articles	Found References/Examples
RA02	p.250(6);
RA04	p.334(1); p.335(2);
RA05	p.9(7);
RA09	p.587(1);
RA19	p.162(1); p.165(4); p.166(5); p.168(7); p.170(9); p.172(11); p.173(12);
RA21	p.411(1); p.425(15); p.427(17);
RA22	p.71(2);
RA23	p.391(6);
RA28	p.157(1); p.167(11); p.173(17);
RA30	p.476(12);
RA32	p.17(1);
RA33	p.641(1); p.653(13); p.655(15);

Narrating Traits: IAC Analysts' Personal Background

The IAC analysts' background itself (e.g., racial, upbringing, academic knowledge, and political standpoints) is a critical factor which leads them to hold a certain argument as well as nourish their subjective writings. Take how the academic background of the RA07 analyst (Michael Hazelton) and the RA23 analysts (Barker, Reynolds, and Ward) influences their standpoint for example.

Example 8-18: Hazelton in RA07 explained how hospital-based nursing education utilizes medical discourse to reconstruct its dominance over nursing-based education when facing threats of losing its sovereignty. In RA23, Barker et al. illustrated how the dominant discourses occupy the interpretive rights to define the meaning of 'caring'; as a result, a concept of 'new-caring' is infused to substitute for a definition of 'caring'.

Most of the time, the IAC analysts of both articles (RA07, 23) adopted an impartial position to analyse their research; nevertheless, somehow they still unwittingly exposed their emotion which shows their certain attitude. After further investigation, this thesis found out that Hazelton (author of RA07) and Barker et al. (authors of RA23) all possess a nursing background.¹¹¹ To a great degree, their academic background has already influenced their analysis.

Although it is uncommon to see IAC analysts directly display their subjectivities due to their background, it is still possible to observe how their background influences their

¹¹¹ Michael Hazelton is from the School of Nursing Studies, Institute of Technology, Tasmania. P.J. Barker is the Professor of Psychiatric Nursing Practice at the University of Newcastle Upon Tyne. W. Reynolds is a Senior Tutor at Highland College of Nursing, Raigmore Hospital. T. Ward is a clinical nurse specialist with Dundee Healthcare Unit.

arguments based on specific sentences.

Example 8-19: In RA25, the analyst, DeFoster (2010), wrote,

An early article in the *Times*' editorial coverage of the Columbine massacre called the two killers "deadly products of a pariah youth culture," indirectly absolving the murderers of responsibility through the argument that their values were neutralized by peer culture and violent entertainment media (p. 474).

DeFoster first quoted 'deadly products of a pariah youth culture' to explain how the European media defined those killers, and then followed with her critiques. To this thesis, the quotation DeFoster cited and his subsequent argument together revealed her subjectivity. The phrase "deadly products of a pariah youth culture" represents more the philosophy of Europe compared to American individual-orientated philosophy. On the other hand, her judgement that the *Times* "indirectly absolv[es] the murderers of responsibility" indeed reflects the American philosophy which refers to a more individual judgement/criticism. It is reasonable to say, to a certain degree, DeFoster's American-educated background¹¹² has led her to make such an analysis/judgement.

To conclude, when IAC analysts deal with topics which are related to their background (e.g., educational, racial, or political), mostly, they are incapable of not involving their own opinion. That is to say, the moment they defend what they believe to be right is also the moment that their personal ideology influences their on-going analysis, which, of course, does not mean to be wrong or bad. Instead, it should say that if the endless loop of 'ideological critique of ideological critique of...' is considered, analysts' personal background becomes a factor to sustain this loop.

Other examples which show how IAC analysts expose their subjectivities due to their personal background are listed as Table 8-6.

Table 8-6: References of Personal Background

SWPs Code: P6-2-PB (Personal Background)	
Articles	Found References/Examples
RA02	p.245(1);
RA05	p.5(3);
RA15	p.455(1);
RA21	p.411(1);
RA24	p.487(1); p.494(8);
RA31	p.218(1);

¹¹² Her education background is: B.A. Mass Communication, magna cum laude, Winona State University; M.A. and PhD, Mass Communication, University of Minnesota, Minneapolis. Retrieved from <http://sjmc.umn.edu/grad/gradprofile.php?UID=defos002> 1st Oct. 2014.

Narrating Traits: IAC Analysts' Assertive Declaration

In the previous sections, this research has introduced three narrating traits that IAC analysts frequently applied in their analyses. In these traits, they (unintentionally) disclose their subjectivities through their writings. Nevertheless, the most obvious subjectivity intervening in IAC analysts' writings is their assertive declarations. Such declarations include directly judging right from wrong, referring meanings of one thing to another, or claiming what the truth really is.

First of all, in terms of their directly judging right from wrong, take RA23 for example.

Example 8-20: In RA23, the analysts, Barker et al. (1995), wrote,

The “science of caring” is not, however, an example of the “reflexive, language-based, interpretive” alternative scientific paradigm to which Van Maanen referred. **The “science of caring” is**, by contrast, an ideology of caring (p. 388);

and

This **cannot**, however, become the *raison d'être* of nursing. “Caring” **is the wrong focus** for any intended development of the profession of nursing (p. 389);

and

That suggestion may **be** either **foolhardy** or **dangerous**, or both (p. 393);

and

The views of “caring” expressed by Waston, and Kirby and Slevin possess great potential for **misleading the profession**. **Their faith** in “caring” **is central to the problem** (p. 398).

In these quotations (all emphasis added), Barker et al. did not hide or claim their position vaguely; instead, they directly expressed their position that X is not A but B (e.g., the first two quotations) or arbitrarily judged that Z's viewpoints are wrong (e.g., the last two quotations). These examples all reveal the IAC analysts' subjectivities.

Second, directly referring meanings of one thing to another is another form with which IAC analysts leak their attitudes. In such conditions, the IAC analysts do not even bother to negate or demonstrate in order to proclaim their ideas. Take RA24 for example.

Example 8-21: In RA24, the analyst, Lu (1990), judged,

such slogans also called for contemplation and reflection on the ideological battle over the previous 30 years for which the Chinese people **have paid a heavy price** (p. 499, emphasis added).

She is right if this ‘heavy price’ judgement is evaluated from the angle of capitalism or

humanism. Nevertheless, for people who desperately pursue equality, they could comment on Mao's era by referring to what the Bible says: 'I have fought the good fight, I have finished the course, I have kept the faith' (II Timothy 4:7). In fact, there are still quite a few people in China who indeed believed in Mao's line and were disgusted with the poverty gap that resulted from Deng's economic reformation (Lee, 2013). Although the contemporary 'historical correctness' supports Lu's judgement, whether it 'paid a heavy price' is still uncertain from one person to another. 'Paid a heavy price', to a great degree, has revealed her political attitude.

Last, regarding the IAC analysts' firmly claiming 'what the truth really is', RA15 and RA10 are taken as examples.

Example 8-22: In RA15, the IAC analyst, Apple (1985), described in several paragraphs (all emphasis added):

I noted that it is a structurally **significant fact** that in the United States... (p. 455);

and

This is brought home **by the fact that** in our economy... (p. 457);

and

Added to this **is the fact that**... (p. 458);

and

The very fact that... (p. 468);

In RA10, the analyst, Goss (2005), wrote in the introduction,

In doing so, Will re-circulates and re-affirms the right-wing meta-ideology and endows it with prestige and the patina of "common sense"—**even as it moves athwart of facts on the ground** (p. 417).

And in the conclusion, he writes that

despite organised efforts to generate an ideologized "reality" that is anchored in right-wing fantasies and mythologies, **what is real always asserts itself decisively in the final instance** (p. 427).

The above quotations, especially those phrases this thesis has emphasised, show that Apple and Goss seem to believe that reality does exist, and they well know what it is. Goss's belief led him to judge that Will's right-wing meta-ideology *violates the reality*. Although these quotations might be attributed to nothing but 'just' representing their personal writing style,

their subjectivities, especially in Apple’s case, are called into being when they assertively declare what the truth really is.

Other references which expose IAC analysts’ subjectivities due to their assertive declaration are listed as Table 8-7.

Table 8-7: References of Assertive Declaration

SWPs Code: P6-2-AD (Assertive Declaration)	
Articles	Found References/Examples
RA01	p.177(13); p.178(14); 179(15);
RA02	p.245(1); p.252(8);
RA03	p.139(3); p.140(4); p.141(5); p.142(6); p.143(7); p.144(8); p.146(10); p.148(12); p.149(13); p.150(14); p.151(15); p.153(17);
RA04	p.335(2); p.338(5); p.340(7);
RA05	p.3(1); p.7(5); p.8(6); p.9(7); p.10(8); p.11(9); p.12(10);
RA06	p.449(5); p.450(6); p.451(7); p.452(8); p.457(13);
RA07	p.107(1); p.113(7); p.114(8); p.115(9); p.116(10); p.117(11); p.118(12); p.119(13); p.122(16);
RA08	p.263(3); p.264(4); p.267(7); p.269(9); p.270(10); p.271(11); p.272(12); p.273(13); p.274(14);
RA09	p.588(2); p.594(8); p.600(14);
RA10	p.417(1); p.420(4); p.424(8); p.425(9); p.426(10); p.427(11);
RA11	p.99(1); p.104(6);
RA12	p.1030(6); p.1031(7); p.1035(11); p.1036(12); p.1037(13); p.1038(14); p.1040(16);
RA13	p.281(3); p.283(5); p.285(7); p.287(9); p.287-8(9-10); p.288(10); p.289(11);
RA14	p.101(2); p.102(3); p.104(5); p.105(6); p.106(7); p.108(9); p.110(11);
RA15	p.455(1); p.456(2); p.458(4); p.461(7); p.462(8); p.463(9);
RA16	p.139(3); p.141(5); p.145(9); p.146(10); p.147(11); p.148(12); p.152(16); p.154(18); p.155(19);
RA17	p.352(4); p.356(8); p.358(10); p.362(14); p.366(18); p.370(22);
RA18	p.154(1); p.155(2); p.156(3); p.157(4); p.159(6); p.159-60(6-7);
RA19	p.164(3); p.165(4); p.166(5); p.168(7); p.169(8); p.170(9); p.171(10); p.172(11); p.173(12);
RA20	p.354(2); p.357(5); p.359(7); p.362(10); p.364(12); p.367(15);
RA21	p.412(2); p.413(3); p.417(7); p.418(8); p.419(9); p.420(10); p.422(12); p.423(13); p.425(15); p.427(17);
RA22	p.73(4); p.74(5); p.76(7); p.84(15);
RA23	p.387(2); p.388(3); p.389(4); p.389(4); p.390(5); p.391(6); p.392(7); p.393(8); p.394(9); p.395(10); p.396(11);
RA24	p.488(2); p.491(5); p.492(6); p.493(7); p.494(8); p.497(11); p.498(12); p.499(13); p.500(14); p.501(15); p.503(17); p.503(17);
RA25	p.466(1); p.468(3); p.469(4); p.471(6); p.474(9); p.475(10); p.478(13); p.479(14);
RA26	p.85(7); p.87(9); p.88(10); p.90(12); p.93(15); p.94(16); p.95(17); p.96(18);
RA27	p.182(3); p.183(4); p.184(5); p.185(6); p.187(8); p.189(10); p.197(18); p.198(19);
RA28	p.158(2); p.161(5); p.167(11); p.170(14); p.172(16); p.173(17); p.174(18); p.175(19); p.177(21); p.178(22); p.179(23);
RA29	p.915(2); p.916(3); p.917(4); p.918(5); p.919(6); p.922(9); p.924(11); p.925(12);
RA30	p.466(2); p.467(3); p.468(4); p.469(5); p.470(6); p.471(7); p.474(10); p.475(11); p.476(12); p.477(13); p.480(16); p.482(18); p.483(19); p.484(20); p.485(21); p.486(22); p.489(25); p.490(26);
RA31	p.219(2); p.220(3); p.223(6); p.225(8); p.226(9); p.229(12); p.230(13); p.232(15); p.233(16); p.236(19); p.238(21);
RA32	p.18(2); p.22(6); p.30(14);
RA33	p.659(19); p.660(20); p.665(25); p.670(30); p.672(32);

8.8 Conclusion

In procedure 6, two sections of discussion are included. First, this thesis illustrated how IAC analysts declare their standpoints which reflect their attitude regarding the power of ideology, including two types of attitude. In terms of the pessimistic attitude, IAC analysts usually display a logic of discourse: the dominant groups will utilize their resources and power to continuously reproduce the relations of production, which can maintain their dominance over the subordinate classes. Hence, resistance is impossible. In terms of the optimistic attitude,

they usually imply that ideological hegemony is not immobile because every group is able to fight for its own interests which, as often suggested by analysts, is based on one condition: only when the oppressed Class awakens to their Class consciousness.

Second, this thesis focused on IAC analysts' writings to investigate: what unremarkable narrating traits that IAC analysts casually apply have invisibly exposed their subjectivities. Four narrating traits are induced.

Regarding the 1) *Title Selection*, this thesis argues: the common and insignificant articles' titles that IAC analysts select could expose the analysts' (unintentional) subjectivities. It also can lead readers to a certain way of thinking as well as make readers self-fulfil the argument that the title implies. Concerning 2) *Asking Question*, whenever the IAC analysts suggest questions, they are pretending to stay in a fair position, when in fact, it is the most obvious way to divulge their personal attitude.

As regards the 3) *Personal Background*, when IAC analysts deal with topics which are related to their background (e.g., educational, racial, or political), they are incapable of not involving their own opinion. As a result, when they defend what they believe to be right (because their background taught them so), their argument usually reveals their personal ideology. Pertaining to 4) *Assertive Declaration*, it means that IAC analysts directly judge right from wrong as well as refer meanings of one thing to another. They clearly confirm what the truth really is. These four narrating traits are frequently seen in IAC articles which disclose IAC analysts' subjectivities.

Section of Empirical Analysis (Chapters 5-8)

Conclusion and Discussion

Conclusion

This study has expounded six standard procedures, which IAC analysts frequently applied when writing articles related to ideological analysis/critique, these are 1) identifying essential elements, 2) applying theoretical foundations, 3) connoting certain meanings, 4) illustration (i.e., articulation and interpellation), 5) selecting expression styles, and 6) revealing personal viewpoints.

A key aspect to note is that these procedures should neither be deemed as sequential, nor should they be regarded as required components in every IAC article. Rather they should be regarded as operating in parallel. The procedures that IAC articles apply depend on the research topics as well as the analysts' knowledge background. This is similar to when near-spectacles patients have an eye-glass prescription filled. Visual acuity of 1.2 is sufficient for patients to see comfortably. Yet, if the patients prefer, they can further correct the problem of astigmatism, or increase the dioptré of the glasses to have a better visual experience.

As with visual acuity and personal preference (subject to need and finance) for better vision, so only a few procedures are required to compose an acceptable IAC article. Of course, analysts could apply more angles (procedures) to improve an analysis/critique, only if they are capable of doing so and, for example, have enough space to thoroughly discuss their research.

The following Table 8-8 summarises the key points of the six standard procedures for writing (analysing/criticizing) IAC articles as proposed in this thesis.

Table 8-8: Summarises of Standard Writing Procedures

Procedure 1: Identifying Essential Elements				
This procedure is to understand the nature of ideology, which is a term about relationship, containing three elements, Class, reality and power. These three elements form the initial motivation of analysts and, most important of all, their presumed standpoints which have affected the coming conclusion of the analysis, even though the analysts might arrive there through different analysis/critique methods.				
Key points/ Subdivision		Explanation	SWPs Codes	Index
FC	Finding the Classes	Class here refers to a competing relationship between diverse groups. Finding the Classes means to confirm what research subjects (i.e., competing Classes) the analysts are concerned with.	P1-FC	5.2
IP	Involving Power	Detecting how power is involved is a way to understand how an ideology is constructed or presented. It is agreed that the invisible operation of power works with much more efficiency on the human mind than applying a visible style.	P1-IP	5.3
PR	Presenting the Reality	Through understanding how people describe reality, it is able to recognize how an ideology is created and what ideology it is. In ideological analysis/critique, analysts have to draw a portrait of reality for their readers, which tells what phenomena they have detected as well as revealing the reason that motivates them to perform such analysis.	P1-PR	5.5
Procedure 2: Applying Theoretical Foundation				
The theoretical foundation that the analysts adopt will influence the whole structure of the discourse including the departure point, the writing trend, and the basis of the argument. All differences could be derived from the manner in which the analysts consider the word <i>ideology</i> , what epistemological position they take in relationship to ideology, whose ideological theory they quote, and how they extend it.				
Key points/ Subdivision		Explanation	SWPs Codes	Index
M	Marx's Analytical Pathway	This pathway is especially used to describe an unbalanced power relationship between two competing groups. Concepts applied here includes 'Class struggle', 'alienation', 'base vs. superstructure', and 'class-in-itself vs. class-for-itself'.	P2-M	6.2

A	Althusser's Analytical Pathway	This pathway is particularly applied to explain how and why ideology comes into existence. Notions applied here includes 'ISAs vs. RSAs', 'material existence', 'interpellation', 'imaginary relation', and 'reproduction of the relations of production'.	P2-A	6.3
G	Gramscian Analytical Pathway	This pathway is usually adopted to describe how an ideological hegemony is created. Yet, on the other angle, this pathway is also applied to stress the 'process of struggle', meaning that dominant ideology is not guaranteed; resistance is possible. Concepts applied here include 'battlefield', 'civil society', 'intellectual and moral leadership', 'dis/re-articulation', and 'hegemony'.	P2-G	6.4
HD	Analytical Pathway of Historical Description	This pathway is usually applied to illustrate the ideology shift of the researched objects regarding the development of history. Through the manner of telling histories, this pathway could create a neutral and objective image for ideological analysis, where the articles' authors are ignored. This pathway even functions efficiently in interpellating readers, especially when these readers are unfamiliar with the history of the researched topic.	P2-HD	6.6
S	Semiotic Analytical Pathway	This pathway is based on semiotic notions to examine how reality/ideology is constructed/presented, including the theoretical concepts, such as 'language', 'parole', 'langue', 'signifier', and 'signified' as well as concept of 'binary oppositional relationships', 'syntagmatic structures', and 'paradigmatic choices', which could be practically applied in ideological analysis.	P2-S	6.7

Procedure 3: Connoting Certain Meanings	SWPs Codes: P3-C	Index: 7.2
<p>This procedure answers the common critique on ideological analysis: By whose authority are you so confident in claiming this is an ideology? Thus, this procedure is based on Barthes's concept of mythology, which helps to mend the criticism above, a demonstrative shortcoming. In so doing, analysts will be able to <i>theoretically</i> answer why the so-called ideology is this ideology or how this ideology has come to exist. This procedure is a bridge to connect the readers' original simple consciousness to the land of ideology.</p>		

Procedure 4: Illustration (Articulation and Interpellation)				
This thesis argues that whether to analyse or criticise an ideology (or the IAC works) or whether to purely present or to construct IAC articles/reports, it always has to go through analysts' illustrations which is composed of two major means—interpellation and (dis/re-)articulation. Through the process of illustration, it is able to <i>practically</i> answer 'how an ideology is formed or revealed' or 'why innocent signs turn into signs which carry certain connotation'. Two aspects are included.				
Key points/ Subdivision		Explanation	SWPs Codes	Index
1 Via Understanding the History or Literature		Since any ideology is shaped through a long-term historical process, the more analysts could comprehend the history and literature, the better they can detect the ideological track of their research subject, and the more efficiently they can apply these history/literature to construct a certain ideology.		7.5
FS	Finding the Similarities	It means to dig out the similarities of texts, concepts, and history (events) between researched subjects and certain history or literature. If the texts/concepts/history in a certain history or literature refers to a specific meaning, then the similar texts/concepts/history found in the researched subjects will easily be linked to signify the same meaning.	P4-1-FS	7.5
UR	Using References	References never speak for themselves. The action of selecting certain reference <i>per se</i> is the result of ideological operation which not only helps to echo, testify, or prove the analysts' arguments, but also to convey their certain intentions.	P4-1-UR	7.5
2 Through Specific Presenting Techniques		This part attempts to dig out: how simple signs start to display specific significances due to analysts' presenting manners which reflect the ideological function of articulation and interpellation.		7.6
T	Transferring	<i>Transferring</i> means the certain ways of presenting articles which contains the ideological effects. It is like to create a channel, through which analyst's writing words will become neutral, objective, and reasonable.	P4-2-T	7.6

UIV	Using Inarguable Values	It means that analysts adopt certain social belief or statistic data, which is considered to be unchallengeable, in order to build the authenticity of their arguments.	P4-2-UIV	7.6
WS	Writing Skills	The inconspicuous or unremarkable <i>writing skills/habits</i> , such as the usages of punctuation marks, personal pronouns, or specific phrases, could create diverse implications which display analysts' certain attitude as well as to influence readers' cognition.	P4-2-WS	7.6
E	Explaining	The process of giving explanation of researches (e.g., methodology or way of data collection) is to hail readers to believe the importance, indispensability, and reliability of such studies as well as to lead readers to a certain way of thinking.	P4-2-E	7.6

Procedure 5: Selecting Expression Styles

Procedure 5 distinguishes three expression styles which is based on the degrees/extent that IAC analysts involve their own viewpoints (including their attitudes, positions, judgements, preferences, etc.) within their writings. Three expression styles, representing the degree of subjectivities that IAC analysts possess, have been generalised.

Key points/ Subdivision		Explanation	SWPs Codes	Index
PDS	Purely Descriptive Style	It means the analysts simply and directly describe the ideology of their research subject without any judgement.	P5-PDS	8.2
IS	Interpretative Style	In the interpretative style, IAC analysts start to argue or judge their research subjects. They also continue to illustrate why this certain ideology is formed, to clarify the differentiation amongst diverse ideologies, or to explain how these ideologies are transformed.	P5-IS	8.2
DCS	Defensive and Corrective Style	In this style, IAC analysts directly and obviously expose their attitudes and even their emotions. Because of this, these analysts are usually considered to be prejudiced, and the arguments they put forth seem as if they just want to refute or remonstrate something they consider unjustified.	P5-DCS	8.2

Procedure 6: Revealing Personal Viewpoints				
IAC analysts' subjective tracks are everywhere in their writings. This procedure attempts to examine in what condition the IAC analysts reveal their personal viewpoints. Two dimensions are considered.				
Key points/ Subdivision		Explanation	SWPs Codes	Index
1 via Declaring a Standpoint		Declaring a stands could reflect the analysts' attitude regarding ideology, including its power, its capacity, and the possibility of resistance.		8.6
P	Pessimistically	It refers to a sense of powerlessness: in spite of everything the oppressed groups effort to change, the ideological hegemony controlled by superior groups is unchallengeable.	P6-1-P	8.6
O	Optimistically	IAC analysts who possess this attitude believe that although unbalance power relationship indeed exists, the ideological hegemony is not immobile. Instead, hegemony could be snatched.	P6-1-O	8.6
2 Due to Narrating Traits		This part attempts to dig out: how IAC analysts reveal their subjectivities due to their Narrating Traits. Four traits have been concluded.		8.7
TS	Title Selection	IAC analysts utilize titles or sub-titles, which reflect their subjectivities, to attract readers in order to force or influence them to agree or adopt their viewpoints.	P6-2-TS	8.7
AQ	Asking Questions	Whenever the IAC analysts suggest questions, they are conspiratorially pretending to stay at a fair position, when in fact, it is the most obvious way to divulge their personal attitude.	P6-2-AQ	8.7
PB	Personal Background	IAC analysts' background (e.g., racial, upbringing, knowledge, and political standpoints) is a critical factor which leads them to hold certain argument and nourishing their subjective writings.	P6-2-PB	8.7
AD	Assertive Declaration	It means that IAC analysts directly judge right from wrong as well as referring meanings of one thing to another. They clearly and confirmedly what the truth really is.	P6-2-AD	8.7

Does A Certain Way of Writing IAC Articles Exist?

This thesis has proposed six SWPs which are based on three types of qualitative-oriented ‘concepts’: the precise usage of terminologies (e.g., articulation), the related ideas (e.g., applying a concept analogous to the concept of articulation), and the ways of description (e.g., describing a phenomenon of articulation). Once a concept (based on the above three types) is repeatedly identified among diverse IAC articles, its accumulation being noticed to a certain degree, it will be pre-considered as part of the SWPs.

This thesis has established several ‘SWPs Codes’ (e.g., P2-M, referring to ‘Marx’s analytical pathway’) to indicate/mark the location in IAC articles where the words, sentences, or ways of description reveal, for example, how IAC analysts apply Marx’s ideas. The marked SWPs Codes alongside each IAC article have been categorised into several ‘reference tables’ which has been attached to the discussion of each (sub-)SWP to support this thesis’ findings.

Figure 8-1 has been compiled according to the data for these ‘reference tables’ and related appendices. RA01 will be used as an example:

- In RA01, a competing Class relationship indeed exists in the IAC article, but its IAC analyst did not clearly indicate the compared/opposite (Secondary) Class.
- Hence, RA01 is linked to the label of ‘Sec. Class exists, but vague’. This is based on this thesis’s finding of Class relationship in 33 IAC articles (reference: Table 5-1).
- Next, according to this thesis’s finding of power’s operation style and ways of presenting reality, the line is linked from the label of ‘Sec. Class exists, but vague’ to the label of ‘Style IV’ (reference: Appendix 5-1) and continue linking to the label of ‘Way I’ (reference: Appendix 5-2).
- From/across five analytical pathways, Gramscian theory was majorly applied in RA01, therefore, the line is linked to the label of ‘Gramscian analytical pathway’ (reference: Table 6-1 to 6-9).
- The following linkages between each procedure all share the same categorisation method.
- References for the categorisation method are listed below:

Procedure 1 → Class: Table 5-1; Power: Appendix 5-1; Reality: Appendix 5-2

Procedure 2 → Table 6-1 to Table 6-9

Procedure 3 → Table 7-1

Procedure 4 → Table 7-2 to Table 7-7

Procedure 5 → Appendix 8

Procedure 6 → Table 8-2 to Table 8-7.

Figure 8-1 shows the analytical trend of each IAC article, and most importantly, it enables the examination of whether certain common trends of writing articles related to ideological analysis/critique exist.

Although different analysts undertake their IAC works through (seemingly) diverse dimensions, according to this figure, it would appear that there indeed is a certain way/trend to undertake ideological analysis/critique. This trend is:

Procedure 1: Identifying Essential Elements. **Classes** → When IAC analysts undertake an ideological analysis/critique, their research subject (i.e., Primary Class) and its compared/opposite subject (i.e., Secondary Class) are usually **identifiable** (70%). **Power** → The relationship of these Classes is usually displayed as how one Class **dominates** (Style I, 42%) the other Class. **Reality** → As a result, the reality (representing certain ideology) is often **constructed** (Way I, 40%).

Procedure 2: Applying theoretical foundation → Among diverse concepts of analysing ideological phenomena, **Gramscian** (45%) theories are frequently applied.

Procedure 3: Connoting certain meanings → While analysing ideology, IAC analysts often occasionally tell readers what connotation their researched subject(s) indicate (51%).

Procedure 4: Illustrating → In IAC analysts' practical analysis, **using references** (70%) and applying specific **writing skills** (33%) are two common methods which will help them to (re/dis-) articulate certain ideas to strengthen their argumentations and to interpellate readers as the subject of their analysis.

Procedure 5: Selecting expression style → During the analysing process, IAC analysts usually/inevitably incorporate their opinions within their analysis when they attempt to **defend** their research subject and sometimes to **correct** the public's misunderstanding (42%).

Procedure 6: Revealing personal viewpoints → Most IAC analysts **did not** expose their attitude during their analysis (54%). Yet, if they accidentally reveal their attitude regarding their research, a **pessimistic attitude** (27%) is what they frequently possess. They reveal their attitude usually because they **assertively declare** their opinion (63%).

To conclude, this section has combined each procedure's findings, and presents Figure (8-1) to display their inter-relationship. In this figure, a certain way to write articles related to ideological analysis/critique is revealed which indicates the existence of SWPs. It also helps to testify that the ideological analysis/critique beyond (personal/social) ideology is arguable.

Figure 8-1: Trend of Ideological Analysis/Critique

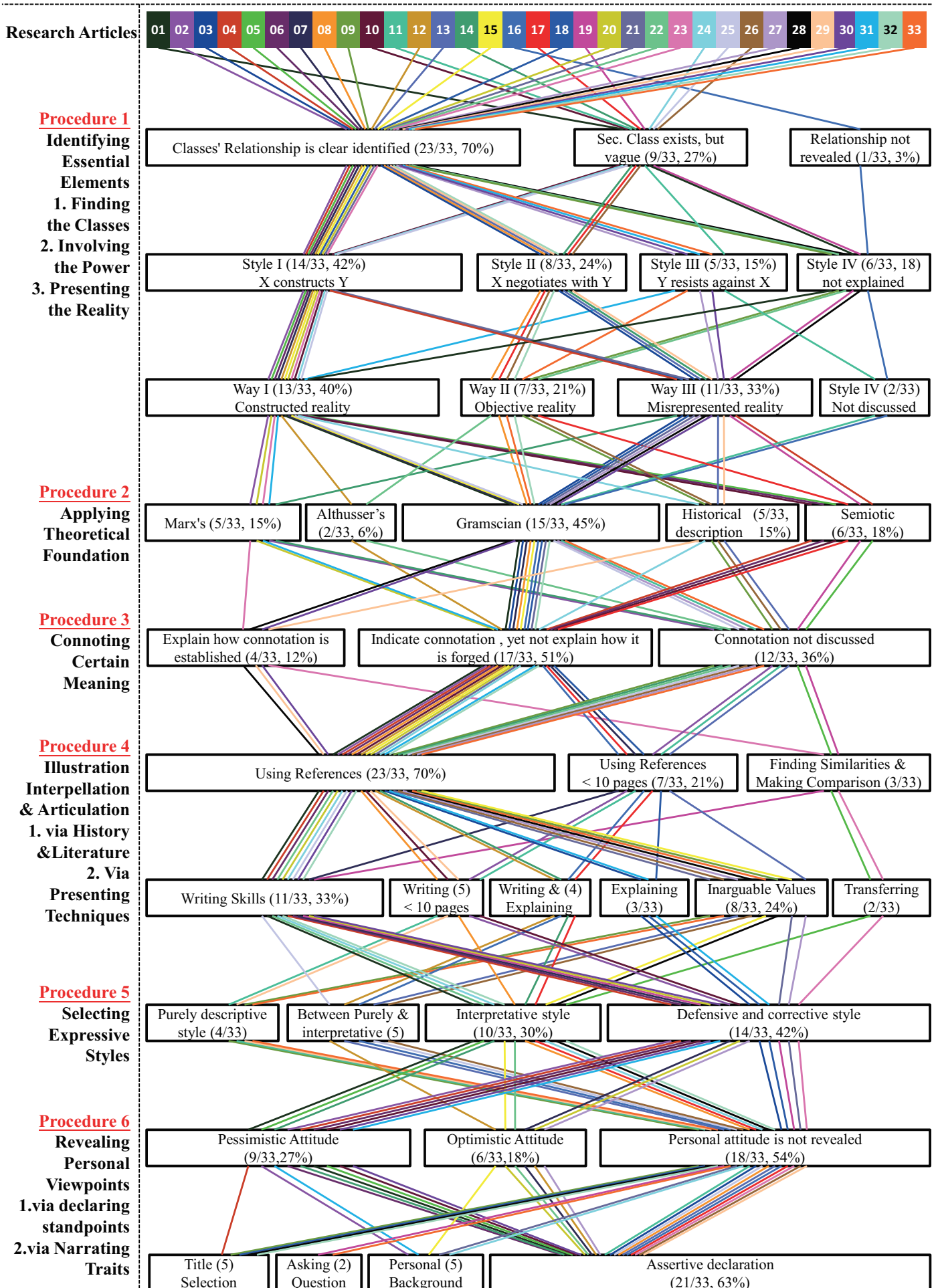

Discussion

Whether human beings are capable of escaping from the cage of ideology, or say, what limits humans' capacity to undertake ideological critique, is the main question of this thesis. To deal with this question, this thesis provides answers through investigating academic scholars' publications to determine if their articles are written according to their free will, or if they adhere to certain writing and thinking regularities. Regarding the genre of these publications, this thesis selected specific articles related to ideological analysis or critique (IAC).

Ideology is a subject about humans' consciousness. Since critics claim to explore the phenomenon of their research fields through the dimension of ideology, it is reasonable to say that *they think* they have found some phenomenon which other people have not recognized which, for example, might be concealed by a certain way of thinking (that only benefits a certain group, sometimes). Accordingly, in Chapter 2, this thesis first explained the difference between general and ideological critics. Since ideological critics notice the power of ideology and strive to investigate how it influences/reflects humans' consciousness and social practices, if there is any person who is capable of escaping from the power of ideology, this thesis argues, these ideological critics could be the most apt persons. Their academic publications related to ideological critique/analysis, likewise, might be the most suitable research data to ascertain whether they have eradicated of the influences of ideology while undertaking the works of ideological critique.

Yet, whilst ideological critics undertake their research through the so-called angle of ideology, do their findings, or the way they analyse or criticise, really break the invisible rules that guide them? For this question, in Chapter 3, this thesis reviewed the Frankfurt School's study on the culture industry in which their argument of 'standardisation' could be the probe/measure to evaluate such a question.

The characteristic of standardisation, a concept of the culture industry, is to create a normal model, via reducing the diversities, to maximise efficiency and profits of production, and finally to establish identity-thinking. Similarly, if such a phenomenon of standardisation happens to academic publications, then it means that there is a rule leading the analysts to compose (i.e., analyse or criticise) their academic works.

After analysis of 33 IAC articles, this thesis has found that there are some features frequently displayed in these articles. Six standard procedures for writing IAC articles were categorized and discussed in previous chapters as shown in Table 8-8. While discussing these writing procedures, this thesis also suggests ways of its application. It implies that there indeed exist rules leading IAC analysts to compose their academic works, even in articles about ideology. To a great degree, this rule is ideology—whether it is IAC analysts' own ideologies or the social (total) ideology surrounding them—as many commonalities have been found among their analyses. The point is that if the phenomenon of standardisation occurs in academic publications, then it demonstrates humans' limitation of undertaking ideological critiques.

That is to say, the IAC articles, which seemingly show the moment/possibility of escaping from the cage of ideology, in fact are still composed of certain guiding rules. The 33 IAC analysts can only analyse or criticise their research according to their own ideology (even though they adopt the analytical angle of ideology). What they can argue depends on what they have already known; such statement applies to any humans' conscious activity.

Doubtless, all arguments this thesis has made are unexceptional. The standard procedures for writing IAC articles suggested by this thesis, in fact, are the product of my ideology resulting from my background (life experiences, education, etc.). My own ideology determines how I compose this thesis. In short, ideology makes a work an ideological analysis/critique.

However, if every analysis or critique, even through an ideological perspective, is the product of (an individual's or the social total) ideology, then what is the meaning of humans' conscious activities? Is there any way out of ideology?

Therefore, in Chapter 9, this thesis will return to review related literatures, specifically focusing on Adorno's philosophy, to ascertain whether early scholars had provided escape routes from the dungeon of ideology. If Chapters 5-8 aim to answer this thesis' research question—whether human beings are capable of escaping from the cage of (their own) ideology—through a practical empirical analysis, then the aim of Chapter 9 is to answer the same question via a philosophical perspective, which also endeavours to answer the meaning of humans' conscious activities.

Chapter 9

Adorno's Way Out of Ideology

9.1 Introduction: A Permanent Dialectic

In the empirical analysis chapters (5-8), this thesis has delineated six standard procedures for writing IAC articles, based on the common features found in 33 IAC articles. If such standard writing procedures exist as this thesis argues, it not only means there is a rule guiding analysts to write their IAC articles. It further implies that despite every effort the IAC analysts have made to break through the cage of ideology, ultimately they are still prisoners of (their or the social total) ideology.

Accordingly, this chapter will re-investigate the literature to determine if early scholars had provided any means of escape from ideological restraints. Many suggestions are found¹¹³, but this thesis will focus on Adorno's ideas while similar notions offered by his colleagues in the Frankfurt School will be provided when relevant. While the capacity of ideology seems unassailable (even to the ideology-specialists), the purpose of this chapter is to offer perspectives proposed by Adorno to examine his fight against the power of ideology.

9.2 Ways out of Ideology's Cage: Diverse Perspectives

The cage of ideology has had diverse interpretations in different epochs of thought. To Marx, the ideological cage meant the domination of the bourgeoisie over proletarians. After his political economy studies, Marx discovered the alienated world that results from capitalism. Correspondingly, to escape this cage, Marx asked workers to unite and fight against capitalists for their own interests. To Lukacs, Marx's suggestion was possible only if the proletarians were to awake to their class consciousness and interests. He suggested striving for a 'totality' where the proletarians would begin to consider themselves as the subject of their consciousness and existence.

¹¹³ E.g., Zizek (1989, 1994, 2009), Marcuse (1991, 1978), etc.

To explain the failure of revolution, Gramsci developed his theory of hegemony. He did not focus much on the question of finding ways out of the dominant ideology, which Marx and Lukacs had dealt with at length. Instead, he required proletarians to create their own new consciousness, one which could fight/compete for hegemony. For Althusser, it is not an exaggeration to say that he never thought about fighting ideology, as to him ideology seemed iron-clad, simply unchangeable. Instead, he analysed the nature of ideology, explaining how an ideology could be constructed. Therefore, if it is possible to understand how one ideology is constructed and what is required to build it, might there not be a way out of its walls? It is the same idea that this thesis has tried to develop in previous chapters: the standard writing procedures—people can analyse as well as create ideologies based on such SWPs.

According to their studies, in the cultural creation in modern capitalist society, the Frankfurt School thinkers, who, to a greater degree, accepted (inherited from) Marx's thoughts, also explained how ideology intruded on humans' life and suggested ways to break free from ideology's restraints. A few Frankfurt School thinkers' suggestions of breaking through ideology will be briefly introduced. The main discussion will focus on Adorno as his ideas regarding this question were more complete and systematic compared to his colleagues.

One way of escaping the ideological cage, according to Horkheimer, is to help people *remember* (Held, 1980, p. 25). To him, the reason why the proletariat could not be awakened to possess their class consciousness is that they had forgotten their historical mission of struggling for emancipation. While the proletariat is forgetful, critical theorists' mission is to remember for the public—not only for the proletarians, as with the Frankfurt School having moved their spotlight towards culture they no longer simply focused on class. Proletarians and critical theorists have to remember why they “struggle for emancipation, the reasons for this struggle, [and] the nature of critical thinking itself” (Held, 1980, p. 25). Here the concept of ‘remembering’ refers to a form of consciousness raising.

Marcuse (1991) in his book *One-Dimensional Man* explained how *instrumental rationality* causes the phenomenon of alienated human beings. Marcuse (1969a) also adopted Freud's notion of *repression* to respond to the phenomenon of alienation in the age of

ideology. To Marcuse, alienation or repression did not develop from nothing so that, he suggested, the first step to escape from them is to recognize their “performance principle” (p. 44)—that is, what factors made them, for example, to find reasons that cause the inequality in a capitalist society. The second step is to create what he called the ‘new sensibility’¹¹⁴ which can be found in artistic creations through an aesthetic dimension. Artistic creations can create a reality which is more real than reality itself; once the historical conditions reach a certain level, utopia will end. This is also the moment when humans escape from ideology’s cage.

Adorno, Horkheimer, and Marcuse strongly criticised the technological developments in artistic creations. Yet, to Benjamin (2003a), it is because of the development of technologies that artistic creations are able to be massively reproduced and widely available. Technological development facilitates and fertilizes humans’ capabilities of percipience as well as fostering their abilities to criticise the vested common knowledge. Although the original ‘aura’ of artistic masterpiece disappears, an intimacy is created between arts and audiences. Accordingly, the manipulation of artistic creations can help to eliminate the limitation of appreciating/accessing cultural masterpieces, which used to be occupied by certain social groups. Artistic creations with the assistance of technological manipulation not only shoulder the responsibility of social reformation but also light up the escape route from the dominant ideology.

Drawing on Habermas, humans’ communication reveals how they are influenced by ideology. To evade the power of ideology, humans have to communicate rationally. According to Habermas (1984), first, a rational communicative action should be based on at least two mutual admitted and recognized subjects. Any unbalanced power inclining to either subject is unacceptable. Second, the communicative action has to go through the intermediary of linguistic symbols; these applied linguistic symbols must be understandable¹¹⁵. Moreover, speakers must meet four requirements: the “corresponding

¹¹⁴ One way of creating the new sensibility is to liberate Eros. Eros, conceptualized by Freud, originally refers to the life instinct pursuing the physical happiness—in Freud’s study, the sexuality. Marcuse’s (1969a) new recognition of Eros contains Freud’s concept of physical happiness and his dimension of spiritual (mental) happiness. This is what he called the “rationality of gratification” (p. 180). In Marcuse’s (1969b) later work, *An Essay on Liberation*, he termed the liberation of Eros as the “new sensibility” (p. 23), a convergence of rationality and sensibility.

¹¹⁵ Habermas (1979) suggested that speakers have to obey the following rules while applying

validity claims of comprehensibility, truth, truthfulness, and rightness” (Habermas, 1979, p. 3). In so doing, rational communicative actions can help people to understand and recognize each other in order to create a harmonious world without the interruption of personal values, that is, their own ideologies.

As introduced above, the Frankfurt School theorists have provided (what they thought to be) ways out of the ideological constraints. Yet, to most readers, their suggestions (ideas) are much like fantastic, unrealistic, abstract theories which reflect more a dimension of philosophical imagination instead of a practical method. However, to the Frankfurt School’s thinkers themselves, these seemingly impractical theories are **indeed** what they considered the *real practice*. To understand their philosophical position, their attitude regarding roles of ‘theory and practice’ should be reviewed. In so doing, it will be easier to comprehend as well as to identify with Adorno’s escape plans from the dungeon of ideology.

Theory and Practice

Marx (1992) in his work *On the Jewish Question* disagreed with Bauer’s idea of ‘political emancipation’. To Marx, political emancipation only referred to a spiritual/mental freedom; yet, there are still many factors which limit humans’ real emancipation, such as economic practice. His argument questioned whether real emancipation could be achieved through a mode of thought or via daily practical activity. Marx’s famous quotation in *Theses on Feuerbach* seems to reveal his answer. He claimed that “The philosophers have only interpreted the world in various ways. The point, however, is to change it” (in Engels, 1976, p. 65).

Since what humans’ emancipation had led to, abruptly, was Nazism and Fascism instead of Marx’s prediction, the dictatorship of the proletariat, Horkheimer and Adorno started to review the tension between *theory* and *practice* (Held, 1980). The contradiction between theory and practice is that, according to Adorno (1973), “theory is legitimate and [...] is hated; without it, there would be no changing the practice that constantly calls for change” (p. 143). In other words, although humans despise dreary theories, their practices

linguistic symbols to communicate: “a. uttering something understandably; b. giving something to understand; c. making himself thereby understandable; and d. coming to an understanding with another person” (p. 2).

always require endorsement of theories in order to obtain legitimacy of their actions.

While Lenin arrived at Finland Station, he claimed,

theoretical classification doesn't matter now [...] It would be indeed a grave error if we tried now to fit the complex, urgent, rapidly-unfolding practical tasks of the revolution into the Procrustean bed of a narrowly conceived 'theory', instead of regarding theory first of all and above all as a *guide to action*" (emphasis original; Wilson, 1972, pp. 546-7).

Although Lenin did not degrade the importance of theories, to him, theories could only play a guiding role. The extent of humans' emancipation still depended on their practical actions.

To some extent, Adorno (1973) agreed with Lenin that theories are a guide to action; yet, Adorno argued that any practices without theories were irrational and amounted to blindness, which would definitely meet with failure. Practices, which are executed mistakenly, cannot be counted as practices; instead, a misapplication of theory might cause serious tragedy. For example, the autocracy of Stalin, who claimed to follow the guidance of Marxism and Leninism, had indeed proved Adorno's argument.

In fact, Adorno (1973) rejected putting theories into practice (e.g., revolution). If asked why humans in contemporary capitalist society recoil from theory and prefer practices, Adorno would reply that the contemporary ideology of pragmatism is guiding human behaviour (echoing the Frankfurt School's critique on instrumental rationality). Besides, in contemporary capitalist society, the standard of establishing knowledge is usually based on a practical evaluation. To Adorno, once the standard (set up by practical evaluation) determines how humans recognize and apply knowledge, it eventually becomes a new myth (echoing the Frankfurt School's critique on the idea of enlightenment). Again, Adorno rejected putting theories into practice. Theory must retain its individuality declining to be applied, just like artistic creations refuse to be appropriated/duplicated.

While it might have been possible for Adorno to state that none of these practices should be engaged in, it could then be asked, what did he see as a way to practice? His answer would be that the *process of developing theories per se* is the *real practice*. The theory does not need material practice to prove its validity; as Adorno (1973) said, "the horizon of such happiness¹¹⁶ need by no means be that of a transparent relation to a possible

¹¹⁶ "Such happiness" here refers to Adorno's (1983) discussion of the birth of thought. It says that "when a man can do nothing that will not threaten to turn out for the worst even if meant for the best, he will be bound to start thinking—and that justifies him as well as the happy spirit" (p. 243).

practice to come” (p. 245). This statement shares the same idea with Žižek (2012) who points out: “Don’t act, just think”. ‘Thinking’ generates continuing dialectics and introspection; the purpose of which is to find a philosophical dimension to explain all phenomena¹¹⁷. “Philosophy cannot in and of itself recommend immediate measures or changes. It effects change precisely by remaining theory” (Richter, & Adorno, 2002, p. 19).

Adorno’s objection against practice reflected on the 1968 student movement. Students adopted the spirit of critical theory to undertake their actions. To Adorno, professed critical theory is indeed born to criticise social problems; however, applying theories to practical actions dogmatically without thoughtful consideration will only help the ‘opponent’, who the critical theory originally tries to condemn. As Horkheimer (1972) put it, “opposition, however despairing, is itself co-opted into the very development it had hoped to counteract” (p. viii).

Drawing on Adorno and Horkheimer, practical actions are unnecessary because regardless of the critical theory itself, or of the criticised target, even to the critics, they are all part of the whole society. They are already in it. Only if social problems exist does the critique have its targets; the process of critique *per se* (via the process of developing theories) is the real practice. When will humans achieve a complete theory so that they obtain the guidance to proceed to the practical actions? Horkheimer (1972) would answer that there will be no such date because

if our knowledge is in fact not yet final, if there is an irreducible tension between concept and being, then no proposition can claim the dignity of perfect knowledge (p. 27).

In short, the process of developing theories is the process of practice. The practical action, such as a strike, which people used to consider as practice, is not the *real* practice. This epistemological foundation regarding the notions of ‘theory and practice’ is important to understanding Adorno’s escape routes from the ideological cage; otherwise, one would simply see his concepts as the fantastic, unrealistic, abstract theories, even considering his concepts as utopian fantasies.

¹¹⁷ This point echoes this thesis’s final argument that *self-critique*—or thinking—is the possible way to escape from the dungeon of ideology which will be discussed in final chapter.

9.3 Adorno's Escape Routes

Adorno (1973), in *Negative Dialectics*, said that “where an unleashed, self-escaping rationality goes wrong, where it becomes true mythology” (p. 148), meaning that if the rationality cannot recognise its foundational faculty, it becomes irrationality. When humans lose their capacity to recognize things, they will just follow a certain way of recognition, which results in their pursuing the identity(-thinking). Such a result is bad for humans' development because, to Adorno, “identity is the primal form of ideology” (p. 146). Hence, he advocates ‘non-identity’ thinking, explained later.

With the influence of this identity-principle comes the human pursuit of totality. One reason to aspire to totality, according to Lukacs (1971), is to expect the combination of subjects and objects; however, Adorno (1973) certainly disagreed with Lukacs. To Adorno, during the forming process of totality, a certain idea will emerge to play the role of subject (or claim itself as the only subject) in order to eliminate ‘others’, i.e., non-subjects, or say, the objects. This process will create an unbalanced power relationship between diverse ideas which also help the vested dominant/ruling ideas of subject to control over the dominated/ruled ideas of the objects/non-subjects. Eventually, the subjects will devour the objects despite any actions of the latter in trying to resist. The Holocaust is the testimony; the philosophy on which the totality particularly relies is also the philosophical example of the Holocaust.

To Adorno, failing to recognize the relationship between subject and object of things, will lead humans irrationally to identify certain guiding ideology which reflects in the common human activity—the pursuit of identity-thinking to reach totality.

Accordingly, drawing on Adorno's ways out of the ideology restraints, he would suggest discarding the identity-principle and its predictable consequence: the pursuit of totality. Three dimensions—ontological, epistemological, and methodological— will be taken to examine Adorno's philosophy to see how he fought against the ideology cage. By way of a brief introduction, in terms of the ontological dimension, Adorno insisted on ‘the preponderance of the object’ and the importance of ‘pursuing **non**-identity(-thinking)’. Regarding the epistemological dimension, Adorno offered concepts of ‘immanent critique’ and ‘constellation’. Finally, for the methodological dimension, he focused on the ‘writing style’.

Ontological Dimension

This thesis in earlier discussions argued that ontology indeed is ideology. Adorno would suggest, one first has to discard what is currently believed in order to escape the ideology's restraints. That is to say, from the ontology angle, humans' existing ideology (i.e., ontology) must be overthrown first in order to escape the cage of ideology. Adorno argued that the existing ontology (in his time) was that people believe in the preponderance of 'subject' and for this reason people are desperately pursuing the identify-thinking to create totality. Adorno attempted to defeat such ontology. Thus, the ontology, or perhaps, new ideology, he tried to establish is the 'preponderance of object'. In so doing, he wished that people would turn to pursue the non-identity(-thinking).

Distinction of Subjects and Objects

Adorno (1978) claimed that one serious problem in the development of Western philosophy is the distinction between subjects and objects since Descartes. Although Descartes focused on the subject's spiritual and philosophical development, the detachment of spirit from material simultaneously created the separation of subjects and objects (Held, 1980). Adorno (in Schweppenhäuser, 2009) argued that humans' ability to categorize things is the reason why the concept of 'subject' is formed. If humans are incapable of undertaking categorization, the existence of the subject will never come about.

Yet, to Adorno (1978, 1973), the serious problem is that same human emphasis on the importance of the subjects, given the above distinction. People started to think that "the subject's concepts produce the world" (Held, 1980, p. 202), considering that the subject itself possesses individual autonomy. What happens next is that the subject arbitrarily subsumes the object into its system; the rights of defining the object are occupied by the subject, which makes the latter forget that it, *per se*, is indeed an object (Adorno, 1978; 1973). As Adorno (1978) explained, "the subject swallows the object, forgetting how much it is an object itself" (p. 499); indeed, "objectivity can be conceived without a subject; not so subjectivity without an object"¹¹⁸ (p. 502).

¹¹⁸ Adorno (1983) interpreted this relationship by using an example. He wrote, "That the I is an entity is implicit even in the sense of the logical 'I think, which should be able to accompany all my conceptions,' because the sequence of time is a condition of its possibility and there is no sequence of time save in temporality. The pronoun 'my' points to a subject as an object among objects, and again, without this 'my' there would be no 'I think.' The being of a subject is taken from objectivity—a fact

Adorno (1978) concluded that the separation of subject and object is “both real and illusory” (p. 498). The real part is seen in the fact that this separation reflects human development of consciousness; the illusory part is in the fact that this separation is seen as an absolute and unchangeable belief.

Consequently, Adorno (1973) rejected such a simple mode of distinction between subject and object. He argued that they (subject and object) are not in an oppositional relationship; instead, it is the ‘difference’ between them.

To Adorno (1973), if their relationship were to take the form of opposition, then such relationship would expunge what concerned him the most: the non-identity(-thinking). This is because the form of the oppositional relationship only exists in a structure which is controlled by the subject. In such a structure, the power between subject and object is unequally distributed. The former always possesses more. Thus, the final results will be either that the object is simplified as the single component of the subject’s identity, or that the object loses its appearance, just as if it had never existed at all (which, in fact, is also the reason/result of humans’ pursuing identity and totality).

With respect to this phenomenon, Adorno suggested reconsidering the relationship between subject and object as a ‘difference’. *Difference* here implies that subject and object are in an inter-constructed relationship. Neither could claim significance or uniqueness of itself. In short, Adorno’s ideal relationship between subject and object would be that there should not be any dominant relation between them, but only interactive and independent differentiability.

The Preponderance of the Object

The ideal relationship between subject and object, to Adorno (1973), is *difference* rather than opposition; yet, such thought (i.e., ideology) ‘the preponderance of the subject’ has dominated humans’ consciousness for a long time, which results in an unequal power distribution. The subject possesses an authority to evaluate things such that even the weakest and most powerless non-identity-thinking will still be seen as a serious threat to the subject. The subject always declares itself as *the whole*, which cannot accept any non-itself/subject.

that lends a touch of objectivity to the subject itself” (pp. 183-184).

For this reason, Adorno proclaimed “the preponderance of the object” (p. 183) to overthrow humans’ existing ontology (ideology). The object here is *not* the one which corresponds to the subject; because if so, then it would be the one which *has already been defined* by the subject. The object that Adorno claimed to be preponderant is *not* the one which needs the subject to intermediate or to interpret for it. On the contrary, it is the one which is even unable to conceptualize itself. In other words, to Adorno, the development of social knowledge has to be built on the indescribable phenomenon *per se* instead of being created/described by the researchers’ consciousness (i.e., their ideology). Researchers have to respect the individuality of their researched things/phenomena, that is, to see the object as one without any pre-existing understandings.

The reasons why Adorno strongly stressed ‘the preponderance of the object’ are not only that this is an interrelated concept with his concept of “constellation” (which will be introduced later), but also because only when the status of object is promoted preponderantly is it able to resist identity-thinking and the outcome, i.e., totality.

That Adorno fought against identity does not mean simply to say “No”, not to eliminate identity. It is similar to that suggesting the idea ‘the dialectics of enlightenment’ does not mean to abolish enlightenment *per se*. Instead, it means to combat the ideologies which worship absolute identity(-thinking) which has even been considered as the only way to reach the truth. It is acceptable to claim that Adorno disagreed with all identity-actions/thinking (although such a claim implies that even our learned knowledge indeed is the product of identity thinking¹¹⁹, which should be criticised as well); yet, it would be much more accurate to state that what concerned Adorno the most was to find out critical factors which eliminate the ‘differences’ between subject and object or erase the non-identity-thinking during the process of pursuing the identity. For instance, what Adorno (Adorno & Horkheimer, 1997) did in the chapter “Elements of Anti-Semitism: Limits of Enlightenment”, in *Dialectics of Enlightenment*, was to investigate the eliminated elements which used to represent the Jews’ non-identity characteristics. Jews’ non-identity characteristics were eliminated which helped to build the Aryans’ identity-thinking of pursuing the pure-blood.

¹¹⁹ As Adorno (1973) said “We can see through the identity principle, but we cannot think without identifying. Any definition is identification.” (p. 149)

The Pursuit of Non-Identify(-Thinking) (Via the Bestimmte Negation)

To Adorno (1973), “identity is the primal form of ideology” (p. 148). To escape from its dominance, the preponderance of the object has to be confirmed, as mentioned, which corresponds to his other notion: the pursuit of non-identity(-thinking). Non-identity is the diversities which reside in the identity(-thinking); it is what identity sees as the Others. These Others, or diversities, are the representatives of non-identity, which permanently struggle against identity. Although for humans it is usually inevitable to simply identify one subject’s authority (because it is the easiest way to recognise the world), what this concept—the pursuit of non-identity(-thinking)—mainly stresses is asking us to admit and be aware of the existence of others’ authority.

According to Adorno (1973), non-identity(-thinking) *per se* cannot be arbitrarily described or categorized by concepts or any existing systematic knowledge, meaning that non-identity(-thinking) *per se* is not even a conceptualized idea. If it were considered as ‘a way of thinking’, then this professed non-identity(-thinking) would become identity(-thinking) immediately. In short, the ‘non’ of non-identity in Adorno’s idea refers to a continually acting and negotiating process. This echoes his attitude toward theory and practice: the process of developing theories is the process of real practice. This also echoes his disgust at standardisation in artistic creations, which reveal nothing but creating identity. As a result, this thesis attempts to discover whether SWPs exist in IAC publications; if so, IAC analysts generate nothing but an identity-thinking in ideological analysis/critique.

As mentioned, the pursuit of non-identity is to prevent the objects from being conceptualized by the subjects or the identity(-thinking). In order to reach this goal, a continuous process of negation is required. Nevertheless, to Adorno (1973), the method of negation here does not refer to what Hegel suggested: *the negation of a negation*. Instead, a real process of negation, to Adorno (1973), is a negation without any positive purpose; it is an absolute negation. Adorno referred it to Hegel’s another less discussed notion: *die bestimmte Negation* (usually translated to English as the ‘definite negation,’ ‘concrete negation,’ or ‘determinate negation’; henceforth, the *bestimmte* negation.).

Adorno (1973) argued that Hegel’s concept of ‘the negation of a negation’ reveals a misunderstanding of the dialectical principle. To Adorno, the real principle refers to “the

resistance which otherness offers to identity” (pp. 160-1) instead of “[reacting] negatively to the Other [... penetrating] the object and [... voiding] the negation which it is” (Hegel’s line in Adorno, 1973, p. 160). Adorno argued that once a thing (e.g., a concept) has been negated, it is impossible to restore it back to normal by way of negating this thing *again*.

Adorno (1973) wrote that “the thesis that the negation of a negation is something positive can only be upheld by one who presupposes positivity—as all-conceptuality—from the beginning” (p. 160). To Adorno, Hegel is the person who pursued this positivity because “this positivity [the result of the negation of a negation] springs from the method—not from the thing, as in Hegel’s view it should” (p. 159). Adorno criticised this method as it follows a mathematic principle such that it “takes minus times minus for a plus”, which indeed is an “anti-dialectical principle” (p. 158). In other words, if people adopt Hegel’s *negation of negation* to negate a thing, their discussion will eventually and inevitably turn back to affirm what is supposed to be criticised and to reach the “self-sameness” (Hegel’s word in Adorno, 1973, p. 160).

Although Adorno logically pointed out the shortcoming of Hegel’s *negation of negation*, what worried Adorno the most was that people innocently misconceive the concept, *negation of negation*, as the only one which could possess the power of negativity. Adorno (1973) was concerned that once people think this way,

the negation of negation would be another identity, a new delusion, a projection of consequential logic—and ultimately of the principle of subjectivity—upon the absolute. (p. 160)

On the other hand, to Adorno (1973), the notion that genuinely possesses the power of negativity should be Hegel’s other concept, the ‘*bestimmte* negation’, that is, to negate the thing (e.g., a concept) which has already been suggested to convey a certain meaning; in other words, to negate the concept which has been determined.

This thesis will provide a way to understand these two terms, ‘the negation of a negation’ and ‘the *bestimmte* negation’, to delineate Adorno’s ideas. Whether it appears in the terminology of ‘the negation of a negation’ or ‘the *bestimmte* negation’, the word *negation* is presented as part of a noun phrase, which, to a certain extent, might cause confusion, especially for non-native-English readers. These terminologies would be much more understandable if read via the following method.

Clarification of terminologies:

1. The bold-faced words in the terms ‘the **negation** of a negation’ and in “the *bestimmte* **negation**” should be read in a sense of verb or seen as an on-going action. It means ‘to negate/criticise a thing’.
2. The bold-faced words in ‘the negation of a **negation**’ and in ‘the **bestimmte** negation’ could be seen as: how the analysts recognize the characteristic of their research subjects. This is also the critical point which distinguishes the difference between Hegel’s two terms.

2-1. Explanation of Terminologies I: The Negation of a Negation:

The bold-faced word of ‘the negation of a **negation**’ refers to things (e.g., concepts or social phenomena) which have already negated other things **before**. Accordingly, the method of *the negation of a negation* means: to negate a thing which has already negated other things before.

Take scholars’ works of ideology critique as an example. Scholars who adopt the notion of ‘the negation of negation’ will (unintentionally) possess the following attitude: ‘This ideology is bad (because it subverts other things already, such that it *per se* possesses a negation), so we criticise it (we have to turn it over again)’.

Adorno would disagree with the method of ‘the negation of a negation’ because these scholars have already defined their research subjects (e.g., one ideology) in terms of wrongness. It also tells why these scholars have decided to criticise or negate again. In other words, these scholars have already possessed an evaluation standard of what is right or better; they negate the ideology based on the rightness in which they believe. Yet, this is just what most troubled Adorno: the identity(-thinking).

2-2. Explanation of Terminologies II: The *Bestimmte* Negation:

The word *bestimmte* means: to negate a thing (i.e., a research phenomenon), which is conceptualized with a specific meaning. The point is that this research phenomenon did not negate others before; it simply represents/conveys a conceptualized meaning.

Similarly, scholars who possess this perspective will only stay in a neutral position, they will not presume whether this ideology is right or wrong. What they are going to find and then to negate is the ‘already-embedded meaning’ that the ideology represents. For instance, the Frankfurt School thinkers found that the already-embedded meanings in the aspect of enlightenment are rational, civil, and progressive cognitions. The point is that they did not directly claim the enlightenment as bad; instead, they evaluated the influences of these already-embedded meanings in the concept of enlightenment first, then negated them. To Adorno, only the *bestimmte* negation is the real negation.

To conclude, in terms of ontology, escaping from the cage of ideology, to Adorno (1973), calls first for confirming the preponderance of the object. This is to avoid identity(-thinking), which results in subject’s invading the object. Since identity is the primal form of ideology, in order to escape from the cage, people have to agree with non-identity(-thinking). Non-identity is not a conceptualized aspect; instead, it is a permanent, continuous, and absolute negating process. This absolute negating process does not refer to the logic of *the negation of a negation*; rather, it refers to the *bestimmte* negation.

Epistemological Angle

Drawing on Adorno (1973), the permanent, continuous, and absolute negating process (i.e., the *bestimmte* negation) is the only way to escape from ideology restraints. This absolute negating process is based on the epistemological acknowledgement regarding the recognition of two important aspects—*critique* and *concept*. First, to reach the goal of absolute negation, the ‘critique’ that analysts apply does not refer to any type of critiques, but to what Adorno referred to as the ‘immanent critique’ (Held, 1980; Jay, 1984). Second, the way of understanding the composed concepts of one research phenomenon should go through the aspect of what he called the *constellation* instead of the traditional understanding of the general term *concept*. That is to say, only when analysts realize the epistemological differences of recognising the aspects of *critique* and *concept* does breaking through ideology become possible.

Immanent Critique

If the endless loop of critiques related to ideology is considered, it seems impossible to establish a neutral critique/analysis. Yet, the concept of *immanent critique* emphasizes that although critics inevitably situate in the same circumstance as the criticised subjects/phenomenon do and even though their own ideology unavoidably becomes involved with their research, it does not mean that they are incapable of producing critiques. The point is how analysts recognize the way they proceed their analysis.

Immanent critique suggests that it is possible to depict, discuss, or criticise an ideology based on an objective perspective. Yet, to criticise one ideology does not mean simply to claim that ‘this ideology is untrue’ based on a viewpoint outside the researched subject; instead, critics can only analyse how this ideology is presented according to the inner constructing logic of the subject. (This also echoes the difference between the negation of a negation and the *bestimmte* negation.)

To Adorno (1967/1981, p. 32, in Jay, 1984, p. 116), the spirit of immanent critique is to “grasp, through the analysis of their [the criticised subjects’] form and meaning, the contradiction between their objective idea and their pretension”. In other words, the method of immanent critique is to appropriate the same logics, concepts, and terminologies that the criticised subject adopts in order to obtain the authority (e.g., standpoint) to support their analysis/critiques instead of simply criticising the subject with an external logic and thinking (in other words, with a different epistemology). In short, immanent critique discovers the researched subjects’ inner contradiction first, then borrows weapons (i.e., the same argumentative logic or concepts) from the researched subjects, and finally fights/detects their inner concealed characteristic. (The fighting strategy—i.e., Adorno’s ‘writing style’ and principle—will be introduced later).

From the perspective of immanent critique, the way out of the ideological cage is required to understand what concepts or logics are used to construct the researched subjects, and then to determine the contradiction of these concepts or logics which could be adopted as critical weapons to subvert these researched subjects *per se*. For example, the Frankfurt School’s critique on instrumental rationality did not directly claim that ‘new technologies are bad’; instead, they first found out the inner characteristics and the operating logics of these

technologies, then argued the possible influences of using these new technologies on humans' consciousness.

Similarly, although this thesis does not mean to undertake (immanent) critique on the 33 IAC articles rather than 'analysis', the validity of the suggested SWPs can be acknowledged only based on the investigation of these IAC articles' common inner constructing logics, such as argumentative logics or writing styles. If the ideological critique/analysis is regarded as a type of critique/analysis, then the findings of SWPs indicate that the inner constructing logic of the type of the ideological critique follows certain guiding principles, which influence how analysts conduct their works of ideological critique.

Constellation

Adorno (1973) rejected only appropriating a few or a set of certain concepts to describe the research phenomenon; this was to prevent the identity(-thinking). Instead, he suggested the notion of *constellation*. According to Adorno, the term *constellation* means that each concept adopted to describe a phenomenon should be equally important. There is no such dominant-subordinate relationship between all concepts—that is, no single concept has priority over others. This is because promoting a particular concept to a preponderant position is just what the identity-thinking does¹²⁰.

In all honesty, this thesis should not have used the word *concept* to describe the notion of *constellation*, considering that, to Adorno, the word *concept* has already referred to a certain scope of meaning. It is already defined, which is not what the notion of *constellation* attempts to suggest. In a constellation, the construction of an object does not occur as concrete concepts; it is more like concepts without boundaries, similar to clouds. One cloud itself is boundless within the sky and sometime mixes with other clouds; clouds integrate and separate all the time. In the notion of constellation, any concepts (just like clouds) do not refer to any certain or concrete meanings; rather, they are presented as a continually changing status, just like clouds.

¹²⁰ For example, both the terms *capitalism* and *communism* originally were created to signify particular social and political systems. There should be no such subordinate or superior relationship between the two concepts. Yet, in some countries with diverse backgrounds, either term is readily demonized or promoted for a country's political purpose. Take my education experience for instance. During the 1990s in Taiwan, the historical education taught students that communism is a worse system and that people in mainland China suffered from starvation due to their political system. As a result, that communism is bad became the dominant ideology, or say, the identity-thinking, among Taiwanese people who were educated in the 1990s.

To Adorno, if people could recognize concepts of one research phenomenon through the dimension of constellation, this would be able to prevent one concept breaking away from the object (where this concept inhabits). Otherwise, if such a concept were to successfully break away from the object, it might claim itself to be the subject. Eventually such concept will consider itself as the only subject and turn back to eliminate its matrix—the object—in order to reach identity(-thinking). To Adorno, the perspective of constellation is a way to prevent such a disaster.

Idea of *constellation* is explained above. To Adorno (1973), the real function of *constellation* is

from without what the concept has cut away within: the “more” which the concept is equally desirous and incapable of being. By gathering around the object of cognition, the concepts potentially determine the object’s interior. They attain, in thinking, what was necessarily excised from thinking. (p. 162)

Concepts that humans are able to perceive are those which are already limited to a certain dimension. These concepts have to eliminate other meanings in order to create its uniqueness (i.e., specific meaning). This is the outcome of a historical modification. Those deleted meanings which are banished from the concrete concept are precisely what the notion of *constellation* is eager to preserve—saving those meanings which could represent “the more” as well as meanings that the concrete concept tries to delete. In short, the notion of constellation is not only a way to recognize the constructed concepts of an object; it is also an angle for re-evaluating the concrete concept at present, or to see how much this concrete concept has lost.

To conclude, in terms of epistemology, for a great escape from the cage of ideology, one has to adopt the angle of immanent critique, that is, to discover researched subjects’ inner contradiction first, then to borrow weapons (i.e., the same argumentative logics or concepts) from them, and finally to fight/detect their inner concealed characteristic of negation. Moreover, the concept of *constellation* attempts to restore the relationship between one subject (identity-thinking, ideology) and its original figure—the object—in order to retrieve the deleted-meanings which are eliminated by this current subject for the sake of its dominance. In so doing, once no single concept is able to suppress others, humans will not be limited to certain concrete ideologies which could be seen as a way to break free from ideology restraints.

Methodological Angle

Drawing on Adorno, his ‘writing style’ could be seen as the methodological angle to escape from ideology. Such an application also echoes his guiding principles of the immanent critique and constellation. Two common writing styles that Adorno frequently applied, as Rose (1978) investigated, are the “ironic inversion” (p. 16) and the “chiasmus” (p. 13).

Rose (1978) interpreted Adorno’s idea that to “[pit] reality against reality is a way to criticise both the ideals and the reality” (p. 21). In so doing, the biggest benefit is that the critics do not have to declare another reality to carry their critiques, considering that any representation of a reality is the reflection of their own ideology (Rose, 1978). As the sayings go, ‘to fight fire with fire’ or ‘set a thief to catch a thief’—to fight against the researched subjects with their own concepts and inner logics—could prevent the critics from limiting themselves to their own opinions (i.e., ideology). This is the guiding principle of immanent critique.

To follow the principle of immanent critique, Adorno adopted the writing style of ‘ironic inversion’. For instance, Adorno (in Rose, 1978) wrote “The Health unto Death” to reply to “The Sickness unto Death” which was written by Kierkegaard. Adorno also penned “This Side of the Pleasure Principle” to contrast with Freud’s “Beyond the Pleasure Principle” (p. 17) and *Minima Moralia* is Adorno’s inversion of Nietzsche’s *Magna Moralia* (ibid., p. 17). To write with this style, Adorno provided an explanation: it is to “[drive] thoughts with the utmost consequence to the point where they turn back on themselves, instead of qualifying them” (in Rose, 1978, p. 17).

Another of Adorno’s writing styles, *chiasmus*, echoes his notion of *constellation*. For example, he displayed his discussion this way: “The subject is the object, the object is the subject” and “history is nature, nature is history” (Rose, 1978, p. 13). This is to avoid conceptualizing meanings during the process of discourse because of the great potential that the discourse will generate a concrete concept, such that eventually a subject will be created out of its matrix, the object. The principle of *constellation* states that all meanings in one object possess the same quality of importance; these meanings are unable to (should not) be conceptualized so that they are always in a continually changing process. In short, what needs to be done while recognizing an object is to focus on the whole constellation but not a

single star¹²¹. The writing style of ‘chiasmus’ could prevent critics from over-emphasising one concept which would unintentionally create a particular and one-dimensional thinking.

To conclude, in the style of *ironic inversion*, Adorno presented the same term with a diverse sense; with respect to *chiasmus*, he played with the relationship of the subject and object, to make them as the alter ego of each other. Such writing styles are for preventing concepts from being defined. They also help bringing all concepts to the same level of importance. In so doing, the writing is able to guard against identity(-thinking); at the same time, it is able to burst out of the ideology¹²².

9.4 The Real Practice: Arts

Adorno emphasized the importance of theory, claiming that none of any real practice (e.g., social movement) should have ever been proceeded; yet, there is still a place outside theory where, to him, the real practice could reach the truth and escape from the influence of ideology—that is, the artistic composition. (This is also the reason why he is so hostile to the invasion of technologies in artistic creations.) Jay (1984) said that “if Adorno allowed any glimmer of hope, it was only in his reference to art” (p. 53). Art, or artistic creations, which represent a way out of ideology’s cage, could be described based on three perspectives: its characteristic, its relation to the society, and its functions.

First, in terms of its characteristics, art is considered to be able to surmount the conflict of interests, so that, as Schweppenhäuser (2009) interpreted, it “[serves] other goals than the making of commodities” (p. 91). As a result of this non-utilized character, artistic creations,

¹²¹ Adorno’s obedience to this constellation principle—or, put another way, to this writing style—corresponds to the logic of the hermeneutic circle, that is, the meaning of the whole text will not be created until the emergence of all individual parts, while the meaning of each individual part will not be understood until it is seen through the angle of the whole text.

¹²² Here, this thesis only introduces Adorno’s writing styles; in fact, his colleagues Horkheimer also developed his specific writing style. Horkheimer (1972) tried to determine the conditions which make things (e.g., society, science, ideology) become such formation instead of other formations. However, he was unable to point to any condition which could be seen as a fundamental and basic element, even to the action of critique per se (1972). That is to say, if it is impossible to have a basic discipline for critique, then to criticize or to write discourses about critique itself is a challenge (Held, 1980). Horkheimer’s solution was to present his thought in the writing style of “essays and aphorisms” (Held, 1980, p. 41) instead of the systematic and monumental literary works which people used to apply. According to Horkheimer, if one wants to create a system of thought, he or she has to externalize those abstract concepts (such as critique, nature, culture, spirit), which, to him, is definitely a mistake. This argument echoes Adorno’s (1983) rejection of the notion of identity-thinking. Hence, an aphoristic style or a form of short essay will prevent the externalization of abstract ideas into concrete concepts, which is the primal form of ideology, according to Adorno (1990).

arts *per se*, and the process of appreciating it are able to break through the limitations of ideology. Adorno (cite in Schweppenhäuser, 2009) claimed that “the purposelessness of the more modern great artwork lives off the anonymity of the market” (p. 150). The anonymity means that the creators of arts should completely avoid the market’s expectations¹²³. Art is able to escape from ideology since it has nothing to do with contention of secular interests¹²⁴.

Second, drawing on Adorno (1956), the notion that art is capable of escaping ideology is based on art’s relationship to society. To Adorno, art is the representation of the authors’ historically conscious accumulations; art represents society as a whole instead of displaying a few or particular ideas of certain interest groups (in Jay, 1984). In short, as Jay (1984) interpreted, “aesthetic merit and social content were inseparable” (p. 135). While what ideology represents is usually a certain concept (that is what Adorno argued, the totality), the role of art in society becomes the possibility to impede/prevent this certain totality. Furthermore, Adorno (*ibid.*) also stressed that art should free itself from representing the “idea of authenticity” (p. 157), meaning that art has to avoid defining one “concept of being-so-and-not-otherwise” (p. 157), at which point it is possible to reach the truth. Conversely, if art claims itself only to represent particular meanings, then its function of fighting ideology disappears.

Third, the reason why art is able to become a weapon against ideology is that, to Adorno, it is the combination of mental and mimetic performances which both represent objectivity (Schweppenhäuser, 2009). In terms of mimesis, since humans are unable to retain every moment they have experienced, art (as the decoding tool of nature) preserves these moments for humans via its mimetic function (Jay, 1984). Yet, Adorno especially emphasized that although art possesses the mimetic function, it does not mean to directly

¹²³ Adorno (cited in Schweppenhäuser, 2009) further explained that in the eighteenth century, although the patrons of artists provided them with protection so that they would not have to be involved in the market’s trends, they were still “subordinate to their clients and their clients’ purposes” (p. 150). Hence, anonymity means that the creator of art should completely avoid the market’s expectations.

¹²⁴ If Barthes’ concept of *the death of the author* is considered here as well, it could provide a better reason why arts could escape from the power of ideology. Drawing on Barthes, during the process of artistic appreciation the creator’s thoughts should be ignored. In so doing, it becomes possible to reach the ideal where the art fully possesses its independent character. Authors should be anonymous; the creations should also break the link with their authors once the work is done. Under this condition, it is possible to claim that arts (and arts appreciation) could be seen as representing a way out of ideology.

copy nature *per se*; instead, it refers to presenting the “natural beauty” (p. 157) of a thing. In the meantime, the mimesis of natural beauty, as Schweppenhäuser (2009) explained, is the “dialectic of mimesis and rationality [which] defines not only the reception and production of works, but also their truth content” (p. 99).

In terms of the mental function of art, it represents the philosophical characteristic of art (Schweppenhäuser, 2009). Art implies the philosophical recognition toward existence and toward phenomena (e.g., an expected happiness) which have not yet come into existence; philosophy is a subject for recognizing human existence (ibid.). Yet, since humans are only able to understand their existence through symbolic materials, as a result, art becomes the method for discovering the mental beauty behind material artistic creations. Because of arts, humans are capable of recognizing the concepts that philosophy tries to display. Adorno thought that “the self-manifesting of the artwork points toward a happiness that could not only appear in the world but also embody its existent truth” (ibid., p. 97-98). In short, art proclaims the possibility of utopia.

Except for the theoretical discussion of art’s characteristic, role, and function, Adorno also answered practically why art is capable of escaping ideology’s cage. As mentioned, Adorno rejected the pursuit of totality because it shows how one identity(-thinking) eliminates the Others. However, this does not mean that Adorno disagreed with all totality. Rather, it should be said that the pursuit of totality is important to the task of reaching the realm of objectification; the critical question is, what equipment and methods are adopted to pursue the real totality.

To Adorno, music can be considered as a possibility to reach his ideal totality, especially Beethoven’s compositions in his middle period (Jay, 1984). These masterpieces, to Adorno, are a “prefiguration of a rationally totalized, yet non-dominating social whole” (ibid., p.143). In other words, the totality that Beethoven had reached in his middle period represents “strong subjects [which] realized their subjectivity in objective form” (p. 147). What Adorno tried to suggest here was still his suggestion of ‘the preponderance of the object’. To Adorno, the representation of a real totality should focus on the object instead of the subject. A practice such as musical composition, which sets up the object with a primary status, is the way to escape from the cage of ideology generated by identity-thinking.

Take the perspective of musical appreciation (instead of professional musical theory) to explain/conjecture why, to Adorno, Beethoven's middle period composition reached the ideal of real totality. Compared with other classical music composers in the eighteenth century especially Mozart, Beethoven's works were barely impressive (Rosen, 1997). It is because Beethoven was the model who broke away from classical music and created a new era of romantic style leading into the nineteenth century that he became exceptional. Beethoven's compositions in the romantic style only began during his middle period, especially his Heroic Symphony (Rosen, 1997). What makes Beethoven different from others is that his music expresses abundant creativity no longer attached to the Classical period.

To a certain degree, the way Adorno praises the particularity of Beethoven's middle period corresponds to Adorno's pursuit of 'difference'. This also links to Adorno's applause to 'atonal' style and atonal music indeed is subversive compared to the established music style (2002). Drawing on Adorno's philosophical perspective, what he hated most was the 'sameness'. Hence, the possibility of real practices is only expressed in the condition of difference. It can be said that the reason art can break through the constraint of sameness as well as ideology is that it can express the aesthetic aura, and because of this humans are capable of sensing 'difference', thus it becomes possible to be inspired, to create, or to question.

Take public culture as example to echo Adorno's ideas. In the movies *Equilibrium* (Wimmer, 2002) and *The Lives of Others* (Henckel von Donnersmarck, 2006), the secret agents are both touched by arts (books) and turn out to be the main force to hit back at the system. These books point out the existence of 'differences' distinguishing from what the system taught them to follow. This is just the same as the butterfly that flies into the base unintentionally in the movie *The Island* (Bay, 2005), or the 15 foot black pillar that appears in front of the apes in the film *2001: A Space Odyssey* (Kubrick, 1968). They (the human clones and the apes) are all inspired by the *difference*. All these differences shown in the above examples testify Adorno's disgust at identity(-thinking) and his dreaming for a non-identity world.

9.5 Conclusion

The study in this chapter mainly introduces Adorno's philosophy regarding the way out of ideology's cage. Adorno suggested that, from an ontological perspective, one has to overthrow the cognition that humans used to possess: the priority of subject and the pursuit of identity(-thinking). Instead, he suggested promoting the object to the preponderant status and to agree with non-identity(-thinking). In terms of the epistemological angle, he suggested following the principle of immanent critique which criticised the researched subject based on its concepts and inner logic. He also required readers to examine the researched phenomenon within the aspect of the constellation. This aspect suggests that critics have to restore concepts of object which are eliminated by the subject, and then create a new recognition towards an object where none of the concepts is prior to the others. In terms of the methodological angle, Adorno applied it in his 'writing style', including the methods of the ironic inversion and the chiasmus. The former follows the logic of immanent critique while the latter refers to the application of constellation. Finally, Adorno considers art (artistic creation) as the possible practical action for escaping the ideological cage based on three dimensions, that is, art's characteristic, its relation to society and its two functions (mental and mimetic). Adorno's studies on music also help to explain how and why art is able to escape from ideology's cage.

Adorno's ideas are specifically introduced in this chapter to consider whether vanguards like him had found ways out of ideology's dungeon. Many of his notions have provided the basic argumentative foundation for this thesis to validate the statement of SWPs. The suggestion of SWPs is based on the commonalities among 33 IAC articles. These commonalities represent the identity(-thinking) of undertaking ideological analysis/critique, which is revealed in the form of standardisation, contributing to what Adorno worried about the most, the totality; in this thesis's case, the totality of writing IAC articles. In addition, Adorno's concepts, *the preponderance of the object*, also influences this thesis' suggestion of *humbleness* in the final chapter, which is the foundation of this thesis' other suggestion, *self-critique*, whereby self-critique is seen as a possible way to escape from ideology's constraints.

9.6 Discussion

This chapter adopted three dimensions (ontological, epistemological, and methodological) to examine Adorno's philosophy to see whether his ideas have led humans to break through the cage of ideology. Yet, the answer depends on whether we, the readers, agree with his aspect regarding the relationship between *theory* and *practice*. His aspect is: the process of developing theories *per se* is the process of real practice. To him, the practical action, such as strikes, which people used to consider as practice, is not the *real* practice.

Accordingly, if it is agreed that Adorno was *theoretically* chasing the brave new world out of ideology intervention, then his suggested notions—e.g., the preponderance of object, the pursuit of non-identity(thinking), immanent critique, and constellation—indeed have shown ways out of ideology's cage which is what Adorno called the *real* practice.

Yet, not all humans, especially the public, live in a theoretical world, their daily practical activities should be brought into consideration as well (practical activities indeed is what people considered as real practice). The common phenomenon is that when these theories are applied practically to daily activities, it usually results in conflict and contradiction between theoretical imagination and practical reality. The application of the communist ideal in Russia and China are worth considering as cases.

Reasons causing these contradictions and conflict are because, first, humans can only recognise the world through using language, and, second, any argument and judgement, whether it is right or wrong, are all humans' conscious products.

First, human beings are only able to display their ideas through language. The reason why languages are understandable is because they are the already conceptualized creations. Since languages convey certain concepts, they all possess the function of signification. Although Adorno offered the notion of constellation, expecting us not to apply the conceptualized aspects (i.e., concrete concepts) to express ideas, such an ideal is still impossible if languages are the only channel to express humans' ideas.

Second, any discussion, judgement, and evaluation in the world would all be the production made by personal consciousness expressed by languages. Since all theories are the creation of consciousness, it is impossible to escape from ideology's cage. Although Adorno (1990) has suggested many aspects (e.g., non-identity-thinking) striving to break this

constraint, he himself realized the impossibility. He described, “we can see through the identity principle”; yet, “we cannot think without identifying. Any definition is identification” (p. 149).

Held (1980) explained that, to Adorno, objective truths do exist, “but these truths were often inadequately interpreted by their creators and were not self-explanatory. To be grasped fully, the intervention of the theorist was necessary” (p. 208). This shows a contradiction for Adorno. While discussing the culture industry, he required anonymity be provided to authors so that they might not be influenced by the market; but, here, he claimed that not everyone has the ability to read artistic creations, so that the mission of interpretation should be left to theorists, who do possess the capacity. Adorno neglected the interpretation of a thing that theorists offer is the interpretation influenced by their “preferred reading¹²⁵”, i.e., their personal consciousness. While their interpretation becomes the only way of recognising a work (e.g., a theory), it gradually becomes an identity-thinking, which, ironically, is what Adorno fought against the most.

Take Adorno and Horkheimer’s critique on the culture industry as another example. They argued that technological development enables business to massively produce artistic products. Such logic of capitalist production causes the culture creations to lose their autonomy and particular ‘aura’ (Benjamin’s term) becoming what they called the culture industry—identical products. Yet, such an argument also resulted from Adorno and Horkheimer’s opinions (i.e., their judgement, their own ideology) *in their specific time*. Similarly, if primitive men who lived in caves were able to travel through time to Adorno’s epoch, they would argue that what they had done by beating rocks or anything else with sticks or hands was the only thing which could be claimed as real music. The recording studio and concert hall which modern people built as well as the equipments like noise reduction or instruments like the piano which modern people invented are indeed all the results of technological development, which affects the factuality of music.

¹²⁵ While the authors encode the message, they will inevitably provide a certain interpretation in order to influence readers. The interpretation that the authors wish their readers to accept is what Hall (2004) called the ‘preferred reading’ which no doubt reveals the authors’ own ideology. Depending on the degree that the readers accept, interrogate, or reject such preferred reading, Hall concluded three common readers’ decoding positions, including the dominant-hegemonic, negotiated, and oppositional position.

Thus, considering the primitive men's argument, the only question is how could Adorno determine the level/extent of technological development that he considered to be acceptable? In what authority could he claim the harmfulness of technology acting on culture creations? The answer is found to be simple. All his arguments against the phenomenon of the culture industry are all his conscious products, his judgement, his own ideology. From a practical perspective, Adorno did not succeed in escaping from the cage of ideology.

It could be concluded that the aspects Adorno offered represent his democratic ideal. In the theoretical, philosophical, imaginal, and mental realm, his aspects have demonstrated one possible way out of ideology's cage. Yet, since human beings cannot express their consciousness without applying language, every usage of language, which all convey particular significances, is the representation of a certain personal ideology. Criticising an ideology of a time via ideology of another time does not mean that the critics succeed in escaping from the dungeon of ideology. One point which could be confirmed is that all aspects of conscious/ideological emancipation (e.g., Adorno's aspects) are all the self-emancipation which does not change the conditions giving rise to it.

Although Adorno's notions attempted to establish a world without the ideology intervention, he still cannot get rid of his own ideology. His dilemma reveals the limitation of undertaking (ideological) critique: criticising one subject, even through an ideological angle, involves an ideology itself. Faced with such a limitation, as a result, in Chapter 10, *Conclusion and Suggestion*, this thesis will explain why human beings have to realise the importance of *humbleness*, which is the foundation of *self-critique*. Self-critique, this thesis argues, is a possible way to escape from ideology's constraints.

Chapter 10

Conclusion and Suggestion —Humbleness and Self-Critique

In the empirical analysis chapters (5-8), this thesis revealed the existence of standard procedures for writing articles of ideological critique. In the previous chapter (9), this thesis pointed out the limitation of (ideological) critique: criticising one subject, even through an ideological angle, involves an ideology itself. Such findings are displeasing since they not only imply the limitation of freely undertaking (ideological) critique but also seem to reveal a dead end with fatalism and determinism.

If all humans' efforts were to follow an invisible guiding discipline to tell the same tale, which reflects (or is influenced by) these persons' or social total ideologies, then what is the purpose of critique? What is the meaning of humans' conscious activities? Before answering these questions, this section will briefly conclude each chapter's arguments after which a suggested response to this question will be provided. This suggestion wishes to answer why we criticise, how to do it as well as indicating an escape route from the ideological matrix.

10.1 Conclusion

The research question of this thesis is: Are analysts or critics capable of extricating themselves from the influences of both their own and society's ideology, even if they are experts in ideology studies? Or say, what factors that limit ideological critics' capacity to undertake ideological critiques?

To answer the above question, three subjects are focused on, including humans, (ideological) critique/analysis, and ideology. To investigate these three subjects' inter-relationships, this thesis focused on *academic* conscious activities, examining their publications which specifically refer to the type of *ideological critique/analysis*. This is to observe how they present their works to determine whether they are able to impart their critique/analysis neutrally and objectively, without referring to a personal ideology.

The *human* subject here specifically refers to ideology-specialists: This thesis, in Chapter 2, has promoted ideological-specialists to a higher position as the few people who are able to carry the role of real-intellectuals. Since they have noticed the power of ideology and systematically learned the related discussion of ideology (of course, they are also inevitably limited to their ideology), this thesis deems that, theoretically speaking, ideological-specialists are, or might be, the most capable people who can escape from the intervention of ideology.

Critique/analysis here refers to actions resulting from humans' conscious activities. This thesis focuses on academics' publications which claim to be written from the angle of ideological analysis or critique (IAC). The reason for selecting the 'ideological' angle is: what other angle of critique/analysis is capable of avoiding the interference of ideology if those which adopt the 'ideological' angle cannot.

Accordingly, this has been a thesis dealing with how humans (i.e., ideology-specialists) undertake critiques (with specific method/dimension, e.g., ideological angle) when another subject, ideology (i.e., their own or social total ideology), has played a powerful role or has been a powerful factor influencing humans' critique work.

In Chapter 2, this thesis discussed the concepts and history of intellectuals and critique. It concluded that academic ideological analysts/critics are the few people able to shoulder the role of intellectuals to discover social problems (via their critique/analysis) especially in the epoch of ideology. According to ideological analysts' characteristics, which are similar to intellectuals and their capacity to analyse ideology-related phenomenon, Chapter 2 concluded that escaping from ideology's dungeon is possible.

Yet, in Chapter 3, this thesis discussed the impacts on academic circles of capitalism. This thesis argues that, in the epoch of capitalism, academic publications become more of an 'academic industry' where a phenomenon of standardisation might exist in scholars' academic works. It would appear that there is a guiding principle for scholars to follow which in this thesis refers to standard procedures (SWPs) for writing IAC articles. If the above presumption of SWPs were true, then it is reasonable to claim that it is difficult for humans to escape from the dungeon of ideology, even the ideology-specialists. An ideological critique without referring to analysts' common analyzing methods, which result from their society's ideology, seems to be impossible.

Accordingly, after explaining the methodology in Chapter 4, this thesis advanced to the empirical analysis (Chapters 5-8) to investigate whether the supposed *standard writing procedures* (SWPs) exist in IAC articles. Six SWPs have been found based on the commonalities between 33 IAC articles. These include procedures of: 1) identifying essential elements; 2) applying theoretical foundations; 3) connoting certain meanings; 4) illustrating; 5) selecting expression styles; and 6) revealing personal viewpoints. While these six procedures are explained, the related ideology theories were reviewed. In so doing, in this thesis, I have sought to identify correspondence between theories and practices whereby the analytical angle of ideological critique/analysis as a ‘methodology’ might be established as well. The conclusion of these six procedures is found in Table 8-8, where this thesis has provided a systematic explanation.

Results from the empirical analysis show that the limitation of undertaking ideological critique, especially when certain guiding rules, like SWPs, were found to be embedded in 33 IAC articles. Thus, in looking for ways out of ideology, in Chapter 9, this thesis returned to review related literature, specifically focusing on Adorno’s philosophy, to ascertain whether early scholars had provided escape routes from the dungeon of ideology, which is different from the contemporary advocates of ideological critique.

Selecting Adorno was not only done to draw a correspondence with the literature discussed in Chapter 3, from which this thesis’ argument (e.g., SWPs in IAC articles) was inspired. It was also because of Adorno’s concepts, such as *the preponderance of the object*, *the pursuit of non-identify-thinking*, *immanent critique*, and *constellation* seemed to guide a way out of the cage of ideology. No doubt the escape route from ideology’s cage exists in *philosophical thinking* like the way Adorno suggested. Yet, in humans’ practical action (e.g., undertaking ideological critique), it is still questionable since Adorno’s works were the conscious products reflected from his own or the society’s certain ideology.

Both the empirical analysis (Chapters 5-8) and the philosophical discussion (Chapter 9) all show that humans, to a great degree, are inevitably limited to their own or the social total ideology while undertaking the analysis or critique. Faced with such an inevitable limitation, in this final chapter (10), *Conclusion and Suggestion*, this thesis suggests that human beings have to *humble* themselves to minimize their self-considered-righteous as much as possible.

This is to prevent humans from adopting their own ideology to judge others' ideology, which turns out to fall into the endless loop of ideology-critique of ideology-critique. Moreover, the only work of critique that humans are able to undertake is limited to the regime of *self-critique*. This argument is undoubtedly a moral perspective, yet, it is what this thesis considers the way out of ideology.

10.2 Suggestion: Way Out of Ideology

Humans understand each other in a range of communication methods. In daily activities, people often confidently claim that they are able to understand others' position or argument. Usually, after such claims, they may continue to respond to others' ideas by offering their own opinion. For example, 'I understand what you are trying to say, but..., and I think...'. While arguments might be politely rejected, people may also retort, 'I don't think you understand my point...'. Meaningless conversation or failure in communication happens frequently and academic discourses are no exception. Humans always consider themselves capable of understanding others while rejecting the acknowledgment that others possess the same capacity. In other words, they are rationally and sincerely trying to comprehend others' ideas, but, to them, other people are easily revealed to be irrational.

Communication failure results from humans' communicating tools, symbolized languages. As mentioned in Chapter 6, due to the various applications of signs and the diverse background of signs' users, all signs (are forced to) carry certain connotations (sometimes obviously and directly representing users' ideology), even to the most basic signs. Humans often unwittingly use their own ideology, which is created according to their symbolic languages, to understand others as well as forcing others to accept their arguments. This is the main reason for communication failures. Thus, unless aliens teach us to communicate *telepathically*, it is impossible for humans to fully understand others if the only channel humans can use to communicate is the symbolized languages.

Any unintentionally, simple applications of symbolic language all already carry certain significances which reflect its performers' life experiences; these symbolic languages are also comprehended differently based on the receivers' life experiences. Namely, humans' communication in fact is a process where diverse ideologies, which reflect the senders' and

receivers' application of symbolic languages, keep being exchanged. On the surface, symbolic languages are being exchanged to communicate with and understand each other; in fact, the process of communication is the exactly process of the competition of ideological hegemony, even though people always claim they communicate *neutrally* and *objectively*.

Academic discourse (or communication) indeed is a competition of ideological hegemony in which styles of communication are not special but merely named with a relatively notable terminology, i.e., critique or analysis. The term, critique/analysis, on the surface, reaches the purpose of understanding by revealing the problem of the researched phenomenon; in fact, the action that critique/analysis carries is to question or controvert other scholars' ideas or problems based on its discussants' own ideology. Sometimes, such action of critique/analysis is simply appropriated as a tool to present what its discussants want to say without any connection to the criticised topics.

The action of communication has no difference between the academic scholars and general publics. Both their communicative actions are built on their ideology fighting for conscious dominance. The only difference is that communication (or discourse) failure in academic circles will only lead scholars to insist their own position. There is no significance, even if other scholars cannot accept their argument even if other scholars illogically or irrationally criticise it. Conversely, they will continue to develop or revise their self-considered system of a great idea, waiting for the day when later scholars are finally wise enough to understand them.

Yet, in daily life, the humans' communication (i.e., their conscious activities) refers to the continual actions of persuasion, rejection, dominating and resisting between persons, organisations, and nations. The problem is that human beings are unable to not to judge others' opinions based on their own thoughts, nor are they unable to not to force others to accept their opinions. That is to say, while all communications that humans undertake carry nothing but their own ideology, humans' rationality is simultaneously limited.

In short, while a certain ideology is displayed in the clothing of symbolic languages, humans forget that they are revealing their ideology instead of expressing their objective ideas via seemingly neutral application of language. They think they are able to present their ideas neutrally and objectively which is an ability others do not possess. As a result,

individuals' egoistic attitude is created, based on their self-granted neutral and objective autonomous consciousness or free will. With the acknowledgement of self autonomous consciousness comes failure in communications. When humans' communications fail, it results in disagreement and fighting among individuals or organisations as well as suppression, resistance or even wars among nations.

Humbleness

Although humans endeavour to understand each other via communication, many negative outcomes occur as a result of failing in linguistic expression. This is because humans can only define or judge others' ideas based on their own thoughts. To overcome such a model of understandings or to escape from the ideology dungeon, this thesis argues that humans have to *humble themselves*, to consider themselves insignificant relative to their social existence.

The concept of humbleness is:

1. People have to realise how ideology influences human conscious activities, to recognise the limitation of human communication.

There is no doubt that humans are willing to communicate neutrally and objectively to reach a full understanding with others. Yet, because of the embedded dominant thought of 'the preponderance of subject' (Adorno's term), humans are unknowingly taught to take an egotistic position whereby they unwittingly value themselves highly. Their arguments are inevitably based on their own perspectives (i.e., ideology) or ideologies surrounding them. According, the first concept of *humbleness* suggests: humans have to understand that their perspectives are all the reflection/representation of their own or the social total ideology, as well as to realise that their conscious activities (e.g., articles, speeches, arguments) will become the possible social factors that, somewhere in time, determine/influence the making of others' perspectives.

Hence, realising that humans' capacity to neutrally and objectively communicate with others is limited, what humans can do to create neutral communication (reducing those negative influences caused by humans' failed communication) is:

2. Endeavouring to minimize their conscious participation in society as well as minimizing their interaction with others. The ways in which humans reveal their conscious activities are various. Take three common styles as explanations, namely general

conversation, suggestions, and critique. In short, the way to minimize participation in society is to diminish or to be mindful of these three styles of communication.

First, To Diminish Critique on Others

The term critique in this thesis means to point out the problem of one research subject; yet, there is no doubt that such critique is also based on analysts' own opinion (i.e., ideology). As previously mentioned, diverse types of conflicts between various levels of actors (i.e., individuals, organisations, nations) usually stem from their failed communications. For this reason, the reduction of critical judgements is a way to decrease unnecessary conflicts to reach the goal of humbleness.

Undoubtedly, direct judgement is an obvious style of communication which displays analysts' own ideology in the neutral and objective state. Yet, most conflicts in fact result from the other two styles, *general conversation* and *suggestions* with/to others, which probably will not be considered by the public as harmful as this thesis suggests.

Second, To Be Mindful of the General Conversation

Despite how general or casual conversations might be, the communication between individuals, to a great degree, always carries certain signification or connotation. A sentence that appears ordinary, without any implication to one person, might be decoded as a judgement or criticism by others. For example, phrases like 'hang in there', 'take care', 'happy birthday' or 'happy new year'.

(Warning: The following examples might cause readers' difficult emotions.)

Consider a mother who has lost her child. Friends and relatives come to give their condolences and support by saying words like 'hang in there', 'be strong', or 'take care'. This mother, for most of the time, will not feel better or comforted when hearing these phrases. Instead, these words do nothing but remind her of her loss. In fact, most people are "talking without speaking"¹²⁶. They think 'they have to' offer those words, to sign the 'I-care-about-you attendance book', otherwise, they will be deemed as indifferent. They say these words *for themselves* more than caring about the mother; and this mother keeps being hurt again and again whenever people talk about her loss, even decades later. If the sadness

¹²⁶ Lyrics from Simon, P. & Garfunkel, A. (1964). 'The Sounds of Silence,' *Wednesday Morning, 3 AM*. New York: Columbia Records.

cannot be described by symbolic languages, why do people think they can use languages to comfort people? It is outsiders' own ideology thinking that words like 'take care' might help¹²⁷.

Take more general conversational phrases like 'happy birthday' or 'happy new year' as another example. To most people, these are just words they have to say at a specific time. Yet, what if a person's mother died when giving birth to him/her? Maybe his/her siblings even hate him/her, thinking that s/he is the jinx causing the broken family? Is not the term, *happy birthday*, again words to remind this person of emotional pain? What if one gossips about a colleague's cheating on her husband while the listener's wife did the same many years ago? What if one says Merry Christmas to friends while the audiences do not follow the religion to which this festival belongs?

People usually respond that they do not know others' stories, and had not meant to hurt them with these general conversational phrases. Yet, this is indeed the reason why this thesis suggests being mindful of and reducing those general conversations which are taken for granted. We will never understand why one specific sentence might mean something to old friends, new friends, or even strangers—in short, we are unable to fully understand one's past experience—that is why people cannot take daily general conversations, which 'they think' are nothing special, for granted.

Third. To Curtail Suggestions

Curtailing suggestions means to reduce applying ideas, which we consider as 'good', to interrupt others' thoughts or to persuade others to accept our views. This thesis argues that the 'good' conscious activities, such as religious leaders asking people to help others, in some cases, still contain negative influences. One good conscious activity is defined by personal ideology; while if it is agreed by many people, it becomes a dominant ideology¹²⁸. Once the goodness of one conscious activity is defined by humans' consciousness, it will never represent the characteristic of such conscious activity in nature. Instead, it only refers

¹²⁷ I have been thinking if my given examples might unintentionally trigger very difficult emotions for readers as I completely have no way of knowing how many academics or students who read this example could have had similar experiences. If this example hurt you, I sincerely apologize. Yet, although I should not have said this, it proves this thesis' argument again that general conversations, phrases, greeting, or innocent comforting words indeed hurt people.

¹²⁸ Definition and diverse characteristics of dominant ideology explained in Chapter 5.

to a dominant ideology agreed by most people. Yet, such conscious activity still might play a negative role for another group of people, even if the influences are difficult to detect.

For example, one person watches an inspirational film and presumes it is good for others, so that s/he strongly recommends friends to watch it. However, even though this film indeed contains some good influences, it still might have a negative influence on other people who have diverse life experience. For another example, people might suggest a younger person to (or not to) undertake a Ph.D (or any future career) based on their own opinions. Yet, they will not be responsible for their suggestion many years later if that younger fails or regrets the decision; they might not even remember that they ever gave such advice despite their suggestion indeed having been adopted by (or influenced) the younger person. Suggestion is an irresponsible human's conscious activity which only attempts to persuade people to accept what they consider as 'good', even though the advisors always state that they have *neutrally* and *objectively* analysed the situation for others. In short, people are likely to give suggestions but they do not take responsibility for them, for the bad influences resulting from their suggestions.

This thesis has explained three common styles of communication which illustrate how ones' personal consciousness might hurt, influence, or unintentionally judge others, which might then lead to unnecessary misunderstandings between persons, simultaneously creating negative influences. It has to be admitted that, to the majority, the above discussions seem to find fault for a purpose. It will not be that serious for those 'general conversations' and 'suggestions'. Only a few people might believe that an inspirational film or a general daily greeting like 'happy birthday' might cause damage to others.

Yet, just because of the above dominant thought (i.e., general conversations and suggestions are not that serious), this thesis argues strongly that: humans' conscious activities (whether to influence or in being influenced) are not a mathematical calculation, excusing that the world would be fine if the amount of good-influences were to surpass bad-influences. In fact, the bad-influences will not be neutralized by good-influences. Every negative factor indeed exists and takes action in humans' society. If a negative seed exists, it should be taken seriously.

People might never know when or how a bad seed is planted by their suggestion or general conversation. All they can do is to minimise their conscious participation in society or interaction with others. In so doing, the goal of humbleness might be achieved in which people:

3. Realize that their opinions (conscious activities) are not important because there is no difference if the world is without them; humans are no-body.

Once people realize their own unimportance, comparatively speaking, they will not insist their own opinions or force others to accept, ignoring that their opinions indeed result from their own ideology which might hurt, influence, and judge others. Once the participation of personal consciousness is reduced, the conflicts between humans could be expected to decrease.

To conclude, symbolic languages can always be read differently. Although some conscious activities are considered to be ‘good’ and even though a greeting like ‘happy new year’ seems non harmful, they are all conscious products which are sensed differently from one person to another. Humans’ conscious activities are all the actions which always reveal certain judgements (i.e., an ideology against another), leading to humans’ conflicts (from individuals’ disagreement, organisations’ fights, to nations’ wars). Therefore, this thesis suggests humans should humble themselves to minimise their conscious participation in society or interaction with others, including not criticising others, not giving suggestions, and even being careful with their general conversations.

Meaning of Critique and the Way to Escape Ideology: Self-Critique

According to this thesis’s statement discussed above, it seems to suggest that there is no meaning for action of critique. Indeed, the action of critique is insignificant. This is because the critique that people usually acknowledge is always the judgements from one ideology against another. Such critique (between individuals’ ideologies) is unable to obtain authority to state the validation of its action.

However, there is still a Pure Land where the action of critique shows its possibility, that is, only when such critique is a *self-critique*. To prevent the negative-influences caused by humans’ conscious activities towards other people, what humans can undertake is a continual introspection of what they have innocently said, suggested, and judged in daily

conversation. The process of introspection, i.e., self-critique, is what this thesis deems as the action of real critique. Namely, criticizing others' ideology via personal ideology will only fall into an endless loop—critique of critique of critique.... On the other hand, only when humans realise the limitation of human communication and endeavour to minimise their conscious participation in society to decrease their influence on others, might they discover the platform of real critique. Real critique should be one which is performed within individuals' personal world where they only criticise their own old thoughts—that is, a critique based on a person's new consciousness fighting against their old consciousness.

Hence, if there exists a moment in which humans overcome the strength of ideology, then it would be the moment when they start to think if they are limited to their own thoughts. If there indeed exists such a moment, it would be the time when humans humble themselves knowing they are insignificant nobodies in the world and start to criticise themselves.

Either via the empirical (ch.5-8) or the philosophical (ch.9-10) perspectives, all arguments show humans' limitation of undertaking ideological analysis/critique, even for ideology-specialists. This conclusion saves me from cognitive disorder, answering why I cannot resist Superman, even though I am familiar with those film elements and narrative tricks that make him a hero. This conclusion also answers why "people know very well what they are doing, but still, they are doing it". Why? **Humans might well know the 'analyzable' or 'visible' part of ideology; but they will never ever detect any piece of the 'invisible' as well as the 'ontological' part of ideology.** That is why we call it *ideology*.

Although I know very well my conclusion, I still tried to find an escape route from ideology in this final chapter, thinking that it might work this time. Unfortunately, the arguments (which have led me thus far) and suggestions, I admit, are all the products of my ideology, representing my life experience. The suggestion in this section, which I consider as a successful way out of ideology, according to my own argument, also might cause negative-influences to others. Obviously, all my arguments fall into the trap of ideology once more, becoming my personal ideology rejecting/criticising others' ideology. My conclusion testifies itself repeatedly. Humans' capacity for undertaking ideological critique is limited.

At the beginning, I thought that Adorno's concepts had unlocked the door of the ideology jail and was grateful for the escape map he had drawn and the weapons (e.g., ideas like non-identity-thinking) to fight the dragon of ideology he had provided. Right after I shed tears of joy, having seen the light penetrate through the crack of the final gate, the door I opened showed, to my surprise, the exact same cell that I had left. Unfortunately, whether Adorno had found the way out of ideology's dungeon (theoretically yes and practically no), his concepts still stemmed from his personal ideology resulted from his life experience.

As a result, I decide to lock myself back in the dungeon and strengthen the lock in order to shrug off any fantasy of escaping from ideology. It is difficult for humans to obtain authority to fairly, neutrally, and objectively criticise others' ideology based on their own ideology. The only ideological critique that humans are able to undertake is to criticise their own ideology (but not that of others). In so doing, a way out of (our own) ideology could be possible, which might be able to be seen as real ideological critique.

The conclusion seems pessimistic and suggesting isolationism. Yet, since the topic of this thesis is ideology *per se*, what else can I say? It is all about ideology.

Bibliography

IAC Articles

- Abbas, T. (2001) Media Capital and the Representation of South Asian Muslims in the British Press: An Ideological Analysis, *Journal of Muslim Minority Affairs*, 21(2): 245-257.
- Apple, Michael W. (1985) Teaching and “Women's Work”: A Comparative Historical and Ideological Analysis, *Teachers College Record*, 86(3): 455-473.
- Barker, P.J., Reynolds, W. & Ward, T. (1995) The Proper Focus of Nursing: A Critique of the Caring Ideology, *International Journal of Nursing Studies*, 32(4): 386-397.
- Bishop, R. (2001) Old Dogs, New Tricks? An Ideological Analysis of Thematic Shifts in Television Advertising for Diet Products, 1990-2000, *Journal of Communication Inquiry*, 25: 334-352.
- Bishop, R. (2005) The Wayward Child: An Ideological Analysis of Sports Contract Holdout Coverage, *Journalism Studies*, 6(4): 445-459.
- Brennen, B. & Duffy, M. (2003) “If A Problem Cannot Be Solved, Enlarge It”: An Ideological Critique of the “Other” in Pearl Harbor and September 11 New York Times Coverage, *Journalism Studies*, 4(1): 3-14.
- Crawford, K. (1998) The Construction of the National Curriculum: An Ideological and Political Analysis, *Research Papers in Education*, 13(3): 261-276.
- DeFoster, R. (2010) American Gun Culture, School Shootings, and a “Frontier Mentality”: An Ideological Analysis of British Editorial Pages in the Decade After Columbine, *Communication, Culture & Critique*, 3(4): 466-484.
- Dilevko, J. (2001) An Ideological Analysis of Digital Reference Service Models. *Library Trends*, 50(2): 218-244.
- Downes, D. (2010) Harry Potter and the Deathly Hollowess: A Narratological and Ideological Critique of J. K. Rowling's Magical System, *International Research in Children's Literature* 3(2): 162–175.

- Ewick, P. & Silbey, S. S. (1999) Common Knowledge and Ideological Critique: The Significance of Knowing that the 'Haves' Come out Ahead, *Law and Society Review* 33(4): 1025-1044.
- Ewing, S. (1991) The Russian Social Insurance Movement, 1912-1914: An Ideological Analysis, *Slavic Review*, 50(4): 914-926.
- Ferreira, S. Morais, A.M. & Neves, I. P. (2011) Science Curricula Design: Analysis of Authors' Ideological and Pedagogical Principles, *International Studies in Sociology of Education*, 21(2): 137-159.
- Garrison, J.L. (1978), Public Assistance in Egypt: An Ideological Analysis, *Middle East Journal*, 32(3): 279-290.
- Gillespie, J. (2002) Transplanted Company Law: An Ideological and Cultural Analysis of Market-Entry in Vietnam, *International and Comparative Law Quarterly*. 51(3): 641-672.
- Goss, B.M. (2005) "Jeffersonian Poetry": An Ideological Analysis of George F. Will's Editorials (2002–2004), *Journalism Studies*, 6(4):417-429.
- Hansen, J.T. (2006) Is the Best Practices Movement Consistent With the Values of the Counseling Profession? A Critical Analysis of Best Practices Ideology, *Counseling and Values*, 50: 165-160.
- Harvey, D.L. & Reed, M. H. (1996) The Culture of Poverty: An Ideological Analysis. *Sociological Perspectives*, 39(4): 465-495.
- Haslanger, S. (2007) "But Mom, Crop-Tops Are Cute!" Social Knowledge, Social Structure and Ideology Critique, *Philosophical Issues*, 17(1): 70-91.
- Hazelton, M. (1990) Medical Discourse on Contemporary Nurse Education: An Ideological Analysis, *Journal of Sociology*, 26(1): 107-125.
- Johnston, K. (1983) A Discourse for All Seasons? An Ideological Analysis of the Schools Commission Reports, 1973 to 1981, *The Australian Journal of Education*, 27(1): 17-32.

- Jones, B. G. (2008) The Global Political Economy of Social Crisis: Towards a Critique of the 'Failed State' Ideology, *Review of International Political Economy*, 15(2): 180–205.
- Kerr, M. (1960) Rashid Rida and Islamic Legal Reform: An Ideological Analysis, *The Muslim World*, 50(2): 99-108.
- Lu, X. (1990) An Ideological/Cultural Analysis of Political Slogans in Communist China, *Discourse Society*, 10:487-508.
- Medvic, S. K. (2007) Old Democrats in New Clothing?: An Ideological Analysis of a Democratic Party Faction, *Party Politics*, 13(5):587-609.
- Moss, G. & O'Loughlin, B. (2005) New Labour's Information Age Policy Programme: An Ideology Analysis, *Journal of Political Ideologies*, 10(2): 165-183.
- Palermo, J. (1977) Reading Asante's Myth of Afrocentricity: An Ideological Critique, *Philosophy of Education*, 1997: 100-111.
- Rooney, E. (1984) 'From Republican Movement to Workers' Party: An Ideological Analysis', in C. Curtin, M. Kelly, & L. O'Dowd, *Culture and Ideology in Ireland* (pp. 79-98). Galway: Galway University Press.
- Sakamoto, R. (2001) Dream of a Modern Subject: Maruyama Masao, Fukuzawa Yukichi, and 'Asia' as the Limit of Ideology Critique, *Japanese Studies*, 21(2): 137-153.
- Smith, D.E. (1975) An Analysis of Ideological Structures and how Women are Excluded: Considerations for Academic Women, *Canadian Review of Sociology*, 12(4): 353-369.
- Talshir, G. (2003) A Threefold Ideological Analysis of Die Grünen: From Ecologized Socialism to Political Liberalism?, *Journal of Political Ideologies*, 8(2):157-184.
- Weintraub, A.N. (2006) Dangdut Soul: Who are 'the People' in Indonesian Popular Music?, *Asian Journal of Communication*, 16(4):411-431.
- Weltman, D. (2003) The Pragmatics of Peremptory Assertion: An Ideological Analysis of Word 'Just' in Local Politicians' Denials of Politics, *Discourse Society*, 14: 349-373.

Bibliography

- Abercrombie, N. Hill, S., & Turner, B.S. (2006) *Dictionary of Sociology*. London: Penguin.
- Abercrombie, N., Hill, S. & Turner, B.S. (eds), (1990) *Dominant Ideologies*. London: Unwin Hyman.
- Abercrombie, N. & Turner, B.S. (1978) The Dominant Ideology Thesis, *The British Journal of Sociology*, 29 (2): 149-170.
- Acton, E. (1997) 'Revolutionaries and Dissidents: The Role of the Russian Intellectual in the Downfall of Tsarism and Communism', in J. Jennings & T. Kemp-Welch (eds), *Intellectuals in Politics: From the Dreyfus Affair to Salman Rushdie* (pp. 149- 168). New York: Routledge.
- Adorno, (1978) 'Subject and Object', in A. Arato & E. Gebhardt (eds), *The Essential Frankfurt School Reader* (pp. 497-511). Oxford: Blackwell.
- Adorno, T. & Horkheimer, M. (1992) 'The Culture Industry: Enlightenment as Mass Deception', in S. Daring (ed), *The Cultural Studies Reader* (pp. 29-43). London: Routledge.
- Adorno, T.W. & Horkheimer, M. (1997) *Dialectic of Enlightenment*. London: Verso.
- Adorno, T.W. (1967/1981) 'The Sociology of Knowledge and its Consciousness', in *Prisms* (pp. 35-50. Trans. Samuel and Shierry Weber) Cambridge, Mass.: MIT Press.
- Adorno, T.W. (1956) Modern Music is Growing Old, *The Score*, No. 18: 18-29.
- Adorno, T.W. (1973, 1990) *Negative Dialectics*. New York: Continuum.
- Adorno, T.W. (1991) *The Culture Industry: Selected Essays on Mass Culture*. London: Routledge.
- Adorno, T.W. (2002) *Essays on Music: Theodor W. Adorno*. London: University of California Press.
- Allen, V.L. (1975) *Social Analysis: A Marxist Critique and Alternative*. London: Longman.

- Althusser, L. (1971) *Lenin and Philosophy, and Other Essays*. New York: Monthly Review Press.
- Althusser, L. (1994) 'Ideology and Ideological State Apparatuses (Notes towards an investigation)', in S. Žižek (ed), *Mapping Ideology* (pp. 93-99). London: Verso.
- Annaud, J.J. (Director) (2001) *Enemy at the Gate*. Paramount Pictures.
- Archer, M. (1998) 'Social Theory and the Analysis of Society', in T. May and M. Williams (eds), *Knowing the Social World*. Buckingham: Open University Press.
- Aron, R. (1957) *The Opium of the Intellectuals*. London: Secker & Warburg.
- Bailey, G. & Gayle, N. (2003) *Ideology: Structuring Identities in Contemporary Life*. Peterborough: Broadview Press.
- Baradat, L. P. (1997) *Political Ideologies: Their Origins and Impact*. New Jersey: Prentice Hall.
- Barrett, M. (1994) 'Ideology, Politics, Hegemony: From Gramsci to Laclau and Mouffe', in S. Žižek (ed), *Mapping Ideology* (pp. 235-264). London: Verso.
- Barth, H. (1977) *Truth and Ideology*. Los Angeles: University of California Press.
- Barthes, R. (1968) *Elements of Semiology*. New York: Hill and Wang.
- Barthes, R. (1993) *Mythologies*. London: Vintage.
- Bates, S.R. and L. Jenkins (2007), Teaching and Learning Ontology and Epistemology in Political Science, *Politics*, 27(1): 55–63.
- Baudrillard, J. (1994) *Simulacra and Simulation*. Ann Arbor: University of Michigan Press.
- Bauman, Z. (1987) *Legislators and Interpreters: On Modernity, Post-modernity and Intellectuals*. Cambridge: Polity Press.
- Bay, M. (Director) (2005) *The Island*. Warner Bros. Pictures.

- Beasley-Murray, J. (1997) So Here Comes a Book that Makes Everything Easy: Towards a Theory of Intellectual History in the Field of Intellectual Production, *Angelaki: Journal of the Theoretical Humanities*, 2(3): 125-146.
- Bellamy, R. (1997) 'The Intellectual as Social Critic: Antonio Gramsci and Michael Walzer', In J. Jennings & T. Kemp-Welch (eds), *Intellectuals in Politics: From the Dreyfus Affair to Salman Rushdie* (pp. 25-44). New York: Routledge.
- Benda, J. (1955) *The Betrayal of the Intellectuals*. Boston: Beacon Press.
- Benda, J. (2006) *The Treason of the Intellectuals*. New Jersey: New Brunswick.
- Benjamin, W. (2003a) 'The Work of Art in the Age of Its Technological Reproducibility: Third Version', in H. Eiland, & M. W. Jennings (eds), *Selected Writings: Walter Benjamin. Vol.4, 1938-1940* (pp. 251-283) London: Belknap Press of Harvard University Press.
- Benjamin, W. (2003b) 'On the Concept of History', in H. Eiland, & M. W. Jennings (eds), *Selected Writings: Walter Benjamin. Vol.4, 1938-1940* (pp. 389-400) London: Belknap Press of Harvard University Press.
- Berger, A.A. (2000) *Media and Communication Research: An Introduction to Qualitative and Quantitative Approaches*. London: Sage.
- Berlin, I. (1979) *Russian Thinkers*. London: Penguin.
- Bhaskar, R. (1998) 'General Introduction', in M. Archer *et al.* (eds), *Critical Realism: Essential Readings*. London: Routledge.
- Bloch, E. (1973) 'The Meaning of Utopia', in M. Solomon (ed), *Marxism and Art: Essays Classic and Contemporary* (pp. 578-582). New York: Alfred A. Knopf.
- Boggs, C. (1976) *Gramsci's Marxism*. London: Pluto Press.
- Boon, S.D. & Lomore, C.D. (2001) Admirer-Celebrity Relationships Among Young Adults. Explaining Perceptions of Celebrity Influence on Identity, *Human Communication Research* 27(3): 432-465.

- Boswell, T.E., Kiser, E.V. & Baker, K.A. (1999) Recent Developments in Marxist Theories of Ideology, *Critical Sociology*, 25(2): 358-383.
- Bottomore, T. (ed), (1983) *A Dictionary of Marxist Thought*. Oxford: Blackwell.
- Boudon, R. (1989) *The Analysis of Ideology*. Cambridge: Polity.
- Brownell, W. C. (1914) *Criticism: An Essay on Function, Form and Method*. Port Washington, N. Y.: Kennikat Press.
- Burbules, N.C. (1992) Forms of Ideology-Critique: A Pedagogical Perspective, *International Journal of Qualitative Studies in Education*, 5(1): 7-17.
- Burchell, G., Gordon, C. & Miller P. (eds), (1991) *The Foucault Effect: Studies in Governmentality*. London: Harvester Wheatsheaf.
- Butler, R. (2005) *Slavoj Žižek: Live Theory*. London: Continuum International Publishing Group.
- Carey, M. (2012) *Qualitative Research Skills for Social Work: Theory and Practice*. Burlington, VT: Ashgate.
- Cassidy, J. (1997, Oct. 3) The Return of Karl Marx, *The New Yorker*, 20-27.
- Cave, D. (1983) Working-class Education: The Nature and Role of 'the Intellectual' in the Writings of Antonio Gramsci, *Critical Studies in Education*, 25(1): 145-168.
- Cazamian, L. (1929) *Criticism in the Making....* New York: Macmillan.
- Confino, M. (1972) On Intellectuals and Intellectual Traditions in Eighteenth- and Nineteenth-Century Russia, *Daedalus*, 101 (2): 117-149.
- Cormack, M. (1992) *Ideology*. Ann Arbor, Michigan: The University of Michigan Press.
- Coser, L. (1965) *Men of Ideas: A Sociologist's View*. London: Free Press.
- Currie, R. (1974) *Genius: An Ideology in Literature*. London: Chatto and Windus.
- Demick, B. (2010) *Nothing to Envy: Real Lives in North Korea*. London: Granta.

- Derfler, L. (2002) *The Dreyfus Affair*. Westport, Conn.: Greenwood.
- Dow, D.R. (2011) *The Autobiography of an Execution*. New York: Grand Central Publishing.
- Durham and, M.G. & Kellner, D.M. (2001) 'Introduction', in M.G. Durham & D.M. Kellner (Eds), *Media and Cultural Studies: Keywords* (pp. 1-9). Oxford: Blackwell Publishers.
- Eagleton, T. (1976) *Marxism and Literary Criticism*. London: Methuen.
- Eagleton, T. (1978) *Criticism and Ideology: A Study In Marxist Literary Theory*. London: Verso Editions.
- Eagleton, T. (1991, 2007) *Ideology: An Introduction*. London: Verso.
- Elliot, G. (ed) (1994) *Althusser: A Critical Reader*. Oxford: Blackwell.
- Engels, F. (1976) *Ludwig Feuerbach and the End of Classical German Philosophy*. Peking: Foreign Languages Press.
- Ennis, R. H. (1987) 'A Taxonomy of Critical Thinking Dispositions and Abilities', in J.B. Baron & R.J. Sternberg (eds), *Teaching Thinking Skills: Theory and Practice* (pp. 9-26). New York: W. H. Freeman.
- Fairclough, N. & Wodak, R. (1997) 'Critical Discourse Analysis', in T. van Dijk (ed) *Discourse as Social Interaction* (pp. 258-84). London: Sage.
- Fairclough, N. (1992a) Discourse and Text: Linguistic and Intertextual Analysis, *Discourse & Society*, 3(2):193-217.
- Fairclough, N. (1992b) 'Michel Foucault and the Analysis of Discourse', in N. Fairclough, *Discourse and Social Change* (pp. 37-61). Cambridge: Polity Press.
- Fairclough, N. (1995) *Critical Discourse Analysis: The Critical Study of Language*. London: Longman.
- Femia, J.V. (1981) *Gramsci's Political Thought: Hegemony, Consciousness, and the Revolutionary Process*. Oxford: Clarendon.

- Festenstein, M. & Kenny, M. (eds), (2005) *Political Ideologies: A Reader and Guide*. Oxford: Oxford University Press.
- Fiske, J. (1989) *Understanding Popular Culture*. London: Unwin Hyman.
- Fiske, J. (1990) *Introduction to Communication Studies* (2nd Ed.). London: Routledge.
- Florian Henckel von Donnersmarck, (Director) (2006) *The Lives of Others (Das Leben der Anderen)* Arte.
- Foucault, M. (1978) *The History of Sexuality, Vol. 1*. New York: Pantheon Books.
- Foucault, M. (1980) *Power/knowledge: Selected Interviews and Other Writings, 1972-1977*. Harlow: Pearson Education.
- Foucault, M. (1991a) *Discipline and Punish: The Birth of the Prison*. London: Penguin.
- Foucault, M. (1991b) *The Foucault Reader*. London: Penguin.
- Foucault, M. (1997) *Ethics: Subjectivity and Truth*. London: Allen Lane.
- Foucault, M. (1998) *The History of Sexuality. Vol. 1, The Will to Knowledge*. London: Penguin.
- Foucault, M. (2002) *The Order of Things: An Archaeology of the Human Sciences*. London: Routledge,
- Fowler, R. & Kress, G. (1979) 'Critical linguistics', in R. Fowler, B. Hodge, G. Kress & T. Trew (eds), *Language and Control* (pp. 185-213). London: Routledge.
- Fowler, R. (1979) *Language and Control*. London: Routledge and Kegan Paul.
- Freeden, M. (2003) *Ideology: A Very Short Introduction*. Oxford: Oxford University Press.
- Freeden, M. (2006) Ideology and Political Theory, *Journal of Political Ideologies*, 11(1): 3-22.
- Furedi, F. (2004) *Where Have All the Intellectuals Gone?: Confronting 21st Century Philistinism*. London: Continuum.

- Gaarder, J. (1996) *The Solitaire Mystery*. London: Phoenix House.
- Galtung, J. (2002) The Role of the Intellectual—An Excursion into Self-Criticism, *Higher Education in Europe*, 27(1): 59-63.
- Gerring, J. (1997). Ideology: A definitional analysis. *Political Research Quarterly*, 50(4), 957-994.
- Geuss, R. (1981) *The Idea of A Critical Theory: Habermas and the Frankfurt School*. Cambridge: Cambridge University Press.
- Giddens A. (1981) *A Contemporary Critique of Historical Materialism*. London: Macmillan.
- Giddens A. (1984) *The Construction of Society*. Cambridge: Policy.
- Glaser, B. G. & Strauss, A. L. (1967) *The Discovery of Grounded Theory: Strategies for Qualitative Research*. New York: Aldine de Gruyter.
- Gramsci, A. (1971) *Selections from the Prison Notebooks of Antonio Gramsci*. London: Lawrence and Wishart.
- Grbich, C. (2007) *Qualitative Data Analysis: An Introduction*. London: Sage.
- Grossberg, L. (1996) 'On Postmodernism and Articulation: An Interview with Stuart Hall', in D. Morley, & K.H. Chen (eds), *Stuart Hall: Critical Dialogues in Cultural Studies* (pp. 131-150). London: Routledge.
- Habermas, J. (1979) *Communication and the Evolution of Society*. London: Heinemann.
- Habermas, J. (1984) *The Theory of Communicative Action, Vol.1: Reason and the Rationalization of Society*. London: Heinemann.
- Hall, S. (1982) 'The Rediscovery of 'Ideology': Return of the Repressed in Media Studies', in M. Curevitch, T. Bennett, J. Curran & J. Woollacott (eds), *Culture, Society and the Media* (pp. 56-90). London: Methuen.
- Hall, S. (1985) Signification, representation, ideology: Althusser and the Post- structuralist Debates. *Critical Studies in Mass Communication*. 2(2): 91-114.

- Hall, S. (2004) 'Encoding/Decoding', in M.G. Durham & D. Kellner (eds), *Media and cultural studies: Keywords* (pp: 166-176). Oxford: Blackwell Publishers.
- Hawkes, D. (2003) *Ideology*. London: Routledge.
- Hay, C. & Wincoot, D. (1998) Structure, Agency and Historical Institutionalism, *Political Studies*, 46: 951-975.
- Hay, C. (1995) 'Structure and Agency', in D. Marsh & G. Stoker (eds), *Theory and Methods in Political Science* (1st Ed) (pp 189-206). Basingstoke: Macmillan.
- Hay, C. (1995) Mobilisation through Interpellation: James Bulger, Juvenile Crime and the Construction of a Moral Panic, *Social and Legal Studies*, 4 (2): 197-224.
- Hay, C. (1999) What Place for Ideas in the Structure-Agency Debate? Globalisation as a 'Process Without a Subject', Paper presented at the annual conference of the British International Studies Association.
- Hay, C. (2002) *Political Analysis*. Basingstoke: Palgrave.
- Hay, C. (2007) Does Ontology Trump Epistemology? Notes on the Directional Dependence of Ontology and Epistemology in Political Analysis, *Politics*, 27(2): 115-118.
- Hay, C. (2007). *Why We Hate Politics*. Cambridge: Polity.
- Hay, C. (2009), King Canute and the 'Problem' of Structure and Agency: On Times, Tides and Heresthetics, *Political Studies*, 57: 260-279.
- Hazareesingh, S. (1994) *Political Traditions in Modern France*. Oxford: Oxford University Press.
- Heidegger, M. (1997) *Plato's Sophist* (Trans. by R. Rojcewicz & A. Schuwer). Bloomington: Indiana University Press.
- Heinlein, R. A. (1956) *Time for the Stars*. London: Pan Books Ltd.
- Held, D. (1980) *Introduction to Critical Theory: Horkheimer to Habermas*. London: Hutchinson.

- Hernadi, P. (ed) (1981) *What Is Criticism?* Bloomington: Indiana University Press.
- Hodge, B. & Fowler, R. (1979) 'Orwellian Linguistic', in R. Fowler, B. Hodge, G. Kress & T. Trew (eds), *Language and Control* (pp.6-25). London: Routledge.
- Hodge, B., Kress, G. & Jones, G. (1979) 'The Ideology of Middle Management', in R. Fowler, B. Hodge, G. Kress & T. Trew (eds), *Language and Control* (pp.81-93). London: Routledge.
- Horkheimer, M. & Adorno, T.W. (2002) *Dialectic of Enlightenment: Philosophical Fragments*. Stanford: Stanford University Press.
- Horkheimer, M. (1972) *Critical Theory: Selected Essays*. New York: Herder & Herder.
- Howarth, D. & Stavrakakis, Y. (2000) 'Introducing Discourse Theory and Political Analysis', in D. Howarth & A.J. Norvai, *Discourse Theory and Political Analysis*. Manchester: Manchester University Press.
- Howarth, D.R. (2000) *Discourse*. Buckingham: Open University Press.
- Huaco, G. A. (1971) On Ideology, *Acta Sociologica*, 14 (4): 245-255.
- Hunt, A. & Wickham, G. (1994) *Foucault and Law: Towards a Sociology of Law as Governance*. London: Pluto Press.
- Hyland, K. (2009) *Academic Discourse*. London : Continuum.
- Jacoby, R. (2000) *The Last Intellectuals: American Culture in the Age of Academe*. New York: Noonday Press.
- Jay, M. (1984) *Adorno*. London: Fontana.
- Jay, M. (1996) *The Dialectical Imagination: A History of the Frankfurt School and the Institute of Social Research*. Berkeley: University of California Press.
- Jennings, J. & Kemp-Welch. T. (1997) 'The Century of the Intellectual: From the Dreyfus Affair to Salman Rushdie', in J. Jennings & T. Kemp-Welch (eds), *Intellectuals in Politics: From the Dreyfus Affair to Salman Rushdie* (pp. 1-24). New York: Routledge.

- Jennings, J. (1997) 'Of Treason, Blindness and Silence: Dilemmas of the Intellectual in Modern France', in J. Jennings & T. Kemp-Welch (eds), *Intellectuals in Politics: From the Dreyfus Affair to Salman Rushdie* (pp. 65-88). New York: Routledge.
- Jessop, B. (1990) *State Theory: Putting Capitalist States in Their Place*. Cambridge: Policy.
- Jewitt, C. & Oyama. (2001) 'Visual Meaning: A Social Semiotic Approach', in T. Van Leeuwen & C. Jewitt (eds), *Handbook of Visual Analysis* (pp. 92-118). London: Sage.
- Johnson, P. (1988) *Intellectuals*. London: Weidenfeld & Nicolson.
- Jones, G. S. (1977) 'The Marxism of the Early Lukacs', in G.S. Jones (ed), *Western Marxism: A Critical Reader* (pp. 11-60). London: NLB.
- Kant, I. (2009) *An answer to the Question "What is Enlightenment?"* (Trans. by H.B. Nisbet). London: Penguin.
- King, R.H. (2006) Introducing Intellectual History, *Culture, Theory and Critique*, 47(1): 1-6.
- Knox, J. (1953) *Criticism and Faith*. London: Hodder & Stoughton.
- Kress, G. (1990) Critical Discourse Analysis, *Annual Review of Applied Linguistics*, 11: 84-99.
- Kress, G. and Van Leeuwen, T. (2002) Colour as a Semiotic Mode: Notes for a Grammar of Colour, *Visual Communication* 1(3): 343-368.
- Kress, G., & Van Leeuwen, T. (1996) *Reading Images: The Grammar of Visual Design*. London: Routledge.
- Kubrick, S. (Director) (1968) *2001: A Space Odyssey*. Metro-Goldwyn-Mayer (MGM).
- Laclau, E. & Mouffe, C. (2001) *Hegemony and Socialist strategy: Toward a Radical Democratic Politics* (2nd Ed). New York: Verso.
- Larrain, J. (1983) *Marxism and Ideology*. London: Macmillan.

- Larrain, J. (1988) 'Lukacs' Concept of Ideology', in T. Rockmore (ed), *Lukács Today: Essays in Marxist Philosophy*. Dordrecht, Lancaster: D. Reidel Publishing Company.
- Larrain, J. (1991) Stuart Hall and the Marxist Concept of Ideology, *Theory Culture Society*, 8 (1): 1-28.
- Larrain, J. (1994) *Ideology and Cultural Identity: Modernity and the Third World Presence*. Cambridge: Polity Press.
- Lash, S. (1990) 'Coercion as ideology: The German Case', in N. Abercrombie, S. Hill, & B.S. Turner (eds) (1990) *Dominant Ideologies*. London: Unwin Hyman.
- Lee, Z. (2013) *Mao Zedong* (Chinese Version). Beijing: China Measure Publishing House.
- Lilienfeld, R. (1978) *The Rise of Systems Theory: An Ideological Analysis*. Chichester: Wiley.
- Lilla, M. (2001) *The Reckless Mind: Intellectuals in Politics*. New York: New York Review Books.
- Longman dictionary of contemporary English (2003) Harlow: Pearson Education Ltd.
- Lukacs, G. (1971) *History and Class Consciousness: Studies in Marxist Dialectics*. London: Merlin Press.
- Lukes, S. (1974, 2005) *Power: A Radical View*. Basingstoke: Palgrave Macmillan.
- Macfarlane, B. (2011) Professors as intellectual leaders: formation, identity and role, *Studies in Higher Education*, 36(1): 57-73.
- Macherey P. (1978) *A Theory of Literary Production* (Trans. G. Wall). London: Routledge and Kegan Paul.
- Machin, D. (2004) Building the World's Visual Language: The Increasing Global Importance of Image Banks in Corporate Media, *Visual Communication*, 13(3): 316-336.
- Machin, D. (2007) *Introduction to Multimodal Analysis*. London: Arnold.
- Machin, D. (2010) *Analysing Popular Music: Image, Sound, Text*. London: Sage.

- Mannheim, K. (1936, 1991) *Ideology and Utopia: An Introduction to the Sociology of Knowledge*. London: Routledge and Kegan Paul.
- Marcuse, H. (1964, 1991) *One-dimensional Man: Studies in the Ideology of Advanced Industrial Society*. London: Routledge.
- Marcuse, H. (1969a) *Eros and Civilization: A Philosophical Inquiry into Freud*. London: Allen Lane.
- Marcuse, H. (1969b) *An Essay on Liberation*. London: Allen Lane.
- Marcuse, H. (1978) *The Aesthetic Dimension Toward a Critique of Marxist Aesthetics*. Boston: Beacon Press.
- Markus, G. (1982) Alienation and Reification in Marx and Lukacs, *Thesis Eleven*, 5(6): 139-161.
- Marshall, P.D. (1997) *Celebrity and Power: Fame in Contemporary Culture*. London: University of Minnesota Press.
- Marx, K. & Dragstedt, A. (1976) *Value: Studies by Marx*. New York: New Park Publications.
- Marx, K. & Engels, F. (1934) *Karl Marx and Friedrich Engels, Correspondence 1846-1895: A selection with Commentary and Notes*. (Trans. Dona Torr). London: M. Lawrence.
- Marx, K. & Engels, F. (1970) *The German Ideology*. London: Lawrence & Wishart.
- Marx, K. & Engels, F. (1982) '201: Marx to Engels', in *Karl Marx, Frederick Engels: Collected Works, vol. 38, Marx and Engels: 1844-1851* (pp. 422-425) (Trans. Peter and Betty Ross). NY, New York: International Publishers.
- Marx, K. & Engels, F. (2009) *The Communist Manifesto*. London: Monthly Review Press.
- Marx, K. (1955) *The Poverty of Philosophy: Answer to the "Philosophy of Poverty" by M. Proudhon*. Moscow: Progress.
- Marx, K. (1957) *The Holy Family, or, Critique of Critical Critique*. London: Lawrence & Wishart.

- Marx, K. (1963) *The Eighteenth Brumaire of Louis Bonaparte*. New York: International Publications.
- Marx, K. (1970) *Economic and Philosophic Manuscripts of 1844*. London: Lawrence & Wishart.
- Marx, K. (1971) *A Contribution to the Critique of Political Economy*. London: Lawrence & Wishart.
- Marx, K. (1976) *Capital: A Critique of Political Economy, Vol.1*. London: New Left Review.
- Marx, K. (1992) 'On the Jewish Question', in *Early Writings* (pp. 211-242). London: Penguin.
- Marx, K., Engels, F. & Raddatz, F. J. (1981) *Karl Marx Friedrich Engels: Selected Letters, the Personal Correspondence*. Boston: Little, Brown & Company.
- McInnes, N. (1972). *The Western Marxists*. London: Alcove Press.
- McKerrow, R.E. & St. John, J. (2006) Review Essay: The Public Intellectual and the Role(s) of Criticism, *Quarterly Journal of Speech*, 92(3): 310-319.
- McLellan, D. (1995) *Ideology* (2nd Ed) Buckingham: Open University Press.
- Milner, A. & Eagleton, T. (1985) Criticism and ideology: Andrew Milner interviews Terry Eagleton, *Thesis Eleven*, 12: 130-144.
- Montag, W. (2003) *Louis Althusser*. Basingstoke: Palgrave Macmillan.
- Mullins, W. A. (1972) On the Concept of Ideology in Political Science, *The American Political Science Review*, 66(2): 498-510.
- Nairn, T. (1982) 'Antoniu Su Gobbu', in A. S. Sassoon (ed), *Approaches to Gramsci* (pp. 159-179). London: Writers and Readers Publishing Cooperative Society Ltd.
- New left review (ed), (1977) *Western Marxism: A Critical Reader*. London: NLB.
- Nietzsche, F. (1996) *Human, All too Human*. Cambridge: Cambridge University Press.

- O'Sullivan, T. (1983) *Key Concepts in Communication*. London: Methuen.
- Oakley, A. (1983) *The Making of Marx's Critical Theory: A Bibliographical Analysis*. Publisher: Routledge & Kegan Paul.
- Otto, B. K. (2001) *Fools are Everywhere: The Court Jester Around the World*. Chicago: University of Chicago Press.
- Panofsky, E. (1955) *Meaning in the Visual Arts: Papers in and on Art History*. Garden City, NY: Doubleday Anchor Books.
- Parekh, B. C. (1982) *Marx's Theory of Ideology*. London: Croom Helm.
- Parkinson, G.H.R. (ed), (1970) *Georg Lukács: The Man, His Work and His Ideas*. London: Weidenfeld & Nicolson.
- Pipes, R. (1974) *Russia Under the Old Regime*. London: Weidenfeld & Nicolson.
- Plamenatz, J. (1970) *Ideology*. London: Pall Mall P.
- Popper, K. (1996) 'Toleration and Intellectual Responsibility', in *In Search of A Better World: Lectures and Essays From Thirty Years* (pp. 188-203 Trans. Laura J. Bennett). London: Routledge.
- Posner, R.A. (2002) *Public Intellectuals: A Study of Decline*. Cambridge, MA: Harvard University Press.
- Pratten, S. (1993) Structure, Agency and Marx's Analysis of the Labour Process, *Review of Political Economy*, 5(4): 403-426.
- Professor of Germany (1919) To the Civilized World, *North American Review*, Vol. 210: 284-287.
- Purvis, T. & Hunt, A. (1993) Discourse, Ideology, Discourse, Ideology, Discourse, Ideology..., *The British Journal of Sociology*, 44(3): 473-499.
- Radder, H. (2010) *The Commodification of Academic Research: Science and the Modern University*. Pittsburgh, Pa.: University of Pittsburgh Press.

- Ransome, P. (1992) *Antonio Gramsci : A new Introduction*. London: Harvester Wheatsheaf.
- Richter, G. & Adorno, T. W. (2002) Who's Afraid of the Ivory Tower? A Conversation with Theodor W. Adorno. *Monatshefte*, 94(1): 10-23.
- Robert, H. B. & Kress, G. (1988) *Social Semiotics*. Cambridge: Polity Press.
- Robert, P. (2006) *Ideology: Contemporary Social, Political and Cultural Theory*. Cardiff: University of Wales Press.
- Rojek, C. (2001) *Celebrity*. London: Reaktion.
- Rooke, R. (1995) The Contemporary Debate on the Role of the Intellectual and the Media, *Contemporary Politics*, 1(4): 109-124.
- Rose, G. (1978) *The Melancholy Science: An Introduction to the Thought of Theodor W. Adorno*. New York: Columbia University Press.
- Rosen, C. (1997) *The Classical Style: Haydn, Mozart, Beethoven*. London: Faber.
- Russell, B. (1946) *History of Western Philosophy and Its Connection with Political and Social Circumstances from the Earliest Times to the Present Day*. London: Allen and Unwin.
- Sahin, H. (1980) The Concept of Ideology and Mass Communication Research, *Journal of Communication Inquiry*, 6(1): 3-15.
- Said, E. W. (1994) *Representations of The Intellectual: The 1993 Reith Lectures*. London: Vintage.
- Salamini, L. (1974) Gramsci and Marxist Sociology of Knowledge: An Analysis of Hegemony-Ideology-Knowledge, *The Sociological Quarterly* 15 (Summer): 359-380.
- Schaff, A. (1976) *History and Truth*. London: Pergamon Press.
- Schweppenhäuser, G. (2009) *Theodor W. Adorno: An Introduction* (Trans. Rolleston, J.) London: Duke University Press.

- Selden, R. (Ed.) (1988) *The Theory of criticism: From Plato to the Present*. London: Longman.
- Seliger, M. (1977). *The Marxist Conception of Ideology: A Critical Essays*. Cambridge: Cambridge University Press.
- Shakespeare, W. (2004) *Hamlet*. Logan, Iowa: Perfection Learning Corporation.
- Shakespeare, W. (2008) *Twelfth Night, Or What You Will*. London: Arden Shakespeare.
- Simon, P. & Garfunkel, A. (1964) 'The Sounds of Silence,' *Wednesday Morning, 3 AM*. New York: Columbia Records.
- Strinati, D. (2004) *An Introduction to Theories of Popular Culture*. London: Routledge.
- Sturrock, J. (2003) *Structuralism* (2nd Ed). Oxford: Blackwell.
- Suchting, W. A. (1983) *Marx: An Introduction*. Brighton: Wheatsheaf.
- Thompson, E. P. (1991) *The Making of the English Working Class*. London: Penguin.
- Thompson, J. B. (1984) *Studies in the Theory of Ideology*. Cambridge: Polity.
- Thompson, J. B. (1990) *Ideology and Modern Culture: Critical Social Theory in the Era of Mass Communication*. Cambridge: Polity.
- Trew, T. (1979) 'What the Paper Say': Linguistic Variation and Ideological Difference , in R. Fowler, B. Hodge, G. Kress & T. Trew (eds), *Language and Control* (p.117-156). London: Routledge.
- Van Dijk, T.A. (2006) Ideology and Discourse Analysis, *Journal of Political Ideologies*, 11 (2): 115-140.
- Van Leeuwen, T. (2001) 'Semiotics and Iconography', in T. Van Leeuwen & C. Jewitt (eds), *Handbook of Visual Analysis* (pp. 92-118). London: Sage.
- Van Leeuwen, T. (2005) Typographic Meaning, *Visual Communication*, 4(2): 137-143.

- Walzer, M. (2002) *The Company of Critics: Social Criticism and Political Commitment in the Twentieth Century*. New York: Basic Books.
- Wander, P. (1983) The Ideological Turn In Modern Criticism, *Central States Speech Journal*, 34(1): 1-18.
- When, F. (2006) *Marx's Das Kapital: A Biography*. London: Altantic Books.
- Whiteside, K. H. (1989) Review: The Company of Critics: Social Criticism and Political Commitment in the Twentieth Century. *Political Theory*, 17(4): 689-692.
- Wiggershaus, R. (1994) *The Frankfurt School: Its History, Theories and Political Significance*. Cambridge: Polity Press.
- Williams, R. (1976) *Keywords: A Vocabulary of Culture and Society*. New York: Oxford University Press.
- Wilson, E. (1972) *To the Finland Station: A Study in the Writing and Acting of History*. London: Macmillan.
- Wimmer, K. (Director) (2002) *Equilibrium* . Dimension Films.
- Wittgenstein, L. (2003) *Tractatus Logico-Philosophicus*. New Tork: Barbes & Noble Publishing, Inc.
- Wolff, J. (2002) *Why Read Marx Today?* Oxford: Oxford University Press.
- Wu, G. (2008) *Spectres of Love and Death: Six Essays on the Critique of Ideology* (Chinese Version). Jilin, China: Jilin Publish. (English Version: Wu, G. (2008) *Spectres of Love and Death: Six Essays on the Critique of Ideology*. Ph.D. Thesis: Monash University, Australia.)
- Žižek, S. & Daly, G. (2004) *Conversations with Žižek*. Oxford: Polity.
- Žižek, S. (1989) *The Sublime Object of Ideology*. London: Verso.
- Žižek, S. (1991) *Looking Awry: An Introduction to Jacques Lacan Through Popular Culture*. Cambridge, Mass.: MIT Press.

- Žižek, S. (1993) *Tarrying with the Negative: Kant, Hegel, and the Critique of Ideology*. Durham [N.C.]: Duke University Press,
- Žižek, S. (1994) 'Introduction: The Spectre of Ideology', in S. Žižek (ed) *Mapping Ideology* (pp. 1-33). London: Verso.
- Žižek, S. (1994) 'Is There A Cause of the Subject', in J. Copjec (ed), *Supporting the Subject* (pp. 84-105). London: Verso.
- Žižek, S. (1994) *Mapping Ideology*. London: Verso.
- Žižek, S. (1999) *The Ticklish Subject: The Absent Centre of Political Ontology*. London: Verso.
- Žižek, S. (2001) *On belief*. London: Routledge.
- Žižek, S. (2009) *The Plague of Fantasies*. London: Verso.
- Žižek, S. (2012) *Don't Act. Just Think*. Retrieved January 23th, 2013 from <http://bigthink.com/ideas/45126>

Appendices

Appendix 1: Disk of 33 IAC Articles	321
Appendix 2: Scholars' Preference Regarding the Roles of Intellectuals	322
Appendix 4-1: Basic Concepts of Textual Analysis	3233
Appendix 4-2: Basic Concepts of Iconographical, Colour, Typographical Analysis	3266
Appendix 5-1: Power.....	329
Appendix 5-2: Reality	333
Appendix 8: Selecting Expression Styles.....	337

Appendix 1: Disk of 33 IAC Articles

Click the following link to start.

If the link fails, please contact Liao729@gmail.com for the research data.

<http://goo.gl/N67NmQ>

Appendix 2: Scholars' Preference Regarding the Roles of Intellectuals

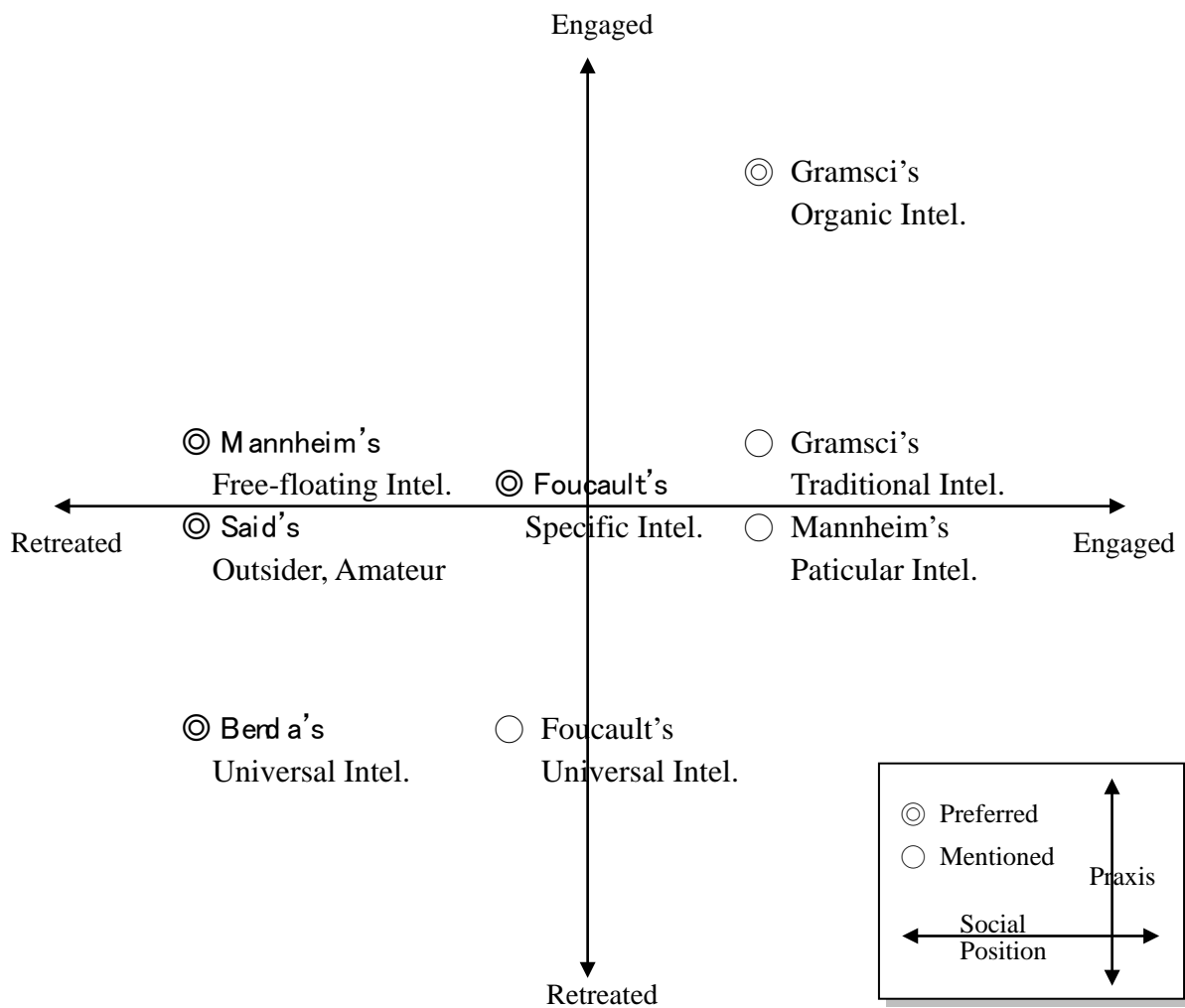

Appendix 4-1: Basic Concepts of Textual Analysis

1. Sentence Analysis: Subject + Verb + Object + Indefinite/Definite Article + Adjective + Noun + Adverb + Adverb of Time + Punctuation Marks

Subject

Notions	Explanation
With or Without a Definite Subject	Shows to what extent the author is engaged in the context (Hodge & Fowler, 1979)
Use of Subject, Pronoun, and Singular/Plural Nouns	Indicates proximity/distance and directness/indirectness (Fowler & Kress, 1979) E.g., I: can be indicated as a witness to show authenticity. E.g., We: 1. The author indicates himself as well as others. 2. Refers to a broader range in order to persuade others. E.g., Usage of 'You' in academia is often deemed as meaning 'we'; for example, Will you still believe this government? = Will we still...?. 'You' is adopted to create an 'us' asking readers to agree.
No Subject, Virtual Subject, Noun Clause	Highlights what the author wants to emphasise (Fowler & Kress, 1979)
Appellation	Indicates the power relationship between the authors and their referred audiences (e.g., the differences between "Mrs. Thatcher", "Baroness Thatcher" and "Prime Minister Thatcher").

Verb

Notions	Explanation
Passive Voice	Eliminates the agents and their responsibility in order to make the sentence appear neutral Decreases the imperative feeling (Fowler & Kress, 1979; Trew, 1979)
Passivisation	Conceals agents and their responsibility (Fowler & Kress, 1979)
Auxiliary Verb	Signals the power relationship between author and reader (e.g., usage of <i>must/might</i>) (Fowler & Kress, 1979)

Object

Notions	Explanation
With or Without a Definite Object	Demonstrates the author's attitude toward his/her research objects (Fowler & Kress, 1979)
Pluralisation	Prevents agents from feeling they are being offensive; Builds up the speaker's power imperceptibly and eliminates distance and alienation (Fowler & Kress, 1979)

Indefinite / Definite Articles

Notions	Explanation
---------	-------------

The	Refers to specific objects
-----	----------------------------

Adjectives

To strengthen authors' attitudes and to display authors' positions
--

Nouns

Notions	Explanation
Nominalization	Replaces adjectives and reduces the usage of describing words in order to decrease the embarrassment of described agents (Fowler & Kress, 1979) Diminishes the presence of actors and their responsibility (Fowler & Kress, 1979)

Adverb

Describe the adjective. E.g., stress the degree; for example, <i>possibly, certainly, necessarily</i> . (Fowler & Kress, 1979)
--

Adverb of Time

E.g., future tense can result in an effect of hinting at and predicting the future (Fowler & Kress, 1979)

Punctuation Marks

Marks	Original meanings	Ideological function or Connotation
Question ?	to show that something is not certain (Oxford, online*)	1. By pointing out a question (instead of directly claiming what is wrong), question sentence could create a neutral image. 2. Asking question is not to ask readers to suspect, but to already display a certain position. E.g., writing 'The end of Ideology' + '?' to pretend neutrality; in fact, what the authors are trying to say is 'it is' the end of ideology.
Exclamation !	to express surprise, anger, or excitement (Longman**, p. 541).	1. to increase the readers' sentimental resonance in order to interpellate them as the subject of such a sentence. 2. To create an imperative order, 3. To invisibly question/disagree with the previous.
Colon :	to introduce an explanation, example, quotation (Longman , p. 295).	1. to add extra information (on the surface); 2 to require readers to pay attention to the following sentence.
Dash —	to separate two closely related parts of a sentence (Longman, pp. 396-7).	1. to add extra information (on the surface); 2 to require readers to pay attention to the following sentence.
Bracket ()	placed around extra information in a piece of writing (Oxford, online).	On the surface to add information or explanation, in fact, it is to lead readers to read, to comprehend such a sentence the way the writers wish.
Quotation “ ”	To show that you are recording what someone has said (Longman, p. 1347).	1. Quotation is used to obtain credit and acknowledgement for writers themselves. 2. To guide readers to what should be focused on.

*The Oxford Advanced Learner’s Dictionary (online). <http://oald8.oxfordlearnersdictionaries.com/>

**Longman dictionary of contemporary English (2003). Harlow: Pearson Education Ltd.

2. Modal Form Analysis

This refers to the interpersonal relationship between authors and readers, which also demonstrates the authors’ attitudes toward their imagined objectives (e.g., usage of the words *obligation, ability, possibility, necessary* and *expectation*; Fowler & Kress, 1979)

Notions	Explanation
Modal Verbs	To indicate authors’ modality, including permission, prediction, suggestion, etc. (e.g., <i>can, should, will, must, may.</i>)
Modal Process Verbs	To point out the start and the end of an action that creates a certain result (e.g., <i>find, meet, graduate, etc.</i>)
Others: Modal Particles, Distancing Devices, Stalling and Hesitation, Hypothetical Forms (Hodge, Kress & Jones, 1979)	

3. Other Concepts related to Textual Analysis

Notions	Explanation
Selection of Vocabulary	To imply the standpoints of the author (e.g., when talking about the issue of races, the vocabulary the author selects to describe the white or the black is diverse from the usage of vocabulary)
Classification	Applies categorisation to determine the order and rules of the sentence (e.g., relexicalisation: looking for the old vocabulary that the author replaces with a new meaning, and seeing how the neologism is being used) (e.g., overlexicalisation: discover the connotative ideology by using a sequence of synonyms (Trew, 1979)
Neutralisation	To provide a responsibility-free zone for the authors (e.g., unfairness is neutralized and cast as only a matter of “difference”)
Articulation	To investigate how a single word is linked to a certain concept to establish a specific meaning (e.g., the word <i>democracy</i> possesses diverse meanings within the diverse circumstances of capitalism and communism)
Mood	Declarative sentences: refer to the meaning of a declaration, persuasion and propagation Imperative sentences: signify authors’ imperative voice, which also displays their views of power
Negative-raising	Using double-negatives to stress the authors’ viewpoint
Jargon	To raise the discussion barrier and to isolate outsiders, which can empower the authors (Fowler & Kress, 1979)
Relexicalisation	Relexicalisation is a way to produce jargon. It will create monopolized terminologies which are for internal use only.
Viewpoint of Process	To discover the developing process of happenings (e.g., begin continue, repeat, end)

Appendix 4-2: Basic Concepts of Iconographical, Colour, Typographical Analysis

First of all, meanings conveyed by icons, colours, or types do not come from nothing; instead, they require historical accumulation, (Kress & Van Leeuwen, 2002; Van Leeuwen, 2005) which also varies from one culture to another and from time to time (Machin, 2007). For example, the gesture of people lifting their hats is a greeting originating in Medieval times when knights took off their helmets in order to prove their goodwill (Machin, 2007; Panofsky, 1955; Van Leeuwen, 2001); yellow can mean sunny, but in some cultures, it refers to sickness, as when people have a liver disease (Kress & Van Leeuwen, 2002). Hence, what should be noticed is that the inductive concepts listed below only offer a general perspective, because the meaning that visual factors convey depends on the condition ‘from text to context’.

1. Iconographical Analysis

“The study of iconographical symbolism means that we look for the way that certain objects, poses, gestures or other elements in a visual composition represent people, values or ideas.” (Machin, 2007, p. 39).

Concepts	Explanation / Function	Examples
Poses	To imply specific significance (Machin, 2010; 2007; 2004)	Jumping with arms or legs out wide signifies youth and freedom. Standing straight with arms-across signifies confidence and professionalism.
Gaze	A part of posing. To fulfill two opposite works: offer and demand (Kress & van Leeuwen, 1996)	Advertising stars gaze at audiences to offer information, services, or goods. Kids in a war look at photographer to demand information, services, or goods. (Machin, 2010)
Objects	Objects means the visible things placed in images. Each object, e.g., horse, car, train, has their own significance. Even the same category of object with various forms signifies differently, e.g, truck and sport-car. Implication of objects relies on the setting.	The thin lady, fluttering hairs, ‘round’ table, rotating pinwheel, waving skirt are all objects (compared to blue jeans and square tables) with specific setting to imply that the product is comfortable, relaxing, and a pleasure.
Settings	“To get general ideas across, to connote discourses and their values, identities and actions” (Machin, 2010, p. 45). The same background with diverse objects receives different significance. Setting results in idea of one image.	E.g., A sandy beach 1. + sunshine + palm tree + beers + surfers + bikini = leisurely and peaceful. 2. + dark clouds + broken ship + floatees = worrisome and fearful.



2. Colour Analysis

The study of colour is to investigate its language-like communicative functions including that of representation, interaction, and composition (Machin, 2007; Kress & Van Leeuwen, 2002; Jewitt & Oyama, 2001). Colours are able “to represent ideas...to convey moods and attitudes, and to create coherence within themselves” (Machin, 2010, p. 59).

Concepts	Explanation									Reference	
	Scale	Connotation / Explanation									
Brightness	rests on fundamental experiences.									Machin,2010, p. 62	
	Lightness	clarity	happy	curing	life	good	secrecy	truth	reason		
	Darkness	obscurity	sadness	killing	death	evil	openness	lie	irrational		
Saturation (same colour)	rests on its ability to express emotional temperature.									Machin,2010, pp. 62-63	
	Pure	intensity of feeling		exuberant		playful	showy	garish	adventurous		
	Diluted (pale)	toned down, subdued		subtle, tender		moody	mild	lacking in energy			brooding
Purity	Purity and hybridity themselves suggest something of the meaning potential of this aspect of colour. E.g., green, brown, black (single name) versus cyan, blue-green, yellow green (names of colours).									Kress & Van Leeuwen, 2002	
	Purity	simplicity	certainty	In art: modernity (single pure, bright colour, e.g., blues)							Machin,2010, pp. 64-65
	Hybridity	ambiguity	complexity	postmodernism (colour scheme of pale, anaemic cyans and mauves)							
Modulation	refers to how ‘real’ a colour is with regard to the object on which it is presented, e.g., comparing the shade of cars in an advertisement with those found in the natural world.									Kress & Van Leeuwen, 2002	
	Modulated	subtle	fussy	detailed	complexity	paintings by Cézanne		perceptual truth			
	Flat	simple	basic	simplified	certain	by Matisse		abstract truth			
Differentiation	refers to the quantity of colour used in images (compared to ‘Purity’ which means the quality of colour used)									Machin,2010, pp. 66-67	
	Monochrome	restraint, classiness, timelessness, timidity				Conversely: old fashion, austerity, lacking energy					
	Palette	diversity, exuberance, energy, liveliness				Conversely: garish, crude, Lacking restraint					
For other colour concepts, such as luminosity and hue, see Machin, 2007; 2010, pp. 58-69; Kress & Van Leeuwen, 1996; 2002											

3. Typographical Analysis

Van Leeuwen (2005) argued that printed words not only have word-meanings but also have typographic meanings. Basically, typography possesses the same function as colour does; but, Machin (2007) emphasized that typographic meanings can be recognized only when “the letterforms are (1) combined with other features...and (2) used in a specific context” (p. 93). Namely, only through a comparison can the special typographic meanings appear.

Concepts	Explication Function / Connotation / Alternative perceived meaning	Examples	References
Weight	is about how bold or heavy a typeface appears. The function is to emphasize. Daring, assertive, solid, substantial / alter. meaning: timid, domineering, overbearing	Do not remove	Machin, 2010, p. 70
Expansion	is connected to human experience of space and how objects and people take up space. Make words' presence felt, be seen in a positive light, quick identification / free, confident, occupy.	EXAMPLE	Machin, 2010, p. 71
Connectivity	means to use 'letter forms' to create a relationship and a consistency and individuality which also helps to emphasize the purpose of such phrases. For example: WORDS ARE ALL CAPITALISED, or written like handwriting, or put further apart.		Machin, 2010, pp. 73-74
Typeface	provides readers with diverse perceptions based on experiential and cultural association. <i>Curvature</i> shows romantic, elegant, natural, or emotional. Roundness signifies smooth, soft, happiness, or youth. Angularity refers to abrasive, harsh, technical, or masculinity. <i>Slope or italic</i> implies personal, informal, organic, old, or permanent. Gothic provides quality, professional, classic, or solid.	as below	Machin, 2007; 2010, pp. 72-73
For other typographical concepts, such as orientation, regularity, and flourishes, see Machin, 2007; 2010, pp. 69-76; Van Leeuwen (2005);			

Appendix 5-1: Power

Style I: The visible or invisible power possessed by a certain group which directly constructs a reality for the other groups (in order to serve the former group’s interests).

Style II: The operation of power is displayed in the dominant and oppressed groups’ negotiating process.

Style III: The oppressed group clarifies the misunderstanding, resists the installed viewpoints, or fights for their power of interpretation.

Style IV: The operation of power does not obviously reveal or apply in IAC articles.

Research Article Number	Category
Explanation	
RA01	IV
This article does not clearly explain how the New Labour government constructs a certain ideology (e.g., toward an information age) to the people. The operation of power in this article is not discussed; if any, it invisibly reflects how their policies lead people to accept such ideology (the importance of being independent in the information age).	
RA02	I
This article clearly points out how U.K. media (falsely) presents the image of Islam which further constructs a (false) reality to its audiences. The operation of power in this article reflects, as the author suggests, the U.K. media’s news reports which were usually non-objective and taking certain sides.	
RA03	II
This article does not clearly explain how power works. This is a paper whose author fights for the power of interpretation (of Fukuzawa Yukichi’s notions) against Maruyama Masao. The author of RA03 argued that because Maruyama Masao was “the most prominent and influential political theorist of postwar Japan”, his illustration toward Fukuzawa Yukichi has become the only way of thinking for Japanese to understand Fukuzawa Yukichi’s political thought. That is to say, from the study of dominant ideology, Masao’s way of understanding Yukichi is the dominant ideology for those who want to study Yukichi. Although the author of RA03 criticised that Masao misunderstood Yukichi’s thoughts, this does not affect the fact that Masao’s way of understanding Yukichi is the dominant ideology for Japanese which has nothing to do with true or false (It is a misunderstanding only to the author of RA03).	
RA04	I
The operation of power in RA04 reflects how diet companies use media advertising (i.e., application of visible signs) to present/construct a certain image (i.e., ideology) for their product. Despite in different periods the purposes of advertisements are diverse (e.g., from fad dieting to healthy dieting), the diet companies constantly imbue the same ideology—dieting is important—which is indeed a dominant ideology to the customers. The diet companies apply visible signs or slogans to spread the invisible unidirectional power to the customers. To the author of RA04, the dominant ideology of “dieting is important” is negatively constructed by advertisements and never sincerely offers customers’ real need and benefits; instead, it only contributes to the diet companies’ interests.	
RA05	I
This article explains how media utilizes news report to present/construct a certain ideology. The operation of power here reflects the discipline of media editorial room (that is what the journalism called the “gatekeeper theory”).	
RA06	I
This article explains how news media (impeded by sport team’s invisible threat to their future news resources) constructs/presents an image of Joey Galloway as a wayward child, greedy, disloyal by their sport news (in which so-called power works). Such an image of demonizing Galloway is to	

sustain the authority of the sport team, its coach, and their vested authority.	
RA07	I
This article explains how the medical profession (the side who possesses power) continually constructs /presents a traditional image by their medical discourse that nursing is subject to the medical profession.	
RA08	II
The author of this article suggests that the 1998 National Curriculum is a product of conscious competition and negotiation fought by diverse interest groups. The operation of power reflects in how individuals and interest groups, who all possess different historical, social, and cultural background, together participate in the discussion and finally construct the legitimate curriculum knowledge (i.e., 1998 National Curriculum).	
RA09	IV
This article does not talk about how power operates or how power constructs reality. The author of this article adopts quantitative data (e.g., voting statistics) to show us where in the spectrum of political ideology (i.e., liberal, centrist, or conservative) these diverse factions of the Democrats party (i.e., Traditional Democrats, New Democrats, Blue Dogs) are located.	
RA10	I
The description of power operation in this article focuses on how George Will's editorials, which were published in the U.S. media, construct, praise, and strengthen a right-wing ideology. The author's argument focuses on the results (or the constructed reality) influenced by Will's power (i.e., his editorials).	
RA11	III
This article discusses how Islamic intellectuals internally fight for the power of interpretation of the reform of Islamic Law. Nevertheless, due to involvement of religion, their arguments usually become a reform plan influenced by particular ideologies. This is an article explaining how reformers—the intellectuals (in this case, not the dominated group)—attempt to fight for the power of interpretation to rethink Islamic Law which is against the original vested ideas (even though they usually failed).	
RA12	I
The first half of this article offers diverse interviewee's opinions regarding law. Power is not described here. The second half of this article discusses why the "Haves" come out ahead in which possessing power (e.g., having legal knowledge such as lawyers) is described as holding invisible tools to influence the judicial results. Namely, the analyst of this article adopts an interview method to investigate people who have legal experience in order to answer why people agree with such a (dominant) ideology that 'the Haves come out ahead'. The interviewees include the lawyers, the people who possess legal knowledge, the one who is capable of hiring lawyers, and the one who is not. Based on their experiences, the author of RA12 answered why 'the Haves come out ahead' is the dominant ideology when people think of legal activities.	
RA13	II
This article does not clearly point out how power is manipulated. Nevertheless, the author of this article implies an invisible process of power application. In this article, the operation of power is reflected in the government's promotion of certain policies (e.g., public assistance law & social insurance) which create an ideology to tame people (workers, farmers) in order to stabilize and maintain its social and political power.	
RA14	II
If what Asante's notion of Afrocentricity tried to do was to evoke black people to fight for power of interpretation for themselves, then what this article tries to argue is that such an action of competition for power of interpretation is unsuccessful. The operation of power in this article reflects how a reality is constructed after a power competition (negotiation and compromise) by diverse groups.	
RA15	I
This article applies history and quantitative data to explain how the value of man (and middle class)	

defines/constructs the social roles of female teachers (and working class).	
RA16	IV
This article is an analysis which focuses on authors' (who designed curriculum for Portuguese middle school) personal ideological and pedagogical principle of their works. This article does not clearly discuss how power operates.	
RA17	II
This article discusses how a single word such as "just" could possess a function at an ideological level. This article does not focus on the description of power operation; instead, it simply points out what ideology effect might be conveyed in texts through a single word.	
RA18	I
This article explains the "best practices movement" which is formulated by the American Counseling Association as the discipline of counselling; in fact, it is a dominant ideology which excludes other movements (ways of treatment) except "the best" one. Power is the key point which starts the ideology shift.	
RA19	IV
This article belongs to analysis of cultural creation which analyses the narrative structure of Rowling's <i>Harry Potter</i> . The author of this article mainly explains what ideology Rowling possesses and embeds in her novels. Basically, this article does not focus on how power is operated in order to create certain ideas.	
RA20	I
This article explains how the academia dominated by males excludes females from power of interpretation via forms of thought, images, and symbols. Such power resulted from the dominant group constructs an academia where roles of females are not included.	
RA21	I
This article, by reviewing history, explains how the definition of Dangdut music has been appropriated by diverse groups to pursue their group interests (e.g., political or economic interests) in which the spirit of Dangdut music—originally representing the people— is reinterpreted by invisible power to serve ideologies of certain groups.	
RA22	IV
This article spends pages on <i>theoretically</i> discussing the relationship between power and reality, to explain how power constructs reality. Nevertheless, while the author of this article brings an example into her discussion, she <i>does not clearly</i> explain how her research objects—parents and daughters—apply their power or resistance respectively to construct or defend their own value (i.e., whether crop-tops are cute or dorky). Hence, this article only theoretically discusses the notion of power, while in the example discussion part how power works is not explained.	
RA23	I
The author of this article argues that the definition of "caring" in the nursing profession has been reinterpreted. The new definition of caring refers to non-skilled treatment of spiritual concern which has replaced the original definition of skilled treatment of healthy concern. Operation of power is reflected in how a new definition of caring replaces the old one.	
RA24	I
This article explains how the Chinese Communist Party applies visible political slogans to change people's invisible consciousness. That is to say, the operation of power reflects in how CCP utilizes political slogans to construct and maintain their dominant ideology. This ideology shifts from time to time which generates diverse influences based on certain periods.	
RA25	I
This article adopts signs and texts to analyse ideology. Diverse texts influence the birth of a certain ideology while journalists' ideologies also determine what texts they might adopt in their report. Power operation reflects in how texts of news reports presents/construct a certain ideology for its readers.	

RA26	II
Operation of power in this article is reflected in how inner groups of Ireland Republican Movement negotiate and compromise between each other. Although the phenomenon of class distinction is clearly pointed out by this author, he did not specifically stress whether one group dominates the other. On the other hand, the author of this article focuses on how an ideology is developed based on power negotiation between diverse groups.	
RA27	I(III)
This article explains how power owned by the dominant groups defines the meaning of a failed state. To the analyst of this article, the term <i>failed state</i> , which is adopted to describe countries such as Somalia, is defined by others (e.g., the western countries, academic). It is indeed a dominant ideology. This dominant ideology resulted from the academic demonstrations, news reports as well as imperial and post- colonialism. That is to say, the definition of a failed state is usually the imagination of the West which is often negatively presented; nevertheless, such an imagination is still the only angle—i.e., the dominant ideology— for the world to evaluate the status of a country. On the other hand, the author of this article also investigates how such a term is inappropriately applied based on Somalia’s history of being colonized. This analyst’s discussion of power could be seen as the discussion of resistant (Foucault’s term).	
RA28	IV
This article mainly discusses the ideology shift in Die Grünen from 1980 to 2002 which is based on their official document. Whether power operation might influence the shift of party’s ideology was not discussed by the author.	
RA29	II
The operation of power in this article includes two dimensions. The first dimension of (invisible) power operation is reflected in how Bolsheviks and Mensheviks fight for ideology dominance while presenting their arguments on issues. The second dimension of (visible) power operation is reflected in how the government tried to postpone the election in order to establish Kassa boards first (which benefits government) as well as the fact that factions such as Mensheviks directly “place their representatives on kassa boards” (p. 921) in order to obtain opinion leadership.	
RA30	I(III)
This article claims that Oscar Lewis’ notion of “subculture of poverty”, in the past thirty years, has been misunderstood as a critique on victims of poverty. The author of this article attempts to clarify how such power operates in (or is dominated by) the mainstream academic discourses in the past thirty years. By distinguishing such a dominated phenomenon, this author also tries to defend and redress the misunderstanding of Lewis’ notion.	
RA31	I (III)
This article explains how “digital reference service models” become the dominant ideology in contemporary library management. In this article, how power constructs the reality (dominant ideology) reflects in academic discourses as well as the practical application of “digital reference” in libraries. Such discourses in academic and application in libraries have generated phenomena such as de-professionalization and low wage-oriented. This article also reinterprets what value the reference work really is.	
RA32	II
This article mainly investigates the “Schools Commission Reports” which is a competed, negotiated, and compromised outcome based on the discussion of diverse groups (e.g., government, commissions, theorists, school, teacher, and parents).	
RA33	II(III)
The description of power in this article focuses on how the outside law and Vietnam elites compete, negotiate, and compromise with the inside culture and local executors in order to fight for power and cognition leadership. This author describes further how the local ideology resists against outside borrowed company law.	

Appendix 5-2: Reality

Way I: The IAC articles show what the constructed reality is.

Way II: The IAC analysts simply illustrate the reality of their research; or objectively describe how a reality is presented.

Way III: The IAC analysts arbitrarily or subjectively claim: the reality that their analyses have found is misrepresented; instead, the truth is...

Way IV: That how reality is described is not clearly explained by the IAC analysts. (Discussion of reality is hardly found)

Research Article Number	Category
Explanation	
RA01	I
The author of this article argues that, after 1997 election, the New Labour has established an ideology of “information age” which is based on the development of information and communication technology. In this ideology of “information age”, the ability of using the technology is emphasized; as a result, meaning of welfare is redefined. A new constructed reality is that the role of government is repositioned: as the assistant. On the contrary, citizens are (invisibly) required to learn new skills and knowledge. They are responsible to themselves. As a result, to the analysts of this article, the political ideology of the New Labour has changed as well.	
RA02	I
The author of this article thinks that due to the U.K. media’s misrepresentation, Islam is stigmatized with an image which is violent, irrational, and radical (a constructed reality).	
RA03	III (I)
The author of this article argues that Maruyama Masao misunderstood Fukuzawa Yukichi’s notions. And also that because Masao was quite an influential person after World War in Japan so, somehow, his understanding of Yukichi’s notions guided/constructed a particular (false) way to read Yukichi. (I) The author also provides his own understanding of Yukichi as well as criticises Masao’s misunderstanding of the former. (III)	
RA04	III (I)
The author of RA04 argues that although diet companies continually revise the advertising of their products to create a fresh image of ‘we understand customers’ demands’, the purposes are all for their business. Namely, although advertising varies periodically, the goal of diet companies remains the same. Drawing on the view from RA04’s author, these various advertisings have created a false demand, i.e., the false consciousness, for the audiences. Thus, this author tries to explore the conversion of reality from a diachronic angle, and explains what reality (or false demand/consciousness) these advertisings really represent.	
RA05	I
The author of this article explains that, by using words and specific description, the U.S. media constructs Muslim and Arab-Americans as the Other after 9/11 (i.e., a constructed reality).	
RA06	I
This article explains how media news reports construct Joey Galloway as a wayward child, greedy, disloyal.	
RA07	I
This article explains how medical discourse continually constructs a traditional image for the public. This constructed image (i.e., reality) is that nursing is subject to the medical profession.	
RA08	II
The author of this article suggests that the 1998 National Curriculum is a product of ideological competition and negotiation fought by diverse interest groups.	

RA09	II
<p>The author of this article adopts quantitative data (e.g., voting statistics) to show us where in the spectrum of political ideology (i.e., liberal, centrist, or conservative) these diverse factions (i.e., Traditional Democrats, New Democrats, Blue Dogs) of the Democrats party are located. The author simply presents what consciousness (i.e., reality) one faction holds without discussing the power operation or whether such a consciousness is true or false, right or wrong, and good or bad to the people. Accordingly, the discussion of Class (faction) consciousness maintains a neutral dimension.</p>	
RA10	I
<p>The author of this article tries to explain why the reality that Will constructs through his editorials is unreal. Will constructs a right-wing ideology for his readers. Hence, this article criticises the reality which is constructed by one side which also dominates the other.</p>	
RA11	IV
<p>This article does not involve a discussion of reality except the explanation which shows the status of current legal reform in the Islam world (the reality of reform).</p>	
RA12	I
<p>In the first half of the article, the author simply explains the different attitudes of law that diverse interviewees possess (i.e., their own reality). The second half explains why most interviewees consider that the haves (e.g., people who have legal knowledge such as lawyers) come out ahead.</p>	
RA13	III
<p>RA13 argues that Egypt's social welfare plans were originally designed to manage the poverty problem in order to reach modernity. However, social welfare plans, such as 'public assistance law' and 'social insurance', have provided Egyptians with nothing but the false consciousnesses which is always just an imagination of social welfare. This is because those diverse welfare plans are more like rhetoric tools which helped diverse political regimes to maintain social order and their authority. The purpose of social welfare plans is not to help people; instead, it is to create a (false) consciousness that the 'government is helping people'.</p>	
RA14	III
<p>The author of this article argues that Asante's notion of Afrocentricity did not work out as Asante expected to lead black people or Africans to escape from the dominance of the west (i.e., a false reality). On the other hand, the reality (what this author thought) is that the notion of "Afrocentricity erects a representation of self that is politically imaginary, that is, an image that hides the real alienated conditions of most of Afro-America's material existence" (p. 100). This author presents what reality it is—i.e., the world is not changed due to such a notion; the black people are still alienated.</p>	
RA15	I
<p>This article applies history and quantitative data to explain how the value of man (and middle class) constructs the image, or the social roles, of female teachers (and working class). Such an image influences the public expectation of female teachers' roles, their teaching contents, their wages as well as their Class (status) location. Thus, the Class consciousness which these female teachers have perceived, to the analyst of RA15, is not their real Class consciousness.</p>	
RA16	IV
<p>RA16 mainly explains the difference between the authors' (i.e., people who designed curriculum for Portuguese middle school) personal ideological and the pedagogical principle of their works. This article does not clearly discuss what reality it is.</p>	
RA17	II
<p>The author of this article adopts the word "just" to explore the ideology which the politician holds in order to explain their way of thinking about the society (i.e., the reality they possess).</p>	
RA18	I(III)
<p>This article argues that the best practices movement formulated by the American Counseling Association indeed is a dominant ideology (a reality which shows what is right). By setting up the best practices movement, other types of treatment (e.g., disorder movement) have been excluded. As a</p>	

	result, this author analyses the claim and application of “the best practice” to see whether such a claim of “the best practice” really proves its professional values in counselling.
RA19	III
	This article belongs to an analysis of cultural creation which analyses the narrative structure of Rowling’s <i>Harry Potter</i> . By pointing out the contradictory narrative embedded in this novel, the analyst of this article argues that Rowling has mixed up the first (i.e., real) and the second (i.e., magical) worlds. Namely, the reality that this novel presents to us (i.e., mixed world) is not the same as what Rowling and her readers thought (i.e., magical world). This analyst tells us what reality it is instead of what we think it is (It is A not B).
RA20	I
	By applying forms of thought, images, and symbols, men intentionally or unintentionally constructs an academia where females are excluded. This is the reality that the author of this article possesses.
RA21	III (I)
	This article, by reviewing history, explains how the definition of Dangdut music has been appropriated by diverse groups to pursue their group interests (e.g., political or economic interests). In so doing, a reality—what meaning “the people” in Dangdut music refers to—is constructed. (I) The author of this article argues that such a reality does not represent the truth, the real meaning of Dangdut music. Consequently, he attempts to show the reality (what meaning the people in Dangdut music really refers to). (III)
RA22	II
	This article spends pages on <i>theoretically</i> discussing the relationship between power and reality, or to explain how power constructs reality. Nevertheless, while the author of this article brings an example into her discussion, she <i>does not clearly</i> explain how her research objects—parents and daughters—apply their power or resistance respectively to construct or defend their own value (i.e., crop-tops are cute or dorky). Hence, this article only discusses how reality (e.g., daughters consider crop-tops as cute.) is constructed from a <i>theoretical</i> perspective.
RA23	I
	The author of this article argues that the definition of “caring” in the nursing profession has been reinterpreted. Such a new definition of caring refers to non-skilled treatment of spiritual concern (i.e., the constructed reality) which has replaced the original definition of skilled treatment of healthy concern (i.e., the real reality, in the author’s position). The reality regarding significance of caring is constructed through the interpretation.
RA24	I
	RA24 points out how the Chinese Communist Party applies diverse visible political slogans to change people’s invisible consciousness, which reflects people’s thinking (i.e., diverse realities) through times (e.g., in the early era: to be loyal to leaders; in later eras: to rationalize the policy of economic development). The reality which represents people’s value here is constructed by the dominant group.
RA25	I
	The author of this article argues that a particular ideology is conveyed in news reports of the Columbine event which creates limited and non-objective discourses. Such discourses regarding the Columbine event is incapable of representing the truth (i.e., a false reality).
RA26	II
	The author of this article does not judge whether the reality influenced by power is true or not. He simply explains the conversion of the Ireland Republican Movement. Such a conversion shifts “from a physical force organisation to a socialist party that emphasises economic rather than national issues.” He does not judge whether the reality, which represented the social condition of a time (e.g., in the ‘force’ or ‘party’ style stage), is influenced by power or is presented truthfully or falsely. The analyst just (objectively) presents the reality of certain times diachronically.

RA27	III (I)
This article tries to tell us that a false reality—the way people consider Somalia as a failed state—exists. The author of this article examines the colonised history of Somalia pointing out the reason (the real reality, i.e., his own perspective) that makes Somalia a failed state.	
RA28	III
This article mainly discusses the ideology shift in Die Grünen from 1980 to 2002 which is based on an investigation of the official documents. The author of this article thinks that Die Grünen nowadays possesses the liberalism ideology (i.e., the reality that the author himself considers) instead of the ideology of ecologized socialism that most people suppose. Namely, the IAC analyst denies one current ideology and reasserts another.	
RA29	III
The author of this article agrees with Haimson that it is workers themselves who triggered the October revolution instead of Lenin and his Bolshevik comrades. (Author tell us) The real reality is that workers were autonomous who expected social change which made the revolution possible.	
RA30	III (I)
This article claims that Oscar Lewis' notion of "subculture of poverty", in the past thirty years, has been misunderstood as a critique on victims of poverty. That is, the whole academia's misinterpretation of Oscar Lewis' notion has constructed a false understanding. (I) The author of this article also attempts to redress that Lewis' ideas maintain basic Marxism. (III)	
RA31	III (I)
This article explains how "digital reference service models" have become the dominant ideology in contemporary library management which constructs a reality of library reference work. Such a reality concludes the phenomena of de-professionalization, female and call-centre orientation, and low wage-oriented. (I) In the second half of the article, its author also redresses what value reference work really is (i.e., her own reality). (III)	
RA32	II
The author of this article analyses the "Schools Commission Reports" and tries to explain what ideology these reports contain and how the ideologies of these reports shift. The discourses of the reports present the reality.	
RA33	II
This article explains that the Vietnam elites try to introduce company law from other countries to respond accordingly to the developing business activities in Vietnam. But the borrowed law does not match with the local Vietnam society as expected. Hence, the author of this article depicts the reality that these diverse groups together construct via the process of negotiation and compromise.	

Appendix 81: Selecting Expression Styles

1: The Purely Descriptive Style means that IAC analysts simply and purely describe or present the (new) ideology they have discovered without involving themselves with any personal subjectivity.

2: The Interpretative Style means that IAC analysts start to argue or judge their research subjects.

3: The Defensive and Corrective Style means that IAC analysts directly and obviously defend and correct the misunderstood parts as well as tell readers what is right.

Research Article Number	Category
Explanation	
RA01	2
This article explains the ideological shift of New Labour (regarding their policy) after New Labour took power. Although the authors of this article just simply depict the party’s ideological shift without explaining how it shifts, their demonstration in fact concealed an invisible critique. The authors seem to suggest that New Labour’s spirit has changed (i.e., inclining to the right).	
RA02	3
The Islamic background of the author of this article might be the reason that influenced the expressive style of this paper—inching to defensive or corrective style. In this article, the author did not focus on explaining what Islam really is; instead, he focused on how Islam is misrepresented through media news reports.	
RA03	3
The author of this article thinks that Maruyama Masao misunderstood Fukuzawa Yukichi’s notions. As a result, he first explains what Masao’s understanding is, and then starts to defend and correct what Yukichi’s notions really are by offering his own understanding.	
RA04	3
This article explains how diet companies use media advertisings to construct a certain image for their product through times (e.g., ideology shifts from fad diets to healthy diets) in order to continue to attract customers. The first person voice is adopted through the whole paper which creates a firsthand experience feeling for its readers. It seems like that we readers are all product consumers who are invited to fight against diet companies, who are usually described as “them”. As a result, the author’s purpose of defending a cognition regarding a diet company is revealed.	
RA05	2
This article focuses on how media constructs certain ideology by their news reports. Although this is not a defensive or corrective style of ideological analysis, it is easy to detect their personal attitude through their demonstration.	
RA06	3
This article explains how news media (impeded by a sport team for future news resources) constructs an image of Joey Galloway as a wayward child, greedy, disloyal by their news report. The author of this article argues that such an image of demonizing Galloway is for sustaining the authority of the sport team and its coach which did not represent the reality (truth) of that time. He tried to defend the reality. The Author concluded, even judged, that this results from modern racism.	
RA07	3
This article explains how the medical profession who are superior in power continually adopt their medical discourses to construct a traditional value: nursing is subject to the medical profession. Because of such discourses, when nursing tries to fight for their independent character, simultaneously, nursing is articulated by the images of crisis, militancy, radicalism, and incompetency. The author of this article criticises such a false image of nursing and, by defending and redressing, he offers readers a real image of nursing.	

RA08	2
<p>This article cites many quotations from interview draft (at least one quarter) which could create a neutral image for the author, that is, let quotations speak for themselves so that the track of the author vanishes. However, the author massively adopts the first person voice (e.g., I argue, p.2; I want to suggest, p.2; I do not want to claim, p.3; The position I adopt is, p.5; I want to illustrate, p.6; What I want to suggest, p. 12; I claimed) in most of his paper which also reveals his attitude and position.</p>	
RA09	1
<p>This article does not talk about how power operates or how power constructs reality. The author of this article adopts quantitative data (e.g., voting statistics) to show us where in the spectrum of political ideology (i.e., liberal, centrist, or conservative) these diverse factions (i.e., Traditional Democrats, New Democrats, Blue Dogs) of the Democrats party are located. The author simply and purely describes what consciousness one faction holds without involving a discussion of power operation or whether such a faction-consciousness is true or false. The discussion maintains a neutral dimension.</p>	
RA10	3
<p>This article explains how George Will’s editorials, which were published in the U.S. media, construct, praise, and strengthen a right-wing ideology. To the author of this article, Will’s arguments did not accurately present the reality. As a result, by uncovering what ideology Will’s writings convey, this author started to criticise and point out the wrongness of such a constructed ideology.</p>	
RA11	1
<p>This article discusses how Islamic intellectuals internally fight for the interpretation right of the reform of Islamic Legal. The author of this article did not display too much personal subjectivity; instead, his discussion is mainly based on historical explanation and quotation. As a result, this article is categorized as purely descriptive ideological analysis.</p>	
RA12	1&2
<p>The first half of the RA12(34) was written via a purely descriptive style in which the authors of this article simply presented stories of their interviewees as well as quoted these interviewees’ own words to show what they think about the law. Yet, in the second half of this article, the authors started to bring their opinions to demonstrate how and why the “Haves come out ahead.” For example, sentences such as “In answering these questions, we suggest precisely the opposite [...]” (p. 1036) and “We reiterate, however, that law's power is only in part derived from its status as transcendent and ideal” (p. 1040). This thesis does not mean to find fault with the way they presented the articles. These sentences indeed exposed the authors’ position and attitude regarding their research topic. Other writings which also displayed their certain attitude include “In point of fact, Rita Michaels [...]”(p. 1030), “In fact, Alan Fox plays law as he plays poker” (p. 1033), etc. Because of these (unintentional) writings, this article turned the expression angle from a purely descriptive to an interpretative style. Thus, it could be said that both purely descriptive and interpretive styles exist in this article.</p>	
RA13	1&2
<p>RA13 methods of historical narrative and offering quantitative data to explain Egypt’s social welfare plans (e.g., public assistance law and social insurance) indeed are the rhetoric tools which helped diverse political regimes to maintain social order and their authority. Regarding the analytical methods this article applied, it could be categorised as a pure descriptive style. Nevertheless, some of her writing such as “This sudden concern” (p. 280), “it is thus not surprising” (p. 281, 288, 290), “It no doubt seemed”, “would (of necessity?) be added” (p. 283), and “Ironically,...”(p. 290), to a great extent, has revealed her own subjectivity. Although these subjective descriptions might be innocent writings due to the analyst’s writing behaviour, from a holistic view, a fair categorizing is to admit the existence of both styles in this article.</p>	

RA14	2
<p>This is an article which obviously shows the author’s personal subjectivities. This article explains that Asante’s notion of Afrocentricity did not work out as Asante expected to lead black people or Africans to escape from the dominance of the west. To the author of RA14, Asante’s demonstration still relies on the vested western logic; the world is not changed due to Asante’s suggestion; black people are still alienated. The author’s subjectivity is found through his writing. He confirmedly argued that things are not going the way that Asante wished. This is an evaluation made from the author’s point of view.</p>	
RA15	2
<p>In this article, historical literature and quantitative data were adopted to explain what roles the female teachers have played in the past as well as the present resulting from the education system. Basically, research topics which deal with gender or religion are usually presented with defensive or corrective style of ideological analysis (e.g.,RA02, 06, 20, 27 etc.). Nevertheless, maybe because the author of this article is male his writing did not try to defend or correct the so-called false ideology which shows how females are oppressed and unfairly treated. As a result, this article is categorized as an interpretative style of ideological analysis which focuses simply on the roles of females in the past and now.</p>	
RA16	1&2
<p>This is an analysis of the authors’ (who designed the curriculum for Portuguese middle school) personal ideological and pedagogical principle of their works. The authors of this article compared interview opinions of authors of the curriculum with texts of “Flexible Management of curriculum”. Nevertheless, in some writings, the authors of this article inevitably display their subjective judgement. As a result, this article is categorized as a style between purely descriptive and interpretative ideological analysis.</p>	
RA17	2
<p>This article explains how a word “just” could possess the ideological function. This article contains much discussion on theory and concepts related to the word “just” which explains why such a single word is able to possess the ideological function. Based on the above viewpoint, this article is purely descriptive in style. Nevertheless, the author of this article adopts the first person voice (i.e., we, our, us) to present his paper. Using the first person voice also reveals this author’s attempt to persuade readers. Because the author did not defend or try to correct any false ideas, this article is categorised as interpretative ideological analysis.</p>	
RA18	3
<p>This article argues that the best practices movement formulated by the American Counseling Association indeed is a dominant ideology which has excluded other movements (i.e., way of treatment) except “the best” movement. In this article, the author corrects and argues against such a dominant ideology (i.e., the pursuit of “the best”) and defends and suggests what real understanding and value should be when people think of the counselling field.</p>	
RA19	3
<p>By pointing out the narrative contradiction within this novel, this author argues that Rowling has mixed up the first (i.e., real) and the second (i.e., magical) world. Namely, the reality that this novel presents to us (i.e., mixed world) is not the same as what Rowling and her readers thought (i.e., magical world). This author corrects the readers’ misunderstanding and tells us what the truth (reality) is.</p>	
RA20	3
<p>This article explains how the academia dominated by males excludes females in the right of interpretation via forms of thought, images, and symbols. The author of this article, by adopting the first person voice, invites readers to dig out the unbalanced power relationship. Moreover, this article employed the percentage of female educators at different levels (e.g., from high schools to universities) and the percentage of women in different positions (e.g., principals, lecturers,</p>	

<p>professors), to respond to its argument: women (their roles and opinions) are excluded from academia, which is dominated by men. Thus, the author provides suggestions to break through such a condition.</p>	
<p>RA21</p> <p>The author of this article historically explains how Dangdut music is appropriated by diverse interest groups to reach their benefits through time. As a result, he tries to defend and correct such false understanding by offering his opinion: what real Dangdut music should be, what it represents, and how it functions.</p>	<p>3</p>
<p>RA22</p> <p>This article <i>theoretically</i> discusses how reality is constructed, e.g., by different social structures, such as school v.s. real society. The author designed an example (not real life example) to discuss how parents and daughters react to this question: whether a crop-top is cute or dorky. Although this author tries to examine what reasons (e.g. relative truth, social truth relativism,) influence parents' and daughters' thoughts, the way he describes it is obviously close to parents' position (even though he tries to present arguments equally). Since this author involves his position in his discussion, this article is categorised as interpretative ideological analysis in which the author tried to suggest what is right (e.g., parents' opinion is right while daughter's is wrong).</p>	<p>2</p>
<p>RA23</p> <p>The way of presentation in this article is to cite many quotations accompanying the authors' own words. After displaying one quotation, the authors of this article start to demonstrate why the concepts of these quoted words are wrong as well as why those words are harmful to the meaning of caring. In so doing, the authors offer ideas on what should be the right meaning of caring (i.e., their own ideology). In a word, they correct and redress the wrong concept and offer another.</p>	<p>3</p>
<p>RA24</p> <p>This article explains how the Chinese Communist Party applies visible political slogans to change people's invisible consciousness. That is to say, the operation of power reflects in how CCP utilizes political slogans to construct and maintain their dominant ideology. Although the author's subjectivity is found through his writing, he did not claim CCP's slogans were wrong or not (so a correction or criticism is need). Hence, this article is categorized as interpretative ideological analysis.</p>	<p>2</p>
<p>RA25</p> <p>This article focused more on quoting sentences or paragraphs to explain what ideology the research object conveys instead of judging whether such an ideology is right or wrong. Nevertheless, some selected words also reveal its author's ideological position and preference. As a result, this article is categorized as a style between purely descriptive and interpretative ideological analysis.</p>	<p>1&2</p>
<p>RA26</p> <p>This article does not tell what ideology is hidden, nor argue how one group dominates the other. Instead, it only explains the process of the Ireland Republican Movement which is "from a physical force organisation to a socialist party that emphasises economic rather than national issues" (p. 79). Nevertheless, the author of this article inevitably exposed his subjectivity through words. As a result, this article is categorized as having a style between purely descriptive and interpretative ideological analysis.</p>	<p>1&2</p>
<p>RA27</p> <p>This article argues that some countries (e.g., Somalia) which are named as "failed states" in fact are defined by others (e.g., the western countries, academics). The author investigates how such a term is inappropriately applied based on Somalia's history of being imperial or economically colonized. He tries to correct what is wrong as well as defends what reality it is.</p>	<p>3</p>

RA28	2
<p>This article compared policies of Die Grünen in two periods (1980 and 2002) in order to explain the ideological shift in the political spectrum. For most of the time, the author of this article is neutral and objective; however, on some occasions, the writing unintentionally reveals their personal opinion.</p>	
RA29	1
<p>This article adopts historical explanation to illustrate how one ideology is presented. The author of this article did not claim whether one group is dominated by the other or not, nor claim such an ideology is right or wrong.</p>	
RA30	3
<p>This article cites much literature to explain how and why most scholars misunderstood Oscar Lewis’s notion of subculture of poverty. By using quotations, the authors could build a neutral and objective image for themselves. However, those selected quotations, in fact, usually invisibly display the authors’ preference and attitude (so that these quotations are selected). In the abstract, the authors write “An attempt is made to remedy this situation [...]” which obviously shows that the authors’ personal opinions have already claimed “someone is wrong”. Hence, this article is categorized as defensive and corrective ideological analysis.</p>	
RA31	3
<p>The author of this article first explains what reality is constructed by digital reference service models which contain bad influences. Such bad influences have generated phenomena such as de-professionalization, call-centre settings, and low wage-oriented. That is why this author tries to correct bad values and defends the real value of reference work.</p>	
RA32	2
<p>The author of this article analyses the “Schools Commission Reports” and tries to explain what ideology these reports contain and how the ideologies of these reports shift. He used many quotations to support his demonstration. Although he tries to stay in a neutral and objective position, he massively adopts the first person voice (e.g., if we wish to; Let us now; we witnessed; we can now see; As we shall see; Perhaps we can, etc.) in most of his demonstration which also reveals his attitude and position.</p>	
RA33	1
<p>This article adopts angles of history and environment to explain why Vietnam cannot fully accept the borrowed company law. The author compares the borrowed company law with Vietnam’s local condition in order to point to the differences between two ideologies. Except for a few subjective descriptions, this article can be seen as a neutral and purely descriptive ideological analysis.</p>	