

The University of Sheffield



U. Martinez-Hernandez

**Autonomous active exploration  
for tactile sensing in robotics**

Thesis submitted in partial fulfilment of  
the requirements for the degree of  
Doctor of Philosophy

2014



**Autonomous active exploration  
for tactile sensing in robotics**

**Uriel Martinez-Hernandez**

Thesis submitted in partial fulfilment of  
the requirements for the degree of  
Doctor of Philosophy

Automatic Control and Systems Engineering  
The University of Sheffield  
Sheffield, UK.

November, 2014





# Abstract

The sense of touch permits humans to directly touch, feel and perceive the state of their surrounding environment. For an exploration task, humans normally reduce uncertainty by actively moving their hands and fingers towards more interesting locations. This active exploration is a sophisticated procedure that involves sensing and perception processes.

In robotics, the sense of touch also plays an important role for the development of intelligent systems capable to safely explore and interact with their environment. However, robust and accurate sensing and perception methods, crucial to exploit the benefits offered by the sense of touch, still represents a major research challenge in the field of robotics.

A novel method for sensing and perception in robotics using the sense of touch is developed in this research work. This novel active Bayesian perception method, biologically inspired by humans, demonstrates its superiority over passive perception modality, achieving accurate tactile perception with a biomimetic fingertip sensor. The accurate results are accomplished by the accumulation of evidence through the interaction with the environment, and by actively moving the biomimetic fingertip sensor towards better locations to improve perception as humans do. A contour following exploration, commonly used by humans to extract object shape, was used to validate the proposed method using simulated and real objects. The exploration procedure demonstrated the ability of the tactile sensor to autonomously interact, performing active movements to improve the perception from the contour of the objects being explored, in a natural way as humans do.

An investigation of the effects on the perception and decisions taken by the combination of the experience acquired along an exploration task with the active Bayesian perception process is also presented. This investigation, based on two novel sensorimotor control strategies (SMC1 and SMC2), was able to improve the performance in speed and accuracy of the exploration task. To exploit the benefits of the control strategies in a realistic exploration, the learning of a forward model and confidence factor was needed. For that reason, a novel method based on the combination of Predicted Information Gain (PIG) and Dynamic Bayesian Networks (DBN) permitted to achieve an online and adaptive learning of the forward model and confidence factor, allowing to improve the performance of the exploration task for both sensorimotor control strategies.

Overall, the novel methods presented in this thesis, validated in simulated and real environments, demonstrated to be robust, accurate and suitable for robots to perform autonomous active perception and exploration using the sense touch.



# Contents

<b>1</b>	<b>Introduction</b>	<b>1</b>
1.1	Motivation . . . . .	3
1.2	Problem definition . . . . .	6
1.3	Aims and objectives . . . . .	6
1.4	Contributions . . . . .	8
1.5	Publications . . . . .	10
1.6	Outline . . . . .	12
<b>2</b>	<b>The Sense of Touch</b>	<b>15</b>
2.1	The sense of touch in biology . . . . .	16
2.1.1	Sense of touch in humans . . . . .	17
2.1.2	Sense of touch in animals . . . . .	20
2.2	Tactile sensing . . . . .	21
2.2.1	Passive sensing . . . . .	21
2.2.2	Active sensing . . . . .	23
2.3	Biological decision-making process . . . . .	25
2.4	The sense of touch in robotics . . . . .	27
2.4.1	Artificial tactile sensor technologies . . . . .	28
2.4.2	Tactile exploration . . . . .	35
2.5	Concluding remarks . . . . .	45
<b>3</b>	<b>Active Bayesian Perception</b>	<b>47</b>
3.1	Perception . . . . .	48
3.1.1	Perception in robotics . . . . .	49
3.2	Tactile robotic platform . . . . .	53
3.2.1	Robotic platform . . . . .	53
3.2.2	Biomimetic iCub fingertip sensor . . . . .	53
3.2.3	Control of the tactile robotic platform . . . . .	57
3.3	Tactile data collection . . . . .	58
3.4	Bayesian approach for tactile perception . . . . .	63
3.4.1	Bayes' rule . . . . .	64
3.4.2	Prior . . . . .	66
3.4.3	Measurement model and likelihood estimation . . . . .	66
3.4.4	Bayesian update . . . . .	67
3.4.5	Marginal angle and position posteriors . . . . .	68
3.4.6	Stop decision for angle posterior . . . . .	68
3.5	Active and passive Bayesian perception . . . . .	69

3.5.1	Passive Bayesian perception . . . . .	69
3.5.2	Active Bayesian perception . . . . .	72
3.6	Concluding remarks . . . . .	77
<b>4</b>	<b>Active Tactile Exploration</b>	<b>81</b>
4.1	Edge detection and edge tracking . . . . .	82
4.1.1	Active and passive edge detection . . . . .	83
4.1.2	Active and passive contour following . . . . .	89
4.1.3	Simulated tactile contour following exploration . . . . .	92
4.2	Contour following with a tactile robotic platform . . . . .	102
4.2.1	Sensorimotor architecture for active control . . . . .	103
4.2.2	Contour following in a real environment . . . . .	104
4.3	Concluding remarks . . . . .	108
<b>5</b>	<b>Sensorimotor Control Strategies for Active Perception</b>	<b>111</b>
5.1	Active perception and predicted information . . . . .	112
5.2	Sensory prediction based on forward model . . . . .	114
5.3	Control strategies for active tactile exploration . . . . .	116
5.3.1	Weighted prior strategy (SMC1) . . . . .	117
5.3.2	Weighted posterior strategy (SMC2) . . . . .	120
5.4	Sensorimotor control strategies in simulated environment . . . . .	122
5.4.1	Weighted prior and active Bayesian perception . . . . .	123
5.4.2	Weighted posterior and active Bayesian perception . . . . .	125
5.5	Sensorimotor control strategies in real environment . . . . .	128
5.6	Concluding remarks . . . . .	131
<b>6</b>	<b>Adaptive Active Perception</b>	<b>133</b>
6.1	Adaptive forward model . . . . .	134
6.1.1	Predicted Information Gain (PIG) . . . . .	136
6.1.2	Dynamic Bayesian Network and PIG . . . . .	137
6.2	Forward model assessment . . . . .	140
6.3	Adaptive active tactile exploration . . . . .	142
6.3.1	Exploration using a weighted prior . . . . .	142
6.3.2	Exploration using a weighted posterior . . . . .	146
6.4	Concluding remarks . . . . .	150
<b>7</b>	<b>Conclusions and Future Work</b>	<b>153</b>
	<b>Appendices</b>	<b>159</b>
	<b>Appendix A Tactile data collection</b>	<b>161</b>
	<b>Appendix B Linear-shaped object</b>	<b>169</b>
	<b>Appendix C Circular-shaped object</b>	<b>171</b>
	<b>References</b>	<b>173</b>

# List of Figures

1.1	Partners of the EU EFAA project . . . . .	2
2.1	Mechanoreceptors and sensitivity of human body . . . . .	18
2.2	Human brain: somatosensory and primay-motor cortex . . . . .	19
2.3	Exploratory procedures with human hands and fingers . . . . .	24
2.4	Psychological decision-making model . . . . .	26
2.5	Artificial tactile sensors for the iCub humanoid robot . . . . .	30
2.6	Artificial tactile sensors for a prosthetic hand . . . . .	33
2.7	Artificial tactile sensor inspired by animals . . . . .	34
2.8	Edge detection and tracking with tactile robots . . . . .	38
2.9	Enclosing objects with tactile robots . . . . .	40
2.10	Sliding and tapping with tactile robots . . . . .	43
3.1	Robotic platform . . . . .	54
3.2	Dimensions and shape of iCub fingertip sensor . . . . .	55
3.3	Layers of the iCub fingertip sensor . . . . .	55
3.4	Tactile robotic platform for exploration . . . . .	56
3.5	Control of robotic platform for data collection . . . . .	58
3.6	Data collection from different regions of the object . . . . .	59
3.7	Construction of angle perceptual classes . . . . .	60
3.8	Samples of tactile data . . . . .	61
3.9	Samples of tactile data around circular object . . . . .	62
3.10	Construction of position perceptual classes . . . . .	64
3.11	Passive Bayesian perception flowchart . . . . .	70
3.12	Passive Bayesian perception accuracy . . . . .	71
3.13	Active Bayesian perception flowchart . . . . .	73
3.14	Active Bayesian perception against belief threshold . . . . .	76
3.15	Active Bayesian perception against reaction time . . . . .	77
4.1	Position region for edge detection . . . . .	83
4.2	Passive and active edge detection with low decision threshold . . . . .	86
4.3	Passive and active edge detection with high decision threshold . . . . .	87
4.4	Active fingertip movements during angle perception . . . . .	90
4.5	Passive perception for contour following exploration . . . . .	93
4.6	Active perception for contour following exploration . . . . .	94
4.7	Contour following of a line shape . . . . .	96
4.8	Contour following of a circle shape . . . . .	98
4.9	Accuracy and reaction time for a contour following task . . . . .	100

4.10	Sensorimotor architecture for active control . . . . .	103
4.11	Contour following with a tactile robotic platform . . . . .	106
4.12	Contour following with various object shapes . . . . .	107
4.13	Object shape extraction with active Bayesian perception . . . . .	108
5.1	Perception biased by combining sources of information . . . . .	113
5.2	Ideal forward model . . . . .	115
5.3	Diagram of the weighted prior control strategy . . . . .	118
5.4	Diagram of the weighted posterior control strategy . . . . .	121
5.5	Analysis of the simulated weighted prior control strategy . . . . .	126
5.6	Analysis of the simulated weighted posterior control strategy . . . . .	127
5.7	Analysis of weighted prior and posterior in a real environment . . . . .	130
6.1	Forward model based on a Bayesian network . . . . .	138
6.2	Analysis of the adaptive weighted prior for the SMC1 strategy . . . . .	144
6.3	Forward model and confidence factor for the SMC1 strategy . . . . .	145
6.4	Analysis of the adaptive weighted prior for the SMC2 strategy . . . . .	148
6.5	Forward model and confidence factor for the SMC2 strategy . . . . .	149
A.1	Training tactile dataset from 0 to 85 angle classes . . . . .	162
A.2	Training tactile dataset from 90 to 235 angle classes . . . . .	163
A.3	Training tactile dataset from 240 to 355 angle classes . . . . .	164
A.4	Testing tactile dataset from 0 to 85 angle classes . . . . .	165
A.5	Testing tactile dataset from 90 to 235 angle classes . . . . .	166
A.6	Testing tactile dataset from 240 to 355 angle classes . . . . .	167
B.1	Passive contour following of a linear-shaped object . . . . .	169
B.2	Active contour following of linear-shaper object . . . . .	170
C.1	Passive contour following of a circular-shaped object . . . . .	171
C.2	Active contour following of a circular-shaped object . . . . .	172

# Chapter 1

## Introduction

The research presented in this thesis is undertaken as part of the European Project ‘Experimental Functional Android Assistant’ (EFAA) whose aim is to develop brain-inspired methods to incorporate perceptual, behavioural, emotional and cognitive capabilities in humanoid robots. Integrated by five institutions across Europe which are The University of Sheffield (USFD), Imperial College London (ICL), Universitat Pompeu Fabra (UPF), Institut National de la Santé et de la Recherche Médicale (INSERM) and Istituto Italiano di Tecnologia (IIT), the EFAA project brings together a set of biologically inspired methods to develop intelligent robots capable to interact with humans. Figure 1.1 shows the corresponding investigations for each partner of the consortium of the EFAA project to be implemented on the iCub humanoid robot.

The investigation developed in this thesis, as part of the contributions by the USFD, addresses the problem of perception with the sense of touch in the field of robotics by the development of biologically inspired methods. This research takes inspiration from the way that humans interact using their sense of touch to perceive and act according to the state of their surrounding environment. The work developed in this thesis contributes to the investigation in active tactile sensing for the iCub humanoid robot observed in Figure 1.1.

The methods developed in this work follow a Bayesian approach based on results from psychophysical studies with humans to perceive and make decisions by touching and exploring the environment with their hands and fingers. The study and experiments presented in this thesis have been developed with

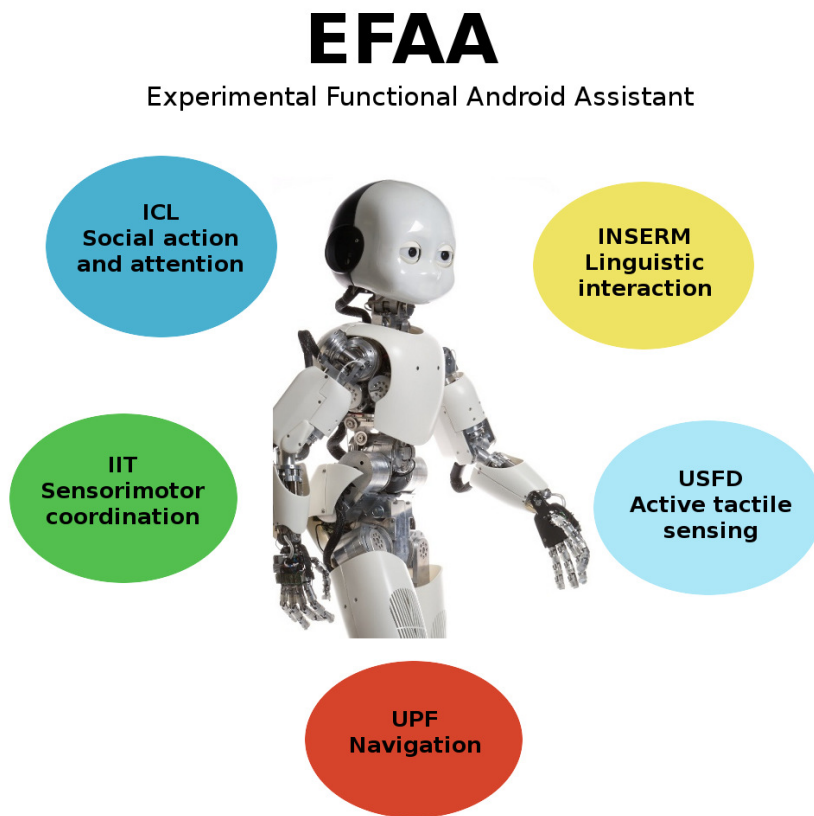

Figure 1.1: The EU EFAA project is composed of five institutions responsible for investigating in biologically inspired methods for the integration of perceptual, behavioural, emotional and cognitive capabilities in humanoid robots. This project uses the iCub humanoid robot for the investigations. The research performed in this thesis is focused on tactile perception and exploration as part of the contributions in active tactile sensing by the University of Sheffield.

biomimetic fingertip sensors that resemble the size and shape of human fingertips. These sensors, that have been provided by the consortium of the EFAA project, are part of the sensory system of the iCub humanoid robot.

The proposed Bayesian methods in this research work have demonstrated to be suitable to achieve high perception accuracy, improving the decisions and actions made according to the state of the environment perceived by the biomimetic iCub fingertip sensors. The proposed methods have been validated with a tactile exploration task chosen from the set of predefined exploratory procedures performed by humans using their hands and fingers.

The achievements in this thesis have served as contributions to the EFAA project working with the tactile sensory system of the iCub humanoid robot.



Moreover, the methods and results described through the chapters of this thesis, have also led to the publication of works on tactile perception and exploration in the field of haptics and robotics.

The rest of this chapter is organised as follows: the motivation that supports the investigations, designs and implementations of this thesis is presented in Section 1.1. The definition of the problem to be addressed through this research work is described in Section 1.2. The principal aim and objectives to be accomplished in this work are presented in Section 1.3. The resulting contributions from the investigations performed in this thesis are described in Section 1.4. In Section 1.5 the list of publications achieved through the realisation of this research work is presented. Finally, Section 1.6 presents the organisation of the chapters that compose the rest of this thesis.

## 1.1 Motivation

Biology has served as inspiration to scientists and engineers for the development of complex robotic systems which are observed in the diversity of animal-like and humanoid robots present in industry and academia (Paulson, 2004; Lepora et al., 2013). Robots in industry are normally able to achieve very high performance for specific tasks under very well controlled environments. However, these robots normally perform a set of actions or instructions already pre-programmed, restricting them to work in protected areas, where the interaction with humans is not permitted for safety reasons and to not interfere with the production.

On the other hand, the necessity to develop robots capable to safely interact with humans is growing in areas such as socially assistive robotics, rehabilitation, search and rescue, and for the study of human behaviour (Brooks et al., 1999; Fong et al., 2003; Goodrich and Schultz, 2007; Tapus et al., 2007; Scasselati et al., 2012). To accomplish this necessity, robots have to make use of their sensing modalities – for instance touch, vision, hearing, taste and olfaction, as humans do in order to perceive and understand the state of their surrounding

environment that continuously changes.

Amongst the sensing modalities available in robotics, the study of touch has started to receive more attention during the last decades which is relatively recent compared to the study of vision. One of the reasons for the increasing interest in the study of touch is due to the advances in sensing technology that permit the fabrication of biomimetic skin and tactile sensors, small enough to be integrated in robots and that are biologically inspired by humans. The study of touch in robotics is also important given that it is the means to accomplish the physical interaction with the environment rather than only seeing it (Lederman et al., 1988).

The sensory systems of several biologically inspired robots have already been equipped with artificial skin and tactile sensors (Nakamoto et al., 2009; Schmitz et al., 2010a; Schmitz, 2010; Chorley et al., 2010). This feature allows robots to touch, feel and understand what is happening in their surrounding environment. This capability requires two main processes: sensation to receive the physical stimuli; and perception to interpret the data and convert them to meaningful information (Schiffman, 1990). The resulting information from the perception process is then useful for making decisions and actions according to the perceived state of the environment. Hence, the use of both sensation and perception provides the possibility to develop intelligent robots capable to behave accordingly to certain situations.

Although sensation has been improved by the advances in sensor technology, this is not the same case for perception where biologically inspired methods are still under development. Most of the works on tactile perception follow the approach based on image processing techniques and fixed set of rules to perform actions (Muthukrishnan et al., 1987; Chen et al., 1995a; Okamura et al., 1997; Nakamoto et al., 2008; Li et al., 2013). Normally, these methods are suitable for planar sensor arrays which provide a tactile image. Tactile images have the advantage to be analysed by well known and widely studied methods such as geometric moments, smooth and edge filters that permit to extract object properties and achieve accurate perception results. Another advantage

is that tactile images provide a complete view of the shape in contact with sensor. On the contrary, these methods require large sensor arrays with large physical dimensions. These sensors and methods are not suitable for the small sensors needed in humanoid robots, and also, the processing of large amounts of data from tactile images exponentially increase the computational cost. For these reasons, these methods are inappropriate for biomimetic fingertip sensors which are designed with small size and rounded shape inspired by human fingertips. This opens the opportunity to investigate on biologically inspired methods for tactile perception in robotics with biomimetic fingertip sensors.

Regarding this motivation, psychophysical studies on perception and decision-making have demonstrated that humans deliberately move their hands and fingers to accumulate evidence and reduce the uncertainty present in the measurements (Lederman and Klatzky, 1987, 2009). This is also observed when humans perform predefined exploratory procedures over objects in the environment with their hands and fingertips to extract useful information from them (Klatzky and Lederman, 1990; Lederman and Klatzky, 1993). This process of re-locating or moving the hands and fingers to improve perception is known as active sensing and is observed not only in touch but in all of the sensing modalities (Bajcsy, 1988; Prescott et al., 2011).

Thus, the study and development of biologically inspired methods to perform active sensing and accumulation of evidence offer the possibility to develop robots capable of exploring their environment with a more natural behaviour. Having robots able to perceive, make decisions and perform actions according to the state of the changing environment, would reduce the necessity to build very fixed and constrained operating environments. Moreover, the reliability and safety, which are important aspects in the design of robots for interaction with humans, could also greatly benefit from the biologically inspired perception approach.

## 1.2 Problem definition

The problem of interaction and exploration using the sense of touch in robots require of the sensation and perception processes. The advances in the technology for the fabrication of tactile sensors have permitted the development of sensors that resemble the shape, size and capabilities of human fingertips. Despite these technological advances for the sensation process, there is still the problem of perception using biomimetic tactile sensors to allow robots to interact, explore and understand their surrounding environment.

Tactile perception requires investigation on the organisation and interpretation of the tactile measurements to build an accurate tactile perception system suitable for robots. This problem also involves investigations on how to reduce uncertainty from the measurements in order to improve perception. A natural way to address these problems is taking inspiration by the sophisticated way that humans actively move their hands and fingers to improve perception during an exploration task. Then, addressing the problem of tactile perception in robotics also permits to investigate on the process of making decisions and actions to allow robots to perform accurate exploration movements.

Undertaking this research to address the described problem, would allow the integration in robots of an accurate biologically inspired framework to safely interact with their environment using the sense of touch.

## 1.3 Aims and objectives

The aim of this thesis is the investigation, design and implementation of biologically inspired methods for tactile perception and decision-making in robots equipped with artificial skin, in order to provide them with the capability to explore and make decisions and actions over their environment according to the tactile sensory observations. This aim is inspired from the sophisticated way that humans and animals behave in specific situations by perceiving their surrounding environment through the interaction using the sense of touch.

The accomplishment of the proposed aim involves the following objectives:

- Conducting the literature review of the following topics: 1) the sense of touch in humans and animals used for the exploration of their environment; 2) perception and decision-making models from psychophysical studies with humans and animals; 3) fabrication technology for artificial tactile sensors; 4) perception in robotics using the sense of touch and its application to tactile exploration.
- Development of a novel tactile robotic platform controlled by active Bayesian perception. This platform permits the performance of active movements with the iCub fingertip sensor in order to improve perception from tactile measurements.
- Construction of novel and robust tactile datasets systematically collected from the biomimetic iCub fingertip sensor for the research on tactile perception. Unlike vision, robust datasets for investigation of tactile perception models are almost non-existent. These datasets are necessary for the investigation of active Bayesian perception using the sense of touch in robotics.
- Design and development of a novel accurate and robust biologically inspired method for tactile perception in robotics using biomimetic fingertip sensors. This process requires methods for organisation, analysis and interpretation of tactile measurements, which allows robots to make decisions and actions through the interaction with their surrounding environment.
- A novel method for tactile exploration actively controlled by the Bayesian perception approach. The test of the proposed tactile perception method is based on the contour following exploration procedure commonly used by humans to extract object shape. This exploration task allows to observe the movements of the fingertip sensor actively controlled by the

proposed Bayesian approach, and also permits to analyse the performance on speed and perception accuracy of the proposed method.

- The objectives previously described are required to validate the accuracy and robustness of the proposed method. Then, experiments in both simulated and real environments need to be designed. For the simulated environment, the contour following exploration is performed on objects created with real tactile data to obtain more realistic results. On the other hand, the robotic platform for active Bayesian perception is used with the iCub fingertip sensor to extract the shape of various objects in a real environment.

## 1.4 Contributions

The principal aim of this thesis for addressing the problem of tactile perception in robotics produced the following contributions:

- A comprehensive review of the sense of touch in biology and robotics. This literature review covers investigations and advances in tactile sensor technology, perception models and tactile perception robotics, providing a better understanding about the state of the art and the gaps for the sense of touch in robotics (Chapter 2).
- The development of a robotic platform controlled by tactile feedback for the investigation of tactile perception using the active Bayesian perception approach. The robotic platform and the control framework developed permit the investigation of tactile perception with a diversity of biomimetic fingertip sensors (Chapter 3).
- Systematic and controlled collection of tactile datasets using the biomimetic iCub fingertip sensor from various stimuli. These robust tactile datasets permit the investigation of the accuracy for the development of perception methods with biomimetic fingertip sensors (Chapter 3).

- The development of a novel biologically inspired method for tactile perception with biomimetic fingertip sensors based on the active Bayesian approach. The method is based on the accumulation of evidence using an active Bayesian approach and a sequential analysis method. This approach is inspired by the results from psychophysical studies with humans for perception and decision-making (Chapter 3).
- Design and implementation of a novel sensorimotor architecture for testing the proposed biologically inspired method for tactile perception with an autonomous tactile exploration task. The tactile exploration actively controlled by the active Bayesian perception approach, is based on the contour following procedure inspired by the way that humans commonly extract object shape (Chapter 4).
- The development of two novel sensorimotor control strategies to combine experience and active Bayesian perception along the tactile exploration task. This combination permits to analyse how the amount of experience used in the active perception process affects the performance on the speed and perception accuracy (Chapter 5).
- A novel algorithm for an adaptive implementation of the proposed sensorimotor control strategies for the combination of experience and active Bayesian perception during an autonomous exploration task (Chapter 6). This method permits to observe how the amount of experience adapts according to the perception along the exploration task.
- Integration of the perception methods using iCub humanoid robot to perform object shape and size classification in collaboration with partners of the EU EFAA project for annual reviews.

## 1.5 Publications

The work developed in this thesis contributed to the following publications:

- Uriel Martinez-Hernandez, Tony J. Dodd, Mat Evans, Tony J. Prescott and Nathan F. Lepora. *Autonomous active exploration for tactile sensing in robotics*. **Submitted to** IEEE Transactions on Robotics.
- Nathan F. Lepora, Uriel Martinez-Hernandez, Mat Evans, Lorenzo Natale, Giorgio Metta and Tony J. Prescott. *Tactile hyperacuity for robotics*. **Submitted to** IEEE Transactions on Robotics.
- U. Martinez-Hernandez, T. Dodd, T. Prescott and N. Lepora. *Active Bayesian perception for angle and position discrimination with a biomimetic fingertip*. International Conference on Intelligent Robots and Systems (IROS), 2013.
- N. Lepora, U. Martinez-Hernandez, G. Pezzulo and T. Prescott. *Active Bayesian perception and reinforcement learning*. International Conference on Intelligent Robots and Systems (IROS), 2013.
- N. Lepora, U. Martinez-Hernandez, G. Pezzulo and T. Prescott. *Active Bayesian perception and reinforcement learning*. International Conference on Intelligent Robots and Systems (IROS), 2013.
- N. Lepora, U. Martinez-Hernandez and T. Prescott. *Active Bayesian perception for simultaneous object localization and identification*. Robotics: Science and Systems (RSS), 2013.
- U. Martinez-Hernandez, T. Dodd, L. Natale, G. Metta, T. Prescott, and N. Lepora. *Active contour following to explore object shape with robot touch*. IEEE International Conference on World Haptics (WHC), 2013.
- N. Lepora, U. Martinez-Hernandez, and T. Prescott. *Active touch for robust perception under position uncertainty*. In Robotics and Automation (ICRA), 2013 IEEE International Conference on, 2013.



- Stéphane Lallée, Katharina Hamann, Jasmin Steinwender, Felix Warneken, Uriel Martinez-Hernandez, Hector Barron-Gonzalez, Ugo Pattacini, Ilaria Gori, Maxime Petit, Giorgio Metta, Paul Verschure, Peter Ford Dominey. *Cooperative Human Robot Interaction Systems: IV. Communication and Shared Plans with Naive Humans using Gaze and Speech*. International Conference on Intelligent Robots and Systems (IROS), 2013.
- N. Lepora, U. Martinez-Hernandez, H. Barron-Gonzalez, M. Evans, G. Metta and T. Prescott. *Embodied hyperacuity from Bayesian perception: Shape and position discrimination with an iCub fingertip sensor*. International Conference on Intelligent Robots and Systems (IROS), 2012.
- U. Martinez-Hernandez, Nathan F. Lepora, H. Barron-Gonzalez, T.J. Dodd and T.J. Prescott. *Edge and plane classification with a biomimetic iCub fingertip sensor*. Post-Graduate Conference on Robotics and Development Of Cognition (RobotDoc). Lausanne, Switzerland, September, 2012.
- Petit, M.; Lallee, S.; Boucher, J.; Pointeau, G.; Cheminade, P.; Ognibene, D.; Chinellato, E.; Pattacini, U.; Gori, I.; Martinez-Hernandez, U.; Barron-Gonzalez, H.; Inderbitzin, M.; Luvizotto, A.; Vouloutsi, V.; Demiris, Y.; Metta, G.; Dominey, P. *The Coordinating Role of Language in Real-Time Multi-Modal Learning of Cooperative Tasks*. IEEE Transactions on Autonomous Mental Development, 2012.
- Uriel Martinez-Hernandez, H. Barron-Gonzalez, M. Evans, N. Lepora, T. Dodd and T. Prescott. *Texture classification through tactile sensing*. Lecture Notes in Artificial Intelligence (Living Machines), Biomimetic and Biohybrid Systems, Springer, 2012.
- H. Barron-Gonzalez, N. Lepora, U. Martinez-Hernandez, M. Evans and T. Prescott. *Towards a framework for tactile perception in social robotics*. Lecture Notes in Artificial Intelligence (Living Machines), Biomimetic and Biohybrid Systems, Springer, 2012.

## 1.6 Outline

The rest of the thesis is organised in the six chapters as follows:

- Chapter 2 provides a comprehensive review of the sense of touch from the point of view of biology and robotics. First, a general description of the sense of touch in humans and animals is covered. This is followed by the description of passive and active perception modalities used in the tactile sensing process. The models for the decision-making process from psychophysical studies are also presented. Then, the state-of-the-art on tactile sensing in the field of robotics is presented, which includes tactile sensor technologies, tactile perception and exploration methods using robotic hands and fingertips.
- Chapter 3 presents the proposed Bayesian perception approach for tactile perception using the sense of touch in robotics. This method is inspired by the way that humans accumulate evidence to reduce uncertainty from the tactile measurements. The modules that compose the proposed perception method are also described. The passive and active characteristics of sensation and perception are also integrated with the proposed Bayesian perception method and tested in a simulated environment. The superiority and benefits of active over passive perception with the Bayesian approach are analysed in terms of the performance in speed and perception accuracy.
- Chapter 4 presents a tactile exploration task inspired by how humans extract object shape based on the contour following exploratory procedure. This task is implemented using the proposed method to actively interact with the environment, perceive, make decisions and actions to successfully accomplish the exploration task. The development of the sensorimotor architecture used for the control of the biomimetic fingertip is also presented. The analysis of the performance in speed and accuracy of the proposed method is presented as well as the contour extracted by both

passive and active perception modalities. The experiments performed in this chapter are tested in both simulated and real environments.

- Chapter 5 presents the analysis of the effects on speed and accuracy when the experience acquired along an exploration task is combined with active Bayesian perception. This investigation is inspired by psychophysical studies where experience, used as a weighted prior, is provided to humans in order to observe how the speed and accuracy in their decisions are affected. Two proposed sensorimotor control strategies are presented to investigate how the amount of experience affects the speed and accuracy of the Bayesian perception approach along an exploration task. The proposed strategies are based on the inclusion of a weighted prior and a weighted posterior controlled by a confidence factor and a forward model. For this analysis, the forward model used for prediction of the sensory observations during the tactile exploration task is assumed to be known.
- Chapter 6 presents an online adaptive approach to improve the performance in speed and accuracy with both sensorimotor control strategies described in Chapter 5. This approach, through the use of a forward model, predicts the tactile observations which are combined with the active Bayesian perception method. The combination is weighted based on a confidence factor that is adapted according to the reliability of the perception process and the forward model. This method permits to improve the speed and perception accuracy for the decision-making process over the results obtained in previous chapters for the contour following exploration task of an object.
- Chapter 7 summarises the work and experiments performed in this thesis. The general conclusions for the proposed active Bayesian perception method and its combinations with the proposed sensorimotor control strategies are provided. The benefits of using the proposed method for tactile perception and exploration with the sense of touch in the field of robotics are described.



# Chapter 2

## The Sense of Touch

Humans and animals have adapted and evolved their sensing modalities or sensory systems to be aware of the state of their environment which continually changes with time. In humans, and in most animals, there exist five specialised senses –touch, sight, taste, hearing and smell– that are used together for a complete understanding of the environment. The information available from the environment is received and interpreted in a specific manner according to the senses triggered (Delius, 1987). For many decades, vision or sight has been the most widely studied sense even though touch is the most primordial sense that allows humans and animals to construct a physical representation of the world by investigating directly with their bodies (O’Shaughnessy, 1989). Psychophysical experiments have demonstrated that the sense of touch permits to feel directly the environment based on the temperature, texture, shape, force, pain and other physical properties (Dargahi and Najarian, 2004; Lederman and Klatzky, 2009). Moreover, the impact of the sense of touch is not only limited to physical contact but also presents important psychological effects to humans and their relations (Fisher et al., 1976; Najarian et al., 2009).

Motivated by this, researchers from the field of robotics have put significant effort into building intelligent systems capable of interacting with their surrounding environment using the artificial sense of touch. This has also encouraged the development of sophisticated artificial tactile sensor technologies to be integrated in a wide variety of robots (Nicholls and Lee, 1989; Lee, 2000), which has opened a large possibility of research in tactile robotics. Most of the

investigations have been focused on tactile exploration using robotic hands and fingers inspired by how humans explore and interact with the world (Stansfield, 1986; Lederman and Klatzky, 1987). This would allow robots to know the state of the environment by directly interacting with it. Despite the progress and achievements in tactile robotics, there is still a long road ahead to have autonomous robots making use of the sense of touch as humans do.

The aim of this chapter is to provide a description of the sense of touch in biology and its implementation in robotics. First, in Section 2.1 an introduction to the importance of the sense of touch in biology is presented. Descriptions of the sense of touch in humans and the animal kingdom are presented in Section 2.1.1 and Section 2.1.2 respectively. Second, the definition and components of tactile sensing are presented in Section 2.2. Section 2.2.1 and Section 2.2.2 introduce passive and active touch modalities. The decision-making process in humans is describe in Section 2.3. Then, the impact and importance of the sense of touch in robots are presented in Section 2.4. Next, the different tactile sensor technologies developed for robotics are mentioned in Section 2.4.1. Section 2.4.2 presents a review of the implementation of the artificial tactile sensing for exploration and recognition in robotics. Finally, Section 2.5 presents the conclusions of the sense of touch and its impact for the design and development in the field of robotics.

## **2.1 The sense of touch in biology**

This section describes the importance of the sense of touch, the characteristics of the different parts involved in the process of sensing and their functionality from the initial tactile contact through to the signals arriving to the brain. Then, an introduction to the different modalities of the sense of touch used by some species of the animal kingdom under different environments is presented.

### 2.1.1 Sense of touch in humans

Touch is located in our skin which is the largest sensory organ, covering the whole body. It is a versatile sensory organ that protects us against foreign agents and physical injury. It also regulates the body temperature, helps to regulate the blood pressure, holds vital body fluids, permits feeling of the external environment and provides a way of physical communication with people. However, touch is commonly underrated even though it is probably the most primordial sense given that it allows humans to feel and construct a physical representation of the world (O'Shaughnessy, 1989).

The sense of touch is really important and its loss would be reflected in the loss of the ability for dexterous hand manipulation, tactile perception, control of movements, knowledge of limbs position and in general the absence of any physical stimuli from the world (Robles-De-La-Torre, 2006). Two cases of loss of the sense of touch demonstrate the catastrophic results, removing the ability to control the limb movements, speaking, chewing and feeling physical contact from the exterior (Cole and Paillard, 1995).

The sensations from the environment start by contacting the skin which is embedded with a variety of nerve endings responsible for the registration of different stimuli from external changes. These nerve endings or receptors are classified as mechanoreceptors (pressure and vibration), nociceptors (pain) and thermoreceptors (temperature) (Dargahi and Najarian, 2004). There are approximately fifty receptors for every  $100\text{mm}^2$  of skin forming about five million sensory receptors over the whole body (Johansson and Westling, 1984). The mechanoreceptors provide a larger contribution to register mechanical disturbances in our skin and four types –Pacian corpuscles, Meissner's corpuscles, Merkel's discs and Ruffini cylinders– are embedded all over the skin where each responds to a specific stimuli (Dargahi and Najarian, 2004). Figure 2.1a shows a cross section of the skin with the different types of mechanoreceptors.

The sensitivity to stimuli from mechanical deformation on the skin is related to the number of touch receptors and their receptive field size, with the sensitivity inversely proportional to the size of the receptive field. Touch re-

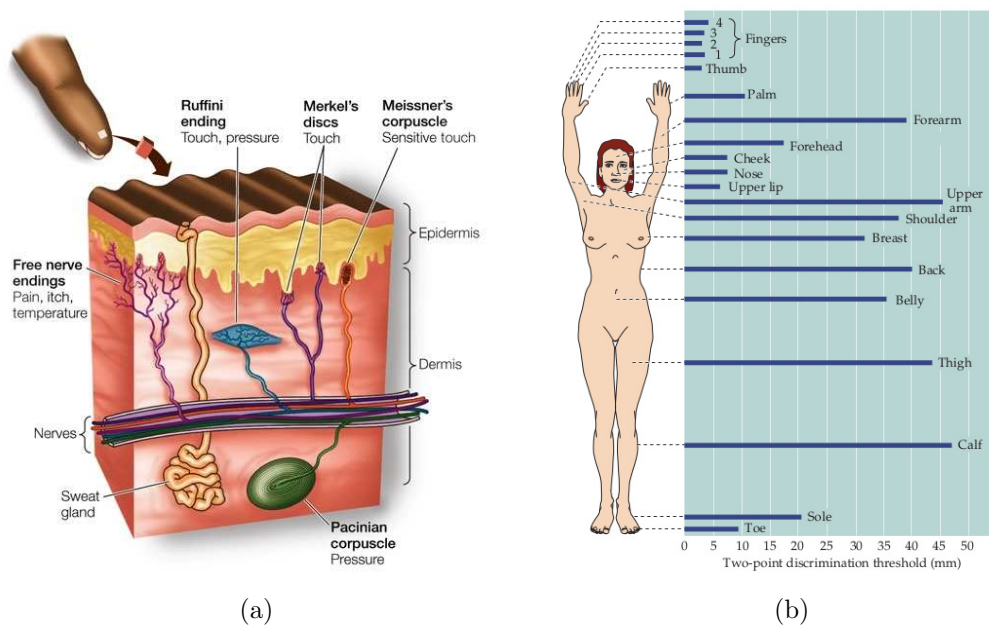

Figure 2.1: (a) Types of mechanoreceptors embedded in the skin used to register specific stimuli (Source: Life: The science of biology). (b) Measure of the sensitivity of different areas of the body based on the two-point discrimination experiment.

ceptors are not evenly distributed in our skin and the fingertips, lips and palms are the most dense areas occupied by mechanoreceptors with small receptive fields. For these reasons, fingertips, composed of a large number of receptors with small receptive field, are the most sensitive areas of the body (Vallbo et al., 1984; Johansson and Flanagan, 2009). The measurement of the sensitivity of the different areas of the body has been undertaken with the two-point discrimination experiment, that detects the smallest separation of two points of stimulation that humans are able to distinguish (Figure 2.1b).

Human sense of touch depends on mechanoreceptors to detect and react to deformations of the skin from contact with external objects. However, humans also depend on the feedback of the internal state of the body provided by the proprioceptive sensory system. Proprioception is located in muscles, tendons and joints and allows us to know the relative angle and position of our limbs. This sensory system has demonstrated to be important for instance, during reaching or grasping tasks with the hands and fingers (Bossom, 1974; Gentilucci et al., 1997).



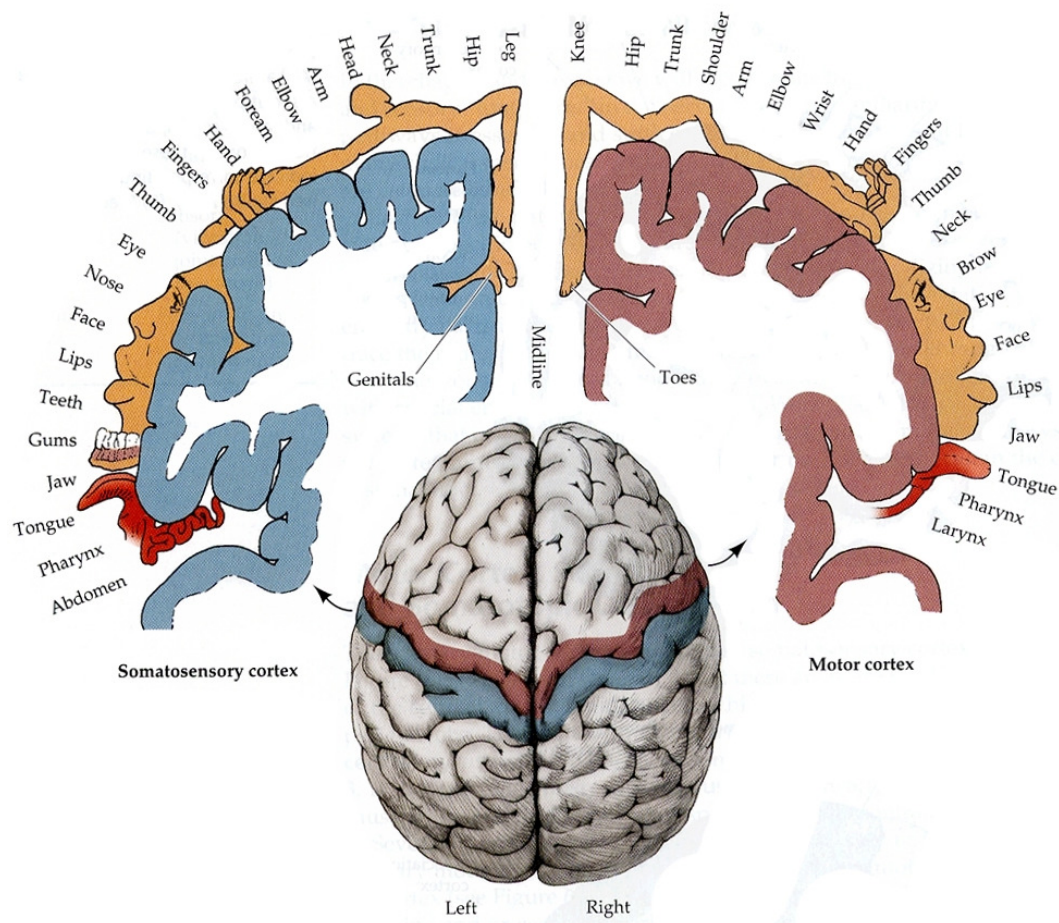

Figure 2.2: Human brain with somatosensory (blue) and primary motor (brown) cortex highlighted. The somatosensory cortex receives and processes the stimuli from touch receptors in the skin. The primary motor cortex sends back the appropriate signals to the different areas of the body. The homunculus (top) shows the sensitivity differences for each part of the body, being the fingers, lips and palms the most sensitive.

The sensory information generated by touch receptors in the skin is sent to the brain passing first through the spinal cord. The somatosensory cortex is the area of the brain that receives the stimulations from the skin (blue region in Figure 2.2). Each area of the skin is projected in specific regions of the somatosensory cortex. Moreover, some areas such as fingertips, lips and palms are represented by larger areas in the sensorimotor cortex since they are more densely embedded with touch receptors. Once the stimuli that arrive to the somatosensory cortex are processed, the corresponding signals are sent back from the primary-motor cortex in the brain to control the different areas of

the body (brown region in Figure 2.2).

Taking into account all the characteristics aforementioned, it is clear that human hands and fingertips in conjunction with proprioception, provide an important, sophisticated and ideal biological tactile sensor for exploration, manipulation, interaction and learning of the state of the world.

### **2.1.2 Sense of touch in animals**

The sense of touch is not only essential for humans but also in the animal kingdom it is of vital importance. Animals need to assess and explore their environment to search for food, communicate or simply to survive from predators. They feel the environment using their sense of touch according to their morphology. For instance whiskers, antennae and spider webs are some examples of different modalities of touch used by animals.

Rats are better at exploring and detecting objects using their sense of touch based on whiskers or vibrissae than vision. This is a sophisticated sense of touch that allows rats to perform successful exploration in darkness. Exploration of their environment by repetitively moving their whiskers back and forth is known as ‘whisking’ (Diamond et al., 2008a,b; Mitchinson et al., 2011). Also they can control the speed of the whisking behaviour and direct the head to the most interesting location for exploration.

Seals are another example of a sophisticated vibrissal system for accurate underwater exploration. They are able to register sensations even under cold temperatures, contrary to humans that for low temperatures lose their tactile sensitivity. Seals possess an adaptation system, allowing them to explore under extreme thermal conditions (Dehnhardt et al., 1998).

Star-nosed moles that live in tunnels completely rely on their sense of touch by moving the tactile ‘star’ when searching for food or exploring the environment (Catania, 1999). They usually touch an object of interest several times and eat it if this is recognised as prey. Similar behaviour has been observed with moles without tactile ‘star’, where instead they perform a tapping proce-

ture with their nose against the object.

Spiders have a specialised sense of touch based on vibrations generated in their webs. It has been observed that their behaviour can be guided and controlled by vibrations from their webs (Barth, 1998). The different properties of the vibrations can inform the spiders about what is happening around them, for instance distinguishing between a prey trapped in the web or simply a vibration generated by the wind. Generation of specific vibrations are also used by spiders to communicate with each other across their webs.

The animal kingdom shows that not only human hands and fingers are an ideal tactile sensor but also, there exist a wide variety of specialised tactile sensors that animals use under different environments and weather conditions where human sense of touch simply does not work properly. The next section describes the tactile sensing process performed by humans in passive and active modalities to measure tactile sensitivity and tactile exploration respectively.

## **2.2 Tactile sensing**

The process of receiving stimuli from mechanical deformations on the skin originating from the external environment is known as tactile sensing. Tactile sensing gives humans and animals the capability of recognising physical properties from objects (Najarian et al., 2009). As aforementioned, humans not only use touch receptors but also proprioception for dynamic exploration and interaction with the world. This brings out, similar to other sensing modalities, a separation of the sensing process into passive and active sensing (Gibson, 1962). These sensing modalities are described in the following sections.

### **2.2.1 Passive sensing**

The recognition task of an object using the hand and fingers, where either the person or the object are not able to move, is known as passive sensing (Gibson, 1962). This means that the exploration of the object by moving hands and

fingers to extract more information is not allowed. This makes the recognition of an object a slow and difficult process with low accuracy. For instance, very low perception accuracy was observed in an experiment for shape recognition where human index fingertip, based on passive sensing, was not allowed to move (Smith et al., 2009). The low accuracy obtained is related to the impossibility to collect more information for reducing uncertainty about the shape of interest. Recognition of three different shapes (bump, hole and flat) was affected by disabling fingertip movements based on an apparatus to keep fixed the arm, wrist and finger (Robles-De-La-Torre and Hayward, 2001). The low accuracy achieved with passive sensing is also related to the small number of mechanoreceptors activated due to the static stimuli (Chapman, 1994). However, there is still controversy about the robustness and evidence provided from the experiments that initially presented passive perception as a low performance and atypical sensing process (Lederman, 1981).

Researchers instead, have focused on the used of passive sensing for measuring thresholds of a static skin contact and determine how the sensitivity differs in each part of the body (Weinstein, 1968; Loomis and Collins, 1978). These measurements have been widely studied with two experiments: a) *absolute threshold* that detects when something has touched the skin; and b) *two-point discrimination threshold* that measures the minimum distance for detecting two simultaneous contact stimulations on the skin. Figure 2.1b shows the sensitivity of different parts of the body obtained from the *two-point discrimination threshold* experiment.

For these reasons, passive sensing is not suitable for exploration and recognition using the sense of touch. However, the controversy of the experiments that suggested the low performance of passive sensing, motivated this work to undertake an investigation of its performance in two scenarios: 1) maximum perception accuracy achieved with a large tactile dataset; and 2) implementation of a tactile exploratory procedure using a biomimetic tactile sensor, and supporting the idea initially provided in (Gibson, 1962).

### 2.2.2 Active sensing

Active sensing, in contrast to the passive sensing modality, refers to the ability to make voluntary movements, e.g. moving the hands and fingers, during the exploration of an object (Gibson, 1962). Humans and animals tend to move or direct their senses purposely to obtain more information about an object or event in the world. For instance, normally we move our eyes, hands and direct our ears to accumulate and gain more knowledge from the interaction with the world. Therefore, sensing is considered to be an active process rather than passive one (Prescott et al., 2011), and this has been experimented under various scenarios probing the superiority of active over passive sensing for object exploration and recognition (Lederman et al., 1988; Chapman, 1994; Robles-De-La-Torre and Hayward, 2001).

For an object recognition process, it has been identified that humans make use of a set of exploratory procedures based on predefined hand and fingertip movements related to the information of interest from the object (Lederman and Klatzky, 1987, 1993). Figure 2.3 shows these exploratory procedures performed by humans. For instance, lateral motion, squeezing and contour following are used to extract information about texture, hardness and shape.

These exploratory movement patterns are an application of active sensing where humans normally perform a certain number of deliberate contacts and movements to extract the information of interest. Another characteristic of these exploratory movements is their invariability with respect to the object to be explored. Psychophysical experiments have demonstrated that active sensing allows humans to achieve high accuracy for the recognition of object properties such as shape, texture and hardness through the exploration with the hand and fingers (Lederman and Klatzky, 1987; Robles-De-La-Torre and Hayward, 2001; Smith et al., 2009).

In the animal kingdom, the active sensing modality is also clearly observed on rats and star-nose moles. Rats tend to direct their whisker towards an object of interest, varying also the speed of the whisking to extract more information during an exploration behaviour (Grant et al., 2009; Mitchinson et al., 2011).

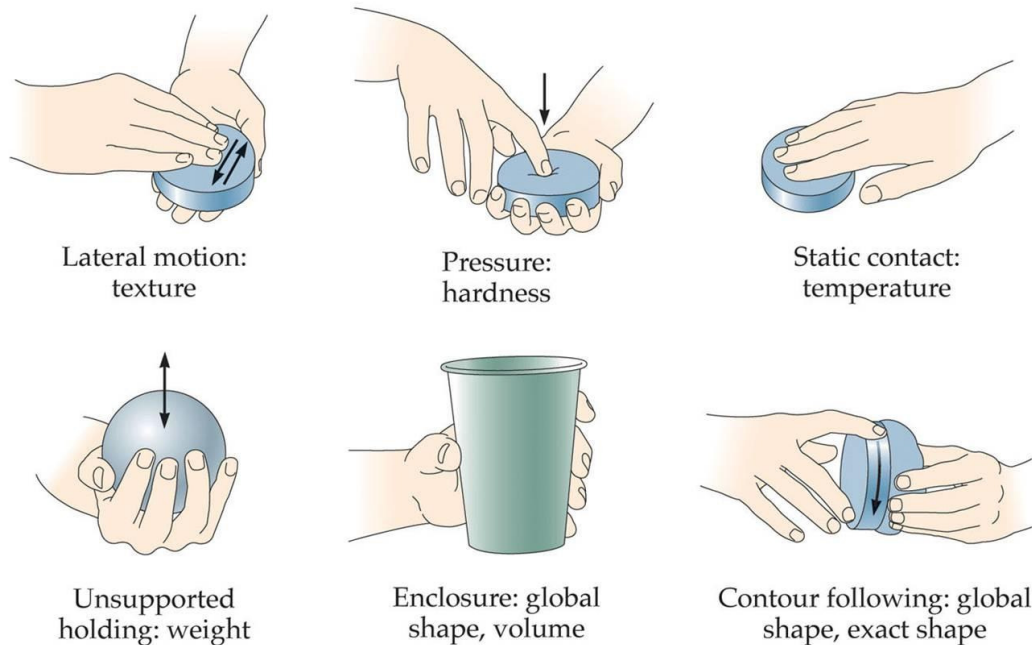

Figure 2.3: Human exploratory procedures used for extraction and recognition of object properties. These movement patterns are related to the information required for recognising the object being explored (Source: Sensation & Perception).

Similarly, star-nose moles move their ‘stars’ towards an object and control the whisking in order to recognise the object being explored (Catania, 2011). These works show that active sensing allows to acquired interesting information to increase accuracy during an exploration and recognition process.

The exploratory procedures performed by humans during an exploration task in conjunction with active sensing provide an efficient and natural method for object recognition based on the extraction of properties. This has motivated the study and comparison of a tactile exploratory procedure using active and passive sensing modalities implemented in a robot equipped with a biomimetic fingertip sensor (see Section 3.5).

The decisions made by humans are based on the evidence that they have collected through the interaction with an object or observation of a certain event. Two models developed for describing how these decisions are made are presented in the next section.

## 2.3 Biological decision-making process

Decision-making is another component that humans use during an exploration procedure. Decision-making, based on the sensing and perception processes, is responsible for making the correspondent decisions between a set of alternatives. Studies from neuroscience and psychology have shown that decisions are based on the accumulation of evidence from certain events (Smith and Ratcliff, 2004; Shadlen and Roskies, 2012). In Psychology, two models have been used to explain the functioning of the accumulation of the evidence for a decision-making process. The first model, known as ‘*competing accumulators*’, determines that a decision should be made once an alternative has exceeded a decision threshold through the evidence accumulated for a certain time. On the other hand, the ‘*diffusion*’ model says that a decision should be made once the difference between the winning alternative and the losing alternative has exceeded a decision threshold (Bogacz, 2007). A description of both decision-making models are shown in Figure 2.4.

Normally, speed and accuracy are the criteria used to determine the threshold for a decision-making process. Typically, during an exploration task, the requirement of highly accurate decisions will increase the time required to make a decision, whilst faster decisions will compromise their accuracy (Shadlen and Roskies, 2012). The speed and accuracy trade-off needs to be tuned to obtain an optimal performance from the decision-making process. However, how to define this criteria is not currently known and some works have proposed the adjustment of speed and accuracy based on 1) rewards and punishments associated with success and failure of certain task (Sugrue et al., 2005); and 2) the use of prior knowledge about the most likely alternative when new evidence is not available (Hanks et al., 2011).

These reasons have motivated the investigation of the effects of the speed and accuracy trade-off during an exploration task with a tactile robot (see Chapter 5). Two methods for analysing the speed and accuracy criteria based on 1) weighted prior; and 2) weighted posterior are introduced and imple-

**A** ‘Diffusion’**B** ‘Competing accumulators’

Figure 2.4: Decision-making models based on the accumulation of evidence. A) ‘*Diffusion*’ model accumulates evidence from the difference between the winning and losing alternatives. Once this difference exceeds the threshold a decision is made. B) ‘*Competing accumulators*’ model makes a decision as soon as the accumulated evidence from one of the alternatives exceeds a threshold.

mented with a tactile exploration procedure.

At this stage, a description of the sense of touch, the tactile sensing modalities and the decision-making process have been introduced. An exploration procedure using the sense of touch can be summarised as follows: the exploration starts with sensations based on stimuli produced by mechanical deformation of the skin. These sensations, registered by mechanoreceptors, are sent to the spinal cord which is responsible for forwarding the signals to the somatosensory cortex. In this region of the brain, signals from tactile sensing are processed and sent to the primary-motor cortex region which is responsible for generating the corresponding action commands for the body. The generation of these commands is based on the output from the decision-making process that governs the actions performed by humans.

The sense of touch in humans and animals has motivated researchers in the design, fabrication and integration of artificial sense of touch in robots. This has opened up a wide range of opportunities for investigations on decision-

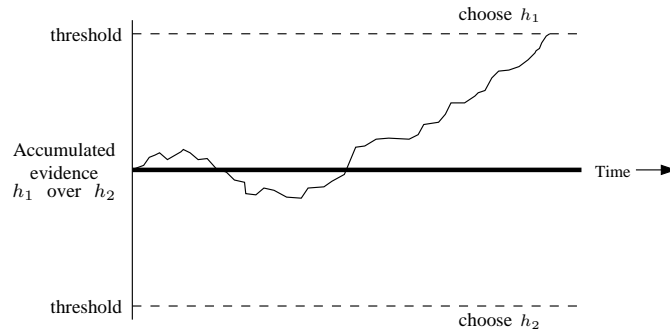
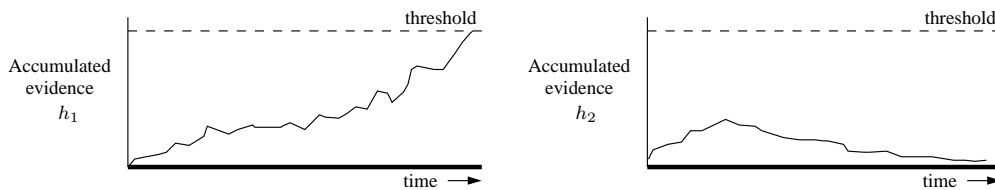

making, exploration and interaction with robots by means of tactile sensing. In the following sections, a review of the artificial sense of touch and their different technologies are presented. Moreover, a description of the integration of artificial sense of touch in robotics is provided, covering applications for tactile exploration, recognition and interaction.

## 2.4 The sense of touch in robotics

Robotics research and design paradigms have changed and evolved over time to solve the necessities of society. Initially, robots were designed to perform specific and repetitive tasks in industry without the intervention of humans (Garcia et al., 2007). These robots did not require knowledge about the current state of their surrounding environment. However, in the 1980s robotics was defined as the science for studying perception, action and their intelligent connection between them (Siciliano and Khatib, 2008). This paradigm shifted robotics research by boosting the development of methods for building safe, flexible and adaptable biologically inspired robots capable to explore and interact with humans and their surrounding environment.

Since biologically inspired robots are expected to explore and interact with their environment, simulating the way that humans and animals do it, they need to be equipped with artificial senses. This would permit robots to observe and understand the state of the world from different modalities (Dahiya et al., 2010). The inspiration from biology for the integration of artificial senses in robots has provided different robust modalities for data collection, exploration and interaction with the world. Most of these advances have been provided by the integration of artificial vision. However, tactile perception based on the integration of the artificial sense of touch is the sensing modality that currently fails to match the capabilities that it provides to humans and animals for feeling and interacting with their environment (Prescott et al., 2009).

For that reason, the study, integration and understanding of the sense of touch is of vital importance in robotics, for enabling them to understand

their surrounding environment by feeling, exploring and interacting. Motivated by this and the vast capabilities that the sense of touch is able to provide, the integration of the artificial sense of touch in a wide variety of robots is growing rapidly. This has also opened the possibility for investigations related to perception, decision-making, exploration, interaction and learning under a large variety of applications.

The integration and understanding of the artificial sense of touch in robotics which is undoubtedly required, will contribute to the achievement of the design and development of autonomous robots able to safely co-habit with humans.

In the following sections, first a description of various artificial tactile sensor technologies and their integration in different robots is presented (Section 2.4.1). Then, Section 2.4.2 provides a description of the different algorithms developed for analysing tactile data under a wide variety of applications.

### **2.4.1 Artificial tactile sensor technologies**

Integration of the sense of touch in robots provides, similar to humans, a natural way for knowing the state of the changing environment. Specifically, robotic hands and fingertips covered with artificial skin offer a sophisticated tool for feeling, grasping and manipulating objects, bodies and tools (Jayawant, 1989). The study and development of artificial tactile sensor technologies have received attention since the 1980s, growing rapidly and making available a wide variety of sensors and tactile data processing methods. However, developments in hardware and software for tactile sensing appear to be very much in their infancy, compared with the advances achieved in artificial vision (Lee, 2000). Some reasons for this are the complexity of the sense of touch, the need of physical interaction, the diversity of touch receptors embedded in the skin, and the characteristics that it needs to incorporate such as robustness, reliability, correct friction, very low forces detection, stable, durable and resistant to repeated impacts against objects (Nicholls and Lee, 1989).

In general, the tactile sensor technologies developed since the 1980s can

be divided into piezoelectric, capacitive, inductive, resistive, optical and magnetic sensors. Each of these technologies that implements specific transduction methods are used for detection of specific stimuli.

### **Capacitive sensors**

Capacitive sensor technology is one of the oldest and most popular transduction methods used in robotics. These capacitive sensors, generally composed of two conductors separated by a dielectric material, can be constructed with very small dimensions (Schmitz et al., 2010b), providing the possibility to build relatively large tactile sensor arrays. Normally this technology is used to detect and measure pressure contact with the exterior. Some drawbacks of this technology are the hysteresis and low time stability, however, usually they offer high accuracy and flexibility for implementation (Tegin and Wikander, 2005). Capacitive sensors can be found in various robots, for example, the iCub humanoid robot (see Figure 2.5) was initially equipped with artificial skin in its fingertips and palms and currently it also has been covered with artificial skin in torso, arms and forearms (Schmitz et al., 2010a, 2011). This converts the iCub humanoid robot into a flexible and reliable open platform for the study of tactile perception and interaction with its surrounding environment (Maiolino et al., 2012). Various robotic arms and hands integrated with artificial tactile sensor based on capacitive technology can be found for the investigation of exploration and recognition (Son et al., 1996; Schneider et al., 2009). These works demonstrate that this sensor technology permits the detection of a variety of properties such as hardness and shape based on physical interaction with the object.

### **Force sensors**

Commonly, robotic arms, hands and fingertips are also integrated with force sensors located in their joints. Force sensors normally are built with strain gauges mounted on a robust metal flexure (Salisbury Jr, 1984). This sensor

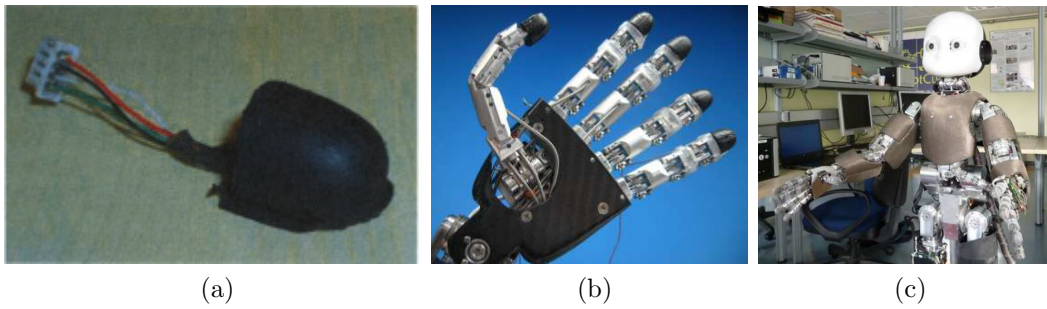

Figure 2.5: (a) Capacitive sensor fabricated for a biomimetic fingertip sensor. (b) iCub hand integrated with biomimetic fingertip sensor. (c) iCub humanoid covered with artificial skin in torso, arms, forearms, palms and fingertips.

technology is observed in a three-fingered robotic hand with force sensor located in its fingers, which permits a more reliable control during a contact detection procedure (Dang et al., 2011). The robotic arm in (Chen et al., 1995b) is equipped with force sensors capable of maintaining a soft and continuous contact with object surfaces. A force sensor integrated in a robotic platform, for the development of a tactile servoing framework, permitted the control of contact position (Zhang and Chen, 2000). The gradual design and integration of pressure and force sensors in prosthetic hands have permitted to mimic the natural motion and contact detection observed in humans (Carrozza et al., 2003; Zollo et al., 2007). In general, the combination of pressure and force sensor technologies permits a more natural contact detection which also are important for a robust control and avoidance of possible damages.

### **Piezoelectric sensors**

Transduction from applied stress or force into an electric voltage can be achieved by piezoelectric sensor technology. Piezoelectric sensors are very sensitive to vibrations producing also high output voltages which makes it a good technology for applications of slip detection (Howe and Cutkosky, 1993). However, this sensor has shown to provide better response to dynamic stress or forces given that the output voltage tends to decrease over time (Puangmali et al., 2008). In (Hosoda et al., 2006) a biomimetic fingertip sensor inspired

by human fingertips was built with piezoelectric technology showing robust detection for lateral motions and pushing against various materials. However, the random location of touch receptors inside the fingertip made it difficult to know the contact location which is required for tactile exploration. This sensor technology was tested with a five-fingered robotic hand in (Takamuku et al., 2007). In this work, hardness and texture properties were obtained based on stereotyped exploratory procedures such as squeezing and tapping, showing reasonable accuracy for a small number of objects.

### **Optical sensors**

Optical sensor technology is based on light emitters and receivers normally used for contact detection and obstacle avoidance. This technology also provides a solution for the wiring complexity problem presented in other sensor technologies (Yousef et al., 2011). The three-fingered robotic hand in (Hsiao et al., 2009) is equipped with optical sensors for measuring the proximity during contacting an object. A transparent fingertip built with plastic optical fibres presents a complete optical touch system (Yamada et al., 2005). This fingertip detects tactile contact when the light transmitted by the optical fibres is reflected, modifying the amount and angle of light received. Sub-millimetre resolution is another property of this sensor technology that was demonstrated in this optical fingertip sensor. Two planar sensor arrays composed by optical fibres and designed for dexterous manipulation are described in (Begej, 1988). The first sensor was composed of a  $32 \times 32$  planar sensor array, whilst the second sensor composed by 169 taxels was designed inspired by the shape of human fingertips. These sensors connected to a display were able to show the shape of various objects, under the constraint that the object needs to be smaller than the dimensions of the tactile sensor. This sensor technology cannot be built in very small dimensions due to the need of light emitters and receivers. However, the information from objects based on variations in the reflectance of the light permits applications for detection of presence, position,

texture recognition and colour (Najarian et al., 2009).

### **Binary sensors**

Contact detection based on discrete values (*On/Off*) is normally implemented with binary sensor technology built with contact switches (Webster, 1988). The integration of this technology observed in a five-fingered robotic hand (Figure 2.6) designed for prosthetic applications emulates the behaviour of the mechanoreceptors (Edin et al., 2006). The binary sensors located in the fingertips permit to detect if there is (*On*) or there is not (*Off*) a contact and then, react to external stimuli. The study presented in (Tajima et al., 2002) proposed a method to overcome the limitation of the binary sensor technology, to work with only two discrete values, by implementing a multi-level binary sensor array. This approach, fabricated with a flexible circuit board and implemented on the torso of a humanoid robot, was able to detect different contact pressure values according to the sensor array levels activated. Binary sensor technology is a simple approach and has been implemented in some robots, however, it has not been as popular as other sensor technologies given its limitation in resolution and accurate magnitude of contact forces.

### **Hall-effect sensors**

Artificial sense of touch, biologically inspired by animals, also has demonstrated advances in tactile sensor technology for different robots. Robotic whiskers based on Hall effect sensor technology were developed in (Pearson et al., 2007; Sullivan et al., 2012). The integration of this sensor in a rat-like robot with a controlled whisking movement was able to perceive different stimuli (Figures 2.7a and 2.7c) . An artificial whisker based on an electrostatic sound sensor was built to actively explore a variety of sandpapers (Lungarella et al., 2002). In this work, the active sensing modality was provided by a rotating cylinder holding different sandpapers, whilst the whisker was contact-

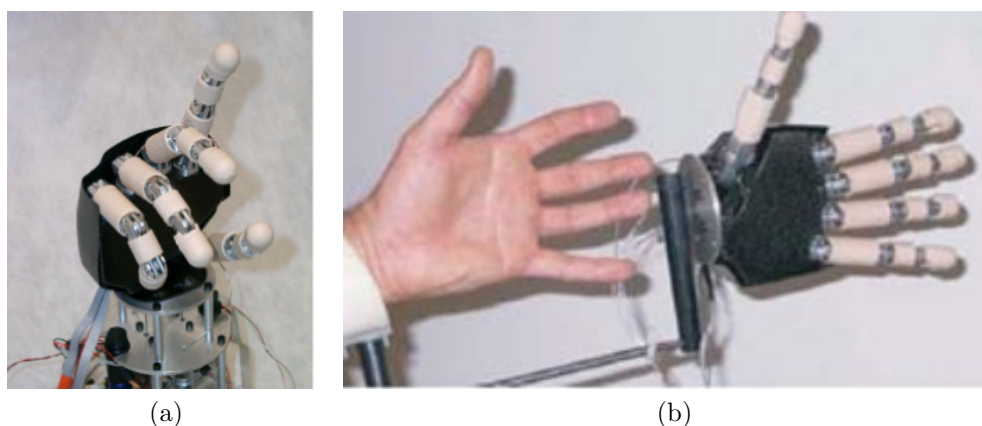

Figure 2.6: (a) Prosthetic hand designed with binary touch sensor technology that emulates the mechanoreceptors located in human hands. (b) Similarity of shape and size between prosthetic and human hand.

ing the different materials passively. However, this sensor was able to extract some properties from textures. A mouse-like robot integrated with artificial whiskers is presented in (Fend et al., 2005), performing wall following and obstacle avoidance behaviour with passive tactile modality. Touch sensing from insects has also motivated the development of artificial antennae for detection and exploration. A work of gradual development of active antennae composed of torque sensors, joint position sensors and actuators is observed in (Kaneko, 1994; Ueno and Kaneko, 1994). Figure 2.7b shows this artificial sensor, which demonstrated to be an accurate contact location tool (position and angle) against an object on the 2D plane. The detection was inspired by the active exploration behaviour performed by insects (Kaneko et al., 1998).

More recently, research in the field of underwater robotics has been inspired by the whiskers from seals given that they have demonstrated to be a robust and sophisticated tactile sensor under extreme thermal conditions. In (Beem et al., 2013) an artificial seal's whisker was fabricated with bend sensors generating output voltages related to the force of bending. This whisker sensor was calibrated in a tank and tested in the sea proving to be a good tactile sensor for angle flow detection with passive sensing modality. Fluid motion, angle and wake detection were achieved by an artificial whisker inspired by marine animals (Eberhardt et al., 2011). This sensor was built with a capacitive

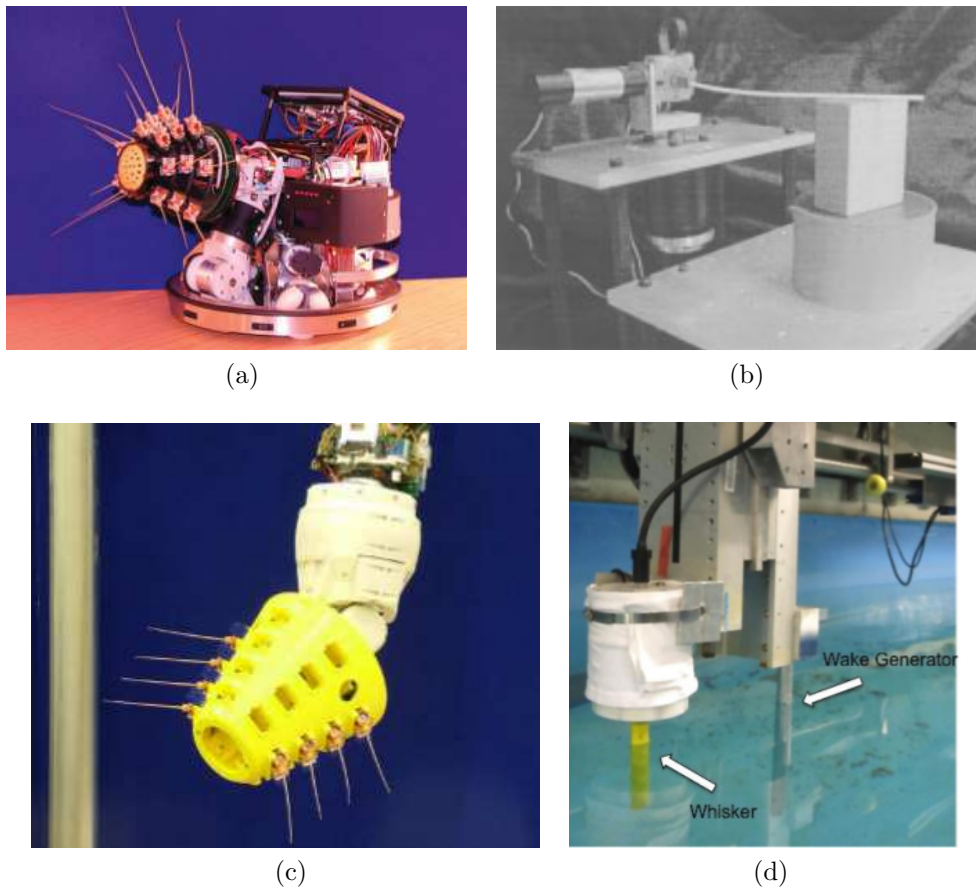

Figure 2.7: (a) Mobile rat-like robot with whiskers using the Hall effect sensor technology. (b) Robotic antenna based on torque and joint position sensors. (c) Robotic arms equipped with robotic whiskers. (d) Artificial harbour's seal whisker using bend sensors to measure fluid motion.

technology, and despite the corrosion observed in the plates of the capacitor and the limit range of frequencies detected, it was shown to be reliable for monitoring fluid motion fluctuations in four possible directions (Figure 2.7d).

The description of the advances in different tactile sensor technologies, motivated by humans and animals, demonstrate that researchers are paying more attention to the study, development and improvement of the artificial sense of touch. Despite these technological advances, touch sensing is still in its early stage compared to the advances achieved in vision. Therefore, the study for a better understanding of the sense of touch and robust data processing models for tactile exploration and interaction are still needed. However, some robots, specifically the iCub humanoid robot that is equipped with artificial skin in fin-



gertips, palms, torso, arms and forearms make it an ideal platform for the study of human tactile sense of touch. Moreover, this humanoid robot is integrated with biomimetic sensors that for example, its robotic fingertips resemble the shape and size of humans fingertips. For those reasons, this humanoid robot has also opened up a large possibility for investigations on human behaviour and interaction models. Thus, the production of robust models biologically inspired by humans and animals will permit to achieve reliable, safe design and development of robots, capable to co-habit with humans.

Although artificial sense of touch has been integrated in different robots for exploration and recognition, the development of robust methods for tactile data processing are still a major research challenge. These methods are required to give meaning to the tactile stimuli from the environment which commonly are used for discrimination and exploration tasks to know the changing state of the surrounding environment. A review of different artificial intelligence methods used to provide meaning to the tactile data obtained from the artificial skin is presented in the following section.

## 2.4.2 Tactile exploration

Integration of artificial tactile sensors in robots has opened the possibility to undertake a wide variety of investigations on tactile exploration, recognition and decision-making models. For this reason, different methods for tactile data processing have been developed in both simulation and real environments, giving meaning to the external stimuli detected with artificial skin. The investigations based on these tactile data processing methods have been focused mainly on the study of exploratory procedures –sliding, tapping, contour following, squeezing– with robotic hand and fingertip sensors inspired by the way that humans perform object exploration. Similarly, inspiration from the whisking performed by rodents has led to the development of robotic platforms for the study of exploration procedures with artificial whiskers.

### **Tactile primitives**

An initial study on tactile primitives and exploratory procedures for robotics was presented in (Stansfield, 1986). In this work, a set of algorithms for detection of tactile contact, edge, corner and texture were proposed for the implementation of exploratory procedures such as contour following with a robotic planar tactile sensor array. However, these algorithms for feature detection were based on simple activation of specific taxel patterns without any other processing method, making this approach not completely suitable for autonomous robots where noise and other external factors affect the tactile data. These tactile primitives were taken as the foundation for a recognition task by means of properties extracted using robotic fingertips (Bajcsy et al., 1987). Unfortunately, there is not a detailed description of the implementation, control and results of the tactile primitives.

### **Edge detection and tracking**

Edge detection and tracking is an essential task required to develop robotic tactile sensor systems capable to explore and extract object shapes whilst following their contours. This procedure, known as *contour following*, is one of the most common exploratory procedures used by humans. One of the first works on edge detection using planar tactile sensors and image processing techniques was implemented in (Muthukrishnan et al., 1987). The method proposed was based on the segmentation of grey scale images by the application of Sobel and Roberts filters to tactile images acquired from the planar sensor array. Results showed the possibility to extract the edge of various objects. However, this method presents some drawbacks: 1) it is completely inspired by vision sensing modality without exploiting the tactile properties of the sensor; b) it is computationally expensive given the convolution operation required by application of filters; and c) the recognition process is constrained to the use of small enough objects that fit in the sensor array.

Edge detection, orientation and contact force using a PUMA robot with a

16×16 tactile sensor array and a three-dimensional force sensor are presented in (Chen et al., 1995a). The contact force sensor is used only to detect when the sensor has contacted an object. Similar image processing techniques were used for edge detection but in this case, also the first three geometrical moments of the tactile image were used for computing edge orientation. This work was extended to allow the fingertip sensor to follow the contour of the object being touched (Chen et al., 1995b). The contact force between the object and the robotic sensor was continuously observed, ensuring a constant movement without losing the contour of the object. However, again these methods are completely based on image processing and certain assumptions such as the edge of the object always need to contact two sides of the sensor array making the system not very flexible and robust for real-time tasks.

An approach based on adaptive thresholds for edge detection using a 9×15 planar tactile array is proposed in (Berger and Khoslar, 1989). This algorithm reads the pressure obtained from each taxel which is then set to one or zero if the threshold was exceeded or not. Even though the edges are extracted, they are fixed to predefined values (one or zero) which does not really show the pressure used for detecting the edge. The authors argue that edge tracking is possible using their method, however, they did not present a method for detection and recognition for edge orientation, testing their method only with straight lines.

Recently, an edge detection and tracking method using a low resolution tactile sensor composed by a 2×2 matrix was proposed in (Phung et al., 2010a). This method is based on recognition of specific patterns with a state machine to determine if the sensor is over the edge or out of the object. Here, a binary sensor technology (*On/Off*) was used which seemed to be faster since there are only 16 different activation patterns. However, it would not be feasible for the large number of patterns that normally can be read from interaction with an object. Also, this method was tested only in simulation without taking into account the presence of noise that certainly would compromise the performance on a real-time task.

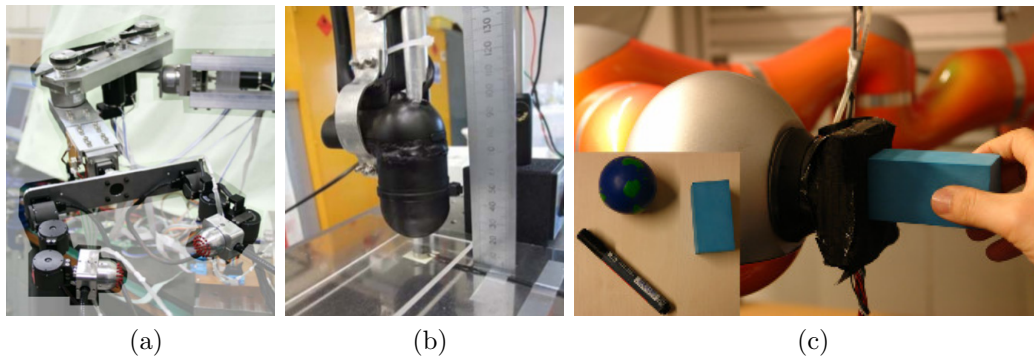

Figure 2.8: (a) Planar sensor array mounted on a Kuka arm for edge recognition and tracking based on image processing techniques. (b) Optical rounded shape fingertip sensor based on the detection of light changes received. (c) Optical three-axis gripper for edge tracking that uses external light receiver and emitter.

An optical three-axis tactile gripper was used for edge detection (Abdullah et al., 2011). One of the gripper works as light emitter, whilst the other works as receiver (Figure 2.8a). The obstructions encountered by the light emitted are observed in the receiver forming a tactile image. This method is easily affected by external light conditions and requires very precise calibration to have aligned every transmitter and receiver. Figure 2.8b shows a more robust implementation of edge detection with a tactile sensor using light emitter and receiver that is presented in (Chorley et al., 2010). To avoid issues with external light conditions, the light emitter and receiver were placed inside the tactile sensor. Thus, any deformation on the fingertip surface is observed inside the sensor and processed using a geometrical approach for edge detection. A drawback with this approach is the limitation on the size of the sensor given the requirement of an emitter and receiver.

A framework to control the contact force and object tracking with a planar sensor array mounted on a robotic arm is proposed in (Li et al., 2013). This work implemented image processing techniques for edge detection, recognition of orientation and tracking (Figure 2.8c). Despite the inspiration from vision sensing methods, this approach demonstrates fast and accurate performance during a real-time contour following task.

Three force resistors mounted on a robotic arm permitted to follow the con-

tour of different objects (Suwanratchatamane et al., 2007). The orientation of the robotic arm during a contour following task is controlled by the force detected on each force resistor. For this reason, this method requires to use large objects for contacting all the resistors. However, this could be overcome using smaller force resistors which would also increase the tactile accuracy.

The review of methods presented for edge detection and tracking commonly use image processing techniques demonstrating large influence from vision sensing. Treating the tactile data as an image matrix is suitable for planar sensor arrays which normally are implemented in industrial processes. However, for biologically inspired robots these methods would not be suitable given the rounded shape and small size of robotic fingertips. In this case, more sophisticated methods inspired by how humans feel, perceived and make decision are still needed.

### **Enclosing the objects**

Enclosing an object with hands for shape recognition is also commonly used by humans. Related to this, several works using a variety of robotic hands and tactile data processing have achieved object shape extraction. A two-fingered robot using a bag-of-features technique was able to recognise a wide variety of objects (Schneider et al., 2009). The construction of the codebook is based on image templates built from several tactile contacts with the objects being touched. For an exploration and recognition process, each tactile contact or tap performed is compared with the templates on the codebook choosing the most similar. Interestingly, an improvement in shape extraction and recognition was observed when taps at specific positions were performed over random taps. This can be seen as an active sensing process.

Object shape was recognised by a three-fingered robotic hand using a Self-Organising Map (SOM) approach (Johnsson and Balkenius, 2007). Pressure and proprioceptive information were used as input data for the SOM approach. The tactile information was obtained from different objects with a predefined

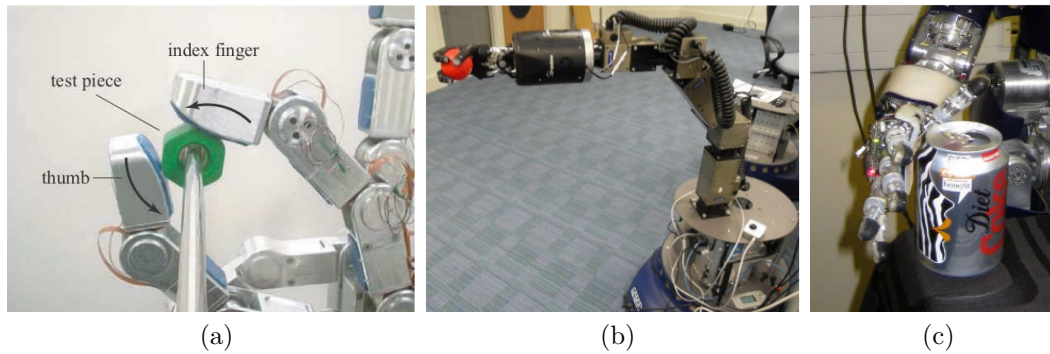

Figure 2.9: (a) Shape extraction by enclosing an object with the fingertips of a robotic hands. (b) Object shape extraction enclosing objects with palms and fingers of a three-fingeres robotic hand. (c) Enclosing objects with a biomimetic robotic hand for object shape extraction.

and fixed set of exploratory movements about each object.

A study of tactile exploration using a five-fingered hand and a potential field approach is presented in (Bierbaum et al., 2008). This method is based on prior knowledge of the objects to be explore. Therefore, the model of different testing objects –sphere, cylinder and a telephone– were computed. The exploration is guided by potential fields enclosing the hand to specific parts of the objects that seem to contain useful data. However, this approach presents two main constraints: 1) the contact detection method requires the use of convex objects; and 2) the exploration time could require nearly 2500 tactile contacts.

A five-fingered robotic hand was used for object shape recognition through an enclosing and rolling procedure (Nakamoto et al., 2008, 2009). This method is based on rolling different objects between two fingers of the robotic hand for measuring the tactile pressure and then computing the kurtosis property for each object (Figure 2.9a). Basically, the kurtosis is used to determinate the number of sides corresponding to each object. Then, a pentagon will provide five large kurtosis values, whilst a circle will provide very small kurtosis values. This is the main feature used by this approach for shape recognition. This work takes a more natural method for tactile sensing instead of being influenced by vision sensing. However, the force and time required for rolling an object need

a very precise control that could be also related to the object size.

A Self Organising Map (SOM), touch sensors and joint angles (proprioception) were used for object shape recognition with a three-fingered robotic hand (Ratnasingam and McGinnity, 2011). The pressure read from tactile sensor was used for contact detection and enclosing an object with the hand (Figure 2.9b). Then, measurements from joint angles were used as input for a SOM in order to categorise the objects by shape and size. This method was tested in a real environment keeping the hand in the same position, and reaching an accuracy of 89% from a set of 25 objects. However, changing the position of the hand induces noise and affects the classification performance. For that, active touch could improve the classification regarding to hand movements and also this would show a more realistic biologically inspired approach. Proprioceptive information from joint angles and tactile data collected from a sequence of palpations by enclosing the object with a robotic hand were proposed for object recognition in (Gorges et al., 2010). Here, a Bayesian classifier method was used for object classification providing good accuracy for a large number of tactile contacts. These results also support the Bayesian paradigm as a natural method for improving robot perception. However, active touch was not tested which is also a key feature for tactile sensing. In (Soh et al., 2012), a spatio-temporal Gaussian process approach for object recognition was implemented in the iCub humanoid robot (Figure 2.9c). The classification was based on signatures composed of tactile data and proprioceptive information learnt in off-line mode and allowing the recognition of a wide variety of objects in a real-time exploration task. The proposed method achieved good accuracy, however, active sensing was not included which would provide three main features to this method: 1) robustness against noise in tactile measurements; 2) improvement on speed and accuracy perception; and 3) biologically inspired tactile exploration.

### Sliding motions

Sliding is another exploratory procedure that has been widely studied with different tactile sensors and robot technologies for texture recognition. A sequence of methods for texture classification based on majority voting and a Naïve Bayes classifier using a biomimetic robotic fingertip sensor (see Figure 2.10a) were proposed in (Jamali and Sammut, 2011) and (Jamali and Sammut, 2010) respectively. Both methods presented good classification accuracy, however the Naïve Bayes classifier approach was superior to the majority voting approach. A drawback of this method is the lack of active sensing for controlling the fingertip movements. Moreover, the accuracy of the decision-making could be improved by accumulating evidence through different movements rather than using a single sliding per texture. High accuracy classification was achieved using active exploration approach with a robotic fingertip sensor (Drimus et al., 2012). Here, the tactile data collected was classified and compared by the following classifiers: K-Nearest Neighbours (kNN), Artificial Neural Networks (ANN) and Support Vector Machine (SVM). Similar high accuracy classification was obtained with all the classifiers, given the large amounts of data employed. However, these methods were tested on a very well controlled platform and without tactile feedback control which is not suitable for an robust real-time application. Also, the discrimination process was based on a single tactile dataset without actively exploring the textures.

Inspiration from the animal kingdom, in particular by rodents, also has motivated research on texture classification through whisking and tapping exploratory procedures against different surfaces. Related to this, an initial work on perception using whiskers is in (Lepora et al., 2010a). In this work, a mobile Roomba robot was equipped with a Hall effect robotic whisker for recognition of various textures through a lateral whisking pattern (Figure 2.10b). Discrimination of tactile data from different textures was performed by Naïve Bayes classifier providing good accuracy. However, tactile exploration was based on passive sensing given that the robotic whisker was not purposely controlled in order to optimise its exploration performance as humans and animals do.



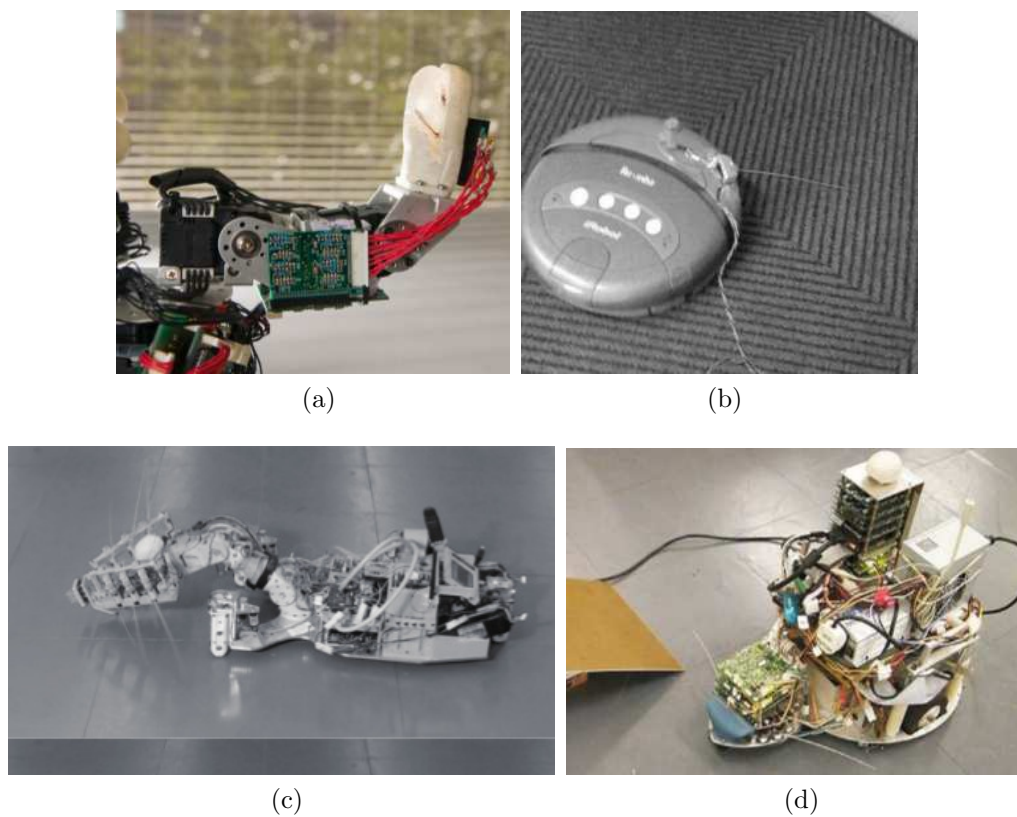

Figure 2.10: (a) Biomimetic fingertip sensor for texture recognition based on sliding movements. (b) Roomba robot equipped with one whisker for texture recognition based on passive taps. (c) Rat-like robot with left and right side whiskers for surface detection based on sliding movements. (d) Tap movements performed by a rat-like robot using a whisker sensor for surface detection.

Application of a Bayesian approach for texture recognition and novelty detection with a rat-like robot is proposed in (Lepora et al., 2010b). In this work, the biologically inspired robot was equipped with a set of robotic whiskers on both sides of its face (Figure 2.10c). Passive sensing based on whisking was used to collect tactile data from the whole whisker system. This method achieved good accuracy classification and included an attention method based on novelty detection. However, active control for whisking according to the level of novelty was not developed. Another method inspired by how rodents explore their environment proposed the use of a combination of features with a Gaussian classifier for improvement of texture recognition (Fox et al., 2009). Figure 2.10d shows the rat-like robot equipped with one whisker passively controlled used for tactile data collection. Different properties from the robotic

whisker –offset, centroid, energy– were combined with a Gaussian classifier during contacting a surface. Despite the passive behaviour of the method, it demonstrated superior accuracy results than the commonly used Artificial Neural Networks (ANN). A mobile robot integrated with a whisker was able to recognise a set of 10 indoor and outdoor textures (Giguere and Dudek, 2011). The tactile data collected from a passively controlled whisker was classified using an Artificial Neural Network, obtaining low accuracy. The classification accuracy was improved by increasing the exploration time by a factor of four. Although this work was implemented in a mobile robot and tested online in different environments, the classification method did not achieve high accurate and robust results.

Investigation, development and integration of tactile sensor technologies is playing an important role in robotics given the necessity of autonomous robots to be capable to co-habit with humans. Undoubtedly, the artificial sense of touch is providing a reliable sensing modality to perceive the state of the continuously changing environment. This is observed in the aforementioned applications of tactile sensing with different robots and tactile data processing approaches. Also, it is clearly observed the large influence that vision sensing has had in most of the tactile data processing approaches, which is understandable for planar sensor arrays since they provide an image matrix. However, robots inspired by humans have started to be integrated with similar rounded shape and small size fingertips where inspiration from vision sensing is not really suitable for tactile data analysis. As has been described, some methods have addressed the tactile data processing using different approaches, e.g. Naïve Bayes classifiers and Artificial Neural Networks, however this is still in an early stage with large possibilities on research of the capabilities that the integration of the artificial sense of touch offers to robotics.

In this sense, the iCub humanoid robot is the most appropriate open platform for investigation of tactile sensing. It is equipped with artificial skin in palms, fingertips, torso, arms and forearms that resemble the human skin. For that reason, it is worth the study and implementation of biologically inspired

perception, decision-making and control methods with the artificial skin of the iCub humanoid robot, which would provide a framework for exploration and interaction with its surrounding environment.

## 2.5 Concluding remarks

The sense of touch is an important and essential component for humans and animals which allows them to explore, interact and be aware of what is happening around them. Despite the important role that the sense of touch plays in the daily life, the advances achieved in robotic applications appear to be in their infancy compared to the investigations and developments in vision sensing modality. This is also related to the large number of components present in touch sensing, which makes its investigation a very complex process.

However, some investigations have provided the foundations for the development and integration of artificial skin in a variety of robots. Artificial skin has been developed using different sensor technologies such as capacitive, optical and hall effect technologies which have been implemented mainly in planar sensor arrays. Vision sensing modality has hardly influenced most of the works where planar sensor array were used since they provide a tactile matrix that can be treated as an image matrix. Although this has provided some results to the field of tactile sensing, these methods are not the most suitable for biomimetic tactile sensor inspired by humans and animals. In this sense, some tactile data processing methods have been developed for biomimetic palm and fingertip sensors. These methods have been applied and studied with exploratory procedures with hands and fingers as humans do. However, they are still in an early stage and do not include features such as tactile feedback for robust control, robustness to noise and reliability in unstructured environments. For that reason, more investigations need to be undertaken to include these aspects in order to have reliable and robust biologically inspired tactile methods.

The iCub humanoid robot designed for the study of cognition is currently

equipped with artificial skin in fingertips, palms, torso, arms and forearms which make it the most appropriate open robotic platform for research on the sense of touch. For that reason, here the fingertip sensors of the iCub humanoid robot are used to investigate and develop robust biologically inspired tactile methods for perception and object exploration based on the predefined exploratory procedures employed by humans.

The next chapter presents a detailed description of perception and the biologically inspired method developed for tactile data processing. First, a description of passive and active perception for touch sensing is presented. Next, the proposed tactile perception approach based on a Bayesian classifier is introduced. Then, the proposed active Bayesian perception method for tactile perception in robotics is described. Finally, the proposed method is validated with a passive and active perception simulation using real tactile data from the biomimetic iCub fingertip sensor.

# Chapter 3

## Active Bayesian Perception

Stimuli from the world are detected through different types of receptors according to the sensing modalities. For the sense of touch, different types of mechanoreceptors are responsible for detecting the stimuli, and sending them to the somatosensory cortex region in the brain. However, this process does not have any knowledge about the meaning of the received stimuli to act accordingly. A process known as perception plays an important role in the analysis of the stimuli for converting them to useful information to make accurate decisions and act correctly according to the stimuli received.

Investigations from psychology and neuroscience have proposed that perception by humans is based on the accumulation of evidence from interactions with the environment across time. Moreover, perception from the received stimuli can be performed in passive and active modalities. Normally, active perception permits humans to extract and recognise object properties faster and more accurately compared to using passive perception. In that sense, active perception methods can be investigated with probabilistic approaches, which normally are more robust against sensor limitations, sensor noise and changing environments permitting the implementation of applications for perception and action in the real world (Thrun et al., 2005). However, probabilistic approaches with perception methods based on accumulation of evidence have not been widely investigated in tactile sensing for robotics, reducing tactile exploration to a single interaction with objects and without accumulation of evidence to improve perception and decision-making.

For that reason, this chapter proposes a Bayesian method for tactile perception which provides improvements in the decision-making process by accumulation of evidence through interaction with an object (Bulthoff, 1996; Wolpert and Flanagan, 2001; Lepora et al., 2010c,b). The proposed probabilistic method also permits to perform active perception by repositioning the tactile sensor towards the places with more interesting information (Martinez-Conde et al., 2004; Najemnik and Geisler, 2005; Prescott et al., 2011). The active modality together with the accumulation of evidence for improvement of perception and decision-making (Smith and Ratcliff, 2004; Bogacz, 2007), offer a robust approach for development of active tactile exploration tasks in robotics (Sullivan et al., 2012).

This chapter provides a description of perception, their passive and active modalities and implementations in robotics for tactile exploration in Section 3.1. Next, the tactile robotic platform used for the experiments in this work is described in Section 3.2. A detailed description of the tactile data collected with the fingertip sensor is presented in Section 3.3. In Section 3.4 the probabilistic method proposed for perception is described. A comparison between passive and active perception is presented in Section 3.5. Finally, section 3.6 presents the concluding remarks.

## 3.1 Perception

Humans are capable of observing and understanding the state of a continuously changing environment through the sensation and perception processes. *Sensation*, which refers to physical stimuli detected and registered by a system was presented in Chapter 2. *Perception* is the process of interpreting sensory data and converting it to meaningful information. Interpretation of sensory data by the perception process generally involves organisation, judgement, past experience and memory, to provide information that makes sense for humans (Schiffman, 1990; Mather, 2006).

Perception for the sense of touch uses the stimuli generated in touch cells,

especially in mechanoreceptors that detect tactile contact and pressure. According to the previous definition of perception, tactile data somehow needs to be organised and judged to convert it into meaningful information for the robot, providing useful information to understand what is happening in its surrounding environment.

There exists a division between perception in passive and active modalities related to the way that the stimuli are received by the sensory system. The description of the perception modalities in the sense of touch is presented in Section 2.2. The use of perception in robotics is introduced in next section.

### 3.1.1 Perception in robotics

The integration of the artificial sense of touch in robots has opened up a large possibility for investigations and tests of different human perception methods. Robots integrated with touch capabilities are normally equipped with artificial skin in the hands and fingertips since they are the most sensitive areas of the human body and an ideal tool for exploration, manipulation and interaction. For that reason, most of the investigations have been focused on exploratory procedures for extraction of object properties using tactile data from artificial skin in hands, fingertips and proprioceptive information from joint angles.

A perception method based on geometric moments and force detection from a planar tactile sensor mounted on a PUMA robot was used for edge detection and tracking (Chen et al., 1995b,a). The robotic system first detects a tactile contact with the edge of an object where image processing techniques such as Roberts and Sobel filters are used for edge extraction and recognition. Then, movements of the robotic fingertip sensor are controlled by matching the orientation between the fingertip sensor and the edge being tracked based on geometric moments extracted from the tactile image. This method, which is one of the first perception approaches for tactile exploration, was able to trace object shape based on a contour following exploratory procedure. However, this method, that is inspired by vision sensing, depends only on data from the

current state. Characteristics such as uncertainty and prior knowledge from previous states are not utilised in the perception.

An extension of the previous work is presented in (Zhang and Chen, 2000), where the first tactile servoing framework is proposed. In this work, a contact model of the tactile sensor is presented which is used for expressing robot task and regulation of contact force. This method also relies on tactile images and their geometrical moments for movement and orientation control. Similarly, this approach does not take into account uncertainty from measurements and decision movements are based on the current state without including prior knowledge from previous states.

Recently, a new tactile servoing framework for edge tracking and exploration using a planar sensor array mounted on a robotic arm is proposed in (Li et al., 2013). Here, a set of primitives is also defined, enabling the robotic system to perform different tactile exploration tasks. This approach uses pressure data from a  $16 \times 16$  tactile sensor array and contact force for controlling tactile contact and recognition of edge orientation. This method does not include uncertainty from measurements, and movement decisions are based on data from a single tactile contact. However, it is demonstrated to be able to accurately trace object shapes with smooth and fast movements.

Shape extraction is not only achieved by a contour following exploratory procedure (edge tracking) but also by enclosing the object with robotic hands. A biologically inspired method based on neural networks was proposed in (Johnson and Balkenius, 2007) for shape perception. In this work, tactile pressure and proprioceptive information from a three-fingered robotic hand were used as features for object shape perception. This perception approach, based on a Self-Organising Map (SOM), used a combination of tactile data and proprioceptive information. A modification in the neural activation of the SOM provided an alternative approach for discrimination between different object shapes. Despite the biological inspiration of this method, it does not include two characteristics that are present during a tactile exploration: 1) multiple tactile contacts for reduction of uncertainty; and 2) active movements to ac-



quire more interesting information and achieve better object perception.

Active perception of object dynamics with tactile sensors was investigated by (Saal et al., 2010). A three-fingered robotic hand mounted on a robotic arm permitted the exploration of object properties by grasping and manipulation. The perception method was based on active learning using sequential analysis and sparse Gaussian Processes.

A similar study for shape extraction and recognition with a SOM is presented in (Ratnasingam and McGinnity, 2011). This work was able to categorise objects by their shape and size using tactile and proprioceptive information from a three-fingered robotic hand. For testing the robustness of this method, Gaussian noise was added to the measurements from joint angles. Results from the shape recognition process, demonstrated this to be a robust and accurate method for a small number of objects and small Gaussian noise. However, even though the robotic system was composed of an arm and a three-fingered hand, the complete capabilities of this robotic platform, e.g. dexterity and autonomous exploration, were not exploited since each object to be explored was placed manually by a person in the robotic hand.

Hand and fingertips of the iCub humanoid robot have also been used for shape extraction using an enclosure exploratory procedure (Soh et al., 2012). The method proposed is based on the generation of a signature for each object during a training phase. First, tactile contact with the object is detected by the fingertip sensors and then proprioceptive information is used to build the corresponding signature with a Gaussian process. This method was demonstrated to be robust to the noise present in joint angles and it was tested with various real object shapes. Despite its robustness and perception accuracy, this method could benefit from multiple and actively controlled tactile contacts with the object to improve perception by accumulation of evidence inspired by how humans perform object exploration.

Object shape extraction has been studied either by performing contour following or enclosure exploratory procedures with robotic hand and fingertip sensors. From the works presented in this Section and previous Section 2.4.2

we observe that most of the methods for recognition with tactile sensors are based on implementation of image processing techniques for the analysis of tactile images which are provided by planar sensor arrays. However, these methods are not the most suitable for perception using biomimetic fingertip sensors given their small size and rounded shape inspired by human fingertips. Another common characteristic present in the current perception methods is the use of a single tactile contact between robotic hands and objects for perception and decision-making (Johnsson and Balkenius, 2007; Takamuku et al., 2007; Ratnasingam and McGinnity, 2011; Soh et al., 2012; Li et al., 2013). In contrast, humans perform repetitive and actively controlled tactile contacts with the objects until they reach certain degree of confidence for making a decision (Smith and Ratcliff, 2004; Shadlen and Roskies, 2012). This exploratory behaviour is used by humans to reduce uncertainty from tactile measurements by accumulation of evidence across time (see Section 2.3).

This research work proposes an alternative perception method based on a Bayesian approach for tactile exploration with biomimetic fingertip sensors inspired by human fingertips. This method includes the following biologically inspired aspects: 1) active movements towards interesting locations for improvement of tactile perception; 2) accumulation of evidence from repetitive tactile contacts with the objects being explored; and 3) decision-making process based on threshold crossing by accumulation of evidence. Unlike the methods for tactile perception described in this Section and previous Section 2.4.2, the proposed approach is able to perform object exploration by repetitive interaction and accumulation of evidence over time. The proposed Bayesian method also permits the fingertip sensors to be actively moved or repositioned towards more interesting locations over the object being explored in order to improve tactile perception and accuracy of the decision-making process.

The description of the robotic platform and the biomimetic fingertip sensor used for data collection is provided in the next section. This is followed by the description of the proposed probabilistic method, which is validated using passive and active perception modalities with a tactile discrimination task.

## 3.2 Tactile robotic platform

A tactile robotic platform used for data collection and online testing of the investigations was built with a Cartesian robot for precise movements in  $x$ - and  $y$ -axes, a NXT robot for movements along the  $z$ -axis and a biomimetic fingertip sensor from the iCub humanoid robot. This tactile robotic platform permitted to perform movements in  $x$ -,  $y$ - and  $z$ -axes whilst simultaneously collecting tactile data. A detailed description of each component of this platform is presented in the following sections.

### 3.2.1 Robotic platform

The robotic platform is composed of two robots: 1) a Cartesian robot arm (YAMAHA XY-x series) with 2-DoF (degrees of freedom) for precise positioning movements in  $x$ - and  $y$ -axes; and 2) a MINDSTORMS NXT robot with 1-DoF for movements along the  $z$  axis. Both robots were integrated to achieve controlled exploratory movements in  $x$ -,  $y$ - and  $z$ -axes by mounting and inter-connecting the MINDSTORMS NXT robot on the Cartesian robot. Figure 3.1 shows the robots that compose the complete robotic platform.

The Cartesian robot arm allowed to perform very precise movements with an accuracy of  $\sim 20\mu\text{m}$ . In contrast, the low performance of the NXT robot did not allow precise movements to be achieved. However, this drawback can be treated positively for: 1) replicating the uncertainty in finger positioning movements performed by humans; and 2) testing the robustness of the method proposed with a more realistic system.

The complete robotic platform shown in Figure 3.1c permitted to perform the data collection process and all the experiments in a real environment presented through this work.

### 3.2.2 Biomimetic iCub fingertip sensor

The iCub humanoid robot is equipped with one of the most advanced sensor technologies offering a robust and reliable open robotic platform for research.

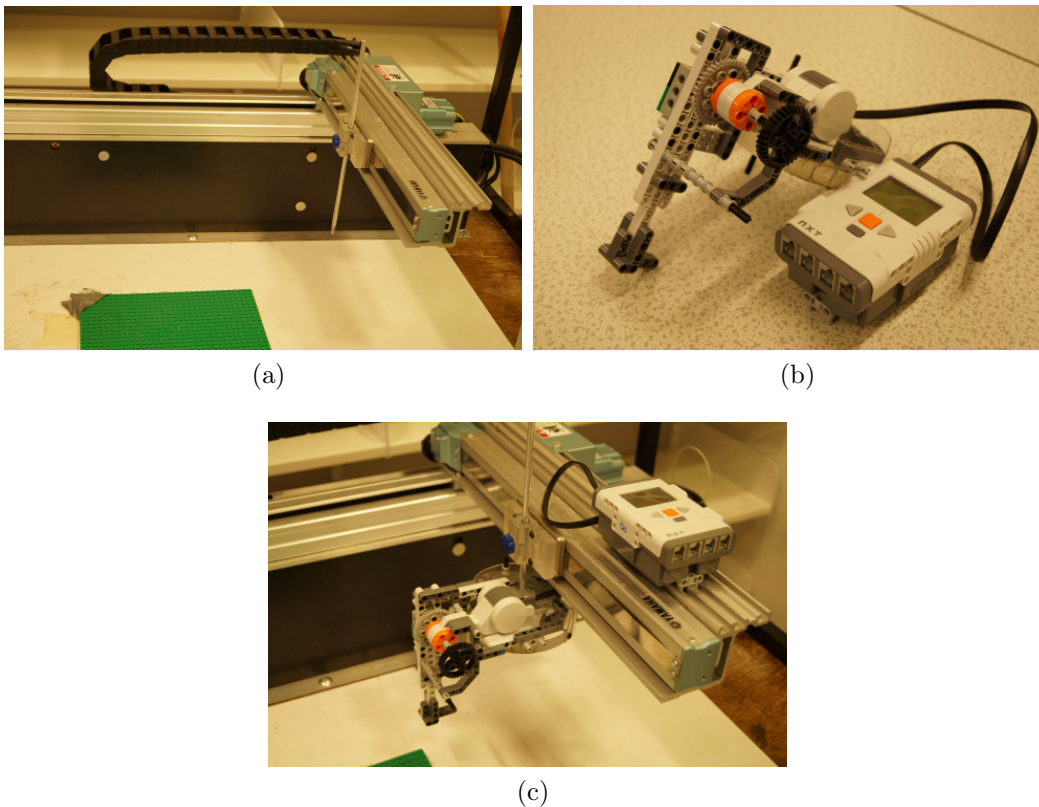

Figure 3.1: (a) Cartesian robot with 2-DoF for movements in  $x$ - and  $y$ -axes. (b) NXT robot with 1-DoF for movements along  $z$ -axis. (c) Integration of both robots for tactile data collection with movements in  $x$ -,  $y$ - and  $z$ -axes.

For that reason, tactile data were collected using a biomimetic fingertip sensor from the iCub humanoid robot. In addition to the advanced technology used for the construction of this fingertip sensor, its small size (14.5 mm long by 13 mm wide) and rounded shaped resembles the human fingertip (Schmitz et al., 2010a,b). Tactile data analysis using this biologically inspired tactile sensor is a more challenging task compared to planar sensor arrays where tactile data can be treated as an image matrix. Also, this fingertip sensor permits to demonstrate the robustness of the method proposed in this work. Figure 3.2 shows the dimensions and shape of the iCub fingertip sensor.

The biomimetic fingertip sensor is built with a capacitive sensing technology containing an array of twelve taxels (tactile elements) or contact pads of  $\sim 4$  mm diameter each that emulate the mechanoreceptors in human fingertips. The taxels cover the inner core of the fingertip with a flexible printed

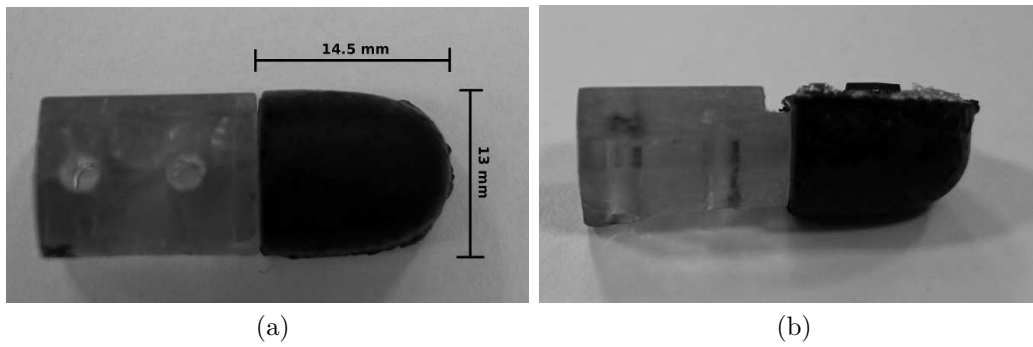

Figure 3.2: (a) Dimensions of the iCub fingertip sensor similar to human fingertip. (b) Rounded shape fingertip resembling human fingertip shape.

circuit board (PCB) (see Figure 3.3a). The separation between the centre of the taxels is  $\sim 5$  mm and they are also arranged in an asymmetric order (see Figure 3.3b) showing once more that image processing techniques do not fit for this type of biologically inspired fingertip sensors. The PCB is covered by a  $\sim 2$  mm dielectric layer of silicone foam. Finally, an outer flexible and conductive layer composed of a carbon black-silicone material covers the entire fingertip to create a capacitor (Figure 3.3c). This flexible material also allows deformations of the surface of the fingertip during tactile contact with an object, analogous to the deformations that occur in human fingertips.

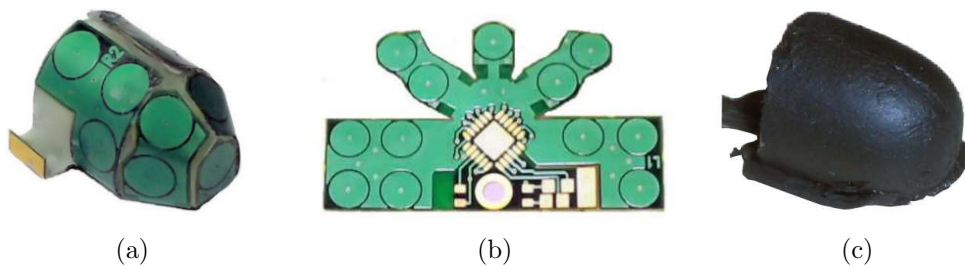

Figure 3.3: (a) Flexible PCB covering the inner core. (b) Taxel arrangement in the iCub fingertip sensor. (c) Dielectric outer layer that allows soft tactile contact with the exterior.

Tactile measurements from the twelve taxels are read with a sample rate of 50 Hz which are digitised with 8 bit resolution, thus obtaining measurements in the range  $[0, 255]$ . The technology used for the fabrication of this fingertip sensor resembles the mechanical and sensory structure of the human fingertip that allows perception of pressure, curvature and edge orientation (Dargahi

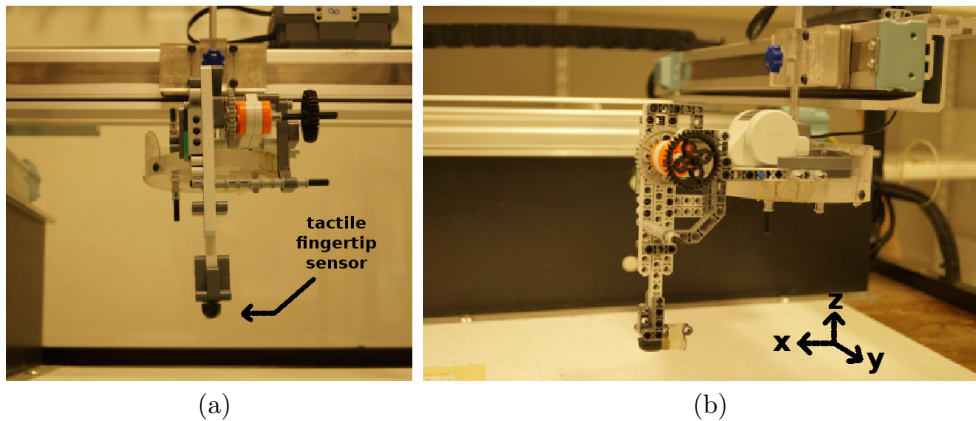

Figure 3.4: Tactile robotic platform composed by two robots and the biomimetic fingertip sensor. (a) The tactile sensor is mounted on the tip of the NXT robot. (b) This architecture permits to perform tactile exploration based on palpations or taps in  $x$ -,  $y$ - and  $z$ -axes. The movements performed by the robotic platform are controlled by tactile feedback.

and Najarian, 2004). In particular, the taxels used in the fingertip sensor respond analogously to the mechanoreceptors in human fingertips to brief and sustained response from tactile stimuli.

The biomimetic fingertip sensor was mounted on the robotic platform in order to have a complete system capable of performing real-time tactile sensing procedures controlled by tactile feedback (see Figure 3.4). An exploratory procedure based on taps or palpations was implemented for data collection and interaction between the tactile sensor and the objects. Exploration based on palpations is a procedure commonly used by humans, e.g. object recognition and medical diagnostics, and it has been previously implemented for an automated diagnostic task (Dario and Bergamasco, 1988). This exploratory procedure also reduces the damage to the soft material (outer layer) that covers the fingertip sensor, which could be deteriorated after repeating the experiments several times with the commonly used sliding procedure.

### 3.2.3 Control of the tactile robotic platform

A set of modules were developed and implemented for synchronisation and control of the tactile robotic platform during tactile data collection. Figure 3.5

shows a diagram with the modules that compose the tactile robotic platform for data collection which are described as follows:

- *Tactile sensor*: This module is responsible for tactile contact detection from the exploration of an object. A tactile contact ( $T_{\text{contact}}$ ) is determined when the pressure from the fingertip sensor ( $T_{\text{pressure}}$ ) crosses a tactile contact threshold ( $T_{\text{threshold}}$ ).

$$T_{\text{contact}} = \begin{cases} True & \text{if } T_{\text{pressure}} > T_{\text{threshold}} \\ False & \text{otherwise} \end{cases}$$

Once a tactile contact is detected a *reflex signal* is sent to the action generation module to protect the fingertip sensor against dangerous contact pressures. Simultaneously, the tactile data is sent to the *Controller* module for its processing.

- *Tactile robotic platform*: This module is responsible for executing tactile movements in the  $x$ -,  $y$ - and  $z$ -axes during the data collection procedure. Displacement movements are in the  $x$ - and  $y$ -axes whilst the palpations or taps are performed along the  $z$ -axis.
- *Controller*: Control and synchronisation of movements based on the tactile contact detection are performed by this module. It controls the direction of displacements and palpation movements during a tactile data collection procedure ensuring robust and reliable data.
- *Action generation*: This module generates the corresponding actions according to the signal received from the controller module. These actions are sent in an understandable format composed of the next  $(x, y, z)$  positioning movement to be executed by the robotic platform.

YARP (Yet Another Robot Platform) was used to ensure a robust communication and synchronisation between the different modules, robots (Cartesian and NXT) and the iCub fingertip sensor. YARP is an open-source software

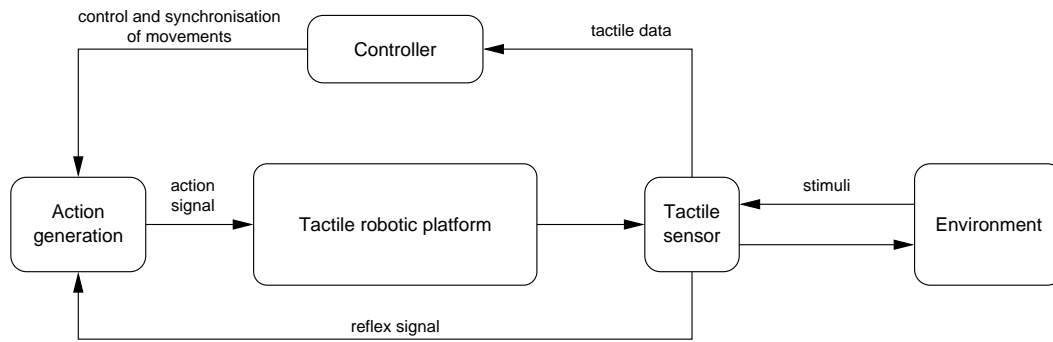

Figure 3.5: Diagram highlighting the modules used for control and synchronisation of data collection using the tactile robotic platform. The system reflexes against dangerous tactile contact pressures. These data are also used for precise control of tactile fingertip movements.

with a set of libraries for interconnection of modules running in one or multiple computers and operating systems (Metta et al., 2006). YARP is also a powerful software for development and control of real-time systems that have been tested with different robotic platforms. The following section presents a detailed description of the procedure performed for the tactile data collection used for training and testing the proposed method.

### 3.3 Tactile data collection

In order to be able to demonstrate the proposed Bayesian perception method with a discrimination task, a set of tactile data is required for training and testing. This requirement can be achieved through the use of the tactile robotic platform previously described. The tactile discrimination task proposed is based on angle and position perception at the current location of the fingertip sensor palpating or tapping over the edge of an object. This task is inspired by the capability of humans to detect tactile contact and perceive edge orientation using their fingertips.

Thus, tactile data were collected in a systematic and well-controlled procedure as follows. First, a circular object was placed on a table for being touched by the iCub fingertip sensor. Then, the fingertip sensor started the data collection process with a full tactile contact over the plane surface of the object.



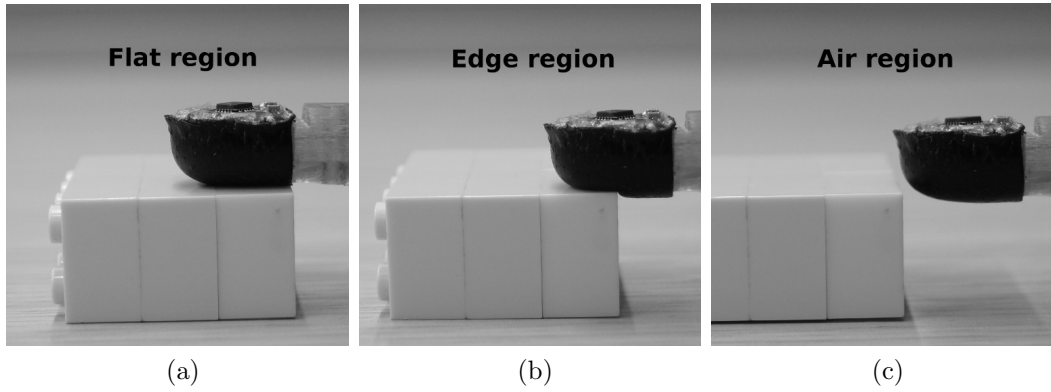

Figure 3.6: Biomimetic fingertip sensor at different stages of the tactile data collection from the plastic object. (a) Full contact over plane surface of the object. (b) Partial contact over the edge of the object. (c) No tactile contact or palpating outside the object.

The tactile sensor was moving perpendicularly to the edge whilst tactile data were collected based on palpations. After moving some time, the fingertip reached the edge of the object, receiving tactile data only from the region of the fingertip sensor in contact with the object. The data collection finished when the fingertip sensor was not in contact with the object, palpating in the air. Figure 3.6 shows the fingertip sensor moving across different regions, e.g. flat, edge and air regions, over the object used as stimuli for data collection.

Each tap of the palpation procedure had a duration of 2 seconds, generating a dataset of  $12 \times 100$  (taxels  $\times$  measurements) pressure measurements from the tactile fingertip sensor. The number of measurements are related to the sampling frequency of 50 Hz. A distance of 18 mm was covered by the fingertip sensor from full contact to no contact with the object, performing palpations at every 0.2 mm and generating a total of 90 palpations with  $12 \times 100$  measurements each. This procedure was repeated along the edge of the circular object by displacing the fingertip sensor at 5 degrees steps, generating a total of 72 discrete angle steps and covering the range of 360 degrees (see Figure 3.7).

The tactile data obtained from the collection procedure is observed in Figure 3.8. For visualisation purposes a representative 18 out of 72 angle steps are presented. The complete tactile data collected is presented in Appendix A. Each angle step at every 5 degrees represents an angle class forming a total

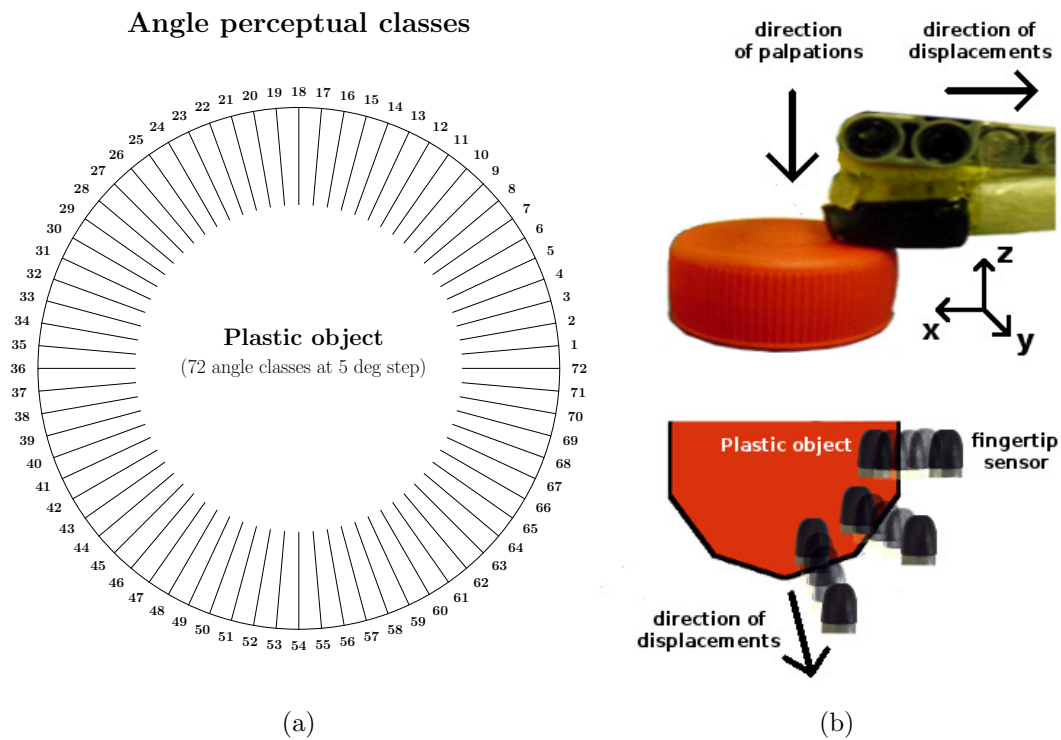
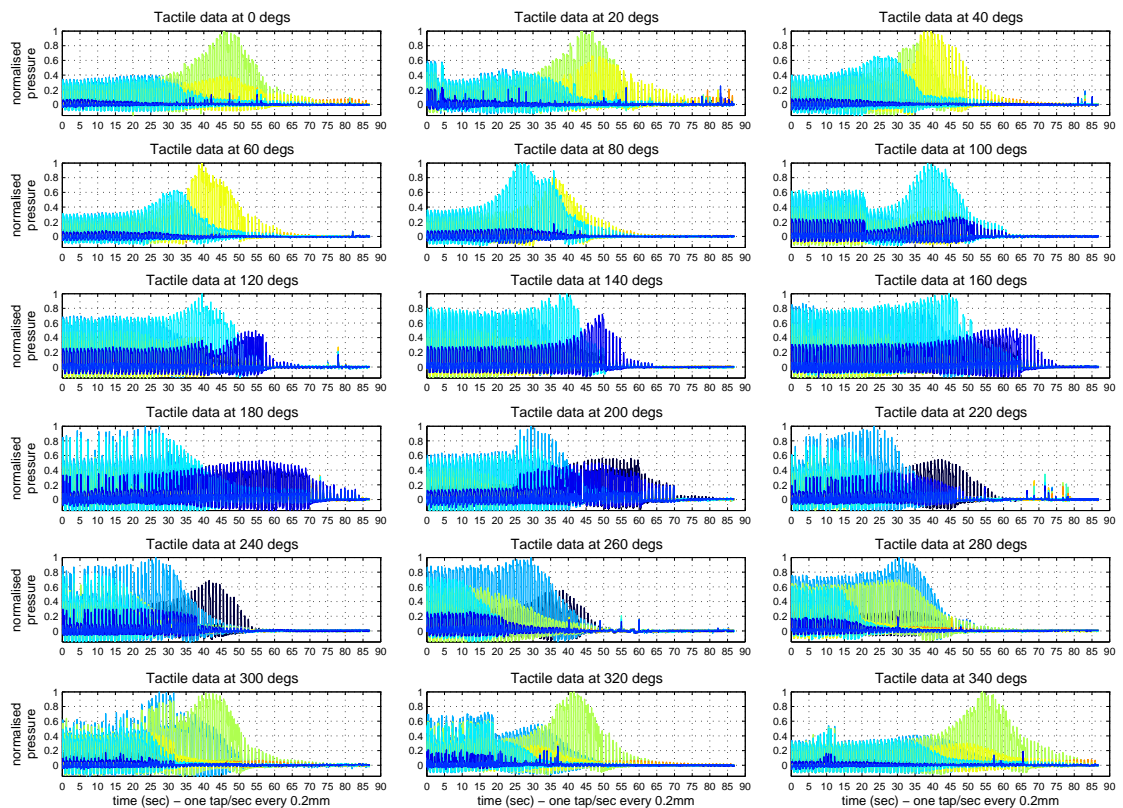

Figure 3.7: Data collection procedure from an edge stimulus of a plastic object. (a) The biomimetic fingertip sensor collects data from 72 angles at 5 degrees steps perpendicular to the edge of the object. (b) The data is collected based on taps along the  $z$ -axis and displacement movements along  $x$ - and  $y$ -axes. For visualisation, only some examples of fingertip sensor moving at different angles for data collection are shown.

of 72 angle classes. As can be observed in Figure 3.8, for some angles the tactile data do not present a smooth shape which is related to variations in the sensitivity of different regions of the fingertip sensor. This can be seen as a positive feature for testing the robustness and reliability of the method proposed against the noise present in measurements (see Section 3.4) and for working with a more realistic tactile system for an exploration task.

Figure 3.9 shows sample data collected from the circular object used as stimuli. Here, we observed how the taxels are activated along the different regions of the circular object. For visualisation purposes, 6 plots at 20 degrees each are presented.

For each angle class there are 90 taps organised in position classes of 5 taps each, forming a total of 18 position classes as shown in Figure 3.10.



(a)

taxel  
geometry

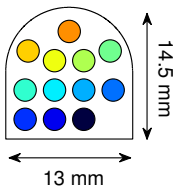

(b)

Figure 3.8: (a) Samples of tactile data collected using the tactile robotic platform previously described. The data collection was done at 5 degrees steps from a plastic object with displacement steps of 0.2 mm perpendicular to the edge of the object. This was repeated 72 times covering the 360 degrees of the circle. For each angle step, we formed an angle and 18 position perceptual classes, obtaining a total of 1296 perceptual classes. The differently coloured plots for different angles correspond to the regions and orientation of the fingertip sensor in contact with the object. For visualisation purposes, here we show only 18 out of 72 plots with data collected at every 20 degrees. (b) Coloured arrangement of taxels that permits to observe which taxels are contacting an object from the different coloured plots.

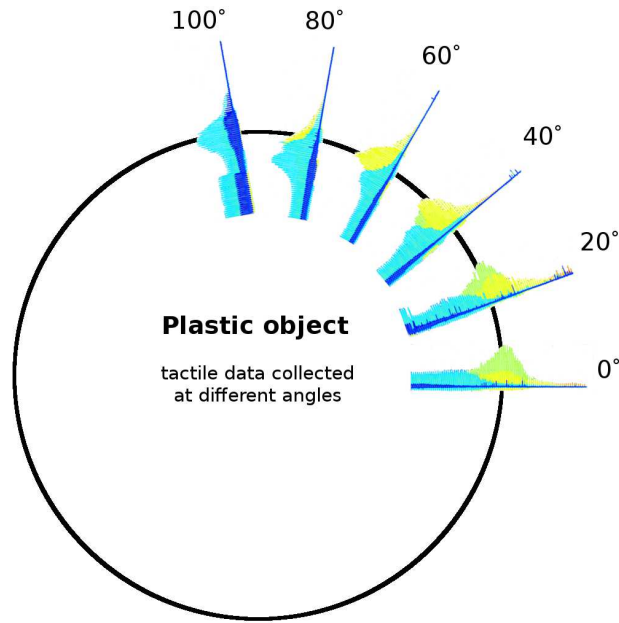

Figure 3.9: Samples of tactile data collected around the circular object used as stimuli. The tactile data shown here correspond to the samples presented in Figure 3.8a. We observed the activation of the taxels for the different regions of the circular object. For visualisation purposes, only 6 plots are showed.

The final tactile dataset from palpating over the complete object is composed of 1296 perceptual classes (72 angles $\times$ 18 positions per angle). The process was repeated two times, collecting one tactile dataset for testing and one for training with a similarity of 56.15%.

The next section describes the probabilistic method proposed for analysis of the tactile data collected. The method will be tested with a tactile discrimination task based on angle and position perception from the 72 angle and 18 position classes. Also, a comparison of the results obtained from the implementation of a passive and active perception task will be provided, demonstrating the superiority and benefits of active over passive perception.

### 3.4 Bayesian approach for tactile perception

Humans and animals normally perform repetitive tactile contacts, e.g. palpating and whisking, for an object exploration and recognition task. This is a natural behaviour used for reduction of uncertainty in perception given the

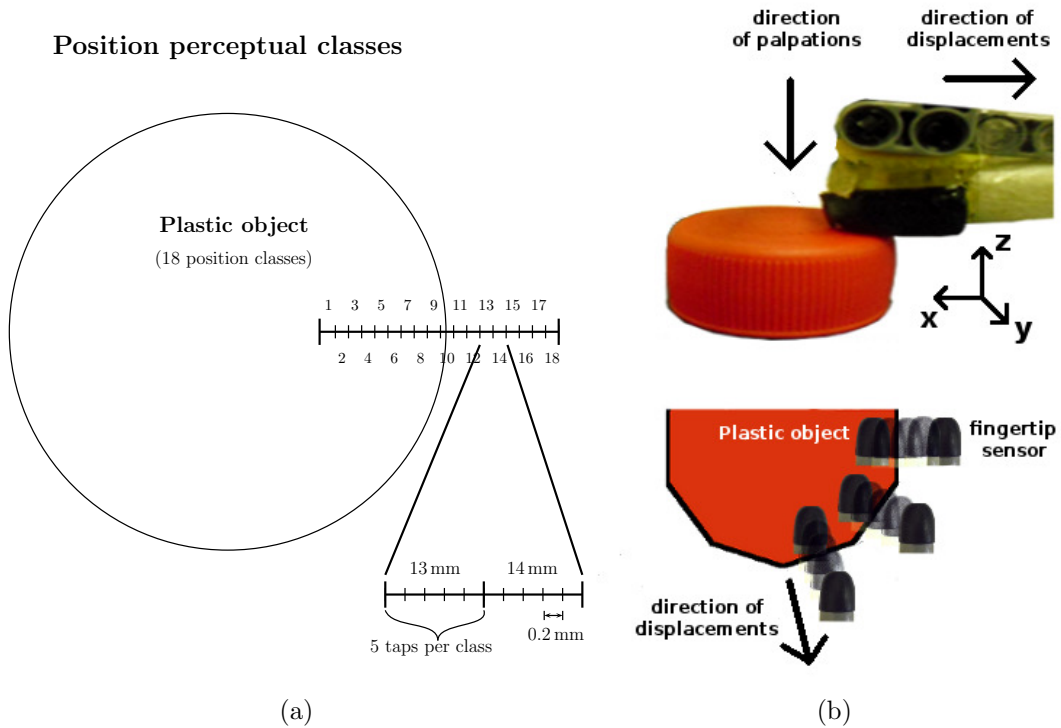

Figure 3.10: (a) The tactile data are collected along 18 mm at 0.2 mm steps perpendicular to the edge of the object. The data are grouped in 5 taps per position class and forming a total of 18 position classes per angle. (b) The fingertip sensor collects data based on taps along the  $z$ -axis and displacement movements along  $x$ - and  $y$ -axes.

noise present in sensors and the environment. The uncertainty reduction is achieved based on the accumulation of evidence extracted from every interaction with the object being explored for recognition (Smith and Ratcliff, 2004). Moreover, every tactile contact during the exploration process is actively controlled by deliberated hand and fingertip movements towards locations where interesting data can be acquired.

For those reasons, the design and control of biologically inspired robots for robust performance of exploration tasks require the integration of these characteristics. In that sense, probabilistic methods are a natural way for dealing with uncertainty and accumulation of evidence, which typically provide robust methods against sensor limitations, sensor noise and environment dynamics (Thrun et al., 2005).

This motivated the investigation presented in this work to develop and

implement a Bayesian approach to incorporate and deal with the characteristics required for tactile exploration with biologically inspired robots. Bayesian theory permits to estimate the state of the world, control the motor system and perform decision-making in a systematic way within a statistical framework (MacKay, 2003). The Bayesian theory approach also provides a natural way for the combination of prior information gathered from experience with new information collected at the current state, and for making optimal decisions to achieve the established goals (Bulthoff, 1996). Despite the advantages offered by Bayesian theory to build robust tactile perception methods, it has not been widely exploited in tactile sensing applications compared to the large number of works and advances that have been achieved in vision.

The next sections describe the components of the proposed Bayesian framework for robust tactile perception. The method is validated with a tactile discrimination task. Also, this approach is extended for investigation of passive and active perception. Finally, a comparison of both perception modalities is presented, where the benefits of active over passive perception is observed.

### 3.4.1 Bayes' rule

The method proposed in this work uses Bayes' rule

$$P(S|Z) = \frac{P(Z|S)P(S)}{P(Z)} \quad (3.1)$$

where  $P(S|Z)$  is the probability of a hypothesis  $S = s$  conditioned by the measurements  $Z = z$ , known as the *posterior*,  $P(Z|S)$  is the *likelihood* of the hypothesis  $s$  given the measurements  $z$ ,  $P(S)$  is the *prior* probability and the *normaliser*  $P(Z)$  permits to ensure that the conditional probabilities of all hypotheses sum to 1.

As mentioned in Section 3.4, Bayes' rule inherently provides a natural way for updating our belief about the hypothesis  $P(S)$  from previous time by combining it with the likelihood  $P(Z|S)$  obtained at the current time. This formula provides a powerful tool for interpretation of sensory data, e.g. during

a tactile exploration procedure. Here,  $Z = \{z_1, z_2, z_3, \dots, z_n\}$  is the set of measurements from the tactile sensor and  $S = \{s_1, s_2, s_3, \dots, s_n\}$  is the set of hypotheses about the object being touch.

The posterior probability from Equation (3.1) is obtained by the combination of the likelihood and the prior but here, Bayes' rule is extended to perform this combination along time until the posterior obtained exceeds a belief threshold. This is inspired by the sequential analysis theory used for statistical inference where a decision is made once the belief of a hypothesis exceeds a decision threshold, making unnecessary prior knowledge about the number of observations required for an experiment (Wald, 1973). Using Bayes' rule with sequential analysis it is possible to build a framework for inference, accumulating evidence for the decision-making process, inspired by studies from neuroscience and psychology (see Section 2.3). Also, a sequential analysis approach with a Monte Carlo sampling method for tactile discrimination was also investigated by (Saal et al., 2010).

This method for making inference can be seen as an active process since several tactile contacts are required for making a final decision, rather than relying on a single tactile contact. This provides an improvement in perception accuracy since the reduction in uncertainty based on the accumulation of evidence provided by the combination of likelihood and prior over time.

The tactile data previously collected is used for an angle and position discrimination task from the current location of the fingertip sensor. The location of the fingertip sensor based on its current position and angle are represented by  $x_l$  and  $w_i$  with  $N_l$  and  $N_i$  perceptual classes respectively. This gives a total of  $N = N_l \times N_i$  perceptual classes  $c_n = (x_l, w_i)$ . The tactile measurements are represented by  $z$ , where the  $t$ th contact is denoted by  $z_t$  and  $z_{1:t-1}$  denotes the tactile contact history along the time. Thus, using this terminology, Bayes' formula for the initial tactile perception at time  $t = 0$  can be rewritten as

$$P(c_n|z_t) = \frac{P(z_t|c_n)P(c_n)}{P(z)} \quad (3.2)$$

The posterior for an angle and position class  $c_n$  given a tactile measurement

$z_t$  at time  $t$  is denoted by  $P(c_n|z_t)$ . The likelihood is denoted by  $P(z_t|c_n)$  which is obtained at time  $t$ . The uniform prior  $P(c_n) = 1/N$  is used for the initial perception at time  $t = 0$ . This combination is normalised by  $P(z)$  which is the history of the tactile measurements. Each component of Equation (3.2) will be detailed in the following sections.

### 3.4.2 Prior

The prior is assumed to be uniformly distributed for all perceptual classes for the first palpation or tap performed of each state during the tactile discrimination task. The initial prior is obtained from

$$P(c_n) = P(c_n|z_0) = \frac{1}{N} \quad (3.3)$$

This defines the posterior  $P(c_n)$  at time  $t = 0$  with all perceptual classes equally probable with  $N$  the total number of perceptual classes. This prior will be recursively updated with the likelihoods obtained from each palpation performed during the discrimination task by the tactile fingertip sensor.

### 3.4.3 Measurement model and likelihood estimation

Each palpation or tap performed by the tactile fingertip sensor provides a time series of digitised pressure values from the  $N_{\text{taxels}} = 12$  taxels. These tactile measurements are used for the construction of a measurement model with a nonparametric estimation method based on histograms using the tactile sensor values from the training dataset collected. The histogram for each perceptual class was uniformly constructed by binning the sensor values into  $N_{\text{bins}} = 100$  intervals. The measurement model is obtained from the probabilities as

$$P(b|c_n, k) = \frac{h(b, k)}{\sum_{b=1}^{N_{\text{bins}}} h(b, k)} \quad (3.4)$$

The number of observed tactile values  $s_k$  for taxel  $k$  in the histogram is



denoted by  $h(b, k)$ . Then, for a given tactile contact  $z$ , the log likelihood is obtained from the measurement model in Equation (3.4) over all samples as

$$\log P(z|c_n) = \sum_{k=1}^{N_{\text{taxels}}} \sum_{j=1}^{N_{\text{samples}}} \frac{\log P(b_k(j)|c_n, k)}{N_{\text{samples}}N_{\text{taxels}}} \quad (3.5)$$

The bin occupied by the tactile measurement  $s_k(j)$  is denoted by  $b_k(j)$ , where  $j$  is the number of the sample. In this case, the number of taxels  $N_{\text{taxels}} = 12$  and the number of samples  $N_{\text{samples}} = 100$  according to the characteristics of the implementation of the data collection procedure (see Section 3.3).

### 3.4.4 Bayesian update

The posterior probabilities are updated by the recursive implementation of Bayes' rule over all  $N$  perceptual classes  $c_n$  and the likelihoods  $P(z_t|c_n)$  from the measurements  $z_t$  of a palpation at time  $t$ .

$$P(c_n|z_{1:t}) = \frac{P(z_t|c_n)P(c_n|z_{1:t-1})}{P(z_t|z_{1:t-1})} \quad (3.6)$$

$$P(z_t|z_{1:t-1}) = \sum_{n=1}^N P(z_t|c_n)P(c_n|z_{1:t-1}) \quad (3.7)$$

The updated posterior from the first palpation to current time  $t$  is represented by  $P(c_n|z_{1:t})$ . The prior from time  $t - 1$  is denoted by  $P(c_n|z_{1:t-1})$ . The normaliser denoted by  $P(z_t|z_{1:t-1})$  is conditioned on the sum of previous tactile measurements as shown in Equation (3.7), which ensures that the probabilities of all hypotheses will sum to 1.

### 3.4.5 Marginal angle and position posteriors

As mentioned in Section 3.4.1, a class  $c_n$  corresponds to the pair  $(x_l, w_i)$  where  $x_l$  and  $w_i$  are the position and angle for each perceptual class respectively. The indices  $l$  and  $i$  denote the number of position and angle classes respectively.

The posterior is the joint distribution over these joint classes and then, the beliefs over an individual position and angle perceptual class are given by the marginal posteriors

$$P(x_l|z_{1:t}) = \sum_{i=1}^{N_i} P(x_l, w_i|z_{1:t}) \quad (3.8)$$

$$P(w_i|z_{1:t}) = \sum_{l=1}^{N_l} P(x_l, w_i|z_{1:t}) \quad (3.9)$$

The position posterior is obtained from the angle beliefs summed over all position perceptual classes and similarly, the angle posterior is obtained from the position beliefs summed over all angle perceptual classes. Thus, the marginal posteriors  $P(x_l|z_{1:t})$  and  $P(w_i|z_{1:t})$  provide the probability of the position  $x_l$  and angle  $w_i$  classes given the measurements  $z_t$  from a palpation at time  $t$  with the tactile fingertip sensor.

### 3.4.6 Stop decision for angle posterior

The process of accumulation of evidence by combination of the likelihood and the prior as shown in Equation (3.6) reduces the uncertainty from measurements collected with the fingertip sensor and also permits improving tactile perception for an exploration task. According to the sequential analysis method, instead of using a fixed number of iterations for accumulation of evidence and decision-making, here the continuous accumulation of evidence is stopped once one of the hypotheses exceeds a decision threshold.

For that reason, a threshold crossing rule is added to the Bayesian framework to stop the accumulation of evidence and then make a better final decision about the angle and position classes. In order to make a decision about the angle and position perceptual classes when a hypothesis has exceeded a decision threshold, the *maximum a posteriori* (MAP) estimate is used

$$\text{if any } P(w_i|z_{1:t}) > \theta_{\text{decision}} \text{ then } \begin{cases} w_{\text{decision}} = \arg \max_{w_i} P(w_i|z_{1:t}) \\ x_l = \arg \max_{x_l} P(x_l|z_{1:t}) \end{cases} \quad (3.10)$$

The angle and position classes estimated are denoted by  $w_{\text{decision}}$  and  $x_l$  respectively for the tactile measurement at time  $t$ . The decision threshold for making a final decision is represented by  $\theta_{\text{decision}} \in [0, 1]$  which trades-off between the decision speed and perception accuracy. This trade-off is an important characteristic for a perception system, e.g tactile exploration with a robotic platform, where normally low decision threshold provides a fast decision making system with a low perception accuracy. On the contrary, a high decision threshold provides a highly accurate perception system but that requires too much time for making a decision. This trade-off is analysed using the Bayesian method with a set of experiments in the following section.

## 3.5 Active and passive Bayesian perception

In this section the results of a tactile discrimination task using passive and active perception are presented to demonstrate the benefits and superiority of active over passive perception. Both approaches are implemented with a Monte Carlo method of drawing random angle and position data from a test dataset with real tactile data from the fingertip sensor.

### 3.5.1 Passive Bayesian perception

The first tactile experiment is the investigation in off-line mode of how accumulation of evidence across successive taps by random drawing of angle and position data can lead to successful perception, with no feedback from perception into the control of sensor movements. For that reason, a palpating

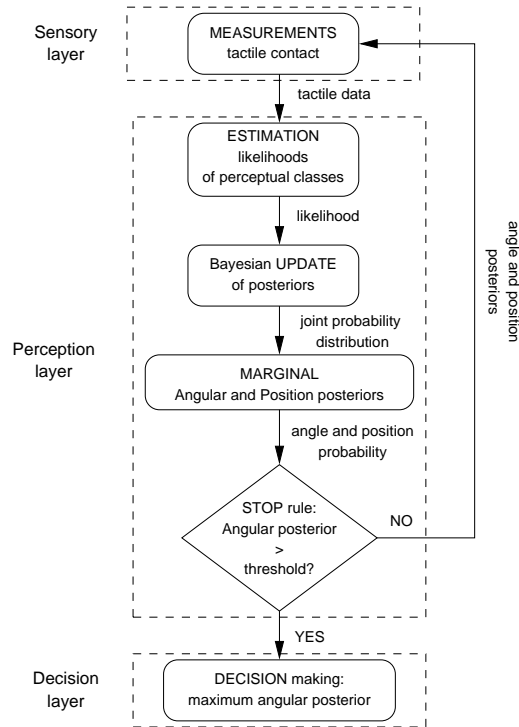

Figure 3.11: Passive Bayesian perception flowchart with the different steps for a tactile discrimination task. The steps are grouped in three layers: *Sensory*, *Perception* and *Decision*, according to the implemented operations.

or tapping process was repeatedly collecting and accumulating evidence from tactile data until one of the angle classes exceeded a decision threshold. This then triggers a decision about the current angle and position where the fingertip sensor is located. The accumulation of evidence for each tactile contact is based on the updating information process as shown in Equation (3.6). The decision made for the current location of the sensor based on its angle and position is represented by Equation (3.10). This is a passive Bayesian perception procedure, meaning that the fingertip sensor is not allowed to move to another location to improve perception.

The flowchart in Figure 3.11 shows the required steps to develop passive Bayesian perception. This process is divided into the *Sensory*, *Perception* and *Decision* layers to perform the discrimination task with the passive perception approach. First, in the *Sensory layer*, tactile measurements are obtained from a tactile contact which are arranged in a  $12 \times 100$  (taxels  $\times$  samples) matrix. In the *Perception layer* this matrix is used for estimation of the likelihood using

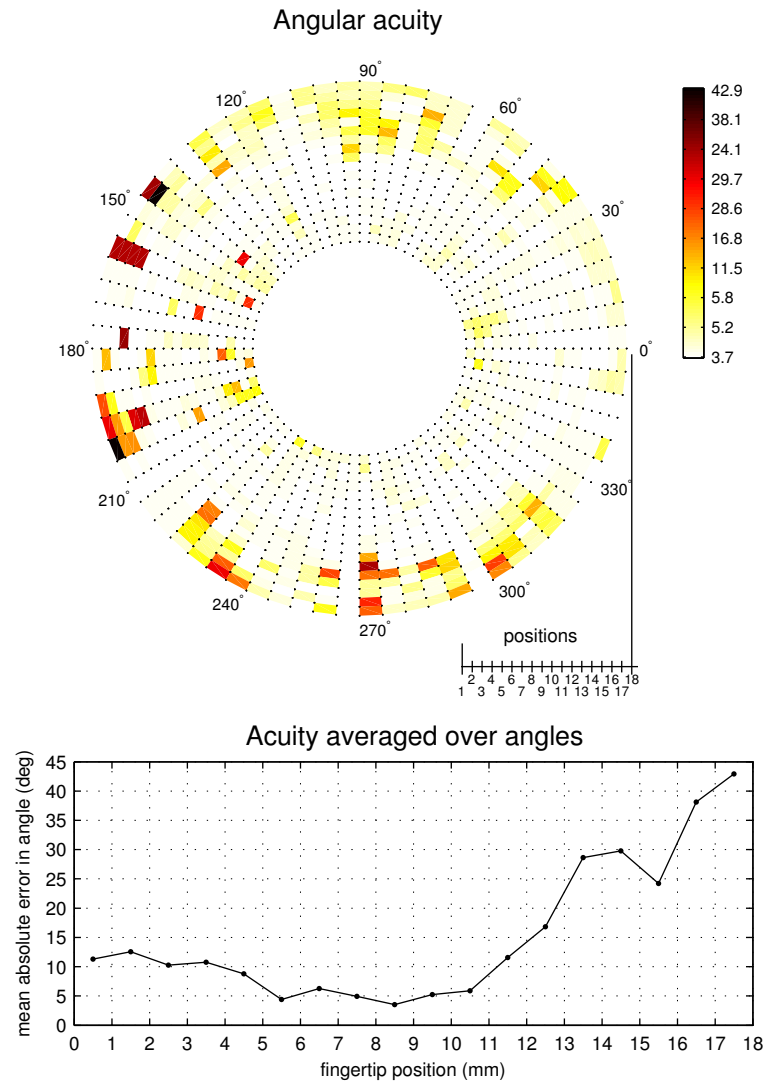

Figure 3.12: Angle acuity based on a passive Bayesian perception (top plot). The accuracy classification is over 72 angle and 18 position perceptual classes. Large and small errors are shown as red and white colours respectively, corresponding to values in the colour bar. The perception position dependency is shown in the bottom plot, which shows that the best perception is obtained at the centre of the fingertip sensor.

the measurement model shown in Equation (3.5). The posterior is updated by performing the accumulation of evidence based on the combination of the likelihood at time  $t$  and the prior from time  $t - 1$ . Then, the marginal angle and position posteriors are evaluated. If the current angle posterior exceeds a decision threshold then in the *Decision layer* a decision about the location of the fingertip sensor is made based on Equations (3.8) and (3.9), otherwise, the

complete process is repeated until the decision threshold is exceeded.

The experiment was implemented with a Monte Carlo method using the tactile data collected presented in Section 3.3. Random angle and position data were drawn repeating the experiment 10,000 times. Figure 3.12 shows the results for the passive Bayesian perception experiment with angle perception in top panel and position perception in bottom panel. Here, the perception was performed over 72 angles classes and 18 positions classes per angle (a total of 1296 perceptual classes). To analyse how the discrimination task is affected by decision thresholds, the passive perception experiment was repeated assigning the values in the range  $\{0.0, 0.05, \dots, 0.99\}$  to the decision threshold parameter in each repetition of the experiment.

The smallest angle classification error achieved with passive perception is 3.7 degrees for the position class at 9 mm which approximately corresponds to the centre of the tactile sensor. This means that the centre of the fingertip sensor is the best position for perception. These classification results were obtained for a decision threshold of 0.45 and a reaction time of 5 palpations or taps per decision.

Normally, passive perception is used for determination of sensitivity of different parts of our body. Therefore, this tactile experiment first, shows that the fingertip sensor is good enough for tactile discrimination and second, that the centre of the fingertip is the best position to improve perception.

### 3.5.2 Active Bayesian perception

Active perception, in contrast to passive, permits movements of the fingertip sensor to other locations in order to improve perception. These fingertip movements are performed by a sensorimotor control loop based on tactile feedback. For active perception modality, a fixation point is required as the target position for moving the fingertip sensor to improve perception during the discrimination task. This is similar to the fixation point in vision sensing modality where eyes move to find the locations with the more interesting

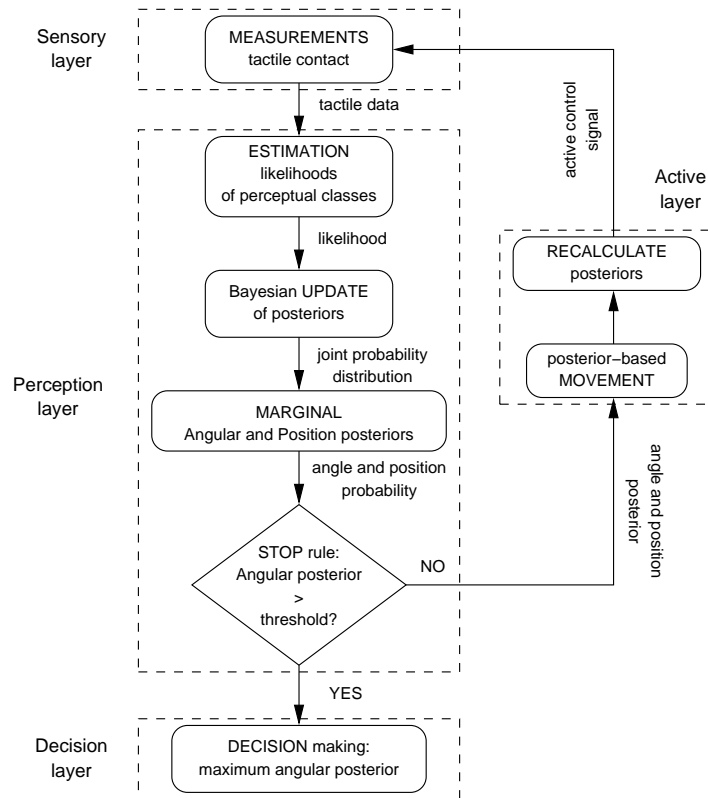

Figure 3.13: Active Bayesian perception flowchart with the required steps for implementation of an active tactile discrimination task. The steps are grouped in four layers: *Sensory*, *Perception*, *Decision* and *Active*. The active behaviour of this approach is performed in the *Active* layer by allowing movements of the fingertip sensor to different locations.

information during a visual exploration (Martinez-Conde et al., 2004; Najemnik and Geisler, 2005). Therefore, the 9 mm position class that achieved the smallest error from the passive perception analysis, is chosen as the fixation point for active control of the fingertip sensor.

The flowchart in Figure 3.13 shows the steps grouped in *Sensory*, *Perception*, *Decision* and *Active* layers, that are required for implementation of active perception with the tactile fingertip sensor. First, the measurements for each palpation with the fingertip are collected in the *Sensory* layer. Then, in the *Perception* layer the likelihood for the measurement at time  $t$  is estimated and combined with the prior from time  $t - 1$  for updating the posterior based on accumulation of evidence. The next step estimates the marginal angle and position posteriors. Then, if the angle posterior exceeds a decision threshold,

a decision about the current location of the tactile sensor is made in the *Decision* layer. Otherwise, the *Active* layer is responsible for moving the fingertip sensor to another location, also known as *repositioning movement*, for improving perception. This process is repeated from the beginning until the decision threshold is exceeded by one of the hypotheses.

### Active control strategy for tactile perception

Actively moving the fingertip sensor for improving perception is the key to the active Bayesian perception approach. From passive perception results, it is observed that the best position for perception with the iCub fingertip sensor is at its centre which corresponds to the 9 mm position class. Then, the target position denoted by  $x_{\text{target}} = 9$  mm class determines the target for repositioning the fingertip tactile sensor when the decision threshold has not been exceeded by the current marginal angle posterior. Thus, the repositioning parameter  $\theta_{\text{repositioning}}$  is used to enable the movement of the tactile sensor to perform an active behaviour. The Bayesian framework is able to perform in passive and active perception modalities by setting the repositioning parameter as follows,

$$\theta_{\text{repositioning}} = \begin{cases} 0 & \text{Passive} \\ 1 & \text{Active} \end{cases}$$

where the repositioning parameter is then set to 1 to perform an active perception behaviour. Then, the distance of the repositioning movement is represented by  $\pi$  which is determined from the target position  $x_{\text{target}}$  and the position decision  $x_l$  of the current location of the fingertip sensor.

$$x_l = \arg \max_{x_l} P(x_l | z_{1:t}) \quad (3.11)$$

$$\pi(x_l) = x_{\text{target}} - x_l \quad (3.12)$$



$$x \leftarrow x + \pi(x_l) \quad (3.13)$$

The position decision  $x_l$  of the current fingertip sensor location is obtained as shown in Equation (3.11). Thus, when an angle posterior does not exceed a decision threshold, the fingertip sensor is repositioned with the value  $\pi(x_l)$  which is obtained as shown in Equation (3.12). Once the repositioning movement is calculated, then it is applied to the fingertip sensor. The position of the sensor is then updated using Equation (3.13), and the process is repeated until the decision threshold is exceeded. This process performs a gradual repositioning of the tactile sensor to a good location for perception,  $x_{target}$ , thereby gradually improving the tactile perception accuracy.

In the second robot experiment, active Bayesian perception with a sensorimotor control loop for moving the fingertip to improve perception based on tactile feedback was examined. Random angle and position perceptual classes were drawn from the dataset previously collected with 10,000 iterations. Similar to the passive perception, the set of decision thresholds  $\{0.0, 0.05, \dots, 0.99\}$  was used for each iteration to analyse their effect on the decision accuracy and reaction time.

Angle, position and reaction time accuracy results against belief threshold are shown in Figure 3.14. Active Bayesian perception results are shown by green curves whilst passive Bayesian perception results are shown by red curves. For passive Bayesian perception, the angle and position results in Figures 3.14a and 3.14b show that the minimum classification errors obtained are  $\sim 12.2$  degrees and  $\sim 0.8$  mm respectively. For active Bayesian perception, the angle and position classification errors clearly contrast with passive modality results, achieving  $\sim 3.3$  degrees and  $\sim 0.2$  mm respectively. In Figure 3.14c, it is observed how active Bayesian perception provides faster reaction time which means that a lower number of palpations or taps is required for making a decision about the location of the fingertip sensor. From these results we can observe two main features: 1) active Bayesian perception provides a better classification accuracy over passive Bayesian perception because of the capability

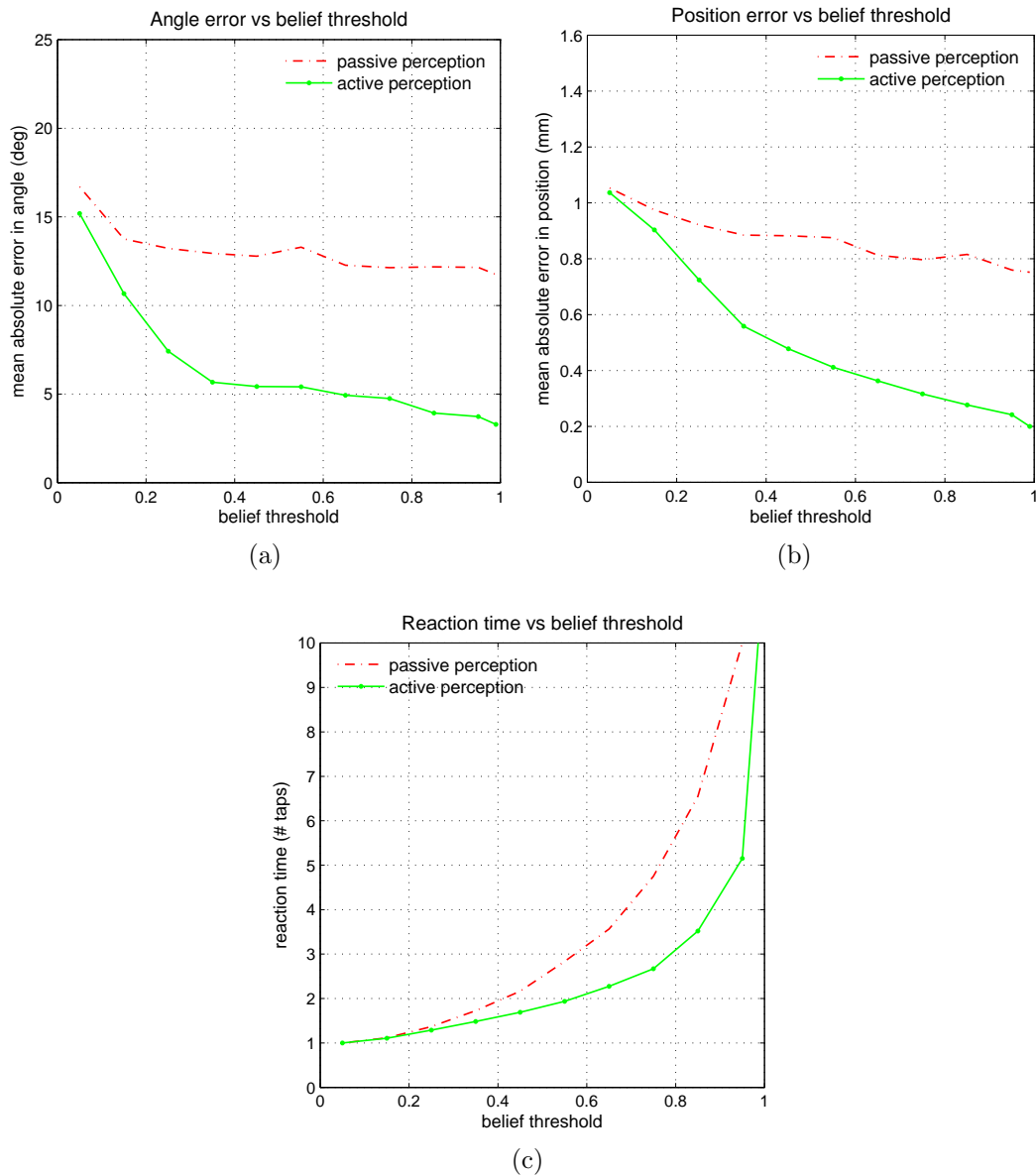

Figure 3.14: (a) Angle and (b) position acuity against belief threshold with active (green solid curves) and passive (red dashed curves) perception approach. (c) Reaction time against belief threshold for making a decision.

to move to locations for improving perception; and 2) the accuracy gradually improves for large values of decision threshold, allowing the acquisition of more evidence and making better decisions.

Results for analysis of angle and position accuracy against reaction time are shown in Figure 3.15. Both passive and active Bayesian perception approaches required a reaction time of  $\sim 5$  palpations or taps to approximately reach their respective minimum classification errors. Also, the perception ac-

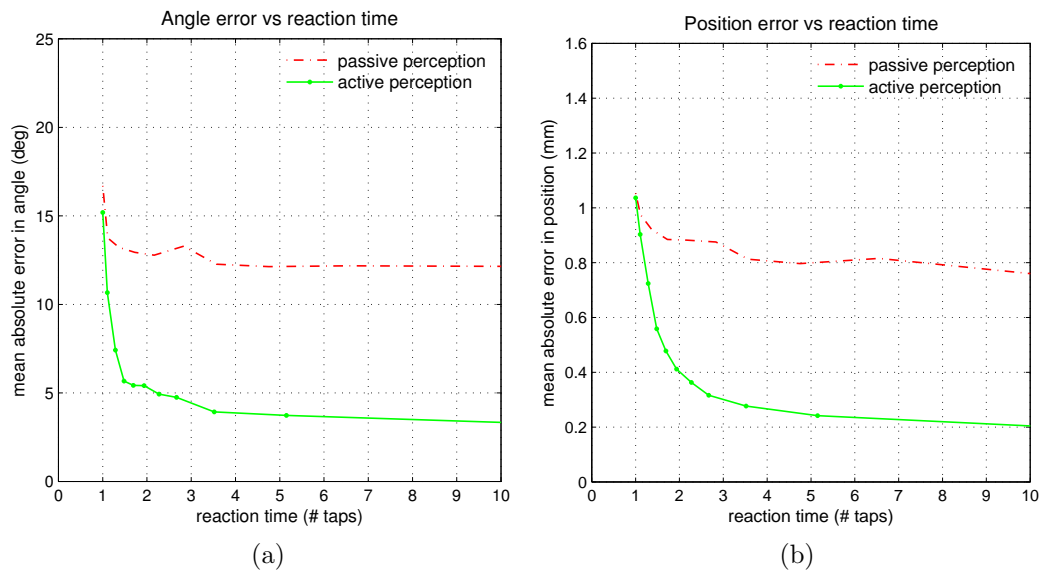

Figure 3.15: (a) Angle and (b) position acuity against reaction time with active (green solid curves) and passive (red dashed curves) perception approach.

curacy with active perception is gradually improved for increments in reaction time whilst with passive perception the classification errors are large despite the improvement for increasing reaction time values.

The comparison performed with passive and active Bayesian perception methods for a tactile discrimination task has demonstrated the benefits and superiority of active perception over passive one. Also, these results show a trade-off between speed and accuracy, where increasing decision thresholds provides a gradual improvement in perception accuracy but also an increment in the reaction time for making a decision.

## 3.6 Concluding remarks

Despite the advances in tactile sensor technology, methods for analysis of tactile data to provide robots with the capability to perceive, understand and give meaning to the data received through interaction with the environment are still in their infancy. Motivated by this and taking inspiration by how humans and animals perceive and make decisions, in this chapter a method for tactile perception based on a Bayesian framework was introduced.

A Bayesian approach is used given its natural way for accumulation of evidence in order to reduce uncertainty from measurements and thus make better decisions. This decision-making method is inspired by models developed from psychology and neuroscience. In other words, humans interact with an object for accumulating interesting information and make a good judgement during a tactile task, e.g. object recognition. Also, the Bayesian method for accumulation of evidence was extended with a sequential analysis method. This method permits to make a decision once a decision threshold has been exceeded rather than defining a fixed number of tactile interactions with an object. Sequential analysis allows to have flexible systems with the capability to make reliable decisions once the belief about a certain hypothesis is strong enough for crossing the decision threshold.

Here, the Bayesian method proposed was implemented to perform a passive and active perception procedure with a tactile discrimination task for perception of the location of the fingertip sensor based on its angle and position over an object. For passive perception the fingertip sensor was not able to move to another location for improving its perception. In contrast, with active perception the fingertip was actively moved or repositioned to collect more interesting data and reduce uncertainty about the location of the sensor. Results from both, passive and active perception, demonstrated the ability to perceive the location of the tactile fingertip sensor after a certain number of palpations or taps. However, active perception demonstrated to be superior by achieving higher perception accuracy with small reaction times. Also, the results show the trade-off between speed and accuracy for a decision-making process, where low decision thresholds allowed a faster decision-making with low perception accuracy, which contrast with the slow decision-making and high perception accuracy achieved for large decision thresholds. This trade-off is an important characteristic for autonomous robots given that they are required to make good decisions but also responding in a reasonable time.

These results and the Bayesian framework proposed can be used for the implementation of a tactile exploratory procedure. In this work, an implemen-

tation of a contour following exploratory procedure was chosen given that this is one of the most common tactile exploration procedures employed by humans to extract object shape. Chapter 4 presents the implementation of this tactile exploration task using the passive and active perception modalities described in this chapter with a simulated and real-time environments.



# Chapter 4

## Active Tactile Exploration

The active Bayesian perception method is implemented and tested in this chapter with an autonomous tactile exploration task in simulated and real environments using the robotic platform from Chapter 3. The exploration task is based on a contour following procedure which is the most common strategy used by humans for extraction of object shape (Okamura et al., 1997).

The results from both experiments in simulated and real environments show the successful accomplishment of the tactile exploration task based on active Bayesian perception. The benefits of active over passive perception also demonstrate that active behaviour is necessary to achieve robust and accurate perception. The trade-off in speed and accuracy from active and passive perception, which is an important characteristic in robotics, is analysed.

The object shapes extracted as a result of the proposed active Bayesian perception method, offer an alternative robust and accurate approach for tactile perception in robotics. This approach demonstrates to be suitable for biomimetic fingertip sensors, where image processing techniques are not the best option given the size and rounded shape inspired by human fingertips.

A description of edge detection and tracking for contour following are presented in Sections 4.1.1 and 4.1.2. The implementation of contour following in a simulated environment is presented in Section 4.1.3. The description and implementation of the sensorimotor architecture for active control with the contour following task in a real environment are presented in Sections 4.2.1 and 4.2.2. Section 4.3 presents the concluding remarks.

## 4.1 Edge detection and edge tracking

Normally, edge detection using planar tactile sensor arrays is based on processing of tactile images by the application of filters and calculation of geometrical moments for detection of orientation (Muthukrishnan et al., 1987; Berger and Khoslar, 1989; Chen et al., 1995a; Phung et al., 2010b). Some works have implemented edge detection based on tactile images for object manipulation (Suwanratchatamane et al., 2007; Abdullah et al., 2011). A recent work has investigated the use of Principal Component Analysis (PCA) with tactile images for the development of a control framework for tactile servoing (Li et al., 2013). Despite the progress and applications achieved by these methods with planar sensor arrays, they are not the most suitable for applications using biomimetic fingertip sensors given their rounded shape and small size inspired by humans fingertips.

The Bayesian perception approach, validated with a tactile discrimination task in Chapter 3, provides an alternative method for robust tactile edge detection. First, from passive perception it is clearly observed that the best position for improving perception with the biomimetic fingertip sensor is in its central region which is composed for the 8 mm to 11 mm position classes (see Figure 3.12). The tactile data for this region of the fingertip sensor correspond to the edge of the object used as stimuli during the data collection process. Figure 4.1 shows the central region of the biomimetic fingertip sensor located at two different orientations and interacting with the edge of an object.

This information can be used by the biomimetic fingertip sensor to detect when it has reached the edge of an object by perception of the position class at each time step during an exploration task. The edge detection task can be seen as a process mainly composed of two operations: 1) perception of the current position where the fingertip sensor is palpating; and 2) active repositioning or movement of the biomimetic fingertip sensor towards the edge of the object based on its central region.

For the first process, the position of the biomimetic fingertip sensor at each



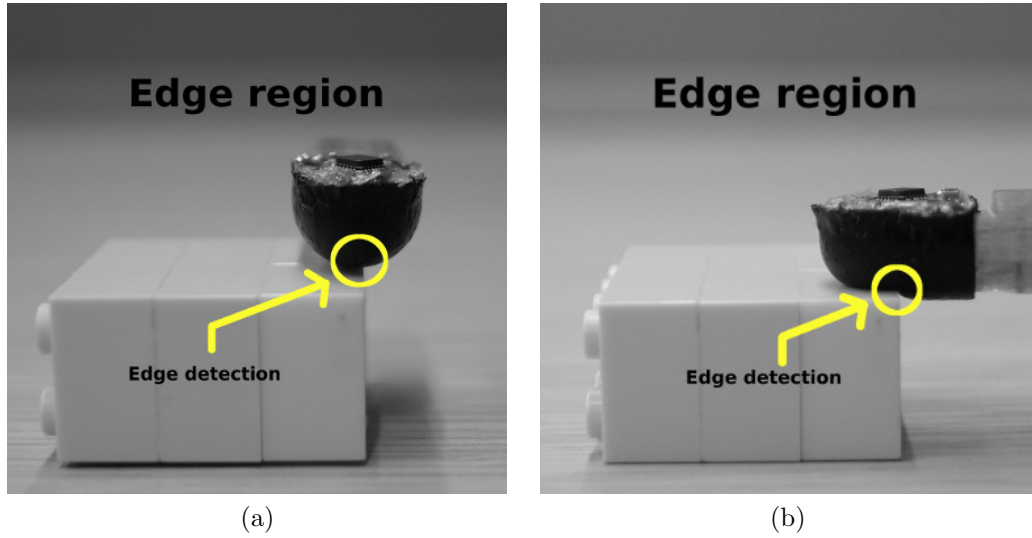

Figure 4.1: Position region for edge detection composed for the 8 mm to 11 mm position perceptual classes. An example of the biomimetic fingertip sensor performing edge detection for two different orientations in (a) and (b).

time step is perceived using Equation (3.8). This tactile Bayesian perception method is based on the accumulation of evidence from interaction with the object being explored. For the second process, active control of tactile movements for reaching the edge of the object being explored is achievable by active Bayesian perception for the repositioning of the fingertip sensor using Equations (3.11), (3.12) and (3.13).

#### 4.1.1 Active and passive edge detection

The procedure for edge detection based on active Bayesian perception is described in Algorithm 1. The input data are the tactile dataset of measurements collected which are denoted by  $Z = \{z_1, z_2, \dots, z_N\}$  with  $N$  the number of perceptual classes. The first tactile measurement  $z$  composed of  $N_{\text{taxel}} \times N_{\text{samples}}$  is read randomly from the tactile dataset. An estimate of the likelihood for the current tactile measurement  $z_{\text{tap}}$  is obtained from the function *estimate-Likelihood* implementing Equations (3.4) and (3.5) repeated here,

$$P(b|c_n, k) = \frac{h(b, k)}{\sum_{b=1}^{N_{\text{bins}}} h(b, k)}$$

**Algorithm 1:** Tactile edge detection based on active Bayesian perception

---

**Data:**  $Z = \{z_1, z_2, \dots, z_N\}$ : tactile measurements of size  $N_{\text{taxel}} \times N_{\text{samples}}$   
**Result:**  $x_{\text{edge}}$ : edge detected  
initialisation  
 $\theta_{\text{decision}} \in [0, 1]$  // belief threshold  
 $\text{Thr}_{\text{decision}} = \text{false}$   
 $x_{\text{init}} = \text{random}(N)$   
 $z_{\text{tap}} = Z\{x_{\text{init}}\}$  // initial random position  
**while** *not*  $\text{Thr}_{\text{decision}}$  **do**  
     $\text{LOC}_{\text{likelihood}} = \text{estimateLikelihood}(z_{\text{tap}})$  /\* obtain position likelihood \*/  
     $\text{LOC}_{\text{belief}} = \text{updateBayesian}(\text{LOC}_{\text{likelihood}}, \text{LOC}_{\text{prior}})$  // update belief  
    **if**  $\text{LOC}_{\text{belief}} > \theta_{\text{decision}}$  **then**  
         $\text{Thr}_{\text{decision}} = \text{true}$   
         $x_{\text{edge}} = \text{getPosition}(\text{LOC}_{\text{belief}})$  // obtain perceived position  
    **else**  
         $x_{\text{perceived}} = \text{getPosition}(\text{LOC}_{\text{belief}})$  // obtain perceived position  
         $x_{\text{movement}} = x_{\text{target}} - x_{\text{perceived}}$  // active sensor repositioning  
         $\text{LOC}_{\text{prior}} = \text{LOC}_{\text{belief}}$  // update prior for next iteration  
         $z_{\text{tap}} = Z\{x_{\text{perceived}} - x_{\text{init}}\}$  // update sensor measurement

---

$$\log P(z|c_n) = \sum_{k=1}^{N_{\text{taxels}}} \sum_{j=1}^{N_{\text{samples}}} \frac{\log P(b_k(j)|c_n, k)}{N_{\text{samples}} N_{\text{taxels}}}$$

whose output is assigned to the location likelihood variable  $\text{LOC}_{\text{likelihood}}$ . A belief about the current location of the biomimetic fingertip is then obtained from the functions  $\text{updateBayesian}$  which implements the combinations of the current likelihood  $\text{LOC}_{\text{likelihood}}$  and the prior location  $\text{LOC}_{\text{prior}}$  based on the Bayesian formulation from Equations (3.6) and (3.7) repeated here from Chapter 3.

$$P(c_n|z_{1:t}) = \frac{P(z_t|c_n)P(c_n|z_{1:t-1})}{P(z_t|z_{1:t-1})}$$

$$P(z_t|z_{1:t-1}) = \sum_{n=1}^N P(z_t|c_n)P(c_n|z_{1:t-1})$$

The output from the Bayesian updating  $\text{LOC}_{\text{belief}}$  is compared against the decision threshold  $\theta_{\text{decision}}$ . If  $\text{LOC}_{\text{belief}}$  does not exceed the decision threshold

defined, then the difference between the current position perceived  $x_{perceived}$  and the target position (central region of the fingertip sensor)  $x_{target}$  provides a relative displacement for the fingertip sensor to collect a new tactile measurement and repeat the complete process. Otherwise, if  $Loc_{belief}$  exceeds the decision threshold, then the position class is obtained from the current location perceived by the fingertip sensor and defined as the edge of the object. The position perceived  $x_{edge}$  is obtained from the function *getPosition* which implements Equation (3.10) repeated here,

$$x_l = \arg \max_{x_l} P(x_l | z_{1:t})$$

where  $x_{edge} = x_l$  is the assignation of the position with the maximum probability to the position perceived variable. This method permits the biomimetic fingertip sensor gradually reaching the edge of the object by actively repositioning or moving the tactile sensor for each interaction with the object.

An experiment to test the tactile edge detection method based on a Bayesian approach in a simulated environment was designed. The tactile data used for this experiment was collected with the biomimetic fingertip sensor and robotic platform described in Section 3.3, which formed a dataset of 72 angle and 18 position perceptual classes. The use of real tactile data for the experiment in the simulated environment provides more reliable results rather than using synthetic data. For the edge detection experiment, first, it was required to randomly draw an initial tactile measurement from the tactile dataset. This process permitted to test the edge detection method for a large number of initial orientations and positions of the biomimetic fingertip sensor with respect to the edge of the object. After the initialisation, the proposed Bayesian perception approach presented in Chapter 3, allowed the fingertip sensor to reduce uncertainty from the tactile measurements by accumulation of evidence. Then, the tactile sensor was able to gradually move towards the edge of the object by the active repositioning procedure provided by the proposed Bayesian perception method. The edge detection experiment for the simulated environment was prepared with a Monte Carlo simulation with 10,000 iterations. Results

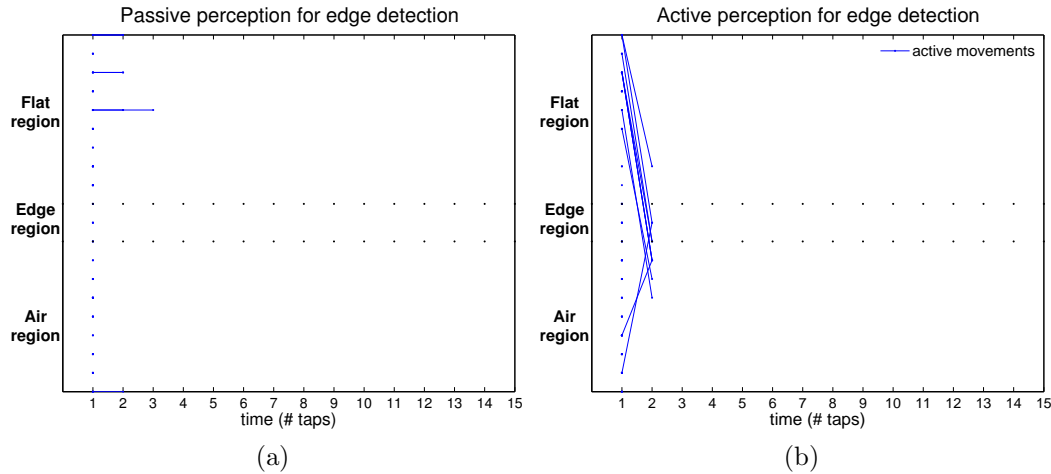

Figure 4.2: Passive and active edge detection with low decision threshold. Initial tactile measurement is randomly drawn from a tactile dataset composed of 72 angle and 18 position perceptual classes. (a) The fingertip sensor was not able to reach the edge of the object given its passive perception modality and the low decision threshold. (b) For active perception the fingertip sensor was gradually repositioning, however the low decision threshold was rapidly exceeded before reaching the edge of the object.

from the experiment using the proposed Bayesian perception approach with passive and active perception modalities are shown in Figures 4.2 and 4.3.

First, the implementation of passive and active Bayesian perception using low decision threshold  $\theta_{decision} = 0$  for the edge detection experiment is presented in Figures 4.2a and 4.2b respectively. The plots are divided in flat, edge and air regions built with real tactile data. The biomimetic fingertip sensor starts the experiment with a random orientation and position between the regions defined. Then, the fingertip sensor, based on Bayesian perception, performs repositioning movements to gradually reach the edge region. For passive Bayesian perception and low decision threshold ( $\theta_{decision} = 0$ ), the fingertip sensor was not able to reach the edge due to: 1) it was hard to perform repositioning movements to a better location to collect more data given the passive perception modality; and 2) the low decision threshold was exceeded faster, reducing the time for accumulation of evidence and producing inaccurate decisions. From these results we observe that in one hand, the fingertip sensor was able to respond faster, requiring  $\sim 1$  palpations to make a decision about

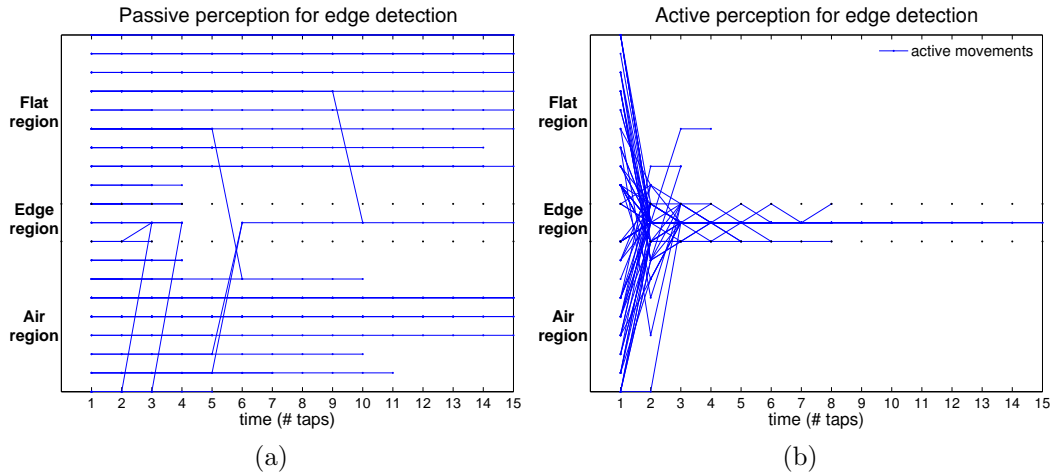

Figure 4.3: Passive and active edge detection with high decision threshold. Initial tactile measurement is randomly draw from a tactile dataset composed of 72 angle and 18 position perceptual classes. (a) The fingertip sensor was allowed to accumulate evidence with a high decision threshold but given its passive perception modality, it was unable to perform repositioning movements to successfully reach the edge. (b) In contrast, active perception permitted both accumulation of evidence and repositioning movements until a decision threshold was exceeded to successfully reach the edge of the object.

the current position of the sensor. On the other hand, the edge detection was not successfully accomplished based on the low perception accuracy achieved. This result is observed on the small number of palpations performed by the fingertip sensor and the inability to move to the edge region (see Figure 4.2a).

For active Bayesian perception and low decision threshold  $\theta_{decision}$ , the fingertip sensor was able to perform repositioning movements actively controlled towards the edge region. However, the low decision threshold was exceeded faster ( $\sim 2$  palpations per decision) which reduced the time to achieve accurate perceptions to reach the edge region. Figure 4.2b shows how even though the fingertip sensor was able to move towards the edge, the sensor did not have enough time to reach it given the decision threshold.

The second edge detection experiment for passive and active Bayesian perception using high decision threshold  $\theta_{decision} = 1$  is shown in Figures 4.3a and 4.3b respectively. For the experiment based on passive Bayesian perception with high decision threshold, the fingertip sensor was able to accumulate evidence over a longer time. However, the edge region was not successfully

reached for most of the trials. This is due to the low perception accuracy achieved by the passive perception modality which makes hard the repositioning of the tactile sensor towards better locations to reduce uncertainty and improve tactile perception. The results of passive Bayesian perception with high decision threshold are shown in Figure 4.3a, where it is observed that even though the fingertip sensor was able to accumulate evidence over a longer time (palpations), the edge region was not reached for most of the trials.

In contrast, the edge detection experiment using active Bayesian perception with high decision threshold presented significant improvements. First, the fingertip sensor was able to accumulate evidence from interaction with the object over a longer time. Second, the active perception modality permitted the fingertip sensor to move towards better locations for perception, reducing uncertainty from measurements and gradually reaching the edge region of the simulated object. Even though the speed of the edge detection experiment was increased to a reaction time of  $\sim 4$  palpations, the fingertip sensor was able to successfully reach the edge region for most of the trials. It is observed from Figure 4.3b that the fingertip sensor was gradually moving towards the edge region, which required about 4 palpations. These results demonstrate the benefits of the proposed Bayesian perception method with active modality and high decision threshold.

The results from these experiments demonstrate how the biomimetic fingertip sensor is able to successfully accomplish edge detection using active Bayesian perception, which also offers an alternative approach to image processing techniques which normally use planar sensor arrays. Moreover, the proposed active Bayesian perception method is inspired by results from psychophysical studies with humans performing decision-making based on the accumulation of evidence through the interaction with the environment.

The experiments for edge detection presented in this section were performed using the tactile dataset composed of 1296 perceptual classes (72 angle  $\times$  18 position classes) obtained with the biomimetic fingertip presented in Section 3.3. For each trial of the experiment, a random orientation and position were drawn

for the initial location of the fingertip sensor. The configuration of the experiment based on active Bayesian perception and high decision threshold permitted to successfully reach the edge region with a mean reaction time of 4 palpations performed by the biomimetic fingertip sensor. These results based on a large dataset of tactile orientations and positions, demonstrate the robustness and accuracy of the proposed method to perform edge detection with the biomimetic fingertip sensor.

In this section, an edge detection method was developed given that this is a required process for the implementation of the contour following exploratory procedure presented in the next section. Therefore, the successful edge detection results achieved in this section by the proposed perception method can be used together with angle perception to perform a continuous edge detection and tracking (see Section 4.1.2), to replicate a robotic platform undertaking the contour following exploratory procedure commonly employed by humans to extract object shape (Lederman and Klatzky, 1987; Okamura et al., 1997).

### 4.1.2 Active and passive contour following

Humans perform contour following based on sliding or palpating with one or all of their fingertips (Lederman and Klatzky, 1987, 2009). This exploratory procedure mainly requires two processes: 1) edge detection; and 2) edge tracking. The first process has been described in Section 4.1.1. The second process requires to perceive the angle where the fingertip sensor is located over the contour of the object being explored to decide where to move next.

For obtaining better results in angle perception, the biomimetic fingertip sensor needs to be actively moved or repositioned towards the edge of the object, which corresponds to the central region of the tactile sensor (see Section 3.5). The process of angle perception during reaching the edge of the object is presented in Figure 4.4. It can be observed in Figure 4.4a how the fingertip is actively moved to reach the edge of the object and simultaneously collecting more information to perform a better angle perception. Once the

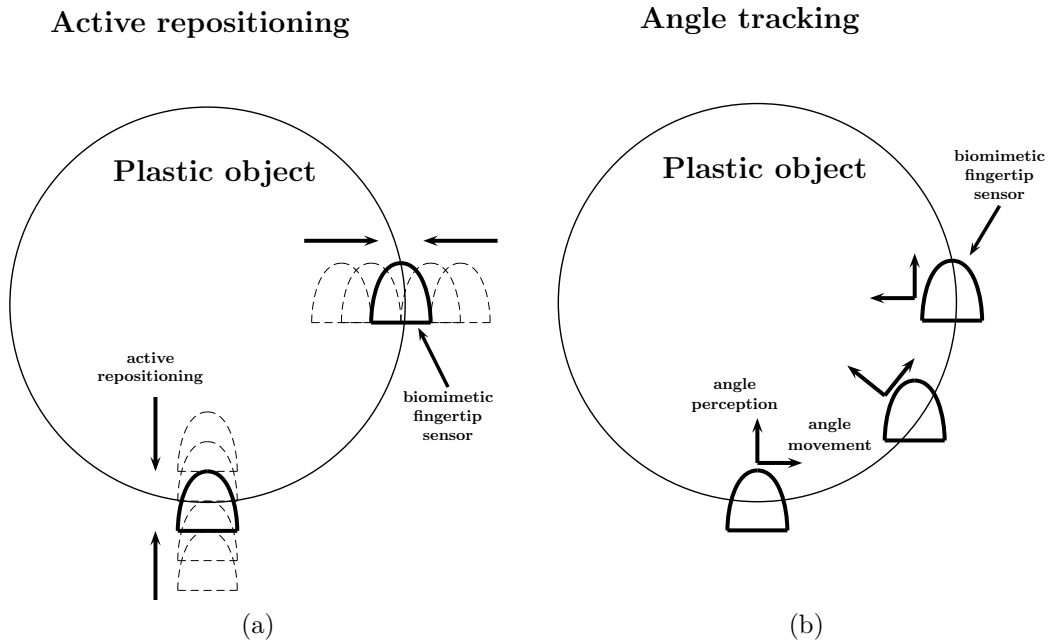

Figure 4.4: Contour following exploration procedure using an active Bayesian approach. (a) The fingertip sensor is repositioning for improving perception. (a) Simultaneously, accumulation of evidence is performed for making an angle perception. Once an angle decision has been made, the fingertip sensor is moved to continue with the exploration task.

belief about the angle perceptual class at the current location of the fingertip sensor exceeds a decision threshold, the tactile sensor needs to know *where to move next* to continue with the contour following exploration. This is accomplished first by making a decision about the angle class for the current edge orientation where the tactile sensor is located. The resulting angle decision is shifted by 90 degrees which is required according to the data collection method implemented in Section 3.3. Thus, the new angle is used to move the fingertip sensor to the new location as shown in Figure 4.4b.

Algorithm 2 presents the steps for implementation of the contour following exploratory procedure. The input data is the testing tactile dataset collected in Section 3.3, whilst the output is the location (position and angle) of the fingertip sensor composed of the pair  $(x, w)$ . Initially, the method takes a random tactile measurement for starting the perception process. Then, the likelihood about the location is obtained by the function *estimateLikelihood* which implements Equations (3.4) and (3.5). This likelihood is combined with the prior



---

**Algorithm 2:** Tactile contour following based on active Bayesian perception

---

**Data:**  $Z = \{z_1, z_2, \dots, z_N\}$ : tactile measurements of size  $N_{\text{taxel}} \times N_{\text{samples}}$   
**Result:**  $(w, x)$ : location (angle and position) of the fingertip sensor  
initialisation  
 $\theta_{\text{decision}} \in [0, 1]$  // belief threshold  
 $\text{Thr}_{\text{decision}} = \text{false}$   
 $x_{\text{init}} = \text{random}(N)$  // random position  
 $w_{\text{init}} = \text{random}(N)$  // random angle  
 $z_{\text{tap}} = Z\{w, \text{init}, x_{\text{init}}\}$  // initial random location  
**while not**  $\text{Thr}_{\text{decision}}$  **do**  
     $\text{LOC}_{\text{likelihood}} = \text{estimateLikelihood}(z_{\text{tap}})$  /\* obtain location likelihood \*/  
     $\text{LOC}_{\text{belief}} = \text{updateBayesian}(\text{LOC}_{\text{likelihood}}, \text{LOC}_{\text{prior}})$  // update belief  
    **if**  $\text{LOC}_{\text{belief}} > \theta_{\text{decision}}$  **then**  
         $\text{Thr}_{\text{decision}} = \text{true}$   
         $(w_{\text{angle}}, x_{\text{edge}}) = \text{getLocation}(\text{LOC}_{\text{belief}})$  /\* obtained perceive location \*/  
         $w_{\text{angle}} = w_{\text{angle}} + \Delta$  // angle updating  
    **else**  
         $x_{\text{perceived}} = \text{getPosition}(\text{LOC}_{\text{belief}})$  // obtain perceive position  
         $x_{\text{movement}} = x_{\text{target}} - x_{\text{perceived}}$  // active sensor repositioning  
         $\text{LOC}_{\text{prior}} = \text{LOC}_{\text{belief}}$  // update prior for next iteration  
         $z_{\text{tap}} = Z\{w_{\text{init}}, x_{\text{perceived}} - x_{\text{init}}\}$  // update sensor measurement

---

of the location to update the belief about the current location of the tactile sensor using Equations (3.6) and (3.7) which are implemented in the function *updateBayesian*. If this belief has not exceeded a decision threshold, similar to the edge detection algorithm, the fingertip sensor is repositioned to a better location for perception but without affecting the angle class by application of Equations (3.11), (3.12) and (3.13) repeated here from Section 3.5.2,

$$x_l = \arg \max_{x_l} P(x_l | z_{1:t})$$

$$\pi(x_l) = x_{\text{target}} - x_l$$

$$x \leftarrow x + \pi(x_l)$$

where the repositioning displacement is calculated by  $\pi(x_l)$  and the new position for the fingertip sensor is defined by  $x$ . From this new location, a tactile measurement is drawn and combined again with the prior until a decision is ready to be made.

On the other hand, if a belief about the location of the fingertip sensor has exceeded a decision threshold, the maximum angle and position are obtained from the function *getLocation* which implements Equation (3.10) as shown below (repeated from Section 3.4.6),

$$\text{if any } P(w_i|z_{1:t}) > \theta_{\text{decision}} \text{ then } \begin{cases} w_{\text{decision}} = \arg \max_{w_i} P(w_i|z_{1:t}) \\ x_l = \arg \max_{x_l} P(x_l|z_{1:t}) \end{cases}$$

where  $w_{\text{angle}} = w_{\text{decision}}$  and  $x_{\text{edge}} = x_l$  are the angle and position perceived from the current location of the biomimetic fingertip sensor.

The edge detected is achieved at the central region of the tactile sensor which is the area that provides better perception (see Section 3.12). The movement decision along the edge of the object is obtained by shifting the angle perceptual class obtained from active perception by  $\Delta = 90$  degrees according to the method used for data collection (see Section 3.3).

This algorithm is implemented in next sections with a tactile contour following exploration task in simulated and real environments. The aim is to demonstrate the robustness, speed and accuracy of tactile object shape extraction using the active Bayesian perception approach.

### 4.1.3 Simulated tactile contour following exploration

In this section a simulated environment is developed to implement the edge detection and tracking procedure shown in Section 4.1.2, to test the speed and accuracy of the proposed active Bayesian perception method. Also, the

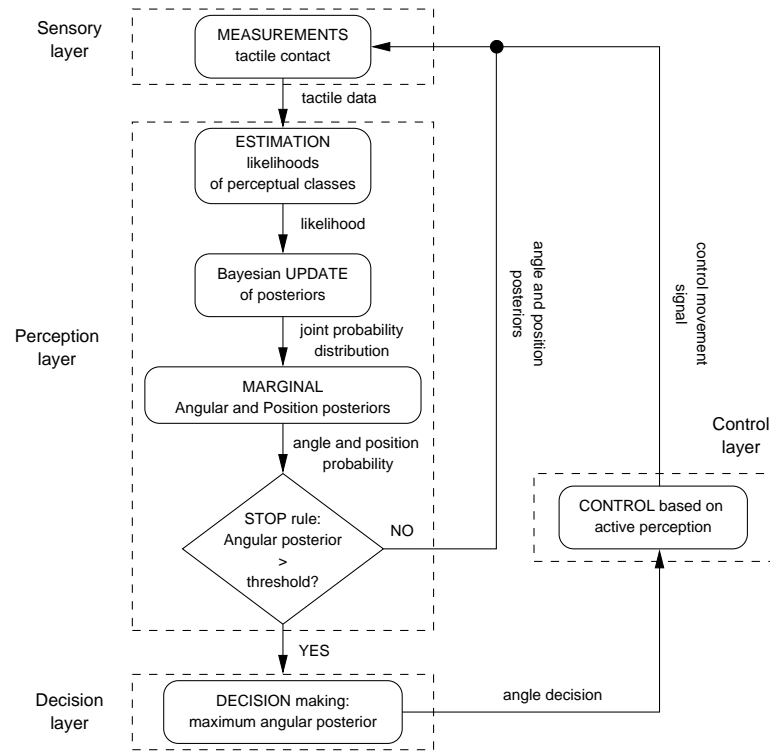

Figure 4.5: Passive Bayesian perception for contour following exploration. The process is divided in different layers: *Sensory*, *Perception*, *Decision* and *Control*. The passive modality do not allow the movement of the fingertip sensor in order to reduce uncertainty from the measurements. The performance is shown with the contour following procedure commonly employed by humans to extract object shape using the sense of touch.

aim of the test is the extraction of the shape of a simulated object by the contour following exploratory procedure. A circular-shaped and linear-shaped objects are constructed for the simulated environment using the real tactile data collected in Section 3.3. The linear-shaped object is built keeping the same orientation along the object, randomly draw from the 72 angle perceptual classes in the tactile dataset. For the circular-shaped object, the 72 angle perceptual classes are used for its construction. For both objects, each angle perceptual class is composed of 18 position classes which are the boundaries for repositioning of the biomimetic fingertip sensor during the perception of its location. These simulated objects can be observed in Figures 4.7 and 4.8.

The process of contour following exploration described in previous Section 4.1 using passive and active perception is shown in the flowcharts of Figures 4.5 and 4.6. Similar to the flowcharts presented in Chapter 3, they are

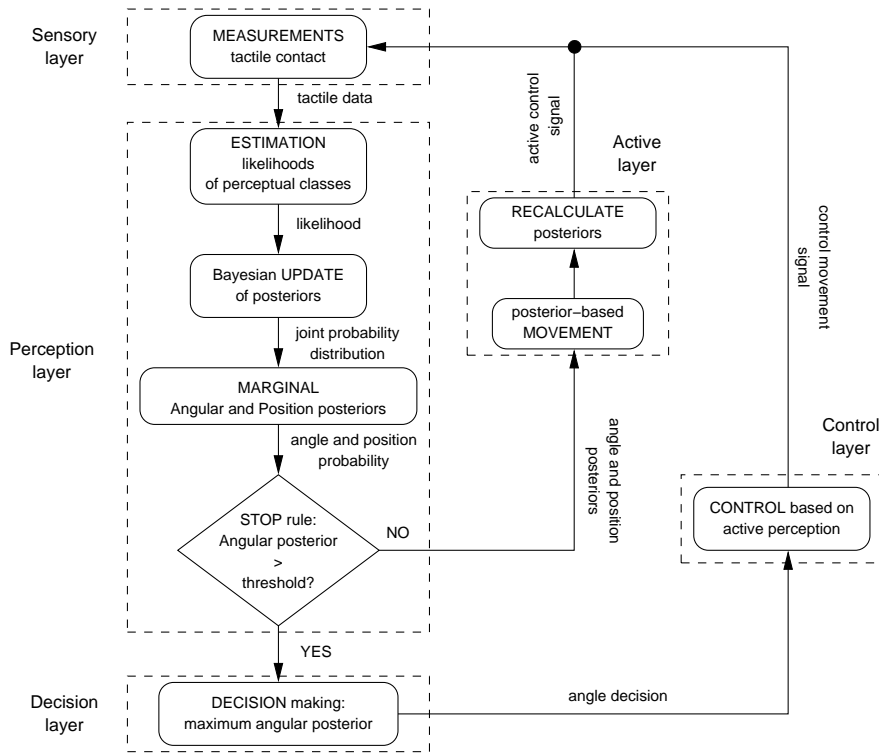

Figure 4.6: Active Bayesian perception for contour following exploration. The process is divided in different layers: *Sensory*, *Perception*, *Decision* and *Control*. Unlike passive perception, here the fingertip sensor is also allowed to move towards better locations in order to reduce uncertainty. As will be observed, this perception modality permits to extract object shape using the contour following procedure as humans do.

divided in *Sensory*, *Perception* and *Decision* layers with the addition to the *Control* layer. The *Sensory* layer received the tactile measurements from each tactile contact performed by the biomimetic fingertip sensor. The *Perception* layer provides an estimation of the likelihoods. The posterior is updated by the combination of the likelihood and prior information. The decision about the location of the fingertip sensor over the object being explored is performed by the *Decision* layer. Finally, the *Control* layer calculates the next location to move the fingertip sensor, and also is responsible for the generation and synchronization of each movement along the exploration task. This process is performed to follow the contour of an object by both passive and active perception modalities. However, active perception also includes the active repositioning and control of movements of the tactile sensor towards better locations to reduce uncertainty.

## Linear-shaped object extraction

The linear-shaped object and the results of the contour following exploratory procedure are presented in Figure 4.7. First, the orientation (angle class) of the simulated object is randomly drawn and kept along the construction of the complete object. The example presented in this section is for a simulated object oriented at 45 degrees (see Appendix B). The edge of the object to be tracked is represented by the dotted line. The limits for repositioning of the biomimetic fingertip sensor at each exploration step are represented by the solid lines. These limits are related to the amount of information contained in the tactile dataset collected.

The contour following experiment for the simulated environment was performed using passive and active Bayesian perception with the decision threshold parameter  $\theta_{decision} \in [0, 1]$ . The results in Figure 4.7 show in the top (red colour) and bottom (green colour) plots the implementation of contour following task with passive and active Bayesian perception respectively.

The edge tracking simulations of the linear-shaped object using passive Bayesian perception are shown in Figures 4.7a and 4.7b which are implemented with low decision threshold  $\theta_{decision} = 0$  and high decision threshold  $\theta_{decision} = 1$  respectively. For the low decision threshold, the fingertip sensor performed a fast exploration of the linear-shaped object, but achieving low perception accuracy which is observed in the unsuccessful edge tracked (Figure 4.7a). For the high decision threshold, even though the fingertip sensor was able to accumulate evidence over a longer time, it could not accomplish the contour following task (Figure 4.7b). This is due to the passive perception modality implemented, which makes it hard to perform repositioning movements of the tactile sensor to better locations for improvement of perception. These results demonstrate that tactile exploration is not successfully accomplished due to the low perception accuracy achieved by passive Bayesian perception.

The results of the edge tracking simulation using active Bayesian perception with low decision threshold  $\theta_{decision} = 0$  and high decision thresh-

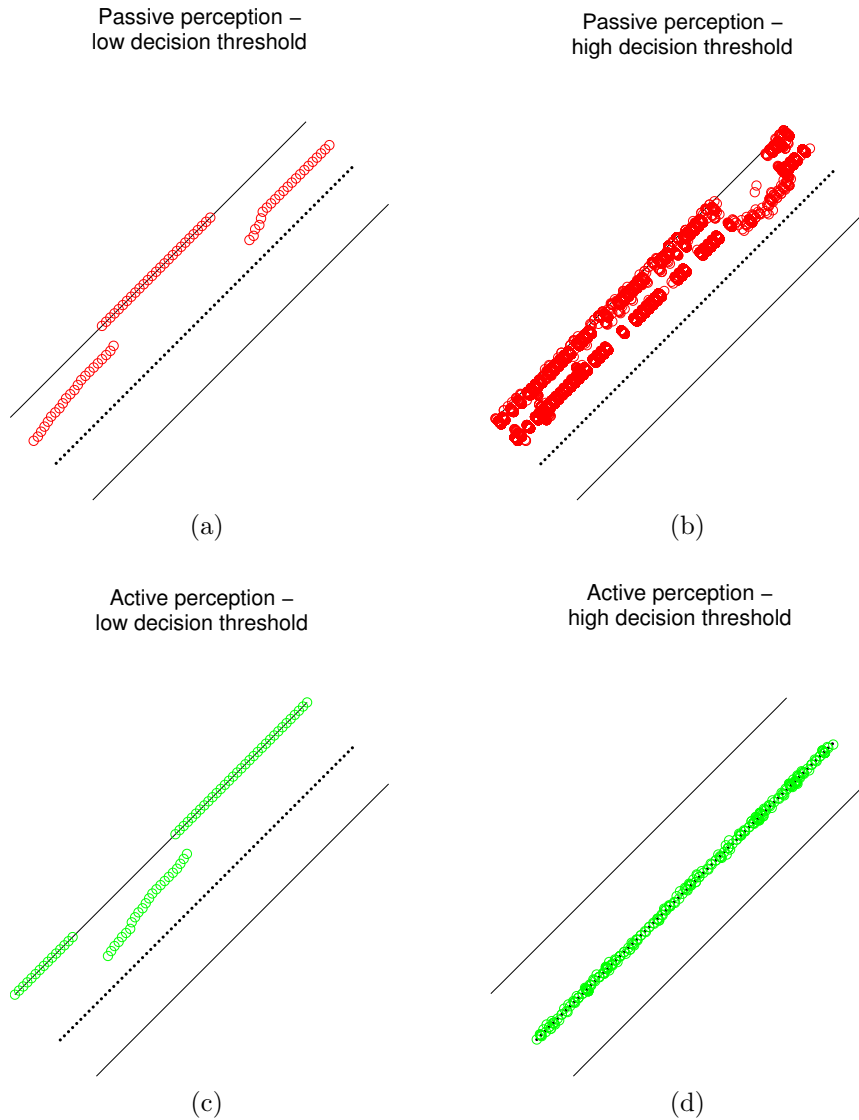

Figure 4.7: Implementation of a contour following exploratory procedure with active and passive Bayesian perception. The linear-shaped object was built using real tactile data. Plots (a) and (b) show the results for passive perception with low and high decision thresholds respectively. Plots (c) and (d) show active perception with low and high decision thresholds for edge tracking. Active perception with high decision threshold successfully accomplished the tactile exploration task.

old  $\theta_{decision} = 1$  are shown in Figures 4.7c and 4.7d respectively. For active Bayesian perception and low decision threshold, the tactile sensor was not able to successfully track the edge of the linear-shaped object (Figure 4.7c). In this case, low perception accuracy was achieved due to the small time required to make a decision, which did not permit to accumulate enough evidence and

perform repositioning movements of the tactile sensor to improve perception. In contrast, for active Bayesian perception and high decision threshold, the fingertip sensor was able to successfully track the edge of the linear-shaped object (Figure 4.7d). In this case, the fingertip sensor was able to accumulate evidence over a longer time whilst performing repositioning movements to better locations in order to improve perception. The green circles in Figure 4.7d, which represent the fingertip sensor, show the repositioning movements of the tactile sensor for each exploration step. These results demonstrate that using active Bayesian perception with high decision threshold it is possible to improve perception accuracy which permits to successfully perform tactile exploration with biomimetic fingertip sensors.

### Circular-shaped object

For this experiment a circular-shaped object was constructed with real tactile data in a simulated environment. The circular-shaped object was constructed using the 72 angle and 18 position classes from the test dataset collected with the biomimetic fingertip sensor (see Section 3.3). This simulated object is presented in Figure 4.8. The edge to be tracked is represented by the dotted line, whilst the limits for repositioning of the biomimetic fingertip sensor at each exploration step are represented by the solid lines. These limits (solid line) are set according to the amount of tactile data collected.

Similar to the linear-shaped object, for this experiment the contour following procedure is performed using passive and active Bayesian perception with decision thresholds  $\theta_{decision} \in [0, 1]$  to extract the shape of a circular object in a simulated environment. The results of the experiment are shown in Figure 4.8 where the top (red colour) and bottom (green colour) plots present the contour following task using passive and active Bayesian perception respectively.

The contour following task for passive Bayesian perception using low decision threshold  $\theta_{decision} = 0$  and high decision threshold  $\theta_{decision} = 1$  is shown in Figures 4.8a and 4.8b respectively. For the case of low decision threshold, the

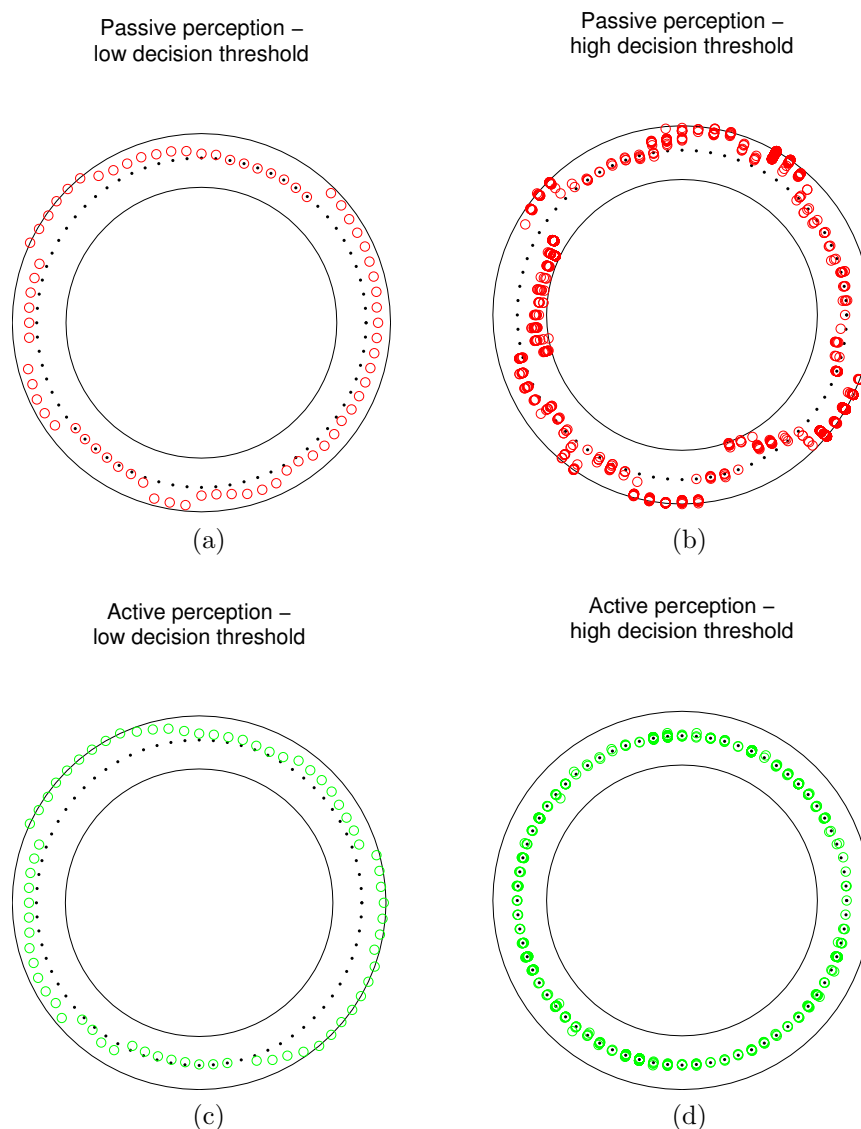

Figure 4.8: Implementation the contour following exploratory procedure with active and passive Bayesian perception on a simulated circular-shaped object constructed using real tactile data. Plots (a) and (b) show the results for passive perception with low and high decision thresholds respectively. Plots (c) and (d) show active perception with low and high decision threshold for edge tracking. The use of active Bayesian perception with high decision threshold successfully accomplishes the tactile exploration task.

fingertip sensor was able to perform a fast exploration task. However, small perception accuracy was achieved, which is clearly observed with the unsuccessful accomplishment of the contour following task (Figure 4.8a). These results are obtained given the small time provided to accumulate evidence and perform repositioning movement to better locations for perception. For



the high decision threshold simulation, the exploration time of the simulated object was increased given that the fingertip sensor was able to accumulate evidence for a longer time. However, the perception accuracy is not improved, which is reflected in the unsuccessful edge tracking achieved (Figure 4.8b). The results obtained from the implementation of passive Bayesian perception, either using low or high decision threshold, show that this perception modality makes it hard to perform repositioning movements of the fingertip sensor to better locations to improve perception, resulting on the unsuccessful tactile exploration task.

The shape extraction of a circular object using active Bayesian perception with low decision threshold  $\theta_{decision} = 0$  and high decision  $\theta_{decision} = 1$  is shown in Figures 4.8b and 4.8c respectively. The result of using low decision threshold shows that the fingertip sensor is able to perform fast decisions but achieving low perception accuracy, resulting in the unsuccessful accomplishment of the contour following task (Figure 4.8c). Even though active perception modality is used, low perception accuracy was achieved given the small time required to accumulate evidence and make decisions which degrades the performance of the exploration task. In contrast, for the use of active Bayesian perception with high decision threshold, the fingertip sensor successfully accomplished the tactile exploration task by following the contour of the simulated circular-shaped object (Figure 4.8d). The exploration time required to trace the contour of the object was increased using the high decision threshold. However, this also permitted to accumulate evidence for a longer time and also to perform repositioning movements of the fingertip sensor allowing to reduce uncertainty and reaching high perception accuracy. The active repositioning of the tactile sensor is observed with the overlapped green circles moved to better locations to improve perception at each exploration step. Similar to the results obtained from the linear-shaped object, here it was found that using active Bayesian perception together with high decision threshold the fingertip sensor was able to successfully accomplish the tactile exploration task based on the contour following of a circular-shaped object. The traced contours from the circular-

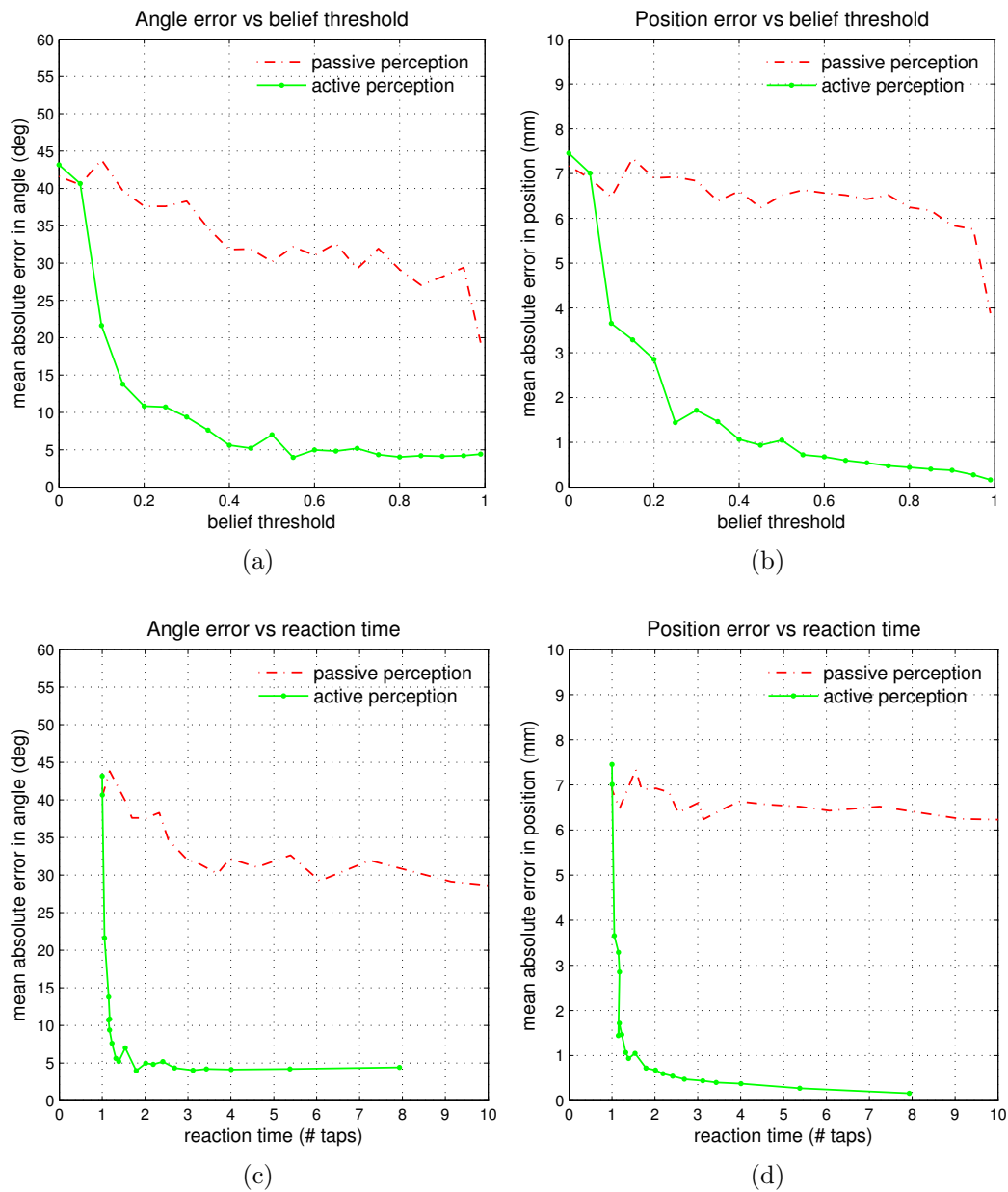

Figure 4.9: Angle and position acuity with active and passive perception approach for a contour following exploration task. Angle errors for passive (red curves) and active (green curves) perception are plotted against belief threshold (a) and reaction time (c). Position errors for passive and active perception are plotted against belief threshold (b) and reaction time (d). The benefits of using active over passive perception are clearly observed for angle and position perception accuracy.

shaped object with different decision thresholds are presented in Appendix C.

The performance in speed and accuracy for the contour following task implemented with the biomimetic fingertip sensor in the simulated environment

using real tactile data is presented in Figure 4.9. The red and green coloured curves show the results from the use of passive and active Bayesian perception respectively. The perception accuracy achieved by the fingertip sensor is shown with the angle and position errors obtained against belief threshold presented in Figures 4.9a and 4.9b. The minimum angle and position errors achieved by passive perception are  $\sim 20$  degrees and  $\sim 4$  mm for a belief threshold  $\sim 1$ . These results are highly improved by the active perception which achieved the minimum angle and position errors of  $\sim 4$  degrees and  $\sim 0.2$  mm. The best angle accuracy achieved with active perception was for belief thresholds between 0.5 and 1. Even though for the position the best accuracy is achieved with a belief threshold of  $\sim 1$ , very small position errors (less than 1 mm) are obtained for belief thresholds starting at 0.5. The proposed active Bayesian perception method, through the perception accuracy results, demonstrate its superiority over the passive Bayesian perception for the performance of tactile exploration.

The angle and position perception results against reaction time, showing the number of palpations required for making a decision, are presented in Figures 4.9c and 4.9d. The best for both angle and position accuracy using passive perception are obtained with a reaction time of 10 palpations per decision-making. For active perception, the best angle accuracy is achieved with 2 to 3 palpations per decision. The best position accuracy with active perception is achieved by 8 palpation, however high accurate perception (less than 1 mm) is obtained starting 2 palpations per decision. These results demonstrate the benefits that the proposed active Bayesian perception offers, allowing the biomimetic fingertip to achieve better perception accuracy with small reaction time over the results obtained from passive perception modality.

The results obtained from these experiments in simulated environment have demonstrated that active Bayesian perception is a robust and accurate method for tactile exploration with biomimetic fingertip sensors. The implementation of the contour following exploratory procedure inspired by the tactile strategy employed by humans to extract object shape, demonstrated the benefits and superiority of active over passive Bayesian perception method. The robustness

of the proposed method is also observed with the accurate results achieved for a large tactile dataset composed of 1296 perceptual classes (72 angles and 18 positions, see Section 3.3). Another important characteristic of the method proposed is the possibility to adjust the accuracy and speed trade-off by selecting a decision threshold for the decision-making process. This feature is important in robotics, where usually robots are required to make fast but also highly accurate decisions and actions.

An implementation of the passive and active Bayesian perception approach with the contour following exploration task is also tested in a real environment which is presented in the next section. This experiment is performed with a circular-shaped object to test the full range of angle and position perceptual classes in the tactile dataset collected. The experiment presented in the next section uses the robotic platform and biomimetic fingertip sensor described in Chapter 3 with a sensorimotor architecture developed for actively controlling the sensor movements in order to accomplish the tactile exploration task.

## 4.2 Contour following with a tactile robotic platform

In this section the contour following exploratory procedure is implemented in a real environment using a robotic platform and a biomimetic fingertip sensor. The implementation is based on the algorithms for edge detection and tracking presented in Sections 4.1.1 and 4.1.2.

The aim is to demonstrate a tactile robotic platform capable of autonomously following the contour of different object shapes using active Bayesian perception. The tactile robotic system will need to make decisions about *what to do next* and *where to move next*. For the first decision, the robot will decide if it is necessary to move to another location to improve perception or not, whilst for the second decision the robot will decide where should it move next along the object edge to continue with the tactile exploration task.

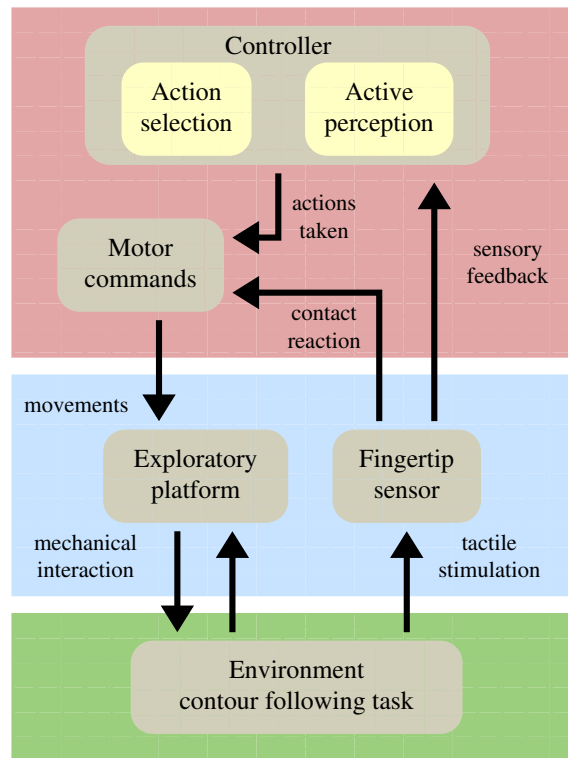

Figure 4.10: Sensorimotor architecture for autonomous active exploration with tactile sensing. The tactile feedback based on the interaction with an object in the environment is used to generate reflex movements of the fingertip sensor and decision by the active perception method. A robotic platform is used to provide mobility to the biomimetic fingertip sensor in the  $x$ -,  $y$ - and  $z$ -axes for exploration of an unknown object.

### 4.2.1 Sensorimotor architecture for active control

For the implementation and achievement of an autonomous tactile exploration task with a robotic platform, a sensorimotor architecture was developed in order to actively control the robot movements by tactile feedback and Bayesian perception. The functioning of this control architecture is described below.

The modules that compose the sensorimotor architecture to perform tactile exploration are presented in Figure 4.10. First, tactile stimulation is applied to the biomimetic fingertip sensor as a result of the interaction with an object in the environment. This process provides tactile feedback which is represented by the arrow from the green to the blue area. Then, the fingertip sensor sends two signals: 1) a reflex movement or contact reaction; and 2) a sensory feedback. The reflex signal produces a movement, through the motor command

module, to protect the sensor against dangerous pressure contacts. This behaviour is similar to human reflexes enacted for protection when a pain is detected (Najarian et al., 2009). At the same time, tactile data from the sensory feedback are prepared and sent to the active perception module, which is responsible for analysing and providing a belief about the localisation (angle and position) of the fingertip sensor. This belief permits to decide what to do next: either to continue the accumulation of evidence at the current location or to do a repositioning movement to another location to improve perception. Once the belief of the location of fingertip sensor exceeds a decision threshold, the resulting location perceived is used by the action selection module to make a decision about where the fingertip sensor has to be moved for the next exploration step. All of the movements of the biomimetic fingertip sensor attached to the robotic platform are performed by the motor command module, which is responsible for generating the movements according to the actions taken. This exploration procedure is repeated by the biomimetic fingertip sensor in order to successfully extract the shape of an unknown object by performing the autonomous active tactile exploration task.

The resulting extracted shapes from a circular-shaped object by actively controlling the movements of the biomimetic fingertip sensor using the proposed Bayesian perception approach with the sensorimotor architecture developed are presented in the next section. This demonstrates the robustness and perception accuracy of the proposed method with a tactile exploration task in a real environment.

### 4.2.2 Contour following in a real environment

The contour following exploration task is implemented in a real environment using the robotic platform and biomimetic fingertip sensor presented in Chapter 3. This exploration task demonstrate the robustness and accuracy of the active Bayesian perception method with a real circular-shaped object.

The results from the implementation in a real environment are shown in

Figure 4.11. This experiment was performed using passive and active Bayesian perception with low and high decision thresholds in order to analyse their accuracy for accomplishment of the tactile exploration task. Figures 4.11a and 4.11b present the results of the contour following task for passive Bayesian perception with low and high decision threshold respectively. Passive perception with low decision threshold ( $\theta_{decision} = 0$ ) did not have sufficient time to accumulate evidence to improve perception about the current location of the tactile sensor. This combination of passive Bayesian perception with low decision threshold provided a fast tactile exploration but with low perception accuracy. Although accumulation of evidence was possible, similar results were obtained for passive Bayesian perception with high decision threshold ( $\theta_{decision} = 0.9$ ) given that the fingertip sensor was not allowed to be repositioned or moved to other positions to collect more interesting information and then reducing uncertainty to improve perception.

Implementation of the contour following task with active Bayesian perception and low decision threshold ( $\theta_{decision} = 0$ ) shown in Figure 4.11c presented a similar behaviour as passive Bayesian perception and low decision threshold. For this case, even though the biomimetic fingertip sensor was able to move to improve perception, the tactile sensor did not have enough time to accumulate evidence given the low decision threshold required for making a decision. For this reason, the fingertip sensor was able to perform a fast exploration task but achieving low perception accuracy.

In contrast, the application of active Bayesian perception and high decision threshold ( $\theta_{decision} = 0.9$ ) for the tactile exploration task successfully accomplished the object shape extraction as shown in Figure 4.11d. It is clearly observed how the fingertip sensor movements, represented by the small green circles, were able to follow the contour of the circular-shaped object. In some parts of the contour being traced are observed the multiple palpations and active repositioning of the tactile sensor to improve perception accuracy and perform good decision-making about its location. Although the use of active Bayesian perception and high decision threshold increased the reaction time

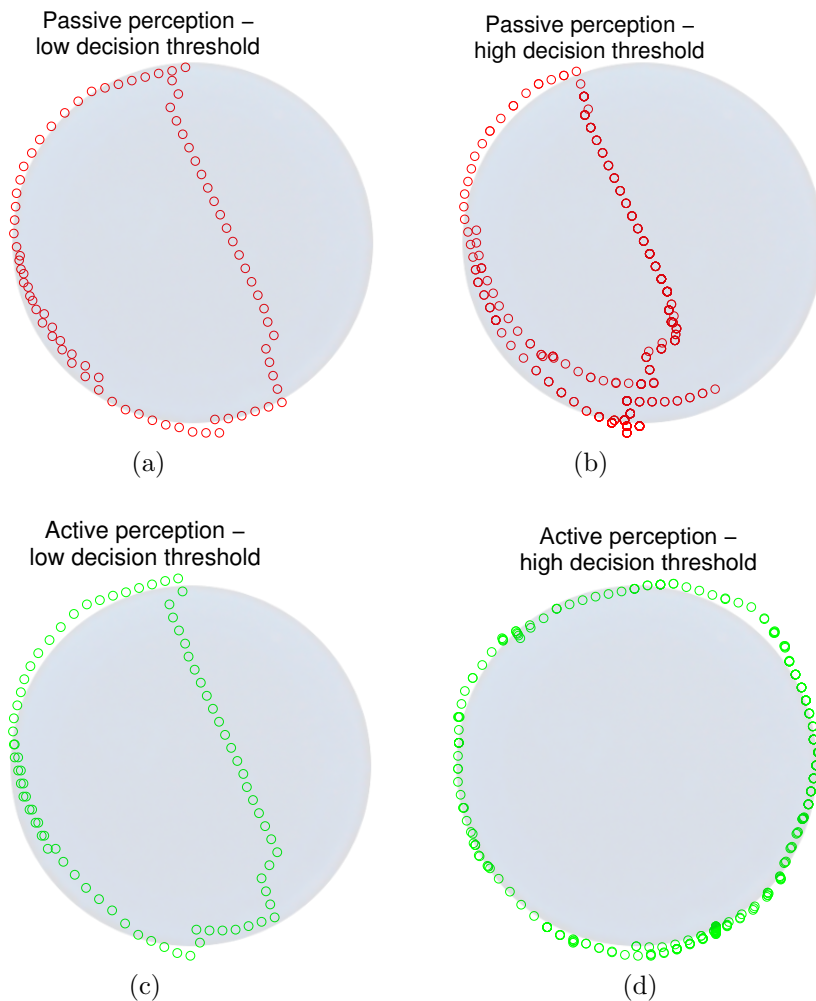

Figure 4.11: Implementation of a contour following exploratory procedure with an active and passive Bayesian perception in a real environment. The grey circle represents the object used to apply the contour following procedure. Plots (a) and (b) show the results for passive perception with low and high decision threshold respectively. Plots (c) and (d) show the active perception results with low and high decision threshold for edge tracking. It is clearly observed that active perception with high decision threshold permits to successfully accomplish a tactile exploration task.

needed for making a decision, it was possible to successfully achieve an autonomous tactile exploration behaviour with high perception accuracy in a real environment.

Finally, the contour following task with active Bayesian perception and high decision threshold was repeated with different object shapes. For this experiment, two circular-shaped objects with diameters of 2 cm and 4 cm, and an asymmetric object (sellotape holder) were used for shape extraction (Fig-



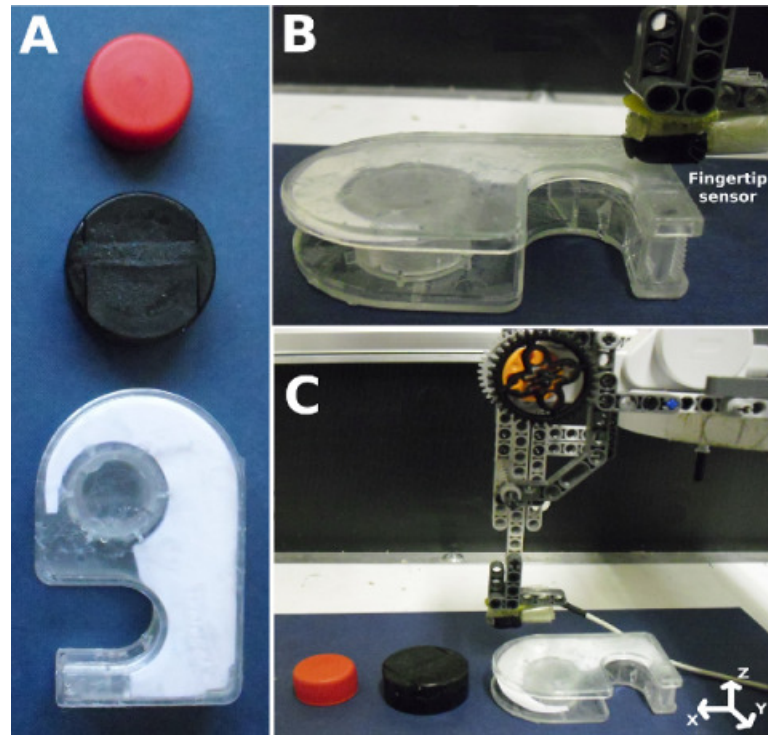

Figure 4.12: (A) Different shaped and sized objects used for active Bayesian perception applied to sensorimotor control. (B) Biomimetic fingertip sensor in contact with the edge of an object at one angle and position. (C) Tactile sensor mounted on a robotic platform allowing mobility in  $x$ -,  $y$ - and  $z$ - axes.

ure 4.12A). The fingertip palpating along the edge of one of the testing objects (sellotape holder) is shown in Figure 4.12B. The traced contours shown in Figure 4.13 demonstrate the robustness and accuracy of active Bayesian perception for autonomous tactile exploration with robotic platforms and biomimetic fingertip sensors.

Similar works for edge detection and tracking were able to extract different object shapes using a robotic finger (Muthukrishnan et al., 1987; Chen et al., 1995b). These works used the sliding procedure and force sensors to ensure a constant contact with the object explored. The movements of the robotic finger were based on detection of the edge orientation using smooth and edge filters. More recently, a control framework permitted to detect edge orientation and follow object shape with a planar sensor mounted in a robotic arm (Li et al., 2013). This framework, based on geometric moments from tactile images, permitted to detect edge orientation and tracking by sliding the sensor over

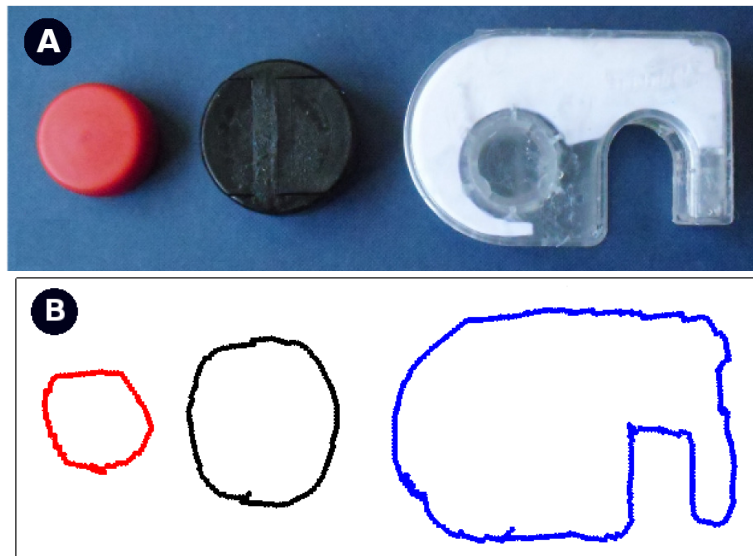

Figure 4.13: Contour following task using active exploration and tactile sensing. (A) Circles with 2 cm, 4 cm diameter and an asymmetric object (sellotape holder) used for real-time contour following. (B) Contours traced as result of active perception with high decision threshold.

the object. These works, unlike the investigation presented in this thesis, did not take into account two important features for robotics: uncertainty present in measurements, and active control and behaviour of the exploration task.

Through different experiments presented in this chapter it has been demonstrated that an autonomous tactile exploration is achievable using active Bayesian perception. The proposed method also demonstrated to be robust and accurate in simulated and real environments. Overall, we observed that tactile sensing in combination with active Bayesian perception offer an alternative and robust method suitable for tactile perception in autonomous robotics.

### 4.3 Concluding remarks

The Bayesian perception method was implemented to perform a contour following task with a biomimetic fingertip in simulated and real environments. The tactile exploration was performed using both active and passive perception modalities to demonstrate and compare their speed, perception accuracy

and ability to accomplish object shape extraction.

A sensorimotor architecture controlled by tactile feedback was developed to provide mobility to the biomimetic fingertip sensor and implement the contour following exploration procedure. The sensorimotor architecture was integrated in the tactile robotic platform presented in Section 3.2, which is composed of a Cartesian robot with 3-DoF ( $x$ -,  $y$ - and  $z$ -axes) and a biomimetic fingertip sensor. Palpations were used for the exploration task for three reasons: 1) this is the tactile method used in medicine for inspection of certain anomalies or pains; 2) inspiration from humans in situations when they prefer to palpate rather than slide over a surface given the possibility of hurting oneself (e.g. on hot, sharp or rough surfaces); and 3) to reduce the damage of the tactile sensor over multiple repetitions of the experiments.

The tactile sensor was able to successfully extract the shape using active Bayesian perception as shown in Figures 4.7 and 4.8. The results demonstrated the benefits of active over passive perception for the tactile exploration task. To support these results, the experiment was repeated with different object shapes in a real environment, where active perception also demonstrated its superiority over passive perception (see Figure 4.11). The objects presented in Figure 4.12 also were used to show the robustness of the proposed active Bayesian perception method, which successfully accomplished object shape extraction as is observed in Figure 4.13.

The results from simulated and real environments have demonstrated that active Bayesian perception is a robust and accurate method suitable for tactile exploration with a biomimetic fingertip sensor. We observed that active perception is needed but also high reliability of perception is required, which is achieved by high decision thresholds. On the other hand, a high decision threshold increases the reaction time, which slows down the exploration task. This is reasonable, given that humans not only explore actively but also employ the appropriate time until a certain belief about the object being explored is reached (Overvliet et al., 2008).

Interestingly, the results from the active Bayesian perception method pro-

posed also demonstrated to be superior in accuracy perception for angle discrimination to those found in both sighted and blind humans under psychophysical studies using active touch (Voisin et al., 2002; Levy et al., 2007; Alary et al., 2008).

An investigation of the impact in the performance of a tactile exploration by addition of a forward model for prediction of the next state during the exploration task is presented in the next chapter. Also, it will be presented the analysis of the impact in speed and perception accuracy when the experience acquired along the exploration task is included in the perception process.

# Chapter 5

## Sensorimotor Control Strategies for Active Perception

The perception process of the contour following exploration presented in Chapter 4 was initialised with a uniform prior for the decision-making of each new location of the tactile sensor. Also, the accumulation of evidence from interaction with the object being explored was performed only for the current exploration state, and no prior knowledge from previous states was included. In other words, the autonomous active exploration performed an independent active perception process for each new location along the exploration task.

However, the decisions made by humans not only depend on the current evidence but also on the experience from previous interactions with the world. This combination permits humans to make more reliable decisions and achieve better perception accuracy (Shadmehr et al., 2010). For that reason, in this chapter an investigation of active Bayesian perception combined with knowledge from previous exploration steps using two novel sensorimotor control strategies is presented. This approach permits to investigate the effects on the speed and perception accuracy for the autonomous active exploration when experience from previous states is included in the perception process.

The first proposed sensorimotor control strategy (SMC1) includes a weighted prior at the beginning of the perception process. The second sensorimotor control strategy (SMC2) uses a weighted posterior at the end of the perception process. The way in that each strategy is applied provides different effects on the performance of the exploration task. Also, this study permits to observe

how the weight assigned to each combined source of information affects the speed and perception accuracy of the autonomous active exploration task.

To validate both sensorimotor control strategies they are implemented in simulated and real environments. The implementation in the simulated environment uses real tactile data (see Chapter 4), whilst the robotic platform presented in Chapter 3 is used for the implementation in a real environment.

In this chapter, the description of the combination of active Bayesian perception and knowledge from predicted observations is presented in Section 5.1. The ideal forward model used for prediction of sensory observations is described in Section 5.2. The proposed sensorimotor control strategies for active perception are presented in Section 5.3. The results from experiments in both simulated and real environments are presented in Section 5.4 and Section 5.5 respectively. Finally, Section 5.6 presents the concluding remarks.

## 5.1 Active perception and predicted information

During a decision making process humans combine current information with experience acquired from interaction with the environment (Shadmehr et al., 2010). Normally, when both the experience and the current information are reliable, this combination provides better perception results than relying only on current sensory measurements. The degree of reliability from each source of information controls the improvement in the decisions made. This has been studied with psychophysical experiments which demonstrated a bias in the perceptual decisions made by humans when prior knowledge is included in the perception process (Green et al., 1966). These experiments also demonstrated that humans assign different weights to each information source according to its reliability. However, the weighting process that occurs during the interaction with the environment is unknown in many situations (Hanks et al., 2011).

The combination of current evidence and the experience from previous interactions with the environment is depicted in Figure 5.1. For the case of

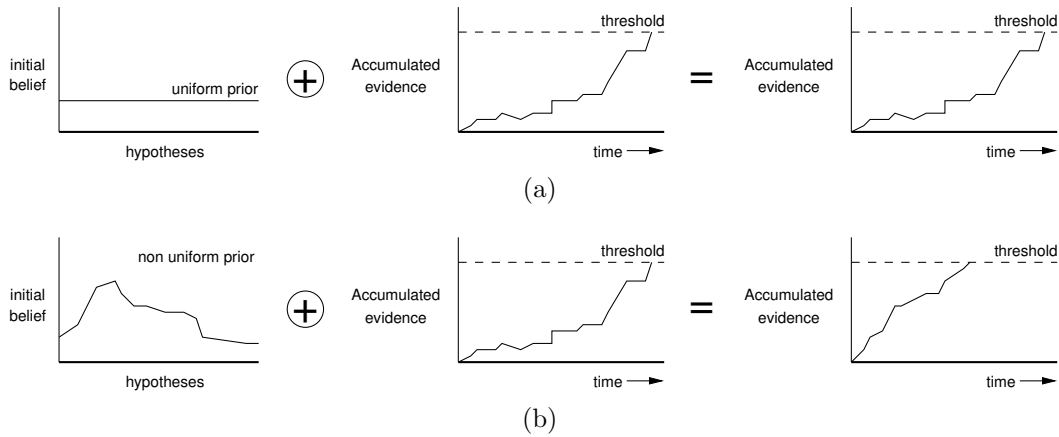

Figure 5.1: (a) Combination of an initial flat prior with accumulation of evidence from sensory measurements. The perception result is not affected or biased by the experience. (b) The experience acquired along an exploration task and used as a non uniform prior is initially combined with the evidence accumulated. This combination affects the time required to exceed a hypothesis, hence improving the reaction time.

using a flat prior, in other words, when no experience from previous states is taken into account, the perception and decision-making processes of the new location of the fingertip sensor are not affected or biased. This is observed in Figure 5.1a where the output from the active Bayesian perception process has not been affected by the initial addition of a flat prior.

In contrast, the perception and decision-making processes are affected when the experience from previous interactions with the environment is included as the initial prior for the active Bayesian perception process. The effect of the non uniform prior is observed in Figure 5.1b, where the belief threshold for making a decision about a hypothesis is reached more quickly.

The illustrative process in Figure 5.1 shows the reaction time affected by a non uniform prior in the perception process. The perception accuracy can also be affected according to the weight assigned to each source of information combined for the perception process.

A procedure to study the effects of the integration and weighting of prior knowledge used by humans during a perceptual decision task was designed in (Hansen et al., 2012). This study proposed the recognition of two objects (A and B) which were presented with a weighted prior knowledge of 80/20

and 50/50. The results demonstrated that for the prior defined as 80/20 the reaction time for making a decision presented an improvement over the prior set as 50/50. Also, it was observed that once a bias is learned it is difficult to return to the unbiased state and make a change to the perception process.

This motivates the design of two sensorimotor strategies for the combination of active Bayesian perception and predicted information, in order to analyse their effects on the performance of an autonomous tactile exploration task. The first sensorimotor control strategy (SMC1) includes a weighted prior at the beginning of the active Bayesian perception process. The prior is obtained from previous states during the exploration task. On the other hand, the second sensorimotor control strategy (SMC2) adds a weighted posterior at the end of the active Bayesian perception method. Similarly, the weighted posterior is obtained from perceptions of previous states of the exploration task. A detailed description of the proposed sensorimotor control strategies is presented in the next sections.

## 5.2 Sensory prediction based on forward model

For an autonomous exploration task, the prediction of the sensory consequences from the decisions and actions taken is achieved by forward models which also permit to have a better knowledge of the surrounding environment (Wolpert and Flanagan, 2001; Dearden and Demiris, 2006). Forward models also permit to know the possible results for each action taken before executing them. This characteristic, which is very important in the field of robotics, permits to choose the best actions and improve the performance of an autonomous active exploration task.

When forward models predict reliable sensory consequences, they provide important information for the improvement of the perceptions and the decisions made (Shadmehr et al., 2010). However, if the forward model cannot accurately predict the sensory consequences from the actions taken, then the



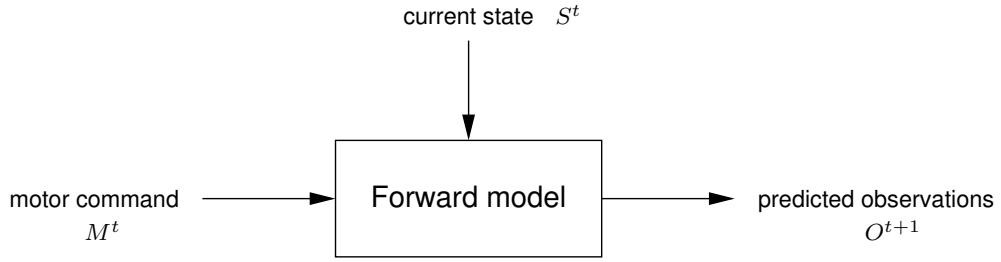

Figure 5.2: Diagram of an ideal forward model for which the inputs received are the current state  $S^t$  and the motor command  $M^t$ . The output is the predicted observations  $O^{t+1}$  which are used for the next time during perception task.

knowledge about the surrounding environment would be negatively biased.

Figure 5.2 shows an example of an ideal forward model where the state ( $S^t$ ) and the motor command ( $M^t$ ) at the current time  $t$  are the inputs used for prediction of the sensory observations ( $O^{t+1}$ ) for the next time  $t + 1$ .

Both sensorimotor control strategies include a forward model for their operation (see Section 5.3). For the purpose of the investigation of the effects of the proposed sensorimotor control strategies during an autonomous active exploration task, the forward model that correctly predicts the observations for the next state of the exploration task is assumed to be known.

The autonomous active exploration used in this chapter is based on the contour following exploratory procedure implemented in Chapter 4. Thus, the forward model is responsible for providing a prediction of the angle observations for the next location of the biomimetic fingertip sensor during the tactile exploration task. For that reason, the output from the known forward model is the angle observations obtained at time  $t$  and shifted by a parameter  $\Delta = 5$  degrees, which corresponds to the angle resolution used in the tactile data collection procedure (see Section 3.3).

The application of the forward model to the output of the active Bayesian perception procedure obtained at the current time  $t$  is as follows:

$$P(c_n|\tilde{z}_t)' = P(x_l, w_i|\tilde{z}_t)' = P(x_l, w_i + \Delta|\tilde{z}_t) \quad (5.1)$$

where the probability distribution  $P(c_n|\tilde{z}_t)'$  is the resulting prediction from the forward model applied to the posterior  $P(x_l, w_i + \Delta|\tilde{z}_t)$  from the *previous*

exploration step. The angle and position classes are represented by  $w_i$  and  $x_i$ , whilst  $\tilde{z}_t$  denotes the observations from the previous exploration step. The *tilde* ( $\tilde{\cdot}$ ) is used to distinguish between the exploration steps from time  $t - 1$  and  $t$ . Similarly, the *prime* ( $\cdot'$ ) represents the predicted observations for the next exploration step. The prediction performed by the forward model is based on shifting the posterior obtained from the active Bayesian perception process by the parameter  $\Delta$ . As mentioned before, for the investigation of the sensorimotor control strategies, it is assumed that the forward model correctly predicts the sensory observations. For that reason the shift parameter is set to  $\Delta = 5$  degrees. This is equivalent to shifting the angle observations by one angle class. The shift of the angle observations by the parameter  $\Delta$  is denoted by  $w_i + \Delta$  for each step along the exploration task.

In the next section, the application of the predicted observations obtained from the forward model to the proposed sensorimotor control strategies is described with the contour following exploration task previously considered.

### 5.3 Control strategies for active tactile exploration

In this section the analysis of the effects on the performance of an autonomous tactile exploration task by the combination of information sources is presented. This investigation is based on two sensorimotor control strategies: SMC1 and SMC2 which combine the active Bayesian perception process with a weighted prior and a weighted posterior respectively. The results demonstrate the impact on the speed and perception accuracy for an autonomous tactile exploration by the combination of the active Bayesian perception with the experience from interactions with the environment.

Both sensorimotor control strategies are implemented and analysed first in a simulated environment using real tactile data with a contour following procedure. Then, the exploration task is repeated in a real environment using the tactile robotic platform to extract object shape.

### 5.3.1 Weighted prior strategy (SMC1)

The active Bayesian perception method for tactile exploration described in Chapter 4 uses an initial flat prior to set all the angle and position perceptual classes to a uniform probability at the beginning of each exploration step. However, it is interesting to analyse the performance of the tactile exploration task when experience from previous exploration steps are combined with the active Bayesian perception process. This motivates the proposed first sensorimotor control strategy (SMC1) for including an initial weighted prior at the beginning of the active Bayesian perception process. The prior is weighted by a confidence factor, which permits to analyse how the amount of experience combined with the active Bayesian perception process affects the performance of the contour following exploration task.

The weighted prior for the SMC1 strategy is built by the combination of a uniform probability distribution  $P_{\text{flat}}(c_n) = 1/N$  with  $N$  the number of perceptual classes and the predicted observations from the forward model, which is represented by the probability distribution  $P(c_n|\tilde{z}_t)'$  as shown in Equation (5.1). The combination of both sources of information is weighted by the confidence factor  $\alpha \in [0, 1]$ . Then, the weighted prior to be used at the beginning of the active Bayesian perception at each exploration step is as follows,

$$P(c_n|\tilde{z}_0) = \alpha P(c_n|\tilde{z}_t)' + (1 - \alpha)P_{\text{flat}}(c_n) \quad (5.2)$$

where  $P(c_n|\tilde{z}_0)$  denotes the new initial weighted prior for the active perception process at the beginning of each exploration step. Thus, the flat prior used in the initialisation of the active Bayesian perception method in Equation (3.2) is modified to include the weighted prior from the SMC1 strategy as follows:

$$P(c_n|z_t) = \frac{P(z_t|c_n)P(c_n|\tilde{z}_0)}{P(z)} \quad (5.3)$$

Given that the SMC1 strategy is applied at the beginning of the active Bayesian perception process, the marginal posteriors are obtained from the perception process by Equations (3.8) and (3.9) which are repeated below,

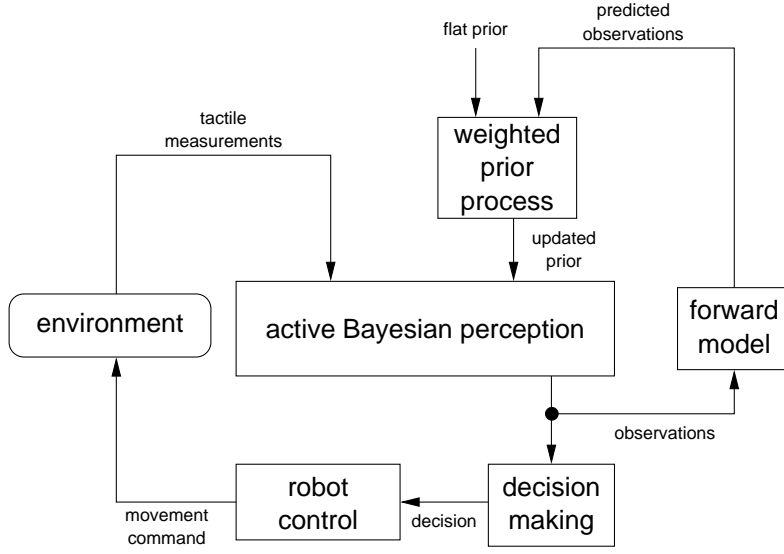

Figure 5.3: Diagram of the SMC1 strategy based on the weighted prior applied to the active Bayesian perception method at the beginning of each exploration step. The weighted prior obtained from the weighted combination of a flat prior and the predictions made by the forward model, affects the performance in speed and perception accuracy during a tactile exploration task.

$$P(x_l|z_{1:t}) = \sum_{i=1}^{N_l} P(x_l, w_i|z_{1:t})$$

$$P(w_i|z_{1:t}) = \sum_{l=1}^{N_l} P(x_l, w_i|z_{1:t})$$

where the position and angle marginal posteriors are represented by  $P(x_l|z_{1:t})$  and  $P(w_i|z_{1:t})$  respectively. The location perceived based on the angle and position of the biomimetic fingertip sensor at each time of the exploration task is obtained using Equation (3.10) (repeated here from Chapter 3.)

$$\text{if any } P(w_i|z_{1:t}) > \theta_{\text{decision}} \text{ then } \begin{cases} w_{\text{decision}} = \arg \max_{w_i} P(w_i|z_{1:t}) \\ x_l = \arg \max_{x_l} P(x_l|z_{1:t}) \end{cases}$$

The block diagram in Figure 5.3 shows the SMC1 strategy applied to the

active Bayesian perception method. The tactile measurements obtained from the biomimetic fingertip sensor and the weighted prior are the input of the active Bayesian perception module. The tactile measurements are acquired repeatedly by the palpations performed by the fingertip sensor. The weighted prior obtained by Equation (5.2) is applied only at the beginning ( $t = 0$ ) of a new exploration step (see Equation (5.3)), and then to continue with the accumulation of evidence using the perception method described in Chapter 3. Once the active Bayesian perception process finishes by exceeding the defined decision threshold,  $\theta_{\text{decision}}$ , the marginal posteriors (see Equations (3.8) and (3.9)) from the output are used to make the decision about the location of the fingertip sensor based on Equation (3.10). The output from the active Bayesian perception is also used to predict the sensory observations by the forward model. Then, the predictions made by the forward model are used to obtain the weighted prior for the next exploration step. The decision made from the output of the active Bayesian perception process, sent to the robotic platform, defines the corresponding movement to be performed in order to continue with the exploration task by the biomimetic fingertip sensor.

From Equations (5.2) and (5.3) it is observed that for confidence factor values of  $\alpha > 0$  the weighted combination in the SMC1 strategy adds a bias to the initial active perception process. In contrast, for  $\alpha = 0$ , the active Bayesian perception uses an initial flat prior without including the influence from previous exploration steps as in the analysis presented in Chapter 4.

The application of the weighted prior which is obtained by the weighted combination of a flat prior and the prediction made by the forward model, affects the performance in speed and perception accuracy of an exploration task. These effects generated by the SMC1 strategy depend on the weight assigned to each source of information and the reliability of the active Bayesian perception process. The results from the implementation of the SMC1 strategy in a contour following exploration procedure are presented in Section 5.4.1.

### 5.3.2 Weighted posterior strategy (SMC2)

In the previous sensorimotor control strategy (SMC1), the active perception process is affected by the influence of the experience acquired along the exploration task. However, it is also interesting to analyse the effects that the experience provides to the performance of the exploration task without biasing the initialisation of the active perception process. For that reason, the second sensorimotor control strategy (SMC2) is proposed to make a weighted combination of the output from the active Bayesian perception process and the predictions made by the forward model. Then, in order to not bias the initialisation of the perception process, the SMC2 strategy based on the weighted posterior is applied after the active Bayesian perception process has finished. The posterior is weighted by a confidence factor,  $\alpha \in [0, 1]$ , which permits to analyse the effects in the performance of the exploration task, according to the amount of experience combined with the output from the active Bayesian perception process.

The proposed SMC2 strategy is based on the combination of the posterior  $P(c_n|z_t)$  obtained from the active Bayesian perception process at time  $t$  and the prediction  $P(c_n|\tilde{z}_t)'$  provided by the forward model in Equation (5.1) from the previous time step of the exploration task. The combination of both sources of information involved in the SMC2 strategy is weighted by the confidence factor  $\alpha \in [0, 1]$ . Then, the new posterior obtained from the weighted combination performed by the SMC2 strategy is as follows,

$$P(c_n|\tilde{z}_t) = \alpha P(c_n|\tilde{z}_t)' + (1 - \alpha)P(c_n|z_t) \quad (5.4)$$

where  $P(c_n|\tilde{z}_t)$  is the new posterior at time  $t$  that provides the marginal position  $P(x_l|\tilde{z}_t)$  and angle  $P(w_i|\tilde{z}_t)$  probabilities using the following equations,

$$P(x_l|\tilde{z}_t) = \sum_{i=1}^{N_i} P(x_l, w_i|\tilde{z}_t), \quad (5.5)$$

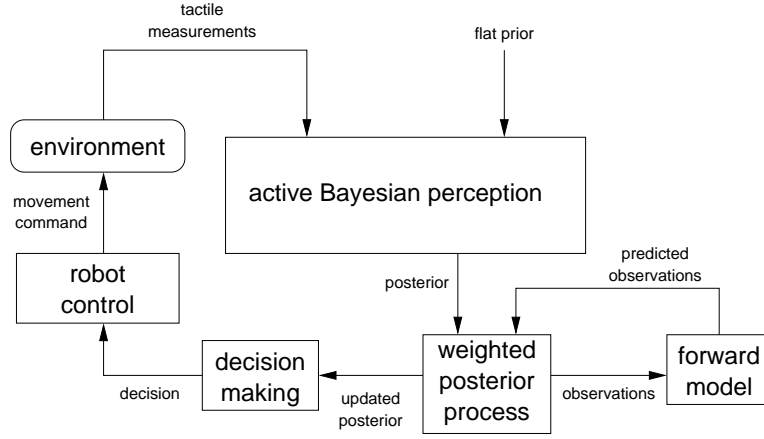

Figure 5.4: Diagram of the SMC2 strategy showing the different modules used to combine active Bayesian perception with a weighted posterior during a contour following exploration task.

$$P(w_i|\tilde{z}_t) = \sum_{l=1}^{N_l} P(x_l, w_i|\tilde{z}_t), \quad (5.6)$$

These marginal probabilities result from the application of the SMC2 strategy and Equations (5.5) and (5.6) are used to estimate the final location of the biomimetic fingertip sensor for each exploration step as follows,

$$w_{\text{decision}} = \arg \max_{w_i} P(w_i|\tilde{z}_t) \quad (5.7)$$

$$x_l = \arg \max_{x_l} P(x_l|\tilde{z}_t) \quad (5.8)$$

where  $x_l$  and  $w_{\text{decision}}$  are the estimate position and angle that represent the location of the biomimetic fingertip sensor for the current exploration step. The resulting angle and position perceived by the application of the SMC2 strategy are sent to the robotic platform to perform the corresponding movements of the biomimetic fingertip sensor in order to continue with the exploration task.

The block diagram in Figure 5.4 shows the application of the SMC2 strategy to the active Bayesian perception process. The inputs for the active Bayesian perception method with the SMC2 strategy are the tactile measurements and the flat prior. This shows that the perception process is not initially affected by the experience acquired from previous exploration steps. In contrast, the

experience is applied to the output of the active Bayesian perception process, which is obtained once the decision threshold has been exceeded. Then, the resulting posterior from the active Bayesian perception process is combined with the predictions made by the forward model. This combination is weighted by the confidence factor  $\alpha \in [0, 1]$ . In one hand, the new posterior obtained from the weighted combination is used to make a decision about the next movement to be performed by the robotic platform and the biomimetic fingertip in order to continue with the exploration task. On the other hand, the new posterior is also used by the forward model to make the sensory predictions for the next exploration step.

The effects of the proposed SMC2 strategy over the output of the active Bayesian perception process are observed for confidence factor values of  $\alpha > 0$  as is shown in Equation (5.4). In contrast, for the case of  $\alpha = 0$ , the output of the active Bayesian perception process is not affected by the experience acquired from previous exploration steps, obtaining the active perception system described in Chapter 4.

The implementation and analysis of the both proposed sensorimotor control strategies are presented in the next sections. They are implemented using the contour following exploratory procedure tested in Chapter 4. The experiments are performed in both simulated and real environments using the robotic platform and biomimetic fingertip sensor described in Chapter 3.

## 5.4 Sensorimotor control strategies in simulated environment

To validate the proposed sensorimotor control strategies, a contour following exploration was implemented in a simulated environment as described in Chapter 4. The results permit to observe and compare the benefits of the proposed sensorimotor control strategies over the unaffected active Bayesian perception process by the experience acquired along the exploration task presented in Chapter 3.



### 5.4.1 Weighted prior and active Bayesian perception

The implementation of the SMC1 strategy is based on the diagram shown in Figure 5.3 which implements Equations (5.1) and (5.2) for shifting and weighting respectively the prior knowledge obtained from the active Bayesian perception method.

To observe how the amount of prior knowledge used affects the performance of the autonomous active exploration, the confidence factor  $\alpha \in [0, 1]$  was used to assign a weight to each source of information. The weighting process shown in Equation (5.2) was applied to the prior knowledge obtained from previous steps of the exploration task and the initial flat prior from the active Bayesian perception process. The results from the SMC1 strategy applied to the contour following in a simulated environment are shown in Figure 5.5.

The weighted combination of the priors is represented by the confidence factor  $\alpha$  shown with the coloured scale curves, where the lightest curve corresponds to  $\alpha = 0$  and the darkest corresponds to  $\alpha = 1$ . Figures 5.5a and 5.5b present the angle and position accuracy results for the use of a weighted prior for different belief thresholds used to make a decision about the location of the biomimetic fingertip sensor. For the results of angle accuracy against belief threshold shown in Figure 5.5a, it was found that for the confidence factor  $\alpha = 0$  the performance of the proposed control strategy corresponds to the perception accuracy results obtained from the contour following task by the application of active Bayesian perception with initial flat prior considered in Chapter 4. The angle perception presented an improvement in the accuracy for belief thresholds greater than 0.3. The maximum angle perception accuracy achieved by the SMC1 strategy was for a belief threshold of  $\sim 0.5$  and confidence factor  $\alpha > 0$ .

For the results for the position accuracy against belief threshold shown in Figure 5.5b, it was found that for the confidence factor  $\alpha = 0$  the perception accuracy is similar to the results obtained by the use of active Bayesian perception with initial flat prior presented in Chapter 4. In contrast, for values of the confidence factor  $\alpha > 0$  there was not observed an improvement

in the perception accuracy, except for the case of belief thresholds  $\sim 1$ . This behaviour in the performance of the exploration task is observed given that for increasing values of the prior knowledge, less accumulation of evidence is required to exceed a threshold for making a decision. This produces a reduction in the reaction time that affects the active repositioning of the fingertip sensor performed by the active Bayesian perception process.

The results for angle and position perception against reaction time are shown in Figures 5.5c and 5.5d. It is observed a gradual reduction of the reaction time required to make a decision for values of the confidence factor  $\alpha > 0$  (see Figures 5.5c). This is related to the amount of experience applied to the initial prior of the active Bayesian perception which is controlled by the confidence factor. Thus, larger amounts of prior included in the active Bayesian perception process are reflected in the faster decisions made. There is also observed a definite minimum in the speed and accuracy curves for angle perception, rather than a monotonically decreasing as in the case where an initial flat prior and active Bayesian perception were used. This behaviour is due to the assumption of having a known forward model which provides perfect predictions of the sensory observations. For the position perception against reaction time in Figure 5.5d, even though there is no change in the position error, there is a reduction in the reaction time required for making a decision. This is related to the weight assigned to the initial prior used in the active Bayesian perception process for values of the confidence factor  $\alpha > 0$ .

On one hand, the perception accuracy results from the SMC1 strategy show that the active Bayesian perception process is improved on values of the confidence factor  $\alpha > 0$ . On the other hand, it is also shown that the reaction time presents an improvement which is related to the weight assigned to the prior for values of the confidence factor  $\alpha > 0$ . Also, for both speed and perception accuracy it is observed an improvement over the used of active Bayesian perception with the initial flat prior ( $\alpha = 0$ ) presented in Section 4.1.3. The autonomous active exploration was able to achieve the smallest angle and position errors of 2.6 degrees and 0.15 mm with a reaction time close to 1 palpation per decision-

making and confidence factor between 0.1 – 1. These results contrast with the angle and position errors of 4 degrees and 0.2 mm achieved by active Bayesian perception and initial flat prior presented in Section 4.1.3. The SMC1 strategy applied to the active Bayesian perception process demonstrated its benefits on the performance in speed and accuracy for an autonomous exploration task.

### 5.4.2 Weighted posterior and active Bayesian perception

The SMC2 strategy is implemented following the diagram shown in Figure 5.4 and Equations (5.1) and (5.4) for predicting the sensory observations and weighting the posterior obtained from the active Bayesian perception process.

The combination of the predicted observations and the posterior from the active Bayesian perception process performed by the SMC2 strategy is shown in Equation (5.4). This combination is weighted by the confidence factor  $\alpha \in [0, 1]$  in order to analyse the effects on the speed and accuracy by the amount of experience used for perception during the exploration task. The SMC2 strategy, in contrast to the SMC1 strategy, does not affect the initial prior of the perception process, but it is applied to the output of the active Bayesian perception. Thus, the perception process requires a longer time for making a decision as in the experiments presented in Chapter 4. The SMC2 strategy, based on the weighted combination of the experience and the output from active Bayesian perception, provides the new marginal posteriors from the current location (angle and position) of fingertip sensor as shown in Equations (5.5) and (5.6). The resulting marginal posteriors are used to estimate the final location of the biomimetic fingertip sensor for the current exploration step based on Equations (5.7) and (5.8). The results of the SMC2 strategy are presented in Figure 5.6.

The weighted combination of posteriors controlled by the confidence factor  $\alpha \in [0, 1]$  is represented by the coloured scale curves, where the lightest and darkest curves correspond to  $\alpha = 0$  and  $\alpha = 1$  respectively. From the results of

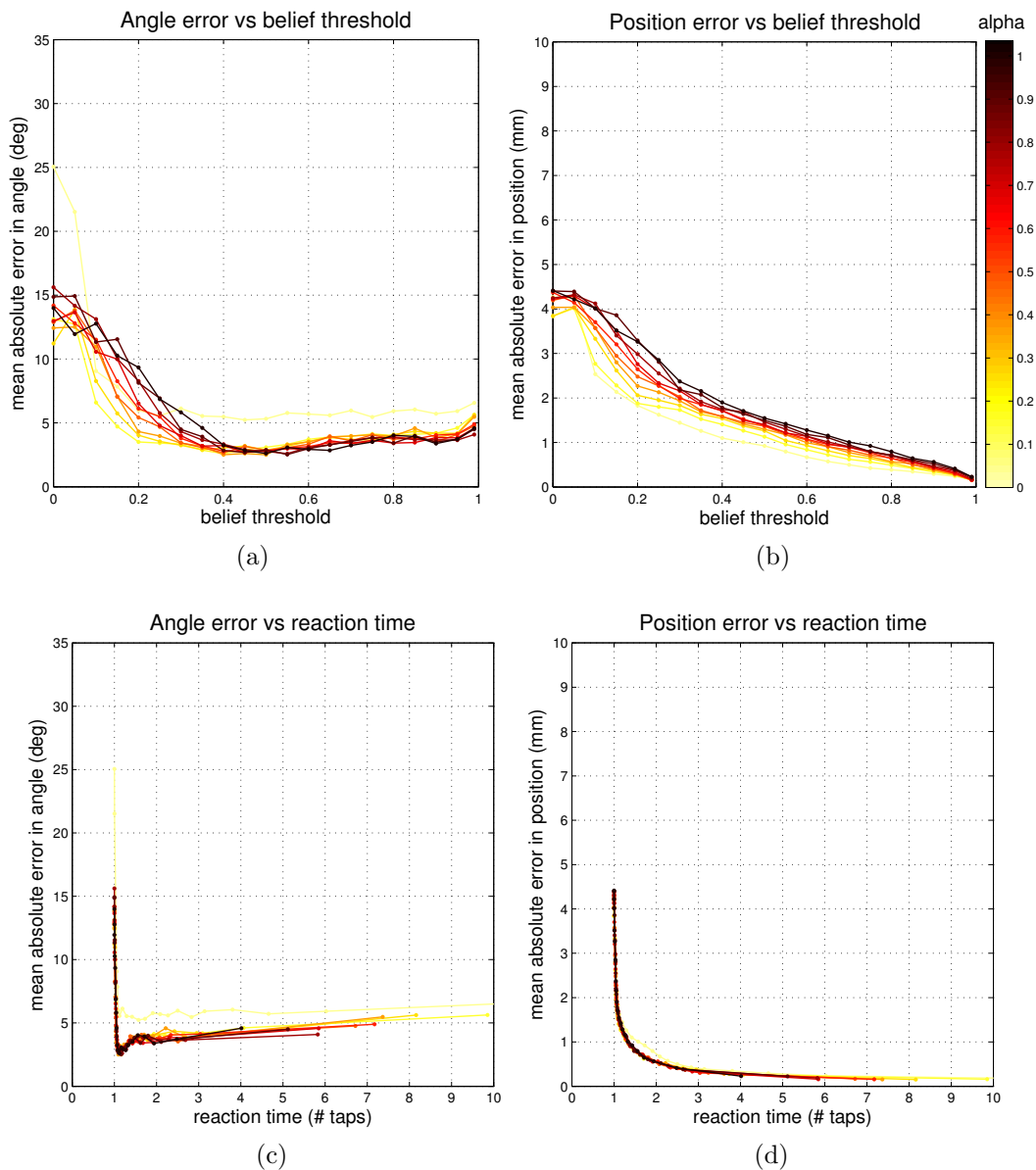

Figure 5.5: Results from the contour following task based on the SMC1 strategy and active Bayesian perception applied to a circular-shaped object. (a) Mean angle and (b) position errors against belief threshold. (c) Mean angle and (b) position errors against reaction time. The prior weighted by the confidence factor  $\alpha$  is shown with the coloured scale curves in the range  $[0, 1]$ .

angle and position perception against belief threshold in Figures 5.6a and 5.6b, it is observed that for  $\alpha = 0$  (lightest curve) the performance achieved corresponds to use of the unaffected posterior from the active Bayesian perception process considered earlier in Section 4.1.3. In contrast, it is clearly observed the improvement in angle perception accuracy for values of the confidence

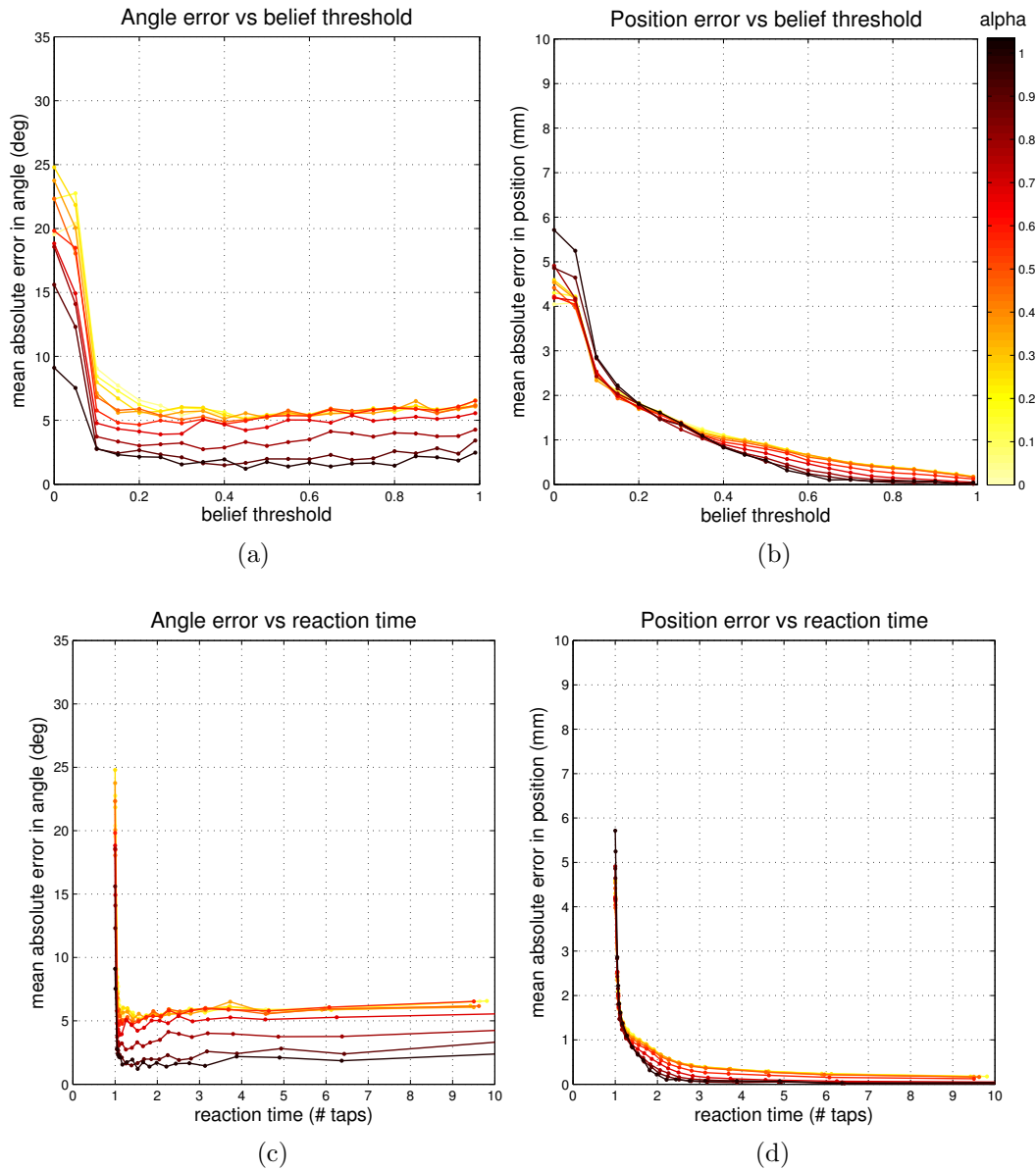

Figure 5.6: Results from the contour following task based on the SMC2 strategy and active Bayesian perception applied to a circular-shaped object. (a) Mean angle and (b) position errors against belief threshold. (c) Mean angle and (b) position errors against reaction time. The combination of posteriors weighted by the confidence factor  $\alpha$  is shown with the coloured scale curves in the range  $[0, 1]$ .

factor  $\alpha > 0$ . These results also present a steady angle perception accuracy for belief thresholds greater than 0.1. The maximum angle accuracy achieved by the implementation of the SMC2 strategy in the contour following exploration task is 1.4 degrees for a belief threshold  $\sim 0.45$  and a confidence factor  $\alpha > 0$ . These results present a superior performance in angle accuracy over

the 4 degrees achieved by the active Bayesian perception process described in Section 4.1.3 where the posterior was not affected by the experience acquired along the exploration task.

Similar to the SMC1 strategy, the position accuracy achieved with the SMC2 strategy for the confidence factor  $\alpha = 0$  corresponds to the results of the active Bayesian perception analysis presented in Figure 4.9b. In contrast, for values of the confidence factor  $\alpha > 0$ , it is observed an improvement in the position perception accuracy for belief thresholds greater than 0.4, which permit to achieve a maximum position perception of  $\sim 0.04$  mm. The high position accuracy achieved by the SMC2 strategy contrasts with the position accuracy of 0.2 mm obtained with the active Bayesian perception with unmodified posterior presented in Section 4.1.3.

Figures 5.6c and 5.6d show the angle and position perception results against reaction time. These plots present an improvement in both angle and position perception as the values of the confidence factor increase ( $\alpha > 0$ ). The best perception accuracy by the SMC2 strategy is achieved for a reaction time between 2-3 palpations. The autonomous active exploration was able to reach a maximum angle and position perception of 1.4 degrees and  $\sim 0.04$  mm with a reaction time between 2-3 palpations for values of the confidence factor  $\alpha > 0$ . In general, both speed and accuracy not only showed a clear dependency on the confidence factor  $\alpha$ , but also presented an improvement over the active Bayesian perception process without including the experience acquired along the exploration task described in Chapter 4.

## 5.5 Sensorimotor control strategies in real environment

To validate both sensorimotor control strategies in a real environment, the contour following exploration task was repeated using a circular-shaped object with a robotic platform and biomimetic fingertip sensor. Similar to the exploration task implemented in the simulated environment, the forward model to

predict the sensory observations for the next exploration step was assumed to be known. The same circular-shaped object used in Section 4.2.2 was prepared for this experiment in a real environment. The results from the implementation of both sensorimotor control strategies are shown in Figure 5.7.

For both proposed SMC1 and SMC2 strategies, the confidence factor was set to the values 0.0, 0.7 and 1.0, selected based on the results in speed and perception accuracy obtained from the experiments in the simulated environment. Also, these values the confidence factor where chosen to observe their different effects on the performance in the speed and perception accuracy according to the amount of experience applied to the autonomous active exploration task. The results obtained from the real environment experiment for both SMC1 and SMC2 strategies are presented in Figure 5.7. First, the results for the confidence factor  $\alpha = 0$  show the large angle errors achieved by both sensorimotor control strategies (see Figure 5.7a). These relative large errors were expected given that for the confidence factor  $\alpha = 0$  the active Bayesian perception does not include experience along the exploration task. This behaviour also corresponds to the experiments performed in Chapter 4 where the initial prior and posterior were not modified during the contour following procedure.

For the confidence factor  $\alpha = 0.7$  the angle perception presented an improvement by both strategies which corresponds to the results from the experiments in the simulated environment. However, the angle error was increased by the SMC1 strategy and decreased by the SMC2 strategy for the confidence factor  $\alpha = 1$ , which permitted to reach a minimum angle error of 1.98 degrees.

For the position perception shown in Figure 5.7b, both sensorimotor control strategies presented similar perception accuracy for the confidence factor  $\alpha = 0$ . This also corresponds to the unmodified prior and posterior of the active Bayesian perception process presented in Chapter 4. For the confidence factor  $\alpha = 0.7$ , the SMC2 strategy presented a better improvement in perception accuracy than the SMC1 strategy. For  $\alpha = 1.0$ , there is a clear contrast in the results, where the position error increased for the SMC1 strategy, whilst it decreased for the SMC2 strategy. This improvement in the position percep-

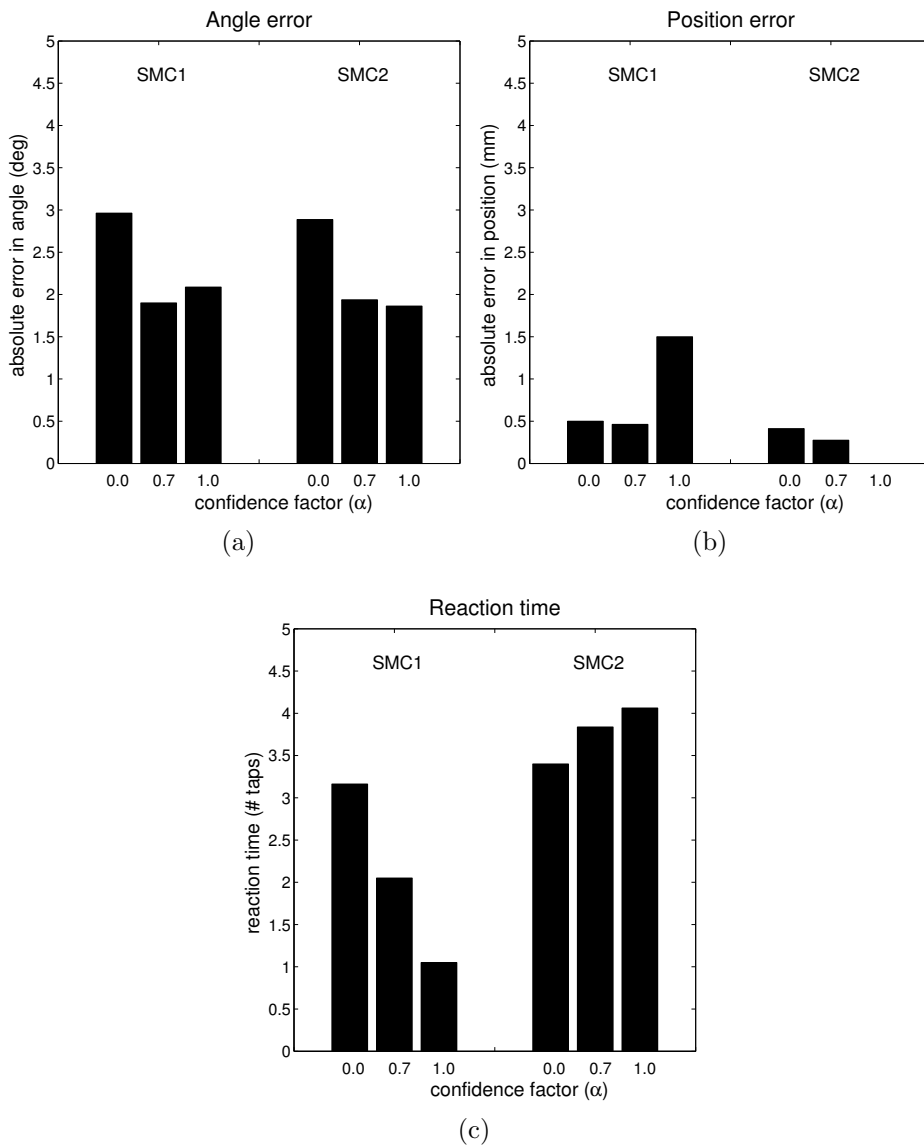

Figure 5.7: Results from the implementation of the SMC1 and SMC2 strategies in a real environment with a contour following exploration task. (a) Mean angle errors against confidence factor. It is shown that both strategies offer an improvement in angle perception. (b) Mean position errors against confidence factor. The SMC2 strategy achieves more accurate position perception. (c) Reaction time against confidence factor. The SMC1 demonstrated to be faster than the SMC2 strategy for increasing values of the confidence factor. Overall, both strategies provide improvements in speed and accuracy over the use of active perception with unmodified prior and posterior.

tion achieved by the SMC2 strategy corresponds also with the improvements obtained from the results in the simulated environment.

The implementation of both sensorimotor control strategies in an autonomous



active exploration task presented an improvement over the use of the active Bayesian perception method with unmodified prior and posterior analysed earlier (see Section 4.1.3). Also, the SMC2 strategy demonstrated to be able to achieve better perception accuracy over the SMC1 strategy in both simulated and real environments. On the other hand, the SMC1 strategy demonstrated to be faster in the decision-making process for certain decision threshold values.

Overall, it has been observed that the autonomous active exploration based on the contour following procedure in a simulated and real environment benefits from the proposed sensorimotor control strategies by improving the performance in both speed and accuracy achieved by the active Bayesian perception process. Moreover, the results obtained from both sensorimotor control strategies demonstrated to be more accurate and faster over the case when no weighted prior or weighted posterior were included in the active Bayesian perception process.

## 5.6 Concluding remarks

In this chapter the combination of evidence from sensory observations and the experience from previous steps during an autonomous active exploration task was proposed with two sensorimotor control strategies. The first sensorimotor control strategy (SMC1) is responsible for including a weighted prior at the beginning of the active Bayesian perception process, whilst the second sensorimotor control strategy (SMC2) is responsible for including a weighted posterior at the end of the active Bayesian perception process.

On the one hand, the SMC1 strategy demonstrated to be faster than the SMC2 strategy, which makes sense given that the initial weighted prior included in the active Bayesian perception process permits to reach quickly the belief threshold for making a decision. On the other hand, the SMC2 strategy which is applied at the end of the perception process, allows the active Bayesian perception to accumulate enough evidence and take the required time to make more accurate decisions. For that reason, the perception accuracy achieved

with the SMC2 strategy was superior to the SMC1 strategy.

Overall, it has been observed that the active Bayesian perception process presented in Chapters 3 and 4 benefits by the use of the proposed sensorimotor control strategies. The application of these strategies for an autonomous exploration task permitted to obtain improvements in both speed and accuracy which are important characteristics in the field or robotics. In this chapter the forward model was assumed to be known and the confidence factor was set to a fix values. In the next chapter a method to learn the forward model based on tactile feedback is presented. Also, a method for an adaptive confidence factor along the exploration task is presented in next chapter. These methods permit to obtain an exploratory procedure with an adaptive behaviour during an autonomous active exploration.

## Chapter 6

# Adaptive Control Strategies for Active Perception

Humans normally use evidence from different sources of information in order to make more reliable decisions and actions. This process was investigated with two novel sensorimotor control strategies in Chapter 5 to integrate the experience obtained along an exploration task into the active Bayesian perception method. The first strategy was responsible for including a weighted prior at the beginning of the perception process, whilst the second strategy performed a weighting of posteriors at the end of the perception process. Both proposed strategies provided different benefits in the speed and perception accuracy of the decision-making process with a tactile exploration procedure.

For the purpose of the investigations undertaken in Chapter 5 the confidence factor parameter and forward model required by both sensorimotor control strategies were assumed to be known and manually controlled. These assumptions are unrealistic in a real environment, for which adaptive approaches are required to automate the learning of the forward model and confidence factor along the exploration procedure.

For that reason, in this chapter an investigation of an adaptive integration of the experience obtained along an exploration task into the active Bayesian perception process is presented. The learning of the forward model and confidence factor is adaptive according to the sensory observations obtained and decisions made along the exploration task. The forward model is learned using the combination of the Predicted Information Gain (PIG) (Little and Som-

mer, 2011) and the Dynamic Bayesian Network (DBN) (Cho et al., 2008) approaches. These methods permit, based on the sensory observations obtained by the active Bayesian perception process, to estimate the observations for the next exploration time. The accuracy of the forward model is then assessed by the confidence factor which is adapted along the exploration task. This allows to increase the confidence on the forward model for correct predictions and decrease it otherwise. These methods have been tested using the contour following exploration task previously validated, to be able to compare their performance with the results obtained in previous experiments.

Section 6.1 presents the approach used to learn the forward model along an exploration task. The accuracy assessment of the forward model based on a confidence factor is described in Section 6.2. In Section 6.3 the implementation and validation of the proposed adaptive control strategies with the contour following exploration task are presented. Finally, Section 6.4 provides the concluding remarks of the results obtained from the proposed methods.

## 6.1 Adaptive forward model

Learning the forward model during an exploration task rather than manually defining it with a set of fixed values not only permits to estimate the future states of a system, but also allows the adaptation of the exploration task, according to the observed changes through the interaction with the environment. The adaptive behaviour of the exploration task is based on the causal relationship between the actions and the observed consequences (Wolpert and Flanagan, 2001). Forward models can be learned and maintained calibrated by motor adaptation and interaction with the environment, which is known as *learning driven by sensory adaptation errors* (Shadmehr et al., 2010).

The combination of information sources has been studied with the Kalman Filter approach (Gao and Harris, 2002). This method is mainly applied to localisation and navigation problems, where the prior belief and the current observations are combined to estimate the posterior for a certain hypothe-

sis (Siciliano and Khatib, 2008). However, this method is not applicable to discrete states and also requires Gaussian distributions (Thrun et al., 2005).

In this chapter, the proposed algorithms are applied to the estimation of discrete states, without the requirement to work with Gaussian distributions. Also, the proposed methods fit in the Bayesian framework for tactile perception presented in Chapter 3, which permits to exploit the benefits offered by the active Bayesian perception process.

The proposed methods for the learning and assessment of the forward model during an exploration task are based on the combination of the Predicted Information Gain (PIG) (Little and Sommer, 2011) and Dynamic Bayesian Network (DBN) (Cho et al., 2008) approaches. On the one hand, the PIG approach permits to observe the possible consequences of choosing a certain action for the next exploration state. The observed state that provides the largest amount of information, determines the action to be chosen by the system. This method has been tested with the learning of an exploration task using an action-perception loop to allow an agent to estimate the amount of information gained by taking an action. This work assumes an agent with a complete knowledge of the environment before starting the experiment.

The output from the PIG approach is used by a DBN to generate the cost of observing an event during the exploration task. The DBN provides the most probable value for the parameter  $\Delta$ , which is needed to learn the forward model according to Equation (5.1). The work in (Cho et al., 2008) presented a method for the online estimation of the parameters of a DBN. This method estimates the transition probability of an observed event from time  $t$  to  $t + 1$  based on the observations from previous and current times. This online DBN method assigns a fixed reward, i.e. 0 or 1 according to the observed events. In (Dearden and Demiris, 2006) a robot performing motor babbling with visual feedback was able to learn the forward model using a Bayesian network approach. In this work, the robot needs to associate the performed motor commands, states and observations. Once the robot learned the forward model, it was used to predict the effect of its motor commands.

### 6.1.1 Predicted Information Gain (PIG)

The PIG approach is used to learn the forward model along an exploration task through the interaction with the environment. Given that the tactile sensor has no knowledge about the observations and states at the next exploration step, the PIG approach is used to observe at time  $t$  ‘what would have happened’ if a certain action had been chosen at time  $t - 1$ . The set of estimated observations denoted by  $\hat{\Theta}$  are provided by the active Bayesian perception process at each exploration time. The set of possible actions and states are denoted by  $a = \{a_1, a_2, \dots, a_N\}$  and  $s = \{s_1, s_2, \dots, s_N\}$ , where  $N$  is the number of angle classes. The PIG approach is defined as follows:

$$\text{PIG}(a, s) = \gamma \sum_{s^*} \hat{\Theta}_{a,s,s^*} \text{D}_{\text{KL}}(\hat{\Theta}_{a,s}^{a,s,s^*} || \hat{\Theta}_{a,s}) \quad (6.1)$$

where the current estimation provided by the perception process for the state  $s$  by choosing the action  $a$  are denoted by  $\hat{\Theta}_{a,s}$ . The hypothetical outcomes  $s^*$  for each possible previous action  $a$  chosen in previous state  $s$ , using the current estimation  $\Theta_{a,s}$ , are denoted by  $\hat{\Theta}_{a,s}^{a,s,s^*}$ . The hypothetical outcomes  $s^*$ , that the perception process would have been currently provided, by choosing the action  $a$  under the state  $s$  is denoted by  $\hat{\Theta}_{a,s,s^*}$ . The normalisation parameter is denoted by  $\gamma$ .

The PIG approach also uses the Kullback-Leibler Divergence ( $\text{D}_{\text{KL}}$ ) which is an information-theoretic measure of the difference between two distributions. This measure permits to have an expectation of the information loss between the action  $a$  chosen to produce  $s$  ( $\hat{\Theta}_{a,s}$ ) and the action  $a$  undertaken to produce  $s^*$  ( $\hat{\Theta}_{a,s}^{a,s,s^*}$ ). The  $\text{D}_{\text{KL}}$  is obtained as follows:

$$\text{D}_{\text{KL}}(\hat{\Theta}_{a,s}^{a,s,s^*} || \hat{\Theta}_{a,s}) = \sum_{s^*=1}^N \hat{\Theta}_{a,s}^{a,s,s^*} \log \left( \frac{\hat{\Theta}_{a,s}^{a,s,s^*}}{\hat{\Theta}_{a,s}} \right) \quad (6.2)$$

The output of the PIG approach, provides the amount of information that would have been lost for each action undertaken from the previous exploration time  $t - 1$  to the current time  $t$ . Then, the action that minimizes the loss of

information can be obtained as follows,

$$a_{\text{PIG}} = \arg \min_a \text{PIG}(a, s) \quad (6.3)$$

where  $a_{\text{PIG}}$  is the action that would have provided the minimum loss of information. The output from the PIG in Equation (6.1) is used in a Dynamic Bayesian Network (DBN) to learn the value for the  $\Delta$  parameter of the forward model shown in Equation (5.1), repeated here,

$$P(c_n | \tilde{z}_t)' = P(x_l, w_i | \tilde{z}_t)' = P(x_l, w_i + \Delta | \tilde{z}_t)$$

The  $\Delta$  parameter is needed by the forward model to predict the sensory observations for the next exploration state. This parameter is applied to the angle classes  $w_i$  to obtain the prediction  $P(c_n | \tilde{z}_t)'$ , which is used by the sensorimotor control strategies proposed in Chapter 5.

### 6.1.2 Dynamic Bayesian Network and PIG

An online DBN approach is used to learn the forward model using the output from the PIG method. This method permits to determine the  $\Delta$  parameter for the forward model based on the online estimation of the transition probability matrix. Figure 6.1 depicts the Predicted Information Gain (PIG) and the Dynamic Bayesian Network (DBN) approach used to learn the forward model.

The variable  $X_t$  at time  $t$  shown in Figure 6.1 takes  $N$  values which determine the possible values for the  $\Delta$  parameter. The estimation of this variable at time  $t$  depends on the states at time  $t - 1$ . Initially, the probability  $P(X_t)$  at time  $t = 0$  starts with a uniform distribution which evolves and adapts along the time, according to the observations and changes occurring in the environment. Then, the probability of  $P(X_t)$  at time  $t$  is estimated as follows:

$$P(X_t) = B_t P(X_{t-1}) \quad (6.4)$$

where the probability from the previous time  $t - 1$  is denoted by  $P(X_{t-1})$ . The

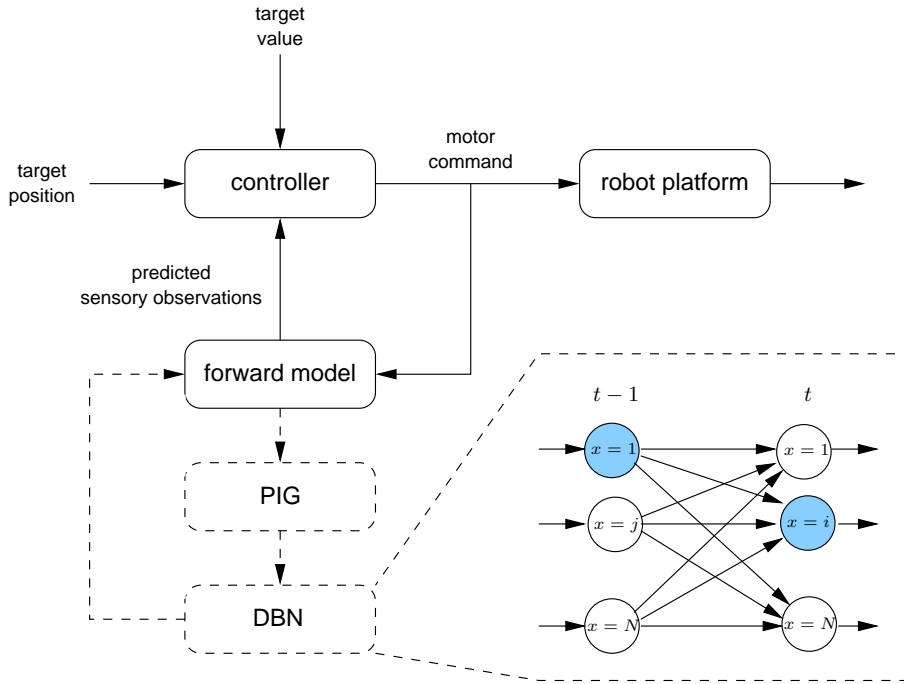

Figure 6.1: The learning of the forward model provides useful information about the sensory observations for future states. Information from past and current perceptions allows to build a forward model capable to adapt along an exploration task. Here, the forward model is learned using the proposed approach composed of the Predicted Information Gain (PIG) and Dynamic Bayesian Network (DBN), whilst an exploration task is performed.

transition probability matrix is represented by  $B_t = b_{i,j}(t)$  for  $i, j = 1, 2, \dots, N$ , which is obtained from the conditional probability as follows,

$$b_{i,j}(t) = P(X_t = i | X_{t-1} = j) \quad (6.5)$$

where  $P(X_t = i | X_{t-1} = j)$  is the probability of observing the event  $i$  at time  $t$  given that the event  $j$  was observed at time  $t - 1$ . The transition probability matrix presented in Equation (6.5) is time-dependant and its estimation is recursively updated based on the observations obtained along the time.

The method to estimate the transition probability  $b_{i,j}(t)$  at time  $t$  is based on the approach presented in (Cho et al., 2008), and then, Equation (6.5) is rewritten as

$$b_{i,j}(t) = \eta m_{i,j}(t) \quad (6.6)$$



where  $m_{i,j}(t)$  is the likelihood of the transition from the state  $j$  at time  $t - 1$  to the state  $i$  at time  $t$ . The likelihood is normalised by the parameter  $\eta$  to have probabilities in  $[0, 1]$ . The likelihood  $m_{i,j}(t)$  is defined as

$$m_{i,j}(t) = \left(\frac{t-1}{t}\right) m_{i,j}(t-1) + \left(\frac{1}{t}\right) \text{PIG} \quad (6.7)$$

where  $m_{i,j}(t-1)$  is the likelihood from the previous time  $t-1$ . The PIG measurement is used as the reward value. Normally, the reward value is pre-defined or set to a fixed value, i.e. 0 for the non observed case and 1 otherwise. However, in the proposed approach the likelihood  $m_{i,j}(t)$  uses the PIG measurement, which takes values in  $[0, 1]$  that vary along the exploration process according to the accuracy obtained from the output of the active Bayesian perception process.

The normaliser parameter  $\eta$  is obtained by adding the information acquired along the exploration task from time  $t = 1$  to the current time  $t = T$  as follows:

$$\eta = \sum_{t=1}^T m_{i,j}(t) \quad (6.8)$$

Once the transition matrix  $B_t$  has been obtained, it is used to estimate the probability  $P(X_t)$  as shown in Equation (6.4). Finally, the variable  $x$  with the largest probability is assigned to the parameter  $\Delta$  and used in the forward model (repeated from Chapter 5) as follows:

$$\Delta = \max_x P(X_t) \quad (6.9)$$

$$P(c_n|\tilde{z}_t)' = P(x_l, w_i|\tilde{z}_t)' = P(x_l, w_i + \Delta|\tilde{z}_t) \quad (6.10)$$

Then, the predicted sensory observations obtained from this forward model are used with the active Bayesian perception approach and the sensorimotor control strategies described in Chapter 5. The accuracy of the predictions obtained from the forward model need to be assessed along the exploration task. For that reason, in the next section a method to assess the sensory

predictions and control the amount of experience used with the active Bayesian perception along the exploration task is presented.

## 6.2 Forward model assessment

The method to predict the sensory observations based on the forward model along an exploration task was described in Section 6.1. The accuracy of the learned forward model needs to be assessed to control the amount of information used from the experience acquired along the exploration task.

First the sensory observations obtained from active Bayesian perception at time  $t$  and the predicted sensory observations obtained from the forward model at time  $t - 1$  are assessed using a DBN approach as in Section 6.1.2,

$$O_t = \eta n_t \quad (6.11)$$

where  $O_t$  contains the observations updated from time  $t - 1$  to  $t$ . The assessment process between the active Bayesian perception and the predictions provided by the forward model is performed by  $n_t$ . The normalising factor is represented by  $\eta$ . The assessment of the predictions by the parameter  $n_t$  is as follows:

$$n_t = \left( \frac{t-1}{t} \right) P(c_n | \tilde{z}_t)' + \left( \frac{1}{t} \right) P(c_n | z_t) \quad (6.12)$$

where the predictions obtained by the forward model are defined by  $P(c_n | \tilde{z}_t)'$ . The output from the active Bayesian perception method at time  $t$  is represented by  $P(c_n | z_t)$ . Then, the result from  $n_t$  is used in Equation (6.11) and normalised by the parameter  $\eta$  which is obtained by adding the information observed from time  $t = 1$  to the current time  $t = T$  as follows:

$$\eta = \sum_{t=1}^T n(t) \quad (6.13)$$

The confidence factor  $\alpha_t$  is then calculated using the previous assessment

of the forward model  $\alpha_{t-1}$  at time  $t-1$  and the result from  $O_t$  at time  $t$  shown in Equation (6.11) as follows:

$$\alpha_t = \left(\frac{t-1}{t}\right) \alpha_{t-1} + \left(\frac{1}{t}\right) O_t(w_{decision}) \quad (6.14)$$

$$w_{decision} = \max(P(c_n|\tilde{z}_t)') \quad (6.15)$$

where  $O_t(w_{decision})$  is the probability of the angle class predicted,  $w_{decision}$ , provided by the forward model in Equation (5.1). The confidence factor  $\alpha_t$  which takes values in  $[0, 1]$  is used to weight the combination of the experience acquired along the exploration task and the active Bayesian perception process. Finally, the weighted combinations performed by Equations (5.2) and (5.4) for both SMC1 and SMC2 sensorimotor control strategies include the parameter  $\alpha_t$ , showing explicitly time dependency along the exploration task as follows,

$$P(c_n|\tilde{z}_t) = \alpha_t P(c_n|\tilde{z}_t)' + (1 - \alpha_t) P_{\text{flat}}(c_n) \quad \text{for SMC1 strategy} \quad (6.16)$$

$$P(c_n|\tilde{z}_t) = \alpha_t P(c_n|\tilde{z}_t)' + (1 - \alpha_t) P(c_n|z_t) \quad \text{for SMC2 strategy} \quad (6.17)$$

Both sensorimotor control strategies were presented in Chapter 5 to analyse their effects on the performance in terms of the speed and accuracy achieved by the active Bayesian perception process during an exploration task. The analysis presented in Chapter 5 was made under the assumption of knowing the forward model that provides the correct prediction of the sensory measurements. Also, the confidence factor  $\alpha$  was set to fixed values in  $[0, 1]$  along the exploration task.

In this section, the methods to obtain and adapt the forward model and confidence factor during the exploration task were presented. In the next section, these methods are included in both SMC1 and SMC2 strategies to

observe how their performance in terms of the speed and perception accuracy are affected during the contour following exploration procedure.

## 6.3 Adaptive active tactile exploration

In this section, the methods for learning the forward model and confidence factor are implemented and tested using the SMC1 and SMC2 strategies investigated in Chapter 5. These experiments permit to analyse the effects on the speed and perception accuracy during the performance of the contour following exploration procedure previously validated.

### 6.3.1 Exploration using a weighted prior

The first experiment is the implementation of the forward model and confidence factor with the SMC1 strategy. This strategy is based on including a weighted prior at the beginning of the active Bayesian perception approach as is shown in the flowchart of Figure 5.3.

The updated prior in the perception process is obtained by the combination of the flat prior  $P_{\text{flat}}(c_n)$  and the prediction of the sensory observations  $P(c_n|\tilde{z}_t)'$  provided by the forward model. This combination is weighted by the confidence factor  $\alpha_t$ , which controls the weighting of the prediction used according to the assessed accuracy of the forward model. The implementation of the SMC1 strategy, based on Equation (5.2), adds the time dependency of the  $\alpha_t$  parameter obtained by Equation (6.14). This modification is observed in Equation (6.16) and repeated here,

$$P(c_n|\tilde{z}_0) = \alpha_t P(c_n|\tilde{z}_t)' + (1 - \alpha_t) P_{\text{flat}}(c_n)$$

The forward model  $P(c_n|\tilde{z}_t)'$  is learned during the performance of the exploration task using the past observations and the current output from the active Bayesian perception process (PIG and DBN) as described in Section 6.1. The

confidence factor  $\alpha_t$  used to weight the contribution provided by the forward model is obtained based on the assessment of the output from the active perception process and the predicted observations described in Section 6.2.

The experiment was performed with the contour following exploratory procedure using a circular-shaped object previously validated (Section 5.4). The circular-shaped object was constructed with real tactile data to achieve more realistic results. The effects on the performance in the speed and accuracy obtained by the SMC1 strategy with the proposed adaptive methods are shown in Figure 6.2. The results from the adaptive exploration are compared with the results from the non-adaptive exploration presented in Chapter 4 and the ideal adaptive SMC1 strategy presented in Chapter 5, where the forward model was assumed to be known and the confidence factor was manually controlled.

The angle and position accuracy achieved against belief threshold by the adaptive exploration (green curves) are presented in Figures 6.2a and 6.2b respectively. The smallest angle and position errors obtained with the SMC1 strategy (green curves) are 2.8 degrees and 1.8 mm for the belief threshold of 0.5 and 0.99 respectively. These results in speed and perception accuracy are improved over the ones obtained by the experiments performed in Chapter 4, where no experience, acquired along the exploration task, was included in the perception process (blue curves). The proposed forward model learning and confidence factor methods (PIG and DBN) permitted the improvement of the performance of the exploration task when experience from previous steps was included in the perception process. These improvements achieved for the SMC1 strategy are similar to the results observed in Figures 5.5a and 5.5b from the investigation presented in Chapter 5. However, here the  $\Delta$  and  $\alpha$  parameters do not need to be set manually, and in contrast, they are estimated and adapted along the exploration task through the interaction between the biomimetic fingertip sensor and the environment.

The results for the angle and position perception against the reaction time (green curves), and their comparison with the non adaptive exploration (blue curves) and the ideal adaptive SMC1 strategy (purple curves) are shown in

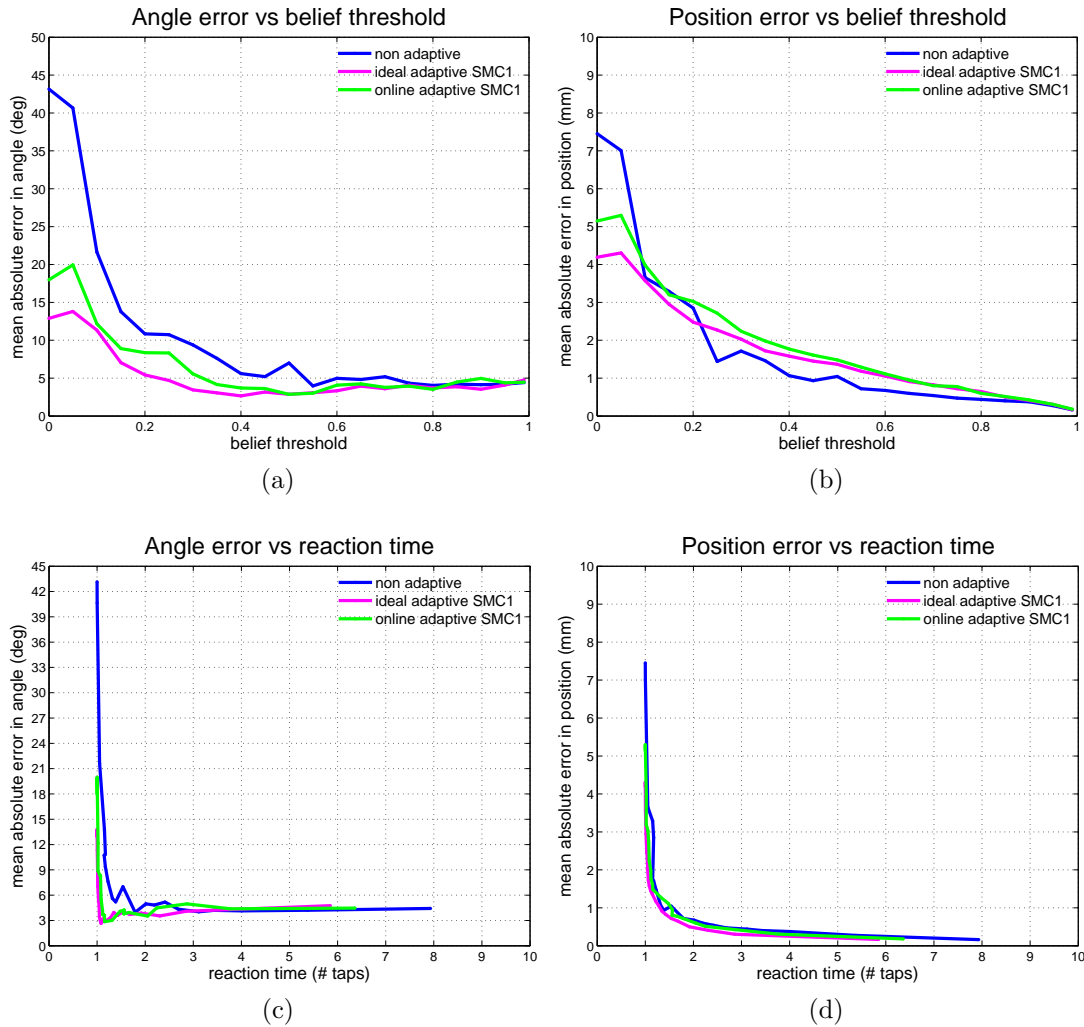

Figure 6.2: Results from the contour following task based on the SMC1 strategy and active Bayesian perception applied to a circular-shaped object. The online adaptive SMC1 strategy (green curve) is compared to the results from the ideal adaptive SMC1 strategy (purple curve) and the exploration with no weighted prior included into the perception process (blue curve). The adaptive SMC1 strategy achieved the smallest (a) mean angle and (b) position errors against belief threshold of 2.8 degrees and 0.18 mm respectively. Plots (c) and (d) present the mean angle and position errors against reaction time.

Figures 6.2c and 6.2d. The smallest reaction time or number of palpations required to obtain the optimal angle and position perceptions are approximately 1 and 6 palpations respectively. These results, similar to the ones observed for the SMC1 strategy in Figures 5.5c and 5.5d, were achieved with the prediction of observations and adaptation of the exploration task based on the PIG and DBN methods. The adaptive behaviour permitted, based on the forward

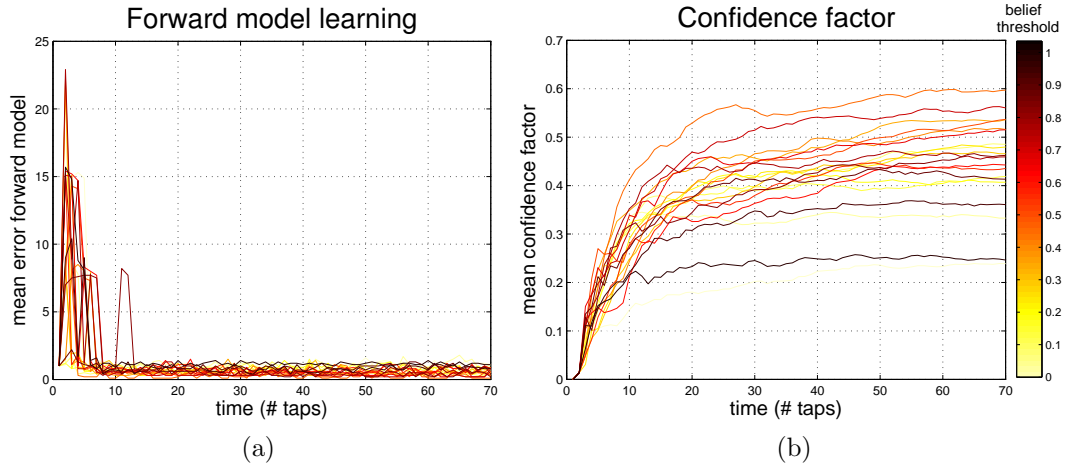

Figure 6.3: Results from the contour following task based on the SMC1 strategy and active Bayesian perception applied to a circular-shaped object. (a) Mean error in the adaptive learning forward model along the exploration task. (b) Adaptability of the confidence factor used to weight the predictions obtained by the forward model. The experiment is performed for the belief thresholds set of  $\{0.0, 0.05, \dots, 0.99\}$  represented by the coloured scaled curves

model assessment and with no need to set the confidence factor manually, to control the weight of the experienced assigned to the SMC1 strategy along the exploration task.

The behaviour of the forward model and the confidence factor observed along the exploration task are presented in Figures 6.3a and 6.3b respectively. The different coloured scaled curves in Figure 6.3a show the adaptability of the forward model during the tactile exploration task for the belief thresholds set to  $\{0.0, 0.05, \dots, 0.99\}$ . It is observed that at the beginning (around 10 palpations) of the exploration task, the forward model presents the largest variation, becoming smaller across time. Figure 6.3b shows the adaptability of the confidence factor, which is controlled by the accuracy of the forward model. The coloured scaled curves represent the set of belief thresholds as in Figure 6.3a. It is observed that the confidence about the predictions provided from the forward model increase along the time for all the curves. Then, the more accurate the forward model the larger the confidence factor, which increases the weight assigned to the predictions used in the SMC1 strategy.

Overall, the proposed learning forward model and confidence factor meth-

ods for the SMC1 were able to achieve an improvement in the speed and perception accuracy along the exploration task. These results have been improved over the case where no experience was used to update the initial prior of the active Bayesian perception process for the exploration task.

### 6.3.2 Exploration using a weighted posterior

For the second experiment, the proposed forward model and confidence factor methods are implemented with the SMC2 strategy. This strategy performs a weighted posterior process at the end of the active Bayesian perception procedure as is described in the flowchart of Figure 5.4.

The weighted posterior is based on the combination of the output from the active Bayesian perception process  $P(c_n|z_t)$  with the predictions obtained by the forward model  $P(c_n|\tilde{z}_t)'$  along the exploration task. The combination of information is weighted by the confidence factor  $\alpha_t$  that adapts according to the accuracy of the forward model. The confidence factor also controls the weight assigned to the forward model for each exploration step. The weighted posterior process performed by the SMC2 strategy based on Equation (5.4) converts in Equation (6.17), showing the time dependency of the parameter  $\alpha_t$  and which is repeated here,

$$P(c_n|\tilde{z}_t) = \alpha_t P(c_n|\tilde{z}_t)' + (1 - \alpha_t) P(c_n|z_t)$$

where the forward model  $P(c_n|\tilde{z}_t)'$  and confidence factor  $\alpha_t$  are learned along the exploration task using the proposed methods described in Sections 6.1 and 6.2. The forward model is learned based on the past and current observations for each step along the exploration time, allowing to predict the sensory observations for the next exploration step. On the other hand, the confidence factor increases according to the accuracy of the predictions provided by the forward model.

The weighted posterior obtained at the end of the active Bayesian perception process is then used to make the angle and position decisions for the



current exploration time as is described by Equations (5.7) and (5.8) (repeated here)

$$w_{\text{decision}} = \arg \max_{w_i} P(w_i | \tilde{z}_t)$$

$$x_1 = \arg \max_{x_l} P(x_l | \tilde{z}_t)$$

The SMC2 strategy was implemented with the contour following exploration procedure using the proposed methods for learning the forward model and confidence factor. The implementation and test of the exploration task was performed using a circular-shaped object constructed with real tactile data collected with the fingertip sensor (see Section 3.3). The results for the contour following exploration procedure using the SMC2 strategy (green curves) are presented in Figure 6.4. The results from the non-adaptive exploration (blue curves) presented in Chapter 4 and the ideal adaptive SMC2 strategy (purple curves) shown in Chapter 5, where the forward model was assumed to be known and the confidence factor was manually controlled are also shown for comparison.

The angle and position perception accuracy results against belief threshold are shown in Figures 6.4a and 6.4b, with the smallest errors of 4.1 degrees and 0.16 mm respectively (green curves). Unlike the SMC1 strategy, the smallest errors achieved by the SMC2 strategy based on the proposed forward model and confidence factor methods, are larger than the results obtained in Chapter 5 where the SMC2 strategy was investigated with an ideal forward model (purple curves). However, it is observed that the angle perception accuracy is able to achieve small errors for low belief thresholds, similar to the behaviour obtained in Chapter 5.

The angle and position perception results against the reaction time are presented in Figures 6.4c and 6.4d. In this case, the speed of the exploration task did not present a large effect by the SMC2 strategy, which is similar to the performance observed in Chapter 5. These results in speed were expected

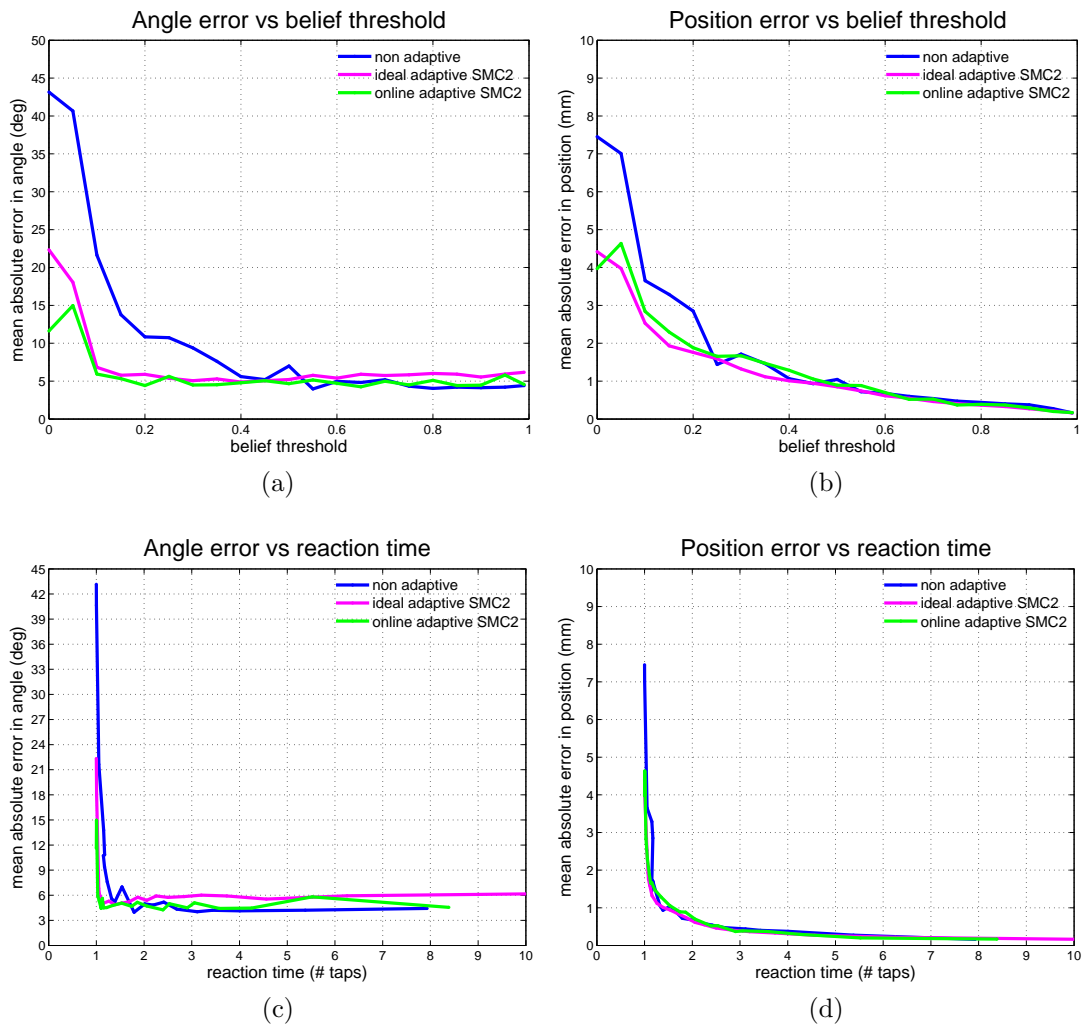

Figure 6.4: Results from the contour following task based on the SMC2 strategy and active Bayesian perception applied to a circular-shaped object. The online adaptive SMC2 (green curve) is compared to the results from the ideal adaptive SMC2 strategy (purple curve) and the exploration with no weighted posterior included into the perception process (blue curve). The adaptive SMC2 strategy achieved the smallest (a) mean angle and (b) position errors against belief threshold of 4.2 degrees and 0.17 mm respectively. Plots (c) and (d) present the mean angle and position errors against reaction time.

given that the weighted posterior process is performed at the end of the active Bayesian perception process, without affecting the initialisation of the perception process.

The behaviour of the forward model and confidence factor along the exploration task of the circular-shaped object are shown in Figures 6.5a and 6.5b respectively. On the one hand, the forward model was able to achieve a small

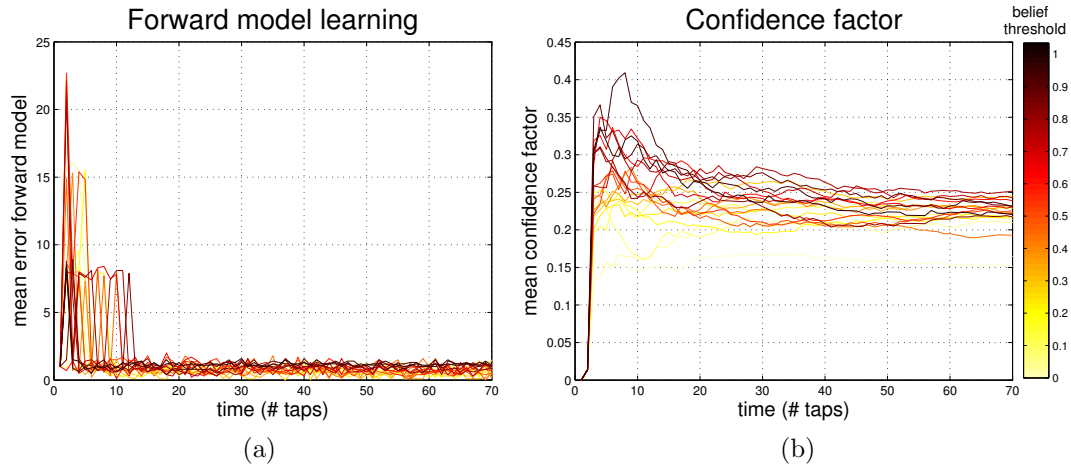

Figure 6.5: Results from the contour following task based on the SMC2 strategy and active Bayesian perception applied to a circular-shaped object. (a) Mean error in the adaptive learning forward model along the exploration task. (b) Adaptability of the confidence factor used to weight the predictions obtained by the forward model. The experiment is performed for the belief thresholds set of  $\{0.0, 0.05, \dots, 0.99\}$  represented by the coloured scaled curves.

error for the  $\Delta$  parameter after about 14 palpations. However, the assessment of the predictions were not very accurate, decreasing the confidence of the forward model as is shown by the coloured scaled curves in Figure 6.5b. These curves represent the set of belief threshold  $\{0.0, 0.05, \dots, 0.99\}$  used for this experiment. Also, they show how the confidence on the predictions decreases for each belief threshold along the exploration task, assigning more weight to the output from the active Bayesian perception process.

Even though the SMC2 strategy was not able to improve the speed and perception accuracy compared to Chapter 5, the results permitted to approximate the accuracy to a smaller error using low belief thresholds which also reduces the required time to complete the exploration task. Also, the results showed an improvement over the experiments where no experience was included into the active Bayesian perception process. Moreover, the effects observed by the adaptive approach (PIG and DBN) along the exploration task, did not require to set the forward model and confidence factor parameter manually as in the experiments presented in Chapter 5.

## 6.4 Concluding remarks

The method presented in this chapter to learn the forward model and confidence factor was composed of a Predicted Information Gain (PIG) approach to observe ‘what would have happened’ if a certain action had been chosen to move from the previous to the current exploration time. The PIG approach was used as the cost of observing an occurred event into a Dynamic Bayesian Network (DBN). The combination of both approaches permitted to estimate the  $\Delta$  parameter required for the learning of the forward model during the tactile exploration procedure. The proposed confidence factor  $\alpha_t$  was responsible for the assessment of the forward model accuracy at each exploration time. The results from the confidence factor permitted to control the amount of experience combined with the active Bayesian perception process according to the SMC1 and SMC2 strategies.

For the SMC1 strategy, the forward model used to predict the sensory observations permitted to improve both the speed and perception accuracy. These results are similar to the ones obtained in the experiments performed with the SMC1 strategy in Chapter 5. The accuracy of the forward model also is observed with the increment of the confidence factor along the exploration task. Thus, the exploration task based on the SMC1 strategy included into the active Bayesian process was benefited by the proposed adaptive methods.

On the other hand, the results from the SMC2 strategy did not present large improvement on the perception accuracy compared to the ones observed in Chapter 5. However, small errors were achieved for low belief thresholds, permitting to reduce the number of palpations required by the fingertip sensor to make a decision. The position accuracy also provided a small improvement with respect to the results obtained with the SMC1 strategy. The values obtained from the confidence factor along the exploration task, also show that the method to learn the forward model was not able to achieve large accuracy for the SMC2 strategy.

Overall, the proposed methods permitted to learn and assess the accuracy

of the forward model along the exploration task. These methods allowed an online adaptability of the forward model and confidence factor during the tactile exploration. The predicted sensory observations were able to benefit the performance of both the speed and perception accuracy achieved by the active Bayesian perception process. The results also demonstrated that the active Bayesian perception can benefit from the SMC1 and SMC2 strategies proposed in Chapter 5 for the combination of information sources.



# Chapter 7

## Conclusions and Future Work

Biology plays an important role in the field of robotics, motivating sophisticated methods for the design and development of intelligent systems to solve a large variety of problems. In this work, investigation of tactile perception in robotics took inspiration from the way that humans perceive and explore their environment using their hands and fingers.

First, a new robotic platform was developed to allow mobility and assess the performance of active controlled movements of a biomimetic fingertip sensor. This platform also permitted the systematic collection of tactile datasets composed by angle and position classes, which also contributed to the limited tactile datasets currently available for research.

A novel tactile Bayesian perception method, inspired by the way that humans perceive using their sense of touch, demonstrated to be robust and accurate. This approach offers a natural way for the accumulation of evidence to reduce uncertainty from the tactile measurements as human does. Passive and active perception modalities were also designed and implemented to analyse and compare their performance in speed and accuracy for tactile perception.

Investigation of the sensitivity of the biomimetic fingertip sensor was undertaken using a passive Bayesian approach, similar to tactile experiments from psychophysics. This study permitted to identify of the optimal location for perception of the tactile sensor. The results provided the central region of the iCub fingertip sensor as the optimal location to achieve the smallest perception error. A tactile discrimination task was performed using passive and

active Bayesian perception to analyse their performance in speed and accuracy for discrimination angle and position classes. Active Bayesian perception was able to achieve high accuracy, clearly contrasting with the results from passive Bayesian perception. This improvement showed the benefits of using active Bayesian perception with biomimetic fingertip sensors.

Overall, the proposed perception method demonstrated the following: 1) active Bayesian perception allows to achieve high accuracy with biomimetic sensors; 2) accumulation of evidence permits to reduce uncertainty from tactile measurements; 3) actively controlled movements of the tactile sensors also permit to improve perception; and 4) biologically inspired methods allow to address tactile perception in robotics in a natural way.

A novel sensorimotor architecture for tactile perception was developed to implement active Bayesian perception. This sensorimotor architecture offers a novel method to actively move the fingertip sensor to locations with better perception in order to reduce uncertainty. The validation of active Bayesian perception was based on the contour following exploratory procedure to extract object shape. First, the exploration task was implemented in a simulated environment using objects constructed with real tactile data. Second, the experiment was repeated in a real environment with various real objects. In both simulated and real environments the exploration task was performed in passive and active perception modalities. The biomimetic fingertip sensor was able to successfully extract the contours of the explored objects by the use of active Bayesian perception. In contrast, passive perception did not permit the tactile sensor to extract the complete shape of the objects due to the low perception accuracy achieved.

The results from the contour following task also showed that not only active Bayesian perception is required, but also a high decision threshold is needed for achieving high perception accuracy. Increasing the decision threshold not only improved the accuracy, but also increases the time required to make a decision, which slows down the speed of the object exploration. This trade-off between speed and accuracy is an important characteristic in robotics, where



not only accurate but also fast decisions are required.

Regarding to the psychophysical studies, the biomimetic fingertip sensor, based on the novel active Bayesian perception approach and the sensorimotor architecture, demonstrated to be able to achieve higher angle perception accuracy than sighted and blind people. This is an important and interesting result which shows that the proposed perception method is accurate and robust, making this approach suitable for tactile perception in robotics.

Two novel sensorimotor control strategies were proposed to investigate the effects of combining active perception with predicted information. The first sensorimotor control strategy (SMC1) included a weighted prior at the beginning of the perception process, whilst the second sensorimotor control strategy (SMC2) applied a weighted posterior at the end of the perception process.

On the one hand, the SMC1 strategy improved the speed, reducing the time required for the contour following task. This effect on the speed is based on the small amount of evidence required to make a decision given the initial weighted prior. However, the perception accuracy presented a small improvement for the angle perception, whilst for the position perception no improvement was observed. On the other hand, the SMC2 strategy permitted to improve the accuracy for both angle and position perception. Moreover, the improvement was observed even for small decision thresholds. In contrast, the reaction time was not affected, given that the initialisation of the active Bayesian process was not biased by a weighted prior.

Motivated by the improvements achieved by the SMC1 and SMC2 strategies, a method composed by the Predicted Information Gain (PIG) and Dynamic Bayesian Network (DBN) approaches was developed to learn the forward model and assess its accuracy along the exploration task. The learning process during the exploration task benefits the active Bayesian perception with an adaptive exploration behaviour, according to the experience and the observations obtained through the interaction with the environment. The method was implemented and validated with both sensorimotor control strategies.

The learning method allowed the SMC1 strategy to improve the perfor-

mance of both, speed and perception accuracy along the exploration task. This shows that the forward model was able to achieve good accuracy on the predictions of the sensory observations. The accuracy assessment performed by the confidence factor, also shows the increment on the weight assigned to the forward model for its combination with the active Bayesian perception process. For the SMC2 strategy, the forward model did not present a large improvement in the accuracy of the exploration task. However, small errors were achieved for low belief thresholds which permit to reduce the reaction time for making a decision. The low accuracy of the predictions provided by the forward model is also observed by the decreasing values of the confidence factor. The results from the confidence factor show that the SMC2 strategy assigned a larger weight to the active Bayesian perception than the forward model. In general, the proposed method for learning and assessing the forward model and the confidence factor, permitted to improve the speed and accuracy over the results where no weighted prior or posterior were included into the active Bayesian perception process.

The investigation of perception using the sense of touch in robotics is important for the design and development of robots capable to safely interact with and understand their environment. This motivated the work presented in this thesis about the study of perception in robotics based on the artificial sense of touch with biomimetic fingertip sensors. Overall, the novel methods and the experiments undertaken in this research work showed that perception biologically inspired by the sense of touch in humans offers a natural and accurate approach to address tactile perception in robotics.

## **Future work**

This thesis has presented an investigation on tactile perception using methods biologically inspired by humans. The proposed methods were validated with the implementation of the contour following exploration task under simulated and real environments, achieving accurate perception results. The achievements presented in this work also can be used to extend the research on tactile perception in robotics with the following list of possible future work.

- Implementation and testing of the proposed Bayesian perception method in a robot with more degrees of freedom (DoF), such as robotic arms or humanoid robots. The achievements from this validation task could be used to support and test the robustness of the results obtained in this research work based on a robotic platform with 3 DoF.
- Extend the proposed perception method to process the tactile measurements from multiple fingertip sensors, for instance, two fingers for a gripper and five fingers for a robotic hand. This extension to the proposed method could provide the requirements for the development of a more flexible perception approach.
- Perception from different sensory modalities is important to have a better understanding of the environment, which can be accomplished by the fusion of the proposed method for tactile perception with biologically inspired methods for visual perception. This process could provide robots with a more robust perception system for interaction in complex environments.
- Validation of the accuracy, adaptability and flexibility of the proposed Bayesian perception approach implemented with different tactile sensor technology and robotic platforms. This would contribute to the development of an scalable tactile perception framework to be used in a variety of tactile robotic platforms.



# Appendices



# Appendix A

## Tactile data collection

The robotic platform and biomimetic fingertip described in Chapter 3 were used to collect the tactile dataset composed of 72 angle and 18 position perceptual classes with a resolution of 5 degrees and 1 mm respectively. The data collection process was repeated two time in order to have one tactile data for training and one for testing. Both tactile dataset are shown below.

### Training tactile dataset

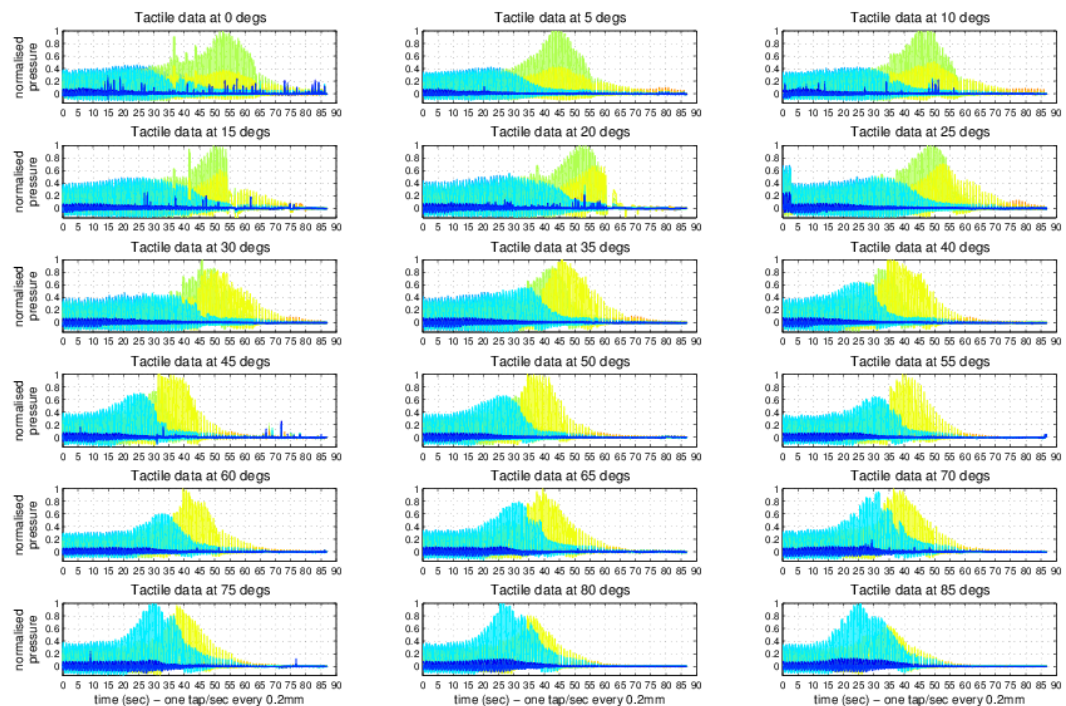

Figure A.1: Training tactile dataset. Angle classes from 0 to 85 degrees.

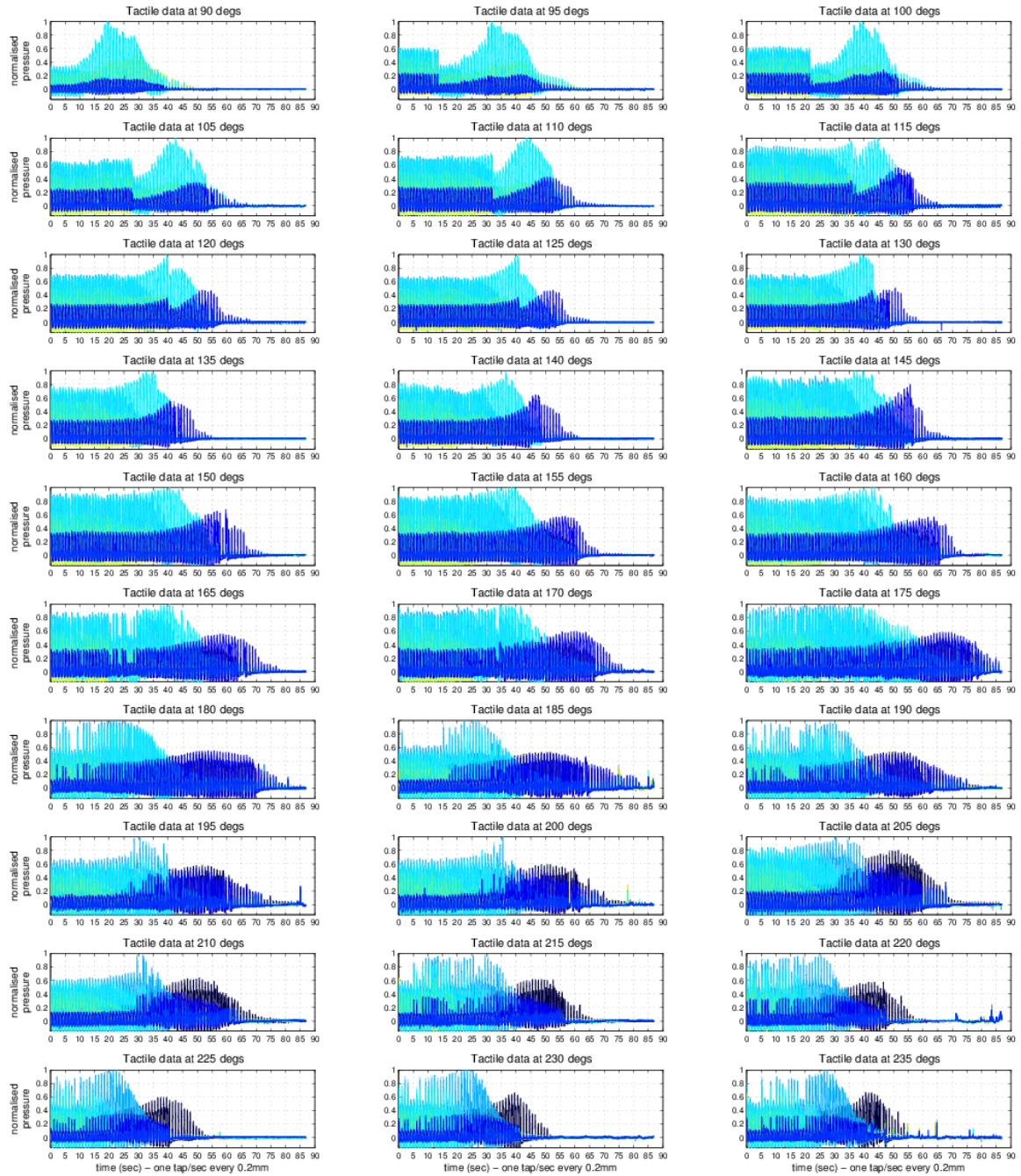

Figure A.2: Training tactile dataset. Angle classes from 90 to 235 degrees.



## Appendix A. Tactile data collection

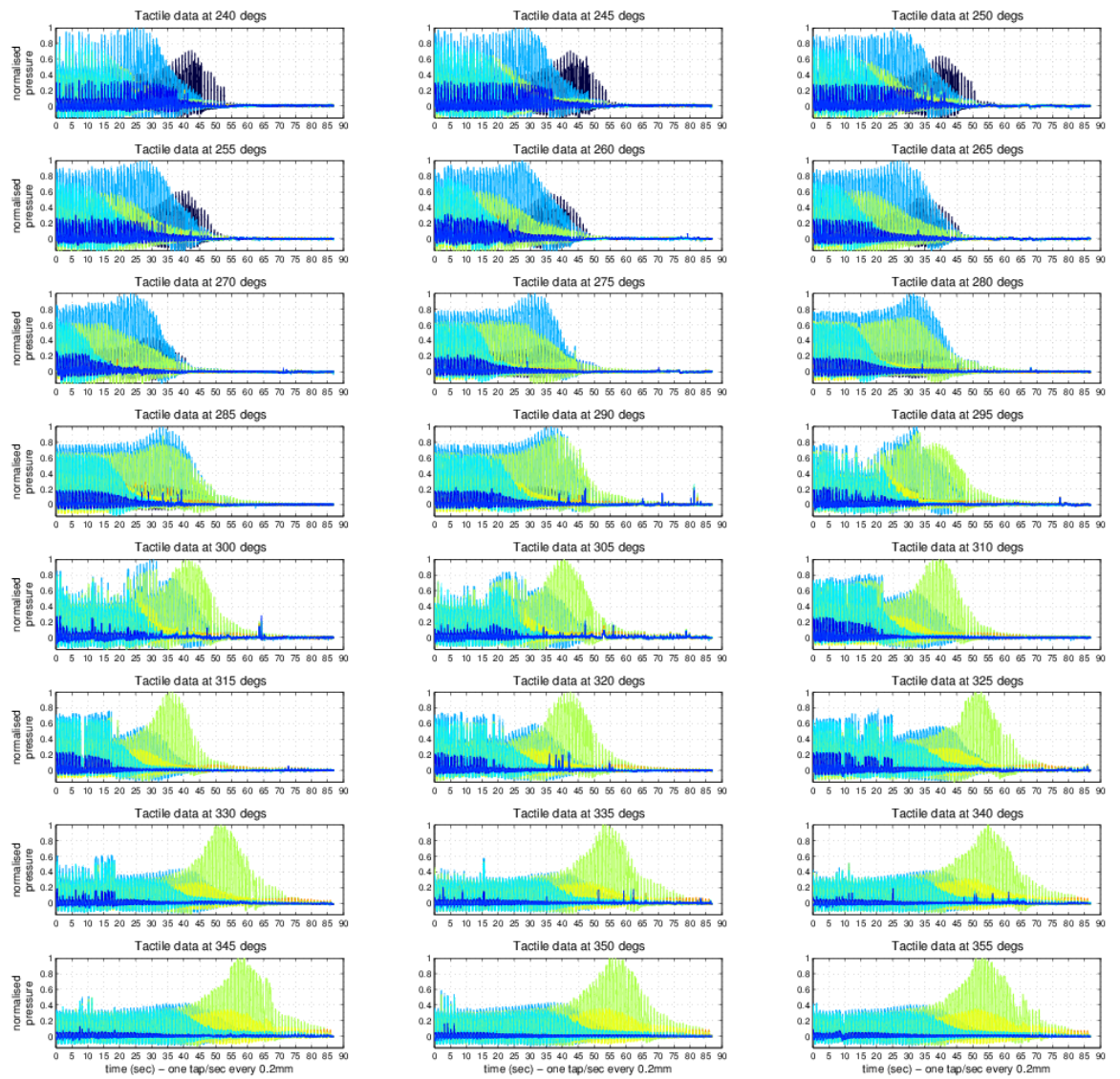

Figure A.3: Training tactile dataset. Angle classes from 240 to 355 degrees.

## Testing tactile dataset

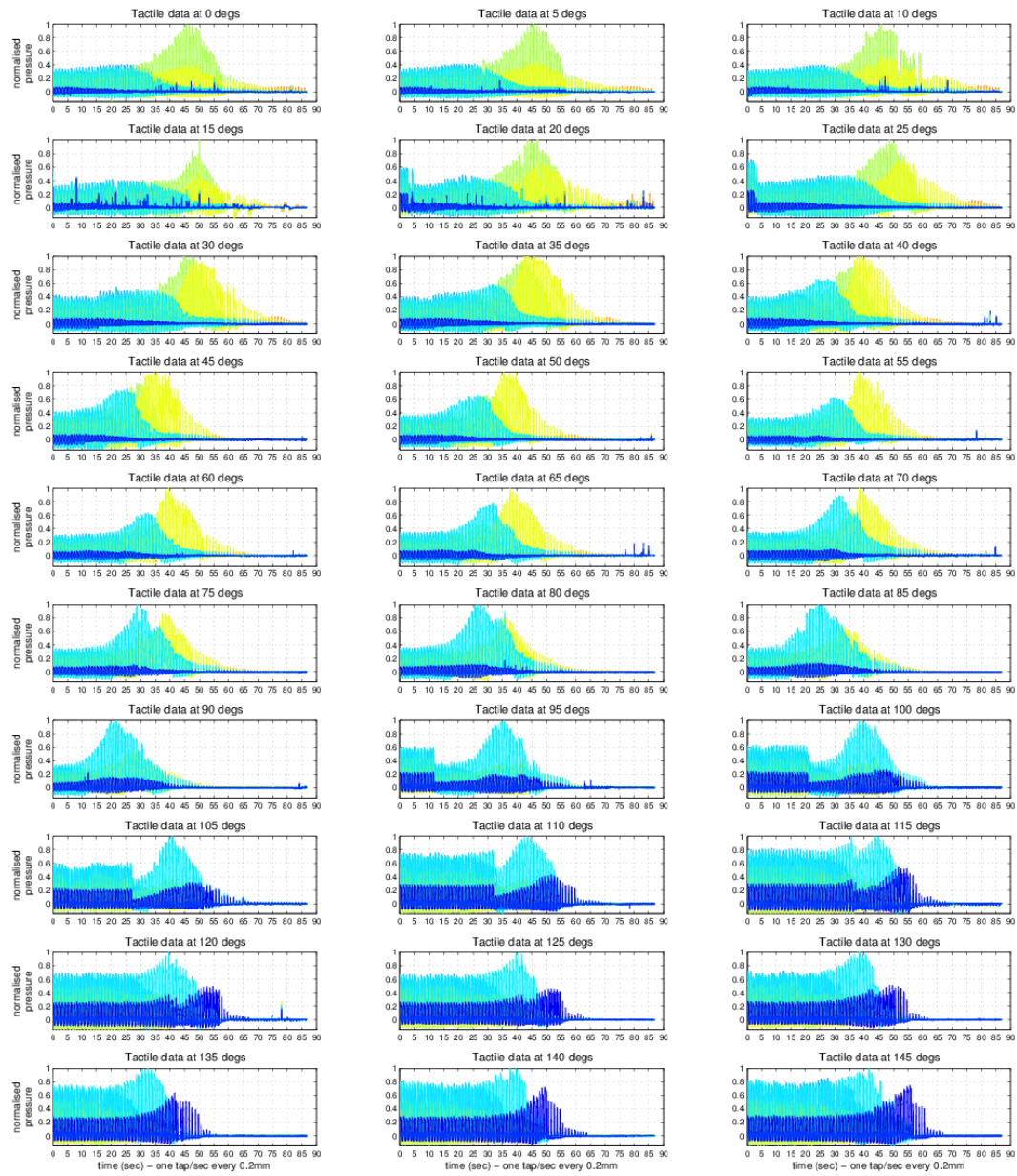

Figure A.4: Testing tactile dataset. Angle classes from 0 to 85 degrees.

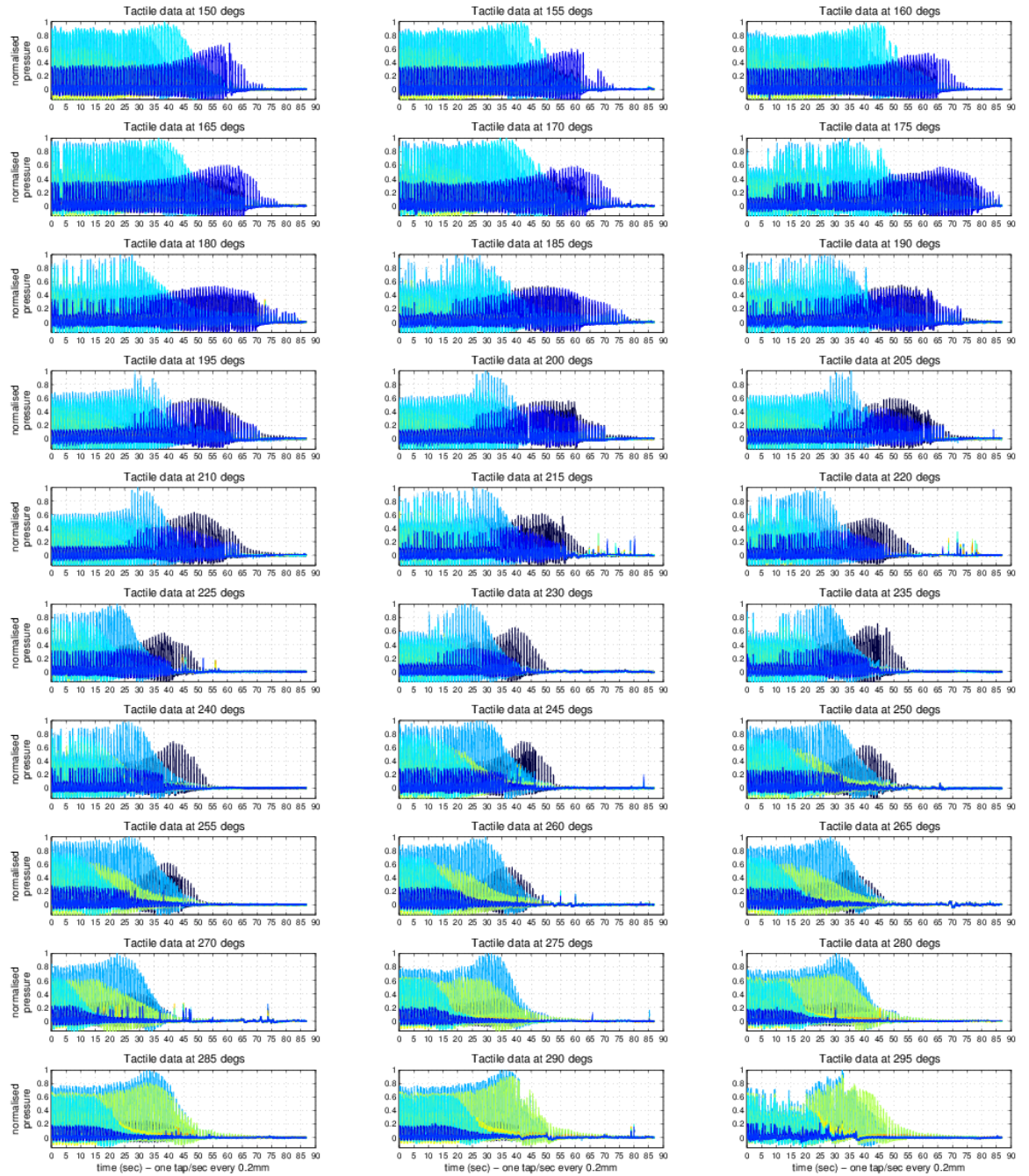

Figure A.5: Testing tactile dataset. Angle classes from 90 to 235 degrees.

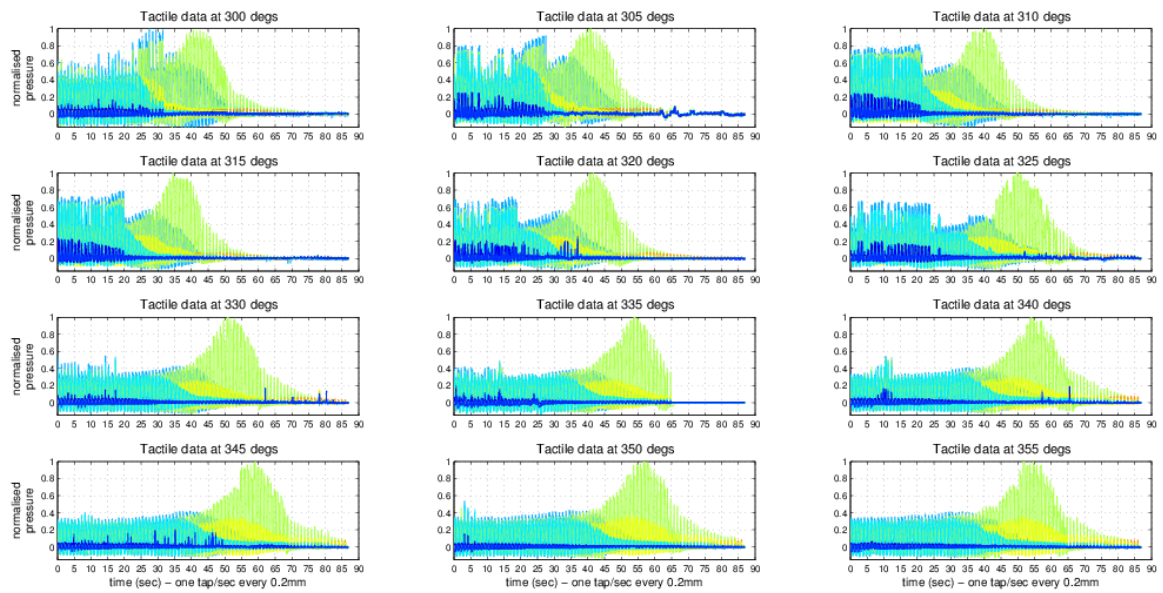

Figure A.6: Testing tactile dataset. Angle classes from 240 to 355 degrees.



# Appendix B

## Linear-shaped object

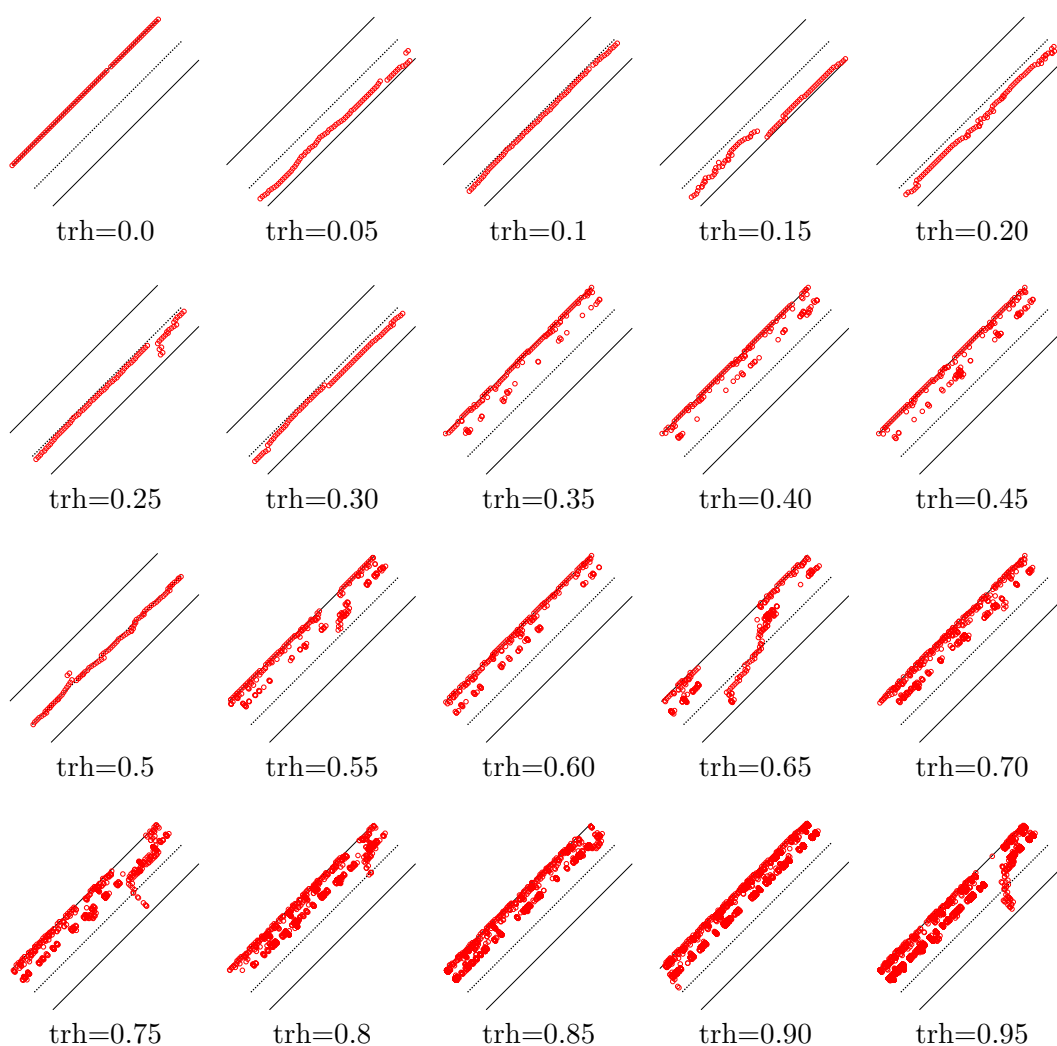

Figure B.1: Passive contour following procedure of a linear-shaped object using real tactile data from the iCub fingertip sensor. The experiment with passive perception is presented for different values of belief threshold. The number of palpations required by the fingertip sensor to make a decision increases with the increment of the belief thresholds.

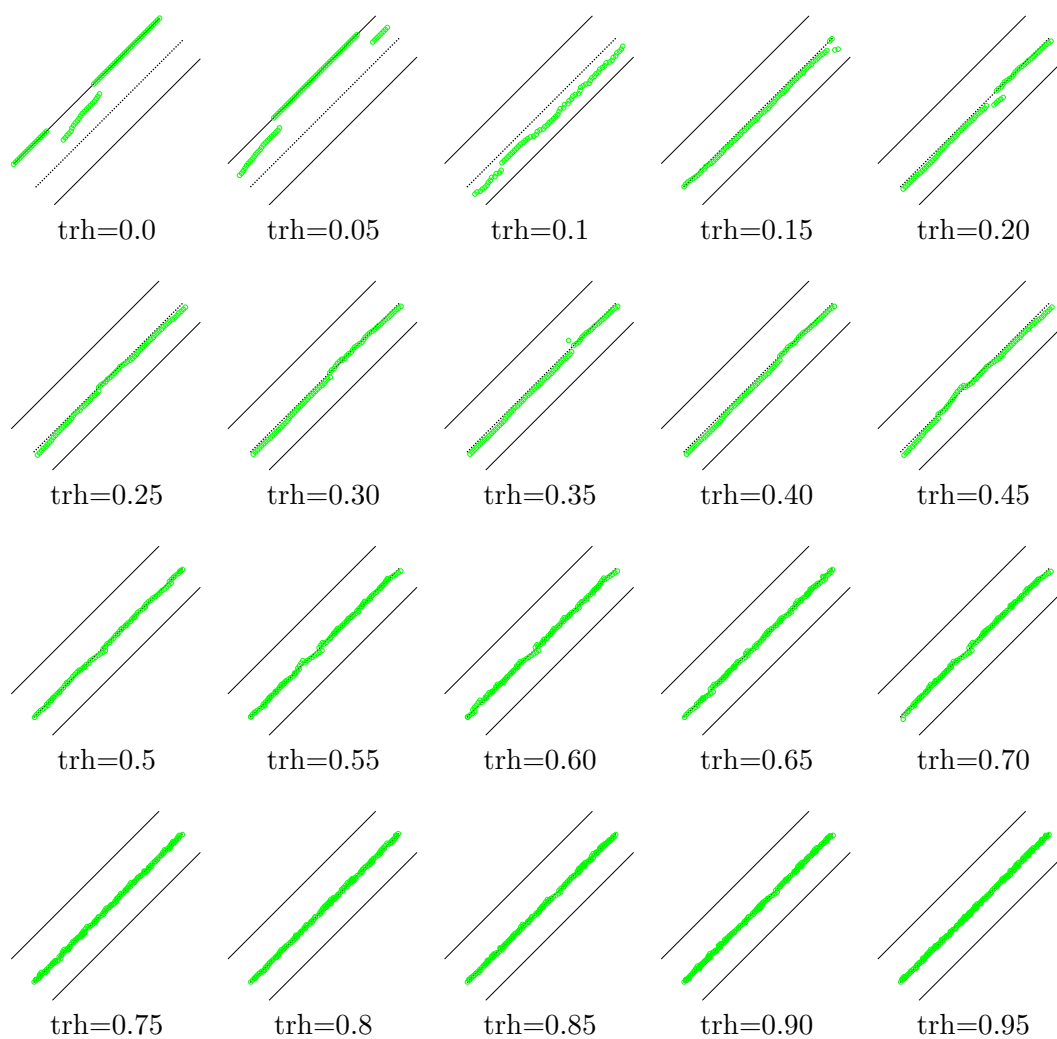

Figure B.2: Active contour following procedure of a linear-shaped object using real tactile data from the iCub fingertip sensor. The experiment with active perception is presented for different values of belief threshold. The number of palpations required to make a decision increases with the increment of the belief thresholds.

# Appendix C

## Circular-shaped object

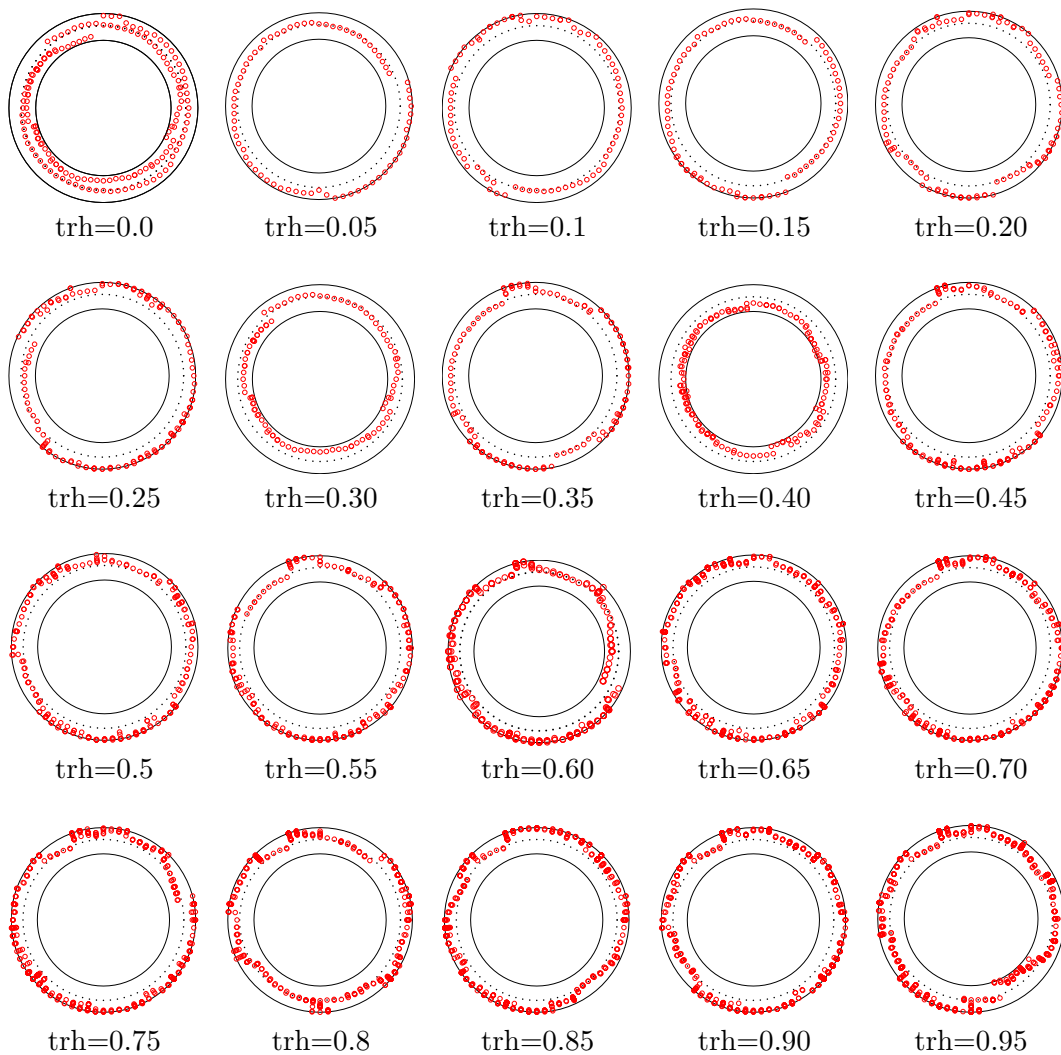

Figure C.1: Passive contour following procedure of a circular-shaped object using real tactile data from the iCub fingertip sensor. The experiment with passive perception is presented for different values of belief threshold. The number of palpations required by the fingertip sensor to make a decision increases with the increment of the belief thresholds.



Figure C.2: Active contour following procedure of a circular-shaped object using real tactile data from the iCub fingertip sensor. The experiment with active perception is presented for different values of belief threshold. The number of palpations required to make a decision increases with the increment of the belief thresholds, which also permit to achieve large accuracy.



# References

- L. D. Paulson, “Biomimetic robots,” *Computer*, vol. 37, no. 9, pp. 48–53, 2004.
- N. F. Lepora, P. Verschure, and T. J. Prescott, “The state of the art in biomimetics,” *Bioinspiration & biomimetics*, vol. 8, no. 1, p. 013001, 2013.
- R. A. Brooks, C. Breazeal, M. Marjanović, B. Scassellati, and M. M. Williamson, “The cog project: Building a humanoid robot,” in *Computation for metaphors, analogy, and agents*. Springer, 1999, pp. 52–87.
- T. Fong, I. Nourbakhsh, and K. Dautenhahn, “A survey of socially interactive robots,” *Robotics and autonomous systems*, vol. 42, no. 3, pp. 143–166, 2003.
- M. A. Goodrich and A. C. Schultz, “Human-robot interaction: a survey,” *Foundations and trends in human-computer interaction*, vol. 1, no. 3, pp. 203–275, 2007.
- A. Tapus, M. Maja, B. Scassellati *et al.*, “The grand challenges in socially assistive robotics,” *IEEE Robotics and Automation Magazine*, vol. 14, no. 1, 2007.
- B. Scassellati, H. Admoni, and M. Mataric, “Robots for use in autism research,” *Annual Review of Biomedical Engineering*, vol. 14, pp. 275–294, 2012.
- S. J. Lederman *et al.*, “The physiology and psychophysics of touch,” in *Sensors and sensory systems for advanced robots*. Springer, 1988, pp. 71–91.
- H. Nakamoto, W. Fukui, F. Kobayashi, F. Kojima, N. Imamura, and H. Shirasawa, “Shape classification based on tactile information by universal robot hand,” in *Industrial Electronics, 2009. IECON '09. 35th Annual Conference of IEEE*, Nov. 2009, pp. 2360–2365.
- A. Schmitz, M. Maggiali, L. Natale, B. Bonino, and G. Metta, “A tactile sensor for the fingertips of the humanoid robot icub,” in *Intelligent Robots and Systems (IROS), 2010 IEEE/RSJ International Conference on*, Oct. 2010, pp. 2212–2217.
- A. Schmitz, “A distributed tactile system for humanoid robot hands,” Ph.D. dissertation, The University of Sheffield, 2010.

- C. Chorley, C. Melhuish, T. Pipe, and J. Rossiter, "Tactile edge detection," in *Sensors, 2010 IEEE*. IEEE, 2010, pp. 2593–2598.
- H. R. Schiffman, *Sensation and perception: An integrated approach*. John Wiley & Sons, 1990.
- C. Muthukrishnan, D. Smith, D. Myers, J. Rebman, and A. Koivo, "Edge detection in tactile images," in *Robotics and Automation. Proceedings. 1987 IEEE International Conference on*, vol. 4, March 1987, pp. 1500–1505.
- N. Chen, R. Rink, and H. Zhang, "Efficient edge detection from tactile data," *Proceedings of the 1995 IEEE/RSJ*, pp. 386–391, 1995.
- A. M. Okamura, M. L. Turner, and M. R. Cutkosky, "Haptic exploration of objects with rolling and sliding," in *Robotics and Automation, 1997. Proceedings., 1997 IEEE International Conference on*, vol. 3. IEEE, 1997, pp. 2485–2490.
- H. Nakamoto, F. Kobayashi, N. Imamura, H. Shirasawa, and F. Kojima, "Shape classification in rotation manipulation by universal robot hand," in *Intelligent Robots and Systems, 2008. IROS 2008. IEEE/RSJ International Conference on*. IEEE, 2008, pp. 53–58.
- Q. Li, C. Schürmann, R. Haschke, and H. Ritter, "A control framework for tactile servoing," in *Proc. Robotics: Science and Systems*, 2013.
- S. J. Lederman and R. L. Klatzky, "Hand movements: A window into haptic object recognition," *Cognitive Psychology*, vol. 19, no. 19, pp. 342–368, 1987.
- S. Lederman and R. Klatzky, "Haptic perception: A tutorial," *Attention, Perception, and Psychophysics*, vol. 71, pp. 1439–1459, 2009, 10.3758/APP.71.7.1439. [Online]. Available: <http://dx.doi.org/10.3758/APP.71.7.1439>
- R. L. Klatzky and S. Lederman, "Intelligent exploration by the human hand," in *Dextrous robot hands*. Springer, 1990, pp. 66–81.
- S. Lederman and R. Klatzky, "Extracting object properties through haptic exploration," *Acta Psychologica*, vol. 84, no. 1, pp. 29 – 40, 1993. [Online]. Available: <http://www.sciencedirect.com/science/article/pii/0001691893900708>
- R. Bajcsy, "Active perception," *Proceedings of the IEEE*, vol. 76, no. 8, pp. 966–1005, 1988.
- T. J. Prescott, M. E. Diamond, and A. M. Wing, "Active touch sensing," *Phil. Trans. R. Soc. B*, vol. 366, pp. 2989–2995, 2011.
- J. Delius, "Senses of animals," *Oxford Companion to Animal Behaviour*, pp. 498–501, 1987.

- B. O'Shaughnessy, "The sense of touch," *Australasian Journal of Philosophy*, vol. 67, no. 1, pp. 37–58, 1989.
- J. Dargahi and S. Najarian, "Human tactile perception as a standard for artificial tactile sensing—a review," *The International Journal of Medical Robotics and Computer Assisted Surgery*, vol. 1, no. 1, pp. 23–35, 2004.
- J. D. Fisher, M. Rytting, and R. Heslin, "Hands touching hands: Affective and evaluative effects of an interpersonal touch," *Sociometry*, pp. 416–421, 1976.
- S. Najarian, J. Dargahi, and A. Mehrizi, *Artificial tactile sensing in biomedical engineering*, ser. McGraw-Hill biophotonics. McGraw-Hill, 2009. [Online]. Available: <http://books.google.co.uk/books?id=RCXCA2YK9a0C>
- H. R. Nicholls and M. H. Lee, "A survey of robot tactile sensing technology," *The International Journal of Robotics Research*, vol. 8, no. 3, pp. 3–30, 1989.
- M. H. Lee, "Tactile sensing: new directions, new challenges," *The International Journal of Robotics Research*, vol. 19, no. 7, pp. 636–643, 2000.
- S. Stansfield, "Primitives, features, and exploratory procedures: Building a robot tactile perception system," in *Robotics and Automation. Proceedings. 1986 IEEE International Conference on*, vol. 3. IEEE, 1986, pp. 1274–1279.
- G. Robles-De-La-Torre, "The importance of the sense of touch in virtual and real environments," *Multimedia, IEEE*, vol. 13, no. 3, pp. 24–30, July–Sept. 2006.
- J. Cole and J. Paillard, "Living without touch and peripheral information about body position and movement: Studies with deafferented subjects," *The body and the self*, pp. 245–266, 1995.
- R. Johansson and G. Westling, "Roles of glabrous skin receptors and sensorimotor memory in automatic control of precision grip when lifting rougher or more slippery objects," *Experimental Brain Research*, vol. 56, no. 3, pp. 550–564, 1984.
- Å. B. Vallbo, R. Johansson *et al.*, "Properties of cutaneous mechanoreceptors in the human hand related to touch sensation," *Hum Neurobiol*, vol. 3, no. 1, pp. 3–14, 1984.
- R. S. Johansson and J. R. Flanagan, "Coding and use of tactile signals from the fingertips in object manipulation tasks," *Nature Reviews Neuroscience*, vol. 10, no. 5, pp. 345–359, 2009.
- J. Bossom, "Movement without proprioception," *Brain Research*, vol. 71, no. 2, pp. 285–296, 1974.

- M. Gentilucci, I. Toni, E. Daprati, and M. Gangitano, "Tactile input of the hand and the control of reaching to grasp movements," *Experimental Brain Research*, vol. 114, no. 1, pp. 130–137, 1997.
- M. E. Diamond, M. von Heimendahl, and E. Arabzadeh, "Whisker-mediated texture discrimination," *PLoS biology*, vol. 6, no. 8, p. e220, 2008.
- M. E. Diamond, M. von Heimendahl, P. M. Knutsen, D. Kleinfeld, and E. Ahissar, "'where'and'what'in the whisker sensorimotor system," *Nature Reviews Neuroscience*, vol. 9, no. 8, pp. 601–612, 2008.
- B. Mitchinson, R. A. Grant, K. Arkley, V. Rankov, I. Perkon, and T. J. Prescott, "Active vibrissal sensing in rodents and marsupials," *Philosophical Transactions of the Royal Society B: Biological Sciences*, vol. 366, no. 1581, pp. 3037–3048, 2011.
- G. Dehnhardt, B. Mauck, and H. Hyvärinen, "Ambient temperature does not affect the tactile sensitivity of mystacial vibrissae in harbour seals." *Journal of experimental biology*, vol. 201, no. 22, pp. 3023–3029, 1998.
- K. Catania, "A nose that looks like a hand and acts like an eye: the unusual mechanosensory system of the star-nosed mole," *Journal of Comparative Physiology A*, vol. 185, no. 4, pp. 367–372, 1999.
- F. G. Barth, "The vibrational sense of spiders," in *Comparative hearing: insects*. Springer, 1998, pp. 228–278.
- J. J. Gibson, "Observations on active touch." *Psychological review*, vol. 69, no. 6, p. 477, 1962.
- A. M. Smith, C. E. Chapman, F. Donati, P. Fortier-Poisson, and V. Hayward, "Perception of simulated local shapes using active and passive touch," *J Neurophysiol*, vol. 102, no. 6, pp. 3519–3529, 2009.
- G. Robles-De-La-Torre and V. Hayward, "Force can overcome object geometry in the perception of shape through active touch," *Nature*, vol. 412, no. 6845, pp. 445–448, 2001.
- C. E. Chapman, "Active versus passive touch: factors influencing the transmission of somatosensory signals to primary somatosensory cortex," *Canadian journal of physiology and pharmacology*, vol. 72, no. 5, pp. 558–570, 1994.
- S. J. Lederman, "The perception of surface roughness by active and passive touch," *Bulletin of the Psychonomic Society*, vol. 18, no. 5, pp. 253–255, 1981.
- S. Weinstein, "Intensive and extensive aspects of tactile sensitivity as a function of body part, sex and laterality," in *the First Int'l symp. on the Skin Senses, 1968*, 1968.

- J. M. Loomis and C. C. Collins, "Sensitivity to shifts of a point stimulus: An instance of tactile hyperacuity," *Perception & Psychophysics*, vol. 24, no. 6, pp. 487–492, 1978.
- R. A. Grant, B. Mitchinson, C. W. Fox, and T. J. Prescott, "Active touch sensing in the rat: anticipatory and regulatory control of whisker movements during surface exploration," *Journal of neurophysiology*, vol. 101, no. 2, pp. 862–874, 2009.
- K. C. Catania, "The sense of touch in the star-nosed mole: from mechanoreceptors to the brain," *Philosophical Transactions of the Royal Society B: Biological Sciences*, vol. 366, no. 1581, pp. 3016–3025, 2011.
- P. L. Smith and R. Ratcliff, "Psychology and neurobiology of simple decisions," *Trends in neurosciences*, vol. 27, no. 3, pp. 161–168, 2004.
- M. N. Shadlen and A. L. Roskies, "The neurobiology of decision-making and responsibility: reconciling mechanism and mindedness," *Frontiers in neuroscience*, vol. 6, 2012.
- R. Bogacz, "Optimal decision-making theories: linking neurobiology with behaviour," *Trends in cognitive sciences*, vol. 11, no. 3, pp. 118–125, 2007.
- L. P. Sugrue, G. S. Corrado, and W. T. Newsome, "Choosing the greater of two goods: neural currencies for valuation and decision making," *Nature Reviews Neuroscience*, vol. 6, no. 5, pp. 363–375, 2005.
- T. D. Hanks, M. E. Mazurek, R. Kiani, E. Hopp, and M. N. Shadlen, "Elapsed decision time affects the weighting of prior probability in a perceptual decision task," *The Journal of Neuroscience*, vol. 31, no. 17, pp. 6339–6352, 2011.
- E. Garcia, M. A. Jimenez, P. G. De Santos, and M. Armada, "The evolution of robotics research," *Robotics & Automation Magazine, IEEE*, vol. 14, no. 1, pp. 90–103, 2007.
- B. Siciliano and O. Khatib, *Springer handbook of robotics*. Springer, 2008.
- R. Dahiya, G. Metta, M. Valle, and G. Sandini, "Tactile sensing – from humans to humanoids," *Robotics, IEEE Transactions on*, vol. 26, no. 1, pp. 1–20, 2010.
- T. Prescott, M. Pearson, B. Mitchinson, J. Sullivan, and A. Pipe, "Whisking with robots," *Robotics Automation Magazine, IEEE*, vol. 16, no. 3, pp. 42–50, 2009.
- B. Jayawant, "Tactile sensing in robotics," *Journal of Physics E: Scientific Instruments*, vol. 22, no. 9, p. 684, 1989.
- A. Schmitz, M. Maggiali, L. Natale, and G. Metta, "Touch sensors for humanoid hands," in *RO-MAN, 2010 IEEE*. IEEE, 2010, pp. 691–697.

- J. Tegin and J. Wikander, "Tactile sensing in intelligent robotic manipulation—a review," *Industrial Robot: An International Journal*, vol. 32, no. 1, pp. 64–70, 2005.
- A. Schmitz, P. Maiolino, M. Maggiali, L. Natale, G. Cannata, and G. Metta, "Methods and technologies for the implementation of large-scale robot tactile sensors," *Robotics, IEEE Transactions on*, vol. 27, no. 3, pp. 389–400, 2011.
- P. Maiolino, G. Cannata, A. Ascia, M. Maggiali, L. Natale, and G. Metta, "Large scale capacitive skin for robots," *Smart actu. sens. sys.-Recent advances and future challenges. InTech, Ed. Berselli, G. R. Vertechy, G. Vassura, ISBN*, pp. 979–953, 2012.
- J. S. Son, R. D. Howe, J. Wang, and G. D. Hager, "Preliminary results on grasping with vision and touch," in *Intelligent Robots and Systems' 96, IROS 96, Proceedings of the 1996 IEEE/RSJ International Conference on*, vol. 3. IEEE, 1996, pp. 1068–1075.
- A. Schneider, J. Sturm, C. Stachniss, M. Reisert, H. Burkhardt, and W. Burgard, "Object identification with tactile sensors using bag-of-features," in *Intelligent Robots and Systems, 2009. IROS 2009. IEEE/RSJ International Conference on*. IEEE, 2009, pp. 243–248.
- J. Salisbury Jr, "Interpretation of contact geometries from force measurements," in *Robotics and Automation. Proceedings. 1984 IEEE International Conference on*, vol. 1. IEEE, 1984, pp. 240–247.
- H. Dang, J. Weisz, and P. K. Allen, "Blind grasping: Stable robotic grasping using tactile feedback and hand kinematics," in *Robotics and Automation (ICRA), 2011 IEEE International Conference on*. IEEE, 2011, pp. 5917–5922.
- N. N. Chen, H. Zhang, and R. E. Rink, "Edge tracking using tactile servo," in *IEEE/RSJ International Conference on Intelligent Robots and Systems*, vol. 2. IEEE Comput. Soc. Press, 1995, pp. 84–89.
- H. Zhang and N. N. Chen, "Control of contact via tactile sensing," *Robotics and Automation, IEEE Transactions on*, vol. 16, no. 5, pp. 482–495, 2000.
- M. C. Carrozza, P. Dario, F. Vecchi, S. Roccella, M. Zecca, and F. Sebastiani, "The cyberhand: on the design of a cybernetic prosthetic hand intended to be interfaced to the peripheral nervous system," in *Intelligent Robots and Systems, 2003. (IROS 2003). Proceedings. 2003 IEEE/RSJ International Conference on*, vol. 3. IEEE, 2003, pp. 2642–2647.
- L. Zollo, S. Roccella, E. Guglielmelli, M. C. Carrozza, and P. Dario, "Biomechatronic design and control of an anthropomorphic artificial hand for prosthetic and robotic applications," *Mechatronics, IEEE/ASME Transactions on*, vol. 12, no. 4, pp. 418–429, 2007.

- R. D. Howe and M. R. Cutkosky, "Dynamic tactile sensing: Perception of fine surface features with stress rate sensing," *Robotics and Automation, IEEE Transactions on*, vol. 9, no. 2, pp. 140–151, 1993.
- P. Puangmali, K. Althoefer, L. D. Seneviratne, D. Murphy, and P. Dasgupta, "State-of-the-art in force and tactile sensing for minimally invasive surgery," *Sensors Journal, IEEE*, vol. 8, no. 4, pp. 371–381, 2008.
- K. Hosoda, Y. Tada, and M. Asada, "Anthropomorphic robotic soft fingertip with randomly distributed receptors," *Robotics and Autonomous Systems*, vol. 54, no. 2, pp. 104–109, 2006.
- S. Takamuku, G. Gomez, K. Hosoda, and R. Pfeifer, "Haptic discrimination of material properties by a robotic hand," in *Development and Learning, 2007. ICDL 2007. IEEE 6th International Conference on*, July 2007, pp. 1–6.
- H. Yousef, M. Boukallel, and K. Althoefer, "Tactile sensing for dexterous in-hand manipulation in robotics—a review," *Sensors and Actuators A: physical*, vol. 167, no. 2, pp. 171–187, 2011.
- K. Hsiao, P. Nangeroni, M. Huber, A. Saxena, and A. Y. Ng, "Reactive grasping using optical proximity sensors," in *Robotics and Automation, 2009. ICRA '09. IEEE International Conference on*. IEEE, 2009, pp. 2098–2105.
- Y. Yamada, T. Morizono, Y. Umetani, and H. Takahashi, "Highly soft viscoelastic robot skin with a contact object-location-sensing capability," *Industrial Electronics, IEEE Transactions on*, vol. 52, no. 4, pp. 960–968, 2005.
- S. Begej, "Planar and finger-shaped optical tactile sensors for robotic applications," *Robotics and Automation, IEEE Journal of*, vol. 4, no. 5, pp. 472–484, 1988.
- J. G. Webster, *Tactile sensors for robotics and medicine*. John Wiley & Sons, Inc., 1988.
- B. Edin, L. Beccai, L. Ascari, S. Roccella, J.-J. Cabibihan, and M. C. Carrozza, "Bio-inspired approach for the design and characterization of a tactile sensory system for a cybernetic prosthetic hand," in *Robotics and Automation, 2006. ICRA 2006. Proceedings 2006 IEEE International Conference on*. IEEE, 2006, pp. 1354–1358.
- R. Tajima, S. Kagami, M. Inaba, and H. Inoue, "Development of soft and distributed tactile sensors and the application to a humanoid robot," *Advanced Robotics*, vol. 16, no. 4, pp. 381–397, 2002.
- M. J. Pearson, A. G. Pipe, C. Melhuish, B. Mitchinson, and T. J. Prescott, "Whiskerbot: a robotic active touch system modeled on the rat whisker sensory system," *Adaptive Behavior*, vol. 15, no. 3, pp. 223–240, 2007.

- J. Sullivan, B. Mitchinson, M. J. Pearson, M. Evans, N. F. Lepora, C. W. Fox, C. Melhuish, and T. J. Prescott, "Tactile discrimination using active whisker sensors," *Sensors Journal, IEEE*, vol. 12, no. 2, pp. 350–362, 2012.
- M. Lungarella, V. V. Hafner, R. Pfeifer, and H. Yokoi, "An artificial whisker sensor for robotics," in *Intelligent Robots and Systems, 2002. IEEE/RSJ International Conference on*, vol. 3. IEEE, 2002, pp. 2931–2936.
- M. Fend, S. Bovet, and V. V. Hafner, "The artificial mouse - a robot with whiskers and vision," *Signal [V]*, vol. 5, no. 6, 2005.
- M. Kaneko, "Active antenna," in *Robotics and Automation, 1994. Proceedings., 1994 IEEE International Conference on*. IEEE, 1994, pp. 2665–2671.
- N. Ueno and M. Kaneko, "Dynamic active antenna-a principle of dynamic sensing," in *Robotics and Automation, 1994. Proceedings., 1994 IEEE International Conference on*. IEEE, 1994, pp. 1784–1790.
- M. Kaneko, N. Kanayama, and T. Tsuji, "Active antenna for contact sensing," *Robotics and Automation, IEEE Transactions on*, vol. 14, no. 2, pp. 278–291, 1998.
- H. Beem, M. Hildner, and M. Triantafyllou, "Calibration and validation of a harbor seal whisker-inspired flow sensor," *Smart Materials and Structures*, vol. 22, no. 1, p. 014012, 2013.
- W. Eberhardt, Y. Shakhsher, B. Calhoun, J. Paulus, and M. Appleby, "A bio-inspired artificial whisker for fluid motion sensing with increased sensitivity and reliability," in *Sensors, 2011 IEEE*. IEEE, 2011, pp. 982–985.
- R. Bajcsy, S. Lederman, and R. Klatzky, "Object exploration in one and two fingered robots." no. 3. Computer Society Press, 1987, pp. 1806–1810.
- A. Berger and P. Khoslar, "Edge detection for tactile sensing," in *In Proc. NASA conf. on space telerobotics*, 1989, pp. 163–172.
- T. Phung, Y. Ihn, J. Koo, and H. Choi, "Edge identification of a small object through a low-resolution tactile sensor array," *International Journal of Precision Engineering and Manufacturing*, vol. 11, pp. 247–254, 2010, 10.1007/s12541-010-0028-x. [Online]. Available: <http://dx.doi.org/10.1007/s12541-010-0028-x>
- S. C. Abdullah, T. Ikai, Y. Dosho, H. B. Yussof, and M. Ohka, "Edge extraction using image and three-axis tactile data." *International Journal on Smart Sensing & Intelligent Systems*, vol. 4, no. 3, 2011.
- K. Suwanratchatamane, R. Saegusa, M. Matsumoto, and S. Hashimoto, "A simple tactile sensor system for robot manipulator and object edge shape recognition," in *Industrial Electronics Society, 2007. IECON 2007. 33rd Annual Conference of the IEEE*, nov. 2007, pp. 245–250.



- M. Johnsson and C. Balkenius, “Neural network models of haptic shape perception,” *Robotics and Autonomous Systems*, vol. 55, no. 9, pp. 720–727, 2007.
- A. Bierbaum, M. Rambow, T. Asfour, and R. Dillmann, “A potential field approach to dexterous tactile exploration of unknown objects,” in *Humanoid Robots, 2008. Humanoids 2008. 8th IEEE-RAS International Conference on*, Dec. 2008, pp. 360–366.
- S. Ratnasingam and T. McGinnity, “Object recognition based on tactile form perception,” in *Robotic Intelligence In Informationally Structured Space (RI-SS), 2011 IEEE Workshop on*, April 2011, pp. 26–31.
- N. Gorges, S. E. Navarro, D. Goger, and H. Worn, “Haptic object recognition using passive joints and haptic key features,” in *Robotics and Automation (ICRA), 2010 IEEE International Conference on*. IEEE, 2010, pp. 2349–2355.
- H. Soh, Y. Su, and Y. Demiris, “Online spatio-temporal gaussian process experts with application to tactile classification,” in *Intelligent Robots and Systems (IROS), 2012 IEEE/RSJ International Conference on*. IEEE, 2012, pp. 4489–4496.
- N. Jamali and C. Sammut, “Majority voting: Material classification by tactile sensing using surface texture,” *IEEE Transactions on Robotics*, vol. 27, no. 3, pp. 508–521, 2011.
- , “Material classification by tactile sensing using surface textures,” in *Robotics and Automation (ICRA), 2010 IEEE International Conference on*. IEEE, 2010, pp. 2336–2341.
- A. Drimus, M. B. Petersen, and A. Bilberg, “Object texture recognition by dynamic tactile sensing using active exploration,” in *RO-MAN, 2012 IEEE*. IEEE, 2012, pp. 277–283.
- N. Lepora, M. Evans, C. Fox, M. Diamond, K. Gurney, and T. Prescott, “Naive Bayes texture classification applied to whisker data from a moving robot,” *Neural Networks (IJCNN), The 2010 International Joint Conference on*, pp. 1–8, 2010.
- N. Lepora, M. Pearson, B. Mitchinson, M. Evans, C. Fox, A. Pipe, K. Gurney, and T. Prescott, “Naive Bayes novelty detection for a moving robot with whiskers,” in *Robotics and Biomimetics (ROBIO), 2010 IEEE International Conference on*, Dec. 2010, pp. 131–136.
- C. W. Fox, B. Mitchinson, M. J. Pearson, A. G. Pipe, and T. J. Prescott, “Contact type dependency of texture classification in a whiskered mobile robot,” *Autonomous Robots*, vol. 26, no. 4, pp. 223–239, 2009.

- P. Giguere and G. Dudek, "A simple tactile probe for surface identification by mobile robots," *Robotics, IEEE Transactions on*, vol. 27, no. 3, pp. 534–544, 2011.
- S. Thrun, W. Burgard, and D. Fox, *Probabilistic robotics*. MIT press, 2005.
- H. H. Bulthoff, "Bayesian decision theory and psychophysics," *Perception as Bayesian inference*, p. 123, 1996.
- D. M. Wolpert and J. R. Flanagan, "Motor prediction," *Current Biology*, vol. 11, no. 18, pp. R729–R732, 2001.
- N. Lepora, M. Evans, C. Fox, M. Diamond, K. Gurney, and T. Prescott, "Naive Bayes texture classification applied to whisker data from a moving robot," in *Neural Networks (IJCNN), The 2010 International Joint Conference on*, July 2010, pp. 1–8.
- S. Martinez-Conde, S. L. Macknik, and D. H. Hubel, "The role of fixational eye movements in visual perception," *Nature Reviews Neuroscience*, vol. 5, no. 3, pp. 229–240, 2004.
- J. Najemnik and W. S. Geisler, "Optimal eye movement strategies in visual search," *Nature*, vol. 434, no. 7031, pp. 387–391, 2005.
- G. Mather, *Foundations of perception*. Taylor & Francis, 2006.
- H. Saal, J.-A. Ting, and S. Vijayakumar, "Active sequential learning with tactile feedback," 2010.
- P. Dario and M. Bergamasco, "An advanced robot system for automated diagnostic tasks through palpation," *Biomedical Engineering, IEEE Transactions on*, vol. 35, no. 2, pp. 118–126, 1988.
- G. Metta, P. Fitzpatrick, and L. Natale, "Yarp: Yet another robot platform," *International Journal on Advanced Robotics Systems*, vol. 3, no. 1, pp. 43–48, 2006.
- D. J. MacKay, *Information theory, inference and learning algorithms*. Cambridge university press, 2003.
- A. Wald, *Sequential analysis*. Courier Corporation, 1973.
- T. Phung, Y. Ihn, J. Koo, and H. Choi, "An enhanced edge tracking method using a low resolution tactile sensor," *International Journal of Control, Automation and Systems*, vol. 8, pp. 462–467, 2010.
- K. Overvliet, J. B. Smeets, and E. Brenner, "The use of proprioception and tactile information in haptic search," *Acta psychologica*, vol. 129, no. 1, pp. 83–90, 2008.

- J. Voisin, G. Benoit, and C. Chapman, “Haptic discrimination of object shape in humans: two-dimensional angle discrimination,” *Experimental Brain Research*, vol. 145, pp. 239–250, 2002. [Online]. Available: <http://dx.doi.org/10.1007/s00221-002-1117-6>
- M. Levy, S. Bourgeon, and C. E. Chapman, “Haptic discrimination of two-dimensional angles: influence of exploratory strategy,” *Experimental Brain Research*, vol. 178, no. 2, pp. 240–251, 2007.
- F. Alary, R. Goldstein, M. Duquette, C. E. Chapman, P. Voss, and F. Lepore, “Tactile acuity in the blind: a psychophysical study using a two-dimensional angle discrimination task,” *Experimental Brain Research*, vol. 187, no. 4, pp. 587–594, 2008.
- R. Shadmehr, M. A. Smith, and J. W. Krakauer, “Error correction, sensory prediction, and adaptation in motor control,” *Annual review of neuroscience*, vol. 33, pp. 89–108, 2010.
- D. M. Green, J. A. Swets *et al.*, *Signal detection theory and psychophysics*. Wiley New York, 1966, vol. 1974.
- K. A. Hansen, S. F. Hillenbrand, and L. G. Ungerleider, “Effects of prior knowledge on decisions made under perceptual vs. categorical uncertainty,” *Frontiers in neuroscience*, vol. 6, 2012.
- A. Dearden and Y. Demiris, “Active learning of probabilistic forward models in visuo-motor developmen,” in *Proceedings of the AISB*, 2006, pp. 176–183.
- D. Y. Little and F. T. Sommer, “Learning in embodied action-perception loops through exploration,” *arXiv preprint arXiv:1112.1125*, 2011.
- H. C. Cho, M. S. Fadali, and K. S. Lee, “Online probability density estimation of nonstationary random signal using dynamic bayesian networks,” *International Journal of Control Automation and Systems*, vol. 6, no. 1, p. 109, 2008.
- J. Gao and C. J. Harris, “Some remarks on kalman filters for the multisensor fusion,” *Information Fusion*, vol. 3, no. 3, pp. 191–201, 2002.