

"ACCOUNTANTS-ELECTRONIC DATA PROCESSING AND MANAGEMENT  
SCIENCE/OPERATIONAL RESEARCH SPECIALISTS' RELATIONSHIPS:  
AN EMPIRICAL INVESTIGATION WITH SPECIAL REFERENCE TO  
BRITISH INDUSTRY"

Ph.D. Thesis Summary

Anas El-Sayed El-Sayed NOOR

July, 1975.

Accounting and Financial Management  
(Division of Economic Studies),  
The University of Sheffield.

ACCOUNTANTS-ELECTRONIC DATA PROCESSING AND MANAGEMENT  
SCIENCE/OPERATIONAL RESEARCH SPECIALISTS' RELATIONSHIPS:  
AN EMPIRICAL INVESTIGATION WITH SPECIAL REFERENCE TO  
BRITISH INDUSTRY

---

This research project was inspired by the researcher's perception of the discrepancy between earlier expectations and the present state of the art with regard to the scope, quality, and features of the collaborative efforts of accountants on the one hand, and Electronic Data Processing (EDP) and Management Science/Operational Research (MS/OR) specialists on the other. Such collaborative efforts are the basis for building decision making and problem solving support systems for their managements. Many unsupported assertions have been made about accountants' actual use of MS/OR models and approaches in their field of specialisation, and about the effects of computers on accountants and accounting, and this research project provided an opportunity for exploring and validating these assertions.

Based on the findings of the study it is concluded that, among other things, accountants' interaction with their EDP and MS/OR counterparts is based on limited and insufficient mutual understanding. Accountants' use and application of model-building approaches and computer-based systems have been very narrowly restricted to the structured, deterministic, and functionally constrained types of activities. Amongst the central causes that impede the desired level of greater mutual understanding are (1) the lack of necessary background orientation (of the three specialist groups - EDP, MS/OR, and accounting) of each other's basic practices and principles and the wider implications of their respective systems, (2) the insufficient appreciation of the wider implications of the synergistic effects of their interdisciplinary contributions, and (3) the apparent incompatibilities amongst respective functional procedures, conventions, practices, and time horizons. Finally, directions for further research have been outlined.



"ACCOUNTANTS-ELECTRONIC DATA PROCESSING AND MANAGEMENT  
SCIENCE/OPERATIONAL RESEARCH SPECIALISTS' RELATIONSHIPS:  
AN EMPIRICAL INVESTIGATION WITH SPECIAL REFERENCE TO  
BRITISH INDUSTRY"

by

Anas EI-Sayed El-Sayed NOOR

A thesis submitted to the  
University of Sheffield  
for the degree of  
Doctor of Philosophy

July 1975

Accounting and Financial Management  
Division of Economic Studies

# Volume One

## Acknowledgements

I wish to warmly thank the organizations participating in the empirical part of this study, particularly their managements for kindly granting me the opportunity to pursue the research. I am especially grateful to all individuals who participated in the study, for their enthusiastic co-operation, time and consideration. Without their help, this study would have been very difficult to carry out.

I gratefully acknowledge the guidance, help, encouragement, and constructive criticism of Professor E.A. Lowe, Professor of Accounting and Financial Management (Division of Economic Studies). His excellent supervision has greatly helped me develop my ideas, during the various stages of carrying out this research project.

I am particularly grateful to: Mr. R.M.S. Wilson (Division of Economic Studies) for reading most of the thesis and providing many valuable suggestions; Mr. A.M. Tinker (Division of Economic Studies) for providing stimulating and encouraging comments on several parts of this study; Mr. S. Fineman (the M.R.C. Social and Applied Psychology Unit) for constructively criticising chapter eight and providing helpful comments on the overall design of the empirical research; and Mr. R.C. Laughlin (Division of Economic Studies) for encouragement and help throughout.

I would like to thank the Council of the Operational Research Society for providing information for the purposes of this research. I am also grateful to the following organizations for their interest and co-operation: the Institute of Cost and Management Accountants, the Institute of Chartered Accountants in England and Wales, and the British Computer Society.

The University of Sheffield Computing Services Department has been of great assistance to me in the data processing. I am grateful to all the staff, particularly Dr. S. Wardle and Mr. R.K. Richards. Without the computing resources that I have used, the data processing of this research would have been extremely difficult, if not impossible.

I would like to express my thanks and appreciation to Mrs. Hazel Bland who has been very helpful in typing earlier draft questionnaires, interview tables and so much correspondence.

The Sheffield University inter-library loans service has been most helpful to me. I am particularly grateful to Miss R. Wells for her valuable assistance.

I am grateful to all the people who have been involved in the typing of this work. In particular, I am indebted to Mrs. Pat Hobson, Mrs. Irene Ashton, Mrs. Jean Horton, and Mrs. Mary Marsden.



The support of the Egyptian Government is acknowledged and very much appreciated. Without their grant this study would not have been possible.

Last, but by no means least, my deepest debt of gratitude goes to my wife, Wegdan, and my daughter, Dahlia, who have suffered throughout the various stages of carrying out this research project.

I am, of course, fully responsible for any omissions or errors there may be in this work.

July, 1975.

Anas E. E. Noor.

To my daughter,  
Dahlia,  
and my wife,  
Wegdan.

## PREFACE

For the last three decades there have been continuous developments in the application and use of new approaches that are designed to assist in the solution of complex business problems. It seems to be the case, however, that technological advances in information technology and management sciences have not been matched by parallel advances in our understanding of the behavioural aspects of these new techniques. This is partly due to the complexity of human and social systems.

This research project was inspired by the researcher's perception of the discrepancy between earlier expectations and the state of present achievements with regard to the collaborative efforts of accountants on the one hand and Electronic Data Processing (E.D.P.) and Management Science/Operational Research (MS/OR) specialists on the other. Such collaborative efforts are the basis for building decision making and problem solving support for their managements. The objective is to explore and explain the nature of the gap in existing knowledge with regard to the constructive relationships between Accountants and E.D.P. specialists on the one hand, and between Accountants and MS/OR specialists on the other.

The goal of the present research is to gain insights into Accountants - EDP and MS/OR specialists' understanding as a multi-dimensional space. In view of the multidimensionality characteristics contained in this concept, it seems necessary to limit the scope of the study, and accordingly to subject this area of research to the multi-variate analysis of interdependence.

Guided by a literature-based survey of the conceptual dimensions outlining the interaction, an empirical search and identification of the behavioural indicators affecting the multidimensional space under study, are conducted. This is followed by an analysis of the inter-



dependence of both the space of Accountants - EDP specialists' understanding and the space of Accountants - MS/OR specialists' understanding. In these analyses of interdependence, the researcher not only relied on the statistical and mathematical techniques of multivariate analysis but also supported his arguments by 'rich' descriptive evidence.

This thesis is divided into two volumes. The first volume contains the text detailing its objectives, methodological approaches adopted, and the analysis and synthesis of the findings of the various dimensions of Accountants - EDP and MS/OR specialists' Interaction. The second volume contains the appendices to the first one.

The design of volume one follows a sequential process in which the logical and historical development of the study have taken place. The researcher began the study with an extensive literature survey. This provides the basis for conceptualizing the problem. Furthermore, it is the foundation whereupon justifications and objectives of the present study can be located. Part II of this volume was designed to empirically explore some of the factual and attitudinal aspects of communication and working relationships between accountants, EDP and MS/OR specialists. The methodology adopted in carrying out this phase was the mailed-questionnaire approach to samples of accountants, EDP and MS/OR specialists working in business organisations within the top third of British Industry (as ranked by the Times 1000). Also, the researcher interviewed a number of management consultants for their related experiences.

Part III of this study involves two main steps. The first step is to conduct detailed analyses of a small number of case studies which focus on the working relationships under consideration. The second step is to gain more observations on a wider basis. This is done by again approaching those respondents who took part in the first empirical phase together with those interviewees from the detailed-case-study analysis.

Part IV contains a synthesis of the essential elements and conclusions of this research project. It provides what the researcher considers to be the main findings of the study with regard to both Accountants - DP specialists' interaction and Accountants - MS/OR specialists' interaction.

The appendices are placed in a separate volume in order to provide supportive evidence for the analysis in the first volume. Furthermore, they provide an accurate account of the various dimensions of the empirical study. Such information is detached from the main arguments in volume one in order to provide a sharper focus.

VOLUME ONE

	Page
ACKNOWLEDGMENTS	
PREFACE	
<u>PART I</u>	
Chapter One	BACKGROUND TO THE STUDY. 1
	INTRODUCTION. 2
	1.1. Nature and purpose of the study. 3
	1.2. Definitions adopted. 23
	1.3. Steps of carrying out the present Investigation. 27
Chapter Two	ACCOUNTANTS - EDP AND MS/OR SPECIALISTS' INTERACTION : A LITERATURE-BASED SURVEY. 32
	2.1. Description of Accountants - EDP specialists' Interaction : A Literature-based survey. 34
	2.2. Description of Accountants - MS/OR specialists' Interaction : A Literature-based survey. 37
	2.3. Identification of conceptual dimensions of Accountants - EDP and MS/OR specialists' Interaction : A Proposed Framework of Interdependence. 46
Summary to PART I	80
<u>PART II</u>	
Chapter Three	AN EXTENSIVE EMPIRICAL SEARCH INTO ACCOUNTANTS - EDP AND MS/OR SPECIALISTS' INTERACTION: OPERATIONAL IDENTIFICATION OF THE PROPOSED FRAMEWORK OF INTERDEPENDENCE. 83
	DESIGN OF THE EMPIRICAL RESEARCH. 84
	3.1. Introduction. 85
	3.2. Necessity for "empiricism". 85
	3.3. Design considerations. 86
	3.4. Methodological strategies of data collection. 89



		Page
	3.5. Measurement: analysis of interdependence.	96
	3.6. Data processing.	97
	3.7. Analysis and interpretation.	98
Chapter Four	AN ANALYSIS OF OPINIONS AND VIEWS OF EDP SPECIALISTS REGARDING THEIR WORKING RELATIONSHIPS WITH ACCOUNTANTS.	101
	4.1. Background information.	104
	4.2. D.P. specialists with neither accounting qualification nor accounting experience.	114
	4.3. D.P. specialists with accounting qualification and/or experience.	119
	4.4. Accountants' involvement in EDP.	121
	4.5. Computerization of accounting activities.	124
	4.6. EDP - Accounting future relationships.	126
Chapter Five	AN ANALYSIS OF OPINIONS AND VIEWS OF MS/OR SPECIALISTS REGARDING THEIR WORKING RELATIONSHIPS WITH ACCOUNTANTS.	137
	5.1. Background information.	140
	5.2. General impression regarding accountants and accounting functions.	151
	5.3. Working relationship with accountants.	173
	5.4. MS/OR concepts and methodology used in dealing with accounting problems.	181
	5.5. Reputation of MS/OR groups.	185
	5.6. MS/OR - Accounting future relationships.	188
Chapter Six	AN ANALYSIS OF OPINIONS AND VIEWS OF 'SOME' ACCOUNTANTS REGARDING THEIR WORKING RELATIONSHIPS WITH MS/OR AND D.P. SPECIALISTS.	202
	6.1. Background information.	205
	6.2. Accountants' involvement in MS/OR.	210
	6.3. Accountants' involvement in EDP	222

	Page
6.4. The proposed framework of interdependence: The accountants - EDP specialists' <u>a priori</u> behavioural indicators.	234
6.5. The proposed framework of interdependence: The accountants - MS/OR specialists' <u>a priori</u> behavioural indicators.	239
<u>PART III</u>	
A CLOSER LOOK INTO ACCOUNTANTS - EDP AND MS/OR SPECIALISTS' INTERACTION : AN ORGANISATIONAL DIAGNOSIS AND AN ANALYSIS OF INTERDEPENDENCE.	248
Chapter Seven AN ORGANISATIONAL DIAGNOSIS OF ACCOUNTANTS - EDP AND MS/OR SPECIALISTS' INTERACTION.	249
7.1. Introduction.	252
7.2. Organisational background information.	253
7.3. Features of accountants - EDP and MS/OR specialists' interaction.	267
7.4. Present and Potential Accountants - EDP and MS/OR specialists' interaction: diagnosis and speculation.	314
7.5. Implications for the organisational effectiveness of accountants - EDP and MS/OR specialists' interaction: A qualitative assessment.	331
Chapter Eight ACCOUNTANTS - D.P. SPECIALISTS' INTERACTION: THE ANALYSIS OF INTERDEPENDENCE.	345
8.1. An investigation into the factors influencing accountants - D.P. specialists' interaction.	347
8.2. Further analysis of the empirical evidence.	383
Chapter Nine ACCOUNTANTS - MS/OR SPECIALISTS' INTERACTION: THE ANALYSIS OF INTERDEPENDENCE.	424
9.1. An investigation into the factors influencing accountants - MS/OR specialists' interaction.	426
9.2. Further analysis of the empirical evidence.	452

	Page
<u>PART IV</u>	512
CONCLUSIONS.	
Chapter Ten	513
SUMMARY OF FINDINGS AND DIRECTIONS FOR FURTHER RESEARCH.	
10.1. An overview.	514
10.2. Findings in relation to Accounting - EDP interaction.	518
10.3. Findings in relation to Accounting- MS/OR interaction. .	526
10.4. Implications for the future education of accounting, EDP, and MS/OR spec- ialists.	538
10.5. Directions for further research.	545
Bibliography	549

VOLUME TWO

INDEX TO APPENDICES

<u>APPENDIX</u>	Appendix to Part II : An extensive empirical search into Accountants - D.P. and MS/OR specialists' interaction.
A	
B	Appendix to Part III : A closer look into Accountants - D.P. and MS/OR specialists' interaction.



## Part I

### BACKGROUND TO THE STUDY

This part is aimed at introducing the study. The organizational problem of accountants' working relationships with EDP and MS/OR specialists is conceptually analysed on the basis of a critical examination of the relevant literature. A framework of analysis of interdependence is proposed.

This part consists of the following two chapters:

Chapter One : is devoted to discussing the nature, objectives, and methods of carrying out the study.

Chapter Two : is a literature-based survey of the conceptual dimensions of accountants - EDP and MS/OR specialists' interaction. It suggests a framework of interdependence to analyse this multivariate area of organizational interaction.

Chapter One

Introduction

1.1. Nature and purpose of the study.

1.1.1. Introduction.

1.1.2. Problem identification

a. in general

b. with special reference to U.K.

1.1.3. An analysis of the problem under study and assessment of the likely contribution of the research.

1.1.4. Basic assumptions.

1.2. Definitions adopted.

1.2.1. Nature of language involved.

1.2.2. Definitions adopted.

1.3. Processes or stages of looking into the problem.

Summary

1.1. Problem definition : need and purpose of the study.

Traditionally, accountants in business organizations have assumed a key position in contributing to directing and monitoring the organizational pulse of financial transactions. Developments of electronic data processing and management science/operational research are amongst the noteworthy forward-looking advances of the fifties and the sixties. Accordingly, an understanding of the factors affecting the quality of the accountant's contribution to management in problem-solving and decision-making represents a real need for those who are concerned with narrowing the gap between theory and practice regarding organizational effectiveness of decision support and control systems in business enterprises.

To look into the problem outlined above the researcher has been concentrating on studying: patterns of communication and processes of accountants' interactions with E.D.P. and MS/OR specialists<sup>1</sup> in business organizations; problem areas involved in this type of organizational processes; and the main factors contributing towards understanding between accountants and E.D.P. and MS/OR specialists.

The objective of this analysis is to explain how the quality of the accountant's contribution towards management problem solving and decision making may be improved by furthering our knowledge about barriers to, and problems associated with, communication between accountants, EDP and MS/OR specialists. In particular, this research is concerned with studying accounting, EDP and MS/OR functions and groups; their attributes and their relationships with corresponding levels of management for the implications for organizational effectiveness.

---

1. Generic terms are used as necessary to denote titles such as: MS/OR specialists, EDP specialists, Finance Director, Chief Accountant, and so on. This is adopted to facilitate interpersonal, intergroup, inter-organization, and intra-organizational comparisons.



Employing the "systems" approach to the examination of a hypothetical managerial enterprise, Figure 1.1. defines the elements and the interaction between those elements, of which decision and control subsystem is a major element. Figure 1.1. outlines broadly the main area of concern to the present research in an organizational context.

This focus on the interrelatedness of these functional specialities is based on the following reasons:

- exploring how each of these functional groups (accounting, EDP., and MS/OR) relates its speciality to the remainder of the organization. In this respect it has not been expected that each specialist would define his role in an exact manner.
- many of the problems facing today's managements are increasingly of the ill-structured, non-programmed, open-type situations that need interdisciplinary collaboration of the related sub-systems.
- efforts to narrow the gap between 'what should be' and 'what is', and between the (conceptually sound) theory and the (thought to be dogmatic and incomplete) practice should be preceded by gathering information in order to analyse the nature, scope and implications of the gap itself.

Basically, the thesis upon which this research is carried out is that improved decision-making and problem-solving can contribute towards achieving <sup>greater</sup> organizational effectiveness. Furthermore, the designing and maintenance of an appropriate management control system<sup>2</sup> fulfilling communication, evaluation,

2. "A management control system might be briefly defined as a system of organizational information seeking and gathering, accountability and feedback designed to ensure that the enterprise adapts to changes in its substantial environment and that the work behaviour of its employees is measured by reference to a set of operational sub-goals (which conform with overall objectives) so that the discrepancy between the two can be reconciled and corrected for.

Decision-making is the basic concept in a modern approach to the study and analysis of an organization and the idea of a 'decision' provides a possible basis for a control system design. Organizational theorists see the enterprise as a bounded collection of information and decision centres (with information links between them) acting upon a derived set of decision rules. Almost invariably each centre is neither purely an information-processor or decision-maker but partly one and partly the other" (Lowe, 1971, p.5). Also, Lowe and McInnes (1971) outline a general conception for an enterprise-environmental relationship as a first necessary step in constructing effective management control systems. The reader is referred to such conceptualization which is basic to the above discussion.



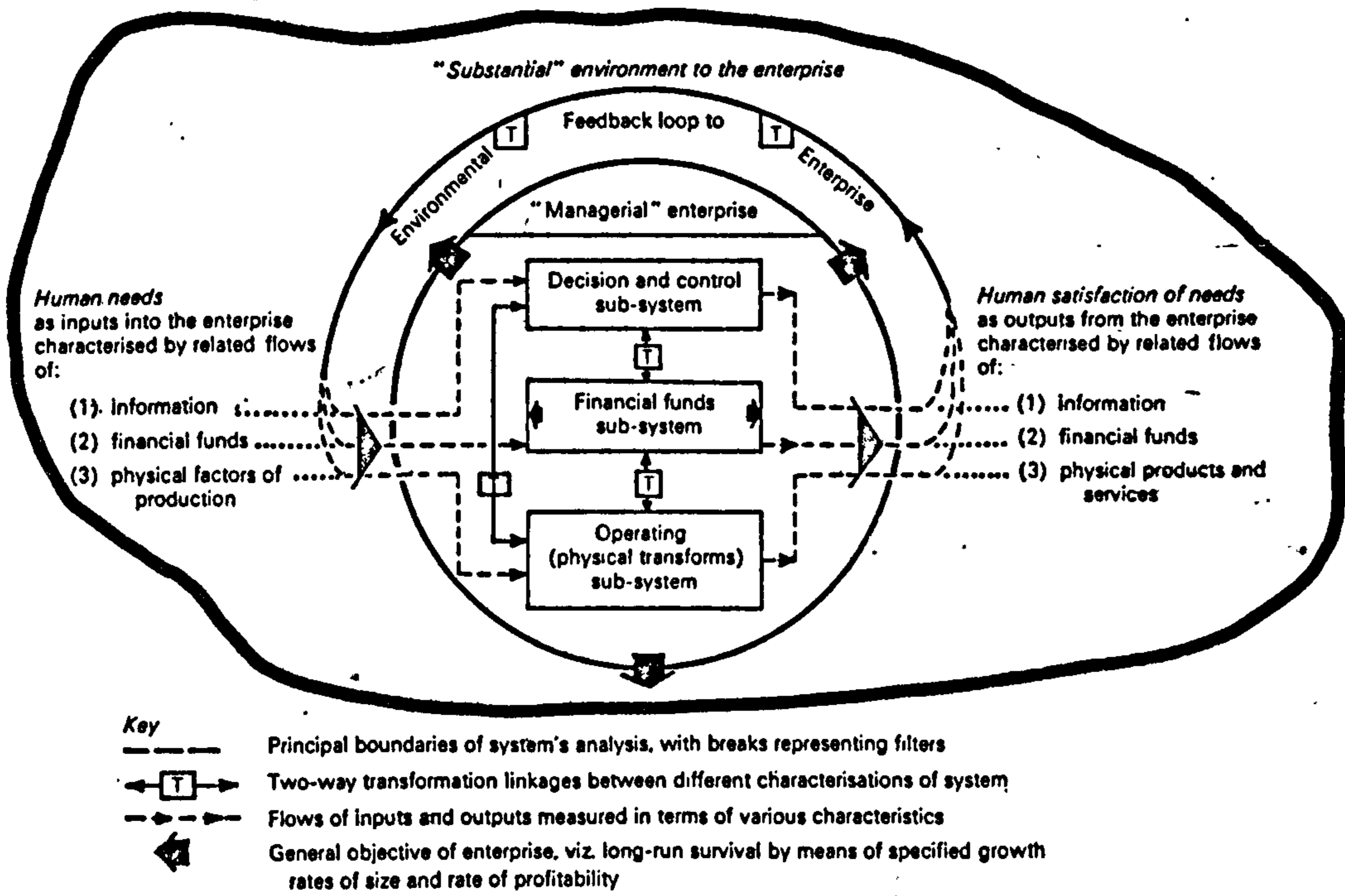

*Figure 1.1 The business enterprise as a financial-economic system portrayed in terms of decision and control, funds flows and operations*

(Source: Lowe, 1972, p.61)

and motivation objectives, is an important ingredient in relation to contributing towards the desired goals of the organization. On the other hand, the attainment of such effectiveness is not expected to take place without the joint effort of varied disciplines and various groups often having different, and conflicting interests.

Highly relevant to the sphere of management information-for-control systems are the three functions that form the focus of this research, namely, accounting, EDP, and MS/OR; each of which has a contribution to make (see figure 1.2. below). Each of these functional contributions is ideally built on collaborative effort, based on mutual understanding, of the interacting groups contained in these types of organizational relationships, since it is only in this manner that an effective decision making system can be evolved. Accordingly, studying the communication patterns and working relationships between the three groups (accountants, EDP, and MS/OR specialists) may help in exploring the effectiveness of support<sup>3</sup> information as a key ingredient in the decision-making process. In other words, the present research has concentrated on studying working relationships between accountants on the one hand, and EDP and MS/OR specialists on the other, as a vehicle for explaining possible ways of contributing towards improved decision-making for the achievement of organizational effectiveness.

The interrelatedness of the three functional groups (accountants, EDP and MS/OR<sup>4</sup> specialists) is real and necessary for the effective design and maintenance of any decision and information system for planning and control

3. The study has adopted the idea of considering each of the three main functions involved in the interaction process accounting, EDP and MS/OR as a 'decision support sub-system'. This is based on the fact that each of these functional groups supports management and the corresponding decision system with some type of services that might be useful in carrying out their managerial responsibilities.
4. The horizontal relationships between EDP and MS/OR specialists have not been studied as such in the context of the present research. They have been subjected to the analysis only in so far as they affect the central issues of this research (i.e. accountants' communication patterns and working relationships with EDP and MS/OR specialists as a basis for an effective decision, and information system for planning and control).



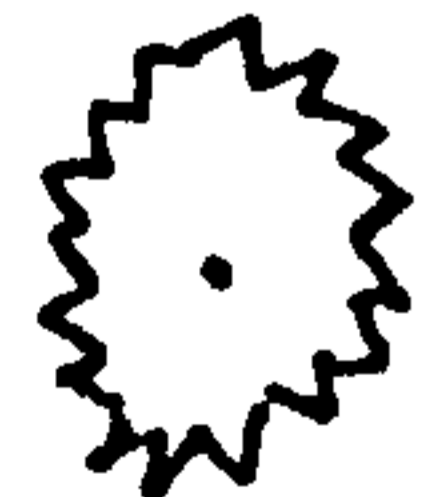
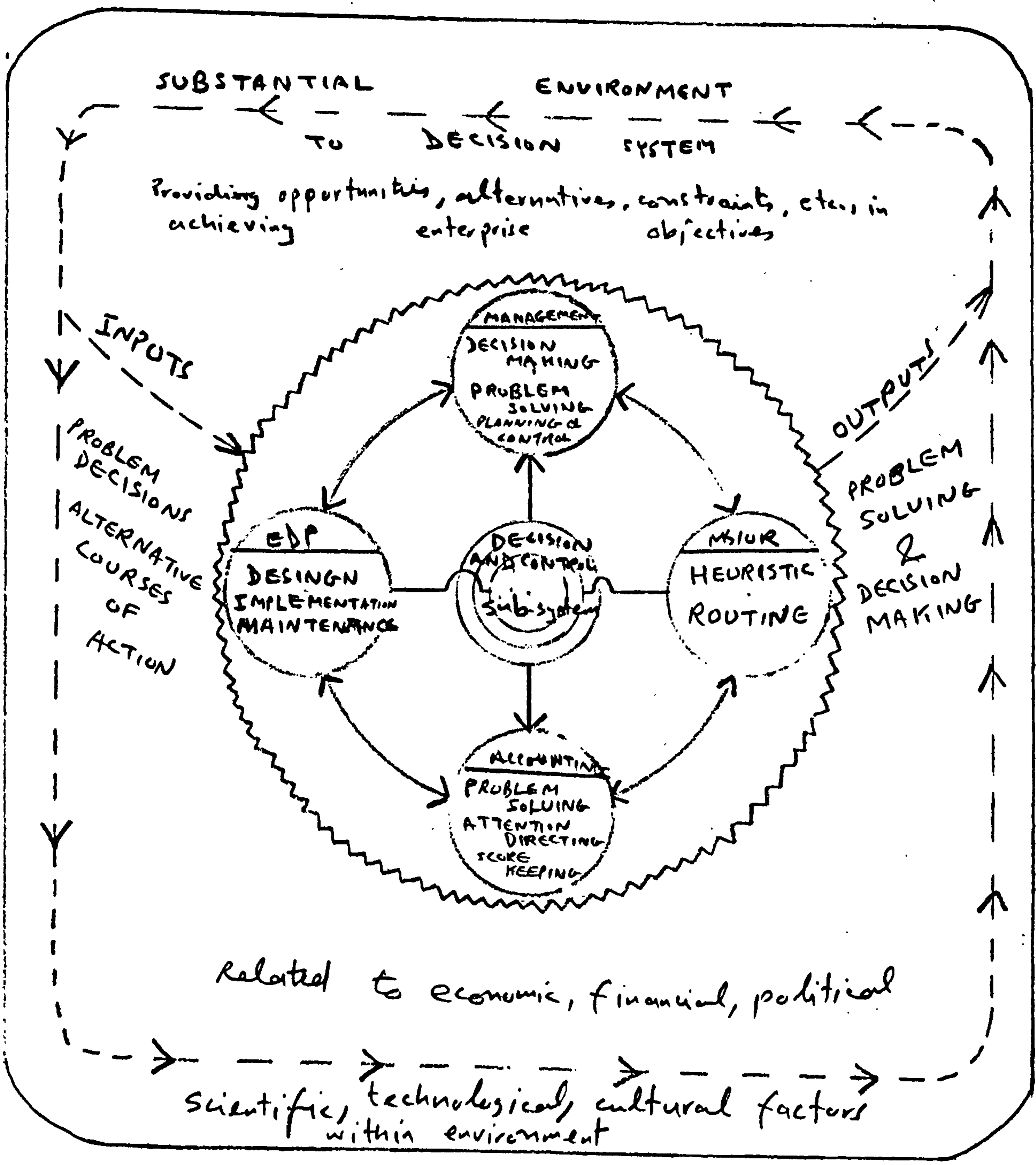

Organizational entity.



Environmental feedback loop to enterprise.

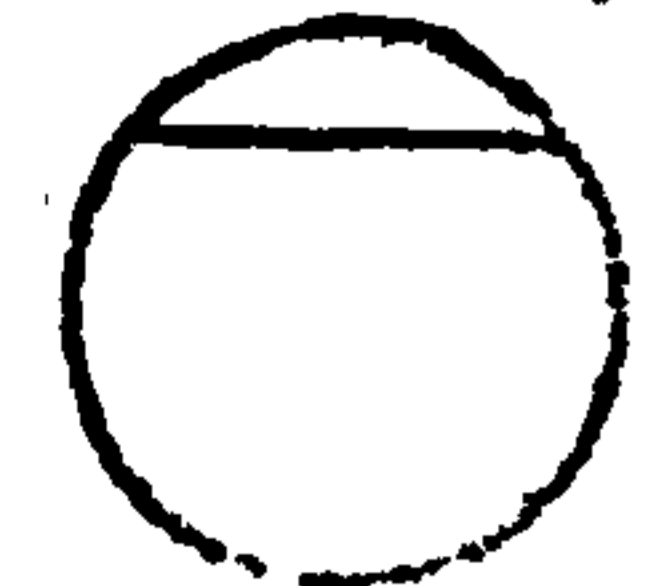

Functions, tasks, responsibilities. Exchanging information through both 'formal' system of decision and control of policies and procedures and 'informal' system of decision influence processes.



Decision and control subsystem as the 'centre of gravity' in the figure.

Figure 1.2. A Diagrammatic representation of the interdependency characteristic of the interacting groups under investigation in the present survey.

purposes. The increasing use of MS/OR models places new demands on accountants to consider the information needs of MS/OR specialists in building, for example, linear programming, inventory control, and simulation models. Also, MS/OR models can be useful to the accountant who recognises the benefits and limitations of the approach adopted in building them. Furthermore, the MS/OR approach is applicable to accounting-type problem areas such as budgeting, pricing, and forecasting. Computer-oriented hardware and software and the associated services of systems development have opened new computational frontiers to the accountant that can be useful in dealing with a high volume of repetitive transactions, sizeable computations, and/or reporting on the basis of fast response time. This depends of course on the type of equipment and the associated auxiliary peripherals. Such technological advances have also facilitated the manipulation of a very large number of variables and the mathematical computations and transformations contained in masses of data featuring MS/OR models that should capture the essence of critical factors of a problem area.

In the meantime, accountants have continued to provide a variety of services to their organisations in the areas of, for example, financial control, tax computation and operating and capital budgeting. Traditionally, the accountant played a substantial role in the development and maintenance of financial accounting systems to comply with statutory requirements based on well-known accounting principles, and in the development of management information-for-planning-and-control systems. The most noticeable of the latter are budgetary mechanisms, practices and principles.

Consequently, there is a need for accountants, EDP and MS/OR specialists to effectively interact to support the management of their organisations in



decision-making and problem-solving.<sup>5</sup>

### 1.1.2. Problem Identification

Having briefly introduced the study, it is desirable to give a more detailed account of the problem signs, indicators and manifestations in general, and the particular circumstances concerning the scope of the problem in the U.K. (That is, the researcher's perception of the various indicators and circumstances that stimulated the idea of the present research).

#### a) in general

Several factors have contributed to the researcher's identification of the problem under study. These factors are not mutually exclusive. Following are some of them:

- i) there has been a concern about the limited usefulness of the information generated by accounting systems in building MS/OR analytical models,<sup>6</sup> in the sense that accountants are not adapting

5. Indeed the idea of a Management Control System of a comprehensive nature is fundamental to improving the accountants-EDP and MS/OR specialists' interactions. The need for such a system is succinctly explained the following quotation:

"The need for a planning and control system within a business organisation flows from certain general characteristics of the nature of business enterprises, the chief of which are as follows: firstly, the enterprise has (by definition) organisational objectives, as distinct from the separable and individual ones of the members constituting the 'managerial coalition'; secondly, the managers of the sub-units of the enterprise must necessarily be ambivalent in view of their own personal goals, as well as have a good deal of discretion in deciding how they should behave and in formulating their part of any overall plan to achieve organisational objectives; thirdly, business situations (and people's behaviour) are full of uncertainty, internally as well as externally to the business enterprise; fourthly, there is a necessity to economise, in human endeavours we are invariably concerned with an allocation of effort and resources so as to achieve a given set of objectives using the minimum amount of total economic resources and effort; or alternatively put, to achieve a maximum amount of objective attainment, given a specified amount of resources and effort" (Lowe, 1971, p.1).

6. See Churchman (1961, p.59).



their systems to the needs of today's complex problem areas. In other words, the state of the art in accounting is not satisfactory in relation to the expectations regarding accountants' updating their tools of analysis and interpretation to the current managerial needs for information. Several citations can be made to explain such a situation. Williams and Griffin (1964, p.23) stated that:

"If accounting practice is in fact a tool of managerial decision-making, it must be responsive to current developments in management's disposition toward the factors which influence these decisions. The message of history is that accounting practice will adjust to and meet the challenges of the times; yet, the pace and direction of its movement presently is less than encouraging. This hesitant spirit, if continued, may create a vacuum which will be filled by one of the many new disciplines - or combinations thereof - now active in aid of management".

(Underlining is the research worker's)

Also, Mattessich (1966, p.521) indicated that:

"... the managerial accountant of the 1950's could not rid himself entirely of the narrow notions of historical business accounting and of the yoke imposed upon him by historical costing. Furthermore, he had neither the educational prerequisite necessary to use the quantitative-analytical methods developed by mathematicians, logicians, and operation analysts, nor had he high-speed computers at his disposal.

During the early 1960's the impact of management science and EDP made itself felt more emphatically and is about to shift anew the point of gravity of academic accounting".

In addition, Robinson and Alexander (1971) explain the reasons behind the wide gap, between the desired characteristics and reality features of today's accountants,<sup>7</sup> in the following manner:

"The authors ... feel that the image of modern accounting still reflects much of the green eyeshade, garter-sleeve, debits-near-the-window flavour characteristics of our predecessors. Precise, reliable, trustworthy, honest, thrifty, and brave, ... he indeed is! But creative, adaptive, flexible, and imaginative ... he too often is not! The blame for this is our own! In our yen for conservatism we have held too long to tradition; in our preoccupation with consistency we have hesitated to venture and experiment, and in our dedication to detail we have allowed the data to wag the information system and disrupt our control procedures. It is time now to reassess our positions in the changing environment, reaffirm our devotion to management needs, and assume a greater leadership role on the management team" (p.19)

---

7. This is not the only view expressing concern about the image of accountants, and the need to recognise the limitations of the accounting systems to explore the possibilities of increasing the effectiveness of accountants' contribution towards decision-making and problem-solving. Gynther (1970, pp.134-141) details why he believes that the image of the accountant has shrunk.



Furthermore, regarding the apparent discrepancy between accounting practice and accounting research literature, Dearden (1973, p.183) writes:

"The increasing interest in the use of mathematical models in accounting in the past five years has resulted in some new applications of mathematical techniques to cost accounting problems. Most of these techniques are only of academic interest at this time. (For many, I do not see any really significant business use even in the future). Also, it is necessary to have at least, a degree of mathematical expertise to understand these applications".

- ii) the lack of a clear picture about the working relationship between accountants and MS/OR specialists in their organization. (This is even more evident in the case of the working relationship between accountants and EDP specialists). Taking the accountants - MS/OR specialists' interaction as an example, the following empirical evidence (based on two independent studies) may be quoted:

On the one hand, Vatter (1967, p.730) indicates that:

"The results of this inquiry do not form a basis for any sort of sweeping generalisation. Most of what has been reported here is confirmation of that which many people have felt was true. There are not a great many companies doing very extensive OR work, but there is a considerable number that are doing interesting and useful things with the tools of OR, and in the context of that philosophy which characterises the OR approach to problems. Perhaps the most pertinent over-all observation is that there is a well established nucleus of interest and activity in which financial executives and accountants have a real stake; the results that are being sought (and obtained) are more than mere promise, and there is more than a dim glow in the Eastern Sky".  
(Underlining is the researcher's)

On the other hand, Radnor, Rubenstein and Bean (1968, pp.138-139) give the following example to explain the controller's attitude regarding the MS/OR function in his organization:

"A large service company formed an operational research group in the late 1950's under the financial vice-president's sponsorship. The group was headed by a military type, a scientist who had learned operational research as a member of an early World War II group. He was formal leader of the corporate-operational research group but continued to devote part time to his duties as a scientist.

After a few small-scale successes, the group undertook a large-scale problem in the early 1960's - an overall corporate planning and budgeting system. After 15 man-years of effort the project was not even partially implemented, although parts of it were ready for implementation. A former member of the group said that the marketing departments in the divisional offices were not receptive to the project in the beginning



because they had to spend their own time gathering data for the operational research group. It also appeared that they would have to change their office procedures to accommodate the new system. As the project continued, it was given wide publicity in the organisation, and eventually reached "monster" proportions in the eyes of top general management.

At a crucial point in the project's development, an important management change occurred and the controller became president of the Company. He instituted a general cost cutting campaign which resulted not only in the "death" of this project but of the whole operational research group. The financial vice-president who had sponsored the group was transferred out of the corporate office and given a position in a division. The scientist who had headed the group returned to his former position and has been passed over in subsequent promotions. He feels that he probably did not handle this particular project as well as he could have, but that in the final analysis, "politics really killed operational research here". (Underlining is the researcher's)

Also, the same study (pp.139-140) indicates that:

"While data collection problems were not a major consideration in general client relations, they represent a higher percentage of the staff relationship problems, especially among controllers. For example, one controller admitted perceiving the operational research group as a glorified data processing group which threatened to infringe on his area of responsibility, so he refused to give them the cost data they needed to solve specific problems. The original operational research group "died" in 1965 and the controller began studying the feasibility of incorporating an OR/MS capability in his own area as a part of a new management information system.

In 10 cases where strained relations were reported between OR/MS and controllers' areas/<sup>and</sup> where the causes were specified, we found that 8 had to do with the general question of the role and function of the controller's department vis-a-vis OR/MS. Thus we had such cases as: "OR/MS was seen by the controller's department to be 'encroaching on their prerogatives' or 'the controller was battling to take over control of MS/OR'. In a number of cases the general environment and approach of a traditional accounting department was at issue.

We may speculate that an important element in the future of OR/MS in U.S. business will be the way in which the controller's function develops. If, as is sometimes suggested, the controller can make the transition to something akin to the management and information scientist, this could have major implications for OR/MS as a central organisational function. (Also) ..., the ownership of the computer and systems design capabilities are important aspects of this question. It was of interest to note that in the several cases where computer and systems design operations had been set up outside the financial area, the controllers were said to have generally 'traditional outlooks' (Underlining is the researcher's).



iii) consulting the relevant literature regarding the 'state of the art' in accounting environments, the researcher can make the following general observations:

- the amount of theoretical conceptualisation, abstraction, and speculation<sup>8</sup> about accounting functions in industrial organisations is, to a large extent, unmatched with practical experiences based on empirical experimentation and exploration. This can be evidenced by reviewing contents of accounting periodicals and current research and working papers. It is interesting to note that the more 'respect-ed' journals are demanding and encouraging (according to their policies) their contributors to consider the importance of empiricism in one form or the other.<sup>9</sup>
- accounting functions and their adoptive practices are facing a challenge of recent developments in information technology and management sciences. Without undermining the traditional role of accounting, such developments have added, to, changed, or affected the shape of accountants' responsibilities and duties towards management and decision making for managerial planning and control. This is not to overburden the accountant with unnecessary commitments (i.e. assuming the responsibilities of a MS/OR, or an EDP specialist). Rather, the object is that the accountant should have a balanced role to play in his organisation. Such a balanced role is meant to enable him to carry out his functional responsibilities and to further his understanding of EDP, MS/OR and the closely related fields without over-or-under playing his organisational role. Regarding these responsibilities there is insufficient empirical evidence that give an indication of the functioning of accounting groups, particularly as seen by other functions such as EDP and MS/OR specialists.

Sarjeant (1971, p.13), for example, concludes his field study in two major Canadian Corporations of conditions affecting the changing role of industrial accountants - indicating the need for further research in the areas of organisational relationships between the accounting functions and the management information department<sup>10</sup> to find out whether or not this information function is sufficiently different from the accounting function to warrant this kind of change. The second area of investigation according to Sarjeant (1971, p.13) is the rise of quantitative methods (normally associated with operational research) in accounting and their relevancy to the practice of accounting.

- 
8. See, e.g. Finerty (1970, pp.28-30); Horngren (1971, pp.1-11).
9. Benjamin and Brenner (1974, pp.360-362) carried out a survey into Perceptions of journal quality as an important factor in evaluating an article. On the basis of an average of responses to this study the following five journals were ranked highest in quality: The Journal of Accounting Research, The Accounting Review, Management Science, Harvard Business Review, and The Journal of Business.
10. Sarjeant (1970, pp.5-6) indicates that large-scale computer systems and operational research have given birth to the concept of 'information department'; that the processing and analysis of business information is now considered by many to be a speciality in its own right, and should be, according to the view held by many, housed in one central department to design and operate systems for gathering and analysing business information leading to the production of reports for management action.

b) with special reference to U.K.

The immediate reactions one gets as a result of researching the relevant literature are that:

- a state of general dissatisfaction regarding financial accountants' role in relation to MS/OR, prevails. Financial accountants are perceived to be an obstacle in the way of implementing MS/OR specialists' recommendations (Stamp, 1971). Language and communication barriers were mentioned as the main pattern of working relationships between accountants and MS/OR specialists.<sup>11</sup> (See, Rivett (1959); and Bennie (?)).
- the inadequacy and insufficiency of empirical information concerning aspects such as: what have been the effects and implications of recent developments in EDP (particularly the third generation computers and the associated software developments) and MS/OR applications on: accountants' approaches to decision and information systems; accountants' patterns of communication and working relationships with EDP and MS/OR specialists; and on accountants' contributions to computer-based and MS/OR models developed by EDP and MS/OR specialists respectively? The effectiveness of decision making systems is not independent of the ability of decision support subsystems/<sup>in</sup> providing information; in contributing toward reducing uncertainties; and in building systems (manual or computerwise) capturing the essence of complexity characterising today's business problems.

---

11. "Accountants - EDP specialists' interaction", and "accountants - MS/OR specialists' interaction" are described in detail in the following chapter.



1.1.3. An analysis of the problem under study and assessment of the likely contribution of the research

a. the need for improved decision making and problem solving.

It is needless to emphasize the accelerating complexity (stemming from technological advances) in modern business organisations.

Rapid product development and obsolescence, the knowledge explosion, multinational businesses, growing government intervention, and increasing awareness of social responsibilities of business, are but a few examples of the increasing complexity of environmental features of today's rapidly changing society. This is certainly affecting value systems and associated cultures, that, in turn, affects organisational life and strategies for adaptation and seeking balance.

Being open systems,<sup>12</sup> complex social organisations tend to move

12. The systems approach provides a conceptual framework for viewing organisations that leads to better understanding of the components, interrelationships, and constraints contained in the structure and processes of the system. When viewed in general systems terms, a formal organisation (whether a business enterprise or a government agency) is:
- "1 A Man-resource system in space and time.
  - 2 Open, with various transactions between it and its environment.
  - 3 Characterised by internal and external relations of conflict as well as co-operation.
  - 4 A system for developing and using power, with varying degrees of authority and responsibility, both within the organisation and in the external environment.
  - 5 A 'feed-back' system, with information on the results of past performance activities feeding back through multiple channels to influence future performance.
  - 6 Changing, with static concepts derived from dynamic concepts rather than serving as a preliminary to them.
  - 7 Complex, that is, containing many sub-systems, being contained in larger systems, and being criss-crossed by overlapping systems.
  - 8 Loose with many components that may be imperfectly co-ordinated, partially autonomous, and only partially controllable.
  - 9 Only partially knowable, with many areas of uncertainty, with 'black regions' as well as 'black boxes' and with many variables that cannot be clearly defined and must be described in qualitative terms, and
  - 10 Subject to considerable uncertainty with respect to current information, future environmental conditions, and the consequences of its own actions". Gross (1965, p.197).

Meanwhile, processes of establishing organisational goals are dynamic, complex, and the product of many overlapping factors and conditions. The concept of a set of constraints imposed by internal and external environments is fundamental to the understanding of the reality of organisational life. For a detailed discussion of the set of objectives forming the goal structure of an organisation, see, Simon (1964, pp.1-22).



towards a continual elaboration of their activities and proliferation of functions.<sup>13</sup> Requirements for survival systems must have maintenance and adaptive mechanisms<sup>14</sup> which may give rise to conflict (which might not necessarily be dysfunctional).

A fairly recently noticeable evolution (particularly) in the organisational life of the relatively large industrial organisation is the introduction and rise of new specialists assuming innovative responsibilities that have implications<sup>15</sup> for older and well-established professional groups. Amongst these new specialists who are of particular interest to this study are EDP and MS/OR specialists.

More specifically, the researcher has been concerned with the system of accountants' interaction with these new specialists - namely, EDP and MS/OR specialists' working relationships and communication patterns with accountants.

Accountants' reaction, for example, to the introduction of EDP functions and specialists in organisations is a mixed one, along a pessimistic - optimistic continuum, where some predict a doomed future for accountants, some others predict a booming horizon for accounting, and indeed some of the rest represent the middle-of-the-road group.

13. "In organic development and evolution, a transition toward states of higher order and differentiation seems to occur. The tendency toward increasing complication has been indicated as a primary characteristic of the living, as opposed to inanimate, nature". (von Bertalanffy, 1950, p.26).
14. Katz and Kahn indicate the nature and importance of such mechanisms as follows:  
 "If the system is to survive, maintenance substructures must be elaborated to hold the walls of the social maze in place. Even these would not suffice to insure organisational survival however. The organisation exists in a changing and demanding environment, and it must adapt constantly to the changing environmental demands. Adaptive structures develop in organisations to generate appropriate responses to external conditions" (1966, p.39).
15. Ritti and Goldner (1969, p.B.234) indicate that the introduction of new specialists is one of the possible sources of organisational conflict. They explain:  
 "Conflict over large professional issues occurs primarily between or among specialist groupings, and stems from at least two sources: from direct competition for resources necessary to perform similar specialist functions, and from attempts by newer specialists to routinise the performance of an older speciality and thereby to preempt some of the professional prerogatives of the latter".



In view of the above analysis, the main purpose of this study has been to explore and to codify (so far as possible) what is contained in the sub-structures of the accountants' interaction with EDP and MS/OR specialists, which might be useful in contributing towards improved decision making and towards considering normative propositions regarding what ought to be.

Therefore, learning about patterns of communication and working relationships between accountants on the one hand, and EDP and MS/OR specialists on the other, has been the prime objective of the present investigation. More specifically, the study has the following objectives:

- (1) to identify the main factors contributing to the understanding (or the lack of it) between accountants on the one hand and EDP, and MS/OR specialists on the other, within larger organisations.<sup>16</sup>
- (2) to learn about patterns of communication and working relationships forming the horizontal interactions: "accountants - EDP specialists' interaction"; and "accountants - MS/OR specialists' interaction", for greater understanding about the causes and consequences of different patterns.

To satisfy these objectives, the following questions have been of particular interest to the study:

What is the effect of recent developments in EDP and MS/OR areas upon accountants and accounting functions, and upon accountants - EDP, and MS/OR specialists' interaction?

How would the various organisational aspects - policies, conditions and circumstances - be described and analysed?

---

16. Chapter two of this study contains a more detailed discussion of what the researcher perceives to be the main conceptual dimensions of the interaction under study.

What is the degree of present and potential inter-disciplinary involvement of accounting, EDP and MS/OR specialists?

Likely contribution of the research

The theory - as opposed to the practice - of MS/OR asserts the usefulness of model-building in a wide variety of managerial problems related to the day-to-day running of businesses as well as organisational growth and survival through the quantitative formulation of problems by means of applying 'standard' MS/OR methodologies and ad hoc investigations. Besides, the model-building effort can provide fresh insights to executive management.<sup>17</sup>

Digital computers (hereafter called computers or EDP) can quickly and efficiently handle the bulk of routine accounting applications - such as payroll, invoicing, debtors' accounts, creditors' accounts, raw material stock control, finished products stock control, general ledger and a variety of cost accounting applications. If this is carried out successfully, the accountant may be able to contribute to the area of non-routine accounting activities - such as investment decisions, cash management and financial modelling. The importance of such computer-based applications increases as the complexity of businesses and the associated problems increase. To put it mildly, the computer has major implications for and impacts on accounting functions and accountants' ways of organising their systems and approaches.<sup>18</sup>

Speculations and conceptual prescriptions about the desired role of the accountant in MS/OR and EDP and what he ought to be doing in relation to these areas indicate that there would be some advantages in getting him involved with EDP and MS/OR specialists on a collaborative basis to assist the

---

17. c.f. Wagner (1971, p.1267).

18. Cunitz (1972, p.5) goes as far as to say that "... the present impact of computers on accounting is immense and the future impact appears almost unlimited".



managements of their organisations in tackling the day-to-day as well as longer-term problem areas.

How much do we know about what accountants actually do in relation to these MS/OR and EDP functions and MS/OR and EDP specialists in their organisations? How much do we know about the present impact of EDP and MS/OR functions on accountants and accounting functions in their organisations? To what extent are accountants utilizing these different approaches and tools in updating their systems and tools - indeed if such different approaches and tools prove to be useful to improving the quality of accounting and finance?

Scanning the relevant literature does not give much help in that direction and leaves the researcher feeling the need to study this under-explored area. Such a possibility raises a highly relevant question - why study the accountant's role, and accounting functions' involvement, in, and relationship with, EDP and MS/OR areas, and not - for example - marketing, or manufacturing?

The main reasons for concentrating on accounting functions and accountants are:

- i) data and information contained in the accounting and finance systems - designed and maintained to conform with statutory regulations and requirements and to provide management with an instrument for planning and control - constitute a substantial part of the information system. Such a system records the history and budgets the future of the organisation and can be used to monitor its future direction. It contains a wide variety of variables affecting the growth and survival longer-term objectives and the associated short-term performance objectives of any organisation. This obviously has its bearing on MS/OR projects affecting in one way or the other the present or future financial position of the particular organisation. The bearing of the accounting systems and policies on EDP activities is even more relevant.
- ii) the 'place'<sup>19</sup> of the accounting function and accountants in their capacities as finance directors or controllers, chief accountants,

---

19. The term 'place' here is not equated with 'rank'. It simply denotes organisational position.



financial and management accountants (even the more junior accountants) should not be overlooked. They develop the above mentioned - in (1) - systems and prepare reports and analyses that can be useful in MS/OR model-building and tracing solutions. Furthermore, the concepts and methodology of MS/OR can be useful in helping the accountant throw some light on some of the patterns, indications, relationships and significance contained in accounting and finance information. Such a 'place' of accountants does have implications for EDP activities in a variety of contexts as users of computer-based systems and as developers of a control mechanism for EDP activities (the simplest of which is the preparation of EDP budgets).

- iii) the outcome of studying accountants' working relationships with EDP and MS/OR specialists is not irrelevant to studying similar relationships within organisations. Future studies could utilise the findings of researching the Accountants - EDP and MS/OR specialists' interaction, for formulating their hypotheses and finding out differences between accountants and marketing specialists for example in their relationship with EDP and MS/OR specialists, for examination of the factors that contribute towards more (or less) understanding between EDP and MS/OR specialists and those other functional areas. Ultimately, the objective of such studies is effective organisational relationships.

Similarly, it might be argued that management - not accounting - is the ultimate user of the output of such EDP and MS/OR systems; and that studying the interaction between managers and EDP, and MS/OR specialists might be more fruitful.

Whilst the researcher agrees with the importance of the area of management - EDP and MS/OR interaction, scanning the relevant literature indicates the following observations:

- i) if one considers accounting, EDP and MS/OR functions as management support sub-systems it is possible to concentrate on either the support sub-systems to management, or on managements themselves. Such a study (of either the sub-systems or the managements) would be desirable as long as the other would be taken into consideration. Researching into the accountants - EDP and MS/OR specialists' interaction is as important as researching managements' interaction with these and other support sub-systems. Lack of or mis-understanding of terminologies, approaches, functional abilities and limitations amongst these support sub-systems, would not help managements in taking effective decisions or sufficiently absorbing the associated organisational activities.
- ii) the area of the relationship between management and EDP has been given some attention which puts it in a slightly better position than the area of accountants - EDP and MS/OR specialists' interaction. This is not to say that the former has been adequately and sufficiently



well researched, rather it is a comparative position. The whole area of the interaction between EDP, MS/OR specialists, accountants and managements contains ample opportunities for further interdisciplinary exploration and research for more understanding about the complexities contained in these recent developments. The area of viewing accountants as users of EDP and MS/OR services and providers of data, information and advice has so far been given insufficient empirical attention and investigation.

- iii) the more we learn about constructive ways and approaches on accountants - EDP and MS/OR specialists' interaction, the better the chance of identifying ways and approaches of supporting the management of their organisations. For example, if accountants and MS/OR specialists in an organisation are capable of developing and presenting a budgeting model which managements of various departments and divisions can utilise in establishing future plans, then this would help managements effectively rationalise their future strategies.

### Basic Assumptions

As the scope of every study has to be explained with sufficient precision to lay down certain assumptions under which it is carried out, the present study is no exception. The following may be considered as the boundary conditions that specify the direction of the present research:

- Theoretically, the nature of the interface is characterised by a kind of reciprocal interdependence to a 'reasonable' extent. It is assumed that accountants as well as MS/OR and DP specialists share an important part of the foundation of decision-making process in complex business organisations. Whether or not this is the case in the organisational reality, will be the interest of this study. To say that accountants do not have to get involved in these new areas and/or computer and management science specialists have nothing (or little) to do with the accounting function and accountants, would be inconsistent with the nature and characteristics of these services disciplines or functions. On the other hand, most MS/OR projects do have elements rooted in and/or implications for accounting and financial information and position of the organisation. In addition, accountants have to participate - to a considerable extent - in the development and implementation of many aspects of computer-based data and information systems (such as: feasibility studies; systems design and analysis; and the creation of computer-based

accounting applications). On the other hand, D.P. specialists have been (and/or are being) asked to computerise many of the routine accounting activities and they can be of value in systematising - and in dealing with - some of the non-routine accounting activities. Also, MS/OR specialists can assist accountants in tackling many of the finance and accounting problems by putting their concepts and ideas together with their accounting counterparts.

This, in effect, refers to the assumption of reciprocal interdependence<sup>20</sup> between the accounting function and these other closely related fields of expertise. It is a fundamental assumption in the analysis of patterns of communication and working relationships between accountants, MS/OR and D.P. specialists.

- Attention is focused upon the horizontal or lateral type of relationships within these organisations. No attempt will be made to discuss the vertical-type of relationships, unless they directly affect the horizontal types under investigation.
- OR and D.P. groups are viable forces and can be identified within organisations. (No matter where they are located).
- It is also assumed that this interface is characterised by a gain function as a result of the attainment of a desired state. This gain is for these interacting groups. No loss function is to be expected as an outcome of the others gain in this kind of lateral interface. (This does not mean that such situations do not arise in practice).
- The study is restricted to relatively large British industrial organisations. On the one hand, consideration is mainly given to private enterprises ranked amongst the top-third-in-rank as classified in 'The Times 1000'<sup>21</sup> (1972-73; 1973-74) and the U.K. nationalised industries.

---

20. See figure 1.2. above.

21. Published by Times Newspapers Limited, Printing House Square, London. E.C.4.



This range of organisations is thought to satisfy one of the basic requirements of the present research, namely, 'the complex nature of business' to warrant the use of MS/OR and D.P. services. The vast majority of organisations within the specified range were found to satisfy at least one of the criteria used (for conditioning inclusion of organisations as possible contacts) : the large number of employees; the large capital intensity, and the high level of sales and turnover.

On the other hand, the study is limited to 'industrial' organisations.<sup>22</sup> Accordingly, exclusion has been made of categories such as: government departments; educational institutions; banks and finance houses; property and insurance companies; unit trusts and building societies.

## 1.2. Definitions adopted

### 1.2.1. Nature of language involved

Perhaps one of the difficult tasks facing the present research (as well as many others) is to adopt clear definitions based on delineated boundaries. What is a D.P. specialist? What is a MS specialist? What is an accountant? Are MS and OR specialists different in their characteristics and features? And if so, how and why? These and other similar questions are by no means easy to find a practical answer to. Perhaps, giving a few examples would demonstrate the point being made here and help in outlining the research strategy in this respect.

---

22. Admittedly, this belief does not have the concrete evidence. But it is partly supported by the analysis of the membership of OR Society at the end of 1967 made by Mercer (1968, pp.371-376) where he indicated that very many organisations do not appear to be strongly committed to OR, and that it could be said that OR only penetrated 241 organisations. Also, his analysis indicated that two outstanding industries: metal manufacturers and chemicals were committed to OR. As for D.P. and computer services, it appears that the situation is clearer (than the case of MS/OR). The high cost of installing and maintaining the computer and its auxiliary devices limit the range of organisations owning such facilities. Also, the various stages of the present research (including the pilot study) have corroborated this belief.

First: MS/OR

Examining a sample of the several definitions<sup>23</sup> of 'Management Science' and 'Operational Research' (MS and OR) - contained in the relevant literature, the researcher has arrived at the following points:

- i) Conceptually MS is considered to have a wider framework than that of OR. Writing of scholars concerning this issue supports the belief that there are some conceptual differences. Symonds (1957, p.126), for example, indicated that although OR and MS are closely related, they are quite different<sup>24</sup> but complementary in their purposes.<sup>25</sup>
- ii) It is difficult to draw a clear-cut distinction between them; where one begins and the other ends is a matter of personal judgment and interpretation. In many cases, both MS and OR are dealing with management problems by means of (mathematical) model building, and both are utilising computer capabilities as a tool for facilitating computational efforts.

Furthermore, a recent study of a randomly selected sample of the membership of The Institute of Management Sciences, indicates that by and large there is a tendency to disagree somewhat with the concept of equivalence between OR and MS, and the whole TIMS membership tends to disagree that their interests are identical to those in operational research.<sup>26</sup>

23. For a sample of definitions of MS, see Ackoff (1970, p.viii); Drucker (1959<sup>a</sup>, p.25); and Bowerman (1956, p.287). For another sample of definitions of OR, see, Beer (1966, p.92); Wanty (1960, pp.68-69); and Kimball (1951, p.1). Both samples may represent the very many definitions offered in this respect. This definitional problem has as yet to be settled. However, Kendall (1958, p.266) is amongst those who took the position of declining to define the OR subject.
24. "Operations research uses specific principles and methods in solving specific problems. Operations research study does not usually produce general laws or fundamental truths. Operations research represents the problem solving objective; management science the development of general scientific knowledge. Nevertheless, much of our understanding of management science came through operations research, as well as industrial engineering and econometrics. Study of specific problem solutions, as, for example, in inventory control, led some investigators to approach an understanding of general theory in this area. All general theory requires the pragmatic test. Operations research, applying general theory to specific operations, is a desirable means for making this pragmatic test". (Symond, 1957.p.126).
25. Drucker (1959<sup>b</sup>, p.249) emphasized that long-range planning constitutes a major area of challenge to management science and management scientists. Also, Churchman in his forward to Starr's (1965, p.iii) work, "Executive Readings in Management Science", indicated that there is a difference of interests of both specialists, MS and OR.
26. See Leonard S.Simon (1971, p.28 and p.36).



In spite of the above evidence, the researcher does not think that there are sufficient practical grounds to warrant making distinction in carrying out an empirical investigation. How clear are these differences between MS and OR in the reality of industrial concerns? Are the MS specialists concerned with establishing general laws whilst OR specialists concern is in problem solving? If the researcher agrees with these conceptual differences between MS and OR he could ask: are users of these types of expertise aware of those differences? And what are the implications of such situations? Has the criticism<sup>27</sup> directed towards "Operational Research" affected the extent to which the term 'Management Science' is used?

iii) Although the researcher recognises the existence of some conceptual differences between the two terms, MS and OR, contained in philosophies and basic objectives of their respective formal bodies: institutes, societies and associations - it is less likely from the empirical point of view to find 'major' differences in application areas.

Consequently, for the purposes of the present study, it seems reasonable to assume the interchangeability of the two terms MS and OR (hereafter arranged alphabetically and titled MS/OR). The generic term 'MS/OR specialist' is used throughout the study to denote those who are engaged in the application of principles, philosophies and approaches of management science/operational research in their organisations as defined by their job titles and job descriptions.

---

27. Wagner (1969, p.4) critically comments on the two words 'operations' and 'research' as follows:  
 "It is bad enough that the word "operations" inadequately describes the diversity of present-day applications. To make matters worse, the word "research" creates the false impression that the method is a "blue-sky approach". On the contrary, in the past decade operations research has proved time and again to be a powerful and effective approach for solving critically real management problems".

Second: D.P. and the so-called 'MIS'

Recently, there has been voluminous discussion and writing in the areas of data processing for managerial purposes of decision making and control and the associated concept of the so-called Management Information System (MIS),<sup>28</sup> which has been given too much publicity resulting in different reactions, ranging from a high degree of enthusiasm to a very high degree of disappointment, in which the latter is probably the dominant.<sup>29</sup> That is, expectations in connection with the 'MIS' were mounting high but were unmatched by: sufficient realization of the limitations inherited in the visualised concept; sufficient practical experience in identifying, diagnosing, resolving or minimizing the effect of associated behavioural problems and difficulties; and the 'proper amount' of attention to plan the introduction, development and implementation of systems containing the fundamental dimensions of the concept, that is, 'management', 'information', and 'system'.

To avoid such misconception the present research adopts the generic term 'D.P.' specialist to embrace: data processing managers, D.P. project leaders, systems analysts, and programmers, and others who are engaging in

28. Under the title 'MIS' or 'Computers for Management', or their variations, the reader can find very many definitions expressing different points of view and reflecting on varied experiences. For example, Emery (1969, p.491) states that MIS is designed to provide information needed to manage an organisation, and that the system is primarily aimed at serving the planning and control function. Clearly Emery's definition is a general one which encompasses all management functions in every organisation. Colbert (1967, p.16) also defines MIS as an organised method for providing each management with all the data and only those data which he needs for decision, when he needs them, and in a form which aids his understanding and stimulates his action. Colbert explains that the concept is one that would be equally valid if the data were obtained and processed through the most simple manual means or through the most sophisticated computer-based systems.
29. A third example is by Stern (1970, p.B.123) in which he views MIS as an automated system which presents to the manager information, both internal and external to the business, that aids him in making a specific set of routine decisions. Although Stern (Ibid, pp. B120-B123) separates information retrieved from MIS, his definition contains some terminological drawbacks, such as: 'automated'; 'presents to the manager'; and 'a specific set of routine decisions'.



computerization activities. This is applied throughout the study, unless otherwise stated, for example, if the attention is directed towards computer-based systems for managerial planning and control, this, therefore, is explicitly stated so. In other words, the loosely coined term 'MIS' is not used as such.

### 1.2.2. Definitions adopted.

Having outlined the nature of language involved in the present research, it is important that this research lays down its strategy towards this definitional problem. Concerning this, the researcher believes that the term 'empirical' contains a partial answer towards the solution of this problem. That is any definition to be adopted should consider the practical limitations imposed on conceptual terms - if one could assume their existence. Accordingly, job titles, description of positions, job responsibilities, the higher and lower organisational level, and area of specialisation, seem highly relevant in defining empirically MS/OR, D.P. specialists and accountants. For example, if a person is an O and M manager he would not be included if his job responsibilities, areas of specialisation, and reporting levels do not indicate that he is carrying out systems modelling and applying the well-known methodologies described in the literature as MS/OR areas. Furthermore, if a person is holding a job title labelled 'MS/OR' specialist, then he would be included in the study even if he is partially doing O & M or programming.

### 1.3. Processes or stages of looking into the problem

Since the present study is empirical by nature, it is preferable that the researcher explicitly defines - even in an approximate manner - the various processes and stages of carrying it out. This

might be useful in outlining the scope, conditions and manner in which the study is carried out, and in putting the findings in perspective.

Generally speaking, three broad but discrete phases can be identified: first is a literature survey<sup>30</sup> of the relevant segments of the literature; the second is concerned with explorative search into accountants - D.P and MS/OR specialists' interaction by means of mailed questionnaires supported by a set of interviews with some management consultants representing the large-sized consulting firms; and the third (and final) phase is concerned with a further detailed investigation based on a closer look into the organisational interaction under consideration in the present analysis, for both qualitative and statistical evidence.

More specifically, Table 1.1. details the various dimensions of carrying out this research project. It is noted that some of these stages may overlap. Obviously, Table 1.1. is a simple representation of the continuous processes culminating in the end product of this study.

---

30. During the course of preparation for this literature survey, the researcher attended the Lancaster "Techniques of Operational Research" course in 1971, run by Lancord Limited, (Lancaster Centre for Operational Research Developments), as well as several computing courses.



Table 1.1

Contents: steps of carrying out the present investigation

Steps or stages	Main features of the study	Library Study	Mix of library Study and Field Observation	Survey and Field Observation
1st		Literature survey leading to the construction of primary dimensions		
2nd				Pilot study: testing draft questionnaire and arriving at a satisfactory design for the search into the interaction under study. Then carrying the study out.
3rd		Analysis of data: facts and findings in connection with accountants - MS/OR and EDP specialists' interaction; and arriving at <u>a priori</u> indicators or assumptions forming the domain of accountant-DP specialist relationships, and another <u>a priori</u> set of assumptions forming the domain of accountants - MS/OR specialists' relationships.		

Steps or stages	Main features of the study	Library Study	Mix of library Study and Field Observation	Survey and Field Observation
4th			Carrying out a few case studies to gain more familiarity with the organisational interactions under consideration	
5th			Carrying out a detailed case-study in a medium sized Company to compare for the size differential as between such a Company and larger organisations. *	Refinement of the <u>a priori</u> assumptions as well as the overall measurement instrument by means of the case-study companies.
6th			Inclusion of more cases by means of contacting some of those contacted earlier (in second stage) and on wider basis.	Continuing visits to case-study companies for more familiarity with the area of interaction under consideration.
7th			Testing the <u>a priori</u> assumptions and arriving at a satisfactory analysis of the accountants - MS/OR and D.P. specialists' interaction.	
8th			Summary, conclusions, and implications.	Feedback sessions with participating organisations.

\* The outcome of this analysis was the subject of a separate paper titled "The Epsilon Company Limited (ECL): An Organizational diagnosis of the acquisition and use of EDP Knowledge". It was presented on May 3rd, 1974 to a Management Control Workshop at Manchester Business School.



## Summary

This chapter has defined the area of accountants - EDP and MS/OR specialists' interaction as the main concern of the present investigation. It has pointed out the need for empirical investigation into the various dimensions affecting this area of organizational interaction. It has raised a number of relevant questions with regard to accountants' working relationships with their EDP and MS/OR counterparts. An assessment of the likely contribution of the research has been made together with its basic assumptions.

Due to the fact that many of the related terminologies (such as EDP, MS, OR) are vague and loose and involve several practical difficulties, the researcher has assumed the interchangeability of the terms MS and OR, has used the generic terms MS/OR, EDP and accountants throughout the study, and has used job titles, description of job responsibilities, the higher and the lower organizational level as an empirical strategy outlining the empirical operationalization of these terminologies.

Finally, the researcher has outlined the various processes or stages to follow. These stages are divided between pure library study, pure survey and field observation and mix of library and field observation.

## Chapter Two

### Accountants - EDP and MS/OR specialists' interaction : A literature-based survey.

#### Abstract

- 2.1. Description of accountants - EDP specialists'  
interaction : A literature-based survey.
- 2.2. Description of accountants - MS/OR specialists'  
interaction : A literature-based survey.
- 2.3. Identification of conceptual dimensions of  
Accountants - EDP and MS/OR specialists'  
interaction : A proposed framework of analysis.

#### Summary



Abstract

suggests that little empirical evidence  
 A review of the relevant body of literature<sup>1</sup>/is available concerning  
 the relationship between accountants on the one hand, and DP and MS/OR  
 specialists on the other in the case of U.K. This reinforces the need  
 for more detailed empirical investigation into the various attitudinal<sup>2</sup>  
 and factual aspects of this type of lateral organizational relationship.  
 To explicitly describe what has been done in these areas, consideration is  
 given to a 'representative' sample of related efforts, only in so far as  
 they are relevant to the issue of accountants - DP and MS/OR specialists'  
 interaction. There also appears to be a great need for the development  
 of an empirical theory as to how these three functions should relate in  
 the light of the technological developments in management information  
 systems. Three separate sub-sections are included in this section. The  
 first pays attention to evidence related to accountants - DP specialists'  
 interaction. The second considers those references in connection with  
 accountants - MS/OR specialists' interaction. The third seeks the concept-  
 ual identification of some primary dimensions - of the accountants - EDP and  
 MS/OR specialists' interaction. These form the basis on which further  
 operationalisation, organisational diagnosis, and the analysis of inter-  
 dependence can be carried out.

- 
1. Generally speaking, the body of literature relevant to the present investigation falls broadly within the social science literature '(sociology, social psychology, economics, management, organisational behaviour, accounting, and other social sub-systems. [All social sciences are studying essentially the same thing, which is the social system, from different points of view and with different vocabularies. Boulding (1974, p.ix)]. More specifically, operationalisation of the above statement involves focusing on certain sources of empirical and conceptual material for practical purposes. This is carried out through consulting references and periodicals relating to social sub-systems under study - "Contents Pages in Management" published weekly by Manchester Business School, U.K., and other business and accounting indices have facilitated the introduction to a good part of the periodicals part of the literature.
  2. Attitude is defined as follows: "A learned predisposition to react consistently in a given manner (either positively or negatively) to certain persons, objects or concepts. Attitudes have cognitive, affective and behavioural components." (Wolman, 1973, p.34).

## 2.1. DESCRIPTION OF "ACCOUNTANTS - D.P. SPECIALISTS' INTERACTION"

Recent developments in D.P. technology have given rise to the problem of the accountant's role and extent of involvement in this field. To what extent should he become involved in D.P? What role should he play in designing computer-based systems for accounting applications? What role - if any - should he play in controlling computer costs? What effects do the computerisation of accounting systems have on the accounting function and on accountants in business organisations? And what are the attitudes of both accountants and D.P. specialists towards each other and towards the accountants - D.P. specialists' interaction. These and other questions are directly related to accountants.

There is an abundance of written material introducing and explaining basic concepts in E.D.P. (i.e. introductory textbooks, manuals, and users' guides). Such discussion ranges, on the one hand, from speculations, predictions, expectations and forecasts, to analysing empirical evidence describing actual situations in different organisations, on the other.<sup>3</sup> A closer look into the latter leaves the researcher with the impression that much remains to be done towards exploring the behavioural dimensions of this sub-system of human organisations.

- 
3. The interested reader might be (for example) referred to:
- Levitt, and Whisler (1958, pp.41-48) for prediction and forecasting.
  - Myers (ed.) (1967) for a discussion of findings and forecasts.
  - McKinsey and Co. (1968) for a discussion of a number of computer applications.
  - Churchill et al (1969) for a descriptive study in a number of American firms reporting on the state of the art of computer-based information systems for management.
  - Whisler (1970) for a discussion of finding in a sample of American insurance companies of the impact of computers on organisations.
  - Stewart, Rosemary (1971) for a discussion of a number of case studies in the U.K. of the impact of computers on management.



However, it is important to note that most of the empirical work that has been carried out is more concerned with the effects of computers on management and in relation to computer-based information systems for management.<sup>4</sup>

Some writers have expressed their concern about the effect of the computer upon the accounting function,<sup>5</sup> and the problem is sometimes discussed in relation to issues such as the implication for the future education of accountants,<sup>6</sup> the proper form of organisational design of computers,<sup>7</sup> and, accountants' use of 'software' packages.<sup>8</sup>

Learning about the characteristics of the working relationship and communication patterns between the two functions is important to the under-

4. "Management Information Systems" is a magical phrase that has been used for some time to refer to what could well be the apotheosis of the data processing art in the service of business. It represents a technical and management challenge of the greatest proportion. MIS calls to mind a variety of systems, depending on the viewpoint of the individual. Generally speaking, it is that collection of computer programs and procedures under which information is collected, processed and reported - information that should serve top management in controlling business operations.

The record is full of major disappointments in the MIS area. It has been oversold to management, underestimated in cost, misjudged as to the implementation time required, and incorrectly assessed as to its eventual usefulness to management. Our writers have addressed themselves to the question "Why?" and "What can be done?"

This quotation is cited from the preface of the proceedings of the eighth symposium on information systems for management (held at UCLA on March 22-24, 1971,) and is made by: W.F. Bauer of Informatics Inc., California, in: Gruenberger (1972, p.vii). Bauer succinctly describes the state of the art of computers in business management and the emphasis being made in that area.

5. Among them are McRae (1964) and Mitchell (1969).

6. Scanning the accounting periodicals (such as The Journal of Accountancy, Accountancy, CA Magazine, and the Accounting Review), provides considerable amounts of material regarding what 'ought to be' done in this area. Most of these discussions are reflections of academicians (and a few practitioners) interested in developing schemes for educating future accountants and continuous learning for professional development.

7. E.g. Joplin (1967); Schoderbek and Babcock (1969).

8. See, Smythe (1973).

standing of the functioning of the related computer-based systems for management which have their elements generated and developed on the basis of their interaction. Each function (D.P. and accounting) can be considered as a management support sub-system and has its role and responsibility in the development and implementation of such systems. This has led the present researcher to study the effect of recent developments in computer and information technology upon the 'accountant' and the accounting function. To do so, the following questions are advanced:

What is the degree of accountants' involvement in EDP areas?

What are the patterns of communications between accountants and D.P. specialists, and the problems - if any - arising out of these developments and associated with these patterns?

What is the suitable strategy for ensuring co-operation between the two specialists for efficient attack on the joint problems?

These selected questions are related directly to the objectives of the present investigation; that is, gaining some insights into the factors affecting accountants - D.P. specialists' understanding for more effective decision and information support in the areas of problem-solving and decision making. Learning about the scope of accountants' involvement in D.P. areas, the patterns of working relationships with D.P. specialists, the type of associated problem areas, and the feasible approaches of furthering and reinforcing organisationally effective information network, gives empirical insights into the extent to which these groups are able to exploit developments in the EDP field for the benefit of their organisations.



## 2.2. DESCRIPTION OF "ACCOUNTANTS - MS/OR SPECIALISTS' INTERACTION

Hartley (1968, p.332) concludes his examination of the role of the accountant in operations research by the following assertions:

" ... , the accountant must accept the responsibility of being an essential member of the operations research group. His role consists of recognising possible applications of OR, identifying the relevant variables and their relationships (i.e. verbal model building), designing information systems which will provide relevant and reliable data for the model and participating in the construction and implementation of solution control systems. Both the internal and external accountant, in varying degrees, have a role in operations research. It is therefore recommended that operations research be a core requirement for college accounting majors and that all accountants familiarise themselves with its basic philosophy and techniques."

Furthermore, Trine (1969, p.865A) in a recent investigation of the nature of accounting and management science and their relationships, has concluded that:

"It was found that the same basic approaches, rigorous, analytical, mathematical, statistical, scientific methods; ... , were common to both modern accounting technology and the management science movement. Boundaries between accounting and the management science movement would be arbitrary and artificial. Therefore it was concluded that the modern field of accounting is an integral part of the management science movement."

The above examples are by no means the only ones.<sup>9</sup> Many attempts and explanations have been made: to describe the theory of mathematical/statistical applications in accounting;<sup>10</sup> to illustrate the useful adoption of some MS/OR models and approaches (such as linear programming and integer programming) in accounting;<sup>11</sup> and to exemplify ways and approaches in which accounting practices could be improved.

Also, there is some evidence that the gap between what 'ought to be done' and what is actually taking place in the real world is wide. The following are among several examples<sup>12</sup> that might be quoted in this respect:

9. Nagy (1959) examined the nature of operational research and its possible influence on accountancy, where he made the following speculation: operations research would define problems and data required for policy formation and control; accountancy must evaluate, interpret and integrate operations research findings; operations research would introduce the need for more mathematical and scientific interpretation; operations research would introduce new cost concepts in some areas - such as opportunity costs and incremental costs; the separate functions of operations research and accountancy are interrelated; and operations research has introduced new approaches and opportunities for accountants. (pp. 163-167). He also asserted that the accountant should have the training and ability to understand and evaluate results obtained by newly developed method and that educational and training programmes should reflect this need. (pp.157-162). Sweeney (1960) examined the use of mathematics in the analysis and interpretation of costs - based on published case studies - with special reference to forecasting and financial planning, inventory and production applications and learning curve techniques. Fahmy (1967) further analysed the relationship between cost accounting and operations research from the following points of emphasis: (1) mathematical models for process costing, (2) statistical applications to cost accounting, (3) set theory and cost accounting, and (4) the application of matrix algebra and linear programming in cost accounting.

[Both Sweeney and Fahmy were supervised by Professor George H. Newlove of the Graduate School of the University of Texas.]

Montgomery (1966) examined the restatement of a considerable portion of the subject matter of cost accounting - specifically; cost-volume-profit analysis, gross profit analysis, manufacturing overhead and standard costs - in a mathematical form. Such restatement, he asserts, implements the use of computers, and simplifies analysis and gives greater insight to decision making because it emphasizes functional relationships and underlying assumptions. Livingstone (1970) edited a collection of journal articles, each of which is followed by an analysis or commentary. The subject matter of the work is the application of mathematical techniques (matrix algebra, input-output analysis, linear programming) to the areas of management accounting. The areas are (1) mathematical representation of cost information systems, (2) cost standards and control, (3) cost-profit-volume analysis, and (4) planning and budgeting future operations.

10. See, e.g. Williams and Griffen (1964); various papers in Williams and Griffen (1967); Ijiri and Jaedicke (1966, pp.535-553); various references contained in American Accounting Associations' Report of Committee on the Measurement Methods Content of the Accounting Curriculum (1971, pp. 213-245).

11. See, e.g. Moore (1966, pp.52-57); Carsberg (1969); Arnoff (1970, pp.11-16).  
12. See, Forrester (1961, p.3); Howard (1968, pp.503-507); Terninko (1968-1969, p.4143A).



(i) Heany (1965, pp. B-146, - B155) is concerned with the gap existing between "managers" on the one hand and many "scientists" doing research under the banner of Management Science. He believes that some "management scientists" applying the MS/OR approach tend to consider "management science" and "applied mathematics" as synonymous, insufficient attention has been paid to the "ill-structured problems" facing top management and tactical, well-structured, organisationally lower-level type of problems have been the main concern of "management scientists". Furthermore, he is concerned about the absence of empirically constructive dialogue between top managers and management science practitioners.<sup>13</sup>

(ii) Dearden and Lastavica (1970) emphasize the under-utilization of OR and the following quotation explains what they headed "Failure of Operations Research";

"Business is not using the potential available from operations research techniques. This is true in inventory control, in asset management, and in investment management. Not only are decisions made on the basis of primitive decision rules, but very little attempt is made to evaluate the alternatives. There are areas of decision making where either linear programming or extended simulations are required to improve the quality of decisions made at the highest level in business. Yet operations researchers have not been successful in convincing top management that there is a superior approach. In most major corporations, one can find areas where either operations researchers have been unable to convince management of the desirability of using a more mathematical approach to decision making, or when models were tried, results were

---

13. "This TIMS gap should be an embarrassment to an organisation bearing the name of "The Institute of Management Sciences". With such a view, a stranger might expect to find managers active in our sessions and in our councils. The facts are different. Managers are staying away in droves. They are literally repelled by what they find classified under the label "management science". Their continual absence deprives our organisation of contributions some of the founders of TIMS valued as most important". (Heany, p.B146).

disappointing and far below those expected. Consequently, the models were either discontinued or, at least, further extensions were inhibited." (p.29).

The problem of communication between them and the executive branches of management has been under continuous investigation and it is always referred to as an acute and important problem.<sup>14</sup> Specifically the empirical findings of a recent research project indicated that some problems have arisen concerning the relationship between the accounting people and the management science team as follows:

"For example, one controller admitted perceiving the operational research group as a glorified data processing group which threatened to infringe on his area of responsibility, so he refused to give them the cost data they needed to solve the specific problems. The original operational research group 'died' in 1965 and the controller began studying the feasibility of incorporating an OR/MS capability in his own area as part of a new management information system". 15

On the other hand, accounting also has been under scrutiny and subject to criticism and objections. Both accounting research and practice<sup>16</sup> are inadequate as far as accounting for managerial decision making is concerned.

More specifically, there is insufficient evidence to systematically learn about the attitudinal aspects of communication and working relationships between the two groups contained in the analysis concerning the relationship between accountants and MS/OR specialists.

---

14. See, Caminer and Andlinger (1964); Churchman and Schainblatt (1965); Eilon, Hough and Betts (1969).

15. Radnor, Rubenstein and Bean (1968, p.139).

16. See, e.g. William and Griffen (1964, p.23); Mattessich (1968).



Bennie<sup>17</sup> (undated), studied the "Impact of Quantitative Techniques on Accountants and Accounting Systems" over the period 1966-1969. Going through the list of questions and the background of Bennie's study, it appears that, though containing some interesting objectives - he 'trapped' his research in the following highly critical comments, on accountants and accounting systems:

1. That the greatest barrier to the utilisation of quantitative techniques in management was not the difficulty of devising mathematical models but the inability of the traditional accounting system to produce the information which was required and that unless accounting systems were developed to provide the type of information which is required, it was unlikely that there would be any significant developments in the application of such techniques. In addition, the limitations of accounting information could be overcome if the "operational research approach" were applied to them.
2. Not only were there deficiencies in the accounting system, but the attitudes of accountants themselves constituted a stumbling block. The attitude was largely negative in that accountants did not welcome the use of quantitative techniques and that the reasons for this derived from the accountant's inability to appreciate the potential of such techniques and that he was apprehensive because his established position in the organisation was threatened by their adoption. (Bennie, p.2).

---

17. Bennie, it appears, was mainly concerned with whether the accountant's training (pre-qualifying) in relation to his appreciation of the potential of OR techniques is narrow or balanced; whether the fields of OR and accounting are merging or diverging; whether the relations between OR and accounting are good or bad; and to what extent did it appear that the use of OR techniques and reporting to management in these terms will replace existing and established forms of reporting for which the accountant is presently responsible - either greatly or little. These are examples of the fifteen question analysis of results of the OR questionnaire. Not to mention the fact that his analysis of three main questions to OR personnel was highly loaded by the use of the term 'OR techniques'.

Apart from the obvious 'misjudgment' contained in the design and scope of his analysis, in collecting empirical evidence, questions are phrased in the form of 'zero-sum' game, well-known in game theory. He probably created the conditions in which both OR specialists and accountants would be mobilized against the research which in turn facilitated his reaching the conclusions he arrived at.

More specifically, although he was aware of MS/OR sensitivity towards the term 'OR techniques', his approach to surveying MS/OR specialists was dominated by its presence and implications. This can be easily noticed by simple content analysis of his set of 'results of OR questionnaire'. In addition, it appears that he was preoccupied with the 'negative' conditions surrounding MS/OR specialists - Accountants' relationships and did not give sufficient observation or analysis of reason and backgrounds. Cause and effect relationships and concentration on patterns were given minimal - if any - attention, which may lead to questioning the value of



the conclusions drawn from Bennie's research.<sup>18</sup>

---

18. One wonders what effects such a report would have on an MS/OR specialist or an accountant? Was the researcher aware of the psychological implications of his design in approaching those MS/OR specialists and accountants? What contribution was sought by doing such a survey? These and similar queries are evident regarding the way the research is designed and analysed. To demonstrate, the following two citations are quoted:

"The purpose of the first stage, that is the analysis of the enquiries carried out by the Industrial Operations Unit of the Department of Scientific and Industrial Research was to identify both the techniques which seemed applicable to business problems and the requirements for accounting information which such studies demanded. It was also hoped that they would provide some indication of the impact which such techniques had had. Although the studies ... were most useful in providing information about the specific techniques ... which were being used and in the areas in which they could be applied, it was not so useful in giving an indicator of the deficiencies of accounting information because most of the firms in which these studies were carried out were by any classification small and the accounting systems which were in use were relatively unsophisticated. It was felt, therefore, that it would be wrong to generalise both on the impact of operational research through a study of very small firms, and on the adequacy of accounting systems in such circumstances. Nevertheless, this did throw-up some interesting observations on accountancy, operational research and the small firm which are developed in the conclusion to this report. At the same time as this analysis was being carried out preliminary interviews were being held in a random sample of organisations. The main purpose of such interviews was to use them as a sounding board for the questions which it was intended to put in questionnaire form and to get some general guidance as to the falseness or otherwise of the various hypotheses about the inadequacy of accounting systems, the attitude of accountants and the impact of quantitative techniques which had given rise to the study in the first place. It was during these discussions that the feeling emerged that despite the weight of publicity that had been given to operational research and quantitative techniques in the management science literature, the actual application of these, and consequently their likely impact not only on accountants but on managers and business in general, was considerably less than had been originally envisaged."  
(Bennie, pp.3-4).

"The early interviews disclosed that when it was realised that similar questions were to be put to both O.R. personnel and accountants answers began to be qualified through a desire to apparently project a good company image or not to wash dirty linen in public. By emphasizing that the purpose was not one of cross checking it was hoped that this would be minimised, although, of course, it was not possible to guarantee this."  
(Bennie, p.10).

Many lessons can be drawn from the above discussion, amongst them are: an inadequate amount of information is available regarding the interaction under consideration which enforces the importance of the need for a more carefully designed explorative study of the environmental, organisational and background conditions and factors affecting these organisational groups; the relations between MS/OR and accountants should not be characterised by one of two values - either good or bad, black or white: certainly this type of intergroup behaviour is the function of a set of complex causes and factors and produces different patterns and consequences (subsequently imposing severe limitations on the research contribution).

Other studies have also mentioned the relationship between MS/OR and accountants within the framework of the problem of the proper location of MS/OR groups in organisations.

For example, "A Survey of Operational Research in British Industry", in 1959 indicated that:

" ... location in a production department is probably far better than location in finance department; some operational research workers find it difficult to get a common language with which to discuss their problems with accountants. Until ... operational research workers and accountants learn a bit more of each other's specialities this language barrier, and possibly also a philosophical barrier, will mean that an operational research group located in a finance department is not likely to flourish." 19

However, another empirical research indicates that:

"The results of this inquiry do not form a basis for any sort of sweeping generalisation. Most of what has been reported here is confirmation of that which many people have felt was true. There are not a great many companies doing very extensive OR work, but there is a considerable number that are doing interesting and useful things with the tools of OR, and in the context of that philosophy

---

19. C.f. Rivett (1959, p.198).



which characterises the OR approach to problems. Perhaps the most pertinent over-all observation is that there is a well established nucleus of interest and activity in which financial executives and accountants have a real stake; the results that are being sought (and obtained) are more than mere promise, and there is more than a dim glow in the Eastern Sky." 20

As can be seen from the above examples, there is no clear picture about patterns of communication and working relationships between MS/OR specialists and accountants, particularly in the case of U.K. There is a need to empirically investigate the interaction under consideration, the contributing factors to more understanding between the two functional groups contained in the analysis; and the associated problem areas, in an attempt to gain more familiarity about this area of organisational behaviour taking into consideration the growing complexity of organisations and their related environments.

---

20. C.f. Vatter (1967, p.730).

2.3. Identification of conceptual dimensions of Accountants - EDP and MS/OR specialists' interaction : a proposed framework of analysis.

---

As can be seen from the above description, there is no clear picture concerning communication patterns and working relationships between accountants on the one hand, EDP and MS/OR specialists on the other. The above description raises many relevant questions:

21

Is the accountant always 'biased' towards his job? Does he consider himself as the 'legal' provider of information for both MS/OR specialists and management? What is his (the accountant's) attitude towards D.P. and MS/OR specialists in his organisation?

What are the main causes and consequences of the above-mentioned 'conflict' situations?

Are these conflict situations typical of the everyday accountant - D.P. and MS/OR specialists' interaction?

Do MS/OR specialists feel 'overpowered' and consider themselves in a 'better' position than that of accountants?

Evidently these questions are direct translations of the above cited examples of interactions between some accountants and some of their D.P. and MS/OR counterparts. The researcher believes, as a matter of interpretation, that some of these questions may not be the appropriate ones

---

21. For the purposes of this study, bias refers to the tendency of one group to interpret situations favourably, to arrive at conclusions in favour of certain outcomes, over others and/or to distort facts or views or introduce judgmental errors.
22. Dealing with money, backed by law, his mastery of manual-based information systems (over many decades in the past) his balance sheet and the determination of his firm's financial position, his income statement and the determination of his firm's income and value of business resources; the accountant may be lead to believe he is still the legal 'provider' of information.



to ask in relation to the objectives of the present study. To help transform the above questions into a more suitable form, the following generalized model (Figure 2.1) for analysing accountants - EDP and MS/OR specialists' interaction <sup>23</sup> may serve as a basis for the identification of relevant conceptual attributes or processes involved in this type of intergroup relationship. Figure 2.1. indicates that the emergent system of intergroup interactions (between E.D.P. specialists and Accountants, and between MS/OR specialists and Accountants) is the product of environmental, organizational, group, and individual determinants and contributions. More specifically:

- 
23. This model is based on the researcher's visualisation of the inputs and the outputs of the emergent system of intergroup behaviour under consideration in this research project. Other researchers might emphasize different dimensions in different models depending upon their research objectives. This generalized model is developed to support the analytical argument concerning the environmental and organizational backgrounds to accountants' interactions with EDP and MS/OR specialists for gaining insights into constructive and effective intergroup relationships. Readers familiar with organization theory will be very well aware of the shortage of solid, empirical evidence and the lack of a completely consistent, reliable and valid conceptual framework to understanding the nature, processes, structures, and implications of the study of organizations. Organizational behaviour and the structural characteristics of organizations have been the subjects of continuous research and investigation by contemporary writers and researchers on organization theory and practice, in an effort to arrive at a (more) systematic and comprehensive typology of the key relationships and regularities contained in organizational processes for more understanding, explanation and prediction towards learning, change and adaptiveness.

For highly analytical efforts to codify behavioural aspects of organizations into propositional inventories, see, March and Simon (1958). For a theoretical orientation of structural variables such as specialisation, centralisation and formalisation, see, e.g. Pugh et al (1963, pp.289-315); Hage (1965, pp.289-320); Pugh et al (1968, pp.65-105); Pugh et al (1969, pp.91-114). For (variables of) differentiation and integration in organisations and environmental uncertainty, see, e.g. Lawrence and Lorsch (1967); Duncan (1971); Duncan (1972, pp.313-327). For viewing organisations as systems, see, e.g. Katz and Kahn (1966); Seiler (1967).

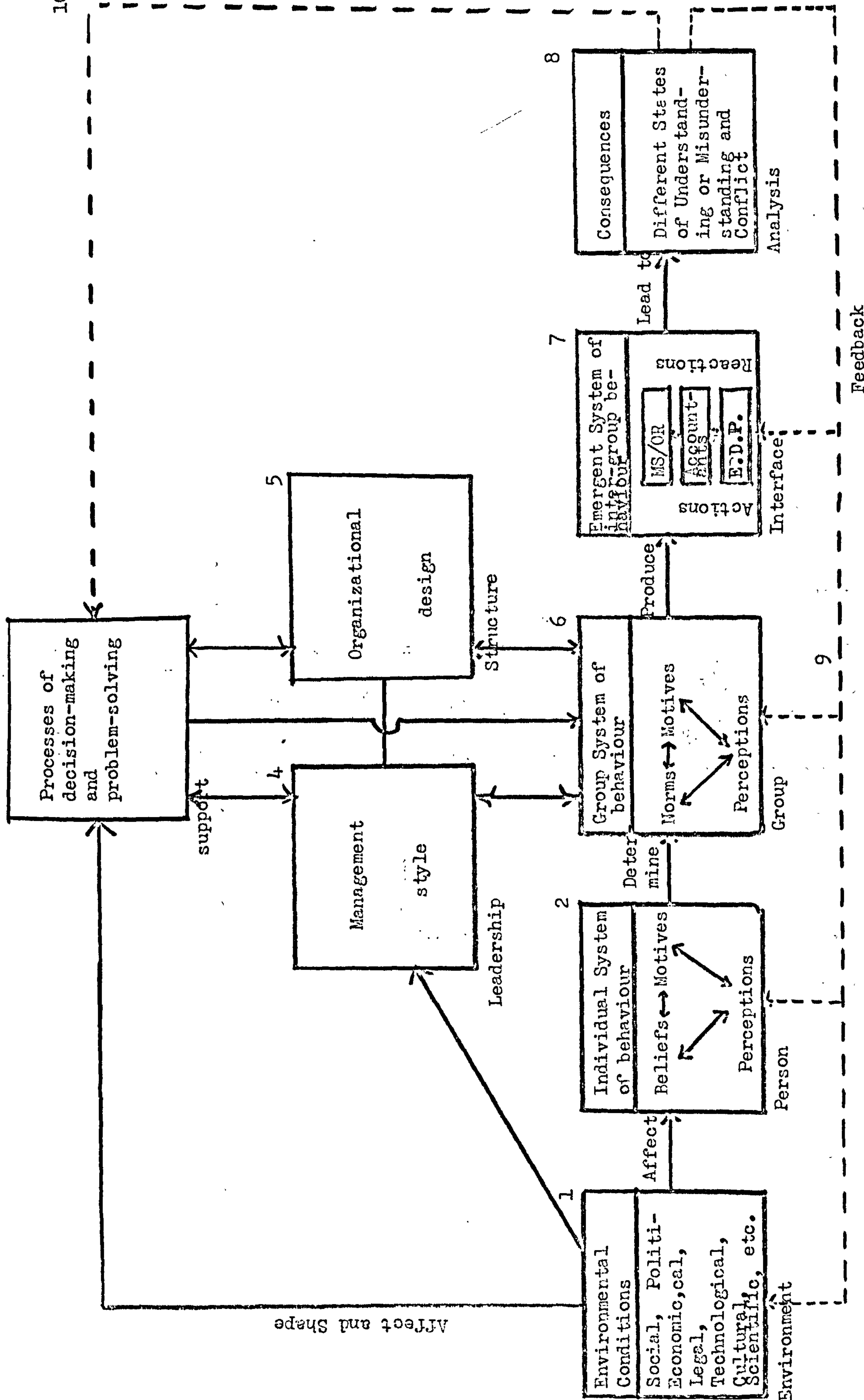

Figure 2.1 A generalized model for analysing "accountants-MS/OR and D.P. Specialists' interaction"



1 Environmental conditions are important factors that affect organizational functioning. As Emery and Trist (1965, pp.21-32) indicate that environmental contexts in which organizations exist are changing at an increasing rate and toward increasing complexity. Drawing on Emery and Trist's above-mentioned work Terreberry (1968, pp.590-613) emphasizes that organizational environments are evolving towards 'turbulent' field conditions characterized by complexity as well as rapidity of change in causal interconnections in the environment. She argues that organizational change is largely externally induced, that survival is the function of adaptability, and that system adaptability (e.g. organizational) is a function of ability to learn and to perform according to changing environmental contingencies.

Technological, political, economic, cultural and other conditions affect, to varying degrees, inputs and outputs of organizational systems. Therefore, the accelerating complexity of modern-large-scale concerns and the associated systems of behaviour need not be emphasized. As for the analysis of accountants - EDP, and MS/OR specialists' interactions, several examples might be quoted to demonstrate the interrelationships between these functional groups - as organizational members in continuous interaction with other systems in society at large and as actors in the behavioural system of their organizations. Amongst these examples are the professionalization issue concerning EDP and MS/OR specialists as members of business (or other organization), the impact of computers on accountants and the structure of accounting functions in business organizations and the nature and reciprocity between accountants on the one hand and EDP and MS/OR specialists on the other as a result of the environmental influences.

More specifically the nature and scope of the relationship between professional and learned societies on the one hand, and their respective

members on the other, are amongst the evident manifestations of this factor on the system of accountants - EDP and MS/OR specialists' interaction. The type and scope of the relationship, for example, between The Institute of Chartered Accountants in England and Wales and its members differs from that nature and scope of relationship between The Operational Research Society (or the British Computer Society) and its (their) members. Studies in the common body of knowledge of accounting carried out recently in the U.S.A., Australia, and the U.K., are illustrations of the nature and scope of on-going interaction between members of the accounting bodies and their professional organizations.

To get a feeling of the types and topics of discussion between the editorial 'Leader' of Accountancy and the journal audience, the following citations may be appropriate:

- titled 'A duty to remain professionally competent, (January 1974, pp.2-3), the editorial 'Leader' states that:

"Like doctors and lawyers, accountants owe a duty to themselves, their clients, patients, or employers, to remain professionally competent. A doctor whose skills were those of a bye-gone era would clearly be seen as a menace to society. Nor could a lawyer practise today on the basis of the law as it was when he qualified. No more should an accountant. Few try, but the pressures and temptations are great.

Accountancy, as everyone knows, involves a wide range of skills, not all of which are necessary to all accountants all the time. Unfortunately, this does not reduce the danger of obsolescence; indeed it may well increase it. For it is so easy to say 'I no longer pretend to be a tax expert. I leave that to ...' or 'I'm too old to try to understand all that algebra ... all those graphs and charts ... I just turn over the page'.

Don't let us delude ourselves: fellowship by examination alone will not cure this - even if, as some might like to see, the examination had to be repeated every five or ten years to retain one's fellowship. And who would pretend that a specialist qualification in tax earned in 1960 was any evidence of skill in 1974?

Professional incompetence is an insidious creeping mental paralysis affecting all age groups and classes of accountant - even those with journalistic aspirations - even occasionally those scarcely past their final examination".



- titled "2000 AD - here we come!" (March 1974, pp.2-3), the editorial leader discusses the need to expand the services offered by the average practising accountant and that need will not wait for the year 2000. He touches upon, among other things, the issues of entry to accounting, education, syllabuses, and post-qualification education and training. These issues are relevant to accountants in industry too. He indicates that:

"Putting its faith in the polytechnics, less perhaps because of their intrinsic merit, more because of an insufficiency of university places in accounting, the Institute has tended to retain at least some of the 'O' Level, 'local boy made good' image which it has been during the last five or six years so anxious to discard.

"Syllabuses, not least the Institute syllabuses, are notoriously difficult to interpret, and it will be interesting to see just how the very considerably revised examination syllabus for 1975 and beyond will work out in practice. The best certainly appears to have been a shift from a craft-orientated belaboured bookkeeping being a memory test to one requiring a new depth of theoretical understanding - a shift which, provided it doesn't go too far, is not unwelcome".

"A change is already with us; the November 1973 Final Part II auditing paper required a breadth of understanding, an imaginative appreciation of problems entirely strange to most candidates, on a scale previously quite unheard of. This is surely the way the Institute must go: away from the rote learning parroted by the countless thousands who ground their way night after night through hours of lonely text book correspondence, towards some more concentrated form of education better adapted to meet the needs of the rapid technological changes which are likely to occur for the next 25 years."

"Equally important if the qualification is to have any real significance are likely to be periodic examinations of those already qualified. As one member remarked recently: 'The MOT test has led to a quicker obsolescence for motor vehicles and to a considerable improvement in general maintenance standards. Would the periodic examination of chartered accountants be any less effective?' "

- emphasizing the need for forward-looking accounting rather than editorial narrowly outlined and restricted accounting practice, the/Leader (April 1974, pp.2-3) indicates that:

"If the accountant is to maintain his position as a valued advisor in the face of rising competition from other professions, he must be seen to offer that which cannot be obtained elsewhere. He need not be a specialist in other disciplines, but he does need the basic rudiments of knowledge and he does need to know to whom he should turn, or to whom he should advise his client to turn for further advice.

To the average small businessman, his accountant is his father confessor, the one man from whom he will seek advice on all matters financial. Send him to a stockbroker for investment advice and he will never be told to invest his money in the local building society, nor to invest it in life assurance. Send him to an insurance broker and he will not be advised to invest in another local business. His accountant will be in the best position to advise the most suitable field of investment, while at the same time keeping his eye on estate duty and tax planning situations.

It is not just the big firms that should be able to offer clients central financial planning expertise and basic advice on improving the accounting systems employed by them; this is something every practitioner should offer as a matter of course. Any firm, large or small, should be prepared to take time to examine clients' internal control systems and, where necessary, to advise improvements.

The accountant who does not provide these services is not doing his job, and he should not be surprised if others do it for him.

Admittedly, all these services take time: not just the time involved in the client interview, but thinking time and research time too. Sadly, the average accountant appears reluctant to allocate pure thinking time; even further study time comes low on the agenda of his day. If, as a profession, we are to retain our splendid reputation, such time allocation must be made by all who seek to practise under our banner".

These comments not only apply to accountants in practice, but also to those in industry and commerce. They illustrate the role assumed by accountancy bodies in guiding and monitoring the education and training, professional ethics, and task orientation. To suggest that these aspects do not affect the accountants' (in industry or elsewhere)



attitudes and patterns of communication with other specialists, such as MS/OR and EDP, would underestimate the effects of these environmental conditions upon the emergent system of accountants - EDP and MS/OR specialists intergroup behaviour. On the other hand, MS/OR and EDP specialists do not look, in the main, to their respective societies for monitoring and guidance on similar matters.

Such differences<sup>24</sup> are likely to affect many of the behavioural implications contained in the emergent systems of intergroup behaviour.

---

24. This logic may serve as a preliminary explanation to the behavioural manifestations, particularly stereotyping behaviour, of some accountants discussed in the preceding section.

2 Individual systems of behaviour play a key role in the systems of interactions under study. Perception, inducement and learning are amongst the basic psychological issues contained in individual, group and emergent intergroup systems of behaviour. A brief discussion of each of these issues is useful in demonstrating their relevance and importance:

- (a) What accountants, EDP, and MS/OR specialists perceive is determined by a complex set of factors that affect their behaviour.

Basically, the complexity of the human organism's perception has to be recognised. March and Simon (1958, pp.10-11) suggest that an individual's behaviour, through a short interval of time, is determined by the interaction between his internal state (which is partly a function of his previous learning) at the beginning of the interval and his environment. It is not only these two sets (the internal state and the environment) that determine behaviour, but also what the internal state will be at the next moment of time.

General findings of studies of perception - summarized by the 'AAA Report of the Committee on Behavioural Science Content of the Accounting Curriculum' (1971, pp.250-252) - have indicated that:

- (i) the perceptions of the individual - his ideas about persons and things - are selectively organised. Only certain objects enter into his conception of the external world. Moreover, this selective organisation of perception is determined not only by stimulus factors which derive from the nature of the stimulus object, e.g. frequency and intensity, but also by personal factors which derive from the characteristics of the perceiving individual, e.g. his wants, emotion, and mental sets.



- (ii) the separate perceptions of the individual about objects and persons develop into systems of perceptions such that the properties of a given perception depend in part upon the particular nature of the inclusive system. The "same" perception may be embedded in different systems and therefore have different properties.
- (iii) changes in perception may be brought about by either a blockage of want satisfaction or by a change in the individual's information. The degree and manner in which changes in wants and information produce changes in perception depend upon the characteristics of the pre-existing systems of perception and upon the characteristics of the person within whom the systems of perception reside.
- (b) The importance of 'learning' in relation to the accountant, EDP and MS/OR specialists, individual systems of behaviour need not be emphasized. A month does not pass without one or more articles in business periodicals concerning the problems of education and training (towards learning) for accountants, EDP and MS/OR specialists. Similarly, conferences or seminars are being held in which these problems occupy an important place on the agenda.

With regard to this, the following observations can be made:

1. education and training is an essential way of keeping abreast of recent developments in the areas of information technology and management sciences. It can help accountants as well as management scientists to ask the right questions about problems facing them and may direct the attention to possible ways of efficiently adapting themselves to the changing environment. In addition, the proper policy of education and training might help in removing some of the barriers that hinder effective communication.

2. As for accountants, it has been generally admitted in the U.K. - by accountancy professional bodies, academics, and those who are interested in maintaining "good standards" of the accounting service - that the present state of the accounting profession is inadequate.<sup>25</sup>
3. Not enough empirical evidence - if any - is available concerning accountants' opinions and attitudes towards recent developments in D.P., and MS/OR areas. Many questions related to this dimension may find better answers by means of field studies. Do accountants in small firms face similar problems to those who are working in larger ones? Are there any significant differences in the nature, size, and acuteness of problems facing 'financial accountants' from those who are working in the 'management accounting' field? These are examples of such questions that need further investigation and empirical evidence before answers can be supplied.

25. No attempt is made here to provide a general review of the detailed discussion on this problem. Nevertheless, urgent questions in this respect may be summarised as follows: Should accounting be a graduate profession (involving graduation through an approved degree from universities and polytechnics)? What are the best methods of qualifying as an accountant? correspondence, part-time or full-time study? What is the best formal relationship between the professional accountancy bodies in the U.K? For a detailed discussion of this issue, see for example; Perrin (1971, pp.554-562); Lewis & Stitt (1972 a. pp.211-212, 1972 b. pp.245-246).

Also, a long-range enquiry has concurrently been conducted by Prof. Solomons on behalf of the six accountancy bodies in the U.K. for studying the common body of knowledge of the accountancy profession. Terms of reference of 'Solomons' enquiry' are as follows: (a) general requirements for entry to the profession; (b) the content of professional education - curriculum, duration and timing of study; (c) the organisation of professional education. The division of responsibility for its provision; (d) the place of practical experience - quantity, quality, problems of supervision. Should it be a prerequisite to qualification? How should educational training be related to each other, as regards timing and division of responsibility?; (e) the nature of examinations. How should professional competence be tested?; (f) Continuous professional education. Post-experience qualifications and specialisation; (g) the future size, organisation and responsibilities of the profession; and (h) relations with other social institutions, e.g. central and local government, other professions (such as the legal profession). See the interview with Professor Solomons by: J.Millen of Accountancy, July 1972, pp.26-29).



- (c) It would be no exaggeration to consider 'motivation theory' as one of the most challenging areas of the behavioural sciences; there is no comprehensive theory that enables the understanding of the reasons, goals, or motives of human behaviour for choosing certain patterns of behaviour and rejecting others.<sup>26</sup> The dynamic, complex and transient nature of an individual's needs and goals, his personality and the diverse factors that determine his behaviour and the unsettled issue of a 'unified' definition of the term (motivation) are some of the elements that have contributed to the difficulty of finding a comprehensive theory of motivation for the explanation and prediction of the forces that motivate individuals in human organisations.

Within the framework of the present research the 'motivation' dimension refers to: the kind of motives (with respect to MS/OR and D.P.) needed for achieving organisational goals; how do accounting functions influence needs and goals of MS/OR and D.P. specialists?; and to what extent accounting and accounting systems assist other functions - D.P. and MS/OR in particular - in the accomplishment of their goals.

---

Although there is some common ground between the American study conducted by Roy and MacNeill (1966) and the British one referred to above, it has to be admitted that there are many points of difference that make the latter enquiry much more difficult than the former. The structure of the accountancy profession in the U.K.; behavioural elements between members of the different bodies; and entrance requirements: are some examples of these differences.

Evidently, both surveys (the present survey and the above-mentioned one) are not mutually exclusive.

26. For a detailed discussion of contemporary theories and models of motivation, see, for example, Maslow (1954, chapter 5) and Vroom (1964, chapter 2).

3 A fundamental objective of the system of intergroup interaction under consideration is to provide managements with the necessary and sufficient support in relation to problem solving and decision making processes.<sup>27</sup>

It is based on the premise that the more isolated each of the groups (accounting, EDP or MS/OR specialists) are from the others, the less effective is the support to their managements and thus the less is the managerial or organizational effectiveness. The quality and quantity of the product of information processing, search and thinking contained in decision making and problem solving processes are influenced by internal features of the organisation as well as external environmental factors.

One of the critical components in the effective support to processes of decision making and problem solving is the amount of certainty/

---

27. For a comprehensive discussion of related concepts, see, e.g. Taylor (1965, pp.48-86); Alexis and Wilson (1967).



uncertainty.<sup>28</sup> Other factors being equal, the greater the certainty in strategic situations, the greater the likelihood of less difficulty in tackling problems. Accordingly how the groups involved can collaborate to reduce the amount of uncertainty is a major consideration in the provision of support services. Also in a direct sense the less the degree of

28. Thompson (1967, pp.134-137) indicates that decision issues always involve two major dimensions (1) beliefs about cause/effect relations and (2) preferences regarding possible outcomes. These are the basic variables of decision-making. For keeping the discussion within bounds, he suggests that each variable can be dichotomized into conditions of certainty and uncertainty as can be seen from the following table

Preferences regarding possible outcomes

		Certainty	Uncertainty
Beliefs about cause/effect relations	Certain		
	Uncertain		

Accordingly each type of decision issue calls for a different strategy:

- where there is certainty regarding both variables, the decision maker can use a "computational" strategy.
- where outcome preferences are clear but cause/effect relationships are uncertain, a "computational" strategy for decision making can be used.
- where there is certainty regarding cause/effect but uncertainty regarding outcome preferences, the issue can be regarded as calling for a "compromise" strategy for a decision making.
- where there is uncertainty on both dimensions, the issue can be regarded as calling for an "inspirational" strategy, if indeed any decision is forthcoming.

Evidently, a common denominator of both Thompson's framework and the above analysis (regarding accountants' interaction with their EDP and MS/OR counterparts) is the quantity and quality of information available in a system. The more (sufficient and relevant) the information about cause/effect relationships, the more certain is decision making.

collaboration the greater the degree of (internal) uncertainty generated, that is, uncertainty about the behaviour of one's colleagues.<sup>29</sup>

---

29. The essential roles of uncertainty and of differential amounts of knowledge in different parts of an organisation in the central problem of organisational control, are explained by Arrow (1964, pp.397-408).



4

The role played by managements (of decision making and problem solving support sub-systems) affect the inputs to the system of accountants - EDP and MS/OR specialists intergroup behaviour within the larger system of their organisations. The degree of management understanding of, and involvement in, the design of relevant decision support systems has its consequences for the effectiveness of the product of such support systems.

Basically, management attitudes in regard to the nature, design and control of decision support systems are the product of multi-interrelated factors. Examples of those factors affecting accountants - EDP and MS/OR specialists' relationships are: environmental conditions, organisational structure and design (and the associated dimensions of differentiation and integration), the characteristics of individuals contained in this type of vertical communications and the specific circumstances prevailing. If, for example, the top management of an organisation (rightly or wrongly) believes that the location of the MS/OR function should be under the responsibility of the accounting leadership, attitudes of MS/OR specialists and their behaviour may not be the same as if they were located under the responsibility of non-accounting directors.

5

Structural arrangements are important factors that affect processes within organisations. Different structural considerations have different implications for the effectiveness of organisational functioning. In particular, the structural characteristics of EDP and MS/OR functions are an important consideration that affects facets of organisational life involved in the accounting - EDP and MS/OR specialists' interaction.

Prior field studies do not give clear ideas about the 'proper' location and the problems attached to each particular design. This can be noticed from the following observations:

- (i) In the U.K. little evidence is available which makes it very difficult to generalize. Rivett (1959, pp.198-199), in his survey of O.R. in British Industry, pointed out that there are some problems of locating O.R. activities in a finance department such as the difficulty of some O.R. workers to get a common language with which to discuss their problems with accountants.
- (ii) In the U.S.A. the available empirical evidence gives some indications that financial areas are a major location of O.R. activities. Vatter (1967) in his enquiry about the use of O.R. in American companies indicates that accounting departments take a fair share of the overall O.R. responsibility in 40% of the total 360 companies (62% of the users).<sup>30</sup>

---

30. It should be noted the size of the sample is too small to generalise right across the whole spectrum of American industry. Enquiry forms were sent to the entire membership of the Financial Executive Institute, asking for information about O.R. activities within their companies. Replies were received from 360 respondents - out of some 3,500 companies represented in the original list (See: Vatter, 1967, pp.721-722). Nevertheless, the study might give some indication to the pattern of using O.R. activities and their relationship with the accounting function.



Also, Radnor, Rubenstein and Bean (1968, pp.127-128) indicated that OR/MS activities started in the 1950's to a large extent in R. and D., engineering, manufacturing (or operations) and in financial areas. They pointed out also that during the first few years there was an expansion of the proportion of R. and D. groups, followed from the late 1950's to early 1960's by a period of very substantial relative contraction of OR/MS in R. and D. Engineering and manufacturing both failed to establish themselves as locations of major O.R. activity. By contrast, the financial area has demonstrated sustained and substantial expansion, to become by the 1960's the major location of OR/MS activities in U.S. business organisations.<sup>31</sup>

Ideally, the measurement of this dimension would require (scientifically) sampling all those British firms, institutions and organisations that conduct formally or informally any kind of MS/OR, and D.P. activities to discover the actual location of such activities, problems arising out of their organisational location, and the best location for the efficient utilization of these organisational resources.

Obviously, this ideal approach is beyond the resources available to the present researcher. Alternatively, asking direct questions to a sample of the concerned parties (MS/OR, and D.P. groups) would be satisfactory as far as the objectives of the present research are concerned. Amongst the direct questions that could be asked are: What is the actual organisational design of each of these functions? What are the associated difficulties and/or problems? What would be the best form of organisational design (as viewed by respondents and participants)?.

---

31. Radnor et al's study is based on multiple interviews which were conducted in 66 major U.S. corporations (among the biggest in U.S. business, with all but 9 appearing in 1965 Fortune listing of the largest U.S. corporations.

6 Groups are formed of two or more individuals to carry out certain tasks for their organisations to satisfy their personal needs and functional and organisational objectives. Norms, beliefs, standards and attitudes are formed within the group about its internal and its external environments. Accountants have their functional responsibilities towards their professional bodies as well as to their employing organisations. By the same logic, EDP and MS/OR specialists adopt their standards, formulate their beliefs, and carry out their assigned tasks.

The interest of this study is not so much within the groups themselves, but in the working relationships between these functional groups involved in the production, interpretation and analysis of information for managerial decision making and problem solving. Although, of course, the two are interrelated and interdependent. However, the focus in this investigation is on the accountants - EDP and MS/OR specialists' intergroup relationships. But the importance of this level of analysis has to be recognised.



7 The 'emergent' system of accountants - EDP and MS/OR specialists' intergroup behaviour is the focal point of this investigation. Emphasis is on interactions between groups rather than within any of them, although the two are interrelated.

In this respect, the researcher does not have the design of a 'perfect' pattern of communication in mind as an objective of the present investigation. Rather, the researcher is seeking to analyse causes and consequences of different communication patterns and to explore the factors that might contribute to less misunderstandings and less vagueness in language, thinking and communication.

The significance of this becomes clear on discussing two issues. The first is the general model of a communication system suggested by Shannon and Weaver (1949) presented on the following page.

32. Kuhn (1974, p.435) explains that:

"... In the simplest case of emergence ... two or more systems combine into a larger system in which each of the previously independent systems is now a subsystem. \_\_\_."

Also he indicates that:

"Since it is the opposite of entropy, emergence is often known as negative entropy, or negentropy. It is also referred to as increasing structure, increasing order, decreasing chaos or randomness, and creativity; ..."

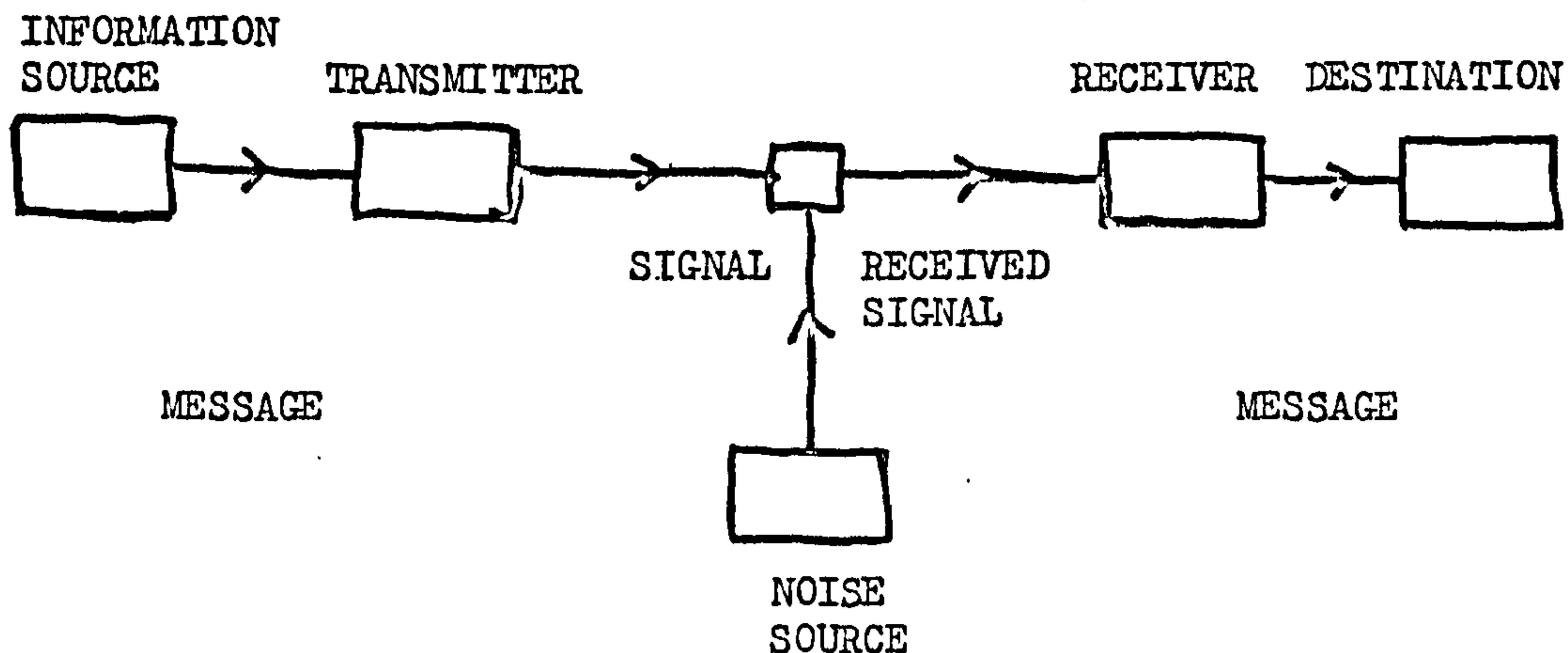

Such a communication system consists of essentially five parts:

1. the information source which produces a message or sequence of messages to be communicated to the receiving terminal. It selects a desired message out of a set of possible messages.
2. a transmitter which changes the message into the signal suitable for transmission over the channel. The function of the transmitter is to encode the message.
3. The channel is merely the medium used to transmit the signal from transmitter to receiver.
4. the receiver ordinarily performs the inverse operation of that done by the transmitter, reconstructing the message from the signal. The function of the receiver is to decode the message.
5. the destination is the person (or thing) for whom the message is intended.

FIGURE 2.2. Schematic diagram of a general communication system.

[Source: Shannon and Weaver, 1949, pp.3-28, and pp.31-35.]



The second is communication problems relating to content, meaning and transformation of messages. Guetzkow (1965, pp.551-558) discusses some of these problems. He indicates that when the symbols fail to carry the full contents of the messages, their semantic properties are transformed as they are handled within a communication flow - either by omission<sup>33</sup> of aspects of the contents, or by introduction of distortions.<sup>34</sup>

33. As Guetzkow (1965, p.551) suggests, omission is the deletion of aspects of messages. It is a common phenomenon within social communication. It sometimes takes place at the point of message reception, in that the two or three levels of meaning of the communication simply are not grasped. Or, more grossly, the message may be neglected because of sheer overload in message-processing capability. Omission may be intentional. Also, omission of detail (filtering - aggregation), as messages are transmitted within organisations, may provide one means for reducing overload.
34. As Guetzkow (1965, pp.553-558) explains, there are a wide variety of ways of getting distortion of the meaning of messages. Condensation, assentuation, assimilation to personal value contexts are amongst the different ways to alter meaning and content of messages. People are selective in their perceptions which affect the way messages are perceived. Guetzko indicates:
- " ... because different persons man different points of initiation and reception of messages, there is much assimilation of meanings to the contexts within which transmission occurs. Frames of reference at a multitude of nodes differ because of variety in personal and occupational backgrounds, as well as because of difference in viewpoint induced by the communicator's position within the organisation". (p.555).

The concepts contained in the above-described communication system and the associated problems are fundamental to the emergent systems of interaction under consideration in this study. What are the types of messages transmitted and received on both sides? What are possible sources of noise contained in the communicated messages? What are communication problems associated with the selecting, coding and encoding of messages? How effective are the conveyed messages in supporting managerial decision making and problem solving? It is necessary that satisfactory answers to such questions be attempted in order to analyse, formulate and propose possible ways of increasing the effectiveness of these groups involved in information analysis, interpretation and support for the managements of their organisations.



8

The emergent systems of accountants - EDP specialists' relationships, and of accountants - MS/OR specialists' relationships leads to different states of understanding between the groups involved. There are very many terms that might be taken to describe the type and quality of the consequences of the emergent system under investigation such as: conflict,<sup>35</sup> non-co-operation, dissonance, disagreement, confusion, challenge, and opposition on the one hand; co-operation, understanding, agreement, team-spirit, sympathy, and reconciliation on the other. However, the term conflict has been widely discussed.<sup>36</sup> As Pondy (1967, pp.298-299) emphasizes:

"The term 'conflict' has been used at one time or another in the literature to describe: (1) antecedent conditions (for example, scarcity of resources, policy differences) of conflictful behaviour, (2) affective states (e.g. stress, tension, hostility, anxiety etc.) of the individuals involved, (3) cognitive states of individuals, i.e., their perception or awareness of conflictful situations, and (4) conflictful behaviour, ranging from passive resistance to overt aggression. Attempts to decide which of these classes - conditions, attitude, cognition, or behaviour - is really conflict, is likely to result in an empty controversy. The problem is not to choose among these alternative conceptual definitions, since each may be a relevant stage in the development of a conflict episode, but to try to clarify their relationships."

- 
35. "While conflict between systems is inevitable by the definitional differences between systems, there is no evidence to support the idea that conflict is inevitably non-productive" (Seiler, 1967, p.15).
36. Ample discussion is available with regard to the issue of organizational conflict. For example, an entire issue of Administrative Science Quarterly (Vol.14, No.4., December 1969) is devoted to the discussion of nature, types and consequences of this conceptual variable (conflict). Also, see, e.g. Walton and Dutton (1969, pp.73-84); Schmidt and Koohan (1972, pp.359-370).

Conflict may be functional or dysfunctional. There are different bases,<sup>37</sup> stages,<sup>38</sup> consequences of conflict as well as different methods of its resolution.

Interpreting Accountants - EDP and MS/OR specialists' interaction (as described above in sections 2.1. and 2.2.) suggests that these systems of interactions (multi-cause situations and conditions producing several outcomes) are the product of a mix of factors, namely, environmental, organisational, and individual ones. Such dynamic, multi-cause, multi-effect phenomena compounded with the implications of adopting the widely discussed but loose term "conflict", have caused the researcher to favour adopting the term 'understanding'. The choice of the latter reflects the angle from which the researcher is focusing upon the interactions under consideration. Therefore,

37. Katz (1964, pp.105-106) describes three sources of organisationally based conflict. The first is the functional conflict induced by various sub-systems within the organisations. The second is that featured by hostile rivalry or good-natured competition. The third is the hierarchical conflict stemming from interest-group struggles over the organisational rewards of status, prestige, and remuneration.
38. On the basis of the view that conflict is more readily understood as a dynamic process, Pondy (1967, pp.299-306) explained that there are five stages of a conflict episode. They are (1) latent conflict (conditions), (2) perceived conflict (cognition), (3) felt conflict (affect), (4) manifest conflict (behaviour), and (5) conflict aftermath (conditions).



concepts as accountants - EDP specialists' understanding,<sup>39</sup> and accountants - MS/OR specialists' understanding are given considerable attention in this research.

---

39. Dictionary of the Social Sciences defines understanding in the following manner.

- "B.1. Definitions of understanding as a group phenomenon refer to the knowledge people have about each other's behaviour when they share expectations in a common cultural setting. \_\_\_\_ .
2. As an individual phenomenon, understanding is defined in terms of levels of personal development which result from a combination of maturation and learning. \_\_\_\_ .
  3. On both the individual and the group level, understanding is limited and shaped by attitude, sentiment, and other effective factors. Accordingly, some social scientists feel that a definition of understanding should take such factors into account. While distinguishing between two kinds of understanding, knowledge about something and sympathetic understanding of it, G.Stratton remarks ... 'A larger kind of understanding [than mere "knowledge about"] is necessary, where tolerance and appreciation are fused with the knowledge, as in the understanding between a man and his dog, or between friends, ... ' Similarly, C.A.Ellwood notes ... 'In general, we find it difficult to understand or sympathise with others unless we think of them as essentially similar to ourselves'.
  4. When defined as a type of behaviour, understanding may be viewed as a process of interaction in which significant symbols are shared, or as a product of interaction having various dimensions. \_\_\_\_ .
  5. When considered in relation to products of interaction, understanding is often defined in terms of role-taking skills which result from meaningful interactions, and which are used to explain social phenomena. \_\_\_\_ . "
- (Gold, 1964, pp.734-735).

9 Feedback concepts are important in understanding the processes of and regulation behaviour/of a human system. They play a central part in organisational control activities in which a system continually regulates its performance according to some criteria or standards. In terms of negative feedback, deviations from standards are reported and the need for a change (or elimination of some elements) are expressed. Clearly, accountants-EDP, and MS/OR specialists have a major role to play in the production and communication of information for monitoring and controlling performance in their organisations. More specifically, this role is made effective via the establishment of standards or goals, in measuring performance, in reporting differences of actualities from standards or goals, in the generation of new standards, and in reducing uncertainty.

Ideally, to study the problem of accountants - EDP and MS/OR specialists' understanding, one has to take into consideration a wide variety of interrelated conceptual dimensions. Examples of these dimensions are acceptance, adaptation, anxiety, authority, communication distortion, communication omission, communication overload, conflict, complexity, co-ordination, competition, co-operation, confusion, conditioning, cognitive style, control, differentiation, dominant coalition, effectiveness, efficiency, image, inducement, integration involvement, knowledge, leadership style, management attitude, patterns of communication, perception, performance, politics, power, pressure, resolution of conflict, sanctions, and structure to enumerate but a short list. Furthermore, the vast majority of these conceptual

- 
40. Closely related to this are: primary regulation, secondary regulation, organisational control function, dynamic equilibrium, negative feedback (error-compensating, self-correcting mechanisms), positive feedback (incentive mechanisms) addition of new elements, organisational learning, uncertainty absorption, bounded rationality. For detailed discussion of systems properties of organisations, see, March and Simon (1958); Katz and Kahn (1956); Miller (1972).



dimensions need to be empirically operationalised into a larger number of indicators (perhaps three to six or more indicators for every conceptual dimension to be operationalised).<sup>41</sup>

The immediate question that arises is which conceptual dimensions should form the basis of such investigation; particularly when the empirical evidence in relation to accountants - EDP, and MS/OR specialists' interaction has undergone very little systematic study. This is the question of strategy to be adopted in investigating such interaction. Should the researcher start with a normative structure of how the groups involved in the interaction should behave? Or, should he start with an attempt to understand how these groups do actually behave?

The advantages of the latter seem to outweigh those of the former.

This is stated on the basis of the following reasons:

- 
41. The issue of empirical operationalisation of conceptual variables is fundamental to any research in the measurement of observations and communication of findings. It is discussed widely amongst behaviourists. See, e.g. Festinger and Katz (1953); Selltiz et al (1959); Runkel and McGrath (1972); Kerlinger (1973).

It is needless to emphasize that the quality of such empirical operationalisation is constrained by the nature of the problem under investigation and the available resources. However, the researcher has transformed the relevant conceptual dimensions into a number of direct and indirect questions (mainly in Part II). This is followed by an analysis of the findings leading to a number of indicators concerning accountants' working relationships with their EDP and MS/OR counterparts. Analysis of the findings in relation to these indicators is presented in Part III.

- (i) the researcher is seeking to gain insights into some of the complexities contained in the behavioural processes forming the space of accountants - EDP, and MS/OR specialists' relationships. Therefore, a fair amount of explorative work is required in the first place to provide further understanding of the empirical reality. Such exploration should avoid the use of buzzwords and simple cause-effect models that would serve the means rather than the objectives. It should provide the researcher with those indicators that seem to be critical in studying the interaction processes and consequences. Evidently, it is a question of priorities rather than one of modelling sophistication.
- (ii) due to the fact that this research is focusing on relatively large-sized organisations (to warrant the use of EDP and MS/OR services), the difficulty in manipulating different, environmental conditions and different internal processes in a variety of organisational settings becomes evident.
- (iii) though the issue of organisational effectiveness is an important consideration that stimulated the very idea of the present research, the researcher is aware of the constraints imposed upon the scope of his analysis. Accordingly, the analysis is not centered upon one dependent variable and a set of other independent variables for explanation and prediction. Rather, it is designed so as to allow for the interdependence amongst a wide variety of behavioural indicators, to take place.

The above analysis emphasizes the multivariate nature of the problem under investigation. It raises the question of the appropriate method(s) to suit mainly such an area of research; that is, method(s) of the analysis



of dependence or methods of the analysis of interdependence.<sup>42</sup> (Of course, the use of one approach does not exclude the use of another - rather it is a question of selecting a suitable strategy.)

Five main points emerge from the preceding discussion in this chapter. They are:

First, the problem under investigation is a complex one. The phenomenon involved is characterised by interdependent multi-variate attributes and consequences. Simple cause-effect models are not sufficient for the analysis of such conditions.

Second, the problem contains a wide variety of conceptual dimensions that do not have standard operational definitions (if any at all). Some of the terminologies involved mean different things for different users of such terms. Therefore, the empirical search for the operational identification of the behavioural indicators featuring accountants - EDP, and MS/OR specialists' interactions should play an important part in the examination of such behavioural processes. This must consequently occupy the early part of the empirical study.

Third, the focus of the study is not on the negative interaction and/or disruptive aspects of conflict and communication. Rather, this research makes use of the terms accountants - EDP' specialists' understanding, and accountants - MS/OR specialists' understanding, as fundamental issues of the study.

---

42. Kendall (1950, pp.60-73) suggested that it is useful to draw a distinction between the analysis of dependence and the analysis of interdependence. In the latter, we are interested in how a group of variables (variates) are related among themselves, no one variable or group of variables being marked out by the conditions of the problem as of greater prior importance than the others. Factor analysis is an example. In the former, we are interested in how a variable or a certain specified group (the dependent variables) depend on other variables. Regression analysis is an example - the regression of  $x$  on  $y$  is not the same as the regression of  $y$  on  $x$ .

Fourth, perceptual aspects of communication between accountants, EDP, and MS/OR specialists are amongst the main inputs to the present analysis. How do accountants perceive recent developments in MS/OR and EDP areas? How do MS/OR and EDP specialists perceive accountants' contributions and involvement in their systems? How does each of these groups see self- and other image? What are the main characteristics of accounting - EDP and MS/OR interactions? What are the main factors that act as stimuli in the development of the different patterns of perceptions? These are examples of the questions that could be asked in relation to these perceptual aspects. Accordingly, asking direct and indirect questions to groups involved seems to be an appropriate approach for tackling the problem of collecting data and information with regard to:

- the 'self' and 'counter' image constituting the system of perceptions determining accountants - EDP and MS/OR specialists' relationships;
- the different patterns of communication and working relationships contained in this type of organisational interaction;
- the causes, processes, consequences and implications of these different patterns and different emergent systems of behaviour.



Fifth, is the need for qualitative evidence for a twofold reason. That is to support the quantitative evidence resulting from the analysis of interdependence as well as to act as propositional hypotheses stimulating further research. This is due to the researcher's desire to provide empirical insights into the nature and consequences of accountants - EDP and MS/OR specialists' interaction.

Based on the literature survey, the researcher can make the following points to serve as guide-lines in the subsequent empirically-based investigation:

- the analysis of interdependence should play a major role in gaining further insights into the multivariate problem under investigation.
- a fair amount of empirically-based explorative work should be carried out for the operational identification of dimensions of accountants - EDP and MS/OR specialists' interaction. This could be carried out by means of fully- and semi-structured as well as open-ended interview tables and mailed-questionnaires. In this respect the researcher should seek to employ those methodological approaches that would satisfy the objectives of the present research. For example, the researcher should use interview tables and mailed-questionnaires for the identification of the sought empirical dimensions. Then, complementing them by case-studies for the refinement of measurement instruments and the generation of hypotheses.
- providing the means of gaining further understanding about organisational processes and environmental conditions as well as individuals' perceptions

and motivations, particularly those involved in the accountants - EDP and MS/OR specialists' relationships. The more the researcher is able to maintain a balance between the so-called 'quantitative' and 'qualitative' or descriptive aspects of evidence, the higher the researcher's satisfaction. No prior assumption is made that qualitative evidence is less useful in gaining further understanding about the problem under investigation.

- having completed the empirical identification the important behavioural indicators of the interaction processes (between accountants on the one hand, and EDP and MS/OR specialists on the other) are then factor analysed to reduce the large-number of empirically-identified behavioural indicators into a considerably smaller subset of 'most important' factors.



## Summary

This chapter has critically examined the relevant literature in relation to accountants - EDP and MS/OR specialists' interaction. The principal message emanating from such an examination is that this area of organizational interaction is characterized by inter-dependent attributes and consequences.

A set of conceptual dimensions of accountants - EDP and MS/OR specialists' interaction has been identified within a proposed framework of analysis. This interaction is the product of environmental, organizational, and individual contributions. Most, if not all, of the identified conceptual dimensions do not have standard operational (or even theoretical) definitions. Accordingly, the researcher has emphasized that the empirical search for the operational identification of the behavioural indicators, featuring accountants - EDP and MS/OR specialists' interaction should play an important part in the consequent examination. Furthermore, the researcher has concluded by discussing the importance of focusing on the understanding aspects of communication and working relationships between accountants and their EDP and MS/OR counterparts.

## SUMMARY OF PART ONE

The main objectives of the present research outlined in the first part of this study are: to learn about patterns of communication and working relationships between accountants, and D.P. and MS/OR specialists within large-sized industrial organisations and the implications of these relationships for the development and growth of organisational information and decision systems; identifying the major factors affecting these interactions; and describing the present and potential interdisciplinary involvement of accounting, D.P. and MS/OR specialists. Also, basic assumptions have been discussed.

Due to the terminological difficulties contained in the areas under investigation, the researcher has to explicitly define his position on the various definitions affecting the discussion of accountants - MS/OR and D.P. specialists' interaction. The researcher has concluded that many of the related definitions could have different meanings for different purposes and sometimes vague and loose. However, to operationalise such definitions (such as D.P. and MS/OR specialists) job titles would be a major criterion in this respect. Also, due to the fact that there is no clear-cut operational definition of a 'management scientist' which distinguishes him from an 'operational researcher', the empirical part of this study has considered "MS" and "OR" specialists as interchangeable.

Following description of the background of the study, a literature-based analysis of the accountants - MS/OR and D.P. specialists relationships was then considered in an attempt to serve as a background of the empirical part. This attempt has outlined the relationship between accountants and MS/OR specialists (where there are some indications of intergroup conflict and misunderstanding - as suggested by the literature);



the relationship between accountants and D.P. specialists (where there is very little evidence regarding this aspect of the interaction under consideration); and the appearances of accountants and accounting functions (which can briefly be described as unsatisfactory regarding accountants keeping pace with recent developments in D.P. and MS/OR areas).

Fundamentally, the intergroup behaviour under consideration should be viewed in terms of its organisational and environmental contexts to show what might be described as the general determinants and consequences of this system of organisational interaction. Accordingly, a set of 'primary' dimensions has been developed to build (in broad terms) the outline of the empirical investigation. These dimensions are to be operationalised and tested for their empirical meaningfulness to satisfy the basic objectives of the present study. Transformation of these seemingly abstract dimensions into indicators, component variables or variables is one of the main tasks of the researcher in collecting the data and information required to form a satisfactory analysis of the type of organisational interaction under consideration. This is the main object of the next two parts of the thesis.

**PAGE**  
**NUMBERING**  
**AS ORIGINAL**



## Part II

### AN EXTENSIVE EMPIRICAL SEARCH INTO ACCOUNTANTS-EDP AND MS/OR SPECIALISTS' INTERACTION : OPERATIONAL IDENTIFICATION OF THE PROPOSED FRAMEWORK OF INTERDEPENDENCE

---

This part presents the analysis of the extensive empirical operationalization of the conceptual framework proposed in Part I. It contains the detailed analysis of the empirical evidence collected from samples of EDP, and MS/OR specialists and accountants.

This part consists of the following four chapters:

- Chapter Three : is a detailed account of the overall empirical design and methodological strategies adopted throughout the survey.
- Chapter Four : is an analysis of opinions and views of EDP specialists regarding their working relationships with accountants.
- Chapter Five : is an analysis of opinions and views of MS/OR specialists regarding their working relationships with accountants.
- Chapter Six : is an analysis of opinions and views of "some" accountants regarding their working relationships with EDP and MS/OR specialists. Bringing together the evidence analysed in the preceding two chapters and the analysis in this chapter, the last two sections in chapter six represent an operational assimilation of the accountants-EDP specialists' a priori behavioural indicators and the accountants-MS/OR specialists' a priori behavioural indicators, respectively.

## Chapter Three

### Design of the empirical research

- 3.1. Introduction.
- 3.2. Necessity for "empiricism".
- 3.3. Design considerations.
- 3.4. Methodological strategies of data collection.
- 3.5. Measurement: analysis of interdependence.
- 3.6. Data processing.
- 3.7. Analysis and interpretation.

### 3.1. Introduction

This chapter aims at outlining the reasons why the researcher has chosen to carry out the study empirically. Also, it describes the nature of design considerations that faces the researcher in the early stages of carrying out the study and the decisions taken in connection with the various alternatives open to the researcher. This is based on the fact that in every (major or minor) stage, a decision has to be taken in view of the need to balance the value of a particular outcome (to satisfy the objectives of the study) against the cost incurred by that decision. This has been a fundamental criterion applied throughout the study whenever the researcher was faced with any decision situation.

In addition, this chapter explains the methodological strategies of data collection adopted in the various stages of carrying out the empirical research, to explain the basis and nature of the work and the analysis contained in the remainder of this thesis.<sup>1</sup>

### 3.2. Necessity of "empiricism"

Looking deeply into the objectives of the present study indicates that the study, by definition, is an empirical one. To learn, explain and understand about the organizational interaction under consideration, facts have to be identified, variables have to be characterized, and patterns have to be outlined.<sup>2</sup> This excluded the possibility of a

- 
1. Those details which the researcher felt are not absolutely necessary from the reader's point of view, are saved to the appendices at the end of the thesis. Appendix A is in relation to Part II (that is: an extensive empirical search into "accountants - D.P. and MS/OR specialists' interaction", whereas Appendix B is in relation to Part III (that is a closer look into "accountants - DP and MS/OR specialists' interaction
  2. The researcher has based his experience - in developing a satisfactory background - in this respect on a mixture needed as reference to the growing systematic body of literature in the socio-psychological field of measurement and observation; consulting teachers and practitioners of sociology and social psychology whenever required; and, personal experimentation. However, the researcher has found, for example, the following works relevant and useful: for a discussion of interviewing see Kahn and Cannell (1957); Cannell and Kahn (1968); for the design of various measurement instruments see Likert (1932); Edwards (1957); Stevens (1968); Upshaw (1971); Moser and Kalton (1971); for data analysis see Festinger and Katz (1953); Cattell (1966-b); Runkel and McGrath (1972).



conceptual discussion based on no empirical evidence. Accordingly, the attention of the researcher has been focused on collecting relevant empirical evidence upon which to base the analysis and discussion of "accountants - MS/OR and D.P. specialists' patterns of communications and working relationships".

To enable those who are or may be interested in evaluating, replicating and/or comparing the findings of the present research with other studies, the researcher has attempted to explicitly describe the various steps followed, and methodological approaches adopted in collecting and analysing the related empirical evidence. Numerous propositions may be generated from the presented evidence, and may be subjected to more detailed 'empirical' investigation.

### 3.3. Design considerations

Having decided that the main approach to satisfying objectives of the present study is to carry out an empirical investigation, the immediate questions that arise in this respect are: what form(s) of empirical design would satisfactorily fulfil the planned objectives of the study? What steps need to be taken to collect the data required to learn about the scope of the problem and the features of the interaction under consideration? Should the researcher study the attitudinal aspects of communication between accountants, MS/OR, and D.P. specialists in a very detailed manner in one organisation to form a basis for a model of the interaction under investigation? How feasible is adopting the experimental strategy to test the effects of a stimulant on one group while exercising 'control' on the other? (and if feasible) how would the adoption of the experimental approach contribute to satisfying the objectives of the present study? What is the most useful approach or combination of approaches in terms of the

expected value to satisfying research objectives? To mention just a few questions -

Basically, the multidimensional spaces of 'healthy organisational mutual understanding'<sup>3</sup> between 'accountants and MS/OR specialists'; and 'accountants and D.P. specialists',<sup>form</sup> /the domain of the present study. In view of the analysis made in the preceding part, several interdependent factors would be selected to account for environmental, organisational, group and personal characteristics.

Given the study objectives (outlined in the introduction of this research) the experimental setting seemed unpromising on several grounds, chief of which are: the lack of prior information and evidence regarding the problem being tackled (to determine which would be the experimental group to be exposed to what stimuli, and which would be the control group, etc.); subjects' awareness of variables causing change in certain outcomes; participants' bias; and above all, it is the researcher's belief that not many organisations and/or groups would enthusiastically partake in this form of research design. Of course, this is not to discount the approach as such (in that it may allow a high degree of control over variables by permitting the isolation of certain variables depending on the objectives and conditions of analysis). But it is the researcher's interest in weighing the expected value of adopting it against the cost of obtaining information that satisfactorily contributes towards the fulfilment of the objectives of the study. It is worth emphasising that the concept of 'cost' here is not limited to the financial resources available to this research, but also includes the 'opportunity cost' of not satisfying the objectives outlined in the introduction.

---

3. 'Healthy' is simply taken to denote not at the expense of other groups and 'contributes to the attainment of organisational goals'; 'organisational' is taken to mean: characterization of processes within an organisation; and 'mutual' is understood to connote 'exchanged' or 'shared' between the two groups involved in the interaction under investigation. Healthy organisational mutual understanding is hereafter designated 'understanding'.



to this study and not gaining richer evidence by imposing restrictions on the conditions upon which a particular form of research design would be utilized for the interest of the research project. Accordingly, forming laboratory experimentation in which students or organisational members of an industrial concern would be the 'study subjects' was excluded from the alternative forms of research design. In view of this, a combination of a 'correlational' study in conjunction with comparative analysis of a small number of case studies, might be more useful in exploring the various dimensions of the problem under investigation.

'Usefulness' of any design in relation to the objectives of this research is based on satisfying the following considerations:

- 1) there is a need for a considerable amount of explorative type work to be done in connection with 'accountants - MS/OR and D.P. specialists' interaction' specifically in the case of the UK. Perhaps it is necessary to outline the relative weight and importance to be given to any particular slice of empirical observation or any piece of conceptual information. Should the research be designed to test the hypothesis - for example - that "the more archaic the attitudes of chartered accountants in major British industrial companies, the less the likelihood of acceptance of OR recommendations", implied by the assertion made by Stamp (1971, p.143), or should the attention be directed towards finding out "how do MS/OR specialists feel about their accounting colleagues?"

Obviously, MS/OR respondents' explanations to the second question may be more informative about this type of functional relationship than the mere hypothesis testing of the first question. The point being made here is that the design of the research survey should be geared to the extent to which it contributes towards our understanding of the various dimensions of the "accountants - MS/OR and D.P. specialists' interaction", and should identify as many of the possible relations



contained in it as are thought to be significant. The design should serve the problem being studied, not the opposite.

- ii) having outlined the related dimensions, aspects and conceptual variables, a considerable amount of 'operationalization' is needed to remove, or at least to minimize the confusion that more often than not may be contained in the conceptual dimension. 'Perception', 'leadership style' and 'learning' are examples demonstrating the need for operational definitions of the various conceptual issues or terms.
- iii) the selected form of research design should serve as a basis for further examination of the various aspects of the problem being studied in a constructive manner by explicitly describing the difficulties facing the adopted approach and the extent to which the objectives of the study are being fulfilled. Accordingly, the obstacles and difficulties met by the researcher and the steps taken to overcome or resolve them in any phase of carrying out this research are described in some detail (proportional to their magnitude) and the effects on the research project (as perceived by the researcher) are also given.

#### 3.4. Methodological strategies of data collection

Having carried out a literature survey, a combination of mailed-questionnaire, interview, and the comparative analysis of a small number of case studies was thought to be satisfactory as far as the objectives of the present investigation are concerned.<sup>4</sup> This view was based on the fact

- 4. The researcher maintains that a carefully thought instrument - be it interview tables, mailed-questionnaire or direct observational guidelines (even the basic approach(es) to be adopted, whether laboratory experiment, field experimentation, historical investigation, or simulation modelling) - is a function of the research objectives, type of research, and feasibility of the approach (cost-wise as well as practical considerations.) The warning given by Homans (1949, p.330) is highly relevant in this respect:

"People who write about methodology often forget that it is a matter of strategy, not of morals. There are neither good nor bad methods but only methods that are more or less effective under particular circumstances in reaching objectives on the way to a distant goal".

that each of these methods has advantages as well as its disadvantages. However, the final mix of approaches adopted in this study has been: First, using the mailed-questionnaire approach to survey opinions and attitudes of samples of accountants, D.P., and MS/OR specialists, regarding the working relationships and communication patterns under investigation. The form of research design aimed at empirically exploring the various aspects of accountants - D.P. specialists' interaction, and accountants - MS/OR specialists' interaction as seen by each of the groups involved: accountants, MS/OR and D.P. specialists.<sup>5</sup> The analysis of findings from this stage would serve as an attempt to identify the possible relationships among component variables and behavioural indicators and be the basis for constructing a priori explanations regarding the patterns of interactions involved in these types of organisational processes. Some of the questions were of the 'open-type', others were of the 'fully-structured' type. Design of the documents was made to contain: some personal and organisational background information (such as: age, length of experience, position, organisational location and other related issues); attitudinal questions regarding his (or her) counterpart; present and potential interaction; and the qualitative expression of opinions and experiences.

In addition interviews were held with some management consultants from a number of large (multi-national and national) consultancy firms operating in the U.K. for the purpose of obtaining their impressions and experiences in connection with the effects of recent developments in the D.P. and MS/OR areas upon accountants and accounting functions in relatively large British industrial organisations. The outcome of this stage of the empirical research is analysed in detail in the remainder of this (second) part of the

---

5. Appendix A details sampling design, summary statistics and raw data, and documentation of the instruments used. Appendix A is specifically concerned with Part II, i.e. the extensive search into 'accountants - MS/OR and D.P. specialists' interaction'.



study. Opinions and views of each of the three functional groups (MS/OR, D.P. specialists and accountants) is presented separately as a quasi-self-sufficient piece of research. This is based on the fact that each of these empirically-based analyses constitutes an independent form of sampling and survey design according to the conditions and circumstances relevant to each of these groups.

Whenever it was felt relevant and appropriate, citations are included of the opinions and views of some of the management consultants surveyed concurrently with the exploratory phase of the empirical research. Inclusion of management consultants in the research design was based on the idea that due to their responsibilities, commitments and backgrounds, it was thought that some of them might contribute towards stimulating the researcher's thinking about the interaction under investigation as well as testing the researcher's visualisation of the scope of the problem in industrial concerns in the U.K. economy. Of course, this does not necessarily mean that management consultants are more knowledgeable of organisational and functional problems and circumstances than members of industrial organisations themselves. Basically, the nature of the research was one of the contributing factors to surveying some management consultants systems and MS/OR models and the related accounting and financial data and information) some management consultants might have an overall view about the effect of recent development in D.P. and/or MS/OR upon accountants and accounting functions. Admittedly, such assumptions might well not be true for all management consultants and some bias - to 'sell' or over-estimate their stature in the market - might creep into their formation of opinion, views and explanations. Nevertheless, the exercise is worthwhile as long as the researcher is aware of the limitations imposed on this aspect of the empirical investigation.



Second, for more statistical and qualitative evidence, the outcome of the analysis of the explorative phase of the empirical part is reviewed and subjected to further analysis for the purposes of arriving at a new design that concentrates systematically on the various dimensions, and characteristics of the accountants - D.P. specialists' interaction and accountants - MS/OR specialists' interaction. In other words, the findings of the empirical exploration (presented in the remainder of this (second) part of the study) should serve as a basis for allowing opinions and views of both: 'accountants and D.P. specialists' and 'accountants and MS/OR specialists' to indicate their attitudinal position towards the relevant set of the constituent elements of their respective interactions. Basically there are two forms of organisational interaction contained in the present study, namely 'accountants - D.P. specialists' interaction' and 'accountants - MS/OR specialists' interaction'. Ultimately, the three functional groups taken together are considered by the researcher to be a sub-system contributing in one way or another to the organisational decision-making processes, and the more understanding between the constituent parties of the respective interaction, the greater the likelihood of contributing towards more effective decision making. Ideally one could suggest experiments on the lines of well known ones in the field of social psychology on relevant intergroup interactions that proceed by manipulating the variables leading towards a greater understanding between the constituent parties and their effect on decision making. But this approach was found to be infeasible for many obvious<sup>6</sup> reasons. However, a practical alternative has been adopted by which a set of indicators or component variables are constructed forming the domain of the respective interaction along a seven-point Likert-type scale ranging from 1, very unfavourable, to 7, very favourable. Differentiating favourable items from the unfavourable ones is

---

6. See sub-section 3.3. above.

done on the basis of the findings of the analysis of the empirical exploration supported by explanations and evidence from detailed empirical observations in three very large British industrial organisations.<sup>7</sup> Having arrived at a satisfactory design of the measurement instruments, surveying a wider sample of accountants, D.P. and MS/OR specialists alongside further empirical research into relevant D.P., MS/OR specialists' and accountants' interactions in the three above-mentioned industrial concerns has constituted the balance of the researchers' empirical investigation. More specifically, the second part of the empirical investigation - presented in detail in part three of this study - is structured on the following combinations:

a) Testing, refinement and measurement of the various dimensions of the respective interaction in three large industrial organisations on an interview basis for the systematic measurement of the attitudinal dimensions of accountants - D.P. specialists' interaction, and accountants - MS/OR specialists' interaction, outlined by the first part of the empirical investigation.<sup>8</sup> These attitudinal dimensions are considered by the researcher to form the a priori (of indicators or explanations) containing items, component variables, or variables of the major contributing factors of developing understanding between the parties involved in the interactions contained in the present analysis. Apart from the statistical evidence sought in this respect, a detailed description of the qualitative evidence, regarding environmental and organisational circumstances surrounding these interactions, is made to enable the researcher to gain more familiarity with the accounting, D.P., and MS/OR functions in their organisational setting.

---

7. See Appendix B, ~~#~~ 3, containing documentary and design.

8. Appendix B details: selection criteria of participating organizations; design of the measurement instruments; description of the several stages of carrying out the three detailed case-studies for the qualitative evidence; summary statistics and raw data; and documentation of the designed measurement instruments. Appendix B is specifically concerned with part III of this study, i.e. the closer look into "Accountants - EDP and MS/OR specialists' interaction".



b) Apparently, the number of 'individual' cases of those three organisations participating in the study is insufficient for the purposes of the statistical analysis for identifying the main factors contributing to 'accountants - D.P. specialists' understanding' and 'accountants - MS/OR specialists' understanding'.<sup>9</sup> Accordingly, a further number of 'individual' cases are contacted. This is carried out through selecting those respondents who took part earlier in the empirical exploration and whom the researcher thinks may be interested in taking part in this further empirical investigation. In addition, an updated sampling design is made to survey<sup>10</sup> an additional number of accountants, D.P. and MS/OR specialists taking into consideration the various relevant factors (such as: the organisational policy of encouraging or discouraging empirical research; the existing facilities and information available regarding these three groups; and the resources available to - and the limitations imposed on - the present survey). However, complete documentation of this form of design is presented in part three of this study in conjunction with the related Appendix B.

c) To compare for the size differential, a case study is carried out in a medium sized firm. The analysis based on this material is presented to a Management Control Workshop at Manchester Business School.

The rationale justifying the adoption of this combination of approaches in the manner discussed above can be explained as follows:

---

9. As a result of the decision taken by the researcher to select factor analysis as a suitable form of multivariate analysis in relation to the problem under investigation, the researcher was guided by the rule of thumb suggested by Cattell regarding the minimum allowable ratio of cases to variables, that is 4 to 1.

The reader is advised to consult any of the references treating the subject in more detail. (See, e.g. Cattell, 1952; Harman, 1967).

10. See Appendix B, ~~1.3~~ 1.3. for a more detailed account of such sampling methodology adopted.



- i) It has been the researcher's belief that understanding the scope of the problem of "accountants - MS/OR, and D.P. specialists' working relationships" in British industry should have some priority in designing the strategy of carrying out the empirical investigation. Accordingly an extensive exploration has been the first empirical step in learning about the scope of the problem in broad terms. This alternative was preferred to other alternatives (such as carrying out an indepth case - study in one or two organisations over a relatively long time period - between one and two years, or joining one organisation for the purpose of collecting, accumulating, and analysing observed day-to-day interactions amongst accountants, D.P. and MS/OR specialists. <sup>11</sup> Subsequently, exploration was favoured (to any other form of detailed investigation, specifically in the early stages of carrying out this empirical study), to be followed by more detailed research based on a closer look at the organisational interaction under examination.
- ii) Having identified the scope of the problem (as viewed by each respondent in the three functions contained in the analysis), indicators, component variables and variables can be outlined and structural relations between and amongst them can be studied. Each respondent or subject or participant is visualised to be a member of a 'psychology group' carrying out certain responsibilities and commitments in their organisation. Then, each subject or participant is asked to indicate the features of their interaction with the corresponding group along the set of various dimensions identified in the exploratory stage.
- iii) What is a MS/OR specialist? What is a D.P. specialist? What is an accountant? These and other related questions can be more meaningfully answered by interviewing coupled with questionnaires and detailed case studies of a small number of organisations (rather than by one single approach). Basically, there are a great number of factors and conditions affecting the 'accountants - MS/OR, and D.P. specialists' interaction'. The accelerating technological advancements in computer hardware systems and application software and support services; the increasing complexity of business problems; and the increasing amount of government legislation dealing with one or other of major topical social issues are examples of the main factors contributing to such complexity in the organisational interaction under consideration in the present study. These factors should be taken into consideration while viewing or considering these organisational processes. Consequently, the means (described above) for gathering the data for the purposes of this study, are considered by the researcher to be satisfactory to describe and analyse the working relationships contained in the 'accountants - MS/OR and D.P. specialists' interaction'. It is emphasised, however, that the research is not concerned with building 'compact' theories of the organisational processes involved in the 'accountants - MS/OR and D.P. specialists' interaction'. Rather, the researcher is more interested in analysing the relevant patterns; in interpreting the causal

---

11. Apart from the practical difficulties associated with such alternatives, the researcher suspected that concentrating on one or two organisations, though enforcing the likelihood of observing and intensively analysing contained relations, findings might be considerably biased to extreme or un-representative cases.



relationships; in describing major problem areas; in relating the findings of the research to their organisational and environmental contexts. Nevertheless, such analysis could serve as a basis for further design and model-building regarding intergroup processes under consideration, perhaps, on a more restricted basis.

### 3.5. Measurement : interdependence or dependence analysis

It is emphasized that accountants - EDP and MS/OR specialists' interaction is the main multi-dimension space contained in the present investigation. It is the conceptual dimension of objective and domain of the study. It has to be operationalized by means of a number of component variables and/or operational indicators. This is carried out by extensive empirical search. Operational indicators are extracted from the empirical evidence presented in detail in part II.

Based on the facts that the area under study has undergone little systematic empirical investigation, and that the interactions are characterized by the multifold complex interrelationships, the researcher concentrated on subjecting the multidimensional spaces of accountants - EDP specialists' interaction, and accountants - MS/OR specialists' interaction to the multivariate form of analysis of interdependence.

In such exploration, the researcher has used extensively factor analysis as a useful tool to investigating this complex behavioural phenomenon. This is based on the experience of leading factor analysts.<sup>12</sup>

---

12. See Cattell (1952; 1966-a). Also, Stogdill (1966, p.388) in organizational research for gaining more insight into complex structures and substructures of organizations. He stated that:

"An organization can be regarded as a set of complex structures and substructures. These structures can be described, at least in some degree, by measuring variables that are assumed in theory to be important, and by determining the relationships between the variables. Such relationships are represented by a table of inter-correlations. The substructures described by a table of inter-correlations can be revealed by factor analysis.

We gain increased insight into, and understanding of, organization when we use methods of study that reveal substructures that are not readily visible by direct observation of the organization itself or by examination of a table of intercorrelations that is based upon measurements of different dimensions of organization. Factor analysis is a useful method in gaining such insight."



Accordingly, having operationalized the conceptual indicators contained in the accountants - EDP specialists' interaction and in the accountants - MS/OR specialists' interaction, and having refined the extracted behavioural indicators by means of detailed analyses of a small number of case studies, factor analyses are, then, carried out to reduce those indicators to a lesser number of more meaningful factors. This is to gain insights into the behavioural phenomenon contained in the respective interactions.

Furthermore, the results of applying mathematical and statistical methods of factor analysis are supported by what the research considers to be a 'richer' qualitative empirical evidence and adequate further analysis in relation to the domains of accountants - EDP specialists' interaction and of accountants - MS/OR specialists' interaction.

### 3.6. Data Processing

At various stages of carrying out this study, the researcher has made considerable use of (manual and computer-based) methods of data processing. Without the aid of software packages available in this field, the researcher's task would have been much more difficult, particularly in the case of the analysis of variance and factor analysis. Although the use of such aids cut drastically the processing time, the amount of time and effort that have to be meticulously spent in studying available facilities and their associated limitations is not by any means small, particularly in the case of the extensive use of such facilities. Nevertheless, it is a worthwhile investment.

Mostly the computational needs of the researcher have been met by the Statistical Package for the Social Sciences - SPSS (Nie, Bent and Hull, 1970) and its use is assumed throughout the study (unless otherwise stated).

### 3.7. Analysis and Interpretation

Basically the analysis and interpretation of the findings of the research project are aimed at learning about patterns of communication and working relationships between accountants on the one hand, and D.P. and MS/OR specialists on the other, for more effective organisational decision-making. The research does not investigate the reasons why MS/OR or D.P. are used in one organisation and are not used in another organisation, per se. This research does not concentrate on the advantages and disadvantages of employing recent developments in management science/operational research and/or computer-based applications. Meanwhile, the researcher may suspect that the research findings might be biased towards those types of organisations applying such developments. This kind of bias does not affect the validity of the findings or the foundations upon which these results are based. Furthermore, the researcher deliberately restricted the study to those organisations employing computer and MS/OR resources and capabilities.

Two types of analyses are contained in the rest of the thesis: the early type of analysis (presented in Part II of this study) discusses details of opinions and attitudes of D.P., MS/OR specialists and accountants; outlines the scope of the problem under investigation; hypothesizes 'a priori' of the domain of the relationship between the respective groups involved in each of the interactions under study; and serves as a basis for further exploration and analysis in the succeeding part. The succeeding part - Part III of the present research - contains the later type of analysis, in which emphasis is on the testing of the constructed 'a priori'; correlation examination of the relationships between items, component variables, variables and factors; and an organisational diagnosis of the 'accountants -



D.P. specialists' interaction' and 'accountants - MS/OR specialists' interaction'.

The findings of the present research are not to be the basis for sweeping generalisations. Whilst the evidence gathered/observed by the researcher has, in so far as possible, been subjected to statistical analysis and related to the outcome of cognate studies as found in the literature, the reader is recommended to interpret the findings and their implications with caution.<sup>13</sup>

---

13. For a well-presented treatment of the uses and misuses of statistical analysis, see Huff (1954). Also, for a discussion of some of the problems and controversies surrounding the application and interpretation of statistical methods, see e.g. Heermann and Braskamp (1970); Lieberman (1971).

## Summary

Due to the fact that this research is by definition an empirical one, this chapter has outlined the design of the empirical research.

This chapter has evaluated several methodological approaches for their appropriateness in relation to the objectives of the present research. The experimental strategy of design was not favoured for a number of practical considerations related to the approach and its feasibility to fulfil the objectives of the present research.

The strategy adopted is one that makes use of a mix of research methodologies (personal interviews, case studies and mailed questionnaires) and types of instruments (structured, semi-structured and unstructured inter-view-tables and questionnaires). Meanwhile, the multivariate analysis of interdependence (as opposed to the analysis of dependence) has been argued for its qualification to play an important role in carrying out systematic investigations into the multivariate and interdependent space of accountants - EDP and MS/OR specialists' interaction.

Finally, this chapter has looked ahead into the remainder of this report on the survey, that is, the problems of data processing, analysis and interpretation of the findings of the present research.



## Chapter Four

An analysis of opinions and views of EDP specialists regarding their working relationships with accountants.

### Abstract.

- 4.1. Background information.
  - 4.1.1. Personal background information.
  - 4.1.2. Organizational background information.
- 4.2. DP specialists with neither accounting qualifications nor accounting experience.
  - 4.2.1. Are accountants helpful in explaining the technical aspects of accounting systems, principles and procedures?
  - 4.2.2. Assisting accountants in computerization.
  - 4.2.3. Pressure experienced from accountants.
  - 4.2.4. Attitudinal aspects of communication.
- 4.3. DP specialists with accounting qualifications and/or experience.
- 4.4. Accountants' involvement in EDP.
- 4.5. Computerization of accounting activities.
- 4.6. EDP-accounting future relationships.
  - 4.6.1. Organizational relationships between EDP and accounting functions.
  - 4.6.2. Characteristics of the systems' or DP accountant.

### Summary.

## Abstract

This chapter presents an analysis of opinions and views of a sample of DP specialists concerning their working relationships with accountants. The findings analysed are the outcome of surveying 230 EDP managers working in large U.K. business organizations.

Questionnaires were mailed on March 1st, 1973, but the several stages of designing and testing the document had been completed by December 1972. The study had drawn a 44% rate of response. Interviews were also held with some management consultants representing a number of large management consultancy firms.

The analysis presented in this chapter seeks to contribute to the operational identification of the relevant dimensions of the interaction under study. It seeks the transformation of the conceptual dimensions identified in chapter two. The operational identification or transformation presented in this chapter together with a similar examination from the accountants' viewpoint presented in a corresponding section in chapter six are to provide the basic data upon which further systematic elaboration could be made. Such combined analyses are the basis for constructing a priori behavioural indicators concerning accountants - EDP specialists' interaction.

Due to the fact that some EDP specialists might have some type of accounting qualification and/or experience, a distinction is made between those EDP correspondents with some type of accounting qualification and/or experience and those EDP specialists with no such qualification or experience.

At this stage of carrying out the survey, it was felt necessary to attempt to answer some of the relevant questions as to the demographic



and behavioural indicators about EDP specialists' working relationship with accountants.

Are accountants helpful in explaining the technical aspects about their systems, principles, and procedures? Do EDP specialists experience pressure from accountants? What is the scope of accountants' involvement in EDP? What is the degree of computerizing routine and non-routine accounting activities? How do EDP correspondents evaluate the present pattern of communication with accountants? What are EDP specialists' expectations or aspirations regarding their future working relationships with accountants? Attempts to answer these and other related questions are necessary for operationalizing many of the conceptual dimensions involved.

#### 4.1. Background information.

##### 4.1.1. Personal background information

Discussion in this subsection is concerned with some relevant personal information about DP specialists participating in this part of the survey.

##### Title of the present job

The examination of respondents' titles<sup>1</sup> reveals that a wide variety of nomenclatures are employed. The generic term 'DP Manager' is widely used with some variations. Amongst these variations are 'management services manager', 'computer services manager', 'management information executive', 'computer and services director', 'computer controller'. Chief executives, chief accountants and controllers are amongst directors in being in charge of DP responsibilities.

Obviously, titles mean different things for different people. Any title such as 'DP manager' may reflect totally different amounts of responsibility and authority for two persons holding the same title. It may be argued, however, that the different types of nomenclatures adopted, are - in fact - reflections of trends or points of emphasis by each organization for each title. Information services, systems, systems applications, computer development, may be examples of such reflections. This is not necessarily true of all organizations. It is desirable that such adoption of grandiose or impressive titles reflects the installation of change

---

1. See table 1, appendix A, ~~4~~ 3.1.

devices to more effective services.<sup>2</sup>

Age and D.P. experience

The modal class of age of the respondents is 36 - 40 years. Approximately three-quarters came in the categories of 36 - 50 years or over.<sup>3</sup>

The modal class of respondents' length of experience is 8 - 11 years. More than four-fifths came in the categories of 8 - 15 years or over.<sup>4</sup>

2. In a discussion with a group of management consultants, the question of the difference between the titles 'DP manager' and 'Information director' was raised. One of this group of consultants quoted an example of the position of a director of information services of a large U.K. business organization as the regular peak for this new function. This function, according to the explanation given by the consultant, embraces many of the activities traditionally known to belong to the accounting function. A colleague of this consultant indicated that accountants have tended to be limited, in their interest in information, to satisfying legalistic and financial issues. They all endorsed the view suggesting that current educational and training programs have as yet to enable accountants to inter-relate their activities to other functional areas. A third colleague within the group pointed out that:

"To a certain extent, accountants may have had the 'best' training to become the head of [manual-based] information services, but I think there is a long way yet to go and the accounting profession has got to wake up to train its people to equip them to become (eligible for the post of) head of [computer-based] Information Services."

The messages emanating from the discussion (with this group of management consultants as well as several consultants from other firms) are that accountants should look forward to the wider implications of information and that those persons who are capable of developing such an information services function might convince the management of their organizations of the importance and worthiness of designing a separate information services function at a higher managerial level than that of the mere processing of data.

3. See table 2, Appendix A, 3.1.  
4. See table 3, Appendix A, 3.1.



Type of experience (with or without accounting qualification or experience) and/or qualification

Summary statistics of the present survey indicates that those who have accounting qualification<sup>s</sup> or experience constitute a high percentage amongst respondents (52.5%). The significance of this is that accountants are responsible for a considerable share of D.P. activities in the organizations participating in the present survey. Although this indicates the position of a static point in time (i.e. when questionnaires were answered) it is unlikely that a sudden change would take place.<sup>5</sup>

Different interpretations may be given in this respect. The first is that the new machine and the new technology appealed to some accountants as a matter of interest, promotion, or as a way out of the 'accountancy conventions and practices'. The second is that accounting applications were one of the main early application areas when these machines were introduced to the business world.

This is not to suggest that those who have accounting qualification<sup>s</sup> or experience dominate the D.P. managership. Other specialists (such as in maths, statistics, engineering, pure science) have a fair share of this responsibility.<sup>6</sup>

---

5. See table 4, Appendix A, ~~3.1~~ 3.1.

6. See table 5, Appendix A, ~~3.1~~ 3.1.

#### 4.1.2. ORGANIZATIONAL BACKGROUND INFORMATION

##### Type of industrial classification

Most types of industry are represented in the survey sample with few categories having a higher proportion of the total. These categories are - in descending order according to their absolute frequency in the survey sample - as follows: engineering and metal, food manufacturing, industrial (miscellaneous), gas, electricity and coal, and electrical and radio. In spite of the fact that other types of industries are represented in the study (such as steels, chemical and plastics, motors and cycles, oil, textiles, etc.), care should be exercised in the interpretation of the results obtained.<sup>7</sup>

Some categories were under-represented - not because they do not have computers, but because their computers are working on the service bureau system or for pure scientific exploration and experimentation. In such situations, it was felt that these cases should not be included for the purposes of this part of the survey.

##### Available EDP Equipment and Manpower Facilities

In an attempt to learn about the organizational structure of DP departments (or divisions) in organizations under investigation, a question was included in the DP questionnaire asking respondents to classify - according to the category of jobs (i.e. DP management, Systems Analysis, Programming, etc.) staff numbers of their departments (or divisions). They were also asked to indicate, in an approximate manner, the number of those staff who have accounting qualification and/or experience.

Of course, the number of accountants<sup>8</sup> in each category is

7. See table 6, Appendix A, 3.1.

8. The term 'accountants' is used here to denote those who have accounting qualification and/or experience.

not in itself an indication of the degree of accounting involvement in the EDP area. Even if it were, it is also the quality and not only the quantity which matters in this respect. Furthermore, some accountants might have joined the DP area as a means of leaving the accounting field.

Having said that, it is still beneficial to give some indication of the approximate direction of the empirical conditions in relation to accountants' joining the EDP field.

Classification of responses reveals that the higher echelons in the EDP field have a higher percentage of those who had some accounting qualification or experience than the lower echelons. DP management comes first. Systems analysis comes second. These observations are based on the percentage of accountants to staff numbers in DP management, systems analysis, programming, and hardware operations and management categories. Summaries of these percentages are shown on table 4.1. on the following page.<sup>9</sup>

---

9. For a more detailed account of these categories, see tables 10-15. Appendix A, § 3.1.



Category	Absolute frequency	Relative frequency (Per-cent)	Cumulative frequency (Per-cent)
<u>D.P. Management</u>			
Percentage of accountants to staff numbers.			
Null representation	32	31.7	31.7
1-39.99%	23	22.8	54.5
40 - 69.99%	20	19.8	74.3
70 - 100%	<u>26</u>	<u>25.7</u>	<u>100.0</u>
	<u>101</u>	<u>100.0</u>	<u>100.0</u>
<u>Systems Analysis</u>			
Null representation	39	38.6	38.6
1 - 39.99%	41	40.6	79.2
40 - 69.99%	15	14.9	94.1
70 - 100%	<u>6</u>	<u>5.9</u>	<u>100.0</u>
	<u>101</u>	<u>100.0</u>	<u>100.0</u>
<u>Programming</u>			
Null representation	69	68.3	68.3
1 - 39.99%	28	27.7	96.0
40 - 69.99%	3	3.0	99.0
70 - 100%	<u>1</u>	<u>1.0</u>	<u>100.0</u>
	<u>101</u>	<u>100.0</u>	<u>100.0</u>
<u>Hardware operations and maintenance</u>			
Null representation	78	77.2	77.2
1 - 39.99%	21	20.8	98.0
40 - 69.99%	1	1.0	99.0
70 - 100%	<u>1</u>	<u>1.0</u>	<u>100.0</u>
	<u>101</u>	<u>100.0</u>	<u>100.0</u>
<u>Total</u>			
Null representation	30	29.7	29.7
1 - 39.99%	67	66.3	96.0
40 - 69.99%	2	2.0	98.0
70 - 100%	<u>2</u>	<u>2.0</u>	<u>100.0</u>
	<u>101</u>	<u>100.0</u>	<u>100.0</u>

Table 4.1. The organizational structure of EDP department or division in respondents' organizations in terms of the category of jobs indicating the percentage of those who have accounting qualifications and/or experience to total staff numbers in each category.

These findings lead to a variety of questions, such as - why are these higher percentage of accountants in the DP management and the systems analysis categories rather than in the programming and operations categories? Are there any specific motivations for accountants to join particular DP categories rather than others? Is there any systematic way of getting accountants acquainted with the basic elements of knowledge that will enable them to fulfil their obligations towards themselves and the organizations to which they belong? What are the professional accountancy bodies' roles in developing a systematic way of equipping their present and prospective members with the necessary tools in this respect?

Though very little could be offered to answer satisfactorily these questions, some of them are further explored in the latter parts of this report.

#### Management and organizational location of EDP activities

The actual location of, and the authority responsible for, EDP activities were the subject of one of the main points included in the questionnaire. Focus was made upon the organizational relationships with accounting and finance responsibilities. Respondents indicated that<sup>10</sup> accountants assume responsibility for a considerable number of DP installations in organizations participating in the study.<sup>10-a</sup> Chief accountants, controllers or finance directors are responsible for about two-fifths of the valid observations in this respect (96 cases). The actual location of these DP installations - which were reported to be under an accounting responsibility -

10. See table 9, Appendix A, ¶ 3.1.

10-a. These findings do not reflect the historical changes that have been taking place in this area of organizational structure. A possible remedy for this situation would have been the addition of another question reflecting the historical developments of both the authority responsible and the location. But it was felt that - apart from increasing the size of the questionnaire or sacrificing other parts - it might not give an accurate account of these aspects of historical developments.

can be divided into two main categories: two thirds are in the accounting department, and one-third is separate from the accounting department or division.

The study also indicates that two-fifths of the valid observations are located in independent departments under the responsibility of non-accounting executives with an organizational level equal to, or higher than, the accounting department.

In addition a small number of EDP installations (less than one-tenth of the valid observations) were reported to be located under the responsibility of the managing director of the organization. Also the question of the best or optimum location of EDP activities (computers for control, planning and managerial decision-making as opposed to those computers for technical experimentation and scientific exploration) was raised with management consultants. Although the present researcher was aware of the fact that a formula for the 'best' or optimum location of such activities does not exist, the aim of this question was to obtain shades of feelings and expressions of experience from those management consultants who were prepared to give them.

Such experience may be analysed as a set of considerations in the following manner:

1. Why EDP was introduced to the organization is an important factor in this respect. Objectives of introducing EDP and the associated antecedent circumstances always have a close connection to the problem of locating these activities into organizations. Each organization - according to its circumstances - had its objectives in introducing these systems, and according to these objectives and organizational conditions



a certain type of location may - or may not - reflect a satisfactory - or even the best - location.

One management consultant expressed this consideration as follows:

"I think you have to look back and see what a company is using its computer for. Is it an extended calculating machine, is it an extension of the technical department, are the users mainly the technical staff, the design staff, aerodynamists, or what? Is it an extension of the accounting department? Is it a vital tool in planning the future of the company in terms of strategic planning?"

As a result of this consideration, one can easily observe the different approaches to dealing with this situation. Some organizations have created a separate 'information' or 'services' function. Some others have set up a separate company for their EDP function as a service bureau of which they are the biggest users. These approaches and others affect - and are in turn affected by - organizational policies and objectives at various points in time.

2. How computers are introduced to the organization is a contributing factor towards shaping following relationships between EDP specialists, management and user functions in their organizations. A considerable number of management consultants indicated that in the early days of EDP it tended to come under the accountant's responsibility, where most of the computer-based applications were of a finance and accounting nature. There could be a variety of reasons and implications for the effective - or non-effective - use of EDP services. The argument regarding the location of EDP under the finance and accounting responsibility is a lengthy one. There are certain advantages as

well as disadvantages regarding this type of organizational policy. The ultimate criteria are the extent to which particular organizations are benefiting from their EDP functions, and the way in which computer technology is developing. Some consultants perceive that this issue might influence the decision regarding the location of EDP activities. Multi-purpose computers (e.g. for process control purposes and commercial applications), bigger and more complex files, and the various aspects of storage, access, and retrieval of data will have their technical implications for the future location of EDP activities.

3. What the actual shape of the interpersonal network of relationships is should not be neglected in the analysis of the issue of the organizational location of EDP activities. Depending upon the individual characteristics, ability and personality of the person in charge of EDP activities in relation to top management and user functions, the location issue would be affected to a considerable extent.

#### Length of experience in the major areas of application

Respondents indicated that their organizations have more DP experience in the commercial areas of application than in the scientific and technical fields. This is supported by the intuitive idea about the introduction of computers into the business world.<sup>11</sup>

---

11. See table 16, Appendix A, # 3.1.

4.2. DP specialists with neither accounting qualification nor experience

Discussion of facts, opinions, and views in this section is confined to those DP specialists without accounting qualification and/or experience (n = 48 cases). Discussion of those respondents having accounting qualification and/or experience will follow next (section 4.3.).

4.2.1. Are accountants helpful in explaining the technical aspects of the accounting discipline?

One of the fundamental aspects of a successful application of EDP systems related to the accountancy function is perhaps the cooperative interaction between the two groups. One aspect of this working relationship is that the accounting system - to be computerized - should be analyzed and understood fully by the DP specialist in charge of this process. Regarding this, DP specialists, without accounting qualification and/or experience, who are asked to change, or modify, an accounting activity to a computer-based system, should seek the user's involvement. The accountant - as a user of DP services - should explain as simply and clearly as possible the technical aspects of his specialisation.

Examination of respondents' opinions reveals that accountants are 'fairly helpful'. The modal class of respondents' opinion indicates this. Also, slightly more than one-quarter of the (valid) observations indicates that accountants are helpful. One-fifth of the DP specialists - without accounting qualification and/or experience - indicated that accountants offer little or no help in this respect. A minority said that accountants are very helpful indeed.<sup>12</sup>

---

12. See table 18, Appendix A, ~~3.1~~ 3.1.



#### 4.2.2. Assisting accountants in computerization

A complementary aspect of a successful application of EDP systems in the accounting field is that DP specialists should be willing, prepared and helpful in the design and implementation of systems related to the accounting discipline.

Interpretation of findings should be cautiously made in view of the fact that wide differences exist between organizations participating in the study, their organizational structures, environmental circumstances, group and individual systems of behaviour. Consequently, when considering the areas in which DP specialists might offer any kind of assistance to his accountant colleague(s), generalization should not be made without considering other aspects of this type of organizational interaction.

Amongst the items which respondents indicated they assist accountants with in the computerization process are: on stock and work-in-progress valuation (about 87% ranging between occasionally to usually); special cost analysis reports (81% ranging from occasionally to usually); stock control (about 75% ranging between occasionally to usually); preparing and revising operating budgets (71% ranging from occasionally to usually). Slightly more than 50% of observations indicated that they assist in the computerization of pricing, analysing standard cost variances, and analysing cash-in-flow and disbursements, (on the same basis i.e. ranging from occasionally to usually).

Other activities such as preparing investment projects, break-even analysis, financial modelling, which can be classified as non-routine activities, do not form a solid basis of 'DP specialists-accountants' intergroup interaction. A relevant query might be

raised regarding accountants' ability to systematize these activities alone without getting any kind of assistance from DP specialists.

#### 4.2.3. Pressure experienced from accountants

To learn whether or not the accounting function within an organization can exercise any type of pressure upon the DP function, a set of questions was included for this purpose. Emphasis was made upon the dysfunctional<sup>13</sup> type of pressure; that is the type in which accountants contest, and take any opportunity to take over some of, the DP specialist's job.

This set of questions had served as a catalyst in stimulating comments and remarks about both types of pressure: the functional as well as the dysfunctional. One-fifth of observations indicated that they experienced no (dysfunctional) pressure from the accounting group in their organizations. Two-fifths of the observations emphasized that they experienced (dysfunctional) pressure from the accounting group in their organizations. Also, one-fifth of the observations indicated that they experience (functional) pressure from accounting groups in their organizations.<sup>14</sup>

#### Functional types of pressure from accountants on DP specialists

Different descriptions and diagnoses were made by respondents to explain their relationship with various levels of authority within the accounting function. Amongst these descriptions are:

- (i) pressure to take as many mundane jobs on the computer;
- (ii) pressure to make sure that the work is done correctly and on time;
- (iii) pressure to monitor closely areas of developments (and other similar reasons).<sup>15</sup>

---

13. According to Seiler (1967, p.18) the prefix "dys" is a convention denoting "impairment", one which has been borrowed from medical language and has become customary in conjunction with "function" in preference to the looser "dis".

14. See table 20, Appendix A, ~~3.1~~ 3.1.

15. See table 20, Appendix A, ~~3.1~~ 3.1.



Dysfunctional types of pressure  
from accountants on EDPspecialists

As indicated above, two-fifths of DP specialists (with neither accounting qualification nor accounting experience) described what could be categorised under the dysfunctional types of pressure. Their answers explain that pressures are exercised more by finance directors or controllers than by chief accountants (when applicable, i.e. when there are the two positions within an organization) and more by chief accountants than by accounting department individuals.<sup>16</sup>

Causes which gave rise to that condition were in the main related to the accounting function and accountants.<sup>17</sup> They are:

- (i) lack of accountants' understanding of the nature, technical aspects, advantages, and limitations of computing.
- (ii) power game and personal motivations. Amongst explanations given to this situation are: Finance Directors' wishes for over-all control and personal ambition either to widen their area of influence or to have more control over systems analysis; fear of redundancy, of less power; and the threat to accountants' positions.
- (iii) location of the computing services is in the finance department and considering the computer as an ancillary function to the preparation of accounts.
- (iv) lack of clarity of organizational roles.
- (v) accountants' narrow approach in playing their role as information technologists.
- (vi) contest for scarce resources.
- (vii) lack of realization on the part of senior management of the 'true' uses and potential of the computer.
- (viii) other cases such as budgetary matters, personality matters and unspecified others.

16. See table 21, Appendix A, ~~3.1~~ 3.1.

17. See table 22, Appendix A, ~~3.1~~ 3.1.



#### 4.2.3. Attitudinal aspects of communication

To understand about DP specialists' attitudes<sup>18</sup> towards accounting functions and accountants, a 14- item Likert-type scale was designed. Items were selected from a larger number of items at different stages of development. The final scale was presented in a tabular form headed by degrees of agreement, neutrality, and disagreement as follows: 'strongly agree', 'agree', 'undecided', 'disagree', 'strongly disagree'.<sup>19</sup>

The main conclusions of the analysis of the attitudinal aspects of communication with accountants are:

- a) the majority of DP respondents indicated that
  - i) accountants are willing to provide any kind of help to EDP personnel,
  - ii) senior accounting executives do not compete for control over DP resources,
- b) some DP specialists disagreed with the statement that accountants welcome questioning accounting systems and principles,
- c) the majority of EDP respondents disagreed with the statement indicating that accountants are one of the greatest obstacles to the development and growth of computer-based systems.
- d) policy, philosophy and structure of the accounting function, accountants' attitudes toward DP, accountants' concepts of who should control DP, and DP specialists' reaction to accountants' attitudes are the main factors<sup>20</sup> characterising the EDP specialists' attitudinal domain towards accountants and accounting functions.

---

18. DP specialists with accounting qualification and/or experience were not asked to take part in responding to the items forming the scale. This decision was made to avoid any sort of bias from those who had accounting orientation towards the accounting function and accountants.

19. Subjects were asked to place a 'tick' below one of the five alternatives. Weights were assigned from 1 to 5 to each item. For positively worded items 5 was assigned to the 'strongly agree' alternative, 4 for the 'agree' item, 3 for the 'undecided' item, 2 for the 'disagree' item, and 1 for the 'strongly disagree' item. For negatively worded statements, 5 was given to the 'strongly disagree' alternative, 4 for the 'disagree' alternative, 3 for the 'undecided' alternative, and so on.

20. See table 42, Appendix, A ~~3.1~~ 3.1.



4.3. DP specialists with accounting qualifications and/or experience 21

As expected, almost every respondent (with accounting qualifications and/or experience) indicated that he had some type of DP training. But examination of respondents' answers in this respect<sup>22</sup> indicates that two main types of training courses were attended by this class of respondents: the first is "computers in management" and its variations; and the second is variations of "assembly" languages.<sup>23</sup> A lesser percentage of respondents indicated their training in COBOL. A smaller number of respondents indicated they had attended some type of EDP training in FORTRAN IV, and in application packages, in particular linear programming, statistical analysis and model-building.

---

21. Discussion in this section is confined to those DP specialists with accounting qualification and/or experience (n = 53) concerning the type of EDP training they had, their use of software application packages and their evaluation of that use. One naturally expects that this class of respondents would have one type or another of training in the EDP field. Given also the fact that technological advances in the EDP areas are un-matched, to varied degrees, with corresponding revisions and updating of the EDP knowledge on the part of accountants in the U.K., one would hardly expect startling progress or a sudden change in the educational and training background of accountants in industry. Consequently, one would be more interested in the type of EDP training that respondents indicate rather than whether or not they have gained some knowledge in EDP.

This is not to suggest that professional accounting bodies have not realised the potential of, and implications for, their membership in connection with these EDP technological advances, but the rate at which these bodies are responding and acting to change has been insufficient to get the most out of these developments. However it is probable that individual members are trying to bridge this gap.

22. See tables 40-A, 40-B, 40-C, Appendix A, ~~3.1~~ 3.1.

23. To overcome the difficulties associated with machine languages, assembly languages have been developed to translate mnemonic operation codes to machine operation codes on a one-for-one representation basis, i.e. every assembly language instruction results in only one machine language instruction. Assembly languages use symbolic representation (as opposed to the binary numbering system in which machine languages must be written).

If this evidence could serve as a basis for making some inferences, it is likely that industrial accountants are involved in the management of computer installations and the "commercial" applications of computer-based systems. The term 'commercial' might be limited in interpretation to areas such as invoicing, payroll, order entry and the like. The researcher would exclude problem solving or advanced types of application areas from those which accountants would be involved in.

Also, there are grounds to believe that some practical advantages are associated with using application packages<sup>24</sup> in the areas of forecasting and financial modelling. These grounds are based on opinions expressed by a small number of respondents. However, it appears that not many industrial accountants are making use of such facilities.

---

24. No titles or descriptions of application packages were specified by the researcher in the form sent to respondents. The few respondents who indicated their use of such facilities expressed their satisfaction with some application packages, particularly financially-oriented ones. (Descriptions of their experience have to be kept unrevealed according to the confidentiality principle, specifically when those experiences and opinions are associated with names of computer manufacturers. This will hopefully be appreciated).



#### 4.4. Accountants' involvement in EDP

One of the main objectives of the present research is to explore the state of accountants' direct participation in the development and implementation of computer-based information systems and the setting up of computer departments. Towards this end, a section was included in the DP questionnaire (under analysis and discussion) to learn about DP specialists' opinions regarding the issue of accountants' involvement in the EDP area.

One way of analyzing the results obtained is to look into the modal interval of each scale adopted to measure a specific dimension of the accountants' direct participation in the EDP field. This is by no means sufficient for the purposes of explorative analysis. In spite of the fact that the answers are 'individually expressed' opinions, they are, in fact, signals or indications of organizational trends, conditions, or circumstances. In themselves, they are clear evidence of the significantly different patterns of communication between the two groups involved in this type of organizational interface. Having said that, the following are some comments in this respect:

- (i) Slightly more than three-fifths of the valid observations indicated that accountants are interested or very much interested; one-fifth indicated that they are fairly interested.
- (ii) Regarding the effect of accountants' actual participation in the EDP field, three-fifths of the valid observations indicated that it had good effect and slightly less than one-third were 'undecided' in this respect. Why was such a considerable number of respondents not sure or not willing to give an answer to this? Many interpretations can be

made to this condition such as: it may be that the effect of actual participation in the EDP field is not yet clear to them, or it may be that accountants are neither deeply involved nor remote altogether from such a field.

- (iii) As to accountants' support of DP services, three-fifths of the valid observations indicated that accountants are supportive or fully supportive to EDP, slightly more than one-fifth indicated that accountants are 'fairly supportive'; and less than one-fifth indicated that accountants are little supportive or not supportive at all.
- (iv) In the opinion of the vast majority of respondents (DP specialists), accountants' participation in EDP services is important with varying degree of emphasis (between "fairly important" and "of great importance").
- (v) Also, it is the opinion of DP specialists that they welcome - or very much welcome - accountants' participation in EDP services. It may be argued that this may not represent the true picture of the actual behaviours involved and assertions may be different from actions and inter-personal or intergroup interactions. This may be true in some cases, but one should view the background organizational circumstances in more detail in order to be able to identify such situations. The 'case study' approach is more suitable to handling such situations than the questionnaire method.

- (vi) Opinions of DP specialists regarding their degree of satisfaction of the accounting involvement in the EDP field, can be classified as follows: about two-fifths of the observations indicated that they were 'fairly satisfied' (which is the modal class); one-fifth were either satisfied or very satisfied; two-fifths expressed little or no satisfaction at all.

It is worth mentioning that the structure of DP specialists' satisfaction is not homogeneous with their description of accountants' interest in or accountants' support to the EDP field.

- (vii) As to respondents' opinions concerning the extent of accountants' oppositions to DP specialists, the situation can be described as follows: one-fifth of the respondents indicated that accountants were 'fairly opposing'; three-fifths indicated that accountants expressed 'little opposition'. The remainder is a mixture of the two extremes which are: accountants showed 'no opposition at all' or 'they were very much opposing'.



#### 4.5. Computerization of Accounting Activities

Respondents were asked whether they had personally supervised or participated in the computerization of some of the accounting activities in their organizations. The answer was that the vast majority of respondents (93%) said that they had such experience. Since respondents are DP managers (or their assistants in a very few cases), it could be assumed safely that their responses in this respect are representative of the extent to which the computerization of accounting activities had been taking place at the time the survey was conducted.

It appears evident that routine accounting activities - or what they consider to be routine - have a better opportunity than that of the non-routine activities. Examples of those considered to be of the routine type are: order entry and analysis, invoicing, wages (payroll), debtors' accounts, creditors' accounts, stock control, general ledger, accounting statistics, manufacturing costs allocation, consolidation of group accounts. Examples of the non-routine activities are: cost effectiveness analysis, D.C.F., financial modelling, break-even analysis.<sup>25</sup>

This, in itself, is an indication of reducing the clerical effort involved in the routine type of accounting processes. This should contribute towards the reduction of the clerical expenses, relieve the accountant of the manual effort involved in such processes, and allow him to devote more time to the managerial aspects of his organization's control system, particularly by providing data and information that are essentially required for decision-making and problem solving.

---

25. See table 41, Appendix A, ~~4.1~~ 3.1.

For more evidence in this respect, the same issue was raised with management consultants. They indicated that most of the big companies they know of had computerized the 'routine' accounting activities. The contents of the following comment - made by one of the surveyed management consultants - was repeated by the majority of those discussing the issue:

"I would have thought anybody with any semblance of a computer installation was doing the routine accounting via computer. Obviously there are exceptions to that. I would have thought that most people have put those types of things on them and are now starting to look for other areas ... I think the bread-and-butter stuff is on these, mostly it is working well, you get hiccoughs when VAT comes along and everybody runs around and sorts it out for a few months. I think most of the bread-and-butter issues are on computers as far as accounting goes. Often it was the first thing to be".

#### 4.6. EDP - accounting future relationships

An unstructured<sup>26</sup> sub-section was included in the EDP specialists' mailed questionnaire for the purposes of exploring various possible diagnostic and prescriptive approaches to the design of accounting - EDP relationships.

Discussion in this section is divided into two main sub-sections. The first is concerned with the organizational relationships between accountants and EDP specialists. The second sub-section presents some prescriptive implications of the findings of this aspect of the study as to the characteristics of the 'systems' accountant.

---

26. It was felt that any structuring of such issues - however precise it would be - would not serve the purposes of the study because of the restrictions that would have been imposed on respondents to express their visualization of this type of relationship.

The importance that is attached to this type of information is not to be found in a statistical sense, but rather in the meaning that is conveyed in its implication, even if the specific opinion under discussion is expressed by a very small minority.

It is the content of each opinion that may reflect either a trend or stream of thought amongst DP practitioners or expression of extreme cases. Consequently, emphasis is placed on the analysis of the content of opinions and views rather than on their absolute or relative frequencies.



4.7.1. Organizational relationships between EDP and Accounting functions

One way of analysing respondents' opinions and views in this respect is to look into their points of emphasis. Some had emphasized 'who should run and control' computerized accounting activities, some others had emphasized the kind of relationship they look forward to. A third group had emphasized the present shape of relationships, a fourth group described the 'organizational distance' between the two functions, and a fifth group had described the way the organizational relationship actually is. It is noticed that some of these categories of classification may overlap with each other, i.e. some of these views may be classified under two - or more - kinds of categorization. They are treated separately merely for the purposes of discussion. Also some of these opinions may reflect a specific type of experience or application in one - or more - of the participating organizations. So, it would probably be fruitful to evaluate any of these views on its (or their) pro's and con's rather than wrong or right application of experience. Meanwhile, presentation of these opinions and views is made according to their absolute frequencies: the highest frequency comes first on the list.

First: those who had emphasized 'who should control and run' computerized accounting activities

## Opinion(s)

## Comment(s)

An open door relationship is necessary to ensure co-operation and effectiveness.

Perhaps this may be the best course of action, providing appropriate security measures are adopted. This requires extensive definition and allocation of authority and responsibility between the two functions.

The accounting function will be solely responsible for the content, accuracy and usage of financial systems and data content - DP specialist will be the adviser and processor.

If this implies that DP specialists would know nothing about accounting systems (their content and structure), then the DP specialists' advice would be limited to the technical type of advice. In that case, the communication barriers would not be easy to remove. Also, allocation of responsibility would be loose in this respect, since the DP specialist would not be responsible for the content accuracy and usage of financial systems. But if this opinion assumes a certain minimum amount of involvement on the part of the DP specialist and a share in the design, development, and implementation of accounting systems, this would be desirable for both functions as well as for their organization.

EDP should provide a service to the accounting function just like any other function.

This is an important element in the mutual understanding between several functions of the organization.

'Total access' to computer files by accounting function.

A necessary condition for the mutual understanding between the two functions.

Accountants will come to DP for 'total reliance' for bookkeeping.

Accounting staff should not control or run their own DP. This should be left to DP specialists with 'proper consultation'.

Evidently, if the term 'proper consultation' is intended to contribute towards 'mutual understanding', then it would be difficult to achieve in the case of DP totally responsible for running and controlling computer-based accounting systems! This later view - particularly its implication of accountants' not being responsible for controlling their DP - would deny the accounting function's proper interaction with the EDP area and the gaining of useful experience in that direction.

Second : those whose emphasis was on 'the kind of relationship they look forward to'

Opinion(s) : I look forward to the day when

Comment(s)

each (EDP and accounting) finds its own role and both are complementary to one another.

In fact this is one of the necessary conditions contributing towards any operational definition of the term 'mutual understanding' between the two functions. Appreciation of one's role and understanding of the other's role, based on the complementarity principle, would be the basis for successful inter-functional interaction.

good working relationships, with full co-operation, are established.

This view describes the 'ends' rather than the 'means', i.e. the objective of the kind of relationships is to be looked forward to. It is very similar to the above view.

accountants 'grow' in understanding of the strengths and weaknesses of computer systems.

This view implies an idea that might convey 'misunderstanding' on the part of some accountants of what computers can - and cannot - do and the nature of computer-based information systems.

complete computerization of the 'drudgery' or routine accounting activities is achieved.

Logically this is the first step towards improving the efficiency of the accounting function, providing the need and abilities (regarding the use of such facility in devoting more time and effort - than now) exist. However, there are grounds to believe that a considerable number of the participating organizations have been working towards this end i.e. for releasing the accountant from the manual burden of the so-called 'drudgery' accounting activities.

accountants making use of a data-base by videos in a real-time environment (and playing a key role as originator or innovator of improved systems needs) is achieved.

Providing that the nature and scale of accounting activities is large enough to warrant the use of such improved systems and data banks, and providing the availability of such technological advances on an economical basis, this would be a great potential and challenge for the accounting function.



Opinion(s) : I look forward to the day when	Comment(s)
<p>a function which looks at the management information needs as a totality using interdisciplinary skills, is evolved.</p>	<p>This is one approach towards achieving 'total information systems' which has its pro's and con's. It raises many questions such as 'who would be the decision makers the management or this function?' It might be argued that this is no alternative to managerial awareness, understanding and involvement in the development and implementation of systems directly affecting them.</p>
<p>more progress towards 'maximum efficiency' is achieved.</p>	<p>Of course, this is a very desirable target that every computer installation should strive to achieve. Apparently, a considerable number of EDP installations find terminologies such as 'efficiency', 'performance' are unfamiliar. Defining objectives, studying the best approach to achieving such objectives under the normal conditions, comparing the actual performance - as defined operationally - with the desired one, following up and updating the measurement criteria and objectives: are important considerations that should be adopted to attain such results.</p>

Third : 'The present shape of relationships' as  
the point of emphasis

Although about two-fifths of respondents had viewed the 'accounting - DP' relationship from the present shape dimensions, their answers reflected the existence of significantly different patterns of communication and working relationships. Their description of this dimension ranged from very favourable attitudes to very unfavourable attitudes as follows:

- (i) at present, it is fairly satisfactory: no major problems.
- (ii) the relationship is improving.
- (iii) at present, it might be described as 'good' and 'stable' relationships.
- (iv) it is better than most.
- (v) no reason why it should not carry on evolving as it has to date.
- (vi) at present it is less than satisfactory.
- (vii) accountants have limited knowledge of EDP; they should realize their own limitations; accounting is one of the biggest problem areas.
- (viii) at present it may be described as bleak, prickly, etc.

Fourth : the 'organizational distance' between the two functions as the point of emphasis

Some respondents emphasized how their relationship could or should be based on (or developed in terms of) how close or far the distance is between the two functions. Loadings on each function's role and responsibility were different among responses. Some pointed out that it is the accountant's responsibility to understand and appreciate the EDP technology and its effect on the accounting discipline, others pointed out it is a shared responsibility of the two functions and they should work toward that end.

Although these views are 'subjective' descriptions, the 'objective' way of looking at them is to consider them as expressions about, or reflections of, actual situations. These views or expressions are:

- (i) need for accountants to appreciate the EDP facilities in a wider context than individual applications.
- (ii) with the 'right' attitudes of both sides, a great deal could be achieved.
- (iii) both functions should largely merge.
- (iv) EDP policy should be based on the approach of 'with the user by the user'.
- (v) relations between the two functions will become more remote as the emphasis shifts to wider areas rather than the accounting activities.
- (vi) team effort is the answer as far as the desired shape of 'DP - accounting' interaction.



#### 4.7.2. Characteristics of the 'Systems' or 'DP' Accountant

To learn about the acceptability of the idea of a 'systems' or 'DP' accountant amongst DP specialists, a question was devoted for that purpose. Also, if it is acceptable, what are characteristics of such an accountant? Empirical evidence is considered to be important in this respect, because it would reflect the DP specialists' observations which are essential for the implications for the future education of accountants.

The evidence indicates that if DP specialists had been asked to appoint an accountant to work with the DP group, the main educational background, training experience and the personality traits that they would require in him for the purpose of that job are (more than three-quarters of respondents had answered this question, and a very small number (2%) did not accept this idea):

1. Communication: the typical answer of the majority of respondents who answered this question was "communicate and get on with other people, especially all management levels, non-accounting types and programmers".
2. Accounting qualification: this requirement of education and training was next to 'communication' in frequency of respondents answering this question. The majority of those who explicitly expressed this requirement did not specify the type of the accounting qualification required. The interesting piece of this observation is that some respondents strongly emphasized that the person would have 'management accounting'

experience - and not particularly financial or auditing experience - and others preferred that he would have a 'chartered accounting' experience. Still some others did not mind if the person would have either 'ICMA' or 'ICA' experience.

(It is worthwhile mentioning that one respondent indicated that he would appoint a 'university graduate' without experience, because - as he explained - accountants tend to get fixed ideas. He would provide him with EDP training so that he would start from scratch with training in both aspects, but due to lack of experience, he would not be fixed in his ideas. )

However, the message is clear, i.e. the accounting profession should equip its members with the necessary educational background that reflects the ability to utilize effectively the potential of, and keep abreast with, recent developments in information technology.

3. DP knowledge: next to an accounting qualification was a 'considerable knowledge of EDP systems' advantages and limitations'. Some respondents had stated that their organizations' experience in this respect had been through 'transferring a young accountant to work in the DP function for a period between 2 to 3 years.'

4. 'Extensive' knowledge about the organization, its object-  
business ives, its market share, degree of competition  
experience: and other related issues is an important require-  
 ment for the development and implomentation of  
 computerized - as well as non-computerized -  
 accounting systems.

The above list is not in any way exhaustive. On the contrary, respondents expressed a very wide variety of requirements. Some of them are mutually inclusive. Also many management consultants - of those who discussed this issue - arrived in one way or another at the same conclusion and viewed the above requirements as important considerations which ought to be taken into consideration in relation to the computerization of finance and accounting activities. The following might be considered as a 'typical' view of those consultants who emphasized the above considerations:

"I think in terms of the organization, he's got to have the recognition, or the backing, of both the senior accounting manager and the senior EDP manager and he's got to have a voice in matters, he's got to have some authority behind him, I think that is important, otherwise he's toothless. I think he's also got to know his own area very well, he should be an expert in that area, not uncertain as to what goes on in his own functions. I think this guy has got to have probably more than a rudimentary training of computer systems, of design methodology. The manufacturers as well as his own EDP department can help with training. I think he's got to be a sort of diplomatic person, with a diplomatic personality. If he goes in there without being prepared to listen to the other angle of the problems he will upset people. I think this is an important aspect."



## Summary

This chapter has analysed a set of opinions and views of a sample of DP specialists regarding their working relationship with accountants. The analysis of findings presented in this chapter and the corresponding section in chapter six is the basis for constructing a priori behavioural indicators in relation to the accountants - EDP specialists' interaction which would be the central concern of the researcher in chapter eight of this thesis. Indeed, the remainder of this part (II) is devoted to the exploration of possible dimensions underlying accountants - EDP specialists' multidimensional space.

This chapter has discussed details of many of the related component variables, behavioural indicators or background variables. Title of present job, age, length and type of EDP experience have been amongst the personal background variables. Type of industrial classification available, EDP equipment and manpower facilities, location of EDP resources, and length of experience in the major areas of application are the organizational background variables.

In penetrating the various aspects of EDP specialists' communication with accountants, a distinction has been made between those EDP specialists with neither accounting qualifications nor experience and those who have some type of accounting qualification and/or experience.

Furthermore a number of related issues have been explored and analysed. These have been the extent of accountants' involvement in EDP, the computerization of accounting activities, and E.D.P. accounting future working relationships.

## Chapter Five

An analysis of opinions and views of MS/OR specialists regarding their working relationships with accountants.

### Abstract.

- 5.1. Background information (personal and organisational).
  - 5.1.1. Personal background information.
  - 5.1.2. Organizational background information.
- 5.2. General impression regarding accountants and accounting functions.
  - 5.2.1. Accounting interest in support and opposition to MS/OR function.
  - 5.2.2. "How important is it to get accountants acquainted with MS/OR concepts?"
  - 5.2.3. "Do accountants constitute a major obstacle in implementing MS/OR recommendations?"
  - 5.2.4. Pressure experienced from accountants.
  - 5.2.5. Attitudinal aspects of communication.
- 5.3. Working relationships with accountants.
  - 5.3.1. State of no communication with accountants.
  - 5.3.2. State of communication with accountants.
- 5.4. MS/OR concepts and methodology used in dealing with accounting problems.
  - 5.4.1. Extent to which MS/OR specialists are involved with accountants.
  - 5.4.2. Reactions to not being called upon by accountants.
  - 5.4.3. Financial modelling as a potential area of involvement.
- 5.5. Reputation of MS/OR groups.
- 5.6. MS/OR-Accounting future relationships.
  - 5.6.1. Organizational relationships between MS/OR and accounting functions.
  - 5.6.2. Desired characteristics of future accountants.

### Summary.

## Abstract

The objective of this chapter is to present an analysis of opinions and views of MS/OR specialists regarding their working relationships with accountants. The study surveyed 251 MS/OR specialists working in the relatively large British industrial organizations by means of mailed questionnaires.<sup>1</sup> Questionnaires were sent on the 1st of March 1973, but several stages of designing and testing the document had been completed by December 1972.<sup>2</sup> The survey was able to draw a rate of response of 70 per cent. Also, interviews were held with some management consultants representing large-sized consultancy firms.<sup>3</sup>

The analysis of findings in this chapter is in six sections. The first presents the background information about MS/OR respondents (age, length of experience, subject of the first degree<sup>4</sup> and year of the award, etc.) and their organisations (such as the actual location of MS/OR groups, the optimum location, and difficulties and problems experienced as a result of the actual location). The second is a detailed analysis of MS/OR

- 
1. For a detailed account of the MS/OR specialists' sample, see Appendix A, ~~#~~ 2.2.
  2. A specimen of the MS/OR specialists' questionnaire is contained in Appendix A, ~~#~~ 4.2.
  3. For a detailed account of the management consultants' sample see Appendix A, ~~#~~ 2.4.  
As adopted in the preceding chapter, reference may be made to 'verbal' descriptions of any specific opinion or point of view made by any of the interviewed management consultants; or by respondents. Such citations are dependent upon the particular opinion's relative richness. In those cases, the specific opinion is analysed and discussed in a manner which does not in any way prejudice the anonymity principle adopted by the present research. However, richness of any opinion does not depend on being in favour or against certain views, but it depends on the particular opinion's capacity to reveal, describe or clarify aspects or circumstances that are not easily discovered or indicated by the relevant statistical summaries.
  4. It could be said that subject of the first degree might not be an accurate indicator of the person's interests (for a variety of reasons due either to the person himself or external pressures or both of them). This is true in general. Nevertheless, the subject of the first degree does give some indications of the individual's interests at one point in time, that could be the basis for comparing positions of both MS/OR specialists and accountants. In addition, a frequency distribution of the subject of the first degree of members of the sample could be viewed in relation to other similar distributions that are available relating to the other samples in other studies.



specialists' general impression regarding accountants and accounting function. The third deals with working relationships with accountants as seen by MS/OR specialists. The fourth discusses MS/OR concepts and methodology used in dealing with accounting problems. The fifth explores the reputation of MS/OR groups as seen by themselves. The final section discusses MS/OR-Accounting future relationships as visualized by MS/OR specialists.<sup>5</sup>

- 
5. This part of the investigation was carried out with an explicitly defined assumption in mind. The assumption was that providing the satisfaction of some requirements, both of the two functions (MS/OR and accounting) can contribute towards the achievement of their organisational goals, and further encourage mutual understanding. The identification, classification and explanation of those requirements has been the driving force of the sought objective; i.e. mutual understanding between the two functions for more effective fulfilment of their functional and organisational objectives.

To find out whether or not there was a basis for thinking that either of the two functions would take over the other was not the object of this research - even though the evidence collected, in few cases, give grounds to such belief. Furthermore, identifying problem areas or points of weakness of either of the two functions was not to apportion blame. (Quite the contrary in fact: it was to describe, analyse and explain causes and effects of such problem areas or points of weaknesses. This is mainly for the purposes of directing the attention of the interested individuals, parties, groups or organisations, to avoid so far as possible such causes as well as to exchange opinions and experiences).

## 5.1. Background information

Two main types of background information are presented in the two sub-sections contained in 5.1. The first is concerned with some background information about the particular respondent, to enable the researcher to draw the features characterised in the 'chosen' sample. The second concentrates mainly on: the actual and optimum organisational location of MS/OR groups as described by MS/OR specialists who participated in the study: the difficulties and problems experienced as a result of the actual location; and the industrial classification of respondents' organisations.

### 5.1.1. Personal background information

#### Age, length of experience

Analysis of respondents' age indicates that:<sup>6</sup> more than a half of the survey's valid observations (58.5%) were between 26-35 years of age; 10.4% were under the age of 25 years; and 3.0% were over 50 years of age.<sup>7</sup> This might be viewed as a reflection of the effect of the history of MS/OR upon the characteristics of the sample of MS/OR specialists who participated in the present survey. Compared with other professional bodies such as medicine and accountancy, MS/OR is a relatively young profession. There is an increased number of MS/OR specialists working in industry compared with those who were engaged in the field immediately after the Second World War.

Examination of respondents' length of MS/OR experience indicates

6. See Table 1, Appendix A, ~~#~~ 3.2.

7. Referring to their 'Profile of Current Members of the O.R. Society' conducted in the Summer of 1967, Eilon, Hough and Betts (1969) indicated that the median age of respondents was approximately 30 years, whilst about one-third came in the 25-30 range and 70% were 35 or younger (p.250).

In spite of the difference in the nature, objectives and time elapsed between Eilon *et al*'s survey and the present one, such reference might give an indication of how far the present survey approximately represents the U.K. industrial MS/OR specialists' population.



that: the modal class was 4-7 years; about four-fifth of respondents had 11 years of experience or less; and about one-fifth of respondents had 12 years or more.<sup>8</sup>

In explaining this general impression regarding MS/OR specialists, one management consultant gave a description of how he saw the historical developments in the MS/OR field and their implications on MS/OR specialists' ability to 'sell' and prove the value of MS/OR discipline - in the following manner:

"Over the last ten years, there has been a considerable change in the O.R. man. 10 years ago you had still largely the people who had grown from war-time application and their immediate disciplines. Those were people who came from a large number of scientific walks of life and from Universities, they brought their analytical skills, not classified as O.R. techniques at that time, to general problems solved. That has changed from the 60's, From that time I think O.R. has been too much off an armchair, it sounds too technique oriented.

The emphasis has changed from a chap who is problem solving oriented, a background of general analytical skills to one who is a younger chap who has recently just left the University. His latest influence has been one of technique and technical exposure of University".

Apparently this observation is concerned with the quality of present MS/OR systems of education and training of some of the MS/OR practitioners whose practical experiences were limited to 'technique' rather than 'problem' orientation.

Although the researcher is aware of MS/OR specialists' reactions to the term 'O.R. techniques'<sup>9</sup> which probably has its implications for the users' image of MS/OR, it is quite often found in discussions,

8. See table 2, Appendix A, ~~3.2~~ 3.2.

9. It is worth mentioning that during the preliminary stages of testing the document, the majority of MS/OR specialists felt strongly against any inclusion of a set of 'MS/OR techniques' in the document (for the purpose of identifying the frequency of their use). They preferred limiting that question to the type of problem areas that had been (or were being) carried out by their groups. Meanwhile, it is interesting to compare this attitude with the accountants' attitude. The 'technique-headed' Table was presented to the accountants, and it was quite acceptable to them. The latter attitude would probably describe how the MS/OR approach is seen from some users' point of view. One possible interpretation to such tendency is the fact that very many of the books treating the subject are emphasising the 'technique-orientation' of the subject.



lectures, articles and books forming the relevant literature.

Another consultant linked this age difference between younger and older MS/OR specialists by the problem of 'selling' their approach to users, where he commented that although he had some experience with companies who had no MS/OR groups, about the ones having this function he made the following remark:

"One finds in a bulk of O.R. groups the business of selling the O.R. concepts is not very good. Mainly because a lot of people tend to be very young, I think they tend to talk really about benefits you can achieve from O.R. without actually ever demonstrating these things within the Company, and my feeling is the sort of floss that one ought to adopt in selling O.R., is that you have to do some good work first and then there can be something comparatively small, preferably it should produce some savings and it should concern people really high-up in the firm, in order to achieve success. I think a lot of people tend to want to involve themselves in things like corporate planning - which is very interesting work and that impinges on the long-term prospects of the Company but, the results perhaps do not appear for 5 years and it is very hard to say that they (the results if successful) have come from you or themselves. So, you have to do things that can demonstrate your ability".

Another management consultant saw the 'selling' problem differently where he said

"MS/OR specialists are not bad at 'selling', and if they were not good at selling they would not be holding MS/OR jobs. I have seen amazing things sold ..."

However, neither over- or under-selling is a productive process as far as the development of a desirable and favourable 'image' of MS/OR function in their organisation's concerned.

10

Subject of first degree and year of the award

Examination of respondents' first degree - if any - indicates the predominance of mathematical/statistical subjects. Electrical, mechanical and other engineering and pure sciences (such as physics and chemistry) account for about one-third of respondents' subject of first degree.

Accordingly, these categories: mathematics/statistics, engineering and pure sciences, account for about four-fifths of respondents' subject of first degree. Also, economics occupies slightly more than one-tenth of respondents' subject of first degree. Arts and others (such as sociology and psychology) occupy a very low percent in the distribution of respondents' subject of first degree.

||

Although nothing is new about the above distribution, such information is of considerable interest as far as the present study is concerned. Educational background and training experience have a significant impact on communication patterns and the language used in forming and contributing to MS/OR specialists' and accountants' organisation behaviour.

Such a distribution raises some other related questions such as: what is the speciality composition of MS/OR groups and/or functions in industrial organisation? How similar is such a distribution to the above one? How reflective is that educational and/or training background of the interdisciplinary nature of which the MS/OR function is supposedly composed?

Regarding the distribution of the year of the award of respondents' first degrees, the study shows that the modal range is 1961-1965; about two-thirds of respondents were awarded their first degree since 1961; and about one-fifth of the respondents had their first degree in 1955 or prior to that.<sup>12</sup>

11. Eilon, Hough and Betts (1969) have found that the subjects of the first degrees held by their respondents' are distributed as follows: arts (2.1%); mathematics/statistics (36.3%); pure sciences (23.6%); mechanical, electrical and other engineering (23.6%); economics/P.P.E. (7.5%); sociology and psychology (1.4%); and others (5.2%) (p.253). These figures show the concentration in mathematics and statistics, the considerable contribution of the engineering and pure sciences - compared with the thin contribution of sociology and psychology to the MS/OR discipline.
12. See table 4, Appendix A, ~~3~~ 3.2.



Education and/or training in accounting and information systems topics

Analysis of respondents' opinions and views regarding the relevance of education and/or training in accounting and information systems topics indicates that: the vast majority of respondents' considered this to be wholly or partly relevant to their job responsibilities; very few MS/OR specialists considered this aspect of education and/or training to be only loosely relevant to their work; an extremely small minority felt 'undecided' about this; and not one of the respondents expressed a view of the irrelevancy of having some kind of accounting education and/or training.<sup>13</sup>

The majority of respondents indicated that they have received some education and/or training in accounting and information systems in one way or another (either formally or informally):<sup>14</sup>

- a. in accounting theory and principles: 30% have received formal examination or formal training courses; 19.7% through informal personal reading and training; 32.8% through a combination of formal and informal education and/or training.
- b. in budgetary control systems: 19.7% have received formal examination or formal training courses; 23.4% through informal personal reading and/or training; and 30.7% through a combination of formal and informal educational and/or training approaches.
- c. in other accounting aspects, such as cost allocation, standard cost systems and estimation of costs, their distribution is similar - with slight variations - to the pattern described in 'b'. One may suspect that some sort of bias probably influenced respondents'

---

13. See table 6, Appendix A, # 3.2.

14. See table 7, Appendix A, # 3.2.



interpretation of these aspects of accounting topics (cost allocation, estimation of costs, cost classification) which resulted in this pattern.

- d. in computer-based management information systems; 20.4% have received their training through formal examination or training courses; 19.7% through informal ways of training; 38.0% through a combination of formal and informal educational and/or training approaches.

Also, very few respondents added that they have received training or informal personal reading in: taxation, takeovers, assessment of capital investment. (It is most likely that this piece of information does not reflect the actual situation regarding respondents' knowledge in taxation, takeovers, and investment appraisal and assessment of capital projects).

When asked "How often do you feel that you should know about accounting and information systems?", 62.2% of the valid observations indicated they quite or very often feel they should know about accounting and information systems; 37.8% indicated that they sometimes or occasionally have that feeling.<sup>15</sup>

In addition, when asked "To what extent do you feel that you are willing to attend training and/or educational courses in accounting and information systems?", only a minority of respondents did not wish to undergo such an experience; whilst the majority expressed their wish to attend such an educational and/or training experience.<sup>16</sup>

For example, regarding accounting theory and principles 32% were willing 'to some extent'; 21.9% were willing 'to a considerable extent'; 12.4% were willing 'to a very great extent'. Regarding budgetary control systems; 33.6% were willing 'to some extent'; 21.9% were willing 'to considerable extent'; and 5.1% indicated their willingness 'to a very great extent'.

15. See table 8, Appendix A, ~~##~~ 3.2.

16. See table 9, Appendix A, ~~##~~ 3.2.

Other topics, such as estimation of costs, cost allocation, and standard cost systems were - with minor variations - on the same scale.

Concerning computer-based management information systems, respondents indicated their willingness to attend such courses as follows: 13.1% to a very great extent; 28.5% to a considerable extent; 28.5% to some extent, making the total of 70.1%.

The common thread underlying respondents' answers in this section - regarding MS/OR specialists' knowledge of accounting and information systems - is the importance attached to such aspects. The complexity of today's business problems necessitates an interdisciplinary attack on these problems to reduce them to a manageable size. Knowledge of accounting and information systems would be useful in this respect, but the immediate obstacle is how such knowledge could be moulded into the MS/OR discipline and presented to MS/OR students and practitioners.<sup>17</sup>

Respondents to this part of the survey have emphasised the relevance of accounting and information systems topics to their work, and have expressed their feeling and wish to attend such courses. Clearly, there is a message to those interested in the future education of MS/OR specialists - as well as accountants - in the interrelatedness of financial and modelling dimensions of their organisational responsibilities.

17. Given that no empirical evidence is available to statistically corroborate or refute the following observation, a MS/OR specialist commented that:

"... I am very interested in the interaction of Operational Research workers and accountants. Feeling in no position to criticise Accountants for their lack of knowledge of O.R. methods while I myself had such a scant knowledge of their subject, I decided to take ... course and examinations (in Accounting). To this end I have been attending evening classes. My impression so far has been of doing long-winded arithmetic and of using frighteningly simplistic methods, in particular with regard to Stock Control. I even had a row with the lecturer one evening on his fallacious stock control calculations, his only defence was that it was an examination question and this is how the examiners would expect us to treat it. On the other hand, I think that O.R. courses could well pay more attention to Accountancy, and in particular the terminology and definitions used. In the M.Sc. Course I took ... in Operational Research ... we did an introductory course in Accountancy. I feel this could have been extended to include principles of Costing".



### 5.1.2. Organizational background information.<sup>18</sup>

It can be assumed that the majority of industries employing the MS/OR type of services are represented in this phase of the present survey: Coal, gas and electricity (17.5%); industrial - miscellaneous (13.1%); electrical and radio, engineering and metal (10.9%); food manufacturing (8%); oil (7.3%); steels (6.6%); machine tools, motors and cycles and components (5.8%); transport and communication (5.8%); beers, wines, spirits, entertainment and catering (5.8%); chemicals and plastics (5.1%); textiles, drapery and stores (4.4%); tobacco (3.6%); and other (5.8%).<sup>19</sup>

### Actual and 'optimum' organisational location

The analysis of responses regarding the actual and optimum location of MS/OR activities reveals that:<sup>20</sup>

- (i) location under the responsibility of the Managing Director of the organisation is the most highly desired form of organisational design amongst a high proportion of the surveyed MS/OR specialists. In other words, Managing Directorship as an authority responsible for MS/OR specialists is the most frequently observed form of desired or optimum location of MS/OR activities.
- (ii) next to this - as an optimum location - is that form of organisational design under the responsibility of a non-accounting director.
- (iii) very few MS/OR functions are actually located in accounting department(s) or division(s). Nevertheless, finance directors or controllers assume responsibility for a fair number of MS/OR functions. 21
- (iv) the position of MS/OR functions on organisational charts is clearly dependent on considerations such as: the importance the particular

18. For a detailed discussion of the type of industries that were included in the sampling design of this stage of carrying out the empirical investigation, see Appendix A, ~~4~~ 2.2.

19. See table 5, Appendix A, ~~4~~ 3.2.

20. See table 10, Appendix A, ~~4~~ 3.2.

21. In designing and presenting the particular question asking about the actual and optimum location of MS/OR activities, a fundamental distinction was made between the accounting department or division and the finance director or controller's responsibility, since not all MS/OR functions reporting to the finance director or controller are located in the accounting department or division.



organisation attached to its MS/OR function, the size of MS/OR activities, MS/OR specialists' abilities to 'sell' their function to present and potential users, and organisational policies affecting and shaping MS/OR activities. In other words, organisational design of MS/OR activities varies considerably amongst surveyed organisations.

Difficulties and problems experienced as a result of the actual location

For exploratory purposes and to learn about the nature and type of problems and/or difficulties facing MS/OR specialists as a result of the actual location of their groups, respondents were asked to indicate which of the categories below would describe their feelings concerning the actual location.

- |   |   |
|---|---|
| Category one: No significant problems:  | slightly more than one half of the valid observations felt that the actual locations were successful and healthy for the development and growth of their MS/OR units.   |
| Category two: some critical difficulties but no need to change the actual location:         | about one-third of the valid observations felt that there were some difficulties facing the development and growth of their MS/OR units mainly because of their actual locations. But by overcoming these difficulties, it is possible to grow in the future. |
| Category three: severe difficulties and the only solution is to change the actual location: | slightly less than one-tenth of the observations felt there were some severe difficulties resulting from the wrong location.  |

Also, respondents were asked to give a brief description of problems and/or difficulties facing them as a result of the actual location of their MS/OR groups. Examination of the cross-tabulations of the various problems and difficulties with the different forms of organisational design indicates that such problems or difficulties could be classified into broad types:

a. general type of problems or difficulties. Examples of this type are:

- i) poor communications; existing relations of confidence and trust (such as: some areas are closed to MS/OR projects); and lack of interest.
  - ii) management understanding and awareness of what MS/OR can offer; management reluctance to start any detailed MS/OR projects, etc.
  - iii) insufficient link and integration with other analytic functions (such as corporate planning department, computing services, etc.)
  - iv) MS/OR specialists' lack of experience and knowledge of user activities; lack of success in 'selling' MS/OR properly to management and user functions.
  - v) overlays with other similar functions (such as planning).
  - vi) 'whims' of management (rather than the actual location).
  - vii) personalities between MS/OR and top management.
  - viii) others (such as: MS/OR is geographically divorced from decision making centre; historical difficulties due to merger; remoteness of MS/OR function in large companies from small subsidiaries who may not be aware of the scope of using MS/OR services).
- b. specific type of problems associated with certain forms of organisational design. Examples of this type are:
- i) not enough proper use is made of MS/OR; lack of work; carrying non-MS/OR type of work.
  - ii) bias towards the function to which MS/OR is attached. Five out of eleven observations emphasised this type of difficulty and expressed the need to change the actual location.
  - iii) the director responsible for MS/OR type of work (who is *not himself* a MS/OR specialist) is more concerned with other interests (such as: the finance director is primarily interested in his role as a treasurer rather than a systems controller, D.P. manager with computing rather than modelling interest and so on).
  - iv) isolation of MS/OR function " MS/OR specialists are research-oriented people who are remote from problem solving and decision making .
  - v) appearance of interference in other's' business (and sometimes having the characteristics of being an outside consultancy unit).
  - vi) being given projects of sufficient importance (the essence of this difficulty explains why it is not always functional to have the full-weight of the 'managing director' behind MS/OR type of work).



Furthermore, respondents were asked to prescribe the possible ways to overcome the above-mentioned difficulties and problems. Amongst the frequently-described suggestions were:

- i) better forms of communication between MS/OR and potential and present users. Periodical review meetings between both managements of MS/OR function and users, is one of the possible ways of developing and establishing such communication networks.
- ii) liaison with user functions to obtain their confidence and trust.
- iii) more effective 'selling' of MS/OR approach.
- iv) education: getting both management and user functions acquainted with MS/OR concepts and methodology.
- v) change, reorganise the existing location of MS/OR function.
- vi) co-ordination between MS/OR and other similar-type functions.
- vii) the need for higher standing in the organisation.
- viii) support from own director.
- ix) more active selling by directors with planning responsibilities.
- x) amalgamation of MS/OR with other similar function.
- xi) other such as: the passage of time, change the physical or geographical location, co-ordination between MS/OR groups with the same company.

In view of the above analysis, the following main conclusion could be drawn concerning the organisational design of MS/OR:

- i) top management should be aware of the benefits and limitations of the MS/OR function in their organisations; and of any 'political manoeuvring' to minimize its dysfunctional effects on the achievements and performance of such functions. MS/OR function should not be established on 'whims' of some managers or directors about what MS/OR can- and cannot - do for their organisations.
- ii) success, non-success or failure of MS/OR is dependent - to a great extent - on the function's ability to sell its approach in a practically convincing manner. The function should avoid being an isolated, research-oriented unit with no apparent proven practicality as well as avoiding a characterising image of interfering in others' business.
- iii) both the importance of MS/OR type of projects and their reporting organisational level should at least be on the same level. Equally, the director responsible for MS/OR should be familiar, enthusiastic and supportive to this type of work.



- iv) the interdisciplinary characteristic of MS/OR should be developed and effectively utilized on the individual as well as on the organisational levels.
- v) co-ordination between MS/OR and other similar type functions should be established and integrated (not necessarily on a formal basis).

However, it is the contention of the present research that the above discussion could be used by any MS/OR specialist as well as any other user as a 'check-list' in reviewing the effectiveness of the organisational design of his (or their) MS/OR function identifying the difficulties or problems associated and suggesting or carrying out improvements.<sup>22</sup>

## 5.2. General impression regarding accountants and accounting functions

Five separate headings are contained in this section to describe different aspects of MS/OR specialists' general impression regarding accountants and accounting functions. Sub-section 5.2.1. discusses accountants' interest in, support and opposition to MS/OR function. Sub-section 5.2.2. attempts to answer the question of importance in getting accountants acquainted with MS/OR concepts. Sub-section 5.2.3. explores the extent to which accountants constitute a major obstacle in implementing MS/OR recommendations. Sub-section 5.2.4. is an attempt to find out the magnitude of pressure - if any - experienced by MS/OR specialists from accountants, whilst sub-section 5.2.5. presents the analysis of the attitudinal aspects of communication based on Likert-type scale.

---

22. Combining the above analysis with experience from managerial psychology, it appears that exploration of concepts such as 'image exchanging', 'organisational development meetings' and 'organisational analysis', may be useful in satisfying some of these objectives. (For a detailed discussion of such concepts see, Du Brin 1972, pp.25-86 and pp.211-242).

### 5.2.1. Accounting's interest in support of opposition to MS/OR function

Clearly the idea of accountants' participation in MS/OR projects and studies is acceptable amongst most respondents. 89.1% indicated that it is 'acceptable' or 'completely acceptable' to have the accountant's participation in such studies and projects. Only a very small minority (2.2%) indicated that such participation is unacceptable in their opinion. Also, only a few respondents (8.8%) felt undecided about this issue. This appears to be compatible with what intuitively was expected. After all, the development of MS/OR was based on the 'team' approach for the joint attack on complicated situations.

As for the degree of accountants' interest in MS/OR projects and studies observed by respondents: the modal class is 'fairly interested' with a relative frequency of 39% of the valid observations; 34.6% indicated that accountants have 'little interest' in MS/OR projects; 20.6% observed that accountants are 'interested'; a few respondents, forming 3.7%, expressed their view that accountants showed 'no interest'; and still fewer respondents found that accountants are 'very much interested' in MS/OR projects and studies. In view of these observations, no generalisation could be made and the main inference from these statistics is that accountants' interest or non-interest depends on other factors.

Turning more specifically to the finance directors' degrees of interest in MS/OR projects as seen by MS/OR specialists, the direction of observation in this respect is slightly different in the



negative direction<sup>23</sup> as follows: the modal class is located where finance directors showed 'little interest' representing 30.4% of the valid observations; 29.6% observed that finance directors are 'fairly interested'; 20.7% observed that finance directors are 'interested' (if one could assume that the difference between the two categories: 'interested' and 'fairly interested' is mainly due to minor differences in interpretation and respondents' judgment, then, and only then, about one-half of the valid observations found finance directors' interested in MS/OR projects and studies); and the extreme categories have slightly higher frequency than those concerned with accountants' interest described above. About 10.4% observed that finance directors showed 'no interest' whilst 8.8% indicated that finance directors are 'very much interested'. Although these observations are no basis for generalisation, it can be argued that some 'finance directors' are totally in favour or totally against carrying out MS/OR projects. Evidently, finance directors' interest - or non-interest - in MS/OR projects and studies is dependent upon other factors. Amongst these factors are: their experience with their MS/OR functions, the history of relations with MS/OR specialists, MS/OR specialists' success in 'selling' their function, as well as background and organisational factors.

Regarding 'how supportive are accountants to their MS/OR functions in respondents' organisations', the analysis indicates that:

---

23. It is interesting to note that a considerable number of management consultants did not see it in the same way. In their view, finance directors or controllers tend to think more broadly than other individuals under their responsibility. Such difference in the direction of interest in MS/OR might be due to factors such as: the finance director's responsibility and attitude towards the consulting assignment as distinct from that of towards his own internal MS/OR group, their location, the type of work they have been doing as well as their image. Besides, differences exist in the interpretation of the word 'interest'. As one consultant pointed out: "In a way they are interested that they try and involve themselves in MS/OR type of work without having sufficient background knowledge to do so".

the modal class is that accountants are 'fairly supportive' accounting for 36% of the valid observations; adding to this the 'supportive' and the 'fully supportive' categories, the frequency rises to 65.5%; leaving 34.6% of the total valid observations indicating that accountants showed 'little' or 'no' support to their MS/OR functions. Caution should be exercised in the interpretation of these observations.

Turning more specifically to the finance directors' degree of support to their MS/OR functions, the analysis shows that: the modal class is that of 'little support' representing 32.3% of the valid observations; 22.6% accounting for the 'supportive' category; 21.1% for the 'fairly supportive' one; leaving about one-quarter of the valid observations sharing equally - with slight variations - the two extreme points on the scale - i.e. the 'fully supportive' and the 'no support' categories.

Contrasting the above observations regarding accountants' interest and support to the MS/OR function with those of accounting leadership - finance directors, controllers and financial directors - the inference that would be made here is that probably the attitude and position of accounting leadership are more easily noticed and reacted to than that of other members of the accounting function.

When asked "How opposing are accountants in your firm to the MS/OR function?" analysis of responses indicates that: more than one-half of the valid observations found 'little opposition'; one-third found 'no opposition' (combining these two categories: little or no opposition accounts for more than 88.3% of the observed values); few respondents found accountants 'fairly opposing' or 'opposing' representing 11.7% of the observed values.



5.2.2. "How important is it to get accountants acquainted with MS/OR concepts?"

It was necessary for this research to identify - based on empirical experience - the extent to which MS/OR specialists consider the idea of getting accountants acquainted with concepts of their discipline to be important. Accordingly, a set of related questions was designed for that purpose. Respondents' views and opinions regarding this issue have been analysed in this section.

First, the 'degree of importance' perceived by respondents is analysed. A two-way classification emerged: on the one hand there were those who were in favour of accountants being acquainted with MS/OR concepts and on the other hand there were those who did not favour accountants becoming acquainted with such knowledge. Second, an examination is made of the grounds for believing accountants need not become acquainted with MS/OR concepts. Finally, a discussion of the rationale of the 'case for' such acquaintance will be presented.

Degree of importance attached to getting the accountant acquainted with MS/OR concepts

An analysis of respondents' views regarding the degree of importance in getting the accountant acquainted with MS/OR concepts, reveals that the vast majority considers it 'important' to attain this condition: about one-half of the respondents favoured the 'important' category; 24.1% favoured the 'fairly important' category; 16.8% were in favour of the 'extremely important' category. Accordingly, 91.2% of respondents indicated that it is important (with varying degree of emphasis) to get the accountant acquainted with MS/OR concepts. Only a few respondents (representing 8.8% of the observations) indicated that it is 'of little importance' or 'not important' to get the accountant acquainted with MS/OR concepts. In spite of the apparent agreement amongst the sizeable majority of the respondents, care

should be exercised in the interpretation of this agreement, mainly due to the differences that may arise in attempting to define words such as 'acquaint' and 'concepts'. Nevertheless two fundamental assumptions underlined this question. The first is that such acquaintance is neither intended to replace the MS/OR specialist by his accounting counterpart, nor to give the accountant a fragile and a useless introduction to the subject. The second is that the objective of such an exercise is to enable the accountant to constructively participate in the development, implementation and sponsoring (if necessary) of MS/OR projects for the mutual benefit of both parties (and of the organisation).

The case 'against' getting accountants acquainted with MS/OR concepts

As indicated above 8.8% of respondents pointed out that it is 'of little importance' or 'not important' to get accountants acquainted with MS/OR concepts. These observations should be considered in conjunction with the reasons indicated that lie behind that belief. These reasons are discussed below.

REASONS	DISCUSSION
(i) 'MS/OR people should have a better knowledge of accounting and should be able to sort out with accountants what information is required'	It appears that the emphasis in this observation is on putting a substantial part of responsibility on MS/OR specialists' shoulders. But why should the MS/OR specialist be acquainted with accounting without accepting the reverse side of the 'case'?



REASONS	DISCUSSION
(ii) 'Communication between MS/OR specialists and accountants should not require that one discipline should learn the trade of the other'.	Given that acquaintance with concepts does not mean in any way that one discipline would be able to replace the other, it is desirable that both disciplines should be able to establish the necessary foundations for building communication networks. Accountants' acquaintance with MS/OR concepts is far better than the lack of it.
(iii) 'Accounting function measures what happened, MS/OR plans what should happen'.	Although this might be the case in some organisations, there is a difference between what accountants do in some organisations and what they should be doing.
(iv) 'Very little contact between MS/OR specialists and accountants'.	Although this observation emphasises that there is a correlation between the 'non' or 'little' contact and the need to get accountants acquainted with MS/OR concepts, it should be subjected to further evidence and analysis. However, such a case of 'little' or 'non' contact between the two functions is dependent on other variables (such as organisational policies, individuals' backgrounds and so on).

It appears that the above reasoning against accountants becoming acquainted with MS/OR concepts, is not a sufficiently clear-cut indication for refuting the need for accountants to become acquainted with concepts of the MS/OR discipline.

It is doubtful, however, that successful communication networks (between both MS/OR and accounting groups) and effective model-building would be effectively achieved, without mutual acquaintance with the framework of the counterpart's discipline.

If MS/OR specialists' acquaintance with accounting concepts is a favourable objective, it is highly desirable (even essential) that accountants become acquainted with MS/OR knowledge. This would enable both parties to

discuss (and possibly engage in) interdisciplinary projects achieving objectives of mutual interest.

The 'case for' getting accountants acquainted with MS/OR concepts

Reasoning

Having discussed the 'case against' getting accountants acquainted with MS/OR concepts and concluded that there is not sufficient evidence to fully support that case, attention is now to be directed towards the reasoning and weight of evidence supporting the 'case for' getting accountants acquainted with such a discipline. This is done below, where observed reasons are classified into categories paired with detailed discussion of each of these categories. Such detailed discussions are the researcher's commentary on respondents' observations.



Given reasons (as perceived by MS/OR respondents)	Frequency		Commentary discussion
	Absolute+	Relative++ %	
i) Experience has shown that there is an apparently 'narrow' approach of accountants to cost allocation, cost analysis, risk analysis and that accountants are too preoccupied with day-to-day problems to bother with MS/OR type of applications.	49	35.8	<p>This is the most frequently mentioned reason for the need to get accountants acquainted with concepts of MS/OR discipline. If accountants get to know the discipline, it may be possible for them to 'widen' their approach, adopt different methodologies, and contribute towards the development and implementation of MS/OR models. This reasoning explains the nature of one of the major constraints imposed on a considerable number of accountants that is the historical dimension of accountancy and the preparation of the year-end results.</p> <p>This raises several questions: 'How did respondents get this impression about that sector of the accounting community?' 'What is the accounting explanation of this observation?' and 'What is a suitable strategy for making accounting data and information more widely used and widening the scope of accounting applications?'</p>
ii) Accountants are not aware of what is required from them for MS/OR models.	32	23.4	<p>Evidently some accountants may not be aware of the nature of the methodology involved and/or the objectives to be achieved by building certain MS/OR type of models. This may be related to those accountants' lack of interest in this type of work, or the MS/OR specialists' lack of success in 'selling' the nature, objectives and methodology of this work.</p>
iii) Need for relevant reliable and reasonably quick provision of information.	26	19.0	<p>Accounting information - by nature - is designed in a specific manner, according to certain 'principles and conventions' to satisfy certain objectives. This applies to the bulk of financial reporting specifically for external purposes and its related prior and posterior processes. Consequently, data and information for different purposes - such as building MS/OR models - should be given more attention by more and more accountants. Presumably</p>



<p>(iv) Need to change approaches in accounting.</p>	<p>26</p>	<p>if computers have come to relieve the accountant from the most tedious clerical type of work, accountants should devote more time to manipulating different data for different purposes!</p> <p>This observation leads to an important question in this respect, that is: would the inclusion of MS/OR concepts in accountants' curricula contribute towards the change desired and contained in this observation?</p> <p>The need to change has already been recognised. But the nature and shape of change are wider issues that are significantly going to affect the future as well as the present generation of accountants. Certainly, the essence of MS/OR methodology is a good possibility in that direction.</p>
<p>(v) Need for more active participation by accountants.</p>	<p>19</p>	<p>13.9</p> <p>Clearly, the active participation by accountants in the development and implementation of MS/OR type of projects could be one of the desired aspects of the future change in accountants' approaches.</p>
<p>(vi) If accountants understand what MS/ORs want to achieve and how, they - accountants - may be able to help with the data as required, accountants provide a high proportion of the data needed for MS/OR projects, so it is important that they understand what the data will be used for.</p>	<p>16</p>	<p>11.7</p> <p>This observation suggests the need to improve possible sources of data for MS/OR projects. Accounting data and information, even in its raw form contain fundamental facts, trends and patterns about an organisation's life. Shrewdly subjecting these (accounting) data and the design of various accounting information systems to constructive criticism, will lead to a change in accounting approaches. This is interrelated with the idea of having accountants to understand more about MS/OR and its interdisciplinary nature. Towards this end, MS/OR specialists must work very hard to 'sell' their models, approaches and ideas and to convince their accounting counterparts of the mutual potential benefits that can be gained. The onus here is on MS/OR specialists to initiate the dialogue with accountants or to improve the quality of the existing one, to deepen accountants' interest in model-building processes. Equally</p>



important is the requirement that accountants should constructively scrutinize the possible MS/OR methodologies, approaches and concepts that could be useful in revising, modifying or reviewing their own approaches.

This observation emphasises the need for bridging the gap between the characteristics of both functions: accounting and MS/OR. As noted above, there is a strong mathematical orientation involved in the training of MS/OR specialists, whilst accountants do not have the same emphasis. Subsequently, one fundamental step towards bridging this gap is to revise the accountants' curriculum to include the necessary and sufficient knowledge in the foundation disciplines (such as mathematics/statistics, philosophy of science) on a well-defined basis.

This observation explains one of the expected outcomes of getting accountants acquainted with MS/OR concepts, that is, the identification of possible future MS/OR applications. The likelihood would probably increase if accountants were interested in this type of work and felt that such projects complement their responsibilities.

This observation points out the ultimate objectives of both functions as common goals. But one may wonder how many of these specialists are following this line of thinking.

Due to the interrelationships between MS/OR and accounting (e.g. financial considerations that involve accountants' records, data, diagnosis, description and/or advice related to diverse issues from simple book-keeping to complicated taxation matters), some kind of understanding

(vii) Accountants suffer from a lack of mathematical training.

15

10.9

(viii) If accountants knew MS/OR concepts, they would be in a position to see possible MS/OR applications.

13

9.5

(ix) Both functions - accounting and MS/OR - are aiming at better utilization of resources for the attainment of organisational goals and improved decision-making.

13

9.5

(x) MS/OR projects often involve major financial decisions (e.g. capital investment, pricing) that emphasise the interrelationship between MS/OR specialists and accountants.

12

8.8



<p>Experience has shown the need for greater integration between accountants and MS/OR specialists.</p>	<p>11</p>	<p>8.0</p>	<p>between them is essential to the effectiveness of major MS/OR projects. This form of mutual understanding between the two specialities does not have to be of the formal type.</p> <p>It is the researcher's belief that it is the essence of 'integration' which is needed, rather than its formal shape.</p>
<p>(xi) Accountants seem to be highly rigid in 'outlook'.</p> <p>Accountants see fully an organisation's financial picture.</p> <p>'High regard of accountants in my organisation, so it is important that MS/OR should try to win them over'.</p>	<p>11</p> <p>8</p> <p>5</p>	<p>8.0</p> <p>5.8</p> <p>3.6</p>	<p>These observations reflect mixed reactions to the accountants' position and outlook in respondents' organisations. They convey different impressions regarding what these respondents consider to be 'characteristics' of accountants in relation to MS/OR functions.</p> <p>But how representative are these observations of opinions and views of the MS/OR specialists community in U.K. industry? What are the main reasons contributing to these impressions?</p> <p>Will there be an MS/OR director on the same organisational level as the finance director or the controller?</p> <p>These and similar questions should be pursued further for elaboration, meaningfulness and statistical significance.</p>
<p>(xii) Accountants often give advice that could be improved with some MS/OR knowledge.</p>	<p>8</p>	<p>5.8</p>	<p>These observations emphasise consequences to be expected by getting accountants acquainted with MS/OR concepts: improving their way of thinking; minimizing the communication gap between both functions involved in this type of interaction; improving the advice they give to management; and improving their provision of data and information to their MS/OR counterparts.</p>



<p>Applying a MS/OR approach to accounting properly, they could advise management better.</p> <p>Accounting projects would be better if they realised that they (accountants) were limited by not including MS/OR thinking.</p> <p>Accountants' appreciation of the MS/OR approach helps minimize the communication gap between MS/OR specialists and accountants.</p>	<p>8</p> <p>8</p> <p>4</p>	<p>5.8</p> <p>5.8</p> <p>2.9</p>	<p>Knowledge of optimization of certain objective function(s) whether maximization of profit or minimization of cost, time etc.; familiarity with decision analysis under conditions of risk, uncertainty or ignorance; manipulation of constraints and resources in prediction and forecasting; and appreciating the essence and objectives of model-building processes: these aspects and others would certainly improve the accountant's way of thinking and deepen the interdisciplinary characteristic of the interrelationship between the two functions.</p>
<p>(xiii) If accountants feel part of MS/OR project and understand the concepts involved, they may well provide active rather than passive help.</p>	<p>5</p>	<p>3.6</p>	<p>This observation emphasises the psychological aspects of getting accountants acquainted with MS/OR concepts and contributing to the development and implementation of MS/OR projects.</p> <p>Although the percentage of respondents mentioning the reason is a very small one indeed, the present researcher considers it to be one of the very important aspects of getting accountants involved in this type of project. Accountants should be psychologically mobilized to participate actively in this respect. MS/OR specialists should help in creating and establishing the idea that MS/OR is a 'complementary' (not a threatening) function.</p>
<p>(xiv) Difficulty in gaining acceptance of MS/OR recommendations.</p> <p>Accountants' misunderstanding of MS/OR approach may not help implementation.</p> <p>Influence of accounting presentation in investment decisions.</p>	<p>8</p> <p>2</p> <p>2</p>	<p>5.8</p> <p>1.5</p> <p>1.5</p>	<p>These observations emphasise one of the implications of getting accountants acquainted with MS/OR concepts, that is, the effect of the inclusion of the accountant's approach in presenting MS/OR proposals to management. Interweaving accounting's way of presentation with 'sophisticated' modelling of complex mathematical relationships - if understood by accountants - may be helpful in structuring and framing MS/OR proposals in acceptable form to the</p>

managerial level authorising their approval or rejection. Obviously, accountants' misunderstanding of such type of work might not help the development of ideas or projects and their implementation.

(xv) The accountant is often the sponsor for the MS/OR project. Very few requests for MS/OR projects are generated by the finance department.

1

0.7

These observations are concerned with accountants as users of MS/OR services. Having possible applications of MS/OR methodologies into accountants' domain (in budgeting, forecasting and financial planning) in mind, it is important to get accountants acquainted with MS/OR concepts. This would enable them to penetrate more deeply the usefulness of their information.

1

0.7

+ This column shows the absolute frequency of those who emphasised the meaning conveyed by the particular item against each frequency.

++ Relative frequencies (in %) do not add up to 100%. This is mainly due to the fact that many of the subjects gave multi-reason replies in response to this 'open-type' question. Also, eight subjects (representing 5.8%) gave no reason in response to this question.



Ways and approaches to get accountants acquainted with MS/OR concepts and methodology in accordance with the extent of their suitability

For those who emphasised the importance of getting accountants acquainted with MS/OR, a set of two-way classification of different approaches or ways in accordance with their extent of their suitability was presented for respondents' comments and opinions. An examination of the results indicates that:<sup>24</sup>

- using the 'case study' approach - to train accountants to be familiar with MS/OR concepts and methodology - was supported by the majority of respondents, where 'to a very great extent' and 'to a considerable extent' labels accounted for about two-thirds of the valid observations, and the modal class is 'to a considerable extent'.
- training accountants in basic mathematics and statistics was the next most important way where the 'to a considerable extent' and 'to some extent' categories accounted for about two-thirds of the valid observations, and the modal class was 'to some extent'.
- less important was training accountants in 'standard MS/OR models' where about two-thirds of the valid observations marked the 'to a small extent' and 'to a very little extent' labels, and the modal class was the 'to a small extent' label.

Moreover, respondents added other approaches which they thought would be useful in this respect. These approaches are: where applicable close interaction on MS/OR projects; comparative studies of 'accounting vs MS/OR' emphasising concepts, limitations and the complementary nature of the two sides; training accountants in model-building thinking in general and financial modelling in

---

24. See table 11, Appendix A, ~~3.2~~ 3.2.

particular, as well as other aspects (such as: selling to accountants the benefits to be gained from MS/OR concepts; detailed explanation of all new areas that affect accountants; instructors should have practical MS/OR experience; training accountants in computing; and surprisingly, training accountants in marginal costing).

If one could assume that these findings express MS/OR specialists' learning (educational and training) experiences, the above observations should be given the proper weight and importance to outlining the accountants' requirements of MS/OR knowledge and the inclusion of MS/OR into an accounting framework of analysis.

Crystallisation of the observed evidence could take the following form: using the case study approach 'to a considerable extent'; and training accountants in basic mathematics and statistics 'to some extent'; explaining 'standard' MS/OR models 'to a small extent' (i.e. attaching less importance to the so-called 'MS/OR techniques'). The organisational context of such acquaintance necessitates: where applicable, close interaction between MS/OR and accounting; and, active selling on the part of MS/OR specialists.

### 5.2.3. Do accountants constitute a major obstacle in implementing MS/OR recommendations?

Of the valid observations: 71% indicated that accountants did not constitute a major obstacle in the way of implementing MS/OR recommendations; 14% felt that accountants were considered to be an obstacle; and 9% indicated that their answer would depend on the type of project under consideration, personalities involved, nature and implications of the particular recommendations for accountants, and the circumstances and conditions prevailing. (In addition, 5% were felt unable to judge).

Basically, these statistics should be confined to their lateral-



scope; they should be considered in view of the interpretation given to each of these conditions. Accordingly, interpretations explaining the nature and foundations upon which each of these conditions is based are classified mainly into three broad categories as follows:

- a. interpretations given by those who felt that accountants did not constitute a major obstacle in the way of implementing MS/OR recommendations (89 observations forming about 71% of the valid observations):

<u>Reasons</u>	<u>Absolute Frequency</u>
i) Accountants generally have little understanding of MS/OR work and are therefore not in a position to dispute findings.	44
ii) The idea of probability and concepts of uncertainty, risk etc., have not been satisfactorily appreciated by accountants and have not yet been included in the accountant's way of thinking. Accountants should not be so proud as to think that their own methods of analysis have a monopoly of producing the best answer.	43
iii) Both parties have interests in securing and maintaining worthwhile relationships and ensuring continued growth of their organisation by taking the right business opportunities.	18
iv) Often accountants are (or pretend to be) too busy to bother with the MS/OR details.	6
v) Open-minded management.	6
vi) Accountants take neither a passive nor a negative interest in such studies.	5
vii) Accountants see themselves in a passive role.	4
viii) MS/OR does not get formally involved in the financial line functions within the organisation.	4
ix) MS/OR specialists are coming to occupy a position in the information network with increasing power (at least similar to that of the accountants).	4

- x) MS/OR recommendations do not greatly affect accounting procedures. Accountants see the MS/OR work as having little impact on their jobs. 3
- xi) MS/OR recommendations, mostly, have a strong support outside finance departments. 3
- xii) Presently, chosen MS/OR projects are of the type which do not involve accountants. 3
- xiii) MS/OR specialists manage to persuade the accountant in the end. MS/OR specialists discuss accounting concepts and methods that are relevant to their jobs. 3
- xiv) The problem is indifference rather than hostility by accountants. 3
- xv) Accountants do not feel responsible for change. 2
- xvi) Accountants are satisfied with the status quo of apparent control. 2
- xvii) Savings on a project make it acceptable. 2
- xviii) Others: Interdepartmental stress does not seem to be severe in our case; operating management see MS/OR solutions as overcoming its difficulties in using accounting data-bases for its decision-making in some situations; finance department itself is not uniform in its attitude towards MS/OR; and accountants have less power now than they had in the past. 4

b. Interpretations given by those who felt that accountants were considered to be an obstacle in the way of MS/OR recommendations (17 observations forming about 14% of the valid observations):

<u>Reasons</u>	<u>Absolute Frequency</u>
i) Accountants are unwilling to accept another function as an information producer, interpreter and management advisor. Psychological reaction to non-accountants dealing in financial matters.	16
ii) Accountants' lack of understanding of basic MS/OR assumptions and methodology.	15



iii) Conventional accounting methods of cost allocation are inadequate for pricing and control (e.g. transfer pricing and product costing in complex organisations). Accountants' failure to believe in the 'best' course of action given imperfect and incomplete information. 14

c. Interpretations given by those felt that whether accountants were or were not considered to be an obstacle, is dependent on other considerations (11 observations forming 9% of the valid observations):

<u>Reasons</u>	<u>Absolute Frequency</u>
i) It depends on MS/OR specialists' willingness to put results in form suitable for accountants' way of thinking. Accountants would want to verify the 'alleged optimal' solution of (MS/OR) study - rather than justify its optimality and if the proposed project 'looks good' in conventional accounting terms. 25	4
ii) Any major obstacle attitudes are connected more with personalities and standards of work than with 'accountants/non-accountants' distinction. It is a matter of personality rather than a profession.	3
iii) Each recommendation is valued on its own merits.	2
iv) Depends on the project (yes, if it directly affects their own work).	2
d. Others: such as: lack of appreciation of how the answers were derived rather than rejection of the answers appears to be a major drawback. Non-acceptance of MS/OR recommendations is due as much to MS/OR men not understanding accountants' style as the reverse.	

---

25. Optimisation of an objective function (such as maximization of profit or contribution or minimization of costs) is one of the main functional areas of activity in MS/OR. Henceforth, arriving at an optimal solution to a given problem is one of the main MS/OR responsibilities. Some accountants (mainly those who are concerned with the attest function) would be interested in verifying MS/OR proposals which are substantially different (in time dimension: past, present and future; in approaches adopted in arriving at an outcome; and in organisational implications) from the transactional activities amenable to financial auditing procedures. It is expected that different accountants would have different reactions to a MS/OR set of proposals depending on factors such as background education and training, attitude towards MS/OR specialists, organisational policies and conditions affecting these functional groups.

To capitulate, the MS/OR specialists who were surveyed gave various descriptions and explanations of their reactions to the nature, and outlook of accountants, features of the accounting function, and attitudes of their managements in relation to the implementation of MS/OR projects. These descriptions and explanations form a substantial part of the domain of the relationship between the two functions. The above evidence appears to reveal fundamental features regarding accountants' attitudes in connection with the implementation of MS/OR recommendations as seen by MS/OR specialists; chief of which are the following:

- i) accountants' attitude toward MS/OR recommendations are considerably influenced by their: knowledge of MS/OR approach (as reflected by their educational background and experiences); awareness of MS/OR work done by their organisations; perception of implications of such recommendations on their (the accountants) position, status, systems and procedures.
- ii) futuristic concepts (such as: uncertainty, risk, etc.) have not yet been satisfactorily appreciated by many accountants.
- iii) where both parties (accountants and MS/OR specialists) feel that they have common goals and interests, it is highly likely that a considerable amount of co-operation would be developed. Subsequently, mutual understanding between the two functions is an essential step towards the desired co-operation.
- iv) not many accountants take positive interest in MS/OR: some accountants show negative interest; others show passive interest; still some others feel indifferent to the problem. 26
- v) the predominance of the conventionality aspect featuring accounting functions. 27 Several examples were quoted (by MS/OR specialists) materialising such conventional

26. Accountants might react to this by saying: why should you (MS/OR specialists) expect us to make positive contribution to the MS/OR discipline whilst some MS/OR specialists themselves do not make such contribution? (or whilst some MS/OR specialists might distort the essence of their discipline?) Most likely, there might be some element of truth in both ways of thinking, but constructively contributing to their organisation's problem solving and decision making is a goal common to both accountants and MS/OR specialists (two functional groups) should enable them to identify possible improvements in their present approaches to their organisation's information for decision and control systems.

27. It appears that such a belief has its impact on the way MS/OR specialists deal with accountants and vice versa.



outlook, amongst them are: the less futuristic (than MS/OR specialists' demand of the accountants ) orientation; a lack of willingness (on the accountants' part) to accept other functions as information producer and interpreter; the wish to keep control over financial decisions; the static, loosely and vaguely defined methods of classification and allocation of costs; the accountant's no (or only slight) belief in alternative courses of action and in optimum solutions to problem solving; and, the rigid application of (full disclosure, consistency, objectivity, materiality, conservatism and realization forming the well-known) accounting principles.

#### 5.2.4. Pressure Experienced from Accountants

A question asking about whether MS/OR specialists had ever been under pressure or stress from accountants (pressure in terms of contesting and utilising any opportunity to take over some of the MS/OR specialist's job) showed that the majority of respondents (slightly less than four-fifths of the valid observations) had not had such experience whilst slightly more than one-fifth of the valid observations had experienced such pressure.

Examination of the data related to those who had experienced such pressure showed that:

- i) regarding the scope of that pressure: *a fair number of them (about half)* indicated that such pressure covered some MS/OR projects related to the accounting department; a smaller number indicated that such pressure covered all MS/OR projects related to the accounting department; still smaller (i.e. very few) indicated that such pressure covered the total responsibility of MS/OR projects and studies.
- ii) causes found to account for such experienced pressure were:
  - . Accountants do not understand the nature of MS/OR.
  - . Accountants believe that any project involving finance can only be solved by trained accountants.
  - . Accountants' narrow view of information needs: slow and accurate rather than fast and approximate.
  - . Threat to accountants' position.
  - . Lack of clarity of organisational roles.
  - . Power game.
  - . Lack of aspiration leads to lack of use and then questioning the value of the MS/OR function.
  - . Accountants do not like MS/OR specialists 'meddling' in their areas of work.
  - . Age differences.

- MS/OR failure to prove its effectiveness.
  - Location of computer services in Finance Department.
  - Management misunderstanding of MS/OR role.
  - Cost reduction.
  - Others (such as: accountants are unwilling to accept another function as interpreter/user of financial data; and accountants' determination to see as much as possible done their own way).
- iii) reactions of MS/OR specialists who had experienced such pressure were mixed: the majority (about two-thirds) of them expressed their dislike of such pressure; about one-quarter of them said that they paid no attention to such pressure, and the rest (a very small minority) said that they welcomed it.
- iv) as for the effect of that pressure on their morale: about 48% described it as 'having bad effect', 41% indicated that it had no effect at all, very few - 11% - indicated that such pressure had a good effect on their morale.

To summarize, slightly more than one-fifth of the respondents had experienced pressure from accountants related to MS/OR projects and studies that mostly affects them (accountants). In these cases the main reasons accounted for that pressure were found to be: Accountants' misunderstanding of (or insufficient understanding about) the nature, and methodology of MS/OR discipline; the narrow approach of accountants regarding management information needs; accountants overestimating their position in the organisation; lack of clarity of organisational role of these functions; and accountants viewing MS/OR as a threat to their position where such pressure was experienced, those subject to that pressure disliked it and indicated that it had had an effect on their morale.

#### 5.2.5. Attitudinal aspects of communication

To learn about MS/OR specialists' attitudes towards accountants and accounting functions in their organisations, a 12-item, Likert-type scale was designed. The scale was the outcome of testing and



retesting a larger number of statements that took place in different stages of development of the instrument used in gathering the data and information under discussion. Presentation of the scale was made in a tabular form headed by degree of agreement, neutrality, and disagreement as follows: strongly agree, agree, undecided, disagree, and strongly disagree.<sup>28</sup>

The main conclusions of the analysis of the attitudinal part of the relationships (as seen by MS/OR specialists) indicates that:

i) there is not sufficient evidence to corroborate the hypothesis that 'senior accounting executives are contesting for control over MS/OR activities'. (This variable was found to have negligible correlation with other variables in the assumed attitudinal domain of interest under consideration).

Many interpretations might be given to explaining this aspect of relationship between MS/OR specialists and accountants in relatively large British industrial organisations, amongst the chief of which are:

a) a considerable number of MS/OR functions in the participating organisations at the time of carrying out this part of the study were under the responsibility of the finance director or the controller. In such a case, there would be no reason for senior accounting executives to compete for control over this function. (But what the study has not answered is the description of the circumstances that led to accountants' control over MS/OR functions. In other words, description of the historical developments of this organisational aspect, however important and relevant, was not included in this part of the study).

b) some senior accounting executives are not bothered with MS/OR for one or more of a variety of reasons.

---

28. The scale object was accountants. All respondents were asked to take part in indicating their opinions and views in this respect. No differentiation was made between those who had had some experience with accountants and those who had not had such an experience. For each statement, subjects were asked to place a 'tick' below one of the five alternatives. Weights were assigned from 1 to 5 to each item. Positively worded statements (i.e. statements phrased favourably describing accountants) were assigned as follows: strongly agree, 5; agree, 4; undecided, 3; disagree, 2; strongly disagree, 1. For negatively worded statements, 5 was assigned to the 'strongly disagree' alternative, 4, for the 'disagree' alternative, 3, for the 'undecided' alternative, and so on. See question (G-1) Appendix A, ~~4~~ 4.2.

ii) Accountants' orientation and accountants' attitude towards MS/OR specialists, feelings regarding working with accountants, the conventional outlook of accounting function and accountants, and MS/OR specialists' beliefs regarding accounts' participation in MS/OR projects: are the main factors summarising the hypothesized MS/OR specialists' attitudinal domain regarding accountants and accounting functions. 29

The underlying behavioural processes of the data appear to be meaningful. In addition the implications of this exploration of data might be useful in organisational design, change and adaptation. More specifically for MS/OR specialists it may be useful in building and developing a satisfactory network of communication with accountants; in selling their function to accountants as present and potential provider of information for (and users of) MS/OR projects; and in evaluating the extent to which managerial and financial data and information are useful and could be used in building MS/OR projects.

iii) The conventional outlook of the accounting function is a 'specific' factor in the attitudinal dimensions of the lateral relationship with accountants as seen by MS/OR specialists. Three main examples, manifestations or circumstances correlated highly with this factor. They are:

- a) accountants' concern with the financial transactions: their recording, classification and legalistic issues rather than the managerial function;
- b) accountants' non-acceptance of any criticism of accounting systems by MS/OR specialists.
- c) accountants' acting as an obstacle to the acceptance of recommendations of MS/OR specialists.

### 5.3. Working relationships with accountants.

MS/OR specialists' communication patterns are one of the central issues of the present survey. Do accountants communicate with their MS/OR counter-parts for the cost and financial information required for MS/OR projects? If not, why not? If yes, how is it carried out? How useful is this type of interfunctional relationship (as seen by MS/OR specialists themselves)? These are the main issues under discussion in the present section.

---

29. See table 12, Appendix A, ~~3~~ 3.2.



The simple description of these organisational situations would not be expected to result in a clear-cut distinction: either the two functions (MS/OR and accounting) are too closely inter-connected, or they are completely disjointed. (Although either of these two organisational settings may equally well be the case in some organisations). However, for simplicity in discussing the related empirical evidence, communication patterns with accountants are classified into three main modes: (a) state of no communication with accountants; (b) state of communication with accountants; and (c) state of mix of the two conditions 'a' and 'b'.

Analysis of responses regarding the 'communication with accountants' issue, indicates that the vast majority of participating MS/OR specialists (91% of the valid observations) were in communication - in one form or the other - with their accounting counterparts; very few of the respondents indicated that they had no communication with accountants (4% of the valid observations); and the remaining percentage (about 4%) indicated that they had mixed experience<sup>30</sup> (i.e. they had some form of communication with accountants in the past, but not at present, or there is communication from time to time, etc.). It is worth mentioning in this respect that this distribution of responses is 'biased' as a result of the 'filtering' system adopted in the document used for collecting these data. That is, the study examines opinions and views of MS/OR specialists who had had - at the time of carrying out the study - any past experience with accountants. Those who had no such experience were not asked to proceed with the rest of the questionnaire questions.

Discussion in this section is organised into two main parts:

---

30. Respondents with mixed experience were classified with both previous patterns 'a' and 'b'.

the first is concerned with the "state of no communications" with accountants (explaining the alternative ways that MS/OR specialists would follow to get the cost and financial information needed for their (MS/OR) projects, and the reasons for not getting such information from accounting functions); and the second is concerned with identifying MS/OR specialists' means of contacting accountants to get the cost and financial information, their degree of satisfaction with this information, and the reasoning supporting each particular point of view.

### 5.3.1. The state of no communication with accountants

MS/OR specialists who did not depend upon the accounting staff for the cost and financial information required for MS/OR projects identified the following sources:

- i) Ad hoc enquiries
- ii) Guess work
- iii) Sensitivity analysis
- iv) Statistical analysis of specific records of the particular (non-accounting) division or department asking for MS/OR service.
- v) Central statistical services
- vi) Annual summaries.

Clearly, the above approaches might have satisfied their purposes, but the complete dependence on them might not give reasonably accurate and reliable cost and financial information. Such approaches might supplement more direct approaches for gathering such data and information.

A variety of reasons were mentioned to explain the reasons for not getting the cost and financial information by means of accountants, amongst them being:



- i) the accounting information is not relevant
- ii) accountants cannot understand the information requirements
- iii) accountants spend too much time providing the required information
- iv) accounting information is not reliable
- v) accountants are not willing to provide the information required.

### 5.3.2. Communication between MS/OR specialists and accountants

To learn about the features and characteristics of MS/OR specialists' working relationships with accountants where it did exist, several questions were included in the document to explain: the means by which accountants provide data and information required for MS/OR projects; MS/OR specialists' evaluation of such data and information; and the reasons supporting any of the different viewpoints. The detailed discussion of these features is as follows:

#### FIRST - Means by which accountants provide costing and financial information for MS/OR projects

Examination of means by which accountants provide data and information required for MS/OR projects indicates that: <sup>31</sup>

- i) apparently, it would be difficult to assume that the accountant has become a 'permanently active' member in MS/OR team discussions. Very few respondents corroborated the idea that they would 'usually' or 'often' get the cost and financial information needed for MS/OR projects through the 'accounting representative' in MS/OR team discussions.

A slightly higher percentage indicated that they get the required cost and financial information through this channel.

---

31. See table 13, Appendix A, ~~7~~ 3.2.

- ii) accountants give detailed and brief information about costing and financial matters.
- iii) some respondents (however few in number) emphasised that accountants provide constructive comments, and often give the detailed logic of taxation and costing methods. (This could be a valuable contribution to MS/OR projects).

SECOND - MS/OR specialists' degree of satisfaction with the accounting information as an aid in building MS/OR models and tracing solutions, and the reasoning supporting the specific view point

- a. the accounting information is valuable - or very valuable - and always used as an important source of the information.

'51 observations representing 39.6% of the valid observations'

Reasoning		
Reasons supporting the corresponding evaluation	AF n = 51	ADJR n = 51
i) There is co-operation between MS/OR specialists and accountants.	41	80.4
ii) MS/OR specialists always discuss accounting concepts and methods that are relevant to their job in order to have more understanding of the problem.	25	49.0
iii) Top management's real concern in the yield of co-operative work of both accountants and MS/OR specialists.	15	29.4
iv) Accountants are usually doing their best to learn more and more about MS/OR concepts and methodology.	7	13.7
v) The organisation always encourages internal or external training for accountants to get them acquainted with MS/OR concepts and methodology.	3	5.9

AF = Absolute Frequency  
ADJR = Adjusted Relative Frequency



Reasoning		
Reasons supporting the corresponding evaluation	AF n = 6	ADJR n = 6
In addition some respondents offered variations (with less or more emphasis on one aspect or the other) of the above reasons, the chief of which are:		
vi) Information is usually available and is objective and reliable.	6	11.7
vii) Accounting department consult MS/OR group for problems such as D.C.F., depreciation, etc.	2	3.9
viii) Most MS/OR projects are assessed financially in the end, hence reliable cost figures must be used throughout.	2	3.9
ix) There is some co-operation between MS/OR specialists and accountants.	2	3.9
x) Some accountants tend to be more receptive to MS/OR methodology than others (e.g. younger accountants tend to be more receptive to MS/OR way of thinking, but the older accountants do not encourage them, although there is an element of 'going along with MS/OR' in case it might be the right thing to do).	2	3.9

b. The accounting information is sometimes useful and often used as a secondary source of information.

'72 observations representing 55.8% of the valid observations'

Reasoning		
Reasons supporting the corresponding evaluation	AF n = 72	ADJR n = 72
i) Accountants are chiefly concerned with financial transactions: their recording, classification, and legalistic issues rather than the managerial functions.	56	77.8
ii) Accountants have limited knowledge of MS/OR concepts and methodology.	51	70.8
iii) The organisation does not offer MS/OR training for accountants.	38	52.8
iv) The organisation does not encourage MS/OR training for accountants.	21	29.2
v) Accountants are not willing to know about MS/OR concepts and methodology and their application in actual business problems.	11	15.3

AF = Absolute Frequency  
ADJR = Adjusted Relative Frequency

Reasoning		
Reasons supporting the corresponding evaluation	AF n = 72	ADJR n = 72
In addition, some respondents preferred to modify (with less or more emphasis on one aspect or the other) some of the above reasons, or to add a new reason, the chief amongst them are:		
vi) Accountants have some ideas about MS/OR concepts and methodologies, but they have no idea about their application in actual business problems.	7	9.7
vii) MS/OR specialists always discuss accounting concepts and methodology that are relevant to their job in order to have more understanding of the problem.	3	3.2
viii) Accountants have no knowledge of MS/OR concepts and methodology.	2	2.8
ix) Accounting information is not always in the form required for MS/OR projects.	2	2.8
x) Accountants cannot always break away from constraints of the present to consider the future.	1	1.4
xi) Some accountants seem to have a feeling that their sets of figures are the only possible interpretation of financial data. Not so true of younger more recently trained accountants.	1	1.4

c. The accounting information is of no use.

'6 observations representing 4.7% of the valid observations'

Reasoning		
Reasons supporting the corresponding evaluation	AF n = 6	ADJR n = 6
i) The organisation does not offer or encourage accountants training in MS/OR concepts and methodology.	3	50.0
ii) Accountants have no idea about MS/OR concepts and methodology.	2	33.3
iii) Accounting information is inadequate and unreliable for the purpose of MS/OR usage.	2	33.3
iv) Accountants have some idea about MS/OR concepts and methodology, but they have no idea about their application in actual business problems.	1	16.8
v) Accountants themselves are not willing to know about MS/OR concepts and methodology.	1	16.8
vi) Accountants have some idea about MS/OR concepts and methodology and their application in actual business problems, but MS/OR specialists have proved little or no confidence in data or information provided by accountants.	1	16.8



In summary, as the analysis is confined to those MS/OR specialists having some kind of experience with accountants in their organisations, some 'bias' in the distribution of responses regarding communication with accountants would be expected. Accordingly, the 'vast' majority of the valid observations corroborated the idea that they had some form of contact with their accounting counterparts. But, taking the sample as a whole reduces this 'vast majority' to a 'moderately high proportion'.

However, based on the present survey statistics, the proportion of those MS/OR specialists who had had some form of communication with accountants is higher than the proportion of those who had no such working relationships.

Evidently, this observation gives some idea about the 'proximity' or 'remoteness' of the two functions within their internal organisational environments. It gives no explanation of the 'quality', features and characteristics of such organisational distance.

In case of 'no contact' between the two functions, several reasons were found to account for that situation, the chief of which are: the accounting information is not relevant; accountants cannot understand the required information; accountants take too much time to provide the required information; and the accounting information is not reliable.

Where communication between MS/OR specialists and accountants did exist, it was found that: (i) it appears that the accountant is <sup>yet</sup> not 'a permanently active member in MS/OR team discussions'. This is likely to have implications for the accountant's contribution to MS/OR projects and studies; (ii) 'co-operation' between the two functions was found to account for most of MS/OR specialists' satis-

faction with accounting information required for MS/OR projects; (iii) the 'dominance' of the transactional features of accounting functions (coupled with less orientation towards the managerial needs, and accountants' limited knowledge of MS/OR) were largely found to account for the secondary importance attached by MS/OR specialists to the use of cost and financial information in developing MS/OR projects and tracing solutions.

5.4. MS/OR concepts and methodology used in dealing with accounting problems

Asked 'Have you been called upon by accountants in your firm or organisation to participate in dealing with accounting problems?' MS/OR specialists indicated the following: 51.8% answered in the affirmative; 39.4% answered in the negative; and for 8.8% this question was not applicable in their case (or their answers were missing).<sup>32</sup> Excluding the last category, (inapplicable/missing) discussion of the first two categories is divided into three subsections: the first is concerned with the extent to which MS/OR specialists were involved with accountants (specifying the type of accounting application, and the difficulties experienced - if any - by MS/OR specialists in participating in such application); the second is intended to describe the reactions of MS/OR specialists to not being called upon by accountants to participate in dealing with such applications; and the third deals with financial modelling as a potential area of mutual involvement.

---

32. To learn about the extent of MS/OR specialists' involvement in dealing with problems that could be said to fall within the sphere of accountants' responsibility, a section was included in the mailed questionnaire for that purpose. This is based on the assumption that there are areas of mutual interest such as capital budgeting, the assessment of capital projects, financial modelling, cost allocation, cost control, analysis of variance. These and other areas could be one of the pillars supporting the foundation of mutual understanding between MS/OR specialists and their accounting counterparts. It is worth pointing out that discussion in this section is limited to opinions and views of MS/OR specialists who emphasised that their experience in conducting MS/OR projects could enable them to participate in discussing and evaluating working relationships and communication patterns with accountants. Consequently evidence presented in this section should be viewed in the light of this fact.



5.4.1. Extent of MS/OR specialists' involvement in participating in dealing with accounting problems

An examination of types of accounting applications indicates that most of MS/OR specialists' involvement occurs in the assessment of capital projects, project evaluation, long range planning and capital budgeting; to a lesser extent, in the analysis of distribution costs, in cost allocation, cost control and variance analysis.

Considering frequencies of those MS/OR respondents who indicated that their extent of involvement in MS/OR projects was to 'a very great extent' or to 'a considerable extent', within the context of the background of this study (that is, restricting the survey companies to those amongst the top third-in-rank of British industry and having their own MS/OR groups), the researcher found it difficult to generally conclude that MS/OR specialists are considerably involved in the application of MS/OR concepts and methodology to problem areas within the sphere of accountants' responsibility.

Although no further evidence is available <sup>about</sup> the nature, scope and consequences of such applications (due to reasons of confidentiality), it would be desirable if further studies could be carried out in this area to (i) explore the present and potential application of MS/OR approaches on a practical basis; (ii) identify the basic ingredients of success, failure and difficulties facing such applications; and (iii) identify the lessons to be drawn from different experiences.

It is interesting to note that the majority of this group of respondents (those who pointed out that they had been called upon by their accounting counterparts to participate in dealing with accounting applications) had found some difficulties in this respect, the main ones being:

- i) accountants do not explain their problems clearly.
- ii) shortage of trained accounting staff to work with MS/OR specialists in dealing with accounting problems.
- iii) senior accounting executives do not encourage the application of MS/OR concepts and methodology.
- iv) the need for training in accounting systems, concepts and methodology, which MS/OR specialists have no time to devote to, and/or find difficult.

Also, some respondents added the following difficulties:

- i) both accountants and MS/OR specialists do not try sufficiently to speak in plain language.
- ii) heavy work load of senior accountants means insufficient time can be spent in consultation.
- iii) accountants' lack of understanding of nature of problems.
- iv) others such as: poor and narrow appreciation (by accountants) of non-accounting use of costing and financial data and information classification and allocation (specifically marginal costing); complexity and magnitude of problems involved; MS/OR specialists do not understand specific accounting methods and procedures.

#### 5.4.2. Reactions to not being called upon by accountants

Varied and mixed reactions were described by MS/OR specialists to the fact they had not been called upon by accountants to participate in accounting applications, the most frequently described (in descending order) being:

- i) it illustrates that accountants are not aware of the value of MS/OR specialists.
- ii) it illustrates that MS/OR specialists do not attempt to sell MS/OR to accountants.
- iii) disappointment.
- iv) it illustrates that accountants do not recognise their own problems.
- v) frustration.
- vi) do not care.
- vii) quite happy.



- viii) it illustrates that the lack of communication between MS/OR and accountants is the fault of both parties.
- ix) irritation.
- x) occasional annoyance.
- xi) indifference.
- xii) others: scepticism; upset; it illustrates the failure of the company to utilize its resources effectively.

The above reactions demonstrate the need for more active selling by MS/OR specialists and the need for accountants to adopt the 'systems approach' (i.e. different approaches and the model-building strategy) in prescribing and operationalising their organisational roles.

#### 5.4.3. Financial modelling as a potential area of involvement

Not many respondents emphasised that 'financial modelling' is an area of collaborative effort between accountants and MS/OR specialists. This is not an unusual observation. It is consistent with other aspects of this research project as well as the comments made by most of the interviewed management consultants, who emphasised the importance and significance of developing financial modelling as an area for mutual exploration with a view to experimentation and the understanding of the organisation's corporate financial pulse, investment decisions, and financial analysis.

The basic contention which underlies the whole idea in getting both MS/OR specialists and accountants engaged in this vital area of organisational strategy, is to couple the modelling knowledge of MS/OR specialists with accountants business experience to simulate and monitor financial tactics and strategy. This in turn would (hopefully) have a feedback effect on the skill of both types of specialist and would (probably) enforce practicality in MS/OR modell-

ing and a more rigorous systemisation of complex business problems on the part of accountants.

The necessity of satisfying these two requirements is corroborated by the following experience expressed by one of the interviewed management consultants where he commented on the value of further exploring 'financial modelling' as an area for 'MS/OR-accountants' co-operation:

"... There is no use in producing something very erudite that is not used. It has got to be practical; and it has got to be a useful thing".

#### 5.5. Reputation of MS/OR groups

A question asking respondents to describe the reputation of their MS/OR groups, (as seen by a given set of organisational personnel and functions, particularly the accountants) was included into the document.<sup>33</sup>

The interesting conclusions that could be drawn from the distribution<sup>34</sup> of responses in this respect are:

- i) few MS/OR specialists were uncertain about their specific opinions (regarding the reputation of their MS/OR groups).
- ii) more than two-fifths of the observations were uncertain about the finance director's, the chief accountant's, and other individual accountants' opinions of the reputation of their MS/OR groups.
- iii) there is some indication that the reputation of MS/OR groups improves with the more satisfactory use of their service (although there is not sufficient statistical evidence to corroborate this). The less use (or awareness) of MS/OR, the less is the likelihood of removing the ambiguity surrounding their function.

---

33. Some elements of bias might be expected to arise in the distribution of responses to this particular section. In spite of that, the danger in relying on such observation is minimized as long as it is to be taken within its limited objectives, i.e. the identification of MS/OR specialists' content, discontent or uncertainty regarding their dialogue with accounting leadership and individual accountants as well as with other managerial members of their organisation.

34. See table 14, Appendix A, ~~3.3~~ 3.3.



- iv) few observations described accountants' visualisation of MS/OR reputation as 'poor'.
- v) almost none of the MS/OR respondents described their reputation as 'very poor'.

To pursue the matter, the question of perceiving the image of MS/OR groups was raised with some management consultants, to help in explaining the different patterns described above.

"I perceive most client MS/OR organisations are very weak indeed, not that they do not have reasonably clever people but they just are often considered back room boys that do analyses when asked to . . . As far as having any say in analysing really strategic decisions in a company I think that often their talents are very, very wasted. They have often done very mechanical MS/OR things, the stock control, the distribution analysis maybe, in a number of warehouses, often a bit of computer work and so on. In terms of investment analysis, planning the future of the company, very often I do not think the internal groups are considered for this sort of thing. Maybe for political reasons, I don't know. There are few notable exceptions that I can think of as successful MS/OR groups . . . I think maybe the airlines, some of the oil groups. Just general industry, the bread-and-butter industry in this country, even . . . (some of the big names) and all these people make very little - if any - use of MS/OR at all in their way of life.

I would say engineering is an industry that is very backward in the use of internal MS/OR groups. I think they may sometimes use external groups like consultants. They have internal MS/OR groups and they don't make use of them. I've heard this of . . . some great big engineering groups, there are some very frustrated MS/OR people working there who don't get the chance to spread their wings and do some useful stuff". 35

Another management consultant:

"There are projects that are long-term, medium-term and very short-term and I think some (MS/OR) groups adopt the attitude of only wanting to work on the long-term project,

---

35. This consultant qualified his opinion by emphasising that his view might be biased towards certain class of companies as follows:

"We may be giving you a biased view . . . for the simple reason that if there is an effective MS/OR group we may not have worked very much in companies. We may have worked in companies where there is not an effective MS/OR group and so are giving you a biased view of ineffective groups. Companies that are doing things for themselves often don't require consultants".

the theoretical groups, and I think quite a lot of (MS/OR) people enjoy that type of work and prefer to be involved there and will avoid direct application work and as to whether there is more or less of any one type, there are perhaps too many of the theoretical ones and not enough of those involved in business, with the month to month and year to year running of the business".

A third management consultant described some of the MS/OR specialists by saying that

" ... they tend to think in very big complex terms and they are very bad simplifiers".

A fourth management consultant described his view of how MS/OR specialists see themselves as follows:

"From the MS/OR point of view I think there is an inferiority complex that has developed over the years, they feel that their discipline is almost sadly understood and totally unappreciated".

Then he went on to say:

"You need a much more humble approach on the part of MS/OR specialists, that an acceptance of what they have to offer is only part of the solution, it is not the only solution".

As emphasised before, the above views and others should be constructively looked at for avoiding creating or enhancing some 'unfavourable' reputation of their functions or groups. Definitely none of the above observations is (or was intended to be) applicable to all MS/OR specialists; they are applicable to specific situations when certain circumstances do exist. These observations are presented for the lessons to be drawn from them for the sake of a more successful application of the MS/OR approach.



## 5.6. MS/OR-Accounting future relationships

Attention in this section is mainly devoted to the discussion of the future prospects for the kind of relationships that may exist between the two functions as seen by MS/OR specialists. Opinions and beliefs expressed below are descriptions of what respondents thought of the futuristic shape of lateral relationships with their accounting counterparts.<sup>36</sup>

Discussion in this section is divided into two main parts: the first is concerned with descriptions of organisational aspects of such intergroup working relationships; and the second is devoted to an analysis of the desired characteristics of future accountants as necessary prerequisites for their involvement in MS/OR type of work.

### 5.6.1. Organisational relationships between MS/OR and Accounting functions

One general comment on the opinions and beliefs - analysed below - is that they are not mutually exclusive: some of them emphasised the complementary dimensions of the relationship whilst others concentrated on specific (past and present) experiences and still some others felt uncertain regarding future relationships between MS/OR specialists and their accounting counterparts. Expressed opinions and beliefs varied significantly in their content and implications.

Specifically, two main patterns might seem to be interesting in this respect: Firstly, the majority of respondents indicated in one way or the other that co-operation, awareness of each others'

---

36. Although it would be difficult to assume that these opinions and beliefs are not based on, and connected with, respondents' experience, it would be agreed that such futuristic speculations had been motivated by the current (at the time of carrying<sup>out</sup> this aspect of the survey) conditions outlining the present relationships between these two functions.

problems and limitations, 'right' attitudes in both functions, and mixed teams are various forms outlining the fundamental concept of 'mutual understanding'. The second delivered a warning signal to both functions:

- i) to those MS/OR specialists detached from practical applications in their organisations - a small number of MS/OR specialists did not think that the title 'OR' would survive;
- ii) and to those accountants whose sole responsibility is the recording and classification of transactional accounting neglecting the managerial needs of information for decision making and problem solving.

Detailed examination of such evidence is as follows:<sup>37</sup>

- 
37. Every opinion or belief is considered to communicate a message from the respondent to the researcher to the reader. Accordingly, the discussion is based on: i) crystallisation of the figurative meaning conveyed by such messages, ii) their categorization according to common features contained in the particular pattern. In addition, some of the expressed opinions and beliefs are not analysed in detail. Examples of this latter category are: relationships are strongly influenced by personalities involved; relationship is improving, but help is needed from senior management who tend to hope that things will improve rather than act to help them; there is uncertainty concerning this type of functional relationship; they are - and probably will remain - separate departments.



	AF	RF %	Discussion
<p>Messages' conveyed by the figurative meaning expressed by opinions and beliefs.</p>	29	21.2	<p>The pattern conveyed by these observations emphasises the following aspects:</p> <p>i) whether they are to be considered as separate functions, or as sub-sections or divisions of the same department or function, objectives of both functions are considerably overlapping, and the (sought) co-operation should be based on co-ordination of effort.</p>
<p>The two functions are complementary in objectives.</p>	15	10.9	<p>(ii) as each becomes aware of the problems, limitations and benefits of the other, chances of co-operating and mutual understanding increase. This is applicable to both functions.</p>
<p>Relations should improve as each becomes aware of the problems, limitations, capability and potential of the other.</p>	5	3.6	<p>(iii) complexities of business problems necessitates the interdisciplinary approach to jointly tackling such problems, which in turn enforces mutual understanding and strengthens co-operation.</p>
<p>TOTAL</p>	49	35.7	<p>(iv) both functions (accounting and MS/OR) are to a considerable extent - serving analogous objectives.</p>

<p>'Messages' conveyed by the figurative meaning expressed by opinions and beliefs.</p>	<p>AF</p>	<p>RF %</p>	<p>Discussion</p>
<p>With the 'right' attitudes on both sides, there are wide areas of potential co-operation.</p>	<p>10</p>	<p>7.3</p>	<p>Although the 'right' attitudes are not explicitly defined, it is most likely that the group of respondents emphasising this meaning had in mind characteristics of good faith, confidence and trust as important features of such 'right' attitudes (also, in which the organisational 'image' of MS/OR is not perceived by accountants as a threatening one).</p> <p>Evidently, good faith, confidence and trust are necessary conditions for mutual understanding to be developed and maintained.</p> <p>Furthermore, creating the 'right' attitudes is dependent on: form of organisational design; organisational policies; and background (personal and group) contributions to such desired attitudes.</p>
<p>Future relationships are dependent on what accountants do to improve their MS/OR knowledge.</p>	<p>8</p>	<p>5.8</p>	<p>Seemingly, respondents whose observations conveyed this meaning were concerned with accountants' general knowledge in MS/OR as users of the discipline. They hung their decision (regarding their future relationships with accountants) on what accountants (in their professional and organisational contexts) would be doing to 'improve' their educational background to use such service.</p>



'Messages' conveyed by the figurative meaning expressed by opinions and beliefs.

AF

RF  
5

Discussion

It seems that this is just one of the various dimensions of the 'accountants-MS/OR' relationships. Fulfilling such a requirement would not be expected to satisfy its objectives unless MS/OR specialists seek to 'improve their knowledge in accounting systems and principles'.

Satisfaction of such a dual objective function would contribute towards emphasising the interdisciplinary features of these service functions to the management of their organisations.

Obviously, this pattern of observations enumerates various likely benefits in getting accountants acquainted with the MS/OR approach for MS/OR applications as well as for improving the quality of accounting information.

Accounting practices should be bent towards the decision-making process and away from the old recording aspects, otherwise accounting is likely to become irrelevant. The management accountant and financial analyst should see MS/OR as essential tools in sensitivity analysis.

Accounting data and information would become more meaningful if accountants became better acquainted with MS/OR.

Some implicit assumptions could be inferred for this pattern of observations as follows:

- i) current accounting practices are not sufficiently oriented towards managerial needs and multi-disciplinary use. The practical application of different analyses (costs/revenues implications/assumptions), for different purposes on a wide scale is an important target for accountants to work towards. Such different approaches and their wider application should be developed and implemented using experiences from a variety of related disciplines.

5.8

8

	AF	RF %	Discussion
<p>'Messages' conveyed by the figurative meaning expressed by opinions and beliefs.</p>			<p>(ii) by adopting a model-building strategy in the analysis and interpretation of the various dimensions of complex business problems the accountant would be in a position to further contribute towards the improvement of MS/OR projects as well as further refining his own measurement and communication methods.</p> <p>(iii) considerable overlaps and similarity in the implications of this pattern of observations and the above-described ones.</p>
<p>Accountants are well entrenched as company advisers. The bridge must be built on doubly qualified personnel. 'OR' will disappear as a title and become part of corporate control skills.</p> <p>Accountants will split more openly between 'book-keepers' and 'developers' or 'designers' the latter will merge with OR skills; OR as a separate entity will die.</p> <p>Eventually, the OR or analytic approach will become part of standard management practice and will be absorbed by planning, accounting and other functions, OR as a function will cease to exist.</p>	7	5.1	<p>Apparently, these respondents were not most contented with 'OR' as a title of their discipline. Furthermore, some of them were even not best satisfied with the discipline occupying a separate function.</p> <p>Such observations might lead to the following queries:</p> <p>Was this group of respondents unhappy about the future of MS/OR function as projections of their existing functions (at the time of carrying out this part of the survey)?</p> <p>Was it (this state of unhappiness) because of these respondents' perception of the organisational position of their MS/OR functions (due to: the importance attached to the objectives of MS/OR; the type of work MS/OR specialists had been carrying out; the lack of awareness on the part of user divisions of what MS/OR could and could not do for them, or the insufficiency</p>



'Messages' conveyed by the figurative meaning expressed by opinions and beliefs.

Accountants will take over OR models in their area of work and will not want anything to do with OR departments.

AF

RF  
%

Discussion

of managerial backing and understanding to such MS/OR functions)?

Is it because of the psychological implications of the terminology used in the title of the discipline, particularly the word 'research' in Operational Research'?

Does it convey misunderstanding on the part of some MS/OR specialists of the real function and responsibility of their accounting counterparts, and consequently over-emphasising the future role that will be played by the accountant in the organisation?

In addition, while discussing the future 'accounting-MS/OR' relationships, one management consultant gave the following comment:

"I find this difficult to answer on how the relationship will develop. I don't know whether OR industry is declining or not; I sort of somehow get a feeling that it is, but perhaps this may be a direction in my own work that has taken me. I think a lot of our people have done a lot of damage to the discipline, by pretending it would solve all problems in consultants' work by next week." (He then mentioned a well known MS/OR scientist whom he described as: "... although he was very nice man to work with, he was grossly impractical and was not ready to accept other people's views, especially views of senior people in business and you have to be a bit pragmatic about it").

	AF	RF %	Discussion
<p>'Messages' conveyed by the figurative meaning expressed by opinions and beliefs.</p> <p>Relations will grow much closer through Accountants and MS/OR specialists' common interests in computer-based information systems for managerial planning and control systems.</p>	4	2.9	<p>The meaning conveyed by such observation reflects the effects on organisational design due to the continuous development of computer-based applications for managerial purposes, and speculates that both functions will have common interests in these systems, which may, in turn, enforce closer relationships.</p> <p>Technological advances in the field of information and data processing (advances in data entry and retrieval, telecommunications, time sharing systems and other areas), would probably relieve the accountant from the burden of clerical and routine accounting systems. This, coupled with the growing complexity of business problems would (probably) contribute towards more use and growth of financial modelling, and, since modelling is one of the fundamental features of the MS/OR approach, this might help bridging the gap between methodologies presently adopted by both functions.</p> <p>It is the researcher's belief that modelling is one of the most potentially fruitful areas contributing towards the interdisciplinary features that need to be developed to facilitate the creation of a common language upon which mutual understanding between the two functions would be based.</p>
<p>MS/OR specialists must 'come down to earth' more and accountants learn to be more flexible.</p> <p>Accountants' main responsibility will still be to provide financial data,</p>	3	2.1	<p>The two functions (MS/OR and accounting) are sometimes criticized on the grounds outlined in this observation. It would be no exaggeration to emphasise that practicality in MS/OR type of work and flexibility in accountants' outlook in</p>



	AF	RF %	Discussion
<p>'Messages' conveyed by the figurative meaning expressed by opinions and beliefs.</p> <p>but the more advanced accountants will be using MS/OR methodology.</p>			<p>dealing with MS/OR projects are necessary conditions for any reasonable amount of mutual understanding between the two functions.</p>
<p>Accountants should be a prime source of opportunity identification of possible MS/OR application.</p>	2	1.5	<p>Clearly such an observation looks into accountants' contribution to MS/OR function where it explains partial responsibility of accountants towards their MS/OR colleagues.</p> <p>Amongst the interpretations that could be made as to the motivations underlining this observation are: the lack of accountants' contribution or involvement in the identification and design of MS/OR projects; the lack of MS/OR type of work to keep them busy all the time, or to make them a company-wide service.</p> <p>Due to their overall understanding of the financial background of the organisation, accountants might be in a better position to identify possible MS/OR applications. But evidently not all accountants would be able to make such a contribution; only those who appreciate the benefits and limitations (as well as the essence) of the MS/OR approach would be able to make material contribution. This is doubly dependent on both functions - MS/OR specialists and their accounting counterparts to encourage accountants' contributions to the identification of possible MS/OR applications.</p>

Principal implications of the above observations for both functions are: awareness of each others' problems, limitations, capability and potential. ; exploiting the analogy of objectives; good faith, confidence and trust; bridging the gap in measurement and communication approaches adopted by each function's groups. More specifically; accountants' acquaintance with MS/OR methodology and model-building thinking, adoption of more analytical approaches as well as MS/OR specialists' acquaintance and familiarity with accounting procedures, systems and principles; making use of technology with accounting advancements in the data processing field (particularly of the time sharing technology).

In addition, the above observations outline a note of warning to both MS/OR specialists who are featuring their discipline as a mere mathematically theoretical exercise, and those accountants whose devotion is confined to one-sided pedantry and over-simplified practices and assumptions.

#### 5.6.2. Desired characteristics in future accountants

Asked "If you have been asked to appoint an accountant to work with your OR group, what type of educational background, training experience and personality traits, would you require in him for the purpose of that job?", respondents gave a wide variety of characteristics featuring general and specific aspects (probably reflecting their own experiences in their working relationships with their accounting counter-parts).

Since this was a non-forced-choice question, patterns of responses might be classified in two main subsets or categories. The intersection of these subsets is very high and sometimes overlapping. These two subsets are:



subset one: outlining essential characteristics forming 'fundamental ingredients of the educational background and training experience of accountants, as necessary conditions for any satisfactory accounting-MS/OR working relationships to be developed.' Examples of these fundamental ingredients are reflected in the following most frequently mentioned characteristics:

<u>Characteristics</u>	<u>Absolute Frequency</u>
Degree in numerate subjects.	44
Creative rather than stereotyped.	43
Ability to communicate and get on with other people.	33
Flexibility of outlook.	32
Management accounting experience.	32

subset two: outlining supporting characteristics featuring points of emphasis for the reinforcement of those explained in the above subset. Characteristics representing this category are the following:

<u>Characteristics</u>	<u>Absolute Frequency</u>
Multi-disciplinary experience (not just accounting):	26
Non-traditional accounting methodology.	23
Graduate.	23
Ability to assess several options.	20
Management - not financial - accounting experience.	18
Model-building and simulation.	17
Advanced mathematics.	16
Training in management accounting as distinct from financial accounting.	16
Operational Research experience.	13
Knowledge of computers.	11
Industrial experience in large company.	10

In addition, fewer respondents explained other characteristics, most likely illustrating specific experiences and/or points of view. Such additional features are:

<u>Characteristics</u>	<u>Absolute Frequency</u>
Training in statistics as numerate subject.	9
Economics background.	9
Able to criticize accepted accounting practices.	8
Non-pedant about detailed figures.	7
Young.	6
Able to express ideas	5
Chartered accounting background.	4
Business studies background	3



It was the view held by the majority of management consultants that the accountant who would join the MS/OR team in a large industrial organisation, to participate in MS/OR team discussions, should be numerate (and able to communicate and get on with other people). 'Numerate', 'analytical', 'quantitative': are taken to express the figurative meaning crystallized by the characteristic 'numerate'. As one management consultant put it:

"... in the strict sense of numerate meaning 'numbers' they (accountants) are; in the sense of being analysts, they certainly aren't, accountants don't adopt analytical approaches to problems at all and I think it is this that someone who is not used to working with accountants where difficulties arise. Talking on things of say, knowledge of forecasting, accountants don't have this; the only forecasting accountants have to do is say that business will grow up 10 per cent next year, and add 10 per cent to all his figures. That is not an unfair statement. I am very familiar with that situation, sometimes is the best thing to do, you can't do any better than weeks of analysis at least you have tried, and the reason accountants can't do this is just lack of it, and this is associated with the training scheme".

## Summary

This chapter has analysed a set of opinions and views of a sample of MS/OR specialists regarding their working relationships with accountants. The analysis of findings presented in this chapter together with the corresponding section in chapter six is the basis for constructing a a priori classification of behavioural indicators in relation to accountants - MS/OR specialists' interaction. The empirical examination of such an a priori classification is the central concern of the researcher in chapter nine of this thesis.

Some of the relevant background (personal and organisational) information about the MS/OR respondents has been analysed. The broad domain of MS/OR specialists' general impressions regarding accountants and accounting functions have been examined in a detailed manner.

In the examination of MS/OR specialists' working relationships with accountants, a distinction has been made between two conditions. The first is the state of no communication with accountants; and the second is the state of communication with accountants. The reason for including the former has been to identify the ways in which MS/OR specialists extract the accounting and financial information required for their MS/OR projects, and the reasons for not seeking to get such information from accountants.

A number of related issues have been examined for their implications for the accountants - MS/OR specialists' interactions. These issues are the extent to which MS/OR specialists are involved with accountants, MS/OR specialists' reactions to not being called upon by accountants to deal with problems falling within their accounting responsibilities, the reputation of MS/OR groups, and the MS/OR specialists - accountants' future relationships as well as the desired characteristics of future accountants as seen by MS/OR specialists themselves.



## Chapter Six

An analysis of opinions and views of some accountants regarding their working relationships with MS/OR and EDP specialists

---

### Abstract

#### 6.1. Background information.

- 6.1.1. Personal background information.
- 6.1.2. Organisational background information.

#### 6.2. Accountants' involvement in MS/OR

- 6.2.1. Working relationship with MS/OR specialists.
- 6.2.2. Attitudinal aspects of communication with MS/OR specialists.
- 6.2.3. Experience in the application of MS/OR concepts and methodology to accounting problems and projects.
- 6.2.4. Reputation of MS/OR specialists.
- 6.2.5. Accounting - MS/OR future relationships.

#### 6.3. Accountants' involvement in EDP areas.

- 6.3.1. Engagement in the EDP field.
- 6.3.2. Attitudinal aspects of communication with EDP specialists.
- 6.3.3. 'Accounting - EDP' future relationships.

#### 6.4. The proposed framework of interdependence: the accountants - EDP specialists' a priori behavioural indicators.

#### 6.5. The proposed framework of interdependence. The accountants - MS/OR specialists' a priori behavioural indicators.

### Summary

## Abstract

This chapter presents an analysis of opinions and views of some accountants regarding their working relationships with <sup>EDP and</sup> MS/OR specialists. This aspect of the study surveyed 240 ICMA members working in relatively large British industrial organisations by means of mailed questionnaires.<sup>1</sup> Questionnaires were sent on March 1 1973, but several stages of designing and testing the document had been completed by December 1972.<sup>2</sup> The rate of response was 46%. Also, interviews were held with some management consultants representing large-sized consultancy firms for relevant experiences in this respect.<sup>3</sup>

The analysis of the empirical evidence regarding accountants' opinions and views is presented in the first three sections of this chapter. The latter two sections present the accountants - EDP specialists' a priori behavioural indicators, and the accountants - MS/OR specialists' a priori behavioural indicators, respectively. These a priori behavioural indicators are the outcome of the analysis presented in the preceding two chapters and the respective two sections in this chapter.

Section 6.1 presents some (personal and organisational) background information about the accountants who responded to this part of the survey. Section 6.2 presents an analysis of respondents' perception of their involvement in the MS/OR areas. Section 6.3 presents an analysis of respondents' perception of their involvement in the EDP field. Section 6.4 is the accountants - EDP specialists' a priori behavioural indicators whilst section 6.5 is the accountants - MS/OR specialists' a priori behavioural indicators.

- 
1. Appendix A, ~~#~~ 4.3. is the abridged 'ICMA' mailed questionnaire.
  2. For a detailed account of the ICMA sampling procedures employed, see Appendix A, ~~#~~ 2.3.
  3. For an account of the management consultants' sample, see Appendix A, ~~#~~ 2.4.



The exploratory search into accountants' opinions and views was a necessary step in order to gain more understanding about accountants' working relationships with EDP and MS/OR specialists. This exploratory search is to be the basis for further systematic examination in the next part of this thesis.

## 6.1. Background Information

This section is concerned with analysing some background information about the respondents who took part in this aspect of the study and about their organisations. The first subsection is devoted to discussing frequency distributions of variables such as age, length of experience (number of years) with their organisation, membership of professional societies and associations. The second subsection is devoted to discussing information about their organisations that are directly relevant to this study.

### 6.1.1. Background Information - Personal

The objective of this analysis is to learn about some demographic features of the participating accountants. This is to be the basis for the comparative analysis of background characteristics of the groups taking part in the survey, that is, accountants, MS/OR and EDP specialists.

#### Age<sup>4</sup>

The modal class of the respondents' age is over 50 years. More than two-thirds of the respondents were classified under the category labelled 'over 41 years of age'. (This is as a result of combining the three categories 41-45 years, 46-50 years and over 50 years into one category).

This throws some light on one of the important background variables of accountants compared with their MS/OR counterparts. It corroborates the generally held belief that the average accountant is older than his MS/OR colleague. Together with some other background information such as educational and training background, it

---

4. See table 1 in Appendix A, ~~4~~ 3.3.



might be possible to draw some conclusions about the scope and quality of their organisational interaction.

It should be remembered that this sample is biased towards those respondents included in the 1970-1971 list of members of the Institute of Cost and Management Accountants.<sup>5</sup> The list at the time of carrying out the study was already "considerably"<sup>6</sup> out of date. This source of bias might have affected the observations to reflect older age groups rather than the normal population.

Length of experience in the field of accounting  
for planning and control      7

The examination of the frequency distribution indicates that the modal class is over 15 years. This category describes 55.5 per cent of respondents. Meanwhile, the distribution of other categories is as follows:-

12-15 years	15.5 per cent
8-11 years	14.5 per cent
4- 7 years	12.7 per cent
Less than 3 years	1.8 per cent

Although one should not take the above distribution for granted (due to the limitations of the present survey), it does give some indications about the average length of experience of ICMA members. However, for the purposes of this study, it is a useful indicator.

This can be explained in terms of the way accountants in general, and ICMA members in particular, are trained. The condition of a minimum number of years as a prerequisite for qualification is an

- 
5. Including alterations notified before 21 August 1970.
  6. In the words of the Institute of Cost and Management Accountants.
  7. Respondents who indicated they had moved into administration, personnel, legal or similar functions within their organisations were excluded from the analysis. This is due to the fact that the researcher had considered these areas - though indirectly relevant - were of little value as far as the objectives of the present research are concerned. The researcher feels, however, that this condition was one of the factors which affected the rate of response.

important factor in the education and training of accountants. This is certainly not the case as regards the education and training of MS/OR specialists. Such difference is expected to cast some influence on the working relationships between the two groups.

Number of years with present organisation

The examination of the raw data available in this part of the survey indicates that the average accountant stays a relatively long time with the same organisation. This is based on the fact that the median is 16 years. It is interesting to note that the range of this variable is 41 years, which gives some idea about the length of time accountants spend with one organisation. This corroborates the intuitive impression that accountants have relatively low turnover (compared for example with MS/OR and EDP specialists).

Number of years in present job

The mean of the number of years is 4.828 years. Slightly more than one-half the valid observation is classified under the category one to three years. 81.7 per cent of the valid observations is classified under the category one to seven years.

Membership of other professional and/or learned societies

The main sampling source was the 1970-71 ICMA list of members. Respondents indicated they were at the time of the contact, members of one or more of other related professional and learned societies and associations. The resulting distribution is not mutually exclusive. The following are the respondents' indications in this respect:



<u>Societies and Associations</u>	<u>per centage</u>
Institute(s) of Chartered Accountants in England & Wales, & Scotland.	12.7
Institute of Chartered Secretaries and Administrators.	10.0
British Institute of Management.	7.3
Association of Certified Accountants.	5.5
British Computer Society.	3.6
Operational Research Society.	1.8
Others.	4.8

The multi-professional affiliation of the accountants taking part in this aspect of the study might reflect their desire to gain specialised knowledge in one or more particular fields of accounting. This might be affected by a number of motivations during their career progression. The small proportion of accountants who were members of the BCS might indicate either that the small proportion is a true indication of the actual scope of accountants' involvement in the EDP or that accountants who had moved into the EDP field were no longer interested in continuing their membership in the accounting profession. The relatively small size of the sample makes it difficult to find a satisfactory clarification in this respect. What is clear from the above percentages is that the intersection between both accounting membership and the OR Society is very limited.

6.1.2. Organisational background information  
Type of industrial classification

The sampling design of the accounting part of the survey follows the same procedure adopted in the EDP and MS/OR parts (reported earlier in chapters four and five). That is, the study is limited to those types of industries where there were grounds to believe that they appear to undertake MS/OR activities.<sup>8</sup> The classification of

---

8. For a detailed discussion see Mercer (1968, pp.371-376). Also, Appendix A, ~~#~~ 2.2.2. is relevant in this respect.

respondents according to the type of industrial classification is as follows:-

<u>Type</u>	<u>Accounted for</u>
Industrial miscellaneous	more than one-fifth of the valid observations
Gas, electricity, engineering and metal industries	more than one-fifth of the valid observations
Food manufacturing, electrical and radio, beers, wines and spirits	about one-fifth of the valid observations
Oil, tobacco, steels, components, motors and cycles, chemicals and plastics.	about one-fifth of the valid observations

The above distribution seems to be consistent with the planned objective of contacting those respondents who would be more likely to be engaged in industrial organisations conducting some form of MS/OR activities.

#### Carrying out some form of MS/OR activities<sup>9</sup>

The responses to the question "Does your firm or organisation conduct (formally or informally) any form of MS/OR activities?" are as follows:

a)	Yes	76%
b)	No	22%
c)	Not us, but parent company; there are no MS/OR specialists but MS/OR techniques are sometimes used	2%

Amongst the interpretation to responses in category "b" are:

- i) there were no MS/OR activities being carried out
- ii) there were some type of MS/OR activities being carried out, but respondents were unaware of it, as a result of the particular form or title not easily identifiable by respondents

---

9. Analysis in this section is confined to those respondents who explicitly indicated that they had some idea about MS/OR concepts and techniques. The percentage of respondents in this category is 80% of the valid observations.



## 6.2. Accountants' involvement in MS/OR areas

Five separate headings are contained in this section to analyse different aspects of accountants' involvement in MS/OR areas as seen by accountants themselves. Sub-section 6.2.1. discusses accountants' working relationships with MS/OR specialists. Sub-section 6.2.2. discusses the attitudinal aspects of communication with MS/OR specialists based on an attitudinal set of statements designed in the form of a 12 item Likert-type scale. Sub-section 6.2.3. analyses accountants' experiences in the application of MS/OR concepts and methodology to accounting problems and projects. Sub-section 6.2.4. indicates accountants' general impression regarding the reputation of MS/OR specialists, whilst sub-section 6.2.5. presents an analysis of accountants' visualisation of their future relationships with MS/OR specialists.

### 6.2.1. Working relationships with MS/OR specialists

The question "What kinds of communication are there between you and the MS/OR specialists in your firm or organisation?" was posed to 67 accountants. The answers indicate that the minority (16 per cent) had not had any kind of communication with MS/OR specialists in their organisation. The vast majority, however, indicated that they had had some kind of communication with their MS/OR colleagues. Since this phase of the study was aimed at exploring the various dimensions and the scope of the problem under investigation, use of such open questions containing less structured categories had to be made. Consequently the researcher's interest is in reasoning behind different situations rather than in the literal classification of "yes" or "no". This is carried out in the remainder of this sub-section.

State of "no" communication with MS/OR specialists<sup>10</sup>

The analysis of responses provided by those accountants classified under this category indicates one or more of the following reasons:

- i) the present job responsibilities did not necessitate contact with MS/OR specialists in their organisations; or they had not had the opportunity to work with, or to provide any kind of information or help for MS/OR specialists
- ii) accounting staff were chiefly concerned with the financial transactions - their recording, classification and legalistic issues rather than the managerial functions.
- iii) MS/OR activities were restricted to certain projects; no specialist MS/OR group existed, therefore contact with MS/OR specialists was on a sporadic basis arising from ad hoc investigations.

Other reasons were also mentioned. Amongst them are: a) MS/OR specialists live in a world of their own, seemingly unrelated to the running of business enterprise; b) accountants were not selling their job well; c) MS/OR specialists had little understanding of accounting systems; and d) MS/OR specialists speak in a too technical language. These indicators are explanatory manifestations of dysfunctional behaviour characterising this type of working relationship.

State of "some kind"<sup>11</sup> of communication with MS/OR specialists

First: Means of providing data and information required for MS/OR projects:

Analysis of the findings concerning the way the accounting function participates in providing MS/OR specialists with the required data and information in accordance with the frequency of adopting the different means, indicates that:<sup>12</sup>

10. Respondents whose answers fall within this category were not requested to participate in considering the rest of questions related to accountants' involvement in MS/OR.
11. Analysis in this section is confined to those observations which indicated that they had 'some kind' of communication with MS/OR specialists; that is the total number of observations here is 54.
12. See table 2 Appendix A, ~~4~~ 3.3.



- i) there is insufficient evidence to indicate that the accountant has become a regularly contributing participant in the MS/OR team discussions, particularly in relation to projects involving financial considerations and implications. This indicates that there is a wide gap between what "ought to be" (13) and "what is".
- ii) It appears that giving detailed information about costing and financial matters is the more frequently adopted approach to providing accounting data and information required for MS/OR projects. Less frequent is giving 'brief' and approximate information about costing and financial matters.
- iii) Few respondents have adopted one of the constructive approaches to providing data and information required for MS/OR projects which involves the exchange of information on interactive projects. The emphasis placed here (by those respondents who practised this form of interaction with their MS/OR colleagues and its relatedness with the high degree of co-operation and satisfaction involved) does indicate the importance and weight to be given to further exploring the advantages and limitations associated with this approach.

Second: data and information provided by accountants to meet the different needs and requirements of MS/OR projects:

It is fair to say that anyone who describes MS/OR as generally a collection of 'standard techniques' will be met, at minimum, by an unhappy reaction from MS/OR specialists refuting this "unfavourable" image of their discipline. They are quick at correcting this belief, indicating that their discipline is aimed at problem solving, decision making, prediction and control based on 'systems modelling' and 'functional relations'. But it is doubtful that the majority of managers and accountants held a view of MS/OR similar to that of MS/OR practitioners.<sup>14</sup>

- 
- 13. It has been widely believed that the industrial accountant can be of value in the identification of potential MS/OR applications, in verbal model building and data collection process, and in solution control. For a detailed discussion of the accountant's place in MS/OR team and the associated potential usefulness, see, e.g. Churchman and Ackoff (1955); Most (1959); Hartley (1968); Sizer (1973).
  - 14. This is based on the researcher's experience in approaching both MS/OR and accountants about the extent of accountants' involvement in MS/OR projects and studies. Whilst MS/OR specialists strongly opposed the inclusion of the term 'standard MS/OR techniques' in the document used to collect data from MS/OR specialists, accountants (intentionally or unintentionally) ignored making any comments on the same term. No accountant did respond to such a term with any favourable or unfavourable reaction.

Analysis of findings regarding accountants' provision of data and information to meet the different needs and requirements of MS/OR projects and studies reveals that:<sup>15</sup>

- i) provision of 'raw data'<sup>16</sup> regarding costing and financial matters was the most frequently adopted approach. Slight modification of data is a less frequently adopted approach. Partial modification of data is still less frequent, whilst complete modification of data is the least frequently adopted approach by accountants to provide costing and financial information for MS/OR projects.

In view of this evidence together with the findings discussed in First above, it is unlikely that accountants make any data modification or transformation to make accounting information more attuned to possible use of MS/OR specialists.

- ii) Forecasting studies were the most frequently indicated type of projects for which accountants provided data. Next to the forecasting projects was inventory control type of projects. Fewer observations indicated that they provided data, and slightly or partly modified information for the purpose of Linear programming models and network analysis. Still fewer observations indicated that they provided information for purposes of 'queueing (waiting line) models, dynamic, quadratic and integer programming and simulation.

Given that accountants' provision of information for the purposes of regression and probabilistic analysis and simulation projects is on a very small scale, coupled with the importance attached to accountants as a main source of generating suitable, adequate and sufficient information and the environmental complexity of business organisations, it would appear that accountants' association with, and involvement in, the development and implementation of MS/OR projects and studies is noticeably insufficient.

Assuming that respondents were aware of the suggested distinction between 'data' and 'information' and that individual interpretations of the terms "slightly" and "partly" were not widely different, there is some indication that the assumed benefits of accountants' interaction with the MS/OR specialists were neither sufficiently utilised by accountants nor had their feedback contributions to the progression of accounting systems for managerial planning and decision making. The apparent predominance of accountants' provision of data over its modifications - as a means for meeting the different needs of MS/OR projects and

---

15. See table 3, Appendix A, ~~3.3~~ 3.3.

16. Emphasis here is placed on accountants' conversion, transformation or modification of data to assist the MS/OR specialist in using 'accounting and financial data' in his analysis and model-building processes.



studies - supports the need for more understanding between the two specialities (accounting and MS/OR) based on sufficient understanding of the basic nature, and implications of their systems on their respective systems as well as on their organisation's growth and survival.

- iii) Distribution of accountants' descriptions of the statement giving their degree of satisfaction with the information provided as an aid in building MS/OR models and tracing solutions,<sup>17</sup> indicates that:
- a) the majority of respondents (58.5 per cent) were partially satisfied,
  - b) about one third of the valid observations (35.8 per cent) were completely satisfied, and
  - c) a very small minority (5.7 per cent) were not satisfied at all.

It may be argued that the degree of accountants' satisfaction with the information provided as an aid in developing MS/OR models neither describes the quality of the provided information nor indicates the extent to which accountants were involved in such models, nor does it indicate the MS/OR specialists' degree of satisfaction of the provided information, nor does it describe the extent of mutual understanding featuring the relationship between MS/OR specialists and accountants.

The above argument could be valid if such a distribution is considered in isolation from the overall picture drawn by the evidence analysed in this chapter. The sought degree of satisfaction is viewed in association with the reasoning supporting the different points of view as a basis for arriving at a set of factors that contribute towards mutual understanding between the two specialities.

#### 6.2.2. Attitudinal aspects of communication with MS/OR specialists

To learn about attitudinal aspects of communication with MS/OR specialists, a 12 - item Likert type scale was included in the accountants' mailed questionnaire. The final scale was presented in a tabular form headed by degrees of agreement, neutrality and disagreement as follows: strongly agree, agree, undecided, disagree, strongly disagree.<sup>18</sup>

Analysis of the findings in relation to this aspect of the study indicates that:<sup>19</sup>

- 
17. See table 4, Appendix A, ~~3.3~~ 3.3.
  18. Studying the attitudinal aspects of communication in this sub-section follows the same procedure adopted in the preceding two chapters; see sub-sections 4.2.3. and 5.2.5.
  19. See tables 5 to 16, Appendix A ~~3.3~~ 3.3.

- a) there is insufficient evidence to corroborate the suggestion that accountants have the preconceived idea that MS/OR as a discipline has no practical value for accountants. This is not to say, however, that accountants are sufficiently motivated towards using MS/OR services in their areas of specialisation.
- b) the majority of respondents felt uncertain about whether or not accountants' criticism of MS/OR proposals and recommendations were welcomed amongst MS/OR specialists. This majority forms more than 50 per cent of the valid observations.
- c) the majority of respondents felt that MS/OR specialists do not understand many things about accounting systems, procedures and practices.
- d) the number of respondents who felt 'undecided' about most of the attitudinal aspects of working relationships is by no means small. Such uncertain pattern of communication has its implications for the inter-functional contribution to problematic search and uncertainty avoidance featuring organisational decision making processes.
- e) the main factors affecting accountants' attitudes towards MS/OR specialists are: 20
  - I accountants' view of MS/OR areas in general and MS/OR proposals and recommendations in particular
  - II image of MS/OR specialists
  - III style of applying MS/OR
  - IV MS/OR specialists' acquaintance with accounting systems

The results should be considered in the further examination of accountants - MS/OR specialists' interaction.

### 6.2.3. Experience in the application of MS/OR concepts and methodology to accounting problems and projects. 21

Analysis of responses in this section indicates that the vast majority of participating accountants (71.6 per cent of the valid observations) had not had any experience in the application of MS/OR concepts and methodology to accounting problems and projects. A small number of respondents had had some experience in that area.

It is worth mentioning that the question asked concerning this aspect

20. This is the outcome of subjecting items that are detailed in tables 5 to 16 to factor analysis. Intercorrelations were featured through computing Pearson's product moment correlation coefficients. Only those factors that have a minimum eigen-value of unity were extracted. Varimax rotation was performed.
21. Respondents who indicated either that their organisations were not carrying out (formally or informally) any form of MS/OR activities, or that they had no communication with MS/OR specialists, are excluded from the analysis in this sub-section.



was of the open-type that imposed no limitations on respondents in commenting, explaining and clarifying their opinions in this respect. In other words, the question - as it was intended - was open to their own interpretations as to whether the application of MS/OR concepts and methodology to accounting problems was the work of MS/OR specialists or the respondents themselves.

Dimensions of the empirical evidence can be analysed in the following manner:

- a) Accounting application areas indicated in accordance with their absolute frequencies are: 22

<u>Areas</u>	<u>Absolute frequency</u>
Stock control and valuation.	8
Manufacturing cost estimation, materials costing and budgeting control and cost calculations.	7
Project evaluation and investment appraisal.	6
Financial forecasting, methods of cash collection, cash flow and finance and planning.	5
Resources allocation and capacity utilisation.	3
Design of computer-based systems and financial modelling.	4
Analysis of distribution costs.	2

- b) MS/OR concepts and methodology used in the above-mentioned areas are:-

<u>MS/OR Tool(s)</u>	<u>Absolute frequency</u>
Forecasting, sampling, regression analysis.	12
Network analysis.	9
Simulation.	7
Linear programming	5
Modelling and systems analysis.	4
Inventory control.	2
Discussion on interactive projects.	1
Others such as: queueing, dynamic programming.	3

- 
22. Total number of valid observations in this section is 23 observations and virtually all of them indicated more than one application area and more than one MS/OR tool.

- c) The extent to which MS/OR specialists participated in dealing with accounting applications are:-

<u>Extent</u>	<u>Absolute frequency</u>
To a very great extent.	-
To a considerable extent.	6
To some extent.	7
To a very little extent.	8
Not at all.	1

Drawing upon the above-mentioned findings, the researcher may make the following comments:-

- i) Though the above titles of problems, projects, concepts and methodologies are simple and brief denotations of the work involved, they do indicate the extent to which MS/OR is applied to accounting problem areas. It was not expected, however, that every accountant would be applying MS/OR to his area of responsibility.

This is a clear indication that accountants make very little use of the MS/OR approach in carrying their accounting responsibilities. If one goes along with the thesis that accountants should be able to use such approaches in tackling today's complex business problems, it is clear that drastic changes have to be made regarding the design and implementation of educational programmes. Serious efforts have to be made in the areas of introducing accountants to such MS/OR concepts and methodologies. MS/OR specialists too have their responsibilities in the selling of their projects.

Of course, the researcher is aware of the multidimensionality of the problem with environmental, organisation, individual, group, and intergroup attributes and consequences. This is an area of major concern of the present research in the next part (Part III) of this empirical investigation.

- ii) None of those respondents who answered this section did attempt to elaborate on the nature of the project, or on the way the particular MS/OR tool was applied, or on how it was applied. Was it because the question had not explicitly asked for such elaboration? Was it due to the confidential nature of MS/OR projects following organisational policies? Was it due to the respondents' ignorance regarding such projects? Was it due to the respondents' insufficient information about these MS/OR projects they reported? The researcher cannot make a definite answer to any of these possibilities.

#### 6.2.4. Reputation of MS/OR specialists<sup>23</sup>

Regarding the development and implementation of MS/OR projects,

23. Respondents who indicated either that their firm or organisation did not conduct (formally or informally) any form of MS/OR activities, or that they had no communication with MS/OR specialists, are excluded from the analysis in this sub-section.



respondents were asked to describe their perception of the reputation of MS/OR specialists as seen by: the managing director, the consensus view of senior management, the finance director, the chief accountant, accounting department individuals, MS/OR specialists themselves, and any other groups (respondents would think might be appropriate) using a 5-point scale ranging from very good to very poor.<sup>24</sup>

Analysis of responses in this respect indicates that:<sup>25</sup>

- i) the category titled 'I don't know' occupied the modal class of responses. This might be related to a variety of interpretations. Amongst these interpretations are:
  - a) the organisational distance between respondents and the particular organisational level
  - b) the less noticeable impact MS/OR specialists had had on accountants
  - c) the inadequate documentation of MS/OR projects and studies
  - d) the tendency amongst some MS/OR specialists and functions to discuss constructively the conditions leading to the success or non-success of particular MS/OR projects, specifically the less successful ones.
- ii) respondents' visualisation of the reputation of MS/OR specialists as seen by the accounting department individuals could approximately be categorised into three main conditions: poor, uncertain, good. This clearly is dependent on other variables such as the quality of accountants' experience regarding their working relationships with MS/OR specialists, the organisational design of MS/OR function and the MS/OR specialists' ability to demonstrate the value of the MS/OR approach in dealing with complex business problems. 26

#### 6.2.5. "Accounting - MS/OR" future relationships

Opinions and views of respondents were sought regarding the kind of relationship between them (the accountants) and MS/OR specialists in their organisations by means of an 'open' type question.

24. The reason for inclusion of this aspect in this phase of the present investigation was to explore accountants' expression of the perceptual image of MS/OR specialists as seen by various organisational groups to be taken into consideration with other relevant dimensions of the relationship.

25. See table 17, Appendix A, ~~3.3~~ 3.3.

26. This issue is given more attention in the next part (III) based on both qualitative as well as statistical evidence.

As indicated earlier, such an approach was thought to be more suitable, in tackling these type of organisational issues, than the 'fully' or 'semi' structured type of questions.

The majority of respondents indicated the need for much closer co-operation between the two specialities in a wide variety of expressions. Examples of such expressions are:- (i) the two functions should overlap in the future as each becomes more aware of the nature and methodology of the other, and (ii) project-based relationships will be the basis for the interdisciplinary involvement between accounting and MS/OR combined with other groups such as corporate planning. Also, some respondents emphasised the underlying reasons for the need for more co-operation and interdisciplinary involvement of both functions where they indicated that complexity of business problems necessitates: a) that accountants widen the prospective of their systems to be geared to satisfy the managerial needs for problem solving and decision making; and, b) that MS/OR specialists should tackle more practical applications for their organisations. Assuming that opinions and views are based on respondents' experiences and given the fact that some opinions and views are incompatible with that of the majority, it is worth discussing a sample of 'representative' expressions regarding the accounting - MS/OR future relationships:

Respondents' expressions	The Researcher's comments
<p>"The ideal relationship is one where co-operation is the keyword, such that joint projects do not engender professional jealousies, prompted by the fear that one or the other function might "take over" the project(s) and increase its importance in the eyes of senior management"</p>	<p>This view:</p> <p>i) expresses the 'suspicion' that any of the participants in a 'project-based' involvement might have in mind. This, of course, would depend on the parties involved: their behavioural attitude, their motivations, and the prevailing organisational conditions.</p> <p>ii) alerts both project management and senior management to the need for taking the necessary measures to minimise the possibility of such aspects of 'political manoeuvring'.</p>



Respondents' expressions	The Researcher's comments
	<p>iii) describes an aspect of organisational "reality" implied by the use of the term 'ideal'. This belief is reinforced by the fact that the same respondent stated that "'political' areas of conflict tend to arise when a problem is given to MS/OR specialists and Accounting people to solve jointly. The result is that one function often tries to monopolise the project as part of its 'empire'"</p> <p>iv) emphasises the need for both functions to be aware of the behavioural implications of having short-term gains at the expense of long-term co-operation.</p>
<p>"Interaction-each understands the other's methodology and potential for helping solve problems and working together".</p> <p>"Should be closely knit to solve business problems, facilitate planning and optimum profitable use of resources ..."</p> <p>"A mutual understanding and working knowledge of techniques, and objectives utilising expertise of both functions to achieve common goals".</p> <p>"Developing liaison - bringing each other into problem areas at earlier times than at present. Both are providing a management service so closer liaison is logical".</p> <p>"Close co-operation is required at all times. We are living in 'changing times' and to keep abreast of all the company's facets is a "must".</p>	<p>This sample of opinions:</p> <p>i) gives weight to the concept of mutual understanding between accountants and MS/OR specialists;</p> <p>ii) emphasises the need for mutual appreciation of each others' sub-goals and objectives based on working knowledge of methodologies and the limitations of others' systems.</p> <p>iii) explains the importance of cross-fertilisation of experiences in exploring ways of improving respective systems and methodologies for achieving common goals, i.e. helping their management in tackling business problems;</p> <p>iv) prescribes a desired state of working relationship between both functions (MS/OR and accounting);</p> <p>v) raises several exploratory questions. Amongst these questions are the following:- how could the sought mutual understanding be achieved? how could the two functions be brought together? how could each be aware of the other's problems, limitations and potential? and how could such expertise be effectively utilised for developing and reinforcing an effective 'management support sub-system' to assist in tackling business problems?</p>



Respondents' expressions	The Researcher's comments
<p>"They must get closer. Emphasis on training and working environment. Problems of departmentalism must be solved".</p> <p>"They will combine with other disciplines as required, on a project basis for a long time yet -".</p> <p>"Two staff departments-working together closely and with mutual confidence if MS/OR is going to make a practical contribution. Especially as accounting staff can provide or generate much of the input that will be needed for studies".</p> <p>" Should be embraced by an overall information function for the organisation".</p> <p>"Depends on demands of the organisation (i) could be part of management services within Financial Director control, or (ii) could be part of Corporate Planning as a direct link with the Board".</p>	<p>This sample of views:</p> <p>i) expresses varied views about the form of organisational design suitable for the accountants - MS/OR specialists' interaction ranging from two separate departments to one "information function".</p> <p>ii) emphasises the fact that irrespective of the adopted form of organisational design, it should facilitate the two disciplines' (accounting and MS/OR and perhaps other closely related functions) getting closer to support their managements.</p> <p>iii) indicates that the shape of working relationship between the two specialists is likely to be influenced by the form of organisational design containing such an interaction.</p>
<p>"As accountants receive more instruction in MS/OR techniques and MS/OR personnel become more versed in accountancy the two functions should overlap more in the future".</p> <p>"Unless accountants become numerate they will lose their influence to "University trained" personnel who can handle mathematical and statistical/MS/OR subjects".</p> <p>"I believe there should be a much closer relationship; each can help the other - neither needs to know all the detail of the other's responsibilities".</p> <p>"The accountant should be aware of the MS/OR technique which can be applied to accounting problems and should consult with the MS/OR Manager on a regular basis".</p>	<p>This sample of views:</p> <p>i) emphasises the importance of the educational and training backgrounds and experiences of both accountants and MS/OR specialists, in developing mutual understanding. Getting working knowledge of each others' discipline should contribute towards narrowing the communication gap between the two specialists. Not only would the MS/OR knowledge contribute towards getting the accountant familiar with terminology, but it can also help him/her identify the possible MS/OR applications to accounting and finance areas.</p> <p>ii) highlights some of the differences in the educational backgrounds between accountants and MS/OR specialists.</p>



Respondents' expressions	The Researcher's comments
<p>"Armslength co-operation between the two functions but I forecast an increase in the use of the MS/OR services by accountants. MS/OR techniques will become more important part of accountants' training syllabus".</p>	<p>iii) implies the need for exploring and developing possible approaches to achieving a high degree of compatibility and co-ordination between the two disciplines on higher resolution levels. (That is on the level of professional and learned societies, or associations).</p>
<p>"There is little room for MS/OR specialists in the accounting function where the accountancy is controlled by high intelligence professional, qualified men".</p> <p>"Limited - MS/OR responsibilities should relate to "real" activities. The accounting function, however erudite, is essentially a recording concept either for the past or present, or an attempt to predict what is likely to happen in the future".</p>	<p>Though these views were expressed by few respondents, they may:</p> <p>i) describe possible source of bias that might affect the stereotyping process in organisations;</p> <p>ii) describe a pattern of working relationships that see an insignificant contribution resulting from MS/OR specialists' co-operation with their accounting counterparts.</p> <p>iii) describe limitations contained in actual interactions between the two functions as a result of a number of individuals, or organisational factors or both.</p>

### 6.3. Accountants' involvement in EDP areas

Four separate headings are contained in this section, which presents an analysis of accountants' involvement in EDP areas as seen by the Accountants themselves. Sub-section 6.3.1. discusses the kind of accountants' involvement in EDP areas. Sub-section 6.3.2. analyses the attitudinal aspects of communication with EDP specialists on the basis of the respondents' observations on a set of Likert-type scales of measurement. Sub-section 6.3.3. presents accountants' visualisation of their future relationships with EDP specialists; whilst sub-section 6.3.4. examines some of the desired characteristics of an EDP specialist to join the accounting function.

### 6.3.1. Engagement in the EDP field

Asked about the relevance of the training in the EDP field to their jobs 92.7 per cent of the valid observations indicated the following distribution: "It is wholly relevant," 53.6 per cent; and "It is partly relevant," 39.1 per cent. If this is to be considered as a measure of the extent to which respondents feel computers should affect the functioning of their jobs and the carrying out of their responsibilities, this evidence leaves little doubt - if any - about the importance of accountants' training in the EDP field.

Focusing on those who indicated that they considered the training in EDP as either wholly or partly relevant, the distribution of the status of their formal training (by means of attending training courses) in EDP is as follows:-

those who had formal training	55.8%
those who did not have training	44.2%

Four-fifths of those who had some formal training in the EDP field were (at the time of carrying out this part of the investigation) engaged in areas related to EDP field. Examination of the type of course attended, its duration in accordance with respondents' classification to it (appreciation, intermediate, or advanced) indicates that:

- appreciation courses are the dominant category of EDP courses attended by accountants, considerably less percentage of accountants attended advanced or intermediate courses in computer-based management information systems, management and control of EDP activities.
- specialised software packages (such as inventory control, network analysis, simulation, linear programming) occupy (considerably) a less prominent place than management courses described above.



- COBOL is the most frequent (high level) programming language indicated by those minority of accountants who have had some training in programming languages. An extremely small minority of accountants indicated that they had had some training in FORTRAN IV and ALGOL programming languages.
- In most cases, appreciation courses are the dominant feature of EDP courses attended by accountants.

### 6.3.2. Attitudinal aspects of communication with EDP specialists

Due to the exploratory strategy fundamental to this part (Part II) of the study, the research used a set of 15 item Likert-type scales to learn about accountants' attitudes towards their EDP counterparts. Tables detailing responses in this respect are contained in Appendix A,

~~3.3.~~ 3.3. On the basis of these observations, the researcher can arrive at the following interpretations:

- In the majority of cases, senior accounting executives do not contest for control over EDP resources in their organisations. Some accountants (one-fourth of the valid observations) felt however, that senior accounting executives in their organisations contest for control over EDP resources. Accordingly, it is the minority rather than the majority of senior accounting executives who were felt to be contesting for control over their EDP functions. Nevertheless, about three-quarters of the valid observations indicated that their senior accounting executives encourage them to co-operate with EDP specialists for the development and growth of computer-based information systems.

- A fair number of respondents felt that they (accountants) do not believe any one else can design a computer-based system which gives due weight to their requirements of control and internal checks. However, the majority of respondents disagreed with this.
  
- Accountants in principle co-operate with and are willing to provide any kind of help to DP personnel. Accordingly, it is the quality of such co-operation that makes the difference. The quality of such co-operation is dependent of course on other considerations such as the accountants' degree of appreciation of EDP concepts and techniques, the area subject of the required co-operation, the related organisational and environmental circumstances.  
  
The vast majority of respondents (accountants) disagreed with the statement that "accountants are one of the greatest obstacles to the development and growth of computer-based information systems". There may be some element of bias on the part of accountants, but the indications are that the success or failure of computer-based systems is not the direct responsibility of accountants. They may be a contributing factor, but they are not the one and only function responsible for either of the outcomes.
  
- The majority of accountants accept the establishment of computer facilities not under their control.
  
- A fair number of respondents (one-third) disagreed with the statement indicating that criticism of accountants and accounting functions are welcomed in the accounting departments, a slightly less number of respondents agreed with the statement; whilst more than one-fourth of the valid



observations felt "undecided" about this. Rephrasing into "accountants do not accept any criticism of accounting systems and principles, particularly by DP specialists" changes the shape of the distribution to one of more inclination to disagree with the re-phrased statement.

- The majority of respondents agreed with the statement indicating that ethical standards of the accounting profession have not been too much affected by recent developments in computer and information technology areas.

### 6.3.3. Accounting - EDP "future relationships"

Accountants' views and opinions regarding their future relationships with their EDP counterparts were the subject of an open question included in the accountants' questionnaire. Analysis of respondents' expressions covers a wide variety of dimensions of the relationships. The most frequently described viewpoint is that the two functions should develop and maintain better understanding of the wider implications of their services to their managements. The majority of respondents indicated the need for more efficiency in the input and output of computer-based systems and the effectiveness of the various stages of computerisation.

Descriptions of the present shape of relations varied significantly from 'very good' to 'very bad', from 'very satisfactory' to 'very unsatisfactory'. Such descriptions referred to a number of problem areas. The following are examples of these problems:

EDP specialists' not meeting accountants' dead-lines and users' needs; inflexibility of computer-based systems to meet the changing needs of users; data retrieval and the critical time lags; lack of harmonisation and integration of day-to-day operations with

monthly, quarterly and other longer term control information for management;

the eagerness on the part of some DP managers to have bigger and better hardware at the expense of economic rationality; the lack of systems analysis, design, maintenance and documentation standards, and the wider problems of communication.

Although one should expect some elements of bias on the part of accountants to creep in, examination of their opinions and views indicates that they raised several points similar to those described by EDP specialists. Based on the frequencies of observations in the first place was the kind of relationships to which accountants look forward. In the second place was the accountants' descriptions of the organisational distance between the two functions. The aspect of who should control and run computerised activities came in the third place.<sup>27</sup>

However, some of the opinions and views expressed by the accountants are commented upon in the following table.

Respondents' expressions	The Researcher's comments
<p>"We have recently appointed an accountant turned computer man to our staff to be 'link-man' with Data Processing Dept. and future co-operation looks good".</p>	<p>These views emphasise the importance of co-ordination and liaison amongst the two specialities; EDP and accountants. The main objective is to provide better service to management.</p>
<p>"Both functions provide a service to line management and directors - a joint service approach to user problems under the control of a joint director".</p>	<p>Organisations have been practising various forms of organisational design to achieve such an objective. Amongst these design approaches are: link-persons, joint directorship and liaison bodies to co-ordinate the EDP/user interface.</p>

27. To avoid repetition, the reader is referred to chapter four, pp. 126-132 for a detailed discussion of EDP specialists' opinions and views regarding their working relationships with accountants. As indicated above, the major difference between the two groups' views is in the overall priorities given by each functional group.



Respondents' expressions	The Researcher's comments
<p>"Developing liaison - bringing each other into problem areas at earlier times than at present. Both are providing a management service so closer liaison is logical".</p>	
<p>"Both technical specialists serving general management - the accountants will generally to have the broader field and to be closer to general management - they will therefore dominate".</p>	<p>This accounting view speculates about the future of accountants in their relationship with EDP specialists. It appears to be based on the assumption that EDP specialists would continue to have limited DP knowledge. Will accountants be able to broaden their knowledge and experience to include EDP concepts and techniques? Will EDP specialists limit their knowledge to the pure technical EDP? These are, of course, debatable questions.</p>
<p>"DP/OR function is a service to all divisions of a company. Accountants need more background training in order to avail themselves of this service".</p>	<p>This view puts more emphasis on the educational and training needs of accountants to take advantage of these recent developments in EDP and MS/OR areas.</p>
<p>"Increasingly economic. As managers learn more and more about computers so they are able to monitor the cost effectiveness of applications".</p>	<p>This view represents those accountants who are concerned about the cost effectiveness of their computer-based systems. Are those systems cost effective? What role should the accountant play in such a problem? These and others are relevant questions to the efficiency of computerisation activities.</p>
<p>"Accounting function will become more and more concerned with cost control, accuracy of input, and management information and less involved in financial accounts recording which will be handled by the computer".</p>	<p>Several respondents have expressed similar speculations with slightly varied emphasis. The computerisation of the bulk of the routine accounting activities should be succeeded by far greater interest in the managerial needs and requirements of information - information that can be used in the search for problem solutions and in the decision-making processes.</p> <p>Such a view raises the following questions:</p> <p>Does it imply that there has been less concern (than should be) with cost control, accuracy of input, and management information?</p>

Respondents' expressions	The Researcher's comments
	<p>Does it imply that accountants give more attention to recording than reporting and analysis aspects of accounting?</p> <p>Should there be some type of more specialisation within the accounting function? or should there be some modification of the accounting hierarchy to include programming accounting clerks?</p> <p>When does the EDP responsibility end and the accounting responsibility begin? For example in a problem such as the following, what is the feasible solution to the raised problem?</p> <p>"A current problem is the responsibility for file contents. The argument is that EDP provides a system; what accountants put on it is up to them and they should be responsible for seeing from file update printoffs that what they intended to happen happened. Some accountants believe their work is finished once they have defined what they want".</p>
<p>"Constructive criticism from both parties based on planned courses of instruction from both EDP and accounting personnel".</p>	<p>It would be no exaggeration to suggest that if the constructive criticism approach prevails, many of the behavioural problems associated with the EDP/user interface would find their way towards solution or, to say the least, be minimised. Accusation, charges, complaint, arguments and recrimination are not unfamiliar to those closely connected with this area.</p>
<p>"Not the best. Takes too long to achieve requirements - too many projects - too much "waffle", not enough effort from DP."</p>	<p>Of course, this view is expressed as a result of a number of contributing factors. Some of them may be of the accountants' own making. Nevertheless it demonstrates the importance of having an atmosphere in which constructive criticism is the dominant feature.</p>
<p>"The computer manager is responsible to the chief accountant and therefore the computer is used as an accounting machine. This will restrict the development of the computer into other fields and as other departments grow in size and importance their demands for computer time may well lead to the independence of the computer department".</p>	<p>These examples of accountants' expressions imply an important message describing the (actual and the) possible use of the computer as an accounting machine or as a tool for gaining more insight into risk and probabilities associated with futuristic and complex decision-making. Each of the possible approaches has its own implications for their organisations.</p>



Respondents' expressions	The Researcher's comments
<p>"Accountants are the main source, and will be, for senior computer staff".</p> <p>"In my company the tendency is towards a data-base system for all accounting and related management information. In this atmosphere accountants will become more concerned directly in (wider applications, model-building for managerial needs and requirements, analysis and interpretation) MS/OR applications and will be absorbed as experts into MS/OR functions".</p>	

6.3.4. Desired characteristics of an EDP specialist to join the accounting function

The controversy over the effective shape of future education for accountants is an on-going one. Naturally, the place of EDP knowledge in the education of accountants is a relevant one. Should the accountant carry out the full-circle of computerising accounting activities? Should the accountant be fully conversant in EDP concepts and techniques that are of importance in relation to the computerisation of his accounting activities? These and other questions have by no means found satisfactory answers so far.

Assuming that the accountant should participate actively in the development, implementation, control of EDP projects related to his work, an open-ended question was included in the accountants' questionnaire. The question was phrased in the following manner:

"If you have been asked to appoint a computer specialist to join your accounting group, what type of educational background, training, experience and personal traits, would you require in him for the purpose of that job?" The objective of including such a question was to explore accountants' reactions to such a stimulus.

70 per cent of the valid observations gave a wide variety of views and opinions in this respect covering several dimensions. Although

simple classification of their answers is no easy matter, the following major indications can be observed:

the ability to communicate with other people was the characteristic dominant to slightly less than 90 per cent of those who answered this question;

given that the appointee should have a good training in EDP, the following characteristic - common to slightly more than half the valid observations of those who answered this question - was that the person should have business experience particularly in user departments. The degree of emphasis on the scope and type of this experience varied widely amongst respondents' expressions;

As to the educational background and training, respondents' answers varied widely in this respect. The phrase 'qualified accountants' was expressed by three-sevenths of those who answered this question. The majority of those who expressed this phrase were not specific about what type of accounting qualification the appointee should have. Fewer respondents expressed that such an accounting qualification should be associate membership of the Institute of Cost and Management Accountants, or should be membership of the Institute of Chartered Accountants.

Having outlined the indications of the empirical evidence it is worth discussing some of the views expressed that might have special implications for the future education of accountants:



Respondents' expressions	The Researcher's comments
<p>"Requirements ideally would be for a business graduate with specialisation in mathematics and an intermediate (not necessary qualified) knowledge of accounting principles and practice".</p> <p>"Mathematical but with sound business experience - could be graduate accountant who specialises in computers".</p> <p>"Mathematical background and training; experience dependent on job specification boffin type couple with extrovert temperament if he/she is to graduate to a team leader".</p> <p>"Maths based University degree. Good general experience in administration. Above average knowledge of accounting, Factful practical with a good knowledge of the capacity and limitations of the equipment (hardware)".</p>	<p>Mathematics, computer-based concepts and techniques, and accounting inter-relationships are outlined in these expressions.</p>
<p>Degree level, preferably ex-consultant (wide range of experience) able to persuade, motivate, and someone who wants an economic pay-off from applications".</p>	<p>Apart from the desired behavioural characteristics of the appointee, the wide experience and the ability to appreciate cost effectiveness are important characteristics seen by this view.</p>
<p>"None specified except that he should be a specialist in some other discipline. A computer specialist who knows only computers, is unlikely to be acceptable.</p> <p>"He would need a comprehensive knowledge of the field in which he was moving".</p> <p>"Preferably one with an original accounting background on considerable experience with accountants".</p> <p>"He must have an accounting background (or be willing to learn)".</p>	<p>These views emphasise the point made by several respondents denoting that computer specialists should seek expanding their horizon to include wider areas of the business in which they are involved.</p> <p>They point out, with varied degree of emphasis, the importance of getting EDP specialists to be familiar with accounting concepts, systems and principles. This would help them appreciate the limitations contained in accounting systems as well as their contributions.</p>

Respondents' expressions	The Researcher's comments
<p>"Assuming he was a satisfactory computer specialist all I would require additionally is a relatively open mind to attempt to understand the peculiarities of the accounting process"...</p> <p>"I should be most concerned about his experience. I should like him to have a good knowledge of the industry he was joining".</p>	
<p>Amongst the various descriptions of what is denoted to be the <u>ability to communicate</u> were:</p> <p>the ability to explain in as simple terms as possible his function and his projects to non-computer staff.</p> <p>ability to converse with and gain confidence from all levels of management.</p> <p>ability to persuade and motivate.</p> <p>ability to get on with people.</p> <p>ability to arrive at joint understanding.</p> <p>ability to listen and communicate ideas effectively.</p> <p>ability not to use too much jargon.</p> <p>ability to get the best out of all levels of management without being offensive or dictatorial in approach.</p> <p>Amongst the various '<u>personal traits</u>' expressed by respondents.</p> <p>not unduly tarnished by the "computer worship trait".</p> <p>appreciative of different points of view.</p> <p>clear thinking.</p> <p>likeable.</p> <p>dogged.</p>	<p>Whether these descriptions are expressions of the respondents' feelings of the lack of such features in their EDP counterparts or are seen to be desired characteristics is a debatable question. In either case, these descriptions convey messages to those EDP specialists who score highly on the negative end of the continuum bearing these characteristics.</p>



Respondents' expressions	The Researcher's comments
<p>high level of intelligence.</p> <p>sober non-flamboyant.</p> <p>ability to make a favourable first impression on people.</p> <p>not to be oversensitive to criticism.</p> <p>objective.</p> <p>independent.</p> <p>should not have a superior air.</p>	

6.4. The proposed framework of interdependence: The accountants - EDP specialists' a priori behavioural indicators.

Experiences and findings discussed within the context of chapter four and in the present chapter outline a set of fundamental dimensions of the 'D.P. - Accounting relationships. This set of dimensions is designed to act as a check-list in the self-appraisal of the relationship between D.P. specialists and accountant (as well as any user of computer services in a similar position to that of accountants). It is the researcher's contention that such a check-list can be used as a 'stimulus':

- i) to assess - in detail - the effectiveness, suitability and sufficiency of the particular aspect under consideration (whether it is accountant's knowledge in D.P. or accountants' involvement in computer-based financial modelling, or, top management involvement in the EDP area, or any of the related aspects);
- ii) to minimise some of the ineffective aspects of the relationships involved; and
- iii) to improve or enhance the effectiveness of some of the satisfactorily developed systems or relationships.

Furthermore, this self-appraisal 'check-list' may be considered as a change agent in the planning and implementation of change. Items contained in the 'check-list' are designed in the interrogative form, so that the interested reader may consider them in the examination of his situation. At minimum, there are two likely outcomes of every question. The answer is either in the negative or in the affirmative. The analysis should not be terminated at this point. On the one hand, any negative answer should be followed by a detailed investigation of the reasoning resulting from posing the 'why' type of questioning. On the other hand, any positive answer should be followed by a detailed evaluation of how improvement can be made. The dimensions of the 'check-list' and the related questions are as follows:-

#### I. OUTLOOK OF ACCOUNTANTS

Are accountants developing an appreciation of benefits of EDP systems?

Do accountants try to explain the regulations, conventions, procedures and standards for developing computer-based accounting systems?

Do accountants avoid making the job more difficult than it is?

Do accountants explicitly define their exact needs and requirements from DP accounting applications?

Are accountants getting to appreciate what the computer can and cannot do for them?

Have accountants been playing a key role as originators in improving EDP systems development and implementation?

Do accountants show flexibility in undertaking change in accounting systems necessitated by considerations involved in the computerisation process?

Do accountants tend to consider the computer as 'company-wide' or as a management tool?

Have accountants started to create a dialogue with their DP specialist counterparts for utilising the computer for improving the non-routine accounting applications (if this proves to be useful for their organisation)?



Are accountants applying the exception principle regarding the printout of computerised accounting applications?

Are accountants using the computer to answer "what if ... " type of questions?

Do accountants avoid exaggerating (or over-emphasising) the significance of their accounting practices?

## II. IMAGE OF DP SPECIALISTS

Has the image of DP specialists improved over the last three years?

Do DP specialists avoid adopting the "know all" attitude?

Do DP specialists accept responsibility for the end product of their work?

Do DP specialists balance their loyalty to DP and to their organisation?

Do DP specialists avoid 'over selling' the expected benefits derived from computerisation of applications under consideration?

Are systems analysts interested in acquiring knowledge about the business and how it works?

Do DP specialists avoid the excessive use of computer jargon?

Do DP specialists - in charge of designing and implementing application systems - avoid being introverted backroom boys?

## III. PRESENT DP - ACCOUNTING RELATIONSHIPS

Do DP specialists find an attentive audience amongst accountants?

Is there any sort of 'professional jealousy' between DP specialists and accountants?

Is the participation of accountants in checking the validity of computer based accounting applications adequate?

Is the DP - Accounting interaction based on friendly attitudes?

Have DP specialists smoothly contributed to the design of computer-based accounting applications?

Do DP specialists have adequate knowledge in accounting to be able to participate in the development and implementation of computer-based accounting applications?

Is there sufficient 'liaison' between DP specialists and accountants?

Do confidence and trust constitute major characteristics of the present pattern of working relationship between DP specialists and accountants?

Is there sufficient understanding on the part of DP specialists and accountants of each other's functions?

Is the present DP - accounting relationship progressing?

Do both specialists (DP and accounting) minimise the jargon used?

#### IV. ORGANISATIONAL POLICIES AND CONDITIONS

Are DP activities based on realistic goals, assumptions, and constraints?

Are objectives of the DP system in the organisation explicitly defined?

Is there any regular review of those - clearly defined - objectives?

Are those objectives clearly understood by present and potential users?

Has reviewing the performance of the various elements of the DP system (hardware, software and human) been assuring of continued progress in handling both the short-term and long-term needs of the organisation?

Is there a long-term strategy for DP activities? Is it reviewed and updated according to the changing circumstances and conditions?

Is there a sufficient link between DP specialists and other user functions in the organisation?

Is there a 'healthy organisational environment' that enables constructive progress discussions between DP specialists and accountants to take place?

#### V. USER MANAGEMENT INVOLVEMENT

Do managers of user departments or divisions avoid disillusion about the benefits of computer-based systems?

Do managers of user departments or divisions feel satisfied with DP projects that have been carried out for them? Do the developed computer-based systems meet effectively their needs and requirements?

Do managers of user departments or divisions have sufficient knowledge and training in EDP to enable them to make effective use of the DP services available to them?

Do managers of user departments participate actively in the computerisation of their activities?

Do managers of user departments or divisions feel satisfied that their initiatives, ideas and comments - regarding computerisation of their activities - are given the proper consideration by DP management?

Do managers of user departments constructively evaluate their position with regard to DP function and DP specialists?



## VI. FEATURES OF DP GROUP OR FUNCTION

Is the philosophy of adopting adequate standards for controlling DP projects well appreciated by top management of the organisation?

Are there well defined standards for controlling DP projects embodied in a system designed for that purpose?

Is the designed DP project control system: simple, fair, suitable, easy to implement, flexible and under continuous review?

Is the progress of DP function reviewed periodically?

Are preventive as well as corrective actions taken in time to solve - or to help in solving - present and/or potential problems?

## VII. FUTURE PROSPECTS OF DP - ACCOUNTING RELATIONSHIPS

Are accountants satisfied with accounting systems that have already been computerised?

Have feasible avenues or approaches to improving computerised accounting applications been tackled?

Within both functions (DP and accounting), is there a reasonable amount of appreciation of the others' problems?

Can present relations between DP specialists and accountants be described as a promising one?

Do accountants feel confident about computerised accounting applications?

Do accountants think that the advantages of computerising their systems outnumber the disadvantages?

Is there enough 'DP - Accounting' involvement in the areas of financial modelling and of building the organisations' corporate strategy?

Has the top management of this organisation found 'DP - Accounting' involvement and joint effort - if any - useful and supportive in taking complex decisions?

## VIII. TOP MANAGEMENT'S UNDERSTANDING AND BACKING

Does top management of the organisation devote sufficient time to consider long-range strategy for the organisation's DP activities?

Does top management review updated plans of its DP activities?

Does top management follow up implementation of DP activities?

Does top management of the organisation understand about its DP capabilities and limitations (as opposed to the disillusion that sometimes prevails, within top managers' thinking regarding objectives of DP functions in their organisations)?

Does top management of the organisation think that the computer is assisting it considerably in decision making?

6.5. The proposed framework of interdependence:  
The accountants - MS/OR specialists' a priori  
behavioural indicators

---

The empirical material and interpretations of findings presented and analysed in chapter five and in this chapter suggest the existence of a logically derived set of fundamental dimensions of MS/OR - Accounting relationships. This set of dimensions has been designed to serve as a check-list for the appraisal of the fundamental aspects of these types of relationships. They are presented in the interrogative form so that the interested reader can utilise them in the course of examining such relationships. At minimum there are two likely outcomes of every question. The answer is either in the negative or in the affirmative. The analysis should not be terminated at this point. On the one hand, any negative answer should be followed by a detailed investigation of the reasoning resulting from posing the 'why' type of interrogation. Whereas on the other, any positive answer should be followed by the detailed assessment of the sufficiency, productiveness and suitability of the aspect under consideration. Such dimensions and the related questions are as follows:-

i) Present MS/OR - Accounting relationships

Can accountants provide ad hoc information that is needed for MS/OR projects?

Are accountants helpful in spotting possible MS/OR applications?

Has the director or manager of MS/OR discussed the possibility of accountants contributing to the development and implementation of MS/OR projects?

Are there any regular meetings or advisory committees in which MS/OR specialists and accountants can constructively clarify the other's image and through which both functions can best achieve mutual understanding for the continued growth of their organisation?



Are accountants aware of MS/OR projects that have been (or are being) carried out by MS/OR specialists in view of the availability of documentation of those projects and studies)?

Have the two groups (accountants and MS/OR specialists) thought about the cross-fertilisation of ideas of both specialists?

Do accountants positively contribute in the implementation of MS/OR projects?

ii) Outlook of accountants

Do accountants try to explain the regulations, conventions, procedures and standards for developing accounting systems?

Have accountants started to include futuristic concepts such as: risk, probability, and uncertainty into their way of thinking as embodied in their discussions, reports, and dealings with other specialist functions?

Are accountants flexible in adapting their figures and procedures to suit the needs of other non-accounting users of their data and information?

Do accountants stick rigidly to accounting conventions in the majority of their dealings with other non-accounting groups, specifically for internal managerial reporting?

Are accountants helpful in explaining the logic behind and practical use of their methods (such as cost allocation and taxation)?

In designing and developing their systems, do accountants take into consideration other users' needs of such data?

Do accountants try to minimise the amount of effort and time on the part of non-accountants' use of data and information?

iii) Features of the MS/OR group or function

Is the inter-disciplinary characteristic reflected in the structure of the particular MS/OR group or function?

Are there adequate measures taken (either by the director or the manager responsible for the MS/OR activities) to ensure the establishment of this inter-disciplinary characteristic?

Has the MS/OR function surveyed the organisation's needs (by suitable data collection means such as interviews and questionnaires) to explore and identify what possible users are looking forward to?

Is there continuous updating of such identified user needs?

Is the balance between 'one-shot' and 'on-going' projects maintained?

iv) Image of MS/OR specialists

Is the particular MS/OR group or function problem oriented as opposed to 'technique oriented'?

Do MS/OR specialists consider their sole responsibility is to define and formulate problems with little or no consideration to phases of implementation?

Are MS/OR specialists sufficiently involved in implementing their proposals?

Is the amount of selling on the part of MS/OR specialists sufficient (neither excessive nor insufficient) to prove the practical value of their discipline?

Do MS/OR specialists have sufficient awareness of the financial and accounting concepts, methods and approaches that dominate the accountants' thinking?



Do MS/OR specialists have sufficient awareness of the inputs and outputs of the accounting system in use in their organisation?

Do accountants (as well as other users) perceive the image of MS/OR specialists as back-room boys doing nice mathematical sophistications divorced from the reality of their business organisation?

v) Future prospects of MS/OR - Accounting relationships

Is there enough MS/OR - Accounting involvement in the areas of financial modelling and building the organisation's corporate strategy?

Has the top management of the organisations found MS/OR - Accounting involvement and joint effort (if any) useful and supportive in taking complex decisions?

Are the objectives of MS/OR defined clearly in such a manner that they enable accountants to easily identify and recognise the benefits and limitations of MS/OR?

Are accountants hopeful regarding the use and application of MS/OR approaches in dealing with their accounting problems?

vi) Top management understanding and backing

Does top management of the organisation understand about their MS/OR capabilities and limitations (as opposed to the disillusion that sometimes occupies top managers' thinking regarding what their MS/OR can and cannot do for the organisation)? Does that understanding (of top management) reflect the actual capabilities and limitations of MS/OR?

Is there enough managerial backing from top management of the organisation to their MS/OR functions?

Has that backing (of top management of their MS/OR function) been received by other function(s) with apprehension?

Is top management of the organisation well informed about the one-shot and on-going projects that have been and are being carried out by their MS/OR function?

Could it be said that a considerable proportion of MS/OR projects completed (developed and implemented) are of the support-for-top-management type?

Does top management devote sufficient time to consider long-range strategy for the organisation's MS/OR activities?

Does top management review updated plans of MS/OR activities?

Does top management follow up implementation of MS/OR projects?

vii) Organisational policies and conditions

Does the organisation offer or encourage training courses in accounting for MS/OR specialists? If so, are such arrangements effective in getting MS/OR specialists (more) aware of the nature, scope, limitations and usefulness of accounting systems?

Does the organisation offer or encourage training courses in MS/OR for accountants to get them to be aware of the nature, scope, benefits and limitations of the 'discipline'? If so, are those arrangements effective in satisfying their planned objectives?

Is there any co-ordinating body between MS/OR specialists and other similar type functions irrespective of its form whether it is embodied in a person, a function or department? If so, has it been effective in making users of MS/OR aware of related project and models?



Are organisational roles (in terms of authorities and responsibilities) adequately defined to establish a basis for mutual understanding between the two functions for more management support?

Is there any organisational measure taken to enhance the cost-consciousness of MS/OR projects and models?

Are there clear criteria upon which acceptance or non-acceptance of a MS/OR project is to be based?

Is the present amount of 'political manoeuvring (if any) at its desired minimum, i.e. that does not hinder progress in the MS/OR areas?

viii) User management involvement

Are managements of user divisions or departments aware of the present and potential capabilities of their MS/OR divisional (and central - if any) groups and functions?

Do managements of user divisions or departments considerably contribute in identifying possible MS/OR applications?

Do managements of user divisions or departments feel satisfied with MS/OR projects that have been carried out?

The researcher's conjectures regarding the above dimensions<sup>28</sup> are considered to form an a priori argument to be subjected to further examination and exploration. This will be the interest of the next part (part III).

---

28. Although these dimensions are based on evidence from MS/OR specialists and accountants (chapter five and the present chapter) regarding their relationships, there is no reason why most of these aspects could not be used in the examination and assessment of MS/OR specialists' communication patterns with other users who are in similar position to that of accountants.

### Summary

Two consecutive steps have been taken in this chapter. The first has been the analysis of a set of opinions and views of a sample of accountants regarding their working relationships with MS/OR and EDP specialists. This has been to examine accountants' involvement in MS/OR and EDP areas. The second has been the generation of the a priori behavioural indicators in relation to accountants - EDP and MS/OR specialists' interaction. This is the main concern of the researcher in chapters eight and nine.

This chapter has presented an analysis of the scope of accountants' involvement in these EDP and MS/OR areas. It has indicated that many of the problems involved are of the behavioural types. In addition, it has indicated that insufficient attention has been paid to developing an operational transition strategy to the stage of interdisciplinary involvement of accountants, EDP and MS/OR specialists. This is particularly clear on the professional levels.



## Summary to Part II

This part has presented an analysis of the findings of the first stage of the empirical survey into the working relationships and communication patterns between accountants on the one hand, EDP and MS/OR specialists on the other. The focus in this part has been on the scope and quality of accountants' involvement in the EDP and MS/OR areas as perceived independently by each of the three groups. Whilst exploring the various aspects of the accountants - EDP and MS/OR specialists' interaction, the researcher has kept in mind the fundamental assumption of this research project; that is, the multidimensional and interdependent nature of the problem under investigation. The significance of this assumption has been materialized in this part by arriving at the proposed framework of interdependence to be the subject of further systematic examination in the following part.

Looking into the background information about respondents participating in this part of the survey has been the first step in the analysis of the findings in relation to each of the groups involved in the interaction. This has corroborated the view that accountants and MS/OR specialists differ on a number of variables such as age, number of years in field of specialization, number of years with present organization, membership of professional and learned societies and/or associations. Accountants tend to be older, and to have longer periods of experience in field of specialization than their MS/OR counterparts. Very few accountants tend to share background characteristics similar to those of MS/OR specialists.

Next to looking into some background information about respondents, has been the analysis of opinions and views of each of the samples surveyed. The analysis of EDP specialists' opinions and views regarding their working relationships with accountants has been presented in chapter four. The analysis of opinions and views of MS/OR specialists regarding their working relationships with accountants has occupied chapter five; whereas the analysis

of opinions and views of accountants participating in this part has been presented in chapter six. The message emanating from these analyses is that accountants' involvement in MS/OR and EDP areas is limited in scope and quality. Restricted by their inadequate and ineffective educational background in the areas related to MS/OR, together with other organizational circumstances, accountants have been either unwilling or unable (or both) to actively participate in the development and implementation of MS/OR projects. Accordingly, it is fair to say that those accountants who take an active part in the design and implementation of MS/OR projects are the exception. The detailed analysis of the findings of both accountants and MS/OR specialists has provided some insights into a number of related questions as to the importance of getting accountants acquainted with MS/OR, the pressure experienced by MS/OR specialists from accountants, accountants' attitudes towards MS/OR recommendations, and other relevant aspects. As to the accountants - EDP specialists' interaction, there has been sufficient evidence to indicate that accountants have made considerable progress in relation to the computerization of the routine accounting activities such as order entry and analysis, invoicing, wages, debtors' accounts, creditors' accounts, stock control. The analysis in this part has indicated that accountants' use of the computational power of today's computers for analytical purposes is very limited indeed. This has been particularly evident in the areas of financial modelling and answering "what if.....?" questions.

Having presented the analysis of the above-mentioned stage of the empirical exploratory examination of the accountants - EDP and MS/OR specialists' interaction, the next part presents the analysis of the findings of further empirical examination of the area under study. This is based on a closer look into the accountants' working relationships with their EDP and MS/OR counterparts.



## Part III

A CLOSER LOOK INTO ACCOUNTANTS-EDP AND MS/OR SPECIALISTS'  
INTERACTION : AN ORGANIZATIONAL DIAGNOSIS AND AN ANALYSIS  
OF INTERDEPENDENCE

---

This part is aimed at the detailed diagnostic and prescriptive analysis of the accountants' working relationships with their EDP and MS/OR counterparts. It is based on two levels of analysis. The first is the functional level in which the three main functions i.e. accounting, EDP, and MS/OR - are the subject of three intensive case studies. The second is the individual level in which participating individuals are the cases. The operationally assimilated dimensions (presented in the preceding chapter) employed are analysed critically in this part.

This part consists of three chapters as follows:

- Chapter Seven : presents the analysis of findings of three case study organizations ALPHA, BETA and GAMMA.
- Chapter Eight : presents the findings of the analysis of interdependence with regard to the factors affecting accountants - EDP specialists' interaction.
- Chapter Nine : presents the findings of the analysis of interdependence with regard to the factors affecting accountants - MS/OR specialists' interaction.

## Chapter Seven

### An organisational diagnosis of Accountants - EDP and MS/OR specialists' interaction

#### Abstract

#### 7.1. Introduction.

- 7.1.1. Initiation of the study.
- 7.1.2. Circumstances of the study.

#### 7.2. Organisational background information.

- 7.2.1. Ownership, degree of competition, technology and financial indicators.
- 7.2.2. Key problems and crucial areas of the business.
- 7.2.3. Organisational structure.

#### 7.3. Features of "Accountants - EDP and MS/OR specialists' interaction".

- 7.3.1. Organisational design of Decision Making and Problem Solving Support System (DMPSSS).
- 7.3.2. Transfer pricing for EDP and MS/OR (and other) services.
- 7.3.3. Computerization of accounting (and other closely related business) activities.
- 7.3.4. Progressing towards "Data Base" and the so-called "MIS".

#### 7.4. Present and potential "Accountants - EDP, and MS/OR interaction": Diagnosis and speculation

- 7.4.1. Preliminary.
- 7.4.2. Diagnosis and speculation.
- 7.4.3. Lessons to be drawn: some prescriptive suggestions.

#### 7.5. Implications for the organisational effectiveness of accountants - EDP, MS/OR specialists' interaction : A Qualitative assessment.

#### Summary



## Abstract

In this chapter is presented the analysis of the researcher's observations concerning the effectiveness of the interaction within three main constituents of Decision Making and Problem Solving Support System<sup>1</sup> - that is accounting, E.D.P., and MS/OR. Observations are mainly based on several interviews with concerned interested individuals in the three organizations.<sup>2</sup> Such analysis is neither seeking the unanimous acceptance and reception (by interviewees and concerned functions) of the findings presented, nor attempting to evaluate the sought interactions in terms of 'right' or 'wrong' attitudes, performance, or patterns of working relationships. Facts, views and attitudes are taken on their face value, coupled with their logical consistency in representing reality of organizational activities as much as possible cross-referenced<sup>3</sup> by other interested individuals. Such cross-reference is made possible and acceptable to most participating interviewees by the fact that the areas under investigation involve highly interrelated and interconnected activities.

- 
1. Admittedly, there are other functions such as Corporate planning, Organization and Methods, Work Study and other forms of managerial services that should not be overlooked in evaluating the effectiveness of the synergist/output of Decision Making and Problem Solving Support Systems in any relatively large business organization. However the present research has tended to concentrate on those managerial decision support subsystems that are the direct outcome of recent developments in E.D.P. and MS/OR areas and their possible effects on accounting (as a main formal Decision Making and Problem Solving Support System).
  2. The researcher reiterates that he gratefully acknowledges the time given by interviewees, their interest and consideration in taking part in the collecting of data analysed in this chapter and the generosity of their organizations in granting the researcher the facilities to carry out the present investigation into "Accountants - E.D.P., and MS/OR specialists' Interactions". If the presented analysis and the discussions on which it is based stimulate further discussion, research, or adaptation (to a more effective position in relation to organizational objectives) the objectives of this research will be satisfied. Any errors or incompleteness are of course the researcher's sole responsibility.
  3. Cross-referencing of opinions and views was adopted by the researcher as a matter of strategy in carrying out the empirical investigation; it was based neither on taking for granted the expressed view of an individual nor on suspecting the credibility of views. Rather, it was used as a means of exploring further the various dimensions of the particular aspect under consideration, and of contributing a constructive evaluation of the view expressed.



After a brief description of some organisation background information (such as: ownership, degree of competition, key problems of the organisation, organisation structure and dimensions of the internal organisational environment), the functioning of Accounting, EDP and MS/OR activities is then presented and analysed. This is followed by the researcher's diagnosis and speculation regarding the present and potential Accountants - EDP, and MS/OR specialists' Interaction. Finally based on the evidence analysed in this chapter, there is presented a construction of an explicit framework of the effectiveness of such 'Decision Making and Problem Solving Support System' (abbreviated hereafter to DMPSSS) in terms of the main independent variables pertinent to DMPSSS' effectiveness arising from the researcher's conceptualisation of the purpose of the framework.

Three organisations pseudonymously labelled ALPHA, BETA, and GAMMA have participated in the study. A description of systems, models, attitudes, and patterns of working relationships is followed (whenever it is felt necessary) by a commentary and discussion for the purposes of further analysis and clarification.

It is worth emphasising that the observations made in this chapter are by definition limited to the participating organisation and are bounded by the framework of facilities, time horizon, and limitations within which this study has been carried out. Accordingly, the reader is advised to consider with due caution the observations and findings contained within it, in order to avoid sweeping generalisations. However, the researcher, in studying the interactions under consideration, was guided by his preceding exploratory search into the various dimensions of accountants, EDP and MS/OR specialists' contribution to the effectiveness of their DMPSSS which, it may be assumed, contributes also to the effectiveness of their organisational decision making systems.



Aspect under consideration

Organization

### 7.1.1. INITIATION OF THE STUDY

In all cases, initiation of the case studies contained in the present context, was made by the researcher. The initial contact was made by writing to the Managing Director of each of the participating organizations, who referred the matter to another director more specifically concerned with the area of the study. Immediately after that, the purposes, scope and methodology of the research were then described in more detail by the researcher to every director (or committee in the case of organization 'A'). The study has been undertaken to learn about: patterns of communication and working relationships between accountants on the one hand, and D.P. and MS/OR specialists on the other; the effect of recent developments in E.D.P. and MS/OR on accountants and accounting functions; and the main factors contributing to accountants - D.P. and MS/OR specialists' understanding.

ALPHA

Although the committee which gave permission to the researcher to undertake the study did not point out specific major problems, the researcher has found numerous aspects that could be explored and developed - forming separate studies that could be taken by other researchers. But sticking firmly to the 'chain of command', and the explicit definition of every major and minor issue, may not be as effective as it should be in facilitating research projects. In addition, although almost every member of the committee was enthusiastic and very co-operative, one may suspect that the 'set up' of the organization's design was a decisively crucial factor.

BETA

This organization has a well-entrenched, highly organized policy of having continuous dialogue with educational and research institutions and always acts in a supportive and co-operative way in accommodating researchers, contributing to management seminars, collaborating with professional bodies and developing research ideas that seem to be relevant and may be of mutual interest. This attitude stems mainly from the personal interest of the Managing Director and his director for 'central resources', who allow researchers to talk to their staff - not because the organization has major complaints and is awaiting the researcher's assistance in solving them, but because they firmly believe in the social responsibility of industry to provide - as far as possible, research facilities to universities and other research institutions. No wonder the organization has created a specialized function to undertake and carry through these responsibilities.

GAMMA

Upon writing to the top management of this organization, the researcher was given the opportunity to ask some questions regarding the area of the research. It was evident afterwards that the degree of co-operation from the majority of sources - of the study - was high.



Aspect  
under  
consideration

Organization

### 7.1.2. CIRCUMSTANCES OF THE STUDY

a. General

1. Perhaps one of the striking limitations imposed on the present study is the fact that not many organizations are very sympathetic to the idea of releasing a full description and analysis of MS/OR projects that have been carried out. Although the request has not - in the majority of cases - been refused, the degree of enthusiasm and willingness to support this idea has not been sufficient to give a complete account of some of the relevant experiences. Although the researcher sympathizes with the apparent advantages behind such attitudes, the accumulated long-term disadvantages will probably not help the further development of such a discipline, that is, the unsuccessful projects will be buried and forgotten, whilst the successful ones will be restricted to their past or present users, and chances for exchanging opinions and experiences - that may lead to more extensive, and useful development and application of the discipline - are slim. Documentation of projects - if carried out on wider bases - may be useful in reinforcing further understanding in this respect.
2. Presentation of the case study and analyses of the findings have been made in such a manner that does not - in any way - jeopardize the anonymity of respondents and participating individuals and their organizations. This has caused the researcher to deliberately withhold some information - some facts, opinions and views - that could have contributed further insight into the present discussion. That is not to say that the results of the analysis would be significantly different from those presented herewith. Such a situation is hard to assess. It may well be, indeed, that such a policy of anonymous analysis and presentation of the evidence contained in the present study - might have encouraged some participants (however small a minority) to express freely their opinions and reactions to the issues under consideration which could be used as a richer evidence to support discussion of some of the variables underlined in the analysis of accountants - MS/OR, and D.P. specialists' understanding (or the lack of it.) Moreover, in detailing some of the background indicators of each of the participating organizations the description is so made as to disguise possibly revealing characteristics, but in a manner that does not distort the main features of the particular organization. Specifically, when it is felt that such disguising would not affect the purposes of the present study.
3. It is worth mentioning that the idea of studying accounting-D.P. specialists' working relationships through specific projects was considered by the present researcher and was found unsatisfactory from several points of view, amongst them are: first, design and implementation of many E.D.P. projects takes longer time than 6-10 months - which is the normal length of time allocated by the researcher to any of the case studies - even if it is assumed that such projects would start and end along with the researcher's timing (which is most unlikely); second, if it is assumed that the researcher would have been willing to extend the time allocated to each of the case studies, it might have been difficult to find organizations that are willing to provide facilities for such a longer length of time; third; changes in personnel over



Aspect under consideration

Organization

### 7.1.2. CIRCUMSTANCES OF THE STUDY

time; fourth, since the study is more concerned with attitudinal data and perceptual variables and since persons working on specific projects might not be too difficult to identify, it was thought that studying specific projects might in some way affect the confidentiality principle adopted throughout the various stages of carrying out this research project; and, fifth, some projects might be intended to modify, change, or amend existing E.D.P. projects that might be affected by historical circumstances or might not be described by some D.P. personnel to be "technically challenging" which would probably contribute to give "biased" opinions and attitudes. Consequently - in view of these factors, the researcher has found that concentrating on the individual's experience regarding the "majority of cases or conditions or factors" might be more useful than adopting an approach bounded by limited experiences.

4. The comparative analysis of accountants - D.P., and MS/OR specialists' interaction, is based on the idea that the reader is aware of the limitations imposed on the analysis such as: personality differences amongst directors and managers, long and short term objectives and policies and other factors that would have given the study more insight. However, the research has attempted to reduce the complexity of the problem under investigation to a manageable extent.
5. Supporting the present comparative analysis of the three organizations with qualitative evidence of interviewees would perhaps have added more richness to the analysis contained in the present chapter. Nevertheless, the strict application of the anonymity approach is above 'richness' of evidence, and is more useful in the longer-term. Accordingly, no citation is made of views held by any participant regarding any of the issues raised in the present chapter. It is interesting to note however that the application of the same principle has made possible the identification - and consequent excluding - of organizations that were inclined to participate in the research for publicity or similar reasons.

Aspect under consideration Organisation	7.2.1. OWNERSHIP, DEGREE OF COMPETITION LOCATION, SIZE, TECHNOLOGY AND FINANCIAL INDICATORS
ALPHA	<p>Ownership: a nationalized industry "state ownership and control". Direct ownership of four major divisions as well as U.K. and overseas subsidiaries.</p> <p>Degree of competition: world-wide competition.</p> <p>Location: operations spread over many parts in the U.K. and overseas.</p> <p>Size: very large according to most indicators of size.</p> <p>Technology: high technology is needed.</p> <p>Product: diversified group of products selling to manufacturers.</p> <p>Sales of one of its major divisions (participating in the study) amounted to about £m 300 (1974) whereas sales for the whole organization amounted to about £m 1500 (1974).</p>
BETA	<p>Ownership: an enterprise listed on the Stock Exchange.</p> <p>Degree of competition; varies considerably from one segment of the business to another.</p> <p>Location: operations spread over many parts of the U.K. as well as overseas.</p> <p>Size: "Large": there are more than 35000 people working for the organization.</p> <p>Technology: varies considerably; from relatively low technology in one of the major divisions to high technology in some other divisions.</p> <p>Product: very diversified.</p> <p>Sales: more than £m 230 (1971); 250m (1972); and £m 300</p>
GAMMA	<p>Ownership: a subsidiary of an American organization listed on the Wall Street Stock Exchange.</p> <p>Degree of competition: highly competitive.</p> <p>Location: the organization's main factories are located in the U.K. and has overseas operations.</p> <p>Size: "Large": the organization employs more than 24000 people.</p> <p>Technology: the organization has diversified activities; batch production.</p> <p>Product: mostly consumer-type products (as well as a smaller engineering division).</p>



### Commentary and discussion

These three participating organizations were not selected at random. They were deliberately selected<sup>4</sup> amongst large to very-large industrial organizations to warrant the use of E.D.P. and MS/OR types of activities. (This is not to say that smaller size of organizations are not employing such specialists, but the likelihood is that bigger organizations utilize these services on a wider scale than that of medium and smaller organizations).

As a result of the complexity of activities of such organizations, and the fact that these organizations are multi-divisional organizations, the study has been carried out in the one major division in BETA and in GAMMA, and one of the main divisions in ALPHA, together with their headquarters, only in so far as it is relevant to the study and convenient to the particular organization.

---

following

4. Selection was made on the basis of the/criteria: first the organization should be one of the relatively large state owned or privately owned organizations as ranked by the yearly publication 'The Times 1000', published by the Times Newspapers; and second, it should be clear to the researcher that the organization (to be contacted for the detailed case study aspect of the research) does not fall under the 'apathetic' category of organizations. The latter criterion was not difficult to fulfil since the researcher was able to identify some of the organizations which for one reason or the other do not encourage research or do not get involved in research, by means of marking records kept by the researcher in relation to the mailed-questionnaires sent to Accountants, E.D.P., and MS/OR specialists whose responses are analyzed and presented in the second part of this thesis.

Aspect under consideration  
Organization

7.2.2. KEY PROBLEMS AND CRUCIAL AREAS OF THE BUSINESS

ALPHA

Production factors (materials, labour, capital), historical factors (of vertical and horizontal integration), world wide competition, and political factors are amongst the chief problem areas of this organization. Because this organization is one of the nationalized industries, external political and economic circumstances tend to materially affect its structure in a wide variety of ways such as: strategic decision making, shape and mechanisms of internal control system - of which the accounting system is a major part - degree of autonomy, sanctions, formal and informal vertical and horizontal communication networks).

BETA

Although this organization has a "well-established" industrial type of business, some of its products are featured by rapid growth markets subject to world wide competition. Accordingly, maintaining its share of the well-established sector of its business, while keeping pace with scientific and technological developments in the rapidly growing sectors for diversification, is one of the major problem areas of this enterprise. Also, sales forecasting and service to customers have crucial implications for this organization's areas of business.

GAMMA

The organization's main division is facing severe competition from organizations in the same type of business. The making and distribution of its main product(s) are highly affected by consumer behaviour, adaptability to changing environment and government regulations. It is believed that the state of the market (of its main activity) is slowly declining, and subsequently, diversification into other activities is the longer-range key problem. Furthermore, U.K. entry into the E.E.C. will have substantial effects on the shape of the organization's growth and survival in general and cost, price and taxation position in particular.



7.2.3. SOME FEATURES OF THE ORGANIZATIONAL STRUCTURE:<sup>5</sup> A PRELIMINARY EXAMINATION

Observing the relatively stable aspects of the patterns of the organizational relationships is the main concern in this section, for the purposes of throwing some light on the formal and informal structure within which "Accountants-E.D.P. and MS/OR specialists interaction" takes place. The researcher's descriptions are based on the interviewees' evaluations and judgments of the existing manifestations of the relevant issues featuring their perceptions of their organization's structure.

All the three participating organizations are complex social organizations (as opposed to biological or mechanical systems). Their formal structures are explicitly defined in manuals (describing position definitions), and depicted in organization charts and other forms abstracting and simplifying the vertical and horizontal patterns of relationships.

As each of the three participating organizations frequently changes its patterns of relationships and form of structure to suit its organizational circumstances and conditions, and due to the fact that organization structure is thought by the researcher to be one of the relevant variables affecting the interaction under study,<sup>6</sup> the researcher has attempted to discuss those dimensions of structure that are of some relation to the area of research and in 'relative' terms. That is, the comparative analysis of the structural characteristics of participating organizations are neither viewed with an 'ideal' or normative design in mind, nor based on preconceived ideas of viewing specific characteristics as 'good' and viewing others differently. A limiting factor in this respect is that this phase of the study is limited to three types of functional areas (namely, accounting, E.D.P. and MS/OR)

- 
5. "Organization structure consists simply of those aspects of the pattern of behaviour in the organization that are relatively stable and that change only slowly" (March and Simon, 1958, p.170).
  6. See chapter two (section 2.3. in particular) of this thesis where the identification of conceptual dimensions of accountants - EDP and MS/OR specialists' interaction - the proposed framework of analysis - is analysed and presented.

within the three participating organizations. Consequently, subjecting this aspect of studying the participating organizations to any highly-structured form of measurement than that which is discussed below would not substantially enhance our familiarization with the main structure characteristics of these organizations.

#### Commentary and discussion

Key problems of the organization and its crucial areas of business have their influence and implications for the type of problem solving and the nature of decision making, which in turn, affect the design, shape, responsibilities, and performance, of accountants, EDP and MS/OR specialists in their capacities as 'Decision Support Sub-Systems'.

For example, historical developments in ALPHA have affected the organizational design of EDP activities and their relationship with accountants where a considerable amount of EDP activities has to do with financial accounting and costing applications.

As an introduction to the researcher's observations regarding the organizational structure of each of the three participating organizations, it is worth mentioning that there is a tendency in contemporary organizational research studies to view the 'Organic-Adaptive' forms of structure as being more effective than the 'Mechanistic-Bureaucratic' ones in the face of rapidly changing organizational environments. Bennis (1966) for example predicts the decline of bureaucracy and that the structure of future organizations will be considerably different from today's forms. Argyris' (1967, pp. 31-55) matrix organization is another example foreseeing tomorrow's forms of organizational design. Whilst the organic-adaptive forms of design may be more effective in some parts of an organization, the 'mechanistic-bureaucratic' form may still be effective in carrying out the objectives in other parts within the same organization. However, the following table developed by Hower and Lorsch (1967, p.168) may be useful in studying some of the features of the organizational structure (in participating organizations) relevant to the area of the present research:



	<u>Types of organization structure</u>	
	Organic	Mechanistic
Span of control	Wide	Narrow
Number of levels of authority	Few	Many
Ratio of administrative to production personnel	High	Low
Range of time span over which an employee can commit resources	Long	Short
Degree of centralization in decision making	Low	High
Proportion of persons in one unit having opportunity to interact with persons in other units	High	Low
Quantity of formal rules	Low	High
Specificity of job goals	Low	High
Specificity of required activities	Low	High
Contents of communication	Advice and Information	Instruction and decisions
Range of compensation	Narrow	Wide
Range of skill levels	Narrow	Wide
Knowledge-based authority	High	Low
Position-based authority	Low	High

Table 7.1. Types of organization structure.

Aspect under consideration

7.2.3. FEATURES OF ORGANIZATIONAL STRUCTURE

Organization

ALPHA

- Vertical differentiation of this organization is established on many levels of authority based on explicit definition of roles and functions.
- Horizontal differentiation of activities is via product-based segmentation of the total organization where each of its major divisions is concerned with a type of product. Within each of the major divisions is a further segmentation into a number of groups which run and direct a number of plants or works.
- Although each of these 'divisions' is formally an autonomous organizational unit, the extent to which decision making is centralized (particularly with reference to major projects and decisions such as investment and pricing) is relatively high. This becomes more apparent in view of the relatively high degree of specificity of the so-called 'guide lines' and formalized definition of position requirements and role specifications.
- (As perceived by several interviewees) contents of messages forming communication networks, although frequently coined in 'advice' form, they - more often than not - carry some form of instructions. (Of course, this varies according to the position and status of the individual).
- Tight control procedures and rules are spelt out in a detailed manner regarding almost every activity. Consequently, a considerable part of the managers job is to make sure that rules and procedures are observed by their subordinates and individuals participating in the relevant activity.
- The well-known line-staff terminology is very frequently used by a considerable number of (inter-viewed-) individuals in their explanation of communication patterns and working relationships, which gives some indication of the extent to which this aspect of organizational structure is rooted in the organizational life of the participants.
- Whilst knowledge-based authority is relatively low in general, position-based authority is relatively high. That is, position is first and knowledge is second (or probably beyond that) as far as the hierarchy of authority is concerned.



- Committees are widely used as integrative devices for co-ordination purposes; the power of such integrative devices stems from their formal position.
  - Within the above-described vertical and horizontal differentiation and integration structure, accounting is a form of management service closely and formally co-ordinated with E.D.P. services.
  - Content analysis of interviewees' commonly-used expressions indicates the dominance of terms such as: committees, sub-committees, working parties, chairmanship, groups. The design of this organization (as a nationalized industry - in contrast with a privately owned enterprise) tends to resemble governmental systems in a variety of ways.
  - 'Politics' can come to this organization under two guises: (a) the commonly known (in the British political system) type and its implications; and (b) the type of politics known amongst individuals.
- 
- BETA
- Vertical differentiation of this organization is established on a small number of levels of authority based on the 'autonomy' philosophy in which independence of divisions is encouraged. The organization's main trading divisions are allowed to exercise a considerable amount of discretion in decision making and control over their divisional activities - against predetermined targets.
  - Horizontal differentiation of activities is broadly via product-based segmentation of the organization's total activities, where each of its major divisions is concerned with a type of product (or group of products). Besides, there is an overseas division. Furthermore, a 'Central Services' and 'Corporate Strategy' are two distinct central units: 'Central Services' Division offers its services on a consultancy basis and has an objective of recovering its annual overheads on a 'chargeout basis'. The major division of this organization is further segmented into regions; each region is further differentiated into branches.
  - The extent to which decision making is centralized is low and the extent to which corporate management of this organization interferes with trading divisions affairs is also low. That is, trading divisions are given the opportunity - and are expected - to solve their own problems.
  - Contents of messages forming communication networks are mostly in the form of advice and information. Channels of communication are open to a fair extent. (Although some interviewees felt this aspect could be improved amongst the various components of this organization, i.e. Group Strategy, Central Services and the Trading Divisions. Also, there is a room for further improving the communication networks and channels between the three functional areas (accounting and finance, E.D.P. and MS/OR).

BETA (cont'd)

- Continuous change in the organizational design of the organization or some of its components is one of the noticeable observations that could be made regarding the current organization.

GAMMA

- Vertical differentiation of this organization is established on few levels of authority based on a broad definition of roles and functions.
- Horizontal differentiation of activities is generally via function-based segmentation of the total organization, where the organization is departmentalized into manufacturing, marketing, finance, engineering and so on. It is perceived by several interviewees that co-ordination of activities does not constitute a major problem facing such functional form of design.
- Hierarchical co-ordination of the various organizational activities for purposes of achieving integration is based on a central body. Apart from that, temporary cross-functional teams and direct managerial contact are also noticeable forms of integrative devices practised by this organization to fulfil the co-ordination aspects of organizational design.



- Integrative device within Central Services sub-systems in Organization BETA.

As a part of the dynamic outlook of organization BETA, the Central Services has been under continuous review and investigation to increase its effectiveness as a central special investigation group offering tdp services to the other units in the organization. The two major limitations of the present structure of the Central Services are: (a) as the formal nature of services is to offer some type of internal consultancy activities, it might sometimes create a false feeling of 'exteriority' and the introduction of an alien element to the on-going internal relationships within the organization; and (b) it does not encourage the interdisciplinary involvement amongst the various functional units within the Central Services.

Regarding the first limitation, elimination of the term "consultancy" from various means of formal and informal communication might contribute partially to the minimization of the dysfunctional consequences resulting from the internal use and practice of such an outlook. The direction of the final outcome (functionality or dysfunctionality) depends to a large extent on the behaviour of the individual member of this central services resource.

Concerning the second limitation, the 'Programme or Project Management' approach - in which integration of functional services might be carried out under the direction of a programme or project manager - might be a possibility in this respect. But this form of integrative device might be more suitable for highly complex large-scale projects. The compromise (between the traditional functional approach and programme or project management) might be suitable for such an organization of the Central Service . In such a compromise, the central services division is functionally structured to provide different services, with interdisciplinary projects or

teams drawing on experiences not only from within the central services but also from other parts of the organization. It should be borne in mind, however, that the nature and scale of the arrangement is a major determinant in designing the structure through which it would be carried out.



- Compared with ALPHA and BETA, the external environment of organization GAMMA (e.g. market conditions, expected supply and demand, degree of governmental control over the type and quality of products) is characterised by more uncertain and unstable long-term circumstances. A variety of integrative devices are used by GAMMA to co-ordinate activities and resolve conflict. Central co-ordination, direct managerial contact, managerial hierarchy, temporary cross functional teams, and individual integrators are the major integrative mechanisms used.<sup>7</sup> More specifically, regarding integrative devices used in co-ordinating accounting, EDP and MS/OR activities, a variety of mechanisms is used; chief amongst them are, first, a central body of management services containing the three functions and offering services to all other functions within the organization, second, individuals are spatially mobilized (secondment of individuals to functions or projects on a temporary basis - for example a management accountant had spent a secondment period with the MS/OR function; the exchange between EDP and accounting functions is another clear example of cross-disciplinary involvement); and, third, the several forms of direct managerial contact.

7. These observations regarding the present design of organization GAMMA in relation to its environment is consistent with the contingency theory of organizations as described by Lawrence and Lorsch (1967-b, pp.133-158) in which they attempted to increase our understanding of the complex set of interrelationships among internal organizational states and processes and external environmental demands. For high performing organizations in three environments, they explained the different combination of devices for achieving integration as can be seen from the following table (Lawrence and Lorsch, 1967-b, p.138):

Table 7.2. Comparison of integrative devices in three high performing organizations

Plastics	Food	Container
Degree of differentiation * 10.7	8.0	5.7
Major integrative devices		
(1) Integrative department	(1) Individual integrators	(1) Direct managerial contact
(2) Permanent cross-functional teams at three levels of management	(2) Temporary cross-functional teams	(2) Managerial hierarchy
(3) Direct managerial contact	(3) Direct managerial contact	(3) Paper system
(4) Managerial hierarchy	(4) Managerial hierarchy	
(5) Paper system	(5) Paper system	

\* High score means greater actual differentiation



### 7.3.1. Organizational design of Decision Making and Problem Solving Support Systems (DMPSSS)

As indicated earlier, the researcher considers accounting, E.D.P. and MS/OR activities as fundamental constituents of Decision Making and Problem Solving Support Systems (DMPSSS)<sup>8</sup> within their organizations. Based on this belief, the researcher's attention is focused in this section on describing the main features of such visualized systems that directly affect patterns of communications and working relationships amongst these elements.<sup>9</sup>

- 
8. The idea of support systems was discussed by Scot-Morton (1971) in a case study describing the manager's use of interactive display (television screen and light per assembly) for the sake of facilitating the accumulation and modification of data and answering "what if" questions, in a household appliance manufacturing company. Manipulation of data for co-ordinating manufacturing and marketing plans was the main problem arising. The scope of using the term 'support' can be described by Scot-Morton's own words from the preface of his book: "The work --- almost fell into the trap of letting the task of building it become an end in itself. Although the initial question was 'what impact will interactive display systems have on management decision making', the effort of building the system very nearly turned the experiment into one that tested whether you could bring such systems and have managers use them'. However, the researcher's use of the term 'support' is emphasized by adopting a wider context of problem solving, and decision making (computer-based or otherwise). The three functions under discussion are taken as a support base for decision making and problem solving.
9. Size of the participating organization ranges from 'relatively large' to 'very large' designs. Subsequently simplification of the rather complicated forms of design is inevitable. However, the amount of detail presented is a function of the objectives of the present survey; that is only those characteristics that capture those details essential to the discussion of the interactions under study are presented.



Aspect under consideration  
Organization

7.3.1. ORGANIZATIONAL DESIGN OF DMPSS

ALPHA

Accounting and finance

- Although accounting and finance functions in this organization have been undergoing some organizational changes, design of these functions is not considerably different from the conventional design of accounting and finance responsibilities. The traditional status of these responsibilities is clearly observed in this organization.
- The hierarchy of accountability for procedural and financial control is well-defined between corporate, divisional and operating (works/trading) levels. Accounting and Administration at the operating level is responsible to the divisional director who is in turn responsible to the corporate director of finance.
- Loosely defined are the following categories of accounting responsibilities: the statistical accountant whose job is to collect and prepare information; the management accountant whose job is to appraise collected information; the development accountant's work starts (in an advisory capacity) when the management accountant feels that a particular system is not meeting certain requirements, and he has to look into more specialized fields such as ensuring that development work is carried on in accordance with accounting principles and conventions adopted and uniformity of applications throughout the organization; and the financial accountant whose responsibilities include book-keeping and financial control in conformity with statutory requirements.
- A standard costing system has been in operation in this organization for a long time and budgetary control practices are widely used throughout the organization based on the sales budget (which is prepared by means of discussions and negotiations between Head Office commercial function and the divisional commercial function based on similar arrangements at lower levels of the organizational structure).

Aspect  
under  
consid-  
eration

Organization

7.3.1. ORGANIZATIONAL DESIGN OF DMPSSS

ALPHA

E.D.P. activities

- This organization has been in the computer field since the early days of using the equipment on commercial leasing. Much of the early work was carried out in the areas of production control as well as the clerical aspects of stock control and accounting.
- Most of E.D.P. resources are located in management services at the divisional level where the majority of systems have been (or were) designed to meet each particular division's own needs. Accounting and Administration committees play a major role in monitoring the direction of E.D.P. developments and priorities.
- At present, there is a large number of specialist individual systems operating throughout the organization. Common systems are very few in number (payroll and stores are typical examples).
- Two computer-manufacturers (IBM and ICL) are represented in the organization, which was perceived to impose certain difficulties on the feasibility of common systems.
- Before the 2nd quarter of 1973, the H.O. of this organization had no D.P. function active in the field (except the very specific unit which was devoted to corporate pensions systems). In the 2nd quarter of 1973, the D.P. function of one of the organization's major divisions joined the H.O.
- Current thinking reflecting future policy is geared towards the strategy of having a centrally-based limited number of standard systems to be applied on a mandatory basis throughout the organization.

MS/OR activities

- This organization has one of the largest MS/OR groups operating in this country with more than 30 MS/OR specialists located in the organization's H.O. management services function and about



Aspect under  
consideration

### 7.3.1. ORGANIZATIONAL DESIGN OF DMFSSS

Organization

ALPHA

200 MS/OR specialists spread throughout the various divisions of the organization, including a small MS/OR unit organizationally located as an extension of the H.O. (geographically located at a distance) to advise the H.O. staff on financial matters.

Co-ordination between the various MS/OR units is carried out by the corporate management services function (not the H.O. MS/OR unit).

Categorization of MS/OR activities can be made on the basis of the level of abstraction contained in the type of problems being tackled and the nature of responsibilities being subjected to this type of analysis: on the one hand, the main H.O. group is engaged in building a very large economic planning system for the organization sponsored at the corporate level, and on the other, the work study type of projects and problems are carried out at the operating level. However, at the corporate level, there are recent examples of MS/OR projects on the basis of collaborative effort with accountants, but they are few in number and limited in scope of application. Concerning this type of organizational interaction, there are numerous problems relating to consistency, relevance, definitions, and computational procedure: of accounting figures and reports for the purposes of MS/OR applications.

BETA

#### Accounting and finance

The recent design of these responsibilities takes a variety of forms depending on the organizational level and the type of organization responsibilities carried out. Amongst these forms are: the traditional accounting responsibilities spread over the whole range of organizational levels (corporate, divisional and operating divisions); a centrally-based common source of expertise to offer a wide range of services in investment, acquisitions and mergers, accounting training and development, and management information; group corporate strategy to advise and formulate the organization's policy containing strategic planning, finance, human resources, business development; and the support function carried out by controlling helping directors in the areas of forward planning, performance evaluation and monitoring the achievement of divisional objectives.

Aspect under consideration

Organization

7.3.1. ORGANIZATIONAL DESIGN OF DMPSS

BETA

E.D.P. activities

- This organization has long experience in the E.D.P. field. Much of the early effort went into systems related to sales accounting and production control activities where initial developments were carried out by the particular division(s).
- Mainly E.D.P. resources are located as follows: (a) (a semi-autonomous) computer centre located in a viable commercial environment employing IBM 370/158 with software support selling time-sharing services to external, as well as internal customers. Percentage of income from external to internal customers varies from one week to the other, but approximately the average is 25:75 percent respectively. The machine is rented from the manufacturer. (b) central systems development group located within the central services division. Furthermore, systems development activities is designed along the functional lines of responsibilities (i.e. accounting, manufacturing, and marketing). (c) divisional systems development groups located at the various divisions of the company. (d) an autonomous software bureau offering its services mainly to outside customers.

MS/OR activities

Compared with ALPHA and GAMMA

- this organization has a medium sized MS/OR group centrally located amongst the central services division at the H.O. of the organization.
- The MS/OR function offers its services on the basis of a charging-out policy adopted in relation to Central Services projects.
- The MS/OR activities are perceived to be carrying out some type of 'technical services'. The function is considered organizationally as part of the computer services (this situation has certain implications).



<p style="text-align: center;">Aspect under consideration</p> <p>Organization</p> <p>BETA</p>	<p style="text-align: center;">7.3.1. ORGANIZATIONAL DESIGN OF DMFSSS</p>
	<p>Corporate financial modelling, optimization (capacity utilization) and network analysis are amongst the main areas of activity that have occupied the MS/OR function for the past three years.</p> <p>Performance of this function is perceived to be satisfactory (in relation to expectations concerning its contribution to the organization's effectiveness). Such assessment represents the modal observation based on views of those users of the product of MS/OR effort (though those users who have had some experience with MS/OR and were interviewed by the researcher are few in number) and views of those MS/OR specialists interviewed in the course of carrying out the present survey.</p>

CHAIRMAN

Legal and  
Secretarial

GROUP  
STRATEGY  
DIRECTOR

Corporate Planning  
Finance  
New Business Development  
Human Resources  
Public Affairs & Communication

MANAGING \_\_\_\_\_ controller  
DIRECTOR

support \_\_\_\_\_ MANAGING \_\_\_\_\_ controller  
staff DIRECTOR

MANAGING DIRECTOR,  
(OVERSEAS COMPANIES)

CHIEF EXECUTIVE DIVISION E

CHIEF EXECUTIVE DIVISION C

CHIEF EXECUTIVE DIVISION B

CHIEF EXECUTIVE DIVISION A

CHIEF EXECUTIVE DIVISION I

CHIEF EXECUTIVE DIVISION H

CHIEF EXECUTIVE DIVISION G

CHIEF EXECUTIVE DIVISION F

CHIEF EXECUTIVE DIVISION D

CHIEF EXECUTIVE CENTRAL SERVICES



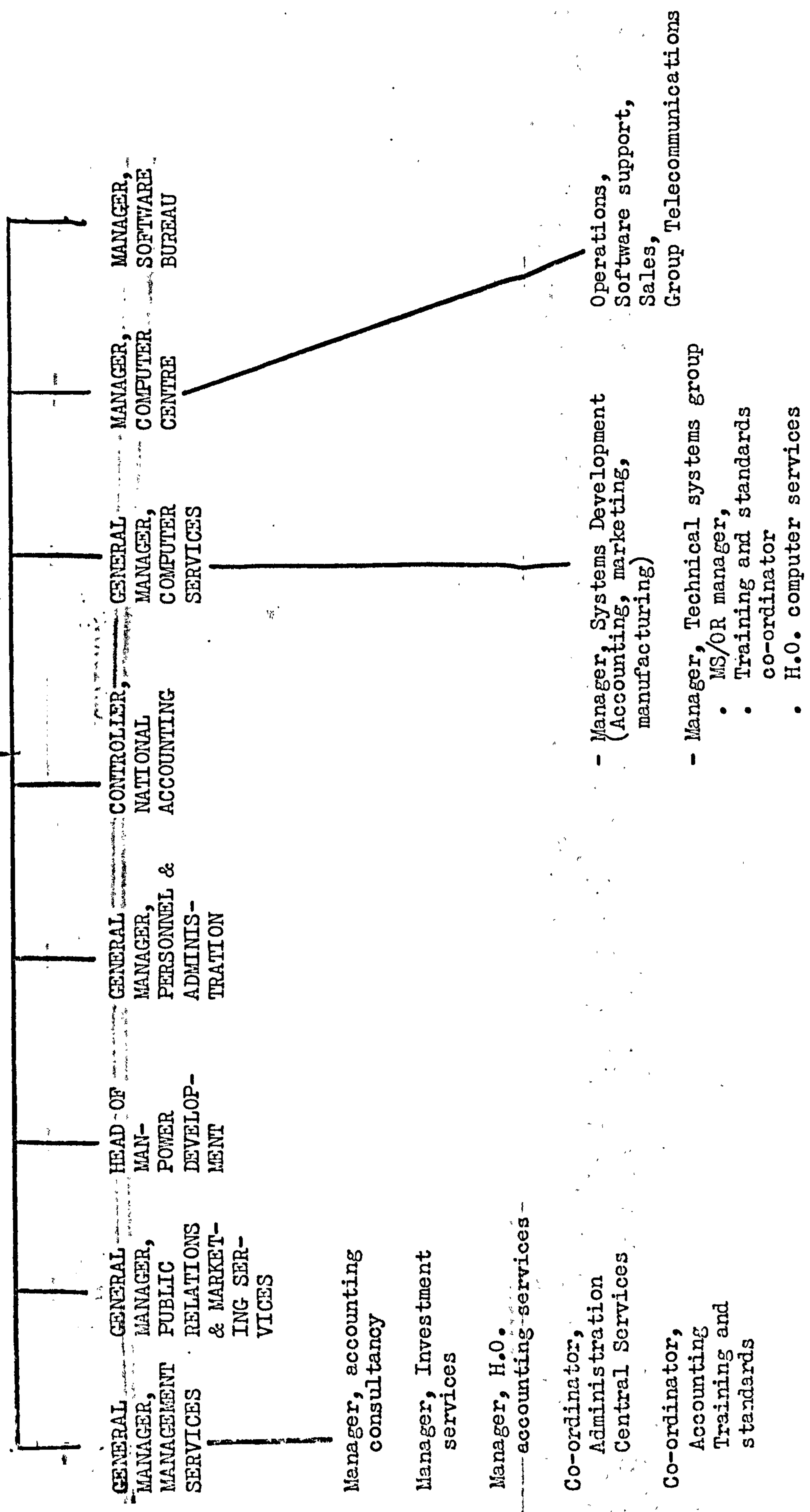

CHART 7.1. BETA COMPANY LIMITED

Aspect under consideration

Organization

7.3.1. ORGANIZATIONAL DESIGN OF DMPSSS

GAMMA

- Accounting and finance cut across all other functional areas (distribution, selling and marketing, and production). There is a different emphasis of accounting in different areas, so broadly speaking the accounting and finance function is broken into four main areas: financial accounts, development accounting (to set up accounting systems of subsidiaries, for example, in line with procedures and principles of the parent company), management accounting, and (computer-based) systems auditing.
- The financial director is responsible for finance, accounts, and management services (containing amongst other things MS/OR and computer services). Meanwhile, every director has his own accountant to prepare accounts, budgets and reports.
- The D.P. manager reports to the management services manager who in turn reports to the finance director.
- The first computer was installed in 1965 and from then on the computing capacity of the organization has gradually been built up. The current computing position of this organization is summarized as follows: two main installations; the first is located near the organization's H.Q. containing two machines (a 196K Honeywell each) and the second is a 124 K regional installation. Data transmission links are installed connecting the two computers. Also, the computer centre (located near the H.Q.) is linked with the organization's distribution branches.
- The MS/OR function is a small-sized section (formed of the manager and two-to-three analysts). A number of projects have been carried out covering wide areas, perhaps the most important of which is the budgeting and forecasting exercise (enabling the management accounting function to base its forecasting and budgeting on the outcome of analysing a number of options subject to a number of constraints.)



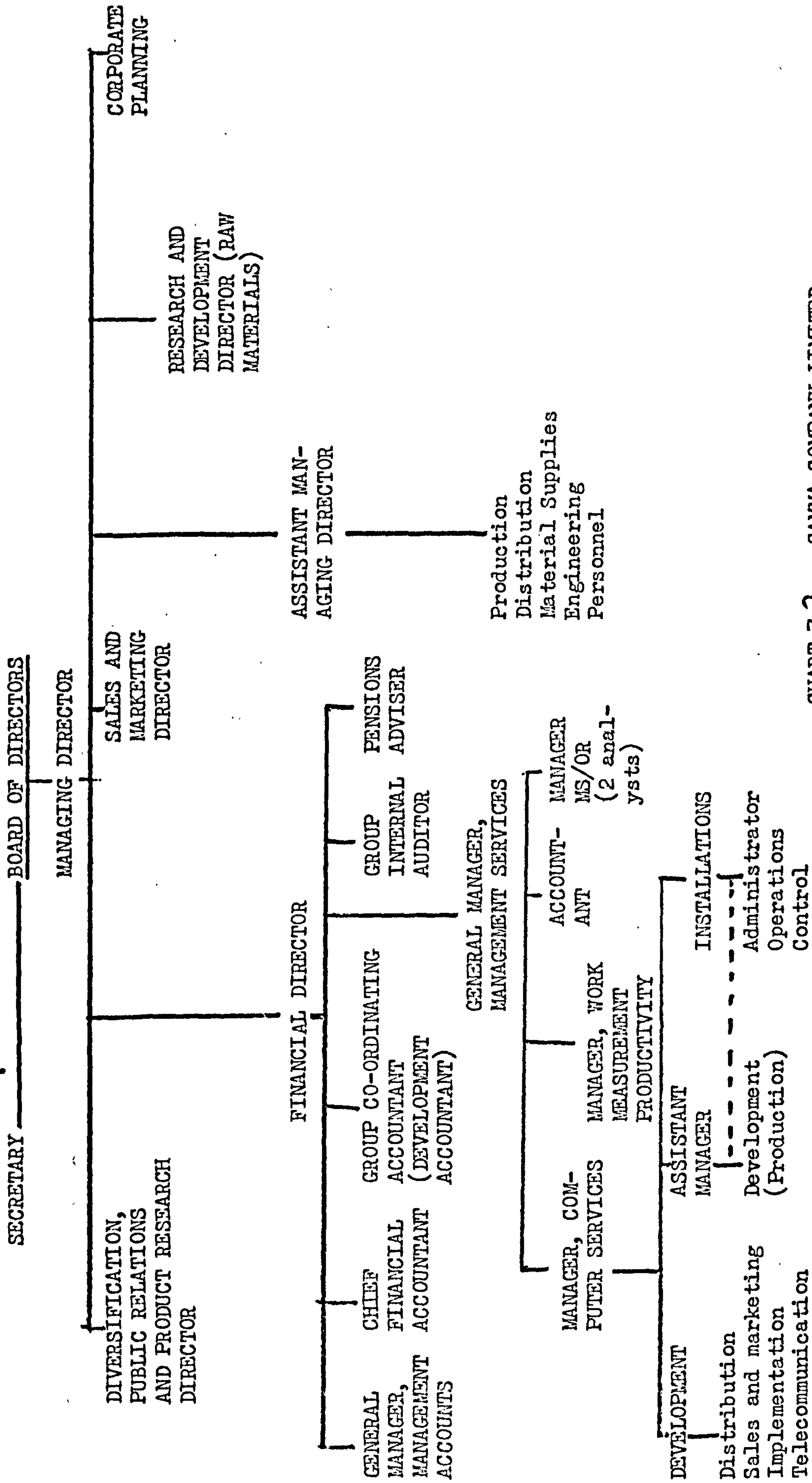

CHART 7.2. GAMMA COMPANY LIMITED

7.3.2. TRANSFER PRICING FOR DP. AND/OR MS/OR ACTIVITIES (MAIN FEATURES)

Aspect under consideration

Organization

ALPHA

1. Annual estimates of costs (of D.P., MS/OR, and other management services activities).
2. Allocation of costs to users are made on the basis of the expected use of these resources (which is based on past year's experience modified according to the conditions expected to prevail).
3. There is a formal system for controlling costs of (D.P. and MS/OR) projects. Costs and savings have to be estimated and documented.
4. No charge out system is in operation. (Incidentally, a compromise system between complete chargeout and no chargeout at all was suggested last year by which: half the cost of the D.P. function was to be considered as overhead, the other half would be variable and would be charged to users. The suggestion was not acceptable, particularly because (it was said) it would not fit into the accounting procedures and regulations.

BETA

1. The Central Services department (including MS/OR and D.P.) is acting as "internal consultancy" group. Rates are computed for the different types of "recovering services' resources" by dividing the Central Services budget by the total number of working days to produce a daily rate for every cost-recovery internal consultant. Also, an algorithm is applied for computing the computer costs and computer services are sold to internal and external users on an equal basis. There are non-directly recovered services such as: internal education and training courses and accounts
2. Preliminary estimation of cost of any projects has to be made. The individual user is responsible for the cost of having any type of internal consultancy.
3. A sub-section of the accounts function within the Central Services is responsible for operating and implementing the "chargeout system".
4. Charges to users are made on the basis of the amount of work (number of hours) involved in each consultancy job.

GAMMA

1. The management services department (including MS/OR) is offering its services to the rest of the organization's divisions and subsidiaries. Corporate development projects are a main feature of this organization.
2. Preliminary estimation of costs of projects has to be made. Corporate development projects are not charged to any user until they prove to be effectively useable. Also, users of services are charged with the cost of the services.
3. There is a formal system for controlling costs of (D.P. and MS/OR) projects. Costs and expected benefits have to be estimated.
4. Charges to users are made on the basis of the amount of work involved in each type of service.



### Commentary and discussion

Evidently each of these three organizations has its own application of what it believes to be the appropriate cost accounting and control systems. Such adopted application reflects the management's philosophy of how to utilize effectively its limited resources. Basically, no one approach would be suitable for all organizations, and the appraisal of any of the above three methods of application, should be carried out cautiously within the context of the particular organization's own conditions. However, any of the methods of application has its pros and cons,<sup>10</sup> and the fewer the disadvantages (for the different parties involved: the service sources, the user, the management and the organization), the greater the likelihood that the adopted approach will fulfill its planned objectives.

10. In an answer to the question: 'should users be charged for computing services?' Gallop summarizes the argument in the following manner (there is no reason why this discussion should not be extended to include other services such as : MS/OR, investment analysis and appraisal).

#### PRO

1. Charging provides an economic basis for resource allocation if facilities are limited.
2. Cost benefit analysis can be done by the user; otherwise only a central authority can evaluate the economic feasibility of proposed projects.
3. Users has a "stake" in the efficiency of systems and the service provided.

#### CON

1. Charging may create barriers to use of available resources, Users can be encouraged to innovate and experiment if no charges are levied.
2. Minimize overhead costs; the cost allocation and negotiation process requires resources and costs money.
3. Since cost allocation may be arbitrary or judgmental, its results can be misleading, inaccurate and argument-prone.

Source : Gallop (1972, p.22).

Judging from the participating individuals' attitudes and opinions regarding methods in use in their organizations, the researcher can make the following observations:

Organization ALPHA

- The system in use - no chargeout for the use of D.P., MS/OR services - is part of the formal design of the organization : simple; easy to budget; partly useful in project control.
- Although the system in use necessitates reporting estimated and actual costs and savings of any project, it is difficult to suggest that the current system either forms any valid basis of carrying "cost-benefit analysis" by the user or is effective in arousing cost-consciousness amongst users (of D.P. and MS/OR projects).
- Some interviewees feel that this system should be replaced by a more effective "chargeback" system, but they emphasize that the current system is an 'organizational policy'. Others feel that the system is designed more to control D.P. resources (specifically personnel) sometimes, the system in use is considered inaccurate and arbitrary.
- Has the system in use encouraged users to innovate and experiment? Has there been any ineffective use of the available resources? These questions (as well as other similar related ones) are difficult to assess!

However, the current system does not contain incentives<sup>11</sup> to users to look very carefully at what they are asking their D.P. function to do.

---

11. Anderson (1974, p.33) in his evaluation of 'indirect' cost allocation methods (such as annual budget allocations based on anticipated resource utilization - or its being supplemented by a memo billing mechanism generating monthly or quarterly reports to users detailing the resources actually used by them during the period, or its further modification by instituting a mid-year budget adjustment designed to correct the original allocation by taking account of actual trends in use), indicates that while these measures would serve to put more cost information in the hands of users, they do not seem to have the potential of the direct charge system for motivating managers to use the information effectively and to take a more active role in the commissioning and monitoring of systems projects.



Organization BETA

- (According to a considerable majority of participating individuals, the practical advantages of this particular application out-number its disadvantages; no substantial evidence is available to suggest that the method has been a major barrier discouraging users from exploring different or new ways of utilizing available resources; but, it has been suggested that the particular method of application is "over-emphasized".
- cost-consciousness is one of the major results of the system, but this should not be interpreted to mean that the vast majority of projects or systems affected at one stage or the other by this chargeout system are cost-effective. Where there have been cost-ineffective projects, the charging system should not be blamed. Nevertheless, the particular application of this control device suffers from major shortcomings, the least of which is the 'fixing' of the final charge by Central Services without consulting<sup>12</sup> the user(s) about the several items included in the charge.
- the need for more corporate development projects has been very frequently suggested particularly in the areas of common systems. The researcher believes that there is a fundamental contradiction in this application of the way costs of Central Services are recovered. On the one hand, although theoretically users are free to decide whether or not to use internal consultancy-type services, they (user divisions) have actually very little control - if any at all - on such a decision. (Had the operating divisions of this organization decided to use external computing services, would it be acceptable and practical? The answer to such a question is no!) In some cases, the user divisions have no control at all on some central services, such as public relations, industrial relations, legal, education, and training and so forth. In some other cases, they (users) have control over the amount of services they use, such as computing re-

12. Many users argue that psychologically speaking consultation on charges for using computer services induces the user to better understand both the logic and application of charge-back systems. This, users argue, contributes to a more constructive organizational relationship.

sources. Still in other cases, they are free to use centralized computer-based Systems Development and MS/OR type of services.

On the other hand, the same principle is applied to these types of central services. (Probably, considering using different approaches for different purposes might be useful in tackling this problem).

the "blanket approach" to the allocation of central services costs may not be the best approach to cost recovery. It may be more desirable if the system in use is modified to avoid some of its disadvantages (perhaps within the context of a revised system of more effective allocation and control costing system).

There is no evidence to substantiate the argument that the work level of the various central services departments - has been fairly reduced by adopting the chargeout policy.

Several users have frequently expressed their wish to have greater details of their charges (as a result of their actual or expected use of the central services) particularly before the service is offered. This might help to avoid any 'misconception, misinterpretation, or any 'wild imagination' about the way in which 'charges' are computed and presented. After all, the system of charging users for the services they use is made to control such cost, arouse cost-consciousness, help the user to effectively demand and use the skills contained in the central services, and monitor and control central services activities.

Although the basic principle of charging users for the services they receive are the same, the application to computing resources is different from that of the Central Services. (It is worth mentioning that the computing centre is organizationally coming to be an autonomous division). The data processing centre offers services to both internal and external users,



based on a resource utilization system<sup>13</sup> which was developed for the IBM System/360. On the one hand, users are provided with information on the cost of their computing service of the various resources utilized with a clear idea of the algorithm on which the charge is computed. On the other hand the multi-programming environment in which the computing centre is operating contributes to the complexity of the mechanism adopted; which has recently been further complicated by the introduction of a sophisticated operating system utilizing virtual<sup>14</sup> storage.

These observations, however, raise some related questions as to the extent of detailed information about the cost of data processing that the user should have to be able to control such cost; the relationship between internal and external users of the computing service within the framework of market prices, and the objectives of the computing centre and their compatibility with other interests within this organization.

13. Details of the system are deliberately withheld in accordance with the confidentiality principle adopted throughout the study. The mechanism adopted in measuring computing resources utilized is similar, in some ways, to the system suggested by Rettus and Smith (1972, pp.74-92), published in the IBM Systems Journal, which measures the job cost and provides throughput analysis and component resource utilization information.
14. The concepts of multi-programming, virtual storage, storage hierarchies, and other recent technical advances in the computer industry are discussed in non-technical manner by Madnick (1973, pp.67-84).

Organization GAMMA

15

- It is perceived that the system in use has achieved reasonable success in the areas of: cost-consciousness amongst users, control of projects, and encouragement of users to explore new applications. Also, it is perceived by interviewed users (mainly accountants) that the system is acceptable.
- A fairly detailed estimate of the expected amount of charge (for using management services including E.D.P.) is made before offering the service. And if (as it sometimes happens) there should be any expected increase in the amount of the estimated amount, the function offering the service has to seek the user's consent to the additional amount. It has been evident that such an approach is useful in creating a favourable 'psychological' reaction to the specific application of the adopted transfer pricing policy.
- Amongst the perceived disadvantages of this particular application are (a) changes in conditions upon which rates are based may result in unrealistic estimates in the charges (but this is a general problem affecting all methods of applying such policy, the updating and revision of rates); (b) the almost non-existence of competitive circumstances with external sources of services. Although organizations, in general, might imply the possibility of using external sources of service, they always consider the capacity of their own facilities already committed to offering such management services.

---

15. Reasonable in relation to users' expectations.



However, experience of participating organizations indicates that applying the approach of charging users for the services they used to either extreme (either a strict system of complete 'chargeback' based on hard and fast rules or no 'chargeback' at all) would probably not be useful and in some cases would probably turn into<sup>a</sup> "counter-productive" system.

It is interesting to note that a very small number of interviewees whose organizations are applying the principle of charging users for the services they use would wish to 'go back' to the old system of 'non-chargeback'. The majority of interviewees have suggested that a 'satisfactory' application is the one that is based both on the user-service centre interests and views and on a dynamic review on a feedback basis.

7.3.3. Computerization of accounting (and other closely related business) activities.

A variety of approaches could be considered in studying the extent to which accountants are utilizing E.D.P. resources for the recording, analysis and interpretation of business activities within the framework of their organizational responsibilities. Amongst these possible classifications are: routine-non-routine; type of the input and output of the different systems; the type of horizontal application; and the managerial orientation of the different systems. Due to the fact that these categories of classification overlap, the researcher believes that the routine/non-routine classification is sufficient for the purposes of the study in describing briefly an overview of the extent to which each organization has computerized its accounting (and some of the closely related business activities). Such categorization implicitly indicates the type of horizontal application, and the managerial orientation of the system.

Although computerization of the routine-type of accounting applications was amongst the early computerized business activities, there is no indication that the same conclusion applies to the non-routine type of application, or even applies to the extent to which each organization has succeeded in computerizing its routine activities.

Having said that, the researcher gives an overview<sup>16</sup> of the computerization position of each of the participating organizations. The aim is not to give a detailed critical evaluation<sup>17</sup> of every system in use, rather, it is

- 
16. Such an overview is an approximation of the actual position based on an analysis of interview(s) with senior member(s) of the E.D.P. function and validated as necessary by evaluations of other associated individuals.
17. Though highly desirable and extremely useful in the assessment of progress achieved in each of the participating organizations, it is beyond the resources available to any one researcher within the given facilities and constraints.



intended to support the present analysis regarding communication patterns and working relationships between accountants and E.D.P. specialists. In describing the organizational experience of each of the participating firms, two main general observations are worthy of emphasis: (i) technological developments in the computer field are highly dynamic in nature and scope. Subsequently, each of these organizations is experiencing change, in one way or the other, in the evolution of its computing resources, which has its implications on the effectiveness of E.D.P. function(s) in carrying out its (their) organizational responsibilities. (ii) rightly or wrongly organizational E.D.P. activities have been dealt with in a manner that is, in many cases, different from other activities within the same organization.<sup>18</sup> Practices differ from one organization to another as a result of the organization structure, top management attitude, and the type(s) of application that is (are) dominating the organization's E.D.P. activities to mention just a few factors.

Evidently, there is a lack of a clearly defined and established set of patterns, norms, or standards that could be used in the assessment of the participating organization's experience in the acquisition and use of its E.D.P. knowledge. However, the framework suggested by Gibson and Nolan (1974, pp.76-88) may be useful in evaluating the participating organizations' experience in applying E.D.P. knowledge to their business activities. Gibson and Nolan's framework indicates that there are four distinct stages in the growth of E.D.P. facilities, each with its distinctive applications, its rewards and its traumata, and its managerial problems. The basis for this framework of stages is that the E.D.P. budget for a number of companies, when plotted over time from initial investment to mature operation, forms an S-

18. Gibson and Nolan (1974) explain that "... E.D.P., as corporations use it today, is so complex that controlling it, or even understanding it, is almost too difficult for words ..." (p.76).

shaped curve (see exhibits on the three following pages). The turnings of this curve correspond to the main events - often crises - in the life of the E.D.P. function that signal important shifts in the way the computer resource is used and managed. A summary of the four stages (1. initiation; 2. expansion; 3. formalization; and, 4. maturity) is presented (on the following pages, in exhibits 7.1; 7.2, and 7.3), in terms of: growth of computer applications, growth in the specialization of E.D.P. personnel, and growth in formal management approaches customarily applied in each of the four stages in relation to organization and control of E.D.P. activities.<sup>19</sup>

---

19. Gibson and Nolan's framework is used by the researcher to locate the computerization position of organizations ALPHA, BETA and GAMMA in terms of computer applications, specialization of EDP personnel and management approaches to the design and control of EDP activities.

In addition, Gibson and Nolan's framework has probably influenced the researcher's evaluation of:

- (a) effectiveness of EDP systems discussed in the later part of this section,
- (b) the degree of progress towards data base applications discussed in section 7.3.
- (c) the present and potential accountants - EDP and MS/OR specialists' interaction discussed in section 7.4.



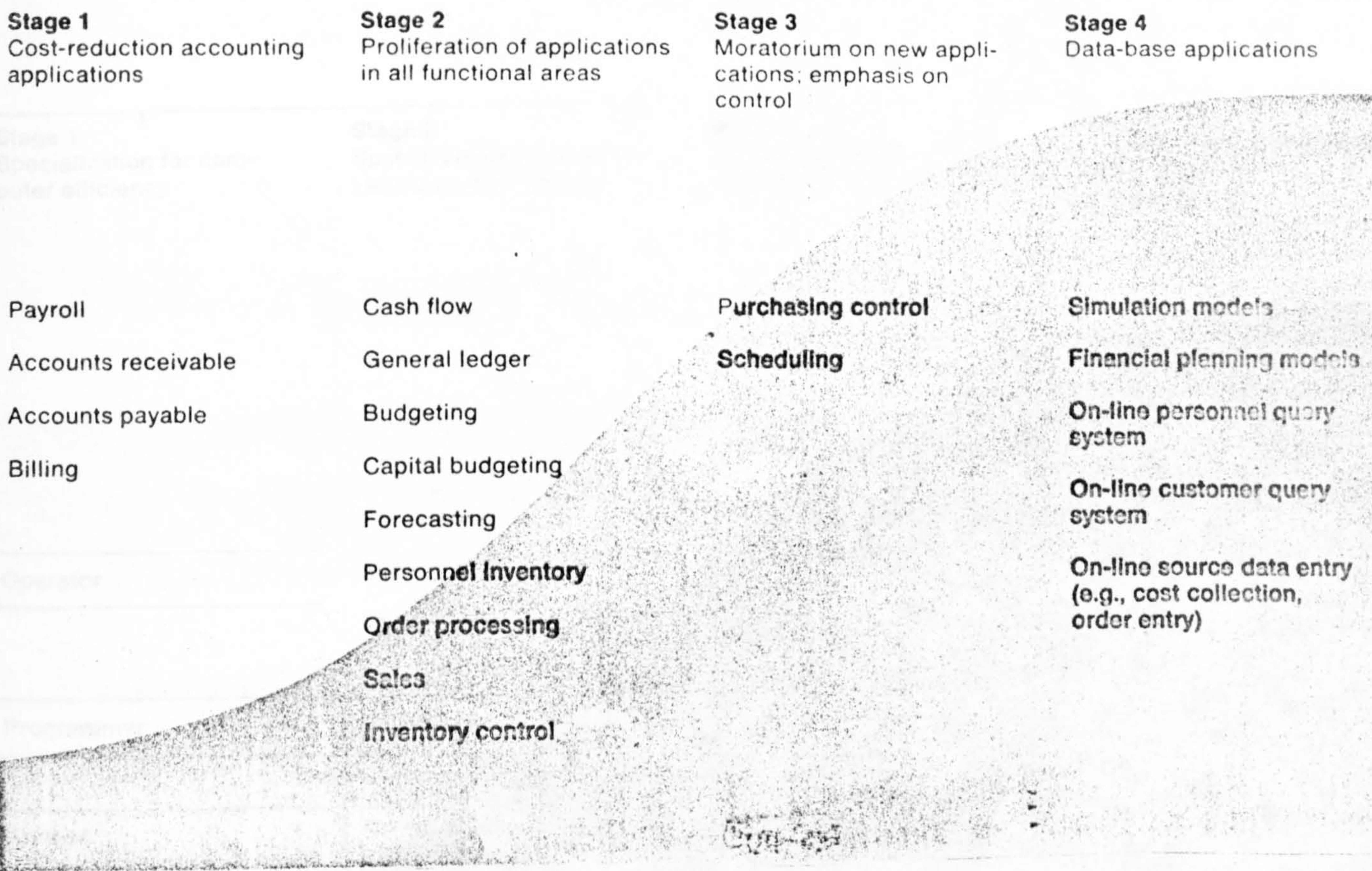

Exhibit 7.1. Growth of application.

Source: Gibson and Nolan (1974)



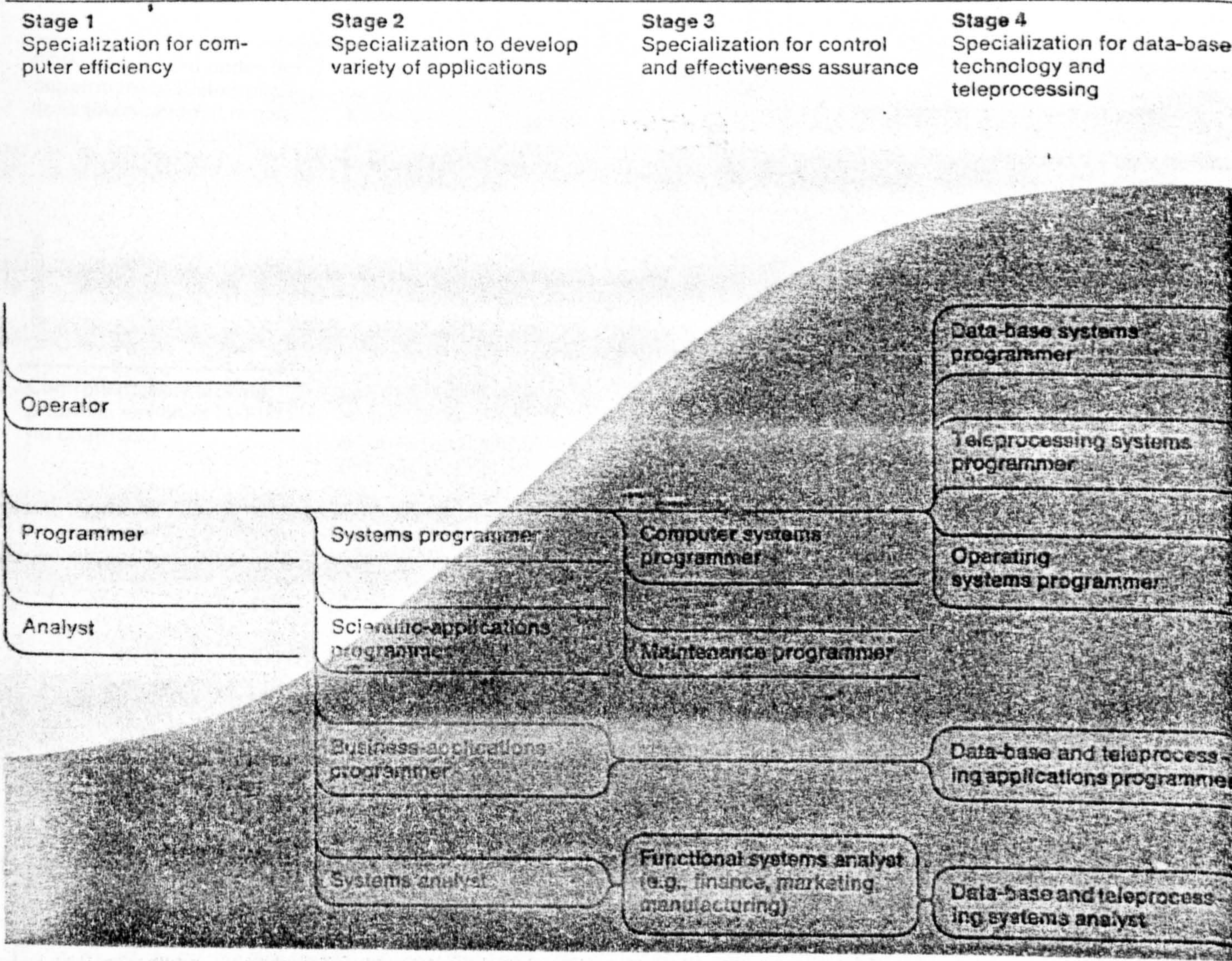

Exhibit 7.2. Growth of personnel specialisation  
 Source: Gibson and Nolan (1974).



	Stage 1 Lax management	Stage 2 Sales-oriented management	Stage 3 Control-oriented management	Stage 4 Resource-oriented planning and control
Organization	EDP is organized under the department of first-applications justification; it is generally a small department.	The EDP manager is moved up in the organization; systems analysts and programmers are assigned to work in the various functional areas.	EDP moves out of the functional area of first applications; a steering committee is set up; control is exerted through centralization; maintenance programming and systems programming become dominant activities.	EDP is set up as a separate functional area, the EDP manager taking on a higher-level position; some systems analysts and sometimes programmers are decentralized to user areas; high specialization appears in computer configuration and operation; systems design and programming take on a consulting role.
Control	Controls notably lacking; priorities assigned by FIFO; no chargeout.	Lax controls, intended to engender applications development; few standards; informal project control.	<p>Proliferation of controls to contain a runaway budget; formal priority setting; budget justification.</p> <p>Programming controls: documentation, standards.</p> <p>Project management initiated; management reporting system introduced: project plan, project performance, customer service, personnel resources, equipment resources, budget performance.</p> <p>Chargeout introduced; postsystem audits.</p> <p>Quality control policies for computer system; systems design, programming, operations.</p>	Refinement of management control system - elimination of ineffective control techniques and further development of others; introduction of data-base policies and standards; focus on pricing of computer services for engendering effective use of the computer.
Plan-ning	Loose budget	Loose budget	Strong budgetary planning for hardware facilities and new applications.	Multiple 3-5 year plans for hardware, facilities, personnel, and new applications.

Exhibit 7.3. Management techniques customarily applied in each of the four stages.

Source: Gibson and Nolan (1974)



ALPHA

As this organization is composed of a number of large operating divisions, a descriptive account of the computing position in one of its major divisions (which may be considered as highly typical of the other divisions) might be a practical way of tackling the question of computerized business activities. But before doing so, the following general comments are relevant:

- (i) accountants in this organization have been early users of computer-based systems; mainly of the routine-type application such as weekly and monthly payroll. Also, the amount of formal (and probably informal) co-ordination between accounting and systems development activities is high.
- (ii) PLAN (mainly) and COBOL (to a lesser extent) are the main languages adopted in programming most of the computer-based 'administration' application systems.
- (iii) Until recently, the policy of this organization had been to allow the smaller operating units within the division to go their own way in developing their computer-based systems. This has resulted in a wide variety of systems more often than not based on duplication of effort which was justified on the basis of different needs for different users. However, the dominance of specific systems, (as appropriate) the need for standard common applications, and the need to release resources from the administration applications into production planning and control areas have been amongst the objectives of the modified plan for centralized control over computer resources and systems development activities. Such a plan is designed to move the organization of computer resources and systems development activities towards making use of economies of scale and the possible



application of data base technological advances. It is needless to emphasize that the overriding objectives of the plan (for computer resources and systems development activities) are to reduce the amount of overlap, and to divert the current dispersed effort into more effective management information.

Computerisation of accounting and other closely related (business) activities: ALPHA

a - routine

Examples of such systems are:

Payroll (weekly and monthly) is used extensively throughout the division except in small places where needs do not warrant the use of a computer-based system.

Stores

is used by departmental managers, management accountants and engineers to reduce the time and effort involved in updating and producing information on the excessively large files in the manual system. Output of the system includes stock statements, reorder reports, exception reports, issues summaries - buying variance reports.

Departmental  
Accounts

is used to detail breakdowns of expenses by expense code and to analyse actual against standards each week.

b - non-routine

Almost all development work on the non-routine type of applications such as DCF has stopped at present to release the current computer resources and systems development work into production, planning and control areas and to pave the way to putting the computer resources and systems development plan into action.



Computerisation of accounting and other closely related activities: BETA.

Type of accounting activities	Manual		Degree to which computerization has taken place				In-applicable	Comments
	with no intention of computerization	with intention of computerization	up to 25%	up to 50%	up to 75%	up to 100%		
ROUTINE Order entry and analysis		✓						
Invoicing					✓+			
Wages (Payroll)					✓			
Debtors Accounts					✓+			
Creditors Accounts				✓				
Stock control		✓						
General ledger				✓				
Sales Accounting statistics					✓+			
Machine (or vehicle) utilization and reporting		✓						
Manufacturing costs allocations				✓				
General overhead cost allocation				✓				

Percentages are approximated in relation to Beta as a whole.

Computerisation of accounting and other closely related activities: BETA (cont'd)

Type of Accounting activities	Manual		with intention of computerization	Degree to which computerization has taken place	In-applicable	Comments				
	with no intention of computerization	with intention of computerization					up to 25%	up to 50%	up to 75%	up to 100%
Budgetary control				✓						
Standard costing				✓						
Consolidation of (group and/or departmental) accounts				✓						
Plant depreciation				✓						
Others (please specify) Requirements Planning				✓						
Purchase Records			✓							
Shop Scheduling			✓							
NON-ROUTINE Cost-forecasting										
Break-even analysis				✓						
Network analysis				✓						
Financial-modelling					✓					



Computerisation of accounting and other closely related (business) activities: GAMMA.

Type of Accounting activities	Manual		Degree to which computerization has taken place				In-appliable	Comments
	With no intention of computerization	With intention of computerization	up to 25%	up to 50%	up to 75%	up to 100%		
<u>ROUTINE</u> Order entry and analysis						✓		
Invoicing						✓		
Wages (Payroll)						✓		
Debtors Accounts				✓				
Creditors Accounts						✓		
Raw materials s.c.						✓		On average
Finished products Stock control						✓		On average
General ledger	✓							
Sales Accounting statistics						✓		
Machine (or vehicle) utilization and reporting							✓	

Computerisation of accounting and other closely related activities: GAMMA (cont'd)

Type of Accounting activities	Manual		Degree to which computerization has taken place				In-applicable	Comments
	with no intention of computerization	with intention of computerization	up to 25%	up to 50%	up to 75%	up to 100%		
Manufacturing costs allocations					✓			The organization is still extending the costing system to include all the factories
General overhead cost allocation					✓			
Budgetary control		✓						
Standard costing					✓			
Consolidation of (group and/or departmental) accounts	✓							
Plant depreciation					✓			
Others (please specify)								
Scheduling		✓						
Purchasing Control		✓						
Gift scheme							✓	approximately



Computerisation of accounting and other closely related activities: GAMMA (cont'd)

Type of Accounting activities	Manual				Degree to which computerization has taken place	In-applicable	Comments
	with no intention of computerization	with intention of computerization	up to which				
			25%	50%			
<u>NON-ROUTINE</u> Cost-forecasting							
Break-even analysis							
Network analysis						✓	
Financial-modelling							
Simulation models							
On-line personal query system							It is being considered since the organization has got a very large personnel file.
On-line customer query system							A two-V.D.U's attachment to the organization's H.Q. computer centre machine is made for an interrogatory customer query pilot scheme for accountants' use to interrogate customer files
On-line source data entry (e.g. cost collecting order entry)							This and other similar systems are being studied for possibility of use within the next two-to-three years.

### Effectiveness of E.D.P. systems

In attempting to answer the question of effectiveness of E.D.P. systems in the three organizations under discussion in this chapter, it is fair to say that whereas none of these organizations has achieved maximum effectiveness, neither can any of them be considered to have failed completely. This comment, of course, is a general one that needs to be discussed in detail.

In trying to operationalize measures to be used for evaluating the effectiveness of computer-based systems in general, and accounting applications in particular, the researcher agrees with McFarlan (1971, p.77) that measuring effectiveness of information systems in such a wide variety of contexts - i.e. scope and nature of E.D.P. activities and applications - is a complex task, and necessarily subjective. To do so the following measures qualitatively are/applied<sup>20</sup> to measure and compare the effectiveness of E.D.P. activities in general, and accounting applications specifically, in each of the three organizations under study:

- 
20. On the one hand, Diebold (1969, p.27) suggested an approach for evaluating E.D.P. investment and operations based on analysing benefits accruing from any management information system - whether computer based or not, classified in the following categories: 1. cost displacement - i.e., savings in data processing cost because of reductions in the clerical workforce and other changes; 2. operational gains resulting from the application by managers of information received through the system - for instance, data on inventory reductions and faster production; and, 3. intangible benefits - i.e. improvement in customer service, corporate planning and forecasting, the ability to sustain growth and other advantages which may not be present without the system but which depend on management's astuteness in using it. On the other hand, McFarlan (1971, p.77) suggested the following factors: 1. the comparative quality of a company's applications in its own critical problem areas - an application is successful if it is demonstrably profitable, in money or intangible benefits; 2. the level of service and support furnished by the central computer staff - the best criterion for judging this is user satisfaction; 3. the innovativeness of the applications - the managerial excellence of a company's basic data flows and management reporting systems is a much more reliable yardstick here than sheer technological sophistication (which might be reflected in extensive real-time system simulation, linear programme modeling, etc.) 4. the competence of the company's professionals - a specialist is best evaluated by his experience, the depth of his background, and his potential for assuming key leadership positions in other, highly progressive organizations, and, 5. the tautness, efficiency and reliability of the E.D.P. operations. Utilizing the intersection of the two viewpoints, the researcher has arrived at the classification outlined in the context of the discussion. Also, although the researcher believes that the above classification is satisfactory for the purposes of the present analysis the scale could be subjected to testing to suit the inclusion of more cases.



1. The comparative quality of the organization's applications in its own critical problem areas:

Organization	Very poor	Poor	Below average	Average	Above average	Good*	Very good
Alpha			✓				
Beta **		✓					
Gamma						✓	

\* In terms of savings of data processing cost because of reductions in the clerical workforce (and the associated problems of managing and utilizing the human factor involved) it is fair to say that all of the three companies have made 'good' progress in this direction.

\*\* Operational gains and intangible benefits are obvious in the case of this organization. (See subsections 7.2.2. and 7.3.1.)

2. Innovativeness of the applications:

Organization	Very poor	Poor	Below average	Average	Above average	Good	Very good
Alpha				✓			
Beta				✓			
Gamma					✓*	✓**	

\* In some areas (in production and accounting)

\*\* In some other areas (such as marketing, forecasting and profit planning) where managers themselves are utilizing forecasting models.

3. The level of service and support furnished by the central systems development staff

Organization	Very poor	Poor	Below Average	Average	Above Average	Good	Very Good	Inapplicable
Alpha								✓
								✓
Beta					✓			
			✓					
Gamma						✓		
					✓			



4. The competence of the organization's E.D.P. professionals

Organization	Low	Very low	Below Average	Average	Above Average	High	Very high
Alpha				✓			
Beta						✓*	✓*
Gamma					✓		

\* But this does not mean that they are utilized for the best interest of the organization

5. Efficiency and reliability of E.D.P. operations

Organization	Very poor	Poor	Below Average	Average	Above Average	Good	Very good
Alpha				✓**			
Beta						✓+	
Gamma		*✓				✓***	

\* For the external source of 'E.D.P.' service.

\*\* For the internal E.D.P. resources.

+ The service is provided on a commercial basis.

Based on the experiences of the participating organisations as discussed above the following general observations can be made. 21.

- the type of industry has little relationship to the use and effectiveness of EDP services.
- typically, as all the participating organisations are industrial concerns, primary attention was given to order entry processing subsystem (as basic sales data).
- due to the high interrelationship between order processing, materials controls, (finished products) inventory control and purchasing on the one hand, and on the other, accounting backed by statutory regulations, accounting subsystems have been given considerable attention in the course of computerising business systems.
- computerisation of accounting activities can vary considerably between, for example, two industrial organisations - from acting as a scorekeeper in one, to providing highly effective managerial analyses and reports in another. This high variability is dependent on the particular approach adopted by the management of such organisations in the design and implementation of the different (sales, accounting, marketing, purchasing, strategic planning, and inventory control) subsystems in a carefully co-ordinated manner.
- In spite of the piecemeal approach to implementing an EDP plan - if indeed there is such a plan - organisations that fail to map carefully their own EDP strategy (and how every individual system would fit into meeting the overall information requirements of the organisation) are likely to pay a high penalty in designing and implementing costly systems serving parochial interests.

21. It should be borne in mind that it was difficult for the researcher to get the costing information about computer-based systems that form the subject of the above qualitative assessment. Indeed, in some cases the information is not readily available, in others the information does not exist at all.



7.3.4. PROGRESSING TOWARDS 'DATA BASE' AND THE SO-CALLED 'MIS' : A PRELIMINARY EXAMINATION

The 'Data Base' concept has come to us fairly recently.<sup>22</sup> Discussion of its various dimensions (i.e. structure and management) sometimes tends to be related with the term 'Management Information System (MIS)', due to the recent advances in E.D.P. hardware and the associated software.<sup>23</sup> Accordingly, it is worth describing some of the general aspects of such developments before discussing and evaluating the position of participating organizations.<sup>24</sup>

22. As Bender et al (1974) assert that in its simplest form, a data base is a collection of data from which the company would like to establish and maintain certain relationships. A Data Base Management System structures and maintains these relationships. Bender et al (1974, p.87) go on to describe the evaluation of data base management system as follows:
- "Data Base Management is an outgrowth of the generalized input/output and file maintenance requirements of information systems with interrelated files. For a number of years, attempts have been made to perform various computer functions with standard software to allow the user greater flexibility in the design of application systems. Historically, these efforts have focused on the specification and development of generalized Data Base Management Systems. In 1969 the Data Base Language Task Group of the Conference on Data Systems Languages (CODASYL) made their first proposal for a data description language (DDL) and a data manipulation language (DML) for the creation and use of data bases with COBOL as a host language. In 1971, the CODASYL Data Base Language Task Group published a revised draft of their proposal and Data Base Systems Feature Analysis. They also established a new CODASYL standing committee - the Data Description Language Committee. This task group's effort is beginning to have the same impact on data base techniques and Data Base Management Systems as COBOL has had on application programming; consequently, it is becoming increasingly important for both the users and suppliers of Data Base Management Systems to adhere as closely as possible to the CODASYL specifications".
23. For the view advocating the vitality of 'data base' to 'MIS', see, for example, Head (1972, pp.21-36); Kanter (1972, pp.135-176); for the debate on 'Data Base Management', see, Canning (1972).
24. The following discussion is intended to introduce the basics of the concept, its materiality and its possible contribution to an organization's DMPSSS. This is to serve as a basis for evaluating ALPHA, BETA and GAMMA's experiences in that direction.



a. An overview of data base concepts

Lyon (1971, pp.1-6) succinctly explains that the data base is the foundation (fundamental constituent) upon which information will be built. It is the starting point from which all information processes are constructed. Since the sole purpose of a data base is to facilitate the production of information, it should never be considered as an end in itself, but rather as the foundation of information. Analysis and logical organization of data are part of the process by which knowledge is derived.

The data base must be broad enough, not only to support an information process, but also to stabilize it. The data base must provide sufficient breadth to permit an information process to 'weather the storms of change'.<sup>25</sup>

---

25. Lyon explains that this view of data base is in direct contrast to the pyramid philosophy of the system design which views a data base as a triangle (figure on next page). He emphasizes that the triangular arrangement of data is based erroneously on the naive belief that it is possible to anticipate the needs of top management and middle level management as well as to anticipate their desires. While the pyramid implies that top management sits directly in the middle of the functional spectrum of the business, managers always view business in terms of their dominant functional background. If an information system is built on a triangular base, ultimately it will serve no-one. If the triangle is biased toward the functional background of the current top management, it will hinder rather than serve the business at a time when information is needed most; namely, when management changes.

The depth of detail (which is the intent of the triangular structure) must be information and not data. Since information is knowledge derived from data, then it follows that the data do not have a triangular structure, but rather, the processing of the data yields information suitable to the user. Effectiveness of such information is not measured by how well it fulfills needs, but rather by how well it fulfills desires. Since management turnover is a fact, it is only logical to provide a data base which is broad enough to cover the desires of any management and which leaves the tailoring of information to the process. The data which describe a company and its relationship to its environment are essentially independent of management. It is only the information that is produced from the data base that reflects the personality of management.



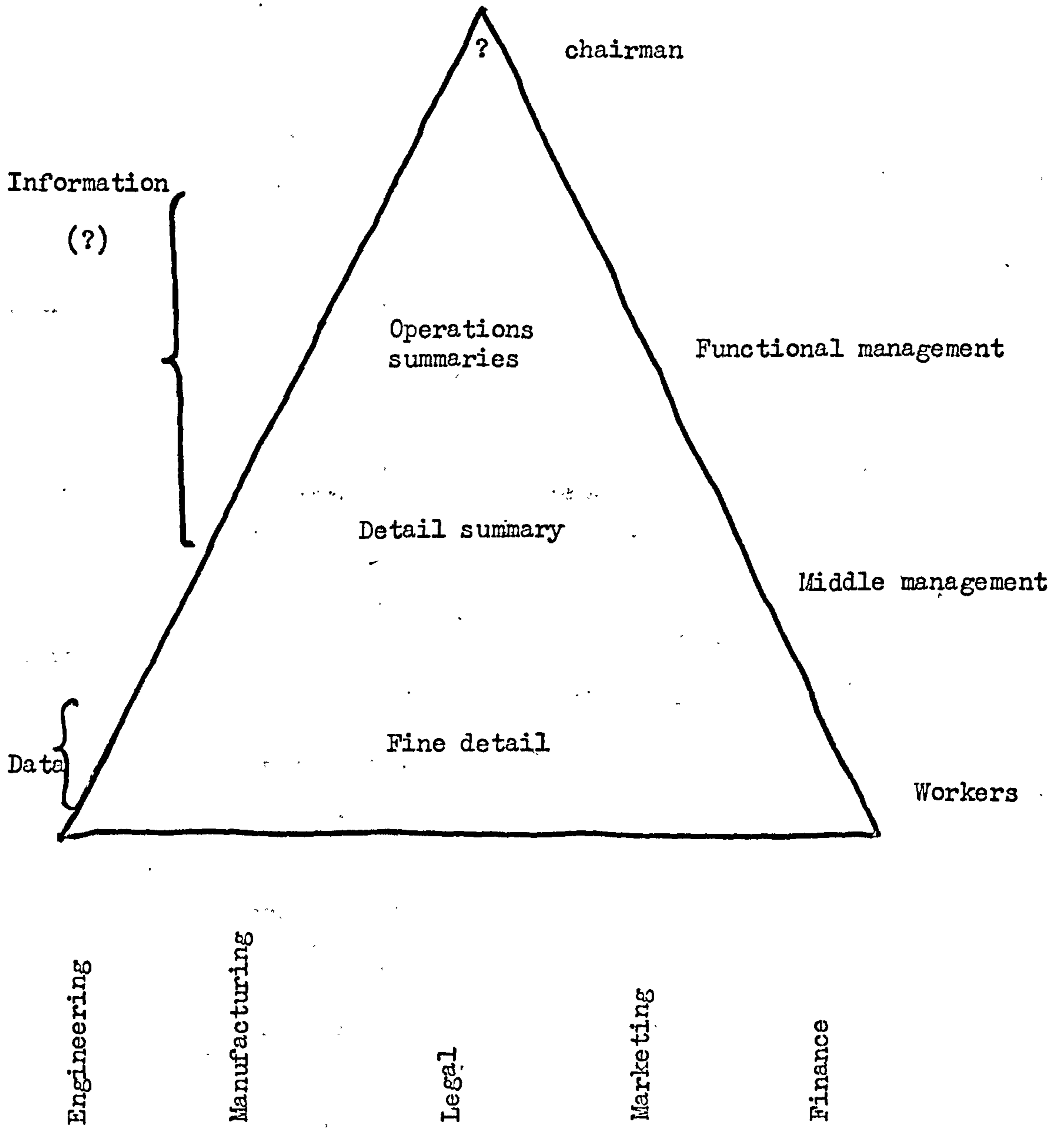

Figure 7.1. Pyramidal organization of data.

Lyon further explains the nature of data, in which he defines datum as: "something actual or assumed, used as a basis of reckoning". Four terms, therefore, stand out to describe the nature of data:

First the fact that datum is 'something' that implies that it can be identified and described; not necessarily physical in terms of the measurable world, but it may also be intangible or purely logical.

Second datum may be either real (facts) or assumed including assumptions, forecasts, and wild guesses.

Third datum is used. It is extremely important that the use property of data should not be limited to current usage, but rather that use be determined by the existence of a logical relationship to other things and hence its potential usage. Structurally or procedurally restricting the 'use' property of data base jeopardizes the stabilizing effects of data base.

Finally, datum is the basis for reckoning, the elemental quantity used to produce knowledge. This implies that the contents of the data base are pertinent to the production of information. To quote Lyon's words:

"the amount and type of 'data' to be incorporated in a data base must reflect the information needs of the business. The primary distinction between 'use' and 'basis for reckoning' is one of potential versus current use. 'Basis for reckoning' determines physically the current contents of the data base. 'Use' determines logically the kinds of data which are, or could be, contained in the data base. 'Use' is the logical design of the base while 'basis for reckoning' is the current physical content. It is imperative that the logical and implementation designs always be compatible".



B. materiality of the 'Data Base' concept

Although few studies have been carried out in this new area in E.D.P. the indications are that this concept is real, viable and beneficial. This conclusion has been drawn by Nolan (1974) based on the results of a survey designed to find out what the data base concept means in strategic and operational terms today. He concludes that:

"The hardware technology, as well as the software technology, for data bases has matured to the point that the data-base concept can be both feasible and cost-effective for many organizations. While the company will not be noticeably hurt in the short run by ignoring data-base technology, it will in the longer run.

Also, the data-base concept cannot be implemented overnight. If a company begins to plan and act now, it can assimilate even drastic technological improvements into its existing systems in a slow, comfortable, and orderly fashion.

To incorporate the technology that will permit data-base operations, an organization must identify its key computer-based systems and restructure them (a) to remove redundancy and (b) to facilitate their use by higher levels of management. For the present, companies must probably acquire commercial software for structuring data and responding to management requests for ad hoc analyses and reports. (Nolan, 1974, p.197).

Martin (1973, pp.12-19) describes a case history that shows how an American Company (Anderson, Clayton Foods, Dallas, Texas) designed a data dictionary/directory system to support its (IBM) Information Management System and to minimize the amount of clerical effort required of the Data Base Administrator. Also, the reported-to-be-successful examples of applying the data base management approach to their activities (Schubert, 1974; Huhn, 1974; Reside and Seiter, 1974; Blanchard, 1974) is worth careful and constructive evaluation by those interested in the concept of data environment for their implications for their organizations.<sup>26</sup>

26. Cohen et al (1973) report on a number of data-base packages chosen for analysis and comparison. Chapter two of this comprehensive discussion addresses itself to two questions (a) how does an organization evaluate its need for a data base system?, and (b) which of the available data base packages (the report concentrates on four packages) should be selected? Chapter three focuses on defining six functional categories as the major elements of a data base system which are: data manipulation, query capabilities, application programming, physical files, data communication, and system installation.

Clearly this is not to indicate that the data base concept is the panacea for computing and systems development functions. Rather, the concept has its problems that should be fully understood before commitments are made. Chief among these problems are: the shortage of well-trained people to implement the concept; the need to invest large sums of money and time (to afford the redesign of those systems that do not conform to data base specification and requirements, to afford the development of the firm's expertise to implement effectively the desired objectives; and to afford the hardware and software associated with the approach); and the necessity for top management commitment throughout the various stages of creating the project and putting it into practice.<sup>27</sup>

It is worth mentioning, however, that as organizations differ (in their environmental circumstances and conditions, in their design structure, in the extent of their management understanding and backing; in their E.D.P. philosophy and resources; and in their accumulated experience in the acquisition and use of E.D.P. knowledge) the type, magnitude and scale of problems, will vary accordingly. The more able a particular organization is in predicting such problems and in understanding them, the better the likelihood of reducing the dysfunctional effects of problems springing from the incorporation of data base approach.

---

27. Bearing the above considerations in mind, Schussel (1972 pp.82-84) summarizes some of the advantages of data base management systems in solving some of the problems associated with computing and systems development departments that have not incorporated such data base developments.



Aspect  
under  
consideration

Organization

### 7.3.4. PROGRESSING TOWARDS 'DATA BASE' AND THE SO-CALLED 'MIS': MAIN FEATURES

ALPHA

- Although the computer was first introduced (a 'considerable' time ago in relation to its introduction to business) to replace manual and mechanized functional systems (primarily accounting), the organization's data concerning some of its activities have been put into specialised applications to satisfy specific purposes for the use of specialized groups.  
For the organization - or even for any one of its divisions - information contained in these specialized applications cannot be correlated or cross-referenced. Furthermore with regard to definitions of information, for any of these (specific) applications, there are no agreed upon common definitions amongst the various developers and users of these systems. Few of these applications can be interrogated by 'on-line' terminals, although any of the developed systems could be interrogated by a 'computer program'.
- Plans are drawn by a specialist group reporting to top management of this organization to incorporate (in the long term) the data base technology.

BETA

- Perhaps the immediate concern of this organization is the refinement of the operational sub-systems mostly featuring the 'transactional' type of systems.
- Machine configurations (IBM 370/158) and the support facilities are suitable for moving towards building this organization's 'data base' system.
- There are a few short-term projects applying the concept to some of this organization's activities, with evident lack of longer-term strategy to outline explicitly the organization's position concerning its data base system.
- This organization enjoys the services of highly skilled E.D.P. personnel (who probably are not fully utilized to the best interest of this organization, due to the lack of co-ordination amongst the various organizational units - at the computer centre, the central systems development, and at the divisional level). Some of those E.D.P. personnel (if properly organised and co-ordinated) may form the 'fons et origo' of the 'data administration' function. (Providing, of course, some of them 'come down to earth').

Aspect  
under  
consideration

7.3.4. PROGRESSING TOWARDS 'DATA BASE' AND THE SO-CALLED 'MIS': MAIN FEATURES

Organization

BETA

- Development of an agreed upon complete 'dictionary' of definitions for all the information to be contained in the 'data base' is one of the crucial tasks that has been given minimal attention in relation to the magnitude of its importance as a basic characteristic in building this organization's management-oriented data base system'.
- Perhaps the most immediate problem facing the development of such a 'data base' system is the identification and definition of information requirements for managerial decision-making and problem solving, and the functional interrelatedness between those requirements. There are various reasons for this (not uncommon) situation; it is partly due to the managers themselves, to E.D.P. speciality or to organizational conditions and circumstances.
- The longer term strategy (covering a period from 5 to 10 years) is aiming towards gradually building a large central system with remote access and support terminal facilities. Subsequently, conditions of systems suitability for on-line usage would be met. (This strategy has not been explicitly defined by top management of this organization, but it was perceived by the researcher through his discussion with several participants throughout the organization). The longer aim, however, is to permit the managerial interface with the system to take place more quickly and directly for more managerial problem solving and decision making.

GAMMA

- Although hardware and software facilities could (with some expansion) enable this organization to move towards the 'data base' developments in the E.D.P. field, the attitude adopted by the E.D.P. function is that the organization should wait until such a development has been officially recognised and justified by its proven success in other organizations.
- A senior member of the E.D.P. function in this organization has attended a course describing the nature, scope and objectives of the 'data base' system and the developments taking place in this direction.
- A file maintenance and a report retrieval system is in operation and considered by the E.D.P. function to be sufficient for the present purpose.



## Commentary and Discussion

More specifically, the researcher can make the following observations in connection with participating organizations:

- (i) in discussing the concept of Data Base as applied to their organizations, some E.D.P. interviewees seemed to consider both 'file maintenance and retrieval systems' and 'data base management systems' as identical systems that differ only in connotation. This, of course, is not the case.<sup>28</sup> Whilst 'data management systems' have the capability to do the maintenance and retrieval functions (carried out by file maintenance systems), 'data management systems (as Bender et al, 1974, p.88 put it), "... implies the use of common, shared and related files of data which may serve as the foundation for a number of different functional areas". Also, Kanter (1972), p.144 and pp.60-61) indicates that 'data management systems' provide the capability of managing and controlling the 'central data base', which he succinctly describes as 'a bucket or bowl of facts' so designed that different levels of management can dip into and sift off the information that is relevant to their particular sphere of operation.
  - (ii) evidently little effort - if any - has been spent (in the course of designing and implementing computer-based systems) in identifying and establishing the interrelationships amongst elements of data across the functional areas. Basically, the predominant pattern in the three participating organizations has been that of creating and maintaining 'independent' systems for specific application. A side-effect in this respect has been the relative absence of crossing the boundaries drawn between the separate functional areas of the business.
- 
28. Although written with Westinghouse Divisions (Pittsburgh, Pennsylvania, U.S.A) in mind, the introductory manual to data base management (by Bender et al) is useful in answering questions such as: What does a data base management system do?; What is a self-contained data base management system?; a host language?; how does a data base management system work?; what are the levels of data definition? How can the integrity of a data base system be guaranteed?; who should design a data base system? how will a data base management system affect application programmes, the role of functional user, and the computer operations areas?'

(iii) a clear feature of the several applications in the participating organizations has been the noticeable variability of the quality of the design of the different systems as a reflection of differences in knowledge and experience of E.D.P. personnel involved in the design processes. This observation is most noticeable in ALPHA and the older applications in BETA. The situation, however, is beginning to change in BETA where increasing attention is being paid to greater elaboration in documentation and standardization. (BETA has a huge residual investment in application programs; a high proportion of it is being converted to more up-to-date versions).

(iv) although BETA has facilities that could be the basis for the development of a comprehensive data base (large central system with remote access facilities as well as highly skilled - in E.D.P. personnel) the foremost step in developing the organization's 'data base' has as yet to be taken; namely the identification of managerial needs and the extent of relatedness between data elements. Had such a step been given 'sufficient' attention, BETA could have been in a much better position than it is now.

(v) regarding the participating organizations' abilities to cope with ad hoc requests for management information that draws across the functions and levels of the company, the example used by Nolan (1974, pp.185-195) seems appropriate, where he assumes that an E.D.P. manager is suddenly given an assignment to this effect. He suggests that an organization's circumstances and conditions might underlie the use of one of three main strategies:

- through brute force:

- the E.D.P. manager can start from scratch, collecting all the needed data, coding them, writing special programs and acquiring hardware capability, if it is required. Such an approach demands prohibitive expenses and intolerable time horizon.

- through piggyback:

- using this strategy, the E.D.P. manager attempts to 'ride the special project' through on more or less existing facilities by extracting data from existing files, structuring them into a special data 'pool', augmenting this pool with new data as necessary, expanding old programs and writing new ones, and increasing (if required) his hardware capabilities. Such an approach has two signal disadvantages - it requires the construction of a totally redundant data pool, and while it consumes less money and time than the brute-force, the money and time are still substantial indeed.

- through a data base/key task strategy:

- in which the E.D.P. manager should have an integrated highly structured key task data base. The data base/key task strategy forces cross-functional and interleaved integration in a manner that will suit upper management's needs; upper management under this task must take a careful look at what it considers its key tasks and make sure that it has settled on the ones that (a) make sense for the company and (b) are clearly understood by the E.D.P. personnel responsible for structuring and maintaining the data base. In view of this, the data base/key task strategy is more effective than 'brute-force' and 'piggyback' approaches.



On the evidence analysed in this part of the study, the researcher could make the following classification according to the circumstances, and conditions of each of the three participating organizations. ALPHA would easily fall under the 'brute-force' approach. Furthermore, the researcher is inclined to think that this approach has been adopted on several occasions on a slightly modified scale, but, fortunately, there are some signs that effort is being made to minimize the adoption of such an approach in the future. BETA in general would be categorized under the 'piggyback' approach, although a few applications could be classified under the key task/data base approach but there is still a long way yet to go towards achieving comprehensively such a desired key task/data base strategy. GAMMA also would be classified under the 'piggyback' approach, where the E.D.P. function of this organization thinks that is sufficient at present particularly when such ad hoc requests are very infrequent.

7.4.1. Present and potential Accountants - E.D.P. and MS/OR specialists interaction : A Preliminary Examination

In looking at the current and potential accountants' interaction with E.D.P. and MS/OR specialists in the participating organizations, it is useful to remind the reader of the following points of emphasis:

First: evolution of computing technology and its associated software is continuing in a manner that according to predictions, will almost certainly affect the way in which users of computer-based systems interface with the then available computer capabilities. Subsequently, a critical look at these developments in the computer field should guide the establishing and monitoring of long-range planning in that direction. However, the following brief description of developments related to the areas under discussion is sufficient for the purposes of the present study:

- The cost-performance ratio for large scale computers has improved significantly over the last two decades. That is, the capabilities of computers have increased dramatically while the price of computing has drastically decreased over the last twenty years.<sup>29</sup>
- All the major computer manufacturers of large computers have introduced important new products in 1973-1974 featuring innovations in hardware, software or both, that if combined and projected to a future condition of reliability, comprehensiveness and efficiency will constitute a new fourth generation of computer systems completed in the range of 1976-1978.<sup>30</sup>

---

29. Schussel (1972, pp.73-74) estimates the improvement in the cost-performance ratio for large-scale computers by a factor of at least 30 to 1 over the last twenty years.

30. The researcher has drawn considerably on Withington (1974-a)'s visualization of the trends featuring the fourth generation computer systems.



Amongst hardware features of such fourth generation computer systems are:

- mass storage devices (perhaps five times as cost-effective as today's);
- logic and memory circuits (perhaps five times as cost effective as even the latest ones - i.e. present speed at one tenth the cost or ten times the speed at the same cost)
- mini computers distributed at the points of transaction, in the communication network and in the central complex itself (the mini computer will approach the status of a component);
- remote terminals (perhaps twice as cost-effective as those available today);
- mechanical peripherals - tape drives and printers - perhaps twice as effective as today's latest.

Amongst software trends featuring fourth generation systems are:

- \* virtual memory techniques and files that permit automatic memory mapping (which are already in use in all the latest systems).
- \* the principle of variable stored logic which is widely used to accommodate various languages will be extended to the point that computers and controllers of various kinds will be able to interchange functions, so that the fourth generation systems can be reconfigured dynamically.
- \* automatic communications management, where varied line, terminal and message characteristics are automatically accounted for by the front-end controller and system management software.
- \* distributed processing, including both multiprocessing in central systems and delegation of functions to the mini computer-based subsystems in the network. (This is already a feature of the most advanced systems).

Fourth generation systems will be directed by interactive, easy to use command languages. The vocabulary used will be symbolic and close to English in nature, and the system will prompt the operator by leading him/her through the needed set of instructions. The central systems of the fourth generation will probably be as shown in Figure 7.2.1. on the following <sup>page</sup> / The centre of the system is the memory which includes several separately powered banks, so that the system can continue despite failure of any one. Virtual logic and the backing store insure against the loss of content. Input and output of all kinds move between the memory and the multiplexed controllers, causing appropriate interrupts.

The hierarchical structure, represented in figure 7.2.2. on the following <sup>page</sup> / applies when the users' application involves interaction with a single set of central files. Networks of terminals located at the points of transaction connect to the system, probably with data concentrators employing mini computers to reduce line costs. Hierarchical networks will apparently also include satellite processors with file handling capability. (Often a Local Office, plant or warehouse will have files of data unique to it - the local payroll, or customer and facility records needed only locally. Invariably it proves most economical to keep these files on site, and use a small computer both to process them and to serve as a terminal for the central system).

If there is no need for a central file (as in a conglomerate organization where each division is in a different business), interconnection is still needed in the interest of sharing computational workloads and exchanging the smaller amounts of data which still invariably require interdivisional transmission.



**FOURTH GENERATION CENTRAL SYSTEM**

Figure 7.2.1.

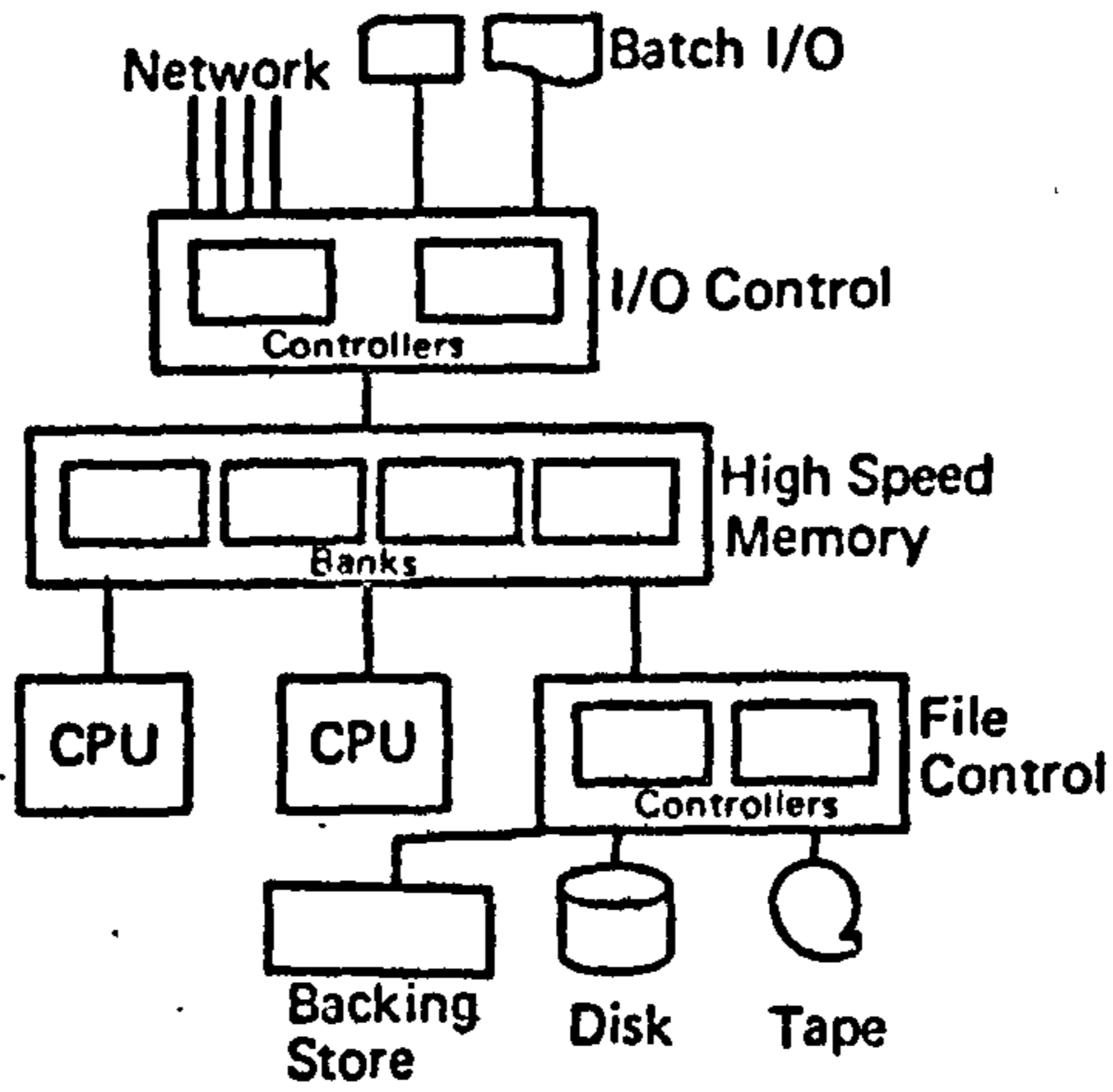

**HIERARCHICAL NETWORK**

Figure 7.2.2.

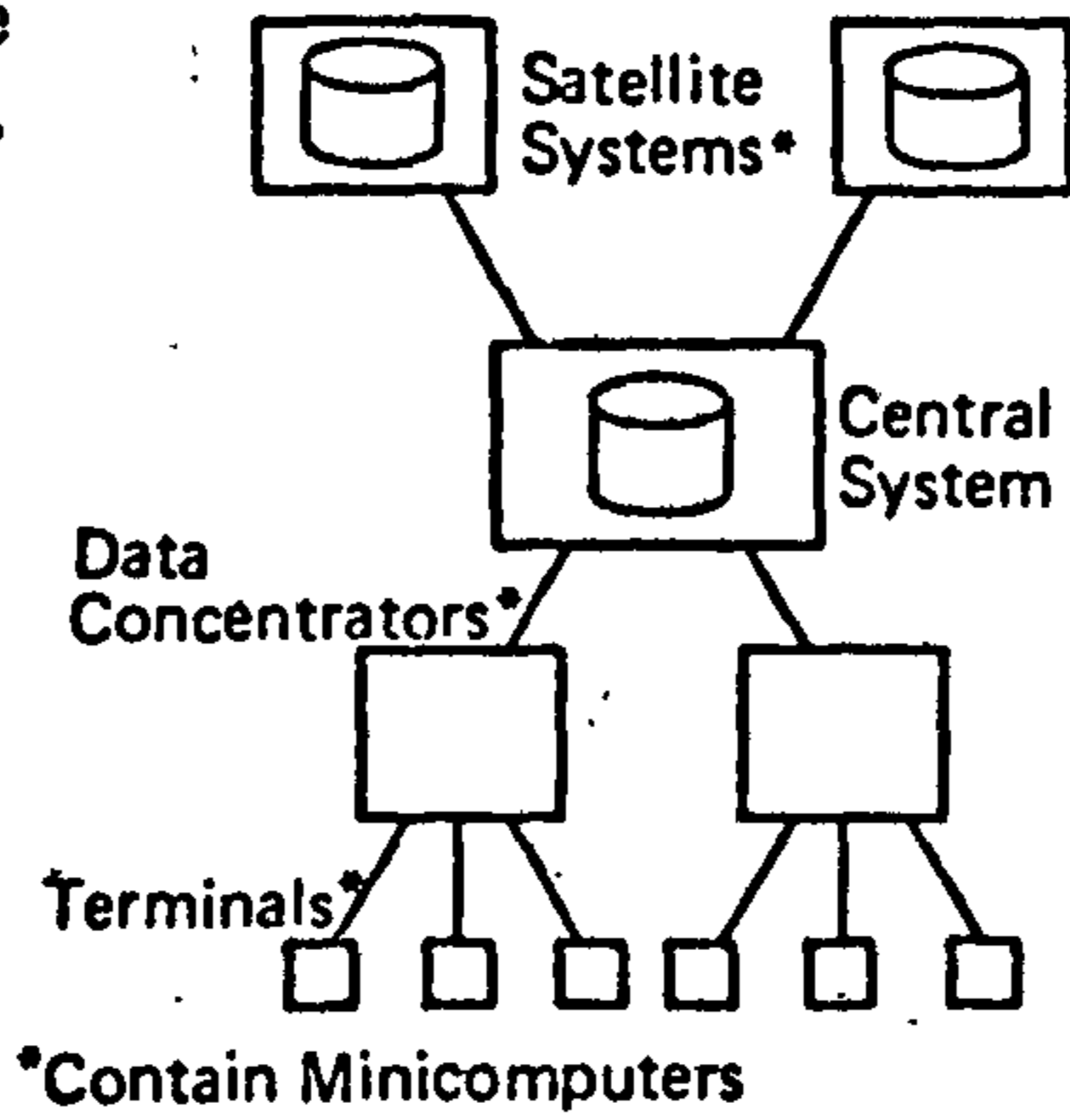

**LOOP (ARPA) NETWORK**

Figure 7.2.3.

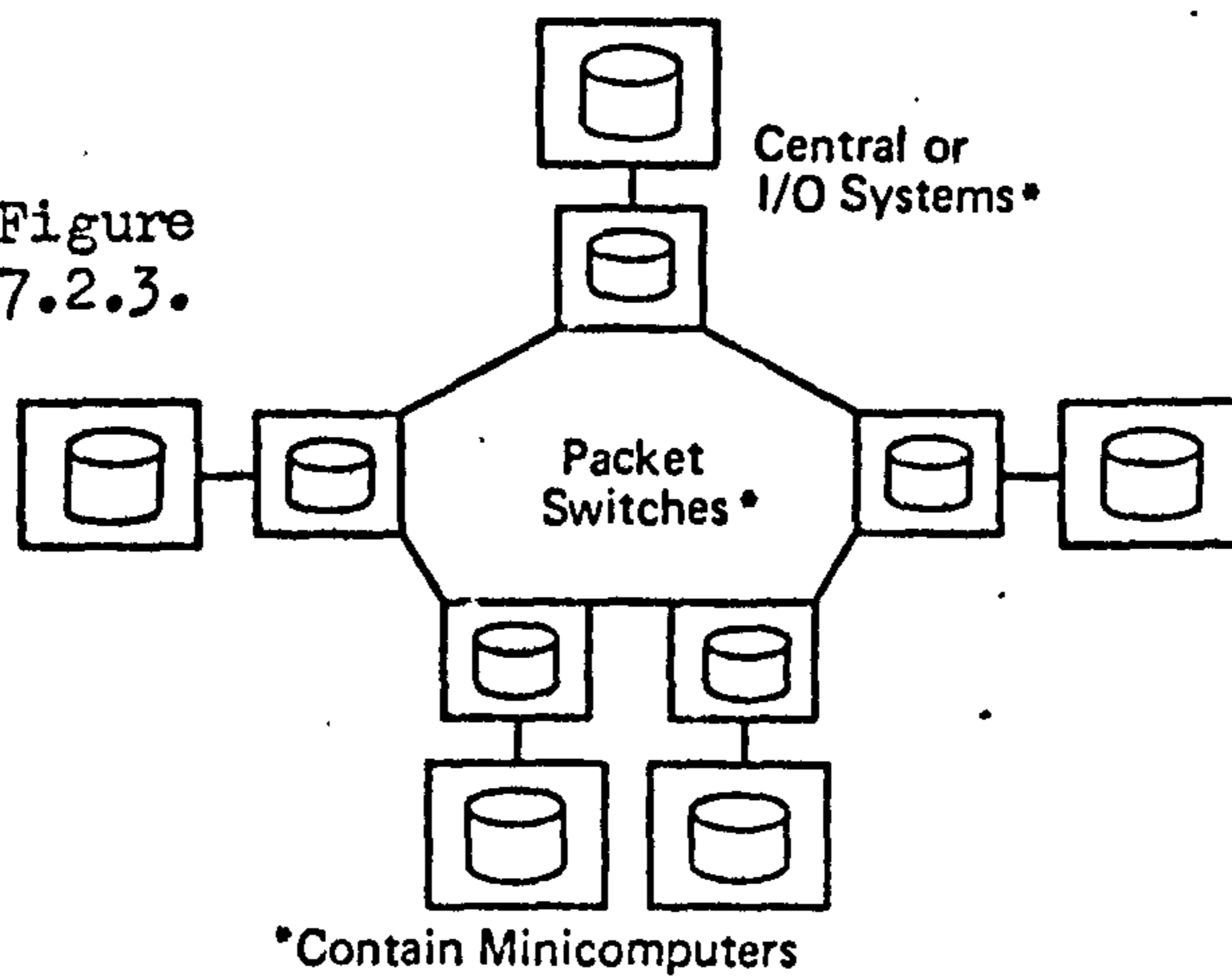

The network might take the form of a loop connecting the divisional system, as shown in Figure 7.2.3.

The local installation need not be a central system. A group of terminals connected to a concentrator can equally well be attached to a node in the loop, with a hybrid of the hierarchical and the loop.

In these fourth generation computer networks, it will no longer be possible to distinguish individual computer systems clearly by either boundary or size. The user will no longer be able to replace the entire network without a catastrophic upheaval. However, it should be easy to replace or add a module - as long as it is compatible with the system software, which is completely responsible for the user's interaction with the machine.

Second: certainly the environment in which accountants (financial, development, or management)<sup>31</sup> operate is rapidly changing with more government intervention, with growing technological development and with expanding international business. Professional accounting bodies are increasingly assuming (however slowly) the role of a change agent to guide and influence accountants in what the professional bodies perceive to formulate a professional approach; efforts of the Accounting Standards Steering Committee (ASSC) for the past three years or so for more uniformity concerning the form and content of company accounts

---

31. Excluding the accountancy clerical grades, foundations of financial and management accountants for example, overlap; an understanding of taxation structure, mercantile law, company law, the social responsibility of business, (national and international) economic trends, and managerial needs and requirements, is useful in providing broader backgrounds to both specialists to enable them to appreciate the wider implications of their contribution to their organizations. This does not imply, of course, that mechanics of computation in both areas of accounting specialization follow the same procedure.



and annual reports<sup>32</sup> and the Stock Exchange

---

32. Such efforts are aimed at feasible (and meaningful) inter-firm comparisons based on what the committee considers to be 'informative' methods of presenting information and reducing the variability resulting from subjective approaches adopted in preparing and presenting it.

The non-accounting reader is reminded that the result of such efforts could be classified in two main categories: the first is discussion papers (labelled Exposure Drafts); and the second is final papers (labelled Statements of Standard Accounting Practice).

Issued Exposure Drafts are:

- ED3 - Accounting for acquisitions and mergers (January 1971).
- ED6 - Stocks and Work in progress (May 1972).
- ED11 - Accounting for deferred taxation (May 1973).
- ED12 - Treatment of taxation under the imputation system (May 1973).
- ED13 - Statement of source and application of funds (April 1974).
- ED14 - Accounting for research and development.
- ED15 - Accounting for depreciation.

Statements of Standard Accounting Practice issued are:

- Accounting for the results of associated companies (January 1971).
- Disclosure of accounting policies (November 1971).
- Earning per share (February 1972).
- Accounting treatment of government grants (April 1974).
- Extraordinary items and prior year adjustments (April 1974).
- Accounting for changes in the purchasing power of money - provisional standards (May 1974).

The ASSC is planning to further develop its program to include other issues such as:

- Accounting for goodwill.
- Accounting for diversified operations.
- Accounting for leases.
- Fundamental objects and principles of periodic financial statements.
- Fundamental principles, form and content of group accounts.
- Events occurring after the balance sheet date.
- Accounting treatment of major changes in the sterling parity of overseas currencies, and
- Accounting for pension funds in company accounts.



regulations are clear examples in this direction.<sup>33</sup>

Present conditions place, on the part of accountants, the need for greater awareness and recognition of the wider contexts in which business objectives are related to social responsibilities of their concerns. This necessitates reformulating accountants' responsibilities towards their managements, organizations, and society at large.

In view of the above-mentioned present conditions and expected circumstances, it seems important that accountants, EDP and MS/OR specialists should collaborate constructively in exploring, developing and progressing the areas in which growth in their interdisciplinary contribution could be achieved for more analysis and interpretation of information for problem solving and decision making.

Computing (either hardware capabilities or systems development) resources should aid and relieve accountants from a substantial amount of computational tasks and repetitive work to pave the way for more analysis and interpretation based on more understanding of the nature, scope and direction of business problems, in which MS/OR specialists could be of considerable help. By the same logic, accountants could be of substantial aid to MS/OR specialists in a wide range of matters containing taxation structure and problems, and financial and non-financial constraints (such as factories' capacities, prices and wages regulations (if any) and acts or guidelines that may be relevant to a particular problem being tackled by MS/OR specialists).

---

33. From an examination of these ED's and SSAPs from the synergistic view of the constituent elements of DMPSSS - particularly accounting, EDP, and MS/OR - as well as the managements that are served by these constituent elements, it can be said that the value of these efforts towards greater uniformity and standardization in accounting practices could have been enhanced by more quantitative formulation. Each of these statements of standard accounting practice deals with a suggested model of an accounting matter to tackle a specific problem. One could imagine the formulation of these efforts in more precise statements involving algorithms, necessary and sufficient conditions, arguments, procedures, variables and parameters, that are more oriented towards problem solving. There is no reason why the formulation of each of these drafts and statements should not reflect conceptual and technological dimensions. That is the conceptualization of the problem subject of the treatment of the draft or standard statement together with the computational procedure using the most feasible and effective technological developments available to accountants today. This, of course, could be a long-term strategy, particularly in view of the past and present educational background of today's accountants.



Aspect  
under  
consideration

Organization

7.4.2. PRESENT AND POTENTIAL "ACCOUNTANTS - E.D.P. and MS/OR SPECIALISTS" INTERACTION: DIAGNOSIS AND SPECULATION

- Much of the effort spent in computing has been, to a considerable extent, devoted to administrative applications, therefore, much more effort is required in some of the other crucial areas of the business; that is production planning and control.
- Steering committees are used to co-ordinate accounting and computer-based activities, and to monitor and control the effectiveness of corporate and divisional organizational resources in relation to accounting and computer-based activities. Such steering committees are formed of top divisional personnel representing finance, data processing, engineering, and administration (MS/OR activities are not directly involved) and are responsible for allocating priorities and for monitoring the development of effective systems according to procedures and rules laid down in corporate policies. The effectiveness of this approach, it is perceived, is limited for a number of reasons, chief amongst them are: (a) Common systems are as yet to be developed on a wider scale, (b) a considerable amount of time on the part of committee members could be more effectively utilized if such an organizational body is relieved to a lesser extent from administrative type of responsibilities. (This is based on the belief that at some point of time attention is inevitably focused on the shape rather than on the essence).
- It has frequently been mentioned that decentralization <sup>of</sup> resources cause undesirable redundancy in D.P. activities and duplication of effort. This is apparent in developing divisional systems without utilizing (as appropriate) similar systems already developed by another (or other) division(s) within the same organization. Centralization of E.D.P. systems has been considered and is favoured in the longer-term policy of this organization. In view of this, the foreseeable future should witness the recognition and the development of an effective scheme to eliminate (or to minimize) a good deal of redundancy existing under the present system that have resulted from developing various systems containing a considerable (built-in) amount of duplication.
- viewing the goals of computing and systems development activities in this organization in a wider perspective, the researcher expects that planned changes into a more centralized structure would replace the current number of problems with some others which might hinder the transition to that planned design. The complex structure of this organization is not flexible enough to facilitate the fast response to environmental changes.

ALPHA



Aspect under consideration

Organization

ALPHA

7.4.2. PRESENT AND POTENTIAL "ACCOUNTANTS - EDP AND MS/OR SPECIALISTS" INTERACTION : DIAGNOSIS AND SPECULATION

- Two notable observations could be mentioned concerning MS/OR activities in this organization; the first is that such activities are carried out on all (corporate/divisional/operating) levels; and the second is that interest in corporate MS/OR projects is an organizational policy. This organization has been very long in the MS/OR field. It has one of the very large MS/OR groups operating in this country. It has formalized accounting and costing procedures, conventions. Senior accountants occupy status positions, and lower grades occupy low status positions. This situation results in a state of possible uneasiness on the part of MS/OR specialists in contacting higher position accountants, and less expected benefits from clerical staff. Given these circumstances, it is difficult to suggest that an effective empirical insight, into the various dimensions of the accounting and costing data and information, has been gained. (The organizational structure and both functions are responsible for such a situation).
- It was pointed out that where the accountant joined the MS/OR team (to learn about what and why type of questions concerning provision of accounting explanations and understanding MS/OR reasoning and foundations) the likelihood of getting more understanding and co-operation between the two functions increased considerably.
- One of the very large projects concerning economic planning aspects, though involving an economist, does not involve finance and accounting specialists. To satisfy and to account for the accounting aspects of the project, some MS/OR specialists involved in carrying out the project have attended appreciation courses in costing system applied throughout the organization.
- Within the framework of the present organizational structure, one might question the extent to which this organization is building up its experience regarding the organization's effective use of MS/OR knowledge; either too abstract thinking at the corporate level or too down-to-earth types of applications at the operating level. However, comparatively speaking the situation is seen to have improved considerably over the last two-to-three years.



Aspect under consideration  
Organization

7.4.2. PRESENT AND POTENTIAL "ACCOUNTANTS - E.D.P. AND MS/OR SPECIALISTS" INTERACTION" : DIAGNOSIS AND SPECULATION

ALPHA

- Cross-functional rotation of accounting, E.D.P. and MS/OR specialists would probably contribute to further effective organizational understanding between the various elements of decision support and information for planning and control systems.
- The answer to the problems raised above (and many others) does not lie in single actions or decisions (for example, cross-functional rotation), but in the recognition that this organization is a system of interrelated and interconnected elements, that is, the control mechanisms are based on the organizational structure affected and shaped to a considerable extent by environmental conditions rooted in history. This has its inevitable implications for organizational effectiveness of decisions support systems containing the constituent functions at various levels.

BETA

- Experienced E.D.P. specialists are not fully utilized to the best interest of this organization. This has led them to feel sometimes annoyed, irritated or frustrated in not being able to contribute more towards more efficient computerization of computer-based business applications.
- Very little effort has been made towards building up the organization's common systems. Computer-based accounting applications are characterized by "tailor-made" individual systems, to satisfy the different needs of different divisions. Subsequently, needs of corporate information would not be easily satisfied - if satisfied at all - and would be based on compilations and computations generated from differently designed systems. (Incidentally, corporate 'or group-systems' are more often than not described as 'weak' ones, and cannot stand the level of rigor and sophistication needed at that level).
- At the same time, the organization's long experience in data processing over many years is not apparently matched by a corresponding competence, and soundness in dealing with even the routine accounting applications, not to mention the non-routine computer-based accounting applications. Briefly described, the organization's experience in these areas is in 'transaction'-oriented applications.

Aspect  
under  
consideration

Organization

7.4.2. PRESENT AND POTENTIAL "ACCOUNTANTS - E.D.P. AND MS/OR SPECIALISTS" INTERACTION" : DIAGNOSIS AND SPECULATION

- There is insufficient co-ordination between the different D.P. specialists within the organization: either between the corporate and divisional levels or between the separate groups located at the corporate level - no matter how different their organizational responsibilities. More specifically, there is an urgent need to find means of co-ordinating efforts of corporate D.P. specialists located at the centre - of the central computer centre and in systems development department - where some users (confirmed by some corporate members) feel that there exists 'dysfunctional' competition between both central sources of D.P. services. (An obvious example has been the selling of 'payroll' packages. Whilst both packages serve the same purpose each group was claiming that its package was the best on the market. This led users to question existing co-ordination policies).
- Notably in the areas of computer-based accounting applications, there have been some major difficulties - such as the excessive time spent on systems development and the underestimated development times, the lack of user involvement and support coupled with the lack of D.P. specialists' involvement in the application areas; and the absence of a staged-approach to the design of systems.
- It appears that centralization of computer resources (the equipment and its auxiliary peripheral units are housed in/bureau<sup>service</sup> offering computer services by means of communication lines for a number of remote terminals) has contributed towards the elimination of redundant hardware and has assisted in reducing undesirable duplication of data processing effort. Also it has probably facilitated the continued expansion of facilities and the use of optimization scheduling methods. This form of organizational design has kept the computer costs under close observation and control. This does not mean that it has no disadvantages. In fact, it has sometimes been pointed out by some internal users of the machine that they feel that more attention is devoted to external users, but - as they emphasized - this is not to say that they are unhappy about the service they are getting. The continued expansion of this central computer facility coupled with the lack of active co-ordination between the highly qualified D.P. personnel (in the computer centre, the systems development, and some divided hisional functions) tend to support the opinion that the computer was acquired - and is being expanded - for 'prestige' purposes. This opinion is reinforced by the fact that the computer has not been effectively used for generating a "true" management information system. Perhaps there is insufficient exchange of D.P. specialists' experience between the group and the trading divisions. This has been expressed by both sides. "More



Aspect  
under  
consideration

Organization

7.4.2. PRESENT AND POTENTIAL "ACCOUNTANTS - E.D.P. AND MS/OR SPECIALISTS" INTERACTION" : DIAGNOSIS AND SPECULATION

BETA (cont'd)

- swapping of D.P. staff round, so people can be seconded to go and work in one of the trading divisions for five or six months, go and work at the computer centre for six months, etc." Although there are bound to be problems, this issue can be agreed upon in the initial contact between the organization and the prospective employee.
- Security of computer-based application was raised by several interviewees who pointed out that they are aware of no adequate measures taken to secure the contents of computer files against either deliberate or unintentional dangers. However, it is the responsibility of the computer centre to make clear to users that this issue is adequately taken care of.
- Practical experience in auditing computer-based accounting applications by accountants is not widely observed. (There is no internal audit function responsible for carrying out these responsibilities. It was felt, however, that this is one of the under-tackled problem areas. Development programs and workshops could be arranged utilizing a generalized software package to fill in this gap serving the dual purpose of demonstrating the usefulness of using the computer as a tool to facilitate the application of audit principles, procedures, and practices on the one hand, and reinforcing the accountants' understanding of E.D.P. concepts and techniques on the other.
- Necessary education and training services are not given sufficient consideration matched with that given to the acquisition of computing power and additional peripherals. The computer centre in collaboration and co-ordination with systems development specialists has an important role to play in that direction. Investment in E.D.P. education and training should be based on proper identification of user needs and relevant programs ought to be designed to meet these needs. (Well-known market research methods could be useful in this respect).

Aspect  
under  
consideration

Organization

7.4.2. PRESENT AND POTENTIAL "ACCOUNTANTS - E.D.P. AND MS/OR SPECIALISTS'  
INACTIION" : DIAGNOSIS AND SPECULATION

BETA (cont'd)

Although the MS/OR function has been kept busy, and scored success on several occasions, it has not developed itself as a necessary function within the organization in a way similar to that of marketing, distribution and accounting for example; some accountants (particularly in the operating/trading divisions) have hardly come across such activities; also, the lack of sufficient co-ordination between MS/OR and group strategy function is noticeable. In addition, little has been done regarding models supporting top management of the organization; an area which is considered to be 'vital' to the success of MS/OR in developing the organization's expertise in applying MS/OR general knowledge to its activities.

Although present 'MS/OR-Accounting' interaction is not characterised by ill-feelings or misunderstanding, and although the MS/OR function has achieved its targets in most cases, it is fair to say that there are wide grounds for the MS/OR activities yet to cover. Examples of these areas are: getting accountants at the divisional level more acquainted with the essence of the MS/OR approach and systems thinking as applied to the organization's main activities on a frequent basis; constructively sharing as a team joint projects on an interdisciplinary basis with colleagues within (and possibly from outside) central services; aiding in building the organization's data base to satisfy adequately divisional and corporate management needs. There is no need to emphasize, however, the importance of establishing information requirements and relationships amongst data elements to be meaningfully used by authorized organizational units. Probably, helping to transfer the current loosely-interrelated transaction-oriented data base into a more meaningful management oriented information systems for planning and control purposes.

Due to the fact that MS/OR is organizationally classified amongst the technical services located amongst computer services, certain disadvantages (as well as some advantages) arise as far as MS/OR specialists are concerned. Amongst the perceived disadvantages are: first, the general belief amongst some users that MS/OR is an extension of the computer department and is concerned with a computer-based cycle of activities (such as systems analysis, flowcharting and programming), which does not help to convey the true message of MS/OR activities and sometimes leads to misconceptions regarding what MS/OR specialists can and cannot do; second, regardless of the perceived image of the computer services (whether good or bad, functional or dysfunctional), perception of the image of MS/OR function would be likely to be associated with that of the computer services; third, it indicates that, organizationally, MS/OR specialists should carry out as deemed necessary



Aspect  
under  
consideration

Organization

7.4.2. PRESENT AND POTENTIAL "ACCOUNTANTS - E.D.P. AND MS/OR SPECIALISTS" INACTION"; DIAGNOSIS AND SPECULATION

BETA (cont'd)

more comprehensive contribution to exploit the opportunities open to them in relation to achieving institutionalization of their discipline. Above all, some of the advantages (of being associated with computer services) would be gained anyway without such association (an example of such an advantage is the access to computing capabilities, facilities and resources).

The researcher should point out, however, that these observations are stated with the fact in mind that having a separate (MS/OR) function with a recognized title and the success of the MS/OR activities are not synonymous.

A possible area of 'accounting-MS/OR' development effort which might take the form of a cross-functional project, is the issue of establishing relevancy and consistency of accounting data and information to be used for building MS/OR types of models. It is not suggested, however, that there would be an absolute degree of relevance and consistency of accounting data and information to meet all the MS/OR needs of such information. What is suggested is that specialists with cross-functional orientation look into the areas of gathering, processing, classification and analysis of information to reduce inconsistencies arising from the inclusion of irrelevant data, or the exclusion of relevant items on the basis of a misunderstanding of the rules followed in preparation of reports.

Disciplined reporting systems based on cycle and response time consistent with users' needs and requirements is an important issue that is in need of further exploration and examination.

GAMMA

There is some evidence to suggest that rotation of accounting, E.D.P. and MS/OR specialists has satisfied its planned objectives in designing and implementing computer-based (routine) accounting applications and building MS/OR models in managerial accounting areas, based on cross-fertilization of interdisciplinary knowledge. The scope of this collaboration could well be applied in the MS/OR - finance and development accounting in relation to relevancy and consistency of accounting data and information.

Participating in formulating the future strategy of this organization is a possible area of synergistic corporate effort amongst accountants, MS/OR and E.D. specialists.

Aspect  
under  
consideration

Organization

7.4.2. PRESENT AND POTENTIAL "ACCOUNTANTS - E.D.P. AND MS/OR SPECIALISTS" INTERACTION": DIAGNOSIS AND SPECULATION

GAMMA

- The mini-MS/OR group of this organization demonstrates the inextensive application of this speciality to its activities. It might also indicate the cautious approach of the management of this organization regarding the acquisition and use of MS/OR knowledge.
- The MS/OR section is sometimes asked to provide computer-programming service not directly involving the use of MS/OR knowledge.
- More managerial involvement in the E.D.P. and MS/OR area is needed for furthering the scope of decision and problem solving support.
- Although the organizational location of E.D.P. activities is in a management services department (whose manager reports to the finance director), it seems that the D.P. function is not biased towards the accounting function (Fundamentally this is different from whether or not accountants in this organization take a broader view of computer-based applications). Furthermore, there is no evidence to suggest that the E.D.P. function is under pressure from a specific functional group within the organisation.
- Interviewed individuals (within finance, accounting and management services including E.D.P. and MS/OR activities) indicated that the present design of these management services is satisfactory in relation to meeting the organization's needs, Development of the new (computer-based MS/OR) projects are not difficult to plan and control under the present system of charging-back the cost of management services which makes it possible to sponsor development projects according to a discretionary system of authorization.
- Current computer-based systems are satisfying their objectives to a reasonable extent. The effects of 'typical' E.D.P. problems (such as turnover of E.D.P. personnel, or maintenance services) are not, by any means, severe.



7.4.3. Lessons to be drawn : some prescriptive suggestions

Basing his observations on the preceding discussions, the researcher outlines some prescriptive suggestions in relation to accountants, EDP and MS/OR specialists' interaction. Much more emphasis needs to be placed on the synergistic contribution towards providing management with relevant, reliable and timely information.<sup>34</sup>

In particular:

- a) accountants need to give sufficient attention to the quantitative approaches to problem solving. The advances in the EDP field have made it more feasible to carry out a vast number of computations involving elements, patterns and relationships amongst the significant variables affecting the future direction of the business.
- b) MS/OR specialists should be able to accept the risk and responsibilities involved in participating materially in the analysis, design, and implementation of decision support systems. MS/OR specialists should explicitly explain what they can and cannot do. They should understand comprehensively their business operations and appreciate perceptually managerial needs and requirements.
- c) EDP specialists need to recognize the implications for widening the scope of their business orientation. EDP specialists should be more loyal to their organizations. They should be more committed to applying sound managerial tools to the control of their activities.

---

34. Some readers are aware of the fact that much lip-service has been paid to terms such as interdisciplinary interaction, management services, and forward interaction in relation to satisfying needs and requirements of management. The emphasis in this research is on the behavioural aspects of the synergistic contribution of accountants, EDP and MS/OR specialists.

Indeed such synergistic contribution needs more than paying lip-service to the collaborative efforts amongst the groups involved. It should not be considered as an example of pie-in-the-sky imagination. Rather a carefully formulated strategy aimed at this synergistic contribution should be designed and implemented. This not only is true on the business enterprise level but also is required on the professional level.



- 7.5. Implications for the organizational effectiveness<sup>35</sup> of Accountants - EDP and MS/OR specialists' interaction : A qualitative assessment. 36
- 

Organizational effectiveness is the orderly arrangement, by which individuals and (functional) groups are persuaded to carry out the allocated responsibilities in an efficient and adaptive manner with adequate success in accordance with some specified organizational standards.<sup>37</sup>

The following concepts stand out to be the necessary and sufficient conditions for achieving such organizational effectiveness in relation to the system of accountants' working relationships and communication patterns with their MS/OR and EDP counterparts:

- the orderly arrangement, systematization, or stabilizing mechanism by which accountants' interaction with EDP and MS/OR specialists is to support decision making and problem solving. The system should be organizationally stabilized; that is the system should be considered by decision makers, individuals and groups involved in the interaction, as an established way of tackling tactical and strategic problems.
  - the ability to persuade or motivate individuals and functional groups to collaborate. Such a mechanism should increase satisfaction of the individual (and by implication should minimize dissatisfaction, frustration and disappointment). Also, such a
- 

35. The Oxford English Dictionary (Vol. III, p.49) defines the term effectiveness as follows:  
 Effectiveness - the quality of being effective.  
 Effective - concerned with, or having the function of carrying into effect, executing, or accomplishing.
36. The scope of studying the concept of organizational effectiveness of an organization as a whole (or of a number of organizations, on a comparative basis) is different from limiting the boundaries of studying such a concept to interfunctional interaction within an organization (though both levels of analysis are highly interdependent). Consequently, adequately tackling the problem of measuring organizational effectiveness on a comparative analysis basis deserves a separate investigation on a wider scope which is beyond that of the present investigation.
37. This is applicable whether one is adopting either the 'goal approach' or 'systems resource approach' in defining effectiveness. For a detailed discussion about these approaches, see e.g. Georgopolous and Mann (1962); Simon (1964); Bowers and Seashore (1966); Seashore and Yuchtman (1967).

mechanism should be double-edged, in that, it should not only contain positive motivations, but it also should provide sanctions for the failure in fulfilling specified organizational objectives.

- the carrying out of allocated responsibilities in an efficient manner with adequate success. One could classify here the components of efficiency into two main categories: (a) intra-functional efficiency; and (b) inter-functional efficiency. The former contains all the functional, structural, and procedural aspects that contribute to achieving all the necessary attributes to being technically efficient within a function. For example, there are certain requirements that should be met in order that the accounting function in an organization be able to fulfil its statutory obligations. By the same logic, there are certain programming specifications and systems analysis requirements (standards, accepted practices, or satisfactory patterns) that should be fulfilled in order that a technically sound computer based system can be designed. The latter (interfunctional efficiency) contains all those considerations that make the particular system under consideration inter-functionally acceptable based on mutual inducement and reconciliation of conflicts. Immediately, the concepts of over-interfunctional efficiency and under interfunctional efficiency, become clear and relevant. An analysis of the over-or-under interfunctional efficiencies may be useful in creating a continuous dialogue between the functions concerned. It is worth mentioning, however, that such concepts and their analysis and interpretation should be based on the flexibility and understanding of the desired objectives in view.
- the quality of being adaptive to contain, and react to, relevant changes and circumstances.



- the quality of being in accordance with some specified organizational standards. Since growth and survival are longer-term objectives, common to most business organizations, specified standards should be in accordance with such longer-term goals. Conformity to organizational goals is a decisive criterion upon which organizational effectiveness of a particular system is evaluated. This dimension of the concept is expected to correlate positively with the dependent variable organizational effectiveness of a particular system. Also it is expected to overlap with organizational effectiveness of a particular system. Also, it is expected to overlap with the inter-functional efficiency indicators.

Indeed, there are some difficulties in the operationalization of the dependent variable 'organizational effectiveness' and the expected independent variable described above. What measures should be taken to quantify the concept of effectiveness? Quoting in particular the case of accountants' interaction with their EDP and MS/OR colleagues, what means could be operationalized to measure their effective support to the management of their organizations? If we suggest that profit could be used to measure organizational effectiveness of an organization (as it is sometimes argued), could we differentiate between those amounts of profits resulting from the collaborative effort of both accountants and EDP specialists in computerizing a set of accounting activities and those amounts of profits resulting from other such service-type activities? Could we control values of the independent variables that are expected to correlate with the dependent variable? These, and others, are some of the questions that indicate some of the difficulties associated with the operationalization of this dimension of organizational analysis. However, such analysis should be considered as a means to an end; that is, sufficiently satisfying the objectives of the particular research project under consideration (i.e. the effectiveness of accountant - EDP, and MS/OR specialists' interaction in the case of the present research).

Due to the fact that this research is concerned with exploring, discussing and diagnosing various patterns of communication and working relationships (and their implications for the improvement of organizational problem solving and decision making processes) the following observations can be made:

- i) It is interesting to note that none of the three participating organizations would score highly either on the organizational effectiveness or the organizational ineffectiveness in relation to the total outcome of the system of accountants - EDP and MS/OR specialists' interaction if such a total outcome were to exist. In other words, the researcher can observe neither of the two extremes. This is a clear indication that the concept of organizational effectiveness of the interaction is a relative one. Each of the participating organizations might score highly on some dimensions whilst having a low score on others.
- ii) considering each of the functional groups (accountants, EDP or MS/OR specialists), it is fair to say that the intra-functional efficiency is (ranging from fairly to very) high. All of the three functions in the participating organization are attempting to achieve adequate success in maintaining their procedural and structural practices and conventions. Accountants are trying to keep up with statutory requirements and deadlines that play a noticeable role in their working environments. Very few MS/OR models would be rejected on technical grounds (i.e. the processes of translating a problem into a mathematical model). Also, the technical considerations in designing a computer-based system (i.e. process of translating programming specifications into machine-readable form) are mostly observed. Problems and difficulties arise in the field of communication.



iii) interestingly enough, the computer is used mainly to increase the speed, accuracy and efficiency of processing volumeness of 'routine' accounting activities. The computer is being used successfully, to a large extent, to handle many of the book-keeping activities that used to be handled manually before the mechanization and then the electronic automation processes. Sales ledger, stores ledger, purchases or bought ledger, payroll, and nominal ledger are obvious examples in this respect.<sup>38</sup>

The evidence suggests that (management or financial) accountants have not 'considerably' utilized the EDP potentiality for managerial problem solving and decision making purposes. This is particularly obvious in the non-routine investigations and analyses in relation to areas such as pricing, cost-volume-profit relationships, and exceptional reporting. Meanwhile, it appears that some accounting functions or groups or accountants (however small in number) are beginning to explore these areas to develop computer-based systems in budgeting, reporting and control.

Furthermore, the evidence indicates that the introduction of computers in the accounting areas of responsibility has not made feasible the wider application of the outstanding concepts of 'opportunity' costing, 'differential' or 'incremental' costing, and probabilistic analysis. Educational and training systems, and background personal factors might be considered as highly relevant factors to this phenomenon.

While the argument goes on (whether or not the accountant should be, as a user, familiar with the nature and implications of the recent technological advances in the EDP field) it is becoming increasingly clear that the less the accountant's knowledge and familiarity in that

---

38. This does not mean, however, that all problems associated with conversion processes are over. In conversion processes - whether from manual, mechanical, one form of machine readable terms to another - several problems are still being encountered and repeated.

direction, the less able he will be in either contributing towards controlling EDP resources or utilizing effectively computing resources available to him.

- iv) If one accepts the logic and dichotomy of programmed and non-programmed decisions classified into traditional and modern approaches<sup>39</sup> (quoted in the table ( 7.2. ), it is possible to highlight an area of difference in the attributes and consequences of the accounting and MS/OR functional systems. Interviews with specialists from both functional areas clearly demonstrate that it is the exception rather than the rule to find accountants applying modern approaches in supporting their managements in decision making. Exceptionally few accountants resort to modern approaches of problem solving and supporting decision making. Standard conventions, common expectations, and well-defined informational channels are the most commonly applied approaches to routine and repetitive processes. Judgment, intuition, and rules of thumb are common approaches adopted by accountants in handling ill-structured problems. In contrast, the majority of MS/OR specialists are highly involved in the modern approaches either for programmed or non-programmed decisions. Education and training, organizational structure, and managerial involvement are highly relevant factors contributing to the differences described above.

---

39. Discussion of these approaches is not presented with any moral judgment (good or bad) in mind; it is presented merely to point out areas of differences in attributes and resultant systems or models of both functional groups (accountants and MS/OR specialists). It is needless to emphasize the fact that without the adequate application of modern approaches to suitable problem areas, one can hardly expect any effective outcome from such adoption.



TYPES OF DECISIONS

DECISION-MAKING TECHNIQUES

Traditional

Modern

Programmed:

Routine, repetitive decisions

Organization develops specific processes for handling them

1. Habit

2. Clerical routine: standard operating procedures

3. Organization structure: Common expectations  
A system of subgoals  
Well-defined informational channels

1. Operations Research

Mathematical analysis  
Models  
Computer simulation

2. Electronic data processing

Non-programmed

One-shot, ill-structured novel, policy decisions

1. Judgment, intuition, and creativity

2. Rules of thumb

3. Selection and training of executives

Heuristic problem-solving techniques applied to:

(a) training human decision makers

(b) constructing heuristic computer programmes

Table 7.2, Source: Simon (1965, p.62)

Basing his conclusions on the preceding discussion, the researcher is able to formulate the following propositions regarding the interactions under study, and their implications for the effectiveness of DMPSSS. 40

Proposition 7.1. Organizations whose DMPSSS are based on a high degree of horizontal understanding (between accountants, EDP and MS/OR specialists) are more likely to have a high degree of effectiveness concerning their DMPSSS.

Propositions 7.2. Organizations whose DMPSSS are based on a high degree of vertical understanding (between accountants, EDP and MS/OR specialists on the one hand and corresponding managerial levels on the other) are more likely to have a high degree of effectiveness concerning their DMPSSS.

Proposition 7.5. Organizations whose DMPSSS are based on a high degree of co-ordination (between accountants, EDP and MS/OR specialists - the constituent foundations of DMPSSS) are more likely to have a high degree of effectiveness concerning their DMPSSS.

Proposition 7.6. Organizations whose DMPSSS are based on a high degree of innovative structure are more likely to have a high degree of effectiveness concerning their DMPSSS.

Propositions 7.7. Organizations whose DMPSSS are based on a high degree of disciplined, analytical, and forward looking reporting systems, are more likely to have a high degree of effectiveness regarding their DMPSSS.  
7.9.

40. An implicit assumption is made throughout the analysis, namely that organizations that have effective DMPSSS's are more likely to have a high degree of effectiveness than those organizations whose DMPSSS's are ineffective (or less effective). Consequently one's attention is directed to studying the effectiveness of DMPSSS's. In doing so, consideration should be given to managements' viewpoints in conjunction with those of accountants, EDP and MS/OR specialists, and their perception regarding the quality of the overall (as well as the functional or managerial level) information support. That is, emphasis should be placed on the quality of accounting information and support, the quality of the EDP support, the quality of the MS/OR support, and the quality of the overall information and support.

In relation to this, the researcher has availed himself of the growing body of knowledge regarding organization theory in general and organisational effectiveness in particular. See e.g. Georgopolous and Mann (1962); Simon (1964); Zetterberg (1965); Bowers and Seashore (1966); Seashore and Yuchtman (1967); Price (1968); chapter two of the present research.



- Proposition 7.10. Organizations whose DMPSSS are based on a low degree of alienation featuring E.D.P. and MS/OR specialists' activities, are more likely to have a high degree of effectiveness concerning their DMPSSS.
- Proposition 7.11. Organizations whose DMPSSS are based on a high degree of rotation of E.D.P. and MS/OR specialists, are more likely to have a high degree of effectiveness concerning their DMPSSS.
- Proposition 7.12. Organizations whose DMPSSS are based on a high degree of interdisciplinary interaction in tackling the crucial areas of the business, amongst E.D.P., MS/OR specialists' and accountants are more likely to have a high degree of effectiveness regarding their DMPSSS.
- Propositions 7.13. Organizations whose DMPSSS are based on a low degree of pedantic, dogmatic and rigid attitudes of accountants in relation to the varied needs of managements and other internal users are more likely to have a high degree of effectiveness concerning their DMPSSS.
- Proposition 7.14.
- Proposition 7.15.
- Proposition 7.16. Organizations whose DMPSSS have a high degree of conformity to specified organizational objectives are more likely to have a high degree of effectiveness concerning their DMPSSS.
- Proposition 7.17. Organizations whose DMPSSS have a high degree of clarity of specified organizational objectives are more likely to have a high degree of effectiveness regarding their DMPSSS.
- Proposition 7.18. Organizations whose DMPSSS have a high degree of systematization are more likely to have a high degree of effectiveness regarding their DMPSSS.
- Proposition 7.19. Organizations whose DMPSSS have a high degree of persuasion (motivations and sanctions) are more likely to have a high degree of effectiveness concerning their DMPSSS.
- Proposition 7.20. Organizations whose DMPSSS have a high degree of adaptiveness (to react to organizational changes or circumstances) are more likely to have a high degree of effectiveness concerning their DMPSSS.

The researcher believes that subjecting the above set of propositions to future analysis by inclusion of more cases is an important step towards our understanding of the concept of organizational effectiveness of DMPSSS and its implications for overall effectiveness of business organizations.



Aspect  
under  
consideration

Organization

ALPHA

### 7.5. ORGANIZATIONAL EFFECTIVENESS OF ACCOUNTANTS - E.D.P., MS/OR SPECIALISTS' INTERACTION": A QUALITATIVE ASSESSMENT

The orderly arrangement by which accountants and E.D.P. personnel have satisfactorily computerized routine accounting activities is not supported by a similar arrangement either between accountants and E.D.P. specialists or between accountants and MS/OR specialists concerning the non-routine accounting and management oriented analyses and reporting activities. The extent to which this statement applies differs according to the organizational level in question. For greater effort is required for the systematic design of mechanisms that would contribute to more analysis and interpretation of problems, performance and results, for the purposes of planning and control based on the genuine appreciation and application of systems analysis and systems modelling. Although there has been some improvement in the last year or so, the road to achieving the desired organizational effectiveness in relation to the contribution of these three functions (accounting, E.D.P., and MS/OR) is full of difficulties and obstacles. The structure of this organization considerably affects the current and potential contribution of these support functions to problem solving and decision making.

Without underestimating the complexity of this organization's structure, the speed at which it reacts to environmental changes is relatively slow. Taking the functional groups contained in the interaction under study (and this is highly applicable to the accounting function, and to a lesser extent to E.D.P., MS/OR) it is not difficult to see how less adaptive this organization is.

DMPSSS in this organization is perceived to be based on the following:

- horizontal understanding between accountants and E.D.P. specialists is mostly featured by - a high quantity of functional and social interactions, mainly directed at the routine type of accounting applications containing highly redundant data
  - a low degree of understanding between accountants and MS/OR specialists due to a variety of reasons (chief amongst them are: differences in backgrounds, differences in time horizon, differences in organizational structure).
- Interdisciplinary interaction of projects is the exception rather than the rule.



Aspect  
under  
consideration

7.5. ORGANIZATIONAL EFFECTIVENESS OF 'ACCOUNTANTS - E.D.P., MS/OR SPECIALISTS' INTERACTION": A QUALITATIVE ASSESSMENT

Organization

ALPHA (cont'd)

- vertical understanding between accountants, E.D.P. and MS/OR specialists with their managements is highly characterized by position based authority. Also, accountants are perceived to occupy a relatively high status due to historical factors. Furthermore, without underestimating the complexity of the nature and scope of decision making and problem solving in this organization, many of the decisions regarding pricing, formulating policies and strategies, are not based principally on the collaborative efforts of accountants, E.D.P. and MS/OR specialists.
- a low degree of co-ordination between accounting and MS/OR activities.
- a low degree of innovative structure.
- a relatively high degree of alienation of MS/OR activities.
- a high degree of discrepancy between the attributes and outputs of accounting, E.D.P. and MS/OR functions.
- inconsistent system of persuasion (excessive emphasis on sanctions with less emphasis on motivation).
- a low degree of adaptiveness.

BETA

DMPSSS in this organization is perceived to be based on:

- insufficient horizontal understanding between accountants and MS/OR specialists. The successful application of MS/OR projects in some areas needs to be explored and applied in many other areas throughout this organization.
- lagged horizontal understanding between accountants and E.D.P. specialists in the utilization of the computing and systems development in this organization for the generation of disciplined, analytical and forward looking reporting systems. Both parties (as well as their corresponding managerial levels) share the responsibility for such a situation.

Aspect  
under  
consideration

Organization

7.5. ORGANIZATIONAL EFFECTIVENESS OF "ACCOUNTANTS - E.D.P., MS/OR SPECIALISTS' INTERACTION": A QUALITATIVE ASSESSMENT

BETA (cont'd)

- the lack of clarity of organizational goals and subsequently the low degree of conformity to organizational objectives, (The organization's position regarding its computing, systems development, and the associated systems of charging internal customers for their use of these resources are clear examples of such vague objectives).
- a low degree of co-ordination between accounting, E.D.P. and MS/OR activities on most organizational levels.
- a high degree of innovative structure.
- a high degree of motivation.
- a high degree of adaptiveness.

GAMMA

DMPSSS in this organization is perceived to be based on:

- a relatively high degree of horizontal understanding between accountants on the one hand and E.D.P. and MS/OR specialists on the other.
- a high degree of rotation of and interchange amongst accountants, E.D.P. and MS/OR specialists in the areas of interdisciplinary interactions for tackling the crucial areas of the business.
- a high degree of co-ordination between MS/OR specialists and (mostly) management accountants, matched by a high degree of co-ordination between accountants and E.D.P. specialists.
- a high degree of innovative structure.
- a high degree of motivation.
- a high degree of adaptiveness.



## Summary

This chapter has presented an analysis of dimensions of accountants - EDP and MS/OR specialists' interaction as a basis for supporting managements of their organization. The interaction was viewed in its organizational context through exposing the circumstances and conditions affecting and shaping the interaction in participating organizations.

Having described how this part of the survey was initiated, a summary of organizational background information (such as ownership, degree of competition, technology, financial indicators, key problems of the organization, and organization structure) was discussed. This was then followed by an examination of the researcher's observations featuring accountants - EDP and MS/OR specialists' interaction where the researcher avoided (as much as possible) making the history of each business the dominant element in the analysis. Historical factors and circumstances were discussed only insofar as they were felt to be a necessary condition in analysing the interaction under study. Apart from drawing forms of organizational design of accounting, EDP and MS/OR activities (as viewed by the researcher to form a fundamental part of decision support systems), major issues of current concern that are believed to have some implications and effects on the functioning of these activities were then discussed. Examples of these issues are transfer pricing policy for EDP and MS/OR activities, scope of computer-based applications, and the organizational position towards current developments in relation to data bases and the idea of information systems for management.

Looking into the future the researcher, utilizing current relevant literature, has attempted to evaluate present and potential accountants - EDP and MS/OR specialists' interaction in the participating organizations.

Each of the participating organizations has its weaknesses, limitations and points of strength that could be further explored for future directions of possible change. None of these organizations is considered as a bad example, nor as a perfect application of present knowledge. Furthermore, such assessment and prediction could be used as a basis for further discussion in reviewing present structures and studying future designs.

Finally, since decision making and problem solving support systems are not ends in themselves, but means to contributing towards achieving organizational effectiveness of their concerns they then were related to such a conceptual framework by means of a qualitative analysis of the accountants - EDP and MS/OR specialists' interaction. The outcome of such an assessment was a set of propositions framing the relationships and consequences of the main variables contained in the present analysis.



## Chapter Eight

### Accountants - EDP specialists' interaction: The analysis of interdependence.

#### Abstract.

- 8.1. An investigation into the factors influencing accountants - EDP specialists' interaction.
- 8.2. Further analysis of the empirical evidence.

#### Summary.

Abstract

This chapter continues to explore and analyse the major dimensions affecting Accountants - E.D.P. specialists' interaction. It is based on views and attitudes of accounting and E.D.P. specialists in participating organizations (derived from interviews) as well as drawing on an additional sample of accounting and E.D.P. specialists (derived from questionnaire responses).

It contains two main sections. Section 8.1. subjects the valid observation of the domain of the behavioural indicators to methods of factor analysis for an investigation into the factors shaping the interaction between the two groups involved. An exploration of such factors might be useful in evaluating similar interactions, and suggesting directions for possible ways of furthering mutual understanding between these two functional groups for more organisationally effective interactions. The application of factor analysis methods reduces the discussion to a considerably smaller number of dimensions. These would be used as the focus in considering the design or redesign of such organizational interactions.

Section 8.2. examines the direction of the empirical evidence in relation to some of the factors resulting from the analysis made in section 8.1. For the purposes of the analysis in section 8.2. the original observations are recoded (from a seven-point scale to a three-point scale). This is to summarize much of the detailed information concerning each indicator. Furthermore, use is made of results of applying the T-Test to answering the question of statistically significant differences between the two groups (accountants and E.D.P. specialists).



## 8.1. An investigation into the factors influencing 'Accountants - E.D.P. specialists' interaction.

The set of data with the space of 59 indicators (of the relationships between accountants and E.D.P. specialists) is subjected to factor analysis<sup>1</sup> to generate some interpretable constructs that might be contained in the relatively large bodies of intertwined observations.<sup>2</sup> The results of such factoring is presented in some detail in this section.

The first sub-section (8.1.1.) presents an overview of the (first-order) factor analytic solutions. Experimentation has been carried out by subjecting the initial solution to orthogonal and oblique models to provide for more clarity with regard to the important factors<sup>3</sup> affecting accountants E.D.P. specialists' relationships. The second sub-section (8.1.2.) aims at analysing those factors and their component indicators. The third sub-section (8.1.3.) is an examination of the a priori behavioural indicators or assumptions based on the direction of the empirical evidence or assumptions based on the direction of the empirical evidence.

- 
1. The computational algorithm used for the purposes of this analysis is the BMD - X72, factor analysis program (see, Dixon (ed.), BMD-Biomedical Computer Programs, 1973), revised 1972 for the 1900 series of computers by Loughborough University computer centre in co-operation with NAG (Numerical Algorithm Groups).
  2. Due to the fact that the results of factor analysis before rotation are less specifically clear than is desired, the following discussion is based on factor matrices after rotation.
  3. The term "important" has two main aspects. The first is the practical significance for the domain of interest under consideration. The second is the statistical significance in terms of the relevant statistics (e.g. eigen-values, the variance summarized by the particular solution). As for the first aspect, detailed analysis of relevant empirical evidence is presented in sub-section 8.1.2. as well as section 8.2. which presents further examination of the indications from the empirical evidence in relation to each factor. As for the second aspect, the amount of variance accounted for the extracted factors and summarized by the particular solution is reported following the results of factor analysis (sub-section 8.1.1.). In relation to this, Pearson's product moment correlation coefficients, eigen-values, cumulative proportion of total variance, and factor matrix before rotation, are reproduced in tables 60-a, 60-b, 60-c, 60-d, respectively, in Appendix B, # 2.1.

8.1.1. Factor analytic models<sup>a</sup>

Descriptive Interpretation of Factors <sup>b</sup>	Orthogonal (uncorrelated-factors) <sup>c</sup>				Oblique (correlated-factors) <sup>d</sup>			
	Factor number	Indicator number	Loadings	Communality $h^2$	Factor number	Indicator number	Loadings	Communality $h^2$
Good versus bad image of E.D.P. specialists	I	34	.79	.75	XVI	34	.74	.75
		36	.72	.72		36	.67	.72
		35	.50	.74		35	.58	.74
High versus low degree of accountants' appreciation of E.D.P. benefits and limitations	II	1	.76	.78	X	1	.72	.76
		4	.70	.66		3	.72	.70
		3	.70	.69		4	.60	.70
		6	.56	.60		6	.50	.60
High versus low degree of co-ordination	III	30	.76	.73	XII	46	.53	.72
		16	.58	.61		16	.52	.61
		40	.53	.69				
		23	.51	.60				
High versus low degree of senior management understanding	IV	15	.65	.64	V	15	.71	.64
		14	.63	.60		14	.56	.60
		22	.61	.70		22	.51	.70
Extensive versus limited business orientation of E.D.P. specialists	V	8	.75	.75	VII	8	.75	.75
						30	.68	.73
						23	.60	.60
						27	.54	.76



Descriptive Interpretation of Factors	Orthogonal (uncorrelated-factors) solution <sup>c</sup>				Oblique (correlated-factors) solution <sup>d</sup>			
	Factor number	Indicator number	Loadings	Commun-ality h <sup>2</sup>	Factor number	Indicator number	Loadings	Commun-ality h <sup>2</sup>
	Efficient versus inefficient computerization activities	VI	57 53 44 59	- .79 - .75 - .66 - .61	.77 .77 .66 .74	II	57 53 44 59	- .83 - .79 - .51 - .54
Positive versus negative interaction	VII	18 19	.75 .67	.69 .76	I	18 19	.73 .53	.69 .76
Competent versus incompetent application of E.D.P. transfer policy	VIII	50	.81	.69	VIII	50	.81	.69
Desirability versus undesirability of users' being seconded to their computer-based projects	IX	58	- .80	.73	XIII	58	- .82	.73
Explicitness versus ambiguity of E.D.P. objectives	X	38	.72	.69	XI	38	- .81	.69
Serious versus superficial effort to professionalize E.D.P.	XI	54	- .80	.71	IV	54	.83	.71
Fruitful versus unfruitful interfunctional rotation	XII	51 45 55	- .68 - .66 - .51	.60 .68 .72		51 45	- .68 - .65	.60 .68

Descriptive Interpretation of Factors	Orthogonal (uncorrelated-factors) solution <sup>c</sup>				Oblique (correlated-factors) solution <sup>d</sup>			
	Factor number	Indicator number	Loadings	Communality $h^2$	Factor number	Indicator number	Loadings	Communality $h^2$
Low versus high pedantic attitude on the part of accountants	XIII	49	.70	.69	VI	49 2	.74 .66	.70 .66
Sufficiency versus insufficiency of applying reporting by exception to computer-based application	XIV	31	.65		XIV	31	.65	.60
Narrowness versus wideness of the gap between achievements and users' expectations regarding their computer-based applications	XV	52	.75	.70	XV	52	.79	.70
Effective versus ineffective control of E.D.P. activities	XVI	32	.68	.71	III	33 25 32	.64 .58 .56	.76 .74 .71

a. R-factoring is employed. The correlation matrix contains Pearson's product moment correlation coefficients leaving unities in the main diagonal as initial communality estimates. (Table 60-a, appendix B, #2.1.).

b. Factoring was stopped when all factors whose eigenvalues (sum of squares) are greater than one are factored. The variance summarized by the sixteen factors (whose eigenvalues are greater than one) represents 68 per cent of the total variance in the fifty-nine indicators.

c. The Varimax method (for simplifying factors) is used.

d. Oblique rotation for simple structure (with gamma equal to 0.000) is employed.



Being aware of the fact that the analysis is based on a set of imperfect data, the researcher has examined the input data with several combinations of factor analysis procedures and options. The following points are the outcome of the further experimentation:

1. Factor labelled high versus low degree of coordination (number III under the orthogonal solution - see above results) does not have the same denotation under different factor-analytic procedures.
2. Using a matrix of Kendall rank order correlation coefficients (table 61, appendix B, #2.1.) does not materially change the conclusions drawn from the above results. Factor analysis results obtained by employing Kendall's rank order correlation coefficients yield the same number of extracted factors. Most of the factors have the same interpretation. The factors contained in the following table represent a noticeable variation from the results reported above.

Descriptive interpretation of factor	Factor number	Indicator number	Loadings
High versus low utilization of computational power for financial modelling.	VI	44 24	- .61 .52
Sufficiency versus insufficiency of accountants' involvement in E.D.P.	VII	6 56	- .79 - .53
Maturity versus immaturity of E.D.P.	X	47 39	- .65 - .58
Sufficient versus insufficient E.D.P. - accounting liaison.	XII	55 16 20	.59 - .57 - .55

3. A number of factors seem to show little change under different factor analytic options. These factors are:
  - good versus bad image of E.D.P. specialists;
  - high versus low degree of accountants' appreciation of E.D.P. benefits and limitations;
  - high versus low degree of senior management understanding;

- extensive versus limited orientation of E.D.P. specialists;
- efficient versus inefficient computerization activities;
- positive versus negative interaction;
- fruitful versus unfruitful interfunctional rotation;
- low versus high pedantic attitude on the part of accountants;
- effective versus ineffective control of E.D.P. activities.

4. Many of the one-indicator factors do not stand severe tests. Their associated indicators seem to either load on other factors or fail to load at all. Using squared multiple correlations as initial communality estimates, for example, eliminates some of the one-indicator factors.

Having said that, it is important to emphasize that degree of confidence in the above results can be established by examining the relevant empirical evidence as well as subjecting the area under investigation to further study and analysis.



8.1.2. On the interpretation of the important factors influencing Accountants - E.D.P. specialists' interaction: a discussion.<sup>4</sup>

---

As the accountants - E.D.P. specialists' domain of interest has undergone little empirically based systematic examination, the researcher has employed factor analysis models for the sake of explaining some of the contained complex interrelationships. As for the practical significance of the results reported above, the following empirical evidence is relevant:<sup>5</sup>

First: discussions with several members of the accounting and E.D.P. functions in participating organizations support the findings of this factoring analysis. The image of E.D.P. specialists is one of the factors affecting the inter-functional working relationships. Several excerpts from such discussions are useful in this respect:

A systems manager describes the image of his function as seen by accountants who would subscribe to the following view:

" ... the systems people have no concept of the importance of cost; they come up with their grand plans that are going to cost n-thousands and they don't seem to understand that this business cannot afford that. Quite apart from that, the one thing you can be sure of with computer people is that if they tell you it is going to cost 5-thousands you're not going to get away with 10-thousands. They can never provide accurate estimates, they always underestimate what it is going to cost."

---

4. This subsection focuses on the results of the factor analysis models employed. It seeks to examine whether these results have any meaningful empirically-based evidence to support them. Consequently, the researcher discusses some of these factors and the relevant evidence.
5. The evidence contained in this (and the following) chapter(s) is the outcome of the researcher's observations in participating organizations based mostly on detailed interviews. Comments, opinions and views are expressed by subjects taking part in this study and presented in a manner which does not in any way affect the confidentiality principle adopted throughout this research project. Where the discussion is an excerpt from the re-

- A programming manager describes the image of (D.P.) specialists (systems analysts and programmers) as seen by users.

"I think that users think (a) we are very expensive people to pay for who charge them a lot of money and who produce for them systems that are difficult to use, and don't really produce the results that they want. They think we're always trying to sell them something they don't want; and (b) there is a tendency for them to think that we are hardly working for the same organization as them. We're in fact working for Kappa, but they think we're somebody who's come along and trying to sell them something.

I certainly think that they think that we are not in touch with their problems, that we vaguely understand the computer, but don't understand the business".

- A (chartered) accountant describes his view of the image of systems (D.P.) people as follows:

X: "I think as we see them, we would not - in any way - regard them as fully professionals, in the same manner as we regard accountants. In other words, we regard accountants - that's ourselves - as fully professional people. We will have accountants and doctors as highly professional as highly reputable people. These systems people are beginning to come up with little thinking, but they have some way to go. We don't fully understand what professional qualification they do have - if any. We have a horrible suspicion that they just don't have any proper training. The fact they don't have any sort of institute in a manner similar to accountants and lawyers .....

At the moment, the feeling is that these are newcomers, they are good technicians; they know the stuff. As a body, they have yet to be recognised; they have yet to really arrive. Until that happens, we do not fully take them as equals. We regard engineers perhaps, yes, they go through a very rigorous period of training. We think differently from engineers, but they are a professional body, but computer people and systems people are not quite yet professionals. But, they're coming along, give them a bit of time. Yes, we tolerate them, they do a very good job.

---

searcher's dialogue with an interviewee, the following identities are always assumed: I, is referring to the Interviewer (i.e. the researcher); and, X, is referring to the interviewee. These views and opinions are scrupulously selected to represent (in most cases) a group of similar views.



But, they are sort of technicians. We don't fully recognize them as professionals in the standards and status as we see it. However, it is coming. To be honest, it hasn't really come yet. There are a few people whom we have met, who are really competent and good. We feel that amongst these D.P. people, we haven't yet fully distinguished between those who are the technicians and those who are the professionals. They're sort of merging; the people who do the different type of work: programming, systems design, etc. Until this begins to come fully clear, then you cannot distinguish the people who are fully professionals. Once they do come to this, then they will get the full recognition.

In this organization, I think they (D.P. people) have on the whole a stronger position than others. And certainly they are developing. In another few years, they will be recognized at an even higher level than they are at the moment. But the idea of a systems person getting to the higher ranks of management would be unheard of, whereas for accountants to get to the higher ranks is absolutely essential.

I: Looking from the other point of view, what do you think systems or D.P. people think of accountants?

X: "I am quite sure they think of accountants as absolute 'beasts'. This is not different from what most other functions think of accountants."

I: Why do they think of accountants in that way?

X: "I think they find accountants rather restrictive. I imagine that the systems people like to feel creative in some ways; and they feel that accountants have been always restrictive, in holding down costs - as to what they can do and also in keeping to the traditional approach. Accountants would argue that there are very good reasons why things have to be done the old ways; there are both legal and financial reasons. I think sometimes the systems people might feel that this is a restrictive approach.

Maybe to some extent they're right; maybe we are a little bit restrictive. I would accept that. But it has protected them in a way, by keeping them on a fairly strict financial approach, and keeping them from getting involved in things that are totally ridiculous.

- A regional/works accounting manager describes the difference - as he sees it - between D.P. specialists working closely with him and those who are located at the centre:

"As far as the accountant's view of E.D.P. specialist is concerned, it falls into two classes: the ones that I work with in the region I have a very good opinion of because one learns to talk the same language. The ones at the centre appear to me to work rather in isolation. They probably think that they can design a system and hand it over. They then - shall we say - opt out and leave the user to sort it out".

Meanwhile, a divisional accounting manager evaluates accountants' image as seen by other managers, as dependent on those managers' orientation towards financial issues as well as on the accountants' ability to move away from book-keeping outlook. He pointed out that:

" ... a lot of people see us as scorers - I was once called a scorer, and I didn't like that, because all of what I was doing was recording facts. But, some managers - I like to think of the more enlightened ones - do look upon us as people who can help them run the business better . . . . However, it is coming more to the interpreter situation than it was ... It is becoming rapidly so because of the pressure that's brought to bear on profits and cash."

It is apparent that E.D.P. specialists' ability to plan and control their activities; their ability to 'sell' their function; the understanding on their part of what is required from them to user departments; their adoption of 'professionally' accepted practices; and their systems of education and training: are amongst the components affecting the formation of the type of functional image under consideration.

On the other hand, accountants who give more attention to analysis and interpretation of their data, and who take wider view of their responsibilities are likely to be more effective in their organization than those who hold very narrow views of their activities and the implications of their systems.



The importance of such a factor is that it could be thought of as one on the behavioural indicators parameterizing the space of accountants' working relationships with their computing colleagues.

Meanwhile, image exchanging in a constructive manner is a possible approach for purposes of conflict resolution.

Second: In terms of the degree of accountants' appreciation of benefits and limitations of E.D.P., the empirical evidence offers varied views. Although there are no unanimous agreements amongst the surveyed individuals that accountants should have an appreciation of such knowledge, the message of the majority supports the view that it is desirable that accountants should be familiarized with D.P. knowledge. Perhaps the reasoning supporting the varied views is more important for the purposes of this study than giving a decision strongly supporting any one direction. On the one extreme, there is a management accountant who strongly opposed knowing anything about E.D.P. systems or problems. He holds the view that accounting is restricted to what he had been able to learn twenty years ago. He expressed the logic behind this attitude as follows:

"... I believe you should always do a job which you have been trained to do, to the exclusion of anybody else's. I certainly have no intention of understanding - if I can possibly avoid it - the problems that they (E.D.P. specialists) 've got, because if you understand the fact that they've got problems, you will have sympathy for them. Therefore I don't want to have any sympathy for them because they have not been doing what I expect them to do".

For the purposes of further exploring some of the roots and foundations of this attitude, the researcher asked the same management accountant about his view with regard to the best way to bring about effective working relationship between himself and the systems people (located on the same floor). He pointed out that he should know nothing about

E.D.P. except for the output of the system that he could use manually.

He asserted that he should have no involvement in E.D.P. The discussion between him and the researcher continued to throw some light on his attitude as follows:

X: " ... I cannot think of any one individual feature which would make our job more effective other than a completely reliable computer performance. That to me is the crux of the matter."

I: What exactly do you mean here by computer performance? Do you mean the performance of the machine itself or the quality of the system in use or what?

X: "I consider them both together. If the computer breaks down, I am not the least concerned whether it is a breakdown caused by machinery or it is a breakdown caused by a failure of the system to operate correctly. If I am expecting a report this morning and I don't get it until this afternoon, then I have got staff this morning doing nothing theoretically until something turns up in the afternoon. The machine can produce its report tomorrow morning and that's O.K. I've got staff now, I would not be able to cope with tomorrow, I should've done the work today. This's always been our problem. We cannot and never have been able to rely upon the machine to produce anything by the date which it was expected to produce it. Obviously they meet it near enough, quite often - perhaps twenty-four hours. But that's beside the point as far as we are concerned, we haven't the ability to manually do our jobs when the machine is late. The machine has the ability to catch up when it is late, because it has got the power to do so. This is the major factor as far as our work goes".

This view:

- demonstrates the gap between E.D.P. and accounting that might exist due to the lack of involvement, that might be the product of many (other background, organizational and environmental) factors;
- explains the fact that stereotyped behaviour is not necessarily associated with one category of accounting speciality. Similar behaviours may be observed on individuals from any of the major accounting categories (financial, management, chartered or otherwise).



On the other hand, there are those accountants who believe in the importance of getting accountants to appreciate the benefits and limitations of E.D.P. A typical view of this group is expressed by an accounting manager who describes his experience before and after getting himself acquainted with E.D.P. knowledge. His experience implies lessons to be learnt and implications for the future education of accountants; amongst them is the fact that considering the computer as a 'black box' does not bridge the communication gap:

" ... I personally went to an evening school to learn FORTRAN programming, because of my desire to know more about computers. It was a 'black' box; and I didn't know what happens from the input to the output. To some extent I was trying to bridge that gap. I am not proclaiming to be a programmer now; but at least I understand some of the problems that these specialists have. I think the day will come possibly in ten, fifteen or in twenty years hence - I hope it's sooner than that, and accountants and the computer people will really see it not as two different functions, but part of the one function".

In order to appreciate the importance of getting accountants to appreciate the benefits and limitations of computing, it is useful to discuss what have been the effects of computers on accountants. The following views have been expressed when asked to describe the effects of E.D.P. on accountants in his organization a systems manager (with an accounting background) explained that:

" ... it has relieved them very little. I think in general they haven't yet seen how much farther it can go to relieve them. They (accountants) would see it as having substituted a new set of problems".

I: Has it contributed to a more effective accounting service?

X: "I don't think it has. I suppose the only thing one could say is that if they hadn't got it life would be even more difficult for them, let's face it, there are a hundred and one jobs where you just cannot get the clerical staff to do jobs. You have also to recognize that, for the accountant - just about everyone else - life has got more complex. There are more statutory regulations to be complied with; there are probably more changes that come up in every (national) budget now than they did ten years ago, to keep pace with.

All it's done - I am afraid - is to enable us just to, perhaps, keep up with some of the new set problems. It's kept our level of problems about the same".



- a senior member of a systems development/<sup>department</sup>(with some type of accounting training before joining the E.D.P. field) - when asked about the effects computers have had on accountants' ways of carrying out their responsibilities and on their approaches to reporting and supporting managerial decision making - emphasized that:

"Based on my experience in this company, I am tempted to suggest that computing has had no impact of any significance on accountants. It doesn't seem to me that computing in this company today does an awful lot for the accountants, except perhaps bring them some new problems; I am not sure that it solves many of the old problems. I'll be very much surprised, in fact I'll be highly sceptical if I heard any accountant in this company saying that they were delighted with the results they are getting from computing or anyone who has made his job easier and so forth. Yes, admittedly, in some areas, they do take some of the boredom and routine side of the job, something that is a little easier than perhaps would have been otherwise. In our (massive) sales accounting section, it is arguable as to whether they could do the job they've got to do, which is essentially an accounting job, without the aid of the computer.

The vast majority of reporting in this company in an accounting sense, use computing works on a monthly cycle. In terms of the information to control your business, it is far too late; it is telling you at least a month after the action actually happened. A lot of those reports should be operating on a weekly, and in many instances, on daily, basis. And until we start having accounting systems that do that, I wouldn't accept that the accountant is getting the proper kinds of information presented to him in terms of what's happening to the business."

- an accounting manager describes the effects computers have had on their (accountants') responsibilities, in the following manner:

"I think it's changed and will continue to change the accountants' attitude. The debit and credit situation of the book - which I miss quite honestly because that's how I started - has now given way to tabulations. These are a little bit more cumbersome to read, in the sense that you can't always go to the tabulation to see all the information that you could from a ledger. But as the use of computer gets more dynamic in the sense of more user-oriented interrogatory and data retrieval facilities.... The biggest facility that I miss is the interrogation facility; we get a variance and we say: why is that? some days before you know - if ever you find out - and you tend to have to go back to the supporting input documentation to give you the answer. This is something we have got to overcome, because what we're doing is that we have used many clerks to do a lot of paper chasing which



has already been in and through the computer. I think once we get this interrogation facility working in a proper manner, then, the accountants will have more confidence in the computer and will put it to more use."

These examples clearly indicate that more needs to be done in that direction and that the adoption of the 'isolationism' policy would not help enforcing the desired effects of computers on the accounting community. It is difficult to suggest, however, that computers have had the desired effects (in relation to more analysis and interpretation utilizing the powerful computational facilities) in carrying out their accounting responsibilities.

Without underestimating the function of appreciation courses offered by a wide variety of organizations, it is apparent that such appreciation courses are not a panacea for E.D.P. - user interaction, as can be evidenced from the following views:

"We run appreciation courses for accountants - as well as for other functions. - to give them an impression that things are more difficult than they would've otherwise thought.

We are trying to impress upon them the amount of detail an analyst has to go, in this kind of work. This is not to give them an impression of how good we are, but the objective is to show them how much detail is needed for the construction of a system.

Although that appreciation gives them an idea about computers, they still go away unconvinced. The next time we would go along they are likely to say: 'we want this and this and this' and they would tell us that on Monday, and you go back on Friday and they want this and this, and not that. This is the problem, they find it very difficult to define what they need and to stick to that definition. It is very often not because the circumstances have changed between time A and time B. But that they happen to think about it, and that it is the thought that've changed and not the circumstances. This is not only with accountants, but with all functions.

My experience is that those who attend appreciation courses might remember the required amount of detail in designing systems for a very short period, but they soon forget about the course, as long as there is not any kind of reinforcement".

Also, a D.P. specialist (with an accounting type of training) describes his experience in the following manner:

"I joined this company about ten years ago through O & M and soon became very computer oriented, and I got involved in the computerization of a part of our accounting application. Looking back now I realize when I worked through the NCR (a type of mechanical accounting machine) the sort of controls that are built into accounting machine procedures were absolutely routine and standard. As soon as I walked into the computer environment I forgot all about them. It wasn't until a year later that I realized that the principles were exactly the same. Some of the accountants - who have had both Mechanical and Electronic data processing - did exactly the same thing: they forget all the same basic principles. In the mechanical system we had a complete hierarchy of control; it was never really a problem and it was beautifully subdivided. When you come to the computer system we had one control on the whole bloody ledger. You tend to say to yourself as I did at a time and they probably did - Oh, the computer doesn't make mistakes".

This discussion emphasizes the need for a carefully planned comprehensive scheme, for providing accountants with the E.D.P. knowledge that places them in a better position (than the case now), to be monitored subsequently according to the changing needs and requirements of the users of the accounting services.

Third: E.D.P.'s efficiency in carrying out its responsibilities is one of the important factors affecting the E.D.P.-user interaction. If the E.D.P. efficiency is high, it is highly likely that a constructive E.D.P.-user interaction will emerge; on the other hand if the E.D.P. inefficiency is the dominant factor, it is highly likely that dysfunctional E.D.P.-user interaction will result.

The inefficiency aspects of E.D.P. were frequently emphasized by interviewees from E.D.P. as well as user functions. This can be demonstrated by the following comments made by two senior D.P. specialists in an organization that has blueprinted its program for achieving high efficiency several years ago (typically similar examples from other organizations are not difficult to find):

On the one hand, a senior systems analyst in that organization emphasized that they (E.D.P. specialists in particular, and his organization in general) ought to be looking more fundamentally at what they want, and how to effectively match and balance their com-



puting needs with their computing resources. He continued to elaborate his point as follows:

" ... computing is going to be one of the critical factors in your success in the future. The faster you get there the better off you are going to be. You can see it in the insurance business and in the banking business. Unless you are a significant and capable user of computing, you are not in business. Now there is going to come a day and a time when that is true of many more types of business than just banking or insurance. It is moving that way fast. Unless you really know how to use computing you just cannot be competitive. I can't believe that it is not going to be so in most other industries. How far away it is I don't know. But the sooner we get closer to the forefront, the better the chance of our success in the future. I am not trying to say that you give computer people a blank cheque".

On the other hand, another systems analyst in the same organization described the reality of designing and implementing computer-based systems and what he labelled the 'off-the-cuff' approach to designing systems (his views were confirmed and were independently supported by several members of his organization). He explained such an approach in the following way:

"Very often, and unfortunately this is still the case, an accountant comes along and says: 'look, I know that this has got to be improved, put a system in', and so we <sup>are</sup> put in a situation which doesn't always help our management. We say 'yes, we'll put it in', and the user manager would say: how long will it take you ' We, off-the-cuff, would say: 'two-men for nine month?

Very often you tend to get held to that, although no feasibility study has been done. All these are 'off-the-cuff' statements. So what we are trying to work towards now is when we're asked to do some work, we ought to look at that work and say: 'yes it is feasible, but these are the constraints, we can't do it in less than that time, and with less than these number of people, and it is going to cost this much of hardware cost and so on, we ought to look at the feasibility study before we start writing systems and putting programmes through the machine. But that is a long hard fight".

One possible interpretation to such apparent discrepancy (between aspiration level and actual performance concerning E.D.P. efficiency) is the view held by many D.P. specialists that E.D.P. is different from other functions within the same organization. The following interpretation by a senior systems analyst explains such a view:

" ... one of the problems with computing is that it is still new; a lot of people in it are still relatively immature; it doesn't have a history and traditions; there are no accepted conventions and standards in way similar to engineering and accounting. People are making their own standards as they go along. O.K. we are getting closer now; a lot of our standards are not dissimilar from those that exist in other major companies, but we still have a long way to go. I mean some of the holes in our standards are so big. They are not funny. We are not sure enough as yet to say: 'that is the way to do it.'"

Another possible interpretation of the above-mentioned discrepancy is the lack of 'systematization' in getting computer-based application systems accepted, implemented and supported by senior management involvement, and monitored by feedback information. Several interviewees have pointed out the importance of such a 'systematization' concept as applied to computing activities, although they have used a wide variety of terms such as: disciplined plan, formalized, standardized procedures. The following view expressed by a D.P. manager illustrates this point:

" ... at some point, if you are going to involve computers you have got to make the thing formal. Take the purchasing system for example; although some of our operating/trading units do insist that every time you place an order or request on outside suppliers there will be an official order, but there are many who do not. Orders are placed by telephone, word of mouth, letter; there is no such thing as an official order. Unless you've got that basic formality in systems, it is very difficult to effectively use the computer. And in reality, I suggest it is very difficult to control your business. There is no encouragement nor compunction that compels you to use a purchase order.

However, unless there are operating procedures that will make people do things formally - at least beyond a certain point, it will be very difficult to effectively operate systems.



To be frank, I think we, in systems development, are not very good at convincing people as to why they should want to use such a formal procedure".

Looking more closely into these examples of interpretations reinforces the view that computing is no different from other function within the same organization. Is it our perception? Is it due to

less familiarity with management theory and practice particularly with special reference to computerization activities? Why should the E.D.P. function be treated differently from the rest of the organization (by means of: different measures of effectiveness, different control procedures, different schemes for financial and psychological rewarding, different investment plans, and so on)?

Is it a psychological shield created by some D.P. specialists for a privileged status in their organizations? Is it a psychological barrier felt by users as a result of their lack of sufficient knowledge regarding such a discipline? or is it due to the E.D.P. specialists' lack of knowledge with regard to the nature of the management processes of planning and control?

Probably a mixture of the above possibilities may have led to such a belief. It is true that the technology contained in computing activities is new and increasing in complexity at an accelerating speed. But this should not be viewed as an excuse to isolate E.D.P. function in an organization from the remainder of the organization or subjecting it to a privileged position particularly in relation to the design and implementation of management control systems.

However by gaining more understanding of the causes, consequences and implications of the different computer-based activities in their organizational functioning, and the organizational and environmental contexts, it is possible that efficiency of E.D.P. functions could be increased.

Fourth: With regard to the degree of interdisciplinary involvement - as one of the main factors affecting accountants - E.D.P. specialists' understanding - the following view (held by a chartered accountant concerning the way E.D.P. specialists may gain familiarity with accounting systems and accountants' way of thinking) may serve as a basis for considering the various ways and approaches that may contribute to such involvement; he said:

"I think the D.P. side is much more of a service to accountants and other functions. Therefore, the onus is much more on him to understand the function that he is serving than it is for finance or marketing to understand the D.P. function. Therefore, I would perhaps be a little more inclined to say than the person on the systems side that the systems people should have a greater understanding of those whom they are serving or are going to serve. This is more significant than for the other functions - such as finance or marketing or engineering or whatever - to understand the systems. But I am not sure that I would go so far as to say that I regard it as absolutely essential that the systems man should fully understand accounting matters. This is a little difficult. Put it two ways: firstly, I expect that the systems man to be fully professionally qualified in his own subject and that is absolutely essential. I'd far rather have that than having a little bit of accounting, or engineering or what have you. He must fully understand his own function. And to understand his own function, he needs to have a certain knowledge of other things.

If - in fact - he can be in addition, a qualified accountant, then obviously that is very helpful because he would then understand the discipline and the thinking of accountants, and that is a highly desirable extra point. If in a team of systems people, they had one person who is additionally a qualified accountant, someone who additionally had three or four years in marketing, this is obviously a highly desirable situation, because they would then understand the thought processes of the accountant and the marketing man. But to say that I would regard it as essential to the professional qualification of a systems man: no, I don't think it is. I regard him as someone who understands his particular subject; someone who can communicate and understand my problems. But that does not require him to have had an accounting qualification or even any long term spell in accountancy. A short period of secondment, a few months to pick up a little bit of the jargon, or a little bit of the thinking. Yes, these are always useful. It is a communication problem."



The above view does not fulfil the inter-disciplinary requirement on both sides; asking one functional group to know the other and applying the same principle would be helpful, as far as enforcing the interdisciplinary involvement is concerned.

As one systems manager explained:

"... I should emphasize that if we haven't got at least three people here who have got a damn good accounting understanding we're in trouble".

Another systems manager indicated that he would like to see that systems analysts should spend some time in the accounting function. He argues that the reverse (i.e. accountants joining the E.D.P. function) would not be as useful, mainly because, as he asserts that many accountants are steeped into accounting traditions and conventions, which has some drawbacks for the design and implementation of E.D.P. systems. He further points out that:

"Systems analysts, because they don't understand accounting functions, tend to be a bit too flippant. Perhaps this is the wrong word to use; also there is a belief (amongst systems people) that accountants make too much of the problems they've got ...

I think the truth is somewhere in the middle; you can't be flippant about it as some systems analysts are and you can't be as serious about it as some accountants are ... "

Obviously, these points are not directed against the principle of inter-disciplinary involvement amongst D.P. specialists and accountants, but mainly against circumstantial symptoms of accounting and E.D.P. intra-functional inefficiencies as well as gaps in the inter-functional efficiency.

Finding ways of developing and enforcing interdisciplinary involvement amongst the two functions should pave the way to more organizationally effective horizontal understanding.

Fifth: Regarding the E.D.P. transfer policy adopted as one of the factors affecting accountants - E.D.P. specialists' understanding, this study has explored some of the behavioural implications of adopting such a policy.

In principle, the E.D.P. transfer pricing policy has certain advantages, the chief of which is the cost-awareness resulting from the application of the policy, as demonstrated by the following statement. This is expressed by an internal consultant working in an organization using such a charge-back policy, where he indicated that:

" ... when I work for a client, the client is aware that he is going to be paying for every minute I am working so he is going to make sure that I have (a) a job to do, (b) that the job is worthwhile. Also, if I find myself doing a job which is counter-productive or non-productive in their terms I would go and see the general manager of my client and say 'look, you have asked me to do this, but it's a waste of time, you are spending a lot of money for nothing at all. What's it all about, this idea of recovery is excellent, in terms of getting everybody, the client and the managers concerned, aware that this is costing money ..."

Also, the policy has its application difficulties as demonstrated by the following example expressed by a D.P. manager:

"Sometimes we get into disagreement with a line manager. I mean he may not wish to do something because he doesn't want to pay for it. On the other hand, because we are using a computer to link together various functions, it is sometimes necessary that I persist with trying to put something in - even if a particular line manager doesn't want to pay for it.

If you take for example our 'branch stock allocation system', the general manager of distribution who wants to know what stock he ought to hold in each branch, may decide to pay for half of a project, because the other half of a project is in the production area where production bloke wants to know what he is going to make and in turn what sort of material he is going to use and when he wants ... and so on ...

So, there is a bit of an argument sometimes about who pays for what, because you can't split the costs of that project".



Of course, this is not the only difficulty in applying a transfer — policy to E.D.P. activities. There is a wide variety of examples of problems associated with each particular application of such a policy. One user of the policy warned against considering the transfer pricing policy as an end in itself; rather it should be considered as a means to an end; that is an effective control mechanism. He emphasized that:

"You can take recharging to an extreme, and if you do, it becomes a nonsense, because what you are really saying is this is a budgetary control method, it doesn't mean a thing in terms of the profit or loss made by the organization, all we are doing is transferring one dollop of cash from one account to another which is irrelevant in terms of the profitability of the company".

Accordingly, the principles underlying the 'charging-back' policy are sound, the application should be discretionary, and the user's constructive criticism should be taken into consideration. The policy should be translated into a suitably designed control system, consistent with the framework of the overall organizational control system.

Probably, many of the problems arising out of a particular application, could be identified and reacted to in a proper manner through a pilot scheme or study, by means of identifying and exploring the various aspects of the constructive criticism of prospective users. Also, following up such a pilot scheme or study by periodic 'check-up' for feedback information, might be useful in the continuous evaluation and updating of the system after putting it into action.

Sixth: For localizing E.D.P. specialists as one of the main factors affecting the accountants - E.D.P. specialists' understanding, there is plenty of evidence to demonstrate two points:

- a considerable number of E.D.P. specialists are less loyal to their organizations than some other functions such as accountants; they load more highly on the cosmopolitans' end of the continuum than on the 'locals' end. A typical view is expressed by a D.P. manager indicating that loyalty of the majority of D.P. specialists in his organization occupy a 'secondary' place, whilst their loyalty to D.P. is of overriding importance. He commented on this in the following manner:

"... the majority of D.P. specialists in this organization have more loyalty to D.P. than they do to their industry and specifically to their organization. I am sad about that, but I think that is true ...  
I know that a large proportion of my young staff really identify themselves as systems analysts 'first' and members of this organization 'second'."

- Loyalty of E.D.P. specialists vary between different locations within the same organization. There is a tendency of those central D.P. specialists to be less involved with users' different locations. This inclination can be demonstrated by the following view expressed by <sup>a</sup> works/regional accounting manager who differentiates between D.P. specialists working at the centre from those who are working close to him, in the following manner:

"If I am speaking about the people that I had met in the works/region, then I would say that their loyalty is probably to the organization rather than D.P., but I would say that central systems development people have got more loyalty to D.P. than their organization. I may be wrong on this, but I feel that this is my opinion regarding the central systems development. I think the people out in the field due to their involvement have got more loyalty to their organization".

And when he was asked to elaborate on this, he continued to describe his experience as follows:



"... if you sat in the centre, you are not involved in the day-to-day crisis, whereas our local systems people understand that things ought to be done quickly; to get things operational, to get the accounts out on time. Our form is, if you were having to rely on the Central Group system development personnel, who didn't understand the pressures of operating in the region, our fear was that 'no!'-things would deteriorate.

I think it would be better if they (D.P. personnel) are completely involved and part of the region, if the accounts don't come out on time, then they are partly responsible.

The people who are out in the field get involved with all the other managers on their day-to-day problems. They become part of that management team, and they know what the target is, whereas at the centre - as far as I know - the feeling is that they are back-room people; if they want three days or three weeks work to sit on a problem, then they get three days or three weeks to do it, accordingly. One wonders sometimes whether they really understand how people have to work when they are in the field. However, I think it would be a good idea if they moved around a bit at times to see how urgent some of the problems are."

Taking into consideration the various kinds of motivations (monetary, psychological, educational and training, etc.) behind this, diagnosis of the conditions affecting accountants-E.D.P. specialists' interaction could be facilitated.

- Seventh: With regard to the extent of applying reporting by exception, the significance of the empirical findings can be explained by a set of typical empirical examples of views expressed by a number of interviewees:
- When asked about the extent to which the computer is used in determining and calculating variances from standards, and reporting on variance analysis, an accounting manager (with access to the central computer facility via terminal) answered in the following manner:

"... very little indeed. We do have tolerances, of course, out of which we get exception reports. We do - in fact - try and break out some of the easier variances such as price and volume; we do adjust our variances by feeding in standards. As far as this is concerned, yes; but to really calculate the extension of these to bring in new variances: product mix and this sort of thing - no; we are not using it to that extent. I don't see it as a major hurdle in so far as our accounting records are functioning, but we've not got all the information yet in the computer with a facility that does all these calculations, this could well be an extension of it".

- A D.P. manager expressed his concern about the amount of print-out from computer files (which not only apply to accounting applications, as he emphasized, but also to other areas as well). He explained that:

"... most of our work is batch oriented, and much of our print-out is produced unnecessarily, particularly for weekly and monthly type runs. In such cases whole files are printed out with massive amounts of paper so that, in fact, when you count it all up, it is impossible to go through unless you tie up all your staff permanently to read all that within a month. It is there as a reference so that they can use it when they get a query they've got to dig their way through".

- A management accountant found himself sunk in the 'routine' tabulations of data, without sufficient thinking about the information he has got. The concept of unused or idle information was implied in his expression of the problem, as follows:

"we have a store of information here which can be used to provide a variety of information to the line managements within the organization's trading divisions which would be of use to them. We produce a very large amount of information, but which is not necessarily in the manner which can be conveniently used by them. A fair amount of exception reporting is required urgently to condense the huge tabulations, and mass of information to provide the meaningful information at the right point at the right time".

These views demonstrate the need for placing more attention on what is actually required rather than the mere accumulation and storage of data. It also emphasizes the fact that information has not been sufficiently considered as an 'asset', 'investment',



or a 'resource'. The value of information contained in such files has been probably under-explored and/or underestimated. They imply the need for information management or information administration for decision-making and problem solving. In particular, they imply the need for accountants to give more attention to the information resources that they are responsible for.

Eighth: With regard to the scope of senior management understanding and involvement, the following evidence is relevant:

- a D.P. manager succinctly emphasizes that the amount and quality of users' involvement differs from one department to the other. This is dependent on the scope of management understanding and involvement, which, in turn reflects the quality of the developed systems. He pointed out that:

"... some departments are not capable of specifying their own requirements, we've got to go and do a study and then agree with them what the requirements are. These type of departments, particularly in the development of new application projects, are not good at specifying requirements. In this case, we've got to lead them along to a large extent. And, to some extent, we've got to try to guess what the requirements are. Sometime, it is a case of trial and error; we say: 'we could present this to you in a specific way', and they say: 'Ah, yes'. They don't really see it, because they find it difficult to try to visualize something in the future, because a lot of them are much more concerned with present day-to-day problems, and they don't spend enough time thinking about the future. This is below the management level. As a result, we sometimes have to do something and produce it for them and then once we've got it, we can adopt it and change it. This is because they suddenly see how they can use the system to provide what they felt they wanted.

Other departments are very specific in what they want and how they want it done and as a result they give us very strict guidelines on which to work. I would think this is mainly to do with the management of the department; if they know what they want and they are very firm about it, they would tell us exactly what they want and we would then do as they ask. But obviously we put up some ideas to them, something they may accept, other things they will reject. Again, usually you find these departments with strong managers, who know what they want. They also bring forward very useful ideas during development stages".

- a systems manager described the relationship between computing and business management in the following manner:

"... the whole area of management understanding - particularly on the part of line business management - is very poor. There are very few managers in this company who subscribe to the view that the use of computing and computing systems is tied up with their long term success. I say that simply on the basis of the actions they take".

- a projects manager expresses what he called the painful experience of computer specialists' joint involvement with users in the development of computer-based systems. He continued to elaborate as follows:

"... it seems that management of user functions tend to think that having, as it were, an agreed project that will take place, they forget about it then. All they have to know is that somebody came and ask computer people 'what happened?' It doesn't work that way and not for a long time is it going to work that way. Having initiated a project they've got to stay with it then; make sure the computing people recognise the real needs of the business; make sure they are not running off in all sorts of directions and all sorts of tangents; make sure that their own staff understand what's going on. To think that having agreed to pay what we (computer systems function) estimated what (a project) is going to cost, and then forget about it, the project is doomed to failure. Users and their management should be prepared to put <sup>in</sup> their own effort and resources."

These experiences indicate the importance of users' and their managements' involvement in specifying requirements of computer-based systems. The success or failure in this area is governed, to a large extent, by the amount of the users' awareness of the nature and limitation of his systems. They also raise the question of the extent to which computational facilities are used amongst the tools and methodologies in developing, formulating and following-up longer-term strategies.



Ninth: As for the width of the gap between achievements and accountants' expectations regarding their computer-based systems, the following experience is of some relevance. A management accountant expressed his hopes that his organization might at last start to benefit from E.D.P. after a long struggle. He pointed out:

"... within two years we shall have a system which's been tried and proved to be working as well as it was specified. Within two years we should be far better than we are now and we should be working effectively as it was expected that we should work twelve years ago. Thereafter, it is a question of getting our credibility established and gradually making more improvements to bring about the necessary flexibility which may be required to take in any of the smaller applications. After all, we've been only set up to deal with large volume of transactions".

Although this view might be considered as an extreme one regarding the width of the gap between achievements and users' expectations concerning the maturity of computer-based systems, it is by no means uncommon.

One accounting manager explained that such a credibility gap in E.D.P. is partly due to accountants having high expectation and spending less time and effort explicitly defining their requirements of computer-based systems. He continued to describe his experience in some detail:

"... in developing computer-based accounting systems, it is important that the accountant should understand how to sit down with a system development person and express himself clearly to the systems person. This is possibly where things had gone wrong in the past, in that the accountant probably hasn't made it abundantly clear to the systems person what he's trying to achieve. Consequently the systems person thinks he's got to know what the accountant wants. They finish up with a system at the end of the day which isn't suitable. So, it is important that somewhere in the training of the accounts, they should have some knowledge of what type of computer is in operation, obviously, what it can do and what it can't do. As I would say - he should make himself (the accountant) quite clear as to what his objective is at the end of it, so that the systems person writes

the system that he wants. This is where we have - as a company - in the past, caused ourselves a fair amount of trouble.

We've got problems at the moment with our accounting systems, possibly due to our own making, and due to the fact that we had not explicitly specified our requirements of those systems. We are now trying to get these systems to operate to our satisfaction. And it is a long, long slog trying to go through the existing systems, specify what's wrong with them and getting everybody now to put them right.

Furthermore, a systems manager explained such a gap in terms of the fact that many computer users do not take full advantage of computing. He then asserted that:

"... if you don't learn to take full advantage of computing, there's going to come a time in the future when you will find it is very difficult to stay in business. It is going to be such an essential part of business as the telephone is today. And now is the time to be learning and start marking up for yourself some competitive advantages over your competitors".

Accordingly, the extent to which the gap between achievements and expectations in relation to computer-based systems, could be narrowed, is directly proportional to joint efforts (of users and E.D.P. specialists) to develop and implement a computer-based system on the basis of mutual understanding of objectives, and realistically matching expectations with contributions.

Tenth: In relation to the quality of the E.D.P.-Accounting interaction as one of the main factors affecting accountants - E.D.P. specialists' understanding, the following cases illustrate some typical examples of the various dimension of this factor:

- an accounting manager describes the void featuring the relationship between accountants and E.D.P. specialists in his division where he indicated that:



"... there has been a bit of void between the two (accountants and E.D.P. specialists). The problems of the computer people have not always been appreciated by the accountants, simply due to their ignorance and because they've never had to stand in the other fellow's shoes. They've not appreciated the sort of problems. To that extent, many accountants, I think, have been very, very sceptical about computerization because all it's done has been to do routine things that they did adequately anyway. They take on the payroll; we always paid our people on time and still do. We have to familiarize ourselves with the new pattern and the new change in attitude. To that extent, we viewed each other with scepticism across this void as it were. I think it is beginning to narrow now as more accountants are more aware of what the computer is about. I think the more we develop the computer, the closer these two specialists (accountants and E.D.P.) will become".

- a head of information services (who had an accounting background - by qualification - before joining E.D.P.) explained that some accountants distrust computer-based systems and do not have the sufficient commitment to make them work. He described his experience as follows:

"... the impression I get here (in a relatively large business organization) is that the accountant tends to take the view: 'well, you (the systems analyst) get the computer-based system to do what you like, but I am going to keep my own sets of books because I am not sure that I can trust you fellows'.

That really is not good enough; you cannot afford in my view to keep multiple sets of records. We should all work from the same base rather than everybody having his own set.

One of the merits of using computers is that, for the first time, it has become practical in a reasonably large organization for everybody to operate off the one record.

To me it is somewhat strange because it is a conviction that should have been passed on a long time ago. That was 'we've got to have one record and that is going to be the computer record and you're not going to keep your manual records; if you want information you got to come and get it from that one computer record. Only if you do that can you ever be sure that computer records are up-to-date and accurate'. I am sure we haven't won that battle yet. I don't believe the task is impossible; I remain hopeful".

- a systems manager explained how E.D.P. specialists do not put their ideas across to accountants in an effective manner, where he pointed out that:

"... systems' documentation are the media which accountants and systems analysts used to communicate with each other. But this is not what they should be ... documentation standards (the production of reports and manuals containing directions on how to use a particular system) do not convey the message across. This is the start of the problem. You produce a document, put it to an accountant, he stops listening to you, because it is not clear to him. He's probably only interested in the cost (of developing the system) and in an outline of what the system was to attain initially. But he can't pick that out. Then he makes the excuse that he does not understand terminology. But I think the truth is that people don't want to listen any more. I think it is partially the responsibility of D.P. staff who just don't put across their ideas effectively".

Although there are very successful examples of accountants - E.D.P. specialists' interaction, in designing and implementing usable up-to-date computer-based systems, it is these examples that contribute to the lack of confidence or mistrust between the two groups.

In spite of the fact that parallel operations (where the system is being run manually and computer-wise) are highly desirable in newly implemented systems, its continuation afterwards constitutes waste of effort and resources. It is evident that the quality of the interaction is the product of several indicators or component variables and is an important factor in determining the direction of accountants - E.D.P. specialists' understanding.



Eleventh: The continuum of explicitness - looseness of E.D.P. objectives, has been amongst the main factors affecting accountants' - E.D.P. specialists' understanding.

Many organizations have several groups and different forms of design of E.D.P. services, which may have inconsistent and conflicting objectives. This not only contributes to the lack of understanding between E.D.P. specialists and users of these services, but also creates dysfunctional behaviour on the part of different E.D.P. groups against each other.

To emphasize the importance of this factor, the discussion between the researcher and an E.D.P. specialist is relevant:

X: As for the relationship between both of us (Central systems development and the Computer Centre) at the centre we feel mutually that we are treading on each other's toes and we're rivals rather than colleagues.

As far as the divisions (divisional E.D.P. specialists) are concerned, they think that both the computer centre and systems development are Head Office people from London who earn more money than they do and don't work as hard. And we think they're all backwards and not very good at designing and programming and lazy. So relations aren't very good I'm afraid.

I: If you were in a position to improve these relationships what would you do?

X: Initially, I would define and lay down in writing exactly what the relationships between various groups (corporate systems development, central computer centre, and divisional systems people) were intended to be. We should start by thinking very carefully what you want the relationship to be between the groups so that the various groups know what is expected from them. Having defined the shape of the relationship, you should seek possible approaches of improving relationships. One possibility is cutting out this business of competing with each other. Make sure you're all trying to sell the same thing to the same people; not saying different things. Make sure you don't contradict each other so that more co-operation between the groups can be achieved".

Several other examples could be quoted to show: the vagueness and looseness of E.D.P. objectives in many organizations; the poor differentiation and integration of E.D.P. activities; and the inadequate and insufficient planning guidelines and control

### 8.1.3. A posterior examination of the a priori of indicators

---

Having carried out the analysis presented in the preceding sub-section, an immediate question that may arise in this respect is: to what extent do the results obtained satisfy the objectives of the present research? Depending on the type of answer, whether in the affirmative or the negative mode, there is a number of associated questions as to the rationale and implications of the analysis.

For the purposes of the analysis in this sub-section, a comparison is made between the a priori behavioural indicators affecting the accountants - E.D.P. specialists' interaction on the one hand, and the results obtained from the application of factor analysis methods. The comparison is presented on the following page.

Close examination of the two sets (the a priori set and the results obtained by applying factor analysis) indicates that the factor analysis results delineated distinctly the behavioural dimensions of accountants - E.D.P. specialists' interaction into a number of meaningful dimensions.

More specifically:

- (a) the a priori behavioural dimension/ of "outlook of accountants" is separated into a number of meaningful factors. The factors are the degree of accountants' appreciation of W.D.P. benefits and limitations and the extent of pedantic attitudes on the part of accountants.
- (b) positivity/negativity of the accountants - E.D.P. specialists' interaction is emphasized by the study to constitute a main factor in this type of organizational relationship. It succinctly indicates one of the main points of emphasis in studying the accountants - E.D.P. specialists' interaction. It contains present and futuristic perspectives of the interaction emphasizing the quality of the interaction.
- (c) the a priori behavioural dimension of "organizational policies and conditions" is separated into a number of more meaningful dimensions such as a degree of co-ordination, competency in applying E.D.P. transfer policy, clarity of E.D.P. objectives and fruitfulness of interfunctional rotation.
- (d) effectiveness of control of E.D.P. activities, sufficiency of applying reporting by exception to computer-based applications, width of the gap between achievements and users' expectations regarding their computer-based applications, E.D.P. project management and secondment to users



The a priori dimensions

Outlook of accountants  
Image of E.D.P. specialists  
Present DP-accounting relationships  
Organizational policies and conditions  
User management involvement  
Features of E.D.P. group or function  
Future prospects of DP-accounting relationships  
Top management understanding and backing

Orthogonal Factor Solution

Good vs. bad image of E.D.P. specialists.  
high vs. low degree of accountants' appreciation of E.D.P. benefits and limitations  
high vs. low degree of co-ordination  
high vs. low degree of senior management understanding  
Extensive vs. limited orientation of E.D.P. specialists  
Efficient vs. inefficient computerization activities  
Positive vs. negative interaction  
Competent vs. incompetent application of E.D.P. transfer policy  
Desirability vs. undesirability of users' being seconded to their computer-based projects  
Explicitness vs. ambiguity of E.D.P. objectives  
Serious vs. superficial effort to professionalize E.D.P.  
Fruitful vs. unfruitful interfunctional rotation  
Low vs. high pedantic attitude on the part of accountants  
Sufficiency vs. insufficiency of applying reporting by exception to computer-based application.  
Narrowness vs. wideness of the gap between achievements and users' expectations regarding their computer-based applications  
Effective vs. ineffective control of E.D.P. activities

are amongst the main behavioural dimensions that have been delineated by the empirical findings of this part of the research and supported by other qualitative evidence presented in detail in the preceding sub-section.

It is interesting to note that the institutionalization issue of either of the two functions (accounting and E.D.P.) has not been questioned. 'Computers are here to stay' is a phrase frequently quoted by interviewees from both functions. Meanwhile, accountants' positions in organizations have not been taken over by the newly arrived specialists. There is insufficient evidence to suggest that the introduction of computers contributes to shrinking of accountants' power in organizations. These indications should reinforce the organizational search into feasible ways of using interdisciplinary knowledge of both specialists towards more effective support for their managements.



## 8.2: Further analysis of the indications of the empirical evidence.

---

The direction of the empirical evidence is subjected to further analysis in this section. This is an attempt to explain some dimensions of the accountants - E.D.P. specialists' interaction. Such analysis takes into consideration the following aspects:

(i) description of the model class of the observed behavioural indicators. For the purposes of analysis in this section, the original seven-point scale is recoded into three categories where, for example, the categories labelled definitely false, usually not the case, and more false than true are taken to form a new category labelled false. Also, the categories labelled definitely true, often true, and more true than false are taken to form a new category labelled true. The "uncertain about this" category remains unchanged. This is to summarize the data contained in the empirical observations<sup>6</sup> leaving much of the detailed information to appendix B, # 2.1.

---

<sup>6</sup> For each indicator there are two tables. The first table contains the original observations and accordingly the letter O is added to the indicator's number.

The second table contains the recoded observations. Accordingly, the letter R is added to the number of the indicator. For example, for indicator 28, there are two tables 28-O and 28-R. They are presented on the same page in Appendix B, # 2.1.

To avoid unnecessary redundancy the reader is advised to consult appropriate tables whenever it is felt necessary.

(ii) utilizing the results of applying the T- Test to answering the question of statistically significant difference between the two groups (accountants and E.D.P. specialists).<sup>7</sup> These results are based on the recoded information (in accordance with the manner described in (i) above). Two pieces of information are provided in this respect. The first is the decision made by the researcher as to the existence of statistically significant difference between the two groups. The second is the two-tailed probability (hereafter abbreviated as "p") at the computed t-value.<sup>8</sup>

7 That is testing the inequality of means.

Statistically speaking, this question could have been phrased differently. The null hypothesis (Ho) is the hypothesis of no difference between the two groups (which is usually formulated for the express purpose of being rejected.) The research or alternative hypothesis is that the two specified groups differ regarding the operational statement contained in the indicator. T- Test is the appropriate statistical test to be used in order to come to a decision about the null hypothesis (Ho). The significance level ( $\alpha$ ) is specified at .05. Based on the computed t-value, the researcher would then either:

- a) reject the null hypothesis (Ho) if the probability is less than or equal to (that is less than or equal to .05) or
- b) fail to reject the null hypothesis if the probability is outside the region of rejection at the chosen level of significance.

To exemplify, tabulation of the above discussion may be useful:

(IF)	(THEN) Decision about (Ho)	Interpretation with special reference to this study
Two-tailed probability "p" is $\leq .05$	reject	The two specified groups <u>differ</u> in their attitude
Two-tailed probability "p" is $> .05$	fail to reject	The two specified groups <u>do not</u> differ in their attitude

8. For a discussion of the computational procedure used for this purpose, see, Nie et al 1972, pp. A-017-244-01 to A-017-250-01.



(111) focussing the analysis around some of the main indicators for the sake of providing more explanation and interpretation. This is to avoid detracting the reader's attention from the indications of the empirical evidence into a mass of details about every component or indicator.

In the course of this discussion, exploration is made of some of the problem areas associated with the computerization of business activities in general, and accounting applications in particular. Indeed, this is a highly dynamic area being affected by the growing E.D.P. technological advances. Accordingly, such a discussion has to take this dynamic feature into consideration. But before doing so, two major conceptions are observable in that direction:

the first is that a substantial number of these problems are of the behavioural type. Communication, interaction, co-ordination, selling, capabilities and limitations, involvement, backing, confusion, image, organisational roles and responsibilities, consultation, liaison are but few examples of the concepts involved in the interaction between E.D.P. specialists and the users of computer-based systems and services. It is needless to emphasize, however, that the insufficient recognition, realization, and comprehension of the nature and implications of such behavioural problems, would affect the effectiveness of the development and implementation of computer-based systems. Accordingly, a balance should be maintained between the technical and behavioural aspects of E.D.P. Exploring the psychology of E.D.P. is as important as the technical considerations involved. <sup>9</sup>

---

9. It is interesting to note that the results of factor-analysis models applied to the domain of accountants - E.D.P. specialists' interactions have captured many of the associated dimensions and problems. For practical considerations, the researcher has limited his discussions to what he considered to be sufficient for the purposes of the present research. The interested reader may wish:

- a) to consult a number of reports on field studies. See, e.g., Taylor and Dean (1966); McKinsey and Co. (1968); Dean (1968); Churchill et al (1969); Diebold (1969); Hofer (1970); Whisler (1970); Johannsen and Birch (1971); Stewart (1971); Lucas (1974);
- b) to refer to discussions that state with varied degrees of emphasis behavioural aspects and problems of computer-based information systems. See, e.g., Schlosser (1964); Ackoff (1967); Dickson and Simmons (1970); Head (1970); Weinberg (1971); Bahr (1972); Schussel (1972); Lucas (1973); Brill (1974); Testor (1974).

The second is the general misconception regarding the management and control of E.D.P. This misconception stems from the feeling of some E.D.P. specialists concerning the way their activities should be treated. In fact, this misconception manifests itself in the anxiety, annoyance or discontent of some users of E.D.P. services. The essence of the misconception is the belief that E.D.P. is not liable to the well-known practices of management and control. Such misconception of immunity on the part of E.D.P. specialists has frequently resulted in ill-feelings and misunderstandings between users and providers of E.D.P. services. Consequent implications of such misconception for either the interacting groups or their organizations are clear enough.

It is true that E.D.P. is a fairly new field of specialisation, particularly from the technological point of view; but this should not put it outside the range of management control systems, practices and guide-lines that are applied to other fields of specialization. Therefore, it is of substantial importance, on the part of those concerned with monitoring and controlling, to maintain a well-balanced knowledge of the technical and managerial sides of E.D.P. This should facilitate the process of exercising control over E.D.P.

Having outlined these considerations, the rest of the present section discusses in some detail the denotation and direction of the empirical evidence in relation to each of the factors defined and extracted in the first section of this chapter.



First: in relation to good versus bad image of E.D.P. specialists

Indicator number and content	Modal Class		Is there any statistically significant difference between the two groups?
	Category Label & Code	Relative Frequency (Per cent)	
34. There is a growing understanding on the part of EDP specialists of what is required from them by user division or departments	Agree (3)	84.2	YES (P= .008)
36. As far as providing good EDP service is concerned, the image of DP specialists has improved over the last three years.	Agree (3)	70.7	NO (P= .185)
35. On both functions, (EDP and accounting) there is a reasonable amount of appreciation of the other's problems	Agree (3)	76.9	NO (P= .203)

Indications of the empirical evidence suggest that:

- (a) relatively speaking, there has been some improvement concerning the image of E.D.P. specialists over the last three years; they are coming to give more attention to users' requirements and to appreciate E.D.P. organizational responsibilities. Accordingly, there has been a relative improvement on the positive side regarding the image of E.D.P. specialists. Several interviewees (accountants as well as E.D.P. specialists) recalled their earlier experiences in connection with second generation computer-based systems, which reinforced their belief that there has been some improvement; the quality and scope of such image improvement can only be established in the light of other relevant considerations.
- (b) the above direction, together with some other relevant dimensions, emphasizes the fact that the above-outlined observations should be interpreted with due caution. As several interviewees pointed out, "improvement" is a relative issue in this respect. However, there is a number of indicators that show a 'slackening' effect upon the direction of the above evidence. Amongst these slackening indicators are: indicator 30 (suggesting the insufficiency of E.D.P. specialists'

knowledge about accounting systems); indicator 23 (suggesting the inadequacy of E.D.P. training to enable E.D.P. specialists to integrate themselves in organizations); indicator 8 (denoting that a considerable number of E.D.P. specialists are looked upon as outsiders whose loyalty is to D.P. rather than their firms; and indicator 57 (corroborating the idea that D.P. specialists tend to oversell the expected benefits to be gained from using E.D.P. systems).

Features of E.D.P. specialists' image are not only the creation of E.D.P. specialists' own making but also a product of other organizational and environmental conditions. Accordingly, in analysing this behavioural phenomenon, one should not treat it in isolation of other relevant conditions.

Expressions of participants in this study have explained several manifestations to this factor. Amongst them are:

"The system has been developed over the last 12 years and because of advances in technology, changes in business structure, organizational conditions, there is a need for review of existing systems but this is not possible because of shortage and inadequacies of sufficient specialist analysts and programmers. New staff do not wish to become involved in the review and maintenance of existing complicated systems where they have to be aware of the effects of any changes on other systems. They would rather work on new self-contained projects." (An accountant)

"There is a tendency for some systems analysts to offer what they think the user needs instead of what the user wants." (An Accountant)

"There is less interest among E.D.P. personnel in correcting and improving current systems and programs than there is in installing new ones." (An accountant)

"D.P. personnel regard knowledge of D.P. techniques as the only skills they need to have to perform their job. They generally lack knowledge about the business and how it works, and are uninterested in acquiring it: their contribution to the business is limited for this reason." (An accountant).



Second: in relation to high versus low degree of accountants' appreciation of E.D.P. benefits and limitations.

Indicator number and Content	Modal Class		Is there any statistically significant difference between the two groups?
	Category Label & Code	Relative Frequency (Per cent)	
1. I feel that the majority of accountants in this organization are developing an appreciation of the benefits of EDP systems	Agree (3)	93.8	NO (P= .292)
4. I feel that more and more of our accountants are getting to appreciate what the computer can and <u>can not</u> do for them	Agree (3)	93.2	NO (P= .472)
3. As yet our accountants have not played a <u>Key</u> role as originators in improving EDP systems development and implementation.	Disagree (3)	53.7	YES (P= .002)
6. Participation of accountants in checking the validity of computer based accounting applications is <u>inadequate</u> .	Disagree (3)	56.6	YES (P= .048)

Detailed examination of the above indicators points out that:

- a majority of participating E.D.P. specialists agreed with the view that as yet accountants have not played a key role as originators in improving E.D.P. systems development and implementation.
- a slightly higher proportion of E.D.P. specialists agreed with the view contained in indicator 6 (that participation of accountants in checking the validity of computer-based accounting applications is inadequate)

In addition, discussions with some E.D.P. interviewees tend to indicate that:

- (a) accountants seem to be unsure about their requirements of computer-based systems;

(b) due to the inadequate appreciation of some accountants of E.D.P. systems, they tend to consume much of the E.D.P. specialists' time, which could otherwise be spent more productively. As one E.D.P. specialist put it:

" - . I feel the frame of mind and [accountants- E.D.P. specialists'] interaction in our organization is about right, but the niggling factors that occur in day-to-day operations rather pull down the performance. Many accountants are so involved in special exercises and accounting queries that it is almost impossible to get them to devote the time necessary for appreciation of new systems and plans at the vital stages."

(c) with the growing complexity and sophistication of computer hardware and software, there is a growing difficulty on the part of accountants to keep abreast of the latest developments in computer-based accounting applications. A number of problem areas are associated with this aspect, such as internal auditing.

The answers of some accountants to the above-mentioned views include the following viewpoints:

- (a) accountants do not have to be systems analysts or programmers to use the computer. According to this view, accountants need not bother with detailing their requirements and needs of computer systems; this should be done by E.D.P. specialists for accountants.
- (b) E.D.P. specialists have an educational and training role; any time spent with accountants and other users should lead to more appreciation of E.D.P. concepts and techniques.
- (c) the rapid advances in E.D.P. technology and the growing complexity of E.D.P. applications reinforce the view that accountants need not be fully "conversant" with E.D.P. technological developments. According to the holders of this view, this should be left to E.D.P. specialists to take care of, both for themselves and for other users.

While these answers might appear plausible, the rejoinder to these answers is more critical and more convincing:

- (i) although accountants need not be E.D.P. specialists (in the sense of taking over various stages of computer-based systems development and implementation) it is expected that they should know what they want and what type of help they should expect from their E.D.P. counter-parts.

Most of the problems that have been associated with the computerization of accounting applications, are probably associated with the (accountants') over-dependence on E.D.P. specialists with regard to computerizing accounting applications. After all, why should E.D.P. specialists be "professionals" in accounting or any other user



(ii) as regards the E.D.P. specialists' educational and training role in their organizations, one should make a distinction between "familiarization" and "assistance" aspects. There is no harm, of course, in E.D.P. specialists' participation in organizing and offering training courses, seminars, and workshops.

The day-to-day E.D.P./user interaction should be devoted to reinforcing the basic understanding of the relevant concepts and techniques and to increasing each others' experience in the respective areas of specialization.

(iii) it is true that E.D.P. technology is increasing in sophistication, but the indications are towards making systems more user-orientated.<sup>10</sup>

The fundamental reason, however, for accountants to be involved in the E.D.P. field is that accountants should be able to utilize opportunities provided by the rapid advances in computer (hardware and software) technology for the reduction of tedious clerical activities and the possibility of exploiting such computational power in budgeting, planning and control.

Those who are concerned with the education and training of accountants should always ask themselves the question: what are the changes necessary to be recognized and included in our strategy to get our members to meet their changing needs?<sup>11</sup>

Accordingly, there is some evidence to indicate that E.D.P. specialists would like to see more involvement on the part of accountants in improving the development and implementation of computer-based accounting systems. The evidence points out to the need for more attention on the part of accountants to audit computer-based systems. This is an area of great importance to accountants as well as E.D.P. specialists.

<sup>10</sup> The 'Financial Times' (Thursday March 13, 1975, p.1) reported that I.B.M. is believed to have decided on a major change in policy which could mean the virtual abandonment of its plans for an entire new generation of highly advanced computers that was to have succeeded its current 370 series. I.B.M. had been expected to introduce the first new system, late next year or early 1977. The machines had been expected to embody many revolutionary features, including the capacity to carry out several processes simultaneously and a software system that no special training was needed for programming.

<sup>11</sup> Although prepared with graduate education in management in mind, the report of the Association of Computing Machinery (ACM) Curriculum Committee on computer education for management (Ashenhurst, 1972) is a useful guide to the analysis of requirements for education relevant to information systems in organizations.

Third: in relation to high versus low degree of co-ordination

Indicator number and Content	Modal Class		Is there any statistically significant difference between the two groups?
	Category Label & Code	Relative Frequency (Per Cent)	
30. I feel that many D.P. specialists do <u>not</u> have enough knowledge about accounting systems	Agree (1)	82.9	NO (P= .364)
16. <u>Far greater liaison</u> between D.P. specialists and accountants is needed	Agree (1)	80.1	NO (P= .061)
40. Terminology used in each function (EDP and accounting) may contribute to misunderstanding.	True (1)	78.9	NO (P= .419)
23. E.D.P. professional training is <u>not</u> adequate enough to enable E.D.P. specialists to integrate themselves in organizations they join.	Agree (1)	68.5	NO (P= .999)
46. Regarding the image of EDP specialists in my organization, <u>not</u> enough improvement has been made as much as I would like to have seen.	Agree (1)	59.2	NO (P= .889)

The above evidence indicates clearly that the majority of participants are not satisfied that there are enough necessary organizational mechanisms for achieving integration and liaison (between E.D.P. specialists and the users of their services within their organizations).

The message conveyed by the above evidence emphasizes the need for organizations to review the design of their existing E.D.P. functions. This is to make sure that E.D.P. resources are utilized effectively.



Fourth: in relation to high versus low degree of senior management understanding.

Indicator number and content	Modal Class		Is there any statistically significant difference between the two groups?
	Category Label & Code	Relative Frequency (per cent)	
15. Regarding computer-based systems for managerial planning and control purposes there is a growing realization on the part of senior managers of what is ' <u>possible</u> ' as opposed to what is ' <u>ideal</u> '.	True (3)	63.9	NO (P= .438)
14. Senior management of user divisions (or depts.) show a reasonable amount of involvement in the EDP area.	Agree (3)	63.9	NO (P= .367)
22. Senior management of user functions knows little or nothing about the mechanism of computer-based systems.	Agree (1)	71.4	YES (P= .002)

If we take the evidence of the above indicators together with indicator 32, this will enhance our understanding of the extent to which senior management of user departments or divisions know about computer-based systems.

In particular, the detailed examination of the distribution of the two groups' observations in relation to indicator 22, emphasizes the view (held in larger proportions amongst E.D.P. specialists than amongst accountants) that senior managements of user functions lack sufficient knowledge about E.D.P. systems. This is not to say that senior managers of user divisions do not get involved in this area, nor to imply that they do not realize the realities of E.D.P. Rather, it is to indicate that without proper and sufficient knowledge about computer-based systems related to the managers' areas of responsibility, the task of managing and effectively controlling these activities becomes a highly difficult one.

The message conveyed by the above evidence can be emphasized by the following two quotations, made by participants from different organizations. One participant described what he called 'narrowness of vision of general management'. He explained that:

"Because - possibly - original DP applications were more in payroll/stores/and other routine applications, general management have failed to realize quickly enough the overall potential benefits of E.D.P. to their business".

The second, on the other hand, indicated that:

"The Chief Executive of the Central Services function has a systems background, therefore great emphasis is placed on this aspect of business management."

The above evidence reiterates the importance of E.D.P. specialists' participation in facilitating user managements' involvement and understanding of computer-based systems. Perhaps, it is worthwhile that E.D.P. specialists should work towards encouraging management to accept, use and be satisfied with computer-based information. One possible approach for E.D.P. specialists to win the support and acceptance of managers of user divisions or departments is to be aware of the information needs of management positions in organizations. <sup>12</sup>

---

12. Taggart (197 , p.6615-A) reports on a study of the problem of management information requirements analysis. He suggests a methodology which incorporates a syntactical approach to support the information needs of management positions in organizations. In broad terms the methodology begins with general and ambiguous statement of management responsibilities and moves through several levels of analysis to arrive at specific and unambiguous statement of management information needs. The phases of the methodology are illustrated in the diagram on the next page.



Management responsibilities in the form of narrative statements

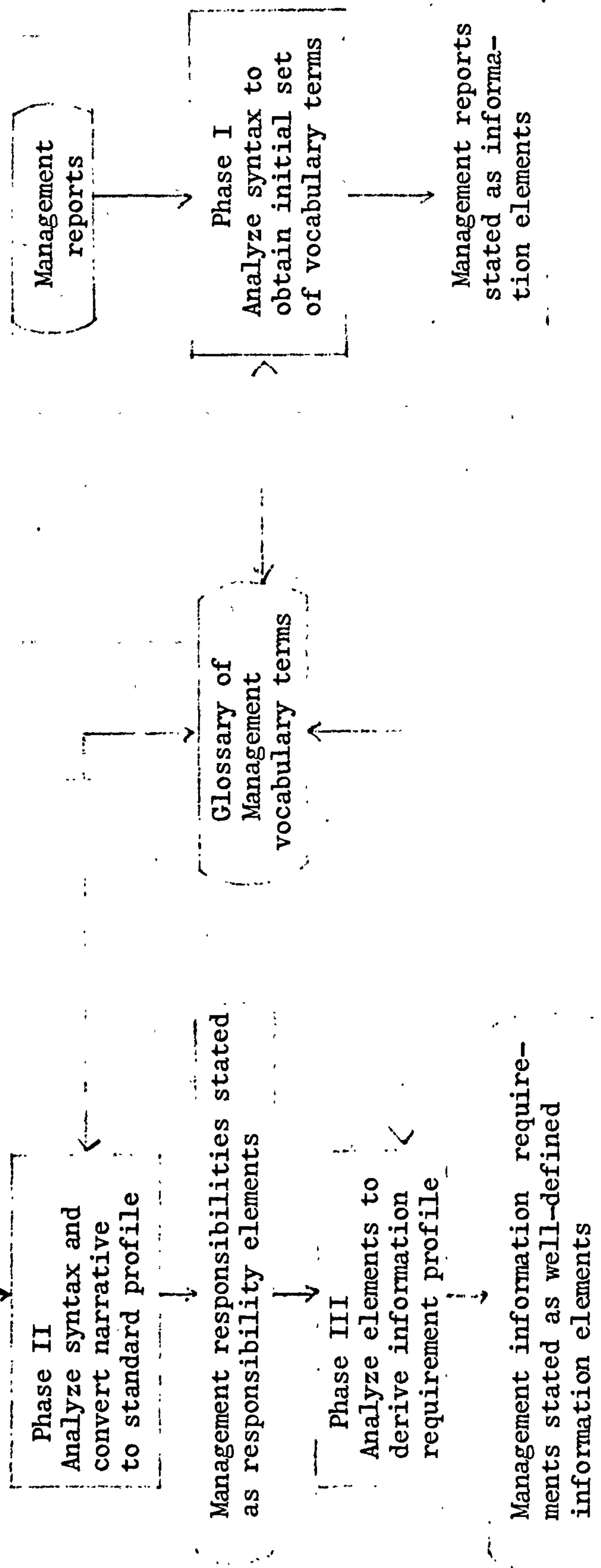

"Bridging the gap between indefinite responsibility statements (upper left of the diagram) and definitive information requirements (lower left of the diagram) depends on the method's syntax which introduces a structure for organizing the detail involved in the analysis. The concept of the information element represents the cornerstone of the syntax. An information element consists of one or more entity, a time, and an attribute data element. This grouping identifies the minimum possible configuration of data elements which may provide information for a manager.

In bridging the gap, Phase II of the methodology takes narrative statements of responsibilities and structures them as responsibility elements (information elements with responsibility and action verbs added to the syntax). Responsibility elements are a more explicit statement of a manager's responsibilities. These elements provide indicators of the information required to support the associated responsibility. Phase III explodes the responsibility element into one or more groups of information elements to support the responsibility. The output of the analysis is a detailed statement of a manager's information needs.

The figure indicates how the methodology achieves the control necessary to arrive at unambiguous statements of information requirements. A glossary of management vocabulary appears in the center portion of the figure. Each of the phases uses the vocabulary in or adds vocabulary to this glossary in order to remove ambiguity from the analysis of information requirements. Finally, the figure shows Phase I on the right side which analyzes the information element content of management reports in order to generate an initial glossary."

Fifth: in relation to extensive versus limited business orientation  
of E.D.P. specialists

Indicator number and content	Modal Class		Is there any statistically significant difference between the two groups?
	Category Label & Code	Relative Frequency (Per cent)	
8. A considerable number of EDP specialists are looked upon as outsiders whose loyalty is to DP rather than to their organisations	Agree (1)	60.0	NO (P= .531)
30. I feel that many DP specialists do <u>not</u> have enough 'knowledge' about accounting systems.	Agree (1)	82.9	NO (P= .364)
23. EDP 'professional' training is not adequate enough to enable EDP specialists to integrate themselves in organisations they join.	Agree (1)	68.5	NO (P= .999)
27. I have the feeling that many DP specialists adopt the 'know-all' attitude	False (3)	45.2	NO (P= .895)

The overall indication of the above observations leaves very little doubt as to the quality and direction of E.D.P. specialists orientation (i.e. organization loyalty vs. DP loyalty, business-based E.D.P. knowledge vs. pure technical E.D.P. knowledge, and grandiosity vs. modesty).

Why do the majority of participating individuals indicate the insufficient organizational orientation of E.D.P. specialists?

Does the message contained in indicator 27 imply any inconsistency with the other indicators 8, 30, and 23? Taking into consideration that there might be some element of bias in the opinions of E.D.P. specialists, why do a considerable number of E.D.P. specialists agree with the overall indication that describes the relatively poor orientation of many E.D.P. specialists? To answer these questions, the following observations are relevant:



(a) the detailed examination of the evidence in relation to indicator 27 does not comprehensively refute the statement that many D.P. specialists adopt the 'know-all' attitude.<sup>13</sup>

Opinions of both groups are consistent and are inclined to support the view that it is more true than false that some E.D.P. specialists adopt the know-all attitude.

(b) since the phrasing of the interview-table statements was made in a manner that should not be taken, either directly or indirectly, as a threat to the participating individuals, it is likely that some E.D.P. specialists were anxious to convey as accurately as possible their perceived view regarding their experiences with their E.D.P. colleagues.

(c) though there has been some improvement in the field of business orientation of E.D.P. specialists, the experience of the last two decades corroborates much of the above-explained indications. A number of circumstances may have contributed to the direction of the above evidence. These circumstances include the manner in which E.D.P. industry has been evolving, the users' reception of the hardware and software advances and the users' dependence on the E.D.P. specialists to understand characteristics, merits and limitations of computer-based systems.

---

13. See table 27-0, appendix B, ~~1~~2.1.

Sixth: in relation to efficient versus inefficient computerization activities.

Indicator number and content	Modal Class		Is there any statistically significant difference between the two groups?
	Category Label & Code	Relative Frequency (per cent)	
57. EDP specialists tend to 'oversell' the expected benefits to be gained from using EDP systems	Agree (1)	81.8	YES (P= .045)
53. There is a tendency amongst DP specialists to think that 'computerization' is the answer to problems they look at	Agree (1)	77.6	YES (P= .048)
44. In general I would say E.D.P. specialists like to make the job more complicated.	Dis-agree (3)	53.1	NO (P= .446)
59. EDP specialists design of computer-based accounting applications <u>falls short</u> of accountants' expectations regarding accounting requirements for internal checks	True (1)	52.4	YES (P= .002)

Although this table may be useful in outlining an overview of E.D.P. specialists' manifestation of their E.D.P. knowledge and experiences, the following observations are of some relevance:

- (a) by examining the detailed evidence concerning E.D.P. specialists' tendency to oversell the expected benefits to be gained from using E.D.P. systems, we can realise that the main difference between the two groups (accountants and E.D.P. specialists) is in the extent of agreement. A large proportion of E.D.P. specialists are inclined to "slightly agree" with the statement 57, whilst a larger proportion of accountants are more inclined to support the "moderately" and "strongly" agree.



- (b) by examining the detailed evidence regarding indicator 59, it will be understood that there is a gap between accountants' expectations and the actual contributions of E.D.P. specialists. More than half the valid observations substantiate the statement. Meanwhile, more than one third of the accountants who answered this question tend to corroborate that E.D.P. specialists' design of computer-based systems falls short of their (accountants') expectations.
- (c) accounting requirements for control and internal checks present a two-fold responsibility for both internal auditors and E.D.P. specialists. Case-study analyses carried out by the researcher indicate that some progress has been achieved in this respect.<sup>14</sup> The problem has already been recognized in the participating organizations, but the degree to which progress has been made in solving it differs from one organization to the other.

The more "progressive" organizations make sure that there is a high amount of co-ordination between both internal auditing and E.D.P. function from the early stages of developing E.D.P. systems. One of the forms of such co-ordination is the establishment of a specialized internal audit group within the E.D.P. function to maintain explicit control standards and security measures. Under such co-ordination built-in mechanisms for control and information security become more feasible and useful. Moreover, in some cases, it was found that such co-ordinated efforts (whether they take the form of specialized group or not) lead to additional advantages, such as participation in training programs, and contribution to more effective internal reporting systems.

The less "progressive" organizations, on the other hand, are mainly focussing on the verification of accounting data. The dominance of ex post facto manner frequently involves the use of output of computer-based systems without the prior involvement of internal auditors in the early stages of developing such computer-based systems. This, more often than not, creates interaction problems.

---

14. The reasons for selecting the word 'some' to describe the scope of progress is that very few internal auditors are applying statistical sampling methods and computer-based procedure programs for auditing purposes. The need for expanding education and training schemes for such purposes is evident.

Seventh: in relation to positive versus negative interaction.

Indicator number and content	Modal Class		Is there any statistically significant difference between the two groups?
	Category Label & Code	Relative Frequency (per cent)	
18. E.D.P.- Accounting interaction is based on friendly attitudes	True (3)	83.6	NO (P= .123)
19. Confidence and trust are major characteristics of the <u>present</u> pattern of working relationships between D.P. specialists and accountants.	True (3)	63.9	YES (P= .035)

Positivity/negativity of the accountants - E.D.P. specialists' interaction is evidently one of the main factors affecting the understanding or the lack of it between the two functional groups. With some E.D.P. specialists feeling that the statement contained in indicator 19 is more false than true, the overall direction of the above evidence is pointing more towards the positive side.

The following observations may further underline the message conveyed by this factor:

(a) on the negative side.

"Accountants on occasions expect too much of E.D.P., particularly on the development side, in assuming that new systems can be designed and implemented in a trice. On the other hand, some accountants may feel that E.D.P. involves a great mystique - sometimes cultivated by certain E.D.P. personnel."

"The need to ensure that the E.D.P. organization is maintained at an efficient optimum level causes a certain amount of friction between D.P. specialists and accountants. The accountants insist that the benefits derived from each project should justify the rest. D.P. specialists tend to regard accountants as rather negative people, placing constraints on their [E.D.P. specialists'] ideas and aspirations. Accountants, on the other hand, tend to regard D.P. specialists as theorists with extravagant ideas, which, if allowed to proceed unchecked, would push E.D.P. activities well beyond the optimum level. It is difficult to overcome these attitudes, since they result from the nature of the roles played by each....."



(b) on the positive side.

"This division has established an Accounting Systems Group whose function is to work with user departments in determining their requirements and also with Management Services to ensure that those requirements are, as far as possible, put into effect. There is a certain amount of rivalry between Accounting Systems and Management Services; on balance, the procedure is definitely beneficial...."

"Having the internal audit function within systems helps to strengthen the accounting systems and enables systems' audits to be carried out regularly."

"In this organization the project leaders are qualified accountants with years of E.D.P. practical experience who have direct access to their counterparts in each user department; and thus to a large extent communication problems are avoided."

This factor, however, raises a number of related questions:

Has there been adequate cost/effectiveness analyses in relation to computer-based applications?<sup>15</sup>

Is there an established procedure for specifying priorities amongst users of E.D.P. services?

Has there been adequate analysis of variances of actual as against budgeted economics of systems development and implementation?

---

15. For a detailed analysis of this aspect of computer-based systems see, e.g., Couger and Knapp (1974, part III).

Eighth: in relation to competent versus incompetent application of E.D.P. transfer policy.

Indicator number and content	Modal Class		Is there any statistically significant difference between the two groups?
	Category Label & Code	Relative Frequency (per cent)	
50. I think the practical advantages of the policy of charging users for computing services outnumber its disadvantages.	Agree (3)	61.2	NO (P= .926)

The direction of the empirical evidence corroborates the usefulness of adopting a charging-out policy to recover the cost of computing services.<sup>16</sup> The effectiveness of an E.D.P. transfer policy is dependent, to a considerable extent, on the particular application in force. Specifically whether or not the application<sup>17</sup> is perceived to be fair, comprehensive in scope, consistent, understandable, accurate, stable and flexible. This is consistent with the researcher's conclusions based on detailed discussions with a large number of interviewees. The greater the intelligent reinforcement of the real motivations behind the transfer policy, the greater the likelihood of the advantages outweighing the disadvantages.

Having been convinced of the usefulness of the policy of charging users for computing services, a number of fundamental questions in designing - or reviewing existing applications must be taken into consideration. These questions are:<sup>18</sup>

Who should be responsible for monitoring and managing the user's data processing costs - user management or D.P. management?

Could users actually manage their data processing costs?

Who should pay for computer operations' capacity in excess of what is required?

What happens to the cost of "unusable" time caused by reruns, equipment failures, and remedial and preventive maintenance?

16. Based on observations of what some U.K. companies are doing, Canning (July, 1974) indicates that the proponents of charging computer services seem to be winning out.

17. For a detailed discussion of features of cost accounting system for E.D.P. resources, see, e.g. Hirsch (1970, pp. 65-74); Prubst (1972, pp. 17-21); Nielsen (1972, pp. 35-49); Dearden and Nolan (1973, pp. 68-78); Anderson (1974, pp. 29-30).

18. c.f. Hand and Rives (1974, pp. 34-35).



How should programmers' and systems analysts' time be allocated back to the user?

Which costs are controllable and which are uncontrollable by either data processing department or user management?

To what extent these questions are given serious attention in industrial organizations is an interesting empirical question. Discussions with interviewees from participating organizations and explanations of respondents indicate that the application of costing and standard budgetary control methods to E.D.P. activities is far from being the general case. Control mechanisms in force may be classified under either of the following broad categories:

- a. paying "lip service" to the objectives of controlling E.D.P. cycle and costs and benefits. This type of organization may go as far as keeping "blue-printed" or ostentatious documentation to prove that both tangible and intangible factors are taken into consideration. The following quotation from the findings of McKinsey & Company's study reported in 1968 is still highly applicable to this category:

"It is dangerously easy to avoid confronting the full implications of feasibility until a project is well under way. Technical feasibility, though less often a question mark today, is still the test most commonly considered at the start. The issue of operational feasibility is far too often neglected until the new application is actually tried out in practice and perhaps found wanting - the costliest kind of feasibility test. And economic feasibility - the measure of how much expected dollar returns will exceed expected costs - is frequently given only superficial examination.

Since a company's computer resources are seldom equal to its computer opportunities, economic feasibility should almost always be a key criterion in weighing the merits of technically feasible projects. Yet it is frequently assessed rather casually, on the grounds that the important benefits are intangible, and intangible benefits can't really be evaluated. Actually, of course, the very difficulty of measuring intangible payoffs is the best argument for imposing on managers the discipline of explicit evaluation."

- b. paying serious attention to the objectives of controlling E.D.P. cycle and costs and benefits; but there are what might be described as "unfavourable organizational conditions" that hinder the process of putting these serious intentions into force. Some E.D.P. specialists might not welcome the application of costing and standard budgetary control methods to E.D.P. activities under their control. In other cases it is evident that accounting functions are unable to "sell" and apply such costing systems to E.D.P. activities.

c. paying little or no attention to the objectives of controlling E.D.P. cycle and costs and benefits. Such organizations have failed to see the importance of subjecting E.D.P. activities to concepts of control.

The researcher, however, sees no substitute to the proper application of concepts of costing and standard budgetary control procedures to E.D.P. activities.<sup>19</sup> Concepts of responsibility accounting, variance analysis and normal standards can be applied to many of the phases of E.D.P. cycle. Of course, E.D.P. has its idiosyncrasies and properties unique to computers,<sup>20</sup> but these do not excuse the inadequate or insufficient application of costing and standard budgetary control procedures.

---

19. For a detailed discussion of relevant issues such as E.D.P. project costing, development of standards, documentation, and control reports see, e.g. Menkus (1970); Charman (1971); McReavie (1972); Pendray (1972); Hussian (1972); Canning (May 1973); Canning (December 1974); Cowdery (1974); Knutsen and Nolan (1974)

20. c.f. Kaufman (1974, pp. 52-53).



It is not suggested that the development and application of systems' standards (in the fields of feasibility, design, test, operation, audit, documentation, maintenance, and variance reporting) would create no organizational problems. But the advantages involved in the development and application of, and commitment to, adopting E.D.P. costing and standards budgetary control procedures would outweigh their disadvantages. This is mainly due to the built-in mechanisms for users' involvement, follow-up, and commitment to the systems building process,<sup>21</sup> and for E.D.P. specialists' protection against the disorganized approach to computerization processes and the frequently quoted charges (of inefficient, and unreliable systems).

---

21. Canning (December 1974) reports on E.D.P. user experiences with three standard approaches aimed at improving the system building process. These systems are:

PRIDE, which is a standardized procedure for the system building process, applying at the application level;

LCP (Laws for Construction of Programs), which is a standardized procedure for designing programs, which applies at the individual computer program level; and

AMS (Application Management System), which is a standardized generator of application systems, applying at the application system level. AMS provides the standard overall architecture within which an application system designer provides the detailed "contents" design.

Having quoted these examples of experiences in the field, the researcher does not limit the phrase "costing and standard budgetary procedures" to such systems. Rather, he has in mind the full-fledged application of standard costing and budgetary control procedures to E.D.P. activities.

Ninth: in relation to desirability versus undesirability of users being seconded to their computer-based projects.

Indicator number and content	Modal Class		Is there any statistically significant difference between the two groups?
	Category Label & Code	Relative Frequency (per cent)	
58. It is desirable that computerization of accounting applications is 'seconded' to an accountant who is well trained in E.D.P.	Agree (3)	86.4	NO (P= .143)

Direction of the empirical evidence suggests the importance of accountants having a sound training and involvement in E.D.P., particularly in relation to their functional application areas. This evidence tends to weaken the argument of those who are in favour of:

- . leaving the computerization of accounting activities (or users' application areas in general) to the E.D.P. specialists.
- . accountants' having a 'token' familiarity with E.D.P. (leading, in most cases, to superficial involvement in the computerization of accounting activities).

As pointed out by a number of interviewees, there are several advantages in accountants' having a sound training and involvement in E.D.P. Chief amongst them are:

- (i) this sound knowledge and training would reduce, and probably overcome, the problem of technical terminologies being used in communication processes. Both specialists (accounting and E.D.P.) would become familiar with a wide variety of "buzz" words and terms.
- (ii) Such sound knowledge increases the likelihood of successful design and implementation of the computer-based system that would be designed. This result would come about mainly through clear E. D.P./user interface in relation to the inputs and outputs of the particular system.
- (iii) successful projects lead, in turn, to reinforcing co-operation and monitoring both specialists to further developing more effective channels of communication.



Tenth: in relation to explicitness versus ambiguity of E.D.P. objectives

Indicator number and content	Modal Class		Is there any statistically significant difference between the two groups?
	Category Label & Code	Relative Frequency (per cent)	
38. There is <u>no</u> explicit statement defining objectives of E.D.P. service in my organization.	Disagree (3)	47.9	YES (P= .051)

Analysis of the detailed evidence with regard to this indicator explains that:

- (a) the modal class of E.D.P. specialists' attitudes is "agree" with the above statement. One can infer from this that the majority of participating E.D.P. specialists see no explicit statement defining objectives of E.D.P. service in their organisations. On the other hand, the majority of accountants tend to assume that E.D.P. objectives are confined to carrying out the computerization processes according to <sup>top managements'</sup> directions.
- (b) fewer accountants tend to agree with the above statement indicating that E.D.P. in their organizations has loose and vague objectives; sometimes interpreted by some E.D.P. specialists to give them wider authorities and privileges than they should have. The following observation explains some of these aspects:

"D.P. departments appear to pass through three phases:

- (a) initial installation to satisfy an initial need. Under this condition systems are under-employed.
- (b) D.P. 'touts' for additional work to use spare capacity. In this case E.D.P. department will accept jobs without real justification as to cost benefits.
- (c) computer overload. In this case there is no allocation of priorities. Further development is stifled even if cost benefits can be demonstrated as important".

The message conveyed by this factor appears to emphasize the importance of explicitly specifying long-term as well as short-term E.D.P. objectives. In the absence of clearly defined E.D.P. objectives, control aspects of such activities become less effective.

Not only should the objectives of E.D.P. functions be explicitly stated, but also/<sup>a</sup> ranking of those objectives should be made together with the constraints imposed on such functions.<sup>22</sup> The researcher believes that clarity of the objectives to and the constraints on, E.D.P. functions are important considerations that affect E.D.P. behavioural environments.

---

22 . Hallam (1974, p.30-A) examined the goals and constraints of E.D.P. departments in a sample of American organizations. The findings of this study indicated that the most important objectives of E.D.P. departments appear to be (1) completion of specific new computer applications within time deadlines, (2) minimisation of costs generated within the E.D.P. departments, and (3) minimisation of turnaround time for batch jobs. The most severe constraints are: number of programmers manhours available (2) number of analyst man-hours available, and (3) the total budget dollars available within the E.D.P. department.

Clearly, any organization might have different ranking of objectives and different constraints at different times.

In the opinion of this researcher, Hallam's findings can be further expanded into a more specific statement of objectives and constraints to suit the particular conditions of the organization(s) under study. This would contribute towards more awareness of the expectations and realities of the E.D.P. functioning.



Eleventh: in relation to serious versus superficial effort to professionalize E.D.P.

Indicator number and content	Modal Class		Is there any statistically significant difference between the two groups?
	Category Label & Code	Relative Frequency (per cent)	
54. The E.D.P. 'professionalization' issue is being given serious attention by the majority of E.D.P. specialists.	Undecided (2)	46.2	NO (P= .992)

Although the lack of agreement concerning the term professionalization and the related problems of definition might have been partially responsible for the above direction of the observed evidence, the following explanatory information is worth mentioning:

- (a) of the respondents who answered this question, 33% were accountants who indicated they were undecided about the above statement. Amongst the reasons for this are: the apparent absence of a system of education and training, ethics and discipline, on lines similar to those adopted by professional accounting bodies; the behavioural implications of the relatively recent growth of E.D.P. industry; and the insufficient information accountants have about the steps taken by E.D.P. specialists towards the professionalization question.
- (b) about one third of the E.D.P. specialists' observations disagreed with the above statement. Some of them think that E.D.P. specialists have not been much concerned with the development of ethical standards or disciplined practice on lines similar to those developed in medicine and law. Some argue that such disciplined practice is restrictive and may not be as functional as is desirable. Others argue that it is necessary to protect organizations, E.D.P. specialists, and users of computer-based systems against the wide variety of problems arising from the immaturity of some E.D.P. systems, inefficiencies in development and implementation of some computer-based applications, particularly in the absence of mutually accepted practices in relation to the computerization of organizational (business) activities.

(c) taking this statement into consideration together with the direction of indicator 47, it appears that E.D.P. specialists have not taken sufficient steps to win the recognition of the community of E.D.P. users.<sup>23</sup> It is interesting to note, however, that some E.D.P. specialists would go along with such a view. Some of those who supported this direction do not ask for an application of the 'ideal'<sup>24</sup> model of professionalising E.D.P. specialists.

23. It should be remembered that the British Computer Society (B.C.S.) has pioneered in the development of a system of professionalization of E.D.P. specialists. But it is fair to say that there is still a long way ahead before such a goal can be achieved.

24. Vollumer and Mills (1966, pp. 2-19) describe the important elements of such an ideal model as involving a lengthy and intensive process of preparation to gain skill in a systematic body of knowledge; authority is based on specialized knowledge within the framework of a social system of sanctions, privileges, code of conduct and ethical standards, and social configuration unique to the profession.

Also, Elliott (1972, pp. 96-97) summarises various features of professionalism in the diagram below.

#### DIAGRAM 8.1

##### Continua in the Professional Ideal Type

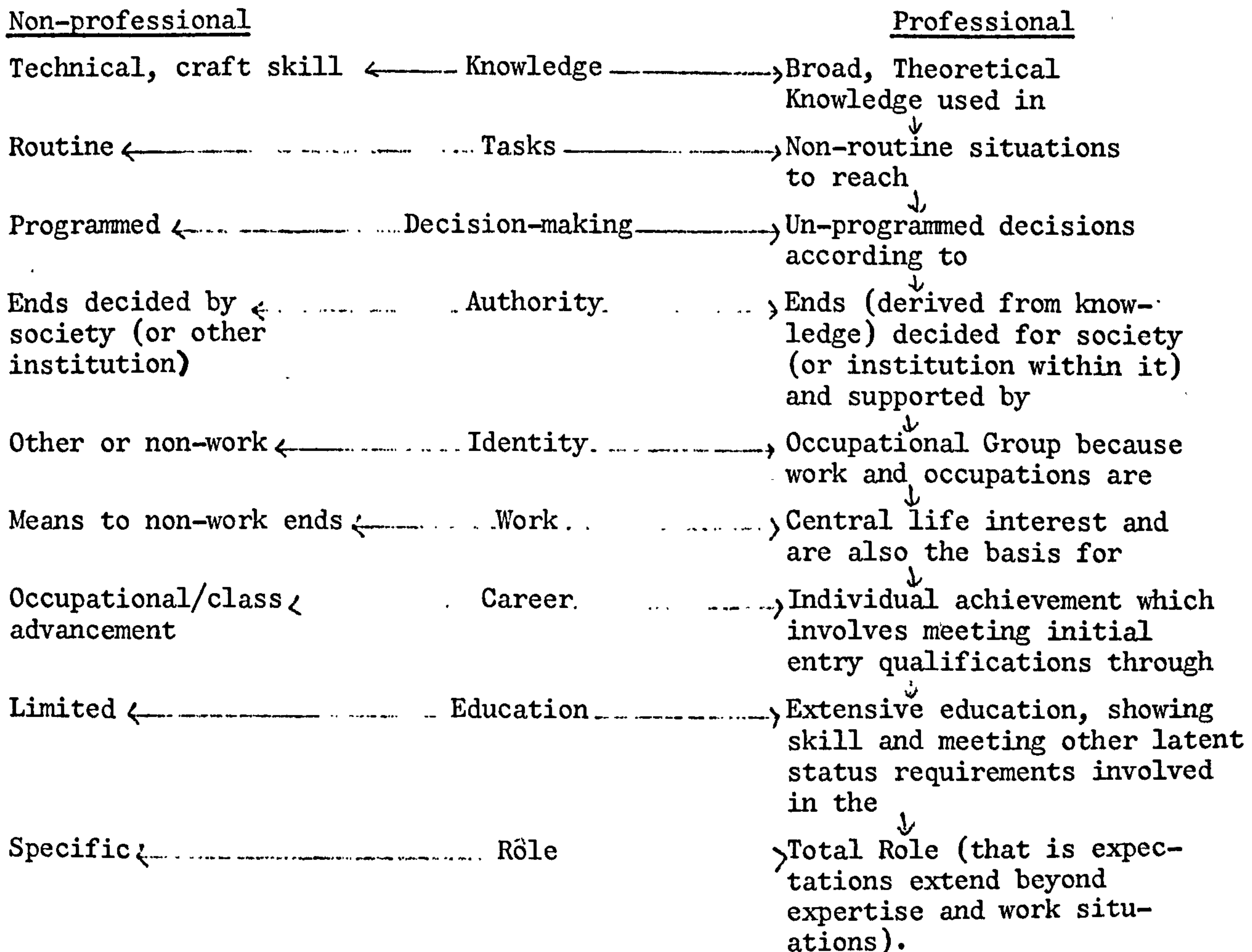



Many of the current features of E.D.P. specialists as perceived by individuals participating in the study would load more on the non-professional than the professional ends of the continua.

Several interviewees have indicated that in comparing E.D.P. specialists to other specialists from other fields such as medicine, law, and accounting, it is clear that much work still has to be done in that direction.<sup>25</sup>

The experience of other fields of specialization should be useful in developing and implementing a 'suitable' scheme for tackling this problem. Of course, there are basic differences between E.D.P. and other fields of specialization, but the lessons learned can serve as guidelines in establishing the sought-for strategy.

25 . Dobelis (1973, pp. 14-19) examines the position of system design specialists from the view point of common characteristics of some professions, both recognized and striving to be recognized, to see to what extent those are applicable to systems design specialists.

He indicates that:

"For many years systems people - and methods and procedures people before them - have asked the world to recognise them as professionals. Meanwhile, with expanding computer technology, the systems persons' reputations by and large have been going downhill, and for good reasons. Bad, unworkable computer systems have been installed; unchecked errors have produced mass distribution of erroneous data and exposed the systems analyst to public ridicule. There still are not too many computer specialists and programmers who can meet their budget and deadline estimates."

He concludes his analysis by the following view:

"Obviously, the systems design 'profession to be' cannot strive to attain the status of the so-called learned professions or even the engineering and mathematical professions. If, at best, it acquires the mantle of respectability attained by the chartered public accountants or the actuaries, it would be very gratifying. However, this is bound to take a number of years of internal policing by the practitioners of the trade, or art, or profession, however, we may choose to call ourselves. It may take even longer due to the constantly changing state of the arts." (p.19)

Twelfth: in relation to fruitful versus unfruitful interfunctional rotation.

Indicator number and content	Modal Class		Is there any statistically significant difference between the two groups?
	Category Label & Code	Relative Frequency (per cent)	
51. A young accountant should be transferred to a D.P. function for a period of 2-3 years, to look after computer-based accounting applications.	Agree (3)	68.1	NO (P= .266)
45. Many programmers are interested in acquiring knowledge about the business and how it works.	Dis-agree (1)	42.5	NO (P= .134)
55. D.P. "know-how" will increase by taking in accountants for training as D.P. specialists.	Agree (3)	86.4	YES (P= .038)

The direction of the above empirical evidence suggests the desirability of E.D.P.-Accounting interfusion. Meanwhile, it is appropriate to note the following observations:

- (a) as to the indicator 51, the phrases 'for a period of 2-3 years', and 'to look after....' were mostly behind the view taken by those whose felt against or uncertain about the statement as a whole. Some individuals, particularly of the E.D.P. group, felt strongly against the phrase 'to look after', which might imply the weakening of the organizational position of the E.D.P. function if users were to join the E.D.P. function to look after their functional applications. Some participants expressed unhappiness about the suggested time horizon. This was on the basis that such a period might be insufficient or inadequate for accountants to acquire the background knowledge necessary for effective computerization of accounting applications. However, this kind of reservation was less markedly pronounced than the previous one.



(b) With regard to indicator 45, it is interesting to note that closer examination of the recoded observations suggests that a larger proportion of E.D.P. specialists tend to disagree with the statement. This has a number of interpretations:

- . Some E.D.P. specialists in general, and programmers in particular, tend to support the view that it is not necessary that programmers seek to acquire knowledge about the type of business that they are associated with. The systems analysts should, according to this view, seek to gain more knowledge about the wider areas of business they are associated with. However, it appears that a number of organizations are moving away from such a dictotomy, mainly because of the inefficiencies<sup>26</sup> resulting from adopting a mutually exclusive policy between systems analysis and programming.
- . Some participants expressed their disagreement with the statement 45 on the basis of their perception of what programmers actually do. That is, casting on their actual experiences with programmers, they think that programmers are not sufficiently interested in acquiring such knowledge. This interpretation has wider acceptance than the above-mentioned one.
- . some programmers think that it is of mutual benefit for themselves and for their organisations that they should stay programmers during their whole E.D.P. career. They think their skills are best utilized in their capacity as programmers.

---

26. As an example of such inefficiencies, the following comment made by a programming manager (in an answer to the question of programmers' knowledge about the business and how it works) might be useful and relevant:

"It is completely vital that analysts should know users' needs and what the business is. Perhaps to a lesser degree, the programmer should know about the nature of the business. However, I do think it is important that a programmer should be prepared to know what the business and the user need.

If one assumes that an analyst has reached a stage where he knows very well what the user needs and he prepares specifications for a programmer. If he makes a slip of the pen or something like this, a lot of programmers will just blindly follow exactly what they think the specifications tell them to do. They would not consider or use commonsense to realize that that couldn't possibly be what was intended. They do exactly what they are told, and they don't stop to think: well that can't really be what the user wants. This is exactly what a lot of programmers do. I think this is really bad."

In developing their experiences and skills in the computerization of their organizational activities, it is hard to see how such a policy of programmers' (self-) alienation would effectively contribute to the organizational effectiveness of <sup>the</sup> computer-based activities they participate in. It is the researcher's view that programmers must, therefore, understand the nature, scope and implications of the business orientation as far as their responsibilities are concerned. Even those who are involved in the development of software packages for computer manufacturers should be able to anticipate the potential requirements of those who will be using such systems.

(c) detailed examination of the empirical evidence with regard to indicator 55, clearly indicates that D.P. 'know-how' will increase by taking in accountants for training as D.P. specialists. A higher proportion of accountants (91.9 per cent) agree with the statement.

The implications of the above evidence emphasize the importance that should be attached to this aspect of the E.D.P./user interface. Several interviewees have pointed to the same direction too. Inter-functional rotation may be fruitful in the areas of tackling the problems of inconsistency inadequacy, and irrelevancy of interfunctional requirements, in the areas of developing the organizations data base, and in the areas carrying out long-term planning and evaluation of capital projects.



Thirteenth: in relation to low versus high pedantic attitude on the part of accountants.

Indicator number and content	Modal Class		Is there any statistically significant difference between the two groups?
	Category Label & Code	Relative Frequency (per cent)	
49. In explaining accounting systems I think many of our accountants do add complexity to the job.	Agree (1)	59.2	NO (P= .070)

The indications of the above evidence corroborate the general belief that accountants tend to explain accounting systems, concepts and procedures for non-accountants in<sup>a</sup> complex manner. It is interesting to note that the majority of participants (53.5 per cent of accountants compared with 68.3 per cent of E.D.P. specialists) agreed with the above statement.

- (a) the real difficulties are contained in accounting (financial and costing) systems, concepts, procedures, and conventions. Examples are: difficulties concerning the nature of the financial accounting conventions (such as: conservatism, realization, materiality, consistency, matching and continuity); difficulties associated with financial accounting statements fulfilling statutory obligations (amongst them are those stated by the Companies Acts of 1948 and 1967) and associated with management accounting reports; difficulties associated with recording mechanisms; and difficulties associated with the wide variety of types of costs (i.e., historical, future, replacement, standard, estimated, product, period, direct, indirect, fixed, variable) which unless carefully defined and presented may confuse the non-accounting person. After all, accountants themselves spend a considerable amount in education and training to be able to comprehend the fundamental principles and application practices underlying accounting systems.
- (b) the added difficulties resulting either from the manner of presenting explanation of accounting systems or the manner of receiving such information. Inefficiencies in discussing, conveying or using basic accounting principles, statements, reports and concepts might arise out of several (personal, organizational, environmental) reasons.

- (c) the narrow interpretation on the part of some E.D.P. specialists of the scope of their organizational responsibilities. They view their areas of responsibilities as being limited to the strict technical knowledge in relation to E.D.P. systems. In spite of the fact that many members of this group might tend to refute this view conversationally, their actions in most cases tend to prove it.
- (d) (rightly or wrongly) "overproudness" of some accountants, particularly the chartered ones, concerning what they describe as the 'rigorous' way of training accountants compared with that of training E.D.P. specialists.

This is no wonder that an accountant described accountants' language in the following way: "accountants tend to use a terminology understood only by themselves. This may be true for any field of specialization that has its own terminology. But, for the sake of increasing co-operation between accountants and the users of their data and information, accountants should be aware of this and endeavour to remedy the situation.



Fourteenth: in relation to sufficiency versus insufficiency of applying reporting by exception to computer-based application.

Indicator number and content	Modal Class		Is there any statistically significant difference between the two groups?
	Category Label & Code	Relative Frequency (per cent)	
31. I feel that little has been done in the areas of applying the 'exception principle' where mass computer print-outs could be summarized.	Agree (1)	76.7	NO (P= .426)

The evidence suggests the need for more concentrated efforts in the direction of applying exception reporting to <sup>the</sup> output of computer-based systems.<sup>27</sup> Certainly, computers have enabled us to produce a vast amount of detailed information. But unless reports are carefully designed and information presented in a digestible manner, it is unlikely that they will be effectively utilized.

27. Guthrie (1974, pp. 221-232) reports the results of a survey in Canadian organizations concerning attitudes of the user-managers towards computer-based systems. Amongst his conclusions is the following: "It is obvious that the problem of 'information overload' (so often mentioned by respondents) should be seriously investigated as soon as possible. Properly structured and summarized information for managers seems to be sadly lacking in today's organizations. It is possible that so-called 'exception reports' or 'triggered reports' are not the answer to information overload. A better course of action might be the investigation of the manager-machine interface. Can managers interact with computer based data banks in order to obtain 'score-keeping information' when they want it, and in order to be made aware of out-of-control situations which require their attention? Can managers blend data from the organization's formal information system with personal, intuitive and external knowledge and thereby extend their capacities by use of the new technology? If not, then the computer will remain a surrogate clerk and perhaps too much is being expected of MIS".

Evidently both surveys (the present one and Guthrie's) emphasize the insufficient attention given to managerial requirements of information for planning and control in the design and implementation of computer-based systems. Guthrie has more faith in man-machine interface than in exception reporting. This might be true for some managers who are prepared to follow such approach in organizations where interactive facilities do not constitute a constraint.

Accordingly, the direction of the evidence reinforces the importance that should be given to the basic elements<sup>28</sup> of the system of reporting by exception to improve the managerial planning and control functions. Perhaps this is one of the most important areas in operating the reporting system and utilizing effectively the enormous computational power capable of being offered by present (and potential) E.D.P. technology. In the absence of a properly and intelligently designed and monitored system of reporting by exception (containing relational parameters, financial as well as non-financial effectiveness measurements, mechanisms for detecting real deviations from targets, and precautionary methods to avoid over-or-under reacting to variations outside tolerance boundaries), it is highly unlikely that the system would satisfy its desired objectives.

- 
28. The American Accounting Association Report of the Committee on Management Information Systems (1974, p. 154) describes the well-known elements of the system of reporting by exception to contain the following elements:
1. A set of measurement processes whereby actual achievements are consistently, accurately, and rapidly recorded in dimensions appropriate to the control process.
  2. A set of targets whereby actual performance may be contrasted with desired performance so as to obtain what the control engineers refer to (in describing negative feedback) as "error signals" (In a managerial context these targets may either consist of budgets which are appropriate for the control of discretionary expenses and are also helpful in cash planning; or these targets may consist of what are essentially flexible budgets - that is to say targets derived by multiplying achieved throughput by some standard cost per unit).
  3. Filters are needed to discriminate between significant deviations (A poorly designed filter will either cause the system to overreact by applying corrective action where none is really needed; or else they may be too sluggish and foul to detect serious deviations until they have been manifesting themselves for an extended period of time. The filters must also discriminate between controllable and uncontrollable deviations to maintain credibility and to select the right type response).
  4. (Ideally the system should also contain) a battery or library of preprogrammed contingency responses if the total response-time from symptom to cure is to be minimized and not merely to minimize the response-time from symptom to diagnosis.



Interviews with a number of managers in detailed case-study organizations indicated that neither exception reporting nor man-machine interactive capabilities are the panacea. They indicated that each of these approaches has its limited objectives as well as its limitations;<sup>29</sup> they are tools that can help managers benefit from computer-based systems. Over-or-under-reliance on any of these approaches would not satisfy the sought objectives and would leave the manager dissatisfied with the system.

Accordingly, each organization should carefully consider its needs and requirements of each the feasible approaches to get the maximum benefit out of its investment in computer-based systems. In this respect, managers' involvement and active participation prerequisites to effective managerial planning and control.

---

29. Kennedy (1974, pp. 22-26) discusses the pros and cons of exceptional reporting and On-line Real Time (OLRT) facilities.

Fifteenth: in relation to narrowness versus wideness of gap between achievements and users' expectations regarding their computer-based applications

Indicator number and content	Modal Class		Is there any statistically significant difference between the two groups?
	Category Label & Code	Relative Frequency (per cent)	
52. Regarding computer-based accounting applications, I think accountants expect too much too soon.	Agree (1)	57.4	YES (P= .043)

The overall direction of the empirical evidence supports the above indicator explaining one of the aspects that prevails in the atmosphere of the organizational relationships between the two groups: accountants and E.D.P. specialists.

Examination of the direction within each group indicates that a larger proportion of E.D.P. specialists (than of accountants) tend to agree with the view that accountants - as users of computer-based systems - expect some kind of 'special treatment' for their computerized activities.

Discussions with several interviewees explained some of the main reasons for such difference in opinion, first, the various accounting dead-lines due to governmental and Stock Exchange regulations imposed on accountants' time boundaries. Accountants are the only functional group responsible for conforming with such obligations. Second, some accountants argue that the reverse is true (i.e. that E.D.P. specialists spend frequently excessive amounts of time developing and implementing systems far beyond the initially agreed upon time tables. This sometimes confuses accountants' priorities in meeting their obligations. Third, the difference in interpretation of the accountants' rights and expectations in relation to their computational needs (some E.D.P. specialists argue that some accountants come at too late a date and ask for their work to be given immediate attention, even at the expense of others' work!)



Sixteenth: in relation to effective versus ineffective control of E.D.P. activities.

Indicator number and content	Modal Class		Is there any statistically significant difference between the two groups?
	Category Label & Code	Relative Frequency (per cent)	
32. Senior management of user divisions (or depts.) are frustrated in <u>not</u> being able to exercise effective control over their D.P. activities.	Agree (1)	66.9	YES (P= .006)

One or more of several interpretations might account for the direction of the above indicator; amongst them are:

- . the centralization of the computing facilities which in most cases is responsible for taking away from senior managers of user divisions or departments what they (sometimes) consider to be part of their managerial spheres of influence.
- . lack of sufficient E.D.P. knowledge on the part of senior managers of user divisions or departments to be able to monitor or control their E.D.P. activities. It is highly likely that the less the manager understands about E.D.P., the less the likelihood of him being able to follow effectively the changing needs and requirements of E.D.P. activities; it is likely that such a real control would be in the E.D.P. specialists' hands. This view is supported by the fact that a larger proportion of accountants (than of E.D.P. specialists) tend to agree with the above direction described by the modal class; some of those accountants are either managers or acting in a managerial capacity which gives more weight to their view.

Examination of interviewees' views in this respect indicates that there are different approaches adopted by senior managements of user divisions; few of them are knowledgeable in the E.D.P. field and base their decisions (directly related to computer-based activities) on sound bases. Some managers, particularly those who have very little or no knowledge about E.D.P., frequently delegate such responsibility to E.D.P. specialists or their subordinates who have this type of technical orientation. The implications of such an approach are obvious, in that the decisions taken,

more often than not, lead to ineffective control over E.D.P. activities. Probably, the worst conditions are those where decisions(aiming at either preventive or corrective control measures) are taken by those managers who have little or no knowledge about E.D.P.

Evidently, there is no easy solution to such a problem, but it should be given serious attention by those organizations that are concerned with the effective use of their E.D.P. resources.



### Summary

This chapter has presented an examination of the proposed a priori behavioural indicators in relation to the multidimensional space of accountants - EDP specialists' interaction. The results of the multivariate analysis of interdependence have been critically subjected to further examination as to the possible interpretations of similarities or differences in the attitudinal domain of both groups: accountants and EDP specialists. Both the qualitative and the quantitative data collected by the researcher have been used in the course of the reasoning provided in this chapter. Whenever it was felt appropriate, the researcher made prescriptive approaches and suggestions as to possible contributions to a more effective (specifically constructive) accountants' working relationships with their EDP counterparts.

To evaluate the researcher's proposed domain of the behavioural indicators, a posterior analysis has been made.

## Chapter Nine

Accountants - MS/OR specialists' interaction:  
The analysis of interdependence.

---

### Abstract.

- 9.1. An investigation into the factors influencing accountants - MS/OR specialists' interaction.
- 9.2. Further analysis of the empirical evidence.

### Summary.



Abstract

This chapter consists of two sections. In the first section, the results of factor analysis of the hypothesized domain of behavioural indicators affecting the interaction between accountants and MS/OR specialists are presented. This is an attempt to examine possible ways of developing and furthering organizationally effective understanding amongst the two groups involved in the interaction. In the second section, an examination of the direction of the empirical evidence in relation to some of the factors resulting from the analysis discussed in the first section is presented. Much of the analysis presented in the second section is based on summarizing the original observations contained in the seven-point scale indicators to a recoded set of observations made up of three-point scale indicators. In addition, use is made of the results of applying the T-Test to examine the issue of statistically significant difference between the two groups.

9.1. An investigation into the factors influencing accountants  
MS/OR specialists' interaction.

---

The results of factor analytic solutions of 60 indicators<sup>1</sup> (forming the domain of the relationship) are presented and discussed in some detail in this section. Indicators were constructed on a seven-point scale and intensively tested (for clarity, consistency and reliability) with interviewees.

Subsection 9.1.1. presents an overview of the (first-order) factor analytic (orthogonal and oblique) solutions<sup>2</sup>, identifying the important<sup>3</sup> dimensions contained in the data and rotating them for more clarity of the main factors affecting accountants-MS/OR relationships. Subsection 9.1.2. is a discussion aimed at the analysis and interpretation of those factors and their related indicators. Subsection 9.1.3. examines the a priori assumptions and the contained clusters of indicators, based on the direction of the empirical evidence.

---

1. The computational algorithm used for the purposes of this analysis is the BMD - X72, factor analysis program (see Dixon (ed.), BMD - Biomedical Computer Programs, 1973), revised 1972 for the 1900 series of computers by Loughborough University Computer Centre in co-operation with NAG (Numerical Algorithm Groups).
2. The following discussion is based on factor matrices after rotation. This is due to the fact that factor matrices before rotation do not clearly produce specifically clear results.
3. As indicated in chapter eight (footnote 3, section 8.1.), the term 'important' has two main aspects which are the practical significance for the domain of interest and the statistical significance in terms of the relevant statistics (e.g. eigen-values, the variance summarized by the particular solution).  
For the purposes of practical significance, detailed analysis of relevant empirical evidence is presented in sub-section 9.1.2. as well as section 9.2. which presents further examination of the indications from the empirical evidence. As for the second aspect, the amount of variance summarized by the particular solution is reported following the results of factor analysis. In relation to this, Pearson's product moment correlation coefficient, eigen-values, cumulative proportion of total variance, and factor matrix before rotation are reproduced in tables 61-a, 61-b, 61-c, 61-d, respectively in appendix B, # 2.2.



a

9.1.1. Factor analytic models

Descriptive Interpretation of factors	Orthogonal (uncorrelated-factors) <sup>c</sup> solution				Oblique (correlated-factors) <sup>d</sup> solution			
	Factor number	Indicator number	Loadings	Communality $h^2$	Factor number	Indicator number	Loadings	Communality $h^2$
Positivity versus negativity of the interaction	I	21	.75	.73	I	9	.75	.68
		3	.69	.69		17	.71	.69
		9	.66	.68		8	.63	.68
		29	.66	.77		29	.55	.77
		15	.65	.69				
		18	.65	.74				
		13	.65	.65				
		8	.58	.68				
		17	.58	.69				
		31	.58	.69				
10	.53	.66						
Efficiency versus inefficiency of MS/OR	II	14	.70	.63	II	6	.65	.73
		6	.68	.73		7	.62	.64
		44	.67	.67		41	.57	.69
		51	.65	.65		4	.56	.63
		23	.64	.65		44	.54	.67
		35	.64	.68				
		4	.62	.63				
		41	.57	.69				
		7	.56	.64				
		33	.54	.68				

Descriptive interpretation of factors	Orthogonal (uncorrelated-factors) c				Oblique (correlated factors) d			
	Factor number	Indicator number	Loadings	Commun-ality $h^2$	Factor number	Indicator number	Loadings	Commun-ality $h^2$
High versus low degree of MS/OR institutional-ization and organizational maturity	III	50	.78	.75	VIII	50	.83	.75
		42	.63	.70		25	.59	.70
		25	.59	.70				
Absence versus existence of organizational hindrances	IV	54	.72	.68	IX	42	.64	.70
		40	.64	.68		39	.60	.64
		55	.52	.68				
Intelligent versus unintelligent organizational selling of MS/OR	V	28	.80	.73	V	28	.79	.73
		52	.69	.67		52	.68	.67
		49	.54	.74		49	.67	.74
High versus low degree of bridging technical terminologies	VI	26	.70	.75	IV	26	.70	.75
		11	.54	.64		11	.59	.64
Co-operative versus monopolistic monitoring of finance	VII	57	.68	.71	VII	57	.57	.71
						45	.50	.70
Sufficient versus insufficient joint (MS/OR-Accounting) simulation modelling	VIII	34	.74	.80	XII	34	.79	.80
		48	.70	.74		43	.61	.75
		43	.56	.75				



Descriptive interpretation of factors <sup>b</sup>	Orthogonal (uncorrelated-factors) solution <sup>c</sup>				Oblique (correlated factors) solution <sup>d</sup>			
	Factor number	Indicator number	Loadings	Communality $h^2$	Factor number	Indicator number	Loadings	Communality $h^2$
Success versus non-success of MS/OR	IX	1	.54	.61	VI	1 35	.59 .55	.61 .68
Significant versus insignificant consultation on financial consideration of MS/OR projects	X	58 46	.74 .54	.80 .73	X	58 46	.81 .57	.80 .73
Low versus high degree of vagueness in relation to MS/OR objectives	XI	2 12	.74 .69	.71 .70	XI	2 12	.83 .67	.71 .70
Active versus passive accountants' recognition of MS/OR applications in their field of specialisation	XII	38	.77	.73	XVII	38	.76	.73
High versus low, degree of contemporaneous view of MS/OR on the part of accountants	XIII	56 60	.70 .58	.65 .66	XIII	56 60	.80 .50	.65 .66

Descriptive interpretation of factors <sup>b</sup>	Orthogonal (uncorrelated-factors) solution <sup>c</sup>				Oblique (correlated factors) solution <sup>d</sup>			
	Factor number	Indicator number	Loadings	Communality $h^2$	Factor number	Indicator number	Loadings	Communality $h^2$
Low versus high pedantic attitude on the part of accountants	XIV	32	.78	.70	XIV	32	.80	.70
Congruity versus incongruity with operative organizational goals	XV	59	.84	.80	XV	59	.87	.80
Absence versus existence of narrow minded financial management in weighing MS/OR proposals	XVI	22	-.70	.81	XVI	22	-.83	.81
		24	-.66	.64		24	-.59	.64
High versus low degree of MS/OR appreciation of accounting systems	XVII	47	-.75	.71	III	47	-.77	.71
Moderate versus excessive amount of professional jealousy	XVIII	30	.80	.85	XVIII	30	.98	.85

a. R-factoring is employed. The correlation matrix contains Pearson's product moment correlation coefficients leaving unities in the main diagonal as initial communality estimates. (Table 61-a, appendix B, 2.2.).

b. Factoring was stopped when all factors whose eigen-values (sum of squares) are greater than one are factored. The variance summarized by the eighteen factors (whose eigen-values are greater than one) represents 70 per cent of the total variance in the sixty indicators.

c. The Varimax method (for simplifying factors) is used.

d. Oblique rotation for simple structure (with gamma equal to 0.000) is employed.



Reiterating the fact that the analysis is based on a set of imperfect data, the researcher has adopted the strategy of subjecting the input data to different approaches of analysis. More specifically, the researcher has examined the input data with several combinations of factor analysis procedures and options. The following points are the outcome of the examination:

1. a number of factors seem to show very little change under different factor-analytic options - These factors are:
  - positivity versus negativity of the interaction;
  - efficiency versus inefficiency of MS/OR;
  - high versus low degree of MS/OR institutionalization and organizational maturity;
  - absence versus existence of organizational hindrances;
  - intelligent versus unintelligent organizational selling of MS/OR;
  - sufficient versus insufficient joint (MS/OR - Accounting) simulation modelling;
  - high versus low degree of contemporaneous view of MS/OR on the part of accountants;
  - high versus low degree of MS/OR specialists appreciation of accounting systems.
2. many of the one indicator-factors do not survive severe tests. Their associated indicator(s) either load on other factors or do not load (according to the specified criterion, i.e.  $0.50$ ) on any of the extracted factors.

- 
4. Deming (1944, pp.359-369) enumerated different factors that affect the usefulness of surveys. Examples of such factors are variability in response, different sources of bias, imperfections in the design of interview tables and mailed-questionnaires, sampling, processing, interpretation errors. Although the researcher has exercised care in designing and implementing this research, the study is no exception.

3. using Kendall's rank order correlation coefficients as the input matrix does not materially affect the conclusions reached on the basis of Pearson's product moment correlation coefficients. The set of factors mentioned in (1) above are also extracted using the rank order correlation matrix. Some of the factors that are defined under Pearson's correlation input matrix are not defined using the rank order matrix. Amongst these factors are (i) success versus non-success of MS/OR, (ii) high versus low degree of bridging technical terminologies, (iii) co-operative versus monopolistic monitoring of finance, (iv) significant versus insignificant consultation over financial considerations regarding MS/OR projects, (v) active versus passive accountants' recognition of MS/OR applications in their field of specialization. Two main interpretations may be made for this aspect of the comparative analysis. The first is that the particular indicator(s) loads on another factor. Success versus non-success of MS/OR is an example of this first interpretation in which the associated indicators load on the factor titled efficiency versus inefficiency of MS/OR. The second interpretation is that the indicator(s) fails to satisfy the minimum absolute value criterion (that is an absolute value of .50) for inclusion amongst the set of indicators describing a factor. The factor titled 'active versus passive accountants' recognition of MS/OR applications in their field of specialization' supports the second interpretation.

In view of these observations, the researcher emphasizes the importance of subjecting the outcome of the above analysis to further investigation. Wider sampling combined with different approaches of analysis can establish a degree of confidence in the above results.



9.1.2. On the interpretation of the important factors influencing Accountants-MS/OR specialists' interaction : a discussion

---

Having outlined the results of applying the orthogonal and oblique factoring models to the input data, it is worthy discussing some of the related empirical evidence:

First: Less contact with the other functional group (MS/OR or accounting) does not give the opportunity to get to know each other's problems, concepts, approaches, and systems.

When asked about his opinion regarding MS/OR specialists' contribution to his (large business) organization, a senior financial accountant commented in the following manner:

"... I feel that because of the very fact that my contact with MS/OR people has not been very extensive, I therefore would be very loath to form any judgment because they must be very highly qualified people in their own area to do the calculations they do and they are a kind of abstract to me at the moment in that I haven't found a use for them in my financial accounting area".

The above comment explains some of the dysfunctional consequences of the insufficiency (or the lack) of constructive communication patterns between accountants and MS/OR specialists. Furthermore, there is no reason why this should not be true of the relationships between managements and MS/OR specialists. Sometimes, the lack of, or insufficient interaction might lead to misconceptions about less clearly defined or less familiar activities to some persons. For example, a MS/OR specialist described his experience with senior managers of user division in his organization as follows:

X: " ... the majority of managers reckon that MS/OR people try to make a problem complicated, that is to do a nice mathematical formulation so that they can spend a lot of time solving it. This is the general feeling before they come across . "

I: Do you think that such attitude would be changed after getting to know you (MS/OR people).

X: "Well! in some cases, we may succeed in changing their attitude. But, if it is a complex mathematical problem, then probably their attitude does take longer to change, because they still don't understand the concepts we are using. However, the more we get into the various dimensions of the problem, the more the (MS/OR) approach becomes clearer"

Given the fact that not many accountants and managers are as yet familiar with the MS/OR approach to the contribution to their organization's problems, the above discussion between the researcher (I) and the interviewee (X), emphasizes the importance of a constructive dialogue between MS/OR specialists and the users of their services. This should be based on sufficient familiarity with each other's objectives, approaches, and fundamental concepts employed.

Second: Organizational effectiveness of MS/OR function(s) is one of the most important factors contained in the type of organizational interaction under considerations, the constituent indicators being: the MS/OR intrafunctional efficiency (indicator 14); the extent of MS/OR systematization, that is being institutionalized and recognized as an integral part of the service functions in their organization (indicator 23); the extent to which top management of the organization is backing MS/OR activities (indicator 6); the role played by MS/OR specialists as analysts in the information network of their organization (indicator 51); MS/OR specialists' ability to 'sell' their ideas and methodology to user functions (indicator 4); the



understanding on the part of MS/OR specialists of what is required from them to user functions (indicator 44); the extent to which the MS/OR function is organizationally successful, in designing accepted and used projects (indicator 35); the amount of awareness and understanding on the part of senior managers of what is 'possible' as opposed to what is 'ideal' concerning their expectations regarding MS/OR achievements (indicator 7); the narrowness of the organizational distance between MS/OR and proceeds of problem solving and decision making (indicator 41); the efforts on the part of MS/OR specialists to improve their image (indicator 1); the extent to which the MS/OR function is supporting senior management of user divisions in assisting in the solution of complex business problems (indicator 33); and the present capabilities and the potential contribution to the long-term survival and growth goals of their organizations (indicator 53). The effectiveness of the MS/OR function is, therefore, a function of both its own structural design and the organizational environment within which it operates.

Third: Absence of organizational hindrances to MS/OR specialists' interaction with users is one of the necessary conditions to more effective interface. There are a variety of ways in which such obstacles take place, chief amongst them are: the rigid application of control mechanisms to which service functions (such as MS/OR) are subjected, by taking the 'charging back' system to either of its extremes; the creation and/or the use of the MS/OR function to serve political manoeuvring between directors or managers, to serve purposes that have dysfunctional effects to the organization, and the unsuitability of the form of organizational design in a manner that

in some ways, hinders the proper use of such services. Any of these circumstances alone might be the major variable affecting the effective use of such services or act in conjunction with others to affect the performance of the MS/OR group(s). For example, the MS/OR function in a particularly large U.K. business organization is located within the systems development function. Hence, it suffers from much of the historically accumulated symptoms of ineffectiveness in carrying out the development and implementation of computer-based systems. This has resulted in the formation of a pre-conceived idea about the relationship between MS/OR and the systems development function amongst managements of user divisions. The implications for the potential use of the MS/OR services in the manner described, is explained by a member of the MS/OR function as follows:

" ... the majority of managers think that we are always going to come up with a computer solution to a problem, and this is not always necessarily the case. They won't approach us with problems they don't feel need computers. Basically, because they have their own ideas about how to solve a problem, they have an idea about how to set about a solution but they don't have the technical 'knowhow' to carry it out, and if they have the preconceived idea that it isn't a computer solution, they're unlikely to come to us. More importantly, users more often than not use their experience in dealing with the computer department to be the basis for formulating their expectations about what we are going to say and do. So, if you have a computer department with a bad record, this, I am afraid, will accelerate the effects of the preconceived idea of some customers - that we are a computer compartment - and whether or not to approach us.

On the other hand, it is useful to be on the side of computing to have good access to the E.D.P. facilities, because the majority of our projects do involve a lot of numerical calculations."



Fourth: The adoption of practical and 'professional-like' approach by MS/OR specialists in dealing with organizational problems is an important factor in their being accepted and organizationally recognized, to be a useful source of support in attacking problems. Much of the criticism directed towards some MS/OR specialists is very much related to these two questions of 'professional-like' and practicality questions.

In terms of the question of practicality, it is evident that theoretical models which are beyond the users' ability to comprehend are of little or no use to them. MS/OR models are not an end in themselves; they are a means to fulfilling specified organizational objectives. This question is related to the global framework in which the discipline is evolving. The general view in this respect indicates that there is a wide gap between the theory and practice of MS/OR. This implies a psychological distance between expectations and reality in MS/OR. A representative opinion expressing this view point was made by a MS/OR specialist. This view reflects on his experience in (U.K.) industry in general, and his function in belonging to a large organization. Incidentally this view is consistent with several opinions and views regarding the state of the art in MS/OR, and the general dissatisfaction regarding the wide gap between theory and application of MS/OR:

"... if you look at the written output (Literature) on MS/OR techniques, I think it would be amazing that a fraction of that has actually been used to solve real problems. There is an enormous amount of theoretical writings - I don't say that it shouldn't churn out all that material. Obviously, the research material should be produced in order to be able to get anywhere. But as far as using MS/OR is concerned, I think (MS/OR) people have tended to be too sophisticated; whilst a much simpler approach to a problem would yield as good results as producing a system that can be used by the management that's got to accept it".

Furthermore, there is a tendency amongst MS/OR specialists to build more complications and higher degrees of sophistication into models they design, which are sometimes unworkable from the users' point of view. Describing such tendency the subject emphasized that he himself is amongst those covered by such views, where he said:

"I must admit that very often when we build a model, there is a temptation to increase the level of sophistication. Often the marginal returns you get from quite heavy increases in sophistication just are not worthy. Forecasting could be quoted as an example in this respect. If you do a fairly elementary statistical forecasting - basically analysing historical data and extrapolating on the basis of those historical data - you are pretty limited as to what you can do and how you can use that information. But you could spend a lifetime on building in additional bits of sophistication into your computer model and getting triple exponential smoothing, and building in lags and adaptive responses and all these sort of things. Fundamentally, you would have made no significant progress although your marginal investments might be the same for each stage, your marginal returns might be negligible. So, some of the models we build are unworkable models mainly due to the high degree of complications built into the model which would not be easily absorbed by the people who are, in effect, would be using that system on a day-to-day basis".

But does the answer lie in building simple MS/OR models that could be easily used by managers? (Although the researcher does not equate simplicity with practicality, both share some common elements). Basically the dialogue upon which the model is designed and implemented should be feasible from the users' point of view. However, simplicity is not always easy (as indicated by several MS/OR specialists) to arrive at such simple solutions. Amongst the reasons that might be responsible for that situation are:



- (i) the constraints imposed by the type of methodology to be applied (as in the case of linear programming, integer programming, or simulation modelling, each of which has its own assumptions and conditions that must be met);
- (ii) the data or information available about the problem and the possible alternative approaches to tackling it (as in the case of an ill-structured problem); and
- (iii) the ambitions of the sponsor of the MS/OR project with regard to his expectations of the outcome of the MS/OR analysis, coupled with the fact that some MS/OR specialists tend not to discourage such attitude on the assumption that MS/OR could handle almost any type of problem (well- or ill-structured).

On the question of MS/OR specialists' professionalization, there are different schools of thought, some are in favour of transforming the present 'learned' Operational Research Society into a 'professional' one on lines similar to those of medicine, accounting, and law; others do not think that such a transformation would contribute to the effectiveness of MS/OR specialists in carrying out their responsibilities; still some others could be described as the 'middle-of-the-road' who do not totally commit themselves to either of the first two schools' norms. But why should the MS/OR be a professional body (on lines similar to Medicine, Law and Accounting)? How would members of the O.R. society react to such a situation? And what are the advantages and disadvantages if such transformations were to take place?

Perhaps it may be worthwhile discussing how MS/OR specialists see their discipline in relation to others. One MS/OR specialist (who was interested in this area) indicated there are some diff-

erences between MS/OR and other disciplines such as medicine and law, when he put it in the following way:

"... Medicine is obvious in that the public needs protection and where human lives could be lost if there weren't a professional code of conduct. Law is - to some extent - just a little light of course. O.R. comes further down the scale to the community at large. As far as measures for public safety, O.R. is not on similar lines to those, for example, civil engineering".

And when the researcher mentioned (to the interviewee making the above comment) that MS/OR is applied to military, public transport, government departments, and (not least) industrial concerns, he said that:

"I agree that O.R. tends to impinge on so many other activities, maybe there are different degrees to look at the same problem. One needs to define O.R's position to these other disciplines"

Obviously the problem is a multi-dimensional one and has many facets. A decision which does not take in account both the client's interest as well as those of the MS/OR specialist himself is not likely to contribute any significant progression in so far as the MS/OR discipline is concerned. The researcher, however, thinks that there is a real need for tackling the professionalization question based on an extensive analysis of the needs and requirements of the discipline in making it learned by examining the experience of other disciplines.

In reference to the reaction of MS/OR specialists to such transformation if it were to take place, distinction can be made between two groups. The first is the newcomers to this field of organization, and the second is the existing members of the MS/OR community (whether or not they are members of the O.R. Society). It is highly likely that those who belong to the former group would study, evaluate, and subsequently accept the status quo. The latter group



would base their decision on a number of considerations, relating to their current position and their future prospective. For example, some members of this latter group might base such a decision on their prediction of their gains or losses as a result of joining an O.R. society on lines similar to Medicine, Law, or Accounting. A typical view representing this group of subjects is:

" ... in so far as it could be a badge of respectability, I would be interested in being a member of the O.R. Society, because it looks as if I would qualify to register on application as a member, so in that sense I would join it. Since it will exist and I can join easily - taking into consideration my qualifications and experience - I will do. I may slightly gain - or not gain - but certainly I wouldn't lose as a result to that. Now! I don't know what my attitude would be if it would be more difficult to get myself into the Society".

In fact, the professionalisation issue manifests itself on this analysis in a variety of forms, namely: extent of bridging technical terminologies, pace of MS/OR organizational progression, accountants' contemporaneous (untraditional) view of MS/OR organizational activities, absence of accountants' overcomplicating issues; absence of rigid, narrow-minded approach to financial management in relation in weighing MS/OR proposals; MS/OR institutionalization and organizational maturity; and moderation of professional jealousy. These factors suggest that there are a number of aspects that could be described as (organizationally) dysfunctional (such as rigidity, narrow-mindedness, and impractical abstractness) and often associated with traditionally organized and maintained professional bodies; probably because of too much involvement in maintaining the established practices. On the other hand, the so-called 'learned'

bodies often find the absence of a well-established character and recognized code of conduct<sup>5</sup> as the main disadvantages.

It is interesting to note that some MS/OR specialists attach more importance to time than formalization of their 'professional code of conduct'; the following is a typical view indicating that time will solve this professionalization issue:

"The O.R. society has not been too long with us (compared with other engineering, accountancy etc.) I have got a sneaking suspicion that respectability (of MS/OR) comes with time anyway. As more people become more accepted as they do useful work to their organizations, O.R. will grow. Respectability - I think - requires time rather than doing any conscious act".

The self appraisal on the part of the MS/OR community in general and the O.R. society in particular is an essential strategy in the dynamic evolution of its discipline to provide supportive services to users of its resources. Basically it is necessary to trace the path of other professional and learned bodies for the lessons to be drawn. Equally important is a sufficient understanding of the nature, scope, reasons, and implications for the gap between aspirations and expectations on the one hand, and reality and achievements on the other. These are to be the foundations upon which the appropriate courses of action might be taken to monitor what MS/OR specialists ought to follow.

Perhaps the discussion could be reduced to a matching process between two main aspects: (a) the qualities essential to the development of a MS/OR specialist's contribution to organizational problem solving and decision processes; and, (b) the present activities of the society (either as educational and training requirements or affiliation conditions). As to the former, a MS/OR specialist expressed the following view:

---

5. With regard to members' standards of practice.



"In a MS/OR man, there should be two basic qualities. He should be technically competent; in that if he does an L.P. application or a similar application of any other classical MS/OR techniques, he should have a grasp of the technique and an ability to apply the technique to realize the limitations of the technique, or to do research really if there is any recent developments that would assist the application. In this he also needs a training of the mind to give him the ability to investigate whether there is a better way to help in the implementation. That is one side.

"On the other side, he's got to have the ability to communicate, to consult with people, to interview people, to carry out a project, and to manage people".

Are the present arrangements to equip members of the MS/OR community sufficient to match the desired goals of the discipline? Clearly not. There is much to be done to fill such a wide gap.

Fifth: Indications from the empirical evidence give weight to the degree of accountants' active recognition of MS/OR applications in their field of specialization as one of the factors affecting the MS/OR-accountants' understanding. This issue is a multidimensional one and needs some detailed analysis and exploration of how both (accounting and MS/OR) specialists feel about it. Some MS/OR specialists classified accountants into categories according to accountants' reaction to MS/OR type of activities. A typical view of this group is expressed in the following detailed manner:

"Although there is a wide variety of accountants, one could identify three main categories as follows: (a) he (an accountant) works in a division where they've got a large number of businesses - which are not couched in accounting terms but couched in terms of other variables (perhaps in non-quantifiable terms such as-you'll run your business in a particular way, you'll develop that market or you will go for higher growth, etc). What this first type of accountants is doing is just maintaining some proper accounting standards there. He, as an accountant, really does not have too much time at all to think about the business; how about the basic business

logic, how about some tax planning or looking into the capital structure? This type of accountant has no time to give these later aspects some consideration. This is not necessarily by choice though, because the work-load is so great; they do an extremely professional job under those conditions.

(b) The second type of accountant takes a much more searching view of the business, but he's got far less businesses to think about; he will look at the cost structure in much more detail; he will say: how vulnerable are we to cost inflation or wage inflation at various rates? How important is our debt financing for our large capital project, capital intensive type of project? What price objective should we have and what effects such price on profit? He is the guy who is doing profit budgeting.

(c) The third type of accountants really doesn't want to know very much about our particular style at all (MS/OR) because he really doesn't understand it; he is a bit protectionist; his attitude to us is the same as his attitude to every other person in the company; external agency that would try to change the situation. I think he is a skilful politician who defends his situation quite well and continue to operate the business he knows how.

I should emphasize that accountants of all the three categories occupy (in the organization) equivalent positions".

Another group of MS/OR specialists were concerned about the 'rigidity' of accountants' costs and computations. A representative view of this group was expressed by a MS/OR specialist where he emphasized that:

"One of the problems with accountants - we find - is that for any particular facet of life such as the capacity of plant or the product cost at a particular plant, they need to have one number, and that number is their standard cost entry if you like, and believe in that number. In real life, costs vary around that number with a probability each way. But they tend to say: that is a precise cost of a precise capacity and all work that is done goes around that particular cost. Finally, that cost might be wrong or somewhat variable which is not shown very well on the accountant's book. So I think accountants are fairly rigid about their costs, and given a cost all our work has to be based around those costs, where in some cases we find it hard to believe that these costs are fixed as they think they are".



These views (as well as other extreme ones - either for or against accountants' degree of active, direct or indirect recognition of MS/OR in general, and particularly in this field of specialization) are the function of a variety of reasons. Amongst these are personal and organizational background variables, as well as internal and external environmental circumstances and conditions.

Basically, to suggest that accountants (or even a particular functional group within the accounting community) have some type of idiosyncrasy against MS/OR type of work or MS/OR specialists implies that there exist unsupported, sweeping generalizations, that would not pave the way for more effective utilization of such organizational resources. Accountants should be familiar with and convinced of the worthwhileness of a MS/OR project. Many MS/OR specialists who were interviewed acknowledged this fact and would be encouraged to think of accountants as providers of information support to, and users of, MS/OR services.<sup>6</sup>

A fact that contributes to more explanation of accountants' degree of active recognition of MS/OR in their field of interest - which was supported by a large number of interviewees in both functions - is the time limitations imposed on accountants by deadlines, reporting time tables and the like. A typical representation of such a view was expressed by an accounting manager that:

"... one gets so absorbed in what one has to do in his occupation from time to time : ... that you haven't the time to sit back and say: 'could we do better if we use the MS/OR function? or how we could both of us (accountants and MS/OR) do more analysis and interpretation? We (accountants) are always under pressure of time constraints, deadlines all along".

---

6. It is possible to assume that accountants at the regional works level are less exposed to MS/OR than their counterparts at the Head Office. One MS/OR specialist emphasized that accountants would not blockade MS/OR projects, for the sake of opposition, where he indicated that:

Sixth: Each function's awareness of what might be termed the psychology of the other's nature of work, scope, and problem area, is an influencing factor in the interaction under consideration.

To explore this aspect, the following citations, which consider what some MS/OR specialists might perceive to be the most boring (and the most interesting) aspects of their work, might be useful: One MS/OR specialist representing one organization explained that:

"The most boring aspect of MS/OR is - I think - the data collection, because they are always inadequate and it always takes a lot of digging out. Data are always in the form which you don't want them.

If the data are on a computer file that becomes quite interesting and converting it into your own pattern in itself becomes quite a good exercise. But if it is sort of sitting in hundreds of files like a wall, you just got to plough through them ...

On the other hand, the most interesting aspect is the formation of the problem; from actually knowing what the problem is, to realizing that there is a solution which you can get."

Another view indicated that:

"... I think the most boring aspects are often the work that goes on in the middle of any project where you tend to be doing a fair amount of slog you are doing a lot of data analysis, or you're in the depth of detail of a model you have probably lost your initial burst of enthusiasm and the light isn't in sight of the end of the tunnel; you're in no-man's land. It tends to be a bit boring; that is the time when a person needs a bit of stamina really".

---

... "I think accountants at the regional/works level have not had all that much exposure (compared with their involvement with computers) to MS/OR type of projects.

I think to a certain extent there is a bit of the case where you may have a MS/OR project - which for argument's sake could save some money doing a particular piece of MS/OR work. I still think the accountants would think of this as being outside their areas and to a certain extent accounting systems and procedures have their sacredness; but I don't think that this would in any way stop them co-operating one hundred per cent with the MS/OR project given that it was seen as worthwhile thing".



Although these are personal views, they do explain the differences in the nature of work between MS/OR and accounting (in general), and this probably has its implications for the formation of attitudes involved.

On the other hand, the psychology of accounting might be explained through descriptions of how some accountants view the present image of industrial accountants. A representative view in this respect is described by a divisional accounting manager in a multi-national industrial organization as follows: <sup>7</sup>

"I think industrial accountants have grown with industry, but they still have this image of being the scorers; the man who produces the figures and doesn't necessarily need to interpret them. In the future we want to see accountants coming out in industry more of the businessman. And if you can sort of say: 'that businessman is also an accountant, so we start to win the battle. You've gone a long way towards it when you say he's not only an accountant, but he's also a businessman'.

Certainly, he still does the scoring, because that's part of it, and we can use the computer to do that. We do in fact use the computer to collect the figures, arrange the figures, churn them out in the format we require. Thus, the accountant's skill comes into being by determining how these figures are to be read, and going along to the manager and telling him all about his market, the market share, telling the operations man about his machine hour rate, telling him about his costs, how they behaved and what caused them to behave like that. This has not been done to a satisfactory and sufficient extent. Instead of tackling this on a very limited manual extent, we ought to be able to adopt the routine package that we have to give us this sort of information - information about product costs, about how the behaviour of variable costs and fixed costs are impacted upon by change in volume.

I think the other aspect of business that is coming into focus very much recently, has been the importance of cash. Very often we've had situations where companies have shown a reasonable profit, but because the debtors were out of control, because the creditors were a bit haphazard, because the stocks have not been properly rationalized or any other reasons - and the impact of one on the other - they've not necessarily generated enough cash to carry on the business and I think with interest rates having increased, this is coming very much into focus now. So, not only interpreting the figures in terms of profit, but also in terms of cash and relative to the capital employed as well".

- 
7. Two main comments are relevant in this respect; the first is that the essence of this view is expressed by several interviewees; and the second is that this view is made by a divisional accounting manager casting on his experience concerning both financial and management accountants reporting to him as well as himself.

Evidently the above description leaves much to be desired in the direction of accountants' approaches to tackling business problems. The dominance of this side of the stewardship function should be reduced to a lesser extent, in order to give proper attention to the other accounting responsibilities towards managerial decision making, and problem solving. This is by no means a call to scrap the book-keeping part of accounting responsibilities, rather, it is a call to put such a mechanism into its proper view amongst accounting tools.

How has the above-described picture of the present image of accountants come about? How do accountants see the way such an image has evolved? To answer these questions (and the like) the following discussion between the researcher and a senior financial accountant, in relation to the inadequacy of the financial reporting system in his relatively large business organization to meet the requirements and expectations of other users of accounting information (amongst them MS/OR specialists is quoted. The interviewee was asked to explain why financial accountants firmly believe in objectivity and demanding a high level of accuracy and exactitude, which may not make the financial reporting system less useful for MS/OR and other analyses:

"X: ... one takes the fact to where one starts to learn one's profession as a financial accountant and it usually is with a ledger. And I can always remember, I think, the first study paper I ever received; it said in it: that you must learn to think in terms of debit and credit; every debit must have a credit: this is the whole fundamental basis of double entry book-keeping and accountancy. Now, if you started to learn with ledgers, if every debit has a credit, quite clearly the proposition is - at the end if you add up all your debits and all your credits that you're absolutely right; both sides balance. This feeling gets strong into you right from the start. It is a whole base you build on and therefore you tend to think of those terms. The financial accountant would build up his approach to his profession on those lines that everything must be tied up and neat. This I think makes the financial accountant more pedantic, more conservative and less venturesome person; just because of all these factors. Furthermore, probably this is tied up with his personality in that he adapts himself to that way of going. Some people in the middle of that will say: 'Oh I just can't bother with



that exactitude and then could switch on to some other field of accounting'. You may find out that chap has got a lively kind of brain that can't sit down and absorb this kind of thing but would be quite happy with quick calculation or some analysis or interpretation in other areas of finance or management. This does mean that financial accountants are not interested in analysis and interpretation. You realise of course that I am generalising about the kind of people that I have worked with and have seen."

I: Do you think that younger members of the profession who have worked with you hold the same attitude?

X: "Yes, I do indeed. I believe in that firmly. Mind you, let me say straight away that it has a virtue, because when it comes to somebody like me I can rely on the chaps that have done this (the interviewee points to a periodical financial statement) to be that way about; and I can perhaps dismiss things based on the fact they have done the base work right. I have to be backed. I take the responsibility. I have to be exact. Although reporting to higher position (directors' level) might not be so exact and to take the measure of the figures in context. This is pretty all right as long as I am backed by this solid lot of people working according to a disciplined system of reporting of exact terms".

This discussion throws some light on the way in which the financial accountant grew and the environment within which he is working; it contains (obvious, but sometimes neglected or unrecognised) implications on a variety of resolution levels.

### 9.1.3. A posterior examination of the 'a priori' of indicators

The results arrived at by means of the factor analytic models employed in the preceding sub-section (9.2.1.) has re-inforced most of the researcher's thinking in relation to organizationally effective 'Accountants-MS/OR' understanding. Furthermore, these results have added some points of emphasis through which 'understanding' (or the lack of it) could be subjected to diagnosis and prescription.

The eighteen-first-order factor solutions arrived at fall broadly within the range of the a priori of factors, proposed at the end of the analysis of the explorative investigation, into opinions and views of MS/OR specialists concerning their working relationship with accountants. Those proposed dimensions are: present MS/OR .-Accounting' relationships; outlook of accountants; features of the MS/OR group or function; image of the MS/OR specialists; future prospects of MS/OR; - Accounting relationships; top management understanding and backing; organizational policies and conditions; and user management involvement.

It is necessary to emphasize that the application of factor analytic models is not a panacea to measurement (and other) errors contained in the data. The following points are worth mentioning as they concern the comparison between the a priori/<sup>classification</sup> of dimensions, with the results obtained by means of the factor analyses detailed above:

- the results do not give indications to question (or perhaps doubt) accountants' place in the information network of organizations. Contrary to the widely held belief that MS/OR specialists (and other specialists) would make the accounting services obsolete, accountants' position in the organization, it seems, is well established. However, the quality of their services to the fairly recently evolved groups and functions, particularly MS/OR, is affected by a number of factors such as: the degree of accountants' active recognition of MS/OR appli-



cations in their field of specialisation; accountants' contemporaneous (untraditional) view of MS/OR organizational activities; the existence/absence of a pedantic view on the part of accountants; the degree of rigid, narrow-minded approach of financial management in weighing MS/OR proposals; the extent of bridging technical terminologies; and the extent of MS/OR - accountants' joint effort in relation to financial simulation modelling.

Although the absence/existence of organizational hindrances to the effective use of support systems is one of the important factors affecting accountants-MS/OR interaction, it has loaded on different indicators in different rotational models. Factor IV in the orthogonal solution which is number IX in the oblique solution. On the one hand, the mode of managing differentiation and integration might be taken to describe such a factor; (though the loading of indicator 55 does not contribute significantly to the clarity of such a factor. On the other hand, the oblique rotation does contribute to more clarity of such a factor with more emphasis on the degree of senior management (of user divisions) awareness of benefits and limitations of MS/OR. These indicators, whether in the oblique rotation or the orthogonal one have one common feature, that is, they describe organizational circumstances and conditions that are related to the manner in which organizations manage differentiation and integration. However, limiting the sampling design of this empirical investigation has probably contributed to such a situation. Therefore, for any further investigation in this direction, the benefits of including several managerial echelons into the sampling design are clear.

## 9.2. Further analysis of the empirical evidence

Each of the hypothesized indicators is considered to propose a direction of the relationship affecting the accountants - MS/OR<sub>1</sub> <sup>specialists'</sup> understanding. Accordingly, this section contains further analysis of the indications of the empirical evidence. Such further analysis involves:

- (i) description of the modal class (its category label: agree, disagree, true, false, or undecided; its relative frequency in percentage terms). For the purpose of the analysis in this section, the original seven-point scale is recoded<sup>8</sup> into three categories where, for example, 'strongly', 'moderately', and 'slightly agree' are taken to form a new category labelled 'agree'; also, 'strongly', 'moderately' and 'slightly disagree' are taken to form a new category labelled 'disagree'; whilst the 'undecided' category remained unchanged. This is to summarize the main body of the data without jeopardizing the message underlying the direction of the empirical evidence.
- (ii) presenting the results of applying the T-Test in relation to answering the question of statistically significant difference between the two groups (accountants and MS/OR specialists). T-Test results are also based on the recoding of the observations in the manner described above in (i). (see section 8.2. for the adopted computational procedure).
- (iii) Centering the discussion around some of the major factors discussed in the preceding section. This would, hopefully, further clarify the various dimensions of each of the factors. Due to the fact that the factors are explicitly defined in terms of the contained operational indicators, the researcher has endeavoured to complement the discussion with explanatory illustrations and supporting rationales to the factors contained in the analysis.

---

8. As adopted earlier (in chapter eight), the originally Observed values of each of the indicators are Recoded into a modified set of category labels. Tables are given the same numbers as indicators. Subsequently two sets of tables are provided; the first set contains tables based on original observations (labelled O), and the second set contains tables based on recoding the original observations and labelled R. For example, in the case of indicator 60, there are two tables; the first is table 60-O, and the second table is 60-R. Those tables related to this chapter are contained in Appendix B, ~~2.2~~ 2.2.



First: in relation to positivity versus negativity of the interaction

Indicator number and content

Indicator number and content	Modal class		Is there any statistically significant difference between the two groups?
	Category Label & Code	Relative frequency (percentage)	
21. On both functions, there is a reasonable amount of appreciation of the others' problems.	Agree (3)	56.1	No (p = .140)
3. MS/OR specialists find an attentive audience amongst accountants.	True (3)	54.6	No (p = .751)
9. I think MS/OR - Accounting interaction is based on friendly attitudes.	True (3)	65.5	No (p = .368)
29. Present relationship between MS/OR specialists and accountants could be described as a promising one.	Agree (3)	54.3	No (p = .075)
15. I feel that more and more of our accountants are getting to appreciate what MS/OR can - and <u>cannot</u> - do for them.	Agree (3)	60.2	No (p = .667)
18. I would say that there is a <u>lack</u> of understanding on the part of MS/OR specialists and accountants of each other's function.	Agree (1)	61.4	Yes (p = .038)
13. Both parties (accountants and MS/OR specialists) show interest in securing and maintaining worthwhile relationships.	True (3)	59.6	No (p = .627)
8. Present MS/OR - accounting relationship is <u>not</u> progressing as it should be.	Agree (1)	54.0	No (p = .282)
17. Confidence and trust are major characteristics of the present pattern of working relationships between MS/OR and accountants.	True (3)	51.7	No (p = .092)
31. On the whole, accountants take a <u>negative</u> interest in MS/OR projects.	Disagree (3)	58.4	No (p = .199)
10. My feeling is that many accountants do <u>not</u> bother with MS/OR type of projects.	Agree (1)	68.2	No (p = .302)

Perhaps the interesting inference that could be made on the above results is that, although the relationships are not characterized by highly dysfunctional conflict between the interacting groups, accountants take - in the majority of cases - a passive interest in MS/OR applications. The joint direction of the empirical evidence, particularly the intersection of indicators 31 and 10, indicates that accountants have not - in the majority of cases - been induced to interact sufficiently and constructively with MS/OR specialists.

Meanwhile, there is no statistically significant difference between the two groups in all the indicators (contained in the above table) except one; that is indicator 18 which is partly due to (i) measurement errors and the relatively smaller sampling of accountants compared with that of MS/OR specialists,<sup>9</sup> (ii) real differences amongst the populations concerned, reflecting different amounts of understanding on the part of some of the participating individuals.

As to indicator 10 in particular, and the working relationship between MS/OR specialists and accountants in general, the following points raised by interviewees seem relevant:

- what is perceived to be 'basic discipline incompatibilities, that is, the methodologies employed by both functions. The dominant use of historical data, and the dominant employment of statutory objectives in the accounting field on the one side, and the dominance of 'mathematical' techniques in the MS/OR field on the other. Even this should not be the case in either field, many interviewees felt this is a true reflection of reality. This illustrates conditions where both functions do not have a 'common objective' or (in language of

9. Analysing the recorded observations (indicator 18) for 95 per cent confidence interval for means, gives the following results:

Group	Count	Mean	Standard deviation	Standard Error	Minimum	Maximum	95 Percent Confidence interval for Mean
Accountants.	44	1.4545	.7911	.1193	1	3	1.2140 to 1.6951
MS/OR specialists	127	1.7874	.9481	.0841	1	3	1.6209 to 1.9539



social psychology) a 'common enemy' or 'superordinate goals' (Sherif and Sherif 1956; 1958)

- the difficulty on the part of accountants to identify explicit MS/OR objectives and tangible MS/OR contribution. As one MS/OR specialist pointed out " --- the terms of reference that a MS/OR unit should have are not easily definable, accountants get upset by the difficulty of pigeonholing MS/OR."
- some MS/OR specialists pointed out that accountants do not sufficiently recognize the limitations, do not adequately see the potential of MS/OR in their field of specialization, and are not sufficiently aware of the MS/OR type of work carried out in their organizations.
- some accountants would question the MS/OR approach adopted by their MS/OR counterparts as being 'technique oriented', based on over-simplified assumptions, and less amenable to verification and auditing. An accountant expressed his view in the following manner:

"There is a competitive element in the relationships. Certainly a suspicion on the part of accountants that MS/OR people do not question adequately the data that they use for its reliability and its relativity. MS/OR will tend to simplify financial data and not take the trouble to enquire about the proper meaning/accuracy/cost-value relationships of financial information needed for some MS/OR studies. In a number of areas this can lead to quite incorrect conclusions from MS/OR studies ..."

These and other considerations highlight some of the psychological conditions restricting the collaborative intergroup contribution to a wide variety of problem areas that are, either in real terms or figuratively, considered to be 'common enemies'.

On the other hand, the following are representative views as to possible approaches to solving the above problem (associated with passive or negative interaction):

"We have witnessed a decline in the influence of the pure accountant and a steady growth in that of business graduate accountant with whom in general we have better relations and who are much better informed as to what we can do. On the other hand they feel they can do more themselves. The latter point particularly relates to top financial management." (MS/OR specialist)

"Budgeting for manpower planning is the point of strength in the interaction between MS/OR and accountants. Our accountants are interested and have co-operated in the analysis of major parameters involved in productivity and the relationships between manpower requirements and productivity." (MS/OR specialist).

"Possibility of developing computerised budget/cost models which could, very quickly determine flows involved in a particular time plan and cost them. Needs close accounting liaison." (MS/OR specialist).

"The main point of strength in the MS/OR specialist relationship with accountants in this organization is that an accountant attends the regular monthly MS/OR meetings and is therefore fully informed on current MS/OR projects (Accountant).

"As an OR unit we have done and are doing a great deal in the field of financial planning, this work being sponsored by 'accountants'. Our relationships are, I understand, reasonably good." (MS/OR specialist).



Second: in relation to efficiency versus inefficiency of MS/OR

<u>Indicator number and content</u>	Category Label & Code	Modal class Relative frequency (percentage)	Is there any statistically significant difference between the two groups?
14. MS/OR function contributes to the organization.	Agree (3)	93.0	No (p = .085)
6. Top management of this organization is backing MS/OR activities.	True (3)	73.7	Yes (p = .025)
44. There is a growing understanding on the part of MS/OR specialists of what is required from them to user functions.	Agree (3)	75.7	Yes (p = .004)
51. MS/OR are coming to play a 'notable' part as analysts in the information network of this organization.	Agree (3)	50.9	Yes (p = .000)
23. I think MS/OR has established its position as an integral part of the service functions in this organization.	Agree (3)	68.6	Yes (p = .000)
35. On the whole I would say that successful MS/OR projects outnumber the unsuccessful work.	Agree (3)	59.8	Yes (p = .005)
4. MS/OR specialists' ability to 'sell' their ideas and methodology to user functions is improving.	Agree (3)	64.9	Yes (p = .001)
41. I feel that MS/OR function in my organization is too remote from decision making and problem solving.	Agree (1)	45.9	Yes (p = .006)
7. Regarding MS/OR expected achievements I think there is a growing realization on the part of senior managers of what is 'possible' as opposed to what is 'ideal'.	Agree (3)	64.9	Yes (p = .051)
33. Senior management of user functions have found that MS/OR function is helpful in assisting them in the solution of complex business problems.	True (3)	76.9	Yes (p = .000)

Further examination of the empirical evidence indicates that with regard to

- indicator 14:

- (i) a very small minority has disagreed with this indicator (none has strongly disagreed with the statement whereas three per cent of the total valid observations have 'moderately' or 'slightly' disagreed).
- (ii) the only difference between the distribution of accountants and MS/OR specialists' views is in the degree to which they agreed with the statement (The modal class of accountants' views is 'moderately agree' whilst the modal class of MS/OR specialists' view is 'strongly agree'). This suggests that in principle MS/OR functions can and are making some contribution to their organizations. The quality of such a contribution is dependent on other factors.

- indicator 41:

- (i) accountants tend to consider MS/OR functions in their organizations as being remote from decision making and problem solving. (About two-thirds of participating accountants took that view).
- (ii) a fair number of MS/OR specialists share this view. (Slightly more than two-fifths of the participating MS/OR specialists indicated that they feel that the MS/OR function in their organization is too remote from decision making and problem solving.



This raises a number of questions as to the interpretation of such an observation. What are the reasons for this situation? What steps should be taken to get MS/OR specialists more involved in the practical realities of managerial processes? These are examples of such questions).

- indicator 35:

more than half the number of observations amongst participating accountants stated they were undecided about this. This raises several questions as to why accountants expressed such views. Do accountants have little (or inadequate) knowledge of the successful MS/OR work? If so, why? Are accountants aware of the type, quality and implications of MS/OR practice within their organizations? Do those accountants consider themselves in no position to judge upon the efficiency of their MS/OR colleagues without having the necessary information? Is it due to a more cautious view held by some accountants? Probably the answer lies in a mixture of these factors and interpretations.

- indicator 23:

participating accountants' views were mostly divided on this indicator; 47.7 per cent disagreed whereas 45.6 per cent agreed (that their MS/OR function has established its position as an integral part of the service functions in their organization).

This should add some information regarding the place of MS/OR amongst the service functions within organizations as perceived by another service function.

- indicator 51:

a small minority of participating accountants agreed that MS/OR specialists are coming to play a "notable" part as analysts in the information network of their organization.

On the basis of the above evidence, the researcher can outline the principal components of this factor (concerning degree of MS/OR efficiency) as follows: <sup>10</sup>

- experience-based;
- practical and 'notable' decision making and problem solving support;
- in the context of intelligent professional "selling"; and,
- backed by managerial awareness and involvement.

In addition, the above analysis leads the researcher to pose a number of closely related questions that might be helpful in the exploration of the extent to which MS/OR is utilized effectively. These questions can be asked by MS/OR specialists, by a manager in an organization, by a planner concerned with designing or revising policies in relation to future educational and/or training programs, or by someone who is concerned with the effective use of MS/OR.

---

10. In his inaugural address as President of the Operational Research Society (January 1974) Tomlinson suggested a number of "principles" that can be used as criteria to judge whether an Operational Research group within an organization is successful or not. They are (1) the principle of partnership (co-operation and trust between OR and decision-makers); (2) the catalytic principle (OR needs to be perceived as a change agent or catalyst within the organization); (3) the principle of inter-penetration (OR must operate at all levels in an organization at the same time); (4) the principle of independence (OR team must not be formally tied to the policies of one function or department within the organization); (5) the balance principle (OR should maintain a balanced programme of short and long projects, tactical and strategic studies, new and old projects); and (6) the catholicity principle (OR team should not be hidebound in techniques, but wide ranging both in its applications and in the methods that it uses). For a detailed discussion see Tomlinson (1974, pp.351-359). These feelings are evidenced in the above analysis in the course of analysing factors affecting accountants - MS/OR understanding.



To what extent are directors and managers of organizations (using MS/OR approaches to decision-making and problem solving) understand needs, steps, and elements of MS/OR approach to problem solving (see figure 9.1. on the following page)?

Is the management style favourable to the conduct of MS/OR approach to their problem areas? <sup>11</sup>

(with particular reference to U.K.,) has the establishment of business-schools and the revision of business education curricula had any effects on the degree of managerial sophistication in relation to reception and evaluation of MS/OR models and approaches?

To what extent are MS/OR proposals and recommendations accepted by their managements (i.e. full, moderate, slight extent, or not accepted at all)? What are the reasons for such situation(s)? What kind of problems are tackled by MS/OR specialists? Is management confident in MS/OR organizational ability to tackle problems? Does management consider MS/OR as a "professional" problem-solver?

In the researcher's view, however, the Operational Research Society can significantly contribute to reinforcing the organizational maturity of MS/OR groups or functions by carefully outlining the ethical standards of carrying out a MS/OR work. This does not mean that the OR Society would be responsible for the activities of those members who do not conform with such ethical standards. Nor is it intended to guard the interests of organizations carrying out MS/OR activities.

The society should undertake the steps necessary to identify the common

---

11. It is worth mentioning that several MS/OR interviewees have pointed out that it makes a lot of difference whether the particular director or manager in question loads high or low on variables such as innovation and adaptivity.

body of knowledge in MS/OR in the U.K. In this respect, there is no reason why the society should not co-operate with other learned or professional bodies either in undertaking studies or in co-ordinating policies of mutual benefit. The co-operation between the OR Society and the professional accounting bodies is a good example in this desired direction.

The researcher firmly believes in the analogy between MS/OR on the one hand, and goods and services marketable in the normal manner, on the other. MS/OR specialists are offering their organizations ('customers') certain type of services. The OR society should be able to identify an appropriate code of conduct that is necessary for the maintenance of the highest ethical standards in providing such MS/OR services.<sup>12</sup> It is not believed, however, that this would guarantee overcoming many of the existing (membership, practising, organizational competence and responsibility) problems.

How can the society draw the lines between those who are professionally competent (technical and business-wise) and those who are not? Can the OR Society discourage those who are professionally unqualified to provide organizationally effective service from doing so without the full knowledge of their skill and capabilities? What should be the shape of relationship between MS/OR specialists, and their current or prospective customers - in industry, government, or in commerce? These are examples of issues that need sufficient consideration from those who are concerned with achieving the highest standards in MS/OR services.

---

12. There is no reason why the OR Society should not subject Tomlinson (see footnote 10 in this chapter, p. 460), principles, to a more systematic investigation for the development of a relevant set of ethical standards of MS/OR activities.



Third: in relation to high versus low degree of MS/OR institutionalization and organizational maturity

Indicator number and content

Indicator number and content	Modal class		Is there any statistically significant difference between the two groups ?
	Category Label & Code	Relative frequency (percentage)	
50. Regarding the image of MS/OR specialists in my organization not enough improvement has been made as much as I would like to have seen.	Agree (1)	71.7	No (p = .300)
42. Senior management of user divisions (or depts.) are not fully aware of what MS/OR can - and <u>cannot</u> - offer.	Agree (1)	76.3	No (p = .376)
25. There is <u>insufficient</u> link between MS/OR function and other analytical functions (such as corporate planning, computing facilities, etc.) in my organization	Agree (1)	48.6	Yes (p = .054)

One would not infer from the direction of this evidence that the MS/OR function in not-a-small-number of organizations, have materially institutionalized to the extent that users (particularly their senior managements) would be able to identify and use the MS/OR services.

The extent of improvement regarding the MS/OR image in their organizations has not been sufficient to enable their users to call upon their services. Certainly, much work remains to be done on the part of MS/OR in relation to their organizational contribution to problem solving and decision making.

Can organizations do without MS/OR? Have MS/OR models and projects contributed significantly to problem solving and decision making of their organizations? Can managers claim that MS/OR is an indispensable tool in the carrying out of their responsibilities? These questions are difficult to answer. It depends, of course, on the particular situation and the prevailing circumstances. The following examples demonstrate this view.

An MS/OR specialist expressed his view about the research in the following manner:

"It is intriguing that you are researching into the relationship between OR workers and accountants. I would have thought that a more profitable line would be the relative decay in influence of Operational Research within the industrial and commercial scene. I think if you took the initial papers on the size of OR groups in the early 60's and the one recently published in the ORQ (Operational Research Quarterly), it could be seen that little progress has been made and the reporting line is still as precarious as ever.

... OR in our organization is a sub-set of the Systems Development group with myself heading up the Information Services Division, and though I always think of myself as an OR man I fear I have prostituted my talents to a wider field.

It is my opinion that Operational Research has failed in many companies because of the inability of OR men to obtain the importance of a project which influences the important decision making. I have deliberately avoided the word strategic because I think that the important decisions are made somewhere between what can be termed strategy and the tactics of the situation. "



The second view is expressed by an accountant in the following manner:

"The main problem area in my experience is that an 'in company' department of experts in MS/OR is necessarily comprised of expensive personnel, if they are worth their salt, who have to justify their existence. In a changing business climate they are naturally vulnerable-during a period of depression to redundancy in an expansionist environment tend to be whisked from one project to another without seeing through their work thoroughly. They are too prone to become a 'pet' of one particular discipline and are not adequately exposed to external competition to ensure appropriate quoting for their services, the most susceptible departments usually bearing the greater costs. All too often they are not profit oriented or profit responsible in their own mode of operation."

With regard to the above views, the researcher can make the following comments:

- (1) although scanning the Operational Research Quarterly, particularly the editorial leadership, the impression one gets is that MS/OR has not made a profound impact on their organizations. This is supported by the fact that not many of the managers or directors, who could benefit from MS/OR activities, are well-equipped with the necessary mathematical/statistical background of MS/OR. To give an example, the following is a quotation from the Operational Research Quarterly' Editorial Leader - March 1970, which is an analysis of results of the readership survey -

"Many correspondents made the point that there is no lack of journals oriented towards pure theory. But if those journals serve the theorist, and the Quarterly serves the practitioner, who serves the manager? No one can doubt the need for a regular publication which puts the case for operational research clearly, simply, practically and persistently before the decision-maker himself.

It has been persuasively argued that the Quarterly should attempt to do this: that it should contain some articles immediately assimilable by the general manager,

and others whose general gist he could grasp by ignoring the mathematical parentheses. This is certainly laudable, but probably illusory. An article meaty enough to be of value to the operational research practitioner is probably too long for the manager. If it is sufficiently innocent of technique to be understandable by a general reader, it may strike a professional as jejune. Many very intelligent and able people are so allergic to technical symbolism that a mere square-root sign occurring in another article may be quite enough to convince them that they have wandered into barbarous intellectual provinces, glangorous with strange dialects. " (p.2)

If the above-underlined statement is true (and many of the indicators are pointing towards that direction), coupled with the indications of the present survey (in that the majority of senior managers of user divisions or departments find it difficult to identify future MS/OR applications and that there is a tendency amongst many MS/OR specialists towards excessive theoretical - particularly mathematical - models at the expense of practicality), much of the above-quoted views of participating interviewees can be understood.

(ii) MS/OR specialists would do well, if they carry out an on-going comparative analysis of their function's contribution to their organization, especially those functions that are of (broadly) similar organizational processes. How did other (organizationally effective) functions change from an immature to a mature state? What type of language is used in communication? What approaches did they follow to be aware of the psychological factors affecting users' attitudes towards MS/OR proposals, recommendations and organizational contribution? Gaining some insights into satisfactory answers to these and other related questions might well pave the way towards more maturity and institutionalization of MS/OR.



With regard to indicator 25, the above tabulated modal class needs further examination and comment. Looking into the cross-tabulation of this indicator<sup>13</sup> by the type of functional specialisation (i.e. accounting and MS/OR), it is evident that participating accountants tend to agree with the statement, whereas the modal class amongst MS/OR specialists is 'disagree' with the statement. As members of the decision making and problem solving support systems - it could be argued - the majority of accountants feel that there is insufficient/<sup>liaison</sup>between MS/OR function and other analytical function in their organizations. A slight smaller number (45.7 per cent) of MS/OR specialists feel the same.

---

13. See Table 25-R in Appendix B, ~~2.2~~ 2.2.

Fourth: in relation to absence versus existence of organizational hindrances

Indicator number and content	Modal class		Is there any statistically significant difference between the two groups?
	Category Label & Code	Relative frequency (percentage)	
54. In my experience, I think there is a need for <u>greater</u> integration between accountants and MS/OR specialists in this organization.	Agree (1)	58.4	No (p = .130)
40. Greater 'liaison' (as distinct from integration) between MS/OR specialists and accountants is needed.	Agree (1)	82.8	No (p = .971)
55. MS/OR specialists' knowledge regarding accounting procedures is <u>inadequate</u> .	True (1)	78.0	Yes (p = .049)
42. Senior management of user divisions (or depts.) are not fully aware of what MS/OR can - and <u>cannot</u> - offer.	Agree (1)	76.3	No (p = .376)
39. Majority of senior managers of user divisions (or depts.) find it difficult to identify future MS/OR applications.	True (1)	70.7	No (p = .245)



The above evidence consistently indicates the existence - in varied degrees - of organizational hindrances to effective MS/OR - accounting working relationships. Inappropriate organizational location, lack of sufficient managerial understanding and backing, inadequate liaison and other dysfunctional organizational conditions, constitute forms of organizational hindrances to effective decision making and problem solving support systems.

A considerable number of interviewees have expressed views corroborating the direction of the above evidence. To quote some of their expressions, the following may be useful:

" ... to me, the most difficult area is the MS/OR- operational management relationships. By this I mean getting managers to appreciate where a MS/OR study might help them."  
(MS/OR specialist).

" I feel that senior management in (large industry) with less 'formal' training and qualifications tend to view MS/OR as just another 'consultant-type' techniques, and not a separate field of specialised support requiring formalised training." (Accountant).

" In my view the single biggest problem area within this organization related to MS/OR - Accounting interaction is the fact that the MS/OR function is within the research organization which itself has limited contact with accountants except in the definition of annual budgets, etc. Project evaluation, an area where accountants should have significant input tends to be carried out within R & D as a 'central services' function and it seems extremely difficult to motivate accountants within operating divisions to contribute to these - or 'post audit' studies." (MS/OR specialist).

On the other hand some interviewees have pointed out a number of approaches that contributed to minimizing (and as far as possible reducing the dysfunctional implications of) such hindrances. Amongst such approaches are:

- increasing the amount and quality of organizational awareness of MS/OR capabilities and resources. (In this respect, the intelligent organizational selling of MS/OR plays a significant role).
- co-ordinating efforts of the different information (collection-analysis-interpretation-reporting) support systems. There are a wide variety of mechanisms that can reinforce high degree of coordination. Integration of MS/OR models and accounting analyses in the areas of planning models.
- ensuring that managers do not lack the sufficient experience to complement their decision-making processes with MS/OR analytical concepts and approaches.
- seriously and constructively considering joint collaborative efforts on a project basis to be approached as a common task in which each speciality has a part to play in an integrated manner. (This does not mean formal statements of everybody's rôle.) As one MS/OR indicated " In our organization we are not now considered as MS/OR workers. Our role is more one of part of the management function. This has improved the working relationship and our effectiveness. We no longer call ourselves the Management Science or Operational Research Dept."



Fifth: in relation to intelligent versus unintelligent organizational selling of MS/OR

<u>Indicator number and content</u>	Modal class		Is there any statistically significant difference between the two groups?
	Category Label & Code	Relative frequency (percentage)	
28. There is a tendency amongst many MS/OR specialists towards excessive theoretical (particularly mathematical) models at the expense of practicality.	True (1)	60.7	Yes (p = .001)
52. MS/OR specialists tend to 'oversell' the expected benefits to be gained from using MS/OR methodology.	True (1)	56.4	No (p = .118)
49. Many MS/OR specialists believe their work is finished once they have proposed a solution for a particular problem.	Agree (1)	48.6	No (p = .056)

The direction of the empirical evidence corroborates the importance of this factor as a major component in the effective utilization of MS/OR functions within organizations where the absence of necessary and sufficient 'selling' has been one of the major problem areas facing MS/OR specialists. This factor puts a considerable amount of responsibility on MS/OR specialists themselves, in that it requires them to look more carefully at the problem of their MS/OR marketing research processes, which should contribute to the development and implementation of an organizationally effective on-going programme for exploiting MS/OR potential and capabilities.

Considering the modal class of the above first two indicators, 28 and 52, in conjunction with a closer look into their cross-tabulation according to the type of group (MS/OR or accounting)<sup>14</sup> it is clear that a high proportion of participants take the view that there is a tendency amongst many MS/OR specialists towards excessive theoretical (particularly mathematical) models at the expense of practicality, and towards overselling the expected benefits to be gained from using MS/OR approach.

There is no lack of advice<sup>15</sup> regarding the disadvantages of over-or-under-selling, simplification, abstraction, problem definition, and/or solution control. Basically, the 'proper' amount of selling, simplification, abstraction, problem definition and solution control depends largely on the size, nature, acceptance, and organizational objectives of the particular MS/OR group under consideration.

---

14. See tables 28-R, 52-R, and 49-R, Appendix B, ~~2.2~~ 2.2. respectively.

15. For examples, see Drucker (1973, pp.506-512).



In relation to this the fable narrated by Peterson (1965, pp.209-211) about a wizard was engaged in developing a course called "games" with chess in mind for the education of princes approaching manhood, seems highly relevant. Peterson was apparently anxious to set moral for MS/OR specialists that half a loaf is not necessarily better than no bread.

Many MS/OR specialists would not be surprised by the essence of this fable. Some senior managers (in organizations using MS/OR approaches) would go along with the conclusions drawn from the fable, mainly because of the attitude adopted by some MS/OR specialists towards their management and their organizations; particularly those MS/OR specialists who devote unbalanced attention to MS/OR models and propositions in favour of theoretical (at the expense of practical) considerations.

It should be borne in mind, however, that this is one of the aspects of the wider areas of management theory and the practice of management. It is part of the broader issue of the application of management concepts into practice. On the basis of this view, the recent research findings of a survey (Duncan, 1974, pp.48 & 52), into the most important barriers to the effective transfer of management theory to practice, are highly relevant. Duncan (1974, pp.50-51) reports that the second most important barrier perceived by both managers and researchers is the lack of practical managerial experience on the part of researchers.

The researcher believes that the less intelligent selling on the part of MS/OR specialists has something to do with the term 'overproudness'. To make the point the researcher gives the following two examples:

First: the definition of OR adopted by the Operational Research Society.

"Operational Research is the application of the methods of science to complex problems arising in the direction and management of large systems of men, machines, materials and money in industry, business, government and defence. The distinctive approach is to develop a scientific model of the system, incorporating measure-

ments of factors such as chance and risk with which to predict and compare the outcomes of alternative decisions, strategies or controls. The purpose is to help management determine its policy and actions scientifically".

Although this definition satisfactorily describes what 'should be', and is preferred to many other definitions available in the literature, it does contain terms and phrases that signifies the achievements that are to be expected from an OR study. Examples of terms and phrases that materialize such belief are: 'methods of science'; 'complex problems'; 'arising in the direction and management of large systems'; 'to develop a scientific model'; 'to predict and compare the outcome of alternative decisions'; and 'to help management determine its policy and actions significantly'.

Such expected high achievements (explicitly outlined in the above definition) when confronted with problems and limitations<sup>16</sup> (whether due to OR specialists themselves or due to conditions prevailing in their organisations) leaves a wide gap that needs a considerable amount of attention on the part of the concerned parties. Although, amending the above definition by replacing the verb 'is' at the outset by the phrase 'should be', might be desirable, it would not solve the 'overproudness' implicitly contained in

---

16. A detailed account of the state of the art in MS/OR, (particularly in relation to their managements and to accounting functions in their organisations) is presented in Part I of this study. The interested reader is recommended to refer back to chapter two of this thesis.



this definition.<sup>17</sup>

Second: Aczel (1969, p.261) in his introduction to 'Operational Research', principally with an accounting audience in mind, states that:

"In the last 10 years, operational research has achieved a distinct place on the business scene. It has achieved this because it is an activity that can be profitable. Much OR work has shown a very good return. Accountants and other managers have become interested in OR because they recognise that this new service may help them. They must discover when and how to apply it. Its application to certain areas, such as inventory control, production control, and specific aspects of transport and distribution has already frequently been shown to offer substantial potential benefits."

There are two other reasons why OR is of interest. First it can assist greatly in the realisation of the enormous potential of electronic computers in ways which are still novel to a great many firms. Second, it is both a new and a practical way of looking at management; it, thus, sheds new light on old problems.

There is widespread evidence that OR is becoming a recognised business discipline. OR teams operate in a wide variety of industries; in recent years a number of consultancy organisations specialising in it have been formed and have operated successfully. Special courses of instruction are now available, and the membership of the OR Society is increasing steadily. Newspaper advertisements show a small but steady demand for OR men, often at high salaries".

---

17. Perhaps the answer lies in adopting a more humble approach based on a strategy characterising the proverb: 'the proof of the pudding is in the eating'. What managers, accountants, and their organisations are demanding from MS/OR specialists is to practically demonstrate the usefulness of their approach to problem solving and supporting managerial decision making.

It may be argued that there has been insufficient evidence to support many of the contentions contained in the above quotation (particularly the underlined ones). Furthermore, one may look at it as an effort to glorify the discipline and probably of Operational Research. Such a feeling (of glorification) can easily be inferred from the above writer's tendency to use words and phrases such as: 'achieved'; 'distinct place'; 'very good return'; 'substantial potential benefits'; 'enormous potential'; and 'recognised business discipline'.

Certainly the analysis of the above two quotations does not in any way discount the value of MS/OR functions' contributions to analysing the attacking complex business (and non-business) problems, but it does explain that such (intentional or unintentional) impressions may create a magnified and a glorified picture of the MS/OR discipline which in turn might not be sometimes matched with equal success (regardless of the courses contributing to the case(s) of non-success).



Sixth: in relation to high versus low degree of bridging technical terminologies

<u>Indicator number and content</u>	Modal class		Is there any statistically significant difference between the two groups?
	Category Label & Code	Relative frequency (percentage)	
26. Terminology used in each function (MS/OR and accounting) may contribute to <u>mis</u> understanding.	True (1)	66.5	Yes (p = .043)
11. Although MS/OR discipline is relatively young (compared with accountancy) I think it has reached a 'professional status'.	Agree (3)	46.8	No (p = .927)

The message conveyed by the direction of the empirical evidence suggests the importance of the extent to which use of jargon and technical terminologies is transformed into communicable language. In addition the role played by learned and professional bodies is important.

This is supported by comments made by several interviewees from both functional specialities. On the MS/OR side, attention is directed to the view that much of the descriptive wording used by accountants changes in meaning from one use to another. This is sometimes misleading to MS/OR specialists and reduces their confidence in the accounting reporting aspects in relation to MS/OR activities.

On the accounting side, several accountants have indicated that use of MS/OR "buzz" words restrict the development and the reinforcement of on-going communication channels on the basis of mutual understanding. Interviewees used several expressions to describe the extent to which communication is not facilitated by the use of "buzz" words. Blockage, hindrance, obstacle, stumbling-block and similar others were used to diagnose symptoms of ineffective use of such technical jargon.



Seventh: in relation to co-operative versus monopolistic monitoring of finance

<u>Indicator number and content</u>	Modal class		Is there any statistically significant difference between the two groups?
	Category Label & Code	Relative frequency (percentage)	
57. Accountants in this organization monitor its financial pulse.	True (3)	77.9	No (p = .066)
45. Whenever required accountants welcome the opportunity to join a MS/OR project team.	Uncertain about this (2)	39.9	Yes (p = .010)

Indicator 57 describes "position" and "power" of accountants in business organizations. This should not be surprising. Accounting functions have external and internal responsibilities. Their reporting responsibilities can be considered as a source of such power.<sup>18</sup> The role assumed by the management of finance (normally directors of finance) is a noticeable basis of power within organizations. There has been no evidence to suggest that newly risen groups such as MS/OR and EDP specialists have significantly outbalanced power relationships in their favour. Examples of accountants who can be considered as authority in many of the financial matters and regulations (such as the stock exchange regulations, taxation, statutory requirements) are evident in organizations.

As to indicator 45, a closer look into the distribution of MS/OR specialists' views,<sup>19</sup> indicates that the majority of MS/OR specialists do not support the view that the accountant has become a permanently active member of the MS/OR team.

The implications of the direction of this factor become evident in view of the fact that the MS/OR activities are by definition and methodology characterized by an interdisciplinary feature. In the absence of accountants' involvement, MS/OR contribution to their organization is questioned.

- 
18. This is not the only source of power assumed by higher-level echelons of accountants. Lower-level participants who control access to information may also affect the distribution of power within organizations. Due to the fact that accounting records and (computer-based) files contain the bulk of data and information concerning financial matters, may hold the key to a power source.
19. For a detailed discussion of the "sources of power" of lower participants in complex organizations, see, Mechanic (1962, pp.349-364).



Eighth: in relation to sufficient versus insufficient (MS/OR-Accounting) simulation modelling

Indicator number and content	Modal class		Is there any statistically significant difference between the two groups?
	Category Label & Code	Relative frequency (percentage)	
34. More and more accountants are getting to be more interested in the areas of forecasting and financial modelling.	Agree (3)	73.0	No (p = .438)
48. Little 'accounting-MS/OR' joint effort is being made in the areas of financial modelling.	Agree (1)	50.9	Yes (p = .006)
43. There is an increasing use of MS/OR services by accountants.	Agree (3)	49.7	No (p = .719)

The direction of the above evidence suggest the need for greater 'accountants - MS/OR' joint effort in relation to financial simulation modelling (with accountants strongly feeling such a need<sup>20</sup>).

Although the current environmental circumstances have made it highly advantageous for those organizations that use intelligently<sup>21</sup> financial simulation modelling (in considering various possible alternatives in dealing with their futuristic activities), little joint effort has been done in that direction. This direction of the empirical evidence is consistent with impressions given by practitioners<sup>22</sup> and observations of other researchers.<sup>23</sup>

20. See table 48-R, Appendix B, # 2.2.

21. The use of the term 'intelligently' is explained by one of the other factors within the same factor-analysis solution. That is, all the resultant factors have to be considered collectively as parts of the one integrated system.

22. Forrington (1973, pp.238-243) examines the recent use of computer-based (business modelling) systems for planning and decision making in business organizations. He concludes that only a limited number of organizations are currently resorting to computer-based business modelling. Although Forrington's discussion is particularly concerned with the extent of EDP departments' involvement in the broad areas of "business" oriented (as opposed to "DP" oriented) computer-based systems to facilitating the planning, controlling, or appraising of a business or of a major area of business, his comments are relevant to our discussion. This is due to the fact that accounting, DP, and MS/OR specialists are major constituent components of decision-making and problem solving support systems.

23. See e.g. Gershefski (1969); Grinyer (1973).



There is some evidence that success in this area might improve communication between MS/OR and accountants and might lead to more effective support to their managements. The experience of those who have successfully used computer-based models - though by no means is the general rule - demonstrates this, as can be evidenced from the following view expressed by an MS/OR specialist:

"The ... Business Planning model served as a very good means of introduction of MS/OR to the Accountants. From this study we have developed many other projects, e.g. the dynamic programming solution to setting prices in future years ... It also served as good publicity for our services as the model can be used by many departments and was the subject of several presentations to management. The accountants are now tending to come straight to us for help ... "

This might lead to the question: if business planning models (be they corporate, or functional/<sup>i.e.</sup> limited to a particular functional area such as finance or marketing) are proved to be useful, why are they not used sufficiently? Basically, such a question embraces the fundamental issues raised by the present investigation. That is, the issues of MS/OR specialists' working relationships with other information support functions such as accounting, and DP, on the one hand, and their managements on the other. However, there are several reasons for choosing computer-based simulation models;<sup>24</sup> there are several limitations to using them; there are fundamental stages that should be followed in developing and using them;<sup>25</sup> and, lessons that can be learnt in that direction.<sup>26</sup>

- 
24. Naylor (1971, pp.9-10) succinctly states some of the principal reasons for using simulation.
25. For a detailed discussion of the characteristics of simulation models, see, e.g. Sisson (1969, pp.25-30).
26. See e.g. Hayes and Nolan (1974).

Ninth: in relation to success versus non-success of MS/OR

Indicator number and content	Modal class		Is there any statistically significant difference between the two groups?
	Category Label & Code	Relative frequency (percentage)	
1. As far as providing good services to users, the image of MS/OR specialists has improved over the last three years.	Agree (3)	67.4	No (p = .450)
35. On the whole, I would say that successful MS/OR projects outnumber the unsuccessful work.	Agree (3)	59.8	Yes (p = .005)



Concerning indicator 35, the majority of accountants participated in this part of the survey were undecided about it for one or more of the following reasons:

- (i) accountants (as well as other users of MS/OR services) do not have a sufficient amount of information about what has been done in such an area. Some accountants felt that their MS/OR group tended to give incomplete information about the organizational contribution of MS/OR. They thought the less successful (in terms of an on-going use) projects were often overlooked and rarely mentioned. It was emphasized that 'turning a blind eye' to these unsuccessful MS/OR activities does not help furthering the organizational learning processes arising out of the lessons contained in such unsuccessful projects. Furthermore, it was argued that these models should constructively be documented alongside with the reasons for such non-success.
- (ii) accountants themselves are too occupied with their systems, procedures and periodic reports to give sufficient attention to MS/OR applications. This reasoning is highly corroborated by the direction of indicator 10.
- (iii) perhaps the use of the word 'outnumber' has not been so indicative of the essence of the indicator as other terms such as 'outweigh' or 'outbalance'.

Tenth: in relation to significant versus insignificant consultation on financial considerations of MS/OR projects

Indicator number and content	Modal class		Is there any statistically significant difference between the two groups?
	Category Label & Code	Relative frequency (percentage)	
58. Chosen MS/OR projects, at present, are of the type which do not involve accountants.	True (1)	50.6	No (p = .328)
46. Majority of MS/OR projects that have been (or are being) carried out involve consulting accountants regarding financial considerations.	True (3)	54.3	No (p = .232)



Detailed examination of the direction of these two indicators within the over-all direction of other relevant indicators - such as indicators 28, 40, 42, 45, 48, 54, 57 - does not substantiate the view that a significant consultation (between MS/OR specialists and accountants) on financial considerations of MS/OR projects is taking place. Although the direction of indicator 46 alone might leave an impression that such consultation exists, the importance of this piece of information is reduced by the other limiting conditions mentioned above.

It is expected that much could be gained by the further reinforcement of significant consultation between the two groups in relation to financial considerations of MS/OR projects. The selection of the term 'significant' emphasizes the need for adopting a well-organized mechanism in relation to steps and procedures of involving accountants at an early stage of MS/OR projects development and in subsequent discussions concerning MS/OR proposals. This is not to indicate that MS/OR projects should be controlled by accountants, or, accountants should have the authority to recommend acceptance or rejection of a proposal; rather, the idea is to get MS/OR specialists to be aware of the financial implications of their projects as well as exposing their proposals and ideas to non-MS/OR specialists for their feasibility, user reactions, and some feedback views.

Eleventh: in relation to low versus high degree of vagueness in relation to MS/OR objectives

Indicator number and content	Modal class		Is there any statistically significant difference between the two groups?
	Category Label & Code	Relative frequency (percentage)	
2. There is <u>no</u> explicit statement defining objectives of MS/OR function in this organization.	Agree (1)	58.4	No (p = .151)
12. Organizational 'roles' of both functions - MS/OR and accounting - are clear enough.	True (3)	48.6	Yes (p = .014)



Direction of this empirical evidence indicates the extent to which objectives of MS/OR groups and functions are defined in a sample of U.K. business organizations. It emphasizes the need for explicit (not necessarily formal or in a blueprint form) definition of MS/OR objectives.

But why this contrast concerning the extent of defining objectives of both functions within an organization? On the one hand, there is an explicit statement defining objectives of the accounting functions in an organization (regardless of the view that such objectives are either correctly or incorrectly specified.) On the other hand, perhaps in the same organization, there is vague or loose or too general statement - if any - of objectives of MS/OR function.

The situation might be explained by the inclusion of the direction of evidence in relation to indicator 12. The areas of specialization of both functions are broadly identified by the terms of reference as conceived by the management responsible for the development of the respective activities. A substantial part of the accountants' responsibilities arose out of statutory regulations and standard practices. This is not to suggest, however, that the introduction of MS/OR statutory regulations would solve the problem.

To clarify what the researcher has in mind in relation to the degree of vagueness of MS/OR objectives, the following excerpts from MS/OR specialists' comments are useful:

"Our company tends to be split between marketing and administration. We work primarily for marketing and have to be careful that we are not used as a weapon against administration. However, we appear to be fairly successful in acting as a bridge rather than a battering ram."

"I am a one-man band, as regards OR or scientific applications in general. I also work for a departmental head, and suspect that departmental politics were responsible for my job. Not the best auging for successful OR, but one learns as one progresses."

"A relatively large number of MS/OR people working at the H.Q. of this organization are working on pie-in-the-sky type all-singing all-dancing super-models for possible implementation in the 21st century."

The observations give evidence to few examples of conditions under which the MS/OR function under which the MS/OR function is created and is functioning in some business organizations. Vagueness in defining what is needed from MS/OR; the lack of appropriate control mechanisms; the absence of suitable circumstances to acquire and utilize effectively MS/OR and the failure to adapt to environmental changes; are examples of consequences of ill-specified organizational goals and objectives in relation to utilization of MS/OR services.



Twelfth: active versus passive accountants recognition of MS/OR applications in their field of specialization

<u>Indicator number and content</u>	<u>Modal class</u>		Is there any statistically significant difference between the two groups?
	<u>Category Label &amp; Code</u>	<u>Relative frequency (percentage)</u>	
38. As yet the accountant has <u>not</u> played a key role as a sponsor in the identification of MS/OR applications.	Agree (1)	72.4	No (p = .884)

Direction of the empirical evidence leaves no doubt as to the scope of current accountants' active recognition of MS/OR applications in their field of specialization.

Taking this indicator into consideration with indicator 48 supports the idea (held by several MS/OR interviewees) that a substantial proportion of the work in the areas of financial modelling is sponsored by other (than accounting) functions, and in some cases by MS/OR specialists themselves.

Enforced by findings of indicator 57 that accountants monitor their organizations' financial pulse, this indicates the extent to which a considerable number of organizations are using traditional approaches to problem solving and decision making. This is highly consistent with the analysis carried out in chapter seven of the present work.

To further analyse the various dimensions of the above indicator, the following comment made by an accountant is relevant and useful. He pointed out that:

"In the past accountants have not taken sufficient interest in the 'statistical approach'. MS/OR believe accounting is 'Keeping the Books' and they know all about it. This creates bad feeling. With bad feeling accountants have resented MS/OR and have kept them out of 'their patch.'"

Another senior financial accountant explained that:

"I think it starts with professional bodies themselves which we look to for guidance. They are doing a lot more nowadays than they were doing ten years ago on this line (getting some familiarity with MS/OR). Perhaps they could give us just like they offer accounting courses for non-financial managers - an MS/OR course for professional accountants. I take this as analogy".



Given the fact that many of today's accounting managers and senior accountants (be they financial or management) had completed their professional education and training some years ago, it is unlikely that they have sufficient familiarity of MS/OR to be able to apply such a tool in their field of specialization.

On the other hand, comments made by several interviewees (amongst them some MS/OR specialists) express almost exactly the same message conveyed by Grayson (1973, p.43) reflecting on his experience as the Chairman of the Price Commission in the United States - from October 1971 to March 1973 - and the fact that, though an MS/OR by background, he did not use MS/OR services. He pointed out:

" Most management scientists are still thinking, writing and operating in a world that is far removed from the real world in which most managers operate ... They often describe and structure non-existent management problems, tackle relatively minor problems with overkill tools, omit real variables from messy problems, and build elegant models comprehensible to only their colleagues. And when managers seem confused or dissatisfied with the results of their activities and reject them, these scientists seem almost to take satisfaction in this confirmation of the crudity and inelegance of the managerial world.  
Have I overdrawn the picture? Only very slightly."

Certainly, there is some element of truth in the above-described views. Carrying out a comparative analysis of some of the observable characteristics of each of the two specialities in broad terms, indicates that there are many aspects on which they differ. Examples of these aspects are detailed on Table 9.1. on the following page. Recognition of similar and dissimilar characteristics is an essential step to getting both specialities to know and use the other's services.

Table 9.1. Accounting and MS/OR specialists: a comparative analysis.

Functional specialization Dimension under consideration	Accounting	MS/OR
Education and/or training.	Mainly of the professional type; emphasis on membership of professional accounting bodies.	Mainly university-based education; emphasis on higher degrees and studies. To a large extent are based on first degrees in mathematics/statistics, physical sciences and engineering.
Assumptions adopted in problem-solving and decision making.	Day-to-day circumstances and conditions concerning transactions, and approximations concerning future events.	Mostly simplifying assumptions.
Standards aimed at.	Conservatism, realization, objectivity, consistency, materiality and full-disclosure play a significant role in the measurement and communication of financial data and information - the researcher would consider it exaggeration to assume that these conventions (dominating the financial accounting responsibilities) do not affect management accounting analyses.	Seeking the adoption of the standards of the scientific approach; the closer the MS/OR model to scientific standards, the more satisfied its developer.
Time horizon.	Tight time-tables and deadlines are parts of the everyday life of the accountant.	Relatively unpressurized time horizon.
Scope of application.	Organization-wide activities.	Mostly limited to certain segments of activities within the organization depending on a number of factors.
Motivations.	Highly motivated by satisfying the organizational managerial needs for internal reporting and fulfilment of statutory of regulations.	Highly motivated by achieving the standards required in building a MS/OR model.
Social psychological image.	Loads relatively close 'locals' than to 'cosmopolitans'.	Loads relatively close to 'cosmopolitans' than to 'locals'.
Affiliations.	Membership of I.C.A., I.C.M.A., A.C.A. and others.	Membership of OR Society, R.S.S.



Thirteenth: in relation to high versus low degree of contemporaneous view of MS/OR on the part of accountants

Indicator number and content	Modal class		Is there any statistically significant difference between the two groups?
	Category Label & Code	Relative frequency (percentage)	
56. Majority of accountants in this organization consider MS/OR function as a complementary activity.	True (3)	43.9	Yes (p = .018)
60. Accountants are getting to appreciate risk, probability and related futuristic concepts.	Agree (3)	75.6	No (p = .087)

The direction of indicator 56 gives another assurance that the majority of accountants do not consider MS/OR function as a threat to them in carrying out their allocated responsibilities. Some accountants related this direction to the less mature and the less materialized image of MS/OR groups in their organizations, to the extent of their being able to take over some information analysis and interpretation responsibilities; other groups of accountants viewed this to the fact that it is a matter of further specialization within the wider information function; still others point out that such direction is due to the ability of both specialists to co-operate and co-ordinate their activities to mutually explore further opportunities of tackling complex business problems.

Taking the findings of indicator 60 within the total picture, the evidence seems to suggest that this is an area where further investigation and collaboration (between the interested parties - be they accounting, MS/OR, or other functional groups within the organization), professional or educational organizations could demonstrate the usefulness of accountants widening the scope and foundations of their applications to organizational problems. Viewing the direction of the above evidence in conjunction with direction of the indicator 38, it seems clear that accountants' appreciation of risk, probability and related futuristic concepts has not been sufficiently strong to enable them to recognize its potential and usefulness. The following expressions substantiate this interpretation.

According to a MS/OR view, the problem is evident on both sides. It stated that:

"accountants need a little more awareness of risk, uncertainty, and probabilistic dimensions of business; they should be made more aware of the problems facing MS/OR specialists and vice-versa. Too many MS/OR specialists have little or no accounting knowledge."



Another MS/OR view indicates why accountants find it difficult to appreciate such futuristic concepts in their field of specialization:

"Most accountants have been brought up on ledgers (debit and credit) and trained into becoming categorising machine. They seem to find it difficult to accept new ideas of accounting, such as use of sampling in auditing, opportunity cost, differential analysis, risk analysis, forecasting approaches, and MS/OR applications to accounting problems".

On the other hand some MS/OR specialists relate this to the lack of adaptation on the part of accountants to react to the changing environmental conditions. Some (however few in number), relate this to lack of imagination where it was stated that:

" What we do find is that accountants have an important role and suffer from a lack of imagination (this is a comment on calibre more than anything). Those that are good help us to produce extremely profitable results and aid in the acceptance - but if they are that good they usually move upwards or outwards fast !" (MS/OR specialist).

Still other views relate such lack of appreciation and use of probabilistic applications to the insufficient appreciation of the prerequisite mathematical and statistical foundations, and to the insufficient knowledge on the part of accountants to fully exploit the potential of computing power available today, particularly in relation to ad hoc type of information involved in ill-structured problem areas. The problems of stimulating accountants towards MS/OR applications have been raised by several MS/OR specialists, reflecting on their experience that some senior accountants tend to be apathetic with regard to MS/OR problems.

Several experiences have called upon managers (accounting managers are no exception) for greater use of computing power in decision making.

Morton and McCosh (1968), Miller (1969), and Jones (1970) are amongst those who argued the case for the need to combine the manipulative power of electronic computer, the managerial business experience, the convenience of the computer terminal in carrying out different analyses for decision making and problem solving.



Fourteenth: in relation to low versus high pedantic attitude on the part of accountants

<u>Indicator number and content</u>	Modal class		Is there any statistically significant difference between the two groups?
	Category Label & Code	Relative frequency (percentage)	
32. I feel that many of our accountants like to make the job appear more difficult than it is.	Agree (1)	52.0	No (p = .997)

The message conveyed by this factor might have been influenced by one or more of the following observations:

- (i) accounting data and information, in most cases, are not in a form that can be used readily in their MS/OR projects. Some MS/OR specialists have expressed their dissatisfaction with accounting data and information. Various expressions can be quoted to highlight such impressions:

"Average figures are of little use per se for decision making purposes, which demonstrates the urgent need for giving more attention to marginal analysis". (MS/OR specialist).

"Accountants largely believe in accounting conventions and provide conforming information because it is traditional, not useful. My general impression of accountants is that they are trained to regard their conventions as 'God-given'. (MS/OR specialist).

"Accountants, generally, have a bookkeeping outlook and are sometimes horrified at the approximations made in some MS/OR studies".  
(MS/OR specialist).

"Accuracy: accountants need to realize that often approximate figures given today are better than accurate figures given sometime in the future".  
(MS/OR specialist).

"Inflation accounting: the need to make big adjustments to accounting reports to make information suitable for decision making".  
(MS/OR specialist)

"The attitude of accountants to data seems very much dependent upon whether £ appears or not. Thus for example overtime at time and a half rates tends to be grossed up by  $1\frac{1}{2}$  - i.e. £ not hours". (MS/OR specialist).



These views indicate the way in which MS/OR specialists evaluate accounting systems, procedure and reports. Also, it indicates their perceptions of the implications and limitations of the basic principles widely used in the production of financial accounting systems. However, one can see various types of communication problems arising in this respect. Accounting reports and messages conveyed, directly or indirectly, to MS/OR specialists more often than not contain various forms of communication problems such as omission and overload.

- (ii) perceptual processes in organizations play an important part in the inputs and outputs of communication systems.<sup>27</sup> The processes of intergroup and interpersonal perception are, at least, a function of the intergroup, group or interpersonal contexts in which the perception occurs.
- (iii) related to above is the stereotyping<sup>28</sup> processes of groups within organizations. MS/OR specialists - amongst other groups - attribute some negative characteristics to accountants (such as pedantry and dogmatism). This, apparently, is based on their (MS/OR specialists) own coding schema employed in their communication system. Such coding schema enables them to perceive accounting function and accountants the way they do.<sup>29</sup>

---

27. Zalkind and Costello (1962, pp.218-235)'s literature-based survey of perception in organizations gives some insights into the determinant factors of the above perceptions. Several factors affect how accurately we see others. Typical examples of distorting influences on the processes of forming impressions are stereotyping, halo effect, projection, and perceptual defense.

28. Stereotype is defined as: "A rigid or biased perception in which individuals are ascribed certain (usually negative) traits regardless of whether they possess these traits, merely because of their membership in a specific national or social group". Wolman (1973, p.357).

29. Katz and Kahn (1966, pp.227-228) indicate that individuals, groups and organizations share a general characteristic which must be recognised as a major determinant of communication: the coding process. They cite the following passages (by Walter Lippman, 1922 - Public Opinion) to explain the place of stereotyping in the coding process.

"For the most part we do not first see, and then define, we define first and then see. In the great blooming, buzzing confusion of the outer world, we pick out what our culture has already defined for us, and we tend to perceive that which we have picked out in the form stereotyped for us by our culture."

Fifteenth: in relation to congruity versus incongruity with operative organization goals

<u>Indicator number and content</u>	Modal class		Is there any statistically significant difference between the two groups?
	Category Label & Code	Relative frequency (percentage)	
59. I think both parties (accountants and MS/OR specialists) have interests in ensuring the organization's continued growth.	True (3)	96.5	No (p = .170)



This is an assertion that survival and continued growth constitute abstract values in the minds of individual members of organizations in relation to their organizational goals. This assertion raises the following questions:

Are these abstract values converted into a set of operative<sup>30</sup> goals?

Does this assertion reflect merely a lip service paid to the concerned organizations?

What are the positions of each of the two functions (MS/OR and accounting) in the dominant relationships affecting the formation of organizational operative goals?

Considering this factor within the framework of the multi-dimensional space of 'accountants - MS/OR' interaction, the researcher believes that accountants play a notable part in the processes of converting official goals into operative ones.

---

30. Perrow (1961, pp.854-866) distinguishes between two major categories of goals. They are "official" and "operative" goals. Official goals are the general purposes of the organization as put forth in the charter, annual reports, public statements by key executives and other authoritative pronouncements. Operative goals designate the ends sought through the actual operation policies of the organization; they tell us what the organization actually is trying to do, regardless of what the official goals say are the aims. Perrow argues that if we know something about the major tasks of an organization and the characteristics of its controlling elite, we can predict its operative goals.

Sixteenth: in relation to absence versus existence of narrow-minded financial management in weighing MS/OR proposals

Indicator number and content	Modal class		Is there any statistically significant difference between the two groups?
	Category Label & Code	Relative frequency (percentage)	
22. With regard to MS/OR projects, senior management of user divisions (or depts.) are reluctant to act upon suggestions which do <u>not</u> have accountants' blessing.	Disagree (3)	47.7	Yes (p = .021)
24. Unless MS/OR user is convinced that a project is immediately cost-saving it would be difficult for the proposals to gain acceptance.	True (1)	48.0	No (p = .166)



The empirical evidence contains the following elements:

Cost-saving is amongst the criteria used to evaluating the potential of an MS/OR project;

it is helpful that the MS/OR specialists make sure that accountants do understand the nature, objectives and the manner in which the MS/OR model or project is to be carried out. If accountants are less informed regarding the particular MS/OR project, it is probable that they would take a passive view of it. On the other hand, if they have sufficient familiarity with MS/OR approaches and are kept informed about the various aspects of such a discipline within their organizations, they may be inclined to provide active support to the institutionalization, efficiency and organizational maturity of their MS/OR function(s). Since accountants' lack of understanding might generate obstacles to the acceptance and/or the implementation of MS/OR projects, and since accountants' familiarity with the MS/OR discipline does not qualify them to be specialists in the field, a comprehensive MS/OR educational program within their organizations, seems a worthwhile investment.

the less the senior managements' familiarity with MS/OR (either as a result of insufficient contact between them and MS/OR specialists, or less appreciation of the nature and implications of MS/OR assumptions and proposals), the greater the likelihood that they (senior managements) seek advice from other groups closer to them; amongst them are accountants. In turn, the destiny of the MS/OR project depends on factors and conditions that might have little to do with the objective evaluation of the project.

Seventeenth: in relation to high versus low degree of MS/OR appreciation of accounting systems

<u>Indicator number and content</u>	<u>Modal class</u>		Is there any statistically significant difference between the two groups?
	<u>Category Label &amp; Code</u>	<u>Relative frequency (percentage)</u>	
47. If an MS/OR specialist had some type of accounting training, it would help in bridging the communication gap.	Agree (3)	90.8	No (p = .953)



This endorsement of the vast majority of participating individuals (three quarters of them are MS/OR specialists) should give those concerned with educational and training programs, in accounting, an incentive to seriously give more fundamental attention to non-accounting users of accounting concepts, systems and procedures. By the same logic, non-accounting users of accounting information should give more a closer look into the nature, purposes, and methodology of accounting.

Non-accountants need to know more how the accounting data are generated. Accountants need to explain the conventions, the postulates and the modus operandi being adopted by them. More significantly, they need to explain the limitations contained in their methods and approaches; along with the associated problems. Accordingly, it is a responsibility that should be shared by accountants and MS/OR specialists.

Eighteenth: Moderate versus excessive amount of professional jealousy

<u>Indicator number and content</u>	Modal class		Is there any statistically significant difference between the two groups?
	Category Label & Code	Relative frequency (percentage)	
30. I do perceive some sort of professional jealousies between MS/OR specialists and accountants.	Agree (1)	53.8	No (p = .497)



Both (accounting and MS/OR specialists) tend to corroborate the view that there exist some kind of professional jealousies between both of them which should be considered - to a manageable extent - as natural. This is substantiated by several interviewees and is consistent with contemporary thinking about behaviour in organizations.

For example, an MS/OR specialist indicated that:

"The culture of each profession is so different:

Accountants - owe allegiance to accountants;

- work on directives, standard systems, etc.,

MS/OR staff - live on their credibility with clients,

report to clients, respond to their

environment.

This makes co-operative working and communication difficult".

Another example is indicated by an accountant who said:

"In my experience most 'professional' people jealously guard the skills of their trade; this leads to misunderstanding and often misuse of information. Both accountants and MS/OR personnel are guilty of this. One is often given the impression that one is an intruder when seeking information and co-operation".

Clearly, both of the two (MS/OR and accounting) communities are characterized by multiplicity of goals and objectives, Some of these goals and objectives may conflict with one another. Even within the accounting community, there are a number of sub-systems each of which might have conflicting objectives with one another.

Due to these environmental differences, one would expect the existence of this type of conflict. On the other hand, the wider the gap in professional orientation of the two functional groups (i.e. accounting and MS/OR), the greater the likelihood of increasing (or probably accelerating) the amount of felt and perceived conflict.<sup>31</sup>

Since the two functions are concerned with information support for their managements, it is desirable that wide gaps between the two be narrowed. If one attempts to measure the extent to which the two communities have established communication bridges, particularly in the case of U.K. (either by means of the number of joint educational and/or training programs, or the number of persons from either side seeking membership of the other, or the number of consultations on matters of mutual interests,) one is left with the impression that still much needs to be done in that direction.

The OR Society, for example, could benefit from the experience of the accounting bodies in tackling the problem of considering an appropriate code of conduct for its membership. By the same logic, the policy making of the two disciplines could be established on the basis of exchanging relevant information and advice on the desired features of present and potential membership populations.

---

31. For a detailed discussion of the dynamics of a conflict episode, see Pondy (1967, p.306).



## Summary

The a priori behavioural indicators in relation to accountants - MS/OR specialists' interaction has been examined empirically. The results of such an examination are presented in this chapter. A posterior evaluation of the a priori indicators has also been presented with a view of the researcher's proposed domain of behavioural indicators.

Further analysis of the empirical evidence has been made as to the diagnostic and prescriptive aspects in relation to the area of organizational interaction under study. Possible ways of installing change devices have been suggested whenever it was felt appropriate.

Excerpts from interviewees' comments and explanations were used to evaluate the direction of the statistical evidence.

## Part IV

### CONCLUSIONS

This part is aimed at summarizing the main findings of the present investigation. It synthesizes the descriptive and analytical body of findings presented (in greater detail) in the preceding chapters.

It is composed of the following chapter:

Chapter Ten : presents a consolidated diagnosis and prescription of the accountants-EDP and MS/OR specialists' interaction. It also points out some directions for further research.



## Chapter Ten

### Summary of findings and directions for further research

- 10.1. An overview.
- 10.2. Findings in relation to accountants-EDP specialists' interaction.
- 10.3. Findings in relation to accountants - MS/OR specialists' interaction.
- 10.4. Implications for the future education and training of accounting, EDP and MS/OR specialists.
- 10.5. Directions for further research.

### 10.1. An overview

For the last three decades there have been continuous developments in the application and use of new approaches designed to assist in the solution of complex business problems. It seems to be the case, however, that technological advances in information technology and management sciences have not been matched by parallel advances in our understanding of the behavioural aspects of these new techniques. This is partly due to the complexity of human and social systems.

This research project was inspired by the researcher's perception of the discrepancy between earlier expectations and the present state of the art with regard to the scope, quality, and features of the collaborative efforts of accountants on the one hand, and Electronic Data Processing (EDP) and Management Science/Operational Research (MS/OR) specialists on the other. Such collaborative efforts are the basis for building decision making and problem solving support systems for their managements. Many unsupported assertions have been made about accountants' actual use of MS/OR models and approaches in their field of specialisation, and about the effects of computers on accountants and accounting, and this research project provided an opportunity for exploring and validating these assertions:

- What are the effects of recent developments in EDP, and MS/OR areas upon accountants and upon accountants-EDP specialists' interaction?
- Will these groups (accountants, EDP, and MS/OR specialists) be able to adapt to environmental conditions affecting their organizations?
- How can these groups utilize effectively the new facilities?
- What is the degree of present and potential interdisciplinary involvement of accounting, EDP, and MS/OR specialists?



These are illustrative examples of questions that are of the main concern to this study. Focussing on the accountants-EDP and MS/OR specialists' interaction, this empirical investigation has attempted to contribute answers to some of the above questions.

The research strategy adopted was dictated by the objectives of the study. A variety of research methodologies have been employed containing personal interviews, case-studies, and mailed questionnaires. Instruments employed involved structured, semi-structured, and unstructured interview tables and questionnaires.

The approach adopted throughout the research project has been one of diagnosis and prescription on the basis of the appropriate conceptual framework and empirical findings. Accordingly, this has been to outline weaknesses, defects, limitations, shortcomings, and drawbacks of certain designs on the one hand, and devices and mechanisms to bring about prescribed changes on the other.

Guided by a critical survey of the literature concerning the scope of the problem and the conceptual dimensions of the interaction, empirical search and identification were carried out by means of the following samples:

- a) 251 Operational Research Society members,
- b) 240 members of the Institute of Cost and Management Accountants,  
and
- c) 230 DP managers.

Respondents were selected from enterprises amongst the top 300 business concerns of British industry as ranked by "The Times 1000" published by the Times Newspapers. Response rates were 70%, 46% and 44% respectively. This stage of the research provided the researcher with a large number of behavioural indicators concerning the interactions between accountants on the one hand, and EDP and MS/OR specialists on the other. In addition a number of related issues such as the desirability of accountants' joining MS/OR team discussions, and EDP projects related to their work,

were also examined.

For the purposes of face and content validity and reliability and consistency, the large number of behavioural indicators resulting from the stage described above were subjected to further examination, mainly on an interview basis within the context of detailed analyses of a small number of case studies which have focussed on the organizational diagnosis of the working relationships under consideration.

Based on the findings of the study it is concluded that, among other things, accountants' interaction with their EDP and MS/OR counterparts is based on limited and insufficient understanding. Accountants' use and application of model-building approaches and computer-based systems have been very narrowly restricted to structured, deterministic, and functionally constrained types of activity. Amongst the central causes that impede the desired level of greater mutual understanding are (1) the lack of necessary background orientation of the three specialist groups (EDP, MS/OR, and accounting) concerning each other's basic practices and principles and the wider implications of their respective systems, (2) an insufficient appreciation of the wider implications of the synergistic effects of their interdisciplinary contributions, and (3) apparent incompatibilities amongst respective functional procedures, conventions, practices, and time horizons.

Neither these conclusions nor the following summary of the main findings (presented in the rest of this chapter) are intended to be substitutes for the detailed analyses presented in parts II and III of this study. This summary of the main findings is aimed at giving an overview of the direction of the empirical evidence in relation to accountants-EDP and MS/OR specialists' interaction.

Due to the nature and scope of the study, along with the limitations imposed upon it, the researcher reiterates the importance of avoiding



indiscriminate generalization from the findings. The study does not claim it has found answers to all of the questions or the problems raised in the course of developing the area of investigation. Nevertheless the researcher is satisfied that he has presented descriptively and analytically some valuable empirical findings in relation to behavioural factors, communication practices, organizational conditions and other related aspects of accountants-EDP and MS/OR specialists' working relationships.

Having briefly reviewed the objectives, scope, strategy and limitations of the research, the researcher will turn next to the main findings obtained in relation to each of the two major areas of the investigation.

The following section (10.2) is devoted to a brief account of the main findings in relation to accountants-EDP specialists' interaction. The succeeding section (10.3) is aimed at summarizing the main findings in relation to accountants-MS/OR specialists' interaction. The final section describes some of the points that the researcher has found in the course of carrying out the present investigation to be potentially useful areas for further research.

## 10.2. Findings in relation to accountants-EDP specialists' interaction

To identify the effect of EDP on accountants and accounting functions in relatively large business organizations, a distinction has been made between two types of accounting activities. The first type is transaction-orientated activities based on the routine type of operations. The second is the future-orientated, non-programmed decision making activities based on the non-routine type of operations. Though in theory the computer should have freed accountants from, or at least minimized, the tedious and uninteresting aspects of accounting, it is difficult to corroborate the view that the computer has assisted the majority of accountants in generating different analyses for different purposes. Those accountants who have used the computational power of today's computers to gain further analytical insights into the complexities of business problems are the exception. Related to this is the fact that the majority of the organizations participating in the survey have indicated that the routine or drudgery accountancy type of work has been computerized, but the situation is far from satisfactory as far as the forward looking and financial modelling types of activities are concerned.

Regarding the actual location of EDP activities, the evidence indicates that accountants assume responsibility for a considerable number of EDP installations in participating organizations. Chief accountants, controllers or financial directors at the time of carrying out the empirical survey were responsible for about two-fifths of participating organizations' EDP installations.

These have been amongst the findings of the present research in relation to the accountants-EDP specialists' interaction. The rest of this section is devoted to a brief outline of the major related findings.



**Behavioural factors affecting accountants-EDP specialists' interaction.**

---

As to Accountants-EDP specialists' interaction, the observations of 148 participants on 59 behavioural indicators were factor analysed using orthogonal (Varimax) and oblique (direct quartimin) rotational methods. This form of multivariate analysis produced the following results in relation to Accountants-EDP specialists' interaction:

GOOD vs. BAD IMAGE OF EDP SPECIALISTS

HIGH vs. LOW DEGREE OF ACCOUNTANTS' APPRECIATION OF EDP BENEFITS AND LIMITATIONS

HIGH vs. LOW DEGREE OF CO-ORDINATION

HIGH vs. LOW DEGREE OF SENIOR MANAGEMENT UNDERSTANDING

EXTENSIVE vs. LIMITED ORIENTATION OF EDP SPECIALISTS

EFFICIENT vs. INEFFICIENT COMPUTERIZATION ACTIVITIES

POSITIVE vs. NEGATIVE INTERACTION

COMPETENT vs. INCOMPETENT APPLICATION OF EDP TRANSFER POLICY

DESIRABILITY vs. UNDESIRABILITY OF USERS BEING SECONDED TO THEIR COMPUTER-BASED PROJECTS

EXPLICITNESS vs. AMBIGUITY OF EDP OBJECTIVES

SERIOUS vs. SUPERFICIAL EFFORT TO PROFESSIONALISE EDP

FRUITFUL vs. UNFRUITFUL INTERFUNCTIONAL ROTATION

LOW vs. HIGH PEDANTIC ATTITUDE ON THE PART OF ACCOUNTANTS

SUFFICIENCY vs. INSUFFICIENCY OF APPLYING REPORTING BY EXCEPTION TO COMPUTER-BASED APPLICATION

NARROWNESS vs. WIDENESS OF THE GAP BETWEEN ACHIEVEMENTS AND USERS' EXPECTATIONS REGARDING THEIR COMPUTER-BASED APPLICATIONS

EFFECTIVE vs. INEFFECTIVE CONTROL OF EDP ACTIVITIES

The assessment and analysis of each of the extracted factors have enabled the researcher to specify a set of dimensions that might be used in relation to the development of an organizational strategy aimed at the constructive interaction based on mutual understanding between accountants and EDP specialists.

Considering each of the above factors as a continuum, the higher the score towards the positive end, the greater the likelihood of contribution towards more constructive understanding between the two groups. For example, the higher the degree of co-ordination, the higher the degree of senior management understanding, the more explicit EDP objectives, etc., the greater the likelihood of more contribution towards accountants-EDP specialists' interaction.

### Co-ordination

The evidence indicates that a large number of EDP functions operate under a relatively low degree of co-ordination with users in general (and accountants amongst them). The problems of lack of clarity of organizational EDP rules and policies, the insufficient attention given to articulating the interdependent accounting-EDP activities, the infrequent constructive discussions about/a preventive co-ordination programme, and the insufficient awareness of the long-run implications of computer-based systems being (or having been) developed and implemented are amongst the clear symptoms of poor co-ordination.

Nothing really new is being said here about the importance of co-ordination activities in complex organizations. Both specialists (EDP and accountants) acknowledge the importance of such an activity to the effectiveness of their interdependent activities.

Although committees, conferences and joint meetings are widely used as means of co-ordination, a large proportion of time is reported to be spent on paying lip-service to this organizational problem, to political manoeuvring, and to minor administrative activities.

The corrective co-ordination (that takes place after the system has been implemented to correct dysfunctions or shortcomings contained in it) should be supported by preventive co-ordination activities based on the constructive exchange of ideas and views between the specialized



but interrelated accounting and EDP activities. The feedback by one of the two groups to the other in areas where it is difficult to completely routinize co-ordination, the frequent discussion about anticipated problems, and the concerted effort on both sides to investigate the adequacy, sufficiency and the quality of co-ordination activities are desirable aspects of organizational co-ordination between the two groups that should be given more serious attention.

Are organizational roles and policies clearly defined and adhered to by both functions? Do both groups (accountants and EDP specialists in this case) share common objectives, and avoid creating difficulties for each other in the course of carrying out their interrelated activities? Are adequate, and sufficient measures taken to tackle anticipated problems and promote further co-operation and smooth working relationships? Has there been sufficient thought given to creating and implementing an accounting-EDP integrator function (be it composed of one or several persons)? Does the organization rely heavily on one form of co-ordination (committees, for example) neglecting other forms (such as informal discussions) of co-ordinative activities? Is there any effective built-in mechanism to improve the co-ordination processes itself in the organization? These are examples of questions that are highly relevant in relation to the co-ordination activities between accountants and EDP specialists. These questions should be given prime importance in the examination of possible ways of improving co-ordination between EDP specialists on the one hand, and their users in general (and accountants in particular) on the other.

#### Internal auditing of computer-based systems

On the part of accountants, more attention is needed to participate in checking the validity of computer-based accounting applications.

One of the fundamental aspects of the accountants/EDP interface is the internal audit of their computer-based systems. Conventional and manual methods are inadequate and insufficient in relation to computer-based accounting applications.

Although some progress has been achieved, much closer co-operation between the (computer-based) systems and the internal audit functions for containing or reducing some of the problems associated with the introduction of computer-based systems, particularly those of verification and security, is needed.

The more "progressive" organizations co-ordinate highly the EDP and internal audit functions at a very early stage in initiating computer-based systems. Some organizations design their EDP function so as to include a specialized group to carry out adequate control checks and security measures and to establish built-in mechanisms for control and information security. It should be remembered, however, that such an approach (of establishing an EDP internal audit within the EDP function) has a limited benefit as far as the EDP function is concerned. This is not a substitute for an independent organizational unit to carry out internal audit activities. Meanwhile, those internal auditors who are applying statistical sampling methods and using computer-based procedures for auditing purposes are the exception rather than the rule. There is a need to expand fundamentally the educational and training programmes for these specialized functions.

#### Scope of accountants' involvement in EDP

A substantial part of accountants' involvement in the EDP field has been in the area of mundane types of accounting activities; those accountants who are involved in the financial modelling and non-routine analyses of accounting information are the exception rather than the rule.



The evidence presented in this thesis indicates that the introduction of computers in the accounting area of responsibility has not made feasible the wider application of the concepts of opportunity costing, differential analysis, incremental costing, and probabilistic analysis. Educational and training systems, and background personal factors might be considered as highly relevant factors to this phenomenon.

The majority of EDP specialists agreed with the view that as yet accountants have not played a key role as originators of EDP systems development and implementation. It is highly desirable that the computerization of accounting (or any other user function) applications is 'seconded' to an accountant (or member of the user function) who is well trained in EDP. This reduces the problem of technical terminologies causing confusion in the communication processes. It also increases the likelihood of the successful design and implementation of such a computer-based system, which in turn increases confidence between EDP personnel and the user(s) of their services.

#### Image of EDP specialists

There has been a relative improvement regarding the image of EDP specialists, particularly when compared with their image in the early days of computing associated with first and second generation computers. This is not to suggest, however, that all problems associated with the bad image of some EDP specialists are over.

#### Managerial understanding and involvement

The questions of managerial understanding of and involvement in the use and control of EDP areas related to their responsibilities have been reiterated by the present study. Using the language of information theory, there are communication problems relating to the content, meaning and transformation of messages. The sheer overload of technical terminologies,

'User' ineptness in computer-based systems and others are amongst the manifestations of this problem in a large number of participating organizations. This has far-reaching implications for the design, implementation, and control of computer-based systems. Whether those managers are engaged in accounting activities or otherwise, the massive redundancy in computer-based reports distorts many of the sought objectives of such systems. The evidence analysed in this survey corroborated the view that little has been done, for instance, in the area of applying exception reporting so that mass computer printouts can be summarized.

One of the prominent shortcomings in the field is the insufficient attention given to data as an investment that needs to be carefully approached, appraised, and effectively administered.

Organizations need to recognize the long-term implications of neglecting or insufficiently realising the importance of tackling the problem of data and information management. The technological advances in the fields of data communications systems and data-based management systems are highly dynamic. Without sound managerial involvement and understanding, it is doubtful whether the effective utilization of such resources can be achieved.

#### Business orientation of EDP specialists

A considerable number of EDP specialists (systems analysts and programmers) have insufficient business knowledge and tend to oversell the expected benefits to be gained from using EDP systems, are looked upon as outsiders whose loyalty is to DP rather than their employing organizations, and tend to think that computerisation is the answer to all the problems they look at.



### EDP transfer-pricing policy and standard budgetary costing

The majority of participants in this survey have endorsed, in principle, the use of EDP transfer-pricing policy. The practical advantages of using such a policy outweigh its disadvantages. The effectiveness of a particular system of "charging-out" for computing services depends mainly on its design, features, and acceptance by those who are using the system. Taking the application to either of the two extremes (superficial with no or little impacts on the one hand, or rigid, literal application on the other) would not satisfy the main objectives behind the policy.

Any transfer-pricing policy to be adopted should not be an end in itself; it should be a means for achieving control. Moreover, it should be part of an integrated system for planning and controlling EDP activities.

It appears, however, that costing and standard budgetary procedures for EDP activities have been given - if any - a highly insufficient amount of serious consideration. This is an area where accountants should have played a greater role. It is not for swinging or maintaining the balance of power in their favour, but accountants' contribution should be aimed at reinforcing effective management control systems for EDP activities.

### Professionalization of EDP specialists

There are some indications that users of EDP services would like to see more of a disciplined system of education and training, ethical standards and code of conduct to be adopted by EDP specialists. Lessons can be drawn from experiences of other areas of specialization such as medicine, law, and accounting.

### EDP/user interfunctional rotation

EDP/user interfunctional rotation that aims at further interaction by being based on the collaborative efforts of both the user (whether accountants or any other functional group) and EDP specialists might have fruitful outcomes. So long as it does not constitute a threat to either side and is based on sound grounds, it is likely to produce useful results.

### Control of EDP activities

The aspect of organizational control of EDP activities has been given insufficient attention by those responsible for the management and control of EDP activities. Some organizations have devised a blue-printed master-plan for the control of EDP activities attaching more emphasis on the means rather than the ends. The concept of responsibility accounting is insufficiently practised by the management responsible for controlling EDP activities. Paying lip-service to the concepts and principles of management control systems has frequently been the apparent feature in the management and organization of EDP activities.

### 10.3. FINDINGS IN RELATION TO ACCOUNTANTS-MS/OR SPECIALISTS' INTERACTION

Casting sweeping generalisations about the degree of accountants' involvement in MS/OR activities and MS/OR specialists' participation in dealing with accounting areas should be avoided. Rather, patterns and attitudes should be viewed within the context of the circumstances, conditions, factors and consequences of the aspect under consideration.

It is interesting to note that there is no impressive evidence to validate the gloomy picture (of the working relationships between MS/OR specialists and accountants) drawn by fragments of the little evidence and speculations implied by the literature survey contained in the



introduction of this research. In other words, the communication patterns under consideration are not overclouded in the bulk of surveyed organisations by accountants' desires to take over MS/OR activities, or accountants' blockage of MS/OR channels of success by not giving them all the data and information needed for MS/OR projects or MS/OR specialists' indulgence in excessively theoretical mathematical abstractions. Equally, considering the population of relatively large industrial organizations in the U.K., it is fair to say that the picture is not too bright. In fact, there are significantly different patterns of communications and kinds of working relationships - including the two extreme cases just described.

To say that accountants constitute a stumbling block in the way of growth of MS/OR activities is by no means the typical case common to the majority of communication patterns and working relationships between the two specialities. In view of the experiences expressed by surveyed MS/OR specialists, casting such sweeping generalisations would be difficult to support. That is not to say that such situations are hard to find. On the contrary, they exist, and where they do exist, most likely, the reasons will not be dominated by the issue whether the accountants involved are of a particular professional qualification. Those types of behaviour are the output of systems whose input might vary from one organisation to the other depending on the circumstances and conditions prevailing.

Amongst the inputs that contribute to situations of misunderstanding or negative interactions there are:

- (i) the over-or-under-selling on the part of MS/OR specialists to prove practically the value of their function or to get users aware of the value that can be gained by the seizure of possible business opportunities contained in the different aspects of mutual understanding between the two parties.

- (ii) the failure of any of the two functions to be aware of (or to strengthen) the interrelatedness of the two groups in the areas of financial modelling, corporate strategy and other complex business problems and opportunities.
- (iii) the insufficient degree of success (or in some cases, the failure) of some finance directors or controllers to utilise the MS/OR resources available to their organisation either due to their background orientation or due to organisational policies.
- (iv) poor communications, lack of confidence and trust between MS/OR specialists and users - and providers of data and (or insufficiency of) information for MS/OR projects and studies.
- (v) lack of managerial awareness of understanding of, and backing to MS/OR activities and projects.
- (vi) the insufficient link and integration of (not necessarily the formal) MS/OR activities with other similar type functions.
- (vii) MS/OR specialists' lack of experience and knowledge of user activities.
- (viii) the conventional, passive, negative or non-constructive view held by some accountants or users towards MS/OR functions.

Having said that accountants do not constitute a stumbling-block in implementing MS/OR recommendations, it must be emphasised that the expressed experiences of participating MS/OR specialists do not suggest that accountants are keenly interested in management-orientated modelling approaches; contributors to the identification of possible MS/OR applications; helpful in providing relevant and reliable data and information needed for MS/OR projects and studies; or permanently active members in MS/OR discussions involving financial considerations.



This aspect of the research has pointed out that in the majority of cases: accountants have little understanding of MS/OR work; and there is a less futuristic orientation in accountants' time horizon manifested in accountants' low interest in and appreciation of concepts such as risk, probability and uncertainty.

But why should accountants bother with MS/OR projects and studies? Why should they support MS/OR specialists? Why should they help in the identification of possible MS/OR applications? The answers to these and similar questions are clearly rooted in the interrelatedness of activities contained in both functions and the financial implications involved. Furthermore, this study has emphasised the importance of getting accountants acquainted with MS/OR concepts. A sizeable majority of respondents gave weight to the idea of getting accountants acquainted with such knowledge. A variety of reasons was given to form the rationale of such 'clearly indicated importance'. Amongst the given reasons were: experience suggests that accountants frequently have a narrow approach to cost definition, cost allocation and cost and risk analysis; accountants tend to have too much of a preoccupation with day to day problems to bother with projects having a much wider perspective; the need for relevant, reliable and reasonably quick provision of information, the need to change approaches in accounting; the need for more active participation (in MS/OR) by accountants; the interrelationships between MS/OR and accounting; the need to minimize the communication gap; the highly rigid attitude and outlook that characterises the overall behaviour patterns of some accountants; and the ability of some accountants to see clearly the organisation's financial picture. This evidence suggests a basic need for 'accounting analysts'. The rest of this section, however, is concerned with pointing out the principal findings in relation to accountants-MS/OR specialists' working relationships.

Behavioural factors affecting accountants-MS/OR specialists' interaction.

As to the Accountants-MS/OR specialists' interaction, the observations of 174 participants on 60 behavioural indicators were factor-analysed using orthogonal (Varimax) and oblique (direct quartimin), rotational methods allowing for the maximum interpretability of dimensions. The outcome of this analysis of interdependence suggests the importance of the following dimensions in affecting the Accountants-MS/OR specialists' relationships:

POSITIVITY vs. NEGATIVITY OF THE INTERACTION

EFFICIENCY vs. INEFFICIENCY OF MS/OR

HIGH vs. LOW DEGREE OF MS/OR INSTITUTIONALIZATION AND ORGANIZATIONAL MATURITY

ABSENCE vs. EXISTENCE OF ORGANIZATIONAL HINDRANCES

INTELLIGENT vs. UNINTELLIGENT ORGANIZATIONAL SELLING OF MS/OR

HIGH vs. LOW DEGREE OF BRIDGING TECHNICAL TERMINOLOGIES

CO-OPERATIVE vs. MONOPOLISTIC MONITORING OF FINANCE

SUFFICIENT vs. INSUFFICIENT (MS/OR-ACCOUNTING) SIMULATION MODELLING

SUCCESS vs. NON-SUCCESS OF MS/OR

SIGNIFICANT vs. INSIGNIFICANT CONSULTATION ON FINANCIAL CONSIDERATIONS OF MS/OR PROJECTS

LOW vs. HIGH DEGREE OF VAGUENESS IN RELATION TO MS/OR OBJECTIVES

ACTIVE vs. PASSIVE ACCOUNTANTS' RECOGNITION OF MS/OR APPLICATIONS IN THEIR FIELD OF SPECIALISATION

HIGH vs. LOW DEGREE OF CONTEMPORANEOUS VIEW OF MS/OR ON THE PART OF ACCOUNTANTS

LOW vs. HIGH PEDANTIC ATTITUDE ON THE PART OF ACCOUNTANTS

CONGRUITY vs. INCONGRUITY WITH OPERATIVE ORGANIZATIONAL GOALS

ABSENCE vs. EXISTENCE OF NARROW-MINDED FINANCIAL MANAGEMENT IN WEIGHING MS/OR PROPOSALS

HIGH vs. LOW DEGREE OF MS/OR APPRECIATION OF ACCOUNTING SYSTEMS

MODERATE vs. EXCESSIVE AMOUNT OF PROFESSIONAL JEALOUSY.



By means of assessing and analysing each of the extracted factors (contained in the factor-analytic solution outlined above), the researcher can prescribe the course of action that should be adopted towards more effective interactions based on constructive mutual understanding between the two groups: accountants and MS/OR specialists.

Treating each of the above factors as a continuum, the greater the score of an organisation on the left hand side (in this specific design) the greater the likelihood of better understanding and effectiveness of the interaction. That is, the higher the positivity of the interaction, the higher the efficiency of MS/OR, the higher the degree of MS/OR institutionalization and organizational maturity and so on, the greater the likelihood of effective interaction.

#### Co-ordination

Inappropriate organizational location, lack of sufficient managerial understanding and backing, inadequate liaison and other organizational conditions constitute forms of organizational hindrances to effective MS/OR-accounting working relationships.

Change devices should be installed to increase the amount and quality of organizational awareness of MS/OR capabilities and resources, to co-ordinate efforts of different information (collection-interpretation-reporting) support systems, and to consider, seriously and constructively, joint collaborative efforts on a project basis.

#### "Selling" of MS/OR

The indications point out towards the tendency amongst many MS/OR specialists to use excessively (mathematical) theorization at the expense of practicality and to "oversell" the expected benefits to be gained from using the MS/OR approach.

The study underlines the importance of an "intelligent" selling of MS/OR to users. It points out the importance of adopting appropriate marketing research approaches to tackling the problem of selling MS/OR to its users. The research puts a considerable amount of responsibility on MS/OR specialists themselves in this respect.

Carrying out initial (and follow-up) surveys into the needs of users and into the crucial areas of the business is an important step towards getting potential customers of MS/OR (i.e. users of its services) to be better informed about the nature, type and quality of service to be expected from MS/OR specialists.

The onus is on MS/OR specialists to convince potential customers that MS/OR tools, concepts, and approaches can be applied to help management make effective more use of the limited resources available to them. MS/OR specialists should present a good case as regards the practicality, validity and usefulness of applying MS/OR to assist management in locating new opportunities, evaluating alternative assumptions, objectives and conditions, developing new plans, and updating current ones.

MS/OR specialists have to prove that they are neither living away from the heart of management's responsibility, nor doing nice mathematical exercises with little resemblance to reality, nor lacking practical experience in the particular field of MS/OR application sought for advice.

The selling of MS/OR operational ideas is an area of great challenge to MS/OR specialists. It must be planned and approached carefully. Market research and the methodological approaches of the behavioural sciences can be of much help to MS/OR specialists in this respect.



### Use of technical terminologies

The problem of the technical terminologies in use has witnessed very little - if any - progress. Accountants use widely technical wording that changes in meaning from one use to another. Many MS/OR specialists, on the other hand, employ a high proportion of "buzz" and "esoteric" words that are not easily understood by accountants or by many other functional users of MS/OR. 'Blockage;' 'hindrance;' 'obstacle;' 'stumbling-block' and similar descriptions were used to diagnose the symptoms of the ineffective use of such jargon.

Each of the two parties should be made more aware of the terminologies that do not contribute significantly to further mutual understanding. This, together with the development of joint projects on common problems, along with the development of a common terminological directory/dictionary containing data and systems, should contribute to bridging the terminological gap. Furthermore, the development of short-training courses and on-the-job experiences have proved to be useful instruments in bridging the gap of technical terminologies.

### Accountants' involvement in MS/OR

The study leaves no doubt as to the very limited scope of current accountants' active recognition - if any - of MS/OR applications in their field of specialisation. Much of accountants' efforts are focussed upon the routine type of reporting activities.

Accounting data and information, in most cases, are not in a form that can be used readily by MS/OR specialists in their projects. Some MS/OR specialists have expressed their dissatisfaction with accounting data and information and have attributed some negative characteristics to accountants such as pedantry and dogmatism. This is based, apparently, on MS/OR specialists' own stereo-typing coding

scheme employed in the communication processes with accountants.

If one accepts the logic and dichotomy of programmed and non-programmed decisions classified into traditional and modern approaches, it is possible to highlight an area of difference in the attributes and consequences of the accounting and MS/OR functional systems. The findings of this research demonstrate that it is the exception rather than the rule to find accountants applying modern approaches in supporting their managements in decision making. Exceptionally few accountants resort to modern approaches of problem solving and supporting decision making. Standard conventions, common expectations, and well-defined information channels are the most commonly applied approaches to routine and repetitive processes. Judgement, intuition, 'rules of thumb,' and training are the common approaches adopted by accountants in handling ill-structured problems. In contrast, the majority of MS/OR specialists are highly involved in modern approaches either for programmed or non-programmed decisions. Education and training, organizational structure, and managerial involvement are highly relevant factors contributing to such differences in approaches.

Are accountants idiosyncratic towards MS/OR?

For the majority of accountants, the answer to the above question is a negative one. Furthermore, the majority of accountants who participated in this survey do not consider the MS/OR function as a threat to them in carrying out their accounting responsibilities. Several explanations for this were discussed earlier (See subsection 5.2.3.)

Providing accountants are exposed "properly" to the MS/OR approach, convinced sufficiently of its usefulness and practicality and realize demonstratively the feasibility of its (MS/OR) success and effectiveness,



there would be a good chance for increasing the likelihood of accountants making a material contribution to improving accounting systems, procedures, and practices to meet the requirements of MS/OR applications and of encouraging more accountants to participate in MS/OR projects and to apply MS/OR concepts to such accounting problems as pricing, capital budgeting, differential cost analysis and performance measurement.

Passive, positive or negative working relationships?

Although the relationships between accountants and MS/OR specialists are not characterised by highly dysfunctional conflict, accountants in the majority of cases take a passive interest in MS/OR. Basic discipline in-compatibilities, the lack of common objectives or superordinate goals, the difficulty on the part of accountants to identify explicit MS/OR objectives and tangible contributions, and an insufficient recognition on the part of accountants of the limitations of accounting systems and procedures are amongst the reasons responsible for the above-described passive stance on the part of accountants.

Tackling these causes on the basis of a long-term strategy is necessary for contributing towards more positive relationships between the two specialities. Getting the two specialist groups to recognize and study the built-in differences in concepts, procedures and approaches between the respective systems is an important step in paving the way to a more constructive dialogue. It should be aimed at making respective systems more feasibly accessible to the other. The two groups should aim at reinforcing their synergistic contribution to managerial decision making and problem solving.

### Power equilibrium

A major source of accountants "power" in organizations comes from their reporting responsibilities. There is insufficient evidence to support the view that such accounting power has been eroded as a result of the rise of new groups such as EDP and MS/OR specialists. Examples of accountants who can be considered the main authority on many financial matters (such as the stock exchange regulations, taxation, statutory requirements) are abundant in most organizations.

Those MS/OR specialists who have explored this avenue in order to contribute towards an interdisciplinary MS/OR model-building approach have emphasized the improvement in the quality of their models that has resulted.

Although accountants can benefit from applying MS/OR in their areas of specialization, it is not immediately apparent to many of them how to improve their accounting systems by adopting the MS/OR approach to tackling their problems. Accordingly, the onus is on MS/OR specialists to get the maximum benefit from those accountants who are knowledgeable about financial considerations that are relevant to MS/OR models.

### MS/OR institutionalization and organizational maturity

Not many MS/OR functions in business organizations have become institutionalized to the extent that users (particularly senior managers) have become able to identify and use MS/OR services. The extent of improvement regarding the MS/OR image in their organizations has been insufficient to enable their users to call upon their services. Much work remains to be done on the part of MS/OR specialists in relation to their organizational contribution to problem solving and decision making. MS/OR specialists provide a service to the



management of their organization. They should make sure that the selling of their (MS/OR) services is based on the practical understanding of customers' attitudes, backgrounds and experiences. Marketing research methods might be useful in this respect.

### Simulation modelling

There has been little joint 'accounting-MS/OR' effort in relation to financial simulation modelling. The experience of those who have successfully used computer-based simulation modelling - though by no means is it a general rule - has demonstrated that success in this area might improve communications between MS/OR specialists and accountants.

In view of this, the study indicates the need for accountants to grapple with computer-based simulation modelling as a necessary step towards accounting problem solving and support for the management of their organizations. By the same logic, MS/OR specialists should gain more familiarity with accounting concepts, procedures and conventions which, in turn, might be useful in constructively suggesting possible approaches to making accounting and costing systems more effective in providing different information for different purposes.

### MS/OR objectives

Compared with accounting functions, the objectives of the MS/OR functions are less explicitly defined. The nature of activities being carried out and the perception of terms of reference of MS/OR functions, particularly by managers, are amongst the factors contributing to this situation.

Vagueness in defining what is needed from MS/OR, the lack of appropriate control mechanisms, the absence of suitable conditions to acquire and utilize MS/OR effectively, and the failure to adapt to environmental changes are examples of consequences of ill-specified organizational goals and objectives in relation to the utilization of MS/OR services.

#### 10.4. IMPLICATIONS FOR THE FUTURE EDUCATION AND TRAINING OF ACCOUNTANTS, EDP AND MS/OR SPECIALISTS

---

It has been evident throughout the analysis presented in this report that there are a number of shortcomings, deficiencies and weaknesses in the relevant educational and training policies and programmes of the related areas of specialization. In this section, the researcher outlines his visualization of the implications of the findings of the present survey for education and training.

##### The need for strategic co-ordination

The researcher perceives a wide gap in the quantity and quality of strategic co-ordination amongst the closely related professional and learned bodies. This is particularly clear in the case of accountancy bodies, the Operational Research Society, the British Computer Society and the British Institute of Management.

It is highly desirable that these related bodies establish and develop concrete plans for promoting the mutual interests of their members to be able to cope with the ever increasing complexity of business problems. Although the areas of interest of the above-mentioned bodies are not identical, certainly they are not contradictory. The value of the interdisciplinary approach in the joint attack of business problems is becoming clearer than has been the case in the past.



Although inviting a distinguished MS/OR specialist to sit on the board of one of the accountancy bodies or write a book for an accounting audience may be useful, it is certainly not sufficient. Devising comprehensive plans based on adequate research into the areas of mutual interest is an important step towards achieving co-ordination amongst these closely related fields. More specifically, this empirically-based project has pointed out a number of worthwhile points:

First, the idea of a systems or D.P. accountant might be useful. Accounting, EDP professional bodies, and computer manufacturers could jointly co-ordinate their policies towards the more efficient utilization of human resources in the areas of computer-based applications. This is not the place, however, to detail specific assumptions, and objectives of policies in this respect.

Second, the importance of creating suitable education and training programmes (courses, seminars, papers, etc.) in accounting for non-accountants, particularly the MS/OR specialists. Professional accounting bodies have a major role to play in this respect by: the inclusion of such an approach into their way of training; the cross-fertilization of concepts, ideas and approaches; and a constructive dialogue between the two areas of interest. This is not to suggest that professional bodies are not aware of this responsibility, but the point being made here is that not enough work has been done in this respect.

A very high proportion of MS/OR respondents expressed their feeling that they should know about accounting and information systems topics, some dimensions of the accounting discipline, particularly those which have a direct relationship and impact upon financial modelling, should be given serious attention by both specialities: accounting and MS/OR. Professional bodies as well as commercial

organizations have considerable interest and obligation in equipping MS/OR functions with information regarding investment appraisal, taxation, and other related dimensions. To put it differently, some education and training of MS/OR specialists in taxation, in the consolidation of group accounts, takeovers, and other corporate financial aspects may be a necessary requirement for a more efficient utilization of organisational resources and for their contribution towards more practical and useful model-building. MS/OR specialists who participated in the early exploratory phase of the survey have emphasised the relevance of accounting and information systems topics related to their work, and have expressed their feeling and wish to attend such educational and training courses. Accounting for non-accountants forms a significantly important dimension of the relationship between MS/OR specialists and their accounting counterparts. Such aspects should be given careful consideration by those who are interested in the future of accounting as well as MS/OR education. The greater the difference between the characteristics and applications of the two disciplines, the greater is the likelihood that critical problems will continue to arise.

The problem is not new, and what is needed is a set of new approaches to tackle it systematically. Amongst the possible approaches that could be suggested in the field of education and training in accounting for non-accountants are:

- (i) attracting non-accounting specialists (such as MS/OR specialists) for their contribution to the accounting discipline by giving them sufficient encouragement to gain such experience.



- (ii) embarking on educational and training programmes to qualify the interested MS/OR specialists in accounting knowledge, which in turn may contribute directly or indirectly to accounting knowledge. It should be mentioned that the researcher focusses on "national" policies based on carefully planned schemes, rather than on scattered and individual efforts limited in scope and implications.
- (iii) cultivating and improving the quality of the curriculum of accountants' education and training on the basis of the basic branches of knowledge such as mathematics, statistics and philosophy.
- (iv) sponsoring research into how best the interdisciplinary aspects of MS/OR and accounting could be dealt with, and presented in a practical manner for the interchangeability and exchange of ideas, approaches and methodologies; facilitating the establishment of constructive communication networks; widening the individual's experience and contributing towards his organisation's continued growth.

#### IMPLICATIONS<sup>1</sup> FOR THE FUTURE INTERRELATIONSHIP OF ACCOUNTANTS, EDP, AND MS/OR SPECIALISTS: A LONG TERM PROPOSITION

The principal conclusions of this survey are that accountants' involvement in EDP is limited, in the majority of cases, to the mundane aspects of accountancy and that the powerful computational facilities that are available are not utilized effectively to support the managements

---

1. In writing up this section, the researcher has drawn on the analyses carried out in the preceding two parts.

of the accountants' organizations. Meanwhile, accountants are passively interested in the MS/OR field. The analysis carried out in this part of the survey corroborates the view that many of the problems, difficulties and obstacles are to do with the organizational effectiveness of the related professional bodies, the respective functions within organizations, and the behavioural dimensions of the interrelationships between accountants on the one hand and EDP and MS/OR specialists on the other.

Due to the fact that this survey is focussing on the accountants-EDP and MS/OR relationships (and differs in scope and facilities from the Long Range Enquiry<sup>2</sup> - Solomons with Berridge, 1974), the discussion in this section is concerned with suggesting a long term proposition for the purposes detecting, planning and satisfying long term needs and requirements of the accounting community in relation to MS/OR and EDP areas of interest.<sup>3</sup> Similar propositions could be drawn for the future long term needs and requirements of MS/OR and EDP specialists. Detail of the long term proposition is as follows:<sup>4</sup>

- 
2. As indicated earlier, this study and the Long Range Enquiry into Education and Training for the Accountancy Profession have been carried out concurrently though the pilot study of the present work had started earlier.
  3. Relevant to this are the recommendations in relation to several elements of a system for the long range education and training of accountants. The elements are:
    - "Basic relevant education leading to a Diploma of higher education of a degree.
    - Practical instruction
    - An experience requirement.
    - A test of professional competence leading to membership of the professional body.
    - Fellowship as a more specialized qualification.
    - Continuing education". (Solomons with Berridge, 1974, p.139).
 Although the report emphasises that these proposals are to be judged as an articulated set or a system, not as a collection of unrelated ideas, the report leaves much to be desired. There is a need, however, for designing a comprehensive system that enables the interested parties to have a sufficient long-range insight into the changing needs, requirements and responsibilities of the accounting community and that contains adaptive mechanisms that monitor the evolution and progression of the accounting profession.
  4. The aim of this discussion is to provoke a dialectic concerning the role professional and learned bodies could play in furthering the present knowledge about needs, requirements and responsibilities of respective members and the optimum strategy to satisfy relevant objectives.



(a) a system for the comprehensive identification and analysis of present and future needs and requirements and responsibilities of the accounting community in general and of the interacting groups (MS/OR, EDP, and their managements) in particular is needed. More explicitly the researcher sees the need for a comprehensive information system serving the varied needs of members, planners, policy strategists, and users of accounting services. The researcher sees the co-ordination of activities and services on the part of the professional and learned bodies as a cornerstone in relation to the formation of future strategies in the longer run. Dimensions of such desired co-operation include the outlining of the common body of knowledge, the interdisciplinary interaction, the development and the reinforcement of codes of ethical behaviour and the minimum standards of competence, the responsibilities to organization and the public and other relevant matters. The researcher believes in the importance of an organized system of information to enable those interested parties to gain insights into the scope of the gap between the desired and the actual interdisciplinary involvement of their respective members.<sup>5</sup>

Actually, this part of the study raises some fundamental questions about the way long-term policies and strategies are formulated which might explain the motivations behind the researcher outlining the proposition under consideration. Amongst these questions are: why has there been a considerable lack of basic information about the members of the accounting profession? In the absence of such information, how are policies and major decisions taken? What are the assurances that could be made as to the suitability of such decisions in relation to interests of the concerned parties? and, What information could be made available to present and prospective members of the profession?

---

5. Not only is the background information about respective members (such as age, length of experience in job, organization and field of specialization, educational and training profile) to be included in the system, but other behavioural indicators regarding matters of importance can be included. The system does not have to be all-embracing of every piece of detail, but principles of scientific sampling design and research should be applied.

(b) the objectives are:

- . to facilitate optimizing the educational and training functions of the accounting, EDP, and MS/OR communities to meet their changing responsibilities.
- . to identify critical issues facing their members (either separately or jointly) (although the professional accounting bodies, and some OR society members have contributed in that direction, there is wide room still for improvement, particularly in the areas of joint collaboration).
- . to facilitate the sharing of knowledge amongst their members and their respective customers.
- . to co-ordinate the relationship between education and practice by means of developing programme for increasing the effectiveness of the services offered.

(c) the operational methodology by which the proposition may be implemented might take the following shape:

(i) building an interdisciplinary team to handle the "search" or research into issues of relevance. The view of an institutionalized body might be considered. This is to co-ordinate policies and schemes of joint interest between the concerned professional and learned bodies. The key point is that strategic planning for the future education of the related disciplines should be based on an effective support of an integrated model of the needs and the satisfaction of those needs.

(ii) developing and implementing a procedure for accumulating, storing and analysing "relevant" data and information. It is essential that such a procedure includes a set of observable dimensions, behavioural indicators and variables whereby features, attributes, characteristics, relationships and consequent behaviours and



attitudes could be investigated. This should help diagnose current problems and project future needs and requirements.

To explain, the cases of the studies into the common body of knowledge of the accounting profession in the U.S.A., Canada, and the U.K. may be quoted. The common denominator of these studies is the fact that they have carried out research into what was considered to be relevant to the respective future education of their members. They have been carried out at a certain time in an attempt to answer a number of questions. Obviously, such studies are limited in scope and long-term benefits. The researcher's contention, accordingly, is aimed at transforming such one-shot-off studies into more elaborate system responsive to the changing needs of such organizations. What are the natural and psychological clusters of the respective members of any of these organizations? What are the variables that discriminate between more progressive and less progressive members, between more effective and less effective methods of training, policies, or qualification practices? What are the appropriate measures of social responsibility of the respective organization? These and other similar questions are likely to find some answers under a comprehensive and on-going system of measurement and analysis of the related attitudes, profiles, preferences, similarities, and proximities.

#### 10.5. DIRECTIONS FOR FURTHER RESEARCH

It is reasonable to say the researcher has carried out both intensive and extensive research into the accountants-EDP and MS/OR specialists' interaction with special reference to British industry.

Most researchers feel that some relevant points, topics, research areas could be further pursued to add more interest to their research

effort. Accordingly, the following are some directions for further research:

1. the further systematic investigation of communication patterns and working relationships amongst the constituent elements of decision and control subsystem on wider scope is a possibility in this respect. This can be done by inclusion of more cases on the individual as well as on the organizational levels.

More specifically, subjecting the set of propositions generated from the detailed analysis of a small number of case studies to an expanded empirical testing is an area worthy of research. (See section 7.5.) The concept of organizational effectiveness of decision support subsystem should play a major role in such area of further examination.

2. the development of a comprehensive system for the identification and analysis of present and future needs, requirements and responsibilities of the accounting community in general and of the interacting groups in particular is another area of possible research. Subjecting the present research as well as relevant others to critical examination might be the starting point of such further research.

3. the comparative analysis of the outcome of subjecting the attitudinal aspects of communication amongst individuals representing decision and control subsystems' elements to both metric and/<sup>non</sup>metric multidimensional analysis.<sup>6</sup>

---

6. It is true that the nonmetric approaches are still evolving and have as yet to enjoy wide application. Also, there are several computational, empirical and conceptual problems associated with such nonmetric approaches of multidimensional scaling. Nevertheless, both metric and nonmetric can be used in tandem. For a more detailed discussion of the nature, promise, methodology, limitations and comprehensive bibliography, see, e.g. Green and Carmone 1970; Shepard et al 1972; Green and Rao, 1972; Mulaik, 1972 (Chapters 15 and 16); Green and Wind 1973.



Emphasis, perhaps, can be made on the methodological points of view rather than on the specific area of application.<sup>7</sup>

4. the use of the theory of directed graphs<sup>8</sup> and Boolean Relation Matrices in studying the structural properties of the bi-lateral systems of interactions between accountants on the one hand, and EDP and MS/OR specialists on the other. After preliminary attempts to pursue this approach in studying the sought type of organizational interactions, the researcher has found that it is useful to concentrate, in a separate research study, upon the structural properties and quantification of certain aspects of communication using "digraph" theory and associated branches of mathematics such as matrix algebra. Such empirical evidence is needed for more understanding about relationships between EDP, MS/OR specialists and accountants.

It would probably be even more beneficial if the study of structural properties - of groups under consideration as well as with other groups - be subdivided into several subsets.

7. It is needless to emphasize that the present researcher has been more concerned with the maximum interpretability of factors or dimensions affecting accountants-EDP and MS/OR specialists' interaction. In other words, the researcher has not been concerned with the spatial representation of dimensions as such. The factor analytic solutions together with the intensive qualitative evidence have provided the researcher with a satisfactory (in relation to his earlier expectations) understanding of the underlying pattern of interrelations in the data.

8. The theory of directed graphs, or briefly "digraphs" (a term suggested by G. Polya) is concerned with patterns of relationships among pairs of abstract elements. As such, digraph theory makes no reference to the empirical world. Nevertheless, it is potentially useful to serve as a mathematical model of the structural properties of any empirical system consisting of relationships among pairs of elements. Three main benefits may be gained by employing digraph theory in the treatment of structural phenomena: (1) the use of terminology having precise meanings to refer to relatively complex structural properties such as the degree of connectedness of a structure, its diameter, its vulnerability, and its stratification into levels; (2) it provides useful means for quantifying certain features of empirical structures; (3) its theorems - or the body of logically derived statements become valid assertions about empirical structure that specifies the axioms of digraph theory and by specifying properties of digraphs that necessarily follow from given condition, they permit us to draw conclusions about certain properties of a structure from knowledge about other properties (Harary, Norman and Cartwright, 1965).



## Summary

This chapter has consolidated the main findings of this survey, outlined their main implications, and pointed some directions for further research.

If the researcher is allowed to make a general observation, he would emphasize that there is insufficient evidence to corroborate that accountants are progressively able to either use the computer power or comprehend the analytical functions of model-building approaches in gaining insights into their accounting data and information. The relative success has been in the mundane and deterministic type of activities. EDP and MS/OR specialists should not be entirely blamed for such a condition. Each constituent group should understand and appreciate the advantages of constructive accountants - EDP and MS/OR specialists' understanding.

This chapter has reiterated the need for impressive educational and training programs (not only for accountants but also for MS/OR and EDP specialists) to bring together the computational and analytical powers of computers and model-building into the functional and corporate areas of problem solving and decision making. The responsibilities of the professional and learned bodies are great in that direction.

The researcher is hopeful that this research would contribute towards more understanding with regard to causes and effects, symptoms and consequences, patterns and attitudes involved in the accountants - EDP, and MS/OR specialists' interaction. The aim is to enhance the likelihood of recognizing the importance of the synergistic use of quantitative and computational tools for better decision making and problem solving.

The objectives of this research would be satisfied if the analysis of findings presented in this report are to stimulate further research and investigation into ways and means of increasing use of these analytical tools and reinforcing them for more effective support to the management of their organizations.



BIBLIOGRAPHY \*

\* This bibliography contains only those references directly quoted in, and/or referred to in, the context and appendices of the present study.

- ACKOFF, R.L., "Management Misinformation Systems", Management Science, Vol.14, No.4. December 1967, pp.147-156.
- ACKOFF, R.L., "A Concept of Corporate Planning", Wiley - Interscience, New York, 1970.
- ACZEL, M.A., "Operations Research" in: BOURNE, A.M., (ed.), "Studies in Accounting for Management Decision" McGraw Hill, N.Y., 1969, pp.261-285.
- ALEXIS, M, and WILSON, C.Z., "Organisational Decision Making", Prentice-Hall, Inc., Englewood Cliffs, N.J., 1967.
- American Accounting Association, "Report of the Committee on the Measurement Methods Content of the Accounting Curriculum" Supplement to Vol. XLVI, The Accounting Review, 1971.
- American Accounting Association, "Report of the Committee on Behavioural Science Content of the Accounting Curriculum", Supplement to Vol. XLVI, The Accounting Review, 1971.
- American Accounting Association, "Report of the Committee on Management Information Systems", Supplement to Vol. XLIX, The Accounting Review, 1974.
- ANDERSON, J.D., "Direct Chargeout of Information Systems Services Costs", Management Adviser, Vol. 11, No.2, March-April, 1974, pp.27-33.
- ARGYRIS, C. "Today's Problems with Tomorrow's Organisations" Journal of Management Studies, Vol.4, No.1, February, 1967.
- ARNOFF, E.L., "Operations Research and Decision-Oriented Management Information System" Management Accounting (N.A.A.) June 1970.
- ARROW, K.J., "Control in Large Organisations", Management Science, Vol. 10, No.3, April 1964, pp.397-408.
- ASHENHURST, R.L. (ed.) "Curriculum Recommendations for Graduate Professional Programs in Information Systems - A Report of the ACM Curriculum Committee on Computer Education for Management", Management Informatics, Vol. 1, No.3/4, 1972. pp.147-175.

- BAHR, F.R., "The Man-Machine Confrontation - the need for humanistic viewpoint", Business Horizons, Vol.15, October 1972, pp.81-86.
- BEER, S., "Decision and Control - the Meaning of Operational Research and Management Cybernetics", John Wiley & Son, London, 1966.
- BENDER, W.E., et al, "Introductory Manual to Data Base Management", Management Informatics, April 1974, pp.87-98.
- BENJAMIN, J.J., and BRENNER, V.C., "Perceptions of Journal Quality", The Accounting Review, Vol. XLIX, No.2, April 1974.
- BENNIE, L.M., "The Impact of Quantitative Techniques on Accountants and Accountancy Systems", Unpublished Report, Department of Accountancy and Finance, Heriot-Watt University.
- BENNIS, W.G., "Changing Organisations" McGraw-Hill, N.Y., 1966.
- BLANCHARD, J.S., "We Bet our Company on Data Base Management", Datamation, Vol.20, No.9, September 1974.
- BOULDING, K.E., Foreword to "The Logic of Social Systems" by: KUHN, A., Jossey-Bass Publishers, San Francisco, 1974.
- BOURTON, R., and RIVETT, P., "A Survey of Operational Research Groups in Great Britain", Operational Research Quarterly, Vol.23, No.2, May 1972, pp.117-123.
- BOWERMAN, E.R., and LITTAUER, S.B., "Operations Engineering", Management Science, Vol.2, No.4, July 1956.
- BOWERS, D.G., and SEASHORE, S.E., "Predicting Organisation Effectiveness With a Four Factor Theory of Leadership", Administrative Science Quarterly, Vol.11, September 1966, pp.238-263.
- BRILL, A.E., "The Alienation of the Systems Analyst", Journal of Systems Management, Vol.25, No.1, January 1974, pp.26-30.
- CAMINAR, J.J. and ANDLINGER, G.R., "Operations Research Roundup", Harvard Business Review, Vol.32, No.6, November-December 1964.
- CANNELL, C.F., and KAHN, R.L., "Interviewing" in: Lindzey, G., and Aronson, Ed., (eds.), The Handbook of Social Psychology, (2nd. ed.), Vol.2, Research Methods, Addison-Wesley Publishing Co., Reading, Mass., 1968.
- CANNING, R.G., (ed.) "The Debate on Data Base Management", EDP ANALYZER, Vol.10, No.3, March 1972.
- CANNING, R.G., "A Structure for EDP Projects", EDP ANALYZER, Vol.11, No.5, May 1973.
- CANNING, R.G. (ed.) "Charging for Computer Services" EDP ANALYZER, Vol.12, No.7, July 1974.



- CANNING, R.G., "Improving the System Building Process", EDP ANALYZER, Vol.12, No.12, December 1974.
- CARSBERG, B.V., "An Introduction to Mathematical Programming for Accountants", George Allen and Unwin Ltd., London, 1969.
- CATTELL, R.B., "Factor Analysis - An Introduction and Manual for the Psychologist and Social Scientist", Harper & Brothers, Publishers, New York, 1952.
- CATTELL, R.B., "Guest Editorial: Multivariate Behavioural Research and the Integrative Challenge", Multivariate Behavioural Research, Vol.1, 1966, pp.4-23. (1966-a).
- CATTELL, R.B., (ed.), "Handbook of Multivariate Experimental Psychology", Rand McNally & Company, Chicago, 1966. (1966-b).
- CHARMAN, J., "Effective Project Costing and Killing Techniques", Paper presented at the American Management Association 17th Annual Management Systems Conference on "The EDP Cost/Technology Confrontation", March 9, 1971.
- CHURCHILL, N.C., KEMPSTER, J.H., and URETSKY, M., "Computer-Based Information Systems for Management: A Survey", NAA Research Study, National Association of Accountants", 1969.
- CHURCHMAN, C.W., "Prediction and Optimal Decisions: Philosophical Issues of a Science of Value", Prentice-Hall, Englewood Cliffs, 1961.
- CHURCHMAN, C.W., Foreword to: STARR, M.K., (ed.) "Executive Readings in Management Science", Coilleir-Macmillan Ltd., London, 1965.
- CHURCHMAN, C.W., and ACKOFF, R.L., "Operational Accounting & Operations Research", The Journal of Accountancy, Vol.99, February 1955, pp.33-39.
- CHURCHMAN, C.W., and SCHAINBLATT, A.H., "The Researcher and the Manager: A Dialectic of Implementation", Management Science, Vol.11, No.4, February 1965.
- COLBERT, B.A., "Pathway to Profit: The Management Information System", Management Services Vol.4, No.5, September-October 1967, p.16.
- COSER, L.A., "The Functions of Social Conflict", The Free Press, New York, 1956.
- COSER, L.A., "Continuities in the Study of Social Conflict", The Free Press, New York, 1967, pp.7-8.
- COUGER, J.D., and KNAPP, R.W., (eds.) "Systems Analysis Techniques", John Wiley & Sons, New York, 1974.



- COWDERY, J.F., "System Documentation - Why Bother?", Computer Management, May 1974, pp.26, 28, 29.
- CUNITZ, J.A., "Computer Cases in Accounting", Prentice-Hall, Inc., Englewood Cliffs, New Jersey, 1972.
- DEAN, N.J., "The Computer Comes of Age", Harvard Business Review, Vol.46, No.1, January-February 1968, pp.83-91.
- DEARDEN, J., "Cost Accounting and Financial Control Systems", Addison-Wesley Publishing Company, Reading, Massachusetts, 1973.
- DEARDEN, J., and LASTAVICA, J., "New Directions in Operations Research" Financial Executive, Vol.XXXVIII, No.10, October 1970, pp.24-33.
- DEARDEN, J., and NOLAN, R.L., "How to Control the Computer Resource", Harvard Business Review, Vol.51, No.6, November-December 1973, pp.68-78.
- DEMING, W.E., "On Errors in Surveys", American Sociological Review, Vol.19, August 1944, pp.359-369.
- DICKSON, G.W., and SIMMONS, J.K., "The Behavioural Side of MIS - Some aspects of the "people problem", Business Horizons, August 1970, pp.59-71.
- DIEBOLD, J., "Bad Decisions on Computer Use" - Thinking Ahead, Harvard Business Review, January-February 1969.
- DIEBOLD, J., "ADP - the Still Sleeping Giant", Harvard Business Review, Vol.42, No.5, September-October 1964.
- DIXON, W.J., (ed.) "BMD - Biomedical Computer Programs", University of California Press, Berkeley, 1973.
- DOBELIS, W.C., "Towards Professionalism in Systems Design", Journal of Systems Management, Vol.24, No.1, January 1973, pp.14-22.
- DRUCKER, P.F., "Potentials of Management Science", Harvard Business Review, Vol.37, January-February 1959 (1959-a).
- DRUCKER, P.F., "Long-Range Planning - Challenge to Management Science", Management Science, Vol.5, No.3, April 1959, pp.238-249. (1959-b).
- DRUCKER, P.F., "Management - Tasks, Responsibilities, Practices", Heinemann, London, 1973.
- DuBRIN, A.J., "The Practice of Managerial Psychology: Concepts and Methods for Manager and Organization Development", Pergamon, New York, 1972.
- DUNCAN, W.J., "Management Theory and the Practice of Management", Business Horizons, October 1974, pp.48-52.
- DUNCAN, R.B., "Toward an Operant Model of Organizational Learning: Adaptation to Environmental Uncertainty", Working Paper 40-71, Graduate School of Management, Northwestern University, 1971.



- DUNCAN, R.B., "Characteristics of Organizational Environments and Perceived Environmental Uncertainty", Administrative Science Quarterly, Vol.17, No.3, September 1972, pp.313-327.
- EDWARDS, A.L., "Techniques of Attitude Scale Construction", Appleton - Century - Crofts, Inc., New York, 1957.
- EILON, S., HOUGH, J. and BETTS, R.J., "Profile of Current Members of the Operational Research Society", Operational Research Quarterly, Vol.20, No.2, March 1969.
- ELLIOTT, P., "The Sociology of the Professions", The Macmillan Press Ltd., 1972.
- EMERY, F.E., and TRIST, E.L., "The Causal Texture of Organizational Environments", Human Relations, Vol.18, No.1, February 1965, pp.21-32.
- EMERY, J.C., "Management Information Systems", in: Aronofsky, J.S., (ed.), "Progress in Operations Research - Relationship between Operations Research and the Computer", Vol.III, John Wiley & Sons, Inc., New York, 1969.
- ESTES, N., "Step - by - Step Costing of Information Systems", Journal of Systems Management, October 1969, pp.20-28.
- ETZIONI, A., "Modern Organizations", Prentice-Hall, Englewood Cliffs, New Jersey, 1964.
- FAHMY, S.B., "Mathematical Aspects of Cost Accounting", Ph.D. Dissertation, The University of Texas, 1967.
- FESTINGER, L., and KATZ, D., (eds.) "Research Methods in the Behavioural Sciences", Dryden Press, New York, 1953.
- FINERTY, J.J., "Accountants in 1984", Management Accounting (N.A.A.), Vol.LI, No.9, March 1970.
- FORRESTER, J.W., "Industrial Dynamics", John Wiley & Sons, Inc., New York, 1961.
- FORRINGTON, C.D.V., "Business Modelling", Data Processing, July-August 1973, pp.238-243.
- GALLOP, W.J., "The great cost allocation debate", CANADIAN DATASYSTEMS, November, 1972, pp.22-25.
- GALTUNG, J., "Theory and Methods of Social Research", George Allen & Unwin Ltd., London, 1967.
- GEORGOPOULOUS, B.S., and MANN, F.C., "The Community General Hospital", Macmillan, New York, 1962.
- GERSHEFSKI, G.W., "Building a Corporate financial Model", Harvard Business Review, Vol.47, No.4, July-August 1969, pp.61-72.

- \* GIBSON, C.F., and NOLAN, R.L., "Managing the Four Stages of EDP Growth", Harvard Business Review, Vol.52, No.1, January-February 1974, pp.76-88.
- GOLD, R.L., "Understanding" in: GOULD, J., and KOLB, W.L., (eds.) "A Dictionary of the Social Sciences", Tavistock Publications, London, 1964, pp.734-735.
- GRAYSON, C.J., "Management Science and Business Practice", Harvard Business Review, Vol.51, No.4, July-August 1973, pp.41-48.
- GREEN, P.E., and CARMONE, F.J., "Multidimensional Scaling and Related Techniques in Marketing Analysis", Allyn and Bacon, Inc., Boston, Mass. 1970.
- GREEN, P.E., and RAO, V., "Applied Multidimensional Scaling: A Comparison of Approaches and Algorithms", Holt, Rinehart and Winston, Inc., 1972.
- GREEN, P.E., and WIND, Y., with contributions by CARROLL, J.D., "Multiattribute Decisions in Marketing - A Measurement Approach", The Dryden Press, Hinsdale, Illinois, 1973.
- GRINYER, P.H., "Corporate Financial Simulation Models for Top Management", OMEGA, Vol.1, No.4, 1973, pp.465-482.
- GROSS, B.M., "What Are Your Organization's Objectives?", Human Relations, August, 1965, p.197.
- GRUENBERGER, F., "Problems and Priorities" Datamation, March 1972, pp.47-50.
- GRUENBERGER, F. (ed.), "Information Systems for Management", Prentice-Hall, Inc., Englewood Cliffs, New Jersey, 1972. Proceedings of the eighth symposium held at UCLA, March 22-24, 1971, sponsored by Informatics Inc. and the University of California at Los Angeles.
- GUETZKOW, H., "Communication in Organizations" in: MARCH, J.G., (ed.) "Handbook of Organizations", Rand McNally & Company, Chicago, 1965, pp.534-573.
- GUTHRIE, A., "Attitudes of the User-Managers towards Management Information Systems", Management Informatics, Vol.3, No.5, 1974, pp.221-232.
- GYNTHIER, R.S., "Accounting in the Seventies", Accountants' Journal, Vol.49, No.4, November 1970.
- HAGE, J., "An Axiomatic Theory of Organizations", Administrative Science Quarterly, Vol.10, No.3, December 1965, pp.289-320.
- HALLAM, S.F., "An Investigation of the Objectives and Constraints of Electronic Data Processing Departments", Dissertation Abstracts International, Vol.35, No.1, July 1974, p.30-A.



- HAMMOND, R.A., "Making OR Effective for Management", Business Horizons, Vol.5, Spring 1962, pp.73-82.
- HAND, A.B., and RIVES, W.L., "Constructing a Data Processing Cost Accounting System", The Magazine of BANK ADMINISTRATION, April 1974, pp.34-44.
- HARARY, F., NORMAN, R.Z., and CARTWRIGHT, D., "Structural Models: An Introduction to the Theory of Directed Graphs", John Wiley & Sons, Inc., New York, 1965.
- HARTLEY, R.V., "Operations Research and its Implications for the Accounting Profession", The Accounting Review, No.2, April, 1968, pp.321-332.
- HAYES, R.H., and NOLAN, R.L., "What kind of Corporate Modelling functions Best?" Harvard Business Review, Vol.52, No.3, May-June 1974, pp.102-112.
- HEAD, R.V., "The Elusive MIS" Datamation, September 1 1970, pp.22-27.
- HEAD, R.V., "Manager's Guide to Management Information Systems", Prentice-Hall, Englewood Cliffs, New Jersey, 1972.
- HEANY, D.F., "Is TMS Talking to Itself?", Management Science, December 1965, pp.B-146-155.
- HEERMANN, E.F., and BRASKAMP, L.A., (eds.), "Readings in Statistics for the Behavioural Sciences", Prentice-Hall, Inc., Englewood Cliffs, New Jersey, 1970.
- HIRSCH, R.E., "Data Processing Can be Cost-Controlled", The Price Waterhouse Review, Summer 1970.
- HOFER, C.W., "Emerging EDP Pattern" Harvard Business Review, Vol.48, No.2, March-April, 1970.
- HOMANS, G.C., "The Strategy of Industrial Sociology", The American Journal of Sociology, Vol.LIV, No.4, January 1949, pp.330-337.
- HORNGREN, C.T., "The Accounting Discipline in 1999", The Accounting Review, Vol.46, No.1, January 1971, pp.1-11.
- HOWARD, R.A., "The Practicality Gap", Management Science, Vol.14, No.7, March 1968, pp.503-507.
- HOWER, R.M., and LORSCH, J.W., "Organizational Inputs", in: SEILER, J.A., "Systems Analysis in Organizational Behaviour", Richard D. Irwin, Inc., and The Dorsey Press, Homewood, Illinois, 1967, p.168.
- HUFF, D., "How to Lie with Statistics", Gollancz, London, 1954. (Penguin 1973).
- HUGHES, P.J., "Organization and Control of Computer Resources in a Large Multi Division Corporation", Management Decision, Vol.11, No.5, Winter 1973, pp.240-251.



- HUHN, G.E., "The Data Base in a Critical On-line Business Environment", DATAMATION, Vol.20, No.9, September 1974.
- HUSSIAN, V.P., "RX for Top Management: A Periodic Checkup of E.D.P. Operations", California Management Review, Vol.14, Spring 1972, pp.31-37.
- IJIRI, Y., and JAEDICKE, R.K., "Mathematics and Accounting" in: BACKER, M., (ed.), "Modern Accounting Theory", Prentice Hall, Englewood Cliffs, New Jersey, Rev.Ed., 1966, pp.535-553.
- JOHANNSEN, H., and BIRCH, S., "Achieving Computer Profitability: A Survey of Current Practice in 102 Companies", (Management Survey Report No.1), British Institute of Management Surveys and Publications Department, 1971.
- JONES, C.H., "At Last: Real Computer Power for Decision Makers", Harvard Business Review, Vol.48, No.5, September-October 1970, pp.75-89.
- JOPLIN, H.B., "The Accountant's Role in Management Information Systems", The Journal of Accountancy, Vol.121, No.3, March 1966.
- KAHN, R.L., and CANNELL, C.F., "The Dynamics of Interviewing", John Wiley & Sons, Inc., New York, 1957.
- KANTER, J., "Management-Oriented Management Information Systems", Prentice-Hall, Inc., Englewood Cliffs, New Jersey, 1972.
- KATZ, D., "Approaches to Managing Conflict" in: KAHN, R.L., and BOULDING, Elise (eds.), "Power and Conflict in Organizations", Basic Books, Inc., Publishers, New York, 1964.
- KATZ, D., and KAHN, R.L., "The Social Psychology of Organizations", John Wiley & Sons, Inc., New York, 1966.
- KAUFMAN, F., "On Understanding the Computer", The Conference Board Record, October 1974, pp.52-58.
- KENDAL, M.G., "Factor Analysis as a Statistical Technique", Journal of the Royal Statistical Society - Series B (Methodological), Vol.XII, No.1, 1950, pp.60-73.
- KENDAL, M.G., "The Teaching of Operational Research", Operational Research Quarterly, Vol.9, No.4, December 1958, p.266.
- KENNEDY, M.H., "Real Time vs. Exception Reports", Journal of Systems Management, Vol.25, No.4, April 1974, pp.22-26.
- KERLINGER, F., "Foundations of Behavioural Research", Holt, Rinehart & Winston, 2nd ed., 1973.
- KIMBALL, G.E., and MORSE, P.M., "Methods of Operations Research", The Technology Press of M.I.T., John Wiley & Sons, Inc., New York 1951, p.1.
- KNUTSEN, K.E., and NOLAN, R.L., "Assessing Computer Costs and Benefits", Journal of Systems Management, Vol.25, No.2, February 1974, pp.28-34.



- KUHN, A., "The Logic of Social Systems", Jossey-Bass Publishers, San Francisco, 1974.
- LAWRENCE, P.R., and LORSCH, J.W., "Differentiation and Integration in Complex Organizations", Administrative Science Quarterly, June 1967, pp.1-47. (1967-a).
- LAWRENCE, P.R., and LORSCH, J.W., "Organization and Environment - Managing Differentiation and Integration", Division of Research, Graduate School of Business Administration, Harvard University, 1967. (1967-b).
- LEAVITT, H., and WHISLER, T.L., "Management in the 1980's", Harvard Business Review, Vol.XXXVI, No.6, November-December 1958, pp.41-48.
- LEWIS, D.R., and STITT, J.A., "Education for Accountants: 1 - Deficiencies of the Present System; 2 - New Policy", The Accountant, Vol.166, Nos.5070, Feb.17th 1972, and 5071, Feb.24th 1972, respectively.
- LIEBERMAN, B., (ed.), "Contemporary Problems in Statistics - A Book of Readings for the Behavioural Sciences", Oxford University Press, London, 1971.
- LIKERT, R., "A Technique for the Measurement of Attitudes", Archives of Psychology, 1932, No.140.
- LIKERT, R., "The Human Organization: Its Management and Value", McGraw-Hill Book Company, New York, 1967.
- LIVINGSTONE, J.L., (ed.), "Management Planning and Control: Mathematical Models", McGraw-Hill Book Co., New York, 1970.
- LOWE, E.A., and McINNIS, J.M., "Control in Socio-Economic Organizations: A Rationale for the Design of Management Control Systems, (Section I)", The Journal of Management Studies, Vol.8, No.2, May 1971, pp.213-227.
- LOWE, E.A., "On the idea of a Management Control System: Integrating Accounting and Management Control", The Journal of Management Studies, Vol.8, No.1, February 1971, pp.1-12.
- LOWE, E.A., "The Finance Director's role in the Formulation and Implementation of Strategy: A Framework for Financial Strategy", Journal of Business Finance, Vol.4, No.4, 1974, pp.58-70.
- LUCAS, H.C., "A Descriptive Model of Information Systems in the Context of the Organization" in: Data Base, Vol.5, Nos.2, 3, and 4, Winter 1973, and the Society for Management Information Systems, Special Report No.2, December 1973, (Proceedings of the Wharton Conference on Research on Computers in Organizations, edited by H.L. Morgan), 1973, pp.27-36.



- LYON, J.K., "An Introduction to Data Base Design", Wiley-Interscience, New York, 1971.
- MADNICK, S.E., "Recent Technical Advances in the Computer Industry and Their Future Impact", Sloan Management Review, Vol.14, No.3, Spring 1973, pp.67-84.
- MARCH, J.G., and SIMON, H.A., "Organizations", John Wiley & Sons, Inc., New York, 1958.
- MARTIN, G.N., "Data Dictionary/Directory System", Journal of Systems Management, December 1973, pp.12-19.
- MASLOW, A.H., "Motivation and Personality", Harper & Row, New York, 2nd ed., 1970.
- MATTESSICH, R., "The Impact of Electronic Data Processing and Management Science Upon Accounting Theory", in: Backer, M., (ed.), "Modern Accounting Theory", Prentice-Hall, Englewood Cliffs, New Jersey, Rev.Ed., 1966, p.521.
- MATTESSICH, R., "Operations Research and Accounting: Competitors or Partners?" in: Thomas, W.E., Jr., (ed.), "Readings in Cost Accounting Budgeting and Control", (3rd ed.), South-Western Publishing Co., Cincinnati, 1968.
- MECHANIC, D., "Sources of Power of Lower Participants in Complex Organizations", Administrative Science Quarterly, Vol.7, December 1962, pp.349-364.
- MENKUS, B., "Defining Adequate Systems Documentation", Journal of Systems Management, Vol.21, December 1970, pp.16-21.
- MERCER, A., "The Membership of the Operational Research Society", Operational Research Quarterly, Vol.19, No.4, December 1968, pp.371-376.
- MILLEN, J., "Education and Training: Wisdom of Solomons", Accountancy, Vol.83, No.947, July 1972.
- MILLER, E.J., and RICE, A.K., "Systems of Organizations", Tavistock, London, 1967.
- MILLER, I.M., "Computer Graphics for Decision Making", Harvard Business Review, Vol.47, No.6, November-December 1969, pp.121-132.
- MILLER, J.G., "Living Systems: The Organization", Behavioural Science, Vol.17, 1972.
- MITCHELL, R., "Computer-based systems and The Accounting Function", The Accountant, Vol.161, No.4945, September 27th, 1969, pp.383-387.
- MITCHELL, R., "Computer-based systems and the Accounting Function - II", The Accountant, Vol.161, No.4946, October 4th, 1969, pp.420-424.



- MOAN, F.E., "Does Management Practice Lay Behind Theory in the Computer Environment?", Academy of Management Journal, Vol.16, No.1, March 1973, pp.7-24.
- MONTGOMERY, S.J., "Cost Accounting from a Mathematical Viewpoint", Ph.D. Dissertation, Graduate School of Business Administration, New York University, 1966.
- MOORE, J.F., "What Operations Research means to the Accountant", Management Services, Vol.3, No.6, November-December 1966.
- MORTON, M.S., "Management Decision Systems: Computer-Based Support for Decision Making", Division of Research, Graduate School of Business Administration, Harvard University, Boston, 1971.
- MORTON, M.S., and McCOSH, A.M., "Terminal Costing for Better Decisions", Harvard Business Review, Vol.46, No.3, May-June 1968, pp.147-156.
- MOSER, C.A., and KALTON, G., "Survey Methods in Social Investigations", Heinemann Education.
- MOST, K.S., "OR and the Accountant", Accountancy, Vol.LXX, No.793, September 1959, pp.460-463.
- MULAİK, S.A., "The Foundations of Factor Analysis", McGraw-Hill Book Company, 1972.
- MYERS, C.A., (ed.), "The Impact of Computers on Management", MIT Press, Cambridge, Massachusetts, 1967.
- McFARLAN, F.W., "Problems in Planning the Information System", Harvard Business Review, Vol.49, No.2, March-April 1971, pp.75-89.
- McKINSEY & COMPANY, INC., "Unlocking the Computer's Profit Potential", New York, 1968, reprinted in: Computers and Automation, April 1968, pp.24-35.
- McRAE, T.W., "The Impact of Computers on Accounting", John Wiley & Sons, London, 1964.
- McREAVIE, K.S., "A Conceptual Approach to Computer Controls", Management Controls, Vol.19, July 1972, pp.166-173.
- NAGY, C.F., "Operations Research and its Possible Influence on Accountancy" Ph.D. Thesis, Department of Accounting, Graduate School of the University of Alabama, Alabama, (U.S.A.), 1958.
- NAYLOR, T.H., "Comouter Simulation Experiments with Models of Economic Behaviour", John Wiley & Sons, New York, 1971.
- NEILSEN, N.R., "Using Your Computing Resources to Best Advantage", Journal of Contemporary Business, Vol.1, Spring 1972, pp.35-49.
- NIE, N.H., BENT, D.H., and HULL, C.H., "SPSS - Statistical Package for the Social Sciences", McGraw-Hill Book Company, New York, 1970.



- NIE, N.H., HULL, C.H., with the assistance of KIM, J., and STEINBRENNER, K., "SPSS - Statistical Package for the Social Sciences - Update Manual", Inter-University/Research Council Series, Report No.10, November 1972.
- NOLAN, R.L., "Computer Data Bases. The Future is Now" Informatie (Netherlands), March 1974, pp.185-197.
- PENDRAY, J.J., "The in-house computer department", AFIPS Conference Proceedings, Vol.41, Part I, Fall Joint Computer Conference, December 5-7, 1972, AFIPS Press, Montvale, New Jersey, 1972.
- PERRIN, J.R., "The Graduate Entrant", Accountancy, Vol.LXXXII, No.938, October 1971, pp.554-562.
- PERROW, C., "The Analysis of Goals in Complex Organizations", American Sociological Review, Vol.26, No.6, December 1961.
- PETERSON, H., "The Wizard Who Oversimplified: A Fable", The Quarterly Journal of Economics, Vol.LXXIX, No.2, May 1965, pp.209-211.
- PONDY, L.R., "Organizational Conflict: Concepts and Models", Administrative Science Quarterly, September 1967.
- PRICE, J.L., "Organizational Effectiveness - An Inventory of Propositions", Richard D. Irwin, Inc., Homewood, Illinois, 1968.
- PROBST, F.R., "Framework for Planning and Controlling New Computer Applications", Cost and Management, Vol.46, July-August, 1972, pp.17-21.
- PUGH, D.S., HICKSON, D.J., HININGS, C.R., MACDONALD, K.M., TURNER, C., and LUPTON, T., "A Conceptual Scheme for Organizational Analysis", Administrative Science Quarterly, Vol.8, December 1963, pp.289-315.
- PUGH, D.S., HICKSON, D.J., HININGS, C.R., and TURNER, C., "Dimensions of Organization Structure", Administrative Science Quarterly, Vol.13, No.1, June 1968, pp.65-105.
- PUGH, D.S., HICKSON, D.J., HININGS, C.R., and TURNER, C., "The Context of Organization structures", Administrative Science Quarterly, Vol.14, No.1, March 1969, pp.91-114.
- RADNOR, M., RUBENSTEIN, A.H., and BEAN, A.S., "Integration and Utilization of Management Science Activities in Organizations", Operational Research Quarterly, Vol.19, No.2, March 1968.
- RESIDE, K.D., and SEITER, T.J., "The Evolution of an Integrated Data Base", Datamation, Vol.20, No.9, September 1974.
- RETTUS, R.C., and SMITH, R.A., "Accounting Control of Data Processing", IBM Systems Journal, Vol.11, No.1, 1972, pp.74-92.
- RITTI, R.R., and GOLDNER, F.H., "Professional Pluralism in an Industrial Organization", Management Science, Vol.16, No.4, December 1969.



- RIVETT, B.H.P., "A Survey of Operational Research in British Industry", Operational Research Quarterly, Vol.10, No.4, December 1959.
- ROBINSON, L.A., and ALEXANDER, M.G., "Are Accountants Adjusting to Change?", Management Accounting (N.A.A.), Vol.LIII, No.5, November 1971.
- ROMNEY, A.K. et al (eds.), "Multidimensional Scaling - Theory and Applications in the Behavioural Sciences", Vol.II - Applications, Seminar Press, New York and London, 1972.
- ROY, R.H., and McNEILL, J.H., "Horizons for a Profession - The Common Body of Knowledge for Certified Public Accountants", AICPA, New York, 1967.
- RUNKEL, P.J., and McGRATH, J.E., "Research on Human Behaviour - A Systematic Guide to Method", Holt, Rinehart and Winston, Inc., New York, 1972.
- SARJEANT, J.A., "Changing Role of Management Accounting for Industry - I Accounting and Management Information", Cost and Management, Vol.44, November-December 1970, pp.5-8.
- SARJEANT, J.A., "Changing Role of Management Accounting for Industry - II Accounting, Mathematics and Computers", Cost and Management, Vol.45, January-February 1971, pp.13-16.
- SCHLOSSER, R.E., "Psychology for the Systems Analyst", Management Services, Vol.1, No.5, November-December 1964, pp.29-36.
- SCHODERBEK, P.P., and BABCOCK, J.D., "The Proper Placement of Computers: Organizational Location Affects Efficiency", Business Horizons, October 1969, pp.35-42.
- SCHUBERT, R.F., "Directions in Data Base Management Technology", Datamation, Vol.20, No.9, September 1974.
- SCHUSSEL, G., "Business E.D.P. Moves to Data Bases", Business Horizons, Vol.15, No.6, December 1972, pp.73-85.
- SCHMIDT, S.M., and KOCHAN, T.A., "Conflict: Toward Conceptual Clarity", Administrative Science Quarterly, Vol.17, 1972, pp.359-370.
- SEASHORE, S.E., and YUCHTMAN, E., "Factorial Analysis of Organizational Performance", Administrative Science Quarterly, Vol.12, December 1967, pp.377-395.
- SEILER, J.A., "Systems Analysis in Organizational Behaviour", Richard D. Irwin, Inc., and the Dorsey Press, Homewood, Illinois, 1967.
- SELLTIZ, Claire et al, "Research Methods in Social Relations", Holt, Rinehart and Winston, Rev.Ed., 1959.



- SHANNON, C., and WEAVER, W., "The Mathematical Theory of Communication", University of Illinois Press, Urbana, Illinois, 1949.
- SHEPARD, R.N., ROMNEY, A.K., and NERLOVE, Sara B., (eds.), "Multidimensional Scaling Theory and Applications in the Behavioural Sciences", Volume 1 - "Theory", Seminar Press, New York and London, 1972.
- SHERIF, M., and SHERIF, Carolyn, "An Outline of Social Psychology", Harper and Row, New York, rev.ed., 1956.
- SHERIF, M., and SHERIF, Carolyn, "Superordinate Goals in the Reduction of Intergroup Conflict", American Journal of Sociology, January 1958.
- SIMON, H.A., "On the Concept of Organizational Goal", Administrative Science Quarterly, Vol.9, No.1, June 1964, pp.1-22.
- SIMON, H.A., "The Shape of Automation for Men and Management", Harper and Row, Publishers, New York, 1965.
- SIMON, L., "Interview with John Dessauer" - The Bulletin - The Bulletin of the Institute of Management Sciences, Vol.1, No.1, November 1970.
- SISSON, R.L., "Simulation: Uses", in Aronofsky, J.S., (ed.), "Progress in Operations Research - Relationship between Operations Research and the Computer", Vol.III, John Wiley & Sons, Inc., New York, 1969.
- SIZER, J., "The Accountant's Contribution to Operational Research", OMEGA, Vol.1, No.4, 1973, pp.411-42.
- SMYTHE, Clare, "The Ledger's Just for Burning", Data Systems, November 1973, pp.8-10.
- SOLOMONS, D., with BERRIDGE, T.M., "Prospectus for a Profession - The Report of the Long Range Enquiry into Education and Training for the Accountancy Profession", Gee & Co. (Publishers) Ltd., London, 1974.
- STAMP, E., "Accounting Principles and Management Accountants", Management Accounting, (ICMA), Vol.49, May 1971.
- STERN, H., "Management Information System - What it is and why", Management Science, Vol.17, No.2, October 1970.
- STEVENS, S.S., "Ratio Scales of Opinion" in: WHILTA, D.K., (ed.), "Handbook of Measurement and Assessment in Behavioural Sciences", Addison-Wesley Publishing Co., 1968, pp.171-199.
- STEWART, Rosemary, "How Computers Affect Management", Pan Books Ltd., London, 1971.
- STOGBILL, R.M., "Brief Report: Some Possible Uses of Factor Analysis in Multivariate Studies", Multivariate Behavioural Research, Vol.1, No.3, July 1966, pp.387-389.



- SYMONDS, G.H., "The Institute of Management Science: Progress Report", Management Science, Vol.3, No.2, January 1957, pp.117-130.
- SWEENEY, R.B., "An Inquiry into the Use of Mathematical Models to Facilitate the Analysis and Interpretation of Cost Data", Ph.D. Dissertation, The University of Texas, 1960.
- TAGGART, W.M., "A Syntactical Approach to Management Information Requirements Analysis", Dissertation Abstracts International, Vol.32, 1972, p.6615-A.
- TAYLOR, D.W., "Decision Making and Problem Solving" in: MARCH, J.G., (ed.), "Handbook of Organizations", Rand McNally & Company, Chicago, 1965, pp.48-86.
- TAYLOR, J.W., and DEAN, N.J., "Managing to Manage the Computer", Harvard Business Review, Vol.44, No.5, September-October 1966, pp.98-110.
- TERNINKO, J., "Application of Operations Research: Current Trends", Dissertation Abstracts, Vol.29A, 1968-1969.
- TERREBERRY, Shirley, "The Evolution of Organizational Environments", Administrative Science Quarterly, Vol.12, No.4, March 1968, pp.590-613.
- TESTA, C.J., "Behavioural Factors in Information Systems", Computers and People, Vol.23, No.4, April 1974, pp.13-17.
- THOMPSON, J.D., "Organizations in Action", McGraw-Hill Book Company, New York, 1967.
- TOMLINSON, R.C., "OR Is", Operational Research Quarterly, Vol.25, No.3, September 1974, pp.347-360.
- TRINE, J.A., "An Inquiry into the Nature of Accounting, the Nature of Management Science and their Relationship", Dissertation Abstracts International - A, Vol.30, No.3, September 1969, p.865A.
- UPSHAW, H.S., "Attitude Measurement" in: BLALOCK, H.M., Jr., and BLALOCK, Ann B., (eds.), "Methodology in Social Research", McGraw-Hill Book Company, New York, 1968, pp.60-111.
- VATTER, W.J., "The Use of Operations Research in American Companies", The Accounting Review, Vol.42, No.4, October 1967, pp.721-730.
- VOLIMER, H.M., and MILLS, D.L., (eds.), "Professionalization", Prentice-Hall, Inc., Englewood Cliffs, New Jersey, 1966, p.2.

- VON BERTALANFFY, L., "The Theory of Open Systems in Physics and Biology", Science, January 13, 1950, pp.23-29.
- VON BERTALANFFY, L., "General Systems Theory", George Braziller, 1968.
- VROOM, V.H., "Work and Motivation", John Wiley & Sons, New York, 1964.
- WAGNER, H.M., "Principles of Operations Research - with Applications to Managerial Decisions", Prentice-Hall, Inc., Englewood Cliffs, New Jersey, 1969.
- WAGNER, H.M., "The ABC's of OR", Operations Research, Vol.19, Part 2, October 1971, pp.1259-1281.
- WALTON, R.E., and DUTTON, J.M., "The Management of Inter-departmental Conflict: A Model and Review", Administrative Science Quarterly, Vol.14, 1969, pp.73-84.
- WANTY, J., "Operational Research and Management", Operational Research Quarterly, Vol.11, Nos.1/2, March June 1960, (Translated by A.W.Swan).
- WEINBERG, G.M., "The Psychology of Computer Programming", Van Nostrand Reinhold Co., 1971.
- WHISLER, T.L., "The Impact of Computers on Organizations", Praeger, New York, 1970.
- WILLIAMS, T.H., and GRIFFIN, C.H., "The Mathematical Dimension of Accountancy", South-Western Publishing Co., Cincinnati, 1964.
- WILLIAMS, T.H., and GRIFFIN, C.H., "Management Information - A Quantitative Accent", Richard D. Irwin, Inc., Homewood, Illinois, 1967.
- WITHINGTON, F.G., "What Will the Next Generation of large Computers be like?", Canadian Data Systems, June 1974, pp.25-27. (1974-a).
- WITHINGTON, F.G., "Five Generations of Computers", Harvard Business Review, Vol.52, No.4, July August 1974, pp.99-108. (1974-b).
- WOLMAN, B.B., (ed.), "Dictionary of Behavioral Science", Van Nostrand Reinhold Company, New York, 1973.
- ZALKIND, S.S. and COSTELLO, T.W., "Perception: Some Recent Research and Implications for Administration", Administrative Science Quarterly, Vol.7, No.2, September 1962, pp.218-235.
- ZEPFERBERG, H.L., "On Theory and Verification in Sociology", The Bedminster Press, 3rd enlarged ed., 1965.