

Murmeration

For tenor saxophone & live electronics

Kier Hall

Murmeration

for tenor saxophone and live electronics

Duration: c. 17 minutes

Equipment Required

Microphone

MIDI footswitch (or TRS footswitch with adapter; see below)

Computer with Pure Data (vanilla) installed.

Murmeration electronic resource folder. This includes the patch and supporting files.

Pure Data will require the following extensions: list-abs, maxlib, cyclone and freeverb.

Note: this patch uses 5.1 surround sound and therefore the computer's sound card will require 5.1 output. The patch will automatically route the output spatially as required. PD settings may need to be checked to include support for DAC channels 1 to 6.

MIDI Information

The patch requires one MIDI note to be pressed multiple times throughout the performance via a footswitch interface. This can be in the form of a MIDI controller footswitch or a more commonly found 'sustain pedal' (non-latching) footswitch with TRS connector which can be connected using a footswitch-to-MIDI adapter.

Note: the patch is configured to detect any MIDI channel and any note in order to trigger events so there is no further configuration required when setting up the controller.

Preparation

Load *murmeration.pd*.

Go to Preferences > MIDI and select the MIDI controller in Input Devices.

Enable audio processing (DSP on) in PD.

Press the footswitch to start the performance.

Note: the microphone signal should also be directly routed to the speakers so there is an equal balance between the unmanipulated saxophone sound and the sound of the patch.

Improvisation & Notation

Performing this piece requires a basic understanding of tonal improvisation, chord symbols and terminology found in jazz.



This symbol instructs the performer to press and release the footswitch once.



This notation describes this section as lasting approximately twenty seconds

Murmeration

Kier Hall

Air sound, fluctuating in timbre and volume

rec. 

20 7 20

Add key clicks to air sound. Play faintly-audible chromatic runs.

rec. 

20 15 20

$\text{♩} = 60$

mf mf

sporadic tongue slap

p fff

20 2

$\text{♩} = 60$

$\text{♩} = 140$

Delay effect of semiquavers. Attempt to play in time with patch-controlled rubato.

rec. 

molto accel.

accel. rit.

fffp < f pp fff mp mp mf p < f p < ff fff p f

fpp f 6 pp mp p fff ppp 6 p f ppp f ppp

rec. 

Sounds from the opening slowly return

mp f p 3 mf p f fff fff pp

6 7 f 3 p 6 mf cresc. 3

rec. 

Chord of B \flat Δ starts here

fff

B \flat Δ G 7 C 7 C 7

Improvise over chord changes to Donna Lee. Press pedal to advance to the next chord. Start slowly like a ballad and build up to a hard-bop frenzy. The first chord is already sounding. The section should last approx. four minutes.

B7(#11) B \flat Δ F-7 E 7 | E \flat Δ | E \flat -7 | B \flat Δ | G 7 | C 7 | C-7 | F 7 | B \flat Δ | G 7 | C 7 | D 7 | G-7 | D 7 | G- | B \flat $^\circ$ | B \flat Δ | G 7 | C-7 | F 7 | B \flat Δ |

Trade short solos with the patch.
Play this repeated section a total of eight times.

Musical notation for a repeated section. It consists of three measures, each with a solo cell icon above it. The first measure is labeled "Patch solo" and contains a whole note with a stem up and a slash through it. The second measure is labeled "Sax solo" and contains a whole note with a stem up and a slash through it. The third measure is labeled "Patch solo" and contains a whole note with a stem up and a slash through it. Below the notes are the numbers "5 - 10", "5 - 10", and "120" respectively, indicating the duration of each solo.

Play the contents of each cell as many times as you like. Start the section with long, sustained notes and advance to a chaotic frenzy by the end of the piece.

Five short musical phrases on staves, each consisting of a few notes with various accidentals (flats, sharps).

A row of ten musical phrases on staves, each consisting of a few notes with various accidentals.

A row of five musical phrases on staves, each consisting of a few notes with various accidentals.

A row of five musical phrases on staves, each consisting of a few notes with various accidentals.

Played as fast as possible

A long musical phrase in 4/4 time, starting with a *fff* dynamic marking. It consists of a series of notes with various accidentals, including a triplet of notes. The phrase ends with a fermata and a solo icon above the final note.

Appendix A: Patch Notes

Interface (a)

The interface for this patch provides all setup controls and information required to perform this piece. There isn't a requirement for the performer to see this interface but it is helpful for monitoring the patch if an engineer is available for the performance. Each subpatch has its own gain control (1) that has been preset to what I believe is a suitable level. However, there may be a requirement to adjust the gain level for different venues depending on their acoustic properties. The performer communicates with the patch via a footswitch MIDI controller. The footswitch makes the patch behave differently depending on when it is pressed during the piece. For example, the first press of the footswitch records a two-second sample of the performer playing air noise while the sixth press instructs the patch to play a sample of the saxophone keys clicking in reverse while varying the playback speed. An engineer operating the patch and following the score will be able to amend any accidental presses by either advancing the footswitch count manually (2) or by using subpatch s6 to choose the exact number of presses from which to resume the performance.

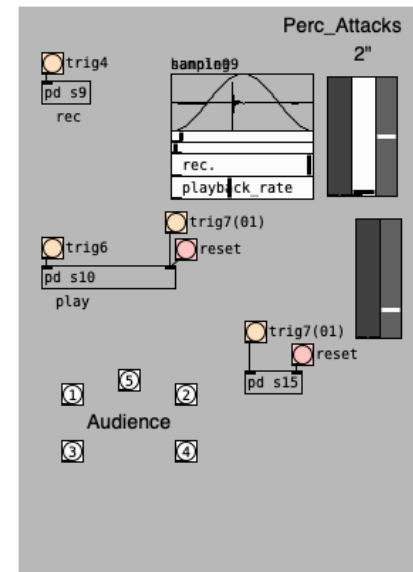
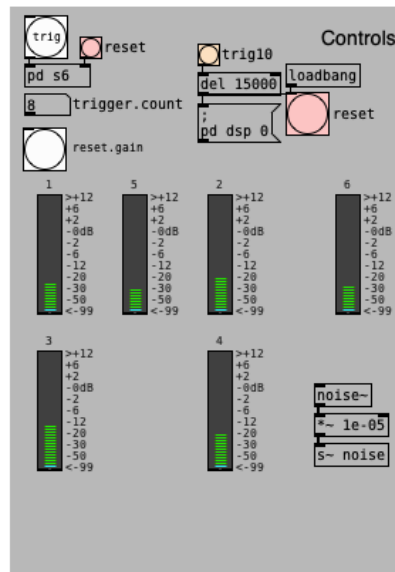
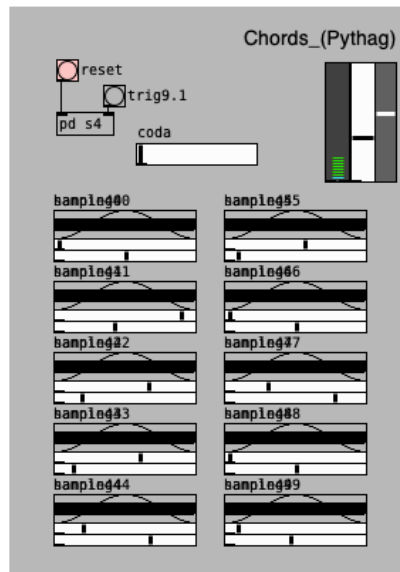
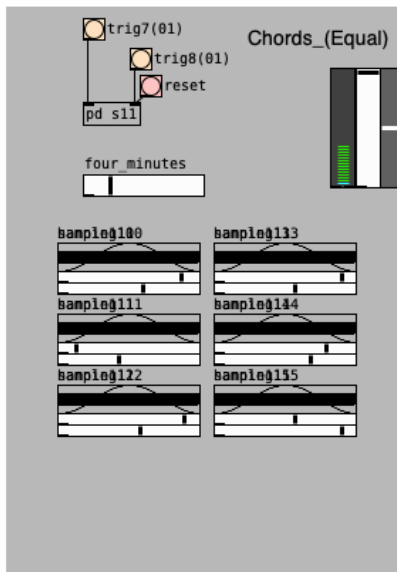
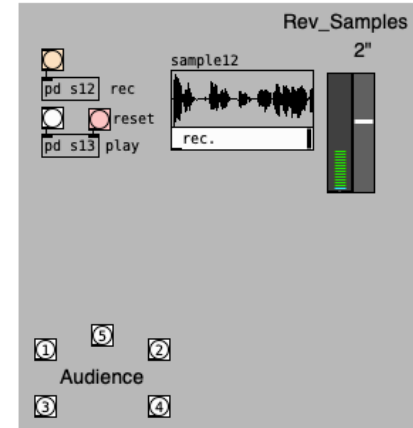
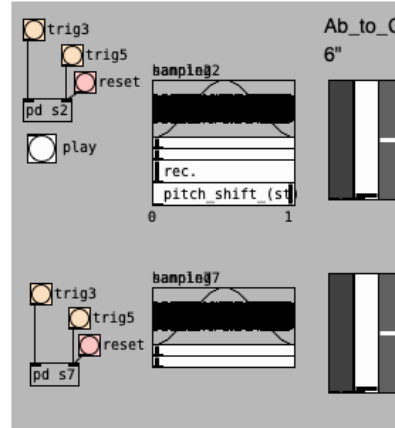
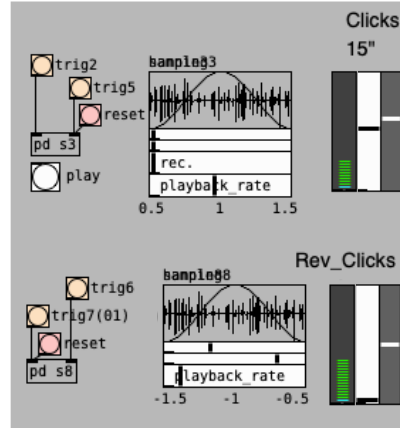
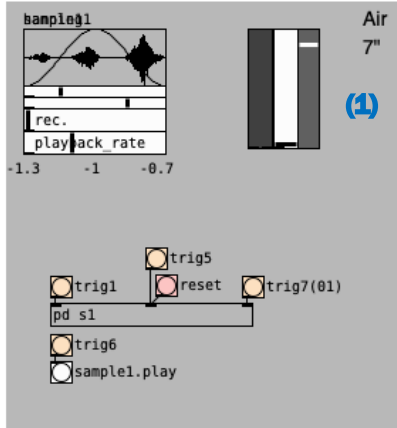

Interface (b)

Mic

The 'Mic' patcher interface features a vertical slider labeled 'Delay' with a scale from 130bpm to 160bpm. Below the slider is a sub-patcher 'pd s5' containing several trigger objects: trig9, trig7(01), trig5, reset, and trig10.

BD

The 'BD' patcher interface features a 'banpleg14' object with a graph showing a bell-shaped curve and a 'playback_rate' control with a scale from -1.5 to -0.5. A sub-patcher 'pd s14' contains trig9.1 and reset objects.

Rand._Samples

The 'Rand._Samples' patcher interface contains a grid of 16 sample triggers labeled sample16a through sample16p. Each trigger includes a 'rec.' object and a waveform display. A sub-patcher 'pd s17' contains trig7(01), trig9, trig8(01), and trig9.1 objects. A volume control slider is located on the right side.

Air_& Clicks_2.0

The 'Air_& Clicks_2.0' patcher interface features two 'playback_rate' controls with scales from -1.3 to -0.7 and -1.5 to -0.5. A sub-patcher 'pd s18' contains trig7(01), trig8(01), trig9, reset, and trig9.1 objects.

This patcher interface contains a sub-patcher 'pd s19' with trig9, trig9.1, and reset objects, and an 'r s19.fadeout' object.

S1

This subpatch, used at the very start of the piece, records a seven-second sample of the saxophonist blowing air through the instrument (1). After the sample is recorded it is played in reverse; the playback speed slowly fluctuating between 0.7 and 1.3 times the original speed (2). The playback of the sample is duplicated and the two waveforms are played half out of phase with one another (3). Combined with a fade in and out at the start and end of each waveform, this process creates a seamless loop that can be played indefinitely. The sound very slowly drifts between the left and right sides of the auditorium (4).

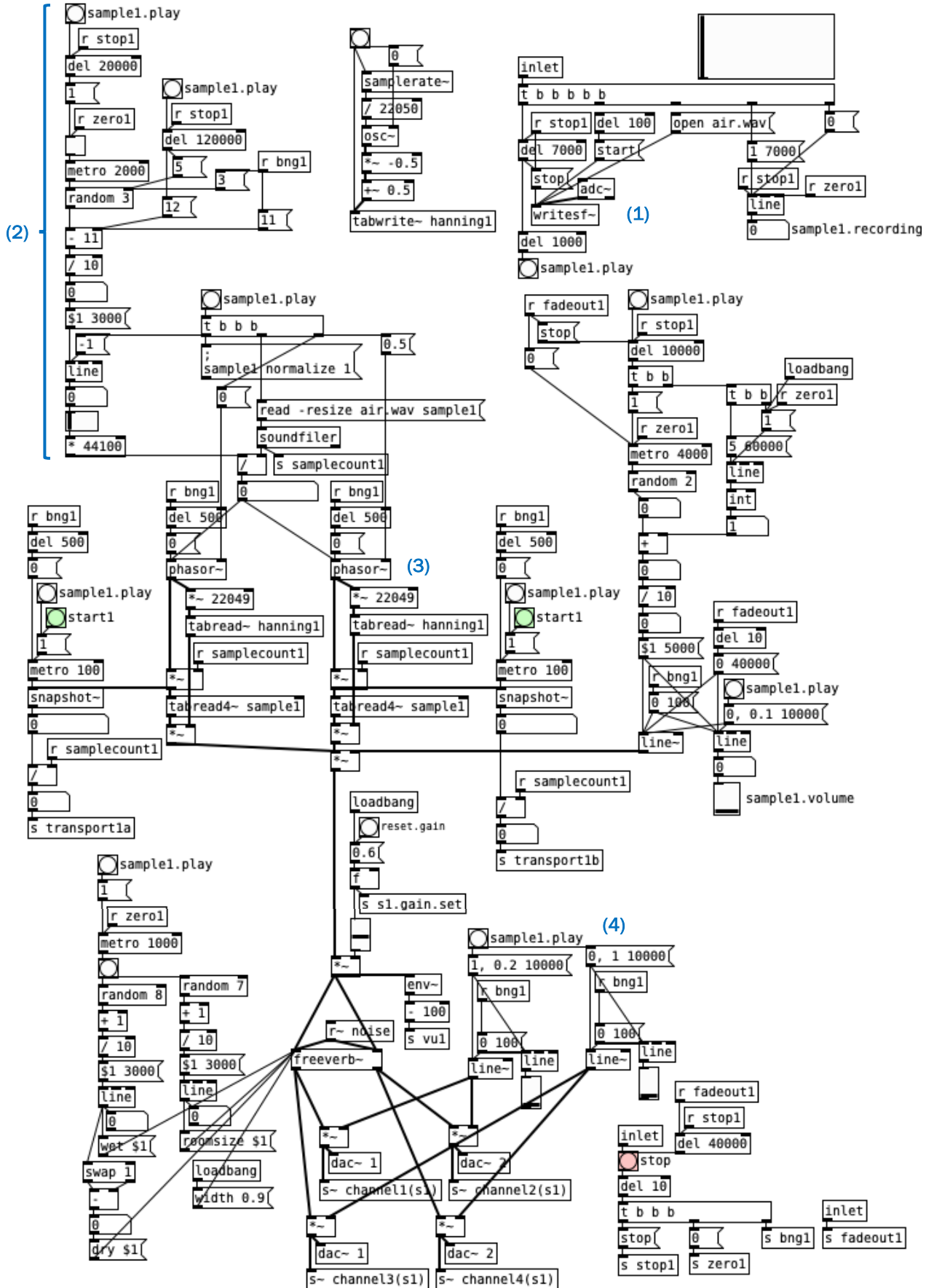

Key clicks are recorded for fifteen seconds (1) and played back in a continuous loop. The playback speed increasingly fluctuates as the section develops (2).

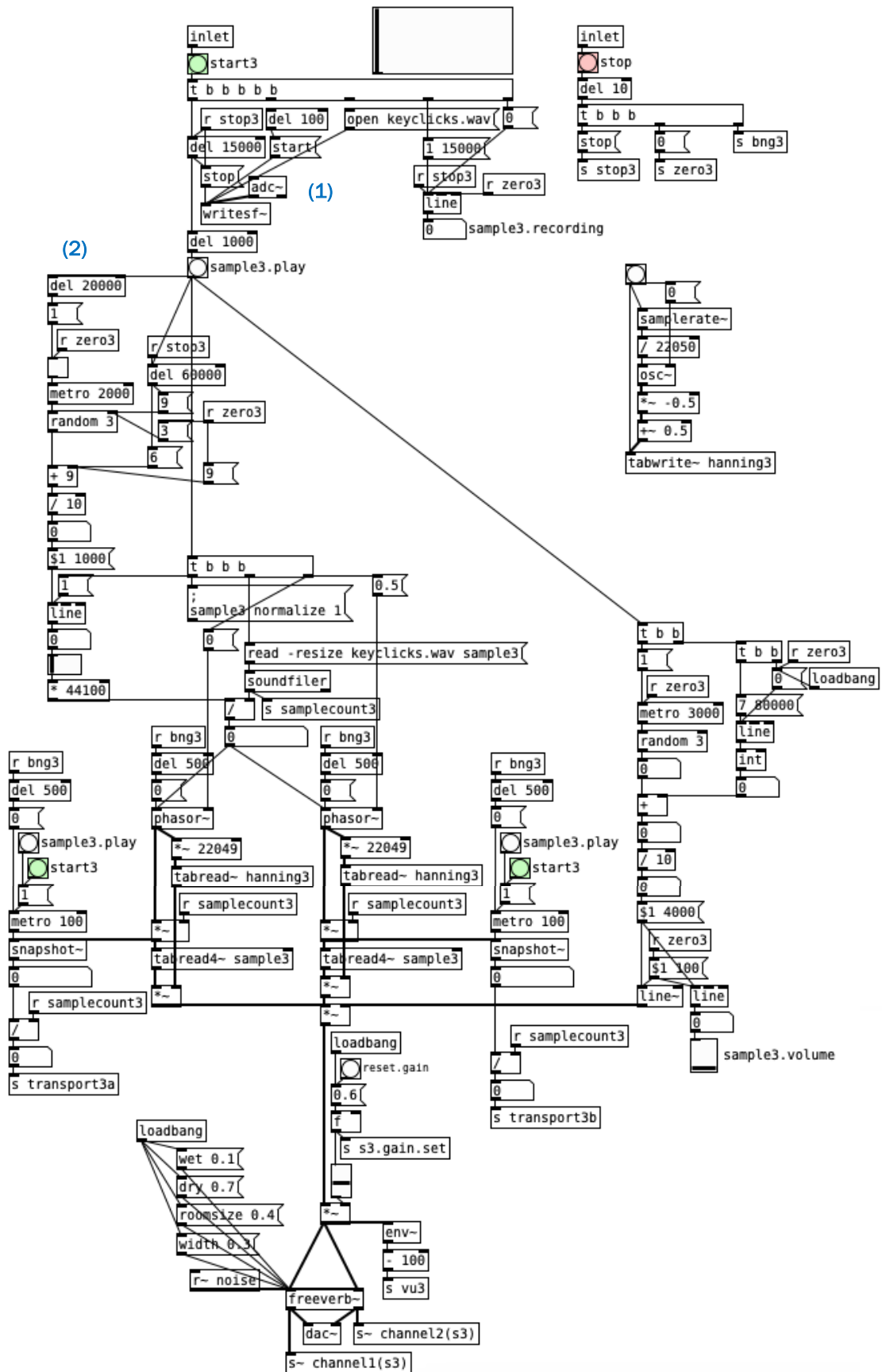

S2

This subpatch records the performer playing a sustained pitch for six seconds (1). Through changing the playback rate (and therefore pitch) of this sample it is used frequently throughout the piece to create a large set of pitches from both equal temperament and three limit Pythagorean tuning systems. In this subpatch the manipulation of the pitch is introduced subtly; the pitch slowly bends down a semitone over twenty seconds while the saxophone remains on the original pitch (2). As with S1, the sample is looped through playing a duplicate waveform half out of phase and fading both in and out at the start and end of their respective cycles (3).

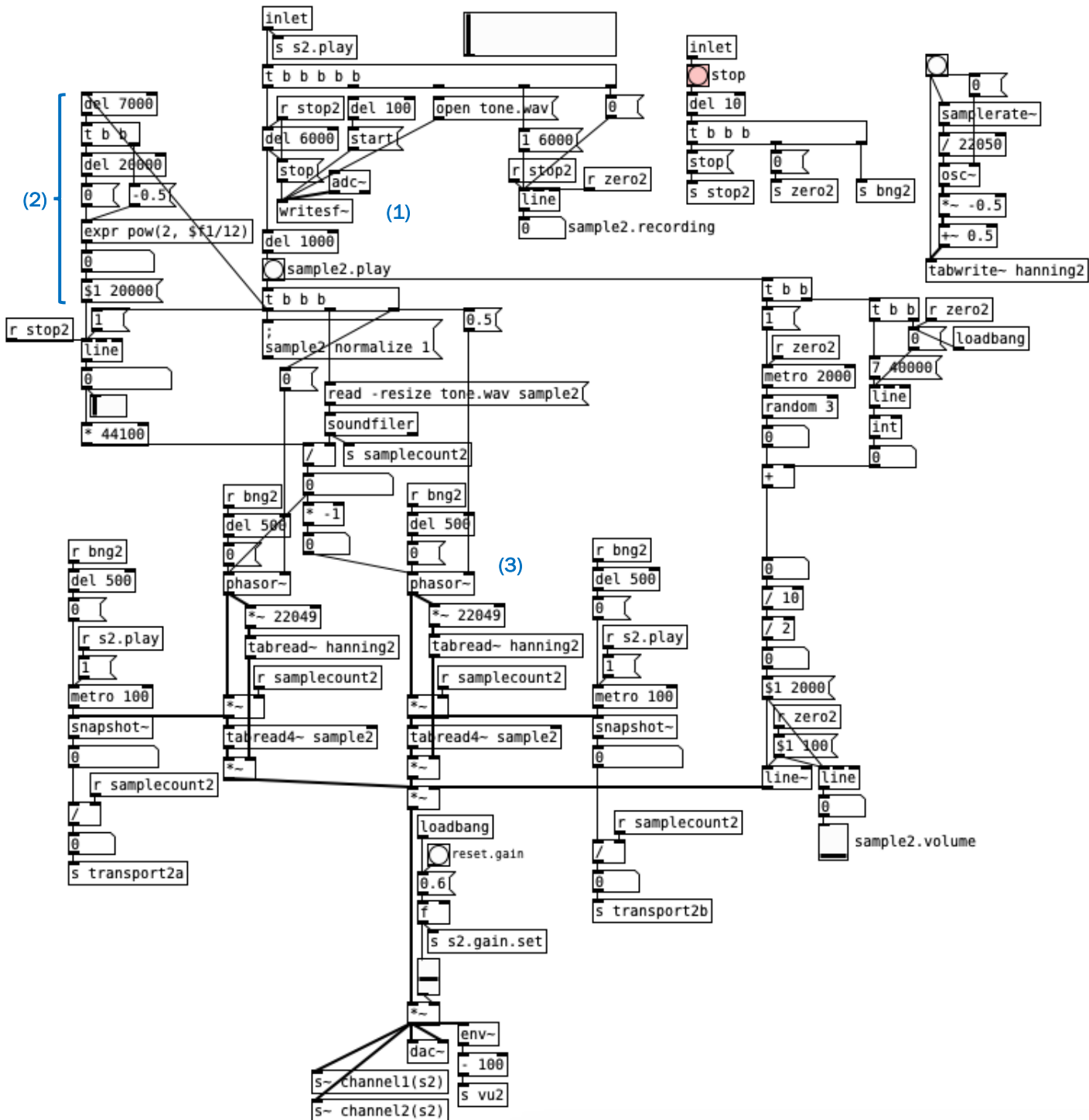

This subpatch records the tongue slap technique (1) and writes the sample to ten identical tables; two for each of the five speakers in the surround sound setup (2). These tables will be read in the following subpatch (S10).

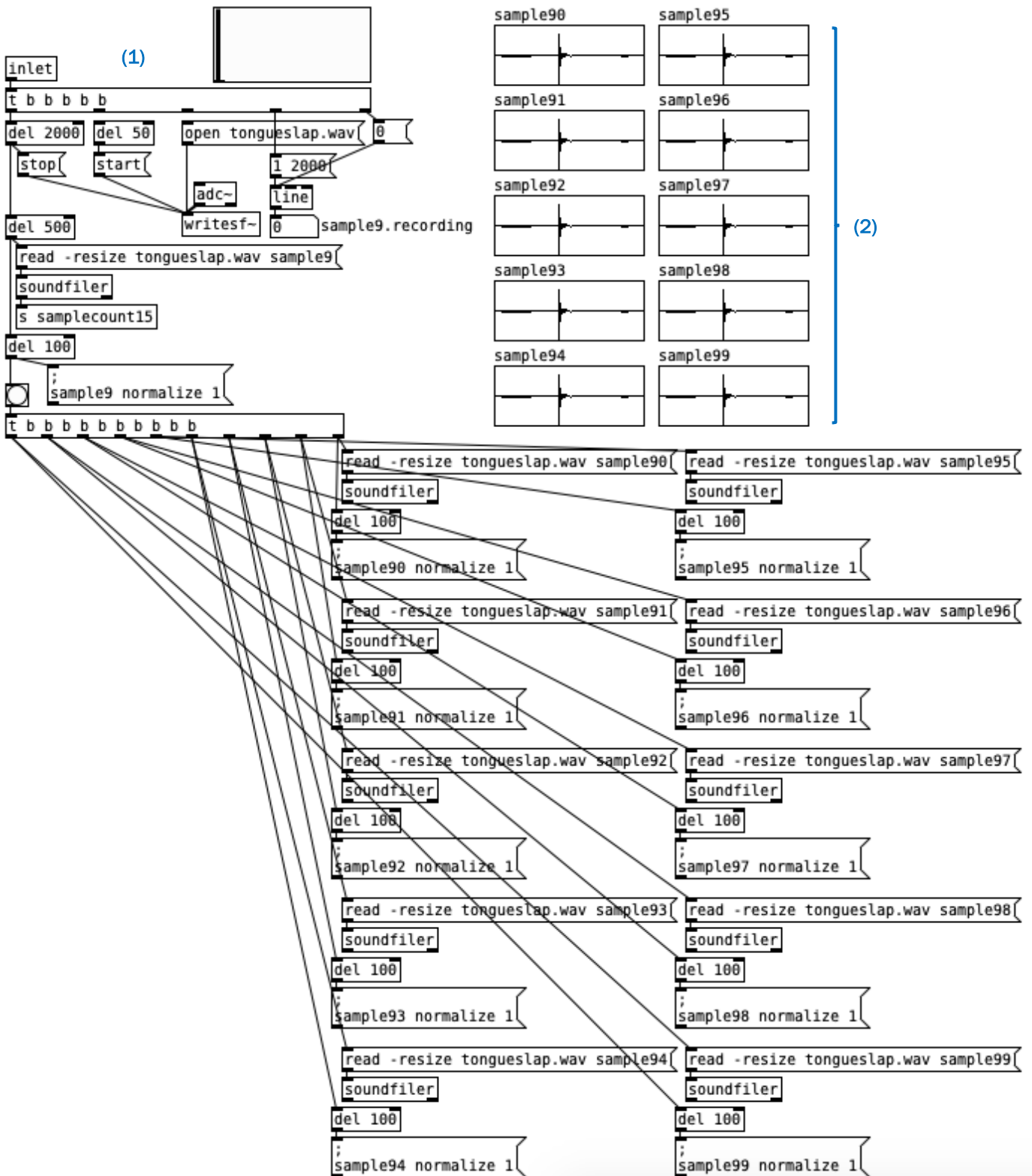

S10

By reading the tables in **S9**, this subpatch allocates two tongue slap samples to each channel (1). For example, the front left speaker uses tables *sample90* and *sample93* (2). The sample being played alternates between the two tables, ensuring the playback doesn't suddenly cut off should the channel replay the sample before the previous playback had finished. The effect of this subpatch is of the tongue slap, played in reverse, being subtly 'bounced' around the audience through random allocation of the speaker within the surround sound setup (3). Playback speed and reverb parameters are randomised, generating different pitches and acoustic effects.

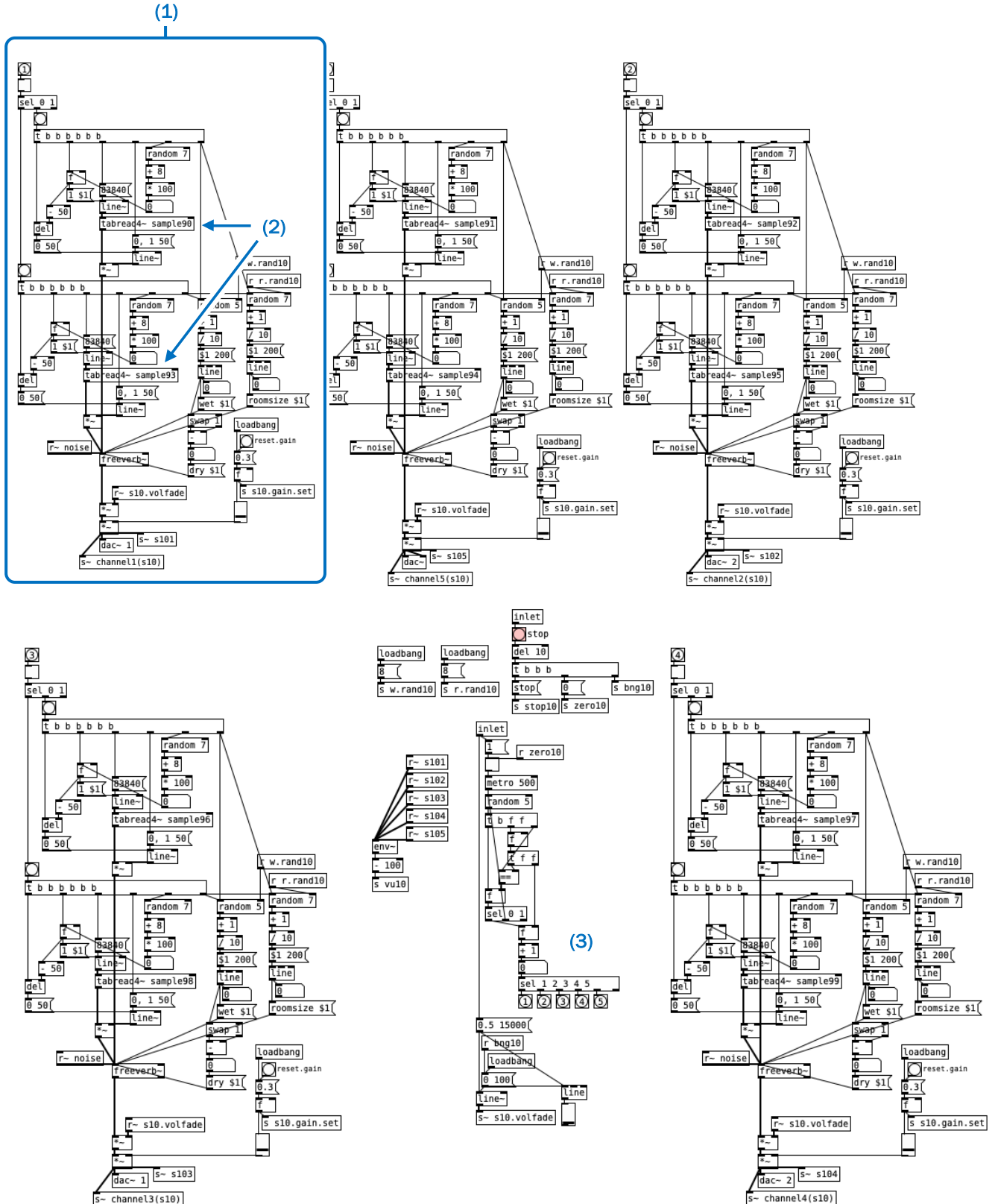

The key clicks sample, having been introduced in **S3**, is transformed further in this subpatch. The sample is reversed and looped, with greater fluctuations in playback speed (1). The sample also drifts between the left and right side of the auditorium (2).

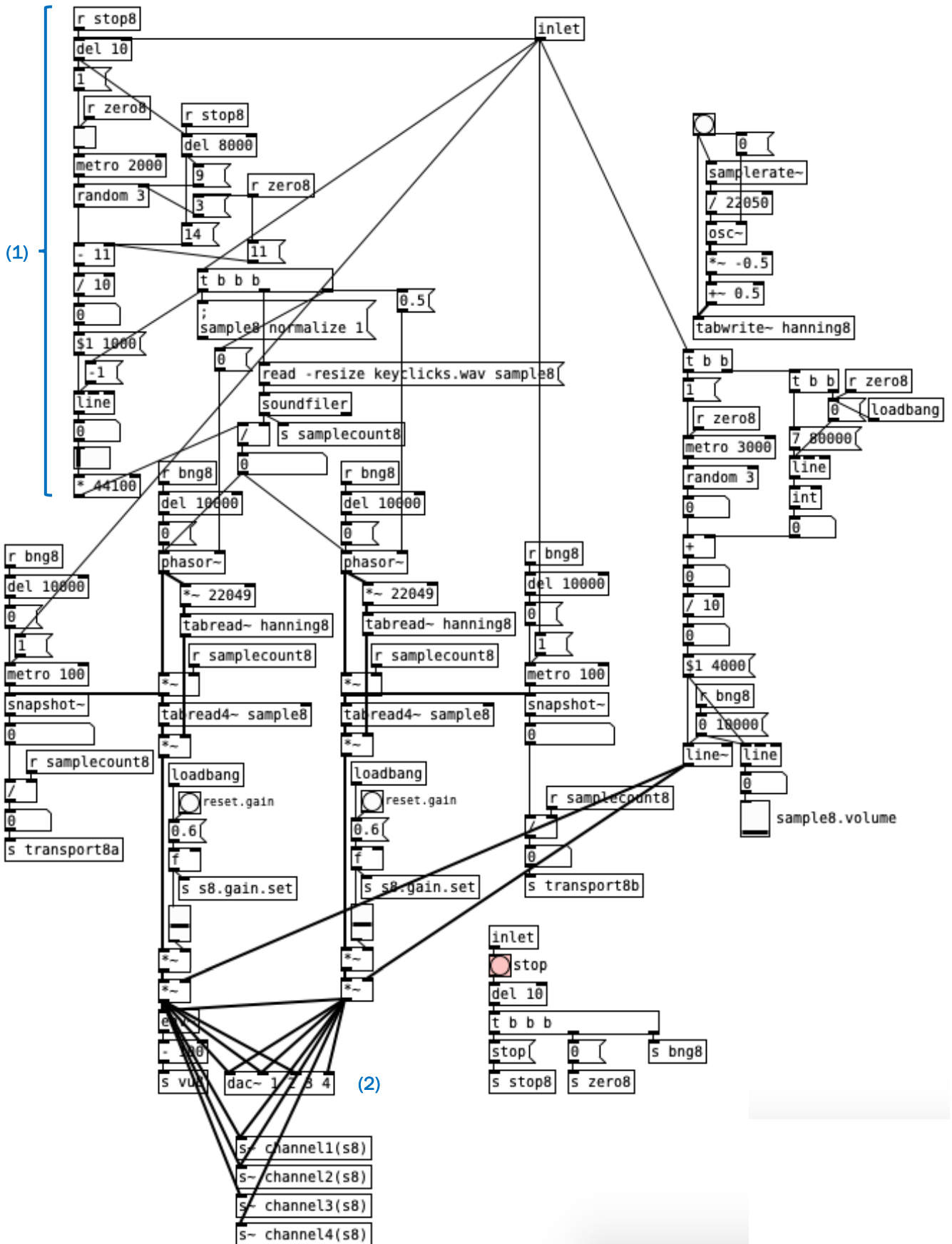

S15

This subpatch is used to bridge the chaotic frenzy of the first section to the ballad-like start of the second. The tongue slap sample played in reverse has a similar timbre to a closed hi-hat often used consistently on off-beats in jazz. This section starts with the reversed tongue slap sample initially played very quickly at a hard-bop tempo before gradually slowing and fading, introducing the ballad theme of the following section (1).

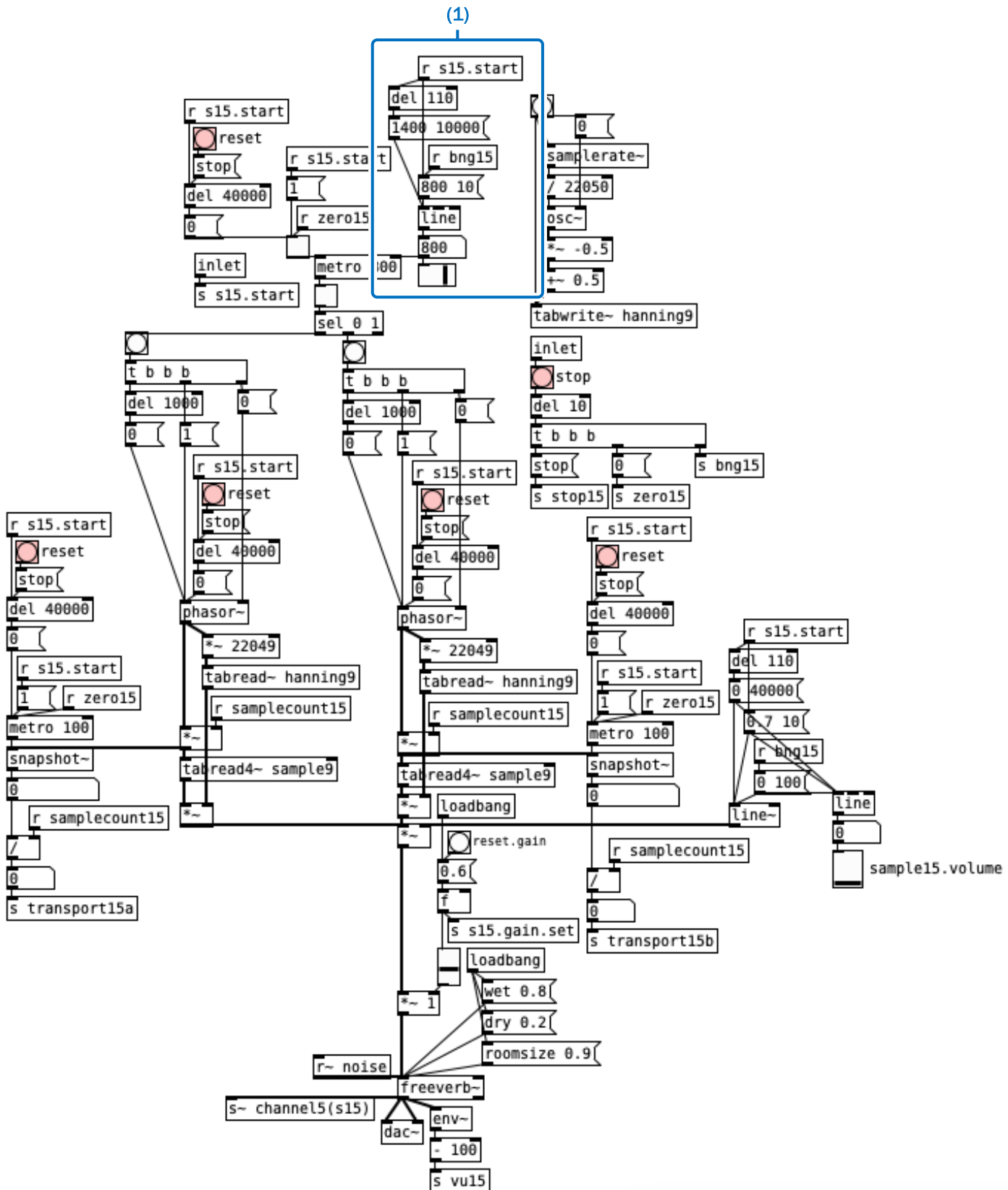

S16

Used throughout the chord-based improvised section, this subpatch automatically records sixteen phrases throughout the section. After a sample is recorded, a debounce time of approximately three seconds ensures all sixteen recording envelopes are not taken from the very start of the section but are instead distributed evenly throughout (1). Each sample is written to a table and stored to be used later in the piece (2). The sample length is randomly selected when the recording starts, ranging from a 400ms to a 1400ms sample (3).

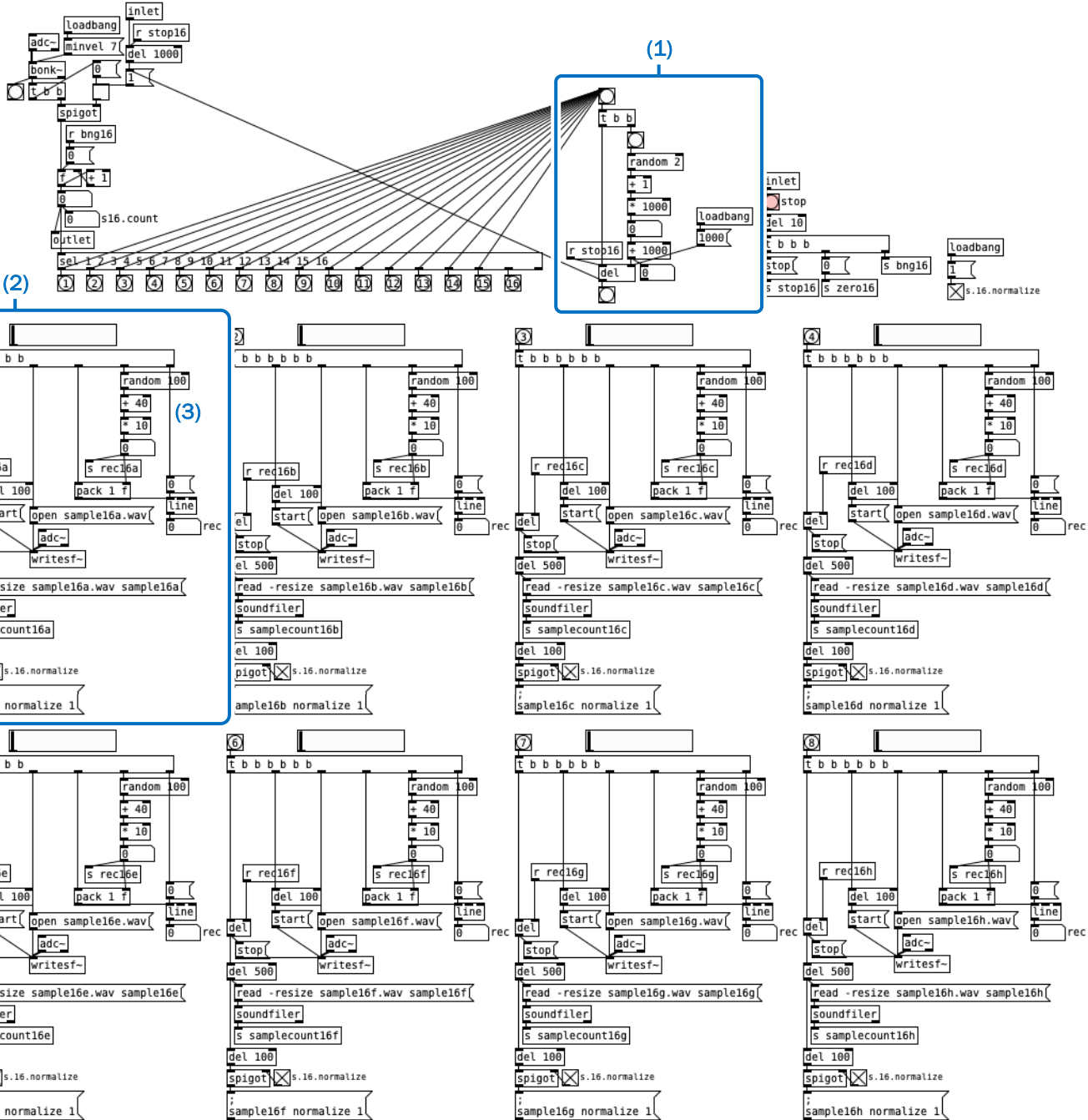

S16 (continued)

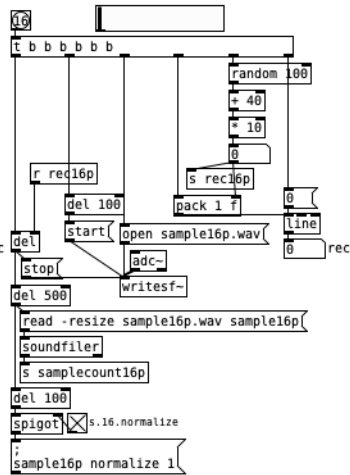
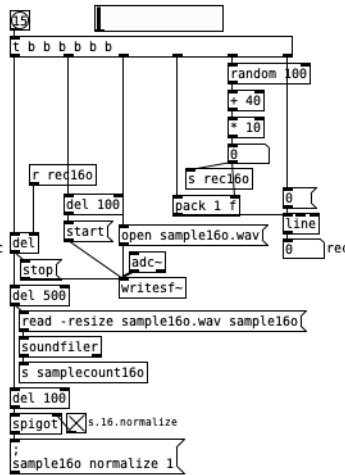
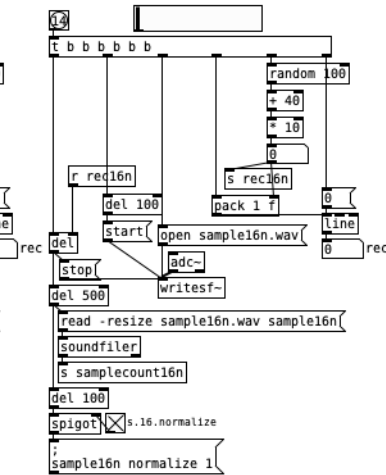
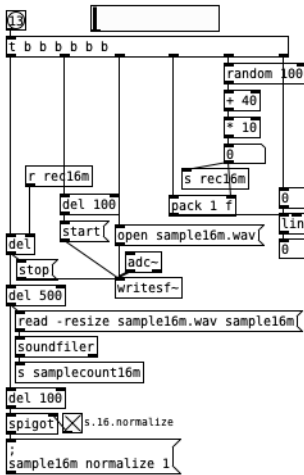
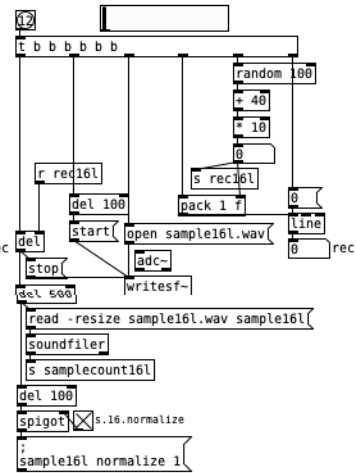
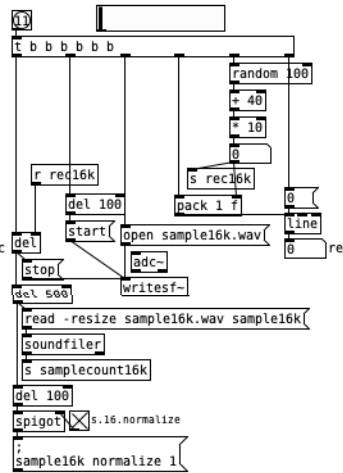
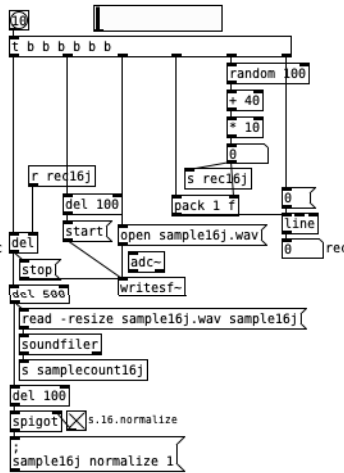
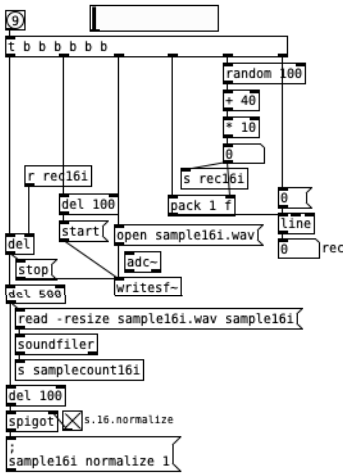

S18

Both the air noise and key click samples are used in this subpatch (1). The sound 'drifts' around the auditorium through random channel selection with the spatial distribution of sound becoming increasingly active and chaotic as the section develops (2).

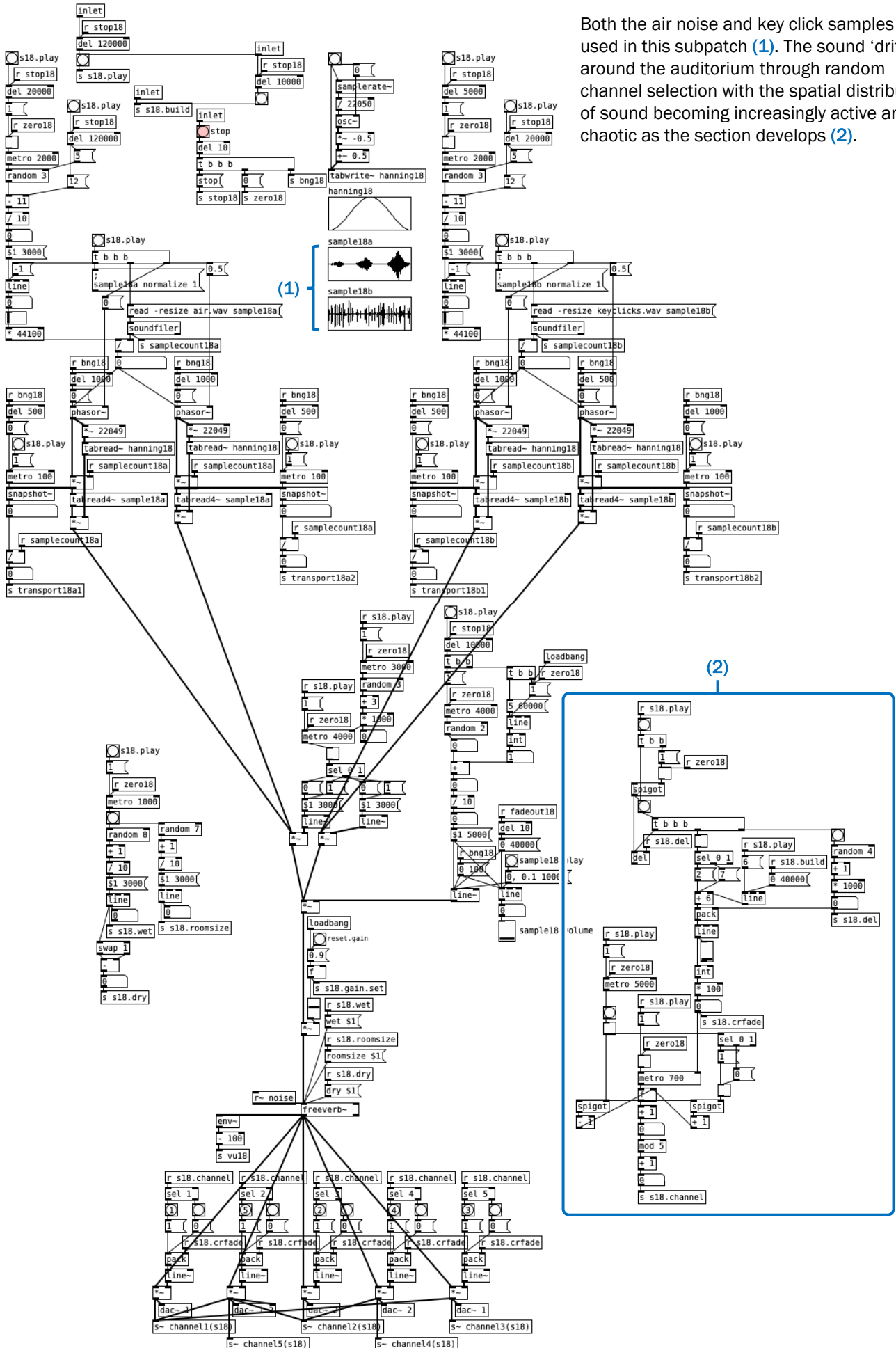

S11

This subpatch is used in the saxophone solo section to advance the chords the performer uses for improvisation. The performer controls the harmonic rhythm in this section through pressing the footswitch to advance the harmony through the chord changes to Donna Lee (1). Each chord has been voiced using five-part harmony with each part being routed to one of the five surround sound channels (2). The intention of designing the texture using this method means an audience member will more clearly hear one of the voices by virtue of being sat nearer one speaker. This will allow an audience member to hear the voice leading of their closest speaker and thus a melody that is more clearly heard by them than other audience members sat elsewhere in the auditorium, creating a unique experience for each member of the audience.

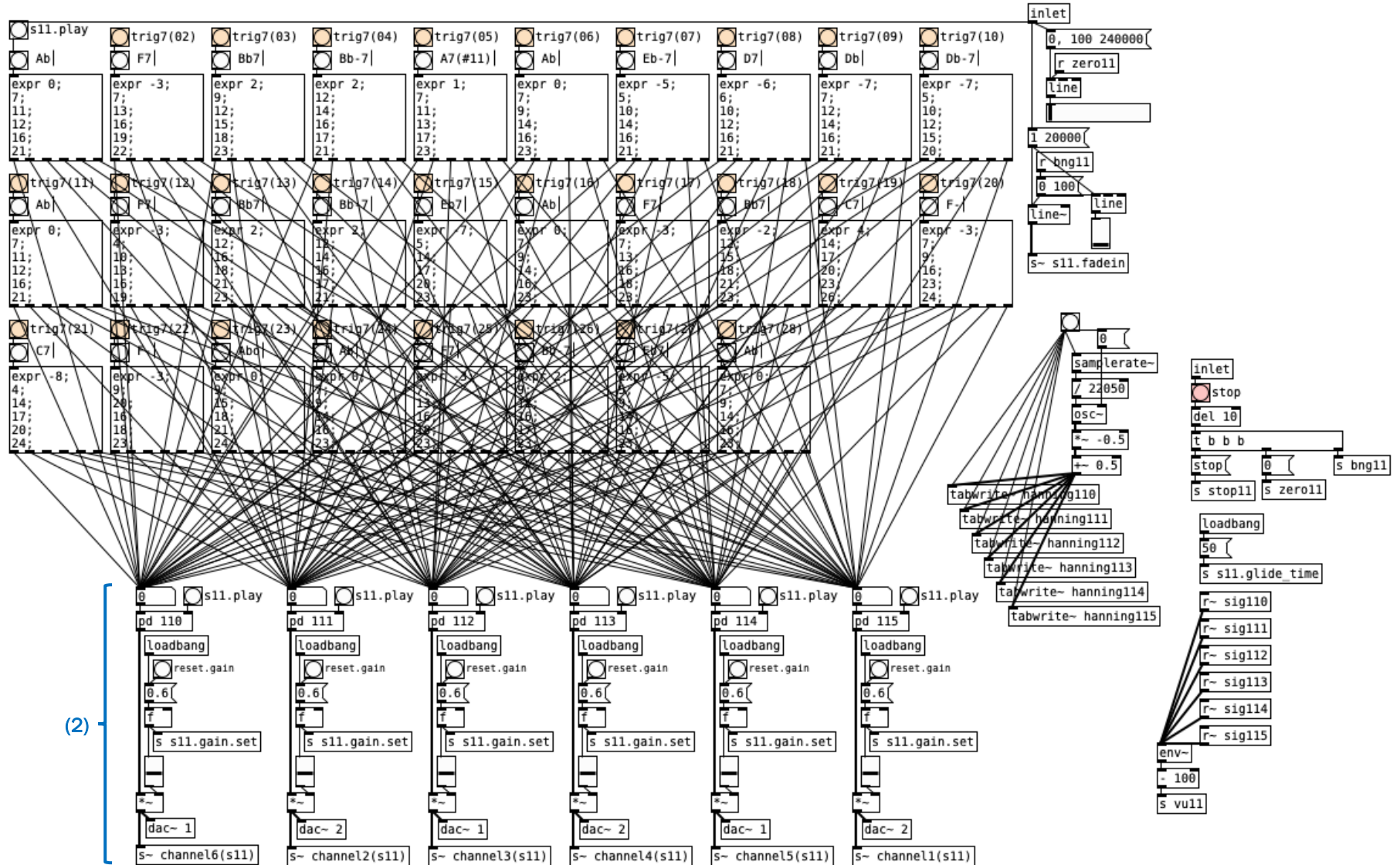

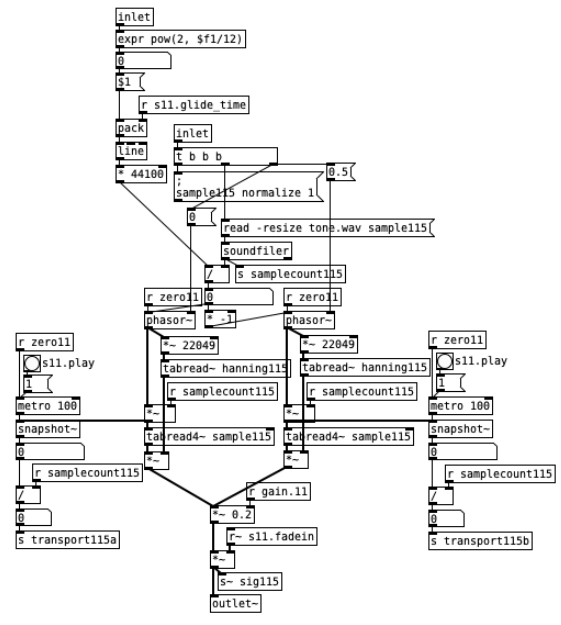
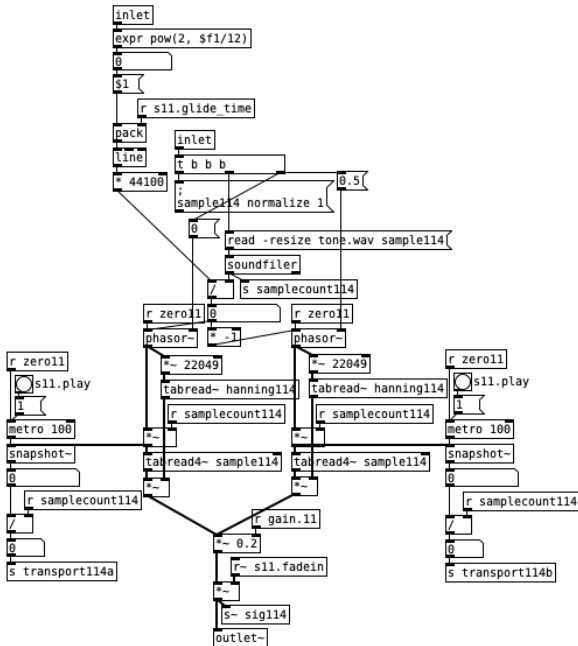
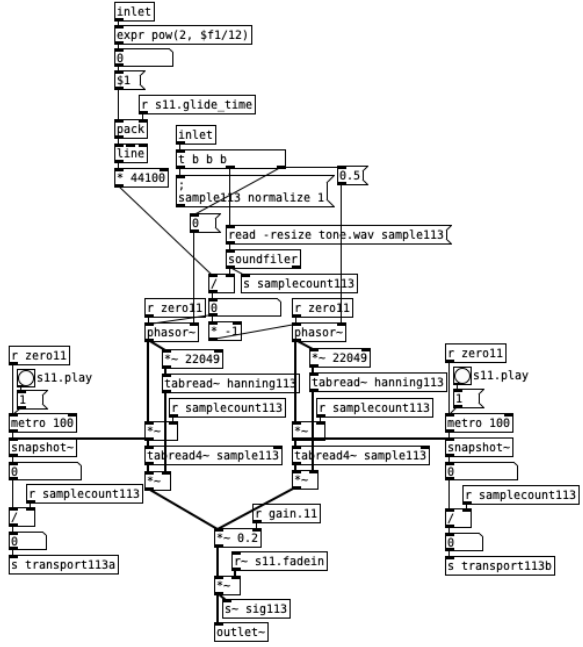
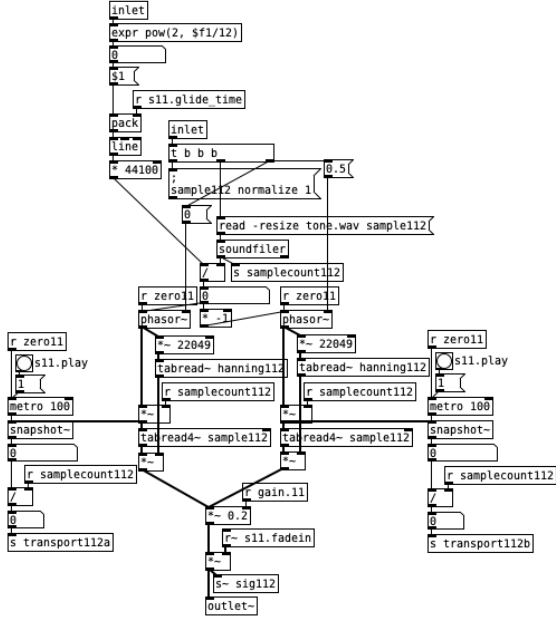
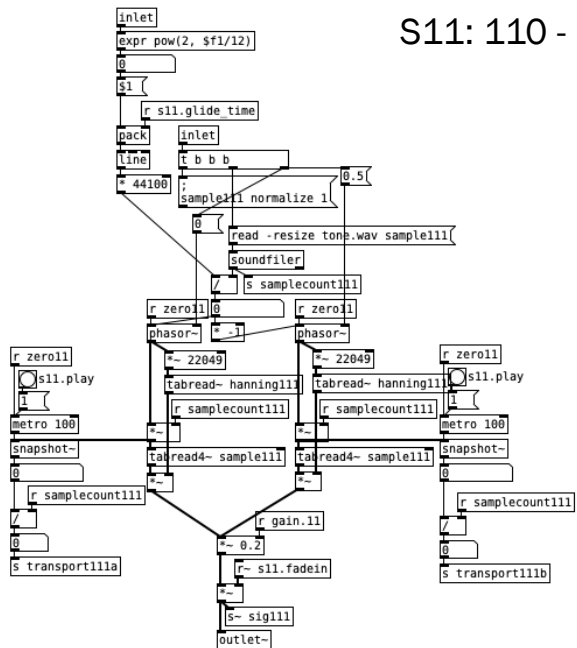
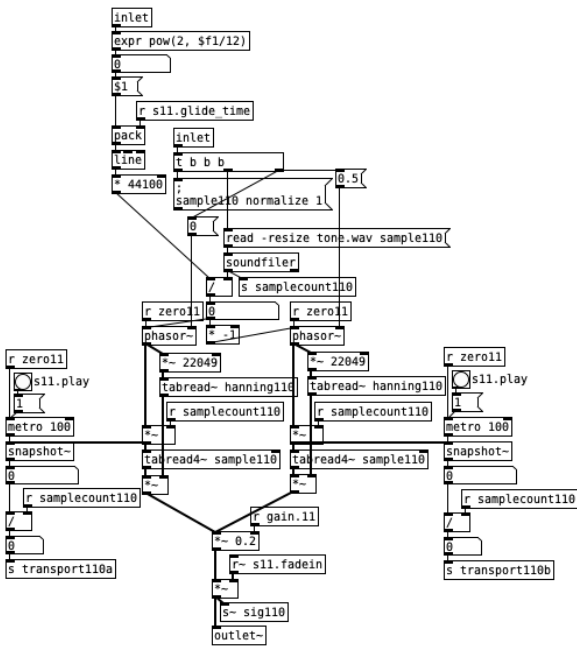

S17

This subpatch is used in the 'trading' section found at the top of the score's second page. Referencing 'trading fours' in jazz soloing, the performer and patch trade short solos between one other, each lasting five to ten seconds. The patch generates its solo material by stacking the sixteen samples recorded in **S16** in a random order (1). Any silence that is detected at the start or end of a sample is automatically removed, creating an endless string of phrases. The patch's solo is controlled by the footswitch, with each press either starting or stopping the improvisation. This subpatch is also used in the coda section, where the samples are played in reverse order with a greater sense of activity through increasingly modulating the phrase length (2), reverb parameters (3) and spatial distribution (4).

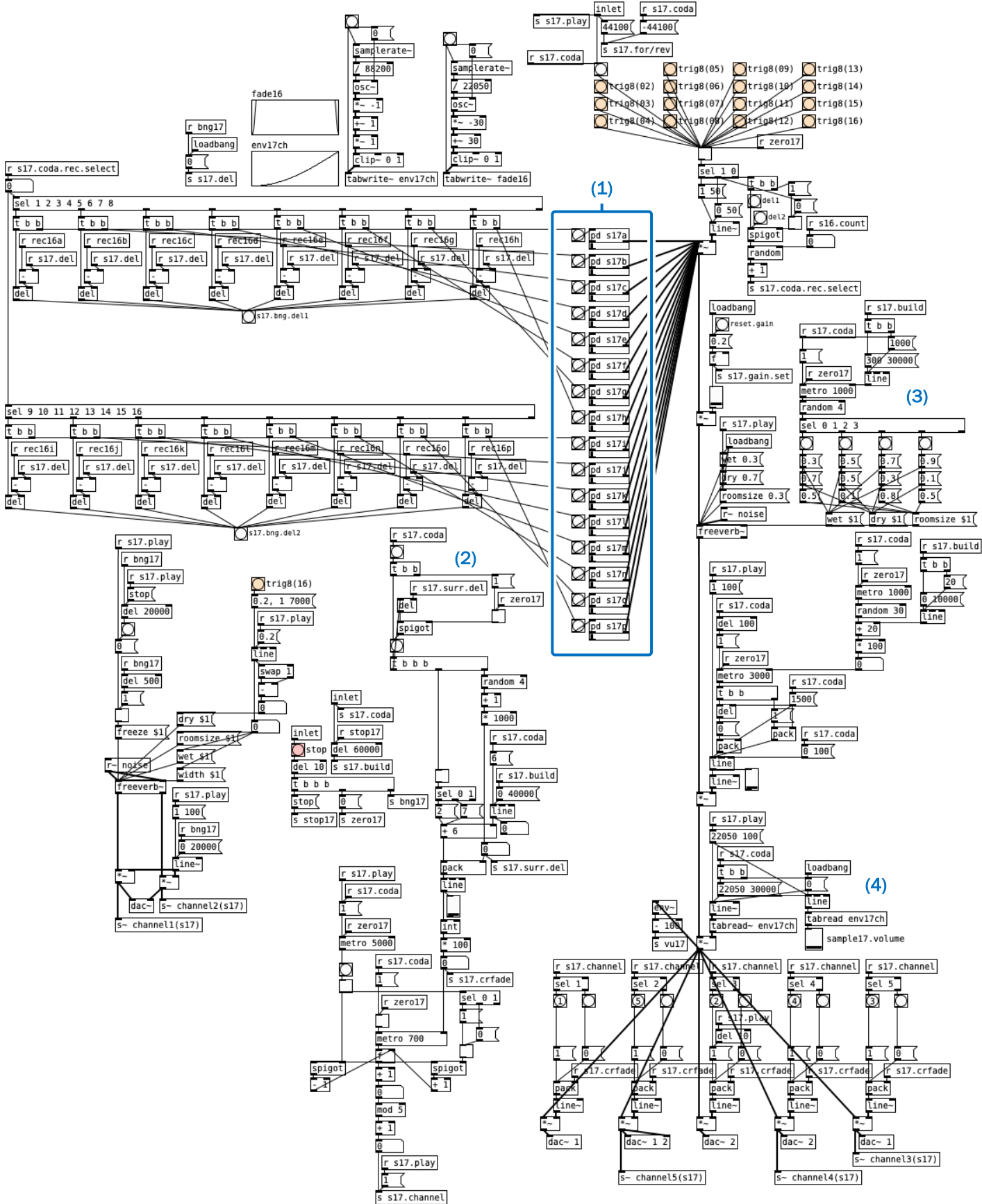

S17: S17a - S17g

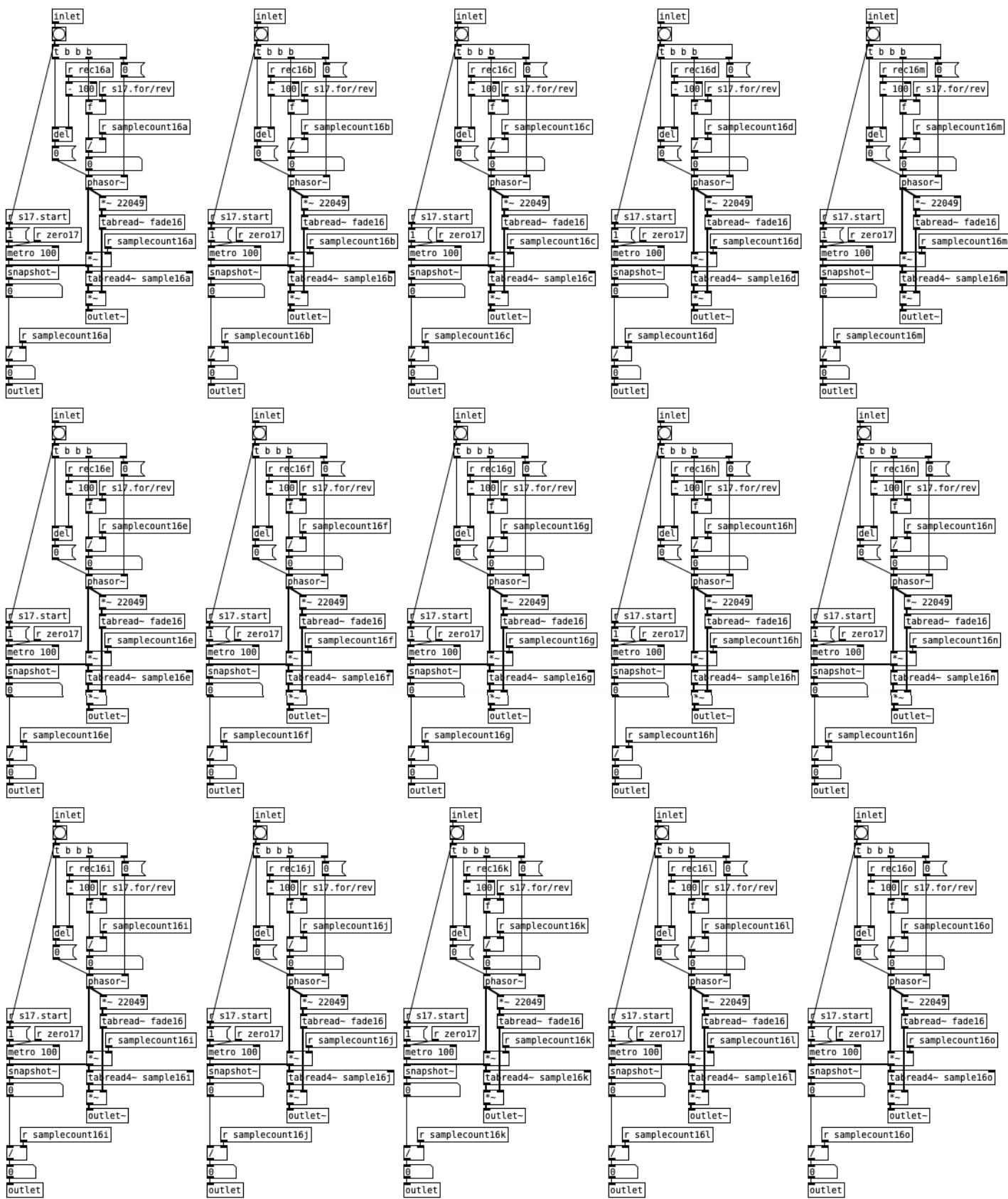

S19: S19a - S19f

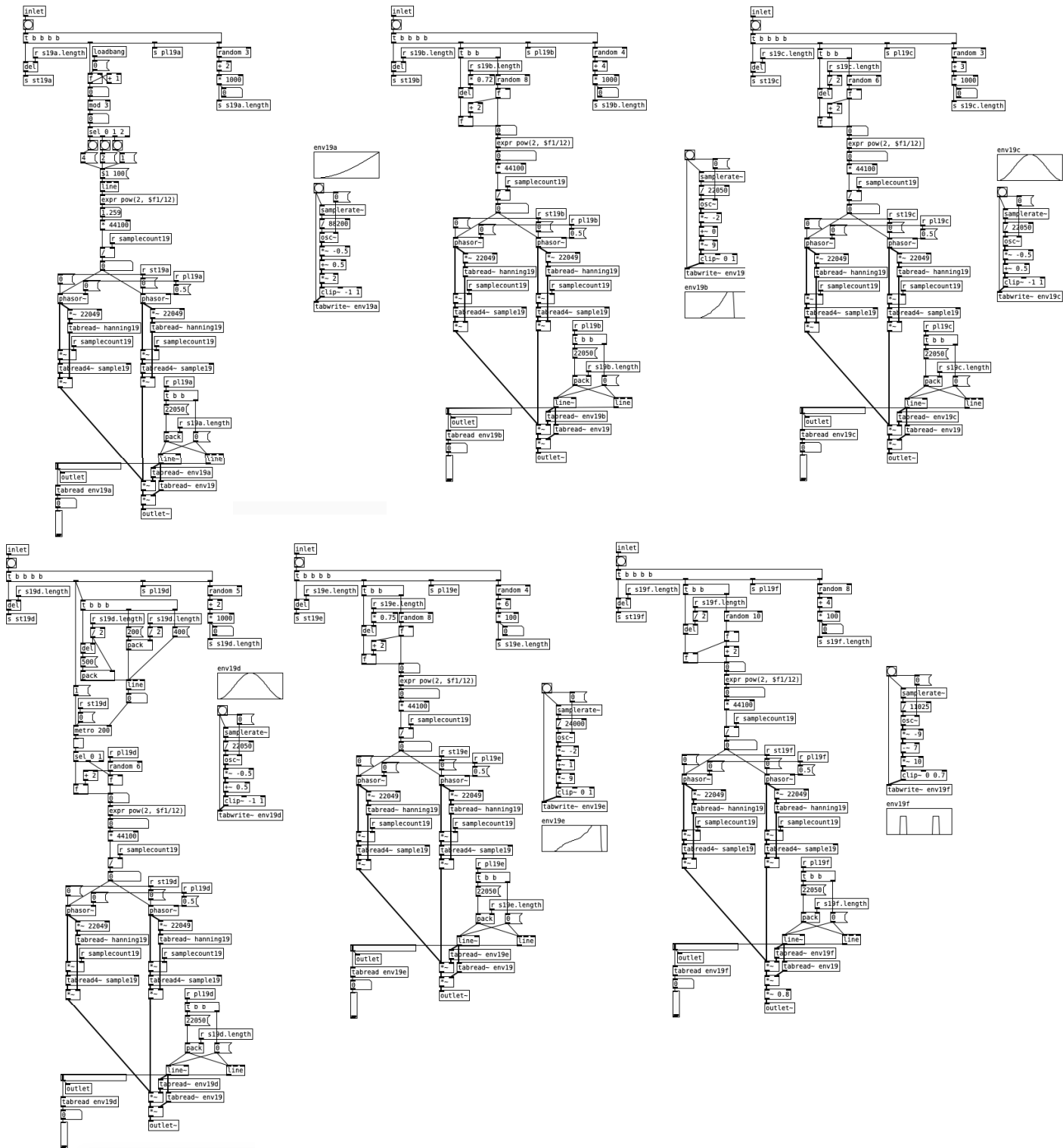

S19: S19g - S19l

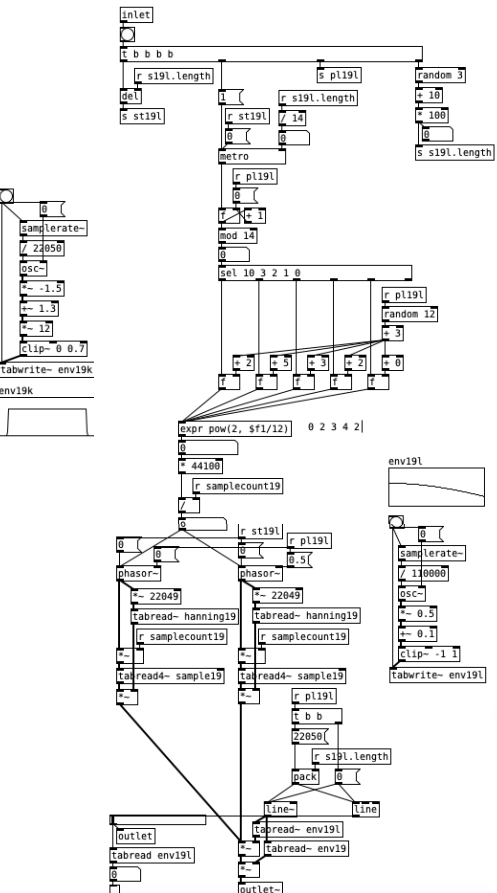
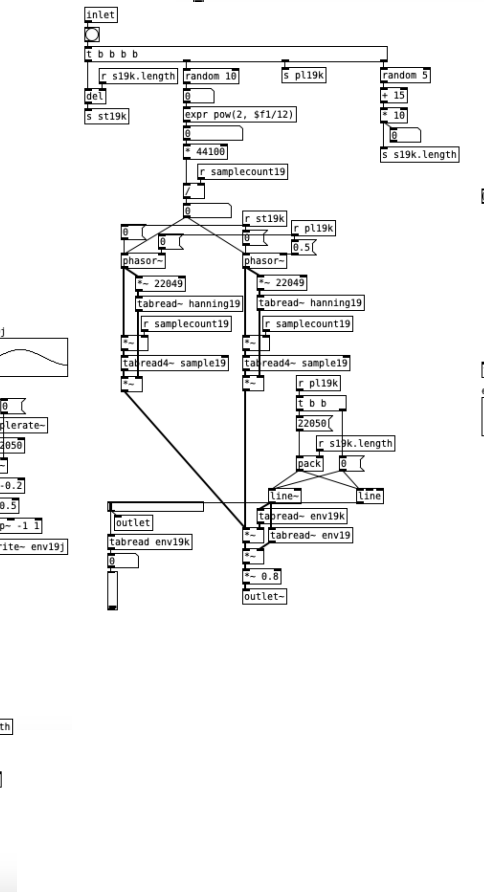
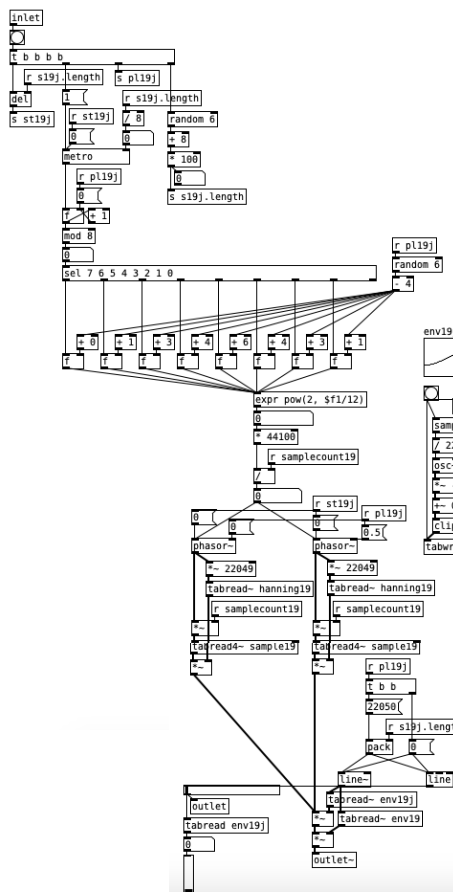
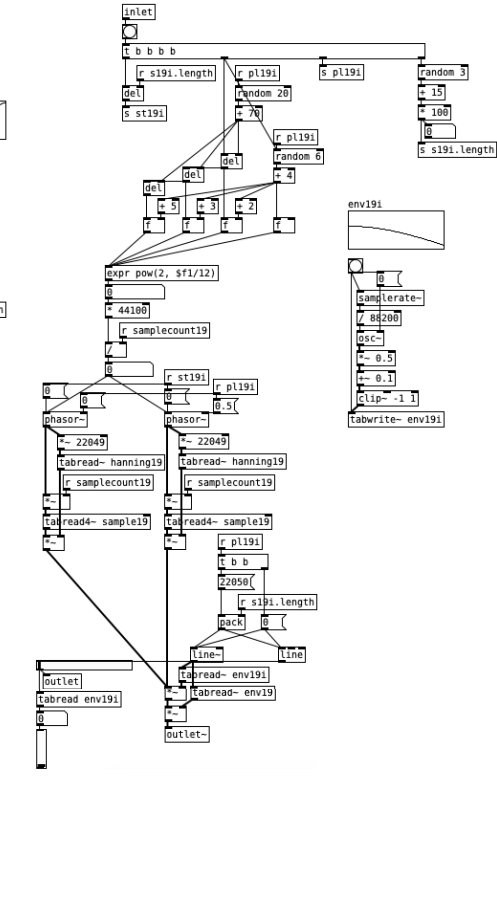
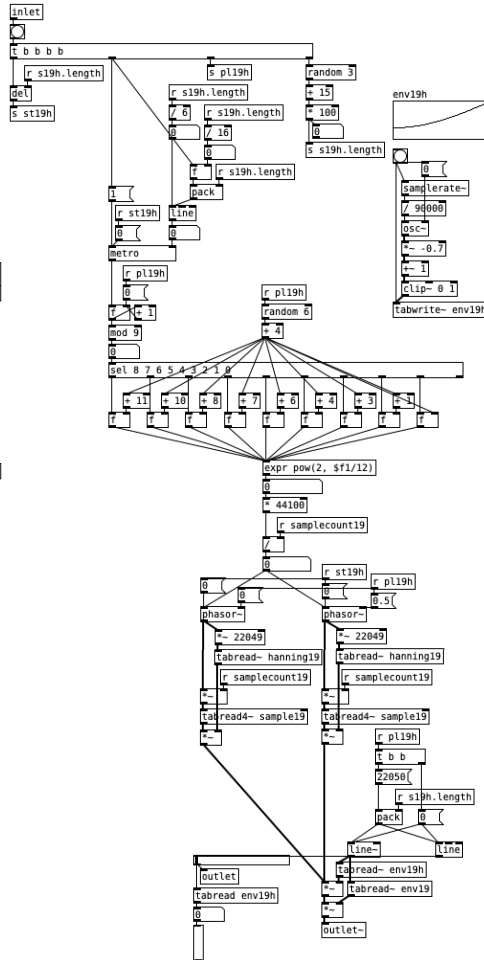
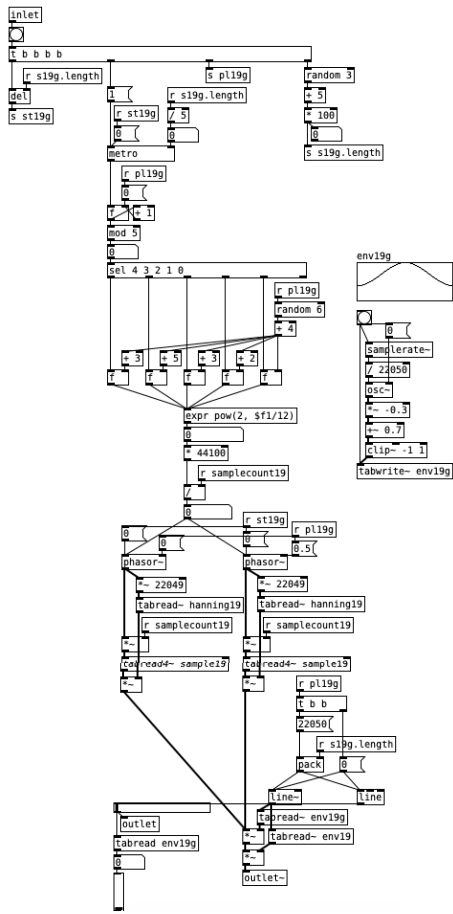

S19: S19m - S19r

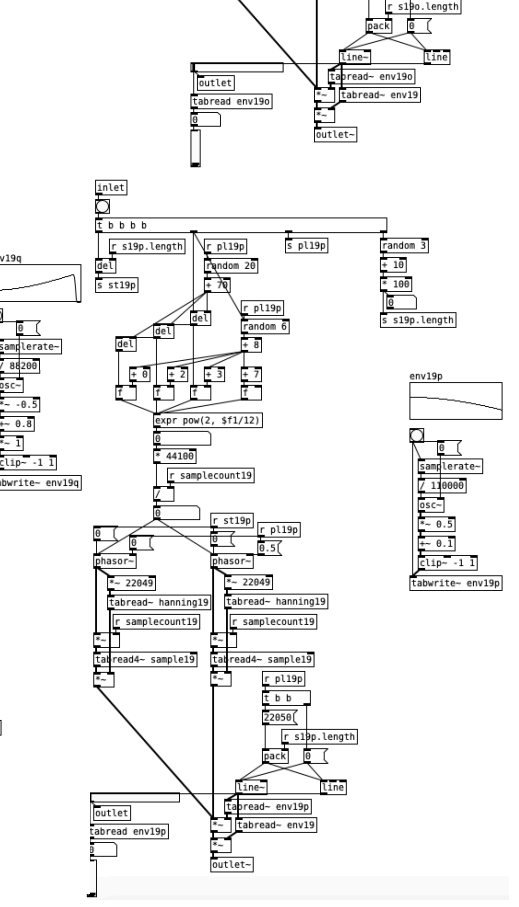
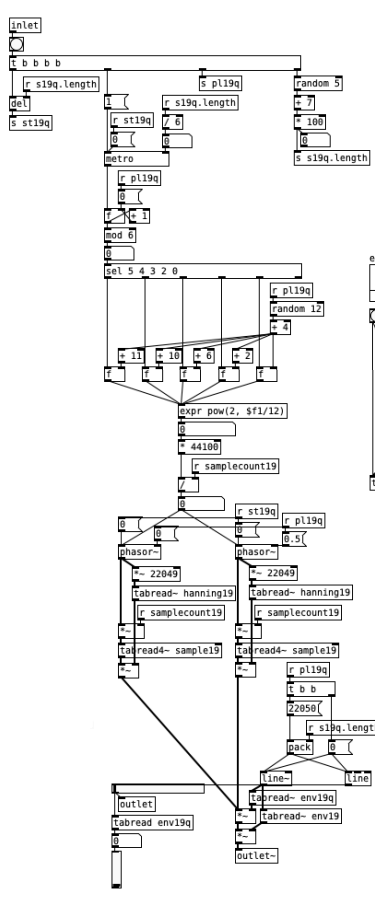
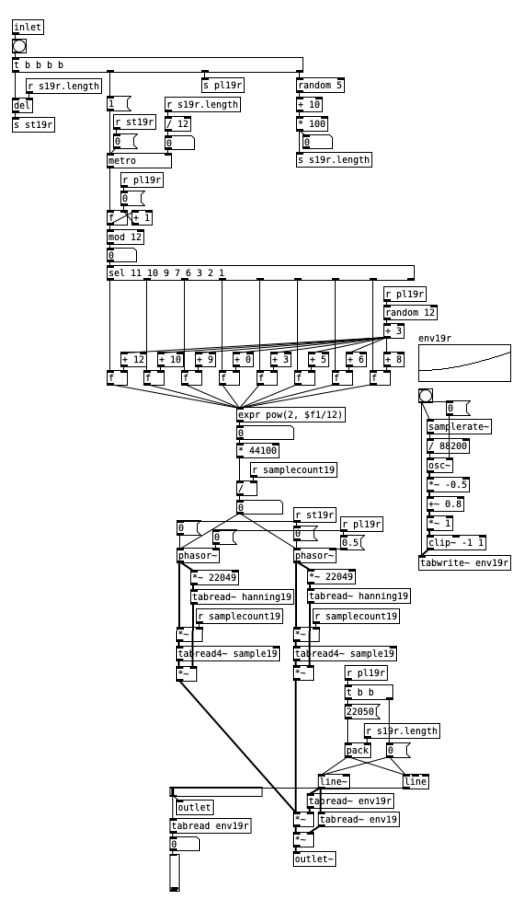
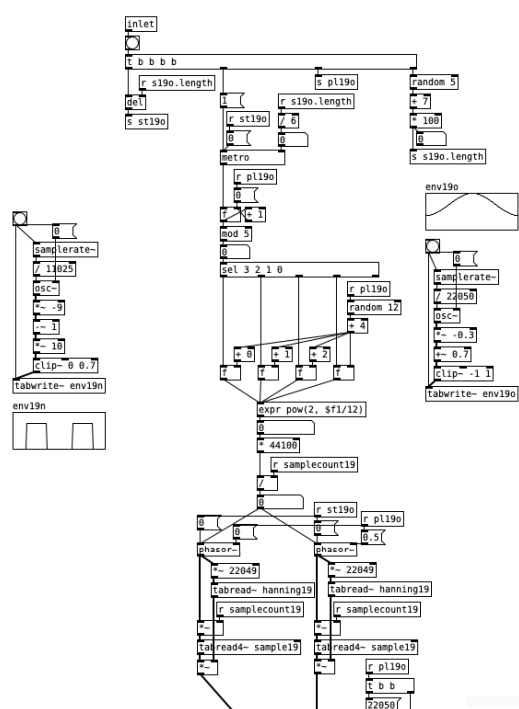
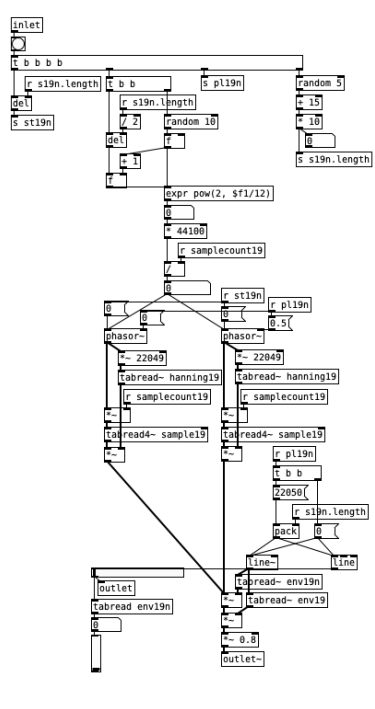
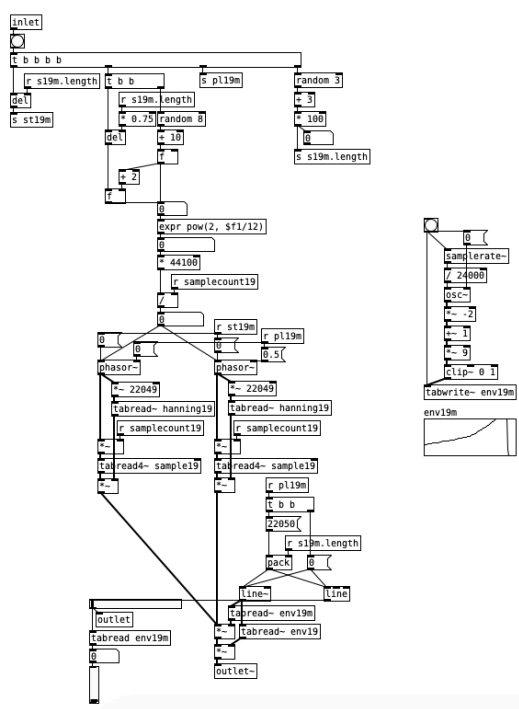

S19: S19s - S19v

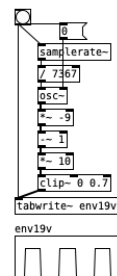
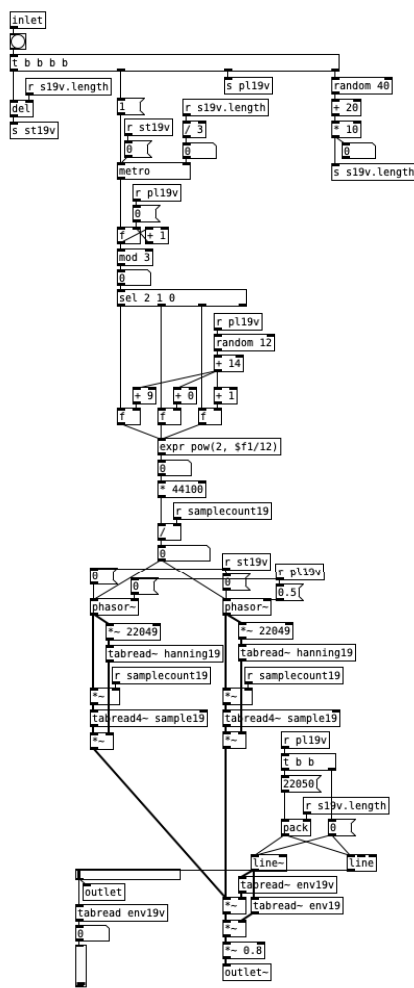
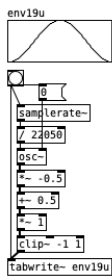
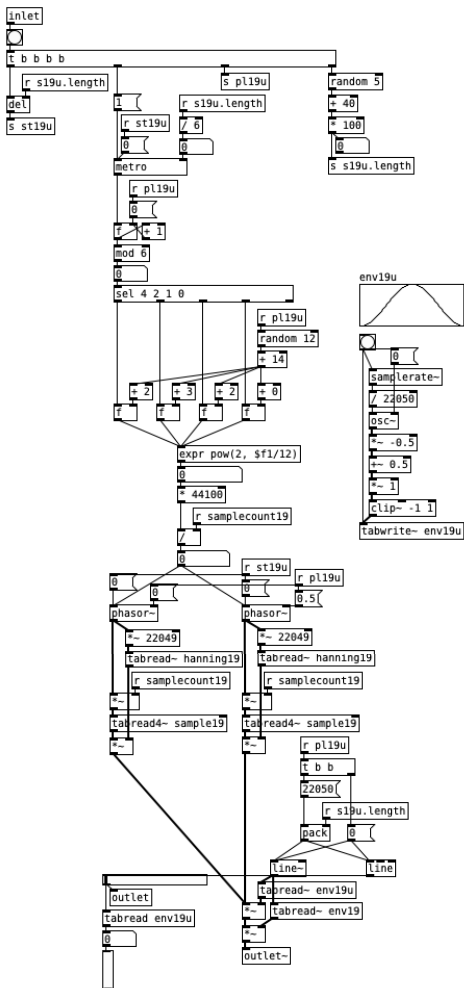
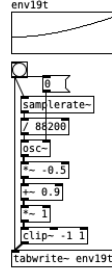
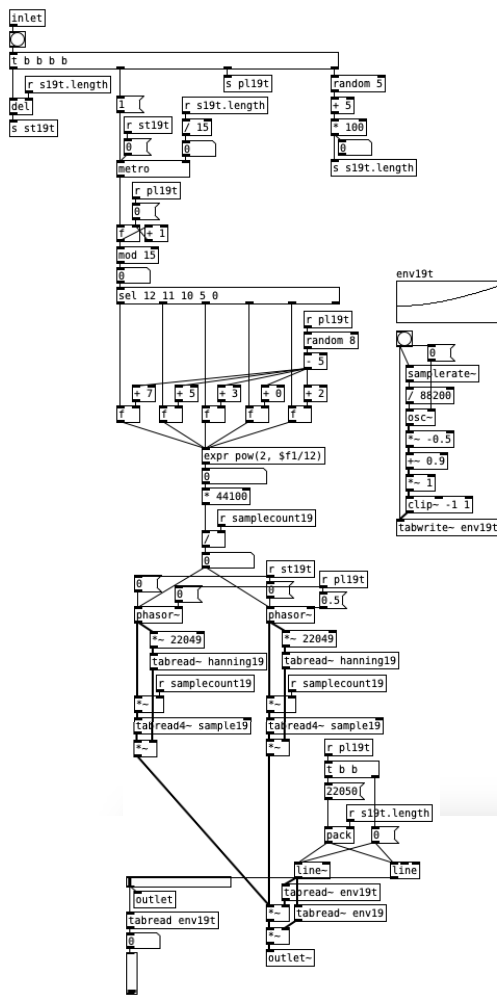
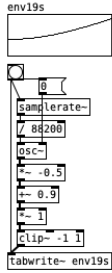
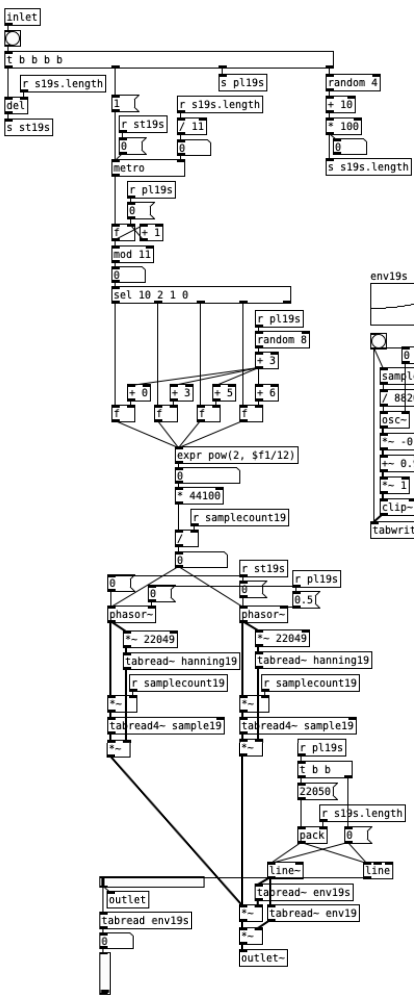

S4: 40 - 43

The following three pages form the calculations for the multiple 'virtual saxophones' that can be heard in the piece. Playback speed of the sustained pitch recorded in **S2** is manipulated according to the Pythagorean interval required. For example, to create a pitch that is a perfect fourth above the sampled pitch, the waveform is played back at $\frac{4}{3}$ the original recorded speed (1).

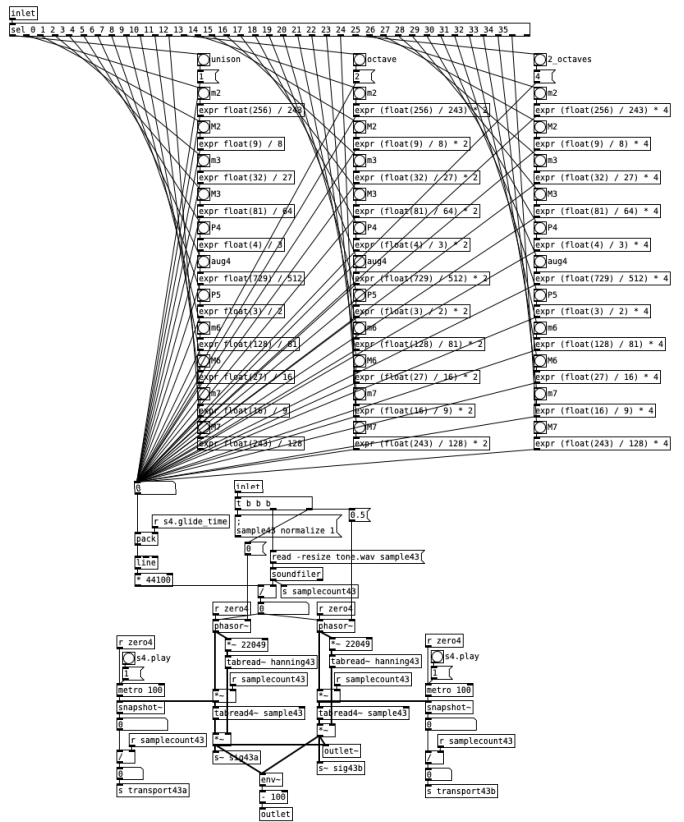
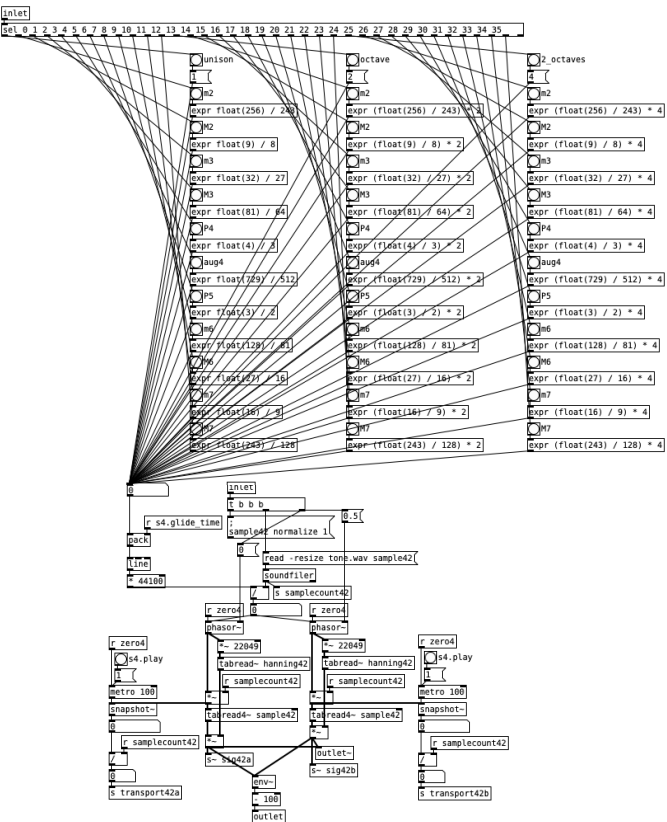
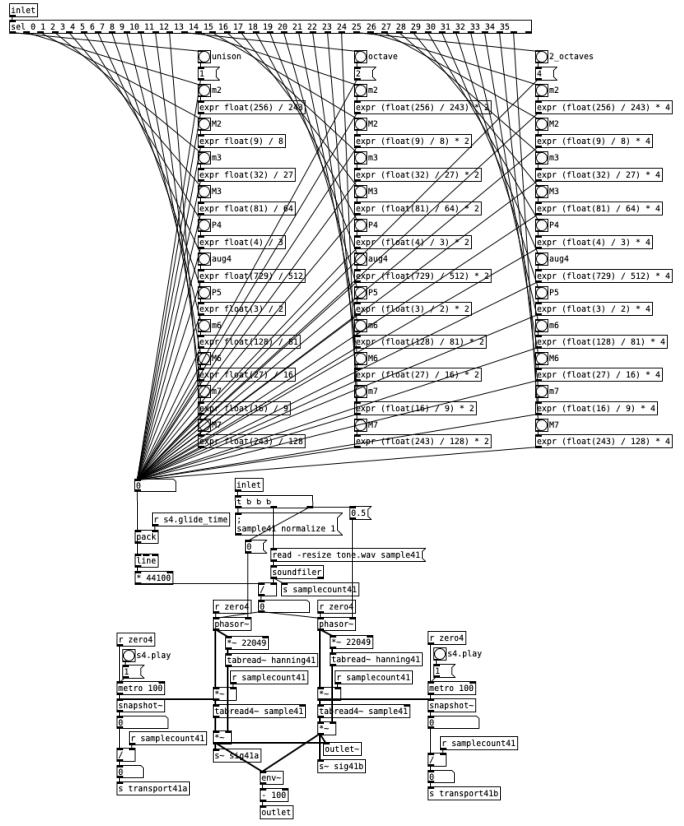
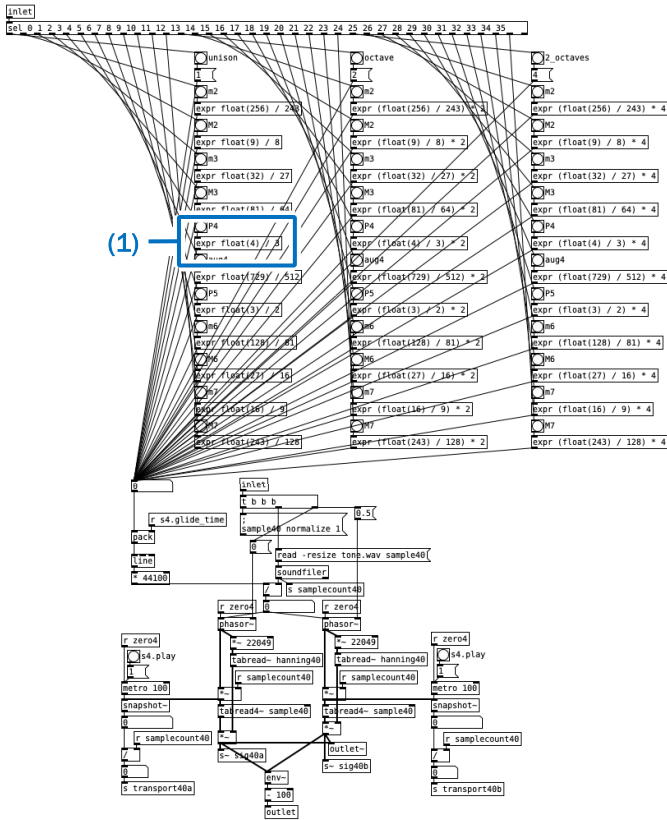

S4: 44 - 47

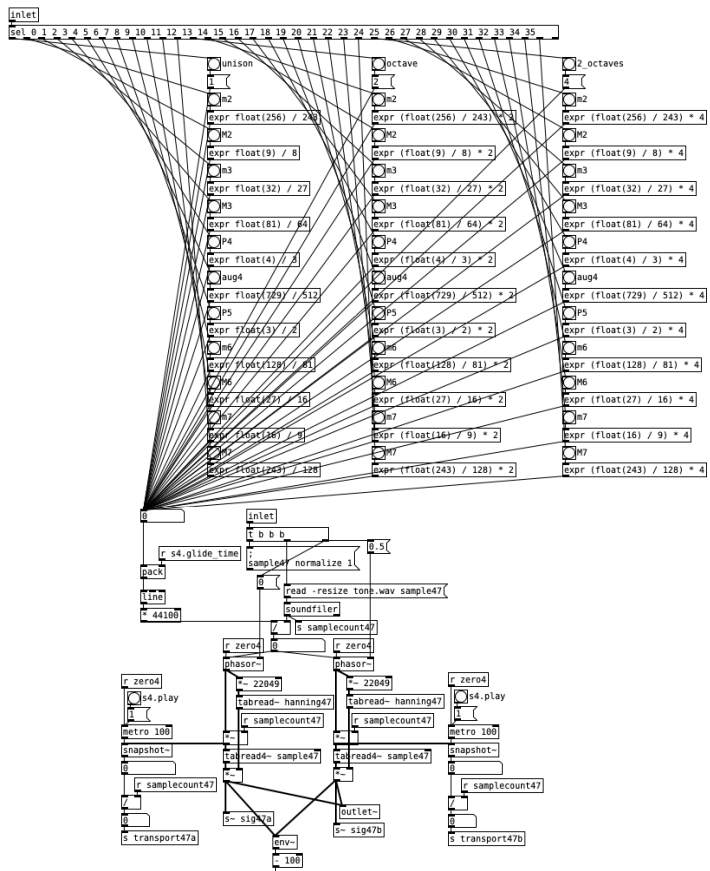
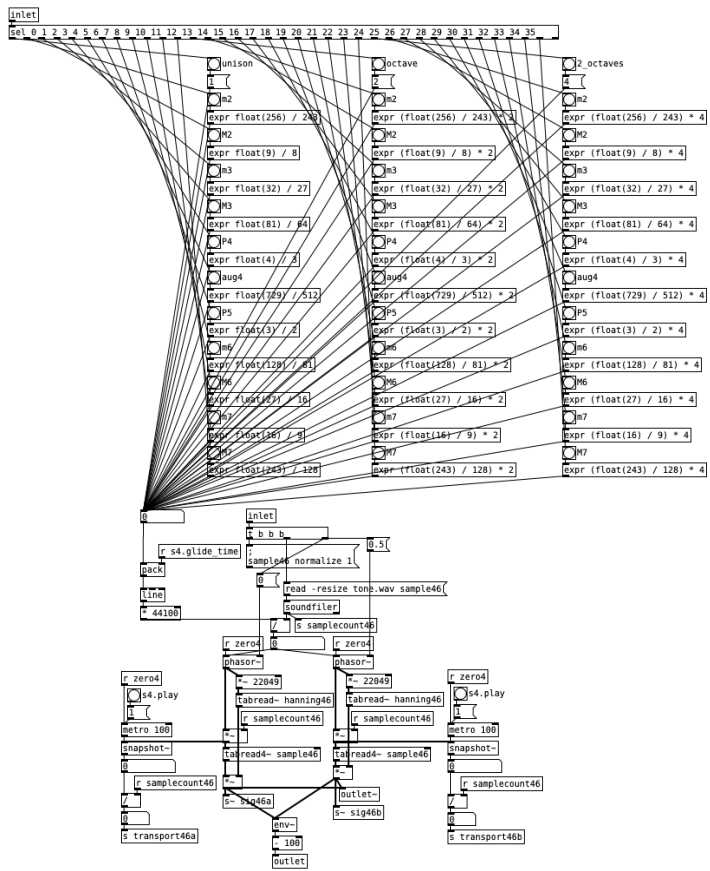
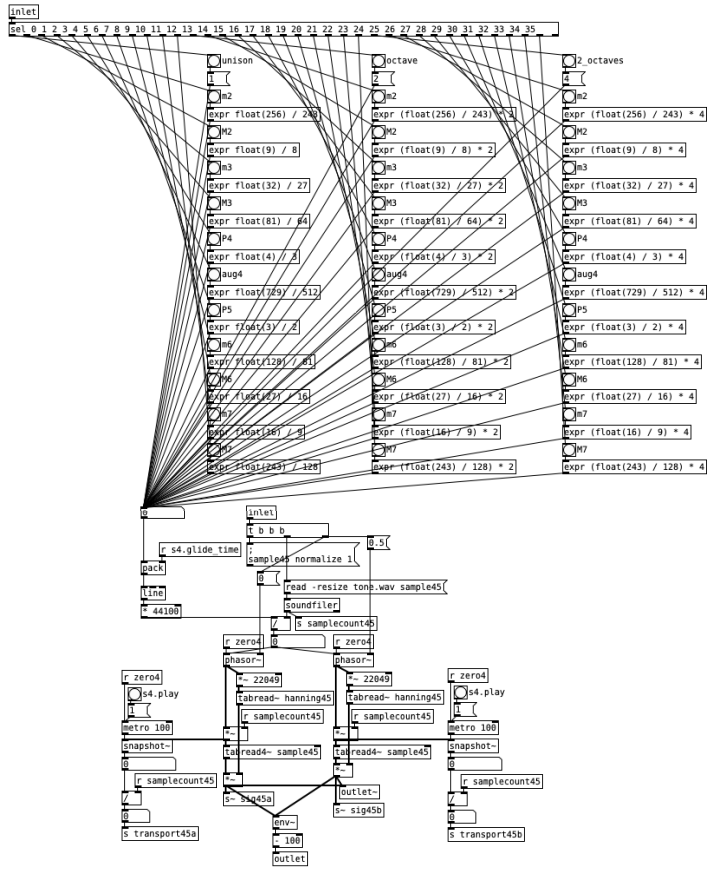
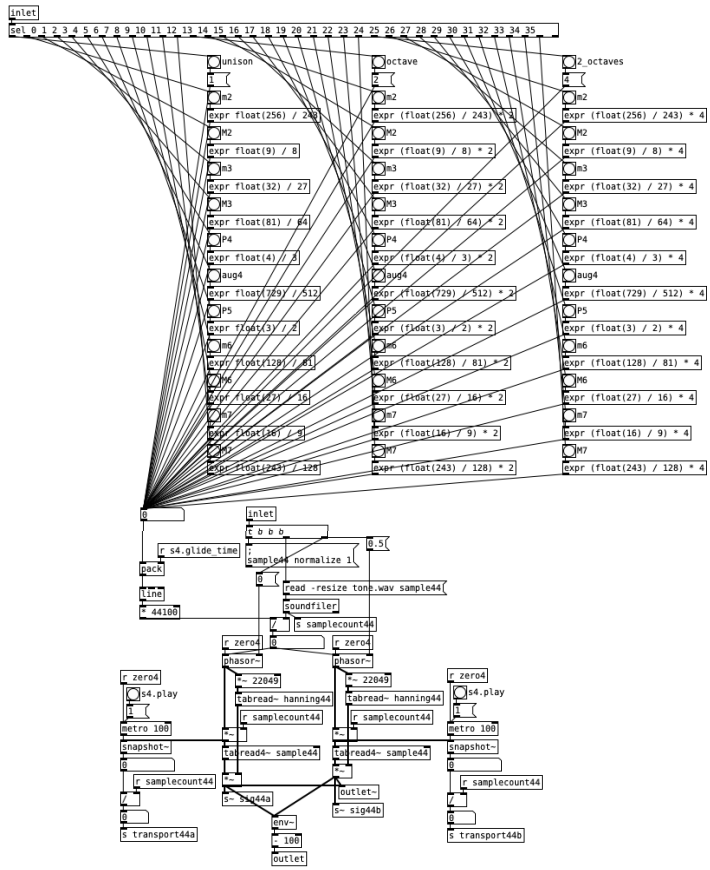

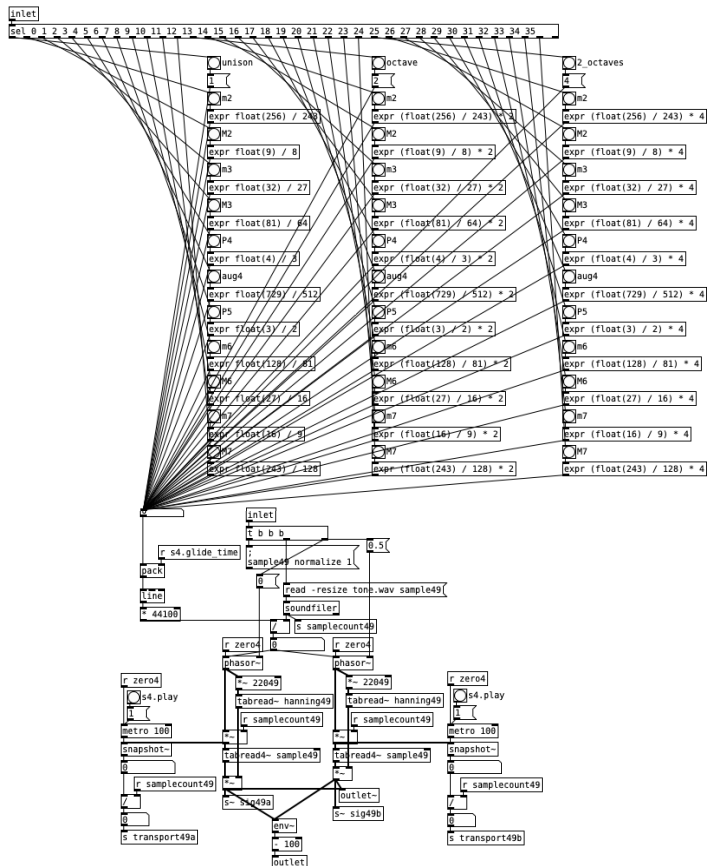
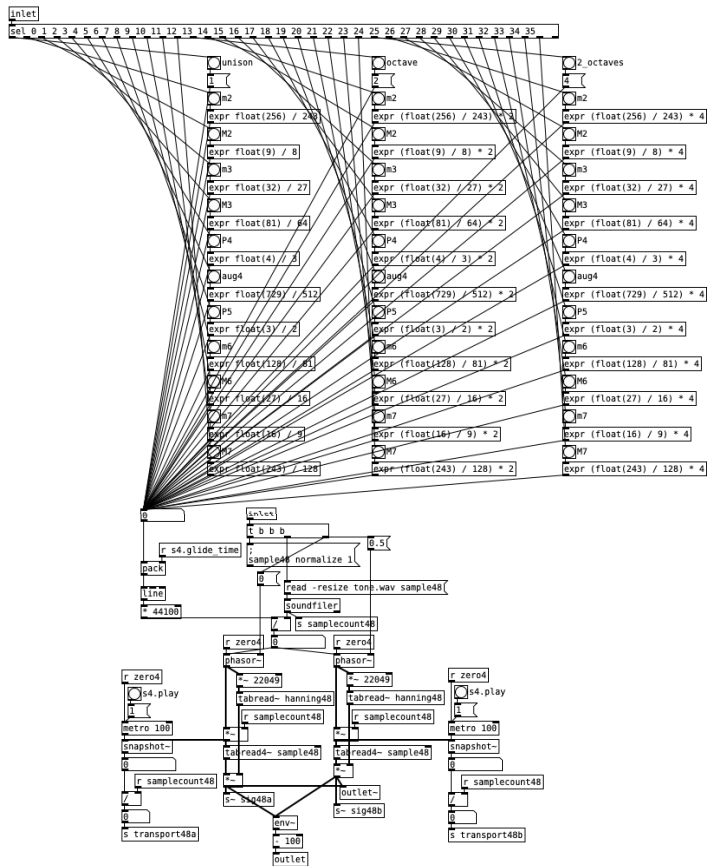

S12

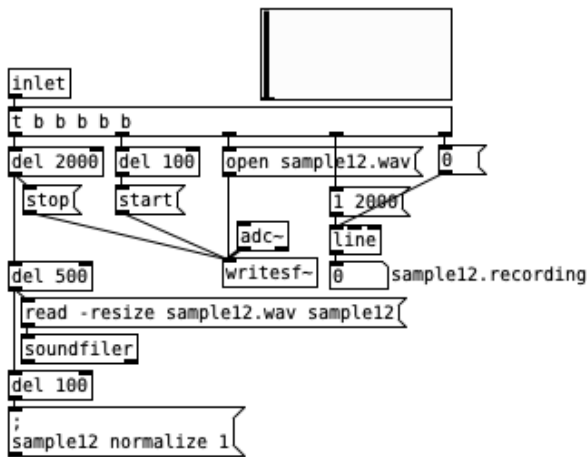

S14

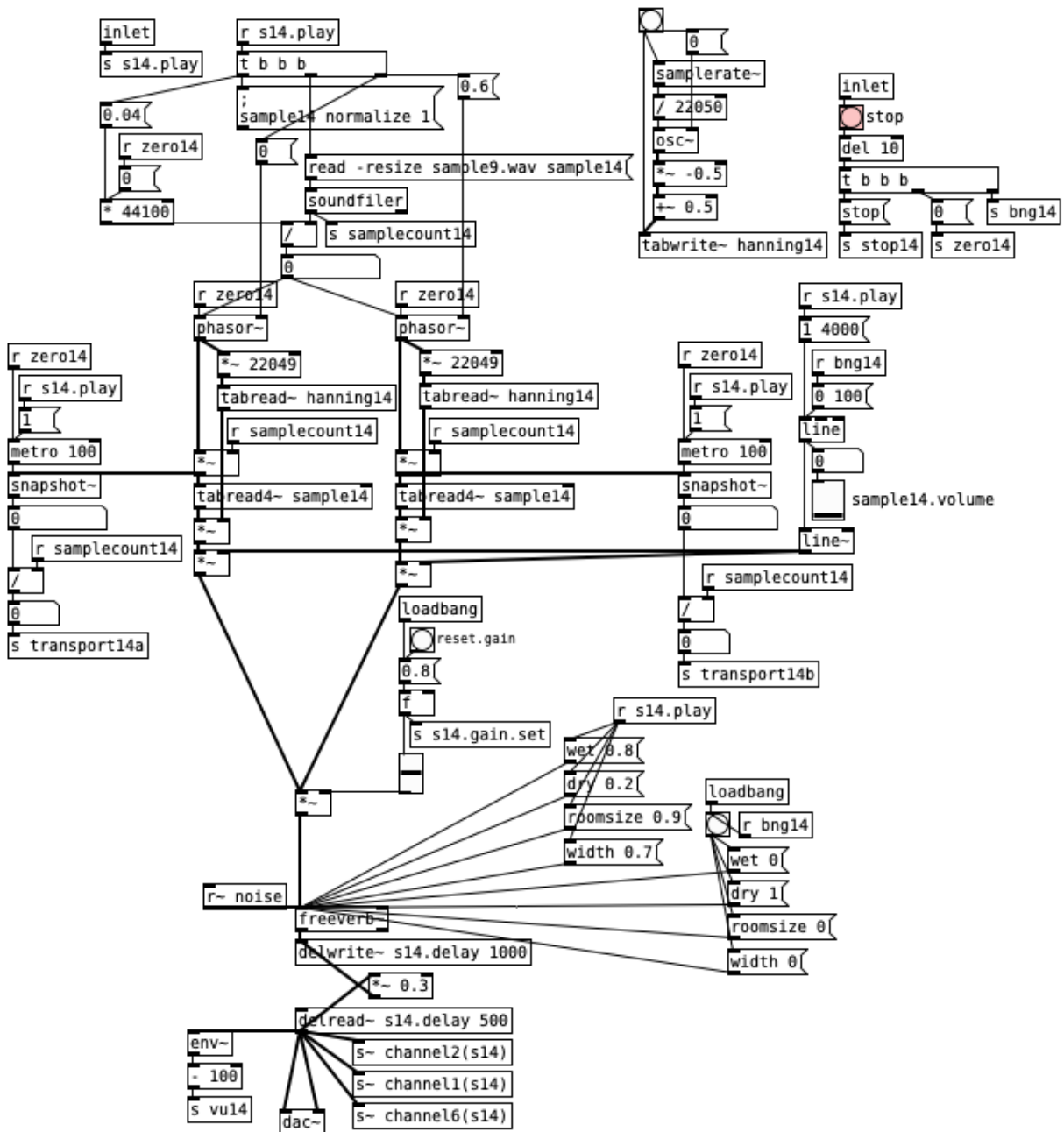

S13

This subpatch randomly selects a short sample from the library of saxophone soloing samples collected in **S16 (1)**. The selected sample's playback speed, duration and pitch are randomised along with the channel (and therefore speaker) to which the output is sent **(2)**.

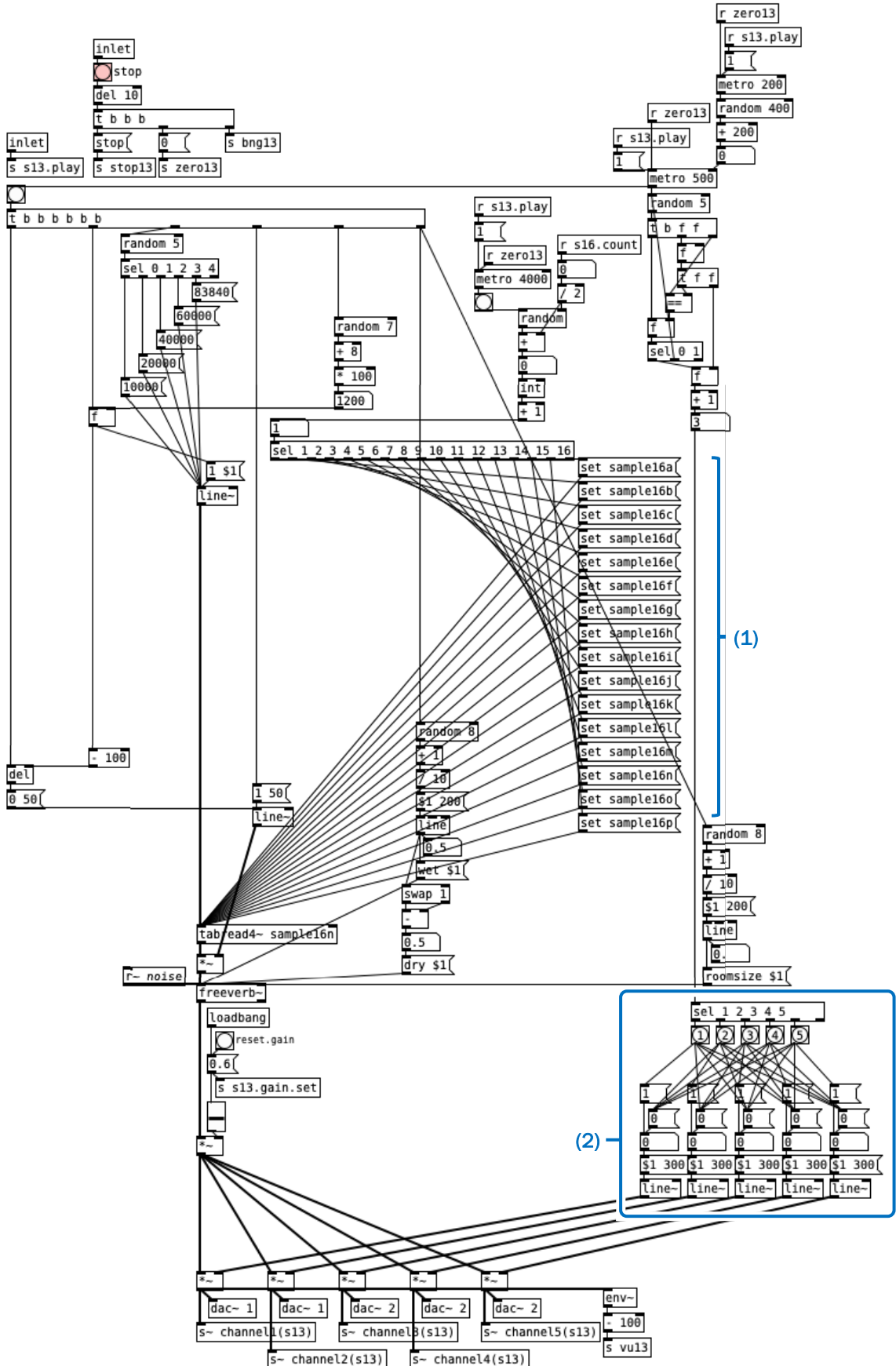

S6

This subpatch controls event triggering via the MIDI footswitch. If the performance is interrupted, the engineer can decide from which point in the piece the performance should resume (1). This subpatch also routes the final audio signals to the sound card's 5.1 surround sound outputs (2).

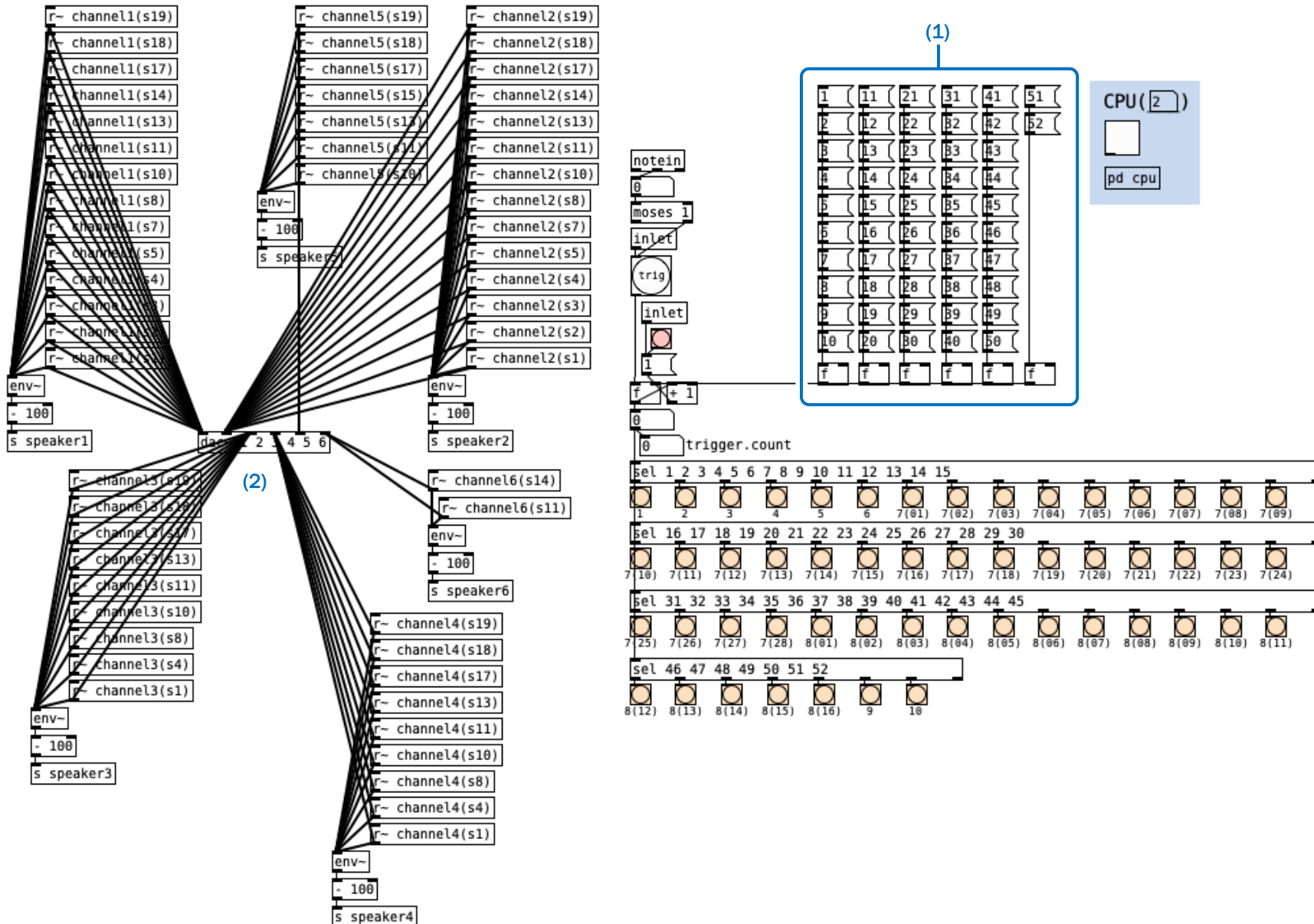

S5

This subpatch controls the effects applied to the microphone signal in the final section of the piece. Delay lines are increasingly added to the signal, creating 'echoes' that bend in pitch as the delay time is altered (1). In addition to applying effects, the microphone signal is also analysed in this subpatch, providing instruction to other areas of the patch regarding signal level and thereby triggering events in the piece (2).

