

“Romanz reding on the bok”: ‘reauralising’  
romances from later medieval English household  
manuscripts

Alana Bennett, BA (Hons), MA

PhD

University of York

Medieval Studies

April 2022

## **Abstract**

Reading aloud has long been accepted as a dominant mode of medieval textual reception following detailed studies on medieval orality and ‘aurality’ (Coleman, Vitz, Putter). However, the further implications of this aurality have received little scholarly attention: theorising about performance is no substitute for the experience of reading aloud and hearing texts read. Using a selection of Middle English romances found in a range of fifteenth-century ‘household manuscripts’, I combine palaeographical analysis, archaeology and practical performance experimentation to investigate the original reading practices associated with these texts. I stage simulations of medieval reading practices in two historic buildings – Gainsborough Old Hall, in Lincolnshire and Barley Hall in York - to experientially examine how modern readers respond to these texts when ‘reauralised’ and returned to surviving late-medieval domestic spaces. This thesis uniquely combines first-person methodology from performance studies, experimental archaeology, reenactment and heritage performance with more traditional approaches from textual and manuscript analysis, allowing for a more nuanced and materially-conscious study that takes into account the lived experience of medieval readers. In reauralising texts directly from the manuscript page, I explore the practical considerations and experiences of reading aloud today and historically, giving new resonances to words, spaces and manuscript features.

# List of Contents

Abstract.....	2
List of Contents .....	3
List of Tables .....	6
List of Figures.....	6
Acknowledgements .....	9
Declaration.....	11
INTRODUCTION.....	12
Corpus.....	14
Reading modalities.....	17
Structure and Aims.....	25
CHAPTER 1. Performance in History and Practice .....	27
1.1 Introduction.....	27
1.2 Definitions and Theory .....	28
1.3 Historical Romance Performance.....	30
1.4 Modern Performance Methodologies and Exemplars .....	37
1.4.1 Reading Malory Aloud .....	41
1.4.2 Musical Performance.....	43
1.4.3 Other Performance Media .....	47
1.4.4 Early Modern Drama .....	50
1.5 Analysing Performance .....	51
1.6 Conclusion .....	54
CHAPTER 2. Texts and Manuscripts.....	57
2.1 Introduction.....	57
2.2 Household manuscripts and their users.....	58
2.3 Minstrel manuscripts.....	67
2.4 Romance in Performance.....	71
2.5 Performative Features of Manuscripts .....	76
2.5.1 Layout and Legibility.....	77
2.5.2 Staining and Wear .....	80
2.5.3 Marginal Additions .....	82
2.5.4 Paratextual features.....	84
2.6 Case Studies.....	87
2.6.1 “The Tournament of Tottenham” and Performance.....	87
2.6.2 <i>Sir Degrevant</i> and Graphic Tail Rhyme Layout.....	94
2.6.3 <i>Sir Eglamour of Artois</i> , Paratextual Features and Internal Divisions .	104
2.7 Conclusion .....	110

<b>CHAPTER 3. Reading Spaces, Reading Books</b> .....	111
<b>3.1 Introduction</b> .....	111
<b>3.2 Medieval Houses</b> .....	113
<b>3.3 Reading spaces: the hall</b> .....	117
<b>3.4 Reading spaces: the chamber</b> .....	120
<b>3.5 Reading spaces: the parlour</b> .....	123
<b>3.6 Further sources for texts and reading</b> .....	125
<b>3.7 The Sensory and Material Experience of Reading</b> .....	130
<b>3.7.1 Lighting and sight</b> .....	132
<b>3.7.2 Acoustics and hearing</b> .....	134
<b>3.8 Historical Houses</b> .....	138
<b>3.8.1 Barley Hall</b> .....	138
<b>3.8.2 Gainsborough Old Hall</b> .....	142
<b>3.8.3 Comparative Analysis</b> .....	145
<b>3.9 Conclusion</b> .....	151
<b>CHAPTER 4. Staging Experimental Performance and <i>Reauralising</i> Romance</b> .	153
<b>4.1 Introduction</b> .....	153
<b>4.2 Performance Overview</b> .....	155
<b>4.3 Method and Aims: Putting Performance into Practice</b> .....	158
<b>4.4 Discussion: The Changing Reading Experience</b> .....	170
<b>4.4.1 Physical changes and material books</b> .....	172
<b>4.4.2 Changing performances</b> .....	180
<b>4.5 Space, Materiality and Performance</b> .....	183
<b>4.6 Middle English Romance in Performance</b> .....	191
<b>4.7 Heritage and Outreach Applications</b> .....	196
<b>4.8 Conclusion</b> .....	200
<b>CONCLUSION</b> .....	203
<b>APPENDIX A: Manuscript Overviews and Contents Lists</b> .....	208
<b>Cambridge, University Library MS Ff.1.6 (the Findern manuscript)</b> .....	209
<b>Description</b> .....	209
<b>Table A.1: Contents of Findern MS</b> .....	210
<b>Cambridge, University Library MS Ff.2.38</b> .....	215
<b>Description</b> .....	215
<b>Table A.2: Contents of Ff.2.38</b> .....	216
<b>Cambridge, University Library MS Ff.5.48</b> .....	220
<b>Description</b> .....	220
<b>Table A.3: Contents of Ff.5.48</b> .....	220

<b>Lincoln, Cathedral Library MS 91 (The Lincoln Thornton Manuscript)</b> .....	222
<b>Description</b> .....	222
<b>Table A.4: Contents of Li 91</b> .....	223
<b>London, British Library Cotton MS Caligula A.ii</b> .....	228
<b>Description</b> .....	228
<b>Table A.5: Contents of CCAii</b> .....	229
<b>Edinburgh, National Library of Scotland Advocates MS 19.3.1</b> .....	231
<b>Description</b> .....	231
<b>Table A.6: Contents of Heege MS</b> .....	232
<b>Oxford, Bodleian Library MS Ashmole 61</b> .....	235
<b>Description</b> .....	235
<b>Table A.7: Contents of Ashmole 61</b> .....	236
<b>APPENDIX B: Video footage of experimental performances</b> .....	239
<b>Table B.1: Experiments in Barley Hall</b> .....	239
<b>Table B.2: Experiments in Gainsborough Old Hall</b> .....	240
<b>APPENDIX C: Teaching resources for Middle English and romance excerpts</b> .	242
<b>Middle English 101</b> .....	242
<b>Text excerpts for performance experiments</b> .....	244
<b>APPENDIX D: Additional Material Pertaining to Experiments</b> .....	251
<b>Participant Information Sheet</b> .....	251
<b>Informed Consent Form</b> .....	253
<b>Barley Hall</b> .....	254
<b>Questionnaire Session 1: Text</b> .....	254
<b>Questionnaire Session 2: Manuscript</b> .....	254
<b>Questionnaire Session 3: Reading aloud</b> .....	254
<b>Questionnaire Session 4: Space and materiality</b> .....	254
<b>Questionnaire Session 5: Space and materiality (part 2)</b> .....	254
<b>Gainsborough Old Hall</b> .....	255
<b>Feedback Sheet</b> .....	255
<b>Abbreviations and Manuscript Shortened Names</b> .....	256
<b>Bibliography</b> .....	257
<b>Primary sources (unpublished)</b> .....	257
<b>Manuscripts and Documents</b> .....	257
<b>Objects and Artworks</b> .....	258
<b>Primary sources (published)</b> .....	259
<b>Secondary sources</b> .....	261

## List of Tables

Table 2.1: Comparison of fitt divisions of <i>Sir Eglamour of Artois</i> .....	107
Table A.1: Contents of Findern MS .....	210
Table A.2: Contents of Ff.2.38 .....	216
Table A.3: Contents of Ff.5.48 .....	220
Table A.4: Contents of Li 91 .....	223
Table A.5: Contents of CCAii .....	229
Table A.6: Contents of Heege MS.....	232
Table A.7: Contents of Ashmole 61 .....	236
Table B.1: Experiments in Barley Hall .....	239
Table B.2: Experiments in Gainsborough Old Hall.....	240

## List of Figures

Figure 1.1: The Findern manuscript annotation.....	12
Figure 1.2: The ‘cloud of modalities’ .....	18
Figure 2.1: Ff.2.38, f. 59rb.....	59
Figure 2.2: The opening of <i>Sir Isumbras</i> in Li 91 .....	60
Figure 2.3: Various additions on f. 49v in Li 91 .....	66
Figure 2.4: Alphabet copied onto f. 59v of the Findern manuscript .....	67
Figure 2.5: Alphabet copied onto f. 150v of the Findern manuscript .....	67
Figure 2.6: Alphabet copied onto f. 159v of the Findern manuscript .....	67
Figure 2.7: Heege manuscript, f. 62r showing dividing line in “henne” .....	78
Figure 2.8: Staining in <i>Sir Eglamour of Artois</i> , f. 74r of Ff.2.38 .....	80
Figure 2.9: Copying hand in the Heege manuscript, f. 125v .....	83
Figure 2.10: Immature hand copying Latin from William Lily’s Latin grammar book in the Heege manuscript, f. 154v .....	83
Figure 2.11: Marginal addition in Tundale in the Heege manuscript.....	83
Figure 2.12: <i>Prose Alexander</i> in Li 91, f. 7v .....	84
Figure 2.13: Large fere-textura line in “King Edward and the Shepherd”, Ff.5.48, f. 50ra.....	86
Figure 2.14: The opening of “The Tournament of Tottenham” in the Pilkington manuscript, f. 62r .....	88
Figure 2.15: Ambiguous addition in Ff.5.48, f. 32v (detail).....	90
Figure 2.16: <i>Aucassin et Nicolette</i> , BnF, fr. 2168, f. 72r .....	93
Figure 2.17: The Findern manuscript annotation.....	95

Figure 2.18: The change of scribes in the Findern <i>Sir Degrevant</i> .....	96
Figure 2.19: The opening of <i>Sir Degrevant</i> in the Findern manuscript, f. 96 ....	97
Figure 2.20: The opening of <i>Sir Degrevant</i> in Li 91, f. 130r .....	98
Figure 2.21: The opening of “Sir Thopas” from the Ellesmere manuscript. San Marino, CA, Huntington Library EL 26 C 9, f. 151v .....	99
Figure 2.22: The opening of “The Feast of Tottenham” in Ff.5.48.....	99
Figure 2.23: The opening of <i>Sir Isumbras</i> in the Heege manuscript .....	100
Figure 2.24: <i>Sir Degrevant</i> in Li 91.....	101
Figure 2.25: Poorly laid-out graphic tail rhyme in Li91.....	102
Figure 3.1: Pragmatic reading. London, British Library Royal MS 15.D.I, f. 18r .....	122
Figure 3.2: Entertainment in the chamber. Paris, BnF, fr. 25528, f. 85v.....	123
Figure 3.3: Mary reading. Merode Altarpiece .....	127
Figure 3.4: St Barbara reading. The Werl Triptych.....	127
Figure 3.5: Barley Hall as viewed from Coffee Yard.....	138
Figure 3.6: Plan of Coffee Yard c. 1981 .....	140
Figure 3.7: Exterior of Gainsborough Old Hall (facing north) .....	143
Figure 3.8: Plan of the ground floor of Gainsborough Old Hall .....	143
Figure 3.9: Stewart’s access analysis diagram of Barley Hall .....	150
Figure 4.1: Snapshot from reading experiment in the hall at Barley Hall reading the opening of <i>Sir Eglamour of Artois</i> .....	160
Figure 4.2: Snapshot from reading experiment in the hall at Gainsborough Old Hall reading excerpt from <i>Sir Degrevant</i> .....	161
Figure 4.3: Snapshot from reading experiment in the ‘lesser chamber’ at Barley Hall reading the opening of <i>Sir Eglamour of Artois</i> .....	161
Figure 4.4: Detail of Heege MS, f. 62r showing separating line.....	168
Figure 4.5: Detail of Li 91, f. 139ra.....	168
Figure 4.6: Detail of Li 91, f. 139rb .....	169
Figure 4.7: Li 91 Facsimile, Findern manuscript stand-in, Ashmole 61 stand-in, CCAii booklet and Heege booklet.....	173
Figure 4.8: Snapshot from reading experiment in the gallery chamber at Gainsborough Old Hall reading Sir Orfeo from the <i>Ashmole 61</i> stand-in .....	176
Figure 4.9: Snapshot from reading experiment in hall at Gainsborough Old Hall reading <i>Sir Eglamour of Artois</i> .....	177
Figure 4.10: Snapshot from reading experiment in the gallery chamber at Gainsborough Old Hall reading <i>Sir Orfeo</i> from the Ashmole 61 stand-in more informally.....	178
Figure 4.11: Snapshot from ‘social roles’ performance with readers seated at the high table underneath the visually-striking canopy in Barley Hall reading from <i>Sir Eglamour of Artois</i> .....	184

**Figure 4.12: Snapshot of ‘professional storyteller’ performance in hall at Gainsborough Old Hall reading *Sir Degrevant* from the Findern MS stand-in ..... 188**

**Figure 4.13: Snapshot from reading experiment in the parlour at Barley Hall reading from *Sir Eglamour of Artois* ..... 190**



## Acknowledgements

First and foremost, immense gratitude and thanks is due to my supervisors Nicola McDonald and Kate Giles. Without their care, assistance, understanding and a lot of patience, this thesis would not exist at all and personally I would be in a very different place. I've learnt so much not just about the subject matter of the thesis, but also about myself.

Many thanks also to Linne Mooney for her support as TAP member, constant source of inspiration for palaeographical analysis and supervision of my MA dissertation which planted some of the seeds for this thesis, and to Ollie Jones for his advice on wrangling with experimental performance and additional support as a TAP member.

The Centre for Medieval Studies has the most incredible academic community that I been privileged and fortunate to be a part of, and at the foundation of that are Gillian Galloway and Brittany Scowcroft – thank you for all that you do to keep this amazing Centre running! Thanks also to Elizabeth Tyler in her position as co-Director and to Gem Kirk from RSA for their additional guidance as I went about this PhD in perhaps the most complicated way possible. And huge thanks to those who made my return to studies possible: James Browne from Disability Services, the Open Door service and my fantastic mentors Cathy, Viktoria and Janet.

This research project was initially supported by the Wolfson Foundation and I am hugely grateful for their generous funding which enabled the ambitious series of research trips to various libraries across the UK. Thanks are also due to Student Finance England and the Centre for Medieval Studies for their additional financial support. I am incredibly grateful to Chris Tuckley at Barley Hall and the property team at Gainsborough Old Hall for allowing me to use the amazing historic buildings, as well as to Marta Cobb for facilitating my session at Leeds IMC. Thanks also to the staff at Lincoln Cathedral Library, the British Library, Cambridge University Library, the Bodleian Library and the National Library of Scotland. And finally thanks to the participants and attendees of the performances and workshops who made this research possible. I also want to acknowledge the importance of two online databases: the Digital Index of Medieval Verse and Middle English Romances. Both provided indispensable assistance with my studies of the manuscripts and their texts.

The culmination of this research took place during the Covid-19 pandemic. The thesis would not be in its current form without the need to adapt to unforeseen situations, both in challenging and in positive ways. I'm grateful that even in such a dark time I was able to rediscover my love for research and writing and that it was possible to mould that into something more PhD-shaped than expected. Thanks to the support of my supervisors, the CMS workroom crew and the York School of Defence for helping me get to this point on the other side, as well as to the amazing staff at York's libraries for making it possible to work safely from home. Sorry for all the scanning I made you do.

On a personal level, thanks must also go to my husband, my family and to the friends around the world. Thanks especially to the CMS workroom crew (I've been living in that attic for so long that there are too many of you to name individually, also, please keep the bonnacon incident tracker updated), the York School of Defence (stabby friends are best friends), the Lords of Misrule (for the dramatic distractions and the lending of costumes), House Hartsleape (love and support) and Waldkauz (the light at the end of a very long and winding tunnel).

## **Declaration**

I declare that this thesis is a presentation of original work and I am the sole author. This work has not previously been presented for an award at this, or any other, University. All sources are acknowledged as References.

Alana Bennett

April 2022

## INTRODUCTION

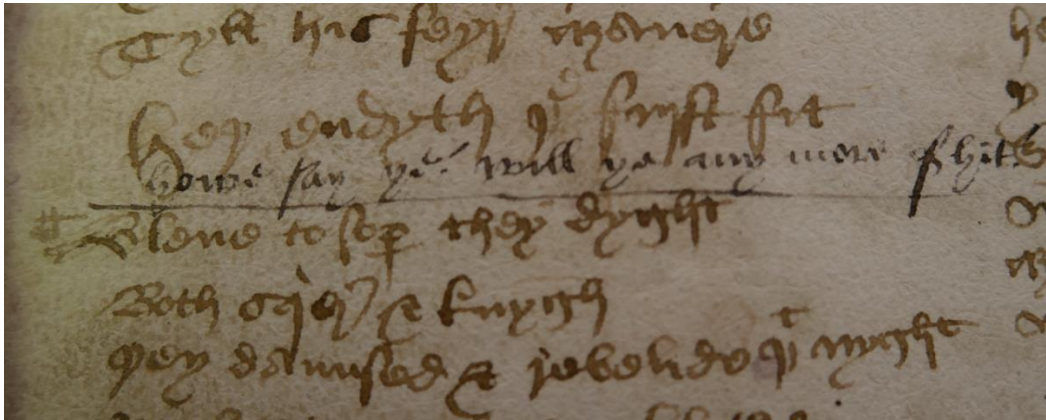

Figure 1.1: The Findern manuscript annotation: Cambridge, University Library MS Ff.1.6, f. 98va (detail).

*“Howe say ye? Will ye any more of hit?”*

This enigmatic addition shown in Figure 1.1 sits squeezed in between lines of the romance *Sir Degrevant* in the Findern manuscript (Cambridge, University Library MS Ff.1.6, f. 98va), in a hand darker and markedly later (possibly sixteenth century) than the main text of the romance, preserving a call to a communal readership who may have in turn answered the disembodied voice of a performative reader. This evocative comment offers a tantalising glimpse at the life and usage of the manuscript and suggests an interactive, performative reception for this text that persisted beyond the immediate time of its copying. Depictions of romance-reading in fiction or historical records are often formal performances or by skilled professionals. One such instance features romance performance among other diverse entertainments at Havelok’s coronation feast in the romance *Havelok the Dane*:

“Wrastling with laddes, putting of ston,  
Harping and piping, ful god won,  
Leyk of mine, of hasard ok,  
Romanz reding on the bok.  
Ther mouthe men here the gestes singe,  
The glewmen on the tabour dinge.”<sup>1</sup>

<sup>1</sup> Ronald B. Herzman, Graham Drake, and Eve Salisbury, eds., ‘Havelok the Dane’, in *Four Romances of England: King Horn, Havelok the Dane, Bevis of Hampton, Athelston*, TEAMS Middle English Texts Series (Kalamazoo, Michigan: Medieval Institute Publications, 1997), ll. 2324-29. Subsequent references will state line numbers in-text in brackets.

(Lads wrestling, stone throwing, harping and piping – a great deal, games of backgammon and also hazard, romance reading from a book, there could men hear gestes sung, minstrels beat on the drum.)

These two examples raise many questions: how are the romance-reading of *Havelok* and the Findern manuscript related? What kind of reading practices are described in *Havelok* and what kind of reading practices would have resulted in the addition to the pages of *Sir Degrevant*, and is it possible to reconstruct these practices? The Findern manuscript is an example of a ‘household manuscript’: a category of miscellany from around the fifteenth century which was used by, made for and sometimes even made by households. This thesis poses a series of questions about the usage of household manuscripts: what actually was ‘romance reading on the (household) book’ in the context of their early usage? How could these books have been used to support communal, domestic romance-reading for leisure or entertainment?

As distinct from the modern sense of family, the medieval household or *familia* was “the co-resident unit” and was a fluid group that could include a married couple, children, servants, plus others related or otherwise.<sup>2</sup> Sarah Rees Jones writes that the exact definition of a household varies between contexts, but was usually a group “sharing a domestic routine focused on a common hearth” and connected to a series of domestic buildings and outdoor areas.<sup>3</sup> The well-ordered and well-managed household was, for writers and philosophers, a reflection of a well-ordered state and world: as Rees Jones continues, the household was the “foundation stone of a civilised society” both “autonomous” and “essential to the state’s existence and smooth operation”.<sup>4</sup> The household was the foremost space of socialisation, education (for both children and servants), devotional activities, and economic or industrial activities (both production and consumption).<sup>5</sup> Importantly, for this thesis, it was also the site of shared leisure activities such as gaming, story-telling, music and communal reading.

---

<sup>2</sup> P.J.P. Goldberg, *Medieval England: A Social History 1250-1550* (London: Arnold, 2004), 13, 13–20.

<sup>3</sup> Rees Jones notes that these outbuildings and spaces could in theory support more than one domestic group. Sarah Rees Jones, ‘The Public Household and Political Power: Preface’, in *The Medieval Household in Christian Europe c. 850 - c. 1550: Managing Power, Wealth and the Body*, ed. Cordelia Beattie, Anna Maslakovic, and Sarah Rees Jones (Turnhout: Brepols, 2003), 11.

<sup>4</sup> Rees Jones, 12. See also Sarah Rees Jones et al., ‘The Later Medieval English Urban Household’, *History Compass* 5, no. 1 (2007): 116. Cf. Aristotle, *Poetics*, Books I, III; Augustine, *City of God*, Book 19, c. 14, c. 16, passim; Bernardus Silvestris’ *De rei cura familiaris* and Richard Whitforde’s *A Werke for Housholders*.

<sup>5</sup> Tara Hamling and Catherine Richardson, *A Day at Home in Early Modern England: Material Culture and Domestic Life, 1500-1700* (New Haven: Yale University Press, 2017), 4–8; Roberta Gilchrist, *Medieval Life: Archaeology and the Life Course* (Suffolk: Boydell Press, 2012), 114.

## Corpus

Household manuscripts, or domestic miscellanies, collected together writings that fulfilled part or all of the textual needs of a household, the diversity of their contents reflecting the manifold social, economic and spiritual activities that took place within it.<sup>6</sup> I focus here on Middle English texts in British manuscripts, but similar books are also found elsewhere, such as the German *Hausbücher*. Julia Boffey defines domestic miscellanies as simply one that “enjoyed ‘household’ use in a range of domestic or communal contexts”, with household manuscripts united more by “content and nature of use” than by “the methods by which they were compiled”.<sup>7</sup> The manuscript pages bear witness to much usage over a long period of time, with staining associated with wear and tear, fingerprints, wax or oil stains, rust from metallic objects left on pages, edits, repairs, ownership inscriptions (which can be particularly revealing of readerships within households and across wider textual networks) and various marginalia. In some manuscripts, a gradual change in their function can be observed, as they were passed from family to household servants and then served primarily as a source of blank paper for haphazard writing of inventories, memoranda, letter drafts, pen trials and doodles: for example, the Findern manuscript has a household account detailing crockery and fabric items at Findern and an inventory added in c. 1550, but also features a significant collection of unique lyric poems dating from this later phase of use.<sup>8</sup>

---

<sup>6</sup> Julia Boffey and John J. Thompson, ‘Anthologies and Miscellanies: Production and Choice of Texts’, in *Book Production and Publishing in Britain 1375-1475*, ed. Jeremy Griffiths and Derek Pearsall (Cambridge: Cambridge University Press, 1989), 279–315; Julia Boffey, ‘Bodleian Library, MS Arch. Selden. B. 24 and Definitions of the “Household Book”’, in *The English Medieval Book: Studies in Memory of Jeremy Griffiths*, ed. A.S.G. Edwards, Vincent Gillespie, and Ralph Hanna (London: British Library, 2000), 125–34; Julia Boffey and A.S.G. Edwards, ‘Towards a Taxonomy of Middle English Manuscript Assemblages’, in *Insular Books: Vernacular Manuscript Miscellanies in Late Medieval Britain*, ed. Margaret Connolly and Raluca Radulescu (Oxford: Oxford University Press for the British Academy, 2015), 263–79; Michael Johnston, ‘New Evidence for the Social Reach of “Popular Romance”: The Books of Household Servants’, *Viator* 43, no. 2 (2012): 303–32; David R. Parker, *The Commonplace Book in Tudor London: An Examination of BL MSS Egerton 1995, Harley 2252, Lansdowne 762, and Oxford Balliol College MS354* (Maryland: University Press of America, 1998); Phillipa Hardman, ‘Domestic Learning and Teaching: Investigating Evidence for the Role of “Household Miscellanies” in Late-Medieval England’, in *Women and Writing c. 1340-c.1650: The Domestication of Print Culture*, ed. Anne Lawrence Mathers and Phillipa Hardman (York: York Medieval Press, 2010), 15–33; George Shuffelton, ‘Is There a Minstrel in the House?: Domestic Entertainment in Late Medieval England’, *Philological Quarterly* 87, no. 1/2 (2008): 55; Margaret Connolly and Raluca Radulescu, ‘Introduction’, in *Insular Books: Vernacular Manuscript Miscellanies in Late Medieval Britain*, ed. Margaret Connolly and Raluca Radulescu (Oxford: Oxford University Press for the British Academy, 2015), 6; Phillipa Hardman, ‘A Medieval “Library in Parvo”’, *Medium Ævum* 47 (1978): 262–73.

<sup>7</sup> Boffey, ‘Bodleian Library, MS Arch. Selden. B. 24 and Definitions of the “Household Book”’, 126.

<sup>8</sup> Rossell Hope Robbins, ‘The Findern Anthology’, *PMLA* 69, no. 3 (1954): 620; Johnston, ‘New Evidence for the Social Reach of “Popular Romance”: The Books of Household Servants’.

I examined nine household manuscripts as part of my research: Aberystwyth, National Library of Wales MS Brogyntyn II.1 (formerly Porkington 10); Cambridge, University Library MS Ff.1.6 (the Findern manuscript); Cambridge, University Library MS Ff.2.38; Cambridge, University Library MS Ff.5.48 (the Pilkington manuscript); Edinburgh, National Library of Scotland Advocates MS 19.3.1 (the Heege manuscript); Lincoln, Cathedral Library MS 91 (the Lincoln Thornton manuscript); London, British Library Cotton MS Caligula A.ii; London, British Library Additional MS 31042 (the London Thornton manuscript) and Oxford, Bodleian Library MS Ashmole 61.<sup>9</sup> Alongside a general palaeographical and codicological appraisal of each manuscript, I searched for evidence of and features relating to reading practices and reader engagement, such as annotations, staining, the layout of the texts and paratextual features. The selection was based on the household manuscripts identified by Julia Boffey and John J. Thompson, manuscripts containing romances from Gisela Guddat-Figge's catalogue and further suitable manuscripts I had identified: a pool of just under 60 manuscripts, which included outliers like commonplace books, which belong to a similar usage context but different production rationales and techniques, and Sir John Paston's "grete bok" (London, British Library Lansdowne MS 285) which is associated with a known figure, but lacks the varied texts and evidence to suggest communal, household usage.<sup>10</sup> I then selected the small group of the nine focus manuscripts above which are datable to the fifteenth century, contain romances (or comparable secular texts for entertainment) and either have specific household connections or sufficient overlapping texts and features to make a strong case for household ownership and usage. I eventually narrowed the focus to consider only a selection of Middle English romances within these manuscripts: *Sir Eglamour of Artois* (CCAii, Li 91, Ff.2.38), *Sir Degrevant* (Li 91, Findern), *Sir Orfeo* (Ashmole 61) and *Sir Isumbras* (Ashmole 61, CCAii, Heege, Li 91) and one comic tale "The Tournament of Tottenham" (Ff.5.48). I ensured that the text and manuscript selection reflected both urban and rural contexts and both commercial and non-commercial production.<sup>11</sup> Whilst some books and quires were sourced or commissioned from professional scribes and booksellers, some of the manuscripts are written and produced by their users, who evidently received no formal training in book creation. These user-creators are often referred to as 'amateur'

---

<sup>9</sup> The manuscripts frequently referenced are henceforth abbreviated as Findern MS; Ff.2.38; Ff.5.48; Heege MS; Li 91; CCAii and Ashmole 61.

<sup>10</sup> Boffey and Thompson, 'Anthologies and Miscellanies: Production and Choice of Texts'; Gisela Guddat-Figge, *Catalogue of Manuscripts Containing Middle English Romances* (Munich: Wilhem Fink Verlag, 1976).

<sup>11</sup> Boffey and Thompson, 'Anthologies and Miscellanies: Production and Choice of Texts', 292; Kathryn Kerby-Fulton and Denise L. Despres, 'Introduction', in *Iconography and the Professional Reader: The Politics of Book Production in the Douce Piers Plowman* (Minneapolis: University of Minnesota Press, 1999), 1–14.

scribes, however, in many cases they show skill in presenting their texts. Robert Thornton executes a complicated layout change from single to double columns on Li 91, f. 98v and uses formal signalling apparatus like titles, incipits and explicits throughout. However, some other technical aspects of bookmaking are executed less-proficiently, and non-commercial scribes often show irregularity in scribal hands and presentation, expanding and compressing their text, line-spacing and layouts.

The nine focus manuscripts are connected with households from the rural gentry and the urban, mainly mercantile, elite: not considered among the nobility but also sufficiently literate and wealthy to own and use a manuscript. Within the pool of manuscripts, some are connected to known households like the neighbouring Derbyshire gentry families who used and perhaps even created the Findern manuscript and the household of prosperous Yorkshire gentleman Robert Thornton, the highest-status of the households and the manuscripts, which contains high-grade paper and professionally-executed decorated capitals.<sup>12</sup> Others are more generally connected to a social group, such as the mercantile elite, whose recent increase in capital and social standing created a new demand for texts and books that reflected their ambitions, including Ashmole 61, which is connected to unknown owners in Leicester.<sup>13</sup> Also represented is a socially-mobile yeoman family: the Sherbrooks, connected with the Heege manuscript.<sup>14</sup> The other manuscripts have not been linked to specific families or even in some cases to specific locations, but

---

<sup>12</sup> Robbins, 'The Findern Anthology'; Kate Harris, 'The Origins and Make-up of Cambridge University Library MS Ff.1.6', *Transactions of the Cambridge Bibliographical Society* 8, no. 3 (1983): 299–333; Ralph Hanna, 'The Production of Cambridge University Library MS. Ff. i. 6', *Studies in Bibliography* 40 (1987): 62–70; Michael Johnston, 'Introduction: The Cheese and the Worms and Robert Thornton', in *Robert Thornton and His Books: Essays on the Lincoln and London Thornton Manuscripts*, ed. Susanna Fein and Michael Johnston (York: York Medieval Press, 2014), 2, 9; George R. Keiser, 'Robert Thornton: Gentleman, Reader and Scribe', in *Robert Thornton and His Books: Essays on the Lincoln and London Thornton Manuscripts*, ed. Susanna Fein and Michael Johnston (York: York Medieval Press, 2014), 71; Joel Fredell, 'The Thornton Manuscripts and Book Production in York', in *Robert Thornton and His Books: Essays on the Lincoln and London Thornton Manuscripts*, ed. Susanna Fein and Michael Johnston (York: York Medieval Press, 2014), 110–13.

<sup>13</sup> Lynne S. Blanchfield, 'The Romances in MS Ashmole 61: An Idiosyncratic Scribe', in *Romance in Medieval England*, ed. Maldwyn Mills, Jennifer Fellows, and Carol M. Meale (Cambridge: D. S. Brewer, 1991), 65, 80–86; George Shuffelton, ed., 'Codex Ashmole 61: Introduction', in *Codex Ashmole 61: A Compilation of Popular Middle English Verse*, TEAMS Middle English Texts Series (Kalamazoo, Michigan: Medieval Institute Publications, 2008); Michael Johnston, 'Two Leicestershire Romance Codices: Cambridge, University Library MS Ff.2.38 and Oxford, Bodleian Library MS Ashmole 61', *Journal of the Early Book Society* 15 (2012): 85–100; Lynne S. Blanchfield, "'An Idiosyncratic Scribe": A Study of the Practice and Purpose of Rate, the Scribe of Bodleian Library MS Ashmole 61' (PhD Thesis, University College of Wales, Aberystwyth, 1991), 157–61, 695.

<sup>14</sup> Thorlac Turville-Petre, 'Some Medieval English Manuscripts in the North-East Midlands', in *Manuscripts and Readers in Fifteenth-Century England: The Literary Implications of Manuscript Study*, ed. Derek Pearsall (Cambridge: D. S. Brewer, 1983), 125–41; Michael Johnston, *Romance and the Gentry in Late Medieval England* (Oxford: Oxford University Press, 2014), 147–50.



contain domestic-oriented texts and are very comparable in terms of contexts and presentation.

### **Reading modalities**

Household manuscripts could be read and used in many different ways, as their varied contents demonstrate. For example, Joyce Coleman, a leading scholar on aurality, calls reading a comic tale in leisure time “recreational reading”.<sup>15</sup> Reading a treatise by picking out a relevant section of text for reference (rather than reading it in order) and following the instructions for practical purposes I have termed ‘referential pragmatic reading’. A single reader has many options for how they can experience a text: there are as many ways to read a medieval text as there are medieval readers. Some ways were only accessible to skilled or trained readers, or to those who had the means to hire them, such as dramatic readings for formal occasions by professional performers, or memorised ‘readings’. Within each type of reading exists further possibilities which Coleman calls “modalities”, reflecting the method and context of the reception.<sup>16</sup> Modalities can be divided into communal or solitary, as well as into oral/aural or written/silent. These two divisions overlap but are not entirely interchangeable. For example, a reader could read aloud privately to themselves, which, as many scholars have noted, was the norm in Late Antiquity and the early Middle Ages.<sup>17</sup> Reading modalities have been historically discussed as a spectrum of composition, transmission and reception possibilities, ranging from *oral* at one extreme to *literate* at the other. However, this imposes a dangerously one-dimensional model on the material, and encourages the erroneous but pervasive narrative of progression with oral texts seen as primitive and undeveloped and written texts as the full realisation of civilised literature. In fact, the complex interaction of medieval oral cultures, aurality and literacy does not map easily onto such a scale. I argue that a better model is a cloud of reception possibilities: some aural, some literate; some solitary, some communal. Importantly, all of these modalities are potentially performative. I have represented possible modalities for the story of a medieval romance in Figure 1.2,

---

<sup>15</sup> Joyce Coleman, *Public Reading and the Reading Public in Late Medieval England and France* (Cambridge: Cambridge University Press, 1996), 88.

<sup>16</sup> Coleman, 34, 229.

<sup>17</sup> This has been widely recognised since the publication of two main articles: Josef Balogh, ‘Voces Paginorum’, *Philologus* 82 (1927): 84–109, 202–40 and G.L. Hendrickson, ‘Ancient Reading’, *The Classical Journal* 25 (1929): 182–96. See also Paul Henry Saenger, *Space between Words: The Origins of Silent Reading* (Stanford, California: Stanford University Press, 1997) and the famous example of Ambrose reading silently in Augustine's *Confessions*, VI.3.

combining the modes and models of reading outlined by Coleman, Parkes, Green and Clanchy and adding my own terms where I found categories missing.<sup>18</sup>

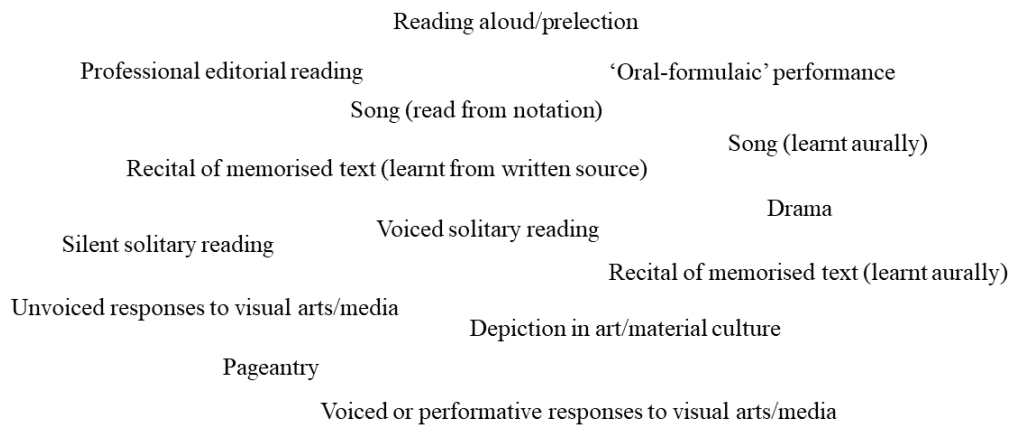

Figure 1.2: The ‘cloud of modalities’: a representation of possible different forms in which a story could be encountered.

The modality of the source material can also be considered: whether the source is oral/aural or written/visual, and additionally whether a material form of the text is physically present during the reception event.<sup>19</sup> The most relevant reading modes and methods for this study are:

- solitary or private reading, which can be both voiced and unvoiced
- communal or public reading aloud, which Coleman terms “prelection”. This is not to be confused with classical prelection or *praelectio*, which is the preparatory reading of texts in *scriptura continua*.<sup>20</sup>
- performing a story memorised from a written text<sup>21</sup>

<sup>18</sup> Coleman, *Public Reading and the Reading Public*, 34–36, 88; M.B. Parkes, ‘The Literacy of the Laity’, in *Literature and Civilisation: The Mediaeval World*, ed. David Daiches and Anthony Thorlby (London: Aldus Books, 1973), 555; D.H. Green, *Medieval Listening and Reading: The Primary Reception of German Literature 800-1300* (Cambridge: Cambridge University Press, 1994), 60; Michael T. Clanchy, ‘Looking Back From the Invention of Printing’, in *Literacy in Historical Perspective*, ed. Daniel P. Resnick (Washington: Library of Congress, 1983), 16–17. Professional editorial reading is discussed at length in Kathryn Kerby-Fulton, *The Medieval Professional Reader at Work: Evidence from Manuscripts of Chaucer, Langland, Kempe, and Gower*, ed. Kathryn Kerby-Fulton and Maidie Hilmo (Victoria: English Literary Studies, University of Victoria, 2001).

<sup>19</sup> Devotional reading in particular, although not the main focus here, adds further specific categories such as preaching, monastic *ruminatio* and voiced and unvoiced devotional textual activities, both communal and solitary.

<sup>20</sup> Coleman, *Public Reading and the Reading Public*, 35; Saenger, *Space between Words: The Origins of Silent Reading*.

<sup>21</sup> A.C. Baugh, ‘Improvisation in the Middle English Romance’, *Proceedings of the American Philosophical Society* 103 (1959): 418–54; Murray McGillivray, *Memorization in the Transmission of the Middle English Romances* (New York and London: Garland Publishing, 1990).

- retelling a story from memorised patterns learnt orally/aurally (similar to what was known in earlier scholarship as ‘oral-formulaic’ performance or what Evelyn Birge Vitz calls “improvised retelling”)<sup>22</sup>
- dramatic performance (involving one or more performers physically acting out the story)

A reader can engage with each text using multiple modalities, perhaps even within the same reception event. For example, a reader-aloud of a romance could momentarily halt their reading from the page to improvise based on their recollection of the next part of the story. In this broad model, ‘reading’ is simply the process of realising a text and does not always imply the presence of a physical book, as in memorised performative reading, or in visual arts which feature literary content which could be read silently or aloud alongside the internalised performative reception of the images – for example the *Pricke of Conscience* window in All Saints North Street, York, which combines images in stained glass with captions of written lines from the mid-fourteenth century poem, or late medieval and early modern wall paintings which include excerpts from Biblical texts or moral precepts as part of their decorative schemes.<sup>25</sup> However, the material form of the book is central to my analysis of domestic reading practices: it takes the texts as found in the household manuscripts as the primary category of inquiry. I will focus only on those modalities that can be linked to reading romances as they are found in household manuscripts. I argue throughout that these textual witnesses are set up specifically in anticipation of multi-modal reading. That is, readers of the manuscripts could choose to use the same romance text for both communal reading and silent, solitary reading, or other modes as they saw fit. I use two main sources for my investigation of reading practices: the manuscripts and physical forms of the texts, and practical, experimental analysis. The latter necessitates a focus particularly on performative reading modalities, as these are most

---

<sup>22</sup> Evelyn Birge Vitz, ‘Introduction’, in *Performing Medieval Narrative*, ed. Evelyn Birge Vitz, Nancy Freeman Regalado, and Marilyn Lawrence (Cambridge: D. S. Brewer, 2005), 3; Milman Parry, *The Making of Homeric Verse: The Collected Papers of Milman Parry*, ed. Adam Parry (Oxford: Clarendon Press, 1971); Albert B. Lord, *The Singer of Tales*, ed. Stephen Mitchell and Gregory Nagy, 2nd ed. (Cambridge, Massachusetts: Harvard University Press, 2000); Francis P. Magoun, ‘Oral-Formulaic Character of Anglo-Saxon Narrative Poetry’, *Speculum* 28 (1953): 446–67; William A. Quinn and Audley S. Hall, *Jongleur: A Modified Theory of Oral Improvisation and Its Effects on the Performance and Transmission of Middle English Romance* (Washington, D.C.: University Press of America, 1982); Karl Reichl, ‘Turkic Bard and Medieval Entertainer: What a Living Epic Tradition Can Tell Us about Oral Performance of Narrative in the Middle Ages’, in *Performing Medieval Narrative*, ed. Evelyn Birge Vitz, Nancy Freeman Regalado, and Marilyn Lawrence (Cambridge: D. S. Brewer, 2005), 167–78.

<sup>25</sup> *Pricke of Conscience Window*, c. 1410-1420, Stained glass, All Saints Church, North Street, York; Heather Blatt, *Participatory Reading in Late-Medieval England* (Manchester: Manchester University Press, 2018), 105–66, <https://doi.org/10.7765/9781526118004>; Hamling and Richardson, *A Day at Home in Early Modern England: Material Culture and Domestic Life, 1500-1700*.

suitable to this practice-as-research methodology. I use first-person practical investigation to not just analyse but to *experience* the reading of these key texts using manuscripts or physical stand-ins.

‘Performative reading’ is difficult to define precisely. Performance encompasses a broad spectrum of human activity, and performance of narrative is likewise multifaceted. Many kinds of medieval reading can be performative and medieval texts evoke and encourage multiple modes of engagement.<sup>26</sup> The reader/performer brings the text to life for their audience, even if the audience is perhaps only themselves. Thus, even a solitary reader reading quietly can be said to be performing. This solitary performative reading is especially related to affective devotional reading.<sup>27</sup> I focus on performative reading related to the practice of reading aloud: a multisensory reading event in which the words and texts are conveyed by a performer using their voice, modulated by the use of elements like gesture, diction, pace, props and music, and experienced by a listening, watching, participating audience. I use ‘performative reading’, ‘communal reading’, ‘audiate reading’ and ‘reading aloud’ throughout more or less interchangeably as a category that contrasts with ‘solitary’, ‘private’ or ‘silent’ reading by virtue of its communal and potentially theatrical reception context/s. Each term reflects a slightly different nuance of the modality: the reader-aloud who performs; the state of sharing a text between reader-aloud and audience; and the sharing in a reading reception by a group of people who are “audiate” – experienced and skilled in receiving texts aurally (a term used to deliberately contrast with ‘literate’).<sup>28</sup> My use of these terms is not intended to diminish the performativity or theatricality of silent reading, but to place the emphasis on modalities that involve oral/aural receptions.

Performative analysis of works that tend to be analysed mainly literarily opens up further nuances and shades of meaning that are lost when they are accessed only silently as written words, a concept Paul Zumthor’s termed ‘*vocalité*’, which is translated by Heather

---

<sup>26</sup> Vitz, ‘Introduction’, 3; Jessica Brantley, *Reading in the Wilderness: Private Devotion and Public Performance in Late Medieval England* (Chicago: University of Chicago Press, 2007); Blatt, *Participatory Reading in Late-Medieval England*, 110.

<sup>27</sup> Caroline Walker Bynum, *Jesus as Mother: Studies in the Spirituality of the High Middle Ages*, vol. 16, Publications of the Center for Medieval and Renaissance Studies (Berkeley and London: University of California Press, 1982); Marlene Villalobos Hennessy, ‘Passion Devotion, Penitential Reading, and the Manuscript Page: “The Hours of the Cross” in London, British Library Additional 37049’, *Mediaeval Studies* 66 (2014): 213–52; Sarah McNamer, *Affective Meditation and the Invention of Medieval Compassion* (Philadelphia: University of Pennsylvania Press, 2010).

<sup>28</sup> W.F. Bolton, ‘Introduction: The Conditions of Literary Composition in Medieval England’, in *History of Literature in the English Language*, ed. W.F. Bolton, vol. 1: The Middle Ages (London: Barrie and Jenkins, 1970), xvii.

Maring as “the notion that texts manifest themselves fully when voiced”.<sup>29</sup> The experience of engaging with a text performatively is fundamentally different from encountering that text written upon the page. Readers encounter the text with different senses, with different reading processes and different depths of comprehension. Psycholinguistics shows that reading aloud and reading silently involve fundamentally separate brain functions.<sup>30</sup> Research by scholars of aurality and textual performativity (foremost among them for my purposes Coleman, Vitz and Linda Marie Zaerr) have paved the way for more extensive engagement with the performativity of medieval texts. As such, this thesis does not dwell overmuch on proving that medieval romances are performative but instead treads new ground, investigating the performative potential of romance and the impact when this potential is realised in the ‘reauralised’ and re-placed romance. The ‘Reading Malory Aloud, Then and Now’ project run by Karen Cherewatuk and D. Thomas Hanks, Jr. at the 26<sup>th</sup> International Congress on Medieval Studies held in Kalamazoo, Michigan in 1991 provided an excellent precedent for investigating and staging the performative reception of a text that is roughly contemporary with the household manuscripts examined here and normally read silently today.<sup>31</sup> Many scholars incorporate reading aloud of romances in a classroom setting to aid Middle English comprehension, and a wide range of videos of performed medieval narrative are collected online, along with the work of performance-scholars like Zaerr and Benjamin Bagby demonstrate that this is a highly effective way to engage with the texts and to bring them to a wider audience.<sup>32</sup> My experiments simulate the medieval experience of performative romance-reading by reading aloud excerpts of Middle English romances directly from the manuscript page and using manuscript stand-ins in surviving medieval spaces with a group of participants who were as close to ‘audiate’ as possible, either through their own expertise, or trained in Middle English, palaeography and performance in a process partially modelled after the contextual training

---

<sup>29</sup> Heather Maring, ‘Performing Pearl’, in *Approaches to Teaching the Middle English Pearl*, ed. Jane Beal and Mark Bradshaw Busbee, *Approaches to Teaching World Literature* 143 (New York: The Modern Languages Association of America, 2018), n.p.

<sup>30</sup> Susan Y. Bookheimer et al., ‘Regional Cerebral Blood Flow during Object Naming and Word Reading’, *Human Brain Mapping* 3, no. 2 (1995): 93–106; Sun-Ah Jun, ‘The Implicit Prosody Hypothesis and Overt Prosody in English’, *Language and Cognitive Processes* 25, no. 7–9 (2010): 1201–33.

<sup>31</sup> The project was detailed in a special issue of *Arthuriana* journal (Vol. 13, no. 4, 2003).

<sup>32</sup> Linda Marie Zaerr, *Performance and the Middle English Romance* (Cambridge: D. S. Brewer, 2012); Linda Marie Zaerr, ‘*The Weddyng of Sir Gawen and Dame Ragnell*’, in *Performing Medieval Narrative* (Cambridge: D. S. Brewer, 2005), 193–208; Benjamin Bagby and Stellan Olsson, *Beowulf: Voice and Anglo-Saxon Harp*, DVD (New York: Charles Morrow Productions LLC and Jon Aaron, 2006); Evelyn Birge Vitz, Nancy Freeman Regalado, and Marilyn Lawrence, ‘Videos’, *Mednar: Performing Medieval Narrative Today A Video Showcase*, accessed 7 January 2020, <http://mednar.org/videography/>; ‘Medieval Tales in Performance’, *YouTube*, accessed 7 January 2020, <https://www.youtube.com/channel/UC2wz1uR1SI93vNMWML2Ieyw>.

sometimes undertaken by practitioners of early modern drama.<sup>33</sup> My research returns performative elements to medieval reading and texts and re-situates them in more ‘authentic’ performance contexts: a process I call ‘reauralising’. This term emphasises the aurality and the acoustics of this reading modality, but the experiments aim to simulate (as far as possible) the entire multisensory, spatial and material experience of communal romance reading in historic spaces. Crucially, this process also returns manuscripts to the centre of studies of textual reception, considering the intersection of performance and materiality and allowing for a more nuanced study of reading practices that suggests insights not just about performative reading, but also about the physical forms of the texts as they survive in household manuscripts. I reconstruct reading events that simulate the original reading contexts of the romance, for example, a gathering of members of a household, or even multiple households or families, to share in the mutual pleasure of story-telling. The experiments also model ways in which the heritage industry can engage visitors and modern pedagogy can provide students with the skills necessary to engage with Middle English romances on deeper levels, considering manuscript context, social history, historical spaces and historical performance practices. Performance is a powerful tool for education and outreach, making historical material engaging and entertaining.

My use of the word ‘authentic’ requires further qualification. In practical historical research areas such as Early Music or living history, the term has been the subject of decades of heated debate, with the result that an ‘authentic’ performance or interpretation merely became one with a different interpretation of the sources to the previous generation of performances, rather than necessarily an accurate reconstruction. Early Music now instead strives for ‘historically informed’ performances, acknowledging the impossibility of complete reproductions of historical music.<sup>34</sup> This study follows a similar mindset, acknowledging that a fully accurate restaging of medieval performative reading is impossible: we are modern readers, not medieval readers, and no matter the extent of our training, we have no access to the life experience, skills, setting and time that generated a medieval reading experience. As Zaerr points out, even an adequate reconstruction of a medieval performance will never be a medieval performance.<sup>35</sup> We can only ever interpret based on an incomplete set of evidence and fill in the gaps with our best guesses obtained through experimentation and our own (modern) experiences. Even if we happen to chance

---

<sup>33</sup> Oliver Jones, ‘The Queen’s Men on Tour: Provincial Performance in Vernacular Spaces in Early Modern England’ (PhD Thesis, University of York, 2012), 144–53.

<sup>34</sup> Daniel Leech-Wilkinson, *The Modern Invention of Medieval Music: Scholarship, Ideology, Performance*, Musical Performance and Reception (Cambridge: Cambridge University Press, 2002); Jonathan Shull, ‘Locating the Past in the Present: Living Traditions and the Performance of Early Music’, *Ethnomusicology Forum* 15, no. 1 (2006): 87–111.

<sup>35</sup> Zaerr, *Performance and the Middle English Romance*, 15.

upon the correct interpretation, there is no way to actually prove its truth. However, nuance can be found in the word authenticity. Authenticity is here used to describe a *quality* of evocative experience, rather than its accuracy. An authentic performance therefore is one that lifts the audience out of their present time and place and invites them to imagine a version of the past. This concept risks confusing authenticity and truth, however, and the reenactor or performer has a crucial responsibility to ensure that the vision of the past they evoke is historically-informed and explicitly a simulation rather than a perfect replica. We create a *simulacrum* of the past: a copy that stands in the place of the original.<sup>36</sup> This *simulacrum* of historical performance can trigger a different mindset in the audience and thus encourage them to interact with medieval texts in different ways and to reflect on their experiences constructively. This is a key part of the methodology and the chief source of value in performative and practical investigations: although they suggest possibilities for the past, they only ever truly reflect the present. Even though we cannot ever hope to accurately replicate a medieval performance, in striving for an accurate or authentic recreation of a medieval experience we in fact learn more about our own assumptions and interpretations as modern readers. By encouraging participants to deeply engage with texts in different ways, particularly ways which are immersive, authentic and experiential, the experiments I devised allowed the readers to view the texts in a new light and to respond creatively and actively to them.

A medieval reading event in a household combines the broader personal, social, aesthetic, religious, educational, gendered, even economic, political or geographical experiences of its audience. My investigation explores not only the relationship between text, performer and audience, but also their relationship to space (the location within the house, its acoustic qualities, its habitual usage), to materiality (the physical form of the book itself, furniture used by reader and audience), and any additional sensory information (the quality of the lighting used, scents associated with the space, the sounds of performance or even sensory input that intrudes on the performance). It is necessary that a modern analysis and reconstruction of medieval reading contexts is sympathetic to these influences. Therefore, I take an interdisciplinary approach, combining literary and palaeographical/codicological analysis with archaeology, particularly the study of material spaces and artefacts, experimental archaeology and archaeoacoustics, as well as social history, music theory and psycholinguistics. Both phenomenology and the concept of 'lived experience' are crucial to this investigation as domestic performative reading is a material, emplaced and multi-sensory experience with specific performative, physical and

---

<sup>36</sup> Jean Baudrillard, *Simulations*, trans. Paul Foss et al. (New York: Semiotexte Inc., 1983).

social contexts.<sup>37</sup> In this approach, I follow recent developments in archaeology, which focus on the material, the sensory, the experiential and the quotidian as central ways to fully understand the multifaceted nature of lived historical practices.<sup>38</sup> Although a result of these new approaches is a focus on empirical and quantitative research, particularly enabled through technological developments and the growth of Digital Humanities which allow for detailed digital mapping of objects, soundscapes, spaces and wider landscapes, my research, whilst it drew on these developments, investigated experience experientially and qualitatively. My qualitative focus follows methodologies found in three kinds of first-person, practical investigations: practice-as-research, living history and experimental archaeology. Experimental archaeology in particular posits that imitating or replicating past actions can lead to a better understanding of them.<sup>39</sup> In the same way that experimental archaeologists try to recreate processes like flint knapping based on material traces, I attempt to recreate a lost practice based on the material form of the household manuscript, although with greater sensitivity towards the original context of the reconstructed act – a process which Dragoş Gheorghiu distinguishes as *experiential* archaeology.<sup>40</sup>

---

<sup>37</sup> Matthew Johnson, 'Introduction', in *Lived Experience in the Later Middle Ages: Studies of Bodiam and Other Elite Landscapes in South-Eastern England*, ed. Matthew Johnson (York: Council for British Archaeology, 2017), 1–8; Christopher Tilley, *The Materiality of Stone: Explorations in Landscape Phenomenology* (Oxford: Berg, 2004); Pamela Sheingorn, 'Performing the Illustrated Manuscript: Great Reckonings in Little Books', in *Visualizing Medieval Performance: Perspectives, Histories, Contexts*, ed. Elina Gertsman (Aldershot: Ashgate, 2008), 57–82.

<sup>38</sup> Gilchrist, *Medieval Life: Archaeology and the Life Course*; Matthew Johnson, *English Houses 1300-1800: Vernacular Architecture, Social Life* (Harlow: Pearson Longman, 2010); Matthew H. Johnson, 'What Do Medieval Buildings Mean?', *History and Theory* 52, no. 3 (2013): 380–99; Johnson, 'Introduction'; Catriona Cooper, 'Lived Experience at Bodiam and Ightham', in *Lived Experience in the Later Middle Ages: Studies of Bodiam and Other Elite Landscapes in South-Eastern England*, ed. Matthew Johnson (York: Council for British Archaeology, 2017), 143–57; Hamling and Richardson, *A Day at Home in Early Modern England: Material Culture and Domestic Life, 1500-1700*; Maryanne Kowaleski and P.J.P. Goldberg, eds., *Medieval Domesticity: Home, Housing and Household in Medieval England* (Cambridge: Cambridge University Press, 2008).

<sup>39</sup> John Coles, *Experimental Archaeology* (Caldwell, N.J.: Blackburn Press, 1979); Stephen Saraydar, *Replicating the Past: The Art and Science of the Archaeological Experiment* (Long Grove, Illinois: Waveland Press, 2008); Colin Renfrew and Paul Bahn, *Archaeology: Theories, Methods and Practice*, 8th Edition (London: Thames and Hudson, 2020), <https://ebookcentral.proquest.com/lib/york-ebooks/detail.action?docID=6178544>.

<sup>40</sup> Dragoş Gheorghiu, 'Lighting in Reconstructed Contexts: Experiential Archaeology with Pyrotechnologies', in *The Oxford Handbook of Light in Archaeology*, ed. Costa Papadopoulos and Holley Moyes (Published online: Oxford University Press, 2017), n.p.



## **Structure and Aims**

The main aims of this thesis are twofold. Firstly, to ‘reauralise’ medieval romance: to return Middle English romances to historically-informed performative reception contexts in the present day, reading from the pages of their manuscripts and re-situating them in historical spaces. This approach requires a deep understanding of the textual, palaeographical, performative, social and archaeological factors upon which reading is contingent, which will be outlined throughout the first part of this thesis. Secondly, to investigate the impact of these reading practices on the modern reader, investigating whether the transformative power of performance can reveal new understandings and appreciation of the text and the spaces within the medieval house, and uncover nuances of meaning. In doing so, I strongly promote the use of performance when studying and teaching Middle English romance and propose a methodology for conducting such experimental performances.

Chapter One establishes the methodological and disciplinary foundations of this thesis, defining key terms, reviewing the field of romance performance and outlining how my analysis will draw on performance studies and practice-as-research. I review other previous performances of medieval romances and consider how my performative analysis can build on their insights. I also consider briefly historical and textual evidence for romance performance. Chapter Two takes a closer look at the focus manuscripts, investigating manuscript features relating to reception, including evidence for readership engagement and the many ways in which scribes and authors anticipate and support certain reception contexts for their works. Chapter Three explores the material and spatial elements of the project, considering the medieval house as a stage for performative textual activities and text and book as physical objects. I discuss the material and multi-sensory experience of reading and the relationship between performer, body, text and location, considering the influence of elements like lighting conditions, furniture, the physical form of the text and the space of the house. It also introduces the buildings used in the experiments – Gainsborough Old Hall, a medieval manor house in Lincolnshire and Barley Hall, a reconstructed historic house in York. Finally, Chapter Four discusses the series of experimental performances which staged readings of excerpts from romance texts in multiple spaces throughout the houses. I discuss the development of participants’ responses to texts when staged in different locations, using different methods and different reading modalities. The reauralised and re-emplaced romances allowed the participants to investigate the embodied experience of reading aloud. I will reconsider the implications of performance for studying romance, household manuscripts and historical reading practices. Additionally, Appendix A provides detailed codicological descriptions of the focus

manuscripts, contextualising the texts used in the experiments. Appendix B catalogues the accompanying video footage of the experiments and Appendix C provides supplementary material used in the experiments (handouts and translations of the romance excerpts). Appendix D contains material related to the formal ethics approval process and reproduces the questionnaires used to obtain participant feedback.

This thesis has at its heart a series of questions to which there can be no definite answers: I seek to investigate a personal and individual experience and to recreate a specific event about which there survives very little concrete evidence. A performance is a collaboration or a conversation between performer and audience. To reconstruct medieval performance is to attempt to eavesdrop on a conversation that has long since fallen silent. As such, much of the evidence is necessarily qualitative rather than quantitative or exact, but in this way is able to account for the nuances and individuality of lived experiences. Above all else this thesis celebrates popular literature. It honours the quotidian and the amateur. It leaves aside notions of the perceived literary merit of romances and instead upholds reading as a pleasant communal or solitary leisure activity that united medieval people in the love of a good story, and invites modern readers to join in as well.

# CHAPTER 1. Performance in History and Practice

## 1.1 Introduction

*“performance is for music a sine qua non, without which it cannot be studied, appreciated, or enjoyed.”<sup>1</sup>*

All medieval reading can be considered performative, as outlined in the Introduction. Why then is performance studies not given greater prominence in the study of medieval literature? This thesis argues that studies of medieval romance that do not engage with reading modalities cannot fully appreciate the medieval experience of the text. It is akin to studying music without hearing or playing it, or analysing Shakespeare without ever watching the plays staged: a limited and one-dimensional study, lacking insight in the dynamics and vibrancy of the performed text.

The discussion of performance in this thesis has two facets. The first is the study of historical performance, exploring the communal and performative reception of texts in the pool of fifteenth-century household manuscripts. Medieval texts are charged with performative potential. I will examine different ways in which this potential could have been realised in medieval romances, engaging with the wider scholarly debates of orality/aurality/literacy that have dominated previous performance-related studies of medieval literature. This analysis will reference contemporary records of narrative performance, both of romances and of other comparable forms like drama and *chanson de geste*. The second facet is the adaptation of this historical evidence to stage modern-day performances of medieval material, including my own romance-reading experiments which use performance as an investigative tool to further understand the contents and usage of household manuscripts.

This chapter lays out the methodological and disciplinary foundations for these two facets of performance. Beginning with performance theory, I will explore definitions and understandings of performance more generally, before narrowing the focus to romance-reading, particularly in a household setting. I summarise previous investigations of romance performance, which often have been preoccupied with musical performance. This discussion continues in Chapter 2, which considers the implications and practicalities

---

<sup>1</sup> Yossi Maurey, ‘Performing Our Practices: Between Music and Musicology’, in *Visualizing Medieval Performance: Perspectives, Histories, Contexts*, ed. Elina Gertsman (Aldershot: Ashgate, 2008), 281.

of musical romance performance on the surviving physical texts and manuscripts. I discuss the methodologies that underlie my experiments as drawn from various practices like experimental archaeology, reenactment/living history and practice-as-research, with reference to the parallel traditions of Early Music and reconstructions of early modern drama. Finally, I explore key examples of modern-day medieval performance which informed my own experimental performances. The inclusion of some form of practical performance is crucial to an effective study of performance and the analysis here anticipates my performative reading experiments which will be the focus of Chapter 4. In anticipation of these experiments I reflect on the unique challenges posed by investigating performance, as well as its unique strengths.

## 1.2 Definitions and Theory

The sociological concept of performance includes not just the artistic productions that instantly spring to mind with the term – theatre, music, performance art – but encompasses all of everyday human action. Sociologist Erving Goffman defines performance as “all the activity of a given participant on a given occasion which serves to influence in any way any of the other participants.”<sup>2</sup> According to performance theorist Richard Schechner, all human activity is “restored behaviour” – that is, actions prepared and practiced – but each performance is unique, based in its time, space, context, reception and interactivity.<sup>3</sup> Following this definition of performance, the everyday actions, habits and social roles of the users of late medieval household manuscripts are just as performative as their reading activities. Schechner clarifies that whilst anything can be studied ‘as’ performance, what *is* performance, especially artistic performance, is culturally and historically contingent.<sup>4</sup> Schechner’s efficacy-entertainment binary creates a contrast between ritual performance, which has a participating, believing audience, and performing arts, which have an observing, appreciating audience.<sup>5</sup> However, for Ronald L. Grimes, this division is erroneous as the audience is always an active element in performance.<sup>6</sup> This thesis follows Grimes: a watching audience is always an active participant in performance, especially in performances of Middle English romances which frequently address a listening audience.

---

<sup>2</sup> Erving Goffman, *The Presentation of Self in Everyday Life* (London: Penguin, 1959), 15.

<sup>3</sup> Richard Schechner, *Essays in Performance Theory* (New York: Routledge, 1988), 30; Richard Schechner, *Performance Studies: An Introduction*, 2nd ed. (New York and London: Routledge, 2006), 29–30.

<sup>4</sup> Schechner, *Performance Studies: An Introduction*, 29–32.

<sup>5</sup> Schechner, *Essays in Performance Theory*, 52, 79–80.

<sup>6</sup> Ronald L. Grimes in Elina Gertsman, ‘Introduction: The Spectrum of Performances’, in *Visualizing Medieval Performance: Perspectives, Histories, Contexts*, ed. Elina Gertsman (Aldershot: Ashgate, 2008), 1–13.

The reactions of the audience and the responses of the performer to these reactions shape the reception event: for example, a modern-day comedian, seeing that some jokes receive greater laughs than others, may alter their performance to better please the tastes of that particular audience. Awareness of performance theory can help literary scholars to better understand medieval performative textuality: these broad sociological definitions help to prime us for a more flexible understanding of text and performance, especially for the performative study of texts that have traditionally only been the subject of literary or historical inquiry.

Heather Maring succinctly defines performance as it applies to the study of Middle English literature: performance is “text made audible in the medium of the human voice and made unique or unrepeatable by the experience of being present” and modulated by “setting, body language, vocalization style...audience reaction [and]...paralinguistic features, such as tone, rhythm, speed, silence, gesture, music, and so on.”<sup>7</sup> When I talk of ‘performative reading’ I mean reading modulated by these techniques and with an audience, which could be a large group or even just the reader themselves. Even private reading can be performative: this kind of solitary performance is often involved in devotional reading, for example, affective piety texts, meditations on the passion (such as “The Long Charter of Christ” [Ff.2.38, ff. 47vb-50va], and a variant version [CCAii, ff. 77ra-79rb]), or virtual pilgrimage texts (such as the Stations of Rome [Brogyntyn II.1, ff. 132r-135v and CCAii, ff. 83rb-86va] or the Stations of Jerusalem [Ashmole 61, article 34, ff. 128r-136r]), which take the reader on an imagined journey around notable holy sites of the cities.<sup>8</sup> This thesis focuses on a single reception modality within a single kind of performance: communal performative reading aloud associated with Middle English romance as preserved in late medieval household manuscripts. This kind of performance is inextricable from the act of reading and is contingent on close engagement with a text preserved in a specific physical form, or orally/aurally mediated. It is somewhat of a contradiction that I seek to investigate immaterial *aural* texts by focusing on their material form in manuscripts as well as the embodied experience of an audiate reader and the physical spaces reading took place in, however, this tension between materiality and immateriality lies at the heart of this study, and of performance studies more generally. Medieval reading is usually discussed from the perspective of literacy, but this study instead focuses on the experience and minutiae of the act of reading itself.<sup>9</sup> I will return to

---

<sup>7</sup> Maring, ‘Performing Pearl’.

<sup>8</sup> Bynum, *Jesus as Mother: Studies in the Spirituality of the High Middle Ages*; McNamer, *Affective Meditation and the Invention of Medieval Compassion*.

<sup>9</sup> Parkes, ‘The Literacy of the Laity’; Michael T. Clanchy, *From Memory to Written Record: England 1066 - 1307*, 3rd ed. (Chichester: John Wiley & Sons, 2013); Saenger, *Space between*

this perspective more fully in the later chapters; here first I will summarise previous investigations of romance performance.

### 1.3 Historical Romance Performance

It is common to note in studies of medieval reading that lay literacy and education were increasing in the fifteenth century. However, it is less frequently acknowledged that the concept of literacy in the Middle Ages was multifaceted: since the reception of texts can be in multiple modes, it follows that the modern concept of literacy (the ability to read and write) is not necessarily a prerequisite for the medieval reception of texts. Moreover, there are skills outside of this definition of literacy that allow participation in performative reading that should be acknowledged. Paul Saenger proposes the categorisation of “phonetic literacy” (ability to read words orally) and “comprehension literacy” (ability to read a written text silently) as a means of recognising these wider skills.<sup>10</sup> However, this still only acknowledges direct engagement with the written word. For a fuller picture I argue that we must also consider those participants in textual culture who would be familiar with the genres, tropes, formulas etc. and were experienced and skilled at hearing texts read aloud but merely lacked the ability to read it from the page. Brian Stock talks of “textuality” as separate from “literacy”, meaning making use of texts, perhaps even by those who were functionally illiterate.<sup>11</sup> W.F. Bolton suggests the term “audiate” in contrast to “literate” to categorise the skills of attention, aural comprehension and memory that audiences of texts received orally would develop.<sup>12</sup> Although some of the audience of household manuscripts would be literate by modern definitions, we cannot assume that all would be. However, their involvement in textual receptions supported by these manuscripts and the skills of an experienced audiate reader should be acknowledged. The skills of audiate readers were used not just in romance-reading but in many text-adjacent activities in daily life, such as devotional activities in the parish church like sermons that aurally interpret written words, manor courts or street proclamations. Medieval textual culture extends beyond the physical forms of text through the spoken word.

The oral/written debate, which analyses the modality of the composition, transmission and reception of texts, has dominated studies of the reception of medieval

---

*Words: The Origins of Silent Reading*; Paul Henry Saenger, ‘Silent Reading: It’s Impact on Late Medieval Script and Society’, *Viator* 13 (1982): 367–414.

<sup>10</sup> Paul Saenger, ‘Books of Hours and the Reading Habits of the Later Middle Ages’, in *The Culture of Print: Power and the Uses of Print in Early Modern Europe*, ed. Alain Boureau and Roger Chartier (Cambridge: Polity, 1989), 141–73.

<sup>11</sup> Brian Stock, *The Implications of Literacy: Written Language and Models of Interpretation in the Eleventh and Twelfth Centuries* (Princeton, N.J.: Princeton University Press, 1983), 7.

<sup>12</sup> Bolton, ‘Introduction: The Conditions of Literary Composition in Medieval England’, xvii.

literature, and thus in turn the study of romance performance. This in itself is not harmful, but earlier scholars too often understood oral as crude and unsophisticated, as an unpleasant but necessary step on the way to refined and sophisticated written texts, especially by canonical authors. There was general resistance to the idea that aurality could continue after the advent of literacy, once oral performances by minstrels are assumed to have been replaced by the spread of private, silent reading.<sup>13</sup> In the Introduction I argued instead for considering orality/literacy as a cloud of modalities and reception possibilities instead of a spectrum with oral and written at either extreme. The overly simplistic spectrum view also distorts understandings of literacy in the Middle Ages. Aural reception, it is commonly assumed, was only the norm because of widespread illiteracy and poor availability of books.<sup>14</sup> Mid-twentieth-century romance scholars go out of their way to explain the continued inclusion of supports for aural reception (the narrator, addresses to listeners, petitions for attention) as evidence of minstrel composition and performance, or, in later fifteenth century texts, as concessions to a fashionable pseudo-oral style, an unsophisticated “regression into oral tradition”.<sup>15</sup>

Albert B. Lord and Milman Parry proposed the oral-formulaic theory as a way to make sense of the composition and transmission of Homeric epic, using surviving oral traditions from Yugoslavia as a model.<sup>16</sup> The oral-formulaic poet effectively recomposes their texts in every iteration of performance, combining both *formulas* (short metrical phrases) and *themes* (longer recurring scenes or events). This understanding of textual composition, transmission and reception relies on a skilled and practiced oral poet who memorises and performs the texts. The oral-formulaic theory was adapted for Middle English romance by focusing on the memorisation of texts.<sup>17</sup> The oral-formulaic poet became the minstrel who used formulas not as building-blocks of the orally recomposed

---

<sup>13</sup> Derek Pearsall, ‘Middle English Romance and Its Audiences’, in *Historical and Editorial Studies in Medieval and Early Modern English for Johan Gerritsen*, ed. Mary-Jo Arn and Hanneke Wirtjes (Groningen: Wolters-Noordhoff, 1985), 37–47; Derek Attridge, *The Experience of Poetry: From Homer’s Listeners to Shakespeare’s Readers* (Oxford: Oxford University Press and Oxford Scholarship Online, 2019), 212, doi: 10.1093/oso/9780198833154.003.0010.; S.T. Knight, ‘The Oral Transmission of *Sir Launfal*’, *Medium Ævum* 38 (1969): 164–70; Stephen Knight, ‘The Social Function of Middle English Romance’, in *Medieval Literature: Criticism, Ideology and History*, ed. David Aers (Brighton: Harvester Press, 1986), 99–122.

<sup>14</sup> Baugh, ‘Improvisation in the Middle English Romance’, 434.

<sup>15</sup> Derek Pearsall, ‘The Development of Middle English Romance’, *Mediaeval Studies* 27 (1965): 93; Ruth Crosby, ‘Oral Delivery in the Middle Ages’, *Speculum* 11, no. 1 (1936): 88–110; Knight, ‘The Oral Transmission of *Sir Launfal*’.

<sup>16</sup> Lord, *The Singer of Tales*; Parry, *The Making of Homeric Verse: The Collected Papers of Milman Parry*. For application of this theory to Old English poetry and genesis of its connection to medieval literature specifically, see Magoun, ‘Oral-Formulaic Character of Anglo-Saxon Narrative Poetry’.

<sup>17</sup> Baugh, ‘Improvisation in the Middle English Romance’; A.C. Baugh, ‘The Middle English Romance: Some Questions of Creation, Presentation, and Preservation’, *Speculum* 42, no. 1 (1967): 1–31; Quinn and Hall, *Jongleur: A Modified Theory of Oral Improvisation and Its Effects on the Performance and Transmission of Middle English Romance*.

text, but rather as aids in memorising a written text. The surviving written romances in this theory are either the written records of oral performances or copies of the texts used by performers as an *aide-mémoire*. The ‘minstrel manuscript’ theory dominated early discussions of romance manuscripts but has been thoroughly debunked by Andrew Taylor.<sup>18</sup> The implications of this theory on the manuscripts will be discussed further in Chapter 2. Middle English romances certainly have elements that align with the *formulas* and *themes* of oral-formulaic theory. *Sir Eglamour of Artois* (CCAii, Li, Ff.2.38) and *Emaré* (unique to CCAii) are two particularly formulaic romances. In *Sir Eglamour*, Christabel is frequently described as “whyte as flowr”, “as whyte as fom”, “as whyte as whalys bon”.<sup>19</sup> *Emaré* is “worthy unthur wede” (and variations “comely unther kelle”, “semely unthere serke”), as well as the familiar “whyte as whales bone” or “whyte as lylve flowre”.<sup>20</sup> Characters in *Sir Eglamour of Artois* often exclaim “so mote Y the” (ll. 187, 199, 220, 514, 649, 1201), the narrative repeatedly references Eglamour’s “dedes of armes” (ll. 10, 23, 41, 88, 94, 130, 216) and the narrator guides the story with all the expected formulaic phrases. Eglamour even takes advantage of the tropes of romance, naming himself as “Antorus” (l. 463) (Adventurous), a common pseudonym of questing knights. *Emaré* features parallel descriptions of Sir Artyus and Emaré: “He was curtays in all thyng / Bothe to olde and to yynge” (ll. 40-1) and “She was curtays in all thyng / Bothe to olde and to yynge” (ll. 64-5). Themes can also be identified in the wider narrative: the repeated fight episodes when Eglamour completes his three tasks to win Christabel’s hand which progress in similar but escalating fashion, the Constance motif of Christabel and Emaré being cast adrift at sea, and the exile and return structure (doubled in *Emaré*) facilitated by tokens of recognition (the gem cloak, the symbolic coats of arms, the scarlet mantle and the golden girdle). The presence of formulas and themes does not suggest that romances were recomposed as they were performed, but rather that these textual apparatus assisted in memorising a text to perform without reference to the written word, thus explaining the apparent “oral residue” remaining in Middle English romance.<sup>21</sup> A.C. Baugh points to the adaptation of many French romances into English as proof that they were composed in writing (and therefore not truly oral-formulaic) and then

<sup>18</sup> Andrew Taylor, ‘The Myth of the Minstrel Manuscript’, *Speculum* 66, no. 1 (1991): 47–73.

<sup>19</sup> Harriet Hudson, ed., ‘Sir Eglamour of Artois’, in *Four Middle English Romances: Sir Isumbras, Octavian, Sir Eglamour of Artois, Sir Tryamour*, TEAMS Middle English Texts Series (Kalamazoo, Michigan: Medieval Institute Publications, 2006), ll. 139, 178, 854, 869, 928, 1208; 674; 783. Subsequent references will state line numbers in-text in brackets.

<sup>20</sup> Anne Laskaya and Eve Salisbury, eds., ‘Emaré’, in *The Middle English Breton Lays*, TEAMS Middle English Texts Series (Kalamazoo, Michigan: Medieval Institute Publications, 1995), ll. 366, 303, 501, 33, 66. Subsequent references will state line numbers in-text in brackets.

<sup>21</sup> Albert B. Lord, ‘Oral Composition and “Oral Residue” in the Middle Ages’, in *Oral Tradition in the Middle Ages*, ed. W. F. H. Nicolaisen (Binghamton, New York: Medieval and Renaissance Texts and Studies, 1995), 7–29.



memorised in order to be performed. According to the theory of memorial transmission, variations in the surviving manuscripts of romances are records of improvisation by minstrels as they perform. Murray McGillivray also argued that memorial transmission is responsible for variations in romances that cannot be explained by scribal error, but goes further than Baugh's suggestion of improvisation and identifies further evidence and explanations of these variations.<sup>22</sup> McGillivray outlines that copying errors tend to be visual and reading mistakes, such as skipping lines or misreading words, whereas memorial errors result in similar lines or events being moved within a text when the copyist misremembers which occurrence should be in which position. Ad Putter suggests that similar evidence of memorial transmission can even be seen in later romances, such as the copy of *Eger and Grime* in the Percy folio (London, British Library Additional MS 27879) – although it is unclear at which point in the text's history this memorial transmission took place.<sup>23</sup> Only perhaps the earliest forms of the earliest Middle English romances (such as *King Horn* or *Havelok the Dane*) could be considered under the oral-formulaic theory: as the later forms of romances come from a time of mixed orality and literacy, they cannot truly be considered oral-formulaic as they are influenced by the written tradition.

More recent romance scholarship tends to acknowledge the oral/aural elements of romances as aesthetic features – evocative of a reception context but not indicative of it. “Oral residue”, especially for the later romances studied here, is no longer understood as (if it ever was) the leftovers of prior oral transmission but as a feature which supports reading aloud or could create an imagined communal reading setting for a solitary reader.<sup>24</sup> This reframing shifts the focus from seeking for the original or ‘oral’ features, to studying their impact and effect. The oral-formulaic poets now merely serve as a model for effective performance of narrative, rather than a model for textual composition and transmission.<sup>25</sup> My experimental performances recontextualised these oral/aural features and explored the changing experience of romance-reading in different modalities. The effectiveness of these features in performance is not proof of exclusive performativity, yet strongly suggests that they are more than mere ambiance: the romances and their manuscripts support flexible and multimodal reading, with different resonances and affective responses experienced in different modalities. This reframing has been part of a wider trend in scholarship accepting and celebrating the literary value of popular Middle English romances because of, rather

---

<sup>22</sup> McGillivray, *Memorization in the Transmission of the Middle English Romances*.

<sup>23</sup> Ad Putter, ‘Middle English Romances and the Oral Tradition’, in *Medieval Oral Literature*, ed. Karl Reichl (Berlin and Boston: Walter de Gruyter, 2016), 347.

<sup>24</sup> Lord, ‘Oral Composition and “Oral Residue” in the Middle Ages’.

<sup>25</sup> See for example Reichl, ‘Turkic Bard and Medieval Entertainer: What a Living Epic Tradition Can Tell Us about Oral Performance of Narrative in the Middle Ages’, 178.

than in spite of, their popularity.<sup>26</sup> This shift is illustrated well by the change in scholarly opinions of one of the focus texts, *Sir Eglamour of Artois*. Mid-twentieth century scholarship saw it as ‘mediocre’ and formulaic, and it is described in Derek Pearsall’s memorable diatribe against popular romance as a “mechanical shuffling-together of stock incidents, whisked vigorously and poured out at a pace that aims to provide little time for reflection on what rubbish it all is.”<sup>27</sup> Today, more objective and nuanced study focuses on the art and expression of the romance, its social and familial concerns, and acknowledges the different expectations of literature for medieval and modern audiences.<sup>28</sup> D.J. Curnow and Putter argue that the density of events and the fast pacing of the narrative – the very feature that was so objectionable to earlier critics – was what made *Sir Eglamour of Artois* so popular in its day.<sup>29</sup> This thesis follows the stance promoted by these recent studies of popular romances of meeting medieval literature on its own terms, rather than imposing modern judgements of quality or literary merit. Reauralising the romances is a further step towards acknowledging and upholding the medieval experience of these works.

In my study of communal reading aloud I follow Joyce Coleman’s extensive investigation, which, firstly, places reading aloud outside of the progressivist narrative of oral to written, which would imply that all fifteenth-century reading is silent (having developed from ‘primitive’ oral reception and production, to ‘sophisticated’ literate silent reception), and secondly provides extensive evidence for medieval ‘aurality’, which she defines as “the reading of books aloud to one or more people”.<sup>30</sup> Coleman argues simply that reading aloud persists throughout the Middle Ages (and indeed long after) because it is

---

<sup>26</sup> This is exemplified by three edited collections and their introductions: Ad Putter and Jane Gilbert, ‘Introduction’, in *The Spirit of Medieval English Popular Romance*, Longman Medieval and Renaissance Library (Harlow: Pearson Education, 2000), 1–38; Nicola McDonald, ‘A Polemical Introduction’, in *Pulp Fictions of Medieval England: Essays in Popular Romance* (Manchester: Manchester University Press, 2004), 1–21; Raluca L. Radulescu and Cory James Rushton, ‘Introduction’, in *A Companion to Medieval Popular Romance*, ed. Raluca L. Radulescu and Cory James Rushton (Cambridge: D. S. Brewer, 2009), 1–8.

<sup>27</sup> Dieter Mehl in Wim Tigges, ‘*Sir Eglamour*: The Knight Who Could Not Say No’, *Neophilologus* 72, no. 1 (1988): 107; Pearsall, ‘The Development of Middle English Romance’, 112.

<sup>28</sup> Tigges, ‘*Sir Eglamour*: The Knight Who Could Not Say No’; Nicholas Perkins, ‘Ekphrasis and Narrative in *Emare* and *Sir Eglamour of Artois*’, in *Medieval Romance, Medieval Contexts*, ed. Rhiannon Purdie and Michael Cichon (Cambridge: D. S. Brewer, 2011), 47–60; D.J. Curnow and Ad Putter, ‘Textual and Familial Relationships: The Place of the Michigan Fragment in the Evolution of *Sir Eglamour*’, in *People and Texts: Relationships in Medieval Literature*, ed. Thea Summerfield and Keith Busby (Amsterdam: Brill | Rodopi, 2007), 51–65; Putter, ‘Middle English Romances and the Oral Tradition’; Phillipa Hardman, ‘Fitt Divisions in Middle English Romances: A Consideration of the Evidence’, *The Yearbook of English Studies* 22 (1992): 63–80; Joanne A. Charbonneau, ‘Transgressive Fathers in *Sir Eglamour of Artois* and *Torrent of Portyngale*’, in *Discourses on Love, Marriage, and Transgression in Medieval and Early Modern Literature*, ed. Albrecht Classen, *Medieval and Renaissance Texts and Studies* 278 (Tempe, Arizona: Arizona Centre for Medieval and Renaissance Studies, 2004), 243–65.

<sup>29</sup> Curnow and Putter, ‘Textual and Familial Relationships: The Place of the Michigan Fragment in the Evolution of *Sir Eglamour*’, 51–52.

<sup>30</sup> Coleman, *Public Reading and the Reading Public*, xi.

a popular and pleasant pastime – literature is “a social event”<sup>31</sup> – a way to share stories with a gathered community. Although her study focuses on courtly, secular literature and specifically excludes popular romances, much of the evidence Coleman discusses in fact pertains to romance-reading. Much evidence of reading aloud comes from internal depictions of reading within romances. This is somewhat circular, but Coleman provides additional evidence from historical records to make a strong case. The onus of proof is perhaps less critical for romances and household manuscripts than it is for courtly literature: the textual habits of the owners of household manuscripts overlap with the courtly elite, in turn often modelled on monastic practices, which have ample evidence for reading aloud, and moreover, reading aloud is a highly accessible way for those not wealthy enough to hire professional prelectors or performers regularly to share stories together.<sup>32</sup> My analysis deliberately moves away from the preoccupation with a professional performer and follows Taylor’s suggestion that ‘minstrel manuscripts’ were more likely to be used and read in a household context.<sup>33</sup> I focus on the kind of ‘amateur’ performances that would result from members of these households using their texts and manuscripts, such as communal reading aloud, which could have some informal elements of theatrical and musical performance. I use the term amateur to contrast with hired professional performers. Amateur performers here are members of the household or extended social network who read for pleasure rather than for monetary gain. The term does not confer a judgement on their skill level – whilst amateur household readers probably had less specific performance training than hired professionals, there is naturally a wide spectrum of performance abilities, and medieval educational practices would foster skills in rhetoric and reading aloud.<sup>34</sup> ‘Amateur’ readers could use their copies of texts in communal and performative reading activities located in a domestic setting. Leisurely domestic reading is rarely recorded or depicted, requiring reconstructions of household romance-reading practices to infer based on other examples. Crisseyyde and her ladies reading in the paved parlour is a key exemplar and will be discussed in more detail in Chapters 2 and 3. A more formal and professional romance-reading is found in *Havelok*

---

<sup>31</sup> Coleman, 28.

<sup>32</sup> Shuffelton, ‘Is There a Minstrel in the House?: Domestic Entertainment in Late Medieval England’, 57; Sarah McLoughlin, ‘Gender and Transgression in the Late Medieval English Household’ (PhD Thesis, University of York, 2011), 134–36; Ann Dobyne, ‘Exemplars in Chivalry: Rhetoric and Ethics in Middle English Romance’, in *Romance and Rhetoric: Essays in Honour of Dhira B. Mahoney*, ed. Georgiana Donavin and Anita Obermeier, vol. 19, Disputatio (Turnhout: Brepols, 2010), 17–32; Phillipa Hardman, ‘Popular Romances and Young Readers’, in *A Companion to Medieval Popular Romance*, ed. Raluca Radulescu and Cory James Rushton (Cambridge: D. S. Brewer, 2009), 161.

<sup>33</sup> Taylor, ‘The Myth of the Minstrel Manuscript’.

<sup>34</sup> Nicholas Orme, *Medieval Children* (New Haven and London: Yale University Press, 2001), 238–67; Orme, Nicholas, *Medieval Schools: From Roman Britain to Renaissance England* (New Haven and London: Yale University Press, 2006), 68–71.

*the Dane* where “romanz reding on the bok” (l. 2327) is part of the loud and varied entertainments at Havelok’s coronation feast. Joyce Coleman suggests that most performative reading was “a domestic, small-scale occasion” rather than the grand practices imagined by Evelyn Birge Vitz’s elite “high” performance, including the *Havelok the Dane* example.<sup>35</sup> “Low” performances are rarely reflected in performative investigations of romance – there is little evidence about the associated performance practices – but they can be revealing about the lived experiences of medieval readers in households of the rural gentry and the urban mercantile elite. A possible example of this “low” leisurely romance reading within a family is depicted in Chrétien de Troyes’ *Le chevalier au lion* where a young maiden reads a romance to her parents in a garden.<sup>36</sup> Romance reading as an informal communal pastime, could have accompanied domestic chores and small handiworks like sewing, repairing, whittling, embroidery, spinning or weaving. Particularly if the audience of the reading event is female, reading could offer a pleasant accompaniment to the everyday tasks that kept the household running (spinning, carding, weaving, sewing, childcare etc.) whilst simultaneously serving the more practical purposes of educating younger members of the family.<sup>37</sup> Other useful exemplars for household reading practices come from a number of domestic conduct texts and household regulations. They mainly concern reading for education or devotional practices, but do show, for example, the involvement of household members of all ages and statuses in reading and the association of reading with particular times of day: morning and evening prayers, reading over mealtimes and instructions for hearing and participating in Mass. Latin conduct instructions found in the papers of the Throckmorton family guide the *pater familias* to lead prayers at morning and night, advise on appropriate conduct during Mass, and, most significantly, instruct that dinner should be accompanied by edifying reading to distract from vain or idle speech by various readers, including children when they are able.<sup>38</sup> This is clearly adapted from the monastic model.<sup>39</sup> A reader – maybe a member of

---

<sup>35</sup> Coleman, *Public Reading and the Reading Public*, 73; Evelyn Birge Vitz, *Orality and Performance in Early French Romance* (Woodbridge: Boydell and Brewer, 1999), 164.

<sup>36</sup> “My lord Yvain enters into the garden / And after him his companions; / He sees leaning on his side / A nobleman who was lying / On a silken cloth, and before him / A maiden was reading / A romance, I don’t know about whom. / And to listen to the romance / A lady who was her mother / Was there too, leaning on her elbows / And the gentleman was her father.” (Chrétien de Troyes’ *Le chevalier au lion*, ll. 5356-66) Translated by Evelyn Birge Vitz, ‘Erotic Reading in the Middle Ages: Performance and Re-Performance of Romance’, in *Performing Medieval Narrative*, ed. Evelyn Birge Vitz, Nancy Freeman Regalado, and Marilyn Lawrence (Cambridge: D. S. Brewer, 2005), 83–84.

<sup>37</sup> Goldberg, *Medieval England: A Social History 1250-1550*, 11–12.

<sup>38</sup> Shuffelton, ‘Is There a Minstrel in the House?: Domestic Entertainment in Late Medieval England’, 56–59; McLoughlin, ‘Gender and Transgression in the Late Medieval English Household’, 141–42.

<sup>39</sup> Benedict, ‘Regula S.P.N. Benedicti’, accessed 30 December 2014, <http://www.thelatinlibrary.com/benedict.html>, Chapter 38; George Shuffelton, ‘Is There a Minstrel

the household, children included, or even a household chaplain – would read aloud suitable material for the edification of the listeners. It is unlikely that romances were considered appropriate reading for this kind of reception, although they could have been read after the formal parts of dining: certainly the household manuscripts are filled with many more appropriate edifying and devotional texts.<sup>40</sup> These key historical exemplars informed my performances and will continue to be referenced throughout my analysis. I will now explore a number of modern performance exemplars, before returning to the consideration of musical performance.

#### 1.4 Modern Performance Methodologies and Exemplars

My study of medieval performative reading draws on a collection of first-person investigative disciplines and methodologies.<sup>41</sup> In first-person investigations, the body of the practitioner is both the subject of the inquiry and the means by which to conduct the enquiry.<sup>42</sup> The use of performance as a research tool has an established academic history dating back to the 1960s and 1970s. Known variously as practice-as-research (PaR), action research, embodied research, practice- or performance-led research, performance-based research, or artistic research, this method uses active, creative practices – theatre, music, film, dance, visual arts, creative writing, and others – as the key means of investigating a research hypothesis.<sup>43</sup> PaR puts the practitioner at the centre of their own investigation, and

---

in the House?: Domestic Entertainment in Late Medieval England’, *Philological Quarterly* 87, no. 1/2 (2008): 57–58. A mealtime reading as part of the education of the future Edward V was also the inspiration for the Reading Malory Aloud project. Karen Cherewatuk, ‘An Introduction to Aural Malory: Sessions and Round Tables’, *Arthuriana*, Reading Malory Aloud, Then and Now, 13, no. 4 (2003): 3.

<sup>40</sup> Li 91 contains a vast array of suitable edifying material in the latter part of section 2 and sections 3-5 (ff. 176v-279v). See contents list in Appendix 1.

<sup>41</sup> Although the use of the term ‘discipline’ here is contentious: PaR often specifically styles itself as an “anti-genre” and reenactment, as Vanessa Agnew writes, is “characterized by its disregard for disciplinary specializations”. Baz Kershaw and Helen Nicholson, ‘Introduction: Doing Methods Creatively’, in *Research Methods in Theatre and Performance*, ed. Baz Kershaw and Helen Nicholson (Edinburgh: Edinburgh University Press, 2011), 3; Baz Kershaw, ‘Practice as Research: Transdisciplinary Innovation in Action’, in *Research Methods in Theatre and Performance*, ed. Baz Kershaw and Helen Nicholson (Edinburgh: Edinburgh University Press, 2011), 66; Vanessa Agnew, ‘Introduction: What Is Reenactment?’, *Criticism*, Special Issue: Extreme and Sentimental History, 46, no. 3 (2004): 335.

<sup>42</sup> Jennifer Parker-Starbuck and Roberta Mock, ‘Researching the Body in/as Performance’, in *Research Methods in Theatre and Performance*, ed. Baz Kershaw and Helen Nicholson (Edinburgh: Edinburgh University Press, 2011), 223.

<sup>43</sup> Robin Nelson, ‘Introduction: The What, Where, When and Why of “Practice as Research”’, in *Practice as Research in the Arts, Principles, Protocols, Pedagogies, Resistances*, ed. Robin Nelson (London and New York: Palgrave Macmillan, 2013), 9; Stephen Purcell, ‘Practice-as-Research and Original Practices’, *Shakespeare Bulletin* 35, no. 3 (2017): 426; Ian Watson, ‘An Actor Prepares: Performance as Research (PAR) in the Theater’, in *Mapping Landscapes for Performance As Research: Scholarly Acts and Creative Cartographies*, ed. Shannon Rose Riley and Lynette Hunter

their own subjective, first-person experience – or what Stephen Purcell calls their “embodied knowledge” – becomes the data output of the investigation.<sup>44</sup> PaR methodologies utilise “lived experience”, but understood in a different sense from archaeological lived experience as discussed in Chapter 3. PaR “lived experience” focuses on the training, preparations, intuitions and performance decisions of the practitioner and their subjective experience of their practice.<sup>45</sup> This aspect of PaR most commonly engages with the discipline and techniques of theatre, with its long history of structured acting methodologies and training. Theatrical performances involve specific uses of space, such as the delineation of performance space and audience space, blocking and the preparation of planned physical movements by the performer within the performance space, using structured artificial lighting to create specific theatrical effects, and the usage and position of props. Clare Wright’s discussion of the ontologies of theatre and performance outlines how modern audiences and critics often expect all performances to be theatrical and to present illusions of truth confined to a separate theatrical reality to a spatially separated watching audience, whereas these theatrical expectations are not applicable to medieval drama.<sup>46</sup> This purely theatrical approach was also not applicable to the casual and everyday performative reading that my research explores, although a general awareness of theatrical principles did influence my practice, in that I used common techniques such as altering the pitch or speed of my vocal delivery, or gesturing to support the meaning of the words I read. Historically-focused PaR research provided a more relevant model than purely theatrical PaR projects, particularly site-specific performances that engage with historic spaces and structures, research into medieval or early modern drama (discussed below), or projects like ‘Performance Learning and Heritage’ that combined dramatic performance, heritage and living history to communicate the past in more engaging, accessible and sensitive ways.<sup>47</sup> PaR productions rely on the instinct and intuition of the performer and

---

(New York: Palgrave Macmillan, 2009), 84; Kershaw, ‘Practice as Research: Transdisciplinary Innovation in Action’, 63–64.

<sup>44</sup> Purcell, ‘Practice-as-Research and Original Practices’, 427; Parker-Starbuck and Mock, ‘Researching the Body in/as Performance’, 210; Lina Gibbings, ‘Performing Pearl: Drama, Middle English Text and Performance Based Research in Medieval Studies’ (Unpublished MFA Thesis, University of Calgary, 2018), 4.

<sup>45</sup> Parker-Starbuck and Mock, ‘Researching the Body in/as Performance’, 227; Susan Kozel, *Closer: Performance, Technologies, Phenomenology* (Cambridge, Massachusetts: MIT Press, 2008), 9, 52–53.

<sup>46</sup> This was observable in the experiments, as will be discussed in section 4.4.2.

Clare Wright, ‘Ontologies of Play: Reconstructing the Relationship between Audience and Act in Early English Drama’, *Shakespeare Bulletin* 35, no. 2 (2017): 187–206.

<sup>47</sup> Sarah Dustagheer, Oliver Jones, and Eleanor Rycroft, ‘(Re)Constructed Spaces for Early Modern Drama: Research in Practice’, *Shakespeare Bulletin* 35, no. 2 (2017): 173–85; Sarah Dustagheer, ‘“Intimacy” at the Sam Wanamaker Playhouse’, *Shakespeare Bulletin* 35, no. 2 (2017): 227–46; Wright, ‘Ontologies of Play: Reconstructing the Relationship between Audience and Act in Early English Drama’; ‘Performance, Learning & Heritage’, The University of Manchester, accessed 9 September 2021, <http://www.plh.manchester.ac.uk/>; Anthony Jackson and Jenny Kidd, eds.,

their ability to self-reflect and analyse qualitative experiences. In purely theatrical PaR projects this intuition is based in modern theatrical training, whereas for historically-focused PaR projects, this is embodied knowledge acquired through close academic study of source material – in my case, familiarity with medieval texts, manuscripts, historical reading methods and my experience performing historical texts. The household manuscripts’ original owners no doubt were themselves exposed to various performance practices from viewing plays, pageants and other performances, and had some degree of rhetorical training and practice reading aloud from their education and household practices.

An equally applicable methodological model for my practical research is experimental archaeology, which investigates material artefacts or structures, with a particular focus on their crafting techniques, and reconstructs technological processes from the past.<sup>48</sup> It follows more rigorously the scientific method and has a greater focus on the replicability of experiments. Its resurgence in the mid-twentieth century saw experiments conducted to investigate the building of prehistoric houses, historical sailing voyages and shipbuilding, flint-knapping and farming techniques.<sup>49</sup> Both PaR and experimental archaeology have a focus on gathering data in practical, experimental investigations, however neither truly captured the entire social or cultural context of the relevant text or activity.

Alongside these two well-established disciplines is the newer category of reenactment studies, which investigates immersive recreations of the past.<sup>50</sup> Although reenactment studies itself is new, reenactment is not: people have been recreating history for as long as there has been history, in both romanticised or fantastical ways and ways that seek accurate representations of the past, from ancient Roman naval battle pageants, to the tournaments and performances described in Sarrasin’s *Le roman de Hem* (1278), to

---

*Performing Heritage: Research, Practice and Innovation in Museum Theatre and Live Interpretation* (Manchester: Manchester University Press, 2011).

<sup>48</sup> Coles, *Experimental Archaeology*; Saraydar, *Replicating the Past: The Art and Science of the Archaeological Experiment*; Gunter Schöbel, ‘Experimental Archaeology’, in *The Routledge Handbook of Reenactment Studies: Key Terms in the Field*, ed. Vanessa Agnew, Jonathan Lamb, and Juliane Tomann (London and New York: Routledge, 2020), 67–73.

<sup>49</sup> Coles, *Experimental Archaeology*, 32; Aidan O’Sullivan and Christina Souyouzoglou-Haywood, ‘Introduction - Defining Archaeology: Making, Understanding, Storytelling?’, in *Experimental Archaeology: Making, Understanding, Story-Telling*, ed. Aidan O’Sullivan and Christina Souyouzoglou-Haywood (Oxford: Archaeopress, 2019), 1.

<sup>50</sup> Vanessa Agnew, Jonathan Lamb, and Juliane Tomann, ‘Introduction: What Is Reenactment Studies?’, in *The Routledge Handbook of Reenactment Studies: Key Terms in the Field*, ed. Vanessa Agnew, Jonathan Lamb, and Juliane Tomann (London and New York: Routledge, 2020), 1–10; Agnew, ‘Introduction: What Is Reenactment?’, Jay Anderson, ‘Living History: Simulating Everyday Life in Living Museums’, *American Quarterly* 34, no. 3 (1982): 290–306; Daria Radtchenko, ‘Simulating the Past: Reenactment and the Quest for Truth in Russia’, *Rethinking History* 10, no. 1 (2006): 127–48; David Matthews, *Medievalism: A Critical History*, Medievalism Series, VI (Cambridge: D. S. Brewer, 2015); Edward M. Bruner, ‘Abraham Lincoln as Authentic Reproduction: A Critique of Postmodernism’, *American Anthropologist* 96, no. 2 (1994): 397–415.

medieval passion plays, to Henry VIII's reconstruction of the round table in Winchester, to the Eglinton Tournament of 1839.<sup>51</sup> The use of 'living history' (first-person costumed and emplaced interpretations of historical living practices) in the heritage industry arose out of the open-air folk museums of late nineteenth-century Europe and early twentieth-century North America and is now a common practice in museums and open air attractions alike.<sup>52</sup> Reenactment as a pastime today encompasses a broad spectrum of activities from fantastical medieval-inspired make-believe play at one end (for example, Live Action Role Playing) to more studious and immersive reenactment that concerns itself with meticulously recreating the materiality, practices and behaviour of specific times, places and people in the past. Authenticity is a central concept in reenactment and living history – especially at the latter end of this spectrum – both the standard to which it strives, and the means by which its success is measured.<sup>53</sup> The Introduction nuanced the definition of authenticity for this project, but the inclusion of authenticity as a central concept at all is due to the influence of reenactment. Reenactment and living history have, until very recently, been viewed with some scepticism in academic circles. However, their use in the heritage industry is widely regarded as an effective way to make history more engaging to a general public.

My performative research aligns most closely with the model of reenactment, but the young state of the discipline as an academic method required heavier use of the critical apparatus of PaR and experimental archaeology. My analysis is based on first-person observational data but is not true creative practice or a fully technologically-focused experiment. It specifically aims to investigate and (as far as possible) simulate the whole physical, social, technological and emplaced experiment of medieval reading. The use of some kind of immersive first-person performance methodology was critical for my research. In becoming an active participant in textual culture and reception, the performer is immersed in an embodied and emplaced simulation of the past. The modern-day PaR

---

<sup>51</sup> Mads Daugbjerg, 'Battle', in *The Routledge Handbook of Reenactment Studies: Key Terms in the Field*, ed. Vanessa Agnew, Jonathan Lamb, and Juliane Tomann (London and New York: Routledge, 2020), 25–29; Schöbel, 'Experimental Archaeology'; Nancy Freeman Regalado, 'Performing Romance: Arthurian Interludes in Sarrasin's *Le Roman Du Hem* (1278)', in *Performing Medieval Narrative*, ed. Evelyn Birge Vitz, Nancy Freeman Regalado, and Marilyn Lawrence (Cambridge: D. S. Brewer, 2005), 103–19.

<sup>52</sup> Anderson, 'Living History: Simulating Everyday Life in Living Museums', 291–93; David Dean, 'Living History', in *The Routledge Handbook of Reenactment Studies: Key Terms in the Field*, ed. Vanessa Agnew, Jonathan Lamb, and Juliane Tomann (London and New York: Routledge, 2020), 120.

<sup>53</sup> Bruner, 'Abraham Lincoln as Authentic Reproduction: A Critique of Postmodernism', 399–403; Agnew, Lamb, and Tomann, 'Introduction: What Is Reenactment Studies?', 3; Vanessa Agnew and Juliane Tomann, 'Authenticity', in *The Routledge Handbook of Reenactment Studies: Key Terms in the Field*, ed. Vanessa Agnew, Jonathan Lamb, and Juliane Tomann (London and New York: Routledge, 2020), 20–24; Radtchenko, 'Simulating the Past: Reenactment and the Quest for Truth in Russia', 127–30, 136.



practitioner, experimental archaeologist or reenactor are prompted to imagine through a shared bodily and sensory experience some of the everyday realities of life in the past, changing text and history from theory into practice in a way that is affective and transformative. The analytical models of the three disciplines demonstrated how to reflect productively on qualitative data and how to value the instinctual and emotional responses of participants. This kind of reconstructed simulation of past activities feels like it raises more questions than it answers. Participant feedback – as we will see in Chapter 4 – often focused on the hypothetical differences between medieval and modern experiences. These first-person investigative methodologies modelled how directed questionnaires and discussions can instead reveal the transformative potential of the material and gave participants a framework through which to mediate their observations. For example, a sensory observation conducted in Gainsborough Old Hall prompted participants to attune to their bodily experiences, reacting to the feel of their historical costumes and how they changed their movements and sensory perceptions, which allowed them to be more mindful of the whole context of the reading experience, to reflect critically on these perceptions and to allow their instincts as performers to be shaped by the space, their observations, and to in turn shape the romance texts. A number of modern performance reconstructions served as specific exemplars for my experimental investigations, some combining modern and creative elements with historical source material, others aiming to replicate or reconstruct historical performances.

### 1.4.1 Reading Malory Aloud

The ‘Reading Malory Aloud, Then and Now’ project held at the 26<sup>th</sup> International Congress on Medieval Studies in Kalamazoo, Michigan in 1991 and run by Karen Cherewatuk and D. Thomas Hanks, Jr, with findings published in a special issue of *Arthuriana*, proved to be a strong analogue for my own performative research and a useful point of comparison for both methodology and results. The project imagined Malory in a performance setting, specifically inspired by the educating of the future Edward V through reading aloud of edifying literature during mealtimes.<sup>55</sup> A series of sessions explored Malory’s work when examined in an aural context, with papers about medieval narrative performance, pronunciation of fifteenth-century Middle English and experimental prelection of the sections of *Le Morte d’Arthur*.<sup>56</sup> There were four prepared readings of

---

<sup>55</sup> Cherewatuk, ‘An Introduction to Aural Malory: Sessions and Round Tables’, 3.

<sup>56</sup> Jeannette Marshall Denton, ‘An Historical Linguistic Description of Sir Thomas Malory’s Dialect’, *Arthuriana*, Reading Malory Aloud, Then and Now, 13, no. 4 (2003): 14–47; Joyce Coleman, ‘Reading Malory in the Fifteenth Century: Aural Reception and Performance Dynamics’, *Arthuriana*, Reading Malory Aloud, Then and Now, 13, no. 4 (2003): 48–70; Rosamund S. Allen, ‘Reading Malory Aloud: Syntax, Gender, and Narrative Pace’, *Arthuriana*, Reading Malory Aloud,

excerpts, before the general audience were invited to participate.<sup>57</sup> The *Le Morte d'Arthur* project was not an attempt to authentically reproduce medieval performance practices: it was in a modern setting, and with performance techniques chosen for inclusivity and to please modern sensibilities rather than taking a more historically-informed or experimental approach. For example, multiple participants were each assigned specific characters to read as, a technique not attested in historical narrative performance, but rather borrowed from drama. The *Le Morte d'Arthur* project resulted in a renewed appreciation of the artistic nuance of Malory's writing, which was brought alive and made prominent by reading it aloud, and participants expressed a renewed love for and enjoyment of the text.

Cherewatuk particularly highlights the ability of oral delivery to enhance the emotion and power of the text and to bring excitement and new life to passages that are less vivid on the page.<sup>58</sup> Rosamund Allen commented on the transformative power of performance in the Malory project: "Malory's style is often dismissed by critics. When the text is performed, however, that so often decried paratactic style of the narrator is much less noticeable.

Throughout, what comes across more impressively in performance than on the page is dialogue".<sup>59</sup> For example, the battle scenes are transformed from dull into linguistically striking passages, and pauses, dialogue and "long hypotactic sentences" after battles were "welcome".<sup>60</sup> Allen suggests that the impact of Malory is in his contrast of tones (for example between battles and dialogue) and this difference is best emphasised by reading aloud. Instead of skipping the battle scenes in favour of the dialogue, when they are read together the impact of both is enhanced.<sup>61</sup> This transformation effected by reading aloud is reminiscent of the contrast between Pearsall's lambasting of *Guy of Warwick* as "hack-work" yet the description of the same text in a sermon summary as moving its hearers to tears when read aloud.<sup>62</sup> Performance has the power to elevate romance texts and to make them more engaging for a modern audience.

---

Then and Now, 13, no. 4 (2003): 71–85; Janet Jesmok, 'Reading Malory Aloud: Poetic Qualities and Distinctive Voice', *Arthuriana*, Reading Malory Aloud, Then and Now, 13, no. 4 (2003): 86–102; Michael W. Twomey, 'The Voice of Aurality in the "Morte Darthur"', *Arthuriana*, Reading Malory Aloud, Then and Now, 13, no. 4 (2003): 103–18; D. Thomas Hanks Jr., 'Epilogue: Malory's "Morte Darthur" and "the Place of the Voice"', *Arthuriana*, Reading Malory Aloud, Then and Now, 13, no. 4 (2003): 119–33.

<sup>57</sup> Cherewatuk, 'An Introduction to Aural Malory: Sessions and Round Tables', 5.

<sup>58</sup> Cherewatuk, 'An Introduction to Aural Malory: Sessions and Round Tables', 7; and see also discussion above and Allen, 'Reading Malory Aloud: Syntax, Gender, and Narrative Pace'.

<sup>59</sup> Allen, 'Reading Malory Aloud: Syntax, Gender, and Narrative Pace', 71.

<sup>60</sup> Allen, 71.

<sup>61</sup> Allen, 76–77.

<sup>62</sup> Pearsall, 'The Development of Middle English Romance', 99; Coleman, *Public Reading and the Reading Public*, 29.

### 1.4.2 Musical Performance

The work of performer-scholar Linda Marie Zaerr also influenced my analysis. Zaerr researches and practices the performance of romance, predominantly Middle English and Old French romance, with musical accompaniment.<sup>63</sup> She often performs at International Congress on Medieval Studies held annually in Kalamazoo, Michigan, but also has a number of filmed performances online.<sup>64</sup> Zaerr frequently accompanies herself with a *vielle* – a medieval precursor to the violin with four or five strings, tuned in such a way that both melodies and accompanying drones can be easily played. This setup allows for easy accompaniment of the spoken word, with both melodic passages and underlying drones. Zaerr is sometimes also accompanied by her sister Laura Zaerr on the gothic harp or by Joseph Baldassare on medieval lute. Zaerr memorises the texts in their original language and fills in any memory gaps with improvisation.<sup>65</sup> In this way, analysis of her performances provides an interesting counterpart to the studies of memorised recitation discussed above.<sup>66</sup> Zaerr uses the practice of *contrafactum* in which new words are fitted to an existing tune, adapting surviving medieval melodies as the musical settings for the romances. For example, her setting of *Sir Orfeo* uses the thirteenth century English tune “Edi beo thu”.<sup>67</sup> Zaerr’s performances modelled how to balance audience comprehension and enjoyment with accurately reproducing the source material in the original language; using appropriate performance techniques to convey the overall meaning of a passage, even if the audience cannot follow every word.

Similarly, Benjamin Bagby’s *Beowulf* project returns the Old English epic poem to the performance sphere.<sup>68</sup> Bagby recites from memory in what could be classified broadly as dramatic recitative, mixing completely sung passages with original melodic themes and dramatically declaimed speech. Bagby accompanies himself on a six-string Anglo-Saxon lyre, based on a 6<sup>th</sup>-7<sup>th</sup> Century exemplar from Oberflacht.<sup>69</sup> The performance is entirely in Old English, with the translation projected as surtitles for the audience to follow the sense. Bagby’s delivery and the

---

<sup>63</sup> Zaerr, *Performance and the Middle English Romance*; Zaerr, ‘*The Weddyng of Sir Gawen and Dame Ragnell*: Performance and Intertextuality in Middle English Popular Romance’.

<sup>64</sup> garible, ‘Abduction of Queen Herodis (with Harp)’, video, *YouTube*, 25 September 2014, <https://www.youtube.com/watch?v=IrTsiN5PyAI>.

<sup>65</sup> Zaerr, ‘*The Weddyng of Sir Gawen and Dame Ragnell*: Performance and Intertextuality in Middle English Popular Romance’.

<sup>66</sup> In particular her analysis of the errors and improvisations in a memorised performance: Zaerr.

<sup>67</sup> Zaerr, *Performance and the Middle English Romance*, 115–23.

<sup>68</sup> Benjamin Bagby, ‘Beowulf: The Epic in Performance’, accessed 30 September 2021, <https://web.archive.org/web/20210930111519/http://www.bagbybeowulf.com/>; Benjamin Bagby, ‘Beowulf, the Edda, and the Performance of Medieval Epic: Notes from the Workshop of a Reconstructed “Singer of Tales”’, in *Performing Medieval Narrative* (Cambridge: D. S. Brewer, 2005), 181–92.

<sup>69</sup> Bagby, ‘Beowulf: The Epic in Performance’.

accompanying music serve the story and present the sense and emotions, even if the words are not fully comprehensible. Bagby's performance owes much to his formal training in Early Music: it is polished and virtuosic, although with room for flexibility and improvisation and shows the clear influence of operatic principles in Bagby's delivery and in the use of surtitles. It is an impressive feat of memorisation and a reminder that memorised performances of long epic texts (and, by extension, romances) by professionals is certainly possible. Although Bagby's *Beowulf* is a formal and professional performance, and *Beowulf* and Middle English romance are many centuries removed, Bagby's highly-skilled performance and dynamic approach to conveying the story were a significant inspiration for my own experimentation. His *Beowulf* project stands as a testament to how talented modern musicians can shape and adapt medieval texts in historically-informed ways that are incredibly compelling to a modern non-expert audience.

As musical performance of romances is such a dominant trend in scholarship and Zaerr's work is the most prominent study of romance performance that combines practical and academic methods, it is worth a brief diversion to discuss the evidence for musical performance and why my performances focus purely on reading aloud. Musical recital is a common interpretation of romance performance. A separate musician could accompany the reader of the text, either playing background music at the same time as the story is spoken, or playing musical interludes interspersed with reading of passages. In both of these methods, the music operates separately from the text. The music can follow the changing shape and feel of the story, enhancing emotional impact through the chosen melodic feel and flow. More elaborate performances could incorporate the music as an integral part of the story, with the words set to music in the manner of a song or chant. Zaerr points to two main sources of evidence for musical romance performance. The first is internal references in romances to their sung reception, such as in the opening of *Sir Bevis of Hampton* (found in Ff.2.38 and five other manuscripts) "Lordinges herkneth to my tale / Is merier than the nightingale / That I schel singe" or the opening and close of *Sir Orfeo* (found in Ashmole 61 and two other manuscripts) which describes how the story is a retelling of a Breton lay which was accompanied by the harp.<sup>70</sup> In the romance *Emaré* (unique to unique to CCAii, ff. 71ra-76vb) the narrator refers to the text as a song, story, romance, and a Breton lay (ll.

---

<sup>70</sup> Ronald B. Herzman, Graham Drake, and Eve Salisbury, eds., 'Bevis of Hampton', in *Four Romances of England: King Horn, Havelok the Dane, Bevis of Hampton, Athelston*, TEAMS Middle English Texts Series (Kalamazoo, Michigan: Medieval Institute Publications, 1997), ll. 1–3; A.J. Bliss, ed., *Sir Orfeo* (Oxford: Oxford University Press, 1954), ll. 1–24; George Shuffelton, ed., 'Item 39, Sir Orfeo', in *Codex Ashmole 61: A Compilation of Popular Middle English Verse*, TEAMS Middle English Texts Series (Kalamazoo, Michigan: Medieval Institute Publications, 2008), 1–26. Subsequent references will state line numbers in-text in brackets.

24, 115, 162, 216, 1030) and describes their own performance as singing (l. 24). The inscribed musical performance also extends to the romance's source and transmission - the narrator cites their own aural reception of the source as an embedded fictional minstrel performance, "As y have herd menstrelles syng yn sawe" (CCAii, f. 72vb, l. 319), and the romance's opening references spoken performance by itinerant minstrels (ll. 13-18) as well as the narrator's own performance of the romance ("As I here syng in songe", l. 24). The second source of evidence is records of comparable performances: a troubadour references a poem set to the melody of "Beves d'Antona"; the account of Herbert the minstrel singing the song of Colbrond and the *geste* of Queen Emma in the priory of St Swithin in Winchester in 1338 (the fight with Colbrond is an episode from the romance *Guy of Warwick* and also survives separately in the Percy folio as *Guy and Colebrand*); an account of 1432-3 which records a performance of "la Tournement de Totyngham" at Rougemont Castle; and a reference in 1497 to two fiddlers who sang *Grey Steel* (or *Eger and Grime*) to King James IV of Scotland, combined with a melody for "Grey Steel" in a nineteenth-century transcription of a seventeenth-century lute book.<sup>71</sup> The first strand is not necessarily compelling evidence on its own: other scholars have already explored the multivalence of the terms "read" and "sing", concluding that they do not map onto modern understandings of the terms and therefore should not be used as definite evidence of modality.<sup>72</sup> It is also worth noting that none of these historical examples are unquestionably performances of romance (or at least not of romance as it survives in written form) – indeed, many are not romances at all. The shared names and subject matter are more likely, I argue, to be evidence of parallel storytelling traditions rather than musical recitations of the romances as they exist in the surviving manuscripts. The multiple versions of the episode from *Guy of Warwick* are a clear example of this (the Anglo-Norman *Gui de Warewic*; Middle English "Guy of Warwick" in both stanzaic and couplet form; Middle English "Guy and Colbrond" episode [Percy folio]; reference to a performance of a "Song of Colbrond" in records of Saint Swithin's priory in Winchester) as is the survival of several ballads that share names or themes with romance heroes such as "King Orfeo" (Child 19) (*Sir Orfeo* is of course itself a reworking of an existing story) and "Sir Lionel" (Child Ballad 18, sometimes called "Sir Eglamore").<sup>73</sup> In further-afield

---

<sup>71</sup> Zaerr, *Performance and the Middle English Romance*, 47, 57–58, 15, 158, 53–54; Putter, 'Middle English Romances and the Oral Tradition', 346–49.

<sup>72</sup> Putter, 'Middle English Romances and the Oral Tradition', 341; Reichl, 'Turkic Bard and Medieval Entertainer: What a Living Epic Tradition Can Tell Us about Oral Performance of Narrative in the Middle Ages', 176; Karl Reichl, 'Orality and Performance', in *A Companion to Medieval Popular Romance*, ed. Raluca L. Radulescu and Cory James Rushton (Cambridge: D. S. Brewer, 2009), 135–37.

<sup>73</sup> The Child Ballads were collected in the nineteenth century but many ballads have much earlier origins. Francis James Child, ed., '18. Sir Lionel', in *The English and Scottish Popular Ballads*, vol. 1 (Boston: Houghton, Mifflin and Company, 1882), 208–15; John Playford, *The Second Book of the*

genres, Harriet Hudson notes the record of a performance of a play *Eglamour and Degrebelle* in St Albans in 1444.<sup>74</sup> Music and dance steps are found in the Gresley dance manuscript dating to c. 1500 under the name “Eglamowr”.<sup>75</sup> The shared names do not necessarily prove that the written forms of romances were performed, nor does any of this evidence suggest the use of household manuscripts in this kind of performative tradition, however, as with oral-formulaic poets, the wide musical performance tradition can be used fruitfully to inform modern reinterpretations.

Musical delivery of narrative items perhaps lay somewhere between song and speech, as in this account from fifteenth-century Italy by poet and scholar Angelo Poliziano:

“No sooner were we seated at the table than [Fabio Orsini, the 11-year-old son of the host] was ordered to sing, together with some other experts, certain of those songs which are put into writing with those little signs of music, and immediately he filled our ears, or rather our hearts, with a voice so sweet that (I do not know about the others) as for myself, I was almost transported out of my senses, and was touched beyond doubt by the unspoken feeling of an altogether / divine pleasure. He then performed an heroic song which he had himself recently composed in praise of our own Piero dei Medici ... *His voice was not entirely that of someone reading, nor entirely that of someone singing; both could be heard, and yet neither separated one from the other; it was, in any case, even or modulated, and changed as required by the passage ... You might have thought that an adolescent Roscius was acting on the stage.*”<sup>76</sup>

This chant-like delivery is a highly effective way of conveying the narrative with great emotional impact, and is a clear influence on the performance style of Bagby. Several narrative items are preserved with musical notation: the thirteenth-century Old French *cantefable Aucassin et Nicolette*, the thirteenth-century play *Le Jeu de Robin et de Marion* and the fourteenth-century romance *Roman de Fauvel*. All three intersperse verses or songs set to music, which is notated in the manuscripts. These three examples are earlier French texts and none of the household manuscripts I examined, nor indeed any manuscripts of romances more broadly, contain any musical notation (Poliziano’s “little signs of music”) connected specifically with the

---

*Pleasant Musical Companion Being a New Collection of Select Catches, Songs and Glees: For Two and Three Voices* (London: Printed for John Playford, 1686), Song 20.

<http://name.umdl.umich.edu/A70826.0001.001>.

<sup>74</sup> Harriet Hudson, ‘Sir Eglamour of Artois: Introduction’, in *Four Middle English Romances: Sir Isumbras, Octavian, Sir Eglamour of Artois, Sir Tryamour*, ed. Harriet Hudson, TEAMS Middle English Texts Series (Kalamazoo, Michigan: Medieval Institute Publications, 2006).

<sup>75</sup> “Eglamowr” in Derby, Derbyshire Record Office, D77/4/25/25 (The Gresley Manuscript).

<sup>76</sup> Quote: Politianus, *Opera omnia*, 1:165–66, trans. Pirrotta and Povoledo, *Music and Theatre*, ch. 1, conclusion. Emphasis added. Quoted and translated in: Anthony M. Cummings, ‘Music and Feasts in the Fifteenth Century’, in *The Cambridge History of Fifteenth-Century Music*, ed. Anna Maria Busse Berger and Jesse Rodin Davis (Cambridge: Cambridge University Press, 2015), 369–70.

texts. The Heege manuscript contains a Guidonian hand (a mnemonic device used for identifying and visualising pitch) (f. 175v) and an excerpt of musical notation of the troped Kyrie “Deus creator omnium” from the Use of Sarum (f. 216v).

Additionally, the Findern manuscript has fragments of musical notation on ff. 139v and 143r, seemingly unconnected marginalia. Zaerr argues that melodies could be memorized and applied to texts on an *ad hoc* basis, especially as not all musicians could read musical notation.<sup>77</sup> This could perhaps follow the model of *chansons de geste* as described by thirteenth-century musical theorist Johannes de Grocheio:

“Versus autem in cantu gestuali [est] qui ex pluribus versiculis efficitur et in eadem consonantia dictaminis cadunt; In aliquot tamem cantu clauditur per versiculum ... ab aliis consonantia discordantem... Numerus autem versuum in cantu gestuali non est determinatus sed secundum copiam materiae et voluntatem compositoris ampliatur. Idem etiam cantus debet in omnibus versiculis ... reiterari.”<sup>78</sup>

*“The verse in a chanson de geste is that which is constituted from many versicles which fall together with the same accord of verbal sound; in some chanson de geste the verse ends with a versicle which does not accord in verbal sound with the others... The number of verses in a chanson de geste is not fixed and may be extended according to the abundance of the raw material and the wish of the one who makes the song. The same melody must be repeated in every versicle.”*

Applying *ad hoc* melodies in this model to the romances as they are preserved in the household manuscripts, however, seems unlikely. Their layout and presentation is often cramped and challenging to read, and is highly unsuited for a musical setting adapted directly from the page. In many cases, even a reader-aloud must concentrate hard to avoid misreadings or eyeskip. The high levels of skill required likely relegates musical romance performance only to professional memorised performance and the clear case for domestic usage and ownership of the focus manuscripts suggests that such a performance likely did not result from their romance texts. Musical performance of the romances, as well as minstrel performers, instead represent a parallel tradition and transmission of romance texts which intermingled with the amateur, domestic story-telling traditions supported by household manuscripts.

### 1.4.3 Other Performance Media

There has also been a push towards multi-media performative engagement with medieval texts that is only growing stronger with developing technologies. The Chaucer Studio was

<sup>77</sup> Zaerr, *Performance and the Middle English Romance*.

<sup>78</sup> Text and translation from Christopher Page, ‘Johannes de Grocheio on Secular Music: A Corrected Text and a New Translation’, *Plainsong and Medieval Music* 2, no. 1 (1993): 27–28.

an early driving force for this from 1986 with their collections of published recordings of medieval and early modern texts.<sup>79</sup> The Chaucer Studio aims to demonstrate pronunciation and delivery of old languages, and to return medieval oral texts to performative modes as research and teaching aids.<sup>80</sup> For example, their CD “Performing Middle English Romance” presents audio recordings of conference proceedings about romance performance and performances of romances.<sup>81</sup> The four romance performances are all musical with sung delivery accompanied by instrumentation. Although the arguments are persuasive and the performances exceptionally well-executed, my overall impression of the recorded performances was the challenge they pose to a listener, especially without the aid of visual elements like gestures and movements. To a modern ear, the melodies are distracting and it is often difficult to follow the sense of the words and the story. This points to the strength of Bagby’s performance, in which the semi-improvised music fits the mood and meaning of the words and thus helps to convey the narrative sense. In performances where words have been retroactively fitted to music, the music is given too prominent a place in the performance and the full impact of the narrative is diminished. Perhaps this merely points to differing expectations and experiences between modern and medieval listeners; certainly those used to musical delivery of narrative items would be more skilled in following a story with a melody, and perhaps the formulaic nature of romances would make them suitable for a more complex method of delivery where content can be easily guessed if it is not discerned fully.

More recent online databases of medieval performances compile both creative and reconstructive performances by professionals, amateurs and students. These include the project “Performing Medieval Narrative Today” by Evelyn Birge Vitz, Nancy Freeman Regalado and Marilyn Lawrence, the TEAMS “Medieval Tales in Performance” YouTube channel and Vimeo channel “Arthurian Legend in Performance”.<sup>82</sup> These databases make performances of medieval material easily accessible and support further study of medieval narrative performance. The performances include a vast number of texts in different languages (both original languages and modern English translations) and performance modes, including reading from books, memorised performances, performance with musical accompaniment, a puppet show, mimed performances and large-scale theatrical performances. Student feedback on the MedNar project confirms that they found

---

<sup>79</sup> ‘Chaucer Studio’, BYU Creative Works, 2021, <https://creativeworks.byu.edu/CreativeworksStore/ProductCategory?SiteID=20>.

<sup>80</sup> *The Chaucer Studio and Its Press: Recordings and Books*, Unpublished brochure, 2017.

<sup>81</sup> Linda Marie Zaerr et al., *Performing Middle English Romance*, CD (The Chaucer Studio, 2015).

<sup>82</sup> Vitz, Regalado, and Lawrence, ‘Videos’; ‘Medieval Tales in Performance’; Evelyn Birge Vitz and Marilyn Lawrence, ‘Arthurian Legend in Performance’, vimeo, 2011, <https://vimeo.com/arthurperform>.



performance a pleasurable and engaging way to study medieval texts and to feel closer to the past.<sup>83</sup> The databases are a clear demonstration of the transformative power of performance on texts and the importance of easily accessible resources.

Another notable performance available online is a two-part portrayal of the paved parlour reading from Chaucer's *Troilus and Criseyde*.<sup>84</sup> In the first part, the excerpt is dramatised, with participants speaking the dialogue of the characters and acting out the actions narrated in the text. In the second part, the performance is re-imagined as Chaucer reading aloud to a group of gathered listeners. These two performances are particularly interesting for their inclusion of audience commentary and intrusions, and their intertextual references. Although the audience comments are scripted, using lines from the work of Chaucer and his contemporaries, they are highly effective for making the performance come to life, and frequently highlight textual parallels. Most performers recite from memory, but each video also includes one prelector reading from a book. The text chosen to represent the Criseyde's "romance of Thebes" is John Lydgate's "Siege of Thebes", particularly fitting despite the forty-year gap between it and *Troilus and Criseyde* as Lydgate's text extensively references Chaucer's work and positions itself as Lydgate's own addition to the *Canterbury Tales*. This paved parlour reading in particular encouraged the development of my own performances. It is compelling and the audience comments hint at a vibrant and collaborative textual tradition. Surveying these modern performance exemplars allowed me to identify several key niches that my performative experiments were to occupy. The first was the engagement with surviving medieval buildings with reconstructed furniture and fittings that could simulate the physical setting associated with reading from household manuscripts. The second was to recreate reading, rather than to stage a performance. I investigate and restage the entire act of reading, including deciphering words and sense. Unlike all of these performance exemplars, my readers were participants before they were performers: I sought instinctive and genuine responses to texts rather than scripting audience engagement and I encouraged creativity in staging the readings in response to the spaces. In addressing these two areas I aimed to simulate the wider context of fifteenth century domestic reading practices.

---

<sup>83</sup> Evelyn Birge Vitz, Nancy Freeman Regalado, and Marilyn Lawrence, 'Explore More', Mednar: Performing Medieval Narrative Today A Video Showcase, accessed 7 January 2020, <http://mednar.org/explore-more/>.

<sup>84</sup> Kevin Caliando, "Reading in Paved Parlor" Pt. 1', video, *YouTube*, 15 April 2007, <https://www.youtube.com/watch?v=1lNkAtRoU1w>; Kevin Caliando, "Reading in a Paved Parlor" Pt. 2', video, *YouTube*, 15 April 2007, <https://www.youtube.com/watch?v=53VPmv6lvJ4>.

### 1.4.4 Early Modern Drama

My methodology was also heavily informed by theatre and experimental historical performance. Early modern drama is the most widely studied pre-modern performance type and Shakespeare studies in particular offered a wealth of resources and a long history of adapting and presenting challenging historical source material to a non-expert modern audience and of researching and presenting original performance practice. The plays of Shakespeare and his contemporaries are complex texts which many find difficult to understand, yet they are frequently staged and enjoyed by modern audiences. Moreover, with projects like Shakespeare's Globe and Sam Wanamaker theatres in London, the Shakespeare North Playhouse in Prescot, and in the USA, the American Shakespeare Centre's Blackfriars Playhouse providing reconstructed historical theatrical spaces, analysis of early modern drama has the ability to be highly conscious of place and space, as well as experiment with practical details like staging in the round, the use of candlelight, or playing in daylight or in the open air.<sup>85</sup>

Oliver Jones' thesis project "The Queen's Men on Tour" provided a methodological model for my own analysis in addressing the specific spaces and buildings associated with performances.<sup>86</sup> The Queen's Men were the royal players for Queen Elizabeth I, and as was common practice in the time, they often travelled between provincial towns, staging performances in the venues and spaces available. Jones proposed an investigative methodology that combined the study of buildings and spaces with experimental reconstructions of performances situated in those historical spaces, staging excerpts from The Queen's Men's play *The Troublesome Reign of John, King of England* in the Stratford-upon-Avon Guildhall. Although theatre demands a more formal and prescribed usage of space, Jones' discussion of how the space of the Guildhall could be shaped to accommodate the performance and how the performance interacted with the space provided a crucial framework for negotiating the relationship between text and space in my experiments. Jones' historical and archaeological research identified a plausible performance space in the hall for the Queen's Men's small-scale licensing performance in front of the Mayor and the aldermen: at the opposite end to the dais, with certain spaces also suggested as a tiring room and an entrance.<sup>87</sup> By specifically locating and then staging performance within the hall, the space and its features and fittings suggested insights about

---

<sup>85</sup> Christie Carson and Farah Karim-Cooper, eds., *Shakespeare's Globe: A Theatrical Experiment* (Cambridge: Cambridge University Press, 2008); J.R. Mulryne and Margaret Shewring, eds., *Shakespeare's Globe Rebuilt* (Cambridge: Cambridge University Press in association with Mulryne & Shewring, 1997); although such reconstructions are not without their shortcomings – see Oliver Jones, 'The Queen's Men on Tour: Provincial Performance in Vernacular Spaces in Early Modern England', 25–26.

<sup>86</sup> Jones.

<sup>87</sup> Jones, 118–19, 155, 167.

the play and performance practices. The playing space had only a single entrance: this simplified some of the staging, and revealed how the play was written to handle large exits, by having smaller conversations play out between two actors whilst the actors portraying armies or large groups were able to exit more slowly in the background and not disrupt the flow of the play.<sup>88</sup> Features of the building, in particular the Queen post truss, proved to particularly affect the performance, directing the gaze of an audience and framing the space of the performance: Jones used this feature as the centrepiece of the play's series of tableaux.<sup>89</sup> Jones was also interested in the relationships between actors and space, in particular how to convey hierarchical relationships and how to allow actors to appear 'above' without any specific platform or balcony in the space. In a performance staged at the low end of the hall, Jones notes that the throne and canopy of King John could be positioned directly opposite the mayor's chair at the high end of the hall, emphasising the authority of the two figures.<sup>90</sup> The inscribed hierarchy of the Guildhall is a direct equivalent for the hierarchy of the medieval hall, with high and low ends and specific formal or ceremonial functions and thus Jones' analysis of space challenged me to anticipate interactions with the space that would directly affect the reading, such as situating reading at the different ends of the hall.

## 1.5 Analysing Performance

Although the performance exemplars and the performance theory discussed above provide some models for analysing performance, performance often resists inquiry. It is a heightened moment in time and experience. A performance can only ever exist at one moment in time, never to be recreated: its interactivity – with time, with audience, with the behaviours enacted – is always changeable and unique.<sup>91</sup> Walter J. Ong expresses a similar opinion about the ephemerality of performance, based on the nature of sound: “sound exists only when it is going out of existence”.<sup>92</sup> In this way, the voiced words of the text in performance and their reception by an audience are a moment never to be repeated. Paul Zumthor's concept of *vocalité* posits that aural texts are only fully realised when voiced.<sup>93</sup> Thus a vocalisation of a medieval text is made out of many unrepeatable, ephemeral performative moments. The uniqueness of every performance may seem on the surface to

---

<sup>88</sup> Jones, 165–67.

<sup>89</sup> Jones, 165.

<sup>90</sup> Jones, 119.

<sup>91</sup> Schechner, *Essays in Performance Theory*, 30.

<sup>92</sup> Walter J. Ong, *Orality and Literacy: The Technologizing of the Word* (London: Routledge, 2002), 70.

<sup>93</sup> Paul Zumthor, *La Poésie et La Voix Dans La Civilisation Médiévale* (Paris: PUF, 1984).

render PaR futile. Yet performance research thrives in this liminal space between ephemerality and materiality. Edward M. Bruner proposes the constructivism model: if every performance is unique and unrepeatably, then re-performances, even when close in time and context to the original, cannot ever replicate it and therefore reproductions transcend concepts of original vs. copy and authenticity.<sup>94</sup> This ephemerality also poses challenges for documenting and analysing performance; Ian Watson writes that performance “only exists in the doing”.<sup>95</sup> Practice-as-research methodologies provide a framework for negotiating and documenting the ephemeral performance, such as the establishment of research hypotheses and key focus questions, documentation of preparations and training, rationale of performance choices, documentation of performance practices (staging, lighting, props), analysis of records of performance, personal self-reflection throughout the whole process.<sup>96</sup> But documentation of performance must always be conscious of its unavoidable and fundamental deficiencies.

Performance also has its own concept of time: a good performance draws the audience into the evoked world and suspends conscious awareness of the real world. The immersed audience loses their sense of the passage of time and become immersed in what ethnomusicologist Ruth M. Stone calls “inner time” and what Zumthor describes as “an all-embracing present that simultaneously remembers, contemplates, and anticipates.”<sup>97</sup> Stone writes of the “subjectively experienced qualitative time” of musical performance: “performance is special and different from ordinary activity. It serves to create a marked-off sphere, within which people may relate to one another differently from how they do in daily life.”<sup>98</sup> These modern observations are strikingly similar to Richard de Fournival’s *Bestiaire d’amours*: “when one hears a romance read, one hears the adventures as if one saw them in the present.”<sup>99</sup> Although the exact mediums and techniques of performance vary, the timeless eternal present that performance evokes suggests a shared qualitative experience. Medieval performative reading and modern performative reading of medieval

---

<sup>94</sup> Bruner, ‘Abraham Lincoln as Authentic Reproduction: A Critique of Postmodernism’, 397, 407–9.

<sup>95</sup> Watson, ‘An Actor Prepares: Performance as Research (PAR) in the Theater’, 89.

<sup>96</sup> Purcell, ‘Practice-as-Research and Original Practices’, 427–28; Gibbings, ‘Performing Pearl: Drama, Middle English Text and Performance Based Research in Medieval Studies’.

<sup>97</sup> Stone’s study focused on musical performances by the Kpelle people of Liberia, yet even outside of this context provide a useful model for describing perceptions of time in performance. Paul Zumthor, *Towards a Medieval Poetics*, trans. Philip Bennett (Minneapolis: University of Minnesota Press, 1992), 11; Ruth M. Stone, ‘Time in African Performance’, in *The Garland Encyclopaedia of World Music, Volume 1: Africa*, ed. Ruth M. Stone (London and New York: Garland Publishing, 1998), 128.

<sup>98</sup> Stone, ‘Time in African Performance’, 126, 128.

<sup>99</sup> Richard de Fournival, *Master Richard’s Bestiary of Love and Response*, trans. Jeanette Beer (Berkeley: University of California Press, 1986), 1–2; Mark Cruse, ‘Matter and Meaning in Medieval Books: The Romance Manuscript as Sensory Experience’, *Sense and Society* 5, no. 1 (2010): 50.

texts are thus united by these commonalities: they can never exist other than in the exact moment that they are realised and this moment is somehow suspended away from the present in a subjective narrative/performative time. They are in a sense a shared – but not identical – qualitative and embodied experiences, differing in the exact context, mediums and performative techniques, but united by the appreciation and experience of the same text realised in speech act. Phenomenology allows performance practitioners to use present reconstructions as a tool to understand past practices, centring the shared bodily and sensory experiences of performance.

Performative reading has affective power that stems not just from the words on the page, but their delivery – their time, space, materiality transformed into immateriality as words from the page become sound, become sense and story. Hence, reading a book privately and silently is a vastly different experience from hearing it read aloud, and not just in the sensory differences of sight vs. hearing. The performer has almost authorial control over the narrative as their presentation can change the text, emphasising certain understandings of the events and words. One site of such dramatic potential in one of the focus texts, *Sir Eglamour of Artois*, is the confrontation with the giant Marras. The giant's mourning for his "lyttyl spotted hogelynn" (l. 539) – the ferocious boar that slays every man and beast it sees – can be shaped for different reactions. When I read this romance aloud, I filled this line with comedic melodrama and the audience obligingly laughed, seeing the ridiculousness of the descriptor. However, a skilled performer could inject the line with sorrow and sincerity and transform it into something else entirely: a genuinely touching moment that foregrounds the feelings of a societal outcast whose usual role in a romance narrative is the dangerous, often heathen, Other consumed by violence, excess and lust.<sup>100</sup> Another key site of performative variance<sup>100</sup> is in the small asides and repeated phrases – especially those associated with the narrator. Formulaic phrases and 'filler lines' – 'sothe for to sayn', 'I undirstond', 'in romance as we rede' and 'so saith the book', for example – are the nexus of narratorial and authorial *auctoritas*.<sup>101</sup> The romance texts have the potential to be changed drastically, depending on how much the reader aligns themselves with the first-person pronoun of the narrator. For example, delivering an authorising statement such as 'sothe for to sayn' or 'I undirstond' in tones heavily laden with irony would very effectively undermine the sincerity of romance characters and their motives, instead of strengthening it. Narratorial intrusions offering judgements on characters or events are also particularly suited to varying in performance.

---

<sup>100</sup> Rebecca Wilcox, 'Romancing the East: Greeks and Saracens in *Guy of Warwick*', in *Pulp Fictions of Medieval England: Essays in Popular Romance*, ed. Nicola McDonald (Manchester: Manchester University Press, 2004), 229–34.

<sup>101</sup> A.J. Minnis, *Medieval Theory of Authorship: Scholastic Literary Attitudes in the Later Middle Ages*, Middle Ages Series (Philadelphia: University of Pennsylvania Press, 1988).

Performance is inherently communal: it implies both performer and audience, even if they are one and the same, or even imagined (for example, the narrator's addresses to a listening audience can become an imagined communal reception for the solitary romance reader). Performance is an experience heightened both in the shared communal spirit of the event but also the way it makes the story tangible through realisation of rhetoric, enacting of dialogue and evoking of affective responses. Performance is communication and community. Folklorist Richard Bauman writes that the power of performance lies in this nexus of communication and response: "in the interplay between communicative resources, individual competence, and the goals of the participants, within the context of particular situations."<sup>102</sup> Performance is give and take; it is shared and communicated affective moments. Performative reading is a text experienced: it elevates reading to a shared multisensory event and a directed aesthetic happening and response.

## 1.6 Conclusion

This chapter has laid out the theoretical basis for my performative experimentation, considering definitions of performance, how other scholars have investigated performance of medieval narrative, as well as how other comparable performance fields – PaR, experimental archaeology, musical performance and early modern drama – can inform this study. I have also reflected on the transformative power of performance, which will be seen in action in Chapter 4: a skilled performer can manipulate their presentation of the text to create a desired emotion or intellectual response, but even non-professional readers aloud can deliberately shape their performance. The performer can utilise a number of methods and techniques to modulate their performance: the style of their delivery – the pitch, rhythm, volume, timing and pauses, speed of delivery, mimicry of characters, both supporting and undermining the text; physical aspects such as gesture, stance, mime, facial expressions or theatrical elements like staging and multiple performers; the use of music either in the text itself or as accompaniment; and interactions with the physical space of performance, its contents and the audience.<sup>103</sup> The reader-aloud could also bring to their performance other supporting arts, and a reader could be accompanied by other performers of various kinds – music, actors, mimers. Emotional inflections colour reception and

---

<sup>102</sup> Richard Bauman, *Verbal Art as Performance* (Long Grove, Illinois: Waveland Press, 1977), 38.

<sup>103</sup> See also Brian J. Levy, 'Performing Fabliaux', in *Performing Medieval Narrative* (Cambridge: D. S. Brewer, 2005), 123–40; Anne Azéma, "'Une Aventure Vous Dirai': Performing Medieval Narrative", in *Performing Medieval Narrative* (Cambridge: D. S. Brewer, 2005), 209–22; Heather Maring, 'Performing Pearl', in *Approaches to Teaching the Middle English Pearl*, ed. Jane Beal and Mark Bradshaw Busbee, *Approaches to Teaching World Literature* 143 (New York: The Modern Languages Association of America, 2018), n.p.

interpretation, for example, presenting a passage deadpan, with heavy irony, or as melodrama. Humour can be found in an appropriately-placed pause or an incongruous facial expression. Social critique can be conjured merely at a slight change in delivery.

Reading aloud is a multi-sensory experience. Words travel from the page through the eyes of the reader to ears of the audience. Hearing a text read aloud is not just about the spoken words, but the entire embodied experience of a listening, watching, participating audience. The performance exists in a specific place and space at a specific time and both performer and audience interact with the physical, material world and its contents. Thus an understanding of the performance context of an aural text is crucial for an understanding of the text as a whole. However, for historical performance, this contextual information is often lost. This thesis attempts to reconstruct some aspects and theorise about the realities of medieval reading aloud. Nonetheless, it unavoidably reflects more on the modern context than it can ever do about the medieval. A scholar can imagine these effects theoretically and abstractly, but both possibilities and limitations are best examined through practice. Practising performance can reveal factors which influence the reading event: are features of the space or setting used to enhance the performance? Are there aspects of the place or the ambient environment that distract from the performance – a smoky fire, light that is intermittent or dim, noises, smells or visual distractions from people or even animals? The reader-aloud may use props or costumes to aid characterisation, or perhaps features of the space of the reading are deliberately presented as the setting of the fictional narrative. This embodied and emplaced aspect of performance will be explored further in Chapter 3 and 4.

Performance is ephemeral. It is specifically tied to the time and place of its enacting: for the kinds of performances envisaged here, this is the instant in which the words are spoken, gestures made, musical notes produced, to die as soon as the sounds fade out of existence.<sup>104</sup> It lives as the sounds travel from the vessel of performance – the reader, the actor, the musician, the musical instrument – through the air to reach the ears (and eyes and other senses) of the audience. Once a performance is over, it is lost: there is no way to accurately or completely record it in a way that meaningfully captures every aspect. Even if a performance is replicated – if every actor were to repeat every line exactly and every audience member attended again in the same seat, small differences are still unavoidable: responses to performances result from the cumulative sum of a person's entire life experience and the exact time of a performance event can never be recreated or recaptured. It is crucial to acknowledge that we will never accurately recreate a medieval performance. For a start, we are modern readers, not fifteenth-century readers. A medieval

---

<sup>104</sup> Ong, *Orality and Literacy: The Technologizing of the Word*, 70.

reader has the advantage of having spent their whole life, or large part thereof, as a medieval reader: this is not something that can be reconstructed in any experimental analysis. We will never be able to do more than theorise about the medieval experience of reading as we have never and will never be able to experience the cumulative sum of a medieval life that led up to the one occurrence of a performative event. Experimental reconstruction can only go so far, especially considering the lack of evidence, a limitation I felt very keenly when piecing together a picture of everyday leisurely reading, an experience no doubt common, but not deemed important enough to be immortalised in iconography or in literary sources as more formal reading events are. However, the impossibility of accuracy does not mean that such studies lack value. And, importantly, there is no way we could ever truly know if an interpretation is accurate: we have no ultimate arbitrator of truth. If by some chance our interpretation of the surviving evidence happens to be correct, we have no ability to actually verify this. The value of these studies lies not in seeking accuracy or truth, but in acknowledging that this is impossible and thus exploring possibilities instead. We create through this kind of study a different value of ‘authenticity’ that is experiential and not tied to absolute truth. It is a sense of authenticity that encompasses both the modern experience and what can be glimpsed of the medieval experience. We open up texts when we experiment with them, moving beyond questions of proof to investigate different kinds of textual potential. Experimentation does not ask ‘can I?’ but instead ‘what happens if I do?’

Even though we will never accurately recreate a medieval narrative performance, the best way to appreciate the performative potential of these texts is through creative practice and experimentation, combined with more traditional scholarly analysis. Experimenting with performative receptions of medieval texts gives modern readers a different experience and a different kind of engagement with the text, which has the potential to reveal new layers of meaning and encourage new understandings of the text. Through experimental performance the texts can come to life again, and by examining our experience as modern readers we can begin to theorise about medieval experiences of reading and change the ways we read, experience and teach medieval texts.



## CHAPTER 2. Texts and Manuscripts

### 2.1 Introduction

*“If the word reading is understood with persnickety literalness as the movement of the eyes over the page, and the thoughts this activity provoked, then we cannot, strictly speaking, study reading from the past. ... What we study is people’s commentary on their reading, expressed in the various ways they make and mark texts.”<sup>1</sup>*

Literary texts are constructed and presented in anticipation of reading: their authors, scribes, editors and decorators shape the reading experience. Authors craft narratives through choices of artistic expression and poetic forms; scribes replicate these texts but often add features and variations of their own; editors correct, amend and add apparatus to assist the reader; and decorators embellish, illustrate and guide the visual reader. Although this thesis in fact sets out to do exactly what Daniel Wakelin expressed is impossible – studying the literal process of reading from the past through comparisons with the modern experience of reading the same material – his argument that at the basis of the study of reading is the study of writing holds true. We cannot examine reading practices without first considering the process of writing: of creating the text and of copying its physical form into the manuscripts in which it is found. Scribes are the first readers of texts. Theirs is a utilitarian, often superficial type of reading when compared to the performative narrative reading that is the focus here, but their reading act supports the replication of the text. In order to understand how best to present texts, scribes must understand their structure and content.<sup>2</sup> The relative success or failure of this reading process, the replication process and the choices of layout and presentation deeply affect the reading experience of later manuscript users. Several of the household manuscripts examined here were written by their users: their copying and organising principles are even more closely connected to their anticipated usages and users. However, as these ‘own-use’ scribes often lack commercial book production training, their presentation choices are often even more revealing in their limitations and idiosyncrasies.

The material form of the book is the first level of engagement in this materially-informed study of reading. Evidence from the pages of household manuscripts grants

---

<sup>1</sup> Daniel Wakelin, ‘Instructing Readers in Fifteenth-Century Poetic Manuscripts’, *Huntington Library Quarterly* 73, no. 3 (2010): 433.

<sup>2</sup> Matthew Fisher, *Scribal Authorship and the Writing of History in Medieval England* (Columbus: Ohio State University Press, 2012), 6, 100.

insights into their production and usage in a domestic setting. This chapter examines the material forms of the romance texts as they are found in fifteenth-century household manuscripts. I begin by considering the features and usage of household manuscripts, providing brief summaries of some of the key manuscripts studied here. This discussion will return to the theory of the ‘minstrel manuscript’ and analysis of romance performance from Chapter 1, exploring the codicological evidence against this theory as well as internal features of the romance genre with performative potential. The majority of this chapter is devoted to detailed analysis of features from the manuscripts I examined. I investigate elements from the manuscript pages pointing to usage and reception, proposing a methodology for identifying and analysing performative features of manuscripts that will underpin the analysis of the romances throughout the rest of this thesis. Further close readings of *Sir Degrevant*, *Sir Eglamour of Artois* alongside the comic poem “The Tournament of Tottenham” use palaeographical and codicological evidence to interrogate the reading practices of their early users.

## 2.2 Household manuscripts and their users

Household manuscripts are late medieval books of a miscellaneous character which gather together texts suited for domestic usage. A core corpus of manuscripts united by their varied contents that support devotional, practical and leisurely activities was identified by Julia Boffey and John J. Thompson and the category has gained wider acceptance in studies of miscellanies.<sup>3</sup> The household manuscript collects together a large body of texts that serve part or all of a household’s textual needs: they are each a “mediaeval ‘library *in parvo*’” as H.S. Bennett described the Heege manuscript.<sup>4</sup> These texts include recipes for medical cures, weather prognostications, moral tracts, a wide variety of prayers, comic tales, conduct literature, treatises on various technical subjects (astronomy, limning, grafting trees, hawking, herbs), excerpts from the work of canonical authors, mnemonics for teaching children, saints’ lives, miscellaneous devotional texts, nonsense verses, lyric poems, precepts, a list of terms for hunting and, of course, romances. Wealthier households

---

<sup>3</sup> Boffey, ‘Bodleian Library, MS Arch. Selden. B. 24 and Definitions of the “Household Book”’, 126; Boffey and Thompson, ‘Anthologies and Miscellanies: Production and Choice of Texts’; Boffey and Edwards, ‘Towards a Taxonomy of Middle English Manuscript Assemblages’; Johnston, ‘New Evidence for the Social Reach of “Popular Romance”: The Books of Household Servants’; Parker, *The Commonplace Book in Tudor London: An Examination of BL MSS Egerton 1995, Harley 2252, Lansdowne 762, and Oxford Balliol College MS354*; Hardman, ‘Domestic Learning and Teaching: Investigating Evidence for the Role of “Household Miscellanies” in Late-Medieval England’; Shuffelton, ‘Is There a Minstrel in the House?: Domestic Entertainment in Late Medieval England’, 55; Connolly and Radulescu, ‘Introduction’, 6.

<sup>4</sup> Hardman, ‘A Medieval “Library in Parvo”’.

of course owned more than one book: the Paston family owned at least twenty books, including Sir John Paston's "Grete Boke" (Lansdowne 285) which contains texts of martial and chivalric interest, and Robert Thornton's two holograph manuscripts surely joined a collection of other books, although no documentary evidence for them survives.<sup>5</sup> The texts also circulated in informal copies, and several of the household manuscripts studied here existed as separate booklets before they were eventually bound together. However, for less wealthy households, the household manuscript could theoretically fulfil all of their textual needs for devotion, education, edification and entertainment.

I study a selection of fifteenth-century household manuscripts as outlined in the Introduction. Each has its own idiosyncrasies but some generalisations can be made: my examination of the manuscripts suggested that there are more commonalities than Boffey argued. They are predominantly what Kathryn Kerby-Fulton terms "utility-grade" manuscripts.<sup>6</sup> Scripts are usually the informal *Anglicana* or *Secretary*, or hybrids that combine letter-forms from both. These cursive scripts enable fast writing but can often be unclear and challenging to read. Simple *textura* or *Anglicana formata* are used occasionally for formal apparatus like headings, running titles and rubrication. (Figure 2.1) These more formal scripts are visually distinct but more involved to execute, particularly for non-commercial or amateur scribes.

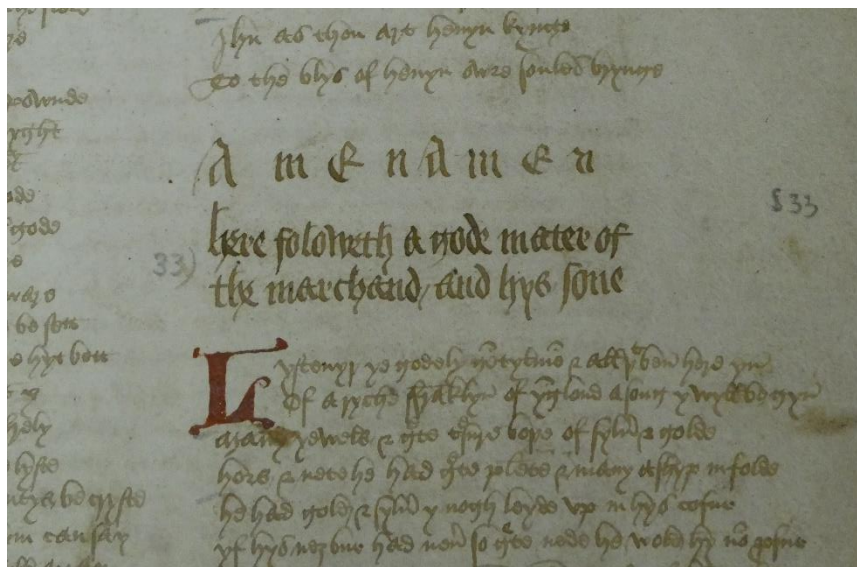

Figure 2.1: Ff.2.38, f. 59rb (detail). Explicit of *How a merchande dyd hys wyfe betray* (Item 32) and incipit of *A gode mater of the marchand and hys sone* (Item 33) in a more formal script.

<sup>5</sup> Parker, *The Commonplace Book in Tudor London: An Examination of BL MSS Egerton 1995, Harley 2252, Lansdowne 762, and Oxford Balliol College MS354*, 6; Michael Johnston, 'A New Document Relating to the Life of Robert Thornton', *Library* 8, no. 3 (2007): 307.

<sup>6</sup> Kathryn Kerby-Fulton, 'Introduction', in Kathryn Kerby-Fulton and Denise L. Despres, *Iconography and the Professional Reader: The Politics of Book Production in the Douce Piers Plowman* (Minneapolis: University of Minnesota Press, 1999), 1–14.

The manuscripts feature very little decoration, with only occasional application of coloured ink. Li 91 also has a collection of professionally-executed decorated capitals in coloured ink.<sup>7</sup> (Figure 2.2) Most other manuscripts lack such formal decoration but have simpler decorated capitals and in some the initial capitals within items are washed or picked out in coloured ink (red or yellow). No formal illustrations are found (although spaces have been left for some planned but never executed in Li 91) but the margins and blank spaces sometimes feature ink drawings or doodles, none of which (apart from Ashmole 61's fish and flowers perhaps) seem to have been planned to a specific decorative scheme.



Figure 2.2: The opening of *Sir Isumbras* in Li 91 with York-style decorated capital, f. 109rb (detail).<sup>8</sup>

The books examined for this thesis were all made of paper, although household manuscripts on parchment are also found and Brogyntyn II.1 mixes vellum and paper. They are a range of sizes, including quartos (CCAii, Findern) and folios (Li 91, Ff.2.38) as well as the tiny Brogyntyn II.1 (140 x 105 mm) and the unusually tall and narrow format of Ashmole 61. The manuscripts show a range of organising principles. Some group texts according to genre (Li 91, Ff.2.38), suggesting some kind of anthologising effort by their

<sup>7</sup> The initials are decorated with human figures, animals, grotesques, a rebus ("Thorn + tun" on f. 23v), a badge with "Robert Thornton" in a banner, and distinctive sprays of floriate decoration. Fredell, 'The Thornton Manuscripts and Book Production in York', 110–15.

<sup>8</sup> Fredell, 115.

scribes or compilers. Other manuscripts like CCAii show small groupings of texts but no wider organisational principles at work, suggesting that texts were copied from exemplars together in sections. Many texts from their varied contents suggest a clear domestic use and this usage context is strengthened by manuscripts with identifiable owners, users and creators. Li 91 is one of two surviving manuscripts written by Yorkshire gentleman Robert Thornton, both of which contain assorted texts probably collected and compiled for the ongoing usage of the Thornton family. Judging by the names of later Thorntons and others added in the margins, the manuscript saw a long period of use, centred in the family home of East Newton Hall in Stonegrave in North Yorkshire. The manuscript records the birth of Robert Thornton's grandson in Ryedale in 1453 in a note added to f. 49v, a small snapshot into the life of the book's creator, as well as the clue that allowed for more specific identification of the 'Robert Thornton' who added his name throughout the book.<sup>9</sup> Li 91 has an identifiable and locatable creator and original usage context, yet many of the manuscripts studied here are more enigmatic, their evidence for domestic usage lying mainly in their common contents. CCAii as it currently stands is a combination of two previously independent manuscripts (previously Cotton Vespasian D.VIII and Vespasian D.XXI), which were bound together sometime before 1654.<sup>10</sup> The first part (the focus here) was copied by a single unidentified scribe in the late fifteenth century in the south-east England or the south-east Midlands. It is orderly in presentation, neatly ruled with carefully planned layouts, and copied in a regular, semi-formal hand, with some textura script in titles and explicits. Nothing is known about its original users, apart from a vague geographical location and a few marginal additions, discussed below.

In some manuscripts, the majority of readership engagement evidence is from later users, where blank leaves and margins are used for pen trials, mundane notes, textual additions and ownership inscriptions. Ff.2.38 dates to the mid-late fifteenth century, but only shows user engagement from the sixteenth century (miscellaneous marginal additions, including a lewd poem, and the cancellation of item 22, a Life of St Thomas Becket [the text on ff. 38r-v is crossed out, as well as f. 19r due to rebinding]). It is a large and carefully-presented volume. The scribal hand is not particularly formal, but its regularity and clarity, as well as the consistent layout of the manuscript, suggest professional production. The contents and compilation of this manuscript are more homogeneous than Li 91 or CCAii: it opens with a long section of religious and devotional material (ff. 3ra –

---

<sup>9</sup> Susanna Fein, 'The Contents of Robert Thornton's Manuscripts', in *Robert Thornton and His Books: Essays on the Lincoln and London Thornton Manuscripts*, ed. Susanna Fein and Michael Johnston (York: York Medieval Press, 2014), 22; James Orchard Halliwell-Phillipps, *The Thornton Romances: The Early English Metrical Romances of Perceval, Isumbras, Eglamour, and Degrevant*. (London: Camden Society, 1844), xxv.

<sup>10</sup> Guddat-Figge, *Catalogue of Manuscripts Containing Middle English Romances*, 169.

53ra; items 1-26), then a short section of moral exempla (ff. 53ra-63r, items 27-33), before concluding with a section of romances (ff. 63ra-261vb, items 34-43).<sup>11</sup> It shares paper stock with Ashmole 61, another focus manuscript, suggesting a similar Leicestershire origin, as confirmed by linguistic evidence.<sup>12</sup> Felicity Riddy categorises the manuscript as one “commissioned for urban domestic use from a local professional”.<sup>13</sup>

Household manuscripts were sometimes originally classified as commonplace books, and the two certainly share in their miscellaneous character and common non-commercial production. The two categories are guided by different copying and collecting principles: where commonplace books tend to be later and collect thematically-grouped smaller excerpts and are often more personal to the individual compiler, household manuscripts tend to address wider usage contexts and are more often made in commercial settings – commissioned from professional scribes or sourced from bookshops.<sup>14</sup> English household manuscripts have more in common, I argue, with a loose group of thirteenth- and fourteenth-century miscellanies which are usually studied separately: Oxford, Bodleian Library MS Digby 86; Edinburgh, National Library of Scotland Advocates MS 19.2.1 (the Auchinleck manuscript) and London, British Library Harley MS 2253. The Auchinleck manuscript is a professional production, with carefully executed formal layouts and a series of illuminations (many now excised) and historiated and decorated capitals, whilst Digby 86 appears to have been created by its user. The prevailing scholarly consensus about Harley 2253 identifies its main scribe as a household clerk serving within an elite household in the Ludlow area – perhaps the Mortimers of Wigmore, the Ludlows of Stokesay Castle or the Cheynes of Cheyney Longville.<sup>15</sup> All three manuscripts have

<sup>11</sup> Although Frances McSparran notes that item 39, “The Seven Sages of Rome” is a slight anomaly, strictly being more a collection of short tales than a romance. McSparran therefore categorises this later section as “secular entertainment”. Frances McSparran and P.R. Robinson, eds., *Cambridge University Library MS Ff.2.38* (London: Scolar Press, 1979), vii, x.

<sup>12</sup> Johnston, ‘Two Leicestershire Romance Codices: Cambridge, University Library MS Ff.2.38 and Oxford, Bodleian Library MS Ashmole 61’, 87–88.

<sup>13</sup> Felicity Riddy, ‘Temporal Virginity and the Everyday Body: *Le Bone Florence of Rome* and Bourgeois Self-Making’, in *Pulp Fictions of Medieval England*, ed. Nicola McDonald (Manchester: Manchester University Press, 2004), 199.

<sup>14</sup> Adam Smyth, ‘Commonplace Book Culture: A List of Sixteen Traits’, in *Women and Writing, c. 1340-c.1650: The Domestication of Print Culture* (York: York Medieval Press, 2010), 90–92; Parker, *The Commonplace Book in Tudor London: An Examination of BL MSS Egerton 1995, Harley 2252, Lansdowne 762, and Oxford Balliol College MS354*, 2.

<sup>15</sup> Although Revard also suggests that the scribe may have been a parish chaplain of the Church of Bartholomew in Richard’s Castle. Susanna Fein, ‘The Four Scribes of MS Harley 2253’, *The Journal of the Early Book Society for the Study of Manuscripts and Printing History* 16 (2013): 36; N.R. Ker, ed., *Facsimile of British Museum MS. Harley 2253*. (London: Oxford University Press for The Early English Text Society, 1965), xxiii; Carter Revard, ‘Scribe and Provenance’, in *Studies in the Harley Manuscript: The Scribes, Contents, and Social Contexts of British Library MS Harley 2253*, ed. Susanna Fein (Kalamazoo, Michigan: Medieval Institute Publications, 2000), 22, 77–81; Carter Revard, ‘Oppositional Thematics and Metanarrative in MS Harley 2253, Quires 1-6’, in *Essays in Manuscript Geography: Vernacular Manuscripts of the English West Midlands from the Conquest to the Sixteenth Century*, ed. Wendy Scase (Turnhout: Brepols, 2007), 101.

similar contexts and evidence of original usage that suggests that the household manuscripts studied here are part of wider reading and bookmaking tradition that predates the fifteenth century. Their prevalence in the fifteenth century perhaps owes itself particularly to the growing availability of paper and increasing literacy rates that allow more non-professional book creators from the rural gentry and the growing urban mercantile elite to create or source their own books to support their textual needs before widespread printing addressed these textual needs and changed the landscape of personal and domestic books in the sixteenth century.<sup>16</sup>

Within the corpus of manuscripts containing romances, household miscellanies are particularly highly represented.<sup>17</sup> Is the prevalence of household manuscript romances merely a fluke of survival, or is there something about the household setting that suits the genre? Romances range from boisterous to courtly and reflect social concerns, anxieties about inheritance and status, and could fuel and support the social aspirations of their readers. The possession of a grand book for the household was certainly a sign of prestige. Thorlac Turville-Petre and Michael Johnston suggest that the Heege manuscript was made for and owned by the Sherbrooke family in Derbyshire who rose from a yeoman family at the time of the manuscript's creation (late fifteenth century) to what Johnston terms "the margins of gentility" in the sixteenth century.<sup>18</sup> The grade and contents of the manuscript would certainly suit ownership by this family and owning a book likely supported their aspirations to the gentry as well as supporting many of their textual needs in a single volume.

Romances are found in manuscripts of varying grades, from informal booklets to luxurious items like Henry III's book of romances with "clasps, hasps and nails of silver".<sup>19</sup> It is difficult to gauge the prevalence of lower grade copies and independent booklets: Susan H. Cavanaugh notes that many owned inexpensive books that were not recorded in wills or inventories.<sup>20</sup> It is likely that families owned numerous texts copied into loose quires or informally-bound booklets: some of the household manuscripts examined here began their life as a series of separate booklets (Ff.2.38, Li 91) and some

---

<sup>16</sup> An important qualification to add here, as shown by Orietta Da Rold's recent study of paper in England, is that expensive high grade paper made up much of England's paper-stock. The common argument about the cheapness of paper assisting book production does not reflect the entire picture of paper books in the fourteenth and fifteenth centuries. Orietta Da Rold, *Paper in Medieval England: From Pulp to Fictions*, Cambridge Studies in Medieval Literature (Cambridge: Cambridge University Press, 2020).

<sup>17</sup> Guddat-Figge, *Catalogue of Manuscripts Containing Middle English Romances*.

<sup>18</sup> Turville-Petre, 'Some Medieval English Manuscripts in the North-East Midlands', 137–38; Johnston, *Romance and the Gentry in Late Medieval England*, 147–50.

<sup>19</sup> John Southworth, *The English Medieval Minstrel* (Suffolk: Boydell and Brewer, 1989), 58.

<sup>20</sup> Susan H. Cavanaugh, 'A Study of Books Privately Owned in England: 1300-1450' (University of Pennsylvania, 1980), 11–13.

show evidence of use in booklet form, with patterns of wear and staining on their outer leaves (Heege, CCAii). Along with the reference to their ‘Grete Boke’, the Paston letters also provide evidence of textual networks and book lending. Margaret Paston writes to John Paston that she cannot find his white book and that Jon Walshame had given her a quire, possibly of that same book.<sup>21</sup> The reference to a section of the book being circulated separately, perhaps even after it was bound, suggests that the materiality of book usage was particularly flexible.

The Findern manuscript is an important case study for secular textual networks and for communal manuscript usage. The manuscript was used by a group of neighbouring Derbyshire families who left their names across its pages (Francis, Cotton, Hungerford and Shirley). Whilst some of the texts were likely copied by commercial scribes, many of the shorter items, particularly the collection of lyrics, are copied by amateur scribes, and are perhaps even the work of some of those named in the book’s margins. It shows clear evidence of excerpting practices, preserving sections of texts by canonical authors (Gower, Chaucer, Hoccleve and Lydgate) alongside a single romance (*Sir Degrevant*) and other shorter items, and of use in booklets, although the evidence for this is obscured by later losses, additions, rebindings and refoliations. The inclusion of household notes from a later period in the manuscript’s life (c. 1550) show its changing status and audience, passing from household members to servants. Across ff. 50v and 70r-v are various household accounts: a butcher’s bill, a fragment of estate accounts, a memorandum and an inventory of parcels of cloth at Findern. The manuscript presents a strong case for female ownership and textual/scribal practices. Kate Harris suggests that the manuscript’s creation was the work of the women of the named gentry families.<sup>22</sup> At the end of *Sir Degrevant* on f. 109v are the names Elizabeth Cotton and Elizabeth Frauncis. Scholars have debated the identification of these hands and whether these names are scribal signatures, pointing to the copying of the romance by both women. Anna Gottschall argues that the addition of these names in the position normally occupied by the scribal signature claims ownership of the text, even if the women were not directly responsible for its copying.<sup>23</sup> *Sir Degrevant*, as noted in the Introduction, is the site of the most conclusive evidence for communal aural reception of romances – the added annotation “How say ye, will ye any more of it?”

---

<sup>21</sup> “Item, I can not, ner Daubeney nowther, fynd your wyght boke; it is not in þe trussing cofyr ner in þe sprucheste nothyr. Jon Walsham toke me a quayere--I suppose it lo[n]gythe to þe same boke; þat same I send you and þe byllis of Walcote wyth ale sealyd. Wretyn þis day. By your M. P.” (Margaret Paston to John Paston I, 1463)

Norman Davis, *Paston Letters and Papers of the Fifteenth Century*, vol. 1 (Oxford: Clarendon Press, 1993), 286, <http://name.umdl.umich.edu/Paston>.

<sup>22</sup> Harris, ‘The Origins and Make-up of Cambridge University Library MS Ff.1.6’.

<sup>23</sup> Anna Gottschall, ‘Textual Provenance Through the Male and Female Names in the Findern Manuscript’, *The Birmingham Journal of Language and Literature* 1, no. 1 (2008): 32.



Elizabeth Cotton and Elizabeth Francis were perhaps involved in the aural reception of the romance as readers or listeners. Beyond the romance, Sarah McNamer suggests that fifteen of the lyrics are written by women.<sup>24</sup> The involvement of women with romance texts invites speculation about reading practices and whether the romances served any specific purpose for their female readers. Other household manuscripts, such as Manchester, Chetham's Library MS 8009 and Naples, Biblioteca Nazionale, MS XIII.B.29, stand alongside the Findern manuscript as books with female readers who access the texts (and particularly the romance texts) in specific ways, adapting and receiving courtly material in their own rural setting, adding their own programme of organising practices and unique texts, and even using the texts for household education, as will be discussed below.<sup>25</sup>

Aristocratic women in late medieval England were instructed in literacy, arithmetic, account keeping and household management by their female relatives using their Books of Hours, alongside its regular use in devotional activities.<sup>26</sup> Marginal additions strongly suggest that household manuscripts were used in a similar way, with younger household members learning to read and write by copying passages and engaging critically with the material. Children or servants, themselves young members of other elite families, were educated in a household setting. The moral exempla and conduct texts included in many household manuscripts provide explicit instruction in appropriate behaviour. "Dame Courtesy" (Ashmole 61) and the closely-related "Lytylle Childrenes Lytil Boke" (Heege) instruct through rhyming proverbs the appropriate way to go about the day, rising early, praying and washing. "Tundale" (Heege), as will be discussed below, features marginal additions in immature hands engaging with the text as moral example. The addition of alphabets to margins or blank leaves are often described as pen tests, but are perhaps evidence of education. A blank page in Li 91 (f. 49v) features many later additions in poorly-formed hands including an alphabet of repeating letters, Latin phrases which are replicated in different hands and an immature hand that attempts to copy phrases across the page with many errors. (Figure 2.3)

---

<sup>24</sup> Sarah McNamer, 'Female Authors, Provincial Setting: The Re-Versing of Courtly Love in the Findern Manuscript', *Viator* 22 (1991): 282.

<sup>25</sup> McNamer, 'Female Authors, Provincial Setting: The Re-Versing of Courtly Love in the Findern Manuscript'; Ashby Kinch, "'To Thenke What Was in Hir Wille": A Female Reading Context for the Findern Anthology', *Neophilologus* 91 (2007): 729–44; James Weldon, 'The Naples Manuscript and the Case for a Female Readership', *Neophilologus* 93 (2009): 703–22; Rhiannon Purdie, 'Sexing the Manuscript: The Case for Female Ownership of MS Chetham 8009', *Neophilologus* 82 (1998): 139–48.

<sup>26</sup> Rebecca Krug, *Reading Families: Women's Literate Practice in Late Medieval England* (Ithaca and London: Cornell University Press, 2002), 67–72; Nicola McDonald, 'A York Primer and Its Alphabet: Reading Women in a Lay Household', in *Oxford Handbook of Medieval Literature in English*, ed. Elaine Treharne and Greg Walker (Oxford: Oxford University Press, 2010), 253–78.

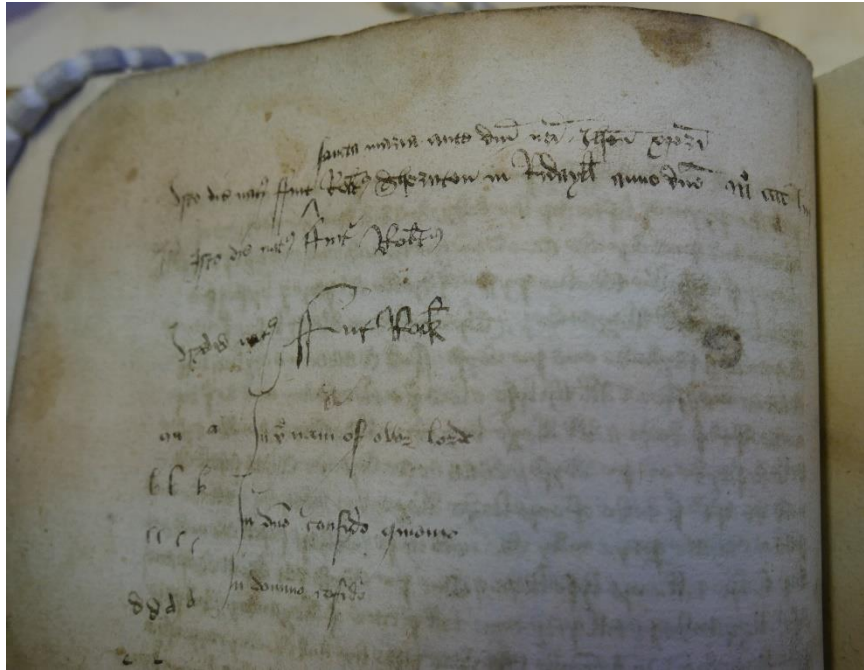

Figure 2.3: Various additions on f. 49v in Li 91: the birth record, copying hands and an alphabet. At the base of the page is an ownership inscription.

An alphabet in the Findern manuscript shows several variant letter forms and below it capital letters have been clumsily copied out. (Figure 2.4) These examples seem more intentional than pen tests – the Findern examples perhaps assist readers (especially those on the margins of literacy) in deciphering the varied scribal hands throughout the book, which use both Anglicana and Secretary letter forms. Later in the Findern manuscript, a clear and well-formed hand copies an alphabet in the lower margin of f. 150v, half forwards and half backwards. A few leaves later, in the lower margins of ff. 159v and 160r, poorly-formed hands copy out the alphabet in this same distinctive format. Some immature hands copy out lines from elsewhere on the page, suggesting closer engagement with the texts. (Figures 2.5 and 2.6) These small details in the margins and blank spaces of books attest to items that were used and reused, a suggestion of their importance within the domestic context, as well as a reminder of the involvement and agency of those usually considered on the margins of literature and book production – women, children and servants. Although their contributions are, quite literally, in the margins of these books, their engagement clearly shows the centrality of these books and items in the textual habits of households.

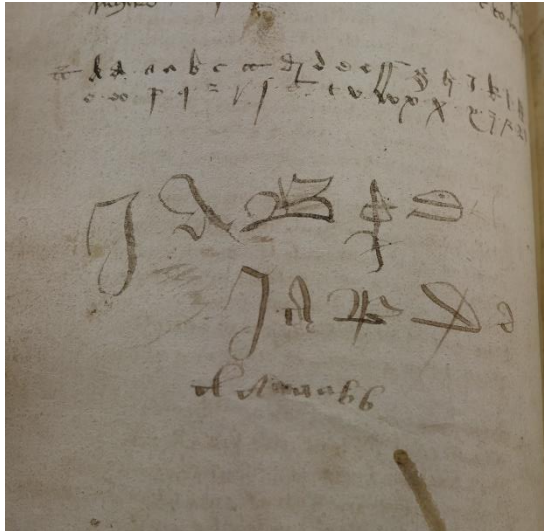

Figure 2.4: Alphabet copied onto f. 59v of the Findern manuscript.

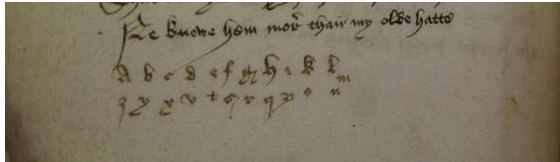

Figure 2.5: Alphabet copied onto f. 150v of the Findern manuscript.

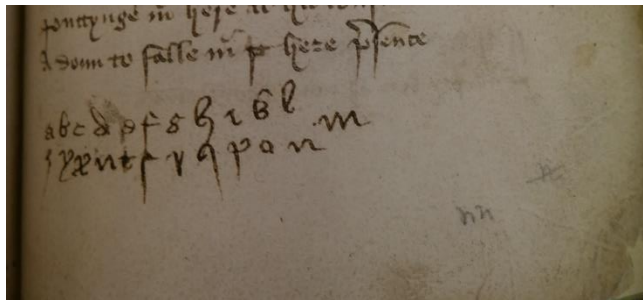

Figure 2.6: Alphabet copied onto f. 159v of the Findern manuscript.

### 2.3 Minstrel manuscripts

No narrative is more pervasive in the study of medieval romance and performance than that of minstrelsy. As discussed in Chapter 1, earlier scholarship identified books containing romances as ‘minstrel manuscripts’, suggesting that their popular literary contents were the basis for performance by these travelling professionals. I return here to that discussion of romance performance, even though it is no longer currently accepted, as several of the arguments pertain specifically to romance manuscripts. Minstrels, *jongleurs*, *gestours*, *joculatores*, *gleemen*, were multi-talented entertainers who told stories, played music and provided other diverse entertainments. Some were itinerant performers and some were employed within noble households where they served by announcing meals and

providing various entertainments.<sup>27</sup> References to minstrelsy are common within medieval romances: in *Havelok the Dane*, minstrels are called upon for music, storytelling and other entertainments (ll. 2325-2330, quoted in the Introduction). Minstrels and their rewards feature heavily in the ending of *Sir Eglamour of Artois* in CCAii. The trope of romance characters disguising themselves as minstrels, using the anonymity and mobility granted by the status of entertainers to gain entrance to enemy castles is widespread (e.g. *Sir Orfeo*, *King Horn*, *Bevis of Hampton*).<sup>28</sup> The focus on minstrel manuscripts is not surprising given this preoccupation within the texts. However, is this a suitable theory for the manuscripts examined here? The ‘minstrel manuscript’, if such a thing existed, is theorised to be a small book, booklet, or even loose pages that contained the text needed to support minstrel performances, as a reference to refresh the memory of the performer or even used in performance. Ashmole 61 in particular has often been cited as an example, due to its contents (many texts for entertainment with a prominent first-person narrator) and its shape: tall and narrow (415 x 137 mm), with text in a single column – often referred to as a ‘holster book’ based on the theory that it could be easily stored and transported in a saddle holster.<sup>29</sup> Andrew Taylor carefully examined categories of manuscript and text that have been considered minstrel manuscripts and concludes generally that features often assumed to be evidence of minstrel ownership are more readily explained in other ways: the well-worn appearance of a manuscript suggests general heavy use or extensive movement through networks of book-lending, rather than necessarily being carried by an itinerant performer; the ‘holster book’ format is due more to the easy availability of ready-made account books in this format – Blanchfield suggests it is more accurate to call it ‘agenda’ format.<sup>30</sup> Interestingly, the format of Ashmole 61 must have been a deliberate choice on the part of its creator, perhaps due to familiarity with account books or perhaps storage requirements for the book. The paper stock was likely stored folded in the more standard format before being refolded into its current configuration: the original fold can still be seen running horizontally across the pages, and the hand of the scribe (who signs their name as Rate) sometimes wavers when writing across it.<sup>31</sup> The presence of so many items with clear rationale for domestic usage, especially conduct texts like *Stans Puer ad Mensam*, *How the Good Wife Taught Her Daughter* and *How the Wise Man Taught His*

---

<sup>27</sup> Shuffelton, ‘Is There a Minstrel in the House?: Domestic Entertainment in Late Medieval England’.

<sup>28</sup> For a list of all references to minstrelsy in Middle English verse romances see: Zaerr, *Performance and the Middle English Romance*, 181–233.

<sup>29</sup> Guddat-Figge, *Catalogue of Manuscripts Containing Middle English Romances*, 249.

<sup>30</sup> Taylor, ‘The Myth of the Minstrel Manuscript’, 57–58; Blanchfield, “‘An Idiosyncratic Scribe’: A Study of the Practice and Purpose of Rate, the Scribe of Bodleian Library MS Ashmole 61’, 18.

<sup>31</sup> A clear example is ff. 51v-52r, however it shows up poorly in images. The folding is discussed in more detail in Blanchfield, “‘An Idiosyncratic Scribe’: A Study of the Practice and Purpose of Rate, the Scribe of Bodleian Library MS Ashmole 61’, 14–17.

*Son*, and prayers for specific times of day is further evidence in favour of its household use. The presence of romances and texts for entertainment show that household manuscripts can also easily support leisurely reading activities. Even though some of the household manuscripts examined have evidence for construction and use in booklet format, there is no evidence to suggest that they were used by professional performers in the way suggested by the minstrel manuscript theory. Moreover, the assumption that a performer required a material support for the text (either in performance or as *aide-mémoire*) rather than having the ability to keep their stories memorised reflects the consistent underestimation of the abilities of oral performers. The physicality of Ashmole 61 and the experience of handling it also strongly suggest its unsuitability as a minstrel manuscript. It is large and heavy, unsuited for easy transport and difficult to handle without the assistance of apparatus to support it and keep its pages open, exacerbated by the tight binding of its current form. Analysis of the manuscript persistently suggests that the agenda format allows for easy handling while reading aloud.<sup>32</sup> However, my observations suggested a different interpretation. The layout has both advantages and disadvantages for performative reading: the single column presentation does mean that the reading has fewer disruptions caused by page turns and column changes, however, the long column of text is more liable to cause eyeskip due to fatigue and the ends of each page are either far away from the reader, or the book must be carefully and frequently moved to maintain an optimal distance for reading. The narrow margins (made even more dramatic by trimming) mean that the holder's hands sometimes obscure the text. I argue that the format makes it *more* difficult to handle: its weight is challenging to support in one hand, especially as it cannot be rested across the forearm as easily as more standard formats, and the pages lack the width to stay open easily on their own. This difficulty of handling Ashmole 61 is partly due to its size (415 x 137 mm; 162 folios): other comparable agenda format manuscripts are smaller – such as London, British Library Egerton MS 2862 (275 x 173 mm; 148 folios) or have fewer pages – such as London, Lincoln's Inn MS Hale 150 (400 x 130 mm; 125 folios). Engaging with the physical form of the manuscripts became an important aspect of the experiments discussed in Chapter 4, and the materiality of the book, including the experience and practicalities of handling them, is a fundamental aspect of reading practices that is often overlooked.

Whilst a separate minstrel performance tradition of course existed, as discussed in Chapter 1, there is no substantial evidence to connect minstrel performance with the forms of the romances preserved in the household manuscripts. The wealthiest households

---

<sup>32</sup> Blanchfield, 19; Myra Seaman, *Objects of Affection: The Book and the Household in Late Medieval England* (Manchester: Manchester University Press, 2021), 11.

studied here like the Thorntons could have afforded to hire professional entertainers to perform memorised narratives, but this would have taken place alongside their usage of their manuscripts, instead of directly connected to it. One related aspect of professional readers and performers that is more applicable to household manuscripts is clerkly reading. This may be somewhat related to minstrelsy – George Shuffelton and Andrew Taylor both cite examples of priests or clerks who were also professional entertainers or *jongleurs* who later became clerks.<sup>33</sup> The term “clerk” can refer generally to either an educated person or, more specifically, a member of the clergy.<sup>34</sup> They played an important role in households: wealthy households could hire a clerk to educate children and servants, take care of household business such as keeping accounts and records or writing letters, or, for those who were members of the clergy, to conduct mass, hear confession and support devotional activities that took place outside of the parish church.<sup>35</sup> *Sir Eglamour of Artois* features the authorising statement “As I herde a clerke rede” (l. 1110), in much the same way that romances refer to written books or oral recitations of the stories. This inferred clerkly reading would surely emphasise the shocking revelation of Christabel and Degrebell’s incestuous marriage as revealed in the preceding line. The Thornton household had a personal chapel built in their manor in the late fourteenth-century, suggesting that they employed a priest – who perhaps oversaw the education of a young Robert Thornton himself.<sup>36</sup> One of the manuscripts examined, Ff.5.48, was most likely written by one Gilbert Pilkington, identified as the same “Gilbertus Pilkynnton” who is recorded in Bishop Hales’ Register as being ordained subdeacon, deacon and secular priest between 1463 and 1465.<sup>37</sup> The contents of the manuscript, which include John Mirk’s *Instructions for Parish Priests* as well as excerpts from the *South English Legendary*, can be interpreted as texts to support Pilkington’s training and work as a priest.<sup>38</sup> Less congruous is the presence of fabliaux and comic tales, including “The Tournament of Tottenham” which will be examined more closely below. Clerkly reading in particular is an aspect that

---

<sup>33</sup> Shuffelton, ‘Is There a Minstrel in the House?: Domestic Entertainment in Late Medieval England’, 69; Taylor, ‘The Myth of the Minstrel Manuscript’, 48.

<sup>34</sup> ‘Clerk n.’, Middle English Compendium: Middle English Dictionary, accessed 17 June 2021, [https://quod.lib.umich.edu/m/middle-english-dictionary/dictionary/MED7991/track?counter=1&search\\_id=7926600](https://quod.lib.umich.edu/m/middle-english-dictionary/dictionary/MED7991/track?counter=1&search_id=7926600).

<sup>35</sup> C.M. Woolgar, *The Great Household in Late Medieval England* (New Haven and London: Yale University Press, 1999), 176–77.

<sup>36</sup> Keiser, ‘Robert Thornton: Gentleman, Reader and Scribe’, 69.

<sup>37</sup> Thomas H. Ohlgren and Lister M. Matheson, ‘*Robin Hood and the Monk* and the Manuscript Context of Cambridge University Library MS Ff.5.48, with Direct Analysis of CUL MS Ff.5.48’, *Nottingham Medieval Studies* 48 (2004): 93; J. Downing, ‘A Critical Edition of Cambridge University MS Ff.5.48’ (PhD Thesis, University of Washington, 1969).

<sup>38</sup> Thomas H. Ohlgren, *Robin Hood: The Early Poems, 1465-1560: Texts, Contexts, and Ideology* (Newark: University of Delaware Press, 2007); Downing, ‘A Critical Edition of Cambridge University MS Ff.5.48’.

deserves more attention, although a full investigation, especially one that takes into account the many devotional texts in household manuscripts, is outside of the scope of this thesis.

## 2.4 Romance in Performance

Having discussed several plausible and less plausible readerships and readers-aloud of the household manuscripts and before beginning the technical palaeographical analysis, it is worth considering the implications of performance on romances in particular. Although the romances in the household manuscripts are, as I argued in the Introduction, deliberately set up to accommodate multiple reception modes, the enjoyment of romance as a genre is enhanced when read aloud. Many of the features of the genre that have been dismissed or criticised actually enhance the text when performed and are devices for comprehension. Far from being the hallmarks of the unsophisticated “regression into oral tradition”, as discussed above, or even “a literary motif designed to give to the poem an air of convivial spontaneity” features such as the narrator, or addresses to a listening audience are devices that underpin the substance and structure of the romance and support multimodal reception.<sup>39</sup> Constant reference to a listening audience, real or imagined, grounds the story in a performative present and make it more accessible for a real listening audience – an audience who receive the text in this way not because they are illiterate, or because they belong to a lower echelon of society, but because hearing texts read aloud was a genuinely pleasurable pastime. Joyce Coleman cites an example from Robert Mannyng’s *Chronicle*: “Listening to texts was ‘solace & gamen / In felawschip when thai sitt samen’.”<sup>40</sup> This is not an oral tradition but an *aural* one: the emphasis is overwhelmingly on reception rather than production. Coleman’s study provides exhaustive examples of historical precedent for people choosing to have texts read to them, even when they themselves are literate and have easy access to texts.<sup>41</sup>

The audience is an active participant in performance: the performer shapes their delivery to elicit certain responses, but also adapts it to the responses that eventuate: emotional responses and audible responses – gasps, laughter, tears, comments or requests. Heather Blatt’s discussion of participatory reading foregrounds communal social reading events and argues for the reader as co-creator of texts – a role anticipated by authors, who

---

<sup>39</sup> Pearsall, ‘The Development of Middle English Romance’, 93; Dieter Mehl, ‘The Audience of Chaucer’s “Troilus and Criseyde”’, in *Chaucer’s Troilus: Essays in Criticism*, ed. Stephen Allen Barney (London: Scolar Press, 1980), 213.

<sup>40</sup> Listening to texts was pleasurable and joyful, in company when they sit together. (My translation.) Mannyng, *Chronicle*, ll. 9-10. Coleman, *Public Reading and the Reading Public*, 31.

<sup>41</sup> Coleman, *Public Reading and the Reading Public*.

call for correction to any defects in the humility topos, address their imagined ideal audience directly and in anticipation of multi-modal reception, reference other literary works and call for participation.<sup>42</sup> The audience are conversation partners who guide the delivery of the tale with their physical and emotional responses. Both reader-aloud and audience interpret the text in the moment of performance as the words are realised and this modality can often reveal previously-unnoticed aspects of the text, especially for the skilled performer familiar with the text who can improvise to match the perceived wishes of the audience.

The medieval romance has an in-built vehicle for performance – the figure of the narrator. Unlike in modern literature where narrators are often fully-realised and self-contained characters, the narrator of medieval romance is more like a function of the story itself: a manifestation of the act of telling, even if this is not always actualised in aural reception. A.C. Spearing's extensive work on medieval narrative applies modern narratology more sensitively to medieval material, exploring different understandings and expectations of, for example, characters and plot.<sup>43</sup> Spearing proposes that the first-person pronoun functions as a deictic rather than referring to a specific individual, allowing medieval audiences to consider the narrator, author and the story-teller as fulfilling various aspects of this persona.<sup>44</sup> Spearing's analysis is particularly insightful for canonical texts where the distinction between named authors and narrators is complex, although not always suited to the anonymous Middle English romances as discussed here, as it often distinguishes too binarily between oral and written rather than exploring the fluidity brought to texts and narrators by multimodal reception and performance possibilities. Here I follow Spearing in considering the first-person pronoun of the narrator as deictic, but aim to acknowledge further the effects of prelection and performance. The first-person narrator is present to varying degrees depending on the romance, and the literary context: they appear to be far more prominent in French romances for example (where the narrator often names themselves, creating an interesting author-narrator dynamic which is not always simple to unravel) especially when compared to fifteenth-century English romances which represent a different phase in the history of the genre, with non-specific narrators who

---

<sup>42</sup> Blatt, *Participatory Reading in Late-Medieval England*, 40–41.

<sup>43</sup> A.C. Spearing, *Textual Subjectivity: The Encoding of Subjectivity in Medieval Narratives and Lyrics* (Oxford: Oxford University Press, 2005); A.C. Spearing, *Medieval Autographies: The 'I' of the Text* (Notre Dame, Indiana: University of Notre Dame Press, 2012); A.C. Spearing, 'What Is a Narrator?: Narrator Theory and Medieval Narratives', *Digital Philology: A Journal of Medieval Cultures* 4, no. 1 (2015): 59–105.

<sup>44</sup> Spearing, *Textual Subjectivity: The Encoding of Subjectivity in Medieval Narratives and Lyrics*, 52; Spearing, *Medieval Autographies: The 'I' of the Text*, 13–20; Spearing, 'What Is a Narrator?: Narrator Theory and Medieval Narratives', 70, 75.



intrude less frequently and more formulaically.<sup>45</sup> The prominence and exact functions of the narrator fluctuate with literary fashion, for example, William Caxton in his edition of Thomas Malory's *Le Morte d'Arthur* edits out Malory's colophon and many self-referential narratorial comments.<sup>46</sup>

The romances are explicitly and often self-consciously performative as the narrator invokes a listening audience. *Sir Degrevant* opens by addressing the “folke” sitting “in fere” (in company, together) (Findern, f. 96ra) and the performative annotation implies an audience who can respond.<sup>47</sup> Similarly, the narrator of *Havelok the Dane*'s request for a “cuppe of ful god ale” (l. 14) implies some kind of audience – real or imagined – who could respond. The narrator is responsible for references (often self-conscious references) to intended or imagined reception of various modalities. For example, “Let we now ben is em Saber / And **speke** of Beves the maseger” (*Bevis of Hampton*, [Ff.2.38, ff. 102v-134r], ll. 1345-6, emphasis added) or “Lordinges **herkneth** to me tale / Is merier than the nightingale / That I schel **singe** / Of a knight ich wile yow **roune** / Beves a highte of Hamtoun / Withouten lesing / Ich wile yow **tellen** al togadre / Of that knight and of is fadre” (*Bevis of Hampton*, ll. 1-8, emphasis added). This performative (or pseudo-performative) style is suitable for multiple reception contexts. For silent or solitary readers the narrator creates an imagined communal reception, with the inscribed audience (the “lordings” or the “you” addressed by the narrator) essentially just another character in the story. The range of imagined reception contexts points to romance as a flexible genre not specifically tied down to one mode of reception but easily adaptable to suit different modalities and the wishes of the reader or audience, for example through improvisation, nuances in presentation, selection of excerpts and through different performance styles and options.

The narrator guides the reader or the hearer through the story – they introduce and conclude the narrative and lead textual transitions in time, place or setting (“Aftyr mete as I you telle” [*Sir Eglamour of Artois*, l. 697]; “Late we now the Erle alone / And speke we

---

<sup>45</sup> Sarah Roche-Mahdi, ed., *Silence: A Thirteenth-Century French Romance*, trans. Sarah Roche-Mahdi (East Lansing: Michigan State University Press, 2007); Thomas of Britain, ‘Tristan’, in *Tristan: With the ‘Tristan’ of Thomas*, trans. A.T. Hatto (London: Penguin, 1960), 301–53; Bérout, *The Romance of Tristan*, ed. Stewart Gregory (Amsterdam and Atlanta: Rodopi, 1992); Thomas, ‘The Romance of Horn’, in *The Birth of Romance in England: Four Twelfth-Century Romances in the French of England*, trans. Judith Weiss (Tempe, Arizona: Arizona Centre for Medieval and Renaissance Studies, 2009), 45–137.

<sup>46</sup> The exact rationale is debatable of course: whether this is merely editing the text to conform to fashions of the time, or whether this can be evidence of the medium of print influencing reception modality and literary practices, or even whether this signals Caxton’s claiming of the text by erasing elements identifiable with Malory.

<sup>47</sup> Erik Kooper, ed., ‘Sir Degrevant’, in *Sentimental and Humorous Romances*, TEAMS Middle English Texts Series (Kalamazoo, Michigan: Medieval Institute Publications, 2005), l. 5. Subsequent references will state line numbers in-text in brackets.

now of Dame Beulybone / How sche was cast in care” [*The Erle of Tolous*, Ashmole 61 version, ll. 475-477/f. 31v]). They may also intrude on the narrative to offer commentary or judgemental asides (“Crist here be milde” [*Bevis of Hampton*, l. 3619]), and their presence provides textual *auctoritas*/authority by referencing textual traditions and sources (“As the boke of Rome says” [*Sir Eglamour of Artois*, l. 862]; and “So hit is fonde in Frensche tale” [*Bevis of Hampton*, l. 888]).<sup>48</sup> Petitions for attention form key points throughout the text, particularly prominent in the introduction and at narrative transitions: “Lordinges herkneth to me tale” (*Bevis of Hampton*, l. 1), “Herken what I schall the say” (*Sir Eglamour of Artois*, l. 687), similarly the request for drink in *Bevis of Hampton* “Ac er than we beginne fighte / Ful us the koppe anon righte” (*Bevis of Hampton*, ll. 4105-8) (a similar request is also found in *Havelok the Dane*, l. 14).

Another way of understanding the narrator of anonymous Middle English romances is theories of narrative levels. In the romances discussed here, the narrator operates heterodiegetically – that is, at a textual level separate from the story they present.<sup>49</sup> Theorist Gérard Genette identified three distinct meanings of narrative: the *story* (that is, the content of the *narrative*, the signified); the *narrative* (the discourse that recounts the content, the signifier); and the *narration* (the act of recounting the narrative).<sup>50</sup> In this model, the figure of the narrator is ingrained in the level of *narrative* and functions on the level of *narration* when the text is performed. Some particularly involved narrators like Chaucer in *The Canterbury Tales* or Heldris de Cornuälle in *Roman de Silence* (both of whom function as author and narrator) also operate on the level of *story*. Kathryn Starkey’s adaptation of Genette’s model to medieval literature expands into five narrative levels and better acknowledges the position of the narrator between text and its realisation in performance: fable (Genette’s *story*), narrative frame (the narrator), poem (the product of the fable and the narrative frame), oral presentation, and manuscript (the textual support and its means of preservation).<sup>51</sup>

The generic first-person pronoun of the narrator is easily inhabited by a performative reader. In performance, the narrator’s lively involvement with the story, with frequent intrusions and self-conscious performativity, make them another character to be played, albeit one operating on a different narrative level. The narrator when inhabited and

---

<sup>48</sup> Minnis, *Medieval Theory of Authorship: Scholastic Literary Attitudes in the Later Middle Ages*; Coleman, *Public Reading and the Reading Public*, 28; Cruse, ‘Matter and Meaning in Medieval Books: The Romance Manuscript as Sensory Experience’, 48; Fisher, *Scribal Authorship*.

<sup>49</sup> For levels of narrative, see Gérard Genette, *Narrative Discourse*, trans. Jane E. Lewin (Oxford: Basil Blackwell, 1982); and for adaptation to medieval literature, see Kathryn Starkey, *Reading the Medieval Book: Word, Image, and Performance in Wolfram von Eschenbach’s Willehalm* (Notre Dame, Indiana: Notre Dame University Press, 2004).

<sup>50</sup> Genette, *Narrative Discourse*, 27.

<sup>51</sup> Starkey, *Reading the Medieval Book: Word, Image, and Performance in Wolfram von Eschenbach’s Willehalm*, 73.

presented by the reader-aloud is the embodied voice of the text itself, imbued with almost authorial drive to shape the story – they certainly cite the authority of an author with their references to sources and deft rhetorical manoeuvring. The narrator takes care not just with the story, but also with how the story is told. The narrator in *Bevis of Hampton* when describing Bevis' fight against the lions states: “Strenger bataile ne strenger fight / Herde ye never of no knight / Byfore this in romaunce telle / Than Beves had of beestes felle / Al that herkeneth word and ende / To hevyn mot her sowles wende” (*Bevis of Hampton*, ll. 2423-8). This passage highlights many of the ways that narrators mediate and shape their story with their numerous asides and commentary. The narrator here addresses a listening audience, adds a blessing, references the literary tradition of romance and contextualises *Bevis*, whilst also magnifying its literary and heroic merit of both text and hero.

The role of the narrator is especially crucial in navigating performed texts: the audience's perception of the text is directly formed from the words, delivery and actions of the performer. In a performative reading context, the audience is unable to make physical reference to the written text, or to flip back a few pages to remind themselves of what happened earlier: it is up to the narrator to provide this narrative support. Evelyn Birge Vitz points out that romance as a genre is written to suit this kind of reception: it is structured “less for reflection and retroactive analysis...than for immediate comprehension and affective response.”<sup>52</sup> When the narrator intrudes with remarks like “Leve ye the chyld with mykyll honour / And speke we of his modur whyte as flour / What weys our Lord here lent” (*Sir Eglamour of Artois*, ll. 853-5) they remind the audience of what they have just heard, signal that a change in narrative focus is about to occur and foreshadow the events that are to be narrated. Similarly, petitions for attention, either short formulaic phrases or longer ones like this in *Sir Eglamour of Artois* “Lestenes lordynges both lefe and dere / What armes the chyld bare ye schal here / And ye wyll undyrstond” (ll. 1003-5) which anticipate the critical moment of recognition and reunion serve to refocus the attention of the listening audience, signalling the importance of the content about to be imparted by momentarily uniting the narrative levels of oral presentation, narrative frame and text. Formulas and repeated phrases create moments of recognition in the audiate reader. The auditory familiarity cues a listener to think back to previous iterations of that phrase, creating interconnecting moments in a narrative and reception context which otherwise does not allow for easy cross-referencing back to previous moments in the text. For example, the three fights in *Sir Eglamour of Artois* use similar stock phrases to describe the action, emphasising the symmetry of each challenge as well as the escalating

---

<sup>52</sup> Evelyn Birge Vitz, *Medieval Narrative and Modern Narratology: Subjects and Objects of Desire* (New York and London: New York University Press, 1989), 219.

scale. The three passages begin remarkably similarly, telling how Eglamour sets out to fight the giant Arrook, the boar and the dragon then adding a narratorial comment that functions as intensification, authorising statement and as a line-filler: “Forth he wente, I undurstonde” (l. 271); “Forth he went, I undyrestonde” (l. 361); “Forth he went, as I you say” (l. 706). In the latter two episodes Eglamour then searches for tokens and signs of his foe (ll. 367, 709). As Eglamour fights, the narrative often dwells on a particularly strong blow that nearly kills him (ll. 575-6, 728-30). The fights last for an unrealistically long time: Eglamour fights Arrook for an entire day (ll. 321-2), the boar for three days or more (l. 399) and Marras for a day (l. 584). The time between fights, the time it takes to journey there and back, the degree to which Eglamour is hurt and the rewards Eglamour is offered compound with each of the three challenges. The aural memory of a listener is triggered by the repeating formulas and they are prompted to remember the previous fight and primed to notice any variations to the formulas which vary the action.

Starkey’s *manuscript* level is obviously of great interest to this investigation, and can also show evidence of involvement in performance. The interlinear comment in the Findern manuscript copy of *Sir Degrevant* paints a picture of a communal performance that the audience have an active role in shaping. Interpreting the paratextual comment “Her endyth þe furst fit” as a line lacking a rhyming partner perhaps, the added line “howe say ye? will ye any more of hit?” hints at communal aural reception as the expected reception context. The “ye” address implies an audience who can answer the question, either to demand more or perhaps to request a pause. The remark would certainly have far less impact for a solitary silent reader. This addition suggests that communication between performer and audience is an expected part of textual reception. This *manuscript* level will be the focus of the rest of this chapter.

## 2.5 Performative Features of Manuscripts

Aside from the performative first-person narrator in Middle English romance, other internal features such as patterns of dialogue and direct speech, differentiation of character, rhyme, alliteration, metrical features, musical form and repetition, such as formulaic diction can suggest or support performative receptions.<sup>53</sup> However, is it possible to look beyond this internal textual evidence to external or contextual evidence of performance from the pages of manuscripts? What features of the material form of the text can offer clues about expected or actual reception contexts and the possibility of performative

---

<sup>53</sup> Vitz, ‘Introduction’, 4.

reception modalities? While examining the household manuscripts for this thesis, I identified the primary categories of features related to reception context:

1. Physicality of the book
2. Layout and legibility
3. Staining and wear
4. Marginal additions
5. Paratextual features.

The physicality of the book will be discussed in Chapters 3 and 4 in relation to the physical supports used in reading and as explored through experimentation. I will now unpack how each of the remaining features relates to reception contexts with relevant examples from the household manuscripts examined, before further applying this in close readings of several texts.

### 2.5.1 Layout and Legibility

Medieval reading is inherently a process of decoding and interrogating. Readers seek the meaning of the words, sentences, and the text itself. For the original readers of medieval romance, reading is also a process of deciphering handwritten scripts. Lacking the uniformity later granted by printing, reading medieval books demands the fuller engagement and attention of the reader, particularly for a reader aloud who must decide on how to decipher the word in the process of utterance. Texts are presented and laid out to support their structure, to signal the rhyme scheme and – by professional or particularly careful scribes – to manage space and place page or column boundaries appropriately. Skilfully-managed layout creates an easier experience of reading and deciphering.

CCAii was carefully laid out by its scribe and supports easy reading. Lines are well sized and spaced. Formal apparatus such as headings, explicits and running titles are used throughout. Care has been taken by the scribe to signal the beginning and end of items, which have mostly been aligned with the beginnings and ends of pages or columns, by compressing or expanding the presentation. Most items begin on versos, which allows readers to begin reading at an appealing two-page spread and thus ensures that every page is signalled with running titles. The layout and presentation of texts on the manuscript page – the *mise-en-page* – can suggest possibilities for reception modalities: as Matti Peikola writes “*mise-en-page* silently guides the reader towards a certain reception”.<sup>54</sup> Whilst in general, texts in household manuscripts seem to accommodate multimodal reading, some layouts – through textual parallels, idiosyncrasies of design and scribal abilities – seem

---

<sup>54</sup> Matti Peikola, ‘Aspects of *Mise-En-Page* in Manuscripts of the *Wycliffite Bible*’, in *Medieval Texts in Context*, ed. Graham D. Caie and Denis Renevey (London: Routledge, 2008), 28.

best suited to certain receptions. Some presentations require more effort to read and are less suited for complex and involved delivery (such as musical performance) in an amateur reading context.

Legibility was clearly a concern and sometimes a challenge for medieval readers. Paul Saenger and Michael Heinlen note an incunable (an early printed book) which contains fragments of one of the same texts on the leaves used as pastedowns: the original was from a fifteenth century manuscript in a dense cursive script which was seemingly recycled once the owners found a more legible and easily accessible copy.<sup>55</sup> Annotations in household books also clearly demonstrate the process of reading and deciphering: an unknown hand has added thin vertical lines to show the separation of minims in multiple texts throughout the Heege manuscript (ff. 4r, 62r, 63r, 71r, 138r and 198r). (Figure 2.7) This is significant evidence of direct reader engagement with the text, and could suggest preparation for reading by a less-skilled party or one who found the scribe's hand challenging, or perhaps for reading aloud where accurate deciphering is key to presenting the text accurately.

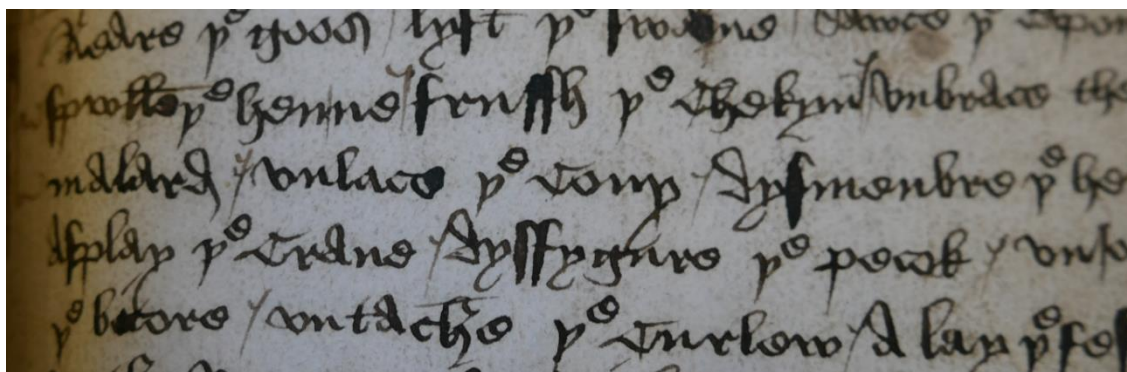

Figure 2.7: Heege manuscript, f. 62r showing dividing line in “henne”. Note also the extensive use of punctuation to separate items in this list of carving terms.

Brackets, often in red ink, are sometimes added by scribes to visually signal the rhyming scheme of poetic items. The brackets connect lines with the same rhyme and their overlapping shows the rhyming scheme overall. Brackets are both a paratextual feature and a manifestation of layout. For example, in a text in tail rhyme verse, brackets connect the a-rhyming couplet, as well as the b-rhyming lines across the units. A more involved variation on this format is what Rhiannon Purdie calls “graphic tail rhyme”, in which the b-rhyming lines are written to the right of the bracket that connects the couplet, which will be discussed further below.<sup>56</sup>

<sup>55</sup> Paul Saenger and Michael Heinlen, ‘Incunable Description and Its Implications for the Analysis of Fifteenth-Century Reading Habits’, in *Printing the Written Word: The Social History of Books, circa 1450-1520*, ed. Sandra L. Hindman (Ithaca: Cornell University Press, 1991), 235.

<sup>56</sup> Rhiannon Purdie, ‘The Implications of Manuscript Layout in Chaucer’s *Tale of Sir Thopas*’, *Forum for Modern Language Studies* 41, no. 3 (2005): 262–74.

A number of other texts copied by Robert Thornton show layout errors or misjudgements, and provide a fascinating counterpoint to the more effectively utilised layouts in CCAii or the simple and consistent layout of Ff.2.38. Thornton added brackets to *Sir Eglamour of Artois*, *Lamentacio Peccatoris*, *Sir Percyuell of Gales* and “Tractatus Williami Nassyngton” that do not match any rhyming scheme or textual pattern. Even more confusingly, Thornton adds visually-striking brackets in red ink to the beginning of the non-rhyming *Alliterative Morte Arthure* (ff. 53r-98v, brackets on ff. 53r-54r). The brackets do not follow alliterative or rhythmic patterns either and cross stanzaic boundaries. Is this peculiarity due to Thornton’s lack of scribal training? Does he copy the brackets erroneously from an exemplar? Or are there more complex patterns at play, or more nuanced uses of brackets than we might otherwise assume? It is overly simplistic and dismissive to blame any non-standard features on an amateur scribe lacking conventional training, when Thornton also shows himself more than capable of sophisticated scribal practices like layout changes (such as the change from single column to double column layout on f. 98v), managing spaces of items and professional paratextual features (not carried out by Thornton, but signalled and planned for). A possible explanation for the form of the brackets in the *Alliterative Morte Arthure* is that Thornton expected to copy a rhyming text and drew a speculative arm from the end of the line into the marginal space. However, finding a lack of rhyming lines, the disordered patterns resulted. Some lines linked by brackets do seem to almost rhyme. However, this does not explain why the brackets continue for so long. The brackets could instead function as a visual and textual allusion: by including brackets (and particularly in striking red ink) Thornton is make a bold statement about the kind of text that is copied. The brackets connect *Morte Arthure* to other kinds of texts that use brackets, providing visual authority, placing the romance in a specific textual tradition and justifying its inclusion in the collection of romances. However, when read from the page, Thornton’s incorrect brackets are a visual distraction from the content of their texts and could guide a reader aloud to incorrectly modulate their delivery.

## 2.5.2 Staining and Wear

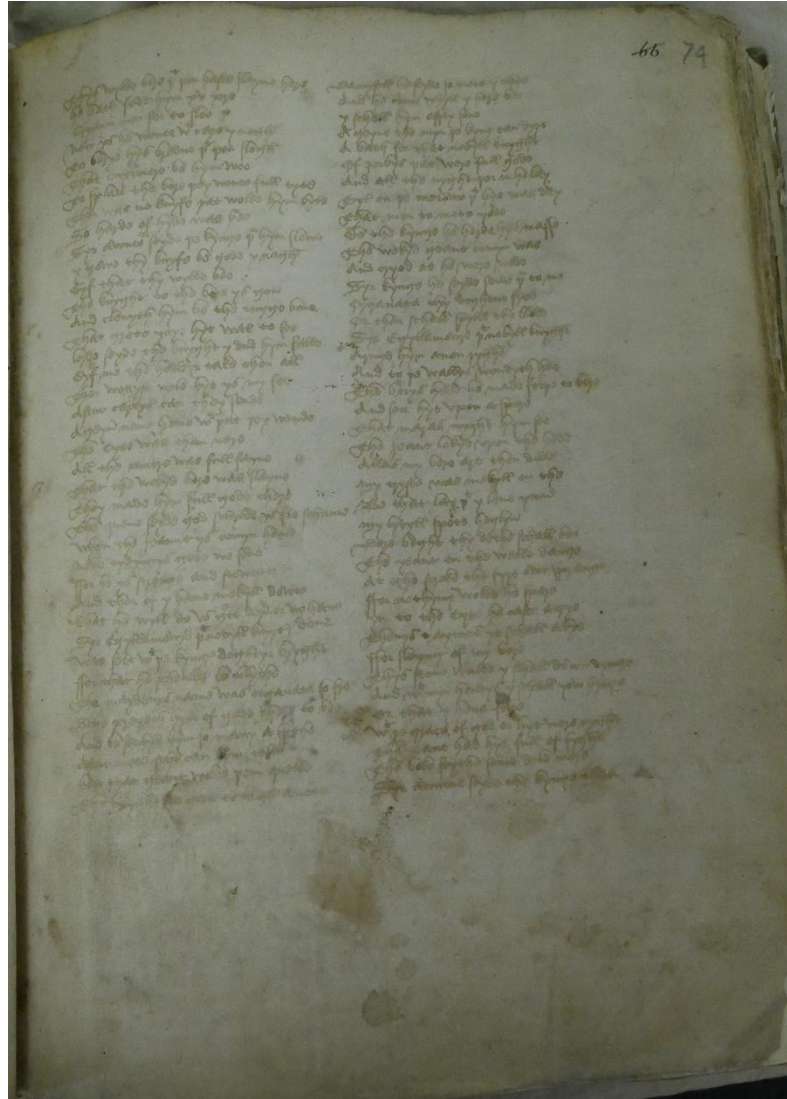

Figure 2.8: Staining in *Sir Eglamour of Artois*, f. 74r of Ff.2.38.

Across the pages of many of the manuscripts, I observed that romance texts attracted a significant proportion of the wear and staining. By examining the manuscripts with UV light it is possible to identify different sources or components of stains: oil appears orange, whilst wax or starch shows as blueish.<sup>57</sup> Kathryn M. Rudy has demonstrated how discolouration around the edges and bottoms of pages, and wear to the writing can suggest how readers handled the book.<sup>58</sup> There is much work still to be done on staining, which can offer tantalising hints of the book's earlier life: ink smudges suggest careless or amateur production, patterns of general wear on the page show where the book was handled most

<sup>57</sup> Dianne van der Reyden, *Identifying the Real Thing* (New York: Smithsonian Centre for Materials Research and Education (SCMRE), School for Scanning, 1996).

<sup>58</sup> Kathryn M. Rudy, 'Dirty Books: Quantifying Patterns of Use in Medieval Manuscripts Using a Densitometer', *Journal of Historians of Netherlandish Art* 2, no. 1–2 (2010).



frequently, and dirty fingerprints preserve the imprint of a past user (for example, Ff.2.38, f. 176r). Staining in Ff.2.38 is mainly concentrated in the ten quires that make up the romance section, *Sir Eglamour of Artois* in particular. (Figure 2.8) The text is worn and faded and the bottoms of pages are particularly discoloured, suggesting frequent handling. On the other hand, Ashmole 61 has many discolourations on romance pages, but also in an equal number of key religious items, perhaps pointing to a more mixed usage.<sup>59</sup> Li 91 shows signs of having been well-used throughout its life. Numerous stains from various sources mark its pages: water damage, oil or wax marks, ink, and possibly even dirty fingerprints (in the *Prose Alexander* on f. 46v). The manuscript was also evidently well cared-for: some tears in pages have been carefully sewn shut, a type of repair normally seen on parchment rather than paper (e.g. ff. 42r, 184r).

Staining evidence must be used with caution - stains do not necessarily date from the original period of usage, and there are certainly other factors that may be at work. Some staining is clearly from later use or from conservation efforts: the latter part of Ff.5.48 was damaged by water at some point in its history, which has obscured some text and faded the ink. However, more damaging were conservation efforts that attempted to reverse this damage, which instead left dark patches on many of the pages, obscuring the text even further (ff. 114-135). Others will continue to remain mysterious: several metallic objects were left sitting on or between ff. 169v/170r and 185v/186r of Ff.2.38, leaving rust-coloured stains.

The prevalence of staining in romances may suggest a specific *kind* rather than frequency of usage. Romance texts are perhaps used in situations more likely to attract mess. Oil, starch and water stains could indicate the presence of food and drink, perhaps linking the book to use over mealtimes. Wax and oil stains could be due to lighting apparatus, suggesting the use of the book after dark, particularly in the winter months where members of the household would have more leisure time.<sup>60</sup> Inky fingerprints and smudges show scribal activities taking place alongside the book – its copying, recopying, annotations, corrections, editing, or referring to the text to support other literary activities.

---

<sup>59</sup> Although how much of this staining points to original usage and how much is due to modern scholarly use is unclear. Guddat-Figge observed that the manuscript had very little staining, but the current appearance of the manuscript is more worn. Pen-tests (e.g. ff. 105r-106r) and some sixteenth-century marginal additions (e.g. ff. 98v, 106v) imply more early usage than Guddat-Figge suggests. Guddat-Figge, *Catalogue of Manuscripts Containing Middle English Romances*, 251.

<sup>60</sup> Sandra Hindman, *Sealed in Parchment: Rereadings of Knighthood in the Illuminated Manuscripts of Chrétien De Troyes* (Chicago: University of Chicago Press, 1994), 3; Vitz, *Orality and Performance in Early French Romance*, 219; Gilchrist, *Medieval Life: Archaeology and the Life Course*, 152.

### 2.5.3 Marginal Additions

Household manuscripts show evidence of long periods of usage and engagement: owners and users add their names to their book, draw doodles, write snippets of music, add annotations related to the content of text (such as *nota* symbols or manicules) and use margins for pen tests or for drafting of documents or letters. Sometimes these marginal additions directly relate to the content of the text, sometimes they are merely making use of an empty page or margin. Often, later users add new texts in blank spaces, such as the Findern lyrics or the medical recipes in CCAii (f. 13v). *Sir Degrevant* in the Findern manuscript, as already discussed, is the site of the most performative annotation found, an address to a potentially listening audience at the end of the first fitt of the romance which could prompt a pause in a performative reading event. These glimpses of the earlier lives and users of the household manuscripts allow scholars to date and locate the books accurately and to trace their later life and usage. Multiple generations of Thorntons, both male and female, have added their names to the pages of Li 91 (Edward Thornton, Ellenor Thornton, Dorothy Thornton, William Thornton), but there are also other seemingly unconnected names (Robert Louson on f. 29r; Jhon Rokeby [sic] on f. 220v; and Roger Blande on f. 265r), suggesting that the manuscript had a wider reach beyond the immediate household to other families or to servants.

Some marginal additions suggest that younger readers used and interacted with texts, perhaps as part of their education, copying out lines in blank spaces around the page or annotating the text in immature hands typified by clumsily-formed and poorly-spaced letters. At the top of f. 61r in CCAii, a poorly-formed fifteenth-century hand copied out the first line of the page in the upper margin and similar marginal additions occur elsewhere throughout the manuscript. The Heege manuscript bears even more marginal activity by immature hands. These hands copy out sections from the main text in the margins, often directly below or above the main text-space (see for example ff. 118v, 125v, 136r, 158r) or add Latin phrases and *aides-mémoire* connected to education (ff. 154v, 176r, 216v).<sup>61</sup> (Figures 2.9 and 2.10) The moral tale *Tundale* has marginal additions on almost every page. (Figure 2.11) Other marginal additions indicate a more specific engagement with the text – immature hands copy many variations on the phrase “Thys lesvn Is of tvndale that wecked man” (f. 123r), suggesting the use of *Tundale* as a text of study (perhaps even for reading aloud) and moral guidance for its readers.<sup>62</sup>

---

<sup>61</sup> For example “est deus ffor god est domynvs ffor our lord” (f. 176r) or a piece of Latin from William Lily’s Latin Grammar book (f. 154v).

<sup>62</sup> ‘lessoun n.’, Middle English Compendium: Middle English Dictionary. Accessed 1 October 2016. [https://quod.lib.umich.edu/m/middle-english-dictionary/dictionary/MED25239/track?counter=1&search\\_id=15601054](https://quod.lib.umich.edu/m/middle-english-dictionary/dictionary/MED25239/track?counter=1&search_id=15601054)

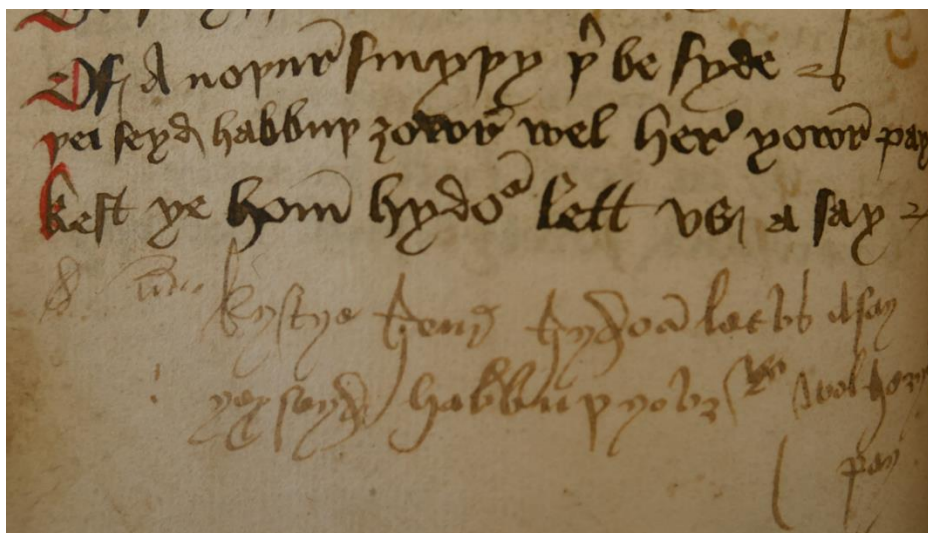

Figure 2.9: Copying hand in the Heege manuscript, f. 125v (detail). Note that the lines are copied in reverse order, suggesting a focus on replication rather than the sense of the text.

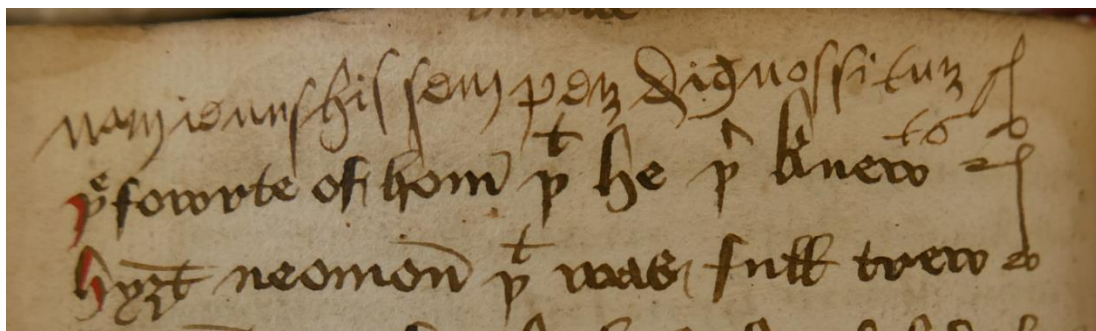

Figure 2.10: Immature hand copying Latin from William Lily's Latin grammar book in the Heege manuscript, f. 154v (detail).

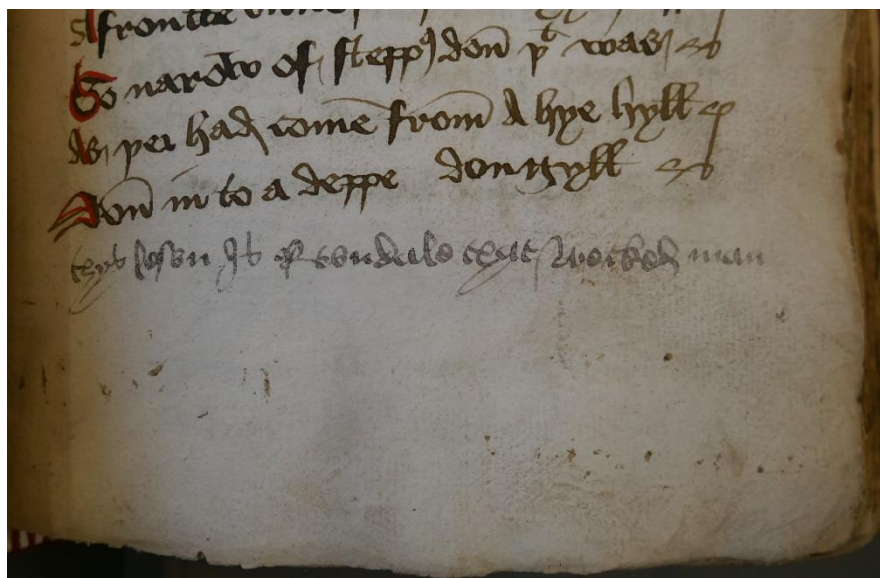

Figure 2.11: Marginal addition in *Tundale* in the Heege manuscript, f. 123r (detail).

### 2.5.4 Paratextual features

Paratextual features are those aspects of signalling, supporting apparatus that exist on a layer outside of the text, including titles, incipits, explicits, rubrication, decorated capitals, catchwords, changes in script or hand, speaker notations, punctuation, foliation or pagination, as well as, arguably, some marginalia and features of layout discussed above. Paratextual features serve the needs of visual readers, drawing attention to important information and features, and guiding the gaze across the manuscript page. They also indirectly support listeners as the reader-aloud is guided to better modulate their delivery for conveying the sense of the words. When reading texts non-sequentially in books that lack foliation or pagination, paratextual features allow readers to locate texts easily. Running titles display the name of the story, rubrication also conveys information in a way that is visually distinct, images summarise the content of the story, and decorated capitals mark the opening and transitional points in the story where reading could be easily paused. Throughout his manuscripts, Robert Thornton often takes care to use paratextual features carefully to support reading fluency. This is particularly noticeable in his prose texts, which, lacking the internal structure of verse texts, rely more on these signalling features. In the *Prose Alexander*, Thornton carefully uses punctuation to distinguish sentences, starting each with a capital letter and using combinations of *puncti* (. or ,) and *virgules* (/) at the end. (Figure 2.12) These symbols also mark other divisions of sense like passages of direct speech or listed items.

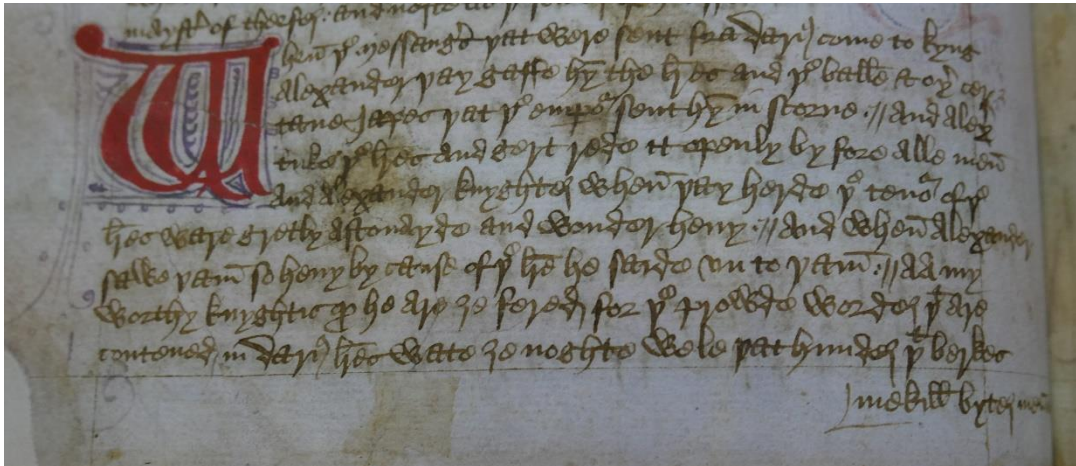

Figure 2.12: *Prose Alexander* in Li 91, f. 7v, showing punctuation and catchwords.

More significant is the programme of catchwords added to almost every verso and many of the rectos, written directly below the end of the final line of the page, and connected to it by an open bracket. John J. Thompson interprets these catchwords as a means for Thornton

to correctly order the as-yet unbound bifolia of the first quires.<sup>63</sup> However, a far more plausible explanation to me (and to Phillipa Hardman) is that they support reading activities.<sup>64</sup> A reader encountering a page transition holds the catchwords in their memory and is able to read continuously across the page boundary. This apparatus is specifically suited to prose items where the sense continues across the page break, unlike poetic items in which sense and metre tend to be contained within lines and are not so easily disrupted by page divisions. Page breaks in prose items are more likely to disturb performative reading, whilst in poetic items, the natural pause at the end of a poetic line can be stretched across the time taken to change pages. That said, the more frequent inclusion of catchwords on versos than on rectos does seem a little counterintuitive: surely the disruption caused by turning a page is more than that caused by merely glancing across to the facing page? However, despite this issue, the catchwords surely must be to assist with the continuation of sense over page divisions as when the end of a section coincides with a page break (as on f. 29v and 36v) catchwords are not used.<sup>65</sup> A sentence split across ff. 45v/46r proves an interesting deviation from this explanation. The sentence reads in whole: “And if þay tourned þan awaywarde with owttē [doute he schulde dye] / And if þay tourned hym bakke with owten dowte he sulde dye” (Brackets indicating words written as catchwords, forward slash indicating page break.) Some form of scribal error is at play in this example, but it is unclear whether the error lies in the lack of catchwords, or in the repetition of the phrase beyond the catchwords on f. 46r. Is Thornton confusing the parallel syntax and repetition of this phrase? And does this then result in the duplication (with variations) of a phrase longer than that covered by the catchwords, or are there no functional catchwords at all?

The comic tale “King Edward and the Shepherd” (found in Ff.5.48 [article 9, ff. 48v-56v], related to “King Edward and the Hermit” in Ashmole 61 [item 41, ff. 157r-161v]) has a notable feature of presentation that could be connected to performance. The tale plays with the inversion of social status, with King Edward disguising himself to seek hospitality from a shepherd named Adam and then inviting him back to the royal court. An ongoing joke in this version of the tale is Adam’s fondness for his headgear in defiance of etiquette. Pilkington writes several lines throughout the text in large fere-textura with red ink decoration which do not align with any internal divisions. Both of the lines are awkwardly located part-way through the twelve-line stanza but happen to share a common

---

<sup>63</sup> John J. Thompson, *Robert Thornton and the London Thornton Manuscript: British Library MS Additional 31042* (Cambridge: D. S. Brewer, 1987), 20, note 4.

<sup>64</sup> Hardman, ‘Domestic Learning and Teaching: Investigating Evidence for the Role of “Household Miscellanies” in Late-Medieval England’, 26.

<sup>65</sup> Inevitably, a number of exceptions exist, such as f. 37v which has catchwords even though f. 38r is the beginning of a new section.

topic: the comic use of the oath ‘by my hat’. On f. 50ra is “**Do way quod Adam let be that** / Be god I wolde not for my hat” (bold text indicates fere-textura) and on f. 51ra is “**I shalle þe whyte be hode myne**”, spoken by King Edward in mockery of Adam. (Figure 2.13)

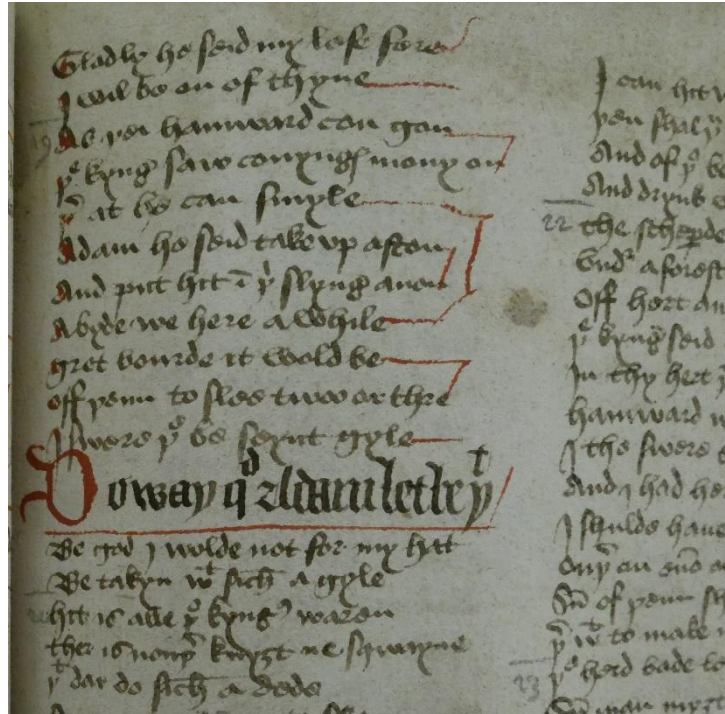

Figure 2.13: Large fere-textura line in “King Edward and the Shepherd”, Ff.5.48, f. 50ra (detail).

Could the prominence of these lines be explained by the scribe Pilkington deliberately foregrounding one of the central ongoing jokes of the text? Pilkington’s usage of the text is unknown: the manuscript contains many comic tales, but they could be compiled as moral exempla for sermons, rather than for their comedic value. The hat joke perhaps suggests deliberate curation of comedic material. By emphasising these lines, a visual reader cannot fail to miss the comedy of the scenes, and for a reader aloud, this presentation would prompt them to performatively emphasise these lines as well. This is an unusually direct example of the influence paratextual features on reading and experiencing the text which highlights key moments in the text and would prompt a reader-aloud to modulate their delivery to convey the joke to a listening audience. Using these performative features of manuscripts identified, I will now examine three texts more closely to explore palaeographical and codicological evidence related to their usage and receptions.

## 2.6 Case Studies

### 2.6.1 “The Tournament of Tottenham” and Performance

As noted above, “The Tournament of Tottenham” (Ff.5.48 [ff. 62r-66r] and two others) is one of a very small group of Middle English narrative texts with a recorded performance. A 1432-3 Exeter account records the payment of 20 d “datis lusoribus ludentibus in Castro de la Tornament de Totyngham per Preceptum Maioris” - that is, given to players performing about the Tournament of Tottenham in the castle (probably Rougemont Castle) by order of the mayor.<sup>66</sup> The relation of the surviving text to the recorded performance is unknown: they may be the same text or different settings of the same story. The “Tournament” is a ‘burlesque’ or comic poem describing a peasant brawl aspiring to be a knightly tournament, with bachelors competing for the hand of Tyb, the daughter of Randolf the Reeve, a clear parody of similar scenes from romance and epic like *Sir Eglamour of Artois* or *Sir Degrevant*. Ff.5.48 is also the only surviving witness of its sequel the “Feast of Tottenham” (ff. 115r-116r). A. Leslie Harris notes that the author and the intended audience must have been part of the elite as the humour relies on familiarity with the format and customs of tournaments: the poem often depicts the peasants unwittingly emulating actual chivalric practice.<sup>67</sup> The poem thus mocks both the peasants and the chivalric tradition. The peasant combatants are armed and armoured in imitation of knights with black bowls and hats worn as crested helmets to protect from the blows of clubs and (threshing) flails, sheepskins for armour, and mares in the place of destriers. They bear comic coats of arms, with charges tending either to the mundane, like the baker’s shovel and dough trough, or the excessive, like the *semy* of fire-breathing dragons (where multiple small charges are repeated or ‘powdered’ across the field). The poem is keenly aware of the tropes of romance and epic, which are particularly evoked and parodied in the descriptions of the combatants and their heroic boasts. The text’s opening mimics a lofty tone that would not be out of place in romance or epic: “Of all þes kene conqueroures to carpe is oure kynde / Off fel feghtyng folke ferly we fynde” (f. 62r).

---

<sup>66</sup> Zaerr, *Performance and the Middle English Romance*, 158; William G. Cooke, ‘The Tournament of Tottenham: An Alliterative Poem and an Exeter Performance’, *Records of Early English Drama* 11, no. 2 (1986): 2.

<sup>67</sup> A. Leslie Harris, ‘Tournaments and *The Tournament of Tottenham*’, *Fifteenth Century Studies* 23 (1997): 81–92.

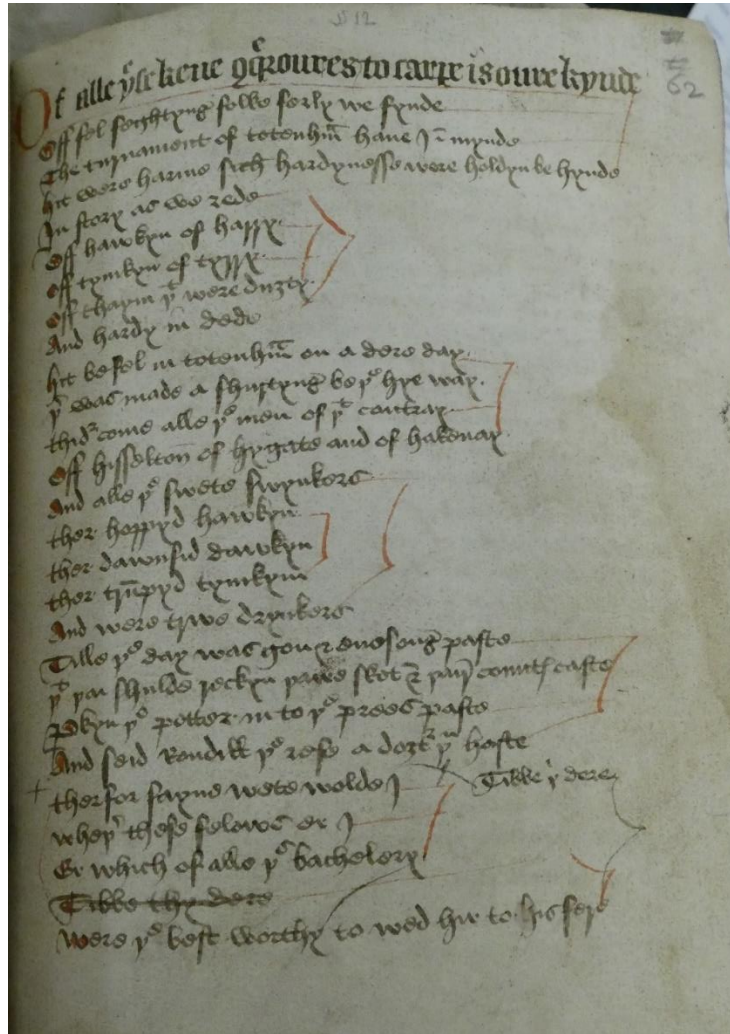

Figure 2.14: The opening of “The Tournament of Tottenham” in Ff.5.48, f. 62r.

Pilkington’s presentation of the item is formal, unlike many other texts in the manuscript (such as “The Clerk and the Nightingale”, ff. 57r-v, or “The Miracle of the Eucharist”, ff. 116v-118v). (Figure 2.14) The text features red ink decoration and the opening line is written in larger fere-textura script. He uses many abbreviations throughout the text, some not commonly seen in other household manuscripts. For example, the first line uses a ‘con’ abbreviation, followed immediately by a superscript e – this style of abbreviation is more common in texts by professional scribes, especially in Latin text, but is rarer in Middle English – and across this same page (f. 62r) are several instances of the two-shaped ‘er’ abbreviation. The other household manuscripts examined do not use abbreviations so frequently. As unfamiliar abbreviations would pose deciphering challenges for the reader, the intended readership of the manuscripts can be inferred. Pilkington’s text would pose no difficulties for himself to read, but within a wider audience would require an educated and skilled reader to read it fluently, whereas manuscripts like Li 91 or the Findern manuscript could suit more general audiences.



The poetic form of the “Tournament” is complex, with five longer lines rhyming *aaaab* followed by three shorter lines rhyming *cccb* – a poetic form sometimes called the Wakefield Stanza due to its use in several mystery plays by the Wakefield Master.<sup>68</sup> Brackets in red and black ink connect the rhyming lines of each stanza, making the poetic structure visually prominent. The eye-catching and formal presentation of the text would make it easy to locate within the booklet or later the bound volume, suggesting it is deemed of some importance or was frequently read or consulted. The margins of the pages are particularly discoloured, suggesting frequent handling of the book or booklet.<sup>69</sup> Pilkington also carefully corrects his copying errors: he mistakenly copies a line out of order on f. 62r, crosses it out, then re-copies it to the right of the main text column, with a cross in the left margin and a line in black ink showing its correct location, then corrects the brackets in black ink. Interestingly, this shows, firstly, a clear timeline of copying, revision and correction and, secondly, that Pilkington is following the rhyme scheme carefully as he copies and reviews the text. Unlike Thornton and his erroneous brackets, Pilkington takes care that his paratextual features match his text. Although the care taken to signal the rhyme scheme suggests consideration for aural reception, the text is not always copied in a similar manner. Pilkington roughly matches the baselines of the column across each page, but does not always copy the same number of lines on each page. On f. 63r he copies one line (visually) ‘more’ than the opposite page to ensure that the four-line a-rhyming unit is not separated. However, this is not done on ff. 63v and 64r, on which the fourth a-rhyming lines are written at the top of the next page. Similarly ff. 64v and 65r separate the last b-rhyming lines of the stanzas. The separated lines are signalled with partial brackets, yet this presentation still disrupts the structure of each stanza and in a performative reading situation would create a pause as the reader turns the page or switches their gaze to the facing page. Pauses can disrupt the sense of the text and – at worst – compromise the reading comprehension of the prelector, causing them to incorrectly modulate their delivery and convey the text incorrectly. I will return to this idea of poetic integrity below as the different scribes of household manuscripts approach the issue in differing ways, leading to varying impacts on performative reading.

Zaerr has experimented with various dramatic and musical performances of the “Tournament” – memorised solo voice and fiddle; the same accompanied by a group of mimers; with voice, fiddle and harp; with voice, fiddle and lute; with a narrator reading

---

<sup>68</sup> M.G. Frampton, ‘Gilbert Pilkington Once More’, *PMLA* 47, no. 3 (1932): 622; Erik Kooper, ‘The Tournament of Tottenham and The Feast of Tottenham: Introduction’, in *Sentimental and Humorous Romances*, ed. Erik Kooper, TEAMS Middle English Texts Series (Kalamazoo, Michigan: Medieval Institute Publications, 2005).

<sup>69</sup> Cf. Rudy, ‘Dirty Books: Quantifying Patterns of Use in Medieval Manuscripts Using a Densitometer’.

and actors speaking memorised dialogue with musical interludes – and has noted the power of music to enhance the text, such as heightening the mock-serious epic mood.<sup>70</sup> All of these experimental performances entail some style of dramatic reading (following the model of the Rougemont Castle performance) and rely on the assumption that the text as it survives can be adapted to mirror the dramatic performance recorded.

The text as Pilkington has copied it does not immediately suggest anticipation of dramatic performance. Speakers are not annotated, although a reader-aloud or singer could easily narrate for mimed performers – the subject matter does seem suitable for a comedic mimed performance. Mysteriously, in a previous text (the *Northern Passion*), a list of payments made to “smyth”, “godleff”, “vicar”, “wife” and “osmwnd” is written at the top of f. 32v in the main text space. (Figure 2.15)

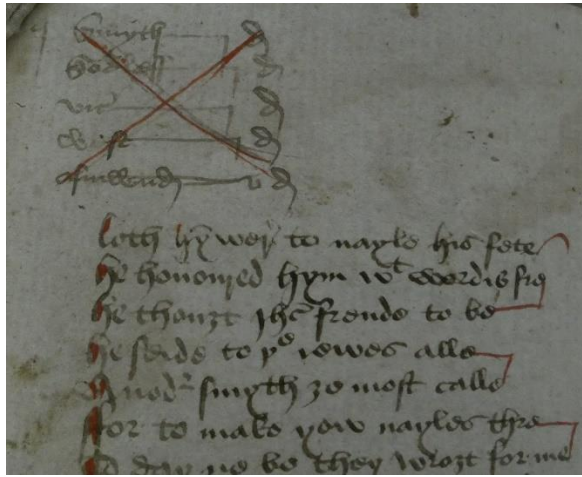

Figure 2.15: Ambiguous addition in Ff.5.48, f. 32v (detail). Note the differing forms of ‘y’, ‘d’ and ‘w’ when compared to Pilkington’s hand in the main text.

J. Downing suggests these are payments made to actors accidentally copied from an exemplar of the *Northern Passion*.<sup>71</sup> However, the ink is lighter than the main text and although the script is of a similar date, several letter-forms are notably distinct from Pilkington’s so I suggest instead this was copied by a different scribe. The addition must have been on the page already as Pilkington begins copying below it lower than on other pages. However, its relation to the text and to Pilkington himself is unclear and it cannot be used as proof of dramatic performance related to the manuscript.

It seems likely that Ff.5.48 was copied for Pilkington’s own usage: the texts were copied over a long period of time and many reflect his occupation in the secular clergy such as John Mirk’s *Instructions for Parish Priests* (ff. 2r-8r), the *Northern Passion* (ff.

<sup>70</sup> Zaerr, *Performance and the Middle English Romance*, 14–15, 24–25, 158–61; Linda Marie Zaerr and Joseph Baldassarre, ‘The Tournament of Tottenham: Music as Enhancement of the Prosody’, *Fifteenth Century Studies* 16 (1990): 239–52.

<sup>71</sup> Downing, ‘A Critical Edition of Cambridge University MS Ff.5.48’, xxxi, xxxviii.

11r-43r), the *Legend of St Michael* (ff. 79r-84r) and the *Feast of the Annunciation* (ff. 84r-84v). There is at least one other scribal hand present in the manuscript at ff. 79r-92v and Ohlgren suggests another at ff. 95r-135v.<sup>72</sup> (Although I disagree – this is more likely Pilkington’s less formal presentation – “The Feast of Tottenham” is definitely in his hand.) Downing and other scholars have posited that the various moral tales (and perhaps even some of the comic ones) served as material for sermons, but Pilkington’s selection of comic tales does seem a little incongruous, however, especially the anti-clerical *Robin Hood and the Monk*.<sup>73</sup> Pilkington perhaps served as a household clerk and used his manuscript to support his priestly duties in the household, as well as providing entertainment by reading the comic tales. Pilkington’s priestly training would cultivate skills in oratory easily adaptable to leisurely secular performance. Usage by Pilkington himself or by another trained cleric would explain the high frequency of abbreviations used, although his lack of formal layout throughout the manuscript suggests that he did not receive formal scribal training. The evidence from Ff.5.48 seems ambiguous about the performance possibilities of the “Tournament”. The manuscript context and evidence from the life and occupation of Pilkington do not specifically preclude it, but there is nothing there that would particularly support it either.

Let us examine some other texts found in the pool of household manuscripts for other evidence related to performance modalities. *The Erle of Tolous* (Ashmole 61 [ff. 27v-38v] and Li 91 [ff. 114vb-122ra]) has a simple layout in both manuscripts: in Ashmole 61 it is presented in a single column with each three-line tail rhyme unit bracketed together and only black ink is used (it appears that some initial capitals were washed with colour, but this has since faded), and in Li 91 it is in two columns, the rhyming scheme is not signalled and red decorated capitals mark internal divisions. Rate (the scribe of Ashmole 61) does not always copy a consistent number of lines on each page, but does ensure that the baselines of pages remain roughly even and that each three-line tail rhyme unit is copied completely on the same page. This allows for reading aloud to be more fluent as the end of a tail rhyme unit is a more natural place to pause for a page turn. As sense is usually confined within these tail rhyme units, this also assists with comprehension, so that a semantic unit is not split across a page turn. Robert Thornton on the other hand, splits tail rhyme units across column and page breaks more often than not. Preserving the poetic structure is a complex detail: it is a complex task to anticipate the bottom of a page and compress or expand the presentation so that the lines fit naturally – as Rate is able to do.

---

<sup>72</sup> Downing, xvi–xvii; Ohlgren, *Robin Hood: The Early Poems, 1465-1560: Texts, Contexts, and Ideology*, 29.

<sup>73</sup> Downing, ‘A Critical Edition of Cambridge University MS Ff.5.48’, xxxii; Ohlgren and Matheson, ‘Robin Hood and the Monk and the Manuscript Context of Cambridge University Library MS Ff.5.48, with Direct Analysis of CUL MS Ff.5.48’, 97–99.

Rate also more consistently uses brackets to signal the poetic structure (although often with small errors as on ff. 28r and 30r) – if brackets are planned – or if the exemplar has brackets – it is easier to copy poetic units together because they are visually distinct. Thornton’s inconsistent column lengths – whilst not a rare thing even for professional scribes – show particularly how Thornton’s verso a columns are inconsistently and poorly copied, which often poses challenges for the reader. This example shows a fairly neutral layout that can be easily adaptable to different reading modalities, although with a few small challenges posed by scribal idiosyncrasies.

It seems far more likely that musical performance of the romances, along with minstrel performers as discussed above, represent a parallel tradition and transmission of romance texts which intermingled with the amateur, domestic story-telling traditions supported by household manuscripts. As Putter writes, “Romances passed easily from the hands of readers to the memories of minstrels or listeners, and from the oral recitations of minstrels or amateurs back into the writings of scribes.”<sup>74</sup> Even if it is unlikely to represent a common modality associated with romances in household manuscripts, the musical performance of romances, especially as shown by Zaerr, demonstrates the adaptability of romance to different performance modalities, as well as the vibrancy that performance can bring to texts. Her analysis of her performances evoked surprising parallels to the medieval material – such as the similarities of mistakes in her memorised performances to apparent memorial transmission errors in romances.<sup>75</sup> Performers of historical material regardless of time period, language and modality face similar challenges in adapting text to performance today, such as the need to balance audience comprehension and enjoyment with accurately reproducing the source material, as well as the constant balance of performance instinct and information from historical sources.<sup>76</sup> Zaerr argues that the manuscript layout of the “Tournament” supports musical performance of the text.<sup>77</sup> My examination of the manuscript evidence does not completely rule out this possibility, but suggests that other receptions contexts were more likely from Pilkington’s copy of the poem. Rhiannon Purdie’s extensive study of the graphic tail rhyme layout concluded that the format could have advantages for musical performance: the clear signalling of the rhyming scheme could have provided a musician with cues to alter the melody to suit the *a*-rhyming or the *b*-rhyming line, particularly if the lines have different rhythms which require different

---

<sup>74</sup> Putter and Gilbert, ‘Introduction’, 13.

<sup>75</sup> McGillivray, *Memorization in the Transmission of the Middle English Romances*; Zaerr, ‘*The Weddyng of Sir Gawen and Dame Ragnell*: Performance and Intertextuality in Middle English Popular Romance’; Baugh, ‘The Middle English Romance: Some Questions of Creation, Presentation, and Preservation’.

<sup>76</sup> Zaerr, *Performance and the Middle English Romance*; Zaerr, ‘*The Weddyng of Sir Gawen and Dame Ragnell*: Performance and Intertextuality in Middle English Popular Romance’.

<sup>77</sup> Zaerr, *Performance and the Middle English Romance*, 158.

melodic adaptation.<sup>78</sup> However, she concludes that the overall evidence was too sparse to suggest an automatic connection. In comparison, the Old French *cantefable Aucassin et Nicolette* (Paris, Bibliothèque nationale de France (BnF), Fr. 2168, ff. 70r-80v) is presented on the manuscript page with features that support comprehension. (Figure 2.16)

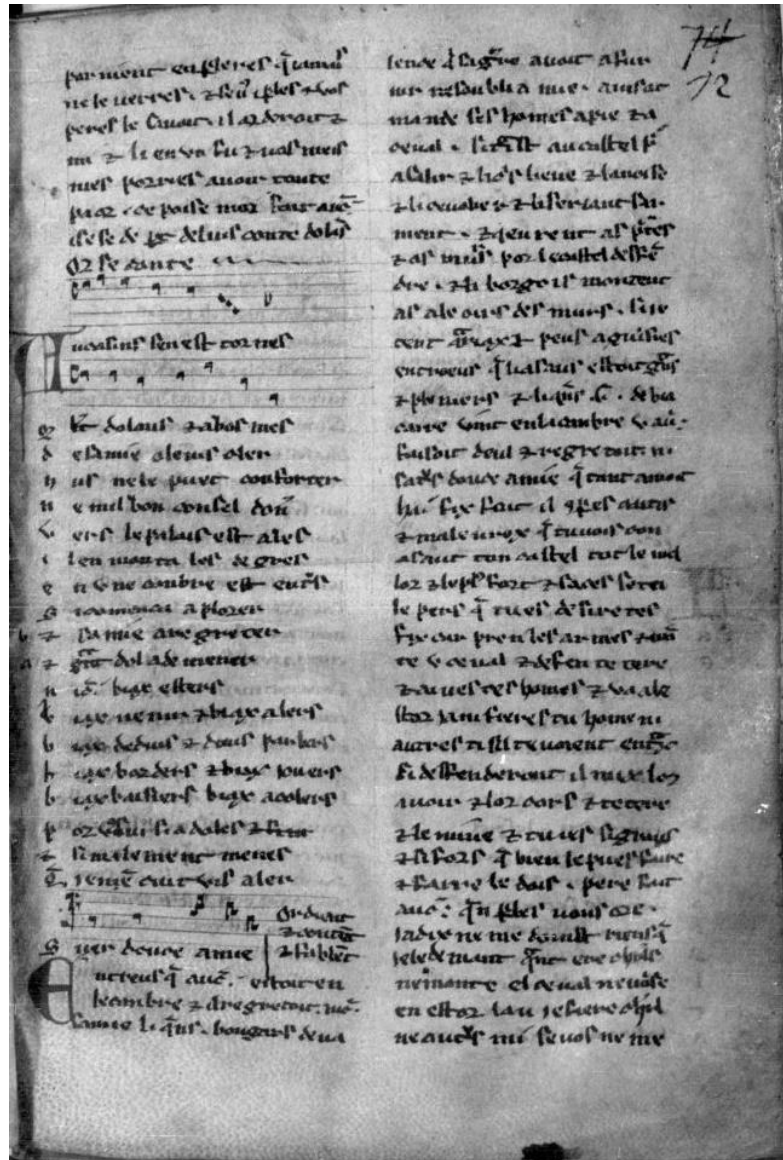

Figure 2.16: *Aucassin et Nicolette*, BnF, Fr. 2168, f. 72r.

The text combines verse and prose and each verse section is presented with musical notation of the first and last lines and signalled with a decorated capital. The baselines in the text space are ruled, ensuring that each line of verse and prose is well-spaced and clearly-written. The initial capitals of each line of verse are separated, a stylistic trait which would aid in avoiding eye-skip, especially if the performer were reading directly from the

<sup>78</sup> Rhiannon Purdie, *Anglicizing Romance: Tail-Rhyme and Genre in Medieval English Literature* (Woodbridge, Suffolk: D. S. Brewer, 2008), 79–80.

manuscript. The two column layout has sufficient space for each verse line to be written clearly on a single line. The page is ruled to accommodate 37 lines per page, which ensures that the presentation is consistent as the text is not required to be compressed or expanded. The clear and regular layout reduces impediments to fluent reading. These are the manuscript features that suggest a text presented in anticipation of musical performance directly from the manuscript page. BnF, Fr. 2168 is clearly a professional manuscript, with carefully planned and well-executed layout, a consistent and neat scribal hand throughout and extensive formal red ink decoration; it is perhaps somewhat disingenuous to compare it directly to the manuscripts of amateur book-producers like Robert Thornton, but the comparison shows clearly how layout can support or undermine reading practices. This analysis is not meant to suggest that Zaerr's interpretation of the evidence is incorrect. Quite the contrary: Zaerr's performances skilfully illustrate one aspect of a much broader multimodal story-telling tradition, and do important work in making romance performance more visible and accessible. Nonetheless, analysing some of Zaerr's focus texts from a different starting point can suggest alternative interpretations of the evidence and provide a more nuanced understanding of medieval textual reception. Household manuscripts are books made to fulfil a particular need and to be used and reused by multiple generations of households. Evidence from their pages – wear and tear, marks left by oily substances such as lighting or food, finger prints, ink smudges, corrections, marginal annotations such as names of readers or owners, or immature copying hands – show direct and tangible engagement with the texts on the page. A reception practice that is inaccessible to most is completely at odds with the rationale of their creation and usage. Reading texts directly from the manuscript page – especially the pages of household manuscripts – involves certain limitations that suggest that simpler and more accessible modes of performance were more common in domestic amateur reading contexts.

### **2.6.2 *Sir Degrevant* and Graphic Tail Rhyme Layout**

*Sir Degrevant* (Li 91 [ff. 130ra-138va] and the Findern manuscript [ff. 96ra-109vb]) is a more dramatic example of the impact of layout on reading practices. The romance has the most compelling evidence for aural reception in the performative annotation on f. 98va and thus analysis of the relationship between the manuscript page and the performative experience is particularly revealing. (Figure 2.17)

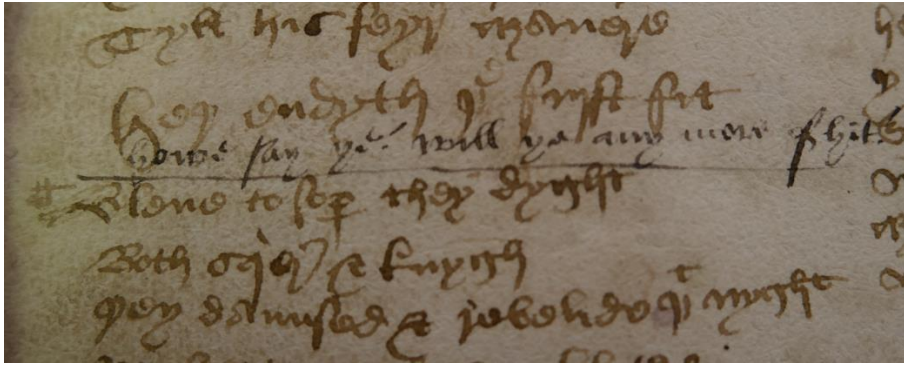

Figure 2.17: The annotation in the Findern manuscript copy of *Sir Degrevant*, f. 98va (detail).

*Sir Degrevant* is the most formally presented item in the Findern manuscript, with features to assist with reading comprehension and navigation, such as a title, ruling and pricking, and running titles. It is the work of two scribes (Scribe 21 and Scribe 22) who do not contribute any other texts to the manuscript (although Rossell Hope Robbins identifies Scribe 22 as the scribe of *Epistre de Cupide* [ff. 71r-76v], several other scholars disagree).<sup>79</sup> Its presentation offers some challenges for the reader. The scribe change part-way through shifts the presentation from a rough fifteenth-century hand to a more formal hand with elements of *textura*. Michael Johnston suggests that *Sir Degrevant* was one of the first texts copied or obtained for the manuscript's production and at some point the first part of this original copy was damaged beyond repair, causing the first half to be recopied.<sup>80</sup> It is perhaps the work of the two women named at the end – Elizabeth Cotton and Elizabeth Francis (f. 109vb). The text is presented in two columns and brackets are added at the beginning of the second scribe's part (f. 100ra-b) to signal the rhyme structure within the column. (Figure 2.18)

<sup>79</sup> Robbins, 'The Findern Anthology'; V.M. O'Mara, 'Female Scribal Activity and Scribal Activity in Late Medieval England: The Evidence?', *Leeds Studies in English*, New Series, 27 (1996): 87–130; Gottschall, 'Textual Provenance Through the Male and Female Names in the Findern Manuscript'.

<sup>80</sup> Michael Johnston, 'Sir Degrevant in the "Findern Anthology" (Cambridge, University Library MS Ff.1.6)', *Studies in Bibliography* 59 (2015): 71–84.

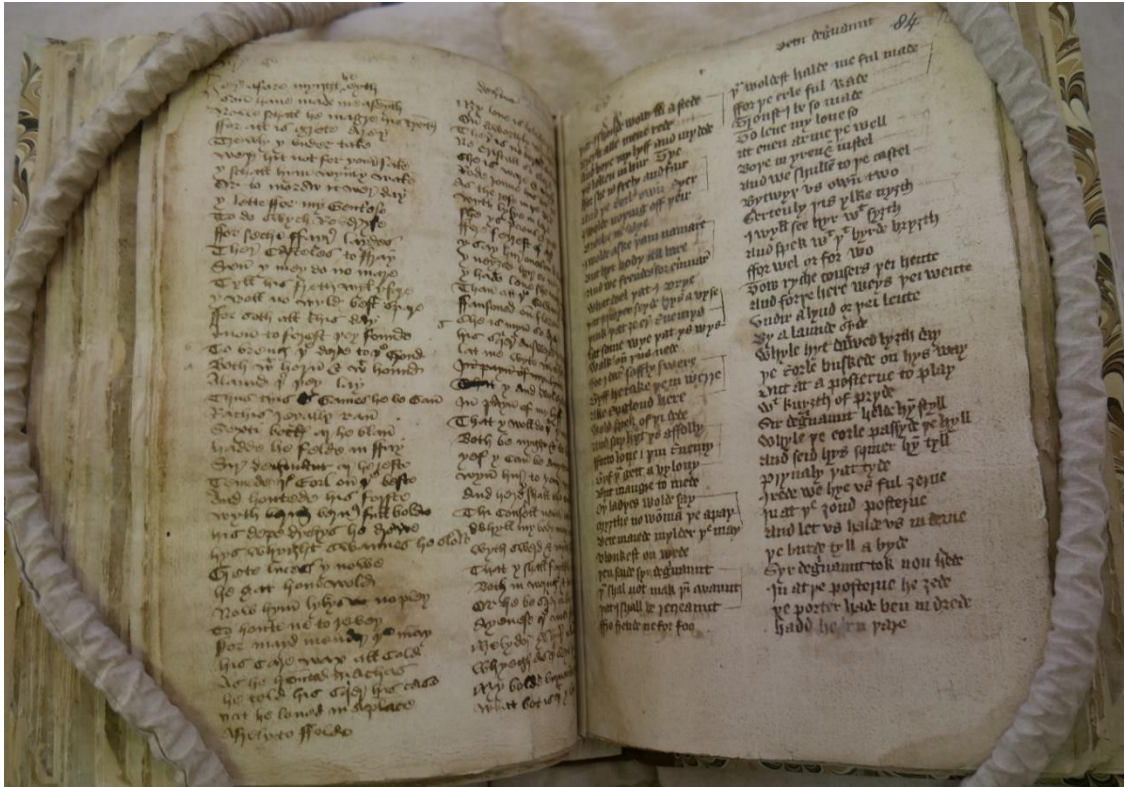

Figure 2.18: The change of scribes in the Findern copy of *Sir Degrevant*, ff. 99v-100r.

The first scribe (Scribe 21) consistently signals the beginning of stanzas with a marginal paraph mark. The second scribe (Scribe 22) writes in a formal hand which is clear and easy to read, although it does gradually become less well-executed towards the end with letter-forms shifting to more informal versions. The inexperienced scribe of the first section, however, makes a poor attempt to duplicate the orderly presentation of their more skilled counterpart, resulting in multiple errors (crossed out and corrected interlineally), lines copied out of order, uneven margins and text edges, and an overall informal, amateur presentation with a cramped, uneven and challenging hand. The polarity of the two halves adds a disjunction to the reading experience, just as it did physically to the production: there are several leaves cancelled in between the two parts. But the disjointed halves and challenges of legibility seem not to have dissuaded readers from using and even annotating the text. The text shows heavy evidence of use, with pages stained and worn. The collaborative and somewhat ad hoc presentation of the romance is a clear reflection of the Findern manuscript and its usage as a whole: created for (and/or by) and shared amongst a network of neighbouring Derbyshire families. Later users – perhaps from some of the named families, or the servants who added the notes and memoranda – added the performative annotation discussed and corrections such as adding the omitted word “hem” in line 7 interlineally, signalled with a caret, and tracing over letters in a darker ink (see for example f. 98va) – correcting spelling or perhaps clarifying letter-forms that were unclear. (Figure 2.19)



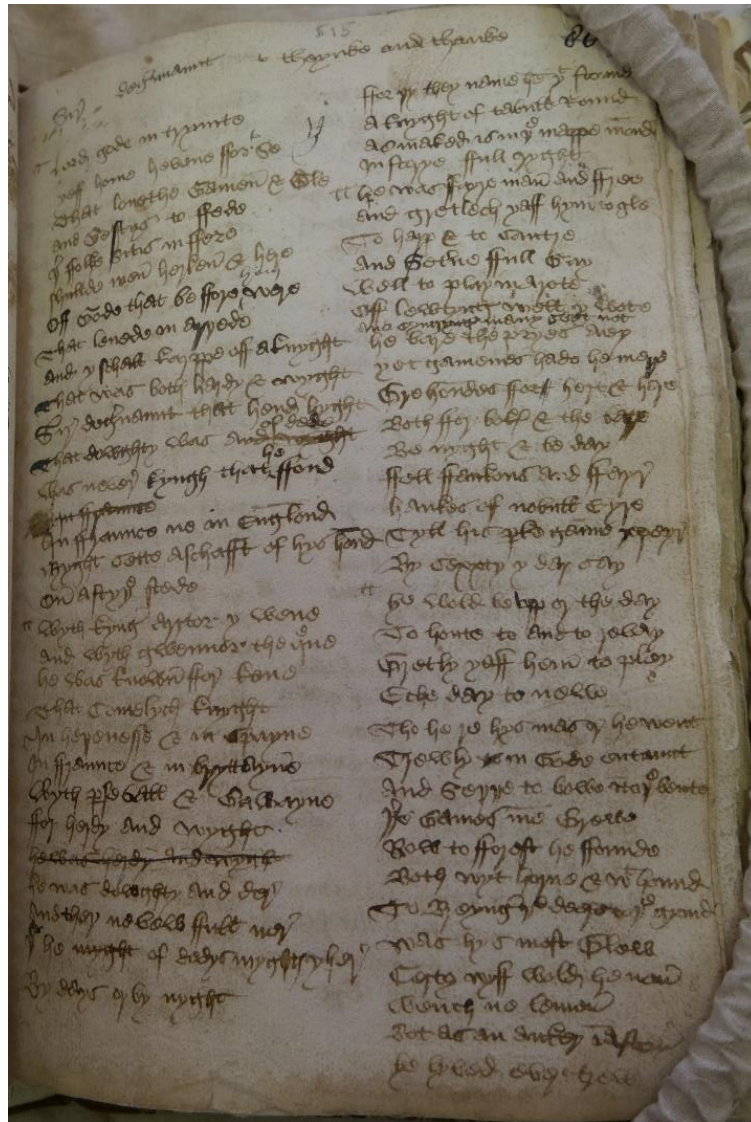

Figure 2.19: The opening of *Sir Degrevant* in the Findern manuscript, f. 96. Note the multiple errors and corrections throughout.

In Li 91, *Sir Degrevant* is presented in two columns in “graphic tail rhyme” format.<sup>81</sup> (Figure 2.20) In each twelve-line stanza (*aaabcccbdddbeeeb*) the triplet of *a*-rhyming lines are linked with a bracket drawn in black ink and the *b*-rhyming line is written to the right of this bracket over two or three lines. More usually in graphic tail rhyme format, the text is presented in a single column with the *b*-rhyming line written beside it, creating the illusion of a second column of text. Chaucer’s “*Sir Thopas*” is notably in this format as are other texts in the pool of household manuscripts studied here, such as “*The Feast of Tottenham*” in Ff.5.48 (ff. 115r-116r) or *Sir Isumbras* in the Heege manuscript (ff. 48r-56v).<sup>82</sup> (Figures 2.21, 2.22, 2.23)

<sup>81</sup> Purdie, ‘The Implications of Manuscript Layout in Chaucer’s *Tale of Sir Thopas*’.

<sup>82</sup> Judith Tschann, ‘The Layout of “*Sir Thopas*” in the Ellesmere, Hengwrt, Cambridge Dd.4.24, and Cambridge Gg.4.27 Manuscripts’, *The Chaucer Review* 20, no. 1 (1985): 1–13; Purdie, ‘The

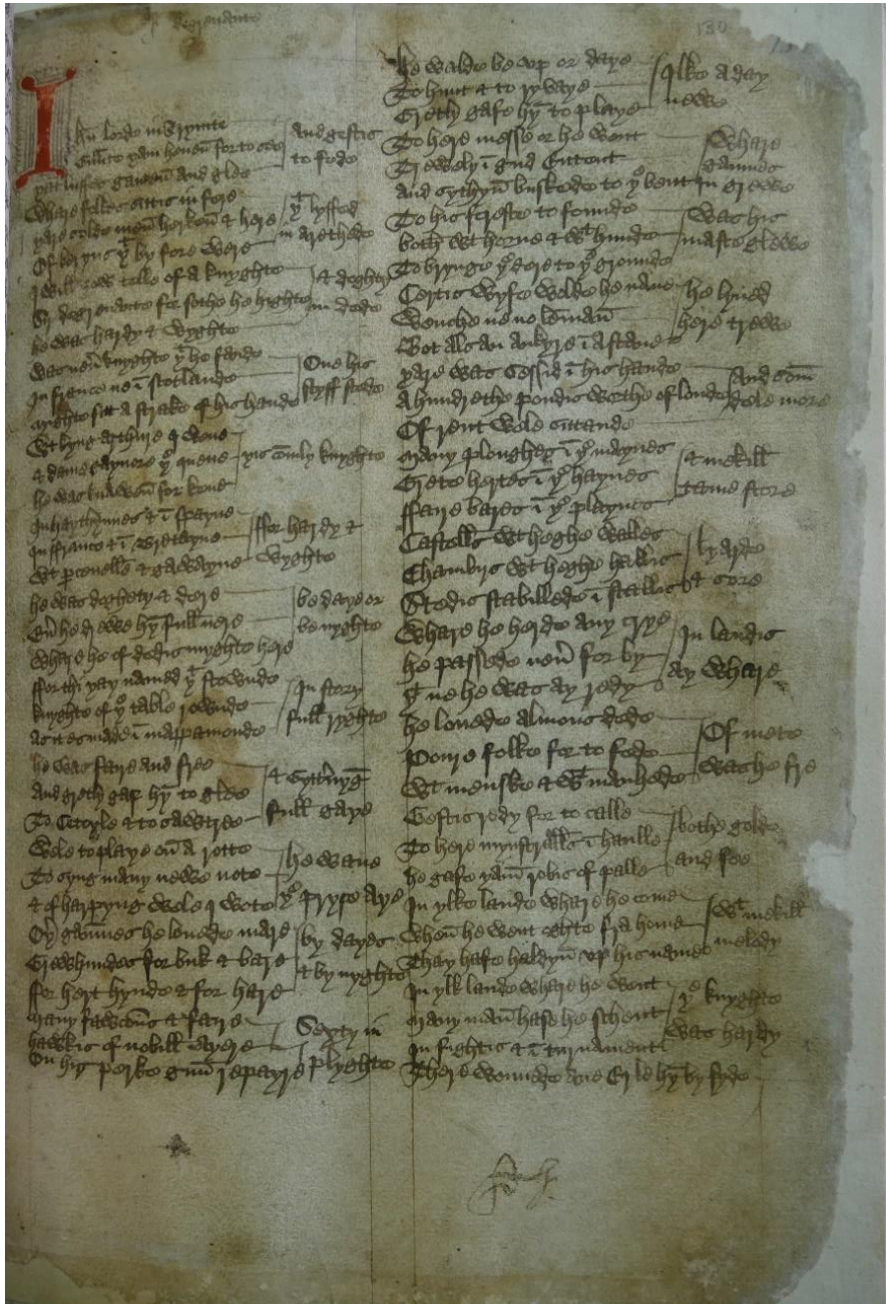

Figure 2.20: The opening of *Sir Degrevant* in Li 91, f. 130r.

Implications of Manuscript Layout in Chaucer's *Tale of Sir Thopas*; Purdie, *Anglicizing Romance: Tail-Rhyme and Genre in Medieval English Literature*.

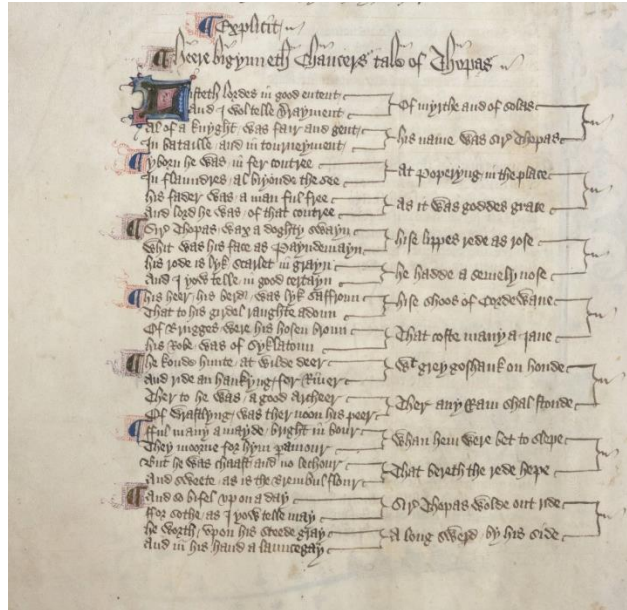

Figure 2.21: The opening of “Sir Thopas” from the Ellesmere manuscript. San Marino, CA, Huntington Library EL 26 C 9, f. 151v (detail).

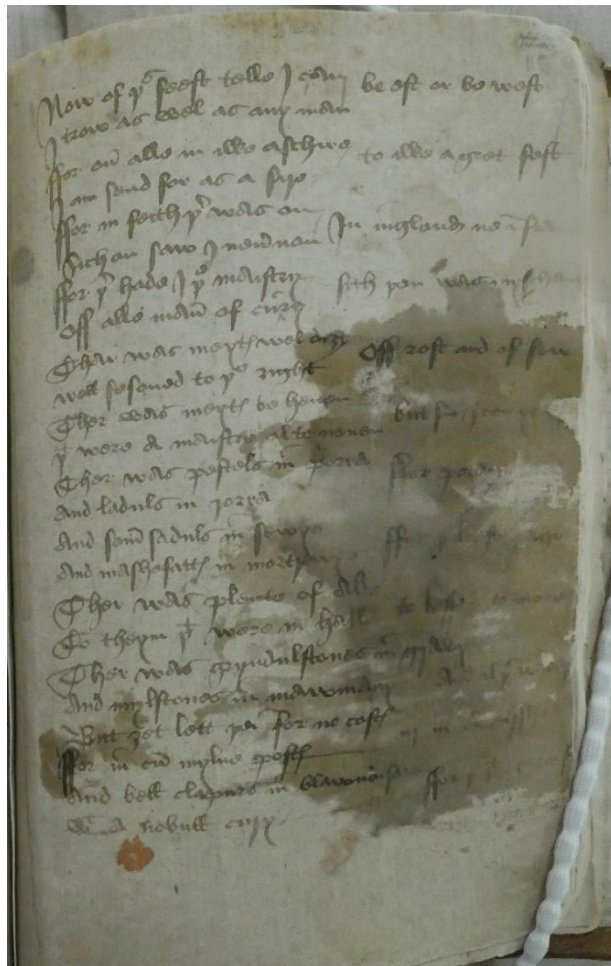

Figure 2.22: The opening of “The Feast of Tottenham” in Ff.5.48 showing graphic tail rhyme format, f. 115r. (The large area of staining is the result of a failed restoration attempt.)

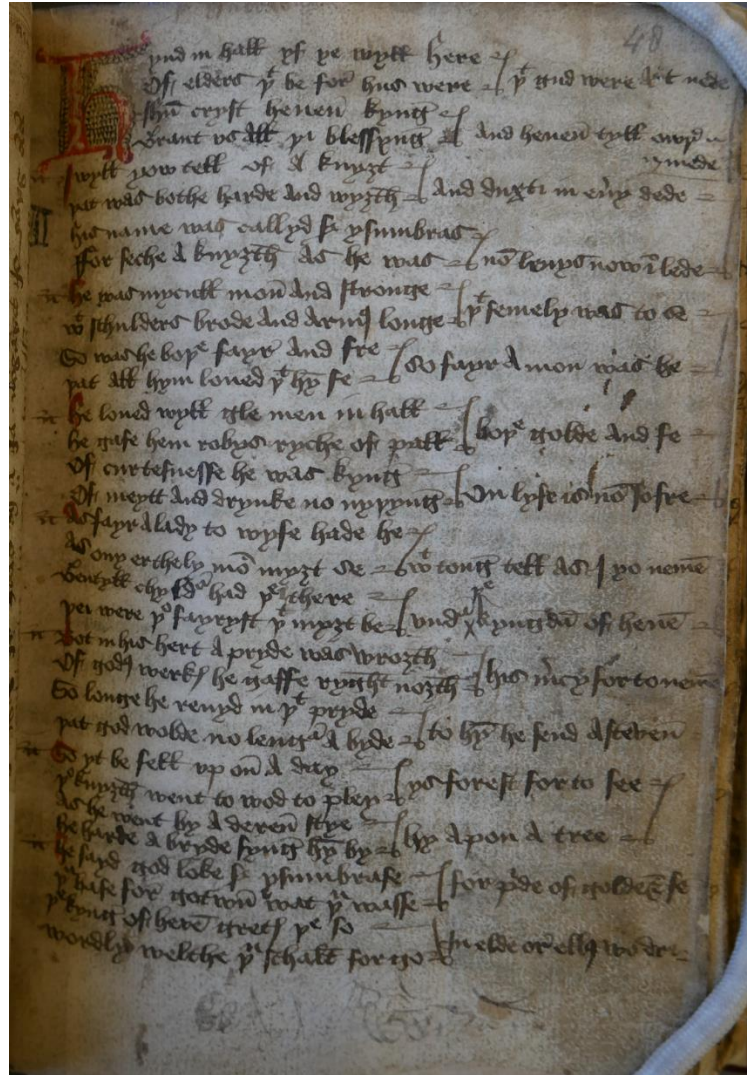

Figure 2.23: The opening of *Sir Isumbras* in the Heege manuscript showing graphic tail rhyme format, f. 48r.

Given Thornton's difficulties with brackets elsewhere, the non-graphical presentation of the previous text *Octavian* which has a similar rhyme scheme (*aabccbddbeeb*), and the unsuitability of the layout to the ruled text space, it is likely that the graphic layout was copied from Thornton's exemplar. It is only the short line lengths of the romance that make it possible to present graphically within the two-column layout at all, but this presentation creates a cramped page filled with text, with the *b*-rhyming lines of column a often intruding into the ruled space where Thornton copies column *b* (see f. 131va in particular). (Figure 2.24) The text is very challenging to read, with a high chance of eye skip. Stanza divisions are not signalled and the gaze of the reader must trace a convoluted path across the page as the *b*-rhyming line is copied level with the first line of the triplet and often ends above the last line of the triplet: additional care must be taken to locate the next line when returning to the main column. Reading errors are very likely, especially for a performative reader.

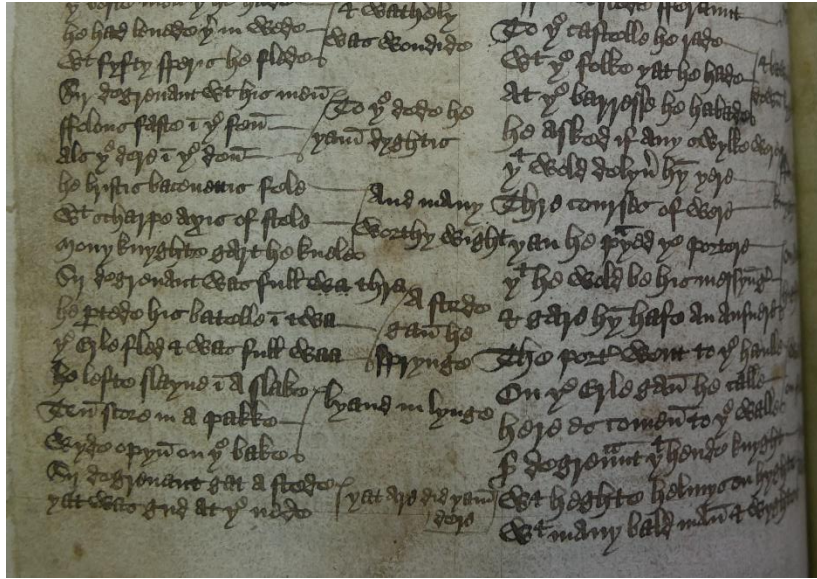

Figure 2.24: *Sir Degrevant* in Li 91, showing poorly laid-out graphic layout with a column intruding on b column, f. 131v (detail). Note also the splitting of the last tail rhyme unit.

As in *The Earl of Tolous*, Thornton does not ensure that each poetic unit stays within columns or pages. On multiple occasions (ff. 130va-b, 132ra-b, 134ra-b, 135va-b, 137ra-b) two *a*-rhyming lines and the *b*-rhyming line are written at the bottom of the *a* column, with the third *a*-rhyming line written at the top of the *b* column. This presentation encourages the disordered reading of the stanza, which disrupts the sense and the rhyme scheme of the tail rhyme unit (especially as each set of four lines is usually one unit of sense – that is, one phrase or sentence). None of these lines create any notable counter-readings if read out of order: most are noticeably non-grammatical. However, some do result in confusing misreadings: one implies that Degrevant’s horse had previously harmed him (instead of his human enemies who the horse will help him to defeat) and one that Degrevant asks Meliador to fight, rather than seeking her permission to fight for her.<sup>83</sup> Misreading these lines in a reading aloud context would likely cause the prelector to back-track and repeat lines to clarify the proper meaning.

Both in graphic tail rhyme layout and in Thornton’s condensed and sometimes disordered presentation, the physical work of reading is challenging. Modern psycholinguistics and computational linguistics analyse eye movements during reading and textual layout can complicate these eye moments, suggesting an impact on reading

<sup>83</sup> “Syr Degrevuant gat a sted  
That was gode in ilk a ned  
Many a side grat he bled  
That byfore dud hym dere” (f. 131va-b) (ll. 353-6 equivalent)

“Madam yef hit be your well  
Y pray you take hit not to ill  
Y am holden thertyll  
To fyght on my foo” (f. 132ra-b) (ll. 457-60 equivalent)

practices.<sup>84</sup> In well laid-out graphic tail rhyme, the reader scans the *a*-rhyming lines in the main column one at a time and the brackets (which are often drawn in red ink in formal and high-grade manuscripts) clearly delineate the borders of the section to be deciphered. The reading of the main column is then suspended and the reader shifts their gaze over to the secondary column created by the tail rhyme line. In less proficient layouts like Thornton's, the eyes of the reader negotiate a more complex path across the page: the path of the gaze is not as clearly signalled with the paratextual apparatus as it is in manuscripts by professional scribes. The reader must work hard to correctly track the lines across the page, selecting the correct graphic line to read and the correct couplet to return to in the main column. Furthermore, Thornton's cramped layout sometimes results in the tail rhyme line being written one word at a time (Figure 2.25).

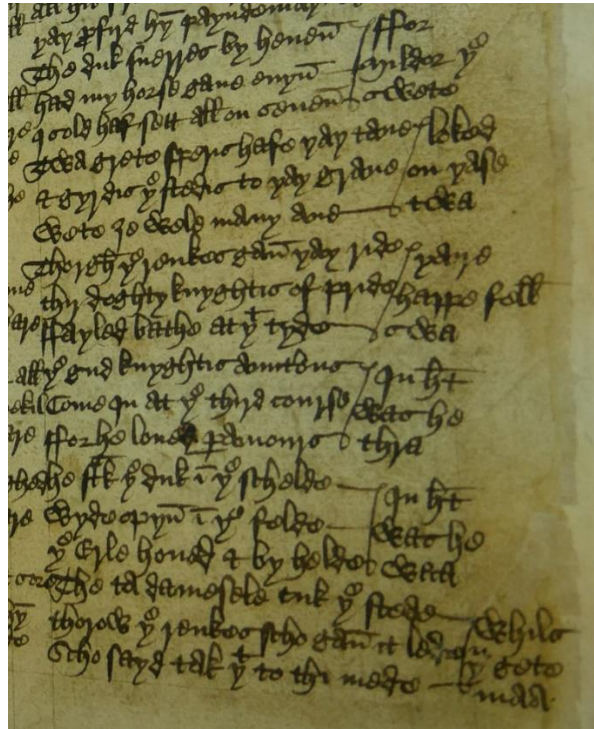

Figure 2.25: Poorly laid-out graphic tail rhyme in Li 91 with tail rhyme lines written one or two words at a time, f. 133rb (detail).

When reading, a reader first decodes or deciphers words, assigning stress and syllabic division in a process called prosodification, comprehends the word and then reproduces the word in speech.<sup>85</sup> Thornton's layout disrupts the natural sight-reading flow

<sup>84</sup> Keith Rayner, 'Eye Movements in Reading and Information Processing', *Psychological Bulletin* 124, no. 3 (1998): 373–76; Alessandro Lopopolo et al., 'Dependency Parsing with Your Eyes: Dependency Structure Predicts Eye Regressions During Reading', in *Proceedings of the Workshop on Cognitive Modeling and Computational Linguistics* (Minneapolis: Association for Computational Linguistics, 2019), 77–85; Jun, 'The Implicit Prosody Hypothesis and Overt Prosody in English'.

<sup>85</sup> Jun, 'The Implicit Prosody Hypothesis and Overt Prosody in English', 1223–24; Roxanne F. Hudson, Holly B. Lane, and Paige C. Pullen, 'Reading Fluency Assessment and Instruction: What,

of a reader: in English the eyes track from left-to-right and from top-to-bottom – it is less automatic to sight-read from top-to-bottom first. This results in the individual words in the graphic line being deciphered and decoded one-by-one, which can impede the flow of reading and delay or even prevent comprehension of the whole line.<sup>86</sup> Research shows that the eyes of the reader are constantly in motion, looking ahead to the material yet to be read (the reader's sight-reading span) and looking back at material already read in small units called *saccades*, especially making reference to important content words to assist with overall comprehension.<sup>87</sup> The eye tracks back to previous words that are syntactically related to assist with comprehension.<sup>88</sup> In Thornton's poorly-presented graphic layout, this process is, if not completely impeded, then somewhat impaired. Whilst Lopopolo et al's research suggested that this did not have a measurable impact on comprehension, it creates a qualitatively different reading experience and a more involved, challenging one. In performative reading settings which involve multiple musical or dramatic elements, a manuscript user would likely find their reading negatively impacted.

This analysis could be interpreted in a few ways. Some scholars of Thornton's manuscripts have argued that he writes mainly for visual readers rather than audiate ones, as do Pearsall and Hardman to explain Thornton's removal of the self-referential fitt divisions in his copy of *Sir Eglamour of Artois* (ff. 138va-147rb).<sup>89</sup> However, these copying inconsistencies would prove challenging to a visual reader as well as a reader-aloud, although a visual reader can silently correct their own performance while a reader-aloud must re-read to clarify the meaning. The layout and errors are more likely due to Thornton's lack of formal training in book production and textual *ordinatio* (formal layout). Thornton's scribal hand is well-formed and usually easy to read, and he demonstrates some complex layouts like the change from one to two column layout part-way down the page on f. 98v to make most efficient use of space when changing from the long lines of the *Alliterative Morte Arthure* to the shorter lines of *Octavian*. Nonetheless, the uneven baselines of pages, variable text size, compression of lines and the disordered layout discussed here certainly result from a lack of training and they disrupt the fluency of reading. Perhaps this was not such a challenge for Robert Thornton in his own usage, given

---

Why, and How?', *The Reading Teacher* 58, no. 8 (2005): 702–14; Timothy Rasinski, 'Issues and Trends in Literacy: Reading Fluency Instruction: Moving beyond Accuracy, Automaticity, and Prosody', *The Reading Teacher* 59, no. 7 (2006): 704.

<sup>86</sup> Jun, 'The Implicit Prosody Hypothesis and Overt Prosody in English'.

<sup>87</sup> Rayner, 'Eye Movements in Reading and Information Processing', 373–76; Lopopolo et al., 'Dependency Parsing with Your Eyes: Dependency Structure Predicts Eye Regressions During Reading', 78.

<sup>88</sup> Lopopolo et al., 'Dependency Parsing with Your Eyes: Dependency Structure Predicts Eye Regressions During Reading', 84.

<sup>89</sup> Derek Pearsall, 'The English Romance in the Fifteenth Century', *Essays and Studies* 29 (1976): 61; Hardman, 'Fitt Divisions in Middle English Romances: A Consideration of the Evidence', 75.

his close familiarity with the text and layout from the copying process, as well as his own scribal hand. However, for readers new to the manuscript these factors would certainly affect reading coherency. In the experiments discussed in Chapter 4, we explored these insights further by experiencing the impact of layout and textual idiosyncrasies on reading practices.

### 2.6.3 *Sir Eglamour of Artois*, Paratextual Features and Internal Divisions

The depiction of communal reading aloud in Chaucer's *Troilus and Criseyde* describes how the ladies cease their reading at "lettres rede" – either a rubrication or a decorated capital in red ink, both of which can indicate the beginning of a new section.<sup>90</sup> The paratextual features allow the ladies to break up their leisurely reading into a number of episodes. Scholars of Old French epics have proposed the idea of the '*séances épiques jongleresques*': sections of an epic that could be performed by a jongleur between dinner and dusk, somewhere between 1000-1300 or even 1000-2000 lines.<sup>91</sup> I observed that many Middle English romances are, by design or by chance, the same length as this proposed episodic performance. Additionally, romances tend to have internal divisions which divide the story into smaller sections. Could Middle English romances have been written to be the ideal length for reading aloud comfortably in one session or to be divided across several smaller sessions? The *séance épique* aids not just the performer, but is also a comfortable amount to read solitarily and silently. Internal divisions, even in shorter romances, strongly suggest some kind of episodic reading, even across different reading modalities. Joyce Coleman recounts the example of Jean Froissart reading aloud his *Meliador* to Gaston Fébus, the count of Foix: over a ten week period in the winter of 1388-9, Froissart travelled to the count's castle at midnight every night and read aloud seven pages of his text for the count's entertainment. The count was either in his hall or chamber (which, the text notes, were brightly-lit), and the reading would end with him either leaving to go to bed, or already in bed.<sup>92</sup> Without access to the physical copy of the text that Froissart was reading from, it is difficult to estimate how much of the text formed one reading session. The one surviving manuscript of *Meliador* (Paris, BnF, Fr. 12557) dates to c. 1400, later than Froissart's reading. However, Elysse Taillon Meredith proposes that the number of

<sup>90</sup> Geoffrey Chaucer, 'Troilus and Criseyde', in *The Riverside Chaucer*, ed. Larry D. Benson, 3rd ed. (Oxford: Oxford University Press, 2008), l. II.103.

<sup>91</sup> Andrew Taylor, 'Editing Sung Objects: The Challenges of Digby 23', in *The Book Unbound: Editing and Reading Medieval Manuscripts and Texts*, ed. Siân Echard and Stephen Partridge (Toronto: University of Toronto Press, 2004), 87–88.

<sup>92</sup> Froissart recounts these reading events in his "Dit du Florin" and they are translated and examined in Coleman, *Public Reading and the Reading Public*, 111–12.



folios in this manuscript match the number implied by Froissart's reading and is thus comparable.<sup>93</sup> Dividing the 30771 lines of this version of *Meliador* across the seventy nights of reading suggests that each reading event covered roughly 440 lines of text. It is curious that Froissart divides the reading episodes according to number of pages rather than events or internal divisions in the text: there are sections in the text, but some are over 6000 lines long, much too long to act as a performative division.

*Sir Eglamour of Artois* (found in Li 91, CCAii and Ff.2.38, along with three manuscripts and one fragment outside of the pool examined) is often noted for its carefully-structured episodic plot and its internal division. The first-person narrator intrudes on the text to offer transitional comments which divide the story into four sections (called *fitts* or *gestes*), roughly aligned with Eglamour's three escalating challenges. Each of these three manuscripts treats and signals the internal divisions in varying ways, which reflects wider scribal practices throughout each of the manuscripts and suggests insights about anticipated usage and reception. Hardman suggests that romance-readers could have used the length of this signalled first fitt to estimate the length of the subsequent sections and thus determine when to make their own pauses in the latter part of the text.<sup>94</sup> Hardman's discussion of fitt divisions later focuses on *Sir Eglamour of Artois* as an example of differing scribal treatments. In my own observations of the three manuscripts I had separately noted these distinctions and reached similar conclusions to Hardman, however, I will go beyond that discussion to focus on the performative potential suggested by these sections.

The scribe of CCAii consistently uses paratextual features to signal the structure of texts throughout the manuscript. Marginal paraph marks sub-divide poetic items into stanzas or divide prose items into sections. *Virgules* (a mark like a forward slash) are sometimes used as an additional layer of division, and brackets indicate poetic structure. At the opening of *Sir Eglamour of Artois*, next to the main title in the upper margin of f. 5v, the scribe writes "Cp. I." - capitulum (chapter) 1. This first section includes the opening and Eglamour's successful first task, concluding with the narrator's fitt division: "Make we mery so have we blysse / For thys ys þe fyrst fytt I wys / Of Sir Eglamour þat he has tane" (f. 7v; ll. 343-5). After this stanza, the scribe writes "ij" in the margin to indicate the beginning of the second fitt (f. 7v, l. 346). The second section encompasses Eglamour's second task and the narrator's remark at the close of the second fitt mirrors that of the first: "This ys þe second fytt of þis / Makes mery so have y blys / For þus ferre have I red" (f. 9ra, ll. 622-4). Particularly significant here is the narrator's specific acknowledgement of

<sup>93</sup> Elysse Taillon Meredith, 'Wearing Identity: Colour and Costume in *Meliador* and *Sir Gawain and the Green Knight*' (PhD Thesis, University of Edinburgh, 2012), 17.

<sup>94</sup> Hardman, 'Fitt Divisions in Middle English Romances: A Consideration of the Evidence', 70, 73.

their own act of reading. The modality of this “red” and the deictic potential of “thus far” (visually, temporally or narratively) are altered by the specific reception context, whether read aloud communally, or read silently and solitarily.

The third fitt includes the largest part of the action in the romance; it begins with Eglamour’s return to Artois, secret marriage to Christabel, his completion of his third and final task, slaying a dragon in Rome, the exiling of Christabel and her son Degrebell and their journeys to Egypt and Israel respectively. Again, the scribe signals the beginning of this fitt with “ijj” in the margin of f. 9ra, corresponding to l. 625. However, the ending of this fitt in CCAii is unclear: “iiij” and “v” appear in close succession, perhaps erroneously. The annotation “iiij” (l. 856) does coincide with a transition by the narrator, but not a major one, and another similar division at l. 931 is not signalled. (“Leve 3e the chyld with mykyll honour / And speke we of his modur whyte as flour / What weys our Lord here lent” (f. 10va, ll. 853-5).) “v” (l. 883) is perhaps the correct location for the division, coming after the narrator introduces the last section. (“Makes mery for yt ys beste / For þis ys þe laste geste / That I now take in honde” (f. 10va, ll. 880-2)) But the internal signalling of this fifth fitt is also oddly placed, inserted part-way through a passage where the king of Egypt sends a squire to save Christabel from her wrecked ship. Although this location does create narrative tension, the close placement of the two divisions may point to scribal error. Narratively, the fourth fitt includes only Christabel’s journey to England, whilst the fifth fitt encompasses the remainder of the romance: Eglamour’s eventual return to Artois, the passage of fifteen years, the tournaments for Christabel’s hand, the accidental incestuous marriage, the eventual reunion and the concluding double marriage feast.

Ff.2.38 generally agrees with the textual divisions in CCAii, although with only one division at the end, aligning with the narrator’s intrusion at ll. 880-2. The scribe uses three–four line-high decorated capitals in a red ink that has faded to a dark brown colour to signal the three main transitions where the narrator delineates the structure and division of the poem on ff. 73ra (l. 346), 74vb (l. 626) and 76vb (l. 883). (See Table 2.1 for comparison of these divisions.) No additional paratextual apparatus like CCAii’s marginal numbers are used. In these two manuscript witnesses, the signalled divisions and narratorial intrusions divide the romance into sections of roughly 250-450 lines.

The agreement of the internal textual divisions across Ff.2.38 and CCAii makes the divergent treatment in Li 91 intriguing. Thornton’s copy lacks the narrator’s metatextual fashioning of the romance into fitts, perhaps due to being copied from a different exemplar, or due to Thornton’s own editorial impulses: many of his other texts show similar evidence of alteration. Robert Thornton marks his divisions of the text with two–three line-high decorated capitals in bright red ink surrounded by dark ink flourishes, which occur on ff. 140vb (corresponding to l. 364), 143rb (l. 709) and 145ra (l. 1003), and

the text opens on f. 138va with a large six line high decorated capital in the same decorative scheme. (See Table 2.1.) Although this splits the romance into four sections, the divisions fall at different points from the other two witnesses, giving emphasis to different points in the narrative. Harriet Hudson suggests that the Thornton *Sir Eglamour of Artois* is close to the fragmentary version found in Egerton 2862.<sup>95</sup> Whether the Egerton copy also followed Thornton’s alternative divisions is unknown since only 160 lines survive.

	CCAii		Ff.2.38		Li 91	
	Begins	Length	Begins	Length	Begins	Length
<b>Fitt 1</b>	l. 1	345	l. 1	345	l. 1	363
<b>Fitt 2</b>	l. 346	279	l. 346	279	l. 364	345
<b>Fitt 3</b>	l. 625	231	l. 626	258	l. 709	294
<b>Fitt 4</b>	l. 856	27	-		-	
<b>Fitt 4/5</b>	l. 883	448	l. 883	458	l. 1003	332
<b>End</b>	l. 1331		l. 1341		l. 1335	

Table 2.1: Comparison of fitt divisions of *Sir Eglamour of Artois*.

In Thornton’s version, each internal division is delayed, usually placed in the first part of the narrative immediately as Eglamour sets out on his next task, which creates more dramatic tension for the reader. The decorated capital on f. 140vb falls just as Eglamour completes his fortnight’s journey and reaches the forest where the boar is known to live. The next division (f. 143r) is similarly delayed: unlike CCAii and Ff.2.38 which place this after Eglamour and Christabel’s clandestine marriage, Thornton signals a break after the Earl sets Eglamour’s third task, opening with Eglamour in Rome finding tokens of the dragon. Although there are no narratorial fitt divisions, this turning point falls after a transitional passage unique to the Thornton version: “And als þe buke of Rome says / To grete Rome he tase þe wayes / To seke þat worme so wylde / þe knyght wendis on his waye / Herkyns now I sall 3ow saye / To seke þat dragone bolde” (f. 143ra-b). The guiding presence of the narrator serves another function here, formulaically citing the authority of the non-specific ‘book of Rome’ and exhorting the audience to listen, rather than specifically dividing the text into fitts. The final section in Thornton’s version begins after Eglamour returns home to find Christabel and her son gone, and his journey to the Holy Land. The story turns to Degrebell and the transition falls as the narrator begins to describe his arms. This final decorated capital opens the narrator’s petition for attention “Now herkyns lordyngs lesse & mare / What arnes þat þe child bare”. (f. 145ra, equivalent to ll. 1003-4.)

Hardman observes that Thornton’s divisions do not align with the tail rhyme stanzas, but that they do make sense narratively, suggesting that the variations are made to

<sup>95</sup> Hudson, ‘Sir Eglamour of Artois: Introduction’. See also Curnow and Putter, ‘Textual and Familial Relationships: The Place of the Michigan Fragment in the Evolution of *Sir Eglamour*’.

accommodate a private reader who is privileging sense and story over poetic structure.<sup>96</sup> I disagree with Hardman's assessment: visual distinctions do not preclude performative reception as they still benefit the reader-aloud. The divisions all occur at the end of a three-line unit – even though the b-rhyme continues across the break, poetic integrity is maintained. Thornton's divisions in fact have two advantages for aural reception: the passages are more equal in length and delaying the breaks until after the next narrative episode begins would create pleasing dramatic tension when hearing the story over successive reading events. Thornton's version does not erase the narratorial presence with its ingrained aural reception, but merely lacks the self-conscious internal signalling of the fitt structure. A reader-aloud could just as easily pause their delivery at a decorated capital as after announcing the end of a fitt. It is more productive to consider the possibility that texts are set up to support multiple reading modalities. Thornton's divergent treatment of *Sir Eglamour of Artois* could support the activities of a solitary reader and communal performative readers. Thornton's divisions serve to emphasise different aspects of the story and create an alternative overarching structure. The four sections created by the visual divisions do not align so well with Eglamour's three tasks, but instead draw attention to events that befall the main characters: the courtship of Eglamour and Christabel, their secret marriage, their sundering, and the events that begin their reunion. The last division sets the entire reunion section apart from the rest of the narrative, emphasising it as narratively important, rather than including it alongside Christabel and Degrebell's exiles. The idiosyncratic and perhaps highly personalised dividing and copying of romances by Thornton does not extend to all of the romances in his two volumes. In his other non-unique romances, Thornton's placement of textual divisions matches other manuscripts more closely. For example, in *Octavian* (Northern version) (ff. 98va-109rb), two of the three textual divisions match the version copied into Ff.2.38 (ff. 90rb-102vb), which lacks the final division. Each part is roughly 500 lines long.

The internal divisions in *Sir Eglamour of Artois* and other romances may seem puzzling to a modern reader, but can in fact offer clues about the reading practices associated with romances. Shorter romances like *Cheualier Assigne* (~350 lines) or *Sir Isumbras* (~800 lines) could easily be read in one session on one evening and neither have signalled internal divisions in the household manuscripts they appear in (CCAii; and Li 91, CCAii, Ashmole 61 and Heege respectively). Longer romances like *Guy of Warwick* (over 11000 lines) (Ff.2.38) or *Bevis of Hampton* (just under 5000 lines) (Ff.2.38) surely

---

<sup>96</sup> Hardman, 'Fitt Divisions in Middle English Romances: A Consideration of the Evidence', 75.

required some sort of episodic reading.<sup>97</sup> Romances around 1000-2000 words tended to be easily divided into four parts and could either fill an evening of reading (*Sir Eglamour of Artois* at roughly 1300 lines was a comfortable amount for one evening of dedicated reading) or be divided across multiple sessions. The internal divisions in romances allow for easy adaptation of a text to suit the context, modality, time and audience, providing clear places to pause for refreshment, to re-centre the attention of the audience, or to end the reading. The addition to the Findern *Sir Degrevant* is perhaps a surviving example of this practice. In response to the reader's question 'do you want any more?', a listening audience could ask the reader to continue, or request a break to perhaps continue the reading on another occasion. As the narratives of romances tend to be episodic themselves, divisions suit the textual structure and allow the text to support multiple ways and modes of reading. A reader-aloud has the flexibility to alter the length of their performance, perhaps adapting to suit the responses of their listening audience. Internally-signalled pauses allow the listening audience to re-centre their attention on the text: a key concern for romance-writers based on the frequency of formulas petitioning for attention. A silent, private reader may also make use of these divisions to structure their own reading, with the frequent narratorial presence at divisions allowing them to connect to an imagined communal aural reception which shapes their own reading experience. The decorated capitals, particularly in more ornate manuscripts, could function as placeholders for the reader to find when they resume their reading activities.

In preparation for the performative reading experiments discussed in Chapter 4, I read *Sir Eglamour of Artois* aloud to a small audience of PhD and MA students from the Centre for Medieval Studies at the University of York. I read the text from the diplomatic edition of CCAii, and I used each of these fit divisions to signal a brief pause of roughly five minutes. I did this originally out of concern that the audience would tire of hearing Middle English, especially as many audience members were unfamiliar with the language and thus could not follow the story easily. However, the breaks were very welcome as a performer, as they allowed me to have a drink and to refresh my own attention. This performance experiment also revealed something significant about the divisions: each section of roughly 300-400 lines equated to around 20-25 minutes of reading. Modern psychology has not reached a consensus about average attention spans, but Neil A. Bradbury notes a study which showed that student attention span began to decline about twenty minutes into a lecture.<sup>98</sup> Further research into performance and orality revealed a

---

<sup>97</sup> *Bevis of Hampton* additionally is found in several manuscripts outside of the main pool studied that are likely also household manuscripts, including the Auchinleck MS, Egerton MS 2862, Chetham's Library MS 8009 and Naples MS XII.B.29.

<sup>98</sup> Neil A. Bradbury, 'Attention Span during Lectures: 8 Seconds, 10 Minutes, or More?', *Advances in Physiology Education* 40 (2016): 510.

parallel to oral-formulaic poetry: A.C. Baugh notes that Yugoslavian oral poets sing stories, whether whole, in part, or in condensed versions, in blocks of twenty minutes, or of an hour or more.<sup>99</sup> As another curious parallel, the average burning time of a rush light is around thirty minutes.<sup>100</sup> Higher status candles would have lasted longer, but an informal reading or reading in a household of lower standing may have preferred the more affordable rush light. It seems then that roughly twenty minutes is the ideal time for a performance and this corresponds closely to the length of the internal divisions in the romances. The *séance épique* is perhaps a suitable model for performances by professionals, however, for amateur readers and communal romance reading in a household setting these twenty minute-long, 300-400-line long sections are more accessible.

## 2.7 Conclusion

Copies of romances in household manuscripts seem to have been read directly from the book: their pages are worn and stained, often to a greater degree than other texts in the same manuscript. An analysis of reading practices associated with these texts should first closely engage with their codicological and palaeographical features. Analysis of the manuscripts of Middle English romances can suggest details about their possible usage and reception. Scribes anticipate their manuscripts and texts being used in particular ways and support reading activities through presentation, paratextual features and layout. The carefully planned and executed layouts of professional manuscripts like Ff.2.38 and CCAii allow texts to be easily adapted to different uses, with the beginnings and ends of texts signalled and internal divisions marked. Own-use manuscripts display more idiosyncratic copying techniques which can sometimes hinder reading practices, as in Robert Thornton's graphic tail rhyme and erroneous uses of brackets. Many generations of users of the household manuscripts have left material traces of their textual activities on the pages – marginal additions that show both close engagement with texts and that merely use the margins as convenient blank spaces for writing; patterns of wear that show customary handling of the volume; and staining that shows tangible hints at how the books' users interacted with them, copied them, attempted to restore them or even examined them. I identified a range of manuscript features that point to their usage, potentially in performative reading practices, and closely examined several key texts to see what these features can reveal about their original owners and users.

---

<sup>99</sup> Baugh, 'Improvisation in the Middle English Romance', 418.

<sup>100</sup> Norman P. Woodward, 'The Rushlight or Rush Candle of Old England', *The Rushlight* 1, no. 4 (1935).

## CHAPTER 3. Reading Spaces, Reading Books

### 3.1 Introduction

*“considering the materiality of texts emphasizes how medieval reading functions as embodied practice. That is, reading materially involves bodily, materially mediated modes of experience.”*<sup>1</sup>

This chapter examines domestic reading practices in relation to space, place and materiality, considering both how books and texts are shaped by the household and the house, and how the household and the house are in turn shaped by the books and texts. This analysis owes much to growing discussions around the ‘lived experience’ in archaeology, defined by the medieval archaeologist Matthew Johnston as the means of “understanding buildings and landscapes in terms of the different human experiences they afford.”<sup>2</sup> Interrogating the experience of reading through this lens of lived experience sheds light on the quotidian and the domestic. I will consider how people interacted with spaces and buildings and in turn how these experiences influenced encounters with household manuscripts and everyday reading activities. My analysis is comparable to Robert Allen Rouse’s “emplaced reading”, which interprets texts and their relationship with their related geographies, their associated social history and relationship to the people, places and landscapes that surrounded manuscripts’ production and consumption.<sup>3</sup> The places investigated by this chapter are smaller in scale than Rouse’s broader landscapes: I consider the spaces within a medieval house where communal leisurely domestic reading might have taken place – specifically the reading of romances from household manuscripts in the households of the rural gentry and the urban mercantile elite. In manuscripts so directly connected to known social contexts, their selections of texts are revealing about the preoccupations, desires, interests, and priorities of the households they belonged to and were made for. For example, the contents of Robert Thornton’s manuscripts in particular show a man dedicated to supporting a pious, moral household.<sup>4</sup> My study privileges the subjective and experiential and this chapter will continue to combine discussion of houses and household manuscripts with experimental analysis of performative reading: I will lay

---

<sup>1</sup> Blatt, *Participatory Reading in Late-Medieval England*, 110.

<sup>2</sup> Johnson, ‘Introduction’, 1.

<sup>3</sup> Robert Allen Rouse, ‘Emplaced Reading, or Towards a Spatial Hermeneutic for Medieval Romance’, in *Medieval Romance and Material Culture*, ed. Nicholas Perkins (Cambridge: D. S. Brewer, 2015), 41.

<sup>4</sup> See for example Keiser, ‘Robert Thornton: Gentleman, Reader and Scribe’, 71.

out the material foundations for the experiments to be detailed in Chapter 4, discussing the historical buildings used in the performance experiments and considering wider debates about authenticity, first-person investigation and the heritage industry.

In communal performative reading, the performer themselves, the audience, the space in the room in the house in which the performance takes place, its contents and decoration, and the text and book exist as material and conceptual objects that both shape and are in turn shaped by the performance. Performance is a fundamentally embodied practice in which the performer physically conveys the words of the story to their audience through voice, posture, gesture and movement. Performance does not merely inhabit real physical space, but performers also, as Anne Azéma describes, “create an area larger in imagination than the physical boundaries of the actual performance space. ... they enable the audience to transcend the physical place in which they find themselves.”<sup>5</sup> A performer can evoke this imagined space through their delivery of the words, through gesture and movement, by engaging with the physical space they inhabit to transcend it into evoked space. Performative reading, in other words, lives in not just the physical space of a medieval building but the imagined space within it and beyond it. Before we can explore this idea more fully in Chapter 4 through experimental analysis, this chapter establishes a foundation of the physical spaces and their contents, examining the two sites used in the experiments and exploring the spaces and materialities of reading.

Spaces in the house encode meaning ascribed through their usages, reflecting the life practices, cultural habits and customs of those who live, eat, sleep, pray, work and play within them. However, this relationship is reciprocal. According to Pierre Bourdieu’s theory of *habitus*, as digested through the lens of archaeology, these spaces shape the accustomed activities and practices of their inhabitants, who are led towards an unconscious understanding of their own place within patterns of order and behaviour and broader society by these spaces.<sup>6</sup> Julienne Hanson argues that a house is not just a collection of rooms and contents to be inhabited and used but “a pattern of space, governed by intricate conventions about what spaces there are, how they are connected together and sequenced, which activities go together and which are separated out, how the interior is decorated, and even what kinds of household objects should be displayed in the different

---

<sup>5</sup> Azéma, “‘Une Aventure Vous Dirai’: Performing Medieval Narrative”, 215.

<sup>6</sup> Pierre Bourdieu, *Outline of a Theory of Practice* (Cambridge: Cambridge University Press, 1977), 78–95; Kate Giles, ‘Ways of Living in Medieval England’, in *Dwellings, Identities and Homes: European Housing Culture from the Viking Age to the Renaissance*, ed. Mette Svart Kristiansen and Kate Giles, vol. 84, Jutland Archaeological Society Publications (Højbjerg: Jutland Archaeological Society, 2014), 14; Jane Grenville, *Medieval Housing*, Archaeology of Medieval Britain (London: Leicester University Press, 1997), 22.



parts of the home”.<sup>7</sup> The space of a house encodes social behaviour and informs the activities that take place within it, but is also a space that can be re-shaped by the users to best fit these activities.<sup>8</sup>

My analysis will engage with space on these three levels – the purely physical, the evoked and the encoded: the physical spaces and their contents, how performance interacts with and transforms these spaces, creating, as Azéma describes, a physically transcendent experience, and the behaviours and practices associated with these spaces. I will use archaeology and material analysis, experimental archaeology, phenomenology and performance theory to build a theoretical foundation for the experimental engagement with medieval performative reading, and exploring the actual spaces of medieval reading, their social and cultural meanings and the broader interplay between performance and space, both real and imagined. By understanding the spaces in which reading and other leisure activities took place we can better understand the practices and resonances of these activities: space informs reading and reading informs space.

I will begin by reviewing current scholarly understandings of the late medieval house and connect historical evidence for emplaced reading to material analysis of those places. This analysis will explore the material and spatial experience of reading to create models for historically informed household reading practices which will then be used in the experimental performances in Chapter 4. Lastly, I will add the final piece of groundwork for Chapter 4 by introducing Gainsborough Old Hall and Barley Hall, the medieval houses that served as the locations for my reading experiments. I will discuss the sites as buildings and heritage attractions, along with the issues they raised around authenticity and reconstruction, and anticipate resonances of these issues in my performative reading experiments.

## 3.2 Medieval Houses

The most common late medieval house form, datable to around the thirteenth century onwards, was the tripartite plan. In this plan, dwellings centred on a large hall (*aula*) open to the roof, a communal space which was the site of the formal functions and rituals of the household as well as various informal communal activities.<sup>9</sup> The hall informs the layout

---

<sup>7</sup> Julienne Hanson, *Decoding Homes and Houses* (Cambridge: Cambridge University Press, 1998), 2.

<sup>8</sup> Two works that epitomise this approach are Hamling and Richardson, *A Day at Home in Early Modern England: Material Culture and Domestic Life, 1500-1700* and Hollie L. S. Morgan, *Beds and Chambers in Late Medieval England: Readings, Representations and Realities* (Woodbridge, Suffolk: Boydell and Brewer, 2017).

<sup>9</sup> M. Gardiner, ‘Vernacular Buildings and the Development of the Late Medieval Domestic Plan in England’, *Medieval Archaeology* 50 (2000): 175; Gilchrist, *Medieval Life: Archaeology and the Life*

and usage of the entire house: Tara Hamling and Catherine Richardson describe the early modern hall as the house's "spatial and functional hub".<sup>10</sup> The hall was organised hierarchically, with both an upper or 'high' end and a lower end, symbolically reflecting the power structures of the household and the purposes of each end of the building. The high end of the hall usually connected to the more private rooms of the house (the chambers and parlour), whilst the lower end adjoined to the service rooms (the pantry and buttery, which stored foodstuff, drink and items associated with their service) through a simple doorway or sometimes through the screens passage, which could lead to the external door and to further auxiliary buildings. This basic tripartite structure (chambers/hall/service rooms) was seen across houses of varying status, with the size of the building, the quality of its construction, and the other connected outbuildings indicative of status, extending to the creation of additional wings in the grander tripartite houses.<sup>11</sup> Separate auxiliary buildings housed the kitchen, privies and spaces for working like barns, workshops or sheds and additional accommodation.

Although this form is remarkably and unarguably pervasive across dwellings of different sizes and stations across an extended period of time, the reality for many buildings was more flexible and nuanced than the tripartite model suggests, as the work of scholars like Jane Grenville, Kate Giles and Danae Tankard argue.<sup>12</sup> The relative sizes and locations of hall, chambers and service rooms exhibit variations and in cities where buildings often combined residential and commercial functions, other house forms predominated or the tripartite form was heavily adapted.<sup>13</sup> The compelling symbolism of the tripartite model, which neatly divides a building into dichotomies of formal/informal

---

*Course*; H.M. Smyser, 'The Domestic Background of Troilus and Criseyde', *Speculum* 31, no. 2 (1956): 297–315; Johnson, *English Houses 1300-1800: Vernacular Architecture, Social Life*; Kate Giles, 'Housing Part 2: Vernacular Housing in the North: The Case of England', in *The Archaeology of Medieval Europe*, ed. Martin Carver and Jan Klápště, vol. 2, Acta Jutlandica, Humanities Series 2011/9 (Aarhus: Aarhus University Press, 2011), 159–76; Giles, 'Ways of Living in Medieval England'.

<sup>10</sup> Hamling and Richardson, *A Day at Home in Early Modern England: Material Culture and Domestic Life, 1500-1700*, 103.

<sup>11</sup> Gilchrist, *Medieval Life: Archaeology and the Life Course*, 118; Hamling and Richardson, *A Day at Home in Early Modern England: Material Culture and Domestic Life, 1500-1700*, 22; Gardiner, 'Vernacular Buildings and the Development of the Late Medieval Domestic Plan in England'.

<sup>12</sup> Grenville, *Medieval Housing*; Giles, 'Housing Part 2: Vernacular Housing in the North: The Case of England'; Giles, 'Ways of Living in Medieval England'; Danae Tankard, 'Form and Function in the Late Medieval Rural House: An Example from the Weald and Downland Open Air Museum, Sussex', in *Dwellings, Identities and Homes: European Housing Culture from the Viking Age to the Renaissance*, ed. Mette Svart Kristiansen and Kate Giles, vol. 84, Jutland Archaeological Society Publications (Højbjerg: Jutland Archaeological Society, 2014), 163–73.

<sup>13</sup> Giles, 'Ways of Living in Medieval England', 18–20; P.J.P. Goldberg, 'The Fashioning of Bourgeois Domesticity in Later Medieval England: A Material Culture Perspective', in *Medieval Domesticity: Home, Housing and Household in Medieval England*, ed. Maryanne Kowaleski and P.J.P. Goldberg (Cambridge: Cambridge University Press, 2008), 135–36; Hamling and Richardson, *A Day at Home in Early Modern England: Material Culture and Domestic Life, 1500-1700*.

and public/private encourages interpretations of spaces that do not match the nuances of historical reality. The form as a representation of wider feudal society and its structures of gender and social status is a pervasive narrative in scholarship, particularly as its persistence suggests its symbolic importance to its medieval inhabitants.<sup>14</sup> The gradual abandonment of the tripartite model in the ‘Great Rebuilding’ of the sixteenth and seventeenth centuries, which saw halls ceiled and larger rooms subdivided into smaller spaces, is often used as a powerful metaphor for the end of the Middle Ages.<sup>15</sup> However, simple dichotomies do not encompass the flexible uses and meanings of domestic spaces: in some houses the high and low ends of the hall are reversed, and even this division of the hall into high and low ends has been nuanced by Tankard’s reframing of the division into dirty and clean ends, particularly in lower-status dwellings.<sup>16</sup> In general, privacy entails limiting access to spaces and interaction with others, although the division between ‘private’ and ‘public’ is complicated in the medieval household.<sup>17</sup> Medieval expectations of privacy were different from modern assumptions, particularly as pertains to nudity, sex and shared quarters for sleeping and living.<sup>18</sup> The concept of privacy shifted in meaning in the fourteenth and fifteenth centuries and although features like opaque windows and multiple separate chambers suggest a desire for privacy, the concepts of ‘public’ and

---

<sup>14</sup> For example, Matthew Johnson writes: “The hall, in its physical layout and in what it meant to medieval people of all social ranks, was a basic building-block of late medieval society.” Johnson, *English Houses 1300-1800: Vernacular Architecture, Social Life*, 68; Gardiner, ‘Vernacular Buildings and the Development of the Late Medieval Domestic Plan in England’.

<sup>15</sup> Suggested reasons for the rebuilding include a greater desire for privacy, increased economic freedom of the lesser gentry and yeomanry and a rise in population. The rebuilding caused rooms to become smaller and more single-purpose, and there is much debate about whether this was a reaction to changing uses of household spaces or the cause of it. Giles, ‘Ways of Living in Medieval England’, 20; Matthew Johnson, ‘Rethinking the Great Rebuilding’, *Oxford Journal of Archaeology* 12 (2007): 117–25; Lena Cowen Orlin, *Locating Privacy in Tudor London* (New York and Oxford: Oxford University Press, 2007); Hamling and Richardson, *A Day at Home in Early Modern England: Material Culture and Domestic Life, 1500-1700*; Johnson, *English Houses 1300-1800: Vernacular Architecture, Social Life*; Giles, ‘Housing Part 2: Vernacular Housing in the North: The Case of England’, 171.

<sup>16</sup> Tankard, ‘Form and Function in the Late Medieval Rural House: An Example from the Weald and Downland Open Air Museum, Sussex’.

<sup>17</sup> Mary Shepperson, ‘Visibility, Privacy, and Missing Windows: Lighting Domestic Space in Ancient Mesopotamia’, in *The Oxford Handbook of Light in Archaeology*, ed. Costas Papadopoulos and Holley Moyes (Oxford: Oxford University Press, 2017), <https://doi.org/10.1093/oxfordhb/9780198788218.013.19>; Bill Hillier and Julienne Hanson, *The Social Logic of Space* (Cambridge: Cambridge University Press, 1984); Cordelia Beattie and Anna Maslakovic, ‘Introduction – Locating the Household: Public, Private, and the Social Construction of Gender and Space’, in *The Medieval Household in Christian Europe c. 850 - c. 1550: Managing Power, Wealth and the Body*, ed. Cordelia Beattie, Anna Maslakovic, and Sarah Rees Jones (Turnhout: Brepols, 2003), 1–8.

<sup>18</sup> Jeremy Goldberg, ‘Making the House a Home in Later Medieval York’, *Journal of Medieval History* 45, no. 2 (2019): 162–80; P.J.P. Goldberg, ‘Space and Gender in the Later Medieval House’, *Viator* 42, no. 2 (2011): 205–32; Jeremy Goldberg, *Communal Discord, Child Abduction and Rape in the Later Middle Ages*, The New Middle Ages (New York: Palgrave Macmillan, 2008), 105.

‘private’ do not correspond to our modern understandings of the terms and should be used cautiously.<sup>19</sup> Considering instead the permeability of each space better reflects the nuanced reality: how accessible it is from the outside or how ‘deep’ the space is in access analysis, and the spaces it adjoins.<sup>20</sup>

Anthony Quiney’s archaeological investigation of halls and chambers showed that identification of rooms and the perceived divisions of formal/informal and public/private are not inherent qualities of the spaces that can be determined archaeologically, but rather a function of their usage and the furniture and fittings that transform the spaces.<sup>21</sup> Surviving documentary records of house contents which list domestic possessions by room can provide clues about the original functions and layout of the space.<sup>22</sup> This reflects the current scholarly consensus on spatial analysis which predominantly focuses on the affordances of spaces – the various options and possibilities a space offers to its users – rather than prescriptive typologies. A focus on affordances foregrounds the flexibility of spaces and buildings and more accurately reflects the historical record.<sup>23</sup> In general, medieval houses were sparsely furnished and most furniture was designed to be easily moved, such as the trestle tables and benches in the hall, and chests containing personal belongings.<sup>24</sup> The use of easily-moveable furniture, along with curtains and screens, ensured that the spaces in the medieval house could be easily transformed and subdivided according to the needs of the users. The houses of the wealthy were luxuriously decorated with wall-paintings, tapestries, floor tiles, and embroidered cloth. In more modest houses, decorative painted cloths offered an affordable and flexible alternative to tapestries or elaborate wall paintings. Decorative textiles are often catalogued in wills and inventories,

---

<sup>19</sup> John Schofield, *Medieval London Houses* (New Haven and London: Published for the Paul Mellon Centre for Studies in British Art by Yale University Press, 1994), 93; David Austin, ‘Private and Public: An Archaeological Consideration of Things’, in *Die Vielfalt Der Dinge: Neue Wege Zur Analyse Mittelalterlicher Sachkultur. Internationaler Kongress, Krems an Der Donau, 4. Bis 7. Oktober 1994. Gedenkschrift in Memoriam Harry Kühnel.*, ed. Helmut Hundsbichler, Gerhard Jaritz, and Thomas Kühtreiber (Wien: Der Österreichischen Akademie der Wissenschaften, 1998), 182–85.

<sup>20</sup> Hanson, *Decoding Homes and Houses*, 44; Morgan, *Beds and Chambers in Late Medieval England: Readings, Representations and Realities*, 5; Goldberg, ‘Making the House a Home in Later Medieval York’; Goldberg, ‘Space and Gender in the Later Medieval House’.

<sup>21</sup> Anthony Quiney, ‘Hall or Chamber? That Is the Question. The Use of Rooms in Post-Conquest Houses’, *Architectural History* 42 (1999): 24–46.

<sup>22</sup> This is particularly relevant for smaller houses with fewer rooms where, for example, servants may have slept in the hall. Gilchrist, *Medieval Life: Archaeology and the Life Course*, 121; Goldberg, ‘Space and Gender in the Later Medieval House’, 223; Lisa Liddy, ‘Domestic Objects in York c.1400–1600: Consumption, Neighbourhood and Choice’ (PhD Thesis, University of York, 2015).

<sup>23</sup> Grenville, *Medieval Housing*; Giles, ‘Housing Part 2: Vernacular Housing in the North: The Case of England’; Giles, ‘Ways of Living in Medieval England’; Tankard, ‘Form and Function in the Late Medieval Rural House: An Example from the Weald and Downland Open Air Museum, Sussex’.

<sup>24</sup> Gilchrist, *Medieval Life: Archaeology and the Life Course*, 121.

which reveal a broad range of decorative imagery and subjects including heraldic motifs, Biblical figures, and characters from mythology or folklore alongside plainer decorative patterns or even simply-coloured cloth.<sup>25</sup> Most decorative elements were located in the hall; however, the bedchambers of the wealthy also contained richly carved beds and decorated bed textiles, some of which served the additional function of enclosing the bed for privacy.<sup>26</sup> When considering spaces as they exist in the house and as reception spaces for reading activities we must imagine them not as empty and whitewashed, but lively and filled with ornament. Using the paradigm of affordances and flexibility, my research can more effectively consider the experience of emplaced reading events, particularly those that do not adhere to expected uses of space, such as informal reading in the hall. In the same way that this thesis acknowledges that there are as many ways to read a medieval book as there are medieval readers, houses are stages for human activity, and these activities are as varied as the spaces they inhabit.

### 3.3 Reading spaces: the hall

Reading, like spaces themselves, is flexible. The time, place, location and occasion of reading could be adapted to suit each manuscript and household. Although this thesis generally considers ‘urban elite and rural gentry’ as a single category to describe the owners of household manuscripts and their reading habits likely overlapped greatly, there are a few key differences. The daily and seasonal rhythms, and careful management of time within each household allowed for different opportunities for reading. Hollie Morgan and Tankard describe the daily rhythm of households and while a rural gentry family structured their day around piety and could more easily conduct leisurely activities, the daily rhythm of mercantile families appears to have involved more work.<sup>27</sup> The centrality of work to the rhythm of the day would have been particularly key for the upwardly-mobile yeoman family connected with the Heege manuscript. Different times for reading – for example, in the middle of the day, after work has been completed or during winter –

---

<sup>25</sup> Goldberg, ‘The Fashioning of Bourgeois Domesticity in Later Medieval England: A Material Culture Perspective’; Goldberg, ‘Making the House a Home in Later Medieval York’; P.M. Stell and Louise Hampson, *Probate Inventories of the York Diocese 1350-1500*, vol. 1 (York: York Archaeological Trust, 2006); Schofield, *Medieval London Houses*, 128–29; Alan Gore and Ann Gore, *The History of English Interiors* (London: Phaidon Press, 1991), 13–16.

<sup>26</sup> Morgan, *Beds and Chambers in Late Medieval England: Readings, Representations and Realities*, 16–39; Orlin, *Locating Privacy in Tudor London*, 109; Goldberg, ‘The Fashioning of Bourgeois Domesticity in Later Medieval England: A Material Culture Perspective’; Goldberg, ‘Making the House a Home in Later Medieval York’.

<sup>27</sup> Morgan, *Beds and Chambers in Late Medieval England: Readings, Representations and Realities*; Tankard, ‘Form and Function in the Late Medieval Rural House: An Example from the Weald and Downland Open Air Museum, Sussex’, 166–67.

produce qualitatively different reading experiences, particularly considering the different lighting provisions required for each. These individual details likely varied between households, their manuscripts and between reading events, an aspect that is important to consider when studying historical reading practices.

Historical examples of relevant reading activities locate them in three main spaces in the house: the hall, chamber and parlour. As noted above, the hall was the physically and symbolically central room of the house. In the wealthiest houses, halls had tile or stone floors, whilst lower status houses had floors of compacted earth. Rushes and fresh herbs could be strewn across the floor and replaced when dirtied.<sup>28</sup> The hall had a central hearth or, less commonly, a fireplace along a side wall, used for warmth, light and for cooking informal meals, particularly in less wealthy households without a separate kitchen.<sup>29</sup> The screens passage at the lower end was sometimes covered, creating a gallery overlooking the hall, which in later elite households provided a space where musicians could play, providing entertainment or announcing the arrival of food.<sup>30</sup> The rituals of elite formal dining in the hall best illustrate the hierarchy of the space, which dictated the seating of each person within it – family, guests and servants – with the higher-status members of the family or honoured guests seated along one side of the high table on the dais looking out over the room and those lower in social standing closer to the low end on perpendicular lower tables.<sup>31</sup> The wealth of the household was displayed with abundant food and drink, the display of valuable tableware such as salt cellars and communal cups, and the decoration of the hall.<sup>32</sup> Conduct texts, some copies of which survive in household manuscripts and therefore address the same or similar readership to the texts read in communal leisurely reading, provide information about expected behaviour during such events, reminding readers to sit only where and when they are directed to, or to wash their hands, say grace and remove their hats before eating, or for the young men serving, advice

---

<sup>28</sup> Smyser, 'The Domestic Background of Troilus and Criseyde', 299.

<sup>29</sup> Johnson, *English Houses 1300-1800: Vernacular Architecture, Social Life*, 70–73; Smyser, 'The Domestic Background of Troilus and Criseyde', 229; Goldberg, 'Space and Gender in the Later Medieval House', 216; Hamling and Richardson, *A Day at Home in Early Modern England: Material Culture and Domestic Life, 1500-1700*, 72; Tankard, 'Form and Function in the Late Medieval Rural House: An Example from the Weald and Downland Open Air Museum, Sussex', 168–69.

<sup>30</sup> Edmund A. Bowles, 'Musical Instruments at the Medieval Banquet', *Revue Belge de Musicologie / Belgisch Tijdschrift Voor Muziekwetenschap* 12, no. 1/4 (1958): 41–51; Smyser, 'The Domestic Background of Troilus and Criseyde', 299; Orlin, *Locating Privacy in Tudor London*, 81–83.

<sup>31</sup> Johnson, *English Houses 1300-1800: Vernacular Architecture, Social Life*, 73; Mark Gardiner, 'Buttery and Pantry and Their Antecedents: Idea and Architecture in the English Medieval House', in *Medieval Domesticity: Home, Housing and Household in Medieval England*, ed. Maryanne Kowaleski and P.J.P. Goldberg (Cambridge: Cambridge University Press, 2008), 37–38; Tankard, 'Form and Function in the Late Medieval Rural House: An Example from the Weald and Downland Open Air Museum, Sussex', 165–66.

<sup>32</sup> Goldberg, 'Making the House a Home in Later Medieval York'.

on their duties of washing, carving meat and waiting on their lord at the table.<sup>33</sup> The space of the hall controls the movement of people through the house, both due to its central location and its hierarchical space. The movement of food from the kitchens or service rooms at the low end of the hall to the high end of the hall encapsulates the act of service and reinforces the place of those serving. Scholars have also pointed to the religious overtones of formal dining, reminiscent of the Eucharistic rituals of the Mass.<sup>34</sup> Most examples of reading in the hall are associated with this formal usage. The Rule of St Benedict codified the practice of reading edifying material aloud over dinner. The rule instructs that a reader should be chosen each week to read while the others eat and drink in silence.<sup>35</sup> Reading over mealtimes according to the monastic model was also adopted by royal and aristocratic households: household ordinances record that Cecily Neville, Duchess of York (1415-1495) heard read “a lecture of holy matter” over dinner and Karen Cherevatuk notes that the future Edward V was to be read edifying material while he ate.<sup>36</sup> Cecily Neville’s reading material included legends, saints’ lives and religious lectures, which are often represented in the contents of household manuscripts. The Hilton text she heard is likely his “Epistle on Mixed Life”, spiritual advice for devout layfolk, which is also found in Li 91 (ff. 223r-229r). Household manuscripts could easily support this edifying reading in the hall. However, what of reading for entertainment? Wace’s *Roman de Rou* advises that feasts should be accompanied by clerks reading about the heroic deeds of the past.<sup>37</sup> Similarly the feast in *Havelok the Dane* offers “romanz reding on the bok” (l.

---

<sup>33</sup> “Stans Puer ad Mensam” is attributed to Lydgate, although the version found in Ashmole 61 (ff. 17v-19v) has been adapted. Another version is found in CCAii (ff. 14r-15v). “Dame Courtesy” is unique to Ashmole 61 (f. 20r), although very similar to ‘The Lytyle Childrenes Lytil Boke’ which is also found in the Heege manuscript (ff. 84v-86v). John Lydgate, ‘Item 7, Stans Puer Ad Mensam’, in *Codex Ashmole 61: A Compilation of Popular Middle English Verse*, ed. George Shuffelton, TEAMS Middle English Texts Series (Kalamazoo, Michigan: Medieval Institute Publications, 2008); George Shuffelton, ed., ‘Item 8, Dame Courtesy’, in *Codex Ashmole 61: A Compilation of Popular Middle English Verse*, TEAMS Middle English Texts Series (Kalamazoo, Michigan: Medieval Institute Publications, 2008).

<sup>34</sup> Phillips points to research by Peter Arnade and Otto Cartellieri, as well as drawing similar conclusions from the ‘Harleian Ordinances’, a household governance text broadly similar to the two conduct texts discussed earlier, but more specific and aimed at servants in elite noble households. Kim M. Phillips, ‘The Invisible Man: Body and Ritual in a Fifteenth-Century Noble Household’, *Journal of Medieval History* 31, no. 2 (2005): 152.

<sup>35</sup> Benedict, ‘Regula S.P.N. Benedicti’. Chapter XXXVIII.

<sup>36</sup> Cecily Neville heard read at dinner a lecture of holy matter, either Hilton on contemplative and active life, Bonaventure de infancia, Salvatoris legenda aurea, St Maude, St Katherin of Sonys, or the Revelacions of St Bridgett.” Cherevatuk’s exemplar prompted the ‘Reading Malory Aloud’ project, considering whether Malory’s *Le Morte Darthur* would have been suitable material for such reading. *A Collection of Ordinances and Regulations for the Government of the Royal Household, Made in Divers Reigns. From King Edward III. To King William and Queen Mary. Also Receipts in Ancient Cookery* (London: Printed for the Society of Antiquaries by John Nichols, 1790), 37; Cherevatuk, ‘An Introduction to Aural Malory: Sessions and Round Tables’, 3.

<sup>37</sup> Pur remembrer des ancesurs / les feiz e les diz e les murs / les felunies des feluns / e les barnages des baruns / deit l’um les libres e les gestes / e les estoires lire as festes. / Si escripture ne fust feite /

2327) as one of many types of entertainment. Although not using a physical book, the performance by Herbert the minstrel discussed in Chapter 2 took place in the hall of the priory of St Swithin in Winchester.<sup>38</sup> Reading by professional entertainers during meals or communal reading amongst those gathered after the courtly proceedings had concluded provides a model for romance-reading in the hall. Beyond its formal use in dining and household rituals, the hall saw general usage as a large communal space which could be adjusted according to the needs of its users. The hall was a likely location for many of the daily tasks needed to sustain the household (especially in urban houses lacking specific workshop spaces) such as childcare, crafting, weaving, sewing, whittling or spinning, and could have been used for storing goods and conducting transactions.<sup>39</sup> Lists of house contents from wills and inventories show gaming tables and other evidence of leisure activities located in the hall, suggesting that, at least for bourgeois families, the house and the hall were the usual location of leisure activities.<sup>40</sup> The romance-reading performances discussed in Chapter 4 proposed informal reading for leisure using the hall as a convenient communal space that was well-furnished, pleasantly decorated, warm, and sufficiently lit with both natural and artificial light. Formal reading of edifying matter and the pragmatic reading of ledgers, bills and documents involved with household management imply that the hall had appropriate apparatus to support reading in multiple modalities: tables, book stands and sufficient lighting. Informal communal reading in the hall could take place between members of multiple households who wish to pass their social time together by sharing stories, or a group who wish for entertainment to accompany their daily household chores, or those privileged enough to lead a life of leisure who wish to read together as a pleasant pastime.

### 3.4 Reading spaces: the chamber

The term chamber or *camera* refers to any of the less permeable or more private rooms found in various locations in the house. It is mostly associated with sleeping but could

---

e puis par clers litte e retraite / mult fussent choses ubliees / ki de viez tens sunt trespassees.” (ll. 1-10)

(In order to remember / The actions and words and customs of our ancestors, / One must read at feasts the books and the deeds / And the stories. / If writing had not been done / And had not then / been read and recounted by clerks / Many things would be forgotten / Which happened in the olden days.)

Quoted in and translated by Vitz, *Orality and Performance in Early French Romance*, 173–74.

<sup>38</sup> Thomas Warton, *History of English Poetry*, ed. W.C. Hazlitt (London: Reeves and Turner, 1871), 97.

<sup>39</sup> Giles, ‘Housing Part 2: Vernacular Housing in the North: The Case of England’, 170; Tankard, ‘Form and Function in the Late Medieval Rural House: An Example from the Weald and Downland Open Air Museum, Sussex’, 169.

<sup>40</sup> Goldberg, ‘Space and Gender in the Later Medieval House’, 219, 225.



serve multiple functions. Chambers adjoining the high end of the hall were higher status – the principal chamber (sometimes called the *solar*) where the lord and lady of the household slept was often found here on the first floor. Lower-status chambers could be found above the service rooms, sometimes linked to the solar by a gallery and additional chambers in wings or auxiliary buildings.<sup>41</sup> The chamber was the least permeable and accessible space and its inclusion in a house was a sign of wealth.<sup>42</sup> In the chamber could be found beds, bed linens, chests and cupboards for storage, a hearth fire, benches, chairs and tables. These contents and other sources attest to multiple uses including sleeping, work, informal dining, more exclusive communal pastimes and of course the space where it was appropriate and expected for the lord and lady of the household to do their marital duties and conceive a child.<sup>43</sup> The chamber was the primary location of personal devotional activities, such as prayer, meditation and devotional reading.<sup>44</sup> Pragmatic reading associated with the invalid or dying was also located there, such as the reading of William Paston’s will as recorded in the Paston letters, or the pragmatic reading of medical recipes depicted in an image accompanying the story of Tobit.<sup>45</sup> (Figure 3.1)

---

<sup>41</sup> Schofield, *Medieval London Houses*, 66; Gardiner, ‘Buttery and Pantry and Their Antecedents: Idea and Architecture in the English Medieval House’, 37–38; Johnson, *English Houses 1300-1800: Vernacular Architecture, Social Life*, 70; Quiney, ‘Hall or Chamber? That Is the Question. The Use of Rooms in Post-Conquest Houses’.

<sup>42</sup> Morgan, *Beds and Chambers in Late Medieval England: Readings, Representations and Realities*, 5, 16, 112.

<sup>43</sup> Morgan, 112; Goldberg, ‘Making the House a Home in Later Medieval York’.

<sup>44</sup> Jennifer Kolpacoff Deane, ‘Medieval Domestic Devotion’, *History Compass* 11, no. 1 (2013): 65–76; Goldberg, ‘Space and Gender in the Later Medieval House’, 225; Sarah Blick, ‘Bringing Pilgrimage Home: The Production, Iconography, and Domestic Use of Late-Medieval Devotional Objects by Ordinary People’, *Religions* 10, no. 6 (2019): 392, <https://doi.org/doi:10.3390/rel10060392>; Morgan, *Beds and Chambers in Late Medieval England: Readings, Representations and Realities*, 56–65.

<sup>45</sup> Davis, *Paston Letters and Papers of the Fifteenth Century*, 1:45; London, British Library Royal MS 15.D.I, f. 18r.



Figure 3.1: Pragmatic reading. London, British Library Royal MS 15.D.I, f. 18r (detail).

Morgan’s comprehensive study of medieval beds and bedchambers discusses reading and books in relation to chambers, outlining its use in the presentation of books to patrons, the storage of books and the reading of material both in the chamber as a general use space and in bed.<sup>46</sup> Literary evidence also shows romance-reading in the chamber and even in the bed itself. Dream vision poems describe reading in great detail, often including the reading posture of the sleepless narrative persona, the source of light and even the format of the text. The narrator of Robert Henryson’s *Testament of Cresseid* reads a “quair” by the light of the fire in the chamber and the dreamer in Chaucer’s *Book of the Duchess* recounts “Upon my bed I sat upright / And bad oon reche me a book / A romaunce, and he it me tok / To rede and drive the night away”.<sup>47</sup> Coleman identifies several examples of varied entertainments taking place in elite bed chambers, including music-making, playing games and reading.<sup>48</sup> An image from a fifteenth century manuscript of Louis de Beauvau’s translation of Boccaccio’s *Il Filostrato* depicts the chamber as a location for communal leisure activities. The sorrowful Troilus lies on the bed whilst a group of women sitting on

<sup>46</sup> Morgan, *Beds and Chambers in Late Medieval England: Readings, Representations and Realities*, 114–15, 124.

<sup>47</sup> Quire here could refer to either an unbound booklet or a whole book. Robert Henryson, ‘The Testament of Cresseid’, in *The Poems of Robert Henryson*, ed. Robert L. Kindrick, TEAMS Middle English Texts Series (Kalamazoo, Michigan: Medieval Institute Publications, 1997), ll. 36–42; Geoffrey Chaucer, ‘The Book of the Duchess’, in *The Riverside Chaucer*, ed. Larry D. Benson, 3rd ed. (Oxford: Oxford University Press, 2008), ll. 46–49.

<sup>48</sup> The household ordinances of King Edward IV and an account of James I of Scotland. Coleman, *Public Reading and the Reading Public*, 130–31.

the floor are gathered to play music and sing. (Figure 3.2) Morgan suggested that the man on the bed is reading a book, however, this is a misidentification: the ‘book’ is merely the pleats and folds of Troilus’ outer garment, and this does not match the scene described by the text, otherwise this would be a key exemplar for leisurely reading located in the chamber.<sup>49</sup> Music-making in the chamber is also described in *Le Roman de Horn*.<sup>50</sup> These related leisure activities suggest a framework that can be applied to reading in the chamber.



Figure 3.2: Entertainment in the chamber. Paris, BnF, Fr. 25528, f. 85v (detail).

### 3.5 Reading spaces: the parlour

The parlour, which could also go by the name of the summer hall or great chamber, was a relatively new space, attested only from the late fourteenth century.<sup>51</sup> It was a more intimate communal space used instead of the hall for members of the household to dine informally and, on more formal occasions, it served as a room to gather with guests before

---

<sup>49</sup> Morgan, *Beds and Chambers in Late Medieval England: Readings, Representations and Realities*, 120–21; Paris, BnF, Fr. 25528, f. 85v.

<sup>50</sup> Thomas, ‘The Romance of Horn’, 95–96.

<sup>51</sup> ‘Parlour n.’, Middle English Compendium: Middle English Dictionary, November 2019, [https://quod.lib.umich.edu/m/middle-english-dictionary/dictionary/MED32480/track?counter=1&search\\_id=12978738](https://quod.lib.umich.edu/m/middle-english-dictionary/dictionary/MED32480/track?counter=1&search_id=12978738); Goldberg, ‘Making the House a Home in Later Medieval York’, 164.

dinner and to retire to after dinner.<sup>52</sup> The parlour tended to be located on the ground floor at the high end of the hall, although this varied between houses of differing status.<sup>53</sup> Schofield suggests that the parlour was often placed near the garden, and had easy access to it.<sup>54</sup> Evidence from wills and inventories show that the parlour contained tables, seating, eating utensils, and in some cases, even beds and bedding, as well as providing additional storage for wares and equipment if needed.<sup>55</sup> The presence of a hearth to provide warmth and light is uncertain: Goldberg argues that the name ‘summer hall’ implies an unheated space, however, the use of portable stoves and candles could have provided light and warmth if needed.<sup>56</sup>

The parlour is the site for perhaps the most famous and detailed example of communal performative romance reading – found in Geoffrey Chaucer’s *Troilus and Criseyde*. Pandarus searches for Criseyde and finds her sitting with two other ladies “withinne a paued parlour” listening to a maiden read them a story of the siege of Thebes.<sup>57</sup> The unusually detailed depiction of romance-reading encodes details about reading practices and how the leisure activity uses the space. The readers appear to be sitting on benches, as Criseyde guides Pandarus to sit upon one, and are presumably gathered close together.<sup>58</sup> The use of “lettres red” suggests episodic reading, as discussed in Chapter 2. The parlour seems a fitting setting for this shared leisure activity and its paved floor is reminiscent of decorative floor tiles found in prestigious buildings. Yet for a modern practitioner attempting to use this as a model to recreate reading practices, it offers more questions than it does answers. The posture of the reader is unspecified – whether she uses a lectern, holds the book or rests it upon her lap – as is the social relationship between the reader and Criseyde – whether she is a professional reader, a servant or more of a social equal would change the dynamics of the reading experience, as well as offering insights into readership within rural gentry and urban mercantile elite households. There is no mention of the light source for the reading, but the parlour likely had a window, which

---

<sup>52</sup> William Langland complains about the wealthy eating in chambers instead of in the hall, a reference which could refer to chambers or the parlour, given the fluidity of the terms in the fourteenth century. William Langland, *The Vision of Piers Plowman*, ed. A.V.C. Schmidt (London and New York: J.M. Dent and E.P. Dutton, 1978), bk. i, l. 292; Margaret Wood, *The English Mediaeval House* (London: Phoenix House, 1965), 91.

<sup>53</sup> Schofield, *Medieval London Houses*, 66–67.

<sup>54</sup> Schofield, 66.

<sup>55</sup> Grenville, *Medieval Housing*, 115; Goldberg, ‘Making the House a Home in Later Medieval York’, 172.

<sup>56</sup> Goldberg, ‘Making the House a Home in Later Medieval York’, 172; Liddy, ‘Domestic Objects in York c.1400–1600: Consumption, Neighbourhood and Choice’, 99; Geoff Eagan, *The Medieval Household: Daily Living c. 1150 - c. 1450*, Medieval Finds from Excavations in London 6 (Woodbridge and London: Boydell Press in association with Museum of London, 2010).

<sup>57</sup> Chaucer, ‘Troilus and Criseyde’, l. II.78-112.

<sup>58</sup> Chaucer, l. II.91.

could be supplemented with artificial lighting. These unstated quotidian details would have varied between households and reading events in practice, and modern experimentation with medieval reading practices reveals how even a detailed representation of medieval romance-reading practices leaves much to be surmised by the practitioner. Leisurely reading itself has left few documentary or material traces: this modality does not leave specific marks on the pages of texts and often used more ephemeral objects, such as texts in unbound booklets which rarely survive.<sup>59</sup> Yet this small survey of reading exemplars in domestic locations has provided parallel examples that can be drawn on in recreating the practice. Various spaces in the house contained the affordances necessary for reading.

### 3.6 Further sources for texts and reading

My discussion of emplaced domestic reading remains mostly hypothetical, as there is little medieval evidence of reading activities in domestic spaces, and even less relating to the texts or manuscripts on which this thesis focuses, or the specific locations used. The narrators of texts sometimes anticipate multimodal reading across multiple spaces, such as in John Metham's *Amoryus and Cleopes* "qwere this boke in chambyr or halle / Be herd or red".<sup>60</sup> The reality of leisurely romance-reading is similarly flexible according to the wishes of the readers, such as in the example of Froissart reading to Gaston Fébus, the count of Foix discussed in Chapter 1 in which reading occurs in both the hall and chamber as the Count wished.<sup>61</sup>

Evidence from visual sources does not provide specific supplementary evidence. A brief survey of visual depictions of reading found two prevalent kinds in domestic settings.<sup>62</sup> The first is author portraits and donation portraits: images which show the author writing the work or presenting the work to their patron. This kind of image, usually found at the opening of a work by a named author, is a clear evocation of the authority of the writer and an appeal to the benevolence and generosity of their wealthy patron. They function similarly to the *envoy* and the humility topos in that they encode a specific and

---

<sup>59</sup> Boffey and Thompson, 'Anthologies and Miscellanies: Production and Choice of Texts', 290; Cavanaugh, 'A Study of Books Privately Owned in England: 1300-1450', 11-14; John J. Thompson, 'Collecting Middle English Romances and Some Related Book-Production Activities in the Later Middle Ages', in *Romance in Medieval England*, ed. Maldwyn Mills, Jennifer Fellows, and Carol M. Meale (Cambridge: D. S. Brewer, 1991), 23.

<sup>60</sup> John Metham, *Amoryus and Cleopes*, ed. Stephen F. Page, TEAMS Middle English Texts Series (Kalamazoo, Michigan: Medieval Institute Publications, 1999), ll. 242-3; Coleman, *Public Reading and the Reading Public*, 200.

<sup>61</sup> Translation and explanation in Coleman, *Public Reading and the Reading Public*, 111-12.

<sup>62</sup> Multiple other categories of book images exist that are not so closely associated with domestic settings, such as preaching, scholastic reading and writing.

expected social and literary transaction, rather than reflecting reality exactly.<sup>63</sup> Well-known examples include the author portraits in the various manuscripts of *Le Roman de la Rose* or the work of Christine de Pizan. The famous frontispiece of the *Corpus Christi Troilus and Criseyde* which shows Chaucer reading or speaking from a pulpit to a group of gathered nobles could also be considered in this category. Although no book is depicted in this image, Chaucer's stance deliberately echoes that of a preacher, occupying a place of authority and offering advice to the listeners. These examples provide important context and show furniture for reading and writing, but as they serve to depict the power of writers and writing over actual textual reception they are only of limited use for reconstructing domestic reading practices.

The second image type is that of devotional reading in specific iconography, particularly Flemish images of the Annunciation.<sup>64</sup> Reading in these images functions as a deliberate illustration of Mary's piety. The settings are specifically domestic and naturalistic, often set in explicitly urban bourgeois residences. Their rich details have made them a popular source for reconstructions of medieval furniture and furnishings (Barley Hall features multiple items recreated from exemplars from fifteenth-century Flemish art, as discussed below). Whilst these images serve a specific purpose, and are in any case a representation of devotional reading rather than communal reading of secular material, they depict more realistically the act of reading, including the use of furniture and lighting. For example, several images show Mary kneeling with a book placed on a bench or table.<sup>65</sup> A settle or *banc à tournis* (a bench with a moveable back that allows a user to sit facing either direction) is used as a support for reading in two altarpieces attributed to Robert Campin: the Annunciation Triptych (Merode Altarpiece) and the Werl Triptych.<sup>66</sup> (Figures 3.3, 3.4)

---

<sup>63</sup> *Roman de la Rose*: i.a. London, British Library, Harley MS 4425, f. 133r; Oxford, Bodleian Library MS Douce 195, f. 1r; Paris, Bibliothèque Nationale de France Fr. 19153, f. 31r; *Christine de Pizan*: i.a. London, British Library Harley MS 4431, ff. 3r, 4r, 259v, 261v; Geneva, Bibliothèque de Genève, MS Fr. 180, f. 3v; Paris, Bibliothèque Nationale de France Fr. 603, f. 81v; *Chaucer frontispiece*: Cambridge, Corpus Christi College Library MS 61, f. 1v.

<sup>64</sup> Dieric Bouts, *The Annunciation*, c. 1450-1455, distemper on linen, 90 x 74.6 cm, J. Paul Getty Museum; Rogier van der Weyden and Hans Memling, *The Annunciation*, c. 1465-1475, oil on wood, 186.1 x 114.9 cm, Metropolitan Museum of Art; Jan van Eyck, *The Ghent Altarpiece: Mary of the Annunciation*, 1432, oil on wood, 350 x 223 cm, St Bavo's Cathedral, Ghent; Robert Campin, *Annunciation Triptych (Merode Altarpiece)*, c. 1427-32, oil on oak, 64.5 x 117.8 cm (open), Metropolitan Museum of Art; Rogier van der Weyden, *Annunciation Triptych*, c. 1440, oil on oak, 86 x 92 cm (central panel), Louvre Museum; Hans Memling, *The Annunciation*, c. 1480-89, oil on panel, transferred to canvas, 76.5 x 54.6 cm, Metropolitan Museum of Art.

<sup>65</sup> Bouts, *The Annunciation*; van der Weyden and Memling, *The Annunciation*; London, British Library Kings MS 9, f. 66v; van der Weyden, *Annunciation Triptych*; Memling, *The Annunciation*.

<sup>66</sup> Campin, *Annunciation Triptych (Merode Altarpiece)*; Robert Campin, *The Werl Triptych*, 1438, oil on panel, 101 x 47 cm, 1438, Museo del Prado, Madrid.



Figure 3.3: Mary reading. Detail from Merode Altarpiece. Robert Campin, *Annunciation Triptych (Merode Altarpiece)*, c. 1427-32, oil on oak, 64.5 x 117.8 cm (open), Metropolitan Museum of Art.



Figure 3.4: St Barbara reading (detail). Right panel of Robert Campin, *The Werl Triptych*. 1438, oil on panel, 101 x 47 cm, Museo del Prado, Madrid.

In the first, Mary sits on the floor, leaning on the settle and holding the book in her hands. In the second, St Barbara reads a book while seated on a settle with her back to the fireplace. The detailed play of firelight on the fireplace suggests that she is using it to illuminate her reading. The settle shows that even a relatively static item of furniture is adjustable and flexible, allowing for different configurations of the space and the use of artificial lighting in reading activities. In this way, it is a piece of furniture useful in both solitary reading activities, as depicted, and communal reading activities, as inferred. These models were used to inform reading posture in the experiments, particularly in Gainsborough which featured a settle in the gallery chamber.

Other items that reference or represent textual elements outside of the confines of books – what Blatt terms “extracodexical texts” – can also offer clues about reading practices.<sup>67</sup> Wall paintings, textiles, crockery, charms and heraldry could include depictions of literary characters and quotations in their decorative motifs. These texts could serve as a focus for devotional activities, or, as in the case of two sixteenth-century examples of rhyming precepts in wall paintings studied by Blatt and Hamling and Richardson, to further the moral education of the household by modelling good behaviour.<sup>68</sup> Depictions of romance stories in decorative items are an important reminder of a wider storytelling tradition in many forms and modalities that exists separately and alongside the romances as found in household manuscripts. Tristan and Isolde seem to have been particular favourites, being depicted in the Chertsey Abbey floor tiles, a quilt and mirror cases.<sup>69</sup> A further series of caskets depict Tristan alongside scenes from other romances such as *Roman de la Rose*.<sup>70</sup> The romance *Guy of Warwick* offers several other performative possibilities in which codexical text, extracodexical texts and material objects interact. *Guy of Warwick*’s fight with the giant Colbrond was supposedly the subject of a

---

<sup>67</sup> Blatt, *Participatory Reading in Late-Medieval England*, 106.

<sup>68</sup> Hamling and Richardson, *A Day at Home in Early Modern England: Material Culture and Domestic Life, 1500-1700*; Blatt, *Participatory Reading in Late-Medieval England*, 128–58.

<sup>69</sup> *Chertsey Tiles: Tristram Series*, late 13th. C., earthenware, 240 mm., The British Museum, London; *The Tristan Quilt*, c. 1360-1400, quilted linen, 320 x 287 cm, Acc. No. 1391-1904, Victoria and Albert Museum, London; *The Tristan and Isolde Quilt*, c. 1360-1400, quilted linen, 247 x 207 cm, Palazzo del Bargello, Florence; S. Randles, ‘One Quilt or Two? A Reassessment of the Guicciardini Quilts’, *Medieval Clothing and Textiles* 5 (2009): 93–128; *Mirror Case: Tristan and Isolde Playing Chess*, 1325-1350, ivory, 10.2 x 1 cm, 1940.1200, The Cleveland Museum of Art.

<sup>70</sup> *Casket with Scenes of Romances*, c. 1330-1350, ivory, 11.8 x 25.2 x 12.9 cm, Inv. 71.264, Walters Art Museum, Baltimore; *Casket with Scenes of Romances*, 14th C., ivory, 80 x 210 x 130 mm, 1856.0623.166 (Dalton 368), The British Museum, London; *Casket with Scenes of Romances*, 14th C., ivory, 95 x 232 x 136 mm, Inv. 39.26, The Barber Institute of Fine Arts; *Casket with Scenes of Romances*, 14th C., ivory, 97 x 257 x 167 mm, Cl. 23840, Paris, Musée de Cluny-Musée national du Moyen Âge; *Casket with Scenes of Romances*, 14th C., ivory, 109 x 253 x 159 mm, 17.190.173; 1988.16, New York, Metropolitan Museum of Art; *Casket with Scenes of Romances*, 14th C., ivory, 103 x 246 x 126 mm, 146-1866, Victoria and Albert Museum, London.



wall painting in Winchester Cathedral, especially interesting as Winchester is the location of the minstrel Herbert's performance of the same Guy and Colbrond episode.<sup>71</sup> More interestingly, seventeenth-century scholar Sir William Dugdale's *The Baronage of England* describes a set of arras hangings which depict the story of Guy of Warwick, and Guy's purported sword and armour among the possessions of Thomas Beauchamp, 12<sup>th</sup> Earl of Warwick (1338-1401).<sup>72</sup> The family clearly valued the connection to their heroic supposed ancestor, with multiple sons across different generations named Guy and one named Reynburn (after the fictional Guy's son).<sup>73</sup> Chris Woolgar suggested the possible usage of these material items in performance or pageantry. Reading *Guy of Warwick* alongside these artifacts connected with the hero suggests a kind of multimedia romance performance, where the objects can act as silent signifiers of the story or even used as props in the retelling.<sup>74</sup> Images, texts, extracodexical texts and what Blatt terms "textually contingent" objects interact in particular spaces which themselves have significance to the family and the ancestry they celebrate, along with their usual roles in social performativity and everyday life.<sup>75</sup> Performing an excerpt from the romance *Guy of Warwick* is a materially and experientially different event when it involves artifacts directly connected to the hero and in spaces also connected to the legend. The material objects function somewhat like secular relics of the romance hero, especially as their veracity is less important than the belief in their authenticity and their almost ritual usage in performance. Alison Wiggins explains how both Warwick and Winchester keenly cultivated their connections to the legendary hero, perhaps as a way of attracting visitors and earning money, acting as sites of secular pilgrimage, to continue the parallel to relics.<sup>76</sup> Curiously, the fascination with Guy of Warwick has not abated much in the current day: the Guy of Warwick society still actively celebrate the legacy of the romance hero, the purported

---

<sup>71</sup> David Griffith, 'The Visual History of Guy of Warwick', in *Guy of Warwick: Icon and Ancestor*, ed. Alison Wiggins and Rosalind Field (Woodbridge, Suffolk: D. S. Brewer, 2007), 119; Alison Eve Wiggins, 'Guy of Warwick: Study and Transcription' (PhD Thesis, University of Sheffield, 2000), 68; Warton, *History of English Poetry*, 97.

<sup>72</sup> William Dugdale Sir, *The Baronage of England, or, An Historical Account of the Lives and Most Memorable Actions of Our English Nobility in the Saxons Time to the Norman Conquest, and from Thence, of Those Who Had Their Rise before the End of King Henry the Third's Reign Deduced from Publick Records, Antient Historians, and Other Authorities*, Early English Books Online Text Creation Partnership, 2011 (London: Printed by Tho. Newcomb, for Abel Roper, John Martin, and Henry Herringman ..., 1675), 237–38, <http://name.umdl.umich.edu/A36794.0001.001>.

<sup>73</sup> Dugdale, 235.

<sup>74</sup> Chris Woolgar, 'Interior Decoration and the Hall in Late Medieval England' (Leeds International Medieval Congress, Leeds, 2019).

<sup>75</sup> Blatt, *Participatory Reading in Late-Medieval England*, 128.

<sup>76</sup> Wiggins, 'Guy of Warwick: Study and Transcription', 67–68.

sword of Guy of Warwick is on display at Warwick Castle and there have been multiple instances of performances that stage and retell Guy's story.<sup>77</sup>

This model suggests fascinating possibilities for the interplay of story, material objects and spaces during reading events. What objects and items in spaces would medieval audiate readers encounter? And how would these spaces and objects interact with the story, especially if connected to it in some way? The reading aloud of a romance in a hall with decorative hangings that depict knightly adventures, or features action which takes place in a hall, intensifies the experience as the events of the story are paralleled in the material objects and spaces. Lisa Liddy's survey of York inventories shows armour and weaponry on display or stored in the hall, chamber and parlour: another possible material resonance when romance was read aloud in these spaces.<sup>78</sup> Similarly, devotional reading which took place with a material focus, such as a portable altar, icons or relics, is intensified by the material surrounds.<sup>79</sup> The reading event itself could deliberately use this to great effect, situating the reading in a space with particular resonance, rearranging the soft and hard furnishings to shape the space in a particular way or even using items as props in performance. Analysis of the reading experience must be spatially aware and consider the whole embodied experience of the reading and audience beyond merely the words of the text, their physical form and how they are performed.

### 3.7 The Sensory and Material Experience of Reading

The embodied reception of reading involves sights, smells, tastes, sounds, touch sensations, proprioception (the sense of the body existing in space) and vestibular senses (movement, balance). The physical and embodied experience of reader and listener – their sensory input (both the reading event and external distractions); comfort (seating and

---

<sup>77</sup> My research found two 'Guy of Warwick Days' organised by the Guy of Warwick Society, a group which aims to "promote and re-enact 'The Wisdom of Guy'" and often stages scenes from the story at their events; a multimedia Guy of Warwick show at Warwick Castle; and a Renaissance Fair performer who has taken on the persona of Guy of Warwick to retell the story. 'Aims of the Society', The Guy of Warwick Society, accessed 30 August 2019, <https://www.thegows.co.uk/gallery>; 'Guy of Warwick!', National Geographic Kids, accessed 12 October 2020, <https://www.natgeokids.com/uk/discover/history/general-history/guy-of-warwick/>; 'IN PICTURES: Warwick's First Guy of Warwick Day', The Warwick Courier, 31 May 2018, <https://www.warwickcourier.co.uk/news/pictures-warwicks-first-guy-warwick-day-832537>; Kirstie Smith, 'Guy of Warwick Day to Return to Warwick for a Second Year', The Warwick Courier, accessed 26 August 2019, <https://www.warwickcourier.co.uk/news/guy-of-warwick-day-to-return-to-warwick-for-a-second-year-1-8931527>; 'Sir Guy of Warwick', Sir Guy of Warwick, accessed 12 October 2020, <https://www.sirguyofwarwick.com/>.

<sup>78</sup> Liddy, 'Domestic Objects in York c.1400–1600: Consumption, Neighbourhood and Choice', 69, 72, 78, 192.

<sup>79</sup> For examples of such objects, see Blick, 'Bringing Pilgrimage Home: The Production, Iconography, and Domestic Use of Late-Medieval Devotional Objects by Ordinary People'.

furniture, lighting, temperature); the presence of others (participating or not) and their surroundings – all influence the experience of reading. First-person experimental phenomenological analysis allows the modern practitioner to recreate the entire embodied experience of communal reading and theorise about original experiences on a basis of shared bodily perceptions. For emplaced reading, three main categories of inquiry are worth exploring further: the materiality of the book, lighting and sight, and acoustics and hearing. In the first category, the material form of the book shapes the reading experience. Some household manuscripts may have been used as entire bound volumes, whereas some, like CCAii, show clear evidence for usage as unbound booklets. For manuscripts created by their owners, the long process of copying could have produced booklets which could have been used unbound before being collected together in one volume. These multiple formats necessarily entail different material engagement with the text. Reading from booklets, for example, can provide the reader aloud with more flexibility for mobile performances. Reading from a large volume, such as Li 91 after it was copied and bound, surely required some kind of physical support, such as a table or lectern, to hold the book and was more static.<sup>80</sup> The visual status of the book and book-related furniture like a lectern convey power through their material presence and the association with other authority-conveying activities like preaching, scholarship and scribal work. References in romances to their source material are actualised when a performative reader is reading from a physical book: in the act of the reading aloud, the physical book becomes concrete symbol of the authority (*auctoritas*) of the textual tradition and the reader-aloud is granted authorial power.<sup>81</sup> The phrase ‘so says the book’ is granted additional power when a listening audience sees the reader aloud reading from a physical book.<sup>82</sup> The book itself has additional significance in devotional reading, in which the metaphor of Christ-as-book aligns Christ’s body with the scraped and stretched animal skin that the text is written on (see for example the *Long Charter of Christ* in Ff.2.38 and the variant in CCAii, and the *Short Charter of Christ* in Ashmole 61). All of the household manuscripts studied here are made of paper, which creates a materially and affectively different reading experience.<sup>83</sup>

---

<sup>80</sup> Examples of lecterns and book stands can be seen in the images of reading discussed above, as well as two extant examples: *Lectern*, 15th century, Spain or France, Wrought iron, 160 x 55 cm, 15th century, Spain or France, Acc. No. 574-1897, Victoria and Albert Museum, London; *Lectern, Folding*, 15th century, Spanish, Walnut wood, 24.8 x 35.9 x 29.2 cm, 15th century, Spanish, A. No. 41.1000.136, The Met Museum.

<sup>81</sup> Minnis, *Medieval Theory of Authorship: Scholastic Literary Attitudes in the Later Middle Ages*; Coleman, *Public Reading and the Reading Public*, 28; Cruse, ‘Matter and Meaning in Medieval Books: The Romance Manuscript as Sensory Experience’, 48; Fisher, *Scribal Authorship*.

<sup>82</sup> The CCAii version of *Sir Eglamour of Artois* twice refers to a “boke of Rome” (ff. 7vb, 10va; TEAMS edition ll. 408. 862).

<sup>83</sup> A common assumption is that paper has connotations of impermanence compared to parchment, however, work by Da Rold has nuanced this, showing that paper was highly valued for its suitability for fast and informal writing, often in cursive, its showing of erasure attempts and greater

How the reader holds and touches the book – particularly in devotional contexts – has been studied further by Kathryn M. Rudy.<sup>84</sup> The household manuscripts examined here also show staining and wear at page corners and the base of pages, suggesting patterns of handling, and have preserved moments of touch in finger prints and stains left by users. The other two categories of sensory considerations – lighting and acoustics – deserve more detailed attention.

### 3.7.1 Lighting and sight

Reading is an activity dependent on sight, with successful deciphering of medieval handwriting dependent on a sufficiently well-lit environment. In general, life in medieval homes was a lot darker than we are accustomed to today and there was greater division between day and night, with natural light delineating possible activities.<sup>85</sup> Artificial lighting was a mark of status – not all could afford the expense of candles to drive away the dark of night. Artificial light could be provided by fires (in hearths and portable braziers), candles (both cheaper tallow and the more stable and pleasant-smelling beeswax for the church and elites), rush lights (a dried rush soaked in oil and burnt, a cheap and accessible light source), and oil lamps (a wick suspended in liquid fat), with various devices to hold, transport and even amplify this light.<sup>86</sup> The hall was relatively well-lit, with light provided by windows, the fire and additional artificial lighting. Wills and inventories record the presence of candles and lighting devices in the hall, although these items were moveable.<sup>87</sup> Plain interior walls in the house were often whitewashed to act as reflective surfaces.<sup>88</sup> Textile hangings on the walls absorb light and sound. Windows would provide variable amounts of light, depending on size, coverings and the presence of shutters. The wealthiest houses had glazed or partially glazed windows, but other window coverings like waxed linen or even horn are documented.<sup>89</sup> Earlier halls had windows at

---

availability. Da Rold, *Paper in Medieval England: From Pulp to Fictions*; Blatt, *Participatory Reading in Late-Medieval England*, 108; M.T. Clanchy, 'Parchment and Paper: Manuscript Culture 1100-1500', in *A Companion to the History of the Book*, ed. Simon Eliot and Jonathan Rose (Chichester: John Wiley & Sons, 2007), 420–46.

<sup>84</sup> Rudy, 'Dirty Books: Quantifying Patterns of Use in Medieval Manuscripts Using a Densitometer'.

<sup>85</sup> Schofield, *Medieval London Houses*, 128; Goldberg, 'Space and Gender in the Later Medieval House'; C.M. Woolgar, *The Senses in Late Medieval England* (New Haven and London: Yale University Press, 2006), 153.

<sup>86</sup> Eagan, *The Medieval Household: Daily Living c. 1150 - c. 1450*, 126–51; David J. Eveleigh, *Candle Lighting* (Princes Risborough: Shire Publications, 2003); Schofield, *Medieval London Houses*, 128.

<sup>87</sup> Schofield, *Medieval London Houses*, 128; Goldberg, 'Space and Gender in the Later Medieval House', 225; Goldberg, 'Making the House a Home in Later Medieval York', 171.

<sup>88</sup> Gilchrist, *Medieval Life: Archaeology and the Life Course*, 121.

<sup>89</sup> Schofield, *Medieval London Houses*, 101; Gore and Gore, *The History of English Interiors*, 11.

the high end of the hall, but in the fifteenth century each bay of the hall often had its own window, set high up in the walls to provide space for the tables and decorative wall hangings below it, with the largest window (often a bay window) near the dais.<sup>90</sup> Various images and texts depict reading (or writing) taking place with natural light from a window (for example, the images of Christine de Pizan cited above), candlelight (for example, in the Merode altarpiece below Mary was perhaps using the recently snuffed candle behind her for illumination – Figure 3.3) and firelight (for example, the narrator in Henryson’s *Testament of Cresseid*, Jankyn in Chaucer’s *Wife of Bath’s Prologue* and St Barbara in *The Werl Triptych* [Figure 3.4]).<sup>91</sup>

Insufficient or inconsistent lighting, or even poor eyesight, can impede reading and cause deciphering errors. In *The Kingis Quair*, the narrative persona (probably James I of Scotland [1394-1437]) stops reading because his eyes hurt from reading all night, perhaps by firelight, as in the similar scene in Henryson’s *Testament of Cresseid*.<sup>92</sup> Different lighting sources offered different qualities of illumination: wax candles burn more stably than tallow candles, and the flickering of firelight can prove challenging to read by.<sup>93</sup> Some light sources also introduce sensory distractions, such as the crackling of wood or wicks and obscuring or smelly smoke. The treatment of walls affects how far light is spread: whitewashed walls reflect light readily, whereas walls covered in fabric or woven hangings result in a darker space (that is also more acoustically dampened).

Lighting levels qualitatively and affectively impact reading events: whether it takes place during daylight hours or after dark, with artificial light, is shown by experimentation to drastically change the experience. M. Bille and T.F. Sorenson outline how the manipulation of light has the ability to “alter human experiences of space”, delineating boundaries, including and excluding, and creating emotional responses.<sup>94</sup> The aesthetic and emotional impact of lighting, whilst secondary to its practical usage can be

<sup>90</sup> Grenville, *Medieval Housing*, 98–99, 111–13; Tankard, ‘Form and Function in the Late Medieval Rural House: An Example from the Weald and Downland Open Air Museum, Sussex’, 165.

<sup>91</sup> London, British Library Harley MS 4431, ff. 4r, 261v; Geneva, Bibliothèque de Genève, MS Fr. 180, f. 3v; Paris, Bibliothèque Nationale de France Fr. 603, f. 81v; Oxford, Bodleian Library, MS Douce 62, f. 105v; Henryson, ‘The Testament of Cresseid’, ll. 27–28, 36–42; Geoffrey Chaucer, ‘The Wife of Bath’s Prologue’, in *The Riverside Chaucer*, ed. Larry D. Benson, 3rd ed. (Oxford: Oxford University Press, 2008), ll. 713–714.

<sup>92</sup> James I of Scotland, ‘James I of Scotland, The Kingis Quair’, in *The Kingis Quair and Other Prison Poems*, ed. Linne R. Mooney and Mary-Jo Arn, TEAMS Middle English Texts Series (Kalamazoo, Michigan: Medieval Institute Publications, 2005), ll. 8–21, 50–56; Henryson, ‘The Testament of Cresseid’, ll. 27–28, 36–42.

<sup>93</sup> Woolgar, *The Senses in Late Medieval England*, 154; Eveleigh, *Candle Lighting*.

<sup>94</sup> M. Bille and T.F. Sørensen, ‘An Anthropology of Luminosity: The Agency of Light’, *Journal of Material Culture* 12, no. 3 (2007): 274, 280; Mikkel Bille and Tim Flohr Sørensen, ‘In Visible Presence: The Role of Light in Shaping Religious Atmospheres’, in *The Oxford Handbook of Light in Archaeology*, ed. Costas Papadopoulos and Holley Moyes (Oxford: Oxford University Press, 2017).

manipulated to create a desired effect. When reading communally after dark, the reader is framed by their light-source whilst the audience are at a distance, physically and symbolically from the text, a dramatic visual tableau that enhances the authority of the reader granted by the book. In high-status books, gold leaf decoration is transformed in different lighting conditions, from matte yellow colouration to a full reflective metallic. Less luxurious decoration in household manuscripts can be transformed in more subtle ways, such as the flickering of fire- or candlelight giving life and movement to marginal grotesques and drawings. The degree of illumination of the space influences the evoked setting of the story and how it relates to the physical location of its telling. The canopy in the hall or a fabric canopy of a bed function to draw the eye towards those sitting beneath them, which could enhance readings. In a darker setting, the imagination is more engaged with the creative dimensions of the text: the physical features of the surroundings are obscured and can be overlaid with the evoked world of the story.

### 3.7.2 Acoustics and hearing

Whilst the impact of light on reading is inarguable, that of sound and acoustics is often more subtle. Investigating the sounds of performance represents a formidable challenge for scholars of historical performance. The sounds of historical performances are long since lost and cannot be reconstructed directly, yet they are a fundamental aspect of historical performative reading: sound is the medium through which the words of the text are produced, transformed and received.<sup>95</sup> It is crucial that performance scholars understand, even if only qualitatively, the acoustic settings that the historical material may have been received in. Whilst the sounds themselves are irretrievably lost, sometimes clues can be found in descriptions of sound and performance and surviving historical buildings. Woolgar suggests that medieval houses were more acoustically permeable than modern houses, with the walls doing little to limit the reach of sounds like conversation.<sup>96</sup> Goldberg frequently cites court cases that use evidence from overheard conversations or activities, suggesting that overhearing things is part and parcel of medieval domestic life.<sup>97</sup> Sound and speech in the medieval house are not private events but are widely audible.

Acoustic analysis allows scholars to understand and recreate historic soundscapes and model the acoustics of medieval spaces and even take into account post-medieval changes to the fabric and fittings of surviving buildings. Catriona Cooper investigated the acoustics of the great hall at Ightham Mote, a moated manor house in Kent, testing the

---

<sup>95</sup> Ong, *Orality and Literacy: The Technologizing of the Word*.

<sup>96</sup> Woolgar, *The Senses in Late Medieval England*, 66.

<sup>97</sup> Goldberg, 'Making the House a Home in Later Medieval York'.

acoustics of the hall in the present day (with post-medieval contents) and then using acoustic modelling to reconstruct the acoustic profile of the hall as it had been in the late Middle Ages.<sup>98</sup> The popular idea of the medieval hall, as Cooper points out, is a raucous place for feasting, merriment and loud entertainment. Woolgar argues that “the great hall was one of the most resonant spaces within the household” and that the grandest halls made of stone and wood would project and sustain sounds.<sup>99</sup> Cooper’s findings suggest that quite the opposite was true: the hall had a limited amplification and a short reverberation time for such a large space, meaning that it would not project or prolong loud sounds and that sounds would taper off in volume after a short duration. This suggests that the hall was a more suitable space for the spoken word (in conversation or more formal readings or speeches) than for music or louder sounds intended to carry across the whole hall. Cooper also noted that there was no difference in reverberation time between the high and low ends of the hall, suggesting a similar quality of sound no matter where people were seated.<sup>100</sup>

Cooper’s analysis matched my own informal observations in historical halls. While visiting surviving medieval buildings at Weald and Downland Living Museum (a combination of empty rooms and rooms with reconstructed soft and hard furnishings), Gainsborough Old Hall (a larger and grander hall with reconstructed soft and hard furnishings) and Barley Hall (reconstructed with modern and extant materials, with soft and hard furnishings), I made informal *ad hoc* tests to qualitatively assess the acoustic profile of the halls and the chambers.<sup>101</sup> By speaking and by making repeated short noises like clicks or claps whilst in different spaces throughout the rooms, I was able to gain some simple qualitative insights into the acoustic qualities of the spaces without complex equipment or modelling.<sup>102</sup> Speaking of course was the most applicable to the experiments, but clicking and clapping mimicked an impulse – a short sound which contains all audio frequencies – allowing a rough impression of the acoustic qualities of the space to be gauged and had the benefit of greater consistency and repeatability across the sites. Woolgar’s assertion of the natural resonance of the hall was certainly not supported by any

---

<sup>98</sup> Cooper, ‘Lived Experience at Bodiam and Ightham’; Diego Murrilo Gomez, Catriona Cooper, and Filippo Fazi, ‘Acoustic Survey of a Late Medieval Building Based on Geometrical Acoustics Methods’ (Forum Acusticum, Krakow, Poland, 2014).

<sup>99</sup> Woolgar, *The Senses in Late Medieval England*, 67.

<sup>100</sup> Cooper, ‘Lived Experience at Bodiam and Ightham’, 156.

<sup>101</sup> I also visited Markenfield Hall as part of this research, however, the modern furnishings made it unsuitable for this kind of informal testing: the stone walls were bare and the room contained considerably more anachronistic furnishings like upholstered sofas, chairs and full bookshelves.

<sup>102</sup> These brief tests are not intended as a stand-in for rigorously conducted acoustic measurement and a full acoustic study of these spaces is outside of the scope of this thesis. Nonetheless, the informal tests helped to reveal and assess the embodied experience of these surviving and reconstructed medieval spaces.

of the spaces that I investigated – or likely the case for any hall that would have seen performative reading from the household manuscript studied. The halls in these surviving buildings are surprisingly acoustically neutral spaces, meaning that sounds produced are not massively altered – sustained like in a cathedral or deadened like in an anechoic chamber. The high roofs and open beams do not serve to direct or amplify sound, instead allowing it to be softly dispersed. The floors of the halls in Barley Hall and Gainsborough Old Hall are tiled, which are more acoustically reflective. The buildings at the Weald and Downland Open Air Museum had compacted earth floors, which, if covered with rushes or rush mats, would absorb sound. The surfaces of many of the walls in those halls with reconstructed furnishings were covered in cloth hangings, which absorb sound instead of allowing it to be reflected off the bare wall. Additional soft furnishings like cushions, curtains or cloth canopies would only heighten this effect. Acoustically reflective surfaces like glazed windows are located higher up in the walls (especially in Gainsborough Old Hall) above a height where they could serve to reflect the sound towards listeners. The impact of the wall hangings was significant in Gainsborough: the preliminary test described here took place on an earlier visit before the fabric hangings along the side walls were removed. In the acoustics test, sound was absorbed well, whilst in the reading experiment our voices reflected off the bare walls and were amplified (although not sustained) by the hall to a greater degree than expected. Whether these common features of medieval halls were incidental or added by design to create this kind of acoustic profile is unclear, nonetheless, they contribute to the acoustic qualities of the space. Barley Hall is the only one of the three hall spaces to include a canopy above the high table. The curved surface created by the encroaching floor of the chamber wing above curves to meet the back wall of the hall, forming a surface that reflects and directs sound in the hall. The canopy functions somewhat like pulpit sounding boards in the way it reflects and directs sound. Sounds made by those at the high table are more audible to others in the hall and, conversely, sounds made in the hall are directed towards those sitting at the high table. A simple qualitative acoustic test proved this with one person seated at the table and another moving around the room and producing easily replicable noises such as claps.

The unremarkable acoustics of the medieval hall were surprising, especially given the myth of the raucous hall that Cooper explains, as well as the claims of previous scholarship that combined acoustic analysis and buildings archaeology, notably, Graeme Lawson's theory about early medieval boat-shaped halls which posits that the poor acoustic abilities of the lyre were compensated for by the amplifying abilities of the hall



space.<sup>103</sup> The grand space of the medieval hall easily encourages the assumption that it should provide similarly impressive acoustic qualities. However, it seems instead that acoustic analysis of medieval halls provides further evidence in support of them as spaces fit for multiple uses, although, as Cooper remarks, being multi-purpose does not necessarily entail that they are particularly well-suited to any of these purposes.<sup>104</sup> In summation, the acoustically neutral space of the hall does not specifically add or subtract anything from the qualitative experience of sound and performance and allows for performative reading in any location in the space.

Qualitatively, the house provided a very different acoustic atmosphere to other spaces regularly experienced by medieval people, particularly for reading aloud – most notably, the church. Churches were specifically designed to project and sustain the human voice, with reflective stone surfaces and the shapes of the vaulted ceiling.<sup>105</sup> The spoken word in the church – and, indeed, any other sounds produced – are elevated by amplification and reverberation. Listeners can be seated quite far away from the speaker and still easily comprehend the speech. The design of church spaces grants authority and power to the spoken word by virtue of its acoustic properties. Reading in the acoustically-neutral space of the house would be an altogether different experience. The voice is not offered the same assistance by the architecture of the house that it is in the church as there is very little natural reverberation created in a hall, chamber or parlour. The qualitative differences would serve to differentiate between more formal reading and listening in the church and the more informal practices at home.

The space of the hall at Barley Hall is small enough that a reader-aloud could be easily heard from the opposite end of the hall, if that were intended, whilst more projection is required by a reader in Gainsborough. Saying grace or reading of edifying material over the meal could in theory be positioned anywhere in the hall without too much of an ill effect on the performance, although, it seems likely to me that a speaker would still position themselves near the high end to ensure that they are best heard by those highest in status. However, the hall could also accommodate smaller-scale readings with a group of people gathered around a reader who is not attempting to project to reach the whole hall. From a reference to an unwelcome guest disguised as a *histrion* at Edward II's Pentecost Feast of 1317, it seems that professional entertainers circled the tables in larger halls, providing multiple smaller-scale performances, rather than projecting to the entire hall at

---

<sup>103</sup> Graeme Lawson, 'Large Scale-Small Scale: Medieval Stone Buildings, Early Medieval Timber Halls and the Problem of the Lyre', in *Archaeoacoustics*, ed. Christopher Scarre and Graeme Lawson, McDonald Institute Monographs (Cambridge: McDonald Institute for Archaeological Research, 2006), 85–94.

<sup>104</sup> Cooper, 'Lived Experience at Bodiam and Ightham', 157.

<sup>105</sup> Woolgar, *The Senses in Late Medieval England*, 66.

once.<sup>106</sup> This would explain how the romance reading in *Havelok* could be heard against the other varied and noisy entertainments.

### 3.8 Historical Houses

Two historic sites were chosen as locations for the performative experiments: one a large rural manor house and one a smaller urban house. Both followed the tripartite plan, although with much variation in the sizes of the rooms and the addition of further wings and auxiliary buildings. The two sites were chosen to represent a rural and an urban dwelling of roughly comparable size to buildings likely owned by owners of household manuscripts.

#### 3.8.1 Barley Hall



Figure 3.5: Barley Hall as viewed from Coffee Yard. On the left of the image is the chamber wing and on the right is the hall, with the large window at the high end easily visible. Image taken from the Barley Hall website.<sup>107</sup>

---

<sup>106</sup> “quaedam mulier...histrionaliter phaleratum...dictam aulam intravit, mensas more histrionum circuivit.” Ianitores et hostiarii: ‘non esse moris regii, alicui menestrallo, palatium intrare volenti, in tanta solemnitate aditum denegare’”

A certain woman, attired like a *histrion* entered the said hall, **she circled the tables in the manner of a *histrion***. The porters: it was not the royal custom to deny entry to any minstrel wishing to enter the palace at so great a solemnity. (My translation, emphasis added.)

Recorded in the *Annales* of Johannes de Trokelowe quoted in E.K. Chambers, *The Mediaeval Stage*, vol. 1 (Oxford: Oxford University Press, 1903), 44.

<sup>107</sup> ‘Education’, Barley Hall, accessed 9 April 2022, <https://barleyhall.co.uk/education/>.

The building now known as Barley Hall stands off the street of Stonegate in York, and was originally built (beginning c. 1360) as the York city *hospitium* of St Oswald's Priory at Nostell, North Yorkshire (roughly thirty miles to the south west of York) housing priory visitors as they conducted business in the city. (Figure 3.5) The building was saved from demolition and acquired by York Archaeology (henceforth YA, previously known as York Archaeological Trust) in 1987. Multiple centuries of alterations had completely obscured the historical plan: the hall and the chamber wing were rebuilt in brick over the seventeenth-nineteenth centuries, the hall was ceiled and had an attic, the chamber wing was divided into three storeys, in the seventeenth century a public alleyway cut through the hall where the screen passage had stood (the doorway in the lower right of Figure 3.5), and overall much of the medieval fabric was lost.<sup>108</sup>

Stonegate stood in close proximity to the Minster and was used in royal, religious and civil processions, as well as for several stations of the York Corpus Christi plays.<sup>109</sup> Around the streets of Stonegate, Goodramgate and Petergate were other similar religious residences, although in the later Middle Ages as religious houses let out their buildings to secular tenants, Stonegate and the area adjoining Petergate became the centre for luxury industry such as goldsmithing.<sup>110</sup> The reconstruction of Barley Hall presents the building as it was in c. 1483 during the tenancy of one such goldsmith – William Snawsell (1415-c. 1494). The house was claimed by the crown in the Dissolution of the Monasteries, then entered a period of gradual decline from the sixteenth century as it was subdivided into dwellings and workshops, with a plumber being the last lessee before the reconstruction.

---

<sup>108</sup> 'Houses: Stonegate', in *An Inventory of the Historical Monuments in City of York*, vol. 5, Central (London: Originally published by Her Majesty's Stationery Office, 1981), fig. 148, [www.british-history.ac.uk/rchme/york/vol5/pp220-235](http://www.british-history.ac.uk/rchme/york/vol5/pp220-235).

<sup>109</sup> 'Houses: Stonegate', 267, 309.

<sup>110</sup> Sarah Rees Jones, *York: The Making of a City 1068-1350* (New York and Oxford: Oxford University Press, 2013), 143, 304; 'Houses: Stonegate'; Liddy, 'Domestic Objects in York c.1400–1600: Consumption, Neighbourhood and Choice', 38–39.

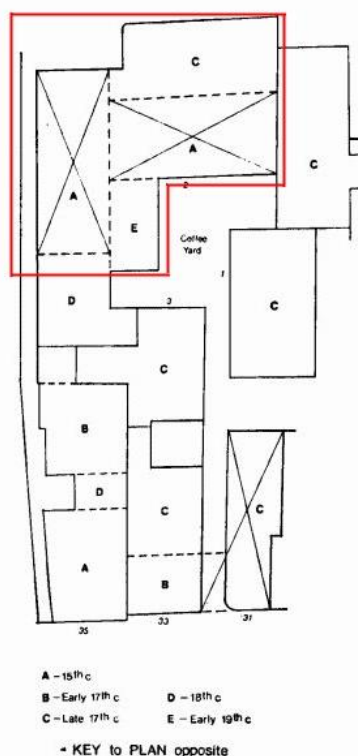

Figure 3.6: Plan of Coffee Yard c. 1981, with Barley Hall structure outlined in red. Note that this is prior to its reconstruction. Detail of original diagram from *The RCHME Inventory of the Historical Monuments in City of York*.<sup>111</sup>

The current structure includes a fourteenth-century wing, originally a series of multi-purpose chambers (accommodation, work and storage), now presented as a lesser and greater chamber (the latter serving as either museum space or gift shop), the stewards' room (a bed chamber and information space) and an entrance space. The wing set at right angles to the chamber wing was rebuilt in the fifteenth century to include a new large hall, indicative of a high status urban dwelling accommodating a household in need of a formal space and testament to the flexibility of house plans as discussed above. This wing contains the hall, the pantry and buttery, and the first floor room above these is currently presented as the parlour.

In the extensive restoration and rebuilding that allowed the hall to open to the public in 1993, the timber-framed façade on the side of the building facing Coffee Yard and part of the north-east wall were reinstated, and the ceilings in the hall and the largest chamber were removed, allowing these rooms to open to the impressively restored timber frames.<sup>112</sup> In place of a small nineteenth-century building, a striking but conjectural

<sup>111</sup> 'Houses: Stonegate'.

<sup>112</sup> 'About', Barley Hall, accessed 15 January 2020, <https://barleyhall.co.uk/about/>; Elizabeth Stewart, 'A History of Historic House Reconstruction: Understanding the Past and Informing the Future', *Internet Archaeology* 29 (2011), <https://intarch.ac.uk/journal/issue29/3/toc.html>.

external staircase leading to the largest chamber was built.<sup>113</sup> (The nineteenth-century structure is still visible in Figure 3.6.) The seventeenth-century addition parallel to the hall remained and is now incorporated into the Barley Hall floorplan, housing museum spaces and the toilets. (The upper-most structure in Figure 3.6.) It is difficult to tell how much this addition overlaps with the building's medieval footprint as documents related to the building were never published. The original screens passage at the south-west end of the hall became a public right-of-way and now large glass windows allow curious passers-by to glimpse into the hall, however, it separated the service rooms from the hall and created interpretative challenges for YA. Charles Kightly notes that there was also evidence of an earlier structure on the same site, although this is not reflected in the current reconstruction.<sup>114</sup> A possible further wing at right angles to the lower end of the hall wing is now obscured under more recent buildings.<sup>115</sup> The overall structure is roughly tripartite, with the surviving wings forming an L-shape.

The dramatic and extensive reconstruction of Barley Hall used medieval materials and techniques to rebuild the timber frame and create the internal features and fittings. The project provided an opportunity for experimentation with historic construction methods that were later applied to projects like Shakespeare's Globe in London.<sup>116</sup> Care was taken to present appropriate furniture and furnishings in the house, with reference to documentary evidence and contemporary images: floor tiles, roof tiles and the roof louvre were hand-crafted, the hand-carved 'Red Chest' that sits in the parlour represents one detailed in the will of Alice Snawsell, the grandmother of William Snawsell and is based on an example from Ripon.<sup>117</sup> Also in the parlour is a chair and lectern based on an image of Jean Mielot and a chandelier based on a fifteenth-century example from Bruges.<sup>118</sup> The hangings in the great hall and parlour are naturally-dyed, handwoven and hand-painted 'say' cloth, a lost type of worsted serge that was reconstructed for the Barley Hall project using microscopic analysis of a surviving piece.<sup>119</sup> The central open hearth in the hall is a

---

<sup>113</sup> Elizabeth Stewart explains that whilst evidence of some structure was found in the courtyard and the staircase was based on historical examples, it is unclear whether the reconstructed staircase is either accurate or appropriate. Stewart, 'Houses: Stonegate', 485; An image of the previous appearance is reproduced in *Barley Hall Guidebook*, Unpublished guidebook, n.d., 12.

<sup>114</sup> Charles Kightly, *Barley Hall York* (York: Barley Hall Trust, 1999), 2.

<sup>115</sup> Kightly, 9; 'Houses: Stonegate', sec. 485.

<sup>116</sup> 'Barley Hall', McCurdy & Co: Craftsmen and Consultants - Historic Timber Frame Reconstruction Specialists, accessed 3 December 2009, <https://mccurdyco.com/barley-hall/>; Mulryne and Shewring, *Shakespeare's Globe Rebuilt*.

<sup>117</sup> 'Hudson Claypotter', Hudson Claypotter: Traditional hand thrown pots, accessed 3 December 2019, <http://www.hudsonclaypotter.co.uk/>; John Goodall, 'Barley Hall, York: A Property of the York Archaeological Trust', *Country Life* 188, no. 49 (1994): 30.

<sup>118</sup> Kightly, *Barley Hall York*, 22.

<sup>119</sup> Goodall, 'Barley Hall, York: A Property of the York Archaeological Trust', 31; Kightly, Charles, 'The Hangings About the Hall', *Medieval Textiles* 28 (2001): 5; *Barley Hall Guidebook*.

relocated medieval original.<sup>120</sup> In some cases, the hall provided an opportunity for experimentation over strict reconstruction, such as the variety of different window coverings presented: the treated linen window panels, the horn window and the wooden window-shutters.

### 3.8.2 Gainsborough Old Hall

Gainsborough Old Hall is a timber-framed hall dating to the third quarter of the fifteenth century with a later fifteenth-century brick tower and kitchen. It is a construction of three ranges and can be loosely typified as a courtyard house, although there is no evidence for a fourth range having been constructed. (Figure 3.7) It was built for Sir Thomas Burgh (c. 1431-1496), whose illustrious political career and opportune marriage to wealthy Margaret, dowager Lady Botreaux furnished a lavish dwelling and cemented the family's fortune and local importance.<sup>121</sup> Gainsborough in Burgh's time was a small market town and important inland port on the river Trent, with the Hall in a powerful position overlooking the river and overseeing the town's economic activities.<sup>122</sup> Burgh's political career saw him serve four kings and elevation to the Order of the Garter amongst other accolades, but also led to the destruction and rebuilding of all or part of the Hall after an attack by his enemies in 1469 or 1470.<sup>123</sup>

---

<sup>120</sup> Kightly, *Barley Hall York*, 18.

<sup>121</sup> S.J. Gunn, 'The Rise of the Burgh Family, c. 1431-1550', in *Gainsborough Old Hall*, ed. P.G. Lindley, vol. 8, Occasional Papers in Lincolnshire History and Archaeology (Lincoln: The Society of Lincolnshire History and Archaeology, 1991), 8; Anthony Emery, *Greater Medieval Houses of England and Wales, 1300-1500. Vol. 2: East Anglia, Central England, and Wales* (Cambridge: Cambridge University Press, 1996), 243.

<sup>122</sup> M.W. Thompson, 'The Architectural Context of Gainsborough Old Hall', in *Gainsborough Old Hall*, ed. P.G. Lindley, vol. 8, Occasional Papers in Lincolnshire History and Archaeology (Lincoln: The Society of Lincolnshire History and Archaeology, 1991), 13; Emery, *Greater Medieval Houses of England and Wales, 1300-1500*, 242.

<sup>123</sup> Gunn, 'The Rise of the Burgh Family, c. 1431-1550', 8; Emery, *Greater Medieval Houses of England and Wales, 1300-1500*, 243-44.



Figure 3.7: Exterior of Gainsborough Old Hall (facing north).<sup>124</sup> Photo: David Dunford.

The Hall is currently managed by English Heritage and is presented with a mixture of reconstructed historical rooms and museum spaces that reflect its long history. The medieval form and fabric is unusually well-preserved, with the brick kitchen and the octagonal tower being particularly notable survivals. The construction of the Hall prizes visually-striking structures as a conspicuous symbol of Burgh's power and status over military defence. The top of the tower and the chimney stacks of the West Range both feature crenellations in mimicry of castle architecture and decorative moulded brickwork.

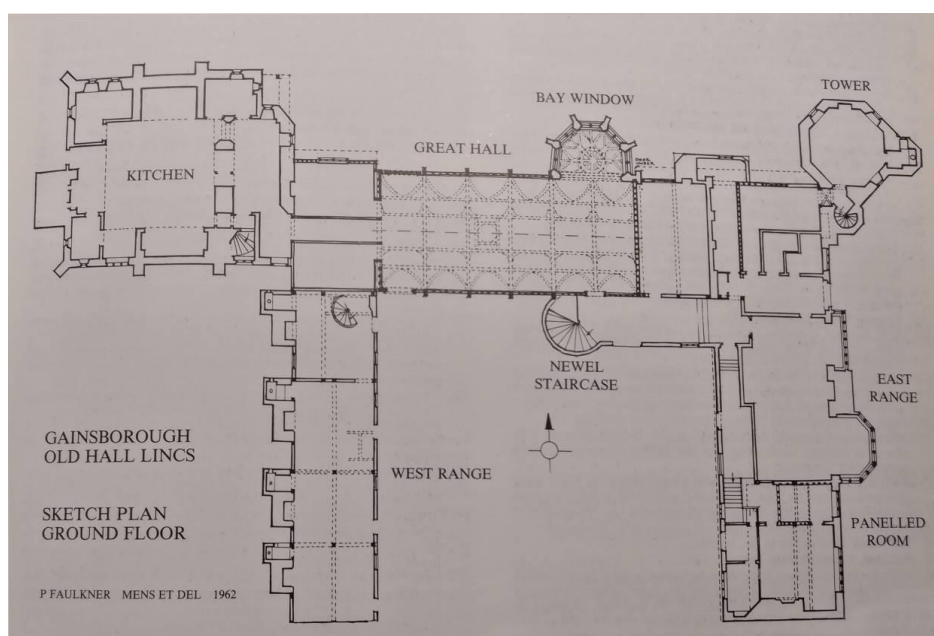

Figure 3.8: Plan of the ground floor of Gainsborough Old Hall.<sup>125</sup>

<sup>124</sup> 'The Old Hall', Historic England, accessed 24 April 2022, <https://historicengland.org.uk/listing/the-list/list-entry/1359773?section=comments-and-photos>.

<sup>125</sup> P. Faulkner in P.G. Lindley, 'Structure, Sequence and Status: The Architectural History of Gainsborough Old Hall to c. 1600', in *Gainsborough Old Hall*, ed. P.G. Lindley, vol. 8, Occasional

Thomas Burgh's partially-surviving probate inventory lists rooms including the hall, chambers in the tower and gallery, a great chamber with adjoining smaller chamber, a parlour and an inner parlour all richly decorated with tapestries and luxurious cloth.<sup>126</sup> The Hall is centred around a six-bay great hall, with a central hearth, impressive roof louvre (now removed and displayed in the east range) and a stone bay window added to the high end of the hall. (Figure 3.8) Several scholars have speculated that the bay window was an addition annexed in the sixteenth century from a monastery replacing an earlier wooden window.<sup>127</sup> Some features like the windows and cast iron mouldings are features of later restorations, but the timber framework and structure of the hall is medieval – particularly the survival of the three original doorways to the service rooms, visible due to the eighteenth century removal of the screens passage.<sup>128</sup> The hall is now presented with simple textile hangings behind the high table, a small collection of trestle tables and benches and several other small pieces of furniture. Of the chambers listed in Burgh's probate inventory, the gallery chamber on the first floor at the high end of the hall was the one used in the experiments. The Burgh family were accommodated in the east range, with the principal bed chamber likely on the first floor nearest the tower. The gallery chamber was likely the quarters for a high-ranking attendant. The reconstruction of the chamber features a window, a fireplace (post-medieval), textile wall hangings, a settle, two chairs, chest, cupboard presented as an altar cabinet and tables that hold interactive display items. Other chambers are found in the tower (three formal chambers, each with separate access from the spiral staircase, window, fireplace, and garderobe), the kitchen (small sleeping quarters for servants) and the west range (accommodation for retainers in rooms of various sizes, each with window, fireplace and garderobe and, for most, individual access from a corridor along the length of the range).<sup>129</sup> Dendrochronological evidence suggests that the hall was built first, followed by the East Range, then the West Range.<sup>130</sup>

---

Papers in Lincolnshire History and Archaeology (Lincoln: The Society of Lincolnshire History and Archaeology, 1991), 25.

<sup>126</sup> London, The National Archives, PRO, PROB2/124; Gunn, 'The Rise of the Burgh Family, c. 1431-1550', 9; Lindley, 'Structure, Sequence and Status: The Architectural History of Gainsborough Old Hall to c. 1600', 21.

<sup>127</sup> Thompson, 'The Architectural Context of Gainsborough Old Hall', 15; Lindley, 'Structure, Sequence and Status: The Architectural History of Gainsborough Old Hall to c. 1600', 24; Emery, *Greater Medieval Houses of England and Wales, 1300-1500*, 245.

<sup>128</sup> Lindley, 'Structure, Sequence and Status: The Architectural History of Gainsborough Old Hall to c. 1600', 24; Emery, *Greater Medieval Houses of England and Wales, 1300-1500*, 245.

<sup>129</sup> Sarah Kerr, 'Collective Living and Individual Identities in Late Medieval England', *Archaeological Journal* 177, no. 1 (2020): 87–88, 92–96, 123; Lindley, 'Structure, Sequence and Status: The Architectural History of Gainsborough Old Hall to c. 1600', 21; Thompson, 'The Architectural Context of Gainsborough Old Hall', 19.

<sup>130</sup> Thompson, 'The Architectural Context of Gainsborough Old Hall', 15; Lindley, 'Structure, Sequence and Status: The Architectural History of Gainsborough Old Hall to c. 1600', 23; Naomi Field, 'Excavations and the West Range', in *Gainsborough Old Hall*, ed. P.G. Lindley, vol. 8,



The Hall has a variety of communal spaces which would have been used depending on social station within the large household. The hall is the central communal space, as well as parlours in the east range for select family and guests, and perhaps the first floor chamber in the West Cross Range (now the ‘steward’s room’) or the larger room in the West Range for the retainers.<sup>131</sup> Gainsborough Old Hall is unusually well-preserved: alterations in the seventeenth century when the hall was sold to the Hickman family represent the most drastic changes, mainly affecting the East Range. The Hall was adapted to serve multiple functions from the eighteenth to twentieth centuries, including theatre, public house, factory, Masonic temple and accommodation, corn exchange, workshops and assembly room but these did not obscure the medieval structure as extensively as in Barley Hall.<sup>132</sup> The East Range was ceiled, the roof raised, the original layout changed and the south end converted to three storeys.<sup>133</sup> Parts of the facades and walls of the east and west ranges were infilled with brick, a process begun under the Hickmans, and staircases were added which changed the original access patterns, particularly between the west range and the hall, and the high end of the hall to the eastern parts of the house. A programme of restoration throughout the nineteenth century added some idiosyncratic details to the Hall such as the cast iron elements at the end of the roof braces, and more recently, restoration between 1951 and 1982 culminated in the hall being opened to the public in 1989.<sup>134</sup> Its recent change in management prompted a major refurbishment and re-interpretation under English Heritage in 2020-2021.

### 3.8.3 Comparative Analysis

The sites represent two extremes of heritage sites: on one end a building largely unchanged from its medieval form, on the other, an experimental reconstruction. Barley Hall’s reconstruction had ambitious goals that were never quite reached: a unique, fully reconstructed ‘living museum’ with costumed actors portraying Snawsell and his

---

Occasional Papers in Lincolnshire History and Archaeology (Lincoln: The Society of Lincolnshire History and Archaeology, 1991), 40.

<sup>131</sup> Emery, *Greater Medieval Houses of England and Wales, 1300-1500*, 249.

<sup>132</sup> Jenny Vernon, ‘“A Fine Wreck of the Feudal Age”: The Later History of Gainsborough Old Hall and Its Owners’, in *Gainsborough Old Hall*, ed. P.G. Lindley, vol. 8, Occasional Papers in Lincolnshire History and Archaeology (Lincoln: The Society of Lincolnshire History and Archaeology, 1991), 27, 32; John Goodall, ‘Gainsborough Old Hall, Lincs: A Property in the Guardianship of English Heritage’, *Country Life* 190, no. 3 (1996): 38.

<sup>133</sup> Lindley, ‘Structure, Sequence and Status: The Architectural History of Gainsborough Old Hall to c. 1600’, 25; Vernon, ‘“A Fine Wreck of the Feudal Age”: The Later History of Gainsborough Old Hall and Its Owners’, 32; Emery, *Greater Medieval Houses of England and Wales, 1300-1500*, 246.

<sup>134</sup> Vernon, ‘“A Fine Wreck of the Feudal Age”: The Later History of Gainsborough Old Hall and Its Owners’, 32–33; Emery, *Greater Medieval Houses of England and Wales, 1300-1500*, 250.

household and servants.<sup>135</sup> YA clearly aimed to follow the success of the Jorvik Viking Centre, which opened in 1984 with its ground-breaking interactive and multimedia presentation of the Norse history of York. Barley Hall would have gone even further than the mannequins and animatronics of Jorvik, presenting a complete and inhabited medieval house more in the model of Colonial Williamsburg in the USA, an entire village restored to its (purported) eighteenth century form.<sup>136</sup> However, funding issues thwarted the full reproduction and the present Barley Hall combines medieval rooms with museum spaces. This hybrid presentation offers visitors multiple modes to engage with historical material, both directly in the reproduction rooms and more analytically through the guided museum exhibits. Barley Hall restored only one era of the building's history, at the cost of five centuries of varied activity on the site.<sup>137</sup> In the reconstruction, the building was almost completely dismantled, then rebuilt, and although many of the original timbers were retained, a significant portion of the material is modern and the historic brickwork from the intervening centuries was disposed of.<sup>138</sup> The work caused the building to be de-listed and the archaeological reports from the initial investigation have never been published – it is currently still difficult to obtain access to the information and records. Criticisms of the reconstruction have called it “fanciful” and “Disneyland heritage”.<sup>139</sup> Its mode of reconstruction is similar to that of open air museums, which remove all non-original features. Its reconstruction may be controversial, but John Goodall argues that the structural losses caused by this restoration are comparable to those that would have been carried out by converting the building into office spaces, and that the educational benefits of the building justify the reconstruction project.<sup>140</sup>

Snawsell's links to the city of York are a compelling narrative for a heritage attraction – he was an active member of city politics, serving as Lord Mayor, a Member of Parliament, Alderman and the Master of the King's Mint. However, his time as the building's tenant was relatively brief, lasting from 1466 until the late 1480s.<sup>141</sup> Whilst

---

<sup>135</sup> J. Grant, 'Changing Face of History at the Museum: Restoration, Interpretation and Education at Barley Hall' (BA Thesis, Department of History, University of York, 2006), 5.

<sup>136</sup> Anderson, 'Living History: Simulating Everyday Life in Living Museums'; R. Handler and E. Gable, *The New History in an Old Museum: Creating the Past at Colonial Williamsburg* (Durham and London: Duke University Press, 1997).

<sup>137</sup> Grant, 'Changing Face of History at the Museum: Restoration, Interpretation and Education at Barley Hall'.

<sup>138</sup> Stewart, 'A History of Historic House Reconstruction: Understanding the Past and Informing the Future'; Goodall, 'Barley Hall, York: A Property of the York Archaeological Trust', 30.

<sup>139</sup> Stewart, 'A History of Historic House Reconstruction: Understanding the Past and Informing the Future'; Goodall, 'Barley Hall, York: A Property of the York Archaeological Trust', 29; Grant, 'Changing Face of History at the Museum: Restoration, Interpretation and Education at Barley Hall', 10.

<sup>140</sup> Goodall, 'Barley Hall, York: A Property of the York Archaeological Trust', 30.

<sup>141</sup> Goodall, 30; Kightly, *Barley Hall York*, 11–14; *Barley Hall Guidebook*, 9–10.

Snawsell's story is an attempt to provide a personal and relatable angle to the building, it eclipses the countless other men, women, children, members of clergy and others who used the building during the multiple centuries of its life. Even the other members of Snawsell's family, whose names are known, are sidelined. Perhaps the best illustration of this is the reconstruction of the parlour as Snawsell's office, rather than a flexible, multi-use space that was utilised by multiple members of the household. The reconstruction focuses only on a small part of the rich and fascinating history of the building and the street it is situated on, a history that is a striking reflection of multiple facets of the history of York itself: the city as an important religious centre, its secular and political power, and later the city in the process of industrialisation. Its selectiveness is also, conversely, one of the reconstruction's strengths: it presents a clear and coherent depiction of fifteenth-century life throughout the entire site which makes it accessible for the general public, as well as highly suited for my experimental performances, which follow similar methodologies for the original intended purpose of Barley Hall as a living history site. A particular attraction of the site is its high-quality decoration, in particular the hall. The striking patterns and painted decorations of the cloth wall hangings, based on examples from York inventories leave a lasting impression on the visitor and created a grand backdrop for the reading experiments.<sup>142</sup>

Gainsborough Old Hall's transition from private manor house to publically-accessible heritage site was more straightforward. It was used as an elite residence for around 350 years and whilst it saw many disparate uses from the eighteenth century onwards, their disruption to the medieval layout was not as severe as in Barley Hall. After it was given to the nation by then-owner Sir Edmund Bacon in 1971, less-invasive repairs were undertaken and medieval and post-medieval features were allowed to coexist throughout. The Hall acknowledges and reflects most parts of its history, with the hall and kitchen presented as fifteenth century, a sixteenth-century bed chamber and parlour in the three-storeyed end of East Range, and the assembly room in the East Range displaying many generations of Hickman and Hickman-Bacon portraits. Interpretative signage throughout addresses both medieval and post-medieval uses of spaces. The site is popular for living history displays, particularly utilising the large medieval kitchen.<sup>143</sup> Its more nuanced interpretation and mixed presentation reflects current heritage practices. An unfortunate side-effect of the ongoing reinterpretation work at the time of our visit was a lack of furniture in some spaces, particularly the lack of beds, and an updating of the cloth decorations in the hall which removed heraldic banners and wall hangings on the side

---

<sup>142</sup> Kightly, Charles, 'The Hangings About the Hall', 3–4.

<sup>143</sup> A now-defunct reenactment group was established to represent the household and staff of Thomas Burgh. 'Lord Burgh's Retinue', Lord Burgh's Retinue 1460-1496, 2016, <https://web.archive.org/web/20160229221616/http://www.lordburghsretinue.co.uk/>.

walls, resulting in a space that felt quite empty. The unique and continuous history of the site allows it to acknowledge different periods of use whilst still presenting a coherently medieval building and it certainly suffered from fewer of the interpretive and practical challenges of the Barley Hall reconstruction.

Only two household manuscripts can be connected to known dwellings, neither of which have survived to the present day. East Newton Hall in Stonegrave near the North Yorkshire Moors, once the home of Robert Thornton, is now largely a post-medieval house. The manors of the Findern family and the other families named in the manuscript in Derbyshire have likewise been lost.<sup>144</sup> The Thornton and Findern manors as high-status rural dwellings likely followed the tripartite plan, although this cannot be confirmed without further archaeological investigation of the two sites. As little is known about theorised urban mercantile owners of household manuscripts, it is difficult to infer much about the houses the manuscripts were used in beyond a general understanding of urban dwellings. I deemed that Gainsborough Old Hall and Barley Hall were sufficiently appropriate equivalents to these urban and rural dwellings to use as the settings for my experimental performances. Whilst Gainsborough Old Hall is higher-status than the surmised houses of rural owners of household manuscripts, with extensive rooms across several large wings (conceivably containing multiple additional spaces used for leisure activities that relegated the hall to a mainly formal space), practical factors like established academic connections and its location within easy travel of the University of York made it the most convenient site to act as a counterpoint to Barley Hall.

Although both sites feature post-medieval material (such as the modern infill in Barley Hall's walls or the cast iron throughout Gainsborough) and the layer of interpretative signage necessary to communicate to visitors, they both also presented reconstructed interiors roughly fitting for the fifteenth century. The showcasing of meticulously-crafted reproduction furniture and fittings allowed for the experiments to engage deeply with the affordances of medieval spaces and experience their adaptability for different usages. The use of these surviving or reconstructed medieval houses became critical to my practical investigation of reading practices. By situating reading experiments in these sites, participants were able to engage with the entire spatial and embodied experiment of reading.

The two sites are not without limitations. The experiments used locations for reading taken from historical sources – the hall, chamber and parlour. At both sites we were granted access to all publically-accessible spaces and were able to select appropriate settings for the experiments at our leisure, using the model of historical performance

---

<sup>144</sup> Robbins, 'The Findern Anthology', 624–25.

examples and the intuitive responses of the participants to the spaces to guide the settings. At Gainsborough, however, the experiments took place during regular open hours and we had to take care not to interfere with the experience of other visitors and to minimise their presence in the video footage. The halls of both sites were well furnished (although Gainsborough somewhat sparsely due to ongoing reinterpretation works), however, neither had a fully furnished and reconstructed main bed chamber. The parlours in both sites also posed challenges. The original parlour in Gainsborough Old Hall is now the café and gift shop so was not able to be used. The parlour in Barley Hall followed a different interpretation to the parlour in the *Troilus and Criseyde* exemplar, but proved an illuminating experience in the affordances of reconstructed spaces compared to their historical forms. The impact of these factors on the performances is discussed in more detail throughout Chapter 4.

In both cases, original access models have been disrupted by later alterations or the encroachment of neighbouring buildings, which influences the overall impression of the houses as a whole. Gainsborough is *more* connected, with later newel staircases linking more rooms and the provision of direct access between the West Range and the hall. In Barley Hall originally permeable spaces like the hall are cut off from the rest of the house, whilst semi-communal spaces like the parlour have become permeable in order to access the rooms on the other side of the public right-of-way. This is illustrated clearly by Elizabeth Stewart's access analysis diagram of Barley Hall (Figure 3.9). The seventeenth-century alleyway has imposed an entirely modern distance between the hall and the service rooms, completely upending hierarchical movement within the hall.<sup>145</sup> Imagining the service of food in the current access plan necessitates a route that traverses almost the entire house – from service rooms, up a staircase, through the parlour, across the gallery space in the seventeenth-century addition, down another staircase before entering the hall at the high end. In Gainsborough, the visitor can wander freely through the house and engage with the site in the order they choose, but Barley Hall guides visitors along a specific path and the ability to retrace the very disparate customary paths and access routes of different members of the household is impeded.<sup>146</sup>

---

<sup>145</sup> Stewart, 'A History of Historic House Reconstruction: Understanding the Past and Informing the Future'.

<sup>146</sup> For a discussion of access patterns of different members of an elite household, see: Austin, 'Private and Public: An Archaeological Consideration of Things'.

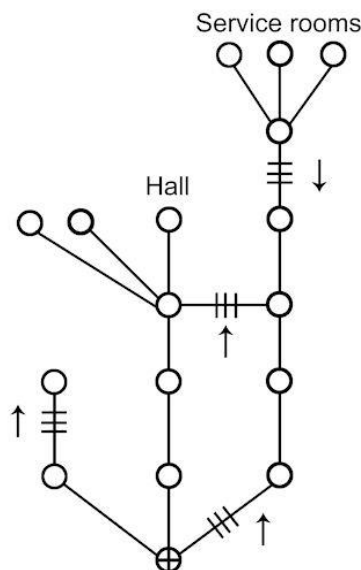

Figure 3.9: Stewart's access analysis diagram of Barley Hall. Note the isolated position of the hall.<sup>147</sup>

Barley Hall's reconstruction that combines recreated – but not original – medieval reality with modern-day fabrication felt like a striking analogue of the reading experiments themselves. Barley Hall is a *simulacrum* of a medieval hall: it is a copy that has replaced the original, albeit a highly-informed copy that uses medieval materials and the archaeological evidence from the investigation of the site.<sup>148</sup> In both buildings, despite the limitations of both reconstructions, participants felt as if they were in a medieval space. The buildings became tools for investigating our modern experiments with the medieval material – texts, reading practices and spaces – and for reflecting on possibilities raised about historical practices. The accuracy of the reconstruction mattered less than the shift in mindset it encouraged, allowing modern readers to critically analyse their engagement with the past. Stephen Saraydar reminds us that the goal of experimental archaeology is to explore possibilities – “how something *might* have been made or used in the past” – not necessarily to prove that this *was* how it was.<sup>149</sup> The main goal of the experimental archaeologist is to make a meaningful connection between the investigated behaviour in the past and the experimental data in the present. In this way, Gainsborough Old Hall and the reconstructed Barley Hall offered highly effective settings for reimagining and re-experiencing medieval communal reading.

<sup>147</sup> Stewart, ‘A History of Historic House Reconstruction: Understanding the Past and Informing the Future’.

<sup>148</sup> Baudrillard, *Simulations*.

<sup>149</sup> Stephen Saraydar, *Replicating the Past: The Art and Science of the Archaeological Experiment* (Long Grove, Illinois: Waveland Press, 2008), 28, 20.

### 3.9 Conclusion

This chapter has explored the spatial and material elements of medieval reading practices through the lens of the medieval house. Domestic communal reading has left few specific traces that can be reconstructed by a modern practitioner. However, the survival of the focus texts in manuscripts with a clear domestic usage context and reference to related literary, visual and material sources provide the building blocks for reconstructing historical reading practices. The setting of these reading activities in various locations throughout the house – particularly the hall, chamber and parlour – necessitates a clearer understanding of the history, location and meaning of these spaces, as well as a broader picture of the dwellings associated with the rural gentry and urban elite owners of household manuscripts. Communal leisurely reading shapes and is in turn shaped by these spaces in which it takes place. Whilst some activities in the medieval house are fundamentally connected to certain spaces – cooking in the kitchens or even in the hall, sleeping in the chamber, formal dining in the hall – reading could be located anywhere that fitted the wishes of the readers as was appropriate to the setting. Professional performative reading to accompany formal events took place in the hall, but the hall could also support reading to accompany communal chores or casual reading after the formalities of feasting had concluded. The chamber provided a more exclusive space for communal activities, but was also the primary location for solitary devotional reading.

Reading as an embodied experience encounters the text physically and multisensorily. The book exists as a physical object; the performance exists in a particular space and the reader and audience perceive the text through multiple embodied senses. Examination of medieval buildings and spaces can inform this second level of spatial analysis, but further investigation is best achieved through practical experimentation, as we will see in Chapter 4. Alongside this model of flexible reading is a clear argument for houses as flexible spaces, adaptable for different activities by the use of moveable furniture and soft furnishings supports. This chapter has suggested that it is not the locations themselves that are most important, but the affordances of the spaces, how the reading events transform them and how in turn they transform the reading events. In this way, a discussion of space should not only focus on the physical location and its contents, but also the embedded social constructs as well as the role of spaces in shaping the identities and activities of those who inhabit them. These considerations are important to consider not just in theory, but also in practice when considering reconstructed historical spaces and evaluating their utility.

The two historic buildings discussed here provided the material and spatial setting for the reading experiments. Awareness of their history and the different paths towards

their current forms as heritage attractions shaped the performance scenarios that were possible within them. Gainsborough Old Hall allowed participants a wider impression of a more complete medieval dwelling and we were able to move through the spaces more like the medieval inhabitants would have done. Limitations in the reconstruction, like the wall hangings and more simplistic furnishings made some experiments more limited in effectiveness. Barley Hall raised fundamental questions about the value of original historical material and the ethics of reconstruction, alongside questions of authenticity in heritage attractions. Its reconstruction, presented more extensive furnishings and a wider variety of spaces but also erased multiple centuries of past usage – even, to an extent, its actual medieval usage. Both sites provided a full *simulacrum* of a historical space in which we could shape and interact with furnishings, fittings, lighting, sound and stage historically-informed reconstructions of medieval reading that were materially and spatially engaged.



# CHAPTER 4. Staging Experimental Performance and *Reauralising* Romance

## 4.1 Introduction

*“texts rooted in oral performance retain enough information that audiences educated in that context can reenter the original performance arena”<sup>1</sup>*

Joyce Coleman’s seminal work on public reading established firmly the evidence for reading aloud – or, as she terms it, prelection – as a common modality in later medieval England and France.<sup>2</sup> This thesis so far has used Coleman’s compelling evidence as a foundation to pose the question of exactly how this reading aloud might have taken place and what, in particular, domestic leisurely prelection might have looked like. In this chapter I move beyond theoretical analysis of performance to a first-hand practical investigation of later medieval domestic reading. As Michael T. Clanchy points out, a musical score is not a replacement for music, even though while looking at the score a musician can hear the music in their head: in the same way, we cannot fully investigate the performance of medieval romance without attempting to actually perform and *reauralise* it.<sup>3</sup> Whilst depictions of medieval reading practices in literature, iconography, historical accounts or other sources – as we examined in previous chapters – provide a base for historical performative reading, they do not amount to an entire practice which modern practitioners can accurately reconstruct. The nature of performance precludes recording without losing its innate qualities and thus any investigation of historical performance practices is founded on speculation. We must use these brief glimpses of an entire system of reception to inform our modern interpretations and experimentation, yet we must also acknowledge that they constitute only fragments of a practice. As with all such investigations, recreating medieval performance is often more revealing about modern practices and experiences than historical reality. However, the value of this kind of study lies in the questions it encourages scholars to ask once they engage with source material in different modalities. It also suggests new possibilities and avenues of engagement for us today, both for scholars of the past and visitors to heritage sites.

---

<sup>1</sup> Zaerr, ‘*The Weddyng of Sir Gawen and Dame Ragnell: Performance and Intertextuality in Middle English Popular Romance*’, 195 paraphrasing John Miles Foley, *The Singer of Tales in Performance* (Bloomington: Indiana University Press, 1995), 213.

<sup>2</sup> Coleman, *Public Reading and the Reading Public*.

<sup>3</sup> Clanchy, *From Memory to Written Record: England 1066 - 1307*, 287.

This chapter focuses on a series of experimental performances I conducted to practically investigate communal performative reading of romances from household manuscripts. I held two main performances: a series of workshops teaching participants Middle English and performance skills which culminated in two sessions in Barley Hall in York in 2019 and a day of experimental reading aloud in Gainsborough Old Hall in Lincolnshire in 2021.<sup>4</sup> I also conducted a performance seminar at Leeds International Medieval Congress in 2019 and a series of informal test performances at home, both with and without audiences (2017-2022). The spaces of Barley Hall and Gainsborough Old Hall became another means by which to engage with the texts on a deeper level and to examine more closely the experiences of modern readers of medieval material, changing reading and spatial practices, and thus considering the experience of reading in the fifteenth century. We staged simulations of medieval performative reading in multiple rooms and spaces in the houses, based on locations for communal reading aloud depicted in medieval sources: the great hall, a bed chamber and the parlour. In returning reading from household manuscripts to a domestic setting and returning romances to aural/oral reception practices, I gave modern readers the chance to experience medieval texts in modes and methods closer to their original reception, resulting in qualitatively different experiences of the texts from how they would encounter them as modern scholars. Unlike the performance exemplars discussed in Chapter 1, these experiments present romance-reading as *reading*, rather than as theatre: that is, centring the practice of reading itself over simply performing the text, and including the entire process of deciphering, with all the vibrancy, spontaneity and errors this involves. The fluency of the performance is provided by education in language and manuscripts rather than memorisation and rehearsal, in order to more accurately recreate the amateur reading being investigated.

This chapter will analyse these performance experiments, tracing the changing experiences of reading through the observations and subjective reflections of myself and the participants, which were collected in the form of verbal and written feedback.<sup>5</sup> Studies of historical reading practices frequently focus on historical literacy rates and reading education, with very little on the physical and embodied experience of reading. I looked to modern linguistics and psychology to help explain our changing experiences of reading in

---

<sup>4</sup> The session at Gainsborough Old Hall took place during the Covid-19 pandemic. Although the disruptions to this experiment session were mainly logistical in nature, delaying the experiment date, the pandemic undoubtedly influenced the participants and public visitors in subtle ways, such as the number and make-up of participants. We were fortunate that safety guidelines were compatible with the planned performances so that the historically-informed reading practices did not need to be adapted, for example, to social distancing and mask-wearing measures. Preliminary sessions were held as online meetings rather than in-person, which did allow easier participation from those outside of York.

<sup>5</sup> Related supplementary material is reproduced and compiled in Appendices B-D.

different modalities. I also continue to draw on experimental archaeology, buildings archaeology and performance theory, combined with literary and palaeographical analysis to return to the central questions of this thesis: how can romances in household manuscripts be read and engaged with effectively by medieval and modern readers; what happens when we return a medieval text to a reception context that is modally, physically and spatially similar to how it would have originally been received; how can we give modern readers and scholars the tools necessary to do this; does this reveal possibilities for historical performative reading; and does this offer any benefits for modern readers, students and visitors to heritage sites? By combining practical experimentation with scholarly research I model a *simulacrum* – not an exact recreation – of historical reading practices, explore possibilities for historically informed performance as a pedagogical tool, and encourage deeper engagement with medieval texts and reading modalities. This joins the scholarly defence of romances, adding a practical investigation to the extensive body of literary and historical analysis, and further reframing how romances can be considered as a performative genre.

## 4.2 Performance Overview

Modern readers of medieval romance face many obstacles and challenges in reading and performing the texts that medieval readers would not have encountered. A highly literate and audiate fifteenth-century reader would easily understand the language of the romances, recognise tropes of the genre and rhetorical strategies, as well as any references to contemporary texts, Biblical or devotional material both aurally and visually. There were certainly many less literate and audiate or less familiar with romances who nonetheless participated in communal readings, yet imagining an ideal romance-reader reveals the gaps between medieval and modern experiences, as well as deficiencies that contextual fluency training can attempt to address. From a lifetime of education and enculturation a fully contextually-fluent romance-reader would know instinctively how to respond to the cues of the narrator-performer, such as in their introductions, petitions for attention or prayers. These responses are as lost to us today as the original performances. We will never know if a performer of *Havelok the Dane* received a cup of ale at their request (l. 14), or if the Findern annotation was ever performed or answered. However, we can see their effect on a modern audience if they are enacted today. I theorised that it was possible to instruct a group of participants already well-versed in medieval history and literature to become a ‘contextually fluent’ audience for reauralising medieval romance and thus come closer to historical reading practices. This term and approach comes from Linda Marie Zaerr’s

performances at the International Congress on Medieval Studies in Kalamazoo, Michigan in which the medievalists stand in for an audience whom John Miles Foley envisioned would allow texts from a performative tradition to successfully “re-enter the original performance arena” and thus reveal insights about their original performance.<sup>6</sup> A contextually fluent audience is more responsive to changes in understanding and impact caused by the return to an original context. For the Barley Hall performances, I conducted a series of workshops to teach the participants the relevant skills in Middle English language, deciphering manuscripts and reading aloud, focusing on the romance *Sir Eglamour of Artois*. Each workshop challenged participants to read in successively more medieval modalities, beginning with encountering the text in a modern critical edition, as most modern scholars read it today, then progressing towards a *simulacrum* of historical performative reading practices where participants read the text and heard the text read from a manuscript facsimile in a historical space. The Leeds session brought these findings to a mixed audience spanning highly-skilled academics to enthusiastic amateurs and tested historically-informed reading practices with this mixed group. I introduced my research then read the same passage from the opening of *Sir Eglamour of Artois* from the Li 91 facsimile. Participants then formed small groups and read aloud excerpts from the same romance using either the Li 91 facsimile, the CCAii edition, the TEAMS edition or modern English translations I had prepared. Due to the modern setting, however, the Leeds session functioned predominantly as a means to showcase my research and test my methodology in a different context, rather than forming a central part of the experimental investigation, so aside from use as a point of comparison, I will focus mainly on the Barley Hall and Gainsborough performances. In the Gainsborough session, I sought out participants with knowledge and familiarity with Middle English and performance, aiming to shortcut the preliminary workshops and build on the conclusions from Barley Hall. A selection of excerpts from a wider pool of romances were used. In the Barley Hall workshops, participants were prompted to think critically about the changing experience of reading the romance in different modalities, whereas the Gainsborough session focused on ways to shape and change readings of texts within a single modality.

I recruited participants from universities across the UK, although most were from the MA and PhD cohorts at the University of York’s Centre for Medieval Studies.<sup>7</sup> Students study interdisciplinary courses combining areas such as medieval history,

---

<sup>6</sup> Zaerr, ‘*The Weddyng of Sir Gawen and Dame Ragnell: Performance and Intertextuality in Middle English Popular Romance*’, 195; Foley, *The Singer of Tales in Performance*, 213.

<sup>7</sup> I recorded video footage and collected anonymised feedback from the participants in the Barley Hall and Gainsborough Old Hall experiments using the procedures outlined by the University of York’s ethics guidelines. The associated Information Sheet and Informed Consent Form are reproduced in Appendix D. The videos are attached and detailed in Appendix B.

literature, archaeology, history of art, palaeography and medieval languages. As such, there was a wide range of Middle English and palaeography abilities, from those who had never encountered original Middle English texts or manuscripts before to those who regularly used them in their own research. A few had read or studied the romances performed before, but only in a formal scholarly context such as reading it for classes, teaching or for analysing in an essay or dissertation. Thus most had a very pragmatic understanding of the romances with a focus on textual analysis engaging mainly with the themes and issues that modern scholarship has deemed important. None had ever performed Middle English romance before. In the Gainsborough experiment, participants had very limited performance experience, although most in the Barley Hall experiments had performance experience through involvement with an amateur dramatic group in the Centre for Medieval Studies at York – the Lords of Misrule – which stages adaptations of medieval texts for modern audiences.

The experiments did not seek to produce a polished or masterful performance as by a trained professional, but rather an informal, everyday type of performance that simulated a communal activity shared among a close group of family and/or friends. Only basic performance principles were required, such as modulating the voice and moving the body to support messages and meaning, and working performatively within non-theatrical spaces. These were discussed during preparations, modelled within my own performances, or brought by those participants with performance experience. The original domestic readers of romances may not have had training or specific knowledge of theatrical principles, however, they would be exposed to performance techniques through educational practices, devotional activities (especially priestly sermons), drama and music (both professional and amateur or impromptu), and pageantry.<sup>8</sup>

Experimental performances are a constant balance between inferring about medieval experiences and the awareness that this reflects more on our modern experiences. Even an experienced and contextually-fluent participant cannot ever replicate the experience of actually being a medieval reader. Although, as discussed in Chapter 3, phenomenology and experimental archaeology can suggest a connection between past and present founded on embodied experiences and technical or physical limitations, we can never truly know the extent of these shared experiences. Azéma encourages the combination of personal intuition and scholarly research in performance reconstructions, as

---

<sup>8</sup> Sheila Lindenbaum, 'Drama as Textual Practice', in *Middle English*, ed. Paul Strohm, Oxford Twenty-First Century Approaches to Literature (Oxford: Oxford University Press, 2007), 388–93; Orme, *Medieval Children*; David Sheffler, 'Late Medieval Education: Continuity and Change', *History Compass* 8, no. 9 (2010): 1067–82; Nicholas Orme, *English Schools in the Middle Ages* (London: Menthuen, 1973).

medieval and modern performers share the same bodily and physical limitations.<sup>9</sup> Nevertheless, it is important to be aware of the conventions, assumptions and knowledge that modern readers bring to medieval material, and to not confuse modern possibilities with historical reality.

### 4.3 Method and Aims: Putting Performance into Practice

The following section summarises the performances and reflects on their experimental methodology. For the Barley Hall performances, participants sight-read already-familiar excerpts, whereas in Gainsborough, participants were encouraged to lightly prepare their performances in advance. The full list of reading scenarios is tabulated in Appendix B but is summarised here:

- Barley Hall :
  - Experiment B 1.1: My informal reading in the hall (*Sir Eglamour of Artois*, Li 91, ff. 138va-139vb)
  - Experiment B 1.2: Listeners seated at high and low tables taking on ‘social roles’ in the hall (*Sir Eglamour of Artois*, ll. 631-72)
  - Experiment B 1.3: Musical accompaniment in the hall (*Sir Eglamour of Artois*, ll. 778-882)
  - Experiment B 2.1: My reading in the chamber, with participants doing domestic chores (*Sir Eglamour of Artois*, Li 91, ff. 138va-139vb)
  - Experiment B 2.2: Reading in the chamber reminiscent of Vitz’s ‘erotic reading’.<sup>10</sup> (*Sir Eglamour of Artois*, ll. 631-72)
  - Experiment B 2.3: Reading in the parlour with one prelector (*Sir Eglamour of Artois*, ll. 1246-320)
  - Experiment B 2.4: Reading in the parlour with participants taking on characters (*Sir Eglamour of Artois*, ll. 631-72)
- Gainsborough Old Hall
  - Experiment G 1.1: My informal reading in the hall, with participants listening (*Sir Degrevant*, Findern MS, ff. 98r-v)
  - Experiment G 1.2: My informal reading in the hall, with participants doing domestic chores (sewing) (*Sir Degrevant*, Findern MS, ff. 98r-v)
  - Experiment G 2.1: Listeners seated at high and low tables taking on ‘social roles’ in the hall (*Sir Isumbras*, Heege MS, ff. 48r-v)
  - Experiment G 2.2: Reading in the bay window (*Sir Isumbras*, Heege MS, ff. 48r-v)
  - Experiment G 3: Formal performance without using the formal hierarchy of the hall (*Sir Eglamour of Artois*, Li 91, ff. 142va-b)
  - Experiment G 4: A performance as if by a professional storyteller to audience seated at high table in the hall (*Sir Degrevant*, Findern MS, ff. 104v-150ra)
  - Experiment G 5.1: Formal reading in the chamber (*Sir Orfeo*, Ashmole 61, ff. 151v-152r/ll. 48-118)
  - Experiment G 5.2: Informal reading in the chamber (*Sir Orfeo*, Ashmole 61, ff. 151v-152r/ll. 48-118)

<sup>9</sup> Azéma, “‘Une Aventure Vous Dirai’: Performing Medieval Narrative”, 218.

<sup>10</sup> Vitz, ‘Erotic Reading in the Middle Ages: Performance and Re-Performance of Romance’.

- Experiment G 1.1: Another informal reading in the chamber using a booklet (*Sir Eglamour of Artois*, CCAii, ff. 9ra-b)

The formats of the performances were drawn from my research into historical performance and impromptu suggestions from the participants in response to the spaces. Techniques were particularly inspired by Brian J. Levy's discussion of fabliaux performance fundamentals from the *artes praedicandi* (arts of preaching) to inform fabliaux performance, such as the effect of the speed of delivery and its potential to represent the mood of the piece, the modulation of the voice to mimic characters, the power of vocal inflection to subvert the words spoken, the impact of the physical book, plus general principles of gesture, facial expressions, mime and the use of silence.<sup>11</sup> I also compiled types and examples of gestures from Quintilian's *Institutio Oratoria*.<sup>12</sup> Some of the performance techniques used in Barley Hall were purely conjectural: reading as assigned characters was deliberately chosen to reflect many modern performances of medieval texts as I was curious to see whether it was viable in our simulated medieval performance setting.

The first part of the Gainsborough experiment was a sensory observation exercise in the hall, designed to provide a common foundation upon which participants could build in the performances. Performance is a moment of embodying a text, and thus awareness of the bodily experience in a space absent of the text provides a baseline for then comparing our embodied experiences as performers. Inspired by Susan Kozel's methods for a "phenomenology of lived experience", we deliberately and mindfully took a moment to experience the space. The participants and I recorded our observations about the space based on simple prompts like 'what can I see?', 'what can I smell?', 'how does my body feel in this space?'.<sup>13</sup> The exercise accustomed participants to the surroundings of the site and allowed them to better attune to the varied performance methods of the experiments. By directing the focus of participants, feedback became more nuanced than that received in Barley Hall.

I began the reading performances Barley Hall and Gainsborough Old Hall by modelling one interpretation of a communal domestic reading event. In the two sessions in Barley Hall I read the opening of *Sir Eglamour of Artois* from Li 91 (ff. 138va-139vb,

---

<sup>11</sup> Levy, 'Performing Fabliaux', 131–37.

<sup>12</sup> For example change the angle of your head to suggest different emotions (grace, humility, arrogance, languor, anger); direct your gaze (turning away); use your hands to point, demand, supplicate, count or measure or to show sorrow, confession, dismissal, approval, wonder or shame; use mimicry to illustrate the action (feel a sick person's pulse, play the air harp). Marcus Fabius Quintilianus, *The Institutio Oratoria of Quintilian in Four Volumes*, trans. H. E. Butler, vol. Vol. 4, Loeb Classical Library (London: Heinemann, 1922), 281–310.

<sup>13</sup> Susan Kozel. *Closer: Performance, Technologies, Phenomenology*. Cambridge, MA: MIT Press, 2008, pp. 52-3.

equivalent to TEAMS, ll. 1-174) and in Gainsborough I read a passage from the Findern MS *Sir Degrevant* (ff. 98r-98v, equivalent to TEAMS, ll. 273-368). (Experiments B 1.1, B 2.1, G 1.1 and G 1.2) The first reading at Barley Hall and my reading in Gainsborough were both located in the hall. I sat at the low side table closest to the bay window and the participants gathered around the same table, to simulate an informal performance. Rather than play with the spatial hierarchies of the hall, I showcased its potential as a multi-purpose space, locating myself in a relatively neutral place that offered the best light (see Figures 4.1 and 4.2). My first reading in Gainsborough was staged with the participants sitting and listening, and I repeated the same excerpt with the participants sewing or embroidering to simulate reading to help pass the time whilst completing domestic chores. In Barley Hall, being later in the day and close to midsummer, light came in from the north-west facing bay window as well as through the open viewing window onto the public right-of-way that cuts through the old screens passage, which I had neglected to close off with curtains, accidentally providing some additional light. In Gainsborough, strong sunlight came through the south-west facing windows on the opposite side of the hall onto the table.



Figure 4.1: Snapshot from reading experiment in the hall at Barley Hall reading the opening of *Sir Eglamour of Artois*. (Experiment B 1.1) Participants are seated at a low side table underneath the bay window and the windows of the screens passage/public right of way can be seen in the background.





Figure 4.2: Snapshot from reading experiment in the hall at Gainsborough Old Hall reading excerpt from *Sir Degrevant*. (Experiment G 1.1) Participants are seated at a low side table and the stone bay window can be seen in the background.



Figure 4.3: Snapshot from reading experiment in the ‘lesser chamber’ at Barley Hall reading the opening of *Sir Eglamour of Artois*. (Experiment B 2.1) The reader is seated on the bed and listeners are gathered around seated on a bench and on the floor. Out of frame to the right hand side is the chamber window.

My second reading in Barley Hall was in the chamber (Figure 4.3), which had a south-east facing window. Originally it was planned for the parlour to mimic the romance-reading in *Troilus and Crisseyde*, however, a notable difference in lighting quality encouraged the change of setting. I sat on the edge of the bed in the chamber while the participants gathered around and sat either on the floor or on a bench and either sewed while they listened or took notes. We relied on natural daylight and, as far as possible, the

modern lighting was turned down or off. As discussed in Chapter 3, additional light required for medieval reading would have been provided by the central hearth and candles or lamps, making reading accessible throughout the year in multiple spaces, however, it was not possible to experiment with historical artificial lighting due to safety concerns. Such an investigation would address the impact of different qualities of light on reading, such as the difference between stable daylight and the flickering of fire- or candlelight for deciphering manuscripts, a comparison of different lighting methods, and the affective power of light in shaping performances.<sup>14</sup> A more immersive and sensorily-detailed reading investigation could also consider the smellscape of domestic reading, such as wood-smoke, beeswax or tallow candles, oil lamps, the reeds or herbs on the floor, cooking from the kitchen or hearth fire, or food served in the hall (especially for formal reading over mealtimes).

I kept my performances neutral and conservative, without introducing any subversive readings. I took care to verbally signal the shift from narrative to direct speech using pitch and tone, pause at transitions, convey the emotions of the words to aid comprehension, and to use simple gestures to support the sense of key words, with directions, numerals, questions or declarations being the most common. For example, for the repeated formula in *Sir Degrevant* “both with spere and with scheld” I gestured first to one side then the other to add contrast; I spread my hands and looked upwards to indicate the meaning of “Bot He that all weldus” and to support the opening prayer of *Sir Eglamour of Artois*; I mimed violent strikes to words describing combat in both sections and I held up two fingers to illustrate “maydyns twa” (f. 139rb). Although the Findern annotation on f. 98v is post-medieval, I included it in my performances at Gainsborough hoping to elicit a response from the listeners. The presence of the fitt division and addition felt natural in the context of reading aloud, and although the listeners did not verbally respond, it drew their attention more strongly than the lines immediately before it and the playful question then signalled that their attention could be relaxed. This moment of tension and release is visible in the video footage and was very palpable in person. Hardman’s suggestion that similar fitt divisions could be improvised in appropriate locations felt plausible in performance.<sup>15</sup>

After my performances, participants were invited to read short three- or four-minute excerpts from a selection of romances: in Barley Hall, passages from *Sir Eglamour of Artois* (Li 91 and CCAii) and in Gainsborough passages from *Sir Eglamour of Artois* (Li

---

<sup>14</sup> Eagan, *The Medieval Household: Daily Living c. 1150 - c. 1450*, 126–51; Eveleigh, *Candle Lighting*; Bille and Sørensen, ‘An Anthropology of Luminosity: The Agency of Light’, 274, 280; Bille and Sørensen, ‘In Visible Presence: The Role of Light in Shaping Religious Atmospheres’.

<sup>15</sup> Hardman, ‘Fitt Divisions in Middle English Romances: A Consideration of the Evidence’, 70.

91 and CCAii), *Sir Degrevant* (Findern), *Sir Orfeo* (Ashmole 61) and *Sir Isumbras* (Heege). I selected passages which I thought would have high impact in performance due to the dynamic events they depicted (battle scenes, moments of recognition and emotionally charged scenes), the clear delineation of character and action, the presence of extradiegetic cues and textual transitions (incipits or explicits, fitt endings, narratorial intrusions, page turns, changes of layout, citations of authority) and the possibility for their meanings to be altered by the performance methods and space/contexts. I ensured that a wide variety of poetic forms, textual formats and manuscripts social contexts were represented, with both tail rhyme and couplet romances, texts presented in booklet form and within a whole book, and manuscripts belonging to the rural gentry and the urban elite.

These performances did not aim to perfectly recreate medieval performance or stage something technically brilliant, but to simply *reauralise* the romances. How then do we measure the success of these experiments? A successful performance is both *effective* and *affective*: it transcends the space and time of its reception and transports the audience to another state of mind.<sup>16</sup> Measuring the success of the performance is thus not a reflection of the skill of the performer or the quality of the text, but how the performer relates to the text, comprehends it, embodies it and transforms it. By understanding these principles and components, it is possible to analyse the performance and its impact more effectively, without concern for its perceived quality. My performance in Barley Hall was under-prepared, with many errors, as a deliberate way to investigate the whole act of reading, rather than test my ability to memorise a text. Unlike Richard Schechner who separates and contrasts efficacy and ritual performance with entertainment and theatrical performance I argue that both efficacy and entertainment, as well as active audience participation are fundamental elements of communal reading performance.<sup>17</sup>

An *affective* performance is one that touches the emotions of the audience. For example, Joyce Coleman cites a sermon summary about an emotional response to romance reading: ““One who is left unmoved by the story of Christ’s Passion read in the Gospel for Holy Week, is stirred to tears when the tale of Guy of Warwick is read aloud.””<sup>18</sup> Similarly, multiple philosophers and scholars have noted the transformative power of musical performance. Isidore of Seville writes: “Musica movet affectus, provocat in diversum habitum sensus” (*Music moves emotions, stirs feelings to diverse states*).<sup>19</sup> An

---

<sup>16</sup> Azéma describes how use of gesture and spatial relations transforms the physical space of the stage into a larger metaphysical space of the imagination; see also the discussion of performance time in Chapter 1. Azéma, ““Une Aventure Vous Dirai”: Performing Medieval Narrative”, 215; Stone, ‘Time in African Performance’, 124–45; Zumthor, *Towards a Medieval Poetics*, 11.

<sup>17</sup> Schechner, *Essays in Performance Theory*, 149.

<sup>18</sup> Coleman, *Public Reading and the Reading Public*, 29.

<sup>19</sup> (My translation.) In the case of music specifically, Isidore believed that the connection to the universal music, the music of the spheres, was the source of this transformative power, but this

affective performance does not always require the audience to be brought to tears or laughter, but rather, that the performance should induce an altered mindset. This was a particularly crucial aim for my performance experiments as I hoped that the *simulacrum* of historical performance could evoke a shifted perspective in the participants. Participant feedback confirmed the success of this altered mindset as they were encouraged to interrogate their own reading practices and to contemplate historical practices. Feedback did also reflect the emotional power of the excerpts in performance. In a reading of *Sir Orfeo* in the chamber at Gainsborough in which the reading accompanied other activities (G 5.2), one participant who was pretending to silently read another book found their attention drawn to the prelector in key moments of tension and emotion, such as when Queen Heurodis/Meroudys cries and scratches at her face as Orfeo begs her to stay.

An *effective* performance is one built on the foundations of good rhetorical and dramatic techniques (pronunciation, movements, intonation and delivery) to deliver the sense of the story to the audience. These techniques should only serve the performance, never detract from it. Karl Reichl describes the ideal of a professional Turkic ‘singer of tales’: “Despite all his skill and individuality, the singer recedes as it were into the background and becomes the vehicle for a traditional tale and the way it is traditionally performed.”<sup>20</sup> In an ideal performance, the performer is secondary to the narrative they convey and their means of conveying it: they should not take attention away from the story due to poor skill or misjudged delivery. Linda Marie Zaerr also notes the importance of an unobtrusive and fluent delivery by the performer: “Given a choice between hesitating and being true to the text or managing to say something to maintain the pace, a performer must choose to keep the pace. It is of primary importance to keep the audience involved and unaware of the performance dimension, so that their focus remains on the tale or song itself rather than on the performer and the mechanics of presentation.”<sup>21</sup> In a narrative performance, the focus should remain on the narrative, not the performance.

Essential for an affective and effective performance is comprehension: the performer must understand the words and the story they convey and must present them so that the audience can also understand. Therefore, in preparation for the experimental performances, I briefed participants in Middle English pronunciation. Pronunciation makes much of the vocabulary comprehensible: often Middle English orthography obscures

---

connection could only be realised through a skilled performer. Isidore of Seville, *Etymologiae*, *Book III*, ed. W.M. Lindsay (Oxford: Clarendon Press, 1911), Chapter 17.

<sup>20</sup> Reichl, ‘Turkic Bard and Medieval Entertainer: What a Living Epic Tradition Can Tell Us about Oral Performance of Narrative in the Middle Ages’, 178. ‘Singer of tales’ here references the performers of oral-formulaic stories as studied in Parry, *The Making of Homeric Verse* and Lord, *The Singer of Tales*.

<sup>21</sup> Zaerr, ‘*The Weddyng of Sir Gawen and Dame Ragnell*: Performance and Intertextuality in Middle English Popular Romance’, 200.

familiar words which correct pronunciation can reveal. Correct pronunciation makes it easier for readers to spot cognates and thus to infer the meaning of unfamiliar words, such as “ayere” (heir) (Li 91, f. 138va) and especially in the cases of words with unfamiliar letters like  $\text{ʒ}$  or  $\text{þ}$ : “ $\text{ʒeve}$ ” (give), “ $\text{nyʒt}$ ” (night) and “ $\text{duʒty}$ ” (doughty) (CCAAi, f. 5va). Similarly, incorrect pronunciation leads readers to false cognates: for example, one less-experienced reader pronounced “harde” (Heege MS, f. 48r, equivalent to TEAMS 1. 8) as “hard”, identifying the final e as unstressed and eliding it, therefore interpreting the word to mean “hard” rather than the correct “hardy”, which would have been apparent with the final e pronounced. I used the pronunciations and general principles outlined by Norman Davis and by E. J. Dobson’s study of later English, with reference to research conducted by Jeannette Marshall Denton as part of the Reading Malory Aloud project.<sup>22</sup> I distributed a handout to participants that synthesised these principles, which is reproduced in Appendix C. I focused on London ‘standard’ Middle English for reasons of transferability and simplicity as the manuscripts feature a variety of dialects. In the past, Middle English education focused almost entirely on preparing readers for the artful poetry of canonical texts by major authors, especially Chaucer (so much so that ‘Chaucerian English’ is a shorthand for London standard Middle English) so models for teaching Middle English offered little advice for teaching romances specifically.<sup>23</sup> I taught the correct pronunciation of vowels, diphthongs and consonants using example words and call-and-response methods. I would demonstrate each sound, comparing it to a sound found in modern English or modern French, read an example word in Middle English containing that sound, and at each step the participants repeated it back. Learning Middle English as a primarily literary language has a different pedagogical focus than teaching languages for communication, however, my methodology aligns with techniques from the Situational Language Teaching method, in which the language teacher establishes models for students to repeat both as groups and individuals.<sup>24</sup>

Overwhelmingly, the participants’ feedback confirmed that they found it much easier to understand the meaning of the Middle English words and text when it was read aloud. One stated that they specifically found it easier when hearing it read aloud as opposed to reading it aloud themselves: the process of decoding to determine

---

<sup>22</sup> Norman Davis, ‘Introduction: Language and Versification’, in *The Riverside Chaucer*, ed. Larry D. Benson, 3rd ed. (Oxford: Oxford University Press, 2008), xxv–xli; E. J. Dobson, *English Pronunciation 1500-1700*, 2nd ed. (Oxford: Clarendon Press, 1968); Denton, ‘An Historical Linguistic Description of Sir Thomas Malory’s Dialect’.

<sup>23</sup> Walter William Skeat, *The Invention of Middle English: An Anthology of Primary Sources*, ed. David Matthews (Pennsylvania: Pennsylvania State University Press, 2000), 229, 231; Denton, ‘An Historical Linguistic Description of Sir Thomas Malory’s Dialect’. For the pervasive anti-romance bias in modern scholarship, see McDonald, ‘A Polemical Introduction’.

<sup>24</sup> Jack C. Richards and Theodore S. Rodgers, *Approaches and Methods in Language Teaching*, 3rd edition (Cambridge: Cambridge University Press, 2014), 44–54.

pronunciation can distract from decoding to comprehend the meaning of words. Learning Middle English in a reading-aloud context is helpful not just for performance, but for better understanding the language as a whole, and in turn for engaging more fully with the literary culture of its creation and reception. I chose to focus only on pronunciation rather than grammar or meter for efficiency, and an assumption that the romances chosen were metrically simple, being standard three-four stress lines.<sup>25</sup> However, this proved to be an erroneous assumption as in one performance, the reader recited with a strict iambic rhythm, even when this did not match the source poetry. The forced iambic meter reading created an almost chant-like performance reminiscent of theorised musical romance performances to simple repeating melodies.<sup>26</sup> However, the irregular and frequently changing number of unstressed syllables in Middle English tail rhyme romance meant that the iambic rhythm often interfered with conveying the sense due to the mixture of non-stressed content words and stressed non-content words.

According to one workshop participant, the reading fluency of the performer above all else aided their comprehension: regardless of whether or not the pronunciation was correct, they were able to follow a fluent reading more than a non-fluent one. Significantly, this observation also separates the effectiveness of performance from the accuracy of performance, emphasising that a successful performer need not always be the most skilful, but one who realises the narrative most effectively. Modern literacy analysis provides comparable standards for performance fluency. Timothy Rasinski, a scholar of literacy education describes reading fluency as including “accuracy in word decoding, automaticity in recognizing words, and appropriate use of prosody or meaningful oral expression while reading.”<sup>27</sup> Rasinski argues that these elements lead to comprehension: “Readers must be able to decode words correctly and effortlessly (automaticity) and then put them together into meaningful phrases with the appropriate expression to make sense of what they read.”<sup>28</sup> These components of deciphering and appropriate delivery from a modern classroom are equally applicable to reading aloud medieval texts. The chief difficulty in reading aloud in Middle English or from a medieval manuscript lies in the first component of fluent reading: decoding and deciphering. When reading in an unfamiliar language, decoding is slower and may easily result in errors. Moreover, reading from a manuscript involves multiple layers of interpretation of the letter forms of the scribe,

---

<sup>25</sup> For discussion of meter and performance see Zaerr, *Performance and the Middle English Romance*, 105–40.

<sup>26</sup> See the discussion of this, particularly in relation to the musical setting of the *chansons de geste* in Chapter 1.

<sup>27</sup> Rasinski, ‘Issues and Trends in Literacy: Reading Fluency Instruction: Moving beyond Accuracy, Automaticity, and Prosody’, 704.

<sup>28</sup> Rasinski, 704.

abbreviations, as well as negotiating errors, erasures or obscuring marks on the page. The second element – automaticity – is built up over time and familiarity with manuscripts, scribal hands, the text itself and the romance genre, which is built upon many formulas and stock-phrases. Automaticity was assisted (or at least simulated) in the performances through careful preparation, repetition and practice of the text and language. Readers in medieval households likely read and reread the same texts so preparation allowed performers to approach this familiarity. The third component – appropriate expression – is the realm of the performance. The performative reader must build upon their own understanding of the content of the text, to shape appropriate diction and delivery and then present the text. Even if a listener cannot follow every word of the original language, there is still delight that transcends sense to be found in hearing a text performed. Thus it is vital that the performer understands and can meet the benchmarks of reading fluency and can support their performance with movement and appropriately modulated delivery: the audience can connect to the affective delivery if it is performed effectively.

In my performances of *Sir Eglamour of Artois* directly from the manuscript facsimile (B 1.1, 1.2) I specifically hoped to trigger deciphering errors because of what this reveals about the reading experience. This kind of error is very difficult to hide in performance. When reading silently, it is easy to pause and take the time to unravel a difficult word or line, or even to skip them. However, performance relies on immediate decisions about interpretation, even when the text has been prepared in advance, perhaps by silent study and solitary reading, or perhaps by annotation – as in Classical *praelectio* with *scriptura continua* texts. The errors – whether small trips or major misreadings – are revealing about the manuscript and the subtleties of Middle English verse.<sup>29</sup> Brief preparation accounted for the challenges of difficult vocabulary, dialect-specific words, unusual spelling and unfamiliarity with the scribal hand, which would be less difficult for the manuscript's original readers (especially Robert Thornton himself). I found no marks in the manuscripts that suggested preparation specifically for reading aloud, so I did not mark up the text. One relevant addition in the Heege manuscript would improve legibility for readers in all modalities, however: at some point in the manuscript's life, vertical strokes were added to separate letters in words across several texts, particularly in words

---

<sup>29</sup> Repeated errors or stumbling points were: the compressed writing at the top of f. 139va; small familiar words which are spelt differently in the Northern dialect (sa for so, na for no, twa for two) – “na child bot ane” (f. 138va), “Sa dose scho þat gentyll knight” (f. 138vb); two challenging p’ abbreviations: “þat hir were p(ro)firde swylke a thyng” (f. 139ra), “p(ar)te frende” (f. 139va); two lines with poor legibility “On þe rode als þu me boghte” (f. 139ra), “& rejoyse hir all(e) my lyfe” (f. 139rb); unfamiliar words and plentiful abbreviations “he nytyde vs neu(er) w(i)t(h) naye: (f. 139rb) and “Oure Menske for eu(er) & aye” (f. 139rb); and challenging word-spacing and letter-forms “I sall(e) avyse me of It” (f. 139va).

with several consecutive minims (Heege MS, ff. 4r, 62r, 63r, 71r, 138r and 198r; see Figure 4.4).

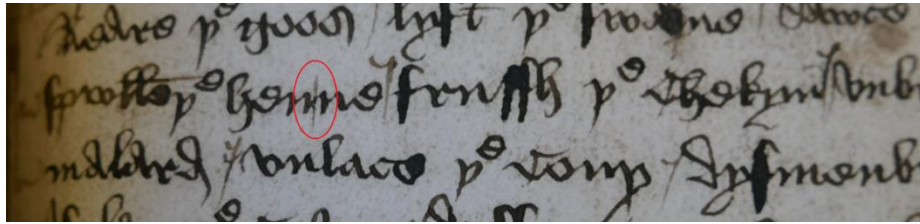

Figure 4.4: Detail of Heege MS, f. 62r showing separating line (circled in red).

When I observed recordings of my own reading, stumbling points were the result of several factors: poor legibility (erasure, small writing, indistinct letter forms) (Figures 4.5 and 4.6), unexpected variations on formulas, and complex units of sense longer than my sight-reading span. Sight-reading span is a term I use here to encompass both the qualitative experience of reading aloud and scientific understandings of eye movement in reading, referring to the amount of text that the reader perceives in each instant, both ahead of and prior to the current word. Cognitive psychologist Keith Rayner describes saccades – the continuous rapid eye movements in reading – and how they enable the reader to see several characters before and several words after the current word.<sup>30</sup> This metric reveals significant insight into the romance genre, which is discussed below.

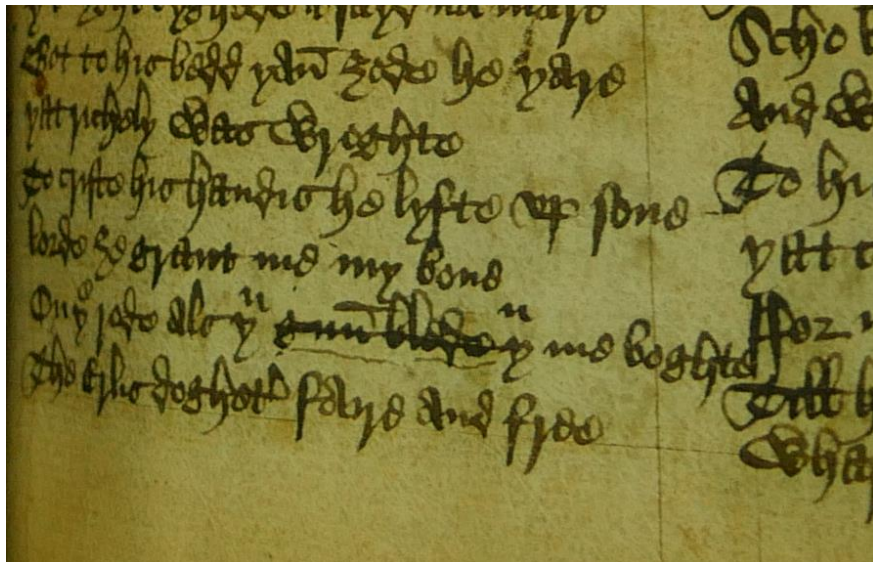

Figure 4.5: Detail of Li 91, f. 139ra. A challenging line: “On þe rode als þu ~~gun-blede~~ þu me boghte”

<sup>30</sup> Rayner, ‘Eye Movements in Reading and Information Processing’, 373–76.



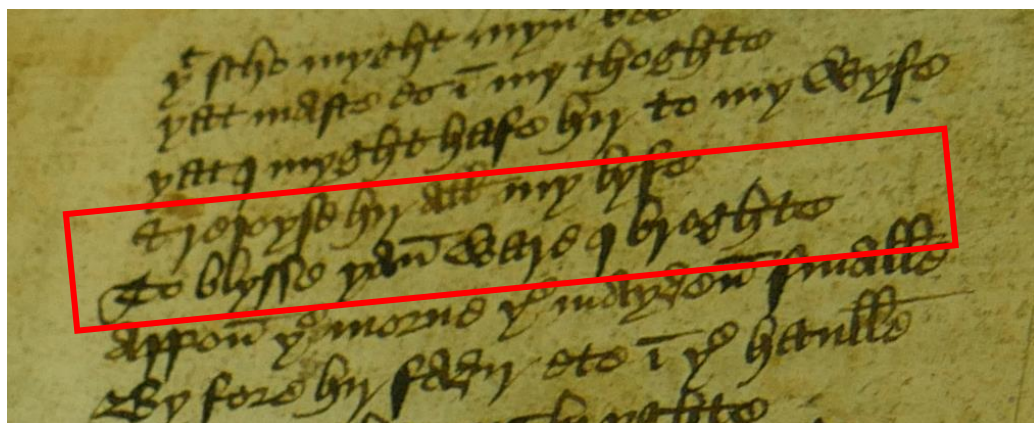

Figure 4.6: Detail of Li 91, f. 139rb, another challenging line (outlined in red).

In my chosen excerpt, an indistinct line on f. 139ra proved particularly challenging. (Figure 4.5) The erasure is bold and distracting with an indistinct ending point, causing erroneous repetition of “þu”. Figure 4.6 shows another challenging line: “& rejoyse hir all(e) my lyfe” (f. 139rb). Several of the letter-forms prove difficult to automatically decipher when reading aloud, not aided by staining on the page. The similar forms of the long ‘r’ and the ‘j’ in ‘rejoyse’ caused confusion, as well as the expanded ductus of the beginning of the word, and the overlap of the ‘j’ and ‘o’, which could be misread as ‘p’. Similarly, the overlapping of ‘l’ and the entry stroke of the ‘y’ in ‘lyfe’ make the word indistinct and the poorly-connected minims in “my” can prove difficult.

Some of my reading errors were due to familiarity with the tropes, formulas and style of Middle English romance: some unexpected variations caused errors, even with advance preparation. For example, I frequently expected ‘so god me *save*’ on f. 137va instead of “so god me see” and either paused or misread the line. In my performance of the Findern *Sir Degrevant* (G 1.1, 1.2) I automatically ‘corrected’ the poetry, changing “Both with spere and sheld” (TEAMS l. 285) to “Both with sper and *with* sheld” to match its later occurrence in the same passage (TEAMS l. 330, emphasis added). This is a common formula in the romance (it occurs three or four times, depending on manuscript witness) and I anticipated the latter version with two unstressed syllables, tripping over the rhythm of the line when it only had one.

Middle English romance also commonly signals speech by beginning the line with “the [character] said”. Two variations on this proved challenging in the excerpt of *Sir Eglamour of Artois*. Firstly, within dialogue on f. 139ra, a line begins “The Erle’s doghter” which I mistakenly interpreted as a change of speaker. Secondly, the dialogue signal on f. 139rb begins “*His* sqwyer sayd” rather than the expected ‘*the* squire said’, causing me to miss the cue to modulate my delivery to indicate direct speech. A similar error resulted from misinterpreting a time-marker which occurs within dialogue. The Earl instructs Christabel to visit Eglamour “aft(er) mete” (f. 139rb), however I mistakenly interpreted

this as a narratorial time transition. Linda Marie Zaerr traced errors in her memorised performance of *The Weddyng of Sir Gawen and Dame Ragnell* and argued that they were consistent with variations between different manuscript versions, following Murray McGillivray's suggestion for memorised transmission of romances.<sup>31</sup> My deciphering and comprehension errors provide insights into the experiences of the manuscript's medieval readers: it seems highly likely that these sources of errors would have also proved challenging to them. The manuscript's original readers must have been able to swiftly change their delivery in the moment of performance to account for these variations, or were more skilled in anticipating them. This adaptability is a key facet of audiacy and contextual fluency. The formalised signalling of modern publishing, with the inclusion of standardised punctuation, pagination and textual divisions has removed this layer of interpretation from modern reading aloud.

#### 4.4 Discussion: The Changing Reading Experience

The performances allowed modern readers to engage with medieval texts on a deeper level in modalities that are closer to their original reception modes. Feedback collected tracked whether engaging with the text in multiple reading modalities, performance techniques and configurations of different spaces changed the reading experience and understanding of the text. Overwhelmingly the participant responses suggested that these different variables did lead to different understandings of the text. First, it must be acknowledged that silent reading and reading aloud are fundamentally different processes: as psycholinguist Sun-Ah Jun explains, they operate in different areas of the brain and the cognitive speed of reading aloud is much slower than silent reading.<sup>32</sup> Reading aloud sometimes produces only “surface prosody”, where the reader assigns features like stress and syllabic division to speech units (a process called prosodification) superficially, without full comprehension.<sup>33</sup> Silent reading in comparison offers the reader more opportunity to obtain deeper semantic and pragmatic comprehension and therefore for more accurate prosodification. Performative reading on a basic level requires a reader to physically embody the text and

---

<sup>31</sup> Zaerr, ‘*The Weddyng of Sir Gawen and Dame Ragnell: Performance and Intertextuality in Middle English Popular Romance*’, 200–208; McGillivray, *Memorization in the Transmission of the Middle English Romances*.

<sup>32</sup> Jun, ‘The Implicit Prosody Hypothesis and Overt Prosody in English’, 1223.

<sup>33</sup> Jun, 1223–24. The term prosody in the linguistic sense is defined as “the rhythmic and tonal aspects of speech: the ‘music’ of oral language” with features including “pitch (intonation), stress patterns (syllable prominence), and duration (length of time) that contribute to expressive reading of a text”. Hudson, Lane, and Pullen, ‘Reading Fluency Assessment and Instruction: What, Why, and How?’, 704.

transform it, but sometimes at the cost of comprehension, which was often observed in the performance experiments.

The unfamiliar language increased the surface prosody effect for many. Two participants noted in an early workshop on Middle English that they were so focused on pronouncing each individual word correctly that their understanding of the story and their ability to appreciate the changes of modality were impeded. With preparation and/or repetition of the performed excerpts the participants' overall comprehension of the narrative increased. One wrote that after a session in Barley Hall they "no longer [viewed] Middle English as a 'foreign' language". Performance was a powerful tool for strengthening comprehension skills quickly: the challenge of needing to confidently understand and convey material rewards fluent reading.<sup>34</sup> The support of either preparation or contextual fluency skills (language, vocabulary, knowledge of textual features and formulas) is essential to move beyond surface prosody to performances with deeper comprehension, especially in an unfamiliar language which takes more sustained effort to accurately prosodify. Performances with surface prosody, whilst theoretically less 'effective', are nonetheless revealing of the process of decoding. Rasinski and Hudson et al describe a cautious way of unprepared sight-reading in which the reader attempts to avoid errors by producing each content word prominently, putting pitch accent on every content word, and adding more frequent prosodic breaks, following phonological and structural constraints.<sup>35</sup> This laborious performance sacrifices nuance for accuracy and draws attention to the process and mechanics of performance. Without signalling the importance of content words with varying emphasis, the sense of the words and the story can be compromised. The effect of this cautious method of reading could be seen when performers focused on difficult content words and mispronounced common words that were spelt the same in modern English. The most frequent mistakes were substituting modern English /aɪ/ for Middle English /i/ in words like "I" or "might" as well as modern English /i/ or /i:/ for Middle English /e/, /e:/ or /ɛ:/ in words like "he" or personal pronoun "the". Also common was the substitution of modern English spelling or word order for similar-looking words and phrases in non-final placements such as "bird" for "brid" and "I will tell you" for "I will you tell". Whilst final placement provides additional data from the rhyming scheme to help avoid these misreadings, it does require the reader aloud to be flexible in their reading and comfortable enough to move their gaze between lines,

---

<sup>34</sup> Rasinski also recommends dramatic performance as a way to improve the reading fluency of modern students. Rasinski, 'Issues and Trends in Literacy: Reading Fluency Instruction: Moving beyond Accuracy, Automaticity, and Prosody', 705.

<sup>35</sup> Hudson, Lane, and Pullen, 'Reading Fluency Assessment and Instruction: What, Why, and How?'; Rasinski, 'Issues and Trends in Literacy: Reading Fluency Instruction: Moving beyond Accuracy, Automaticity, and Prosody'.

something not possible in a cautious performance. This was observable in one performance, where the reader read “quen” as “queen”, substituting a familiar modern pronunciation as they were not able to look far enough ahead to see the rhyming word “gren” in time to correct the rhyme.

Performers with less Middle English experience read at a noticeably slower pace, allowing themselves more time to decode as they read. Those who prepared in advance were able to supplement their visual deciphering with their aural and visual memories of rehearsal. Cautious performances result in limited comprehension by the reader, who focuses on accurate delivery over the meaning of each word and the story. One participant observed that their comprehension was delayed, and that they followed only the phonology, then belatedly shifted their delivery to represent direct speech after missing the speech cue.

#### **4.4.1 Physical changes and material books**

In my first performance (B 1.1), nerves compromised my comprehension and resulted in simple deciphering errors and eye-skip. I compensated by using my finger to track my progress through the page, freeing some attention to refocus on meanings. This strategy was surprisingly revealing: I instinctively placed my finger to the right of the text column, which was only possible in the *a* column of the verso without obscuring the text or switching hands. This manoeuvre would be challenging for readers supporting a large book in their hands, and requires a little foresight for those using book furniture.

Another physical limitation of reading revealed in performance was page turns. A seamless page turn requires planning so that the moment of readjusting the gaze and physically shifting the book does not disrupt fluent reading. Exploring these physical limitations was aided by the use of physical stand-ins of two whole household manuscripts (Findern MS and Ashmole 61) and two booklets from manuscripts with evidence of use in unbound quires or booklets (Heege MS and CCAii) in the Gainsborough performances. The stand-ins were constructed with awareness of the manuscripts’ original physical forms, but with also an eye to represent a range of formats. (Figure 4.7) As much as possible with my limited bookbinding experience, I followed appropriate methods described by J.A. Szirmai.<sup>36</sup> In each I copied out the chosen excerpts by hand in the appropriate location, reproducing as closely as possible the features of the original manuscripts like line spacing, headings and capitalisation, although in my own modern

---

<sup>36</sup> J.A. Szirmai, *The Archaeology of Medieval Bookbinding* (Farnham, Surrey and Burlington, USA: Ashgate, 1999).

handwriting. I made small concessions for ease of comprehension, such as silently expanding abbreviations, normalising word separation only where it could cause misreadings (e.g. “be fell” to “befell”) and changing u to v, i to j and yogh to gh or y as necessary, although all other spelling was retained. The irregularity of handwriting compared to printed text – especially the handwriting of someone else – has greater potential for misreadings due to unclear letterforms, and by using handwritten excerpts I hoped to recreate this feature of reading directly from the manuscript at a more accessible level. A few deciphering errors in the performance session, such as ‘rayles’ for ‘nayles’ caused by a poorly-formed ‘n’, suggested that this theory was successful, and that modern handwriting is a helpful and accessible substitute for challenging medieval scribal hands.



Figure 4.7: Li 91 Facsimile, Findern manuscript stand-in, Ashmole 61 stand-in, CCAii booklet and Heege booklet.

The recreated copy of the Findern manuscript broadly followed the collation as reconstructed by Ralph Hanna and gathered the quires between leather-covered wood covers.<sup>37</sup> The reconstruction of Ashmole 61 took a more experimental approach. When viewing this manuscript, I was struck by its weight and unwieldiness. There is no evidence about the original binding of the manuscript and the current binding is too tight for any

<sup>37</sup> Hanna, ‘The Production of Cambridge University Library MS. Ff. i. 6’, 65–70.

insights, so I decided to recreate Ashmole 61 using limp binding to investigate whether this improved its handling. This format binds the quires with vellum, thin leather or fabric instead of wooden boards. Szirmai describes account books and journals in limp bindings from the early fifteenth century, although none specifically in agenda format.<sup>38</sup> In practice, the lighter weight was offset by the lack of rigidity in the paper used, and the book became difficult to handle in different ways. Historical limp-bound books were more rigid, with stiffer paper and support from thicker leather and tighter sewing, which I was unable to achieve in my reconstruction. Although Ashmole 61's long pages make for fewer physical disruptions when reading due to column changes or page turns, the size of each page made it difficult to position the book so that the top of the page and the bottom of the page were both at a comfortable reading distance.

Both performances also used the facsimile of Li 91 as a physical stand-in (B 1.1, 1.2, G 3). It reproduces the pages in black and white and although the dimensions of this volume are not an exact replica of the manuscript, its size and weight gave participants an idea of the large scale of the book, especially when compared to the representations of the other manuscripts.

The copy of *Sir Eglamour of Artois* in CCAii appears to have been used as a stand-alone booklet before being bound into the book, so I constructed a roughly to-scale stand-in by printing, trimming and binding the text from a diplomatic edition of CCAii.<sup>39</sup> This edition replicates most features of the original manuscript (layout, spelling, abbreviations) in a modern printed script, although it does not reproduce all paratextual features like decorated capitals or marginal additions. Another romance with evidence of possible booklet usage is *Sir Isumbras* in the Heege manuscript. I created a physical stand-in by trimming the appropriate number of pages and binding them with pamphlet stitch. As the layout of this romance is challenging, I provided a number of presentation options: both handwritten and printed graphic tail rhyme, and handwritten and printed presentation in a single column. The graphic layout proved demanding in performance and the reader defaulted back to the single-column text in the middle of their reading.

Varying textual formats notably led to different reading experiences. Reading directly from the manuscript takes more time and skill to gain proficiency: the reader must build familiarity with the scribal hand and learn to automatically interpret abbreviations and paratextual features with reference to scribal standards of the relevant time and place and the scribe's own idiosyncrasies. Only I and a few participants from the Leeds IMC

---

<sup>38</sup> Szirmai, *The Archaeology of Medieval Bookbinding*, 309.

<sup>39</sup> Denise C. White, 'BL Cotton Caligula Aii, Manuscript Context, The Theme of Obedience, and a Diplomatic Transcription Edition' (PhD Thesis, Georgia State University, 2010), [http://scholarworks.gsu.edu/english\\_diss/97](http://scholarworks.gsu.edu/english_diss/97).

session used this format. The process of deciphering is doubled as the reader must correctly interpret both the scribe's letterforms and the word itself. The process leaves even less time for determining suitable delivery and modulation of the words. When less-experienced readers-aloud attempted to read from the manuscript facsimile, they noted that they lost sight of the narrative due to the additional "layers of interpretation to battle through", as one participant put it. Another even pondered whether the "lack of clarity" of the script meant that manuscripts were meant as "a memory aid rather than something meant to be read aloud cold." Familiarity with and study of scribal hands and abbreviations do allow modern readers to sight-read manuscripts, so medieval readers certainly were able to do so, especially scribe-users like Robert Thornton or household clerks who are deciphering their own hand. Reading was not without challenges though, as the insights of the experiments suggest.

The challenges of reading fifteenth-century hands highlighted other features of the text. One participant noted that they found the rhyme scheme more prominent when reading from the manuscript, perhaps due to the increased dependence on the rhyming scheme when decoding difficult words. In this context, the added brackets that sometimes link rhyming lines would be a helpful aid to reading. Similarly, another participant noted that they relied on their knowledge of romance story formulas to decipher the text, a clear argument for the importance of contextual fluency and familiarity with genre tropes. One observed that although it made reading the text more challenging, the unstandardized Middle English spelling made the original pronunciation seem closer, unlike the standardised spelling from the TEAMS edition. However, one participant noted that the normalised spelling in the TEAMS edition often confused them and they found the more irregular orthography in the diplomatic edition to be easier for reading aloud with proper pronunciation: seeing a familiar word spelt strangely prompted them to engage with the word more deeply and think about the correct pronunciation rather than pronouncing it like modern English.

The experience of reading from the manuscript influences the overall reading performance, most notably the pace of reading. Since deciphering is such a major component of reading from manuscripts, the reader must examine the text much more closely and carefully, leading to a reduced reading speed. For a reader-aloud this has the added benefit of moderating the speed of delivery and thus aiding the comprehension of the listener. This resulted in a strange dichotomy: most participants noticed that the slower pace of reading meant that the text was more engaging because you had to put more effort into it to read. However, deciphering is a different level of textual engagement than deeper comprehension and with so much focus spent on deciphering individual words rather than the story, a reader easily loses sight of the wider narrative.

The material form of the book and the presence of reading furniture had a demonstrable qualitative impact on the reading performances. In the hall, the book could be rested on the tables. Formal mealtime reading which followed the monastic model closely could have used a lectern placed in the hall. However the chambers used in Barley Hall and Gainsborough offered a more limited selection of furniture and readers who used books therefore had to rest them on their laps or hold them in their hands, which proved physically challenging for the stand-in for Ashmole 61 and the Li 91 facsimile. (Figures 4.3, 4.8 and 4.9)



Figure 4.8: Snapshot from reading experiment in the gallery chamber at Gainsborough Old Hall reading *Sir Orfeo* from the Ashmole 61 stand-in, note position of book resting upon the reader's lap. (Experiment G 5.1)





Figure 4.9: Snapshot from reading experiment in hall at Gainsborough Old Hall reading *Sir Eglamour of Artois*. (Experiment G 3) The reader stands in the centre of the hall with their back to the high end and the listeners are seated along the bench of one of the low tables.

Images depicting reading in the chamber show a variety of reading postures, both with and without material supports. (See discussion in Chapter 3.) Whilst readers using booklets were freer in the physical aspects of performing (e.g. posture and gesturing), those reading from whole books were physically limited. For books too heavy to hold upright, the gaze of the reader is drawn downwards, which creates a somewhat shut-off performance which cannot be easily projected. (Figure 4.3) The reader of the Ashmole 61 stand-in found that the format of the manuscript posed an additional challenge: they could not easily support the book and so rested it on their lap at about a 45 degree angle, but then were unable to read the text at the bottom of each page clearly. They felt strongly that the book would only have been usable with the aid of a lectern, book stand or cushion. This matched my observations of the challenging size, shape and weight of the original manuscript. Although one participant found that when the large books were held in the hands they were less of a status symbol as they were closer and more accessible, another said that the physical presence of the book when compared to the booklet, as well as the rigid posture it required, made the reading feel more formal. The lack of specific book furniture led to some unorthodox reading postures as readers struggled to adapt the physical form of the book and its challenges to the furniture we had access to. In their second reading from the Ashmole 61 stand-in (G 5.2), the participant decided to sit on the chest directly under the large south-west-facing window in the chamber and to lay the book out flat in front of them on the chest. (Figure 4.10) Without the challenges of supporting the book themselves and with the aid of the improved lighting, this was a more fluent reading, with fewer

stumbles (especially at the bottom of pages), more affect added, and the participant found it more physically comfortable. The importance of considering the physical book and the material experience of reading cannot be overstated. Reading is influenced by the location on the page, the physical limitations of the reader for holding and manipulating the book, and the furniture and lighting which can support or impede the reading. This crucial dimension is overlooked when medieval texts are encountered only in critical editions and when manuscripts are encountered only in specific environs in which they cannot be interacted with fully. The persistent argument about the ease of holding Ashmole 61 as a strong factor in arguing for its use in performative reading does not hold up when the manuscript (or at least an approximate physical stand-in for it) is handled outside of the context of the library, without the aid of specialised book stands and snake weights. This is a clear indication of the value of hands-on first-person investigative research: facsimiles and physical stand-ins can help to recreate a fuller impression of manuscripts historical reading.



Figure 4.10: Snapshot from reading experiment in the gallery chamber at Gainsborough Old Hall reading *Sir Orfeo* from the Ashmole 61 stand-in informally. (Experiment G 5.2)

In the Barley Hall performances, participants chose to use the modern critical edition by TEAMS Middle English Texts Series.<sup>40</sup> This edition is primarily based on the CCAii text of *Sir Eglamour of Artois*, with elements from other manuscript witnesses. Modern editions provide a well-established standard of critical apparatus to assist readers with texts in an unfamiliar language and style. The TEAMS texts are “lightly modernized

<sup>40</sup> Hudson, ed. ‘Sir Eglamour of Artois’.

for reader convenience.”<sup>41</sup> Difficult words are glossed in a parallel column to the main text or in footnotes. Punctuation is added, capitalisation and word separation is modernised, all abbreviations from manuscripts are expanded silently and spelling is normalised, removing the barrier of challenging medieval letter forms and orthography. Verse is laid out with stanza divisions and structured indentations, and lines are numbered. Explanatory notes about more complex points are also provided in endnotes which are hyperlinked in the online edition. A more detailed introduction provides relevant information on authorship, dating, manuscript history and features, historical and cultural context, critical themes and a bibliography of other versions, editions and criticism. In short, this edition provides a wide readership with everything they need to begin to understand the medieval text and its context. Some interpretative work has already been carried out to better enable modern readers to read the text seamlessly and offers them ways of tracking their progress through the text that other editions and medieval readers did not have, such as line and page numbers. The participants noted that this created a sterile, sanitised version of the text that wasn’t particularly engaging in and of itself but was easy to read and analyse.

Reading from the modern critical edition creates a vastly different experience than reading from the manuscript or the diplomatic edition. It is available online and in print, stanza breaks enforce greater pauses, whereas in the manuscripts, stanzas are written continuously. The editorial work removes a layer of interpretation: dialogue is signalled, diacritics are added to signal stressed final ‘e’, punctuation is added which shapes the pitch and pace of delivery – question marks signal rising inflection, commas prompt brief pauses and full stops mark borders of sense units. The reader aloud thus has less flexibility in their performance. For the modern amateur reader, sometimes this assistance is welcome, but it does delineate and restrict the performance as it is harder to think of alternative readings when the ‘accepted’ sense is already outlined, signalled and explained in notes and glosses. Although some of these features make performative reading easier by removing the layer of decoding, critical editions are certainly not created with performance in mind. In the preparatory workshops for the Barley Hall performance, we ‘staged’ a modern reading event by sitting together and reading the text silently for a short time, imitating how we as modern scholars would most likely read the romance. ‘Staging’ a mundane reading practice we all regularly engaged in felt somewhat absurd, but was a deliberate contrast for the medieval reading practices of later sessions as well as a prompt for participants to interrogate their own reading practices and the multiple ways of reading a text, both physical and digital, more carefully. The device used to access an online edition offers a

---

<sup>41</sup> ‘Middle English Texts Series Editorial Staff’, TEAMS: Middle English Texts Series, accessed 5 May 2020, <https://d.lib.rochester.edu/teams-middle-english-text/middle-english-texts-series-editorial-staff>.

different physical interaction and features such as touch screens, a mouse or the ability to annotate directly onto the text shape the experience. One participant noted their preference for the online edition as it gave them a way to avoid eye-skip by aligning the line they were reading with the top of their browser page. Another suggested that the ability to scroll continuously through the text replicated the convenient features of the historical roll format. Physical copies are easier for non-sequential reading – a reader can mark their place easily with a finger, and each line remains in the same place on the page. I have remarked before in this thesis that there are as many ways to read medieval books as there are medieval readers, but certainly this can also be said of modern readers. The ‘scholarly referential’ or ‘scholarly pragmatic’ modality of modern academic reading encounters the text out-of-sequence, with frequent reference between text, gloss, notes, and additional reference material alongside it, enabling citation, annotation and critical enquiries without the need for low-level structural interpretation (as a manuscript does for stanza divisions or dialogue etc.).<sup>42</sup> This is a mode of reading that does not privilege the story for its own sake, but values the utility of the text as part of an academic inquiry, in contrast to performance which uplifts the story.

#### 4.4.2 Changing performances

Returning to the experiments, the Gainsborough performances had only a single prelector, whilst the readings in Barley Hall and at the IMC involved multiple prelectors. At the IMC, participants were divided based on their Middle English ability, gathering in circles to read either from a modern English translation, the TEAMS edition or the manuscript facsimile. They took it in turns to read a passage as long or short as they liked before passing the book or copy of the text onto the next person. This matched my expectations, given historical depictions of a similar performance practice. In this context, readers used the poetic structure to guide their divisions, usually reading until the end of a tail rhyme unit. In contrast, the Barley Hall performances repeatedly saw an unexpected method of textual division. Two readers took it in turns to read short sections of the text, rapidly swapping backwards and forwards between themselves. This created multiple internal divisions in the excerpt where there were none signalled by the manuscript. Practically, this also meant that two readers were simultaneously looking at one copy of the text, rather than a single reader using the text at a time. In all three instances of this performance type, the divisions were generated based on dialogue. In the first, a performance where readers and listeners took on roles of householders, the ‘lady’ read all of the narrative, while the

---

<sup>42</sup> Coleman, *Public Reading and the Reading Public*, 88; Parkes, ‘The Literacy of the Laity’, 555.

‘lord’ read all of the dialogue, altering the pitch of their delivery to portray each character. (B 1.2) In the second and third, readers assigned themselves characters from the text and read aloud until they came to a line of dialogue belonging to the other reader’s character. (B 1.3, 2.4) In both cases, performers struggled to clearly and evenly divide the passage. Modern performances such as the Reading Malory Aloud project used similar divisions of narration and characters (after careful planning and scripting) but these Barley Hall performances showed that romances do not easily support this method. The persistence of this dialogue-based reading method is revealing of modern assumptions about performance and how modern readers comprehend medieval romances. Performance is equated with drama, in which actors embody particular characters and when the assumptions of this form are brought to non-dramatic texts like romances, dialogue and character-driven performance practices are less successful. The Malory project noticed a similar focus on dialogue by modern silent readers of Malory who are likely to skip the long descriptions of battles in favour of more immediate dialogue: “The modern silent reader...homes in on the conversations, looking for difference of expression as a clue to personality, and seeking an equivalent for the elaborate speech of characters in the modern novel.”<sup>43</sup> Modern readers often recreate the familiar over what the text tells us about itself, leading them to emphasise different features of the text than those that seem to be valued by medieval readers. Reading in formats as close to the original manuscript as possible mitigates this. Although a performance with multiple readers taking on characters is an accessible way for a large number of participants to engage with medieval texts, it does not transfer easily to reading in a more historically-informed context. Drama has a clear division between dialogue and narrative, whereas divisions in romance are driven more by poetic structure, as shown by manuscript layout and paratextual features like decorated capitals, brackets and paraph marks. Dialogue is rarely signalled paratextually: more complex poetry (such as Gower’s *Confessio Amantis*) or plays and dialogues which lack narrative use marginal speech markers to indicate the speaker, but my research found no evidence of this in Middle English romances.<sup>44</sup> As a single reader I found the internal speech signals sufficient, however, multi-lector reading divided by dialogue lacked sufficient supporting textual apparatus, obscured the poetic structure of the text by creating unnecessary internal divisions and therefore seemed unlikely as an original reading practice.

This reading practice and participant feedback pointed to a general unfamiliarity amongst modern readers with hearing texts performed. One commented that they found it

---

<sup>43</sup> Allen, ‘Reading Malory Aloud: Syntax, Gender, and Narrative Pace’, 77.

<sup>44</sup> The closest example is the Middle English fabliau *Dame Sirith* (Oxford, Bodleian Library MS Ashmole 86, ff. 165r-168r) which has speech markers added.

easiest to “follow the flow of the narrative” when they read the written text while another read, but when they “looked away from the text [they] found it more difficult to understand”. This suggests that modern readers are less audiate and that combining information from both orthography and pronunciation assists with inferring the meaning of unfamiliar words, with visual cues from the reader being less important. The written word offers a comforting solidity and familiarity to modern readers-aloud, with the ability to refer to previous or future lines as they wish, but one aim of exploring performativity is to reduce reliance on the written word when engaging with texts and thus to open up engagement possibilities. Another participant noted that when they heard someone read aloud it “Removed [them] more from the meaning of the text, [so it] felt more like a performance than a story.” The separation of performance and story here is significant, revealing how modern readers are most likely to encounter stories in written form and thus that performances of stories are viewed as performances first and stories second. Performance was assumed by the participants to be the realm of music or of drama, not of audio books, poetry recitals or reading aloud a book to children. Yet these are fundamentally performative reading modes and closer to the kind of medieval performative reading studied here than modern drama or music are.

In the Gainsborough performances, which were conducted during general opening hours, we observed that we were frequently interrupted when set up for informal readings where we were gathered around in a circle, and interrupted much less when we had one reader (usually standing) addressing a (seated) audience facing them. Despite both being equally performative by my definitions, one looked like a performance (which should not be interrupted) to modern observers and one did not. There are certain expectations of what a performance looks like, taking modern theatrical performance as a norm, for example a clearly visible divide between performer and audience signalled by divisions of space, lighting and social roles (who speaks, who listens), such that performances that deliberately break that mould are still seen as notable. However, the performance that I felt best represented historical depictions of communal leisurely reading breaks down these barriers. The audience is an essential and involved party in the performance – as the Findern annotation, the romances’ inscribed audiences and the performative narrators evince. Modern expectations about performance also explain why many participants struggled to view romances as performative, expecting certain editorial conventions and textual features to be present such as stage directions, speech markers and exits and entries. This unfamiliarity – even distrust – of performative modalities is deeply ingrained, and prominent especially in the long debate between ‘oral’ and ‘written’ composition, transmission and reception of medieval texts in which ‘oral’ is often shorthand for ‘unsophisticated’ or even ‘non-canonical’. Expanding these boundaries and limitations is

why this research is crucial to show how performative analysis can bring out nuances in texts, as well as demonstrate to sceptical modern readers that performance is more mundane and accessible than assumed.

#### 4.5 Space, Materiality and Performance

Staging these readings in reconstructed medieval spaces prompted participants to consider the historical reality of communal reading. Only in historic spaces can we simulate first-hand the multi-sensory experience of inhabiting and performing in space. The acoustic environs and the visual impact of the fittings and furniture shaped our activities in ways that a modern space could not. In the hall at Barley Hall with cloth hangings on all four walls, sound was absorbed readily, and although the performer had to exert some effort to project and fill the space, an audible performance could be generated from anywhere in the hall, and the shaped canopy helped to direct sound from the high table out to the rest of the room. The much larger space of the hall at Gainsborough amplified and carried all sounds within it, meaning that our readings were often disturbed by the conversation or footsteps of passers-by. Participants wondered how much attention would have been given to the reader-aloud, especially if the reading was competing with other distractions like conversations, entertainment or eating, particularly in a setting like the feast from *Havelok the Dane*. The hall certainly originally had more soft furnishings like wall hangings (as described in Thomas Burgh's probate inventory), cushions and rushes on the floor, which would have dampened the sound.<sup>45</sup> Both halls supported Catriona Cooper's argument that sound produced anywhere in the hall was equally amplified, rather than the high or the low end being specifically shaped to amplify more or less.<sup>46</sup> I found the large space at Gainsborough surprisingly easy to 'fill' in performance, and whilst reading – even though I only directed my performance to those sitting around the table with me – I was aware of my voice being spread throughout the hall and up towards the roof, although as Cooper notes, the reverberation time is shorter than expected from such a large space. This created quite a theatrical atmosphere: one participant noted that they were particularly aware of changes in vocal tone and volume because of how the voice carried.<sup>47</sup> The distracting noises of the passers-by became an incidental test of a situation like the *Havelok* romance-

---

<sup>45</sup> PRO, PROB2/124; Gunn, 'The Rise of the Burgh Family, c. 1431-1550', 9; Lindley, 'Structure, Sequence and Status: The Architectural History of Gainsborough Old Hall to c. 1600', 21.

<sup>46</sup> Cooper, 'Lived Experience at Bodiam and Ightham'; Murrilo Gomez, Cooper, and Fazi, 'Acoustic Survey of a Late Medieval Building Based on Geometrical Acoustics Methods'.

<sup>47</sup> The theatrical comparison was rather apposite as the hall at Gainsborough was converted into a theatre in the late eighteenth century, with the stage placed at the high end. Patrick A. Faulkner, 'Gainsborough Old Hall (SK 813900)', *Archaeological Journal* 131 (1974): 368; Vernon, "'A Fine Wreck of the Feudal Age": The Later History of Gainsborough Old Hall and Its Owners', 31.

reading. If this depiction is interpreted literally rather than rhetorically, such a romance reading could only effectively reach a small group of listeners gathered around closely, and even then would likely prove challenging to follow.

The hierarchical structure of the hall, from the polarisation of the space, the encoded social information in the seating arrangements, and the visual prominence of the dais and high table very deliberately directs the attention of listeners towards readers at the high end. This directly contributed to the power and impact of performances by participants sitting at the high table. Both Mark Gardiner and Matthew Johnson frame their analysis of the hall in performative and ritual metaphors, calling it a “stage” upon which formal social behaviours are enacted.<sup>48</sup> A similar impression was made on the participants: one compared the feel of this performance to a church, another formal space within which attention is directed towards a specific focal point. The high end in Barley Hall is lavishly decorated with carved wooden trestles, heraldic wall-hangings, and luxurious tableware. Above the dais is a canopy and the curved roof and beams draw the eye down inexorably to the high table. Figure 4.11 demonstrates how effectively the canopy frames the ‘lord’ and ‘lady’ seated at the centre of the high table.



Figure 4.11: Snapshot from ‘social roles’ performance with readers seated at the high table underneath the canopy in Barley Hall reading *Sir Eglamour of Artois*. (Experiment B 1.2)

The shape of the canopy also directs and enhances sounds in the hall, as discussed in Chapter 3, both making speakers at the high table more audible and directing sounds from the rest of the room towards those at the high table. In this reconstructed space, the

<sup>48</sup> Gardiner, ‘Buttery and Pantry and Their Antecedents: Idea and Architecture in the English Medieval House’, 38; Johnson, *English Houses 1300-1800: Vernacular Architecture, Social Life*, 73.



material features and space of the hall work to subtly influence audiences and reinforce the hierarchical space of the hall and the status and authority granted to performers. The canopy is perhaps not an original feature but an invention of the reconstruction: as Stewart outlines, the YA archives on Barley Hall show no clear evidence that the building ever included such a structure.<sup>49</sup> Its visual impact is perhaps the reason for its inclusion. Kate Giles notes the potential for internal jetties to emphasise the power and symbolism of the high end of the hall, whilst also enhancing the status of the room which protrudes into the hall.<sup>50</sup> In a tripartite model hall-house, this would usually be the first floor chamber. In Gainsborough, the reconstruction (perhaps due to the financial challenges of fitting such a large space) does not work as effectively with the surviving material structure. The lack of dais, the simple table, small textile canopy and wall hanging not level with the beams, seem comparatively small in the expansive hall and whilst they are undeniably the focal point of the space, the gaze is more readily drawn upwards to the roof and to the bay window. Performances at the high end were easily dwarfed by the space of the room.

By staging readings in different spaces throughout the historical sites, the experience of reading was altered. In the chamber, attention is not directed so forcefully as in the hall, which tended to lead to more informal and equal readings. The neutral and unpolarised space allowed us to easily place the readers in various locations and angles throughout the room. There still exists an external hierarchy between the chambers based on their relative size and position at either high or low end of the hall. Gainsborough Old Hall has a large variety of chambers belonging to many different social ranks, from the formal and spacious rooms of the Burgh family members in the east range and tower, to the smaller but still well-appointed chambers for retainers in the west range, the first-floor chambers at either end of the hall (the ‘gallery chamber’ and the ‘steward’s room’), and a number of small sleeping quarters in the kitchen.<sup>51</sup>

It is curious (and somewhat frustrating) that neither site had a fully reconstructed main bed chamber. In Barley Hall the ‘grand chamber’ (large, two storeys high and open to the roof) is now used as either the gift shop or an additional museum space and in the performance session we used the ‘lesser chamber’, a smaller space adjoining it with plain furnishings. The site of the original principal chamber in the east range at Gainsborough has been obscured through the many alterations from the seventeenth century onwards under the Hickman family. Previous interpretations of the site presented the gallery chamber and one of the tower chambers as bed chambers, however, when we visited, the

---

<sup>49</sup> Stewart, ‘A History of Historic House Reconstruction: Understanding the Past and Informing the Future’.

<sup>50</sup> Giles, ‘Ways of Living in Medieval England’, 22.

<sup>51</sup> Faulkner, ‘Gainsborough Old Hall (SK 813900)’, 367; Emery, *Greater Medieval Houses of England and Wales, 1300-1500*, 246–49.

beds had been removed following recent renovation work. It is unfortunate that such an engaging space with potential for many activities was not represented fully.<sup>52</sup> Interestingly, in the reconstructed Bayleaf Farmhouse at the Weald and Downland Living Museum in West Sussex, another site considered for the performances, the main bed chamber is presented with a small desk, writing slope and chair, anticipating multi-purpose usage and textual activity in the chamber even in a lower-status dwelling than those of the owners of the household manuscripts examined here (except perhaps the Heege manuscript).<sup>53</sup>

In Barley Hall, the lesser chamber had only a small bed and a bench (as well as a large chest in the corner too big to use). We used the bed as the focal point for the performances and gathered around in a circle, with some sitting on the bed, some on the bench and some on the floor, placed in the corner furthest away from the door. (B 2.1, 2.2) One passage from *Sir Eglamour of Artois* read here culminates in Eglamour and Christabel's secret marriage and reminded me of the "erotic" romance reading that Evelyn Birge Vitz posits.<sup>54</sup> Vitz argues that the erotic potential of romances greatly contributed to their popularity and that communal reading could provide romantic or sexual stimulation, with the archetypal romance characters as audience surrogates. Vitz points to numerous examples within texts where couples read romances in private together to speed along their own love and relationship. Obviously, our performance did not engage with the full extent of Vitz's suggestion, however, the potential was clear, assisted by the intimate and private feel of the Barley Hall chamber as supported by the arrangement of the furniture, secluded away from the gaze of passers-by. The same excerpt read in the hall felt dramatically different: one participant observed that the chamber made the scene feel suggestive and scandalous.

In the gallery chamber at Gainsborough, lacking a bed, we improvised with the existing furniture. The wall hangings, ornate decorative features and the fireplace made for a grand and luxurious-feeling space. The settle proved crucial to the flexibility of the space, with its moveable back allowing us to direct readings in different configurations, as were two chairs which we moved in relation to the settle. For example, a more formal reading of *Sir Orfeo* (G 5.1) had the reader sitting on the settle facing two other participants in the chairs, whilst an informal reading of the same passage had the chairs in a separate part of the room facing each other and only the settle facing the reader, who sat against the window. (Figures 4.8 and 4.10; compare also the settles in Figures 3.3 and 3.4.)

---

<sup>52</sup> Morgan, *Beds and Chambers in Late Medieval England: Readings, Representations and Realities*.

<sup>53</sup> Images and information can be found on the museum's website: 'Bayleaf Farmstead from Chiddingstone', Weald & Downland Living Museum, accessed 14 April 2019, <https://www.wealddown.co.uk/buildings/bayleaf-farmstead/>.

<sup>54</sup> Vitz, 'Erotic Reading in the Middle Ages: Performance and Re-Performance of Romance'.

We also speculated about the impact of facing the settle towards or away from a hearth fire, but of course were unable to experiment with this. The informal readings (G 5.2, 6) made use of the simple games in the chamber, just as we had used the sewing in the hall to create a scene of communal leisurely activities. The directionality of the performance combined with how strongly the attention of the listeners was directed at the reader influenced the perceived formality of the performance.

Feedback from the Gainsborough performances frequently addressed the fact that participants found formal readings “uncomfortable”. This perhaps was due to their lack of performance experience, as ‘formal’ layouts put more pressure on the reader. It certainly reflects a modern readership less accustomed to formal prelection and preaching than medieval readers likely were. This raises questions about the purpose of performative reading, with a range of scenarios depicted from true leisure to more formal edifying reading of literature for entertainment. Different methods of adapting the performances changed their feel. One participant found the pressure of the formal reading in the hall (G 3) to be as if they were “a child who was told to read...aloud for the other elder household members” whereas they directed their informal reading in the chamber mainly to one listener whilst others did other activities and felt “a little more comfortable”. Another participant found that the performativity of the hall directed their attention to the reader, which allowed them to easily follow along, whilst others found that the inclusion of other activities (in the chamber at Barley Hall and both spaces in Gainsborough) with its more neutral attention more conducive to understanding. The appropriate activities to accompany the reading varied between spaces and different configurations and between participants, with some distracted, but others finding sewing to be an aid to imagining the story more vividly. Certainly, for medieval householders, accompanying necessary domestic chores with a story, whether read from a book or not, would make them more pleasant.

The contrasting qualities of the chamber and the hall transformed the same romance excerpts and how the participants understood and experienced them. Participant feedback from the chamber performances in Barley Hall focused on the content of the text itself, whereas feedback from the hall focused on the social setting and dynamics. Reading a passage in the hall felt inherently more performative, perhaps because of the embedded social performativity of the space, whilst the same passage in the chamber felt like a pleasant pastime shared amongst social equals. Participants felt more open about exploring possibilities for performance in the chamber: one wrote that they felt the weight of “expectations” in the hall, whereas reading in the chamber felt “more natural and suitable”. The Barley Hall performances suggested a clear duality of the hall as a formal and performative space and the chamber as an informal and intimate one. In Gainsborough, we

further tested this hypothesis by deliberately creating formal and informal performances in both spaces. The ease of transforming both spaces to fit different performances suggests that this model of formal vs. informal is too simplistic, and was more likely a direct response to the presentation of the spaces in Barley Hall, which compared an ornate and visually-striking hall to a small chamber without decoration, as well as inapplicable modern assumptions about privacy and formality. Furniture and fittings allow the user to dramatically transform a space according to their needs. For example, screens or curtains can provide partitions and the trestle tables and benches that are the usual furniture for the medieval hall are designed to be easily moveable, such that a single space can serve multiple functions.<sup>55</sup> The room itself and its degree of privacy and permeability shaped the performance less than the furniture and fittings and their usage. The changing impact of the staged readings was a direct result of the affordances of the different spaces, rather than a quality or status inherent to each space. The hall supported both formal and informal readings depending on which furniture we used, and where in the hall it was placed, and this varied usage of space would only be enhanced by the use of further partitions. The high table and the floor before it was a natural playing space for a dramatic reading imitating a professional storyteller (G 4), whilst my opening reading, confined to a single table (G 1.1, 1.2), created a subdivision of the space and referenced the use of the hall as a communal space for informal leisure activities (Figures 4.1, 4.2 and 4.12).



Figure 4.12: Snapshot of ‘professional storyteller’ performance in hall at Gainsborough Old Hall reading *Sir Degrevant* from the Findern MS stand-in. The listeners are seated at the high table. (Experiment G 4)

<sup>55</sup> Goldberg, ‘The Fashioning of Bourgeois Domesticity in Later Medieval England: A Material Culture Perspective’, 136; Schofield, *Medieval London Houses*, 130; Smyser, ‘The Domestic Background of *Troilus and Criseyde*’, 299; Hamling and Richardson, *A Day at Home in Early Modern England: Material Culture and Domestic Life, 1500-1700*, 125.

One participant was surprised by the “unexpected” ability to separate space in the hall in this reading to create a private-feeling area in such a large communal space. The size and grandeur of a hall like Gainsborough makes this relative privacy particularly remarkable: one participant found the hall “intimidating”, with the differences in ceiling height between the hall and the adjoining rooms contributing to the contrast and demarcation of the formal space and the service rooms. Another surprising subdivision of space was created by one participant who read in the bay window at the high end of the hall (G 2.2). It is a post-medieval addition of ornately-carved stone and extends beyond the footprint of the main hall (although perhaps replacing a medieval original). The reader stood with their back to the window, taking advantage of the natural light, whilst the listeners gathered on a bench facing them. The bay window offered a secluded area that felt separate from the main hall whilst the impressive lights of the window and stonework created a formal-feeling space. The bay window in Gainsborough and large window at Barley Hall, both situated at the high end of the hall, easily supported reading activities with ample natural light. Grenville tracks the development of elaborate features at the high end of the hall such as canopies, bay or oriel windows and decorated screens, particularly in the fifteenth century when the hall plays an important role in hospitality and supporting the formal activities of large households.<sup>56</sup> The enhanced lighting in the hall not only improves the formal appearance of the high end, but supports high-status activities in the space. The reading of edifying material over mealtimes in noble households would certainly have been made easier by the greater provision of light at the high end of the hall and surely similar conclusions apply to the more informal readings in rural gentry and mercantile elite households discussed here. The reading of the excerpt from *Sir Isumbras* in the bay window contrasted strongly with the other staging of the same excerpt in which the reader and one listener sat at the high table, with the others at the low tables (G 2.1). The high table reading was stretched over a large space and the reader found it challenging to project their performance sufficiently – this, combined with the physical separation of the high and low tables in the reconstruction made those further away feel like they were eavesdropping instead of directly participating. The two spaces both framed the reader with striking visual surroundings that drew the gaze towards them, but the closed and expanded areas of the performances led to two drastically different-feeling performances of the same excerpt.

In Barley Hall, we staged two readings in the parlour (B 2.3, 2.4), hoping to experiment with a space in between the hall and the chamber in terms of formality, access and permeability, as well as referencing the *Troilus and Criseyde* exemplar. (We were unable to stage a comparable performance in Gainsborough as the parlour is now the café

---

<sup>56</sup> Grenville, *Medieval Housing*, 111–14.

and gift shop.) However, the overwhelming response from the participants was how unnatural the parlour felt as a location for performative reading, due almost entirely to features of the reconstruction. The parlour is presented as William Snawsell's office where he conducted his business and met with important guests (ironically, a space very well suited for solitary and pragmatic reading), whilst the "paved parlour" in which Crisseyde and her maidens read is a multi-purpose space with more capacity for leisure activities, likely situated off the high end of the hall and serving as a retiring room or an informal dining room.<sup>57</sup> The readers sat at the small desk and ornately decorated chair while the audience arranged themselves around the edges of the room sitting on a small bench or standing (Figure 4.13).



Figure 4.13: Snapshot from reading experiment in the parlour at Barley Hall reading from *Sir Eglamour of Artois*, note position of listeners relative to reader. (Experiment B 2.3)

Neighbouring buildings and the size of the window limited the natural light available. The bench was positioned against the same wall as the desk and was too heavy to move, and the room also contained two large chests which obstructed the space, resulting in an awkwardly-angled performance which could not be directed efficiently towards the listeners. Having the reader perpendicular to the audience was effective in the hall due to the openness of the space. However, in the parlour, the listeners were beyond perpendicular, resulting in an unnatural and ineffective performance. This example highlighted that the flexibility of spaces is not just in how furniture can be moved, but also in how static furniture can be shaped and reused for different purposes, often with the aid

<sup>57</sup> See Chapter 3 for more detailed discussion. For 'pragmatic literacy' see Parkes, 'The Literacy of the Laity', 555.

of soft furnishings, cushions, screens and positioning of people. It also emphasised that the aims of a heritage site and the aims of a historical reconstruction are often mutually exclusive. Heritage sites must interpret and convey historical information to visitors. Buildings are necessarily obscured by interpretive signing, museum displays, safety features and rooms dedicated to practical functions like gifts shops, receptions, offices, cafes and kitchens.

The affordances of reconstructed spaces are thus more limited than their historical forms. Nonetheless, practical experimentation with historical spaces gives more nuance to historical performances than when they are conducted in modern spaces. The care taken in reconstructions, such as using appropriate materials and crafting techniques, allows the historic spaces to simulate a medieval reality (insofar as that can be determined). It seems likely, therefore, that large and heavy items of furniture were challenging to move for medieval householders as well and hence left in place, with their arrangement carefully chosen to either maximise affordances of the space or to shape the space for a specific purpose. Neither rationale seemed to be the case in the Barley Hall parlour reconstruction, in which the chests were positioned to aid visitor movement, hold displayed items and be easily visible to visitors (particularly the intricately carved red chest which features prominently). The participants observed that the parlour felt like a formal room, with the physical space and angle between the readers and the listeners adding to this impression: one participant compared the space to a “waiting room”. Although the space of the parlour gives power and status to the one sitting in the formal chair, creating a directional and hierarchical space much like the hall, the Barley Hall parlour lacked the innate performativity, flexibility or sense of communality of the hall.

#### **4.6 Middle English Romance in Performance**

The major finding of my performance experiments was the confirmation of how ideally suited Middle English romances are to performance. The text, which can seem flat when read silently, comes alive in performance. Participant feedback noted that reading aloud “makes the text closer”, “added nuances to the story, emotion” and “brings characters to life, and also gives an idea of how the reader interprets the work.” Another observed that the stylistic traits of romance became very prominent in performance, specifically the interplay of narrative action and dialogue, and the role of the narrator compared to the characters. Yet another noted that the “comedy comes out nicely” and we found a surprising amount of humour in the story, especially when experimenting with more exaggerated performance strategies. A sudden narrative diversion in *Sir Degrevant* which

was confusing when read silently, was transformed into a joke when performed very theatrically in the ‘professional storyteller’ performance (G 4). When the Duke protests Degrevant’s interruption of the feast and challenges him, this boastful challenge is immediately followed with a description of Degrevant’s fine clothes and how he is admired by those at the feast. When read silently, this is a confusing non sequitur, but in performance becomes a deliberate and amusing diversion as both Degrevant and the text itself ignore the Duke’s challenge. The sudden shift takes the power away from the Duke and aligns the audience with Degrevant, who, despite his clear social misconduct, is nonetheless the hero of the narrative. Similarly, the abrupt and rather contrived death of the Earl of Artois in *Sir Eglamour of Artois* (which occurs entirely within the space of one tail rhyme unit) caused the listeners to react with amusement. The battle scene I read from *Sir Degrevant* (G 1.1, 1.2) is repetitive and a little tedious on the page – the same action is described two or three times over with only small variations – but in performance this becomes a highly effective and engaging piece of alliterative verse. The aural poetics of the alliteration are pleasing to the ear and the variety of words in the repeated action paints a vivid description of the martial landscape of the poem and its creation, with the multitude of synonyms (gomes, ledes, lords for ‘men’) and specific arms and armour (gambeson, jupon, “jesseraund”, bascinet, hauberck). In performance, the repetition amplifies the action and emphasises Degrevant’s martial prowess.

Performative reading accentuates the meter and rhythm of the romances. A silent reader can ignore verse features but a reader-aloud can only choose how much to emphasise them. Tail rhyme verse contains a natural rise and fall, with each tail rhyme line reflecting back on the previous rhyming lines, both poetically and in sense. I found that I instinctively pitched tail rhyme lines lower and paused slightly at the end of each unit. It is significant but unsurprising that every narratorial petition for attention in *Sir Eglamour of Artois* is found in a tail rhyme line (ll. 15, 39, 195, 686). Similarly, six out of the seven authorising formulas in *Sir Isumbras* are found in tail rhyme lines.<sup>58</sup> The intensely performative tail rhyme lines reflect back on the preceding lines and on the text as a whole, whilst being self-contained, poetically and in sense. Shorter and simpler narratorial intrusions such as “I undyrstond” (*Sir Degrevant*, l. 1839, 1909; *Sir Eglamour of Artois*, l. 44) or “As I will you tell” (*Sir Eglamour of Artois*, l. 238) are more commonly found in the couplet lines, evidently they often serve as line-fillers. Moreover, longer narratorial

---

<sup>58</sup> Harriet Hudson, ed., ‘Sir Isumbras’, in *Four Middle English Romances: Sir Isumbras, Octavian, Sir Eglamour of Artois, Sir Tryamour*, TEAMS Middle English Texts Series (Kalamazoo, Michigan: Medieval Institute Publications, 2006), ll. 27, 135, 144, 177, 501, 759. The exception, l. 601, is the first line in a tail rhyme unit.



statements such as the prologue, conclusion and fitt transitions are confined to tail rhyme units or stanzas (commonly four tail rhyme units).

In comparison, the couplet romance *Sir Orfeo* happens to have no narratorial intrusions outside of the opening and the conclusion, with both the poetic form and the lack of self-referential performative asides creating a noticeable contrast to the other excerpts. Couplet romance feels very different to read: where tail rhyme verse is a constant ebb and flow of anticipation and reflexivity, each line in couplet verse has equal weight and less variation in pitch. Structures like stanza divisions are less obvious, meaning that pauses are taken in response to the sense of the lines rather than poetic boundaries. The versification of romance is a fundamental part of its composition which is best experienced aurally, and understanding this structure allows for fluent and organic delivery.

Formulas are another poetic feature easily missed in silent reading but highlighted by performance. Middle English romance is relentlessly formulaic, with repeated phrases, epithets and narratorial comments. *Sir Degrevant* frequently repeats “both a and b” type formulas as a rhetorical device to subtly amplify the verse. “Both with spere and [with] sheld” is particularly common (ll. 286, 330 1254) as a rhetorical shorthand to support a martial scene, echoed in “Thei toke ther sperus and there scheldus” (l. 1202) and subverted in “Nothur schelde ne spere” (l. 1621). In social settings and once in a battle, the gathered masses are encompassed in the phrase “Bothe to the grete and to the smalle” (ll. 1242, 1734) and “Both lase and the mar” (l. 278). The constant reference to “dedes of armis” in the opening of *Sir Eglamour of Artois* becomes impossible to ignore in performance (both as a reader-aloud and a listener) and sets the tone of the romance as one heavily concerned with martial prowess. Eglamour’s three challenges are also formulaic and repetitive, each following a broadly similar pattern and mode of retelling. The similarities here emphasise the compounding scale of each fight: the dimensions of the giants and the dragon increase, as does the time each fight lasts and the physical consequences to Eglamour. The repetition helps listeners orient themselves in the text. This kind of mnemonic aid is critical in texts received aurally as, unlike a solitary visual reader who can turn back the pages to reference previous events in the text, a listener relies on their aural memory, which is easily triggered by repetition, prompting them to remember and compare previous occurrences of familiar phrases and quickly identify variations. The story is mapped through recurrences of these common phrases.

The regularity and repetition in Middle English verse assists the reader-aloud with easy comprehension. Divisions or transitions that would be signalled by punctuation in modern English are signalled instead in the text itself. This was particularly noticeable in dialogue in *Sir Eglamour of Artois* when performed. In *Sir Eglamour of Artois*, the character performing the action of the phrase is usually clearly indicated at the beginning

of the phrase, meaning that any line beginning with “the knyzt”, “the Erles doughtur” or similar can be safely assumed to be a sense-boundary. Even without speech marks, it is easy to determine what is dialogue and what is exposition. Consistently, speech is signalled by a statement of the character, usually the formula “the [character] said” at the beginning of the poetic line. It is rare to see speech begin before it is signalled in this way, unless it is in a longer section of dialogue.<sup>59</sup> For example, in a conversation between Eglamour and his squire, the beginning and end of the dialogue are clearly signalled by statements of setting and of movement (it opens by placing the interaction “In chambur” [l. 51] and closes by describing Eglamour moving “tyll his bed” [l. 98]) and clear statements of subject indicate the changes of speaker (ll. 49-51, 61, 85, 96). In the other romances, dialogue more often begins without signal, which proved challenging to anticipate and had more potential for errors in performance. In *Sir Degrevant*, I relied on changes of tense or changes in person and number of pronouns (such as ‘you’ to ‘they’, or introduction of non-formulaic first-person [the use of first-person in formulas is usually the narrator]). One participant noticed in their preparation of *Sir Isumbras* that transitions in the excerpt often began with “so” (“So hit byfell upon a day”, [l. 37]) and used these as fixed points to base their performance around. In addition to the self-contained signalling of dialogue are transitions signalled with time markers (“Sone aftyr” [*Sir Degrevant*, l. 821]; “Uppon the morn” [*Sir Eglamour of Artois*, l. 109]) and setting markers (“To his chamber” [*Sir Eglamour of Artois*, l. 125]; “Now to forest he founde” [*Sir Degrevant*, l. 57]) which all occur most frequently at the beginning of lines. The predictability of this signalling proved invaluable to reading aloud as a contextually-fluent performer can easily modulate their delivery even as they sight-read the text. The figure of the narrator also provides a ready-made role for a reader-aloud to assume when presenting the text, offering formulaic comments to guide the narrative such as petitions for attention (“Lestynyth I wyll you tell” [*Sir Eglamour of Artois*, l. 39]), statements of subject (“Lestenes lordynes both lefe and dere / What armes the chyld bare ye schal here / And ye wyll undyrstond” [*Sir Eglamour of Artois*, ll. 1003-5]), citations of authority (“In storye as clerkes seye.” [*Sir Isumbras*, l. 135]; “For sothe as I say.” [*Sir Degrevant*, l. 892]), smaller line-fillers (“I undyrstond” [*Sir Degrevant*, l. 1839, 1909; *Sir Eglamour of Artois*, l. 44] or “as I you say” [*Sir Eglamour of Artois*, l. 460]), and longer passages like the introduction, conclusion and the transitions for the fitt endings. The contrasting styles of *Sir Eglamour of Artois* and the other romances performed do not necessarily imply anything about their compositional or transmission practices, but it is

---

<sup>59</sup> An example of longer-form dialogue is Eglamour taking counsel from his squire. A tail rhyme unit signals the fact that Eglamour is talking, but the exact beginning of the dialogue is easy to miss when reading from the manuscript: “Till his sqwyere gun he saye / In chamber whare þay ryste / Belamy couthe þu layne...” (Li 91, f. 138vb) The squire’s response is not specifically signalled but easy to infer as his speech begins by addressing Eglamour: “3a mayst(re) p(er) ma faye” (f. 138vb)

certainly clear that these features are particularly prominent and often helpful in reading aloud.

The simplicity of romance verse aids in their performance. As I read the romances aloud, I observed that sense is always confined within poetic boundaries: either contained within a single line or within a tail rhyme unit. (The sole exception in the excerpts performed is a unit of sense that begins in a tail rhyme line found only in the Heege version of *Sir Isumbras* [f. 49r].<sup>60</sup>) This is comforting as a performer: with the security that the sense of one phrase will be resolved by the end of the line you can focus your sight-reading span safely on a single line at a time and easily anticipate appropriate delivery. For the experienced reader-aloud of romance, this helps to avoid surface prosody. With this simply-structured poetry, it is rare that the experienced performer must backtrack to correct their delivery or emphasis. The few occasions of this in my readings were caused by similarly-spelt non-content words. For example “or þat”, which could be interpreted as either ‘before that’ or ‘or else that’, both of which require different delivery. These shorter segments result in greater ease of prosodification for the reader aloud. The saccades that make up the physical process of reading can cover only a few words at a time and Rayner outlines that saccades in reading aloud are slower and shorter than in silent reading.<sup>61</sup> Long or complex sentences negatively impact the reader’s comprehension and ability to convey sense to their audience. Middle English romance’s relatively simple poetry, self-contained sense units and the placement of signalling devices and transition markers, as well as important content words, like the subject or the speaker, at the beginning of lines prioritises the most essential information for a reader aloud. Similarly, formulas allow the reader to mentally ‘auto-complete’ the poetic line and more quickly prepare the next.

Another benefit of this self-contained poetry is that the performer does not need to prepare specific points for breathing, as the structure provides frequent points for brief pauses. Breathing in long run-on sections that should not have pauses disrupts the sense, however, with the structure of romance it is possible to breathe freely almost anywhere. Longer pauses are also provided by the structured poetry, and usually signalled by narratorial comments. I discussed in Chapter 1 the division of *Sir Eglamour of Artois* into four sections of roughly twenty minutes of reading. When I read aloud the whole romance in an evening in preparation for the performance experiments, I found that these divisions were perfectly placed to allow the audience to renew their attention and for me to drink

---

<sup>60</sup> þo k[night] þat was so styffe in stowr / þat no mon myt his dyntys dowr / *when þe fowle was away* / And he of hym had no syth / ys sted þat was stalword & wyghth / dede under hym ley (f. 49r, emphasis added)

<sup>61</sup> Rayner, ‘Eye Movements in Reading and Information Processing’, 375; Jun, ‘The Implicit Prosody Hypothesis and Overt Prosody in English’, 1222.

and refresh myself. Water (or the Havelok narrator's ale) is essential for reading a whole romance without vocal fatigue.

Thus, it is clear that the most commonly-criticised elements of Middle English romance – their formulaic nature, simple poetry and ‘unsophisticated’ expression – are precisely the features which are most helpful for a performative reader. It is only in performance that the advantages of these features can be fully realised, whereas on the page they can seem lifeless and simplistic. Whether these features are deliberate design on the part of romance poets to support performance, or a feature inherited from a long period of oral composition preceding the fifteenth-century romance manuscripts is impossible to determine and ultimately meaningless for this project. More important here is the proof that performance of romances increased reader engagement with the source material, heightening their appreciation of the material's poetic features, assisted their ability to comprehend the original language and contributed to increased enjoyment of the nuances, humour and story of the texts.

#### **4.7 Heritage and Outreach Applications**

The ability for these performance experiments to shape and transform the romance texts suggests the potential of performance as a tool for student or visitor engagement. In the Introduction, I reflected that the aim of this performative investigation was less to exactly replicate original romance reception than to encourage modern readers to engage with the texts in different ways. The accuracy of the experiments was important but in many ways secondary to whether the participants *thought* that it was accurate. One participant wrote of my reading of *Sir Degrevant*: “It felt like we were doing this because it's just nice to hear a story. ... It felt pretty realistic. I know that's a bold claim to make, but it *felt* like it anyway.” The historic setting was instrumental in this impression, as was the use of the material stand-ins for the books and booklets and the use of costume. Participants wore costumes that approximated fifteenth-century dress and women were encouraged to wear some kind of head-covering. Although they were far from ideal standards of historical accuracy, the costumes were a useful tool to encourage a mental shift and feedback confirmed that participants found them helpful to get into the mindset of medieval readers. Feedback from the sensory observation activity in Gainsborough showed that the participants moved and stood in different ways when in costume, which in turn encouraged them to observe the space differently. Veils and headdresses muffle sound and limit peripheral vision slightly, creating a narrowed sensory focus, and closely-tailored dresses shape the body towards a different posture. The act of putting on different clothing

encourages a shift in mindset that acknowledges the recreation of the simulated past. Heritage sites frequently use costumes as a way to engage visitors, with both costumed interpreters providing a major method of public outreach, and ‘dress-up’ corners a popular activity. I and many other reenactors consciously use costuming as a transitional activity from a modern headspace to a historical one.<sup>62</sup> In particular, items of clothing that feel unfamiliar (such as garters or leather-soled shoes that require careful movement and lighter steps) are a tactile cue to shift mindset, and the feeling of historical clothing a tangible link to the past. It is crucial to acknowledge, however, that this unfamiliarity owes purely to the difference between historical and modern dress: for the medieval person, headwear or the constriction of supportive tailored garments were not strange circumstances to observe and adapt to, but accustomed everyday reality.

Combining first-person interpretation or living history with more traditional scholarly analysis creates a powerful format for public outreach, as demonstrated by the popularity of costumed interpretation and historical crafts at heritage attractions. Frequently these costumed interpretations focus on practical activities like displays of cooking, food production, woodworking, falconry and martial arts. Performance in this context is the domain only of the professional, with highly skilled musicians and storytellers presenting medieval music and texts to the public. Visitors are positioned as the audience, and although they may participate at a surface level, they mainly observe. Communal leisurely reading provides an involved and engaging activity which is familiar and accessible, and breaks down this practitioner/audience boundary: it can be easily compared to listening to an audiobook to accompany chores, reading aloud to a child to help them sleep, or reading a novel at bedtime. The engaging and often fantastical stories of romances make them a very suitable genre for this kind of leisurely reading. Too often in the public imagination, historical reality is intertwined with a pastiche of medievalist fantasy fiction. However, first-person investigation as outlined here is a powerful tool to combat misinformation. A public outreach activity of this kind directly challenges assumptions about literacy rates in the Middle Ages. Nicholas Orme powerfully reframes the narrative of medieval literacy rates by contrasting personal literacy with access to literature, centring the community and communal activities.<sup>63</sup> By this definition, all of medieval society was indirectly literate – they all had access to literature, whether that was their own personal books, hearing mass read at church or listening to stories read aloud. Inventories show the presence of books in multiple rooms in the house, and this is rarely

---

<sup>62</sup> Radtchenko, ‘Simulating the Past: Reenactment and the Quest for Truth in Russia’, 130; Amanda Card, ‘Body and Embodiment’, in *The Routledge Handbook of Reenactment Studies: Key Terms in the Field*, ed. Vanessa Agnew, Jonathan Lamb, and Juliane Tomann (London and New York: Routledge, 2020), 31.

<sup>63</sup> Orme, *Medieval Children*, 238–40.

ever represented in reconstructions of medieval domestic buildings. Experiencing what this indirect but widespread literacy means through participation in historical reading practices can help to fight incorrect narratives about the Middle Ages and help modern people expand their own understandings of literacy, literature and performance.

The experimental performance methodology requires adaptation for use with wider audiences who cannot reasonably achieve contextual fluency. To be an effective engagement tool, the participants in performative readings should comprehend what they read with minimal preparation, so this must be adapted to the target audience: an experienced academic participant could easily sight-read from an adapted Middle English edition or manuscript facsimile, but an audience of the general public, or school children – key target audiences for heritage sites – is better served by a modern English adaptation of the text. The format of the performance can also be adapted, in tailored sessions for interest groups (drama students, scholars, hobby groups) or as an integrated interactive display at the site that visitors can choose to engage in. The use of physical book stand-ins, costumes and the shaping of spaces modelled by my experiments can be directly adopted. Additional spaces can also be added that investigate other modes and types of reading supported by household manuscripts or attested in domestic spaces: for example reading recipes in the kitchen, reading and writing household accounts, or devotional reading in a chapel or chamber. There is much scope for future performative and traditional scholarly investigations of these modes of reading and their applications. The performative use of spaces provides an engaging framework to directly model complex social issues of space and to let participants effectively experience these themselves. For example, the relative status of the different ends of the hall is easily demonstrated by staging a performance: a modern audience intuitively understands the hierarchical dynamic of audience and performer, and the visual status of the table with dais and formal furniture, especially if reinforced by the use of appropriate costumes that distinguish between high and low status, provides the supporting backdrop to this practical demonstration of social issues in performance.

One Barley Hall performance illustrated the power of performance to investigate social history. (B 1.2) Participants took on the roles of different household members – the lord and lady of the household read to gathered children, guests and servants, and all were encouraged to react and respond to the story as they felt. Those lower in status were impressed by the visually and physically signified authority of the lord and lady at the high table and felt too intimidated to interrupt the performance. When reading as the Earl of Artas/Artois, the lord emphasised their delivery, transforming this outburst of frustration that Eglamour had not been killed by his foes into a moment of relatable anxiety by the head of a household about the usurpation of their power by a younger man of greater

proress but lower station. (“Thow art abowte, I undirstande / To wynne all Artas of my honde / And my dowghtyr schene!” [ll. 646-8]) This moment of keen observation and insight by the participant used the power of performance to bring out the nuances of the text and convey it effectively to the listening audience.

This performance led to discussion about the status of the reader and how a reading event could vary depending on who was reading aloud. My research did not uncover any specific rules or customs regarding who would read in a communal reading event. However, it seems likely that this was shared around depending on the text, skill levels, who was present, who wanted to read and a large number of other potential factors. A reading by the male head of a household combines their social and familial authority with the authority provided by the act of reading. The ability to read in itself grants authority but a reader-aloud also has authority over the text: by oralising the story they have *authorial* power in this moment, just as authors do when they create texts and cite other texts, or scribes do when they copy texts.<sup>64</sup> A reading by a child or a servant offers a contrast. Multiple examples point to the inclusion of children in reading activities, including formal reading of prayers or edifying material and leisurely reading. Chrétien de Troyes’ *Le chevalier au lion* depicts a young maiden reading a romance to her parents in a garden.<sup>65</sup> George Shuffelton notes an early fifteenth century conduct manual which instructs children to read over dinner as soon as they are able to.<sup>66</sup> Nicholas Orme extensively discusses children’s involvement in reading practices and the possible uses of household manuscripts in this context.<sup>67</sup>

Encouraging children to read for a gathered audience formed a valuable part of their education, fostering literacy and rhetorical skills. Children and young servants on the margins of audiate would be less able to follow heard texts or adapt their own performances effectively. Romance-reading perhaps offers a space in which it is acceptable to talk across social/status boundaries, to explore and critique social conventions: one participant argued for humorous passages read communally as a site of Bakhtin’s Carnavalesque.<sup>68</sup> A communal reading event could provide a rare acceptable

<sup>64</sup> For further discussion, see Fisher, *Scribal Authorship*; Minnis, *Medieval Theory of Authorship: Scholastic Literary Attitudes in the Later Middle Ages*.

<sup>65</sup> “My lord Yvain enters into the garden / And after him his companions; / He sees leaning on his side / A nobleman who was lying / On a silken cloth, and before him / A maiden was reading / A romance, I don’t know about whom. / And to listen to the romance / A lady who was her mother / Was there too, leaning on her elbows / And the gentleman was her father.” (Chrétien de Troyes’ *Le chevalier au lion*, ll. 5356-66) Translated by Vitz, ‘Erotic Reading in the Middle Ages: Performance and Re-Performance of Romance’, 83–84.5356-66) Translated by Vitz, 83–84.

<sup>66</sup> Shuffelton, ‘Is There a Minstrel in the House?: Domestic Entertainment in Late Medieval England’, 57.

<sup>67</sup> Orme, *Medieval Children*, 240, 263–67, 274–91.

<sup>68</sup> See M. M. Bakhtin, *Problems of Dostoevsky’s Poetics*, trans. Caryl Emerson, *Theory and History of Literature*, V. 8 (Manchester: Manchester University Press, 1984).

space, like certain festivals or times, in which children or servants could talk back to parents or masters, or take the lead in a social setting, surely an important aspect of training to run their own future households. Considering this possible aspect of domestic reading alongside the conduct texts contained within the many household manuscripts effectively illustrates the range of their contents and the potential uses of a single book across many modalities, purposes and contexts and provides a precedent for participation by people of varying social statuses and abilities.

Immediately after finishing reading the excerpt, the ‘lord’ spontaneously posed a question to the audience: “Now kids, the moral of our story is...?” and the participants then continued to discuss the reading in character, the participant portraying a female child pointing out that they thought the parents would want them to be married off, while the ‘lord’ clarified, not to “some random vagabond” like Eglamour. By close engagement with the romance mediated through their adopted household roles, the participants brought out the nuances of the social issues raised by *Sir Eglamour of Artois* as well as spontaneously reenacting the *demande* tradition more commonly found in canonical texts, such as the *demande d’amour* in Chaucer’s “Franklin’s Tale” and *Parliament of Fouls* or Boccaccio’s *Il Filocolo*. Middle English romances tend to be more narratively closed than these examples, often concluding with a summary of the lives of the protagonists, rather than ending with an open-ended question, however, it seems likely that the audience was highly involved in performances, discussing the story, or requesting more (or a break) as suggested by the Findern annotation.<sup>69</sup> By performing the romances through the lens of specific medieval figures with established roles and statuses, the participants engaged closely and critically with social history and the text in a mode more immediate than just classroom discussion. They did not just study these social issues, they inhabited them. As a way to experience the past, to make the texts and stories come alive, to encounter manuscripts as whole physical items, and to fill spaces with sound and movement, the performances discussed here have modelled a way to make the past tangible.

## 4.8 Conclusion

Performance allowed the participants in my series of experimental workshops to engage more deeply with Middle English romance and to experience a recreation of romance reception in a domestic setting. Reading aloud often brought out the humour of the text and proved to be a powerful way for participants to appreciate medieval romance, not just for

---

<sup>69</sup> Although, as Nicola McDonald examines, romances often pose and explore questions within their narratives. Nicola McDonald, *The Question of Middle English Romance* (Oxford: Oxford University Press, 2017), doi:10.1093/oxfordhb/9780199935338.013.57.



its light-hearted jokes, but for the more serious social concerns it raises and its relation to its medieval readers. Participant feedback consistently pointed to the transformative power of performance: one participant from the Leeds IMC seminar observed that for the first time they were prompted to consider the physicality of the reading experience, specifically the “size of the book and the technicalities of handling it”. The changing experiences of reading texts from different physical and digital supports, as well as the experience of engaging with manuscript features such as format, binding, weight, dimensions, layout, paratextual features and original handwriting shows that materially-engaged study is crucial for a fuller picture of medieval texts.

Performance celebrates the smaller aspects of the poem often deemed unimportant. The patterns, flow and rhythms of the tail rhyme verse, the carefully woven tapestry of repetition and variation, the nuances of the formulas and stock phrases. Performance recontextualises the performative features of romance and, beyond that, suggests the utility of the often-criticised features of the genre: its formulaic nature and simple poetic structure. These features are incredibly valuable for the performer as they assist in easy oral delivery, easy sight-reading and easy memorisation. Performance also changes how people interact with the manuscript and the words on the page: it demands confidence in deciphering and comprehension, which can be challenging for a reader-aloud from the manuscript page. This encourages a slower pace of delivery and thus a more effective performance. More widely, performance also encourages the building of skills in literacy and languages and is a powerful tool for use in education and outreach. Focusing on small tangible elements that produced qualitative changes to the text in performance – reading challenges, transitions and errors caused by sight-reading – suggested practical aspects of original reading practices. The multi-sensory immersion in spaces and texts of the past allowed for experiential over theoretical investigation. The performer has the power to transform the text, to prompt the listeners towards certain reactions or to highlight important points through skilful application of performance techniques, or perhaps on the other hand, to detract from the text due to lack of ability. In a practised or skilled performer, their fluency helps to present the story clearly and artfully. Performance reinvigorates the romance texts and makes the unfamiliar familiar. By making romances communal texts once more, they are given great potential for entertainment and enjoyment and to open up resonances in the social and spatial setting in which they are read. One participant observed that their interpretation of romances and medieval textual reception was completely altered: “My understanding used to be confined to reading as a private experience; this has completely reversed this.” Reauralising romances may also make the familiar unfamiliar: readers who already know the text now experience it in a different context, allowing for new interpretations, understandings and ways of teaching the text.

Communal textual performance has potential application in heritage sites and public outreach. Adaptation of the methods used here – accessible textual performance and the use of historical spaces, supported by appropriate manuscript stand-ins, costuming and reconstructed furniture – has potential for wider transformative experiences.

A reading in a specific context connects the text and the performance to that specific space, time and setting. Parallels related to that space are likely to be more easily observed because of the immediate physical context of the performance. This is the central assumption that underlies my staging of reading performance experiments in different spaces. A moment of recognition and immediacy is created when the text features action that takes place in a familiar domestic location. On the other hand, scenes in other locations – the forest adventurous, battlefields, the sea, the tournament field, the hunt – now become works of spatial imagination as performative readers overlay their imaginings of the conjured fictional space onto the actual space they read or hear in. But for modern readers of medieval texts, this is doubled: reauralising romance prompts them to imagine a medieval space alongside the fictional scenes. By staging reconstructions of medieval reading events, modern readers are brought closer to the heart of medieval romance.

## CONCLUSION

*“prelection is not associated with technological deficiencies...[but]...is a neutral, unstigmatized companion format with private reading, both conceived as pleasant ways to pass time stolen from official duties”.*<sup>1</sup>

This thesis has refocused the idea of the performance of Middle English romances onto a reading context informed by a particular category of manuscript in which they are preserved: domestic amateur reading of household manuscripts. This specific usage context entails a path of analysis separate from many common preoccupations and assumptions about romance performance, particularly the focus on minstrel performance – or worse, the claims that romances were not performed but were unrefined imitations of an oral style, which upholds an unnecessary oral/literate binary of textual reception. Although the latter is, fortunately, less accepted in romance scholarship today, the legacy of this idea is pervasive.

Romances were written with the possibility of performative reception in mind and yet very rarely do studies of the genre engage fully with the implications and impact of performative reception modalities. To ignore this category of evidence is to miss a crucial facet of the genre and of other medieval literature too: reception studies have the potential to dramatically transform our understandings of texts. As frequently noted throughout this thesis, it is fruitless to theorise about performance without actually performing. Thus, analysis of potentially performative texts should engage with performance: experiencing performance by reading texts aloud, or experiencing it through the work of performer-scholars like Linda Marie Zaerr, Benjamin Bagby, or wider performance projects like Reading Malory Aloud and the works of the Chaucer Studio. Although the performance of Middle English romances in some form or another has been broadly accepted by the field, the exact specifics are still cause for much debate. My research suggested that not only is the performative narrator a useful vehicle for a reader-aloud, but that the poetic form of the romance is itself extremely well suited to performative reading. The poetic form, characterised by short line-lengths, with the initial placement of important cues to a performance such as internal speech markers, or transitions, and the containment of sense within poetic lines and units (such as *Sir Eglamour of Artois*' three- or six-line tail rhyme units) allows the text to be divided into short sections that can be easily sight-read by the

---

<sup>1</sup> Coleman, *Public Reading and the Reading Public*, 81.

## Conclusion

reader in the moment of reading. This is of particular benefit for readers aloud who in the act of reading must decipher the handwriting on the manuscript page, comprehend the sense of the words and semantic unit, decide how to suitably moderate their delivery to create an artful and skilful reading, and then actualise this delivery with appropriate expression and physical support such as gesture or posture. My research also confirmed the well-established concept that formulas make it easier to read and memorise texts – although with the caveat that variations of familiar formulas can sometimes impede the reading. These conclusions are best realised and analysed through the act of performance: the ease of reading the poetry, or the challenge posed by scribal hands reveal themselves clearly to the reader through the experience of practical experimentation.

By combining performance and palaeographical/codicological analysis I demonstrated that romances in household manuscripts could be adapted to suit different lengths of performance and that, specifically, they were frequently divided into sections that last roughly twenty minutes when read aloud. These sections are signalled by internal textual divisions, marked by the intrusion of the first-person narrator, and can be indicated in the manuscript by a variety of paratextual features, mainly decorated capitals and paraph marks/chapter notations. The divisions provide readers of romances with the flexibility to alter their reading practices to suit the occasion: they allow a reader-aloud to refresh themselves and renew the attention of the audience, or for a private reader to pause their reading. The divisions allow users of the manuscripts, regardless of reading modality, to break up their reading into episodes, with the starting-point clearly signalled. Although romance divisions have been remarked upon before, and historical evidence of romance reading shows episodic reading, the performative analysis of this feature provides further detail, such as the time span of these episodes, and shows parallels to other performative traditions.

This thesis brings another performance resource to the study of romance, one that is materially and experientially engaged. I have focused throughout this thesis very literally on ‘romance reading from the book’, taking this popular reference from *Havelok the Dane* and exploring the impact when this description of romance performance is realised. By combining practical performative investigations with more traditional literary and palaeographical analysis, in returning texts in manuscripts to the aural sphere and focusing on a more complete materially and spatially conscious understanding of texts and reading practices, we are able to better understand the material and performative experience of reading from medieval books today and in the past. The minutiae of the weight, script legibility, layout, scribal practices and manuscript formats are crucial to consider in studies of reading practices and manuscripts more generally. Interacting with manuscripts or (ideally) suitable physical stand-ins outside of the usual confines of library apparatus can

drastically change our perceptions of books and texts, encouraging us to consider the material consequences for the reader/user in handling, touching and interacting with the book. For example, the conclusions reached about Ashmole 61 here go against common arguments about its supposed ease of handling and suitability for transport. Studies even of canonical texts can be radically altered by materially-informed engagements. Consider how analysis of *Pearl* would be transformed with greater awareness of the diminutive size of London, British Library Cotton MS Nero A.x/2. In several images, the river and the Pearl maiden are close enough to the page edges for a reader's hands to touch them as they hold the book, surprisingly tangible for a reader as they are not for the dreamer.<sup>2</sup> However, in scholarship, the text and manuscript loom larger than their actual physical size.

Household manuscripts are still a relatively recently-acknowledged category of manuscripts but one that offers a wealth of information about medieval lived experience. The significance of manuscripts that can not only be located within a specific social and economic context but also sometimes a highly specific geographical location – like the Findern manor in Derbyshire or East Newton Hall in Stonegrave, North Yorkshire – cannot be overstated. Their relatively plain presentation and utility-grade production belies a rich variety of evidence about textual and manuscript production, compilation and reception, an important counterpoint to studies of manuscripts of canonical works or those with grander decoration and production. Even those manuscripts without known origins and users offer a glimpse into a deeply personal world, with traces of usage like wear, staining, rebinding, annotations and marginal additions. The evidence in household manuscripts has a lot of scope for future investigations: the other various genres represented each entail different ways of engagement and reading. Although growing amounts of research have focused on domestic devotion, there is little that focuses on devotional activities as supported by the household manuscripts: Robert Thornton's manuscripts and Ashmole 61 in particular show a body of carefully-chosen pious material with often very clear usage contexts. A similar pattern of domestic locations for textual reception is apparent in these devotional texts as in the romances. Similarly, the more practical texts, such as medical recipes, scientific tracts and treatises were clearly designed for specific use and reference. The traces left by usage on the pages of household manuscripts – staining from light sources or proximity to food and drink, fingerprints and handprints, ink smudges by careless writers and even the patterns of wear from handling on the pages – have much to offer for future materially-focused manuscript studies, combined with rigorous scientific imaging and analysis techniques. Household

---

<sup>2</sup> Staining along the centre of the lower edges suggests that it was more usually held there. For more on staining and manuscripts: Rudy, 'Dirty Books: Quantifying Patterns of Use in Medieval Manuscripts Using a Densitometer'.

## Conclusion

manuscripts are books made to be used: to be read and reread by multiple generations, or even across multiple families, to delight and entertain with tales of adventure or parodic verses, to educate and to serve as reference for the educated, to edify with prayer and devotional lyrics, to heal bodily and spiritually, and to uplift with stories of saints or ancient heroes. Romance reading using these books united people in a shared reception and appreciation of a story, bringing together readers and hearers in a reception context that was experientially, materially, psychologically and sensorily distinct from silent, private/solitary reading.

In all aspects of this topic, flexibility has been the key concept. Houses, rooms, and contents are flexible according to the needs and wishes of their users. Similarly, texts can be read and experienced in multiple different modes, again, depending on the preferences and abilities of the reader and their audience. Both houses and books are set up in anticipation of this flexible usage. Houses are filled with moveable fixtures and both soft and hard furnishings can be moved and utilised in order to be adaptable to different purposes. Household manuscripts have features which support both reading aloud and solitary silent reading. This textual flexibility gives nuance to the discussion of orality, aurality and literacy, suggesting that a more nebulous cloud of modalities is a better model than a spectrum of oral vs. written. For manuscripts that may have offered the principal source of written texts for a household (although others, like Robert Thornton's manuscripts, were doubtless part of a wider collection), having texts that can be flexibly adapted to different modalities allows them to be freely read and reread for different purposes, in different contexts and by different audiences across their own lives and those of their families and related households.

Even though the experience of the medieval reader is lost to us, by experimenting and engaging with medieval texts in different ways, we as modern readers can become 'fluent' in reading aloud and romance-reading and begin to discover subtleties and layers of meaning we would not notice otherwise. This is amplified when we return these medieval texts to surviving medieval spaces. Reconstructed medieval buildings can serve as experimental laboratories and research tools to engage with the past and make the past more interesting to people today. Performance and reading aloud of Middle English material makes the language more accessible and gives vibrancy and new resonances to the text. Reading and performance are critical for Middle English teaching and allowing students to get the most out of texts. By encouraging engagement with texts in modes unfamiliar to modern readers, yet familiar to their original readers, we allow modern readers of medieval texts a glimpse of the possibilities of their original reception contexts.

The findings of the performance experiments suggest resonances with the reading experiences of the original users of the household manuscripts: textual or manuscript

## Conclusion

features that help or hinder the modern reader likely had a similar impact on medieval readers too. The challenge of reading a poorly laid-out text, an unclear erasure, complicated abbreviations or messily-written text apply equally to all users of manuscripts, and are particularly noticeable when used in performance. Although these modern observations cannot stand in for the medieval experience of reading, they provide a brief glimpse of them and a persuasive explanation for some idiosyncrasies of romance.

Qualitative research of this nature – especially qualitative research investigating subjective lived experiences – is difficult to validate and conclusions are usually couched in disclaimers. It is difficult to define the success of a project that often seems to pose more questions than it answers. After all, experimenting with reconstructing historical performance can only ever offer conclusions about the reconstruction, not the historical performance itself. However, an overarching theme of this thesis is giving authority to the subjective, to the overlooked, to the popular, and to the quotidian. A study like this has value beyond its perceived success or failure. If this research can provoke a reader (or hearer) to ask different questions of the material they read, to challenge assumptions about medieval romances and performance, to prompt shifts in perspective, or if it can persuade others to read aloud medieval material and engage with it more deeply, then it has succeeded.

## APPENDIX A: Manuscript Overviews and Contents Lists

The following provides a brief description of the focus manuscripts studied throughout this thesis, along with a table showing their contents and structure. The tables also represent the internal divisions of material within the manuscripts into booklets or thematic groupings as relevant. Booklets refers to sub-units of the manuscript that align with quire boundaries, signalling that they could be separated, either for usage or for copying purposes. Thematic groupings suggest anthologising principles at work in the construction and copying.

For ease of reference, the titles listed are those used in secondary material and therefore do not always match the titles given in the manuscripts themselves. Focus texts are signalled in bold. Titles of longer works are shown in italics, titles of shorter texts in quotation marks and generic or descriptive titles in plain text. In contents lists “wants” refers to pages that are missing but are counted in the foliation; “cancelled” refers to pages that are missing that are not counted in the foliation.

The description format follows the standard laid out by the Text Encoding Initiative (TEI).<sup>1</sup> The information in the manuscript descriptions consolidates the descriptions cited, including Gisela Guddat-Figge’s survey of manuscripts containing Middle English Romances, relevant library catalogues, manuscript facsimiles, my own observations and relevant secondary analysis.

---

<sup>1</sup> ‘10 Manuscript Description’, < Text Encoding Initiative >, 19 August 2020, <https://tei-c.org/release/doc/tei-p5-doc/en/html/MS.html#msph>.



## Cambridge, University Library MS Ff.1.6 (the Findern manuscript)

### Description<sup>2</sup>

Support: Paper

Dimensions: Approx. 210 x 150 mm

Extent: 188 folios (blank leaves added in 1896 rebinding to replace 29 missing leaves)

Scribes: Unknown – estimates vary between 28 and 40, mid-fifteenth to mid-sixteenth centuries. Some names added, in the manner of scribal signature or colophons.

Scripts: Anglicana and Secretary

Decoration: Spaces left for decorated capitals that were not completed. Small drawing of two fish and a barrel on f. 139r.

Condition: Good condition, although 29 leaves lost and end of book damaged.

Collation: 22 quires of varying sizes interpreted in varying ways<sup>3</sup>: A<sup>10</sup> (wants 1-2) + B<sup>16</sup> (wants 1-4) + bb<sup>8</sup> (wants 1, inserted after B10) + C<sup>10</sup> (wants 9, 10) + D<sup>16</sup> (wants 10, 11, 16) + E<sup>12</sup> + e<sup>4</sup> (inserted after E3) + F<sup>8</sup> + G<sup>12</sup> (12 cancelled) + H<sup>16</sup> (wants 15, 16) + I<sup>4</sup> (wants 1) + K<sup>10</sup> + L<sup>8</sup> (8 cancelled) + M<sup>6</sup> (wants 4-6) + N<sup>10</sup> + n<sup>8</sup> (inserted after N7) + nn<sup>4</sup> (wants 4, inserted after N9) + O<sup>14</sup> (wants 14) + P<sup>8</sup> (wants 6-8)

Watermarks: 11 watermarks.

Signatures: Partially.

Foliation: Two sets of modern foliation, the later by Henry Bradshaw in c. 1866.

Layout: Mostly single column, *Sir Degrevant* in two columns. Mostly unruled.

Music notation: Fragments on ff. 139v, 143r

Binding: Rebound in 1896 by Sydney M. Cockerell and assistants.

Origin: 1446-1550, Derbyshire.

Provenance: Held by Findern family in mid-sixteenth century, then in the library of Sir Thomas Knyvett (c. 1539-1618). Acquired by Bishop John Moore, then bought by George I who presented it to the University Library in 1715.

---

<sup>2</sup> A *Catalogue of the Manuscripts Preserved in the Library of the University of Cambridge*, vol. II (Cambridge: Cambridge University Press, 1857), 286–90; Guddat-Figge, *Catalogue of Manuscripts Containing Middle English Romances*, 90–94; Robbins, ‘The Findern Anthology’; Richard Beadle and A.E.B. Owen, eds., *The Findern Manuscript Cambridge University Library MS.Ff.1.6* (London: Scholar Press, 1978); ‘Found Records: Cambridge UK, Cambridge University Library Ff.1.6 [Findern MS]’, The Digital Index of Middle English Verse, accessed 3 June 2016, <https://www.dimev.net/Records.php?MSS=CULFf16>.

<sup>3</sup> The following is Ralph Hanna’s collation. For this and other interpretations, see: Hanna, ‘The Production of Cambridge University Library MS. Ff. i. 6’, 62; Robbins, ‘The Findern Anthology’; Harris, ‘The Origins and Make-up of Cambridge University Library MS Ff.1.6’; Johnston, ‘Sir Degrevant in the “Findern Anthology” (Cambridge, University Library MS Ff.1.6)’.

**Table A.1: Contents of Findern MS**

Section <sup>4</sup>	Quire	Folios	Notes	Watermarks <sup>5</sup>	Texts	Scribe <sup>6</sup>
I	A <sup>10</sup>	1-10	Wants 1-2	Bull	1. <i>Confessio Amantis</i> : “Philomene and Tereus” John Gower, ff. 3r-5r 2. <i>Confessio Amantis</i> : “A Lover’s Plaint” John Gower, ff. 5r-7r 3. <i>Confessio Amantis</i> : “Herypus King of Armenia” John Gower, ff. 7r-10r	1 1 1
	B <sup>16</sup>	11-20	Wants 1-4	Bull	ff. 11-14 missing 4. “The Complaynt unto Pite” Geoffrey Chaucer, ff. 15r-17r 5. “A Lover’s Plaint”, ff. 17r-18v 6. “To his Mistress”, ff. 19r-19v 7. “A Lover’s Plaint”, f. 20r 8. “To his Mistress”, f. 20v 9. “To his Mistress”, f. 20v (envoy of previous)	1 2 2 3 4 4
II (insert)	bb <sup>8</sup>	21-28	Wants 1, inserted after B10	Demi-bull	f. 21 missing (stub) 10. <i>The Book of Cupid or The Cuckoo and the Nightingale</i> , ff. 22r-28r 11. “To his Mistress”, f. 28v	5 (Clanvowe) 4
I cont.	B <sup>16</sup> cont.	29-34	[Wants 1-4]	Bull	12. <i>Parlement of Foules</i> Geoffrey Chaucer, ff. 29r-42v	6, 7 (W. Calverley)

<sup>4</sup> Following Johnston’s revision of Hanna’ collation and booklet divisions. Johnston, ‘Sir Degrevant in the “Findern Anthology” (Cambridge, University Library MS Ff.1.6)’; Hanna, ‘The Production of Cambridge University Library MS. Ff. i. 6’.

<sup>5</sup> Robbins, ‘The Findern Anthology’.

<sup>6</sup> Following Harris who is often quite conservative in scribal identification. Strong cases can be made for decreasing the number of scribes. Harris, ‘The Origins and Make-up of Cambridge University Library MS Ff.1.6’.

	C <sup>10</sup>	35-44	Wants 9, 10	Bull	12. <i>Parlement of Foules</i> Geoffrey Chaucer cont., ff. 29r-42v ff. 43, 44 missing (f. 43 stub)	6, 7 (W. Calverley)
III	D <sup>16</sup>	45-60	Wants 10, 11, 16. Copied after E, bound in reverse order.	Cap with Fleur-de-lys	13. <i>Confessio Amantis</i> “Three Questions” John Gower, ff. 45r-51r 14. <i>The Parliament of Love</i> , ff. 51r-53r 15. <i>The Rule of Fortune</i> / “When Fortune list give her assent”, f. 53v 16. Gnostic verses, f. 53v ff. 54, 55 missing (stubs) 17. <i>On Feigned Love</i> , f. 56r 18. “Give my License to live in Ease”, ff. 56v-58v 19. “Complaynt to his Empty Purse” Geoffrey Chaucer, f. 59r f. 59v has a memorandum about expenses	8 9 9 10  11 12 (Lewestoun) 12 (Lewestoun)
	E <sup>12</sup>	61-63	Copied before D, bound in reverse order.	Cap with Fleur-de-lys	20. Excerpt from <i>Anelida and Arcite</i> – “The Complaynt of Anelida the quene upon fals Arcite” Geoffrey Chaucer, ff. 61r-63v	13
IV (insert)	e <sup>4</sup>	64-67	Inserted after E3	Cap with Fleur-de-lys	21. Excerpt from <i>The Legend of Good Women</i> , “Thisbe” Geoffrey Chaucer, ff. 64r-67v	14 (Nicholas plenus amoris)
III (cont.)	E <sup>12</sup> cont.	68-76		Cap with Fleur-de-lys	22. <i>Complaint of Venus</i> Geoffrey Chaucer, ff. 68r-69v 23. “My woeful heart thus clad in pain”, f. 69v f. 70v has a later household account added 24. <i>Litera Cupidinis</i> / <i>Lespistre de Cupide</i> Thomas Hoccleve/Christine de Pizan, ff. 71r-76v	15 11  6

*ff. 77-80 not present in manuscript foliation due to theorised existence of lost quire.*

Va	F <sup>8</sup>	81-88		Crown with lance Heads	25. <i>Confessio Amantis</i> “Introduction to the Story of King Antiochus and Story itself” John Gower, ff. 81r-84r 26. <i>Confessio Amantis</i> “Introduction to the Story of King Antiochus and Story itself” John Gower, ff. 84v-95r	16, 17 16, 17, 18, 19, 20
	G <sup>12</sup>	89-99	12 cancelled	Crown with lance Heads	26. <i>Confessio Amantis</i> “Introduction to the Story of King Antiochus and Story itself” John Gower cont., ff. 84v-95r f. 95v blank later filled with pen tests and names <b>27. <i>Sir Degrevant</i>, ff. 96r-109v</b>	16, 17, 18, 19, 20  21 (Elizabeth Cotton/Elizabeth Francis)
Vb	H <sup>16</sup>	100-115	Wants 15, 16	Bull variation or goat	<b>27. <i>Sir Degrevant</i> cont. (other hand), ff. 96r-109v</b> 28. “The cronekelys of seyntys and kyngys of yngelonde”, ff. 110r-113r 29. Arms of the Kings of Europe, ff. 113r-113v ff. 114-115 missing	22 (Elizabeth Cotton/Elizabeth Francis)
VI	I <sup>4</sup>	116-119	Wants 1	-	f. 116 missing 30. “La Belle Dame sans Mercy” (?) Sir Richard Roos, ff. 117r-134v	6, 15
	K <sup>10</sup>	120-129		Bull head with stars; Cap with Fleur-de-lys	30. “La Belle Dame sans Mercy” (?) Sir Richard Roos cont., ff. 117r-134v	6, 25
	L <sup>8</sup>	130-136	8 cancelled	Bull head with stars	30. “La Belle Dame sans Mercy” (?) Sir Richard Roos cont., ff. 117r-134v 31. A love cycle, ff. 135r-136r 32. “A Slighted Lover’s Complaint”, ff. 136v-137r	6, 25 26 27

	M <sup>6</sup>	137-142	Wants 4-6	Bull head with stars	32. "A Slighted Lover's Complaint" cont., ff. 136v-137r 33. Desire to serve his mistress, f. 137r 34. "A Pledge of Loyalty to his Mistress", f. 137v  35. "A Lover's Distress", ff. 137v-138r 36. "The Vicissitudes of Love", f. 138v  37. "The Lover's Plaint", ff. 138v-139r  38. "A complaint against Fortune", f. 139r  39. "The Delivered Lover", f. 139v ff. 140-142 are missing	27 9?, 28 29 ('A god when') 4 30 ('Crocit. dyton', 'desormais') 4 29 ('A god when') 30 ('Crocit. dyton', 'desormais')
VII	N <sup>10</sup>	143-149		Hand with fleuron; Crown with lance heads	f. 143r is blank 40. A love song, f. 143v 41. A moral lament, ff. 144v-145r f. 145v is blank 42. A hymn to the Virgin, f. 146r 43. A prayer to Christ against perils, f. 146v 44. "The Wicked Tongue" John Lydgate, ff. 147r-150r	31 31 32 32 32 32
	n <sup>8</sup>	150-157	Inserted after N7	Crown with lance heads	44. "The Wicked Tongue" John Lydgate cont., ff. 147r-150r 45. "The Tongue", ff. 150r-151r 46. "Tyed with a Line" (excerpt), f. 151r 47. "Seven Wise Counsels", ff. 151r-152r 48. A Complaint for lack of mercy" John Lydgate, ff. 152v-153r 49. "On the Cruelties of his Mistress", f. 153r 50. "A complaint against his mistress", ff. 153r-153v 51. "The Faithful Lover", f. 153v 52. Love lament, f. 153v-154r	32 32 32 32 33 33 33 33 32

					53. A balade, f. 154r 54. "To his mistress", f. 154v 55. "The Pain and Sorrow of Evil Marriage", ff. 155r-156r 56. "How myschaunce regnyth in Ingeland" / A prayer for England, ff. 156v-159v	32? 21? 32 34 35, 36
	N <sup>10</sup> cont.	158-159		-	56. "How myschaunce regnyth in Ingeland" / A prayer for England cont., ff. 156v-159v 57. "A compleint vn to dame Fortune", f. 159v-161v	35, 36  35
	nn <sup>4</sup>	160-163	Wants 4. Inserted after N9	Unknown device with base	57. "A compleint vn to dame Fortune" cont., f. 159v-161v 58. "On the Four Complexions", f. 162v f. 163 is missing (stub)	35 37
	N <sup>10</sup> cont.	164		Hand with fleuron	59. "A tretise for lauandres" (??)John Lydgate, f. 164r f. 164v is blank	37
<i>f. 165 not present in manuscript foliation due to theorised existence of bifolium around O.</i>						
VIII	O <sup>14</sup>	166-179	Wants 14	Cap with Fleur- de-lys; Bull's head?	60. <i>Voeux du Paon</i> (extract) - The courtly game of "Le roi que ne ment" / "Alexander Cassamus", ff. 166r-177v 61. "Complaint against Fortune", f. 178r f. 178v is blank f. 179 is missing	38  39
<i>f. 180 not present in manuscript foliation due to theorised existence of bifolium around O.</i>						
IX	P <sup>8</sup>	181-188	Wants 6-8	-	62. "Cato Major" Benedict Burgh, ff. 181r-185v	40

## Cambridge, University Library MS Ff.2.38

### Description<sup>7</sup>

Support: Paper

Dimensions: Approx. 297 x 210 mm

Extent: 247 folios.

Scribes: Gisela Guddat-Figge suggests that it is the work of two main scribes, Scribe 1 writing from the beginning until f. 93ra line 5 (in *Octavian*), Scribe 2 writing from this point until f. 156vb line 6, and Scribe 1 then continuing until the end.<sup>8</sup> Other scholars believe the manuscript is the work of a single main scribe. Other hands add small marginal additions.

Scripts: Anglicana, fere textura titles and incipits/explicits.

Languages: Middle English

Decoration: some modest decoration throughout. 2-4 line capitals in red ink at beginnings of texts and at internal divisions. Some initial capitals washed in red ink. Some ascenders elongated and decorated.

Condition: Defective at beginning and end. Damage, staining and wear to text throughout, but mostly in good condition.

Collation: i<sup>20</sup>-xi<sup>20</sup> + xii<sup>20+1</sup> + xiii<sup>20</sup>

Catchwords: Yes. Some variation in orthography.

Watermarks: Yes. Only three types across entire manuscript, suggesting a well-planned production.

Signatures: Yes, see table below.

Foliation: Two sets of modern foliation, earlier nineteenth century and later nineteenth century by Henry Bradshaw, University Librarian. The most recent was added after the rebinding and restoration of the correct order of the manuscript's contents. Both orders are noted in the table below.

Layout: mostly double columns throughout. Frame ruled in hard point, some imprints and folds have caused damage to the pages.

Binding: Current binding 1972.

Origin: Mid 15<sup>th</sup> C.

Provenance: Unknown. Marginal additions name a previous owner or user as "Robert" (ff. 163v, 170v).

Other notes: Coherent and uniform layout and presentation, along with watermark evidence suggests that this is a professional production. Three distinct groups of contents signalled in table below.

---

<sup>7</sup> Guddat-Figge, *Catalogue of Manuscripts Containing Middle English Romances*, 94–99; McSparran and Robinson, *Cambridge University Library MS Ff.2.38*; 'Found Records: Cambridge UK, Cambridge University Library Ff.2.38', The Digital Index of Middle English Verse, accessed 27 October 2016, <https://www.dimev.net/Records.php?MSS=CULFf238>.

<sup>8</sup> Guddat-Figge, *Catalogue of Manuscripts Containing Middle English Romances*, 95.

**Table A.2: Contents of Ff.2.38**

Booklet	Quire	Folios	Notes	Signatures	Texts (old item number before rebinding in brackets)
1	i <sup>20</sup>	3-20	Wants 1 and 2. Religious and didactic lyrics.		1. (19) <sup>9</sup> W. Lychefelde <i>Pe compleynt of god</i> , ff. 3ra-6ra 2. (20) <i>þe ix lessons of dryge whych ys clepyd pety joob</i> , ff. 6ra-10ra 3. (21) <i>þe prouerbis of Salamon</i> , ff. 10ra-14va 4. (22) “The markys of medytacyoune” (“Stimulus Conscientie Minor”), ff. 14va-19rb 5. (23) “xij profytes þat men may gete in sufferyng of bodely anger”, ff. 19rb-20vb 6. (24) “þe mirroure of vices and of vertues, which also ys clepid þe seuene ages”, ff. 20vb-21vb

<sup>9</sup> The manuscript was previously misbound and not correctly rebound until 1972. Thus some older criticism features different item numbers. Frances McSparran and P.R. Robinson, eds., *Cambridge University Library MS Ff.2.38* (London: Scolar Press, 1979), xvi.



	ii <sup>20</sup>	21-40	Wants 2-7 (after f. 21). Religious and didactic lyrics; saints' lives.	a	<p>6. (24) "þe mirrou of vices and of vertues, which also ys clepid þe seuene ages", ff. 20vb-21vb (cont.)</p> <p>7. (1) Thomas Brampton, "The seuene salmes", ff. 28ra-31va</p> <p>8. (2) "A salutation of oure Lady", ff. 31va-32ra</p> <p>9. (3) "þe x commaundementis of almyzty god", ff. 32ra-32rb</p> <p>10. (4) "þe vij werkis of merci bodily", ff. 32rb-32va</p> <p>11. (5) "þe vij werkis of merci gostli", f. 32va</p> <p>12. (6) "The v bodyly wyttis", f. 32va</p> <p>13. (7) "þe v goostly wyttys", ff. 32va-vb</p> <p>14. (8) "þe vij deedly synnes", f. 32vb</p> <p>15. (9) "The vij vertues contrarie to þe vij dedli synnes", f. 33ra</p> <p>16. (10) "þe xij articlis of þe beleuee", ff. 33ra-va</p> <p>17. (11) "þe vij sacramentis schortly declarid of seynt Edmonde of pounteneye", ff. 33va</p> <p>18. (12) "A tretice of þre arowis þat schullen be schett on domesday azenste þem þat schullen be dampnedd", ff. 33va-35rb</p> <p>19. (13) "The viij tokenes of mekenes", ff. 35rb-va</p> <p>20. (14) þe life of marye mawdelyn, ff. 35vb-37rb</p> <p>21. (15) The lyfe of seynte margaret, ff. 37rb-38ra</p> <p>22. (16) þe life of seynt Thomas, ff. 38rb</p>
--	------------------	-------	---	---	---

	iii <sup>20</sup>	41-60	Religious and didactic lyrics; saints' lives and exempla.	ba/b	23. "On the Assumption of the Virgin", ff. 40va-45ra 24. <i>þe lyfe of seynt kateryn</i> , ff. 45ra-47vb 25. <i>þe chartur of criste</i> / The "Long Charter of Christ" (B text), ff. 47vb-50va 26. "þe xv tokenys before the day of dome", ff. 50va-53ra 27. "How the goode man taught hys sone", ff. 53ra-54rb 28. "A good ensauple of a lady þat was in dyspeyre" (Miracle of the Eucharist), ff. 54rb-55ra 29. "A Lamentation of the Virgin", ff. 55ra-55vb 30. "A Lamentation of the Virgin", ff. 55vb-56rb 31. <i>The Adulterous Falmouth Squire</i> , ff. 56rb-57va 32. <i>How a merchande dyd hys wyfe betray</i> , ff. 57va-59rb
	iv <sup>20</sup>	61-80	Didactic poem, romances.	c	33. <i>A gode mater of the marchand and hys sone</i> , ff. 59rb-63r 34. <i>The Erle of Tolous</i> , ff. 63ra-70vb <b>35. <i>Syr Egyllamore of Artas</i>, ff. 71ra-79rb</b>
	v <sup>20</sup>	81-100	Romances.	d	36. <i>Syr Tryamowre</i> , ff. 79va-90rb 37. <i>Octavian</i> (Northern version), ff. 90rb-102vb
	vi <sup>20</sup>	101-120	Romances.	e	38. <i>Sir Bevis of Hamtoun</i> , ff. 102vb-134r
	vii <sup>20</sup>	121-140	Exempla.	a	39. <i>The Seven Sages</i> , ff. 134ra-156vb
	viii <sup>20</sup>	142-156	Wants 1 (before f. 142), 4 (before f. 145) and 17-20 (after f. 156, probably blank) Exempla, lewd verse.	b	39. <i>The Seven Sages</i> , ff. 134ra-156vb (cont.) 39a. "Adieu my pretty pussy", f. 147r (16 <sup>th</sup> C. marginal addition)
2	ix <sup>20</sup>	161-180	Romance.	c	40. <i>Guy of Warwick</i> , ff. 161ra-231r

x <sup>20</sup>	181-200	Romance.	d	40. <i>Guy of Warwick</i> , ff. 161ra-231r (cont.)
xi <sup>20</sup>	201-220	Romance.	e	40. <i>Guy of Warwick</i> , ff. 161ra-231r (cont.)
xii <sup>20+1</sup>	221-241	f. 230 added, before 10. Romances.	f	40. <i>Guy of Warwick</i> , ff. 161ra-231r (cont.) 40a. <i>Syr Harrowde þe Gode Baron</i> , ff. 231va-239va 41. <i>Le Bone Fflorenc of Rome</i> , ff. 239va-254rb
xiii <sup>20</sup>	242-261	Romances, legend.	g	41. <i>Le Bone Fflorenc of Rome</i> , ff. 239va-254rb (cont.) 42. <i>Robert of Sicily</i> , ff. 254rb-257vb 43. <i>Sir Degare</i> , ff. 257vb-261vb

## Cambridge, University Library MS Ff.5.48

### Description<sup>10</sup>

Support: Paper

Dimensions: 200 x 140 mm

Extent: 132 folios

Scribes: Two main scribes

Scripts: Anglicana and Secretary hybrids

Decoration: simple ink drawings

Condition: Fair – end heavily damaged and obscured by staining caused by damp and by restoration attempts.

Signatures: Modern signatures, added in pencil

Layout: Single column except for item 9 in two columns. Unruled.

Binding: Late seventeenth-century.

Origin: 1450-1500, West Midlands.

Provenance: Early history unknown. Likely owned by Reverend William Bedwell in the seventeenth century, then passed to the Master of Emmanuel College, Cambridge later that century. Joined the collection of the University Library in 1664.

**Table A.3: Contents of Ff.5.48<sup>11</sup>**

Section	Quire	Folios	Notes	Watermarks	Texts
I					f. 1 missing. 1. Directions to parish priests (John Mirk), ff. 2r-8r 2. “The ABC of Aristotle” (with prologue), ff. 8v-9r 3. “When thonder comeþ in Ianeuere” (weather prognostications), ff. 9v-10v 4. “Contra Fures et Latrones”, f. 10v

<sup>10</sup> Guddat-Figge, *Catalogue of Manuscripts Containing Middle English Romances*, 127–30; Phillipa Hardman, ed., *The Heege Manuscript: A Facsimile of National Library of Scotland MS Advocates 19.3.1*, 16 (Leeds: Leeds Texts and Monographs, 2000), 13–47; ‘Found Records: Edinburgh, National Library of Scotland, Advocates’ 19.3.1’, *The Digital Index of Middle English Verse*, accessed 10 August 2016, <https://www.dimev.net/Records.php?MSS=NLS1931>.

<sup>11</sup> Guddat-Figge’s contents list misses several items. I have retained her numbering but added in missed texts where they occur based on my own observations signalled with letters.

					<p>5. "Passio Domini" (Northern Passion), ff. 11r-43r  6. "Memento homo", f. 43v  7. Against the seven deadly sins, ff. 43v-44r  8. A tale of an incestuous daughter, ff. 44r-48r  9. A tale of King Edward and the shepherd, ff. 48v-56v  10. The song of the Nightingale/The Clerk and the Nightingale, ff. 57r-v  11. The Tale of the Basin, ff. 58r-61v  12. "Turnament of Totenham", ff. 62r-66r  13. Prognostications derived from the day on which Christmas falls, f. 66v  In Latin prose.</p>
II					<p>14. The adulterous Falmouth Squire, ff. 48r, 67r-70r  f. 70v is blank  15. A Lamentation of the Virgin, ff. 71r-72v  16. A Lamentation of the Virgin, ff. 73r-74v  17. Orison to the Virgin Mary from the <i>Speculum Christiani</i>, ff. 74v-75v  18. Prognostications drawn from the day of the week on which the year commences, ff. 75v-78v</p>
III					<p>19. A few metrical expositions of some of the Church-festivals and Gospels, ff. 79r-91v  19a. Legend of St. Michael from the <i>South English Legendary</i>, Pt 1, ff. 79r-80r  19b. Legend of St. Michael from the <i>South English Legendary</i>, Pt 2, ff. 80v-84r  19c. The Feast of the Annunciation from the <i>South English Legendary</i>, ff. 84r-87v  19d. Septuagesima from the <i>South English Legendary</i>, f. 84v  19e. Quadragesima from the <i>South English Legendary</i>, ff. 84v-87v  19f. "The Southern Passion" from the <i>South English Legendary</i>, ff. 87v-92vb  ff. 93, 94 missing</p>
IV					<p>20. "Principium Anglie" (metrical chronicle of England from Brut to Edward II), ff. 95r-112r  21. The mourning of the Hare, ff. 109v- DIMEV has ff. 112v-113v  22. Prognostications about the seasons of the year, ff. 114r-v</p>

					23. The Betrayed Maiden's Lament, f. 114v
V					24. "The Feest of Tottenham", ff. 115r-116r 25. The Lady who buried the Host/Miracle of the Eucharist, ff. 116v-118v 26. Thomas of Erceldoune's Prophecy, ff. 119r-128v 27. A Little Jest of Robin Hood and the Monk, ff. 128v-135v

## Lincoln, Cathedral Library MS 91 (The Lincoln Thornton Manuscript)

### Description<sup>12</sup>

Support: Paper

Dimensions: Approx. 290 x 210 mm

Extent: Originally 335 folios.

Scribes: One main scribe, who names himself as Robert Thornton. Other scribes add filler items, small notes and marginal additions.

Scripts: Anglicana.

Languages: Middle English, Latin.

Decoration: Some modest decoration throughout. Decorated initials in coloured ink (red, blue, green, purple, brown and black), in two main styles, 3-12 lines high, with flourishes, probably additions by a professional decorator. Some inhabited initials. Spaces left for images which were not carried out.

Drawing of armoured knights and a horse on f. 52v. Smaller marginal drawing of two armoured knights fighting on f. 75v.

Condition: Good – some loss of pages, many outer corners of pages damaged and lost.

Collation: a<sup>24</sup> (wants 1-4, 23) + b<sup>24</sup> (wants 1) + c<sup>18</sup> (11-18 cancelled) + d<sup>16</sup> + e<sup>18</sup> + f<sup>16</sup> + g<sup>22</sup> (wants 1, 22) + h<sup>22</sup> (12 is a stub) + i<sup>20</sup> + k<sup>16</sup> (wants 16) + l<sup>20</sup> + m<sup>24</sup> + n<sup>18</sup> (wants 1, 16-18) + o<sup>18</sup> (wants 1) + p<sup>30</sup> (wants 1; 10-12 cancelled) + q<sup>36 or 40</sup> (? Wants 1-2, 38-40) + r<sup>?</sup> (fragments of seven leaves).<sup>13</sup>

Catchwords: Only in English prose texts, on verso and recto although not consistently. Some variation in orthography.

Watermarks: Yes, detailed in table below.

<sup>12</sup> Guddat-Figge, *Catalogue of Manuscripts Containing Middle English Romances*, 135–42; D.S. Brewer and A.E.B. Owen, eds., *The Thornton Manuscript (Lincoln Cathedral MS. 91)* (London: Scholar Press, 1975); 'Found Records: Lincoln, Lincoln Cathedral Library 91 [Robert Thornton MS]', *The Digital Index of Middle English Verse*, accessed 17 January 2017, <https://www.dimev.net/Records.php?MSS=Lincoln91>.

<sup>13</sup> Brewer and Owen, *The Thornton Manuscript (Lincoln Cathedral MS. 91)*, xiii.

Signatures: Yes, but many are lost due to damage to outer edges of pages.

Foliation: Modern, c. 1800.

Layout: Prose generally in a single column, verse generally in two columns. Frame and margins are marked but often written over.

Binding: 1974. Cockerell. In heavy wooden boards with leather on spine.

Origin: c. 1430-50. Yorkshire (North Riding).

Provenance: Held by the Thornton family of East Newton until the late seventeenth century, then held by the Lincoln cathedral library.

**Table A.4: Contents of Li 91**

Section	Quire	Folios	Notes	Signatures	Watermarks <sup>14</sup>	Texts
I	A <sup>24</sup>	1-19	Wants 1-4, 23	*	K (crossed axes) and F (sole of shoe)	1. <i>Prose Alexander</i> , ff. 1r-49r
	B <sup>24</sup>	20-42	Wants 1	b	F (sole of shoe) and K (crossed axes)	1. <i>Prose Alexander</i> , ff. 1r-49r (cont.)
	C <sup>18</sup>	43-52	11-18 cancelled	c	K (crossed axes)	1. <i>Prose Alexander</i> , ff. 1r-49r (cont.) 2. Weather prognostications, ff. 50r-v 3. <i>Lamentacio Peccatoris</i> , ff. 51v-52r
II	D <sup>16</sup>	53-68		d	B (bull's head)	4. <i>Alliterative Morte Arthure</i> , ff. 53r-98v
	E <sup>18</sup>	69-86		e	B (bull's head) and E (fleur-de-lis/dolphin)	4. <i>Alliterative Morte Arthure</i> , ff. 53r-98v (cont.)

<sup>14</sup> John J. Thompson, 'Robert Thornton and His Book Producing Activities: Aspects of the Transmission of Certain Late Medieval Texts in the Light of Their Present Context in Thornton's Manuscripts' (D. Phil thesis, University of York, 1983), 458-59.

F <sup>16</sup>	87-102		f	E (fleur-de-lis/dolphin)	4. <i>Alliterative Morte Arthure</i> , ff. 53r-98v (cont.) 5. <i>Octavian</i> , ff. 98va-109rb
G <sup>22</sup>	103-122	Wants 1, 22	*	H (hammer); C (cart) and L (bull's head and cross)	5. <i>Octavian</i> , ff. 98va-109rb (cont.) 6. <i>Sir Isumbras</i> , ff. 109rb-114va 7. <i>The Earl of Toulous</i> , ff. 114vb-122ra 8. <i>Vita Sancti Christofori</i> , ff. 122vb-129vb
H <sup>22</sup>	123-143	12 is a stub	*	E (fleur-de-lis/dolphin)	8. <i>Vita Sancti Christofori</i> , ff. 122vb-129vb (cont.) 9. <i>Sir Degreunte</i> , ff. 130ra-138va <b>10. <i>Sir Eglamour of Artasse</i>, ff. 138va-147rb</b>
I <sup>20</sup>	144-163		*	B (bull's head)	<b>10. <i>Sir Eglamour of Artasse</i>, ff. 138va-147rb (cont.)</b> 11. <i>De Miraculo Beate Maris</i> , ff. 147rb-148rb 12. "Lyarder", ff. 148rb-149r 13. "Thomas off Ersseldoune", ff. 149va-153vb 14. <i>The Awentyrs off Arthure</i> , ff. 154r-161r 15. <i>Sir Percyuell of Gales</i> , ff. 161ra-176ra
K <sup>16</sup>	164-178	Wants 16	k	K (crossed axes); F (sole of shoe) and A (bull)	15. <i>Sir Percyuell of Gales</i> , ff. 161ra-176ra (cont.) 16. Three charms for toothache, ff. 176rb-176v 17. <i>Epistola Sancti Saluatoris</i> , f. 176v 18. Prayer, f. 176v 19. English indulgence and Latin prayer, ff. 176v-177r 20. "A Prayer Off the ffyve Joyes of owre Lady in Ynglys and of the ffyve sorowes", ff. 177v-178r 21. "Psalmus Voce mea ad dominum clamaui", f. 178r 22. "fyve prayers to the wirchipe of the ffyve wondus of our lorde Ihesu Cryste", ff. 178r-v 23. Oracio in Inglys, f. 178v 24. "A Colett to owre lady Saynt Marye", f. 178v 25. "Oracio in modo Collecte pro amico", f. 178v



						26. "Antiphona Sancti Leonardi, cum Collecta", f. 178v
III	L <sup>20</sup>	179-198		1	E (fleur-de-lis/dolphin)	<p>27. "The Previte off the Passioune", ff. 179r- 189r</p> <p>27a. "Of all thing it is the best", f. 189r</p> <p>28. "Tractatus Williami Nassyngton", ff. 189r-191v</p> <p>29. "A thanksgiving to God", f. 191v</p> <p>30. "An orison to the Trinity", f. 191v</p> <p>30a. A morning prayer, f. 191v</p> <p>31. "A prayer to Jesus for mercy", ff. 191v-192r</p> <p>32. "Ihesu of whayme all trewe luffe sprynges", f. 192r</p> <p>33. Rolle "Of the vertus of the haly name of Ihesu", ff. 192r-193v</p> <p>34. "Narracio: A tale þat Richerde hermet made", f. 193v</p> <p>35. "A prayere þat Richert hermet made þat es beried at hampulle", f. 193v</p> <p>36. "Ympnus quem composuit Sanctus Ambrosius", ff. 193v-194r</p> <p>37. "De imperfecta contricione", f. 194r</p> <p>38. "Moralia Richardi hermite de natura apis", ff. 194r-v</p> <p>39. "De uita cuiusdam puelle incluse propter amorem christi", ff. 194v-r</p> <p>40. "Richardus hermyta", f. 194v</p> <p>41. "Item inferius idem Richardus", f. 195r</p> <p>42. "A notabill Tretys off the ten Comandementys", ff. 195v-196r</p> <p>43. "Item idem de septem donis Spiritus sancti", ff. 196r-v</p> <p>44. "Item idem de dilectatione in deo", f. 196v</p> <p>45. <i>Speculum Sancti Edmundi</i>, ff. 197r-209v</p>

	M <sup>24</sup>	199-222		m	E (fleur-de-lis/dolphin); M (circle)	<p>45. <i>Speculum Sancti Edmundi</i>, ff. 197r-209v (cont.)</p> <p>46. “Tractatus de dominica oratione”, ff. 209v-211r</p> <p>47. A prayer to Jesus “Jesu Christ Saint Mary son”, ff. 211ra-211va</p> <p>48. A prayer to the Trinity, ff. 211vb-212rb</p> <p>49. Prayer to Jesus, f. 212rb</p> <p>50. “A meditacione of þe ffyve woundes of oure lorde Ihesu criste”, ff. 212rb-vb</p> <p>51. “A medytacion of the Crosse of Criste with a prayere”, ff. 212vb-213r</p> <p>52. A warning on the transitoriness of life, ff. 213r-v</p> <p>53. Prayer to Jesus, ff. 213v</p> <p>54. The Lay Folk’s Catechism by John de Gaytryge, ff. 213v-218v</p> <p>55. A song of love to Jesus, ff. 219ra-219v</p> <p>56. W. Hilton’s “Of Angels’ Song”, ff. 219v-221v</p> <p>57. An exhortation to love Jesus, ff. 222r-v</p> <p>58. A warning against wordly vanity, f. 222v</p>
IV	N <sup>18</sup>	223-236	Wants 1, 16-18	N?	M (circle)	<p>59. W. Hilton’s Epistle on mixed life, ff. 223r-229r</p> <p>60. W. Hilton. From “Scale of Perfection”, ff. 229v-230v</p> <p>61. “Of Sayne John þe Euangelist”, ff. 231r-233v</p> <p>62. On prayer, ff. 233v-236v</p>
V	O <sup>18</sup>	237-253	Wants 1	o	H (hammer) and M (circle)	<p>63. Six things are to wit in prayer, ff. 237r-240r</p> <p>64. “De gracia dei”, ff. 240r-243v</p> <p>65. “Our daily work”, ff. 243v- 250v</p> <p>66. “A Reuelacyoun Shewed to ane holy woman now one late tyme”, ff. 250v-258v</p>

	P <sup>30</sup>	254-279	Wants 1, 10-12 cancelled	*	C (cart); E (fleur-de-lis/dolphin) and N (Catherine wheel)	66. "A Reuelacyoun Shewed to ane holy woman now one late tyme", ff. 250v-258v (cont.) 67. Psalm "Miserere mei deus", ff. 258r-v 68. Hymn "Veni Creator Spiritus", f. 258v 69. "Sayne Ierome Spaltyre", ff. 258v-270v 70. "Religio sancti spiritus", ff. 271r-276r 71. "Prick of Conscience", ff. 276v-277r 72. "De vii gaudia beate marie uirginis per sanctum Thomam et martyrem Cantuariensem Archiepiscopum", ff. 277va-b 73. "A noþer Salutacioun till oure lady of hir fyve joyes", ff. 277vb-278r 74. "Ane antyme to þe ffadir of heuene with a colett", f. 278r 75. "Anoþer Antyme of þe passyoun of criste ihesu", f. 278r 76. "A Colecte of grete perdone vnto crist ihesu", ff. 278r-v 77. "A Preyere to þe wounde in Chrystis syde", ff. 278v-279r 78. "Erthe upon Erthe", ff. 279r-v 79. Prescription "ffor the Scyatica", ff. 279v
VI	Q <sup>36</sup>	280-314	36 or 40. Wants 1-2, 38-40	*	O (letter A and cross)	80. <i>Liber de diuresis medicinis</i> , ff. 280r-317r
	R <sup>?(7+)</sup>	315-321	Fragments of 7 leaves	*		80. <i>Liber de diuresis medicinis</i> , ff. 280r-317r (cont.) 80a. <i>A tretys of diverse herbis</i> , ff. 317r-321v

## London, British Library Cotton MS Caligula A.ii

### Description<sup>15</sup>

Support: Paper

Dimensions: Approx. 225 x 180 mm in current binding. Pages approx. 215 x 145 mm.

Extent: 210 folios. 2 (ff. 1-2: early modern endleaves) + 137 (ff. 3-139) + 2 (ff. 140-141: early modern leaves) + 69 (ff. 142-210)

Scribes: 1 main scribe.

Scripts: Secretary; titles in Anglicana Formata

Languages: Middle English, Latin

Decoration: letters washed in faded red ink, spaces left for more complex decorated capitals (not completed).

Condition: Good. Some losses, particularly in quire 4, but difficult to ascertain due to uncertainty of collation.

Collation: Difficult to determine due to rebinding and trimming causing loss of catchwords and signatures. Quire divisions proposed by John J. Thompson are used in the table below.<sup>16</sup>

Catchwords: None found, likely removed during trimming.

Signatures: None found, likely removed during trimming.

Foliation: Two sets of modern foliation, one cancelled.

Layout: Single and double columns. Ruled frame in ink supported by prickings in four corners.

Binding: British Museum, 1957.

Origin: First part 1446-1500. South-East or South-East Midlands. Second part is later: 3<sup>rd</sup> quarter of the 15th century – 1<sup>st</sup> quarter of the 16th century, from a London Charterhouse.

Provenance: Previously owned by Jo. Rogers, 17th century; the Cotton family, Bts, Conington, 17th century. Second part previously owned by Thomas Cooke of Milton, 2nd half of the 15th century; the Cotton family, Bts, Conington, 17th century.

---

<sup>15</sup> Guddat-Figge, *Catalogue of Manuscripts Containing Middle English Romances*, 169–72; ‘Cotton Manuscript Caligula A II’, British Library: Explore Archives and Manuscripts, accessed 3 November 2015, [http://searcharchives.bl.uk/IAMS\\_VU2:IAMS040-001102311](http://searcharchives.bl.uk/IAMS_VU2:IAMS040-001102311); ‘“The Pistill of Susan” (3r–5r: Boffey 3553, Imperfect);...’, British Library: Explore Archives and Manuscripts, accessed 3 November 2015, [http://searcharchives.bl.uk/IAMS\\_VU2:IAMS041-001102312](http://searcharchives.bl.uk/IAMS_VU2:IAMS041-001102312); ‘Statutes of the Carthusian Order (144r–148r);...’, British Library: Explore Archives and Manuscripts, accessed 3 November 2015, [http://searcharchives.bl.uk/IAMS\\_VU2:IAMS041-001102313](http://searcharchives.bl.uk/IAMS_VU2:IAMS041-001102313); ‘Found Records: London, British Library Cotton Caligula A.II’, The Digital Index of Middle English Verse, accessed 3 November 2015, <https://www.dimev.net/Records.php?MSS=BICottCalAII>.

<sup>16</sup> John J. Thompson, ‘Looking behind the Book: MS Cotton Caligula A.Ii, Part 1, and the Experience of Its Texts’, in *Romance Reading on the Book: Essays on Medieval Narrative Presented to Maldwyn Mills*, ed. Jennifer Fellows et al. (Cardiff: University of Wales Press, 1996), 171–87.

**Table A.5: Contents of CCAii**

Quire	Folios	Type	Texts
1	x-13	Bible story	1. “The Pistill of Susan” (imperfect), ff. 3ra-5r
		Romance	<b>2. <i>Syr Egyllamore of Artois</i>, ff. 5v-13r</b>
		Later addition	3. Recipes added in a later hand, f. 13v
2	14-33	Practical and didactic Lydgate poems	4. “Stans puer ad mensam” (Lydgate), ff. 14r-15v
			5. “Dietary” (Lydgate), ff. 15v-16v
			6. “The Chorle and the Birde” (Lydgate), ff. 17r-22r
3	34-55	Romances	7. <i>Octavian</i> , ff. 22v-35rb
			7. <i>Octavian</i> (cont. across proposed quire boundary)
			8. <i>Sir Launful</i> , ff. 35va-42va
4	56-81		9. <i>Libeaus Desconus</i> , ff. 42vb-57rb
			9. <i>Libeaus Desconus</i> (cont. across proposed quire boundary)
		Elegy	10. Elegy on Ralph Cromwell, 3rd Baron Cromwell (d. 1456), ff. 57v-58r
		Bible retelling	11. Paraphrase of the Ten Commandments, f. 58v
			12. On the nightingale as a symbol of Christ (Lydgate) (imperfect), ff. 59r-64r
		Prayer	13. “Deus in nomine tuo saluum me fac” (Lydgate), ff. 64v-65r
		Medical treatise	14. Recipe for treating pestilence, ff. 65v-66v
		Religious lyrics	15. “I see a ribbon rich and new”, ff. 67r-67v
			16. “The great God full of grace”, f. 68r
			17. “By a way wandering as I went”, f. 68v
			18. “Make amendes”, f. 69r
		Religious text	19. Form of Confession, ff. 69v-70r
		Prayer	20. Orison to Christ of the Wounds John Audelay, prayer (extract), ff. 70vb
Romance	21. <i>Emaré</i> , ff. 71ra-76vb		
Bible retelling	22. <i>Carta Jhesu Christi</i> (The Long Charter of Christ) (B text), ff. 77ra-79rb		
Legendary poem	23. <i>Ipotis</i> , ff. 79v-83ra		
5	82-101		23. <i>Ipotis</i> (cont. across proposed quire boundary)
		Devotional treatise	24. <i>The Stacions of Rome</i> , ff. 83rb-86va

		Prayer	25. <i>Trentale of St Gregory</i> , ff. 86vb-88ra
		Conduct poem	26. “Vrbanitatis”, ff. 88rb-88vb
		Linked religious poems	27. “Quindecim signa”/Invocation to the Creator, f. 89ra-b
			28. “Quidecim signa”; Fifteen signs before the Day of Judgment, ff. 89r-91r
			29. A song of Love to the Virgin Mary, ff. 91rb
		Purgatory poems	30. <i>Owayne Miles</i> , ff. 91va-95rb
			31. <i>Visio Tundali</i> , ff. 95va-107vb
5	102-119		31. <i>Visio Tundali</i> (cont. across proposed quire boundary)
		Moral/devotional lyrics	32. Song of Christ to the Virgin Mary, ff. 107vb-108ra
			33. “Myn owene woo”/Moral poem, ff. 108rb-108vb
		Chronicle	34. Chronicle from Brutus to Richard III, king of England (1483–85), ff. 109r-110v
		Romances	35. <i>Siege of Ierusalem</i> , ff. 111r-125r
6	120-139		35. <i>Siege of Ierusalem</i> , ff. 111r-125r (cont. across proposed quire boundary)
			36. <i>Cheuelere Assigne</i> , ff. 125v-129v
			37. <i>Sir Isumbras</i> , ff. 130ra-134rb
		Paired religious lyrics	38. “Wuinque wlnera” (Lydgate), f. 134v
			39. “Quinque Gaudia” (possibly Lydgate), f. 135r
		<i>Vitae</i>	40. <i>St Jerome</i> , ff. 135v-137r
			41. <i>St Eustace</i> (137v–139v, imperfect), f. 137v-139v
	144-148	Previously separate London Charterhouse Material.	Statutes of the Carthusian Order, ff. 144r–148r Notes of visitations, 1470–71, ff. 156v–157r Formulary for electing a prior, ff. 157v–158v Index, ff. 159r–164v Constitutions of the Carthusian General Chapter, 1411–1504, ff. 165r–206v

## Edinburgh, National Library of Scotland Advocates MS 19.3.1

### Description<sup>17</sup>

Support: Paper

Dimensions: 210 x 140 mm

Extent: 216 folios

Scribes: Two named scribes: Richard Heege and John Hawghton. Several other unnamed hands and several later additions.

Scripts: Hybrid Anglicana-Secretary hands

Decoration: Initials in red ink, some initial capitals washed in red. Marginal doodles.

Condition: Good – well-used but well-preserved. A few leaves missing. Trimming to upper edges has damaged some running titles.

Collation: A<sup>10</sup> + B<sup>20</sup> (wants 20) + C<sup>10</sup> + D<sup>20</sup> + E<sup>20</sup> (wants 1) + F<sup>12</sup> (wants 12) + G<sup>24</sup> + H<sup>16</sup> + I<sup>20</sup> + J<sup>18</sup> + K<sup>12</sup> + L<sup>16</sup> + M<sup>14</sup> (wants 14)

Catchwords: None

Watermarks: 8 watermarks

Signatures: 1-3 in quires G-I, possible 4 in J. i- iij in quires K-M.

Foliation: Modern foliation throughout, early foliation ff. 1-40.

Layout: Mostly single column, except for items 7 and 33

Music notation: ff. 153r, 216v

Binding: Rebound in 1964.

Origin: North Midlands, second half of the fifteenth century.

Provenance: Early history unknown. Held by the Sherbrooke family since at least the sixteenth century, then sold to Advocates Library in 1806.

---

<sup>17</sup> Guddat-Figge, *Catalogue of Manuscripts Containing Middle English Romances*, 127–30; Hardman, *The Heege Manuscript: A Facsimile of National Library of Scotland MS Advocates 19.3.1*, 13–47; ‘Found Records: Edinburgh, National Library of Scotland, Advocates’ 19.3.1’.

**Table A.6: Contents of Heege MS<sup>18</sup>**

Section	Quire	Folios	Notes	Watermarks	Texts
I	A <sup>10</sup>	1-10		Crown (Briquet 4645)	1. <i>The Hunting of the Hare</i> (ff. 1r-7r) 2. Parodic Sermon (ff. 7r-10r) 3. Nonsense Verse (f. 10v)
II	B <sup>20</sup>	11-29	Wants 20	Crown (Briquet 4645)	4. <i>Sir Gowther</i> (ff. 11r-27v) 5. <i>Stans puer ad mensam</i> (ff. 28r-29v)
III	C <sup>10</sup>	30-47		Eagle	6. <i>Seynt Kateryn</i> (ff. 30r-47r) 6a. Form of indulgence (f. 47v)
IV	D <sup>20</sup>	48-67		Bull's head (Briquet 15100)	<b>7. <i>Sir Ysumbras</i> (ff. 48r-56v)</b> 8. <i>þe Masse</i> (ff. 57r-58v) 9. Macaronic carol of the Nativity (ff. 59r-59v) 10. Nonsense verses (ff. 60r-60v) 10a. Fragment of a lyric (later hand) (f. 61r) 11. <i>Deceyte</i> (f. 61v) 12. Proverbs (f. 61v) 13. Rhyming Proverbs (f. 61v) 14. Terms of Carving (f. 62r) 14a. Fragment of charm or medical receipt (later hand) (f. 62v) 15. Terms of hunting (ff. 63r-64v) 16. <i>For a Malaundre</i> (later hand) (f. 64v) 17. <i>Ave regina coelorum</i> (ff. 65r-65v) 18. <i>þat pes may stond</i> (ff. 66r-67v)

<sup>18</sup> Guddat-Figge's contents list misses several items. I have retained her numbering but added in missed texts where they occur based on my own observations signalled with letters.



V	E <sup>20</sup>	68-86	Wants 1	Letter P (Briquet 8522)	19. <i>Sir Amadas</i> (ff. 68r-84r) 20. Courtesy poem (ff. 84v-86v) 21. <i>Foy the cholyc</i> (f. 86v)
VI	F <sup>12</sup>	97, 87-96	Wants 12. f. 97 incorrectly bound at end instead of beginning of quire.	Hand (Briquet 11154)	22. <i>Miserere mei Deus</i> (ff. 97r-97v, 87r-89r) 23. <i>Ecce Ancilla Domini</i> (ff. 89v-90v) 24. Lyrics (f. 91r) 25. <i>Servis is no heritage</i> (ff. 91r-92v) 26. Lyric (ff. 93r-94r) 27. <i>Verbum caro factum est</i> (ff. 94v-95v) 28. Lyric (ff. 95v-96r) 29. Form of Indulgence (f. 96v)
VII	G <sup>24</sup>	98-121		Two keys (Briquet 3887) (8 outer leaves); Bull's head (Briquet 15100)	30. <i>Tundale</i> (ff. 98r-157v)
	H <sup>16</sup>	122-137		Bull's head (Briquet 15100)	30. <i>Tundale</i> cont. (ff. 98r-157v)
	I <sup>20</sup>	138-157		Bull's head (Briquet 15100)	30. <i>Tundale</i> cont. (ff. 98r-157v)
VIII	J <sup>18</sup>	158-175		Wheel (Briquet 13310)	31. <i>Complaint of God</i> (ff. 158r-170v) 31a. Religious lyric (ff. 170v-173r) 31b. Lyric (later hand) (f. 173v) 32. List of expenditures (later hand) (f. 173v)

					33. 'Lamentacio Peccatoris' (ff. 174r-175r) 34. Didactic verses (f. 175r) 35. Rhyming precepts (f. 175r) 35a. Guidonian hand (f. 175v)
IX	K <sup>12</sup>	176-187		Hand (Briquet 11154)	36. Lydgate's <i>Life of Our Lady</i> Bk IV (ff. 176r-185v) 37. Prayer against bleeding (later hand) (f. 185v) 36a. Lydgate's <i>Life of Our Lady</i> Bk V (ff. 186r-202v)
	L <sup>16</sup>	188-203		Hand (Briquet 11154)	36a. Lydgate's <i>Life of Our Lady</i> Bk V cont. (ff. 186r-202v) 36b. Lydgate's <i>Life of Our Lady</i> Bk VI (ff. 203r-210r)
	M <sup>14</sup>	204-216	Wants 14	Paschal lamb (Briquet 22)	36b. Lydgate's <i>Life of Our Lady</i> Bk VI cont. (ff. 203r-210r) 38. Religious lyric (ff. 210v-211v) 39. Prescription (f. 211v) 40. Prognostications of weather (ff. 212r-212v) 41. <i>Trentalle sancti Gregorii</i> (ff. 213r-216r) 42. <i>Deus Creator Omnium</i> (f. 216v)

## Oxford, Bodleian Library MS Ashmole 61

### Description<sup>19</sup>

Support: Paper

Dimensions: 415 x 137mm (often referred to as 'holster book' format)

Extent: 162 folios, an additional leaf added after f. 30 is not included in foliation

Scribes: One scribe who names themselves 'Rate'

Scripts: Anglicana

Decoration: Ink drawings mainly of fish and flowers, some initial capitals washed in yellow ink

Condition: Good but defective at end

Collation: Binding too tight to ascertain. One suggestion is A<sup>8</sup> + B<sup>10</sup> + C<sup>12</sup> + D<sup>16</sup> + E<sup>12</sup> + F<sup>10</sup> (wants 9 and 10) + G<sup>12</sup> + H<sup>14</sup> + I<sup>13</sup> (8 is cancelled) + J<sup>16</sup> + K<sup>16</sup> + L<sup>14</sup> + M<sup>16</sup> (wants 12–16)

Catchwords: After quire except F, L-M

Watermarks: 3 watermarks

Foliation: Two sets of foliation, one modern, one potentially earlier (16<sup>th</sup> century)

Layout: Single column, irregularly ruled and pricked.

Binding: Rebound in 1986.

Origin: c. 1500 – made sometime in the late fifteenth – early sixteenth century. Northern midlands, possible connection to Leicester.

Provenance: Early history unknown. Part of collection of Elias Ashmole (1617-1692) which was donated to the University of Oxford.

---

<sup>19</sup> Guddat-Figge, *Catalogue of Manuscripts Containing Middle English Romances*, 249–52; Blanchfield, “‘An Idiosyncratic Scribe’: A Study of the Practice and Purpose of Rate, the Scribe of Bodleian Library MS Ashmole 61”; Blanchfield, ‘The Romances in MS Ashmole 61: An Idiosyncratic Scribe’; Lynne S. Blanchfield, ‘Rate Revisited: The Compilation of the Narrative Works in MS Ashmole 61’, in *Romance Reading on the Book: Essays on Medieval Narrative Presented to Maldwyn Mills*, ed. Jennifer Fellows et al. (Cardiff: University of Wales Press, 1996), 208–20; ‘Found Records: Oxford, Bodleian Library Ashmole 61 (SC 6922\*)’, The Digital Index of Middle English Verse, accessed 10 August 2016, <https://www.dimev.net/Records.php?MSS=BodAsh61>.

**Table A.7: Contents of Ashmole 61**

Quire	Folios	Notes	Watermarks	Texts
A <sup>8</sup>	1-8		-	<p>1. <i>Legend of St Eustace</i> (ff. 1r-5r)            2. Lydgate's "Ram's Horn" (ff. 5v-6r)            3. <i>How the Wise Man Taught His Son</i> (ff. 6r-v)            4. <i>How the Good Wife Taught Her Daughter</i> (ff. 7r-8v)</p>
B <sup>10</sup>	9-18		-	<p>5. <i>Sir Isumbras</i> (ff. 9r-16v)            6. Ten Commandments (ff. 16v-17r)            7. <i>Stans Puer ad Mensam</i> (ff. 17v-19v)</p>
C <sup>12</sup>	19-30a		Briquet 694	<p>7. <i>Stans Puer ad Mensam</i> cont. (ff. 17v-19v)            8. <i>Dame Curtasy</i> (ff. 20r-21v); 9. "Tempere Felici" (f. 21v)            10. Rules for Land Purchase (f. 21v)            11a. "O asside asside" (f. 21v)            11b. "Tres infelices" (f. 21v)            12. <i>Prayer at Night</i> (f. 22r)            13. <i>Prayer at Morning</i> (ff. 22r-v)            14. Ten Commandments (f. 22v)            15. Prayer to Mary (ff. 22v-23r)            16. <i>Debate of the Carpenter's Tools</i> (ff. 23r-26r)            17. <i>Prayer at the Levation</i> (ff. 26r-v)            18. The Forgiving Knight/Legend of the Cross (ff. 26v-27v)            19. <i>The Earl of Tolous</i> (ff. 27v-38v)</p>
D <sup>16</sup>	30b-45		Briquet 694	<p>f. 30b is unfoliated            19. <i>The Earl of Tolous</i> cont. (ff. 27v-38v)            20. <i>Lybeaus Desconus</i> (ff. 38v-59v)</p>
E <sup>12</sup>	46-57		Briquet 694	<p>20. <i>Lybeaus Desconus</i> cont. (ff. 38v-59v)</p>

F <sup>10</sup>	58-65	Wants 9 and 10, loss of text ff. 65-66	Briquet 11159	20. <i>Lybeaus Desconus</i> cont. (ff. 38v-59v) 21. <i>Sir Corneus</i> (ff. 59v-62r) 22. Miracle of the BVM (ff. 62r-65v) 23. Tale of an Incestuous Daughter (ff. 66r-67v)
G <sup>12</sup>	66-77		Briquet 11159	23. Tale of an Incestuous Daughter cont. (ff. 66r-67v) 24. <i>Sir Cleges</i> (ff. 67v-73r) 25. All Saints and All Souls (ff. 73r-78v)
H <sup>14</sup>	78-91		Briquet 11159	25. All Saints and All Souls cont. (ff. 73r-78v) 26. Grosseteste's "Castle of Love" (ff. 78v-83r) 27. <i>Ypotis</i> (ff. 83r-87v) 28. <i>Northern Passion</i> (ff. 87v-105v)
I <sup>13</sup>	92-104	8 is cancelled	-	28. <i>Northern Passion</i> cont. (ff. 87v-105v)
J <sup>16</sup>	105-120		Possibly Briquet 10116	28. <i>Northern Passion</i> cont. (ff. 87v-105v) 29. Short Charter of Christ (f. 106r) 30. <i>Lamentacio Beate Marie</i> (ff. 106r-107r) 31. Lydgate's <i>Dietary</i> (ff. 107r-108r) 32. Maydestone's Psalms (ff. 108r-119v) 33. <i>Prick of Conscience Minor</i> (ff. 120r-128r)
K <sup>16</sup>	121-136		Possibly Briquet 10116	33. <i>Prick of Conscience Minor</i> cont. (ff. 120r-128r) 34. Stations of Jerusalem (ff. 128r-136r) 35a. <i>Lamentacio Peccatoris</i> (ff. 136r-v) 35b. <i>The Adulterous Falmouth Squire</i> (ff. 136v-138v)
L <sup>14</sup>	137-150		Possibly Briquet 10116	35b. <i>The Adulterous Falmouth Squire</i> cont. (ff. 136v-138v) 36. Legend of the Resurrection (ff. 138v-144v) 37. St Margaret (ff. 145r-150v) 38. On the Seven Deadly Sins (ff. 150v-151r)

M <sup>16</sup>	151-161	Wants 12-16, loss of text after f. 161	Possibly Briquet 10116	38. <i>On the Seven Deadly Sins</i> cont. (ff. 150v-151r) 39. <i>Sir Orfeo</i> (ff. 151r-157r) 40. <i>Vanyte</i> (ff. 156v-157r) 41. <i>King Edward and the Hermit</i> (ff. 157r-161v)
-----------------	---------	--	---------------------------	---

## APPENDIX B: Video footage of experimental performances

**Table B.1: Experiments in Barley Hall**

Text	Experiment Name	MS	Lines	Format	Scene	Scenario	Associated video file/link
<i>Sir Eglamour of Artois</i>	B 1.1	Li 91, ff. 138va-139vb	Equivalent to ll. 1-174	Read directly from Li 91 facsimile	The opening of the romance	Informal reading in the hall using a side table	Bennett_201042558_VideoFile_1 <a href="https://youtu.be/qJxvzN-gq9s">https://youtu.be/qJxvzN-gq9s</a>
<i>Sir Eglamour of Artois</i>	B 1.2	- (TEAMS edition)	ll. 631-72	Printed excerpt of TEAMS edition <sup>20</sup>	Eglamour's return to Christabel and their secret marriage	'Social roles' in the hall – participants seated at high and low tables taking on roles of members of the household	Bennett_201042558_VideoFile_2 <a href="https://youtu.be/i6_X9bZYzkY">https://youtu.be/i6_X9bZYzkY</a>
<i>Sir Eglamour of Artois</i>	B 1.3	- (TEAMS edition)	ll. 778-882	Printed excerpt of TEAMS edition	Christabel and Degrebell set adrift at sea	Readers seated at high table in the hall with improvised musical accompaniment on harp	Bennett_201042558_VideoFile_3 <a href="https://youtu.be/M9B2BTPoX98">https://youtu.be/M9B2BTPoX98</a>
<i>Sir Eglamour of Artois</i>	B 2.1	Li 91, ff. 138va-139vb	Equivalent to ll. 1-174	Read directly from Li 91 facsimile	The opening of the romance	Informal reading in the chamber, accompanied by domestic chores	Bennett_201042558_VideoFile_4 <a href="https://youtu.be/6GnMZRIHpM4">https://youtu.be/6GnMZRIHpM4</a>

<sup>20</sup> Hudson, ed. 'Sir Eglamour of Artois'.

<i>Sir Eglamour of Artois</i>	B 2.2	CCAii, ff. 9ra-b	ll. 631-72	Booklet with printed text of diplomatic edition <sup>21</sup>	Eglamour's return to Christabel and their secret marriage	Informal reading in the chamber reminiscent of Vitz's 'erotic reading'. <sup>22</sup>	Bennett_201042558_VideoFile_5 <a href="https://youtu.be/eFlqeX380DI">https://youtu.be/eFlqeX380DI</a>
<i>Sir Eglamour of Artois</i>	B 2.3	- (TEAMS edition)	ll. 1246-320	Printed excerpt of TEAMS edition	The end of the romance, reunion and marriages	Reading in the parlour with one prelector	Bennett_201042558_VideoFile_6 <a href="https://youtu.be/abag8ZEor9w">https://youtu.be/abag8ZEor9w</a>
<i>Sir Eglamour of Artois</i>	B 2.4	- (TEAMS edition)	ll. 631-72	Printed excerpt of TEAMS edition	Eglamour's return to Christabel and their secret marriage	Reading in the parlour with multiple readers assigned characters	Bennett_201042558_VideoFile_7 <a href="https://youtu.be/cyP94VgEzDw">https://youtu.be/cyP94VgEzDw</a>

**Table B.2: Experiments in Gainsborough Old Hall**

<b>Text</b>	<b>Experiment Name</b>	<b>MS</b>	<b>Lines</b>	<b>Format</b>	<b>Scene</b>	<b>Scenario</b>	<b>Associated video file/link</b>
<i>Sir Degrevant</i>	G 1.1	Findern MS, ff. 98r-v	Equivalent to ll. 273-368 <sup>23</sup>	Physical stand-in of whole book with handwritten text	Battle scene and end of first fitt	1. Informal reading in the hall using a side table	Bennett_201042558_VideoFile_8 <a href="https://youtu.be/J8ZjEnZmGOg">https://youtu.be/J8ZjEnZmGOg</a>
	G 1.2					2. Informal reading in the hall using a side table, accompanied by domestic chores	

<sup>21</sup> White, 'BL Cotton Caligula Aii, Manuscript Context, The Theme of Obedience, and a Diplomatic Transcription Edition'.

<sup>22</sup> Vitz, 'Erotic Reading in the Middle Ages: Performance and Re-Performance of Romance'.

<sup>23</sup> Kooper, ed. 'Sir Degrevant'.



<i>Sir Isumbras</i>	G 2.1	Heege MS, ff. 48r-v	Equivalent to (ll. 1-72) <sup>24</sup>	Booklet with handwritten text in both graphic tail rhyme form and single column layout	The opening of the romance	1. Using the high and low tables in the hall (playing with social roles)	Bennett_201042558_VideoFile_9 <a href="https://youtu.be/9cf_f1VPJts">https://youtu.be/9cf_f1VPJts</a>
	G 2.2					2. Read in the bay window	
<i>Sir Eglamour of Artois</i>	G 3	Li 91, ff. 142va-b	Equivalent to ll. 631-72	Thornton facsimile with written transcription	Eglamour's return to Christabel and their secret marriage	Read formally in the hall without using the formal hierarchy of the hall	Bennett_201042558_VideoFile_10 <a href="https://youtu.be/ExugoB4lpAM">https://youtu.be/ExugoB4lpAM</a>
<i>Sir Degrevant</i>	G 4	Findern MS, ff. 104v-150ra	Equivalent to ll. 1185-248	Physical stand-in of whole book with handwritten text	Degrevant enters the hall during a feast and challenges the Duke	Read as if by a professional performer to an audience seated at the high table	Bennett_201042558_VideoFile_11 <a href="https://youtu.be/xFbaz80Suso">https://youtu.be/xFbaz80Suso</a>
<i>Sir Orfeo</i>	G 5.1	Ashmole 61, ff. 151v-152r	Equivalent to ll. 48-118 <sup>25</sup>	Physical stand-in of whole book with handwritten text	The opening of the romance after the prologue, the ympe-tre	1. Read formally in the chamber	Bennett_201042558_VideoFile_12 <a href="https://youtu.be/qpJeCfn5KfE">https://youtu.be/qpJeCfn5KfE</a>
	G 5.2					2. Read informally in the chamber	
<i>Sir Eglamour of Artois</i>	G 6	CCAii, ff. 9ra-b	Equivalent to ll. 631-72	Booklet with printed text of diplomatic edition	Eglamour's return to Christabel and their secret marriage	Read informally in the chamber	Bennett_201042558_VideoFile_13 <a href="https://youtu.be/VIAivyRD5xI">https://youtu.be/VIAivyRD5xI</a>

<sup>24</sup> Hudson, ed. 'Sir Isumbras'.

<sup>25</sup> Shuffelton, ed. 'Item 39, Sir Orfeo'.

## APPENDIX C: Teaching resources for Middle English and romance excerpts

In order to make the experiments replicable and to offer resources for others undertaking similar performances, I reproduce here two resources used in the experiments and the preparation of the texts. The first is a short hand-out used in learning Middle English pronunciation. The second is a series of modern translations of excerpts used to prepare the performances: by ensuring that participants understood the content of the excerpts they read, their performances in Middle English were more successful in conveying the sense of the story to the listeners. The excerpts used were transcribed from the manuscripts, but all are available in Middle English via the TEAMS website.

### Middle English 101

#### Short vowels:

- Before two consonants
- Before a single consonant at the end of a word

Short vowel	Sounds like	Medieval example
a	Pat	Gatt, can
e	Pet	Wes
i	Pit	I, y, bidde
o	Pot	Son, doth
u	Put	Upon

#### Long vowels:

- Can be written as double vowels
- Before a single consonant
- On their own at the end of a word (except for final or unstressed 'e')

Long vowel	Sounds like	Medieval example
ā	Father	Name, fare, naam
ē (closed)	Obeyed	Eten, speken
ē (open)	There	Feld, deed

ī	Ski	Lyf, child
ō (closed)	Home	Good, mone
ō (open)	Saw, bought	Moder, old
ū	Food	Grund
ü	French u or German ü	Vertu

Diphthong (and alternative forms*)	Sounds like	Medieval example
ai (ay)	I (modern)	Day, saide
ei (ay)	Day (modern)	Wei, preie, seint
oi (oy)	Boy (modern)	Joy, poysoun
au (aw)	Cow (modern)	Straw, graunt
eu (ew)	e + u (medieval)	Blew, dew
iu (iw) (yw)	i + u (medieval)	Triwe
ou (ow)	o + u (medieval), go (modern)	Soule, thouȝt
ui (uy) (wy) (wi)	u + i (medieval)	Quik, wilk/quilk/which

\* i is interchangeable with y; u is interchangeable with w in diphthongs

### Consonants

- Much the same as modern consonants.
- In general, pronounce them all!
  - e.g. ‘knight’ = k-ni-ch-t
  - gh/ȝ = Scottish “ch” or German “ch”
- ‘ng’ as in “finger” not “singing”

### Different characters

- Thorn - þ
- = ‘th’
- Yogh - ȝ
- Value depends on context – can be ‘gh’ ‘y’ or even ‘z’ finally

### Other handy hints

- French loan words can be pronounced in a French-like manner.
- Final unstressed ‘e’ is optional: can be pronounced or not to fit the metre. Usually dropped if the next word starts with a vowel. (Just use your instincts.)

- Don't always trust words that look familiar! Some common false friends are 'i' (pronounce as in 'sit' not as in 'side') and 'ee' (pronounce as in 'fate' not as in 'seek')

### **Text excerpts for performance experiments**

As part of the preparation of the Middle English excerpts for performance, I prepared modern translations to assist the participants in understanding the scenes. These were not the excerpts used in the performances, but I am reproducing them here so that, if desired, performances can be staged by groups of non-specialists.

#### ***Experiment G 1.1, 1.2: Sir Degrevant from the Findern manuscript***

Sir Degrevant was so near  
 That he could hear the words (of the Earl)  
 He said, "Forward, banner  
 And sound the trumpets!"  
 His archers who were there  
 Both those of high and low station (i.e. all)  
 As quick as they could be  
 Were ready to shoot.  
 Then the Earl was pleased  
 Soon his troops were arrayed  
 He was not at all afraid  
 Of the fierce knight (Degrevant)  
 Now the armies meet on the field  
 With both spear and shield  
 Valiantly they wield their weapons  
 And fight fiercely.  
 And when they joined the battle  
 They thrust fiercely with spears  
 No man could be spared  
 Who fought on the battlefield.  
 With bright swords on the battlefield  
 They tore well-made hauberks (coats of mail)  
 Glittering glaives were deflected  
 By golden shields  
 They struck steeds in the battle,  
 Knights through their armour  
 Lords of honour  
 Fall upon the field.  
 They fought so fiercely  
 That none knew, regardless of his might  
 Who would have the victory  
 Except for He (God) who rules all.  
 The brave knight Sir Degrevant  
 Lays low the lords upon the land  
 Through jupon and jesserant (armoured coats)

And wounds the men.  
Bright shields they hack  
Many a brave man was dead  
Fine chain-mail turns red  
There were many bold deeds (or bold men dead)  
Thus they fought in the woodland  
Brave knights in their forest  
Their wrath causes woe  
Those valiant in deeds.  
Young warriors he had cut down  
Men with gambesons (quilted jackets)  
Lie upon the battlefield brown  
And died under [their] horses  
Sir Degrevant the good knight  
Shatters the bright bascinets (helmets)  
His company fights fiercely  
And fell them (the enemy) to the ground.  
The knight's of the Earl's house  
That were held to be so chivalrous  
And in battle so virtuous  
They all died then.  
The Earl lingered and beheld  
Both with spear and with shield  
How they fared on the battlefield  
And sighed woefully.  
The best men that he had led  
He had left at home for security/surety  
He fled with fifty spearmen  
And was grievously wounded.  
Sir Degrevant and his men  
Felled them quickly in the dirt  
Just like deer in a den  
He strikes them to death.  
With sharp axes of steel  
He pleated/bent their bascinets (helmets) well.  
He caused many a knight to kneel  
In the morning.  
Sir Degrevant was so fierce  
[that he] split their army in two.  
The Earl fled and was woeful  
He mounted a steed.  
He left slain in a hollow  
800 men all together  
Spread upon their backs  
Dead in the heather.  
Sir Degrevant won a steed  
That was good in time of need.  
He made many a side bleed  
With strikes of his spear.  
And chased the Earl in good time  
More than eleven miles.  
Many bold men he caused to fall  
That had harmed him before.  
He came riding back  
And was pleased about his folk

And found none of them slain  
Or any worse for wear (lit. not worse by a pear)  
He kneeled down in that place  
And thanked God for his Grace  
And everyone who was there returned  
To his fair manor.

*Here ends the first fitt (section)*

*What do you say? Would you like to hear more?*

***Experiment G 2.1, 2.2: Sir Isumbras from the Heege manuscript***

Noble folk, [if] you would hear  
Of ancestors who came before us  
Who were ready at need  
Jesus Christ, heavenly king  
Give us all your blessing  
And heaven as our reward.  
I will tell you of a knight  
That was both stout-hearted and valiant  
And a doughty in every deed.  
He was called Sir Isumbras  
Another knight like he was  
Has never lived in humankind.  
He was a great man and strong  
With broad shoulders and long arms  
And was beautiful to look at.  
He was both fair and noble  
Everyone who saw him loved him  
So beautiful a man was he  
He loved minstrels well  
And gave to them expensive robes,  
gold and property.  
He was king of courtesy  
Not stingy with food and drink  
No-one else in the world was so generous.  
He had a fair lady as his wife  
As any man could see  
As I tell you now [with tongue]  
Between them they had [three] children  
The fairest that could be  
Beneath the kingdom of heaven  
But he had so much pride in his heart  
He never thought about God's works  
And receiving His mercy.  
He lived for so long in this state of pride  
That God could no longer abide it  
And he sent to him a message.  
So it befell one day  
That the knight went out to amuse himself  
And look at his forest.  
As he went along a secret path  
He heard a bird singing near him  
High up in a tree.  
The bird said, "God save Sir Isumbras  
You have forgotten what you were

Because of your pride in wealth and property  
The king of heaven greets you thus:  
Worldly wealth you shall lose  
In age or else in [youth]  
With care-filled heart and much sighing  
The knight fell upon his bare knees  
And held up his hands  
“I will forsake worldly wealth  
And entrust myself to God’s mercy  
I give my soul to Him.  
Lord, if it be your will  
Send me penance in my youth  
And wealth in my age.”  
The bird flew away  
And left the dejected knight  
In that same field  
The knight that was so brave in battle  
That no-one could endure his blows  
When the bird was gone  
And he had lost sight of it  
His horse that was stalwart and brave  
Lay dead underneath him.  
His hawks and his hounds  
Ran away to the forest as if they were mad  
Each one a different way  
Is it any wonder that he was sorrowful?  
He had to go on foot  
All his pleasure turned to pain.

***Experiment G 3: Sir Eglamour of Artois from the Lincoln Thornton manuscript***

Christabel white as seafoam  
Heard that he (Eglamour) had come home  
To his chamber she made her way  
“Sir knight” she said “how have you fared?”  
“Damsel, well, and worked hard  
To bring us both out of care.”  
The knight kissed that gentle lady  
And went into the hall  
To meet the Earl  
He laid down the two heads  
“Lo, lord” the knight said  
“In Sidon have I been.”  
The Earl was then full of woe  
“What, devil!” He said, “can nothing slay you?  
By St James, I suppose,  
You want, as I understand,  
To win all of Artois from my hand  
And my daughter bright and shining!”  
The knight said, “So may I prosper,  
Not unless I am worthy,  
by God who is best.  
Good lord, I beg of you  
Give me fifteen weeks  
To rest my bones.”

Through the wishes of the gentlemen  
Twelve weeks the Earl granted him then  
No longer would he delay him.  
After supper Eglamour went  
To Christabel's chamber where she was  
There were torches burning bright.  
The lady was very honourable  
And set him at her bedside  
And said, "Welcome, sir knight!"  
"Damsel" he said, "so have I succeeded  
Through the grace of God I will wed you"  
And there they plighted their troths.  
So graciously he began to tell her  
A deed of arms that befell him  
And there he stayed all night.

***Experiment G 4: Sir Degrevant from the Findern manuscript***

Sir Degrevant at nightfall  
Armed himself at all points  
And called two knights to him  
That were always discreet.  
"Prepare yourselves on steeds  
In young men's (prob. not damsel's) clothes  
For I have need to travel  
As fast as I can.  
Both of you take spears  
Both of peace and of war  
Ready my horses in their gear  
And look that they be richly attired,  
That they be clad in fashionable trappings  
With head coverings and caparison (cloth covering)  
In fine violet cloth  
And do not delay."  
And when their horses were prepared  
They took their spears and their shields  
And quickly galloped on the field  
No longer would they stay.  
And then they rode straight west  
Through a fair forest  
[Line copied here by scribe by mistake.]  
With two very fine horns/trumpets  
That rang like a bell.  
On a hill he took a rest  
They gave him his helmet while he rested  
He was the boldest guest  
Between Heaven and Hell.  
Sir Degrevant without delay  
Rode to the Earl's castle.  
He found the gate wide open  
Suck a stroke of luck befell him.  
And he rode up to the dais  
As they were being served their meal  
He made for the maiden Melidor  
And claims her as his prize



The Duke stood up in haste  
 "Here I make a promise to you  
 I shall deliver this fair one to you  
 Tomorrow you will see  
 Early in the morning  
 Make sure you come at that time  
 One of us will fall in a swoon  
 The lady shall see it.  
 And truly, without a lie  
 You will get what you deserve before I stop  
 Both war and peace (types of jousting)  
 Three courses of either."  
 The knight was so dressed  
 It was a great joy to see  
 So fair a horseman as he  
 They had never seen before.  
 Some looked at his steed  
 And some on his rich clothes  
 And some began to interpret the motto  
 That the knight bore.  
 He bows down to them all  
 Both to the (great)\* and to the small  
 And rides out of the hall  
 And prepares himself.  
 Of all who looked upon the knight  
 There was none who knew him by sight  
 Except for the Maiden Melidor the bright  
 Of all who were there.  
 [\*word accidentally omitted by scribe]

***Experiment G 5.1, 5.2: Sir Orfeo from Ashmole 61***

If befell in the beginning of May  
 When birds sing on every branch  
 And blossoms grow on every bough  
 Everywhere grows merrily enough  
 Then the Queen Dame Merodis  
 Taking with her noble ladies  
 Went out one midday (or midmorning)  
 To take their leisure beside an orchard  
 Then the ladies all three  
 Sat underneath a grafted tree.  
 She laid herself down, that beautiful queen  
 And fell asleep upon the green grass  
 The ladies did not want to wake her  
 But let her lie and take her rest.  
 She slept until well after noon  
 Until the morning time had passed.  
 And when the ladies awoke her  
 She cried and made a great noise  
 And wrung her hands together in sorrow  
 And scratched her face until it bled.  
 Her beautiful clothes she ripped  
 And was robbed of her wits.  
 The ladies that stood beside her

Fled and dared not stay for long  
But went back to the palace  
And told both knight and swain  
How the queen would run away  
And bade them come and see her.  
Sixty knights and more  
And many ladies as well  
Quickly came to the queen  
And took her in their arms  
And quickly brought her to her bed  
And kept her separate and secure  
And she began to continuously cry  
And she wanted to leave and go her way.  
The king came to the chamber to see the queen  
And his knights preceded him  
And (the king) wept and said with great sorrow  
“My dear wife, what ails you?  
You who are usually so calm  
Why do you cry so shrilly?  
And you who were before so meek and mild  
You are become mad and wild.  
Your flesh that before was so white  
You have torn with your nails.  
Your lips that were such a bright red  
Seem as pale as if you were dead.  
And your fingers long and small  
Are bloody and pale.  
And your two lovely eyes  
Look upon me as if I were your enemy.  
Good sweetheart, I cry to you mercy!  
That you let be all this woeful crying  
And tell me, lady, for your pride,  
What thing can help you now?”  
She lay still at last  
And began to speak quickly  
And she spoke to the King thus:  
“Alas, my lord, Sir Orfeo,  
I have loved you all my life  
There was never strife between us  
Since we were wedded  
For this I am grieving  
[because] now we must be parted  
Do your best, for I must go.”  
“Alas,” said the King, “I am lost!  
Where will you go and to whom?  
Wherever you are I would also be  
And wherever I am, you shall be with me.”

## **APPENDIX D: Additional Material Pertaining to Experiments**

Permission was sought to conduct the two experiments using the University of York formal ethics approval process and to use the anonymised feedback data and video footage in this thesis. The Information Sheet and Informed Consent Forms are included here as part of that process. I include here also the questionnaires used to collect written feedback from the participants in the experimental performances. In addition to these questionnaires, verbal feedback was collected from participants in discussions immediately after each performance. This was recorded as part of the video footage then transcribed for analysis.

### **Participant Information Sheet**

#### **What is this study?**

I'm Alana Bennett, a PhD student at the University of York researching the reading practices associated with a selection of 'household manuscripts' – domestic miscellanies from the fifteenth-century. As part of this research, I am exploring the performative potential of some of the texts contained within these manuscripts. I am investigating how modern readers interact with medieval texts in various contexts and reading modes, hoping to build a better understanding of how medieval readers may have interacted with the texts.

#### **What is involved in participating? (Barley Hall Information Sheet)**

The study takes the form of a series of workshops culminating in an excursion to a surviving medieval building (Barley Hall).

This research project will take place over five consecutive weeks. In the first session, we will begin with an initial briefing session where we will discuss the project, read this Information Sheet and collect Informed Consent Forms. This is your chance to ask any questions you may have about the project. The first three workshop sessions (timing and locations as per email) will each explore a different mode of engaging with a medieval text. The workshops in the last two weeks will be held in Barley Hall.

The workshops will involve voluntary performances and reading aloud.

In each session, we will engage with the selected text/s in a slightly different way and your feedback, both oral and written will be requested. Any changes or developments in how you relate to the text/s across the span of the study will be examined. This feedback may be used anonymously in my thesis as evidence for how modern readers engage with medieval texts.

Sessions will be audio recorded for research purposes only. The final sessions in Barley Hall will be video recorded and photographed.

### **What is involved in participating? (Gainsborough Old Hall Information Sheet)**

The study takes the form of a performance recreating the medieval reception of some of these texts.

Participation involves attendance at two events: a rehearsal meeting (conducted over video call) and an in-person performance at Gainsborough Old Hall. The latter will involve staging short excerpts of medieval texts in a tableaux of medieval reading practices.

The performance experiment in Gainsborough Old Hall will request the participant to:

- Interact with the physical space of the building
- Listen to short excerpts of texts read in Middle English
- If participants are willing, read short excerpts of a text in Middle English (pronunciation assistance and translations provided during initial meeting)
- Interact with physical stand-ins for medieval books
- Wear suitable costumes (provided by organiser unless participant has their own)
- Provide written and oral feedback on the experiments

Both the rehearsal and the performance will be recorded and analysis of these will form part of my PhD thesis.

### **How will information be used? How will it be stored?**

Your oral and written feedback collected during the rehearsal and the performance will form an important section in my thesis, as well as possible publications arising from my thesis, exploring how modern readers relate to medieval texts and how that relationship changes when engaging with the text/s in different contexts or modalities.

Excerpts of the video footage of the performance will be included in the thesis.

In all cases, the data will remain anonymous and no personal information which may identify you will be used. The data and information will be stored securely and destroyed after ten years.

### **What do I get out of this? Are there any benefits or risks?**

I cannot cover any expenses, but there will be delicious baked goods on offer as thanks for your time. I also hope that the opportunity to engage with original texts in a surviving medieval building is something that you will find enjoyable! You have the opportunity to learn some valuable skills related to Middle English (pronunciation, comprehension), manuscripts (palaeography and codicology), medieval buildings and performance.

There are no apparent risks in participation, although you should be aware that the reconstructed building has some small hazards like steep staircases, tripping hazards and open flames. All activities are voluntary and if anything makes you uncomfortable you are able to stop or withdraw from the workshops.

**Participation in this study is voluntary - you can withdraw from it at any time without negative consequences.**

**Any questions? Contact:**

Alana Bennett [ab1795@york.ac.uk](mailto:ab1795@york.ac.uk)

**Department:**

Centre for Medieval Studies, University of York, King's Manor, York, YO1 7EP  
[cms-office@york.ac.uk](mailto:cms-office@york.ac.uk) or telephone (01904) 323910

**Supervisors:**

Kate Giles [kate.giles@york.ac.uk](mailto:kate.giles@york.ac.uk)

Nicola McDonald [nicola.mcdonald@york.ac.uk](mailto:nicola.mcdonald@york.ac.uk)

## **Informed Consent Form**

**Alana Bennett**

**University of York, Centre for Medieval Studies**

By signing this form you confirm and agree that:

- I have read the Participant Information Sheet about the research project and understand what it involves.
- I have had the opportunity to ask questions about the project, the process and what my feedback will be used for.
- I agree to participate in the research project.
- I am aware that my participation is voluntary and I can withdraw from the research project at any time.
- I am aware that sessions will be audio recorded for research purposes only.
- I am aware that the final sessions will be filmed and this footage may be used in the thesis.
- I am aware and consent that my feedback, written and oral, may be quoted or used anonymously in the thesis.

## Barley Hall

### Questionnaire Session 1: Text

1. What is your prior experience with medieval texts? And with this particular text?
2. What do you like about modern editions of medieval texts? Is there anything you don't like?
3. What are your expectations for this experiment? (Do you think it will make you think about texts differently?)

Free space for any other comments or reactions.

### Questionnaire Session 2: Manuscript

1. Think back to how you read the text in a modern edition... How was the experience of reading from the manuscript different?
2. Did encountering the text in the manuscript change how you understood or responded to it? How and why?

Free space for any other comments or reactions.

### Questionnaire Session 3: Reading aloud

*Reflecting on how performance and reading aloud change the experience of reading – for example, new understandings of words and text, nuances revealed, emotional responses, anything that struck you as different compared to the reading modes of the past two weeks.*

How did you respond differently to the text when:

- a) you heard someone reading it aloud
- b) you read it aloud yourself

Free space for any other comments or reactions.

### Questionnaire Session 4: Space and materiality

1. Consider the questions we've been asking over the previous weeks about the experience of reading. Does this new setting change your understanding of or perspective on the text **as a modern reader**? Please write any observations down as we experiment with the performances.
2. Do you have any thoughts about how this might reflect the **medieval** experience of reading?
3. Did you prepare the text ahead of time?

Y/N

If Y, please describe how briefly:

### Questionnaire Session 5: Space and materiality (part 2)

1. Consider the questions we've been asking over the previous weeks about the experience of reading. Does this new setting (especially compared to last week's setting in the hall) change your understanding of or perspective on the text **as a modern reader**? Please write any observations down as we experiment with the performances.
2. Do you have any thoughts about how this might reflect the **medieval** experience of reading?

3. (Optional) Did you prepare the text ahead of time?

Y/N

If Y, please describe how briefly:

## **Gainsborough Old Hall**

### **Feedback Sheet**

After each reading excerpt please write down any observations and thoughts. You might like to consider the following prompts:

- What was different or surprising about this experience? (From your expectations? From the preliminary rehearsal? From the other readings?)
- If you were the reader, how was the experience? (Expectations? Challenges? Anything surprising?)
- Was there anything in particular you liked about this reading?
- If we changed anything about the reading and re-read it, what was different between the two? How was the text transformed?
- **Was the text and your understanding of it changed by hearing it read aloud in a historical space? How? (e.g. nuances of the text brought out?, meaning transformed?)**

**Experiment 1. Investigating *Sir Degrevant* in the Findern manuscript.**

**Experiment 2. Materiality of the book/main reading experiment**

**Text 1 (*Sir Degrevant*)**

**Text 2 (*Sir Eglamour of Artois*)**

**Text 3 (*Sir Orfeo*)**

**Text 4 (*Sir Isumbras*)**

**Experiment 3. Reading in the Chamber**

## Abbreviations and Manuscript Shortened Names

<b>BnF</b>	Bibliothèque nationale de France
<b>CCAIi</b>	London, British Library Cotton MS Caligula A.ii
<b>e.g.</b>	For example
<b>Ff.2.38</b>	Cambridge, University Library MS Ff.2.38
<b>Ff.5.48</b>	Cambridge, University Library MS Ff.5.48 (the Pilkington MS)
<b>Findern or Findern MS</b>	Cambridge, University Library MS Ff.1.6
<b>Fr.</b>	Français
<b>Heege or Heege MS</b>	Edinburgh, National Library of Scotland Advocates MS 19.3.1
<b>Li 91</b>	Lincoln, Cathedral Library MS 91
<b>mm</b>	Millimetre
<b>MS</b>	Manuscript
<b>PaR</b>	Practice-as-Research/Performance-as-Research
<b>RCHME</b>	Royal Commission on the Historical Monuments of England
<b>YA</b>	York Archaeology (previously known as York Archaeological Trust)



# Bibliography

## Primary sources (unpublished)

### Manuscripts and Documents

- Aberystwyth, National Library of Wales MS Brogyntyn II.1  
Cambridge, Corpus Christi College Library MS 61  
Cambridge, University Library MS Ff.1.6  
Cambridge, University Library MS Ff.2.38  
Cambridge, University Library MS Ff.5.48  
Derby, Derbyshire Record Office, D77/4/25/25  
Edinburgh, National Library of Scotland Advocates MS 19.2.1  
Edinburgh, National Library of Scotland Advocates MS 19.3.1  
Geneva, Bibliothèque de Genève, MS Fr. 180  
Lincoln, Cathedral Library MS 91  
London, British Library Additional MS 27879  
London, British Library Additional MS 31042  
London, British Library Cotton MS Caligula A.ii  
London, British Library Cotton MS Nero A.x/2  
London, British Library Egerton MS 2862  
London, British Library Harley MS 2253  
London, British Library Harley MS 4425  
London, British Library Harley MS 4431  
London, British Library Kings MS 9  
London, British Library Lansdowne MS 285  
London, British Library Royal MS 15.D.I  
London, Lincoln's Inn MS Hale 150  
London, The National Archives PRO, PROB2/124  
Manchester, Chetham's Library MS 8009  
Naples, Biblioteca Nazionale MS XIII.B.29  
Oxford, Bodleian Library MS Ashmole 61  
Oxford, Bodleian Library MS Digby 86  
Oxford, Bodleian Library MS Douce 62  
Oxford, Bodleian Library MS Douce 195  
Paris, Bibliothèque nationale de France Fr. 603  
Paris, Bibliothèque nationale de France Fr. 2168

Paris, Bibliothèque nationale de France Fr. 12557

Paris, Bibliothèque nationale de France Fr. 19153

Paris, Bibliothèque nationale de France Fr. 25528

San Marino, CA, Huntington Library EL 26 C 9

## Objects and Artworks

Bouts, Dieric. *The Annunciation*. c. 1450-1455. Distemper on linen, 90 x 74.6 cm. J. Paul Getty Museum.

Campin, Robert. *Annunciation Triptych (Merode Altarpiece)*. c. 1427-32. Oil on oak, 64.5 x 117.8 cm (open). Metropolitan Museum of Art.

———. *The Werl Triptych*. 1438. Oil on panel, 101 x 47 cm. Museo del Prado, Madrid.

*Casket with Scenes of Romances*. c. 1330-1350. Ivory, 11.8 x 25.2 x 12.9 cm. Inv. 71.264. Walters Art Museum, Baltimore.

*Casket with Scenes of Romances*. 14th C. Ivory, 80 x 210 x 130 mm. 1856,0623.166 (Dalton 368). The British Museum, London.

*Casket with Scenes of Romances*. 14th C. Ivory, 95 x 232 x 136 mm. Inv. 39.26. The Barber Institute of Fine Arts.

*Casket with Scenes of Romances*. 14th C. Ivory, 97 x 257 x 167 mm. Cl. 23840. Paris, Musée de Cluny-Musée national du Moyen Âge.

*Casket with Scenes of Romances*. 14th C. Ivory, 103 x 246 x 126 mm. 146-1866. Victoria and Albert Museum, London.

*Casket with Scenes of Romances*. 14th C. Ivory, 109 x 253 x 159 mm. 17.190.173; 1988.16. New York, Metropolitan Museum of Art.

*Chertsey Tiles: Tristram Series*. late 13th. C. Earthenware, 240 mm. The British Museum, London.

Eyck, Jan van. *The Ghent Altarpiece: Mary of the Annunciation*. 1432. Oil on wood, 350 x 223 cm. St Bavo's Cathedral, Ghent.

*Lectern*. 15th century, Spain or France. Wrought iron, 160 x 55 cm. Acc. No. 574-1897. Victoria and Albert Museum, London.

*Lectern, Folding*. 15th century, Spanish. Walnut wood, 24.8 x 35.9 x 29.2 cm. A. No. 41.1000.136. The Met Museum.

Memling, Hans. *The Annunciation*. c. 1480-89. Oil on panel, transferred to canvas, 76.5 x 54.6 cm. Metropolitan Museum of Art.

*Mirror Case: Tristan and Isolde Playing Chess*. 1325-1350. Ivory, 10.2 x 1 cm. 1940.1200. The Cleveland Museum of Art.

*Pricke of Conscience Window*. c. 1410-1420. Stained glass. All Saints Church, North Street, York.

*Tristan and Isolde Quilt, The*. c. 1360-1400. Quilted linen, 247 x 207 cm. Palazzo del Bargello, Florence.

*Tristan Quilt, The*. c. 1360-1400. Quilted linen, 320 x 287 cm. Acc. No. 1391-1904. Victoria and Albert Museum, London.

Weyden, Rogier van der. *Annunciation Triptych*. c. 1440. Oil on oak, 86 x 92 cm (central panel). Louvre Museum.

Weyden, Rogier van der, and Hans Memling. *The Annunciation*. c. 1465-1475. Oil on wood, 186.1 x 114.9 cm. Metropolitan Museum of Art.

### **Primary sources (published)**

*A Collection of Ordinances and Regulations for the Government of the Royal Household, Made in Divers Reigns. From King Edward III. To King William and Queen Mary. Also Receipts in Ancient Cookery*. London: Printed for the Society of Antiquaries by John Nichols, 1790.

Benedict. 'Regula S.P.N. Benedicti'. Accessed 30 December 2014.  
<http://www.thelatinlibrary.com/benedict.html>.

Béroul. *The Romance of Tristan*. Edited by Stewart Gregory. Amsterdam and Atlanta: Rodopi, 1992.

Bliss, A.J., ed. *Sir Orfeo*. Oxford: Oxford University Press, 1954.

Britain, Thomas of. 'Tristan'. In *Tristan: With the 'Tristan' of Thomas*, translated by A.T. Hatto, 301–53. London: Penguin, 1960.

Chaucer, Geoffrey. 'The Book of the Duchess'. In *The Riverside Chaucer*, edited by Larry D. Benson, 3rd ed., 329–46. Oxford: Oxford University Press, 2008.

———. 'The Wife of Bath's Prologue'. In *The Riverside Chaucer*, edited by Larry D. Benson, 3rd ed., 105–16. Oxford: Oxford University Press, 2008.

———. 'Troilus and Criseyde'. In *The Riverside Chaucer*, edited by Larry D. Benson, 3rd ed., 471–586. Oxford: Oxford University Press, 2008.

Child, Francis James, ed. '18. Sir Lionel'. In *The English and Scottish Popular Ballads*, 1:208–15. Boston: Houghton, Mifflin and Company, 1882.

Dugdale, William, Sir. *The Baronage of England, or, An Historical Account of the Lives and Most Memorable Actions of Our English Nobility in the Saxons Time to the Norman Conquest, and from Thence, of Those Who Had Their Rise before the End of King Henry the Third's Reign Deduced from Publick Records, Antient*

- Historians, and Other Authorities*. Early English Books Online Text Creation Partnership, 2011. London: Printed by Tho. Newcomb, for Abel Roper, John Martin, and Henry Herringman ..., 1675.  
<http://name.umdl.umich.edu/A36794.0001.001>.
- Fournival, Richard de. *Master Richard's Bestiary of Love and Response*. Translated by Jeanette Beer. Berkeley: University of California Press, 1986.
- Henryson, Robert. 'The Testament of Cresseid'. In *The Poems of Robert Henryson*, edited by Robert L. Kindrick. TEAMS Middle English Texts Series. Kalamazoo, Michigan: Medieval Institute Publications, 1997.
- Herzman, Ronald B., Graham Drake, and Eve Salisbury, eds. 'Bevis of Hampton'. In *Four Romances of England: King Horn, Havelok the Dane, Bevis of Hampton, Athelston*. TEAMS Middle English Texts Series. Kalamazoo, Michigan: Medieval Institute Publications, 1997.
- , eds. 'Havelok the Dane'. In *Four Romances of England: King Horn, Havelok the Dane, Bevis of Hampton, Athelston*. TEAMS Middle English Texts Series. Kalamazoo, Michigan: Medieval Institute Publications, 1997.
- Hudson, Harriet, ed. 'Sir Eglamour of Artois'. In *Four Middle English Romances: Sir Isumbras, Octavian, Sir Eglamour of Artois, Sir Tryamour*. TEAMS Middle English Texts Series. Kalamazoo, Michigan: Medieval Institute Publications, 2006.
- , ed. 'Sir Isumbras'. In *Four Middle English Romances: Sir Isumbras, Octavian, Sir Eglamour of Artois, Sir Tryamour*. TEAMS Middle English Texts Series. Kalamazoo, Michigan: Medieval Institute Publications, 2006.
- James I of Scotland. 'James I of Scotland, The Kingis Quair'. In *The Kingis Quair and Other Prison Poems*, edited by Linne R. Mooney and Mary-Jo Arn. TEAMS Middle English Texts Series. Kalamazoo, Michigan: Medieval Institute Publications, 2005.
- Kooper, Erik, ed. 'Sir Degrevant'. In *Sentimental and Humorous Romances*. TEAMS Middle English Texts Series. Kalamazoo, Michigan: Medieval Institute Publications, 2005.
- Langland, William. *The Vision of Piers Plowman*. Edited by A.V.C. Schmidt. London and New York: J.M. Dent and E.P. Dutton, 1978.
- Laskaya, Anne, and Eve Salisbury, eds. 'Emare'. In *The Middle English Breton Lays*. TEAMS Middle English Texts Series. Kalamazoo, Michigan: Medieval Institute Publications, 1995.
- Lydgate, John. 'Item 7, Stans Puer Ad Mensam'. In *Codex Ashmole 61: A Compilation of Popular Middle English Verse*, edited by George Shuffelton. TEAMS Middle

- English Texts Series. Kalamazoo, Michigan: Medieval Institute Publications, 2008.
- Metham, John. *Amoryus and Cleopes*. Edited by Stephen F. Page. TEAMS Middle English Texts Series. Kalamazoo, Michigan: Medieval Institute Publications, 1999.
- Playford, John. *The Second Book of the Pleasant Musical Companion Being a New Collection of Select Catches, Songs and Gleees: For Two and Three Voices*. London: Printed for John Playford, 1686.  
<http://name.umd.umich.edu/A70826.0001.001>.
- Quintilianus, Marcus Fabius. *The Institutio Oratoria of Quintilian in Four Volumes*. Translated by H. E. Butler. Vol. Vol. 4. Loeb Classical Library. London: Heinemann, 1922.
- Roche-Mahdi, Sarah, ed. *Silence: A Thirteenth-Century French Romance*. Translated by Sarah Roche-Mahdi. East Lansing: Michigan State University Press, 2007.
- Seville, Isidore of. *Etymologiae, Book III*. Edited by W.M. Lindsay. Oxford: Clarendon Press, 1911.
- Shuffelton, George, ed. 'Item 8, Dame Courtesy'. In *Codex Ashmole 61: A Compilation of Popular Middle English Verse*. TEAMS Middle English Texts Series. Kalamazoo, Michigan: Medieval Institute Publications, 2008.
- , ed. 'Item 39, Sir Orfeo'. In *Codex Ashmole 61: A Compilation of Popular Middle English Verse*. TEAMS Middle English Texts Series. Kalamazoo, Michigan: Medieval Institute Publications, 2008.
- Thomas. 'The Romance of Horn'. In *The Birth of Romance in England: Four Twelfth-Century Romances in the French of England*, translated by Judith Weiss, 45–137. Tempe, Arizona: Arizona Centre for Medieval and Renaissance Studies, 2009.

## Secondary sources

- < Text Encoding Initiative >. '10 Manuscript Description', 19 August 2020. <https://tei-c.org/release/doc/tei-p5-doc/en/html/MS.html#msph>.
- A Catalogue of the Manuscripts Preserved in the Library of the University of Cambridge*. Vol. II. Cambridge: Cambridge University Press, 1857.
- Agnew, Vanessa. 'Introduction: What Is Reenactment?' *Criticism*, Special Issue: Extreme and Sentimental History, 46, no. 3 (2004): 327–39.
- Agnew, Vanessa, Jonathan Lamb, and Juliane Tomann. 'Introduction: What Is Reenactment Studies?' In *The Routledge Handbook of Reenactment Studies: Key*

- Terms in the Field*, edited by Vanessa Agnew, Jonathan Lamb, and Juliane Tomann, 1–10. London and New York: Routledge, 2020.
- Agnew, Vanessa, and Juliane Tomann. ‘Authenticity’. In *The Routledge Handbook of Reenactment Studies: Key Terms in the Field*, edited by Vanessa Agnew, Jonathan Lamb, and Juliane Tomann, 20–24. London and New York: Routledge, 2020.
- Allen, Rosamund S. ‘Reading Malory Aloud: Syntax, Gender, and Narrative Pace’. *Arthuriana*, Reading Malory Aloud, Then and Now, 13, no. 4 (2003): 71–85.
- Anderson, Jay. ‘Living History: Simulating Everyday Life in Living Museums’. *American Quarterly* 34, no. 3 (1982): 290–306.
- Attridge, Derek. *The Experience of Poetry: From Homer’s Listeners to Shakespeare’s Readers*. Oxford: Oxford University Press and Oxford Scholarship Online, 2019. doi: 10.1093/oso/9780198833154.003.0010.
- Austin, David. ‘Private and Public: An Archaeological Consideration of Things’. In *Die Vielfalt Der Dinge: Neue Wege Zur Analyse Mittelalterlicher Sachkultur. Internationaler Kongress, Krems an Der Donau, 4. Bis 7. Oktober 1994. Gedenkschrift in Memoriam Harry Kühnel.*, edited by Helmut Hundsichler, Gerhard Jaritz, and Thomas Kühtreiber, 163–206. Wien: Der Österreichischen Akademie der Wissenschaften, 1998.
- Azéma, Anne. “‘Une Aventure Vous Dirai’”: Performing Medieval Narrative’. In *Performing Medieval Narrative*, 209–22. Cambridge: D. S. Brewer, 2005.
- Bagby, Benjamin. ‘Beowulf, the Edda, and the Performance of Medieval Epic: Notes from the Workshop of a Reconstructed “Singer of Tales”’. In *Performing Medieval Narrative*, 181–92. Cambridge: D. S. Brewer, 2005.
- . ‘Beowulf: The Epic in Performance’. Accessed 30 September 2021. <https://web.archive.org/web/20210930111519/http://www.bagbybeowulf.com/>.
- Bagby, Benjamin, and Stellan Olsson. *Beowulf: Voice and Anglo-Saxon Harp*. DVD. New York: Charles Morrow Productions LLC and Jon Aaron, 2006.
- Bakhtin, M. M. *Problems of Dostoevsky’s Poetics*. Translated by Caryl Emerson. Theory and History of Literature, V. 8. Manchester: Manchester University Press, 1984.
- Balogh, Josef. ‘Voces Paginorum’. *Philologus* 82 (1927): 84–109, 202–40.
- Barley Hall. ‘About’. Accessed 15 January 2020. <https://barleyhall.co.uk/about/>.
- Barley Hall. ‘Education’. Accessed 9 April 2022. <https://barleyhall.co.uk/education/>.
- Barley Hall Guidebook*, Unpublished guidebook, n.d.
- Baudrillard, Jean. *Simulations*. Translated by Paul Foss, Paul Patton, Philip Beitchman, and Sylvère Lotringer. New York: Semiotexte Inc., 1983.
- Baugh, A.C. ‘Improvisation in the Middle English Romance’. *Proceedings of the American Philosophical Society* 103 (1959): 418–54.

- . ‘The Middle English Romance: Some Questions of Creation, Presentation, and Preservation’. *Speculum* 42, no. 1 (1967): 1–31.
- Bauman, Richard. *Verbal Art as Performance*. Long Grove, Illinois: Waveland Press, 1977.
- Beadle, Richard, and A.E.B. Owen, eds. *The Findern Manuscript Cambridge University Library MS.Ff.I.6*. London: Scolar Press, 1978.
- Beattie, Cordelia, and Anna Maslakovic. ‘Introduction – Locating the Household: Public, Private, and the Social Construction of Gender and Space’. In *The Medieval Household in Christian Europe c. 850 - c. 1550: Managing Power, Wealth and the Body*, edited by Cordelia Beattie, Anna Maslakovic, and Sarah Rees Jones, 1–8. Turnhout: Brepols, 2003.
- Bille, M., and T.F. Sørensen. ‘An Anthropology of Luminosity: The Agency of Light’. *Journal of Material Culture* 12, no. 3 (2007): 263–84.
- . ‘In Visible Presence: The Role of Light in Shaping Religious Atmospheres’. In *The Oxford Handbook of Light in Archaeology*, edited by Costas Papadopoulos and Holley Moyes. Oxford: Oxford University Press, 2017.
- Blanchfield, Lynne S. “‘An Idiosyncratic Scribe’: A Study of the Practice and Purpose of Rate, the Scribe of Bodleian Library MS Ashmole 61”. PhD Thesis, University College of Wales, Aberystwyth, 1991.
- . ‘Rate Revisited: The Compilation of the Narrative Works in MS Ashmole 61’. In *Romance Reading on the Book: Essays on Medieval Narrative Presented to Maldwyn Mills*, edited by Jennifer Fellows, Rosalind Field, Gillian Rogers, and Judith Weiss, 208–20. Cardiff: University of Wales Press, 1996.
- . ‘The Romances in MS Ashmole 61: An Idiosyncratic Scribe’. In *Romance in Medieval England.*, edited by Maldwyn Mills, Jennifer Fellows, and Carol M. Meale, 65–87. Cambridge: D. S. Brewer, 1991.
- Blatt, Heather. *Participatory Reading in Late-Medieval England*. Manchester: Manchester University Press, 2018. <https://doi.org/10.7765/9781526118004>.
- Blick, Sarah. ‘Bringing Pilgrimage Home: The Production, Iconography, and Domestic Use of Late-Medieval Devotional Objects by Ordinary People’. *Religions* 10, no. 6 (2019): 392. <https://doi.org/doi:10.3390/re110060392>.
- Boffey, Julia. ‘Bodleian Library, MS Arch. Selden. B. 24 and Definitions of the “Household Book”’. In *The English Medieval Book: Studies in Memory of Jeremy Griffiths*, edited by A.S.G. Edwards, Vincent Gillespie, and Ralph Hanna, 125–34. London: British Library, 2000.
- Boffey, Julia, and A.S.G. Edwards. ‘Towards a Taxonomy of Middle English Manuscript Assemblages’. In *Insular Books: Vernacular Manuscript Miscellanies in Late*

- Medieval Britain*, edited by Margaret Connolly and Raluca Radulescu, 263–79. Oxford: Oxford University Press for the British Academy, 2015.
- Boffey, Julia, and John J. Thompson. ‘Anthologies and Miscellanies: Production and Choice of Texts’. In *Book Production and Publishing in Britain 1375-1475*, edited by Jeremy Griffiths and Derek Pearsall, 279–315. Cambridge: Cambridge University Press, 1989.
- Bolton, W.F. ‘Introduction: The Conditions of Literary Composition in Medieval England’. In *History of Literature in the English Language*, edited by W.F. Bolton, 1: The Middle Ages: ix–xxxvi. London: Barrie and Jenkins, 1970.
- Bookheimer, Susan Y., Thomas A. Zeffiro, Teresa Blaxton, William Gaillard, and Wiliam Theodore. ‘Regional Cerebral Blood Flow during Object Naming and Word Reading’. *Human Brain Mapping* 3, no. 2 (1995): 93–106.
- Bourdieu, Pierre. *Outline of a Theory of Practice*. Cambridge: Cambridge University Press, 1977.
- Bowles, Edmund A. ‘Musical Instruments at the Medieval Banquet’. *Revue Belge de Musicologie / Belgisch Tijdschrift Voor Muziekwetenschap* 12, no. 1/4 (1958): 41–51.
- Bradbury, Neil A. ‘Attention Span during Lectures: 8 Seconds, 10 Minutes, or More?’ *Advances in Physiology Education* 40 (2016): 509–13.
- Brantley, Jessica. *Reading in the Wilderness: Private Devotion and Public Performance in Late Medieval England*. Chicago: University of Chicago Press, 2007.
- Brewer, D.S., and A.E.B. Owen, eds. *The Thornton Manuscript (Lincoln Cathedral MS. 91)*. London: Scholar Press, 1975.
- British Library: Explore Archives and Manuscripts. ‘Cotton Manuscript Caligula A II’. Accessed 3 November 2015. [http://searcharchives.bl.uk/IAMS\\_VU2:IAMS040-001102311](http://searcharchives.bl.uk/IAMS_VU2:IAMS040-001102311).
- British Library: Explore Archives and Manuscripts. ‘Statutes of the Carthusian Order (144r–148r);...’ Accessed 3 November 2015. [http://searcharchives.bl.uk/IAMS\\_VU2:IAMS041-001102313](http://searcharchives.bl.uk/IAMS_VU2:IAMS041-001102313).
- British Library: Explore Archives and Manuscripts. ‘“The Pistill of Susan” (3r–5r: Boffey 3553, Imperfect);...’ Accessed 3 November 2015. [http://searcharchives.bl.uk/IAMS\\_VU2:IAMS041-001102312](http://searcharchives.bl.uk/IAMS_VU2:IAMS041-001102312).
- Bruner, Edward M. ‘Abraham Lincoln as Authentic Reproduction: A Critique of Postmodernism’. *American Anthropologist* 96, no. 2 (1994): 397–415.
- Bynum, Caroline Walker. *Jesus as Mother: Studies in the Spirituality of the High Middle Ages*. Vol. 16. Publications of the Center for Medieval and Renaissance Studies. Berkeley and London: University of California Press, 1982.



- BYU Creative Works. 'Chaucer Studio', 2021.  
<https://creativeworks.byu.edu/CreativeworksStore/ProductCategory?SiteID=20>.
- Card, Amanda. 'Body and Embodiment'. In *The Routledge Handbook of Reenactment Studies: Key Terms in the Field*, edited by Vanessa Agnew, Jonathan Lamb, and Juliane Tomann, 30–33. London and New York: Routledge, 2020.
- Carson, Christie, and Farah Karim-Cooper, eds. *Shakespeare's Globe: A Theatrical Experiment*. Cambridge: Cambridge University Press, 2008.
- Cavanaugh, Susan H. 'A Study of Books Privately Owned in England: 1300-1450'. University of Pennsylvania, 1980.
- Chambers, E.K. *The Mediaeval Stage*. Vol. 1. Oxford: Oxford University Press, 1903.
- Charbonneau, Joanne A. 'Transgressive Fathers in *Sir Eglamour of Artois* and *Torrent of Portyngale*'. In *Discourses on Love, Marriage, and Transgression in Medieval and Early Modern Literature*, edited by Albrecht Classen, 243–65. Medieval and Renaissance Texts and Studies 278. Tempe, Arizona: Arizona Centre for Medieval and Renaissance Studies, 2004.
- Chaucer Studio and Its Press, The: Recordings and Books*. Unpublished brochure, 2017.
- Cherewatuk, Karen. 'An Introduction to Aural Malory: Sessions and Round Tables'. *Arthuriana*, Reading Malory Aloud, Then and Now, 13, no. 4 (2003): 3–13.
- Clanchy, Michael T. *From Memory to Written Record: England 1066 - 1307*. 3rd ed. Chichester: John Wiley & Sons, 2013.
- . 'Looking Back From the Invention of Printing'. In *Literacy in Historical Perspective*, edited by Daniel P. Resnick, 7–22. Washington: Library of Congress, 1983.
- . 'Parchment and Paper: Manuscript Culture 1100-1500'. In *A Companion to the History of the Book*, edited by Simon Eliot and Jonathan Rose, 420–46. Chichester: John Wiley & Sons, 2007.
- Coleman, Joyce. *Public Reading and the Reading Public in Late Medieval England and France*. Cambridge: Cambridge University Press, 1996.
- . 'Reading Malory in the Fifteenth Century: Aural Reception and Performance Dynamics'. *Arthuriana*, Reading Malory Aloud, Then and Now, 13, no. 4 (2003): 48–70.
- Coles, John. *Experimental Archaeology*. Caldwell, N.J.: Blackburn Press, 1979.
- Connolly, Margaret, and Raluca Radulescu. 'Introduction'. In *Insular Books: Vernacular Manuscript Miscellanies in Late Medieval Britain*, edited by Margaret Connolly and Raluca Radulescu, 1–29. Oxford: Oxford University Press for the British Academy, 2015.

- Cooke, William G. 'The Tournament of Tottenham: An Alliterative Poem and an Exeter Performance'. *Records of Early English Drama* 11, no. 2 (1986): 1–3.
- Cooper, Catriona. 'Lived Experience at Bodiam and Ightham'. In *Lived Experience in the Later Middle Ages: Studies of Bodiam and Other Elite Landscapes in South-Eastern England*, edited by Matthew Johnson, 143–57. York: Council for British Archaeology, 2017.
- Crosby, Ruth. 'Oral Delivery in the Middle Ages'. *Speculum* 11, no. 1 (1936): 88–110.
- Cruse, Mark. 'Matter and Meaning in Medieval Books: The Romance Manuscript as Sensory Experience'. *Sense and Society* 5, no. 1 (2010): 45–56.
- Cummings, Anthony M. 'Music and Feasts in the Fifteenth Century'. In *The Cambridge History of Fifteenth-Century Music*, edited by Anna Maria Busse Berger and Jesse Rodin Davis, 361–73. Cambridge: Cambridge University Press, 2015.
- Curnow, D.J., and Ad Putter. 'Textual and Familial Relationships: The Place of the Michigan Fragment in the Evolution of *Sir Eglamour*'. In *People and Texts: Relationships in Medieval Literature*, edited by Thea Summerfield and Keith Busby, 51–65. Amsterdam: Brill | Rodopi, 2007.
- Da Rold, Orietta. *Paper in Medieval England: From Pulp to Fictions*. Cambridge Studies in Medieval Literature. Cambridge: Cambridge University Press, 2020.
- Daugbjerg, Mads. 'Battle'. In *The Routledge Handbook of Reenactment Studies: Key Terms in the Field*, edited by Vanessa Agnew, Jonathan Lamb, and Juliane Tomann, 25–29. London and New York: Routledge, 2020.
- Davis, Norman. 'Introduction: Language and Versification'. In *The Riverside Chaucer*, edited by Larry D. Benson, 3rd ed., xxv–xli. Oxford: Oxford University Press, 2008.
- . *Paston Letters and Papers of the Fifteenth Century*. Vol. 1. Oxford: Clarendon Press, 1993. <http://name.umdl.umich.edu/Paston>.
- Dean, David. 'Living History'. In *The Routledge Handbook of Reenactment Studies: Key Terms in the Field*, edited by Vanessa Agnew, Jonathan Lamb, and Juliane Tomann, 120–24. London and New York: Routledge, 2020.
- Deane, Jennifer Kolpacoff. 'Medieval Domestic Devotion'. *History Compass* 11, no. 1 (2013): 65–76.
- Denton, Jeannette Marshall. 'An Historical Linguistic Description of Sir Thomas Malory's Dialect'. *Arthuriana*, Reading Malory Aloud, Then and Now, 13, no. 4 (2003): 14–47.
- Digital Index of Middle English Verse, The. 'Found Records: Cambridge UK, Cambridge University Library Ff.1.6 [Findern MS]'. Accessed 3 June 2016. <https://www.dimev.net/Records.php?MSS=CULFf16>.

- Digital Index of Middle English Verse, The. 'Found Records: Cambridge UK, Cambridge University Library Ff.2.38'. Accessed 27 October 2016.  
<https://www.dimev.net/Records.php?MSS=CULFf238>.
- Digital Index of Middle English Verse, The. 'Found Records: Edinburgh, National Library of Scotland, Advocates' 19.3.1'. Accessed 10 August 2016.  
<https://www.dimev.net/Records.php?MSS=NLS1931>.
- Digital Index of Middle English Verse, The. 'Found Records: Lincoln, Lincoln Cathedral Library 91 [Robert Thornton MS]'. Accessed 17 January 2017.  
<https://www.dimev.net/Records.php?MSS=Lincoln91>.
- Digital Index of Middle English Verse, The. 'Found Records: London, British Library Cotton Caligula A.II'. Accessed 3 November 2015.  
<https://www.dimev.net/Records.php?MSS=BIcCottCalAII>.
- Digital Index of Middle English Verse, The. 'Found Records: Oxford, Bodleian Library Ashmole 61 (SC 6922\*)'. Accessed 10 August 2016.  
<https://www.dimev.net/Records.php?MSS=BodAsh61>.
- Dobson, E. J. *English Pronunciation 1500-1700*. 2nd ed. Oxford: Clarendon Press, 1968.
- Dobyns, Ann. 'Exemplars in Chivalry: Rhetoric and Ethics in Middle English Romance'. In *Romance and Rhetoric: Essays in Honour of Dhira B. Mahoney*, edited by Georgiana Donavin and Anita Obermeier, 19:17–32. Disputatio. Turnhout: Brepols, 2010.
- Downing, J. 'A Critical Edition of Cambridge University MS Ff.5.48'. PhD Thesis, University of Washington, 1969.
- Dustagheer, Sarah. "'Intimacy" at the Sam Wanamaker Playhouse'. *Shakespeare Bulletin* 35, no. 2 (2017): 227–46.
- Dustagheer, Sarah, Oliver Jones, and Eleanor Rycroft. '(Re)Constructed Spaces for Early Modern Drama: Research in Practice'. *Shakespeare Bulletin* 35, no. 2 (2017): 173–85.
- Eagan, Geoff. *The Medieval Household: Daily Living c. 1150 - c. 1450*. Medieval Finds from Excavations in London 6. Woodbridge and London: Boydell Press in association with Museum of London, 2010.
- Emery, Anthony. *Greater Medieval Houses of England and Wales, 1300-1500. Vol. 2: East Anglia, Central England, and Wales*. Cambridge: Cambridge University Press, 1996.
- Eveleigh, David J. *Candle Lighting*. Princes Risborough: Shire Publications, 2003.
- Faulkner, Patrick A. 'Gainsborough Old Hall (SK 813900)'. *Archaeological Journal* 131 (1974): 366–68.

- Fein, Susanna. 'The Four Scribes of MS Harley 2253'. *The Journal of the Early Book Society for the Study of Manuscripts and Printing History* 16 (2013): 27–53.
- . 'The Contents of Robert Thornton's Manuscripts'. In *Robert Thornton and His Books: Essays on the Lincoln and London Thornton Manuscripts*, edited by Susanna Fein and Michael Johnston, 13–66. York: York Medieval Press, 2014.
- Field, Naomi. 'Excavations and the West Range'. In *Gainsborough Old Hall*, edited by P.G. Lindley, 8:34–42. Occasional Papers in Lincolnshire History and Archaeology. Lincoln: The Society of Lincolnshire History and Archaeology, 1991.
- Fisher, Matthew. *Scribal Authorship and the Writing of History in Medieval England*. Columbus: Ohio State University Press, 2012.
- Foley, John Miles. *The Singer of Tales in Performance*. Bloomington: Indiana University Press, 1995.
- Frampton, M.G. 'Gilbert Pilkington Once More'. *PMLA* 47, no. 3 (1932): 622–35.
- Fredell, Joel. 'The Thornton Manuscripts and Book Production in York'. In *Robert Thornton and His Books: Essays on the Lincoln and London Thornton Manuscripts*, edited by Susanna Fein and Michael Johnston, 109–29. York: York Medieval Press, 2014.
- Gardiner, M. 'Vernacular Buildings and the Development of the Late Medieval Domestic Plan in England'. *Medieval Archaeology* 50 (2000): 159–79.
- . 'Buttery and Pantry and Their Antecedents: Idea and Architecture in the English Medieval House'. In *Medieval Domesticity: Home, Housing and Household in Medieval England*, edited by Maryanne Kowaleski and P.J.P. Goldberg, 37–65. Cambridge: Cambridge University Press, 2008.
- garible. 'Abduction of Queen Herodis (with Harp)'. Video. *YouTube*, 25 September 2014. <https://www.youtube.com/watch?v=IrTsiN5PyAI>.
- Genette, Gérard. *Narrative Discourse*. Translated by Jane E. Lewin. Oxford: Basil Blackwell, 1982.
- Gertsman, Elina. 'Introduction: The Spectrum of Performances'. In *Visualizing Medieval Performance: Perspectives, Histories, Contexts*, edited by Elina Gertsman, 1–13. Aldershot: Ashgate, 2008.
- Gheorghiu, Dragoş. 'Lighting in Reconstructed Contexts: Experiential Archaeology with Pyrotechnologies'. In *The Oxford Handbook of Light in Archaeology*, edited by Costa Papadopoulos and Holley Moyes, n.p. Published online: Oxford University Press, 2017.

- Gibbings, Lina. 'Performing Pearl: Drama, Middle English Text and Performance Based Research in Medieval Studies'. Unpublished MFA Thesis, University of Calgary, 2018.
- Gilchrist, Roberta. *Medieval Life: Archaeology and the Life Course*. Suffolk: Boydell Press, 2012.
- Giles, Kate. 'Housing Part 2: Vernacular Housing in the North: The Case of England'. In *The Archaeology of Medieval Europe*, edited by Martin Carver and Jan Klápště, 2:159–76. Acta Jutlandica, Humanities Series 2011/9. Aarhus: Aarhus University Press, 2011.
- . 'Ways of Living in Medieval England'. In *Dwellings, Identities and Homes: European Housing Culture from the Viking Age to the Renaissance*, edited by Mette Svart Kristiansen and Kate Giles, 84:13–28. Jutland Archaeological Society Publications. Højbjerg: Jutland Archaeological Society, 2014.
- Goffman, Erving. *The Presentation of Self in Everyday Life*. London: Penguin, 1959.
- Goldberg, Jeremy. *Communal Discord, Child Abduction and Rape in the Later Middle Ages*. The New Middle Ages. New York: Palgrave Macmillan, 2008.
- . 'Making the House a Home in Later Medieval York'. *Journal of Medieval History* 45, no. 2 (2019): 162–80.
- . *Medieval England: A Social History 1250-1550*. London: Arnold, 2004.
- . 'Space and Gender in the Later Medieval House'. *Viator* 42, no. 2 (2011): 205–32.
- . 'The Fashioning of Bourgeois Domesticity in Later Medieval England: A Material Culture Perspective'. In *Medieval Domesticity: Home, Housing and Household in Medieval England*, edited by Maryanne Kowaleski and P.J.P. Goldberg, 124–44. Cambridge: Cambridge University Press, 2008.
- Goodall, John. 'Barley Hall, York: A Property of the York Archaeological Trust'. *Country Life* 188, no. 49 (1994): 28–31.
- . 'Gainsborough Old Hall, Lincs: A Property in the Guardianship of English Heritage'. *Country Life* 190, no. 3 (1996): 38–41.
- Gore, Alan, and Ann Gore. *The History of English Interiors*. London: Phaidon Press, 1991.
- Gottschall, Anna. 'Textual Provenance Through the Male and Female Names in the Findern Manuscript'. *The Birmingham Journal of Language and Literature* 1, no. 1 (2008): 32–40.
- Grant, J. 'Changing Face of History at the Museum: Restoration, Interpretation and Education at Barley Hall'. BA Thesis, University of York, 2006.
- Green, D.H. *Medieval Listening and Reading: The Primary Reception of German Literature 800-1300*. Cambridge: Cambridge University Press, 1994.

- Grenville, Jane. *Medieval Housing*. Archaeology of Medieval Britain. London: Leicester University Press, 1997.
- Griffith, David. 'The Visual History of Guy of Warwick'. In *Guy of Warwick: Icon and Ancestor*, edited by Alison Wiggins and Rosalind Field, 110–32. Woodbridge, Suffolk: D. S. Brewer, 2007.
- Guddat-Figge, Gisela. *Catalogue of Manuscripts Containing Middle English Romances*. Munich: Wilhem Fink Verlag, 1976.
- Gunn, S.J. 'The Rise of the Burgh Family, c. 1431-1550'. In *Gainsborough Old Hall*, edited by P.G. Lindley, 8:8–12. Occasional Papers in Lincolnshire History and Archaeology. Lincoln: The Society of Lincolnshire History and Archaeology, 1991.
- Guy of Warwick Society, The. 'Aims of the Society'. Accessed 30 August 2019.  
<https://www.thegows.co.uk/gallery>.
- Halliwell-Phillipps, James Orchard. *The Thornton Romances: The Early English Metrical Romances of Perceval, Isumbras, Eglamour, and Degrevant*. London: Camden Society, 1844.
- Hamling, Tara, and Catherine Richardson. *A Day at Home in Early Modern England: Material Culture and Domestic Life, 1500-1700*. New Haven: Yale University Press, 2017.
- Handler, R., and E. Gable. *The New History in an Old Museum: Creating the Past at Colonial Williamsburg*. Durham and London: Duke University Press, 1997.
- Hanks Jr., D. Thomas. 'Epilogue: Malory's "Morte Darthur" and "the Place of the Voice"'. *Arthuriana*, Reading Malory Aloud, Then and Now, 13, no. 4 (2003): 119–33.
- Hanna, Ralph. 'The Production of Cambridge University Library MS. Ff. i. 6'. *Studies in Bibliography* 40 (1987): 62–70.
- Hanson, Julienne. *Decoding Homes and Houses*. Cambridge: Cambridge University Press, 1998.
- Hardman, Phillipa. 'A Medieval "Library in Parvo"'. *Medium Ævum* 47 (1978): 262–73.
- . 'Domestic Learning and Teaching: Investigating Evidence for the Role of "Household Miscellanies" in Late-Medieval England'. In *Women and Writing c. 1340-c.1650: The Domestication of Print Culture*, edited by Anne Lawrence Mathers and Phillipa Hardman, 15–33. York: York Medieval Press, 2010.
- . 'Fitt Divisions in Middle English Romances: A Consideration of the Evidence'. *The Yearbook of English Studies* 22 (1992): 63–80.
- . 'Popular Romances and Young Readers'. In *A Companion to Medieval Popular Romance*, edited by Raluca Radulescu and Cory James Rushton, 150–64. Cambridge: D. S. Brewer, 2009.

- , ed. *The Heege Manuscript: A Facsimile of National Library of Scotland MS Advocates 19.3.1*. 16. Leeds: Leeds Texts and Monographs, 2000.
- Harris, A. Leslie. 'Tournaments and *The Tournament of Tottenham*'. *Fifteenth Century Studies* 23 (1997): 81–92.
- Harris, Kate. 'The Origins and Make-up of Cambridge University Library MS Ff.1.6'. *Transactions of the Cambridge Bibliographical Society* 8, no. 3 (1983): 299–333.
- Hendrickson, G.L. 'Ancient Reading'. *The Classical Journal* 25 (1929): 182–96.
- Hennessy, Marlene Villalobos. 'Passion Devotion, Penitential Reading, and the Manuscript Page: "The Hours of the Cross" in London, British Library Additional 37049'. *Mediaeval Studies* 66 (2014): 213–52.
- Hillier, Bill, and Julienne Hanson. *The Social Logic of Space*. Cambridge: Cambridge University Press, 1984.
- Hindman, Sandra. *Sealed in Parchment: Rereadings of Knighthood in the Illuminated Manuscripts of Chrétien De Troyes*. Chicago: University of Chicago Press, 1994.
- Historic England. 'The Old Hall'. Accessed 24 April 2022.  
<https://historicengland.org.uk/listing/the-list/list-entry/1359773?section=comments-and-photos>.
- 'Houses: Stonegate'. In *An Inventory of the Historical Monuments in City of York*, 5, Central: 220–35. London: Originally published by Her Majesty's Stationery Office, 1981. [www.british-history.ac.uk/rchme/york/vol5/pp220-235](http://www.british-history.ac.uk/rchme/york/vol5/pp220-235).
- Hudson Claypotter: Traditional hand thrown pots. 'Hudson Claypotter'. Accessed 3 December 2019. <http://www.hudsonclaypotter.co.uk/>.
- Hudson, Harriet. 'Sir Eglamour of Artois: Introduction'. In *Four Middle English Romances: Sir Isumbras, Octavian, Sir Eglamour of Artois, Sir Tryamour*, edited by Harriet Hudson. TEAMS Middle English Texts Series. Kalamazoo, Michigan: Medieval Institute Publications, 2006.
- Hudson, Roxanne F., Holly B. Lane, and Paige C. Pullen. 'Reading Fluency Assessment and Instruction: What, Why, and How?' *The Reading Teacher* 58, no. 8 (2005): 702–14.
- Jackson, Anthony, and Jenny Kidd, eds. *Performing Heritage: Research, Practice and Innovation in Museum Theatre and Live Interpretation*. Manchester: Manchester University Press, 2011.
- Jesmok, Janet. 'Reading Malory Aloud: Poetic Qualities and Distinctive Voice'. *Arthuriana*, Reading Malory Aloud, Then and Now, 13, no. 4 (2003): 86–102.
- Johnson, Matthew. *English Houses 1300-1800: Vernacular Architecture, Social Life*. Harlow: Pearson Longman, 2010.

- . ‘Introduction’. In *Lived Experience in the Later Middle Ages: Studies of Bodiam and Other Elite Landscapes in South-Eastern England*, edited by Matthew Johnson, 1–8. York: Council for British Archaeology, 2017.
- . ‘Rethinking the Great Rebuilding’. *Oxford Journal of Archaeology* 12 (2007): 117–25.
- . ‘What Do Medieval Buildings Mean?’ *History and Theory* 52, no. 3 (2013): 380–99.
- Johnston, Michael. ‘A New Document Relating to the Life of Robert Thornton’. *Library* 8, no. 3 (2007): 304–13.
- . ‘Introduction: The Cheese and the Worms and Robert Thornton’. In *Robert Thornton and His Books: Essays on the Lincoln and London Thornton Manuscripts*, edited by Susanna Fein and Michael Johnston, 1–12. York: York Medieval Press, 2014.
- . ‘New Evidence for the Social Reach of “Popular Romance”: The Books of Household Servants’. *Viator* 43, no. 2 (2012): 303–32.
- . *Romance and the Gentry in Late Medieval England*. Oxford: Oxford University Press, 2014.
- . ‘Sir Degrevant in the “Findern Anthology” (Cambridge, University Library MS Ff.1.6)’. *Studies in Bibliography* 59 (2015): 71–84.
- . ‘Two Leicestershire Romance Codices: Cambridge, University Library MS Ff.2.38 and Oxford, Bodleian Library MS Ashmole 61’. *Journal of the Early Book Society* 15 (2012): 85–100.
- Jones, Oliver. ‘The Queen’s Men on Tour: Provincial Performance in Vernacular Spaces in Early Modern England’. PhD Thesis, University of York, 2012.
- Jun, Sun-Ah. ‘The Implicit Prosody Hypothesis and Overt Prosody in English’. *Language and Cognitive Processes* 25, no. 7–9 (2010): 1201–33.
- Keiser, George R. ‘Robert Thornton: Gentleman, Reader and Scribe’. In *Robert Thornton and His Books: Essays on the Lincoln and London Thornton Manuscripts*, edited by Susanna Fein and Michael Johnston, 67–108. York: York Medieval Press, 2014.
- Ker, N.R., ed. *Facsimile of British Museum MS. Harley 2253*. London: Oxford University Press for The Early English Text Society, 1965.
- Kerby-Fulton, Kathryn. *The Medieval Professional Reader at Work: Evidence from Manuscripts of Chaucer, Langland, Kempe, and Gower*. Edited by Kathryn Kerby-Fulton and Maidie Hilmo. Victoria: English Literary Studies, University of Victoria, 2001.



- Kerby-Fulton, Kathryn, and Denise L. Despres. 'Introduction'. In *Iconography and the Professional Reader: The Politics of Book Production in the Douce Piers Plowman*, 1–14. Minneapolis: University of Minnesota Press, 1999.
- Kerr, Sarah. 'Collective Living and Individual Identities in Late Medieval England'. *Archaeological Journal* 177, no. 1 (2020): 83–98.
- Kershaw, Baz. 'Practice as Research: Transdisciplinary Innovation in Action'. In *Research Methods in Theatre and Performance*, edited by Baz Kershaw and Helen Nicholson, 63–85. Edinburgh: Edinburgh University Press, 2011.
- Kershaw, Baz, and Helen Nicholson. 'Introduction: Doing Methods Creatively'. In *Research Methods in Theatre and Performance*, edited by Baz Kershaw and Helen Nicholson, 1–15. Edinburgh: Edinburgh University Press, 2011.
- Kevin Caliendo. "'Reading in a Paved Parlor" Pt. 2'. Video. *YouTube*, 15 April 2007. <https://www.youtube.com/watch?v=53VPmv6lvJ4>.
- . "'Reading in Paved Parlor" Pt. 1'. Video. *YouTube*, 15 April 2007. <https://www.youtube.com/watch?v=1INkAtRoU1w>.
- Kightly, Charles. *Barley Hall York*. York: Barley Hall Trust, 1999.
- . 'The Hangings About the Hall'. *Medieval Textiles* 28 (2001): 3–6.
- Kinch, Ashby. "'To Thenke What Was in Hir Wille": A Female Reading Context for the Findern Anthology'. *Neophilologus* 91 (2007): 729–44.
- Knight, S.T. 'The Oral Transmission of *Sir Launfal*'. *Medium Ævum* 38 (1969): 164–70.
- . 'The Social Function of Middle English Romance'. In *Medieval Literature: Criticism, Ideology and History*, edited by David Aers, 99–122. Brighton: Harvester Press, 1986.
- Kooper, Erik. 'The Tournament of Tottenham and The Feast of Tottenham: Introduction'. In *Sentimental and Humorous Romances*, edited by Erik Kooper. TEAMS Middle English Texts Series. Kalamazoo, Michigan: Medieval Institute Publications, 2005.
- Kowaleski, Maryanne, and P.J.P. Goldberg, eds. *Medieval Domesticity: Home, Housing and Household in Medieval England*. Cambridge: Cambridge University Press, 2008.
- Kozel, Susan. *Closer: Performance, Technologies, Phenomenology*. Cambridge, Massachusetts: MIT Press, 2008.
- Krug, Rebecca. *Reading Families: Women's Literate Practice in Late Medieval England*. Ithaca and London: Cornell University Press, 2002.
- Lawson, Graeme. 'Large Scale-Small Scale: Medieval Stone Buildings, Early Medieval Timber Halls and the Problem of the Lyre'. In *Archaeoacoustics*, edited by

- Christopher Scarre and Graeme Lawson, 85–94. McDonald Institute Monographs. Cambridge: McDonald Institute for Archaeological Research, 2006.
- Leech-Wilkinson, Daniel. *The Modern Invention of Medieval Music: Scholarship, Ideology, Performance*. Musical Performance and Reception. Cambridge: Cambridge University Press, 2002.
- Levy, Brian J. ‘Performing Fabliaux’. In *Performing Medieval Narrative*, 123–40. Cambridge: D. S. Brewer, 2005.
- Liddy, Lisa. ‘Domestic Objects in York c.1400–1600: Consumption, Neighbourhood and Choice’. PhD Thesis, University of York, 2015.
- Lindenbaum, Sheila. ‘Drama as Textual Practice’. In *Middle English*, edited by Paul Strohm, 386–400. Oxford Twenty-First Century Approaches to Literature. Oxford: Oxford University Press, 2007.
- Lindley, P.G. ‘Structure, Sequence and Status: The Architectural History of Gainsborough Old Hall to c. 1600’. In *Gainsborough Old Hall*, edited by P.G. Lindley, 8:21–26. Occasional Papers in Lincolnshire History and Archaeology. Lincoln: The Society of Lincolnshire History and Archaeology, 1991.
- Lopopolo, Alessandro, Stefan Frank, Antal Van den Bosch, and Roel Willems. ‘Dependency Parsing with Your Eyes: Dependency Structure Predicts Eye Regressions During Reading’. In *Proceedings of the Workshop on Cognitive Modeling and Computational Linguistics*, 77–85. Minneapolis: Association for Computational Linguistics, 2019.
- Lord, Albert B. ‘Oral Composition and “Oral Residue” in the Middle Ages’. In *Oral Tradition in the Middle Ages*, edited by W. F. H. Nicolaisen, 7–29. Binghamton, New York: Medieval and Renaissance Texts and Studies, 1995.
- . *The Singer of Tales*. Edited by Stephen Mitchell and Gregory Nagy. 2nd ed. Cambridge, Massachusetts: Harvard University Press, 2000.
- Lord Burgh’s Retinue 1460-1496. ‘Lord Burgh’s Retinue’, 2016.  
<https://web.archive.org/web/20160229221616/http://www.lordburghsretinue.co.uk>
- Magoun, Francis P. ‘Oral-Formulaic Character of Anglo-Saxon Narrative Poetry’. *Speculum* 28 (1953): 446–67.
- Maring, Heather. ‘Performing Pearl’. In *Approaches to Teaching the Middle English Pearl.*, edited by Jane Beal and Mark Bradshaw Busbee, n.p. Approaches to Teaching World Literature 143. New York: The Modern Languages Association of America, 2018.
- Matthews, David. *Medievalism: A Critical History*. Medievalism Series, VI. Cambridge: D. S. Brewer, 2015.

- Maurey, Yossi. 'Performing Our Practices: Between Music and Musicology'. In *Visualizing Medieval Performance: Perspectives, Histories, Contexts*, edited by Elina Gertsman, 279–94. Aldershot: Ashgate, 2008.
- McCurdy & Co: Craftsmen and Consultants - Historic Timber Frame Reconstruction Specialists. 'Barley Hall'. Accessed 3 December 2009. <https://mccurdyco.com/barley-hall/>.
- McDonald, Nicola. 'A Polemical Introduction'. In *Pulp Fictions of Medieval England: Essays in Popular Romance*, 1–21. Manchester: Manchester University Press, 2004.
- . 'A York Primer and Its Alphabet: Reading Women in a Lay Household'. In *Oxford Handbook of Medieval Literature in English*, edited by Elaine Treharne and Greg Walker, 253–78. Oxford: Oxford University Press, 2010.
- . *The Question of Middle English Romance*. Oxford: Oxford University Press, 2017. doi:10.1093/oxfordhb/9780199935338.013.57.
- McGillivray, Murray. *Memorization in the Transmission of the Middle English Romances*. New York and London: Garland Publishing, 1990.
- McLoughlin, Sarah. 'Gender and Transgression in the Late Medieval English Household'. PhD Thesis, University of York, 2011.
- McNamer, Sarah. *Affective Meditation and the Invention of Medieval Compassion*. Philadelphia: University of Pennsylvania Press, 2010.
- . 'Female Authors, Provincial Setting: The Re-Versing of Courtly Love in the Findern Manuscript'. *Viator* 22 (1991): 279–310.
- McSparran, Frances, and P.R. Robinson, eds. *Cambridge University Library MS Ff.2.38*. London: Scolar Press, 1979.
- Mehl, Dieter. 'The Audience of Chaucer's "Troilus and Criseyde"'. In *Chaucer's Troilus: Essays in Criticism*, edited by Stephen Allen Barney, 211–29. London: Scolar Press, 1980.
- Meredith, Elysse Taillon. 'Wearing Identity: Colour and Costume in *Meliador* and *Sir Gawain and the Green Knight*'. PhD Thesis, University of Edinburgh, 2012.
- Middle English Compendium: Middle English Dictionary. 'Clerk n.' Accessed 17 June 2021. [https://quod.lib.umich.edu/m/middle-english-dictionary/dictionary/MED7991/track?counter=1&search\\_id=7926600](https://quod.lib.umich.edu/m/middle-english-dictionary/dictionary/MED7991/track?counter=1&search_id=7926600).
- Middle English Compendium: Middle English Dictionary. 'lessoun n.'. Accessed 1 October 2016. [https://quod.lib.umich.edu/m/middle-english-dictionary/dictionary/MED25239/track?counter=1&search\\_id=15601054](https://quod.lib.umich.edu/m/middle-english-dictionary/dictionary/MED25239/track?counter=1&search_id=15601054)

- Middle English Compendium: Middle English Dictionary. 'Parlour n.', November 2019.  
[https://quod.lib.umich.edu/m/middle-english-dictionary/dictionary/MED32480/track?counter=1&search\\_id=12978738](https://quod.lib.umich.edu/m/middle-english-dictionary/dictionary/MED32480/track?counter=1&search_id=12978738).
- Minnis, A.J. *Medieval Theory of Authorship: Scholastic Literary Attitudes in the Later Middle Ages*. Middle Ages Series. Philadelphia: University of Pennsylvania Press, 1988.
- Morgan, Hollie L. S. *Beds and Chambers in Late Medieval England: Readings, Representations and Realities*. Woodbridge, Suffolk: Boydell and Brewer, 2017.
- Mulryne, J.R., and Margaret Shewring, eds. *Shakespeare's Globe Rebuilt*. Cambridge: Cambridge University Press in association with Mulryne & Shewring, 1997.
- Murrilo Gomez, Diego, Catriona Cooper, and Filippo Fazi. 'Acoustic Survey of a Late Medieval Building Based on Geometrical Acoustics Methods'. Krakow, Poland, 2014.
- National Geographic Kids. 'Guy of Warwick!' Accessed 12 October 2020.  
<https://www.natgeokids.com/uk/discover/history/general-history/guy-of-warwick/>.
- Nelson, Robin. 'Introduction: The What, Where, When and Why of "Practice as Research"'. In *Practice as Research in the Arts, Principles, Protocols, Pedagogies, Resistances*, edited by Robin Nelson, 3–22. London and New York: Palgrave Macmillan, 2013.
- Ohlgren, Thomas H. *Robin Hood: The Early Poems, 1465-1560: Texts, Contexts, and Ideology*. Newark: University of Delaware Press, 2007.
- Ohlgren, Thomas H., and Lister M. Matheson. 'Robin Hood and the Monk and the Manuscript Context of Cambridge University Library MS Ff.5.48, with Direct Analysis of CUL MS Ff.5.48'. *Nottingham Medieval Studies* 48 (2004): 80–115.
- O'Mara, V.M. 'Female Scribal Activity and Scribal Activity in Late Medieval England: The Evidence?' *Leeds Studies in English, New Series*, 27 (1996): 87–130.
- Ong, Walter J. *Orality and Literacy: The Technologizing of the Word*. London: Routledge, 2002.
- Orlin, Lena Cowen. *Locating Privacy in Tudor London*. New York and Oxford: Oxford University Press, 2007.
- Orme, Nicholas. *English Schools in the Middle Ages*. London: Methuen, 1973.
- . *Medieval Children*. New Haven and London: Yale University Press, 2001.
- . *Medieval Schools: From Roman Britain to Renaissance England*. New Haven and London: Yale University Press, 2006.
- O'Sullivan, Aidan, and Christina Souyouzoglou-Haywood. 'Introduction - Defining Archaeology: Making, Understanding, Storytelling?' In *Experimental*

- Archaeology: Making, Understanding, Story-Telling*, edited by Aidan O'Sullivan and Christina Souyouzoglou-Haywood, 1–4. Oxford: Archaeopress, 2019.
- Page, Christopher. 'Johannes de Grocheio on Secular Music: A Corrected Text and a New Translation'. *Plainsong and Medieval Music* 2, no. 1 (1993): 17–41.
- Parker, David R. *The Commonplace Book in Tudor London: An Examination of BL MSS Egerton 1995, Harley 2252, Lansdowne 762, and Oxford Balliol College MS354*. Maryland: University Press of America, 1998.
- Parker-Starbuck, Jennifer, and Roberta Mock. 'Researching the Body in/as Performance'. In *Research Methods in Theatre and Performance*, edited by Baz Kershaw and Helen Nicholson, 210–35. Edinburgh: Edinburgh University Press, 2011.
- Parkes, M.B. 'The Literacy of the Laity'. In *Literature and Civilisation: The Mediaeval World*, edited by David Daiches and Anthony Thorlby, 555–77. London: Aldus Books, 1973.
- Parry, Milman. *The Making of Homeric Verse: The Collected Papers of Milman Parry*. Edited by Adam Parry. Oxford: Clarendon Press, 1971.
- Pearsall, Derek. 'Middle English Romance and Its Audiences'. In *Historical and Editorial Studies in Medieval and Early Modern English for Johan Gerritsen*, edited by Mary-Jo Arn and Hanneke Wirtjes, 37–47. Groningen: Wolters-Noordhoff, 1985.
- . 'The Development of Middle English Romance'. *Mediaeval Studies* 27 (1965): 91–116.
- . 'The English Romance in the Fifteenth Century'. *Essays and Studies* 29 (1976): 56–83.
- Peikola, Matti. 'Aspects of *Mise-En-Page* in Manuscripts of the *Wycliffite Bible*'. In *Medieval Texts in Context*, edited by Graham D. Caie and Denis Renevey, 28–67. London: Routledge, 2008.
- Perkins, Nicholas. 'Ekphrasis and Narrative in *Emare* and *Sir Eglamour of Artois*'. In *Medieval Romance, Medieval Contexts*, edited by Rhiannon Purdie and Michael Cichon, 47–60. Cambridge: D. S. Brewer, 2011.
- Phillips, Kim M. 'The Invisible Man: Body and Ritual in a Fifteenth-Century Noble Household'. *Journal of Medieval History* 31, no. 2 (2005): 143–62.
- Purcell, Stephen. 'Practice-as-Research and Original Practices'. *Shakespeare Bulletin* 35, no. 3 (2017): 425–43.
- Purdie, Rhiannon. *Anglicizing Romance: Tail-Rhyme and Genre in Medieval English Literature*. Woodbridge, Suffolk: D. S. Brewer, 2008.
- . 'Sexing the Manuscript: The Case for Female Ownership of MS Chetham 8009'. *Neophilologus* 82 (1998): 139–48.

- . ‘The Implications of Manuscript Layout in Chaucer’s *Tale of Sir Thopas*’. *Forum for Modern Language Studies* 41, no. 3 (2005): 262–74.
- Putter, Ad. ‘Middle English Romances and the Oral Tradition’. In *Medieval Oral Literature*, edited by Karl Reichl, 335–51. Berlin and Boston: Walter de Gruyter, 2016.
- Putter, Ad, and Jane Gilbert. ‘Introduction’. In *The Spirit of Medieval English Popular Romance*, 1–38. Longman Medieval and Renaissance Library. Harlow: Pearson Education, 2000.
- Quiney, Anthony. ‘Hall or Chamber? That Is the Question. The Use of Rooms in Post-Conquest Houses’. *Architectural History* 42 (1999): 24–46.
- Quinn, William A., and Audley S. Hall. *Jongleur: A Modified Theory of Oral Improvisation and Its Effects on the Performance and Transmission of Middle English Romance*. Washington, D.C.: University Press of America, 1982.
- Radtchenko, Daria. ‘Simulating the Past: Reenactment and the Quest for Truth in Russia’. *Rethinking History* 10, no. 1 (2006): 127–48.
- Radulescu, Raluca L., and Cory James Rushton. ‘Introduction’. In *A Companion to Medieval Popular Romance*, edited by Raluca L. Radulescu and Cory James Rushton, 1–8. Cambridge: D. S. Brewer, 2009.
- Randles, S. ‘One Quilt or Two? A Reassessment of the Guicciardini Quilts’. *Medieval Clothing and Textiles* 5 (2009): 93–128.
- Rasinski, Timothy. ‘Issues and Trends in Literacy: Reading Fluency Instruction: Moving beyond Accuracy, Automaticity, and Prosody’. *The Reading Teacher* 59, no. 7 (2006): 704–6.
- Rayner, Keith. ‘Eye Movements in Reading and Information Processing’. *Psychological Bulletin* 124, no. 3 (1998): 372–422.
- Rees Jones, Sarah. ‘The Public Household and Political Power: Preface’. In *The Medieval Household in Christian Europe c. 850 - c. 1550: Managing Power, Wealth and the Body*, edited by Cordelia Beattie, Anna Maslakovic, and Sarah Rees Jones, 10–18. Turnhout: Brepols, 2003.
- . *York: The Making of a City 1068-1350*. New York and Oxford: Oxford University Press, 2013.
- Rees Jones, Sarah, Felicity Riddy, Cordelia Beattie, Charlotte Carpenter, Matthew Holford, Laura McClure, Sarah Williams, et al. ‘The Later Medieval English Urban Household’. *History Compass* 5, no. 1 (2007): 112–58.
- Regalado, Nancy Freeman. ‘Performing Romance: Arthurian Interludes in Sarrasin’s *Le Roman Du Hem* (1278)’. In *Performing Medieval Narrative*, edited by Evelyn

- Birge Vitz, Nancy Freeman Regalado, and Marilyn Lawrence, 103–19. Cambridge: D. S. Brewer, 2005.
- Reichl, Karl. ‘Orality and Performance’. In *A Companion to Medieval Popular Romance*, edited by Raluca L. Radulescu and Cory James Rushton, 132–49. Cambridge: D. S. Brewer, 2009.
- . ‘Turkic Bard and Medieval Entertainer: What a Living Epic Tradition Can Tell Us about Oral Performance of Narrative in the Middle Ages’. In *Performing Medieval Narrative*, edited by Evelyn Birge Vitz, Nancy Freeman Regalado, and Marilyn Lawrence, 167–78. Cambridge: D. S. Brewer, 2005.
- Renfrew, Colin, and Paul Bahn. *Archaeology: Theories, Methods and Practice*. 8th Edition. London: Thames and Hudson, 2020.  
<https://ebookcentral.proquest.com/lib/york-ebooks/detail.action?docID=6178544>.
- Revard, Carter. ‘Oppositional Thematics and Metanarrative in MS Harley 2253, Quires 1–6’. In *Essays in Manuscript Geography: Vernacular Manuscripts of the English West Midlands from the Conquest to the Sixteenth Century*, edited by Wendy Scase, 95–112. Turnhout: Brepols, 2007.
- . ‘Scribe and Provenance’. In *Studies in the Harley Manuscript: The Scribes, Contents, and Social Contexts of British Library MS Harley 2253*, edited by Susanna Fein, 21–109. Kalamazoo, Michigan: Medieval Institute Publications, 2000.
- Reyden, Dianne van der. *Identifying the Real Thing*. New York: Smithsonian Centre for Materials Research and Education (SCMRE), School for Scanning, 1996.
- Richards, Jack C., and Theodore S. Rodgers. *Approaches and Methods in Language Teaching*. 3rd edition. Cambridge: Cambridge University Press, 2014.
- Riddy, Felicity. ‘Temporal Virginity and the Everyday Body: *Le Bone Florence of Rome* and Bourgeois Self-Making’. In *Pulp Fictions of Medieval England*, edited by Nicola McDonald, 197–216. Manchester: Manchester University Press, 2004.
- Robbins, Rossell Hope. ‘The Findern Anthology’. *PMLA* 69, no. 3 (1954): 610–42.
- Rouse, Robert Allen. ‘Emplaced Reading, or Towards a Spatial Hermeneutic for Medieval Romance’. In *Medieval Romance and Material Culture*, edited by Nicholas Perkins, 41–57. Cambridge: D. S. Brewer, 2015.
- Rudy, Kathryn M. ‘Dirty Books: Quantifying Patterns of Use in Medieval Manuscripts Using a Densitometer’. *Journal of Historians of Netherlandish Art* 2, no. 1–2 (2010).
- Saenger, Paul. ‘Books of Hours and the Reading Habits of the Later Middle Ages’. In *The Culture of Print: Power and the Uses of Print in Early Modern Europe*, edited by Alain Boureau and Roger Chartier, 141–73. Cambridge: Polity, 1989.

- . ‘Silent Reading: It’s Impact on Late Medieval Script and Society’. *Viator* 13 (1982): 367–414.
- . *Space between Words: The Origins of Silent Reading*. Stanford, California: Stanford University Press, 1997.
- Saenger, Paul, and Michael Heinlen. ‘Incunable Description and Its Implications for the Analysis of Fifteenth-Century Reading Habits’. In *Printing the Written Word: The Social History of Books, circa 1450-1520*, edited by Sandra L. Hindman, 225–58. Ithaca: Cornell University Press, 1991.
- Saraydar, Stephen. *Replicating the Past: The Art and Science of the Archaeological Experiment*. Long Grove, Illinois: Waveland Press, 2008.
- Schechner, Richard. *Essays in Performance Theory*. New York: Routledge, 1988.
- . *Performance Studies: An Introduction*. 2nd ed. New York and London: Routledge, 2006.
- Schöbel, Gunter. ‘Experimental Archaeology’. In *The Routledge Handbook of Reenactment Studies: Key Terms in the Field*, edited by Vanessa Agnew, Jonathan Lamb, and Juliane Tomann, 67–73. London and New York: Routledge, 2020.
- Schofield, John. *Medieval London Houses*. New Haven and London: Published for the Paul Mellon Centre for Studies in British Art by Yale University Press, 1994.
- Seaman, Myra. *Objects of Affection: The Book and the Household in Late Medieval England*. Manchester: Manchester University Press, 2021.
- Sheffler, David. ‘Late Medieval Education: Continuity and Change’. *History Compass* 8, no. 9 (2010): 1067–82.
- Sheingorn, Pamela. ‘Performing the Illustrated Manuscript: Great Reckonings in Little Books’. In *Visualizing Medieval Performance: Perspectives, Histories, Contexts*, edited by Elina Gertsman, 57–82. Aldershot: Ashgate, 2008.
- Shepperson, Mary. ‘Visibility, Privacy, and Missing Windows: Lighting Domestic Space in Ancient Mesopotamia’. In *The Oxford Handbook of Light in Archaeology*, edited by Costas Papadopoulos and Holley Moyes. Oxford: Oxford University Press, 2017. <https://doi.org/10.1093/oxfordhb/9780198788218.013.19>.
- Shuffelton, George. ‘Codex Ashmole 61: Introduction’. In *Codex Ashmole 61: A Compilation of Popular Middle English Verse*, edited by George Shuffelton. TEAMS Middle English Texts Series. Kalamazoo, Michigan: Medieval Institute Publications, 2008.
- . ‘Is There a Minstrel in the House?: Domestic Entertainment in Late Medieval England’. *Philological Quarterly* 87, no. 1/2 (2008): 51–76.
- Shull, Jonathan. ‘Locating the Past in the Present: Living Traditions and the Performance of Early Music’. *Ethnomusicology Forum* 15, no. 1 (2006): 87–111.



- Sir Guy of Warwick. 'Sir Guy of Warwick'. Accessed 12 October 2020.  
<https://www.sirguyofwarwick.com/>.
- Skeat, Walter William. *The Invention of Middle English: An Anthology of Primary Sources*. Edited by David Matthews. Pennsylvania: Pennsylvania State University Press, 2000.
- Smith, Kirstie. 'Guy of Warwick Day to Return to Warwick for a Second Year'. The Warwick Courier. Accessed 26 August 2019.  
<https://www.warwickcourier.co.uk/news/guy-of-warwick-day-to-return-to-warwick-for-a-second-year-1-8931527>.
- Smyser, H.M. 'The Domestic Background of Troilus and Criseyde'. *Speculum* 31, no. 2 (1956): 297–315.
- Smyth, Adam. 'Commonplace Book Culture: A List of Sixteen Traits'. In *Women and Writing, c. 1340-c.1650: The Domestication of Print Culture*, 90–110. York: York Medieval Press, 2010.
- Southworth, John. *The English Medieval Minstrel*. Suffolk: Boydell and Brewer, 1989.
- Spearing, A.C. *Medieval Autographies: The 'I' of the Text*. Notre Dame, Indiana: University of Notre Dame Press, 2012.
- . *Textual Subjectivity: The Encoding of Subjectivity in Medieval Narratives and Lyrics*. Oxford: Oxford University Press, 2005.
- . 'What Is a Narrator?: Narrator Theory and Medieval Narratives'. *Digital Philology: A Journal of Medieval Cultures* 4, no. 1 (2015): 59–105.
- Starkey, Kathryn. *Reading the Medieval Book: Word, Image, and Performance in Wolfram von Eschenbach's Willehalm*. Notre Dame, Indiana: Notre Dame University Press, 2004.
- Stell, P.M., and Louise Hampson. *Probate Inventories of the York Diocese 1350-1500*. Vol. 1. York: York Archaeological Trust, 2006.
- Stewart, Elizabeth. 'A History of Historic House Reconstruction: Understanding the Past and Informing the Future'. *Internet Archaeology* 29 (2011).  
<https://intarch.ac.uk/journal/issue29/3/toc.html>.
- Stock, Brian. *The Implications of Literacy: Written Language and Models of Interpretation in the Eleventh and Twelfth Centuries*. Princeton, N.J.: Princeton University Press, 1983.
- Stone, Ruth M. 'Time in African Performance'. In *The Garland Encyclopaedia of World Music, Volume 1: Africa*, edited by Ruth M. Stone, 124–45. London and New York: Garland Publishing, 1998.
- Szirmai, J.A. *The Archaeology of Medieval Bookbinding*. Farnham, Surrey and Burlington, USA: Ashgate, 1999.

- Tankard, Danae. 'Form and Function in the Late Medieval Rural House: An Example from the Weald and Downland Open Air Museum, Sussex'. In *Dwellings, Identities and Homes: European Housing Culture from the Viking Age to the Renaissance*, edited by Mette Svart Kristiansen and Kate Giles, 84:163–73. Jutland Archaeological Society Publications. Højbjerg: Jutland Archaeological Society, 2014.
- Taylor, Andrew. 'Editing Sung Objects: The Challenges of Digby 23'. In *The Book Unbound: Editing and Reading Medieval Manuscripts and Texts*, edited by Siân Echard and Stephen Partridge, 78–104. Toronto: University of Toronto Press, 2004.
- . 'The Myth of the Minstrel Manuscript'. *Speculum* 66, no. 1 (1991): 47–73.
- TEAMS: Middle English Texts Series. 'Middle English Texts Series Editorial Staff'. Accessed 5 May 2020. <https://d.lib.rochester.edu/teams-middle-english-text/middle-english-texts-series-editorial-staff>.
- Thompson, John J. 'Collecting Middle English Romances and Some Related Book-Production Activities in the Later Middle Ages'. In *Romance in Medieval England*, edited by Maldwyn Mills, Jennifer Fellows, and Carol M. Meale, 17–38. Cambridge: D. S. Brewer, 1991.
- . 'Looking behind the Book: MS Cotton Caligula A.Ii, Part 1, and the Experience of Its Texts'. In *Romance Reading on the Book: Essays on Medieval Narrative Presented to Maldwyn Mills*, edited by Jennifer Fellows, Rosalind Field, Gillian Rogers, and Judith Weiss, 171–87. Cardiff: University of Wales Press, 1996.
- . 'Robert Thornton and His Book Producing Activities: Aspects of the Transmission of Certain Late Medieval Texts in the Light of Their Present Context in Thornton's Manuscripts'. D. Phil thesis, University of York, 1983.
- . *Robert Thornton and the London Thornton Manuscript: British Library MS Additional 31042*. Cambridge: D. S. Brewer, 1987.
- Thompson, M.W. 'The Architectural Context of Gainsborough Old Hall'. In *Gainsborough Old Hall*, edited by P.G. Lindley, 8:13–20. Occasional Papers in Lincolnshire History and Archaeology. Lincoln: The Society of Lincolnshire History and Archaeology, 1991.
- Tigges, Wim. 'Sir Eglamour: The Knight Who Could Not Say No'. *Neophilologus* 72, no. 1 (1988): 107–15.
- Tilley, Christopher. *The Materiality of Stone: Explorations in Landscape Phenomenology*. Oxford: Berg, 2004.
- Tschann, Judith. 'The Layout of "Sir Thopas" in the Ellesmere, Hengwrt, Cambridge Dd.4.24, and Cambridge Gg.4.27 Manuscripts'. *The Chaucer Review* 20, no. 1 (1985): 1–13.

- Turville-Petre, Thorlac. 'Some Medieval English Manuscripts in the North-East Midlands'. In *Manuscripts and Readers in Fifteenth-Century England: The Literary Implications of Manuscript Study*, edited by Derek Pearsall, 125–41. Cambridge: D. S. Brewer, 1983.
- Twomey, Michael W. 'The Voice of Aurality in the "Morte Darthur"'. *Arthuriana*, Reading Malory Aloud, Then and Now, 13, no. 4 (2003): 103–18.
- The University of Manchester. 'Performance, Learning & Heritage'. Accessed 9 September 2021. <http://www.plh.manchester.ac.uk/>.
- Vernon, Jenny. "'A Fine Wreck of the Feudal Age": The Later History of Gainsborough Old Hall and Its Owners'. In *Gainsborough Old Hall*, edited by P.G. Lindley, 8:27–33. Occasional Papers in Lincolnshire History and Archaeology. Lincoln: The Society of Lincolnshire History and Archaeology, 1991.
- Vitz, Evelyn Birge. 'Erotic Reading in the Middle Ages: Performance and Re-Performance of Romance'. In *Performing Medieval Narrative*, edited by Evelyn Birge Vitz, Nancy Freeman Regalado, and Marilyn Lawrence, 73–88. Cambridge: D. S. Brewer, 2005.
- . 'Introduction'. In *Performing Medieval Narrative*, edited by Evelyn Birge Vitz, Nancy Freeman Regalado, and Marilyn Lawrence, 1–11. Cambridge: D. S. Brewer, 2005.
- . *Medieval Narrative and Modern Narratology: Subjects and Objects of Desire*. New York and London: New York University Press, 1989.
- . *Orality and Performance in Early French Romance*. Woodbridge: Boydell and Brewer, 1999.
- Vitz, Evelyn Birge, and Marilyn Lawrence. 'Arthurian Legend in Performance'. vimeo, 2011. <https://vimeo.com/arthurperform>.
- Vitz, Evelyn Birge, Nancy Freeman Regalado, and Marilyn Lawrence. 'Explore More'. Mednar: Performing Medieval Narrative Today A Video Showcase. Accessed 7 January 2020. <http://mednar.org/explore-more/>.
- . 'Videos'. Mednar: Performing Medieval Narrative Today A Video Showcase. Accessed 7 January 2020. <http://mednar.org/videography/>.
- Wakelin, Daniel. 'Instructing Readers in Fifteenth-Century Poetic Manuscripts'. *Huntington Library Quarterly* 73, no. 3 (2010): 433–52.
- Warton, Thomas. *History of English Poetry*. Edited by W.C. Hazlitt. London: Reeves and Turner, 1871.
- The Warwick Courier. 'IN PICTURES: Warwick's First Guy of Warwick Day', 31 May 2018. <https://www.warwickcourier.co.uk/news/pictures-warwicks-first-guy-warwick-day-832537>.

- Watson, Ian. 'An Actor Prepares: Performance as Research (PAR) in the Theater'. In *Mapping Landscapes for Performance As Research: Scholarly Acts and Creative Cartographies*, edited by Shannon Rose Riley and Lynette Hunter, 84–90. New York: Palgrave Macmillan, 2009.
- Weald & Downland Living Museum. 'Bayleaf Farmstead from Chiddingstone'. Accessed 14 April 2019. <https://www.wealddown.co.uk/buildings/bayleaf-farmstead/>.
- Weldon, James. 'The Naples Manuscript and the Case for a Female Readership'. *Neophilologus* 93 (2009): 703–22.
- White, Denise C. 'BL Cotton Caligula Aii, Manuscript Context, The Theme of Obedience, and a Diplomatic Transcription Edition'. PhD Thesis, Georgia State University, 2010. [http://scholarworks.gsu.edu/english\\_diss/97](http://scholarworks.gsu.edu/english_diss/97).
- Wiggins, Alison Eve. 'Guy of Warwick: Study and Transcription'. PhD Thesis, University of Sheffield, 2000.
- Wilcox, Rebecca. 'Romancing the East: Greeks and Saracens in *Guy of Warwick*'. In *Pulp Fictions of Medieval England: Essays in Popular Romance*, edited by Nicola McDonald, 217–40. Manchester: Manchester University Press, 2004.
- Wood, Margaret. *The English Mediaeval House*. London: Phoenix House, 1965.
- Woodward, Norman P. 'The Rushlight or Rush Candle of Old England'. *The Rushlight* 1, no. 4 (1935).
- Woolgar, Chris. 'Interior Decoration and the Hall in Late Medieval England'. Leeds, 2019.
- . *The Great Household in Late Medieval England*. New Haven and London: Yale University Press, 1999.
- . *The Senses in Late Medieval England*. New Haven and London: Yale University Press, 2006.
- Wright, Clare. 'Ontologies of Play: Reconstructing the Relationship between Audience and Act in Early English Drama'. *Shakespeare Bulletin* 35, no. 2 (2017): 187–206.
- YouTube. 'Medieval Tales in Performance'. Accessed 7 January 2020. <https://www.youtube.com/channel/UC2wz1uR1S193vNMWML2Ieyw>.
- Zaerr, Linda Marie. *Performance and the Middle English Romance*. Cambridge: D. S. Brewer, 2012.
- . 'The Weddyng of Sir Gawen and Dame Ragnell: Performance and Intertextuality in Middle English Popular Romance'. In *Performing Medieval Narrative*, 193–208. Cambridge: D. S. Brewer, 2005.
- Zaerr, Linda Marie, and Joseph Baldassarre. 'The Tournament of Tottenham: Music as Enhancement of the Prosody'. *Fifteenth Century Studies* 16 (1990): 239–52.
- Zaerr, Linda Marie, Laura Zaerr, Ad Putter, Frances Eustace, and Rosamund Allen. *Performing Middle English Romance*. CD. The Chaucer Studio, 2015.

Zumthor, Paul. *La Poésie et La Voix Dans La Civilisation Médiévale*. Paris: PUF, 1984.  
———. *Towards a Medieval Poetics*. Translated by Philip Bennett. Minneapolis:  
University of Minnesota Press, 1992.