

Identification and assessment of body alignment in
children with cerebral palsy

Frances Kathleen George

Submitted in accordance with the requirements for the degree
of PhD

The University of Leeds

York St John University

Faculty of Health and Life Sciences

April 2021

The candidate confirms that the work submitted is her own, except where work which has formed part of jointly-authored publications has been included. The contribution of the candidate and the other authors to this work has been explicitly indicated below. The candidate confirms that appropriate credit has been given within the thesis where reference has been made to the work of others.

This copy has been supplied on the understanding that it is copyright material and that no quotation from the thesis may be published without proper acknowledgement.

The right of Frances Kathleen George to be identified as Author of this work has been asserted by in accordance with the Copyright, Designs and Patents Act 1988.

Publications arising from the work:

Chapter 3:

George, F.K., Benham, A., 2020. Clinical Assessments designed to measure body alignment posture in children with cerebral palsy – A systematised review (Poster presentation abstract). *Physiotherapy*, 107, pp.e206.

George, F.K., Benham, A., 2020. Clinical Assessments designed to measure body alignment posture in children with cerebral palsy – a systematised review. *Association of Paediatric Chartered Physiotherapists*, 11(1), pp.4-16.

Chapter 4:

Publication: George, F.K., Benham, A., Gabriel, L. and Purton, J., 2020. Development and Content Validity of the Clinical Assessment of Body Alignment for Children with Cerebral Palsy. *Pediatric Physical Therapy*, 32(2), pp.137-143.

Chapter 6:

George, F.K., Benham, A., 2021 Evaluating the CABA'S ability to identify change in body alignment in posture management programmes for children with cerebral palsy (Poster presentation). In: World Physiotherapy Congress 2021, 9th – 11th April 2021, Online.

Chapters 4, 5 and 6:

George, F.K., Benham, A., Gabriel, L. and Purton, J., 2021 Development and psychometric testing of the Clinical Assessment of Body alignment for posture management approaches in children with cerebral palsy (Abstract and platform presentation). In: World Physiotherapy Congress 2021, 9th – 11th April 2021, Online.

Work attributed to candidate: conception and design of the work of the assessment and article/posture and presentation structure and content; analysis and interpretation of data and discussion.

Acknowledgements

I wish to acknowledge the following people for their supervision and support with this work. Dr Alex Benham, whose support and encouragement has been invaluable in keeping me motivated on this journey. Professor Lynne Gabriel and Dr Judy Purton for their advice and support. My sincere thanks and appreciation to all of them, they have helped shape my ideas and develop my research skills in a supportive atmosphere of constructive criticism. Together, we have shared a long and special journey for which I shall always be grateful.

The following people have contributed to this programme of research and I thank them sincerely: APCP members who participated in the studies in chapters 4 and 5. The head teacher, children and parents who so willingly participated in the studies without which this research would not have been possible.

Several staff at York St John University have been supportive of the work, either involved for short time periods as supervisors or offered expert advice. Professor Patrick Doherty, Dr Simon Rouse and Dr Chris Boyes with whom I started this journey. Dr Charikleia Sinani, Professor Pam Dawson and Professor David Sugden for their support and advice.

Finally, I must thank my family who have supported me throughout. In particular I would like to thank my partner, Paul, for his unwavering patience, encouragement and understanding over the last several years and for offering technical support. I would also like to mention my parents, Gwen and Graham George for their tremendous support of my education throughout my life. Without their encouragement and consistent support this process would have been far more difficult.

Dedication

I dedicate this thesis to my partner, Paul, whose unwavering support and outlook throughout has kept me grounded and reminded me that life goes on even when there is a thesis to be written.

Abstract

Introduction: Body alignment is the position of body segments in relation to one another and their orientation in space. Children with cerebral palsy (CP) present with disorders in posture and body alignment. These postural difficulties prompt the need for a child's body alignment to be managed for them. Assessment of body alignment is important in evaluating therapeutic approaches and as an outcome measure of intervention. This research aimed to identify the clinical measures used by therapists to measure body alignment. It reports on the development, and psychometric evaluation of the Clinical Assessment of Body Alignment (CABA) as a measure of body alignment in children with CP.

Method: A literature review highlighted the limited evidence of psychometric testing, identifying no single measure which adequately examined body alignment in children with CP. The CABA was developed and psychometric testing was undertaken among children with CP by paediatric physiotherapists. Properties examined were content and construct validity, inter-rater and intra-rater reliability and responsiveness to immediate change.

Results: The content validity of the CABA items were reviewed by 283 paediatric physiotherapists and demonstrated a high percentage agreement that the items match the construct of body alignment. The CABA demonstrated excellent levels of inter-rater and intra-rater reliability and demonstrated statistical significance to CP classification levels supporting construct validity. The CABA demonstrated responsiveness which strongly correlated to and showed statistical significance in measuring alignment with and without positioning equipment.

Conclusion: The CABA has been carefully and extensively developed and shown to have excellent validity, reliability and responsiveness properties. This preliminary analysis suggests it is a useful tool for measuring postural alignment in clinical and research settings. The CABA has been shown to be responsive to immediate change in body alignment when posture management equipment is used in children with CP GMFCS IV and V.

Contents

CHAPTER 1:	1
1.1 Body alignment difficulties in children with cerebral palsy	1
1.2 Personal and professional rationale for the study.....	8
1.3 The research objectives and aims.....	9
1.4 The thesis structure and presentation.....	10
1.5 Conclusion.....	12
CHAPTER 2:	14
2.1 Introduction	14
2.2 Historical overview.....	17
2.3 Development of posture.....	18
2.4 Posture development difficulties for children with CP	20
2.5 Body alignment, postural and motor control overview.....	25
2.6 Theoretical framework of postural control.....	27
2.6.1 Postural control system framework.....	28
2.6.1.1 Individual postural control systems.....	30
2.6.1.2 Functional movement tasks.....	32
2.6.1.3 Environment constraints.....	33
2.6.2 Postural control motor systems - alignment	34
2.6.2.1 Body Alignment.....	35
2.6.2.2 Muscle Tone.....	35
2.6.2.3 Postural tone.....	36
2.7 Theoretical framework of motor control.....	40
2.7.1 Relevance of motor control to body alignment and CP.....	40
2.7.2 Understanding the control of movement	40
2.7.3 Applying motor control theories to physiotherapy	43
2.8 Theoretical underpinning of clinical approaches.....	48
2.8.1 Clinical application to children with CP.....	51
2.9 Posture management.....	52
2.10 Assessment	57
2.11 Implications for children with CP.....	62
2.12 Implications for therapy intervention.....	66
2.13 Conclusion.....	69
CHAPTER 3:	71

3.1 Introduction	71
3.2 Method.....	74
3.2.1 Article selection and data extraction	76
3.3 Results	76
3.3.1 Clinical assessments used by therapists to assess body alignment	79
3.3.2 Assessment characteristics	80
3.3.3 Psychometric properties	84
3.3.4 Reliability.....	84
3.3.5 Validity	85
3.4 Discussion.....	86
3.4.1 Methodological properties of the assessments.....	87
3.4.2 Clinical usability and overall utility.....	89
3.4.3 Application to body alignment in children with CP.....	89
3.4.4 Limitations.....	91
3.5 Conclusion.....	92
CHAPTER 4:	93
4.1 Introduction	93
4.1.1 Assessment construction	94
4.1.1.1 Theoretical foundations: Test Theory	95
4.1.1.2 Problems in measurement of psychological constructs	97
4.1.2 Error of measurement	99
4.1.3 Role of test theory in research.....	102
4.2 Methods	104
4.2.1 Development of the Clinical Assessment of Body Alignment (CABA).104	
4.2.2 Item construction.....	105
4.2.3 Posture categorisation	109
4.2.3.1 Posture categorisation in the CABA.....	114
4.2.4 Study design.....	114
4.2.4.1 Participants	115
4.2.4.2 Clinical Assessment of Body Alignment (CABA).....	115
4.2.5 Procedure.....	127
4.2.5.1 Weighting of items to reflect importance	128
4.2.5.2 Framework for matching items.....	129
4.2.6 Data analysis	130

4.3 Results.....	132
4.3.1 Response:.....	132
4.3.2 Content validity (item agreement).....	134
4.3.3 Respondent inter-rater reliability	136
4.3.4 Clinical Utility	137
4.3.5 Respondent Inter-rater reliability (clinical utility attributes).....	139
4.4 Discussion.....	140
4.4.1 Response	140
4.4.2 Content validity (item agreement).....	140
4.4.3 Respondent inter-rater reliability	142
4.4.4 Clinical Utility	143
4.4.5 Benefits of the CABA.....	144
4.4.6 Limitations of the CABA	145
4.5 Conclusion.....	146
CHAPTER 5:	147
5.1 Introduction	147
5.1.1 Reliability in clinical measures	148
5.2 Methods.....	149
5.2.1 Reliability.....	149
5.2.2 Construct validity	150
5.2.3 Study design.....	151
5.2.3.1 Participants	151
5.2.3.2 Instrument to determine psychometric properties.....	151
5.2.3.3 Description of children evaluated.....	154
5.2.4 Procedure.....	156
5.2.5 Data Analysis	158
5.3 Results.....	161
5.3.1 Inter-rater reliability.....	163
5.3.2 Intra-rater reliability.....	167
5.3.3 Examination of the change in scores between test 1 and test 2.....	168
5.3.4 Rater variability	171
5.3.5 Construct Validity.....	175
5.4 Discussion.....	176
5.4.1 Respondent base.....	176

5.4.2 Reliability.....	178
5.4.3 Examination of the change in scores between test 1 and test 2.....	181
5.4.4 Rater variability	183
5.4.5 Construct validity	184
5.4.6 Study Limitations.....	186
5.5 Conclusion.....	188
CHAPTER 6:	189
6.1 Introduction	189
6.1.1 Responsiveness in clinical measures.....	190
6.2 Methods.....	192
6.2.1 Responsiveness	192
6.2.2 Study design	193
6.2.2.1 Participants	194
6.2.2.2 Description of children evaluated.....	194
6.2.3 Procedure.....	195
6.2.4 Data Analysis.....	198
6.3 Results.....	199
6.3.1 Sum scores for normality	199
6.3.2 External responsiveness - correlation of body alignment with and without equipment	200
6.3.3 Internal responsiveness	200
6.3.3.1 CABA's responsiveness to change in body alignment.....	200
6.3.3.2 Level of change in CABA scores.....	203
6.3.3.3 CABA's responsiveness to change at GMFCS IV and V.....	205
6.4 Discussion.....	207
6.4.1 External responsiveness correlation of body alignment with and without equipment	207
6.4.2 Internal Responsiveness	209
6.4.2.1 CABA's responsiveness to change in body alignment.....	209
6.4.2.2 Level of change in CABA scores.....	212
6.4.2.3 CABA's responsiveness to change at GMFCS IV and V.....	213
6.4.3 Study Limitations.....	215
6.4.4 Implications for clinical practice	216
6.5 Conclusion.....	216
CHAPTER 7:	218

7.1 Introduction	218
7.2 Summary of findings	219
7.3 Clinical Implications	222
7.3.1 Assessment	223
7.3.2 Measurement of outcome	228
7.3.3 Procurement of equipment	230
7.3.4 Clinical utility.....	233
7.3.5 Wider context	235
7.4 National guidance and service provision	237
7.5 Limitations of the project.....	239
7.6 Recommendations for future research.....	243
7.7 Thesis conclusion	245
References	247
Appendices.....	269
Appendix 1: Permission to use Images White (2011)	269
Appendix 2: Ethical approval letter- Content Validity	270
Appendix 3: Example of initial CABA items- arm alignment.....	271
Appendix 4: Example of revised CABA items- arm alignment	273
Appendix 5: Electronic Survey – content validity	274
Appendix 6: Email information – content validity	290
Appendix 7: Participant Information – content validity	291
Appendix 8: Ethical Application – content validity	295
Appendix 9: Ethical approval letter- Reliability and construct validity.....	301
Appendix 10: Gate Keeper Letter – Reliability Study.....	302
Appendix 11: Caregiver participation Information – Reliability	304
Appendix 12: Caregiver consent form – Reliability.....	308
Appendix 13: Child participant info example – Reliability	309
Appendix 14: CABA Score sheet.....	310
Appendix 15: Electronic Survey – Reliability.....	312
Appendix 16: Email information – reliability study.....	365
Appendix 17: Participant Information – reliability study.....	366
Appendix 18: My Day template example.....	370
Appendix 19: Ethical Application – Reliability and responsiveness studies.....	371
Appendix 20: Gate Keeper letter – Responsiveness Study	393

Appendix 21: Caregiver participation Information – Responsiveness.....	395
Appendix 22: Caregiver consent form – Responsiveness	398
Appendix 23: Child participant info example – Responsiveness	399
Appendix 24: Kolmogorov Smirnov test results	400

Tables

Table 2.1: Individual constraints which may affect the functional movement of a child with CP (Kenyon and Blackinton, 2011; Rosenbaum, 2009; Shumway-Cook and Wollacott, 2007).	24
Table 2.2: A taxonomy of tasks combining two attributes - stability / mobility and open / closed (Shumway-Cook and Woollacott, 2007).	42
Table 2.3: Motor Control theories, summary of their premise and clinical implications (Shumway-Cook and Wollacott, 2007).	45
Table 2.4: Underlying assumptions and clinical application of neurofacilitation and task orientated rehabilitation approaches (Shumway-Cook and Woollacott, 2007).	49
Table 3.1: Search strings and key words.	75
Table 3.2: Reliability data for selected body alignment posture assessment	82
Table 3.3: Validity data for selected body alignment posture assessments.	83
Table 4.1: Clinical Assessment of Body Alignment initial items*.	107
Table 4.2: Clinical Assessment of Body Alignment revised items*.	108
Table 4.3: Optimal Posture category sizes and number of categories (Van Wyk et al. 2009).	110
Table 4.4: Posture category size for seven CABA items.	113
Table 4.5: Completion of the questionnaire.	132
Table 4.6: Key characteristics of all respondents (N=283).	133
Table 4.7: Key characteristics of respondents of partial and completed responses.	134
Table 4.8: Percentage agreement that the CABA item matches body alignment.	135
Table 4.9: 95% CI for matched CABA items to body alignment.	136
Table 4.10: Fleiss' Kappa measure of respondents' inter-rater reliability.	137
Table 4.11: Net scores of essential/important, mean and standard deviations of attributes.	138
Table 4.12: All responses (n=84) of rating of importance across all attributes.	139
Table 4.13: Fleiss' Kappa measure of inter-rater reliability for 13 attributes by time in post, NHS/non NHS, Community/non-community	140
Table 5.1: Response breakdown of total number of responses (n=167).	161
Table 5.2: Respondents by regions (n=167).	162
Table 5.3: respondent characteristics of time in job, area of expertise and area of work (n=167).	162
Table 5.4: Inter-rater reliability Mean scores and Standard deviation of the CABA for GMFCS level and position given by 15 raters.	164
Table 5.5: Inter-rater reliability Mean scores of the CABA by body segment for GMFCS level II and III given by 15 raters scores at test 1 (k=15) across sitting and standing.	165
Table 5.6: Inter-rater and intra-rater reliability of the CABA total score (N=355 ratings per rater) for different positions and body segments of children with CP.	166
Table 5.7: Inter-rater and intra-rater reliability of the CABA total score (N=355 ratings per rater) across GMFCS level.	167
Table 5.8: Mean and standard deviation (SD) ratings given at test 1 and test 2 by the k=11 raters for each GMFCS level.	169

Table 5.9: Percentage of scores which increase and stay the same between test 1 and 2 for the k=11 raters across GMFCS levels, positions and body segments.	170
Table 5.10: Percentage of scores between test 1 and 2 (k=11 raters) for the CABA dimension of body segment across GMFCS levels IV and V.	171
Table 5.11: Intra-rater reliability tests assessed by 11 Raters (N=355 ratings) across GMFCS level, positions and body segments.	172
Table 5.12: Intra-rater reliability tests for each individual rater.	175
Table 5.13: Construct validity pairwise comparisons between each GMFCS level based on raters scores at test 1 (k=15).	176
Table 6.1: Internal responsiveness summed percentage, mean, standard deviation and paired t tests of the CABA for positions and body segments.	201
Table 6.2: percentage of measurements which changed within equipment compared to the baselines measure without equipment across positions.	202
Table 6.3: Percentage of measures which showed no change, broken-down into each scoring category of the CABA across positions.	203
Table 6.4: Mean improvement score (standard deviation) and the statistical significance for each position, body segment and overall.	204
Table 6.5: Internal responsiveness for GMFCS IV and V summed percentage and Independent t tests of the CABA for positions and body segments.	205

Figures

Figure 2.1: Human Sandwich Concept (Pope, 2007).	17
Figure 2.2: Early developmental spinal curves (Wright 2011 p.4).....	18
Figure 2.3: Developmental stage (Wright 2011 p.4).	19
Figure 2.4: Spine curvature developments for postural control (Wright, 2011 p.4).....	20
Figure 2.5: Concept model representing that posture arises from interaction of the individual, task and environment (Shumway-Cook and Woollacott, 2007).	29
Figure 2.6: Feedforward / feedback system of postural control (Shumway-Cook and Woollacott, 2007).	31
Figure 2.7: How the CoM position and speed relates to stability (Shumway-Cook and Woollacott, 2007; Pai et al., 2000).....	38
Figure 2.8: The ICF Model: Interaction between ICF components (WHO, 2007).....	59
Figure 3.1: PRISMA flowchart (Moher et al, 2009).....	78
Fig 4.1: Position of the individual's Head. Item scores the head position from 0 - 3.....	130
Figure 5.1: Mean Rating scores of alignment by position and GMFCS Level.	164
Figure 5.2: mean test-retest rating of alignment by GMFCS Level.....	168
Figure 5.3: Distribution of Mean CABA scores at each GMFCS level for test and retest scores by each rater (k=11).	173
Figure 5.4: Outlier rater examples* for test-retest rater reliability.	174
Figure 6.1: Total percentage scores of all measures with and without equipment.....	201
Figure 6.2: Percentage scores of all measures at GMFCS Level IV and V with and without equipment.....	207

Abbreviations

Abbreviation	Definition
AIMS	Alberta Infant Motor Scale
APCP	Association of Paediatric Chartered Physiotherapists
BHTA	British Healthcare Trades Association
BoS	Base of support
CABA	Clinical assessment of body alignment
CI	Confidence intervals
CLAS	The Chailey Levels of Ability Scale
CNS	Central Nervous System
CoG	Centre of gravity
CoM	Centre of mass
CP	Cerebral palsy
GMFCS	Gross Motor Function Classification System
GMFM	Gross Motor Function Measure
HCPC	Health and Care Professions Council
ICC	intra-class correlation coefficients
ICF	International Classification of Functioning, Disability and Health
NHS	National Health Service
NICE	National Institute for Clinical Excellence
NSF	National Service Frameworks
PHE	Public Health England
PPAS	Posture and Posture Ability Scale
PREMs	Patient-reported experience measures
PROMs	Patient-reported outcome measures
ROM	Range of motion
SAROMM	Spinal Alignment and Range of Motion Measure
SD	Standard deviation
SEM	Standard error of measurement
SME's	Subject matter experts
SPCM	Seated Postural Control Measure
SPSS	Statistical Package for the Social Science

WCPT World Confederation for Physical Therapy
WHO World Health Organisation

CHAPTER 1:

INTRODUCTION AND RESEARCH AIMS

1.1 Body alignment difficulties in children with cerebral palsy

Cerebral palsy (CP) is the most common physical disability of childhood (Novak et al., 2020). It is a neurodevelopmental condition affecting the developing brain in early childhood (Baxter et al., 2007). It is characterised by disorders in movement and posture due to non-progressive brain damage (Rosenbaum et al., 2007). The problems of movement and posture that children with CP present with result in restrictions on their activity and participation (Rosenbaum et al., 2007). The ability to maintain and control posture and body alignment enables a child to achieve positions which are comfortable and stable, meaning they can explore, play, and learn effectively (Hadders-Algra, 2013; Hadders-Algra, 2005). Furthermore, a child with CP does not solely have impairments in posture and movement skills, but may also present with impairment in sensation, cognition, communication, and, or behaviour (Rosenbaum et al., 2007).

A child with CP may face a range of challenges in their everyday lives. Deficiencies in posture and motor control required to function, means, not only is a child's ability to maintain body alignment significantly impaired but so too is their ability to communicate a need to change their position or raise their discomfort (Hill and Goldsmith., 2010). The adoption of postures which are misaligned can lead to problems both in terms of those which immediately impact on the child such as, discomfort and reduced engagement, to longer term impacts such as pain, musculoskeletal deformities, and reduced body functions (PHE, 2018; Gough, 2009; Scrutton, 2008; Pope, 2007). These have significant impact on a child's participation

in needed and desired activities and roles, indicating the importance of postural alignment in a child's everyday function.

Changing postural alignment is the natural response to intrusive body sensations of discomfort, but in children with CP this ability is impaired. Most people have probably experienced discomfort from sitting, lying or standing in a poor posture for too long. Noticeably the normal response is an increase in fidgety movements and, eventually movement to change position. This illustration sets the scene for this research, from the perspective of children with CP, who require their body alignment to be assessed and correctly managed for them.

Body alignment is a fundamental component of life; it is defined as the position of body segments in relation to one another and their orientation in space (Raine and Twomey, 1994). The ability to maintain and make precise controlled changes to alignment enables participation and functional movements in everyday life. The ability to alter and change body alignment becomes so automatic that it scarcely intrudes upon consciousness – so much so that we often forget the functional importance and impact it has on quality of life.

The development of body alignment is intertwined with postural control and movement skills as part of typical child development. Postural control is the ability to control the body's position in space for the dual purposes of orientation and stability (Shumway-Cook and Woollacott, 2007). Collectively body alignment and postural control enables positions of balance and stability to be achieved resulting in efficient functional movement (Dusing and Harbourne, 2010). These are essential parts of motor development and develop alongside normal child development (Van Balen et al., 2015). The theoretical frameworks of postural development and its relationship to children with CP and body alignment are discussed in greater detail in chapter 2.

As children develop, they cultivate and establish body alignment and postural control which facilitates motor skill development (Dusing and Harbourne, 2010).

The ability to adopt variable alignment of different segments of the body, the position of the head, trunk, pelvis, arms, legs and feet, enables a child to identify positions of comfort and stability so as to explore, play and learn effectively (Hadders-Algra, 2013; Pope, 2007; Hadders-Algra, 2005).

Movement difficulties associated with cerebral palsy (CP) means normal development is compromised (Rosenbaum et al., 2007). CP is a neurodevelopmental condition affecting the developing brain in early childhood (Baxter et al., 2007). It is characterised by a disorder in movement and posture with poor alignment of body segments being common features in the physical presentation (Rennie, 2007; Rosenbaum et al., 2007). For some, this could be a direct result of poorly developed postural control, while for others it could be a far more complex problem with potential long-term consequences (Van Balen et al., 2015; Hadders-Algra, 2010; Scrutton, 2008; Rosenbaum et al., 2007; Carlberg and Hadders-Algra., 2005). Indeed, children with CP not only lack the ability to maintain optimal body alignment necessary to function efficiently in everyday settings, they also lack posture and motor competencies necessary to cope with the demands of functional movement under the effects of gravity (Baxter et al., 2007; Harris and Roxborough, 2005).

Posture is the ability to adopt various positions that are stable and enable efficient functional movement in the presence of environmental forces: gravity and ground reaction force, while not causing damage to body structures (Pope, 2007). Children with CP who present with higher levels of ability are more likely to develop dysfunctions in postural control (Carlberg and Hadders-Algra, 2005). This is a deficiency in coordinating postural muscles in the right sequence during the performance of functional tasks where interactions between sensory, motor and musculoskeletal systems are affected, resulting in reduced balance and an inability to maintain a position of stability (Shumway-Cook and Woollacott, 2007).

Conversely, these interactions in children with lower levels of ability are so affected that they have severely limited independent movement (Palisano et al., 1997). Pope

(2007) illustrates this using the idea of a human sandwich. The human body is the middle of the sandwich, exposed to constant pressure from gravity above and ground reaction force below. For a child to function and move effectively within the 'sandwich', posture must be developed. Abilities of body alignment and postural control are required so that motor development can be established.

Posture is an umbrella concept for the ability to adopt stable positions required for efficient functional movement, (Pope, 2007). Postural control is the specific motor skills, of both orientation and stability, which underpin posture development (Shumway-Cook and Woollacott, 2007). Posture development and the underpinning theoretical concepts of postural control are discussed in greater detail in chapter 2. Extensive research has shown the important relationship between postural control and motor development (Van Balen et al., 2015; Pavao et al., 2013; Dusing and Harbourne, 2010; Hadders-Algra, 2010; Shumway-Cook and Woollacott, 2007; Pollock et al., 2000; Breniere and Bril, 1998). To accomplish efficient motor skill performance, postural control must be present and developed (Dusing and Harbourne, 2010). The efficiency and success of postural control and motor performance is related to an individual's ability to achieve body alignment (Shumway-Cook and Woollacott, 2007). Few studies have examined the role of body alignment within posture or explored its association to postural control and functional movement. The ability to achieve antigravity body alignment is an important fundamental component of motor development and postural control. In its absence a child's stability, efficiency, movement, and function are impaired against gravity (Carlberg and Hadders-Algra, 2005; Harris and Roxborough, 2005; White, 1999).

Children with CP adopt body misalignment because of disorders in postural control and movement (Rosenbaum et al., 2007). This deviation in body alignment has been variously described in the literature; for example, terms such as *asymmetrical posture*, *postural deformity* and *destructive postures* have all been used. For children with CP who find maintaining optimal body alignment challenging the risk of developing secondary complications as a consequence of the altered body

alignment is significant (Goldsmith et al., 2009; Graham, 2002). Musculoskeletal issues such as limited joint range, hip dislocation, chest asymmetry and spine scoliosis are commonly associated with body misalignment (Hill and Goldsmith, 2010; Pountney et al., 2009, Porter et al., 2008; Graham, 2002; Pountney et al., 2002; Clarke and Redden, 1992). The development of postural deformities can result in movement and function being severely compromised (Scrutton, 2008), hence early identification of body misalignment is important in the clinical management of posture in children with CP (Gericke, 2006).

It is well established from a variety of studies, that the development of posture deformities in children with CP is associated with prolonged body misalignment against gravity (Hill and Goldsmith, 2010; Scrutton, 2008; Porter et al., 2007). A seminal study in this area is the work of Fulford and Brown (1976, p.313) which established the source of postural deformities in children with CP, stating that “deformities are caused by the effect of gravity on an immobile child”. Children with CP have severe difficulties achieving and maintaining body alignment against gravity. Consequently, these children have severe difficulties in efficient movement, meaning that motor skills such as head control and sitting balance are profoundly challenging (Rosenbaum et al, 2007). Posture, in this context, is not a temporarily arrested movement, but a permanent body position that children with CP adopt as a result of gravity and severely impaired movement (Scrutton, 2008; Fulford and Brown, 1976). This makes achieving optimal body alignment against gravity extremely difficult and, therefore, is of interest to health professionals.

The postural difficulties of children with CP prompt the need for a child’s body alignment to be managed for them (Gericke, 2006). Posture management is an established therapy approach in children with CP, counteracting the effects of gravity and asymmetrical postures through correcting body misalignment (Gericke, 2006; Carlberg and Hadders-Algra, 2005). Primarily this is through the use of adaptive equipment to achieve symmetrical total body alignment, minimise postural deformity and enhancing function (Pountney et al., 1999; Clarke and Redden, 1992). This approach involves a therapist observing and assessing a child’s

body alignment in lying, standing and/or sitting throughout their development and growth (Hong, 2005). The provision and use of equipment such as sleep systems, standing frames and specialist seating are then used to correct asymmetries and achieve symmetrical total body alignment (Pope, 2007). The primary aim of this intervention is to prevent and reduce the risk of posture deformities (Gericke, 2006). Secondary, it aims to enhance comfort and enable the child to function at their optimal level (Pountney et al., 2009).

Therapists use observational assessment as part of their everyday clinical practice to assess body alignment in CP (Hong, 2005). This informs interventions, treatment planning and outcomes. The very nature of implementing a posture management approach means that assessment of body alignment is an inherent part of a therapist's assessment (Hill and Goldsmith, 2010). It establishes a baseline of body position; this enables early changes in body alignment to be identified, preventative intervention to be implemented and outcomes of treatment to be measured through changes in body alignment.

When considering the 'human sandwich' concept (Pope, 2007) in CP further; children with lower levels of ability may have difficulty in adopting and maintaining stable and functional positions (Rosenbaum et al., 2007). Adaptive equipment is used by therapists to support body alignment in the absence of the child being able to do this for themselves. Therefore, the child is reliant on the therapist selecting the optimal body alignment. The gold standard aimed for in positioning, is a symmetrical body segment alignment (Pope, 2007). This aligns the body segments and body linkages in an optimal position minimising stress on body structures, gives a position of stability and maximises opportunities for efficient movement and function (Carlberg and Hadders-Algra, 2005). However, for some children with CP this may not be possible due to the development of secondary musculoskeletal complications such as muscle shortening, resulting in fixed postural deformities. Therapists working with children who have fixed secondary complications aim to achieve as optimal alignment as possible observing graded changes towards optimal alignment.

Interest in the posture of children with CP has been driven by the recent shift in the recognition of the role posture management programmes have within deformity prevention and rehabilitation (Public Health England (PHE), 2018; National Institute for Clinical Excellence (NICE), 2012). Although the benefits of posture management approaches are well documented in children with CP (Pavao et al., 2013), the research to date has tended to focus on motor function rather than body alignment. Assessment instruments selected in research to demonstrate the outcome and effectiveness of posture management are diverse and show little correlation to total body alignment, such as single joint X-rays or motor function and movement abilities (Pountney et al., 2009; Pountney et al., 2002). Consequently, there is little high-quality data available on posture management effectiveness in correcting body alignment in children with CP.

Few clinical measurements of body alignment report psychometric properties or specificity in the assessment of body alignment (Field and Livingstone, 2013). At present there is no consistent view on the best assessment tools to use in the clinical assessment of body alignment (NICE, 2012). Provision is often dependent on therapists' knowledge, experience and local budgetary priorities (Humphreys and Pountney, 2006), meaning currently posture management services, equipment provision and quality vary on a local and national context. The lack of standardisation in both assessment and approach makes it challenging for therapists to evaluate posture management accurately and objectively between local physiotherapy services or across wider regional and national provisions.

Standardised assessments are essential in ensuring clinical approaches can evidence their effectiveness and outcomes (Fawcett, 2013). Posture management is no exception to this; standardised assessment of body alignment which is applicable within everyday clinical practice and responsive to changes in alignment is essential in evaluating posture management practices.

1.2 Personal and professional rationale for the study

As a working clinical physiotherapist in a special school for children with complex needs, I have used a variety of measures to evaluate and justify the outcomes of posture management interventions. Many of the children in the school had a diagnosis of CP with the majority of those and children with other diagnoses presenting with body alignment postural problems. I had noted that in clinical practice, there were few clinically usable standardised measures of body alignment. These resulted in me developing my own alignment measure used to monitor progress and justify provision of equipment. As a physiotherapist involved in purchasing and providing postural equipment there was increased awareness that funding for equipment was frequently being challenged; justification with evidence-based assessment outcomes relating to the impact and benefit of this provision were required. This related not only to the speciality and service but also to other multi-professional services such as wheelchairs, home equipment and occupational therapy.

An important aspect of the posture alignment problems which face children with movement difficulties is the lack of accurate clinical standardised measurement to detect changes in alignment. The absence of high-quality evidence to support posture management approaches (Gericke, 2006) led to the professional presumption that current approaches lacked a clinically credible evidence-based background in relation to body alignment. A search of the literature on current assessment found that empirical evidence was poor; this is explained in greater detail in chapter 3 supporting the rationale for this research project. In addition, the majority of measurements used in posture management research had little relationship to body alignment. Those which did could not be relied upon due to a lack of evidence to support validity, reliability and responsiveness levels. The exploration of developing a body alignment assessment and testing of psychometric properties was, therefore, considered an essential way forward, clinically and professionally. Whilst the focus of this research is children with CP, it is recognised that postural and body alignment issues cross a wide scope of children with various presentations. As such this research has much wider implications across various

health service provisions and multiple health professionals. The development of a standardised assessment can be utilised by clinicians and researchers to evaluate body alignment and the effectiveness of posture management approaches.

1.3 The research objectives and aims

To address the problem of body alignment assessment in children with CP, this research can be broken down into a number of areas in the exploration of the research question. Can body alignment be assessed in children with CP through a standardised and clinically useful measurement tool?

1. To identify current clinical assessments of body alignment used in children with CP by physiotherapists.

A central aim of identifying body alignment difficulties in children with CP is to be able to provide appropriate management and intervention at the earliest opportunity. One advantage of identifying body alignment changes in children with CP is that most of these children require the use of equipment to correct their body posture in order to support function (Gericke, 2006).

2. To develop a clinical measurement (known as the Clinical Assessment of Body Alignment) to identify and assess body alignment in children with CP.

The first step in providing appropriate intervention and management is to consistently and effectively identify changes in body alignment difficulties. In order for clinical practice and research to inform an evidence-based approach, assessment must demonstrate psychometric properties in measurement of the construct of body alignment.

3. To assess the psychometric properties of the Clinical Assessment of Body Alignment in measuring body alignment in children with CP.

The findings from the literature review directly led to the generation of the Clinical Assessment of Body Alignment. The central theme of this study was to design and construct a clinical applicable and accurate assessment to aid in the identification and assessment of body alignment in children with CP.

4. To investigate the Clinical Assessment of Body Alignment clinical utility in evaluating posture management programmes in physiotherapy practice.

The Clinical Assessment of Body Alignment is constructed so that body alignment is organised into sections, with each section focusing on a specific body segment. It is also constructed to assess alignment across 3 positions, sitting, lying and standing. This will allow therapists to assess body alignment across various alignment needs for each individual child, indicating the type of alignment issues and the specific postural context in which the alignment difficulties occur.

1.4 The thesis structure and presentation

This research is divided into seven chapters numbered sequentially throughout. Chapter 2 examines the role of body alignment within the wider context of postural control and movement. It forms the contextual theoretical framework from which exploration commenced. Chapter 3 examines and critically evaluates current clinical assessment measures of body alignment. Chapters' 4 to 6 map the development and psychometrical testing of a clinical assessment of body alignment. Chapter 7 brings together the main discussion points arising from this PhD research. It presents a synthesis of the findings and discusses the implications of these in relation to the primary research question and objectives. It concludes the research, identifying scope for future research as part of wider post-doctoral projects. A summary of each chapter is provided below.

Chapter 2 examines the role of body alignment within the wider context of postural control and movement. It forms the contextual theoretical framework from which exploration commenced. It explores the concept definitions of body alignment,

postural control and motor development within the context of children with CP and physiotherapy assessment. Rationale for the framework undertaken to examine assessment construction are given through scrutiny and critical analysis of test theory and psychometric investigation. The final section of the chapter considers the therapy implications and interventions used in supporting body alignment in children with CP and propose the need for an assessment measure to quantify body alignment in clinical practice with CP children.

Chapter 3 examines and critically evaluates current clinical assessment measures of body alignment. The systematised review identified seven assessments used by health-care professionals to assess body alignment changes in children with CP. Many of the identified clinical assessments which measure body alignment were found to have limited psychometric properties. This was valuable as it provided an oversight in the different clinical assessments, their psychometric properties and research design methods designed to measure body alignment, enabling analysis of the psychometric properties of current measurements.

Chapter 4 outlines the process undertaken in developing and investigating the content validity of the clinical assessment of body alignment. Content validity and clinical utility were examined through expert opinion of 283 paediatric physiotherapists. Rationales for the methodology and framework of test and item construction were outlined, examining item construction and posture categorisation. This study represents the first phase into the investigation of the CABA's validity in children with CP.

Chapter 5 examines the construct validity, intra-rater and inter-rater reliability of the Clinical Assessment of Body Alignment in children with cerebral palsy. A study was undertaken whereby thirteen paediatric physiotherapists observed a sample of children with CP Gross Motor Function Classification System (GMFCS) I – V (Rosenbaum et al., 2008), via an electronic survey. The study outlined the process undertaken in developing and investigating the reliability and construct validity of the clinical assessment of body alignment. Rationales for the methodologies to

examine assessment construct validity and reliability are given thorough scrutiny and critical analysis of test theory and psychometric investigation. The use of photographs was selected as it is a widely used approach in research studies of postural alignment and a comprehensive and rapid way to assess body alignment (Fortin et al., 2011; Akel et al., 2008; Perry et al., 2008; Normand et al., 2007; Dunk et al., 2005, McEvoy and Grimmer, 2005; Dunk et al., 2004). This chapter discusses the results in relation to clinical and research implications.

Chapter 6 reports on the third phase of the investigation into the psychometric properties of the clinical assessment of body alignment in children with CP. A responsiveness study was carried out with a paediatric physiotherapist observing a sample of children with CP GMFCS IV and V. The responsiveness study considers external and internal responsiveness using two frames of reference for determining responsiveness: Immediate change in and out of posture management equipment and CP classification criterion. The use of one physiotherapist, the main researcher, was selected due to ethical considerations and to limit random errors occurring in alignment. As the lead researcher was a known physiotherapist to the children, this ensured that the children remained relaxed and in their 'typical' therapy routines. This minimised the children presenting with altered alignment presentation that would have occurred with unfamiliar therapists and multiple raters, ensuring the assessment of body alignment was as close to typical everyday practice as possible.

Chapter 7 brings together the main discussion points arising from this PhD programme of research. It presents a synthesis of the findings and discusses the implications of these in relation to the primary research question and objectives. It concludes the research identifying scope for future research as part of wider post-doctoral projects.

1.5 Conclusion

Body alignment does not develop as a solitary entity; the development of alignment and postural control is closely intertwined. The intimate relationship of the development of these two aspects on motor behaviour is not only because

movement always requires postural alignment adjustments, but also that the development of both posture and movement systems are the result of developmental nervous system processes (Hadders-Algra, 2013).

The need for a standardised and clinically usable measurement of body alignment has been highlighted, as have the gaps in psychometric testing of assessments among children with CP. The theoretical and clinical approaches have been outlined and demonstrate the importance of a clinical body alignment assessment in children with CP. The potential to assess changes in body segment alignment in clinical settings is of crucial importance to the field of paediatric rehabilitation. It is important that clinicians are able to evaluate, justify and develop posture management practices based on clear, strong clinical rationale derived from evidence-based assessment. The aims and objectives of this research have been stated and an overview of the research structure undertaken to address them has been described. Chapter 2 begins by discussing the theoretical frameworks of postural development and its relationship to children with CP and body alignment. This gives an understanding of the context in which an assessment of body alignment needs to relate to in order to be an effective and appropriate clinical measurement tool.

CHAPTER 2:

POSTURE DEVELOPMENT

2.1 Introduction

This chapter examines the role of body alignment within the wider context of postural control and movement. It forms the contextual theoretical framework from which exploration commenced. It begins by giving a background of the postural problems children with CP can face, describing typical posture development and how this translates to children with CP. It explores the concept definitions of body alignment, postural control and motor development within the context of children with CP and physiotherapy assessment. Rationale for the framework undertaken to examine assessment construction are given through scrutiny and critical analysis of test theory and psychometric investigation. The final section of the chapter considers the therapy implications and interventions used in supporting body alignment in children with CP. It proposes the need for an assessment measure to quantify body alignment in clinical practice with CP children.

The study of posture in children with CP has had a renewed interest during the last decade not only with evaluating children's postural abilities, but also because of new ideas which have led to exciting theoretical concepts underlying the explanations of the integral role of posture development within children's motor function abilities. Research studies have raised the importance of posture alignment and its management within complex conditions such as CP (Novak et al., 2020; PHE, 2018; Collins, 2007; Farley et al., 2003; Goldsmith, 2000; Porter et al., 2007), stroke (DoH, 2005; Chatterton et al., 2001; Jones et al., 1998) and multiple sclerosis (DoH 2005; Chan and Heck, 1999); this key intervention is now getting more recognition within key policy papers. MENCAP published a seminal report Raising Our Sights (Mansell, 2010); within this publication it recognises the need for

posture management, and acknowledges the associated problems such as movement difficulties, breathing and eating problems. Mansell (2010, p.24) goes on to make recommendations to NHS bodies, that services should be developed which “focus on protection of body shape”. This has resulted in a shift in the recognition of the role posture and its management has within therapeutic rehabilitation approaches (NICE, 2012).

Posture is not easily defined. Its definition is variable and idiosyncratic. At the simplest level, posture is the ability to remain upright against the forces of gravity (Fortin et al., 2011). It is frequently referred to in terms of ‘good’ and ‘bad’ posture (Pope, 2007), indicating that there is a specific optimal posture. This is often perceived to be an upright spinal column with the natural vertebral curvature and with the limbs in perfect alignment. However, posture is a variable concept which is used to help us interact with each other and our environment influenced by internal (e.g., muscle tone) and external factors (e.g., gravity) placed on the body (Breniere and Bril, 1998; Raine and Twomey, 1994). The possible permutations for head, neck, thorax, pelvis, legs and arms are vast and so to suggest that one of these constitutes being either good or bad is rather simplistic.

Various definitions of posture have been proposed describing this concept within CP as: a particular position of the body (Pope, 2007); a dynamic process underpinned by postural control and motor function (Hong, 2005); and the use of antigravity muscles to enable movement skill development (Newman, 2005). Others have argued that posture is an active dynamic process which underpins movement and function (Hong, 2005), and that posture and movement are indistinguishable, referring to posture as a temporary arrested movement which is constantly changing (Howe and Oldham, 2001). These descriptions attempt to consider the theoretical conceptual relationship between posture and movement. Definitions of posture must establish a relationship between theoretical concepts and observable indicative attributes to be applicable within the real world (Mcdowell and Mcdowell, 2006).

Pope (2007) considered posture not only as a position of the body, but how this was inextricably linked to task, environment and postural deformities. Pope (2007) describes posture as the ability to adopt various positions which are stable and enable efficient functional movement in the presence of environmental forces of gravity and ground reaction force, while not causing damage to body structures. Her stance is explained by considering the demands of the task as it relates directly to the body alignment appropriate for this task. The more difficult an individual finds a task the less efficient they are in dealing with it, so contributing to the higher demands of maintaining body alignment and completing the movement. The impact of task and environment on body alignment and how this combined interaction preludes to postural deformity is fundamental to Pope's (2007) view of posture development.

Body alignment has such obvious and dramatic changes that it is easy to overlook the subtle changes, for example when reaching forward to grasp a toy. In this example, arm alignment would be the obvious change so as to move the arm towards attaining the task of grasping the toy. However, more subtle body alignment changes in the trunk would accompany this movement; forward flexion and rotation of the trunk would occur on the side of the arm reaching to the toy whilst simultaneously backward trunk rotation would take place to counterbalance this. These subtle body alignment changes happen in relation to the task and the ability to react to a changing centre of gravity (CoG) in relation to base of support (BoS) (Barela et al., 2011). The BoS is defined as the area of the body that is in contact with the supporting surface (Cumberworth et al., 2007). The centre of mass (CoM) is a central point of the total body mass, the vertical projection of this is termed the CoG (Hof et al., 2005). Though therapists may interpret research knowledge about stability as controlling the CoM within the base of support, in clinical application the focus is often on controlling the CoG, the vertical representation of the CoM, within the base of support (Woollacott and Shumway-Cook, 2005).

Pope (2007) illustrates this using the human sandwich model (figure 2.1).

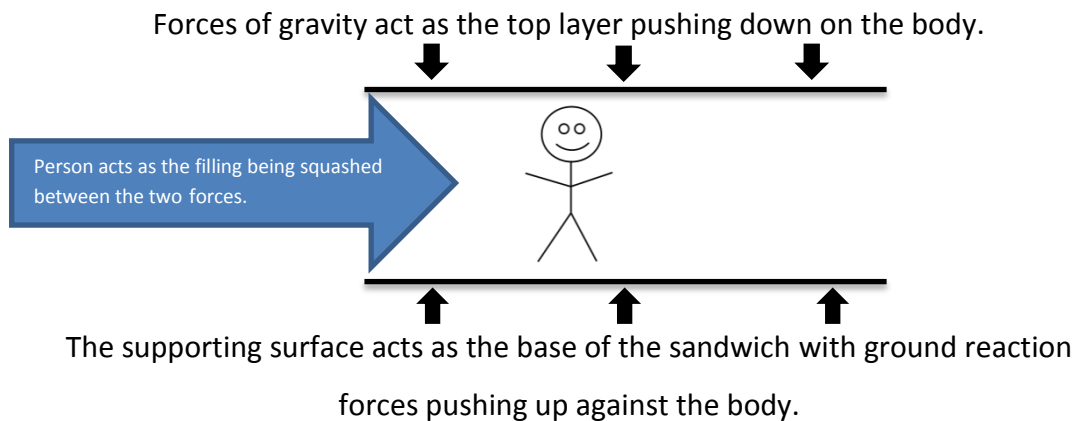

Figure 2.1: Human Sandwich Concept (Pope, 2007).

For an individual to function and move within the ‘sandwich’ body alignment, postural control and motor development should be established. This model can be directly related to numerous body position configurations, functional tasks or environments typical within child development and movement such as, pulling up on a sofa to stand, crawling over a toy cluttered floor to the TV or reaching to get a toy off a high table. This concept can be applied to across postural and motor theoretical approaches, which underpin current therapeutic clinical approaches concerning the characteristics and causes of posture and movement dysfunction. The next part of this chapter considers posture development and the theoretical frameworks of posture development, which relate to body alignment in children with CP and motor function.

2.2 Historical overview

A seminal article back in 1976 by Fulford and Brown strongly linked posture deformities to the CP child, stating that “deformities are caused by the effect of gravity on an immobile child” (p.313). This first approach involved postural and motor developmental concepts, amongst others by Bernstein (1976), Adams (1971) and Schmidt (1976) who explain motor development, and in turn posture, in terms of a top-down developmental sequential approach. In this approach development is viewed as a rigid process influenced solely by the central nervous system with

reflexes thought to be the dominant abnormal movement patterns. This approach differed greatly from the systems theory approach (Shumway-Cook and Woollacott, 2007) which places much greater emphasis on a multiple body systems input based on task orientated movement and interactions with the environment. However, it is still concerned with alignment difficulties against gravity having a significant impact on motor function. The concept proposed by Fulford and Brown (1976) while old, remains relevant to current therapeutic approaches. It has been applied to recent therapy approaches to postural alignment management (Pountney et al., 2009; Porter et al., 2008; Collins, 2007; Porter et al., 2007; Rennie, 2007; Hong, 2005; Pountney et al., 2004; Pountney et al., 2002; Pollock et al., 2000; Goldsmith, 2000), applying a task orientated approach to posture development and its management.

2.3 Development of posture

During typical development babies predominantly have a flexed (C-shaped) posture when they are born with two primary curves (Wright, 2011). These present as the thoracic curve (mid back) and sacral curve (bottom) (Wright, 2011; Pountney et al., 2004); as demonstrated in figure 2.2.

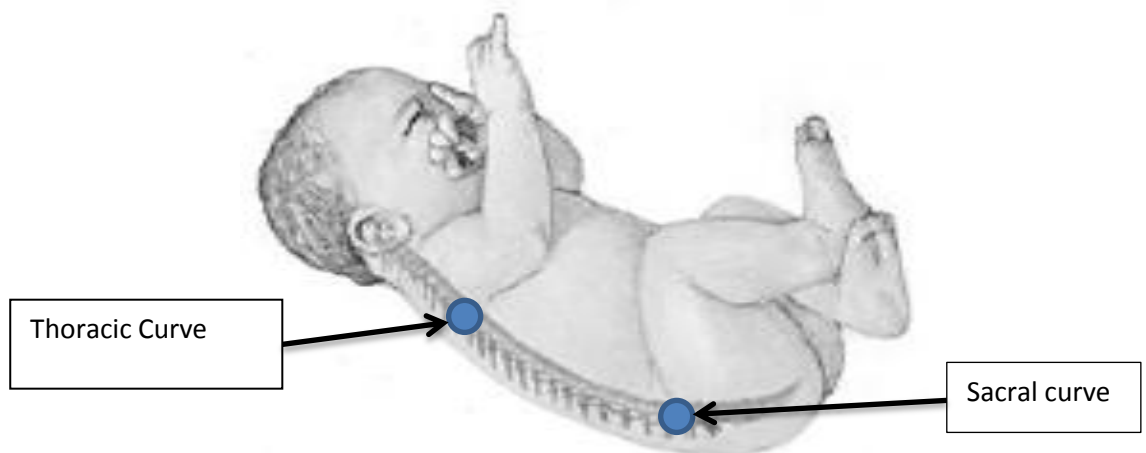

Figure 2.2: Early developmental spinal curves¹ (Wright 2011 p.4).

¹ Permission obtained from author to use image (See appendix 1).

Following birth, babies effortlessly move through developmental stages (Wright, 2011), for example rolling achieved by age 6 months, sitting by age 9 months, cruising at age 9-12 months and walking by age 18 months (Sheridan, 1980); these developmental stages are clearly displayed in figure 2.3.

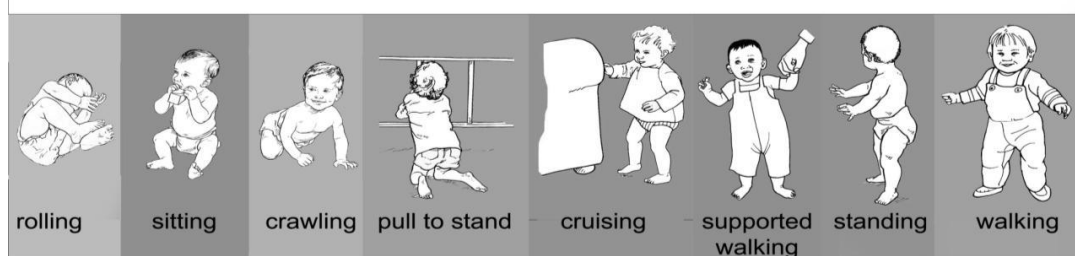

Figure 2.3: Developmental stage² (Wright 2011 p.4).

As children go through these developmental stages, they initially develop ability to gradually bring their body alignment upright against gravity (Breniere and Brill, 1998). This moves sequentially from lifting the head and head control in lying and sitting by 3 months, to being able to control trunk and head in sitting at aged 9 months and standing upright by aged 12 months. In conjunction with body alignment against gravity, positions of stability with a wide BoS and balanced CoG are also adopted to enable them to explore and play (Pountney et al., 2004). These positions become refined and the base of support becomes smaller as their posture skills become more established (Graaf-Peters et al., 2007). As part of this they start to develop postural alignment and control against gravity and their spines develop secondary curves (Pavo et al., 2013). These secondary curves occur firstly in the cervical spine through activities such as, a child holding their head upright against gravity when in prone; and then secondly in the lumbar region by gaining independent sitting and standing balance (Wright, 2011), see figure 2.4.

² Permission obtained from author to use image (See appendix 1).

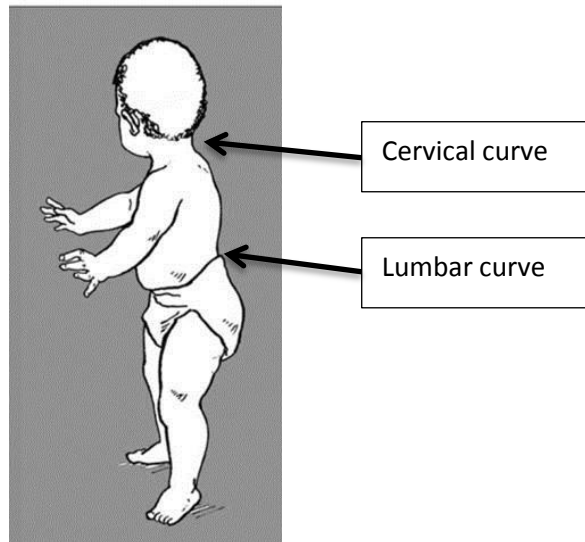

Figure 2.4: Spine curvature developments for postural control³ (Wright, 2011 p.4).

Body alignment and postural control develop concurrently alongside normal developmental stages; this includes the maturing of postural reactions such as righting and equilibrium reactions (Wulf et al., 2001), and the assimilation of primitive reflexes such as an asymmetrical tonic neck reflex (Wright, 2011; Pountney et al., 1990). The development of posture skills also requires the presence of normal muscle tone and intentional controlled movements (Wright, 2011; Pountney et al., 1990).

2.4 Posture development difficulties for children with CP

Children with CP by virtue of their movement impairments are more likely to display disturbances in posture resulting in alterations of body alignment (Chapter 1). These can lead to long-term deformities, reduced participation, discomfort and pain (PHE, 2018; Gough, 2009; Scrutton, 2008). Children with CP may be unable to change their position without assistance or communicate their discomfort clearly, being reliant on caregivers and professionals to recognise and respond to their discomfort cues and requirement for a change of position (Hill and Goldsmith, 2010; Pope, 2007).

³ Permission from author obtained to use image (See appendix 1).

CP is a neurodevelopmental condition affecting the developing brain in early childhood (Baxter et al., 2007). It is characterised by a disorder in movement and posture, due to non-progressive brain damage (Rosenbaum et al., 2007); poor alignment of body segments such as head and trunk are common features in the physical presentation (Rennie, 2007). Maintenance of a centrally and symmetrical body alignment is fundamental to motor function activities such as being able to sit or stand quietly, reach and move within the environment (Hadders -Algra, 2013). As discussed in chapter 1 movement difficulties associated with cerebral palsy (CP) means normal development is compromised (Rosenbaum et al., 2007).

This impaired development in children with CP results in difficulties achieving optimal body alignment within everyday functional settings and activities; for example, a child who is unable to maintain upright sitting on the floor in order to play with a toy. In this example, the inability to maintain optimal body alignment results in the child leaning to one side, in an asymmetrical sitting posture, in which their CoG has shifted outside their BoS (Barela et al., 2011). This means that the posture is unstable requiring more work and effort from the child to maintain it. The asymmetrical body alignment means that more stress is being placed on body structures such as joints, muscles and internal organs resulting in discomfort and pain. Collectively these factors impact on the child's ability to sit and play with a toy efficiently and effectively in the short and longer term. The higher the demands are in maintaining body alignment the less proficient the child is at completing the desired movement or task (Pope, 2007); in this example, playing with the toy. The more asymmetrical body alignment persists the greater the risk of developing significant long-term complications and fixed deformities (Goldsmith et al., 2009; Graham, 2002). These postural deformities can result in functional movement and participation being severely compromised (Scrutton, 2008). The impact of body alignment on the task and environment and how this combined interaction preludes to long term postural problems is dependent on a child's movement disorder (Rosenbaum et al., 2008).

Movement disorders of children with CP are typically described in terms of functional intentional movement using the GMFCS (Rosenbaum et al., 2008; Palisano et al., 2008). This is a 5-level ordinal grading system across five age bands 0-2 years, 2-4 years, 4-6 years, 6-12 years and 12-18 years. Distinctions between the levels is based on assessment of self-initiated / independent movement, with a focus on motor and functional ability such as sitting, walking and wheeled mobility (Palisano et al., 2008; Rosenbaum et al., 2008; Rosenbaum et al., 2007; Palisano et al., 1997).

Palisano et al. (1997) followed the ICF framework (World Health Organisation (WHO), 2001) and developed the Gross Motor Function Classification System (GMFCS) to record the functional abilities and limitations that children with CP experience in their daily living. Several years later, Palisano et al (2007) revised the GMFCS and developed the Gross Motor Function Classification System Expanded and Revised, introducing the age group of 12 to 18 years old.

The respective psychometric properties of the GMFCS have been examined in detail. The classification system was drafted using several phases (Palisano et al., 1997). Firstly, the authors (n=6) developed an initial outline, secondly, a nominal group process involving 28 therapists was undertaken to reach consensus, and finally, a Delphi survey method involving 20 experts (physiotherapists, occupational therapists and paediatricians) from across North America, Europe, and Australia was repeated twice. The GMFCS demonstrated good content validity with consensus agreement >80% being reached between all participants across all statements. The GMFCS also examined inter-rater reliability; paired therapists (n=46) evaluated 37 children aged <2 years and 40 children aged 2-12 years demonstrating good ($k=0.55$) and excellent ($k=0.75$) inter-rater reliability respectively. Further evaluation of the GMFCS reliability and stability was examined by 2 blinded therapists across 85 children, showing high inter-rater ($G=0.93$) and test-retest reliability (0.97) using a generalisability ability (G) coefficient (Wood and Rosenbaum, 2000). The GMFCS at 1 to 2 years showed high positive predictive value to predict walking by age 12 years (0.74), with a high negative predictive

value to predict requirement of a wheelchair (0.90). The GMFCS can validly predict motor function for children with CP (Wood and Rosenbaum, 2000).

Researchers at McMaster University in Canada developed the expanded and revised GMFCS. This revised the age band of 6 to 12 years and included an additional age band of 12 to 18 years (Palisano et al., 2007). Content validity of this was initially assessed from a group of 18 physiotherapists (Palisano et al., 2008). Subsequently, a Delphi survey involving 30 health professionals repeated 3 times, established strong content validity of >80% on the clarity and distinction between levels (Palisano et al., 2008). The GMFCS has been extensively evaluated showing it to be an international classification system supporting communication, clinical decisions, and research (Piscitelli et al., 2021; Löwing et al., 2015; Shi et al., 2014; Silvia et al., 2013; Rosenbaum et al., 2008).

The GMFCS classifies children into 5 levels according to their movement impairment and function; level I being the least impaired to level 5 most severely impaired (Rosenbaum et al., 2008). In terms of body alignment issues, children classified at levels IV and V have little ability to control their body position against gravity and are more likely to develop postural deformities (Rosenbaum et al., 2008; Gericke, 2006). Whereas children at levels I-II have the ability to adjust their body alignment and participate in many activities against gravity such as walking and sit to stand; these movement skills are typically executed with little difficulty with the exception of some balance deficits and limitations on the distance they are able to walk (Palisano et al., 2008). Children at GMFCS level III whilst able to maintain body alignment in sitting and standing may require some positioning support to maintain stability and body alignment to complete movement skills efficiently (Palisano et al., 2008).

The presentation of CP is variable and multifaceted in its clinical presentation meaning individual constraints can present across numerous areas, affecting multiple systems (Rosenbaum et al., 2007). A summary of some of the individual

constraints which CP children may present with, related to the categories of motor control are listed in Table 2.1.

Table 2.1: Individual constraints which may affect the functional movement of a child with CP (Kenyon and Blackinton, 2011; Rosenbaum, 2009; Shumway-Cook and Wollacott, 2007).

Category	System affected	Individual constraints
Action	Neuromuscular System	<ul style="list-style-type: none"> • Marked asymmetries in posture and movement. • Poor isolation and control of core and extremity movements. • Poor bilateral coordination skills. • Difficulties controlling shift in body position. • Abnormal muscle tone.
	Musculoskeletal System	<ul style="list-style-type: none"> • Reduced active range of movement. • Poor pelvic stability. • Muscle weakness.
	Cardiopulmonary System	<ul style="list-style-type: none"> • Fatigues quickly. • Difficulty matching activity level of typically developing peers.
Perception	Sensory systems	<ul style="list-style-type: none"> • Reduced tactile discrimination. • Altered body schema. • Decreased awareness of body position in space. • Lack of integration of core with extremity movement. • Visual impairments.
Cognition		<ul style="list-style-type: none"> • Easily distracted. • Frustration. • Impaired problem solving. • Difficulty planning how to complete or attempt task.

The individual movement constraints in children with CP results in an inability to change and adapt body position in relation to the motor task and environment (Pountney et al., 2004; Farley et al., 2003; Goldsmith, 2000). This means that refinement of positions where the CoG remains within the BoS in relation to a functional movement such as, reaching to grasp a toy are significantly impaired (Carlberg and Hadders-Algra, 2008). This suggests that children with an

accumulation of interrelating factors from both individual and environmental constraints, such as altered muscle tone, gravity and muscle shortening, are at greater risk of developing posture deformities as a result of asymmetrical body alignment. The issues not only impact on body alignment but mean stable and efficient BoS positions, from which a child functions and plays, become more challenging to achieve and maintain.

The postural difficulties of children with CP prompt the need for a child's body alignment to be managed for them (Hong, 2005). A detailed description of neurophysiological systems involved in posture and its control, a highly integrated process under the control of the central nervous system, is beyond the scope of this chapter. Therefore, only those aspects relevant to the provision of adaptive positioning equipment will be outlined. This is because disturbance of the neurodevelopmental mechanisms necessary for control of posture may, in the severest of circumstances, prevent a child from holding their head upright or being able to sit without additional support under the pull of gravity (Pope, 2007). These are the children who will require specialist positioning equipment to support their posture and optimise functional movement.

2.5 Body alignment, postural and motor control overview

An important relationship exists between body alignment, postural control and motor development (Shumway-Cook and Woollacott, 2007). As body alignment becomes controlled and established, base of supports used for function become smaller and selective to the task in hand (Pavao et al., 2013; White, 1999).

As defined in chapter 1, body alignment is the position of body segments, head, trunk, pelvis, arms, legs and feet in relation to one another and their orientation in space (Raine and Twomey, 1994). It requires intrinsic antigravity movements, enabling selective positioning of body segments relative to stability, motor task and environment (Shumway-Cook and Wollacott, 2007). Whereas, postural control is the ability to maintain CoM within the BoS (Pavao et al., 2013). It requires active sequenced control of postural muscles to change and refine the base of support,

while keeping the centre of mass within the selected base relative to a specific functional task (Van Balen et al., 2015); such as reaching forward to grasp a toy.

Postural control necessitates the presence of normal muscle tone, anti-gravity body segment alignment and intentional controlled movements (White, 1999). The combination of body alignment and postural control enables a child to achieve positions of balance and stability (Rose et al., 2002; Pountney et al., 1990). This enables efficient movement that is specific to an intended task or function (Dusing and Harbourne, 2010). These abilities are essential parts of motor development and develop alongside normal child development (Van Balen et al., 2015).

Motor development is adaptive change; it involves a change in motor development and motor performance over time as the child develops (Sugden, 2013). Motor development is more than just skill performance (Sugden, 2013); it also involves the exploration of movement in relation to the environment (Newman, 2005). During development a child will explore numerous positions of body alignments and bases of support (Hadders-Algra, 2010). This develops sequenced muscle activation alongside integration of sensory and nervous systems (Newman, 2005). As stability is improved, motor performance becomes refined and skill outcome more successful (White, 1999). Antigravity body segment alignment is an intrinsic, responsive and embedded aspect of motor development (Newman, 2005). Movement is an important consideration in how coordination and control are achieved as part of motor development (Hadders-Algra, 2010).

As body alignment and postural control skills become refined through exploratory play as part of typical development (Pountney et al., 2004), movement becomes controlled and adaptive to a changing CoG within and around a selected BoS, meaning motor performance becomes more successful (Carlberg and Hadders-Algra, 2005). As a result, the relationship between postural control and movement is well established (Pavao et al., 2013). Few studies have examined the role of body alignment within posture, or explored its association to postural control and functional movement. The ability to adopt selective body alignment postures

against gravity is an important fundamental component of postural control (Shumway-Cook and Woollacott, 2007). In its absence a child's stability, movement efficiency and function are impaired (Carlberg and Hadders-Algra, 2008; White, 1999).

The remaining part of this chapter discusses the theoretical frameworks of postural control and motor control to maintaining body alignment in sitting and standing. These two positions are focused on because they require, at minimum, static alignment to maintain an upright postural orientation against gravity, from which to perform functional tasks. The clinical implication of both postural and motor control theories are discussed in relation to children with CP. This will be followed by application of these theoretical concepts into practice and the role assessment has within research and clinical approaches in children with CP.

2.6 Theoretical framework of postural control

Postural control is the ability to control the body's position in space for the dual purposes of orientation and stability (Shumway-Cook and Woollacott 2007).

Postural orientation is defined as the ability to maintain body segment alignment in relation to the environment and task (Graaf-Peters et al., 2007), whilst postural stability is the ability to control the CoG in relation to the BoS (Pollock et al., 2000).

Stability is created when the direction of the force of gravity through the body is downward through the CoG, (Shumway-Cook and Woollacott, 2007). This line of stability is important to understand and visualise when determining a child's ability to successfully maintain body alignment and balance to perform functional movements (Liao and Hwang, 2003). When the line of stability falls outside the BoS, a reaction such as an adjustment of body alignment, is then needed to stay balanced (Liu et al., 2007). In children with CP these reactions are known to be affected, which may be a reason why postural control is impaired and the maintenance of posture orientation is critical (Pavo et al., 2013; Woollacott and Shumway-Cook, 2005).

Postural control requires intrinsic antigravity movements, enabling selective positioning of body segments relative to stability, motor task and environment (Burtner et al., 2007; Ferdjallah et al., 2002). Postural control necessitates the presence of normal muscle tone, anti-gravity body segment alignment and intentional controlled movements (White, 1999). The combination of body alignment and postural control enables a child to achieve positions of balance and stability (Liu et al., 2007). This enables efficient movement that is specific to an intended task or function (Dusing and Harbourne, 2010).

These abilities are essential parts of motor development and develop alongside normal child development (Van Balen et al., 2015). In children with CP, the major postural dysfunction is the inability to coordinate the activation of postural muscles in the right sequence, especially during the performance of functional movements (Graff-Peters et al., 2007; Brogren et al., 1998). This impairment can lead to children with CP experiencing functional constraints due to an impairment in body alignment and stability adjustments and during movements (Graaf-Peters et al., 2007; Carlberg and Hadders-Algra, 2005; Rose et al., 2002). This degree of postural dysfunction relates to the classification level a child with CP has; the higher the level the worse muscle coordination and activities becomes and the greater the impairment in body alignment (Rosenbaum et al., 2007).

2.6.1 Postural control system framework

Postural control is a requirement in all functional tasks (Pavo et al., 2013). The demands of stability and orientation vary dependent on the task and environment, with some tasks placing more importance on one element at the cost of the other (Shumway-Cook and Woollacott, 2007) (Figure 2.5).

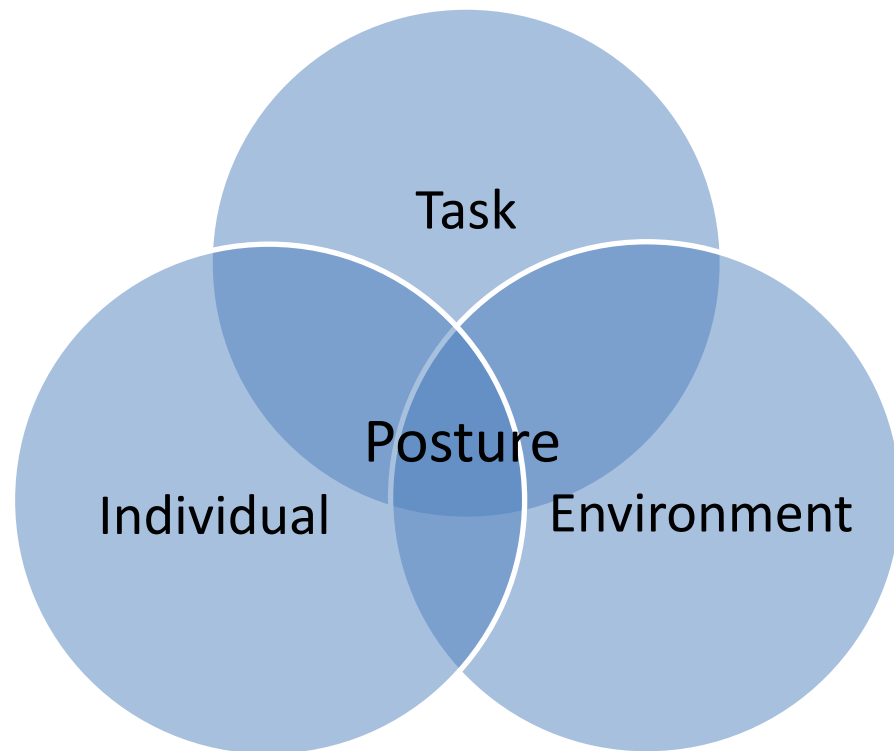

Figure 2.5: Concept model representing that posture arises from interaction of the individual, task and environment (Shumway-Cook and Woollacott, 2007).

When considering this in relation to children with CP, the individual constraint of impaired body alignment means that a child is unable to adopt appropriate postural positions in relation to the environment and the task. This ultimately results in poor adaptability to their environment and task resulting from ineffective postures. As posture is fundamental for all functional tasks, recognition of a child's and family's goals is important in guiding therapy intervention and priorities (Pope, 2007). For example, a child is unable to maintain sitting posture on the floor (environment), to watch TV with their siblings (task), due to their poor body alignment (individual constraint). Within this framework therapists need to consider adaption of the environment and/or task taking into consideration the limitations of the individual. In this example the provision of positioning equipment such as a floor seat, would adapt the environment accommodating the child's impairment in maintaining body alignment. This not only supports the child to sit upright through a change to the environment but also provides stability and reduces effort in sitting making the task

easier. This approach maximises a child's ability to participate in their desired goal, in this case watching TV with their siblings. This demonstrates the importance this framework has on a goal orientated therapy approach, whereby a child's and family's goals are at the forefront of postural interventions.

2.6.1.1 Individual postural control systems

The ability to control the body's position in space arises from the complex interactions of both musculoskeletal and neural systems (Corrêa et al., 2007; Woollacott et al., 1998). Musculoskeletal components include joint range of movement, flexibility, muscle and soft tissue properties and the biomechanical relationship between body segments (Shumway-Cook and Woollacott, 2007). Neural components which are thought to be essential to postural control include motor, sensory and higher-level cognitive processing (Massion, 1998).

Constraints in any of these individual components can lead to impairment in postural control (Dusing and Harbourne, 2010). A child with CP at GMFCS I may only have mild impairment in postural control such as limited control and range of movement at the hip joint (Roncesvalles et al., 2002). This may restrict them from adopting a wider base of support during a task such as walking, making them less stable and the task harder to complete (Woollacott et al., 1998). Whilst children at GMFCS I are described as being able to walk without limitations this impairment in postural control could, however, also significantly increase the risk of falls (Palisano et al., 2007). In contrast children with greater severity in their CP presentation can have impairment in multiple systems and their components would significantly impact their ability to complete a functional task and may even increase their risk of mortality and morbidity (Shumway-Cook and Woollacott, 2007). This is unfortunately the case in children at GMFCS IV and V who are severely affected and present with multifactorial impairments across both musculoskeletal and neural systems (Carlberg and Hadders-Algar, 2005; Roncesvalles et al., 2002). These will be discussed further in the exploration of postural control motor systems (see section 2.7).

In a systems approach, postural control results from the complex interactions of many body systems, of which understanding the role of higher-level cognitive processes is particularly important (Shumway-Cook and Woollacott, 2007; Thelen, 2005). Cognitive processing is the basis for achieving reactive and anticipatory aspects of postural control (Shumway-Cook and Woollacott, 2007). Reactive postural control involves modifying sensory and motor systems in response to changes to the task or environment (Barela et al., 2011). Whereas anticipatory control, primes sensory and motor systems for postural demands based on previous experience and learning (Bigongiari et al., 2011; Girolami et al., 2011).

This creates a feedforward, for expected postural disturbances, and a feedback system, for unexpected (Haas et al., 1989). The integration and coordination of both incoming and outgoing information from musculoskeletal and neural systems results in postural adjustments to maintain postural control during functional movement (Shumway-Cook and Wollacott, 2007). This concept is shown in figure 2.6. The specific organisation of this is determined not only by individual constraints but also those of the task and the environment (Massion, 1998).

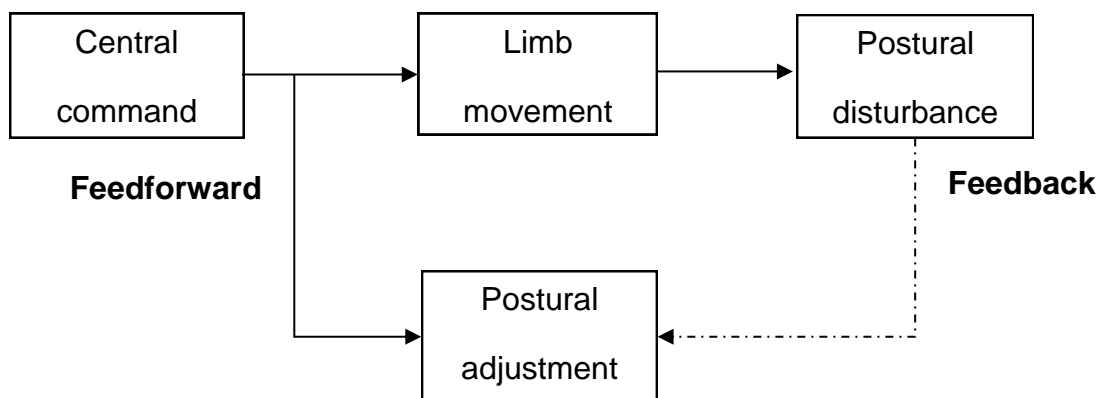

Figure 2.6: Feedforward / feedback system of postural control (Shumway-Cook and Woollacott, 2007).

2.6.1.2 Functional movement tasks

Functional movement requires control of body alignment and ability to engage reactive and anticipatory postural responses (Dusing and Harbourne, 2010). During execution of functional movements reactive control is the ability to recover a stable position following an unexpected perturbation (Barela et al., 2011). For example, a child walking and tripping over a toy requires the activation of multiple leg and trunk muscles to regain a stable position with the CoG within the BoS (Burtner et al., 2007). For children with CP the inability to rapidly generate and apply the required corrective muscle forces to recover balance results in a fall (Hsue et al., 2009). Anticipatory control is the ability to activate muscles prior to destabilising voluntary movements (Bigongiari et al., 2011). Sitting and reaching forwards is an example of a functional movement which requires anticipatory balance (Brogren et al., 1998). For children with CP delayed or absence of anticipatory muscle activation leads to loss of balance, increased effort in completing the task and reduced accuracy (Ju et al., 2012).

Body alignment is the ability to orientate body segments to maintain the CoG within the BoS in predictable, non-changing conditions; For example, sitting or standing quietly requires alignment to achieve stability (Shumway-Cook and Woollacott, 2007; Pollock et al., 2000). In children with CP the ability to maintain body alignment, even during quiet stable set positions such as sitting or standing, is challenging because alignment demands complex interactions for these to be efficiently carried out against gravity (Carlberg and Hadders-Algra, 2008; Cherng et al., 2009; Burtner et al., 1998). It is important to recognise the range of abilities within CP; whilst the above examples demonstrate how children with mild to moderate postural impairment may struggle with functional movement tasks, those children most severely affected, GMFCS IV and V, have such a degree of impairment in coordinating and activating the necessary muscle control that selecting a body alignment posture from which movement will be created is significantly impaired (Carlberg and Hadders-Algar, 2005). This means that for this group of children with CP anticipatory and reactive control is redundant, due to the significant impaired

ability to select body alignment meaning the foundation required for functional movement is absent.

Functional tasks, whether these are dynamic or just quiet sitting and standing, require all three aspects at some point within their execution (Graaf-Peters et al., 2007). For example, sitting and reaching to play with and explore a toy requires alignment of body segments to maintain quiet sitting balance initially prior to reaching, anticipatory control to reach forward and reactive control if the object is heavier than expected, and finally static alignment after the task is completed. These components required for functional movement are known to be significantly affected in children with CP GMFCS IV and V, primarily the inability to maintain a static body alignment which is fundamental to postural control and effective motor control (Saavedra et al., 2015; Carlberg and Hadders-Algra 2005).

2.6.1.3 Environment constraints

The environmental conditions in which movement is being performed can impact on how the postural control systems (sensory, motor and cognitive) are organised to maintain balance (Pollock et al., 2000). Changes in supporting surfaces affect the organisation of muscles and forces needed to maintain balance (Shumway-Cook and Wollacott, 2007). For example, sitting on a flat surface requires sitting alignment to remain balanced (Saavedra et al., 2010). In contrast sitting on a sloped surface also requires anticipatory control to move the CoG backwards over the BoS to maintain balance (Cherng et al., 1999). In children with CP, body alignment is known to be affected, which is a reason why maintaining body alignment in quiet postures such as sitting and standing are challenging against gravity, particularly for those at GMFCS IV and V (Graaf-Peters et al., 2007; Fulford and Brown, 1976). The environment needs to be adapted to assist children with CP to achieve alignment and postural control skills and support functional movement tasks (Borgen et al., 1998). Adapting the support surface through use of positioning equipment provides an increased base of support and correction of body alignment in set functional postural positions (Pope, 2007). This improves functional movement, stability and motor control efficiently (Scrutton, 2008; Vekerdy, 2007;

Pountney et al., 2002). This use of equipment varies dependent on the level of classification a child with CP has. Children at GMFCS I-III equipment is typically used as an aid to support independent movement such as, a pacer to aid walking and can be short lived in terms of its use, whilst children at GMFCS IV and V equipment is used as permanent adaption of their environment across sitting, standing and lying to enable body alignment to be maintained against gravity to then assist in function movements (Palisano et al., 2007).

2.6.2 Postural control motor systems - alignment

Motor systems ensure body alignment and stability through generating coordinated forces in appropriate muscles to control the body's position and movement in space (Shumway-Cook and Woollacott, 2007). Motor systems also include frontal cortex and motor cortex higher-level planning, coordination through brainstem and spinal networks and force generating systems, motor neurons and muscles which produce effective movement of body position within space (Hadders-Algra, 2010; Shumway-Cook and Woollacott, 2007).

Stability underlying sitting or standing quietly requires maintenance of body segment alignment as the BoS does not change (Cumberworth et al., 2007; Ferdjallah et al., 2002). However, this interpretation has recently been challenged as misleading. The body state when sitting or standing quietly has been found to be continuously moving within its BOS (Hadders-Algra, 2013). This is termed postural sway, characterised as involving varying amounts of small body movements within a BoS (Donker et al., 2008). Thus, static balance in typical development is more dynamic than stationary. Children with CP are known to exhibit greater postural sway compared to typical development (Donker et al., 2008). This impairment leads to greater stability and functional constraints (Hadders-Algra., 2013).

Two primary factors contribute to our ability to maintaining balance, or ensuring we keep our postural sway within our BoS (Pollock et al., 2000). Firstly, achieving optimal body alignment minimises the pull of gravitational forces which may shift

our CoG away from centre (Dusing and Harbourne, 2010). Secondly, muscle tone keeps the body from collapsing in response to the effects of gravity (Pope, 2007).

2.6.2.1 Body Alignment

Body segment alignment and muscle control are both critical aspects of maintaining static balanced postures (Shumway-Cook and Woollacott, 2007). Optimal body alignment is where the CoG falls in a vertical line within the BoS (See section: 2.6). Sitting or standing with the optimal body alignment allows the body to be maintained in equilibrium with the least energy expenditure (Hill and Goldsmith, 2010). However, in typical development children rarely maintain a perfectly optimal body alignment, hence there is wide variance in body alignment dependent on the individual, movement task and environment (Hadders-Algra, 2010). Nonetheless, the ability to be able to achieve and maintain optimal alignment when standing or sitting is the foundation of effective and efficient functional movement (Scrutton, 2008; Vekerdy, 2007; Pountney et al., 2002; Brogren et al., 1998).

Individual constraints associated with CP results in an impairment to control body alignment (Carlbergh and Hadders-Algar, 2005). As a result, body alignment may not always be optimal resulting in impaired ability to maintain stability in relation to movement and environment (Scrutton, 2008; Porter et al., 2007). Put simply, misaligned body alignment means poor adaptability to function and environment, resulting in ineffective movement. Children with CP are likely to experience individual constraints such as altered tone and restricted movements meaning their ability to adopt various body alignment positions which are relevant to movement task and environment is challenging at best (Graaf-Peters et al., 2007).

2.6.2.2 Muscle Tone

Muscle tone refers to the inherent resistance to passive stretching or lengthening, that is to say its stiffness (Gurfinkel et al., 2006). This is often tested clinically by passively moving a child's limbs and feeling the resistance offered. Muscle tone receives input from both neural and nonneural mechanisms (Shumway-Cook and Woollacott, 2007). At rest, a certain level of muscle tone is present (Gurfinkel et al.,

2006). Researchers have argued that this is a nonneural mechanism as no electrical activity can be recorded when a muscle is at rest (Cacciatore et al., 2004). This resting tone is argued to be maintained by free calcium in the muscle fibres creating low level continuous cross bridges to maintaining muscle tone (Shumway-Cook and Woollacott, 2007). Neural contributions to muscle tone are associated with the activation of the stretch reflex (Beith and Harrison, 2004). This is when the muscle resists lengthening aiming to support active co-contraction of specific muscles to achieve a desired movement. The ability to recruit and control both resting and active muscle tone is essential in the sequencing and coordination of muscle responses to reactive and active postural disturbances undertaken as part of everyday functional movement (Massion, 1998).

Individual constraints associated with CP results in an impairment to recruit resting muscles and coordinate an appropriate response required for functional movement such as reaching to grasp a toy (Carlbergh and Hadders-Algar, 2005). As a result, the ability to maintain body alignment against the effects of gravitational forces is impaired and quiet and active postures are unstable and effortful (Scrutton, 2008; Porter et al., 2007). Put simply, impairment in recruiting and controlling muscle tone means body alignment lacks adaptability to function and environment, resulting in ineffective movement and development of postural deformities. Children with CP are likely to experience individual constraints such as altered tone meaning their ability to adopt various body alignment positions at rest are effortful and challenging (Graaf-Peters et al., 2007).

2.6.2.3 Postural tone

In positions which require the force of gravity to be counteracted, for example standing upright, an increase in antigravity postural muscles is required; this is referred to as postural tone (Hadders-Algra, 2005). Within clinical literature, considerable emphasis has been placed on the trunk muscles as a major postural control mechanism in supporting the body against gravity (Pavo et al., 2013). Research exploring EMG activity of trunk muscles in sitting showed significant baseline tonic activity during upright sitting (Kim et al., 2018). This suggests that

trunk muscle activity is critical to maintaining body alignment within the BoS in a sitting position.

Many muscles in the body have been found to be tonically active during static balanced positions for example sitting or standing quietly (Mok et al., 2004). Research has suggested that activation of trunk muscles is important to postural control, discussing this stabilising activity in relation to core stability (Hodges et al., 2002; Mok et al., 2004). These studies suggest that there is a level of tonic muscle activity throughout the body to maintain a vertical position within the BoS during quiet positions such as sitting or standing. As previously discussed, this emphasises the point that posture is not static but dynamic, coordinating sensory inputs from multiple systems so that the body can calculate where it is in space, predict what task is being planned and what actions will be necessary to control the required movement (Hadders-Algra, 2010; Donker et al., 2008; Shumway-Cook and Woollacott, 2007). Children with CP have variable deficits in postural control (Carlberg and Hadders-Algra, 2005). Posture, in this context, is not a temporarily arrested movement, but a permanent position which some children with CP, generally GMFCS IV and V, adopt as a result of gravity and severely impaired movement (Fulford and Brown, 1976). Posture for children at these GMFCS levels is not adaptive and changeable; it is static and restrictive (Goldsmith, 2000). It is, therefore, essential that the ability to achieve and maintain body alignment is regarded as an important part of posture in CP.

Movements used to control postural sway vary depending on the BoS as neural mechanisms activate to control the CoG within an individual's stability limits (Pai and Patton, 1997). Stability limit is the point at which a person will change the configuration of their BoS to achieve or maintain stability (Shumway-Cook and Woollacott, 2007). Characteristics of the individual including strength, range of movement, task and environment impact upon and change the stability limits (Hof et al., 2005). The provision of adaptive equipment for children with CP is provided to enhance their BoS and support alignment in the absence of their ability to do so

for themselves (Hong, 2005). This corrects body posture to optimal alignment and a more stable base from which to function (Pope, 2007).

Stability limits were previously conceptualised solely using the physical characteristics of the BoS, such as foot position (Shumway-Cook and Woollacott, 2007). Early understanding of postural control tended to focus on the size of the BoS and position of the CoG in relation to this to maintain stability (Pai and Patton, 1997). More recent research has suggested that stability is influenced by the position and the velocity of the CoG (Pai et al., 2000). Determining whether a person will remain stable and balanced within their BoS depends on the interaction between these two variables (Pai and Patton, 1997). Practically this would determine whether a child with CP would be able to remain stable within their current BoS or would have to take a step or reach out to regain stability. Figure 2.7 illustrates this point (Shumway-Cook and Woollacott, 2007; Pai et al., 2000).

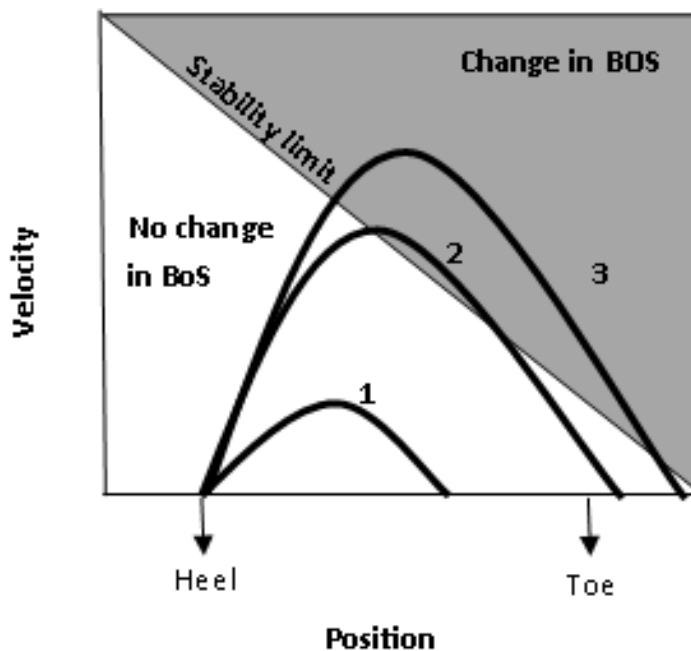

Figure 2.7: How the CoM position and speed relates to stability (Shumway-Cook and Woollacott, 2007; Pai et al., 2000).

This figure presents three possible trajectories of the CoM combining velocity and displacement in relation to an external perturbation (Pai et al., 2000). In trajectory 1 the change in the velocity and CoG is small meaning stability is recovered without the need to change the BoS (Shumway-Cook and Woollacott, 2007). Whereas in trajectory 2 and 3 the displacement and velocity of the CoG are great enough to move the CoG beyond the point of stability resulting in the need for a step to recover stability (Pai et al., 2000).

When considering this in relation to children with CP; children at GMFCS IV and V have impaired ability to maintain whole body alignment or activate sequenced control of postural muscles, meaning they are unable to adopt stable positions where their CoG is aligned within their BoS (Dusing and Harbourne, 2010; Carlberg and Hadders-Algra, 2005). In relation to the stability limits outlined in figure 2.7, children at GMFCS level IV and V are unstable across all trajectories. Whereas, children at GMFCS I – III are able to maintain body alignment, however, they have difficulty controlling muscle sequencing necessary to react and anticipate changes to BoS (Van Balen et al., 2015; Hadders-Algra, 2010; Scrutton, 2008; Rosenbaum et al., 2007; Carlberg and Hadders-Algra, 2005). Consequently, alignment for children across all GMFCS levels is hard to maintain over time, with alignment loss and instability presenting at specific body segments rather than whole body (Hadders-Algra and Carlberg, 2010).

Those children at GMFCS IV and V individual constraints such as spasticity, muscle weakness, excessive co-activation of agonist/antagonist muscles, decreased muscle coordination, and decreased response result in problems with organisation of movement and muscle activation (Saaverdra and Wollacott, 2015). This results in a deficiency or inability to recruit postural muscle activation for the purpose of maintaining body position within the BoS (Saaverdra and Wollacott, 2015). The reduced ability of these children with CP to achieve and maintain optimal biomechanical alignment of body segments in relation to gravity and supporting surfaces results in significantly impaired motor control and functional movement (Curtis et al., 2015; Butler and Major, 1992). Assessment of body segment

alignment may help physiotherapists to determine the stability of different postures to better support functional movements.

2.7 Theoretical framework of motor control

Motor control is defined as the ability to adjust or direct mechanisms which are vital to movement (Shumway-Cook and Woollacott, 2007). The field of motor control studies the nature of movement and how movement is controlled (Rosenbaum, 2009). It explores how the central nervous system (CNS) regulates the many individual muscles and joints to create coordinated functional movement (Schmidt et al., 2018). It relates to how sensory information from the body and environment impacts on movement, and how the tasks we perform and the environment in which we are moving, influences our selected movement patterns (Shumway-Cook and Woollacott, 2007).

2.7.1 Relevance of motor control to body alignment and CP

Physiotherapists employ strategies which are designed to improve the quality and movement in children with CP (Carlberg and Hadders-Algra, 2005). Children with CP have motor control problems producing functional movement disorders (Pope, 2007). Functional movement is a critical aspect of life (Bate, 1997). It is essential to our ability to walk, run and play. The ability to control our body alignment in space is fundamental to our movement ability; in essence, to everything we do (Shumway-Cook and Woollacott, 2007). Thus, understanding motor control, specifically the nature of normal and abnormal movement, is critical to clinical practice.

2.7.2 Understanding the control of movement

Motor control, like aspects of postural control, emerges from the interaction of the individual with the task and environment (fig 2.5) (Shumway-Cook and Woollacott, 2007). Similar to postural control, individual movement emerges from understanding the interaction of multiple systems and complex interactions in a systems approach, of which understanding the role of higher-level cognitive processes is particularly important (Pavao et al., 2015).

Understanding how motor systems, both neuromuscular and biomechanical, contribute to functional movements is important (Rosenbaum, 2009). The body contains numerous muscles and joints, which during functional movement must be coordinated and controlled (Schmidt et al., 2018; Shumway-Cook and Woollacott, 2007). There are multiple ways in which a movement can be carried out (Sugden, 2013). The problem or process in selecting and coordinating the muscles and joints to create functional movement means children with CP, particularly those at GMFCS IV and V who are more severely affected, have inabilities with postural and motor control (Hadders-Algra, 2013; Butler and Major, 1992).

Sensory and perception systems are fundamental in controlling functional movement (Shumway-Cook and Woollacott, 2007). Perception is the integration of sensory input into meaningful information (Pavao et al., 2015). This involves both peripheral sensory mechanisms and higher-level processing which aids interpretation of incoming afferent information (Shumway-Cook and Woollacott, 2007). It provides information about the state of the body, for example the position of different body parts in space. And finally, since movement is not usually performed without intent, cognitive processes are also essential to motor control (Sugden, 2013). In this thesis cognitive processes are defined broadly to include attention, problem solving, planning, motivation and emotional aspects of motor control which underlie the intent or goal of movement (Shumway-Cook and Woollacott, 2007). Motor control organises both action and perception systems in order for the individual to achieve their specific functional movement goal or intent (Sugden and Dunford, 2007).

Practicing functional movement tasks is accepted by physiotherapists as an important part of rehabilitation for individuals with movement disorders (Pope, 2007). However, the order and selection of task to be practiced is less clear (Shumway-Cook and Woollacott, 2007). Understanding the attributes of tasks can provide physiotherapists with a framework for structuring tasks, known as taxonomy, this enables task to be sequenced from least to most difficult based on their relationship to shared attributes (Larin, 1998). An example of a taxonomy of

tasks using two attributes – stability / mobility and open / closed environment is shown in table 2.2.

Table 2.2: A taxonomy of tasks combining two attributes - stability / mobility and open / closed (Shumway-Cook and Woollacott, 2007).

	Stability	Mobility
Closed environment	Standing in a stander with support at feet to trunk.	Walking on a non-moving surface.
Open environment	Standing on a rocker board	Walking over an uneven surface.

Here it can be seen that the easiest task is standing with body alignment support through use of a stander or tasks which are stable and in predictable environments. Alternatively, the most difficult tasks are those which require mobility or open unpredictable environments such as, standing with no body support on a rocker board (Shumway-Cook and Woollacott, 2007). However, the exact timing of when to increase task difficulty will depend upon the individual (Larin, 1998).

An alternative to classify tasks based on their attributes is to categorise them functionally. This is commonly how tasks are classified within clinical practice, with tasks being grouped most often into functional categories such as floor ability, sitting, mobility or transitional skills, for example moving from one static position to another such as, lying to sitting (Thonnard and Penta, 2007). A taxonomy of task can provide physiotherapists with a useful framework for assessment and treatment (Shumway-Cook and Woollacott, 2007). The order of tasks can create a pathway of progression for developing functional movement in children with movement disorders such as CP (Sugden and Dunford, 2007). An example of a taxonomy of task used with CP children is the GMFM (Russell et al., 2002); This assessment looks at tasks across several functional categories from floor ability to walking and running. It assesses and scores a child's functional movement in a sequential order of difficulty. This provides physiotherapists with a framework on which to assess, monitor and structure the selection of a functional task to be

worked on next to guide an individual child's development (Alotaibi et al., 2014; Avery et al., 2003).

If recognising that, in theoretical principle, movement is the product of interaction between the individual, the task and the environment then specific individual constraints that influence the child's ability to perform functional tasks need to be determined. As discussed earlier, (see table 2.1, page 24), this is particularly important in children with CP (Hadders-Algra, 2010). The presentation of CP is variable and multifaceted in its clinical presentation meaning individual constraints can present across numerous areas, affecting multiple systems (Rosenbaum et al., 2007). This adaption of task and environmental influences such as the use of positioning equipment varies dependent on the level of classification a child with CP has (Palisano et al., 2007). With children at GMFCS I-III tasks and equipment may be used to support and develop movement skills, such as a reverse rollator to aid walking which provides minimal balance support to aid a child to maintain body position at the same time enabling active functional walking across different surfaces and settings. Whereas, with children at GMFCS IV and V, task and environment are combined to reduce demand and difficulty of movements through providing permanent adaption of their environment, such as a using a supportive seat to control trunk, hip, leg and foot alignment enabling a child to hold head upright and engage with peers or play with a toy at a table.

2.7.3 Applying motor control theories to physiotherapy

Motor control theories provide a framework for interpreting movement behaviour, guide clinical action, present new ideas and offer working hypotheses for the assessment and planning of interventions to individuals with movement impairments (Shumway-Cook and Woollacott, 2007). This section of the chapter will review the theories of motor control and their influence on physiotherapy approaches to assessment and intervention in relation to body alignment.

Motor control theories may be classified in various ways, the allocation of each theory to a group being dependent on the classification criteria (Rosenbaum, 2009).

Current models of movement control which relate to physiotherapy practice are described, and common assumptions about each are placed within a theoretical context. Implications of these assumptions for rehabilitation of movement in CP are discussed in section 2.8.1. The motor control theories, their theoretical premise and clinical implications are outlined in table 2.3:

Table 2.3: Motor Control theories, summary of their premise and clinical implications (Shumway-Cook and Wollacott, 2007).

Motor Learning Theory	Premise	Clinical Implications
Reflex Theory (Sherrington, 1906 in Levine, 2007)	<ul style="list-style-type: none"> • Basis for movement control is stimulus-response. • Reflexes combine together to create movement. 	<ul style="list-style-type: none"> • Use sensory input to determine functional motor control. • Promote control of desirable reflexes, Inhibit primitive reflexes.
Dynamical Systems Theory (Bernstein, 1976; Turvey, 1977; Kelso and Tuller, 1984; Thelen et al., 1987)	<ul style="list-style-type: none"> • Movement tasks require controlling degrees of freedom. • Functional synergies are developed coordinating multiple muscles and joint movements at once to create flexible, adaptive movement patterns. • Movement patterns self-organise within the context of environment and individual body systems. • Does not require CNS commands, rather movement control emerges as a result of physical and environmental interactions. 	<ul style="list-style-type: none"> • Movement is an emergent property from the interaction of multiple elements based on physical and dynamic properties of the body. • Variability is an important element of movement functionality – patients who have greater variability in their movement patterns are able to adapt these to optimise motor function.
Hierarchical Theories (Adams, 1971)	<ul style="list-style-type: none"> • Cortical (higher) centres control movement in a top-down structure. • Closed-loop theory: Sensory feedback is required to control movement. • Voluntary movements initiated by higher levels which inhibit reflexive movements. 	<ul style="list-style-type: none"> • Identify neural maturity and functional potential. • Normalise tone and inhibit primitive reflexes. • Facilitate typical movement patterns in normal developmental sequences.
Motor Program Theory (Schmidt, 1976)	<ul style="list-style-type: none"> • Generalised motor programmes elicit specific patterns of movement based on sensory or central stimulus – does not require reflex action. • Central pattern generators concept - rules for generating movements with common characteristics are stored. 	<ul style="list-style-type: none"> • Ability to relearn the correct rules for generating movement patterns. • Rehab movements important to functional task rather than specific muscle activation.
Ecological Theories (Gibson and Pick, 2000)	<ul style="list-style-type: none"> • Movement determined from perceptual information of the environment in relation to the intended motor task. • Effective goal orientated movement facilitated through exploration of environment. 	<ul style="list-style-type: none"> • Active exploration of environment develops multiple ways to perform the task • Facilitates discovery of best movement solution given individual movement limitations.
Systems Model (Shumway-Cook and Woollacott, 2007)	<ul style="list-style-type: none"> • Multiple body systems overlap to activate movement synergies for goal-directed task orientated movement. • Considers interaction of the person with the environment. 	<ul style="list-style-type: none"> • Movement rehab focus on goal led functional tasks. • Considers individual limitations and modification of environmental contexts to optimise motor perform.

Traditional theories of motor control, such as the reflex theory (Levine, 2007), motor programming (Schmidt, 1976) and hierarchical theory (Adams, 1971), describe movement control as a top-down process in which the CNS function as the focal control point for movement tasks. Lower centres are thought to be inhibited by higher centres within the CNS, such as the motor cortex, in order to regulate movement (Kenyon and Blackinton, 2011).

According to these top-down theories, the loss of this inhibition from the higher centres results in individuals with CNS damage having movement dysfunctions (Shumway-Cook and Woollacott, 2007). Without this inhibition, abnormal movement patterns are thought to emerge as reflexes govern movement control (Shepherd, 2001). Similarly, these theories view motor development as arising in accordance with brain maturation (Schmidt et al., 2018).

In contrast to these top-down theories, systems theory (Shumway-Cook and Woollacott, 2007), dynamic systems theory (Bernstein, 1976) and ecological theory (Gibson and Pick, 2000) conceptualise movement control as a process that results from the interaction of the multiple factors and systems working together to generate controlled movement. Bernstein (1976), considered by many to be the founder of systems theory (Kenyon and Blackinton, 2011), described the body as a mechanical system with a vast number of joints and muscles, termed degrees of freedom, that need to be controlled during any movement task. Bernstein (1976) stated that the many degrees of freedom alongside the effects of gravity are controlled, organised, and coordinated by CNS through movement synergies. Dynamic theory also describes motor control as a self-organising system, meaning movement arises based upon system demands, as opposed to being controlled by higher CNS centres (Thelen, 2005). The concept of control parameters are specific to this theory, these are variables that if changed, result in changes within the movement control system (Kenyon and Blackinton, 2011). In contrast, ecological theory describes movement organisation occurs as a result of interactions between the environment and goal-orientated movement tasks (Gibson and Pick, 2000).

Ecological theories also describe perception, rather than sensation, as playing a greater role in movement action (Shumway-Cook and Woollacott, 2007).

Within the field of neurology many researchers recommend adoption of a systems model of motor control, incorporating neurophysiology, biomechanics and motor learning principles which also considers learning solutions based on the interaction between the individual, the task and the environment (Cano-De-La-Cuerda et al., 2015; Rosenbaum, 2009; Shumway-Cook and Woollacott, 2007). The systems model (Shumway-Cook and Woollacott, 2007) is reflective of current physiotherapy clinical practice in children with CP and posture management. The assessment of an individual's constraint, such as body alignment, enables the environment to be appropriately adapted, through postural equipment, supporting functional tasks (Novak et al., 2020). The theoretical foundations of the systems model directly underpinned the CABA's development.

An integrated motor-control theory, which represents key elements of hierarchical, systems, dynamic action, and ecological theories, was presented in the description of postural control (figure 2.5). This integrated systems-based theory conceptualises movement as a process resulting from the interaction of the individual, the task, and the environment (Graaf-Peters et al., 2007; Massion, 1998). This theory reflects many of the concepts of other systems-based theories, in which movement is thought to be generated by an individual to meet the demands of a specific task performed within a specific environment (Cano-De-La-Cuerda et al., 2015; Kenyon and Blackinton, 2011; Shumway-Cook and Woollacott, 2007).

Physiotherapy practice is often focused on specific body impairments and individual constraints that influence an individual's ability to complete movement activity tasks (Kenyon and Blackinton, 2011; Pountney et al., 2004). A clinical approach that also recognises the influence of the task and the environment on an individual's execution of a specific functional movement activity, body alignment and postural control may help physiotherapists to better support functional movements (Novak

et al., 2020; Pavao et al., 2013; Farley et al., 2003). These key areas are central in the planning and delivery of postural interventions (Pope, 2007). Therapists often change the environment through provision of adaptive equipment to support body alignment in order to facilitate task completion and goal attainment (Hill and Goldsmith, 2010). Although physiotherapists may not always be aware of the theories they use to guide postural interventions, clinical practice is a reflection of a therapist's philosophical approach towards the causes of movement dysfunction (Kenyon and Blackinton, 2011; Shumway-Cook and Woollacott, 2007).

2.8 Theoretical underpinning of clinical approaches

Neuro-rehabilitation is increasingly taking account of scientific findings (Skoutelis and Dimitriadis, 2016). Research areas directing rehabilitation are neurophysiology; adaptability; biomechanics; skill learning; and exercise science such as task and context specificity (Carr and Shepherd, 2006). Understanding impairments and adaptations to movement enables a reflective review of interventions, for example, changes in motor control resulting from CNS impairments and secondary soft tissue changes (Shepherd, 2001). There is increasing evidence on the effectiveness of many newer methods of intervention, developed out of recent scientific investigations and focusing particularly on a task-orientated approach (Carr and Shepherd, 2006).

This has shown a shift in emphasises from neurofacilitation approaches, most notably the Bobath approach, which was developed from motor control models of reflex and hierarchical (Graham et al., 2009), towards a contemporary task-orientated approach which not only incorporates reflex and hierarchical theoretical models but also system motor control theories (Skoutelis and Dimitriadis, 2016) (table 2.4).

Table 2.4: Underlying assumptions and clinical application of neurofacilitation and task orientated rehabilitation approaches (Shumway-Cook and Woollacott, 2007).

Rehabilitation Approach	Underlying assumptions	Clinical application
Neurofacilitation	<ul style="list-style-type: none"> • Normal movement results form a chain of reflexes organised hierarchically within the CNS • Incoming sensory information drives movement patterns. • Abnormal reflexed occur due to lesions in the high cortical CNS leading to abnormal movement. • Abnormal movement patterns are a direct result of the CNS lesion. • Inhibition of abnormal movement patterns through facilitation of normal movement patterns will return functional skills. • Repetition of normal movement patterns will automatically transfer to functional tasks 	<ul style="list-style-type: none"> • Examination focus on absence or presence of abnormal reflexes. • Intervention aims to modify reflexes which control movement. • Sensory stimulation is used to modify CNS organisation of movement patterns /responses. • Regaining normal patterns of movement. • Shifting emphasis to incorporate functional training with reduced emphasis on retraining normal movement pattern.
Task-orientated	<ul style="list-style-type: none"> • Movement emerges as an interaction between multiple systems. • Organisation of movement is behaviour or goal driven. • Movement is constrained by the environment. • Sensory input results in predictive and adaptive movement, rather than just stimulus / response. • Impairment in one or more systems results in abnormal movement. • Abnormal movement patterns are a result of compensatory strategies from remaining functioning systems – these are not always optimal. • Emphasis on improving the efficiency of compensatory strategies. 	<ul style="list-style-type: none"> • Focus on movement which is functional and based on specific task. • Retraining of movement by practicing functional tasks. • Adaptation of the environment to aid function. • Problem solving issues related to functional task. • Development of a variety of ways to achieve functional task rather than a single repetitive normal movement process.

Task-orientated approach, also termed as a motor learning approach, has assumptions which are markedly different from those underlying the neurofacilitation approach (Kenyon and Blackinton, 2011). Most notably is the emphasis of a goal orientated, problem solving emphasis to achieving functional

movement. This is based on the systems theory that movement and posture is influenced by multiple systems, the individual, task and environment as discussed earlier in sections 2.6: Theoretical framework of postural control and 2.7.2: Understanding control of movement (Cano-De-La-Cuerda et al., 2015). Clinical practice has moved away from rigid top-down models of motor development to more integrated function based approaches to rehabilitation (Cano-De-La-Cuerda et al., 2015). Concepts of participation, problem solving and generalisability are now at the forefront of neuro-rehabilitation clinical approaches (Novak et al., 2020).

This is evident in patient led outcomes being at the forefront of modern healthcare (CSP, 2012). The use of patient-reported and experience measures to demonstrate success of physiotherapy interventions, denotes a significant change of emphasis towards patient goal focused health care interventions (Kyte et al., 2015). This is reflected in a shift in clinical rehabilitation approaches which has seen a move away from rigid CNS organisation and modification models (Skoutelis and Dimitriadis, 2016), such as Bobath (Graham et al., 2009), towards a task orientated approach where interventions are tailored and evaluated based on individual needs and goals (World Confederation for Physical Therapy (WCPT), 2019; Kenyon and Blackinton, 2011). The shift in clinical practice in response to the emerging concepts from the field of motor control show just how dynamic and closely linked clinical practice and scientific theory are.

Clinical approaches which focus on correction of body alignment and posture in children with CP fit well within the theoretical framework of a systems theory approach. Enabling a child's movement and function to be as efficient and effective as possible across various settings is a central aim of postural interventions (Curtis et al., 2018; Pountney et al., 2004). Therapists routinely take into account individual constraints in body structure and adapt the environment to provide support to body alignment to maximise opportunities to function (Pope, 2007). Demonstrating that body alignment as part of a rehabilitation technique relates strongly to a task orientated approach. This establishes that body alignment plays an important role

in therapeutic interventions surrounding posture and movement in children with CP.

2.8.1 Clinical application to children with CP

Children with CP who are more severely affected, rated at GMFCS levels IV and V are unlikely to have reached or progressed through their developmental stages (Palisano et al., 2007). As a result, the ability to achieve functional movements, such as to maintain head control in prone, or achieve independent sitting or maintain balance in sitting, are significantly impaired (Rosenbaum et al., 2008). In addition, a number of children will have abnormal tone, an immature nervous system with the presence of one or more primitive reflexes (Curtis et al., 2018; Rosenbaum et al., 2008) and will fail to develop the higher skill sets required for postural control, a skill they may never achieve (Pavo et al., 2013).

Children with CP at GMFCS IV and V exhibit the most significantly impaired development and movement; typically exhibiting little to no antigravity movements, impaired body alignment and reduced selectivity to adopt positions of stability (Palisano et al., 1997). Movement impairment means postural control skills may be unattainable and motor development significantly impaired (Dusing and Harbourne, 2010). Consequently, these children have severe difficulties moving from the positions in which they are placed (Rodby-Bousquet et al., 2013). This movement impairment combined with the environmental effects enhances the development of asymmetrical body segment alignment postures (Scrutton, 2008).

The adoption of asymmetrical postures contributes to impaired movement and posture deformities in children with CP (Rodby-Bousquet et al., 2013; Porter et al., 2008; Gericke, 2006). Early intervention and identification of body asymmetry is important in the prevention of deformity development (Gericke, 2006). Changes in muscle length, soft tissue shortening and reduced joint range not only restrict or prevent symmetrical body alignment (Porter et al., 2008; Scrutton, 2008) but leads to body linkage deformities (e.g., chest asymmetry, spine scoliosis and joint dislocation) (Porter et al., 2008). Once body asymmetry is present, the

development of asymmetrical postures has a self-perpetuating effect causing gross deformities (Goldsmith et al., 2009). Early identification and prevention of body alignment asymmetries from occurring at the outset, is a significantly important aspect in the management of CP children's posture (Rodby-Bousquet et al., 2013).

Postural alignment against gravity is profoundly difficult for these children to achieve without support (Palisano et al., 1997). In order to achieve this, they require assistance commonly in the form of posture management programmes and the use of adaptive equipment (Gericke, 2006). The use of adaptive equipment is universally used to support a child's body alignment, enabling them to adopt symmetrical positions against gravity to prevent deformity development, optimise function, offer changes of position, access different environments and facilitate social interactions (Gericke, 2006; Newman, 2005).

When considering the 'human sandwich' concept (Pope, 2007) in CP (see figure 2.1, page 17); Children at GMFCS IV and V have impaired ability to adopt stable and functional positions. Adaptive equipment is used, which supports body alignment in the absence of the child being able to do this for themselves. Therefore, the child is reliant on a therapist selecting the optimal body alignment. The gold standard aimed for in positioning, is optimal body segment alignment.

The use of adaptive equipment is universally used to support a child's body alignment, enabling them to adopt optimal alignment against gravity to prevent deformity development, enhance function, offer a change in position, access different environments and facilitate social interactions (Farley et al., 2003; Gericke, 2006; Newman, 2005; Pountney et al., 2009; Pountney et al., 2002). This therapeutic approach is termed posture management (Pope, 2007).

2.9 Posture management

Posture management is an established approach in children with CP (Gericke, 2006). Defined as "the use of any technique to minimise postural abnormality and enhance function" (Farley et al., 2003, p.449), it aims to counteract the effects of

gravity and asymmetrical postures through symmetrical optimal positioning. (Collins, 2007; Porter et al., 2007; Rennie, 2007; Carlberg and Hadders-Algra, 2005; Pountney et al., 2004; Pountney et al., 2002; Goldsmith, 2000; Fulford and Brown, 1976). Where achieving optimal body alignment is not possible, positioning equipment is employed to support body position towards as symmetrical position as possible (Farley et al., 2003).

The provision of positional equipment such as sleep systems, standing frames and specialist seating are then used to correct asymmetries, taking into account any restrictions in joint range to achieve symmetrical body alignment (Pountney et al., 2009; Rennie, 2007; Goldsmith, 2000). Furthermore, this intervention is applied within various environmental settings that the child accesses such as school, home, respite and therapy centres (Humphreys and Pountney, 2006; Farley et al., 2003). This illustrates the potentially therapeutically diverse components that accompany the reality of implementing and assessing body segment alignment and posture management in daily practice (WHO, 2007).

Current literature recommends that children with CP of GMFCS levels IV and V should all be receiving posture management intervention (Pountney et al., 2009; Gericke, 2006). Managing posture alignment in children with cerebral palsy has long been an established intervention (Pountney et al., 2009; Gericke 2006; Farley et al., 2003; Goldsmith et al., 1992). Multiple studies using a variety of methods have documented the positive effects posture management has in children with CP (Pountney et al., 2009; Pountney et al., 2002; Vekerdy, 2007; Farley et al., 2003; Goldsmith, 2000). For example, hip displacement was prevented and occurrence of hip problems reduced in children who used adaptive equipment to support their body alignment (Pountney et al., 2009). Managing a symmetrical body alignment improved trunk and spinal position, resulting in improved function such as head control and feeding abilities (Vekerdy, 2007). Collectively this research-base advocates a 24-hour approach in the use of adaptive equipment, this approach requires supporting optimal body alignment, across all postures a child adopts

across their day and night typically, lying, sitting and standing positions (Gericke, 2006).

Implementing a 24-hour approach to posture management is a complex area, with issues surrounding equipment. Pountney et al (2009) identified that, although equipment use was variable, the least used item of equipment was the lying support. They state that the use of this dropped off significantly between the ages of 30 and 60 months, hypothesising that other associated health complications and sleep disturbances could be possible reasons for equipment not being used. Several studies have found that many children with CP have sleep problems and are compromised with their respiratory system and reflux when in a lying position, making successful night time positioning a particularly problematic area (Hill et al., 2009; Khan and Underhill, 2006; Hankinson and Morton, 2002; Goldsmith, 2000). However, this is not to say that lying supports do not have a place within posture management; Pountney et al (2002) found that lying supports can provide a long period of stretch, and are an essential aspect of managing hip position. Other recent studies have indicated that the use of lying supports improved sleep patterns (Collins, 2007; Goldsmith, 2000), and have highlighted that lying is a fundamental position which aids development and prevents deformity (Hong, 2005).

Common barriers to equipment use were identified by Maher et al (2011) who reported the main issues to be timely provision of correct quality equipment, and ease of its use. This has been echoed in other studies; according to Hong (2005) careful assessment and support was required, to ensure the most appropriate piece of equipment is provided. Provision of equipment that incorporates environment, personal factors and is easy to use is essential to ensure correct and successful equipment provision and use (McDonald et al., 2007). Equipment selection may also depend upon a number of factors, such as comfort, acceptance, quality and ease of use (Collins, 2007; Taylor-Cookson and Mitchell, 2001). These findings indicate that equipment choice, the goals surrounding its implementation and the support given, are key factors to consider when providing equipment.

The 24-hour approach to posture management has been challenged by some authors who suggest this approach to be unnecessary, over burdensome and may have negative effects to pain and lack of compliance (Gough, 2009). Evidence to support this approach is limited; Pountney et al (2009) found that using a combination of standing, lying and sitting equipment for a minimum of 6 hours a day or more, achieved significant improvement in posture and hip position. Whereas Pountney et al (2002) indicated that children who used equipment in standing, lying and sitting over a 24-hour period, were significantly more likely to maintain hip integrity than children using other combinations. Alternatively, Gough (2009) argued that continuous posture management created more barriers than benefits and highlights a lack of guidelines surrounding posture equipment provision. Whilst various studies have endorsed positioning as an essential part of a therapy programme with children with movement problems (Case-Smith, 2001; Chia and Howard, 2000; Burns, 1996; Diamant, 1992), with some making recommendations for the use of a 24-hour approach (Collins, 2007; Hong, 2005; Goldsmith, 2000). The current evidence lacks specificity in benefits of posture management and practicability across the complex and heterogenous population of children with CP.

Early postural intervention programmes have shown to reduce the need for more intensive procedures, and surgery later (Pountney and Green, 2006). Good positioning from an early age helps reduce muscle tone and maintains body symmetry (Goldsmith, 2000), by reducing the predisposing factors to hip migration and subsequent dislocation (Young et al., 1998; Fulford and Brown, 1976). Early identification and assessment of alignment issues and their correction are a fundamental aspect of posture management if the use of positioning equipment is to be efficient and successful (Humphreys and Pountney, 2006; Pountney et al., 2004; Goldsmith, 2000).

Interest in the posture of children with CP has been driven by the recent shift in the recognition of the role posture management programmes have within deformity prevention and rehabilitation (NICE, 2012). The key drivers for national and local

change within the National Health Service (NHS) are widely recognised as being through National Service Frameworks (NSF) and guidelines produced by the National Institute for Clinical Excellence (NICE). Two known publications relevant to this are; the NICE Spasticity in under 19's management guidance (NICE, 2012). This paper recommends assessment and goals focus on the domain of body structures and intervention should consider using 24-hour posture management strategies (NICE, 2012). The other paper is the NSF for long term conditions (DoH, 2005). This paper included aspects which related to the care, treatment and service provision for children with CP; as well as including other conditions linked to severe physical impairment (DoH, 2005).

Public Health England (2018) published guidance on postural care in people with learning disabilities. This guidance identifies assessment of body alignment as an important issue, stating that measurement of body asymmetry is fundamental to evaluating outcomes of posture management interventions. The Goldsmith Indices of Body Symmetry (Goldsmith et al., 1992) is mentioned as an assessment, however, evidence to support it as a standardised outcome measure is lacking in the guidance (PHE, 2018). Furthermore, MENCAP published a report Raising Our Sights (Mansell, 2010); within this publication it recognises the need for posture management, and acknowledges the associated problems such as movement difficulties, breathing and eating problems. Whilst these reports make clear that physiotherapy services should be utilising standardised assessments of body alignment and implementing posture management strategies, they lacked specificity on the detail and composition of measures and provision. This signifies that there is still a need for a collective approach, to ensure accurate assessment of body posture and equality in service provision.

A recent scoping review of the relevant research literature by Robertson et al (2018) identified a number of gaps in the evidence base. Effect-studies of posture management programmes for children with CP frequently use outcome measurements which examine motor function or x-rays of a specific joint to evaluate the effectiveness of posture management interventions (Pountney et al.,

2009; Pountney et al., 2002), making them difficult and lacking in relevance to put into clinical everyday practice. Despite the recognition that posture management involves assessment of total body alignment (Gericke, 2006; Hong, 2005; Farley et al., 2003), there is a paucity of evaluative studies which utilise clinical assessments that measure body alignment in posture management. Given the proposed population a tool to measure posture needs to encompass more than just one aspect of body position as CP children often have global body involvement (Hadders-Algra, 2013).

2.10 Assessment

Paediatric rehabilitation has seen an increase in the measurement tools used clinically (Dewar et al., 2015). Several tools used frequently in rehabilitation evaluate a broad spectrum of postural abilities (Argetsinger et al., 2019; Rodby-Bousquet et al., 2016; Barlett and Purdie, 2005; Pountney et al., 1999), but may not be sensitive in measuring total body alignment and detecting changes within specific dimensions of this (Butler et al., 2010; Dusing and Harbourne, 2010). During assessment, body position is often determined through an observational judgement of whether the child's posture has improved when they are supported in adaptive equipment (Hong, 2005). This approach is subjective in its assessment, in common with other visual or tangible methods of quantifying body position such as a body angle measurement, range of movement at a specified joint and palpation of body landmarks (Fortin et al., 2011).

Therapists regularly use their observational skills to judge body alignment (do Rosário, 2014). Although observational assessment is not standardised, it does enable early identification of changes in body alignment, and the impact of equipment use, to be evaluated. By determining the amount of change in body alignment towards optimal, therapists are able to make an observational, subjective, judgement on the impact a piece of equipment has on an individual's body alignment (Hong, 2005).

Current measures of postural abilities whilst reporting some aspects of psychometric testing, have not been evaluated to meet all criteria for instrumental development (Pavao et al., 2013). Observational posture analysis has not been widely utilised in children with CP, however, it has been explored within the field of ergonomics. Observation based posture assessment methods are widely utilised to quantify working postures and calculate the risk factors, as a result of job design and demand (Lowe et al., 2014). These ergonomic assessments include body alignment, static and dynamic movement, repetition and force items that are considered important parts of safe working limits (Sutherland et al., 2008). Whilst the focus of ergonomic observation-based assessment may not transfer directly to CP their method of posture classification provides a structured approach to classification of body alignment within clinical assessments.

It is important that assessments are able to be used flexibly by therapists within clinical practice (Sarathy et al., 2019). Quantifying observational assessment of body posture would support changes to be determined accurately and quickly as an integral part of a child's day-to-day function, instead of in a one-off specific position, setting or task (Goldsmith et al., 2009). This is in keeping with the International Classification of Functioning, Disability and Health (ICF) (WHO, 2007) approach to disabilities, which advocates a collaborative holistic framework, taking into account context of needs, wishes, lifestyle and environment of the individual (See figure 2.8). The framework gives emphasis to dynamic interaction between contextual factors and health conditions and allows for assessment between the abilities of an individual and the functioning of that individual in different environmental contexts (Odom et al., 2007). This is important for CP children as they make up a highly heterogeneous population, with clinical assessment occurring across diverse environmental settings (Sarathy et al., 2019).

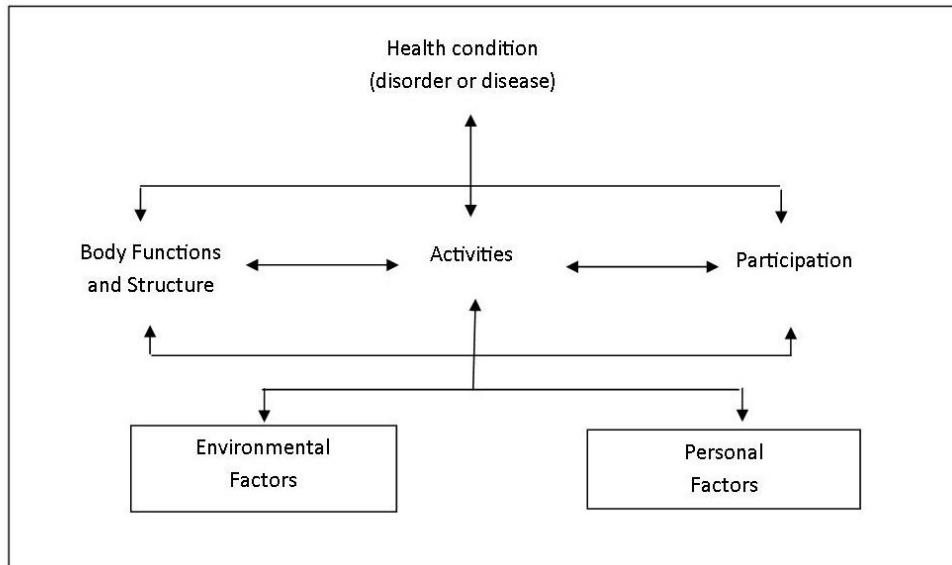

Figure 2.8: The ICF Model: Interaction between ICF components (WHO, 2007).

The lack of a standardised approach to observation of body alignment has resulted in therapists developing their own assessment instruments. This is often dependant on the local therapists' knowledge and expertise (Humphreys and Pountney, 2006), resulting in inconsistent and unregulated approaches to assessment of body alignment and evaluation of posture management interventions.

Measuring outcomes at a clinical level has been an established practice for some time (Stokes, 2011). The use of standardised, validated outcome measures in clinic practice is an explicit requirement of the Chartered Society of Physiotherapists (CSP) Quality Assurance Standards (CSP, 2012). The CSP acknowledge that with outcomes increasingly becoming the currency of modern healthcare, patient-reported outcome measures (PROMs) and experience measures (PREMs) are important to demonstrate the success of physiotherapy (CSP, 2012). PROMs were introduced into the NHS in England in 2009, marking a significant change of emphasis to a desire to measure the impact of health care interventions from the patient's perspective (Kyte et al., 2015).

The government's NHS white paper *Equity and Excellence: Liberating the NHS* (DoH, 2010) recommended that PROMs and PREMs be used wherever practicable. Since

then, commissioners and service planners have increasingly included PROMs and PREMs in their service and treatment specifications. They have become a routine element in clinical governance and service redesign. The Health and Care Professions Council (HCPC) reflects this evolving need for quality assurance in Standard 12 of the Standards of Proficiency for Physiotherapists (HCPC, 2016) which states that registrant physiotherapists must be able to assure the quality of their practice. This includes gathering qualitative and quantitative data, participating in audit activity, using appropriate outcome measures and evaluating interventions to ensure they meet service users' needs and changes in health (WCPT, 2019). This indicates the vital role standardised assessment and outcome measurement can play in enabling physiotherapy services to demonstrate their cost- effectiveness and impact. This is particularly pertinent to posture management in CP, where there is a paucity of standardised assessments to enable therapists to evaluate and evidence the impact, they have on body alignment.

Various methods of quantifying body alignment are suitable in a research or lab-based environment. Translation of these methods into a clinical environment is, however, difficult. Radiological images are used to assess or monitor change in body structure and spinal alignment over time (Fortin et al., 2011). Radiographs are invasive and thus cannot be used for frequent repeated measures of body segment posture (Tyson and DeSouza, 2003). 3D posture analysis or topography systems can be used to quantify and assess posture (Pazos et al., 2005). Assessment of body alignment in children with CP can often only be achieved with at least two people surrounding the child, especially if the child cannot sit or stand unaided (Sarathy et al., 2019). This can affect the accuracy of measurement as markers can be obscured. Additionally, 3D systems are not readily or easily accessible for clinicians; they are expensive, with demanding data collection protocols and processes making them impracticable in a clinical context (Fortin et al., 2011).

It has already been established that impairment in body alignment impacts on body functions, participation and quality of life in children with CP (Scrutton, 2008; WHO, 2007). Accurate measurement of a child's postural alignment is important in the

provision of posture managing equipment to prevent postural deformities, optimise functional potential and improve a child's overall quality of life (Hill and Goldsmith, 2010). There is a need for assessment tools used in research and clinical practice to establish the evidence for the development and psychometric properties of body alignment measures in children with CP (Fortin et al., 2011). The ability for research and clinicians to accurately measure changes made to a child's body alignment through the provision of positioning equipment would enable the impact and effectiveness of postural interventions, in terms of alignment to be evaluated.

In order for assessments used for measurement of change to be meaningful, relevant and effective, they need to be standardised (Finch et al., 2003). Assessments for both clinical and research use are expected to demonstrate good performance in psychometric characteristics of validity, reliability and responsiveness (Terwee et al., 2003). Closer adherence to the principles for comprehensive assessment construction and empirical field testing, prior to experimental studies being undertaken, would do much to improve the overall quality of research in physiotherapy, CP body alignment and posture management.

Test theory provides a general framework for viewing the process of assessment development (McDonald, 2013). The principles of test theory have been uniquely derived to meet the specific measurement needs of researchers in social sciences (Miller and Lovler, 2018). Within the broader framework of research and evaluation methodology, test theory is a process of inquiry consisting of well-defined stages characterised through the testing of psychometric characteristics (Brennan, 2010). The tenets of test theory have relevance and fit well into the evaluation and development of clinical body alignment measures in CP and are discussed in greater detail in chapter 4.

The psychometric properties of current clinical assessment used in practice to measure body alignment will be explored and critiqued in chapter 3. Obtaining and evaluating the evidence on how assessments relate to the construct of body

alignment and CP and are applicable within the real world is the ultimate challenge in assessment development.

The model of posture described by Pope (2007) takes into consideration the constructs of CP and postural alignment. Posture for these children is not a temporarily arrested movement, but a permanent position they adopt as they are unable to change their position independently. Their stability and function are solely dependent on their body alignment, if this alignment is not optimal it can impact on the stresses placed on the body resulting in the development of postural deformities (Shore et al., 2012; Pountney et al., 2009; Porter et al., 2008; Pountney et al., 2004). How children with CP are positioned, how assessments of this support take into account not only the deviation but also correction of body alignment which impact on posture, is vital in maintaining a stable and efficient BoS from which these children can function from.

2.11 Implications for children with CP.

As outlined earlier in this chapter, a child's GMFCS classification level not only describes the effects on motor development but also indicates the degree to which body alignment problems may be present (Rennie, 2007; Finnie, 1997). The higher the GMFCS level is, the greater the difficulty in maintaining body alignment which predispose to the development of asymmetrical postures (Gericke, 2006; Goldsmith, 2000). The literature indicates that a child at higher GMFCS Levels and non-ambulant is particularly vulnerable to developing body alignment deformities (Rodby-Bousquet et al., 2013; Palisano et al., 2007; Porter et al., 2007; Pountney et al., 2004).

The GMFCS has been widely used for clinical, research and administrative purposes. It has been adopted internationally and used as a stratification system to describe important and significant differences, in rates and limits of gross motor ability among individuals with CP. It is supported by robust studies to support its validity and reliability and, consequently, is the benchmark of classification of CP presentation in research (Palisano et al., 2008; Rosenbaum et al., 2008; Palisano et

al., 2006; Morris and Bartlett, 2004; Bodkin et al., 2003; Wood and Rosenbaum, 2000; Palisano et al., 1997).

Individuals with CP who have impaired voluntary control of movement affecting their whole-body, fall into classification level IV and V (Rosenbaum et al., 2008). These individuals have extremely limited movement and find control of posture against gravity extremely difficult (Palisano et al., 2006). In 2005, Ostensjo et al found the use of assistive devices and other environmental modifications increased with GMFCS level, in use by 80% of children with GMFCS levels IV and V. More recently, a cross-sectional study found 42% of children with CP used adaptive seating (Rodby-Bousquet and Hagglund, 2010). None of the children classified as GMFCS level V and only 5% of children classified at GMFCS level IV could sit in a standard chair (Rodby-Bousquet and Hagglund, 2010). This indicates that this group of children required the use of adaptive equipment to support their body alignment against gravity. As outlined in chapter 1, assessment of body alignment is essential in order to develop an accurate therapeutic plan to target promotion and maintenance of posture.

Whilst the GMFCS provides a framework for grouping and comparing children with CP, they are heterogeneous classification levels with variation of abilities of children within each specific level (Bodkin et al., 2003). CP can present in a varied number of ways, dependent on the location and area of the brain that has been affected (Baxter et al., 2007). Common terminologies used to identify types of CP are spastic, ataxic and athetoid; these describe the movement patterns associated with central nervous system injury (Morris, 2007). Another set of terminologies used alongside this identifies the different parts of the body affected; hemiplegia means only one side of the body being affected, diplegia indicates that the legs are affected but not the arms and Quadriplegia indicates both the legs and arms are equally affected (Rosenbaum et al., 2007). It is also important to recognise that CP can affect the entire body, and a combination of several types and body presentations are typical in a diagnosis of CP (Finnie, 1997).

This diversity is reflected in the gross motor development curves which give prognosis of motor function abilities based on age and GMFCS of CP (Rosenbaum et al., 2002). This has been applied within the Gross Motor Function Measure, a clinical assessment which assesses movement in children with CP in relation to their GMFCS level (Russel et al., 2002). Percentile curves enable therapists to view the degree of ability and motor variability each child has within their GMFCS level (Rosenbaum et al., 2002). This enables therapists to determine a child's motor abilities at a specific time; be this the top, middle or lower aspect of the percentile curve (Hanna et al., 2008).

The GMFCS sits within the framework of the World Health Organization's ICF (WHO, 2007). The ICF defines health as "a state of complete physical, mental, and social well-being and not merely the absence of disease or infirmity" (WHO, 2013 p.6). This is a collaborative holistic framework which considers the context of needs, wishes, lifestyle and environment of the individual and those concerned with his or her care (see Figure 2.8). The ICF offers a context for interpreting body alignment within the wider impacting factors of health. Whilst body alignment and posture fit within the body function and structure component unit of the ICF this area is interlinked with the units of activities and participation, in relation to an individual's disability and function (WHO, 2007). These components interact in contextual aspects of environment and personal factors to give a holistic view of an individual's functioning disability (WHO, 2013). To make linear inferences from one component to another is incorrect, rather contextualising function, health and disability is inclusive of multiple domains and their interaction with one another.

The ICF has helped shape perspectives on childhood disability within health care and offers a model of disability and function, which is holistic and bio-psychosocial in orientation (Shevell, 2009). The framework gives emphasis to the continual bi-directional dynamic interaction between contextual factors and health conditions and allows for "examination of the dynamic relationship between the abilities of an individual and the functioning of that individual in different environmental contexts" (Odom et al., 2007, p.9). This is representative of the systems theory

approach to motor control and is important for CP children as they make up a highly heterogeneous population. McDonald et al (2007) presented this ICF framework to address the area of adaptive seating for children encouraging professionals working with children with movement and communication difficulties to take account of the potential limiting factors of an individual's disability. Terzi (2005) recommends that using the ICF framework within educational settings would facilitate the adoption of flexible approaches to learning, teaching, and assessment to maximise learning, participation and physical development. The GMFCS sits as a comprehensive system of classifying CP difficulties within the frameworks of postural and motor control approaches in physiotherapy practice discussed earlier in this chapter. As such it provides an indication of body alignment needs children with CP at different classified levels may require. This enables physiotherapists to identify those at risk children who require assessment of their body alignment and enables posture management approaches to be implemented timely and effectively.

As an approach, posture management correlates directly to the International Classification of Functioning, Disability and Health (ICF) (WHO, 2007) as an integration and interaction of physical, individual and social factors. The need for the use of adaptive equipment as part of posture management means that often, children with CP at GMFCS IV and V are in set positions for prolonged periods of time across their day (Hong, 2005). This has a compounding effect on issues such as pain, pressure, soft tissue adaptations and joint stiffness (Pope, 2007). Posture management programmes are extensive; although they are primarily about supporting body segment alignment through adaptive equipment (Gericke, 2006). This illustrates the potentially therapeutically diverse management of the severe issues that accompany poor body alignment, all having a significant impact on a child's health, function, wellbeing and comfort.

2.12 Implications for therapy intervention

Posture management is an established therapy approach in children with CP, utilising positioning equipment to correct body alignment, minimise postural deformity and enhance function (Gericke, 2006; Carlberg and Hadders-Algra, 2005; Newman, 2005). As discussed earlier; this approach involves a therapist observing and assessing a child's body alignment in lying, standing and/or sitting throughout their development and growth (Hong, 2005).

This informs interventions, treatment planning and outcomes (Pountney et al., 2004). The very nature of implementing a posture management approach means that measurement of body alignment is an inherent part of a therapist's assessment (Pope, 2007). It establishes a baseline of body position; this enables early changes in body alignment to be identified and preventative intervention to be implemented, and outcomes of treatment to be measured through changes and correction of body alignment. Whilst assessments of body alignment only measure one aspect of health as defined by the ICF (Who, 2007), the association this has with the components of activity and participation in relevant and meaningful contexts is clear. Consequently, clinical assessments which measure the construct of body alignment among children with CP need to be reflective of how this varies in respect to environmental factors such as support surface, gravity and postural position to be applicable to real life.

As discussed earlier, the presentation of CP is variable and multifaceted in its clinical presentation, with a variety of individual constraints (See table 2.1, page 24). This means therapists must look at various aspects of a child such as body alignment supporting surface and environment when looking to support and develop functional movement. When analysing constraints on movement tasks in children with CP, physiotherapists must not only consider neuromuscular constraints on action but also consider biomechanical factors such as the specific muscle strength and the range of motion (ROM) required for the movement (Carlberg and Hadders-Algra, 2005; Butler and Major, 1992).

Such consideration may mean supporting body alignment in the absence of the child being able to do so in order to perform a motor task (Pountney et al., 2004). Therapists may also need to consider restriction in joint range and muscle shortening resulting in limitations of fixed positions of the body (Hong, 2005). Although ideally body alignment would be corrected to optimal, this may not be completely achievable and, therefore, the impact this may have on task completion or movement needs to be taken into consideration when devising programmes and goal setting (Pavao et al., 2013; Farley et al., 2003).

Assessment instruments utilised in research studies to demonstrate the outcome and effectiveness of posture management, such as single joint X-rays (Pountney et al., 2009), motor function and movement abilities (Pountney et al., 2002), are diverse and show little correlation to posture deformity or body segment alignment. Consequently, there is little high-quality data available on posture management effectiveness in children with CP (Farley et al., 2003). Few clinical measurements of body alignment demonstrate psychometric properties or specificity in the assessment of body alignment (Rodby-Bousquet et al., 2016), meaning that therapist's abilities to accurately and objectively evaluate posture management approaches are impaired.

Clinical guidelines lack specificity, with recommendations for practice referring to classification groups of children with CP and collective posture management interventions (PHE, 2018; NICE, 2012; Mansell, 2010; Gericke, 2006). A lack of differentiation between presentation of CP and types of posture management limits directed specific interventions (Farley et al., 2003). Currently physiotherapists have general all-encompassing guidance which fails to recognise the individualised constraints child with CP present with (Carlberg and Hadders-Algra, 2005).

This is unrepresentative of everyday clinical practice whereby therapists use comprehensive assessment to identify the correct piece of equipment (Hong, 2005), taking into consideration practicalities within family life (Castle et al., 2014). With research demonstrating that the use of equipment varies across positions

(Pountney et al., 2009) and that equipment choice, the goals surrounding its implementation and the support given, are critical to ensure equipment is not only correct but also usable within the various environments the child interacts within family life (Castle et al., 2014; Maher et al., 2011; Collins, 2007; McDonald et al., 2007; Taylor-Cookson and Mitchelle, 2001). As discussed earlier, application of positioning equipment following a 24-hour approach across lying sitting and standing has significant compliance issues (Gough, 2009). Evidence to support the efficacy of such an approach lacks the complete representation of clinical applicability. Whilst some studies evaluate aspects of posture management (Pountney et al., 2009; Vekerdy, 2007; Pountney et al., 2002), collectively these studies endorse a 24-hour approach to be effective, this assumption has not been validated within clinical data.

Therapists are under increasing pressure to justify their approach and use of funding resources for equipment being a major focus of this (Robertson et al., 2018). It would be useful to have studies looking at the potential cost effectiveness of postural care services (PHE, 2018). Evidence has proposed that if better provision of equipment which supported body alignment resulted in reduction in secondary complications such as surgery, the costs of the equipment could be recuperated (British Healthcare Trades Association (BHTA), 2014). With funding sources wanting to know that their resources are being effectively used (Lenker et al., 2005), therapists are becoming more critical of their assessment choices as they tailor intervention strategies to adopt an evidence-based approach (Majnemer and Mazer, 2004); whilst research is being more specific in the criterion for measures selected to explore treatment effectiveness and evaluation of programmes (Beaton et al, 2001). Studies examining postural interventions which can give clear recommendations on the type of posture management intervention that is most effective across specific cohorts of children with CP would be far more beneficial in supporting therapists to focus on practical solutions which provide the best outcomes.

Standardised assessments are essential in ensuring clinical approaches can evidence their effectiveness and outcomes (Fawcett, 2013). Posture management is no exception to this; standardised assessments of body alignment which are applicable within everyday clinical practice and responsive to changes in asymmetry are essential in evaluating current posture management practices (WCPT, 2019; Dean et al., 2014). A standardised clinical body alignment assessment is required to enable a relevant and applicable evidence base to be established.

2.13 Conclusion

Posture is adaptive, changeable and, therefore, difficult to easily quantify. The definition of posture in this chapter is underpinned by the establishment of body alignment, postural control and motor development skills. The ability to achieve antigravity body alignment is an important fundamental component of movement and postural control. For those children with CP at GMFCS IV and V with severe difficulties in attaining body alignment, their stability, movement and function are greatly dependent on their body segment alignment (Pountney et al., 2009; Porter et al., 2008; Pountney et al., 2002).

CP children at GMFCS IV and V require posture management programmes, primarily the use of adaptive equipment (Gericke, 2006), to achieve body alignment against gravity. A symmetrical body alignment is considered the gold standard for positioning in posture management (Fulford and Brown, 1976). Failure to support body segments in symmetrical alignment is conducive to deformity development such as, spinal scoliosis and hip dislocation (Scrutton, 2008), impacting on a child's health, function and comfort.

Little high-quality evidence is available to support posture management approaches (Gericke, 2006). Current clinical assessments lack specificity and psychometric properties among children with CP, meaning therapists' current abilities to accurately and objectively identify and evaluate posture management approaches are impaired.

The theoretical and clinical approaches demonstrate the importance of a clinical body alignment assessment in children with CP. The potential to assess changes in body segment alignment in clinical settings is of crucial importance to the field of paediatric rehabilitation. It is important that clinicians are able to evaluate, justify and develop posture management practices based on clear, strong clinical rationale derived from evidence-based assessment. Further critique of current clinical assessment measures, to inform the development of a standardised clinical assessment of body alignment is needed and will be explored in detail in the next chapter (chapter 3).

CHAPTER 3:

CLINICAL ASSESSMENTS OF BODY ALIGNMENT – A SYSTEMATISED REVIEW

3.1 Introduction

This chapter aims to identify and critically appraise current clinical measurements used to assess body alignment in children with CP. This is a crucial step in providing appropriate intervention and management to consistently and effectively identify changes in body alignment difficulties. In order for clinical practice and research to inform an evidence-based approach, assessment must demonstrate psychometric properties in measurement of the construct of body alignment.

This systematised review aims to provide valuable insight into the different clinical assessments, their psychometric properties and research design methods designed to measure body alignment, enabling analysis of the psychometric properties of current measurements. Furthermore, this review aims to critically review the clinical assessments used by therapist to assess and measure body alignment in children with CP, to determine if identified assessments have psychometric properties specifically for this population, outline their main characteristics and clinical application. The validity and reliability of current clinical assessment methods are evaluated, together with their place within clinical practice.

It was clearly established in chapter 2, that body alignment is an important component of postural control and motor function. Management of posture is generally considered to be related to maintaining or improving body alignment. However, this assumption has not been validated by clinical data. As summarised in chapter 2, few clinical measurements of body alignment demonstrate specificity in the assessment of body alignment and clinical guidelines lack specificity (Rodby-Bousquet et al., 2016). Accordingly, the therapist's abilities to accurately identify and evaluate posture management approaches is currently impaired.

The importance of body alignment in children with CP was discussed in the last chapter (chapter 2). Disorders in movement and posture observed in children with CP lead to adoption of asymmetrical body alignment (Pountney et al., 2009; Rosenbaum et al., 2007). The development of postural deformities can result in movement and function being severely compromised (Scrutton, 2008; Porter et al., 2007). Posture management is an integrated part of a child and families' life, applying to positions a child wants to adopt, and environments and situation they wish to access (Hong, 2005). Assessment measures which quantify body alignment among children with CP should be able to identify postural misalignment, encompass total body alignment accurately and with specificity (Scrutton, 2008).

The use of observational assessments in assessing body alignment is part of everyday clinical practice (Fawcett, 2013). However, the evidence of standardised clinical measurements of body alignment in children with CP is relatively sparse. Current standardised assessments of body alignment concentrate on body linkages rather than total body alignment. Development and severity of postural alignment asymmetry is identified through hip and or spine x-ray analysis to determine degrees of curvature or hip displacement (Gericke, 2006). Although the psychometric properties of this approach are well documented, applicability in clinical practice and therapists' daily assessment of total body segment alignment is limited.

Standardised assessments mean that therapists can justify inferences drawn from the scores to determine or evaluate clinical interventions (Kimberlin and Winterstein, 2008). Such justification has two prerequisites: validity and reliability. Validity is the degree to which assessments measure the construct it purports to measure (Stokes, 2011). As validity pertains to what the assessment intends to measure and in who, the defined population, studies evaluating an assessments validity should clearly describe the construct being measured and the target population (Roach, 2006). Content validity is the degree to which the content of the assessment sufficiently reflects the construct being measured (Mokkink et al., 2010).

Three aspects of content validity can be distinguished; firstly, relevance in which all items in the assessment are relevant for the construct being measured, and context the assessment will be applied in, secondly, comprehensiveness which means that no critical components of the construct are missing, and thirdly, comprehensibility of the assessment meaning all items should be understood by intended users, such as physiotherapists (Terwee et al., 2018). Construct validity relates to the ability of an assessment to measure the underlying concept of interest, such as CP (Roach, 2006), whereas criterion validity is the degree to which the scores of the assessment agree when compared to a gold standard test (Terwee et al., 2012). Validity alone is not sufficient in determining the psychometric properties of a measure. If an assessment does not produce consistent and repeatable findings it lacks accuracy in measuring its intended construct (Dunn, 2000). Reliability is the degree to which the assessment measure reflects true differences of the construct in the individual being measured, the amount to which the measurement is free from measurement error (Terwee et al., 2012).

Reliability of a measure is the examination of the extent to which scores for individuals when no real change has occurred remain the same (Mokkink et al., 2018). Test-retest reliability is when scores are taken over time (Roach, 2006); inter-rater reliability relates to scores taken by different persons on the same occasion, or intra-rater reliability by the same person on different occasions (Mokkink et al., 2018); internal consistency is the extent to which all of the assessment items address the same underlying concept (Roach, 2006). To accurately quantify body alignment of children with CP, assessments must be valid, reliable and have functionality within clinical settings (Fawcett, 2013). All these factors must be considered when selecting the most appropriate available assessment to use in clinical practice. There is a lack of appropriate clinical tools which address entire body posture (Fortin et al., 2011), there is also a lack of evidence supporting the strength of clinical measurement properties (Field and Livingstone, 2013).

This chapter aims to identify clinical tools used by therapists to assess body alignment in children with CP; to determine if assessments have psychometric properties specifically measured for this population, and to identify the assessments main characteristics. This was undertaken as a systematised review.

The review focused on assessment of body alignment, but also included outcome measurement of posture alignment intervention, as there is a tendency for assessment use to be identified and established alongside providing effectiveness of postural alignment interventions. Finally, it was decided to limit the search to tools used by therapists because they are the main group dealing clinically with posture in children with CP.

3.2 Method

The research method selected to explore the evidence was a systematised literature review, as this review only used one reviewer to identify articles in the selection process. A systematised review attempts to include elements of systematic review process while stopping short of systematic review, enabling appraisal of quality and limitation in methodology to be identified (Grant and Booth, 2009). The aspects used in this systematised review that are similar to that of a systematic review were a full comprehensive search within the chosen databases, quality assessment of articles and data produced in tabular form. This facilitated exploration and critical analysis of the evidence supporting assessment properties used within clinical practice in the field of CP.

A literature search was conducted using the databases AMED, CINAHL, MEDLINE, PeDro and the Cochrane Library with the search string described in table 3.1. In addition, reference lists of selected articles were reviewed along with a manual search of journals which published identified assessments over the last year of publication. Forward reference and author searching was also carried out on all selected articles. Searches were carried out from inception to March 2019.

Table 3.1: Search strings and key words.

Study group	Posture terms	Assessment	Age of interest
Cerebral palsy OR AND CP	Postur* OR Body Alignment OR Body Position* OR Anatomical Alignment OR Body Orientation OR	Measure* OR AND Outcome* OR Tool* OR Assessment*	Infant* OR Child* OR Teen*

This resulted in 491 unique hits. Original articles were selected if they fulfilled the following criteria: (1) assessed children aged 0 -18 with cerebral palsy; (2) assessed whole body; (3) description of assessment related to body alignment or position; (4) article included description and development or psychometric testing of assessment; (5) usable within health care-professional clinical practice; and (6) publication in English. Ten articles fulfilled the criteria (Rodby-Bousquet et al., 2016; Rodby-Bousquet et al., 2014; Field and Roxbourough, 2011; Goldsmith and Goldsmith, 2009; Goldsmith et al., 2009; Bartlett and Purdie, 2005; Goldsmith, 2000; Pountney et al., 1999; Goldsmith et al., 1992; Fife et al., 1991).

Papers were excluded if: (1) the primary intention of the tool was not to assess body alignment, the assessment was part of a wider assessment of other therapy interventions (i.e., postural control, balance, gait, postural stability); (2) children with CP comprised less than 30% of the total population; (3) the assessment was lab based; (4) the assessment was not designed for use by therapists; and (5) the papers were reviews. Review papers were full text screened to assist in identification of possible assessments of body alignment which might be relevant to this review.

3.2.1 Article selection and data extraction

Titles and abstracts were independently reviewed against the inclusion and exclusion criteria. Data was extracted and quality was assessed using the CanChild Outcome Measures Rating Form (Law, 2004). The methodological qualities of the studies were examined according to the McMasters critique forms (Law et al., 1998; Letts et al., 2007). Members of the supervision team helped with data extraction. The researcher and one other examined quality; if agreement could not be reached a third reviewer was consulted.

Data extraction retrieved the following information: study objectives; study design; participants' selection and characteristics; measurement tool description; findings; and conclusions. The psychometric quality of the instruments was examined in terms of reliability (inter-rater, intra-rater, test-retest, internal consistency), validity (content, criterion and construct). Quality was rated on a three-point rating scale poor, adequate or good. Reliability was graded using bands proposed by Fleiss et al (2013); less than 0.40 being poor, 0.41-0.75 adequate and greater than 0.75 good. Validity was assessed using McMaster Ratings (Law, 2004) to give an overall rating based on the number of studies completed. The validity of an assessment was judged to be excellent when more than two well-designed studies supported the instrument, adequate when there were one or two well-designed studies and poor when validity studies were poorly completed or when one or two well-designed studies did not support the instrument (Law, 2004).

3.3 Results

The initial search produced a total of 696 articles; of these 205 were duplicate titles, resulting in 491 unique articles. Inclusion and exclusion criteria resulted in a final sample of 10 articles and 7 assessments (figure 3.1). Figure 3.1 shows the process of identifying relevant articles. After reading the titles and abstracts, 135 studies were excluded according to the inclusion and exclusion criteria. Of the remaining 356 articles, 350 were excluded after full text screening. Stage one of the search identified six articles utilising five clinical assessment instruments to assess body alignment in children with CP. Stage 2 involved a manual search of the reference

lists and journals the assessments had been identified in, 91 records were identified. Of these 87 were excluded leading to a total of 10 articles and seven assessments identified and included in this review.

The methodological properties of the instruments were examined in terms of reliability and validity, as outlined above. Description of the psychometric properties of each clinical assessment is described for all 7 assessments (table 3.2 & 3.3). Firstly, an overview of the 7 clinical assessments properties is provided. Following this the psychometric properties and assessment characteristics are discussed. Finally, these findings are discussed considering the findings of assessment properties, clinical usability, overall utility (Law, 2004) and literature on the development of body alignment posture problems in children with CP.

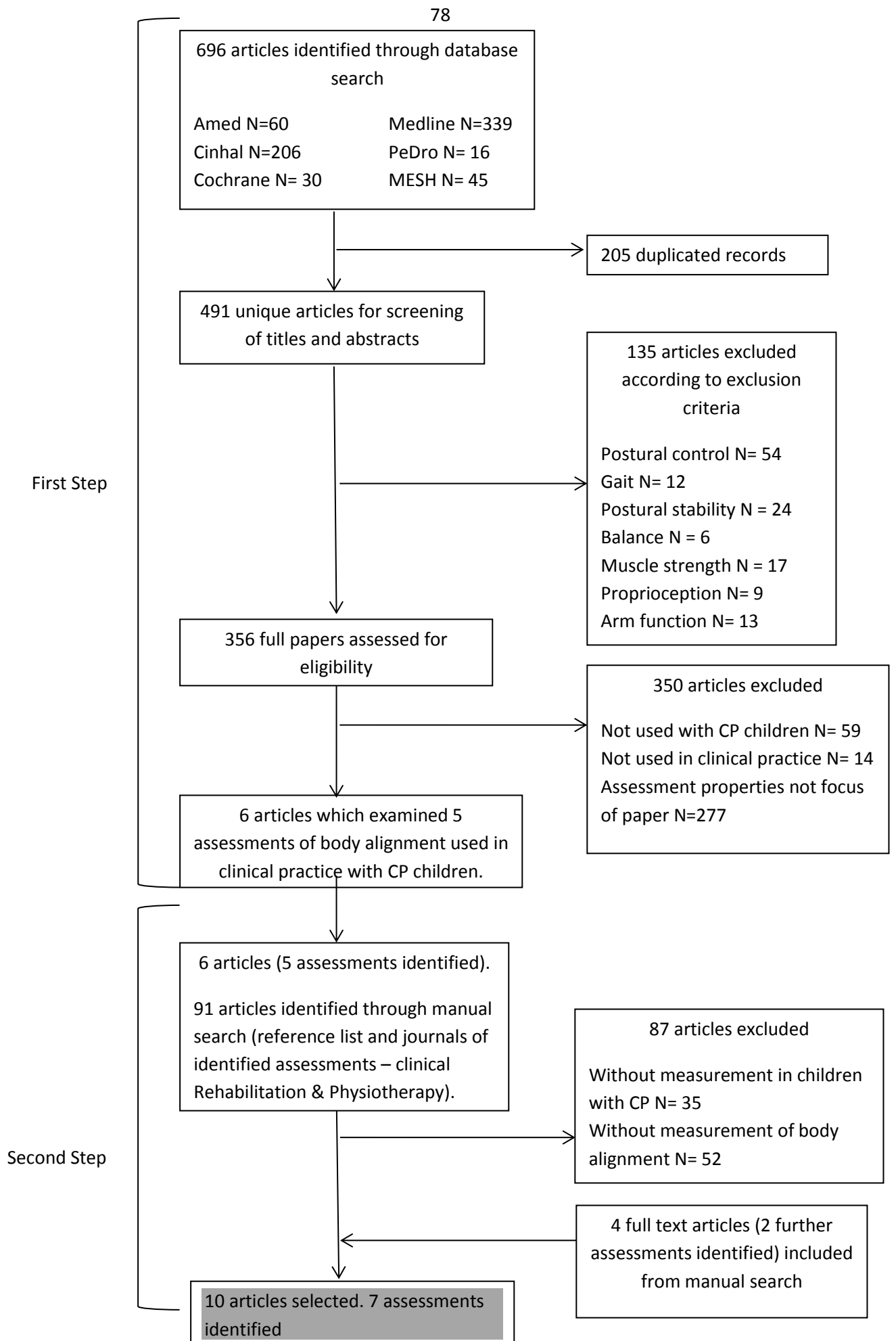

Figure 3.1: PRISMA flowchart (Moher et al, 2009).

3.3.1 Clinical assessments used by therapists to assess body alignment

The search identified 7 clinical assessments which meet the criteria. The included assessments were: The Chailey Levels of Ability Scale (CLAS) (Pountney et al., 1999), Goldsmith Indices (Goldsmith and Goldsmith, 2009; Goldsmith et al., 2009), the Goldsmith Index of Windswept Deformity (Goldsmith et al., 1992), Mansfield Checklist (Goldsmith, 2000), Posture and Posture Ability Scale (PPAS) (Rodby-Bousquet et al., 2016; Rodby-Bousquet et al., 2014), the Spinal Alignment and Range of Motion Measure (SAROMM) (Bartlett and Purdie, 2005) and the Seated Postural Control Measure (SPCM) (Field and Roxborough, 2011; Fife et al., 1991).

Of the assessments identified 6 were observational measurements; five observed body alignment (Goldsmith Indices, Goldsmith Index of Windswept Deformity, PPAS, SAROMM, SPCM), and one observed gross functional movement (CLAS). One assessment (Mansfield Checklist) was a checklist, providing a set of five questions relating to posture. The PPAS and SPCM combined observational measurement across two components of posture quality and function ability, whilst the SAROMM combines observational measurement of the spine in the sagittal and frontal planes with range of motion assessment of upper and lower limbs.

All the articles included participants with CP, six studies had participants aged from 0 - 18 years. Whilst two studies (Pountney et al., 1999; Goldsmith et al., 1992) included participants with CP over the age of 18, one study (Pountney et al., 1999) had a sample age range of 4.5-19 years old, and one (Goldsmith et al., 1992) ranged from 10 -48 years. Only two articles (Rodby-Bousquet et al., 2016; Bartlett and Purdie, 2005) described the participants by their type and CP presentation, using the GMFCS (Palisano et al., 2006) to clearly classify groups of children. Whereas one article (Fife et al., 1991) included participants with neuromotor disabilities (n=40), 19 of which had CP, described in terms of body area affected e.g., Hemiplegic.

3.3.2 Assessment characteristics

Six assessments' primary purpose was to measure body alignment (Rodby-Bousquet et al., 2016; Goldsmith and Goldsmith, 2009; Goldsmith et al., 2009; Bartlett and Purdie, 2005; Goldsmith, 2000; Goldsmith et al., 1992; Fife et al., 1991). The PPAS scored quality of posture through observation of the individuals body alignment; a score of 1 given for midline/symmetrical or a score of 0 for asymmetry. Six body items are scored: head; trunk; pelvis; legs; arms; and weight distribution. These are scored in sitting, standing, supine and prone from both the frontal and sagittal view (Rodby-Bousquet et al., 2016).

The SAROMM (Bartlett and Purdie, 2005) has fifteen items; four items for spinal alignment and 11 for range of motion. Each item is scored on a five-point ordinal scale ranging from 0 (representing ability to align normally with no passive limitations) to 4 (severe deviations in spinal alignment or limitations in joint range of motion).

The Goldsmith Index of Windswept Deformity (Goldsmith et al., 1992) involves three measurements of pelvis, hips and leg position in supine crook lying. Each measurement is repeated four times and an average calculated for the overall score. The Goldsmith Indices (Goldsmith and Goldsmith, 2009; Goldsmith et al., 2009) is a further development of this assessment; three measurements repeated four times, taken of chest proportion, symmetry of movements of knees, symmetry of range of movement at the hips.

The Mansfield Checklist (Goldsmith, 2000) is a set of five 'yes' or 'no' questions; the questions ascertain if the body stays in a limited number of positions, if the knees fall to one side, if the head turns to one side, if the body tends to flex or extend or both and if so to which side and if the body shape is asymmetric.

The SPCM (Fife et al., 1991) assess sitting position in two sections. Section one measures posture alignment and consists of 22 items. Assessment is carried out through visual observation and palpation. A score of 0-3 is given defined by

arbitrary angles representing mild, moderate and severe abnormal alignment. The setting of these posture categorisation angles lacked clear rationale, leading to the assessment scale being indiscriminate as a measurement of alignment. Section two measures functional movement and consists of 12 items scored from zero to complete.

Finally, the CLAS' (Pountney et al., 1999) primary purpose is measurement of a child's motor and postural ability in relation to function. Body alignment posture is measured as a sub-section of the assessment, which is an observational assessment of a child's motor ability scored from level 1–8. A child is assigned a level of ability based on their overall skill performance of motor tasks following normal developmental movements. Each movement is measured across nine constructs: loadbearing when still and moving; ability to move areas of loadbearing; position of pelvis; trunk and legs; position of the shoulder girdle, arms and trunk; the position of the head and chin; lateral body profile; effect of movement on body parts; ability to isolate movement; and predominant joint positions.

Table 3.2: Reliability data for selected body alignment posture assessment

Instrument	Study	Participants	Internal consistency (Cronbach's alpha)	Test-retest reliability	Intra-rater reliability	Inter-rater reliability
Chailey Levels of Ability Scale (Chailey)	(Pountney et al., 1999)	2 sample groups. 85 children with CP aged 0-18 years (yr). 30 children with disabilities. 29 CP children aged 4.5 – 19y.	Not reported	Not reported	Not reported	Not reported
Goldsmith Index of Windswept Deformity	(Goldsmith et al., 1992)	50 children and adults, 25 with movement difficulties (CP N= 14 age range <10 – 30y), 25 without disabilities. Ages <10– 48 yr.	Not reported	Not reported	Not reported	Not reported
Goldsmith Indices	(Goldsmith and Goldsmith, 2009; Goldsmith et al., 2009)	Sample not reported	Not reported	Not reported	Not reported	Not reported
Mansfield Check list	(Goldsmith, 2000)	31 CP children aged 9 months – 19yr (N=15 male, 16 female). Families of participating children.	Not reported	Not reported	Not reported	Not reported
Posture and Posture ability Scale (PPAS)	(Rodby-Bousquet et al., 2016; Rodby-Bousquet et al., 2014)	29 children with CP aged 6-16yr (N=15 male, 14 female).	0.95-0.96	Not reported	0.85-0.99	Weighted Kappa: 0.77-0.99
Spinal Alignment and Range of Motion Measure (SAROMM)	(Bartlett and Purdie, 2005)	25 children with CP aged 2-18yr (N=17 male, 8 female).	Not reported	ICC*:0.93 SEM*:3.09	Not reported	ICC*: 0.89
Seated Postural Control Measure (SCPM)	(Field and Roxbourough, 2011; Fife et al., 1991)	2 raters with 5 years' experience. 2 seated conditions with 40 children (n=19 CP)	Not reported	Kappa coefficient Alignment = 0.35 Function = 0.29	Not reported	Kappa coefficient Alignment = 0.45 Function = 0.85

*ICC, Intraclass correlation coefficient; SEM, standard error of measurement

Table 3.3: Validity data for selected body alignment posture assessments.

Instrument	Study	Participants	Content validity	Criterion validity	Construct Validity
Chailey Levels of Ability Scale (Chailey)	(Pountney et al., 1999)	2 sample groups. 85 children with CP aged 0 - 18 y. 30 children with disabilities. 29 CP children aged 4.5 – 19y.	Limited Literature review (articles n=2). Assessment of Review by a panel of experts (n= 2) clinically skilled observers. Field testing among CP children (n=85).	Compared with the AIMS* and GMFM*. Pearson Product Moment correlations score: GMFM = 0.85 AIMS = 0.90	Not reported
Goldsmith Index of Windswept Deformity	(Goldsmith et al., 1992)	50 children and adults, 25 with movement difficulties (CP N= 14 age range <10 – 30y), 25 without disabilities. Ages <10– 48 y.	Not reported	Not reported	Not reported
Goldsmith Indices	(Goldsmith and Goldsmith, 2009; Goldsmith et al., 2009)	None given	Not reported	Not reported	Not reported
Mansfield Check list	(Goldsmith, 2000)	31 CP children aged 9 months – 19y (N=15 male, 16 female). Families of participating children.	Not reported	Not reported	Not reported
Posture and Posture ability Scale (PPAS)	(Rodby-Bousquet et al., 2016; Rodby-Bousquet et al., 2014)	29 children with CP aged 6-16y (N=15 male, 14 female).	Not reported	Not reported	Ability to detect gradations in disability compared with GMFCS* (p<0.01)
Spinal Alignment and Range of Motion Measure (SAROMM)	(Bartlett and Purdie, 2005)	25 children with CP aged 2-18y (N=17 male, 8 female).	Not reported	Not reported	Ability to detect gradations in disability compared with GMFCS* (r ² =0.44)
Seated Postural Control Measure (SCPM)	(Field and Roxbourough, 2011; Fife et al., 1991)	40 children (n = 19 CP)	Assessment reviewed by panel of experts (n=7)	Not reported	Not reported

*AIMS, Alberta Infant Motor Scale (Piper et al., 1992); GMFM, Gross Motor Function Measure (Russell et al., 2002); GMFCS, Gross Motor Function Classification System (Palisano et al., 2006).

3.3.3 Psychometric properties

Among articles identified, six examined the assessment's psychometric properties (Rodby-Bousquet et al., 2016; Rodby-Bousquet et al., 2014; Field and Roxborough, 2011; Bartlett and Purdie, 2005; Pountney et al., 1999; Fife et al., 1991). All seven clinical assessments applied to children with CP. Only three assessments reported on both validity and reliability properties: the PPAS (Rodby-Bousquet et al., 2016; Rodby-Bousquet et al., 2014); SAROMM (Bartlett and Purdie, 2005); and SCPM (Fife et al., 1991). Validity properties were reported for one further assessment: CLAS (Pountney et al., 1999). Studies investigating the psychometric properties for children with CP were not found for the three following assessments: Goldsmith Indices (Goldsmith and Goldsmith, 2009; Goldsmith et al., 2009); Goldsmith Index of Windswept Deformity (Goldsmith et al., 1992); and The Mansfield Checklist (Goldsmith, 2000).

Strength of reported psychometric properties are shown in Tables 3.2 and 3.3. For ease of interpretation on the level of evidence a traffic light colour system is utilised; Green indicated a good level of evidence, amber indicated adequate level, red indicated poor and light grey denoted not reported. The traffic light system was applied to assist clinicians in obtaining clear, clinically useful information that can be used by therapists and researchers in developing a common understanding of the best-available evidence (Novak et al., 2020; Novak, 2012). Reliability was graded using bands proposed by Fleiss et al (2013); less than 0.40 being poor, 0.41-0.75 fair and greater than 0.75 good. Validity used McMaster Ratings (Law, 2004) to give an overall rating based on the number of studies completed. For example, more than two well-designed studies supporting validity would merit an overall rating of good. An assessment with one to two studies supporting validity would score adequate and no validity studies or unsubstantial methodology would indicate poor.

3.3.4 Reliability

Evidence of Inter-rater reliability was found for all three assessments which reported reliability: the PPAS (Rodby-Bousquet et al., 2016; Rodby-Bousquet et al., 2014); SAROMM (Bartlett and Purdie, 2005); and SCPM (Fife et al., 1991) (see table

3.2). Excellent inter-rater reliability was demonstrated for the SAROMM and PPAS with intraclass correlation coefficient (ICC) exceeding 0.80. The PPAS also reported a weighted Kappa which range exceeded 0.80. The SCPM reported excellent reliability for the function section (Kappa coefficient 0.85) but only adequate for alignment (Kappa coefficient 0.45).

Both the SAROMM (Bartlett and Purdie, 2005) and SCPM (Fife et al., 1991) showed evidence for test-retest reliability. Excellent reliability was demonstrated by the SAROMM, intraclass correlation coefficient (ICC) exceeded 0.80, whilst the SCPM alignment demonstrated poor test-retest reliability with a Kappa coefficient of 0.35 and 0.29 for alignment and function sections respectively.

Evidence of internal consistency and Intra-rater reliability was found in one assessment. The PPAS (Rodby-Bousquet et al., 2014) reported Cronbach's Alpha and ICC scores exceeding 0.80 indicating excellent internal consistency and intra-rater reliability. No evidence could be found for the reliability of the CLAS (Pountney et al., 1999), Goldsmith Indices (Goldsmith and Goldsmith, 2009; Goldsmith et al., 2009), Goldsmith Index of Windswept Deformity (Goldsmith et al., 1992) or Mansfield checklist (Goldsmith, 2000). The Goldsmith Index of Windswept Deformity reported P values of <0.001 and >0.1 with regards to reliability. The authors did not report the statistical test used to provide the P value. As a P value is not a measure of reliability, the evaluation of its reliability remains inconclusive.

3.3.5 Validity

Validity was reported in four of the assessments these are shown in table 3.3. The CLAS established content validity through use of a review by a panel of experts and field testing among CP children. The SPCM (Pountney et al., 1999) indicates adequate content validity with description of development and expert panel review.

Criterion validity was established for the CLAS through comparison with the Alberta Infant Motor Scale (AIMS) (Piper et al., 1992) and Gross Motor Function Measure

(GMFM) (Russell et al., 2002), showing a high correlation between both assessment and between the CLAS and GMFM = 0.85, and between the CLAS and AIMS = 0.90. Construct validity of both the PPAS and SAROMM used the GMFCS to establish construct validity, showing an ability to detect gradations in disability.

The available evidence indicates that the CLAS has adequate content and criterion validity (Pountney et al., 1999) and the PPAS (Rodby-Bousquet et al, 2016; Rodby-Bousquet et al, 2014) and SAROMM (Bartlett and Purdie, 2005) have adequate construct validity based on each having one study reporting on their validity. There is no direct evidence available which reports on validity aspects for the Goldsmith Index of Windswept Deformity (Goldsmith et al., 1992), Goldsmith Indices (Goldsmith and Goldsmith, 2009; Goldsmith et al., 2009) or Mansfield checklist (Goldsmith, 2000).

3.4 Discussion

This review focused on assessments of body alignment which are applicable to everyday clinical practice and settings. This approach is consistent with the ICF (WHO, 2007) model, which has been widely used to guide service delivery and clinical thinking for children with CP (See figure 2.8, Chapter 2). The ICF model views body structure as an integral component alongside other domains of activities and participation, as well as an interaction with social and environmental factors (Baxter, 2004). Body alignment and posture fit within one component unit of the ICF, body function and structure, which is incorporated within the wider framework in relation to an individual's disability and function (WHO, 2007). To make direct inferences from one component to a diagnosis or functional limitation is too simplistic. Whilst interactions are complex and dynamic in their relationships between all ICF domains, it is important to empirically investigate these entities independently and then explore association between them on functional abilities (WHO, 2013). As such, the assessment and quantification of body alignment among children with CP needs to be reflective of how body alignment varies in respect to wider contextual factors such as, the support surface, the effect of gravity on the body, and the environment.

Therapists target postural alignment to support activity and participation through posture management interventions (Pope, 2007). Supporting body alignment occurs in various environmental settings across a child's social environment such as home and school, often encompassing support of body alignment in lying, sitting and standing (Field and Roxborough, 2011; Goldsmith, 2000). The use of postural equipment to correct total body alignment is generally considered to be related to improvements in a child's participation and function (Gericke, 2006; Pountney et al., 2002). However, this assumption has not been validated with clinical data; hence, accurate clinical measurement of a child's postural alignment is important in the provision of posture management equipment.

Whilst assessments of body alignment only measure one aspect of health as defined by the ICF, the association this has with the components of activity and participation in relevant and meaningful contexts is clear. None of the identified assessments addressed or associated assessment of body alignment to wider contextual components of the ICF such as environmental and personal factors. Consequently, assessments which aim to measure the construct of body alignment among children with CP needs to be reflective of how this varies in respect to environmental factors such as support surface, gravity, postural position as well as applicable to real life settings.

3.4.1 Methodological properties of the assessments

Currently the most common method used for assessment of body alignment in research is x-rays and motor function (see chapter 2). Obtaining an accurate assessment of body alignment as part of clinical practice can be rather challenging (Hill and Goldsmith, 2010) because established assessment methods have been mostly derived from lab-based techniques or movement-based measurement. This critical review found 7 assessments of body alignment that are usable within clinical settings. Evidence supports adequate to poor overall reliability and validity of most of the instruments.

The overall methodological properties of the studies that support these assessments were found to be limited. The PPAS (Rodby-Bousquet et al., 2016; Rodby-Bousquet et al., 2014) and SAROMM (Bartlett and Purdie, 2005) are supported by published studies which demonstrate good to excellent validity and reliability in samples which include children with CP, in addition to established evidence for construct validity.

The unique characteristics of the population being assessed are important considerations in measurement selection (Sarathy et al., 2019). This critical review found few true validated measures of body alignment in children with CP are available. Although both the PPAS (Rodby-Bousquet et al., 2016) and SAROMM (Bartlett and Purdie, 2005) were able to demonstrate excellent to adequate construct validity. Detail on the development and validity of the assessments' content is not reported in detail. Although the SAROMM (Bartlett and Purdie, 2005) provides limited detail on content of items, it is imprecise and ambiguous in terms of specificity when examining the development process. As such, the validity of the test items and criterion limits the assessment applicability as a measurement of clinical outcome. Furthermore, with regards to reliability, the number of raters is small for the PPAS (Rodby-Bousquet et al., 2014) and SARROM (Bartlett and Purdie, 2005) with three and two raters used respectively. Only the SARROM clearly outlines the model used to calculate ICC scores. Therefore, the accuracy of the reliability of the PPAS is questionable and the values related to these assessments must be interpreted with caution.

Those instruments, which do have established psychometric properties for assessment of body alignment among children with CP, have limitations in their methodological approach needed to address clinical assessment and monitoring within this population. No assessment that measures specific variation of total body alignment symmetry has been validated, nor found reliable, for children with CP.

3.4.2 Clinical usability and overall utility

An assessments' validity and reliability does not mean it is automatically usable within a clinical setting; many named 'clinical' assessment are unused for practical reasons such as cost, administration time, training requirements, score interpretation, portability and ease of use (Fawcett, 2013). The clinical assessments reviewed in this paper are judged to have adequate to poor clinical utility. This review identified two assessments; the PPAS and SAROMM as having adequate clinical overall utility with both demonstrating, adequate to excellent reliability, adequate to excellent validity and are easily available. Both assessments use a paper-based format, are observational with relatively low cost, easily portable and assessment applications require no specific equipment, environment or training need to be administered. The PPAS and SAROMM are associated with either symmetry alignment or joint positions. The SAROMM appears to have discriminatory assessment of spinal alignment and then focuses on assessment of joint range of motion not body alignment position. Whilst the PPAS assesses total body alignment it only identifies symmetry and, therefore, is unable to detect changes or variation in symmetry, which CP children often present with. As such, their utility in children with CP may be limited by the child's variation into body alignment position. Nevertheless, these two assessments appear to have some capability in observing and evaluating components of body alignment. These may enable therapists to determine an overview of a child's current body alignment, however, have a reduced capability to assess changes or adaptations to symmetrical body alignment.

3.4.3 Application to body alignment in children with CP

The body position of a child with CP results in an array of problems which affect the whole body (Fortin et al., 2011; Porter et al., 2008), leading to the adoption of various degrees of asymmetrical postures (Hill and Goldsmith, 2010). Subsequently assessment of body alignment in children with CP needs to be able to measure both symmetrical and asymmetrical posture alignment and discriminate between changes in asymmetry.

Of the seven assessments reviewed in this paper only two (PPAS, SAROMM) demonstrated adequate valid and reliable assessment of body alignment. These two assessments are observational of body alignment position, which implies that they are able to detect changes in body posture. The PPAS allows for observation of five parts of the body to be assessed as being symmetrical or not. This gives limited responses to body symmetry, making it unresponsive and unable to detect changes in asymmetrical body alignment. As such, ability to assess and measure change in body alignment are lost. The SAROMM has one section devoted to body alignment, which offers a detailed and systematic way to examine and monitor emerging changes in spinal alignment. However, it is limited to a measure of body alignment due to an emphasis on body linkage position (joint range) and does not encompass body segment position in relation to body alignment. The PPAS and SAROMM application methods vary; the PPAS presents a more comprehensive body alignment measure of a CP child's body alignment in sitting, standing and lying across all GMFCS levels; whilst the SAROMM offers a specific and accurate analytical approach to measurement of body alignment (spine).

Only the SPCM (Field and Roxborough, 2011) examined responsiveness to change, identifying that the assessments lack discrimination when assessing a change in alignment. The SPCM validity and reliability are reported as adequate to poor; as such, its strength as a clinical measure of change remains questionable. Furthermore, the Goldsmith indices adapted from the Goldsmith Index of Windswept Deformity assess a limited number of items related to body alignment. Whereas the Mansfield Checklist appraises movement and body alignment, reflective of a non-specific screening on an individual's position, movement and body shape. These three assessments lack psychometric properties to support assessment accuracy and reliability of measurement of body alignment.

Assessments of body alignment need to take into consideration the child's entire body alignment (Fortin et al., 2011). Being sensitive and applicable to the complex presentation and wider social and environmental issues, which impact on body

alignment in children with CP, is essential if an assessment is able to measure change and determine outcomes of intervention, which effect postural alignment.

3.4.4 Limitations

It is a limitation of this review that only English-Language publications were included. The reason for this exclusion was purely a pragmatic decision in the context of a PhD study where translation of foreign language articles into English was not available.

Best practice indicates that more than one author would be involved in identifying evidence meeting the inclusion criteria and extraction of data (Siddaway et al., 2019). In the context of a doctoral level study, this was not possible and, therefore, the review has not been designated 'systematic' although rigorous and comprehensive steps had been taken in the search strategy and data extraction. It is acknowledged, however, that the lack of a second assessor may have introduced bias or error.

A further limitation is that psychometric properties for clinical assessments may have been established unintentionally, which suggests that those studies could have potentially been missed in this review. Assessments used within studies examining the effectiveness of postural interventions, could assume establishment of some psychometric properties through their use, without having examined validity or reliability aspects in an appropriate methodology. Every effort was made to retrieve any relevant data through accessing appropriate databases and scrutinising reference lists, although it is not possible to say that all evidence has been reviewed. In addition, it is possible that the search strategy was not adequate to find every study of relevance. On-going familiarisation with the literature resulted in four articles (Rodby-Bousquet et al., 2014; Goldsmith et al., 2009; Goldsmith and Goldsmith, 2009; Goldsmith, 2000) being retrieved through manual searching and found relevant to the study but were not identified in the initial search strategy. The use of terms such as test, instrument, checklist as well as adolescen* and young people were not used and therefore could limit the initial

search strategy. This suggests that the terms used may have missed relevant articles although extensive attempts were made to identify relevant material.

3.5 Conclusion

Although this critical review identified seven clinical assessments the evidence supporting their use for entire body alignment measurement is limited, as is the evidence supporting the strength of their measurement properties. Few assessments address sensitivity, accuracy and responsiveness to change in body alignment in children with CP.

It has already been established that impairment in body alignment impacts on body functions, participation and quality of life in children with CP (Scrutton, 2008; WHO, 2007). Accurate measurement of a child's postural alignment is important in the provision of posture management equipment to prevent postural deformities, optimise functional potential and improve a child's overall quality of life.

There is a need for further research to establish evidence for the development and use of a clinical assessment of body alignment in children with CP. The ability for therapists to accurately measure changes they make to a child's body alignment through the provision of postural equipment will enable the impact and effectiveness of postural management in terms of alignment to be evaluated.

The development of a clinical assessment of body alignment (CABA) for use in children with CP will be discussed in the next chapter (chapter 4). This formed the first phase of the investigation into assessment construction and psychometric properties. The focus of chapter 4 will be on the construction of the assessment and consider clinical utility properties to support its applicability within clinical practice. This will examine the CABA's items in relation to the construct of body alignment to ensure that the assessment items measure this intended clinical attribute.

CHAPTER 4:

**DEVELOPMENT AND CONTENT VALIDITY OF THE CLINICAL ASSESSMENT OF BODY
ALIGNMENT**

4.1 Introduction

This chapter reports on the development of a clinical assessment of body alignment (CABA) for use in children with CP. This is the first phase of the investigation into the CABA's construction and content validity. Based on the systematised review, presented in chapter 3, no single measure was identified which adequately examined body alignment in children with CP. Identified measures demonstrated limitations in the scope of body positions assessed and ability to selectively identify changes in overall body posture asymmetry. Limited evidence was found to support the strength of their measurement properties with few assessments addressing validity, reliability and responsiveness to measurement of body alignment in children with CP. Therefore, this study aimed to develop a tool to specifically address the need for a clinical measure to assess body alignment.

The chapter outlines the process undertaken in developing and investigating the content validity of the CABA items in relation to the construct of body alignment and considers clinical utility properties to support its applicability within clinical practice. Rationales for the methodology and framework of test development are outlined, examining item construction and posture categorisation.

This chapter examines the development and content validity of the CABA through a study whereby paediatric physiotherapists reported on the content of the CABA items examining relevance, comprehensiveness and comprehensibility of the assessment items via an electronic survey. To ensure that functionality and applicability to clinical practice remained at the forefront during development, physiotherapists were also asked to rank attributes which relate to the clinical utility of assessment in order of importance. Throughout the chapter the

methodology and data analysis are discussed in relation to CABA's worth as a clinical measure of body alignment in children with CP. A final section looks at limitations and implications for clinical practice.

4.1.1 Assessment construction

Standardised assessment tools used within health to measure the outcome of interventions require the properties of validity, reliability and responsiveness in order to provide quality information and guide clinical decisions (Terwee et al., 2018; Roach, 2006). In the development of a standardised assessment, it is important to consider the process and framework followed. Crocker and Algina (2008) acknowledged that failure to adhere to sound practices in developing assessments may in part account for the conflicting and ambiguous results that often characterise social science research. This is reflective of the research pertaining to assessment of body alignment within posture management in children with CP.

Based on the review carried out in chapter 3; too often has the research attempted to demonstrate the effectiveness and outcome of posture management interventions, by using virtually untried, unstandardised or unrelated tests. As a result, this has produced inconsistent and inaccurate results. Therefore, meaning that clinicians and researchers are unable to determine, with clarity and conviction, whether postural interventions were effective; or the measurements were so imprecise that the true effects of the intervention went undetected. Closer adherence to the principles for sound assessment construction and empirical field testing, prior to experimental investigations being undertaken, would do much to improve the overall quality of research in physiotherapy, CP body alignment and posture management.

Test theory provides a general framework for viewing the process of assessment development (McDonald, 2013). The principles of test theory have been uniquely derived to meet the specific measurement needs of researchers in social sciences (Miller and Lovler, 2018). Within the broader framework of research and evaluation

methodology, test theory is a process of inquiry consisting of well-defined stages characterised through the testing of psychometric characteristics (Crocker and Algina, 2008). The tenets of test theory have relevance and fit well into the development of the CABA assessment as a clinical instrument and, as such, will form the structure to examine its validity, reliability and responsiveness.

4.1.1.1 Theoretical foundations: Test Theory

At its simplest level, test theory is a statement of the possible relationship between a physiological construct and an observable phenomenon, contextualised in an understanding that it is possible to predict or control certain patterns of behaviour through empirical investigation and substantiation of theoretical constructs (Crocker and Algina, 2008). To achieve this, it is necessary to quantify the observations of behaviour representing the specified construct (Cappelleri et al., 2014). The comprehension of test theory requires an understanding of the fundamentals of assessment, measurement, constructs and psychological tests (Miller and Lovler, 2018).

Assessment is the overall process of selecting and using instruments, which obtain data through measurement (Mcdowell and Mcdowell, 2006). Information collected is interpreted to inform clinical decisions and evaluate outcomes of therapeutic interventions (Fawcett, 2013). Measurement has been described as a process undertaken within the real world by an observer (Crocker and Algina, 2008), the allocation of numbers to attributes according to a preestablished set of rules or guidelines (McDowell and Newell, 2006) and the measurement applies to the properties of a construct rather than the construct itself (Rothstein, 1985). Measurement is taken of a specific physical attribute such as development of a child (Miller and Lovler, 2018). Psychological attributes are constructs, or hypothetical concepts of observed behaviour, which cannot be directly measured, unlike height and weight (Crocker and Algina, 2008).

When considering this in relation to this PhD. Physiotherapists working with children with CP notice that some children, those more severely affected GMFCS IV

and V, adopt asymmetrical body alignment. These asymmetrical body shapes are significantly improved when these children are placed in adaptive equipment. After observing this kind of 'behaviour' consistently over time and across different contexts for the same individuals, physiotherapists may begin to label such behaviour as 'alteration in body alignment'. This created theoretical construct which encompassed a number of similar established behaviours grounded in practice and research such as; an impairment in movement and normal development (Pavao et al., 2013; Hadders-Algra, 2010; Shumway-Cook and Woollacott, 2007), severity of impairment within CP (Rosenbaum et al., 2007), inability to change position (Fulford and Brown, 1976), adoption of asymmetrical body alignment (Porter et al., 2008) and requirement for the use of adaptive equipment (Pountney et al., 2009; Gericke, 2006).

However, developing a construct is not the same as measuring it (Crocker and Algina, 2008). To measure the construct, it is first necessary to establish a correlating rule between the theoretical construct and observable behaviours, indicative of the construct (Miller and Lovler, 2018). This process is known as operational definition (McDowell and Newell, 2006). In relation to measuring alterations in body alignment it is important to specify what types of behaviours in children with CP are related to body alignment. The researcher must devise a strategy for collecting and recording observations of such behaviours in children in a standardised format. This requires the development of an instrument or assessment to measure the construct of body alignment.

An assessment is required to have a standard procedure for obtaining a sample of behaviour over a specified domain (Finch et al., 2003). Assessment procedures can refer to obtaining a sample of the individual's optimal performance, as characterised by an academic test, or of an individual's typical performance such as in questionnaires (Crocker and Algina, 2008). Another approach to sampling typical performance is a list of behaviours, which may be used by the observer (Anastasi and Urbina, 1997). This approach is known as standard scheduling and enables the observer to record behaviours across naturalistic settings (Crocker and Algina,

2008), for example a researcher who prepares a list of body alignment components to be checked and rated by an observer using a predetermined schedule.

Measurement of these attributes is achieved through assignment of a quantifiable value to the behaviours specified in the assessment (Crocker and Algina, 2008). For instance, a measurement has been taken when a therapist counts and records on a checklist the number of asymmetrical body segments that the child displayed in a set position; this measurement of the construct of body alignment provides an efficient and useful method for classifying and describing position of body segments. Without this construct observing and defining this complex phenomena would result in confusion (Stokes, 2011). The use of constructs enables the observer to begin to categorise and group occurrences of similar behaviour and communicate observations in a concise manner (Brennan, 2010).

4.1.1.2 Problems in measurement of psychological constructs

Physiological constructs are concepts which can only be measured indirectly (Miller and Lovler 2018). As such the design of assessment to measure such notions present several challenging problems (Crocker and Algina, 2008). In the development of an assessment of a child with CP body alignment for use in clinical settings. This represents a situation in which measurement of a psychological construct is desired (Anastasi and Urbina, 1997). Although the constructs of CP, body alignment and clinical settings are diverse within themselves, the assessment developer must also cope with five measurement problems common to all physiological assessments (Crocker and Algina, 2008).

Firstly; in the measurement of any construct there is no one single universal process (Brennan, 2010). As construct measurements are always indirect and based on perceived relevant behaviours to the construct, there is always the possibility that two therapists who identify the same construct may identify different behaviours to define the construct operationally (Crocker and Algina, 2008; Benson and Clark, 1982). In the case of the development of a clinical assessment body alignment in children with CP, since it is not possible to look directly at the skeletal alignment,

the developer must designate some superficial observations, which permits inference about the alignment of a child's body. One approach maybe the requirement of a physiotherapist to identify bony anatomical landmarks; another is to observe the positions of specified body segments (arms, legs, trunk, and head); whilst another is to combine these two approaches. These differing operational definitions would likely result in differing measurement procedures, and could well lead to different conclusions (Crocker and Algina, 2008; Benson and Clark, 1982).

Secondly; construct measurements are typically founded on limited samples of behaviour (Crocker and Algina, 2008). In the development of a body alignment assessment, it would be impossible to assess all children with CP in all situations in which possible body alignment problems might occur. Thus, any attempt to measure their body alignment must involve only a sample of possible problems (Benson and Clark, 1982). Determining the number of items and diversity of content required to provide an adequate sample is a major problem in developing a comprehensive measurement process (Cappelleri et al., 2014; Crocker and Algina, 2008).

Thirdly; the measurement obtained is invariably subject to error (Roebroek et al., 1993). Measurement development is based on a limited sample of observations, taken at a given point in time (Terwee et al., 2003). If the assessment of body alignment is taken twice over different positions, or between different physiotherapists, it is possible that the scores would not be identical (Stokes, 2011; Crocker and Algina, 2008) because of the effects of tone, fatigue, change of position, gravity, and clothing. Such inconsistencies in scores due to sample or presentation are important considerations when devising psychometric testing of the construct and methodological design (Rothstein, 1985).

Fourth; the lack of well-defined items in the assessment scale (Miller and Lovler, 2018). Defining properties of the assessment, labelling of items and interpretation of scores are complex issues which need to be considered (Andrews et al., 2012). The fact that one child has no body alignment alterations in sitting, does not

necessarily mean they also will not in lying or standing. Alternatively, assuming that the higher the child scores in relation to their body alignment variation, the greater the asymmetry of their body alignment will be. These are components which must be considered when developing an assessment and scoring system in relation to the construct and those related to it (Crocker and Algina, 2008; Clark and Watson, 1995).

And finally; constructs should not be defined exclusively by operational definition (Crocker and Algina, 2008; Clark and Watson, 1995). They must also demonstrate relationships to other constructs (Miller and Lovler, 2018). An assessment would have little meaning or usefulness if it cannot be interpreted within its underlying theoretical construct (Roebroeck et al., 1993). For this reason, it is important that theoretical constructs, which underpin assessment, be defined on two levels (Miller and Lovler, 2018). Firstly, the construct must be defined in terms of observational behaviours (Crocker and Algina, 2008). This stipulates how the measurement will be taken (Clark and Watson, 1995). Secondly, the construct should be defined in terms of its relationship to other constructs relevant to the underlying theoretical concept (McDonald, 2013). This provides a basis for interpreting the measurements construct validity (Miller and Lovler, 2018).

4.1.2 Error of measurement

In the early 1900's Charles Spearman reported on measurement and errors relating to scores, producing a method for examining these (Lovie and Lovie, 2010; Levy, 1995). This can be broadly categorised into random or systematic errors (Tripepi et al., 2010). Systematic measurement errors are those which consistently affect an individual's score because of a particular characteristic of the person or the assessment that has nothing to do with the construct being measured (Terwee et al., 2003). Systematic errors do not result in inconsistency of measurement, but still may cause assessment results to be inaccurate and thus reduce their practical utility (Anastasi and Urbina, 1997). Therefore, in development of the CABA, items were rigorously examined by an extensive expert panel to ensure they matched the construct of body alignment. Further examination of the CABA's items in relation to

the construct of CP will be examined in more detail in the next chapter as part of this PhD project (chapter 5). These approaches aim to minimise any systematic errors associated with the CABA.

In contrast, random measurement errors affect individuals' scores because of purely happen chance (Spearman, 2010). Potentially confounding variables may occur in either the assessor or the individual being measured and may affect an individual's score in either a positive or negative direction (Crocker and Algina, 2008). Random errors reduce both the consistency and the usefulness of the assessment scores (Mcdowell and Mcdowell, 2006). Consequently, in examination of the CABA's reliability it is important to ascertain how likely it is that potential sources of random error will influence the assessment scores.

Spearman's model was that any observed test score could be described as two hypothetical elements; a true score and a random error (Crocker and Algina, 2008).

$$X = T + E$$

Measurement = true value + error

This is where X = observed score, T = the Individual's true score and E = Random error (Brennan, 2010). For example, on the 20 item CABA, a child with CP may actually have perfect body alignment, a score of 0. However, by chance today they are ill; consequently, this causes the child to lean to the side increasing their overall score by 2 points, resulting in the child's observed score becoming:

$$X = 0 + 2 = 2$$

Furthermore, a child with CP may actually have optimal body alignment, a score of 0, however the assessing therapist misreads 3 items marking body alignment on these three items deviating by a score of 1 for each item. Consequently, the observed score is:

$$X = 0 + 3 = 3$$

These examples illustrate the effect of measurement errors. An error may assume any one of a set of variables (McDonald, 2013). As such, random errors can be defined as a variability in score that occurs according to a number of possibilities (Brennan, 2010; Crocker and Algina, 2008).

Whenever an assessment is undertaken, the score obtained can also be considered a realisation of this variability (Lovie and Lovie, 2010). Assessment scores can be conceptualised in this way; for example, the CABA consists of a specific number of items, 20. Of the CABA items all 20 score 0-3; eleven of these items record a separate score for left and right sides of the body. A child's score may fall anywhere between 0 and 93. Before the assessment is administered, we cannot know what random measurement errors may occur, to both the child and therapist administering the assessment. Therefore, we can view the child's CABA score as possibly assuming one of several values according to an unknown set of probabilities (Crocker and Algina, 2008).

The distribution for a set of possible scores for an individual can be considered a random variable (Spearman, 2010). The score obtained when the assessment is administered is a realisation of the random variable (Crocker and Algina, 2008). To obtain an estimation of this hypothetical distribution of scores for a therapist or child, repeated administration of the assessment is required (McDonald, 2013). The fluctuation of CABA scores and their distribution from repeated testing provides an estimate of the probabilities of how close observed scores are to true scores on any particular testing occasion. Given the definitions of true and error scores, it seems clear that when therapists or researchers administer a measure, they only know the observed scores when the true score would be of greater interest (Crocker and Algina, 2008). An important consideration for test researchers is how closely the true scores on a test are to the observed scores (McDonald, 2013).

4.1.3 Role of test theory in research

Within the broader context of research and evaluation methodology, test theory is a process of inquiry within a precise framework. Crocker and Algina (2008, p.11) characterise this as well-defined stages:

1. Formulating a research question or hypothesis
2. Specifying operational definitions for each variable in the hypothesis by determining how it should be controlled or measured during the study.
3. Developing or selecting the instrument and procedures needed to obtain and quantify the observations on each variable.
4. Testing the accuracy and reliability of the instrument and procedures to be used.
5. Collecting experimental data within the framework of an experimental design that will permit the original question to be answered.
6. Summarising the data mathematically, and when appropriate, conducting statistical tests to determine the likelihood that the observed results were due to chance.

A systematic process for assessment development should be grounded in consideration of the intended purposes for which scores derived from the assessment will be used (Crocker and Algina, 2008). For example, suppose a physiotherapist wanted to develop an assessment of body alignment for CP children. Ultimately, information from the scores of such an assessment would be useful for determining the degree of body alignment change and supporting clinical rationale for provision of positioning equipment. Yet such an assessment would not be able to accurately collect child and parents' opinions of their body alignment and use of equipment. The content of an assessment designed to assess child and parent opinions to approaches to body alignment, would probably differ from an assessment designed to identify specific changes in body alignment. As such, it is doubtful whether a single assessment could be developed to meet all these needs optimally (Finch et al., 2003). Therefore, clarity in regards to the purpose of the assessment is important in ensuring that the developed tool measures what it intends to (Mcdonall and Mcdowell, 2006).

Generally, the process of translating constructs into specific items is largely undocumented and informal (Crocker and Algina, 2008). However, Crocker and Algina (2008) have outlined steps, which developers of assessment tools may follow to develop a strong tool with fewer idiosyncrasies. These steps were undertaken in the item construction of the CABA. Steps 1 and 2 were undertaken first to create an initial outline of an assessment. Steps 3 and 4 were then undertaken to gain further development of the assessment and investigate validation of the content.

1. *Direct Observation*

This is where the assessment developer identifies behaviours by direct observation (Crocker and Algina, 2008). For example, a physiotherapist, developing an assessment of body alignment in children with CP, might find that real life observations of children would help identify and develop items which represent body alignment.

2. *Review of the research*

Identifying behaviours that are most frequently studied and reported by others are used to define the construct of interest. This can be a heterogenous approach or focus on the work by one particular research field (Crocker and Algina, 2008).

3. *Content analysis*

Open ended questions to participants about the construct of interest utilises responses to identify topical groupings. The topics that predominately occur are taken as main components of the construct (Crocker and Algina, 2008).

4. *Expert Judgement*

The assessment developer attains input from individuals who have direct, in the field, experience of the construct. Information is collected by interviews or surveys (Crocker and Algina, 2008). For example, a physiotherapist who wants to develop an assessment for body alignment of CP children, can survey a group of paediatric physiotherapists to identify types of behaviours that should be included.

The tenets of test theory have great relevance in the construction and psychometric examination of the CABA assessment (chapter 2). As such, these informed the construction, content and construct validity, inter-rater and intra-rater reliability and responsiveness of the CABA assessment.

As this study is part of a wider investigation into the clinical assessment of body alignment in children with CP as part of a PhD research project, the aim of this first phase of the project is the construction of the Clinical Assessment of Body Alignment (CABA) and its content validity. This chapter represents the first phase in the psychometric investigation of the CABA assessment in children with CP.

The purpose of this chapter was to develop a tool to provide a clinically useful measure of postural alignment and to examine the content validity through a study whereby paediatric physiotherapists reported on the content of the CABA items.

4.2 Methods

Approval for this study was obtained from the Ethics Review Board of York St John University, UK; REF: 069011429_George_04032017 (appendix 2).

4.2.1 Development of the Clinical Assessment of Body Alignment (CABA)

Body alignment as described in chapter 2 is the position of body segments in relation to one another and their orientation in space (White, 1999). Body segments are defined as the position of the head, trunk, pelvis, arms, legs and feet. These are connected through the spinal joints, hips, shoulders, knees, and wrist and ankle joints, known as the body linkages (Pope, 2007). Impairments in body alignment have been documented in children with CP. Depending on the GMFCS level of CP, children may show primary impairments in body alignment owing to stability and postural control, functional movement abilities and musculoskeletal structures, environmental forces and demands. Body alignment requires the individual to have controlled antigravity movements that enables selective positioning of body segments relative to stability, motor task and environment.

As discussed in chapter 2 the relationship between body alignment, postural control and motor development has been implied in many research studies, yet remains underexplored. The importance of body alignment for functional movement in children with CP, denotes the need for a valid, reliable and clinically feasible assessment measure of body alignment. The ability to describe and analyse when and how body alignment is impaired and monitor change in body alignment is an important component of clinical reasoning within therapy for children with CP. This should lead to amelioration as much as possible via specific interventions, prominently posture management programmes.

4.2.2 Item construction

In developing an assessment, a developer must ask the question how to measure it (McDonald, 2013)? Developing a pool of items to measure a construct involves selecting an appropriate item format, verifying that the proposed format is feasible for the intended assessment group and writing the items (McDowell and Newell, 2006; Clark and Watson, 1995).

Different types of expertise are required to review the item pool (Crocker and Algina, 2008). For example, experts in subject matter and the field of CP and posture are best qualified to certify that the items are relevant, comprehensive and identify any possible bias. General experience in measurement and test construction for example, those involved in research and psychometric test evaluation may assist in ensuring that items are free from construction flaws (Crocker and Algina, 2008). As such, in the development and review of the CABA items experts in a research and clinical background were sought.

An initial list of items was compiled by the primary researcher, who has just over 15 year's clinical experience within paediatric physiotherapy. The items were based on the researchers' knowledge of posture and movement as well as their clinical experience and compared to items on the PPAS (Rodby-Bousquet et al., 2014), SPCM (Fife et al., 1991) and CLAS (Pountney et al., 1999) to ensure no significant items were missed. No outstanding items were identified by the primary

researcher; it was noted that sections of the CABA were common to those in other assessments items (head, trunk, pelvis, arms, legs, feet), however the subsections of these sections were different in the CABA. A preliminary list of body segment items was collated and items expanded upon to cover all planes of movement across lying, sitting and standing; this created a detailed initial list of 56 items for the CABA (see table 4.1).

The initial 56 items were reviewed by three researchers; these were members or associate members of the PhD supervision team, physiotherapists with collectively over 40 years' experience in research and paediatric physiotherapy. Discussions were held among the researchers to reach consensus regarding: 1) how to reduce clinical and respondent burden by decreasing the number of items; 2) identification of technical item-construction flaws and bias; 3) how to improve item/test readability.

No items were removed; two items were added to enable differentiation between upper and lower leg position in sitting (Section E: leg – in sitting: flexion / extension upper leg and flexion/ extension lower leg). In a second revision, items scored on the right and left side (e.g., arm flexion / extension) were combined into a single item with a separate score for each side, an example of this for arm alignment item combination is shown in appendix 3 initial version and appendix 4 revised version. This decreased the number of items but captured asymmetries between sides of the body. This resulted in thirty-six items being combined; reducing the total number to 20 items (table 4.2).

The next step following the agreement of the revised list of CABA items by the research experts was to determine the categories to grade changes in alignment across all 20 items. Decisions on posture category size are important in optimising analysis and minimising observer error (Andrews et al., 2012), as the CABA is an observation assessment of alignment this was an important component in the assessment's accuracy and functionality.

Table 4.1: Clinical Assessment of Body Alignment initial items*.

Section	CABA item	Movement
A: Head	CABA 1	Flexion / extension
	CABA 2	Side flexion Right
	CABA 3	Side flexion Left
	CABA 4	Rotation Right
	CABA 5	Rotation Left
B: Trunk	CABA 6	Flexion / extension
	CABA 7	Side flexion Right
	CABA 8	Side flexion Left
	CABA 9	Rotation Right
	CABA 10	Rotation Left
C: Pelvis	CABA 11	Anterior Tilt
	CABA 12	Posterior Tilt
	CABA 13	Obliquity Right
	CABA 14	Obliquity Left
	CABA 15	Rotation Right
	CABA 16	Rotation Left
D: Arms	CABA 17	Flexion Right
	CABA 18	Flexion Left
	CABA 19	Extension Right
	CABA 20	Extension Left
	CABA 21	Abduction Right
	CABA 22	Abduction Left
	CABA 23	Adduction Right
	CABA 24	Adduction Left
E: Leg – Standing / lying	CABA 25	Flexion Right
	CABA 26	Flexion Left
	CABA 27	Extension Right
	CABA 28	Extension Left
	CABA 29	Abduction Right
	CABA 30	Abduction Left
	CABA 31	Adduction Right
	CABA 32	Adduction Left
	CABA 33	Internal rotation Right
	CABA 34	Internal rotation left
	CABA 35	External rotation Right
	CABA 36	External rotation Left
E: Leg - Sitting	CABA 37	Flexion Right
	CABA 38	Flexion Left
	CABA 39	Extension Right
	CABA 40	Extension Left
	CABA 41	Abduction Right
	CABA 42	Abduction Left
	CABA 43	Adduction Right

	CABA 44	Adduction Left
	CABA 45	Internal rotation Right
	CABA 46	Internal rotation left
	CABA 47	External rotation Right
	CABA 48	External rotation Left
F: Foot	CABA 49	Inversion Right
	CABA 50	Inversion Left
	CABA 51	Eversion Right
	CABA 52	Eversion Left
	CABA 53	Plantarflexion Right
	CABA 54	Plantarflexion Left
	CABA 55	Dorsiflexion Right
	CABA 56	Dorsiflexion Left

*Specific scoring criteria for each item noted on CABA assessment (Section: 4.2.4.2).

Table 4.2: Clinical Assessment of Body Alignment revised items*.

Section	CABA item	Movement
A: Head	CABA 1	Flexion / extension
	CABA 2	Side flexion
	CABA 3	Rotation
B: Trunk	CABA 4	Flexion / extension
	CABA 5	Side flexion
	CABA 6	Rotation
C: Pelvis	CABA 7	Anterior / posterior Tilt
	CABA 8	Obliquity
	CABA 9	Rotation
D: Arms	CABA 10	Flexion / extension
	CABA 11	Abduction / Adduction
E: Legs – Standing / lying	CABA 12	Flexion / Extension
	CABA 13	Abduction / Adduction
	CABA 14	Internal / External rotation
E: Legs - Sitting	CABA 15	Flexion/ extension Upper Leg
	CABA 16	Flexion / Extension Lower Leg
	CABA 17	Abduction / Adduction
	CABA 18	Internal / External rotation
F: Foot	CABA 19	Inversion / eversion
	CABA 20	Plantarflexion / dorsiflexion

Specific scoring criteria for each item noted on CABA assessment (Section: 4.2.4.2).

4.2.3 Posture categorisation

Current selection and justification of posture category size remains subjective and inconsistent. Observational posture analysis has not been utilised in children with CP however has been explored within the field of ergonomics. Observation based posture assessment methods are widely utilised to quantify working postures and calculate the risk factors, as a result of job design and demand (Lowe et al., 2014). These ergonomic assessments include body alignment, static and dynamic movement, repetition and force, items that are considered important parts of safe working limits (Sutherland et al., 2008). Body alignment assessment involves observation of trunk, neck and arm positions, classifying posture into sections, termed posture categories (Lowe et al., 2014). Each category is determined by a set range of movement, such as 0° - 30° , and assigned a numerical score. Risk level is identified by combining the posture category score with other items relating to load, force and movement.

Many of the ergonomic observation-based methods used are not standardised in terms of how the postures are recorded or the posture categories used to quantify working postures (Lowe et al., 2014). Rationales for setting the number and size of posture categories used are often brief and subjective (Andrews et al., 2012). The selection of posture categories varies across the assessments with some studies selecting categories in 45° sections as this is thought to be an angle easily distinguished (Juul-Kristensen et al., 2001), with others selecting anywhere from 15° to 50° of variance (Lowe, 2004). The narrower the range and greater the number of categories increases error likely to occur between borders dividing different classification, known as bin border errors (Andrews et al., 2008b). Van Wyk et al (2009) found that the narrower the posture category is, the increased likelihood that observer error would occur. While Lowe et al (2014) identified that observation ranges between 15° and 30° were found to be an acceptable variance to enable posture categorisation and have a reduced observer error in some movements. Lowe (2004) identified that having fewer posture categories, between a three and six category scale, provides a greater likelihood of making a correct

posture classification, posture categories greater than six were accompanied by higher error in classification.

Determining the optimal size of posture categories is a trade-off between minimising observer error and the degree of precision (Andrews et al., 2012). This approach has been used for the trunk, shoulder and elbow. More specifically Van Wyk et al (2009) investigated optimal posture category size in a video-based posture assessment to classify working postures. Different body segments and views were examined by 90 university students; participants were divided into three equally sized groups (n=30) to determine movement across three body segments. The study concluded optimal posture category sizes and number of categories for each body segment movement to improve observer accuracy (table 4.3).

Table 4.3: Optimal Posture category sizes and number of categories (Van Wyk et al. 2009).

Segment*	TRFL	TRLB	SHFL	SHAB	ELFL
Category size	30°	15°	30°	30°	30°
No. of categories	4	3	5	5	4

*Trunk flexion (TRFL); Trunk lateral bend (TRLB); Shoulder flexion / extension (SHFL); Shoulder abduction /adduction (SHAB); Elbow flexion / extension (ELFL).

This provides guidance on the selection and size of posture categories in workplace posture risk assessments. Its transferability to the field of CP and body alignment assessment has not been explored, yet the method used to classify observable posture in work-based setting has merit and applicability to the clinical use of a body alignment assessment in CP.

The predominant factors that influence the selection of the outline posture categories are based on body position and the risk this places when considering load, force and repetition (Lowe et al., 2014). Ergonomic posture categories are, therefore, more specific to these factors rather than those important to CP assessment. This is evident in the category size of ergonomic observation-based

posture assessments. Categories start from and are inclusive of a 0° body position, such as 0°-30° as body alignment within this deviation from optimal is deemed lower risk (Lowe et al., 2014). However, in children with CP a deviation of 30° could be considered a marked and significant risk to their body alignment (Rodby-Bousquet et al., 2013). The aim of posture management intervention is to maintain an optimal body alignment to prevent deformity and enhance function (Farley et al., 2003). Children with CP who require posture management intervention (GMFCS IV and V) not only have difficulty with body alignment but also muscle tone and musculoskeletal system limitations (Rosenbaum et al., 2007). These are important factors which impact on body alignment and should be a consideration when selecting posture categorisation.

Being able to discriminate between degrees of asymmetry and deviation from optimal is needed to measure alterations in body alignment, which are relevant to children with CP and their therapy intervention. Early detection of change in body alignment or corrections within body alignment towards optimal are core principles within the posture management of this cohort (Gericke, 2006; Fulford and Brown, 1976). Although the focus of ergonomic observation-based assessment may not transfer directly to CP their method of posture classification does provide a structured approach to classification of body alignment. This approach and method influenced the development of the CABA posture classification and assessment.

During the development of the CABA posture classifications from both the ergonomic assessment literature, the needs of children with CP and posture management interventions were considered. To reduce observer error a lower number of classification categories were aimed for (Lowe, 2004), and so 3 categories which identified a deviation from optimal were set for each item. These are scored 1-3 with 1 being the mildest deviation and 3 being the severest deviation. It was necessary to also be able to identify an optimal body alignment for each item. Therefore, an additional posture category which ranged 5° either side of optimal was created with a score of 0, indicating optimal alignment. This was set for two reasons; firstly, it was felt that a broad category which started from

0° would lack responsiveness to early changes in body alignment and, therefore, would have reduced applicability to children with CP. Secondly; observers find it more difficult to classify postures with little or no category range (Andrews et al., 2012), making determining a score of zero, 'optimal' posture, difficult and open to increased error. The setting of a range 5° either side of optimal would improve observer classification of optimal posture whilst still allowing for responsiveness to changes in body alignment.

In setting the size of posture categories it is important to take into consideration the differences in range of motion at different joints (Lowe et al., 2014). Conversely, having ranges which are set in similar division across fewer categories, aids observer response and can reduce errors (Van Wyk et al., 2009). These principles were considered on the development of the posture category sizes in the CABA items. The posture category size for all items was set as follows 5° - 20° / 20° - 60° / 60°+, with the exception of seven CABA items. Four of these items: Arm flexion / extension, arm abduction / adduction, leg sitting upper leg flexion / extension, leg sitting lower leg Flexion / extension had a greater range within each posture category due to their being a greater range of movement at the joints. Three of these items: leg rotation, foot inversion/eversion and foot plantarflexion / dorsiflexion had a smaller range within each posture category. The posture category sizes for these seven CABA items are shown in table 4.4.

Table 4.4: Posture category size for seven CABA items.

Segment	Arm flexion extension	Arm abd add	Leg sitting upper leg flexion extension	Leg sitting lower leg Flexion extension	Leg rotation	Foot inv ev	Foot* PL DF
Category size	5° - 40° 40° - 90° 90°+	5° - 40° 40° - 90° 90°+	5° - 20° 20° - 60° 60° - 85° 95° - 120° 120°+	5° - 20° 20° - 60° 60° - 85° 95° - 120° 120°+	5° - 20° 20° - 40° 40°+	5° - 20° 20° - 40° 40°+	15° + 5° - 15° 5° - 20° 20° - 40° 40°+
No. of categories	3	3	3 2	3 2	3	3	2 3

* Abduction (Abd); Adduction (Add); Inversion (inv); Eversion (ev); Plantarflexion (PL); Dorsiflexion (DF).

Four of the items; Leg sitting upper leg flexion / extension, leg sitting lower leg flexion and foot plantarflexion / dorsiflexion also had a reduced number of categories in one direction of movement, this again was because of the limitation of the joint range from optimal. The division of these into smaller ranges to model the 3-category method was decided against as the division of category sizes into greater number but with smaller ranges has been found to increase observer error (Andrews et al., 2008b; Lowe, 2004), therefore, two categories were kept for four of the items in one movement direction.

How the categories are presented can also impact on accuracy and assessment time (Andrews et al., 2008a). Andrews et al (2012) examined the effect of category salience on decision time and error of observation-based posture classification. This study compared several presentations of posture categories to 90 participants, concluding that posture category diagrams with a grey border enhanced response time and reduced error. Each posture category item on the CABA was presented in a grey border, again for the purpose of reducing observer error and increasing speed of assessment. This resulted in the revised items of the CABA (table 4.2) with

posture classification categories ranging from 0 -3 complete for expert content validity evaluation.

4.2.3.1 Posture categorisation in the CABA

The CABA posture classifications used a 0-3 scoring system to rank the alignment with 0 indicating a position within 5 degrees, either side of optimal alignment, and three indicating the most significant deviation away from optimal alignment. All revised CABA items (table 4.2) were based on this scoring system with the exception of four items (items 15, 16,19 and 20). Due to the limited joint range from optimal, which would result in narrow ranges within each score, these items were scored based on a 0-2 scale in one movement direction to minimise observer error. With the exception of 3 items (1, 4 and 7), all scoring was designed to differentiate the left and right of the body. Items 1, 4 and 7 are scored based on the direction of the movement.

4.2.4 Study design

A non-experimental, cross sectional design was used to examine the content validity of the CABA. Responsible use of standardised assessments requires users to be able to rationalise interpretations drawn by having a clear justification for using the scores for the intended purpose of the assessment and for selecting this over other possible procedures (Fawcett, 2013). Such justification has two prerequisites: validity and reliability.

A high reliability coefficient indicates that there is consistency in the therapist's scores (Benson and Clark, 1982), but this does not mean that the therapist's inferences are defensible. Evidence of an assessment measure's reliability is not sufficient to justify the results (McDowell and Newell, 2006). Validation is the process by which an assessment developer or user collects evidence to support the types of inferences that are to be drawn from the scores (Stokes, 2011).

When planning a validation study, the desired inferences must be clearly identified (Crocker and Algina, 2008). For situations where the therapist wants to draw

inferences from the assessment scores to a larger domain, validity of the content is required (Gotch, 2014). Content validity was required as the CABA scores are to be applied to the domain of children with CP. In the absence of criterion or a universally accepted quality to be measured of body alignment (see chapter 3) to justify inferences, more than one type of validation study may be required (Gotch, 2014). In relation to the CABA the process of validation of an assessment's content and validation of the nature of the construct it relates to are inseparably linked. Content validity is a process within the establishment of construct validity (Gotch, 2014); as this research aims to investigate construct validity of CABA, content validity will be explored first as part of the assessment's development and validation.

4.2.4.1 Participants

A purposeful sample of all members of the Association of Paediatric Chartered Physiotherapists (APCP), a special interest group within the field of paediatric physiotherapy, was undertaken.

Purposeful sampling techniques involve selecting participants based on a specific purpose rather than randomly (Bowling, 2014). It is used when the researcher wants to select a sample that represents a broader group of individuals as closely as possible (Hickson 2013), in this case paediatric physiotherapists. This sampling method was selected to achieve representativeness across a specific criterion (experience of clinical assessments of body alignment) and cohort of individuals (paediatric physiotherapists).

4.2.4.2 Clinical Assessment of Body Alignment (CABA)

The Clinical assessment of body alignment assessment, with scoring system is shown on pages 116 to 126.

Clinical Assessment of Body Alignment: CABA:

The CABA is an assessment of body alignment in children with CP. It enables you to record alignment, or deviations from optimal in terms of body segment, left and right and direction of deviation. This can be applied across lying sitting and standing positions.

Definition of Body alignment:

The position of body segments in relation to one another and their orientation in space. Body segments are defined as the position of the head, trunk, pelvis, arms, legs and feet.

Scoring Guidelines:

Each body segment to be assessed is clearly titled in sections A - F. Each corresponding body alignment item, relating to the specific body segment, is outlined underneath the titled section.

The first picture for each of the items depicts 'normal' or 'optimal' body alignment; a score of '0' is given if there is no deviation observed.

Circle the score which best fits your observation of alignment.

You score what you see:

The CABA has 20 items split into 6 sections A-F. In each of these sections, the protocol begins with observation of the individual's body alignment. If 'normal' or 'optimal' body alignment is observed (i.e. the first picture for each of the items), a score of zero is given for these items. 5 degrees either side of 0 is regarded "normal" posture.

If the individual cannot attain 'optimal' alignment, observation of body alignment is conducted and the severity of body alignment is scored according to the amount of deviation away from 'optimal'.

For cases in which you cannot decide between one of two scores, document the 'highest' value.

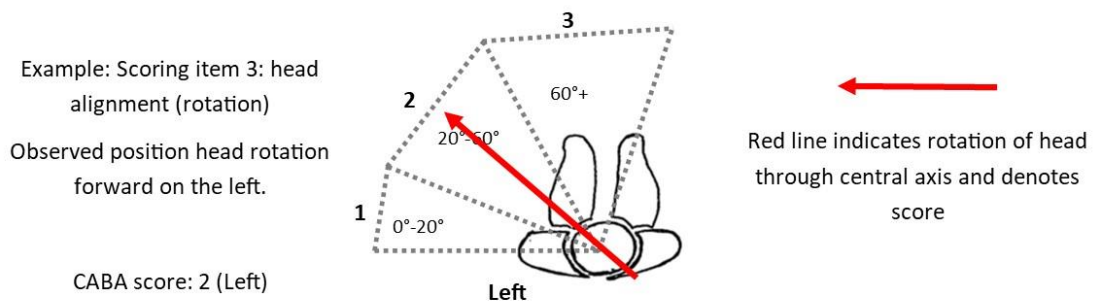

Scoring across arm / leg and foot

Items relating to leg, arm and foot record a score for left and right sides of the body, so two scores are given for each.

Example: Scoring item 20: Foot alignment (Plantarflexion / dorsiflexion)

Observed position Right and left foot.

CABA score: 1 (Right Dorsiflexed)

1 (Left plantarflexed)

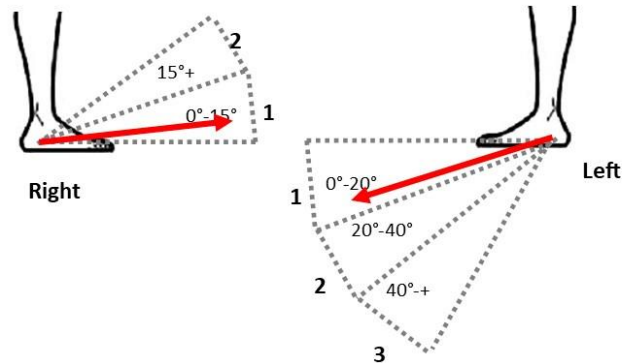

Unable to Score

If you are unable or do not make an observation for an item then it must be scored as not tested (NT). NT should always contain a comment regarding the nature of the absence of observation for future reference.

Total Scoring:

After completing the CABA, record the value for each item on the score sheet. Record the score next to the item and direction of deviation, left or right side.

Determine the head score by summing items 1-3 (section A). Determine the trunk score by summing items 4-6 (section B), the pelvis by summing items 7-9 (section C) and the arms by summing items 10-11 (Section D).

Determine the standing or lying leg position by summing items 12 – 14 (Section E) or the sitting leg position by summing items 15 – 18 (Section E), and the foot position by summing items 19-20 (section F).

Determine the total CABA overall Body Alignment score by summing all the items together.

A score of '0' indicates that the individual has no body alignment deviations and that their body alignment is in the optimal position.

A score of greater than '0' indicates alterations in body alignment, the greater the score is from '0' the greater the severity of deviation in body alignment.

Section A: Head position

Item 1: Locate head alignment (flexion / extension)

Position of the individual's head from the side. Item scores the head position from 0 - 3.

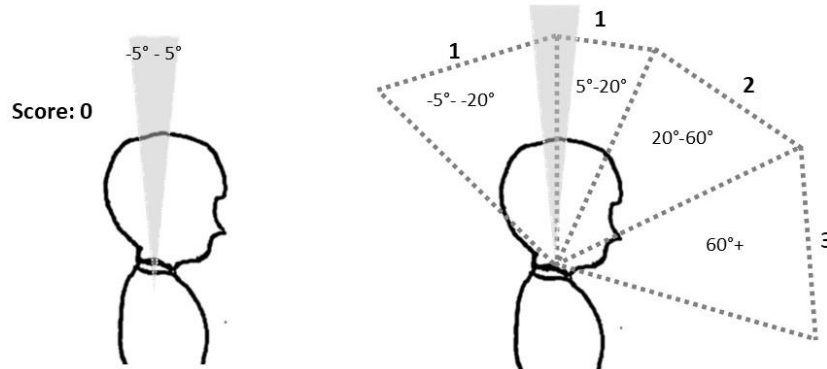

Item 2: Locate Head alignment (side flexion)

Position of the individual's head from the front or back. Item scores the head position from 0 - 3.

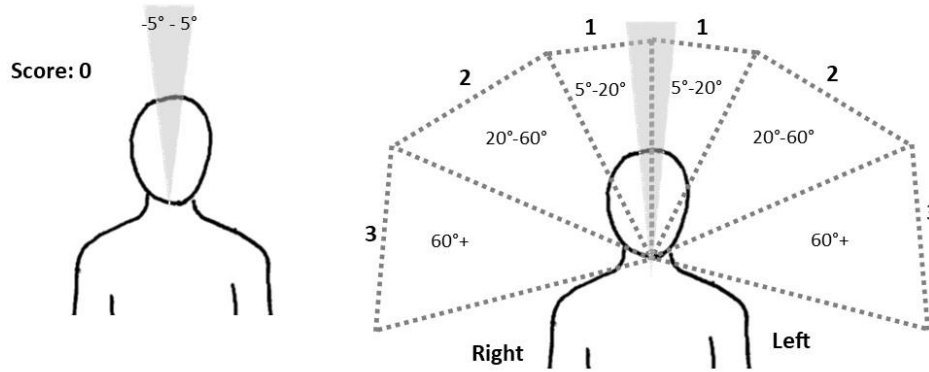

Item 3: Locate head alignment (rotation)

Position of the individual's head in the transverse plane. Item scores the head position from 0 - 3.

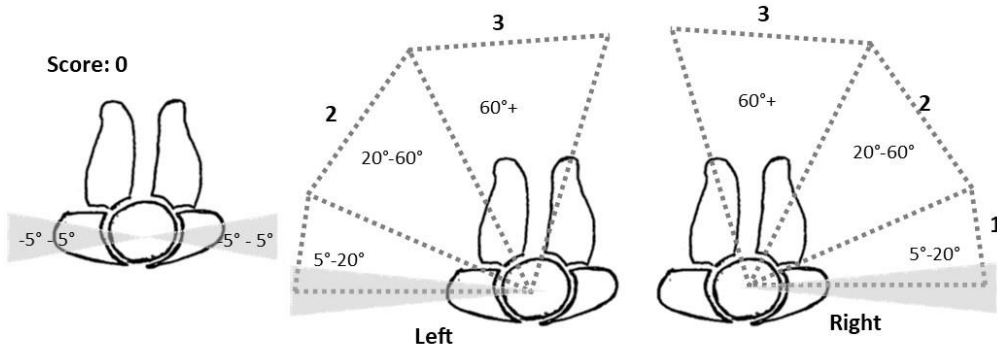

Section B: Trunk Analysis

Item 4: Locate trunk alignment (flexion / extension)

Position of the individual's trunk from the side. Item scores the trunk position from 0 - 3.

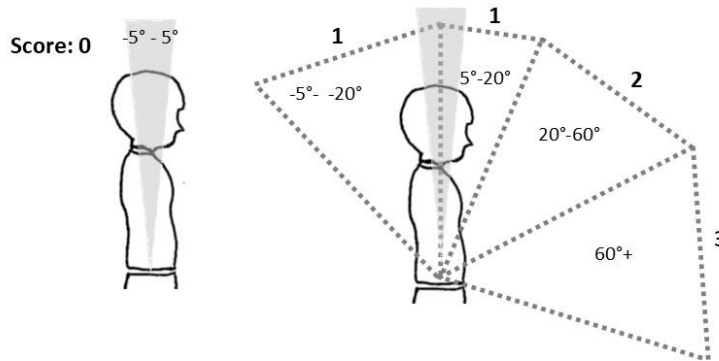

Item 5: Locate trunk alignment (side flexion)

Position of the individual's trunk from the front or back. Item scores the trunk position from 0 - 3.

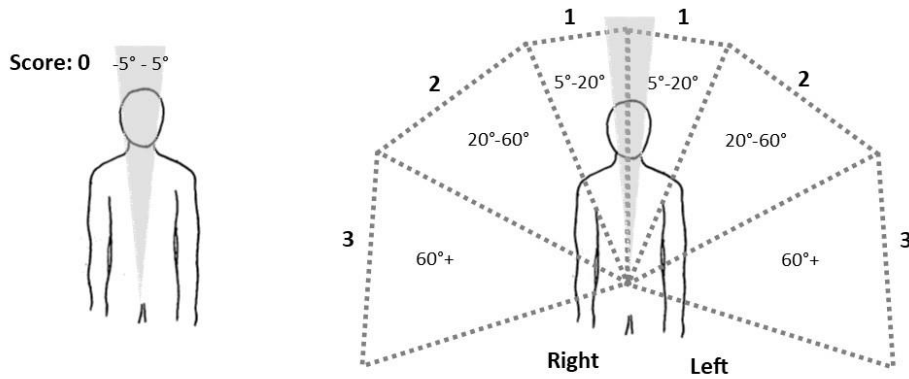

Item 6: Locate trunk alignment (rotation)

Position of the individual's trunk in the transverse plane. Item scores the trunk position from 0 - 3.

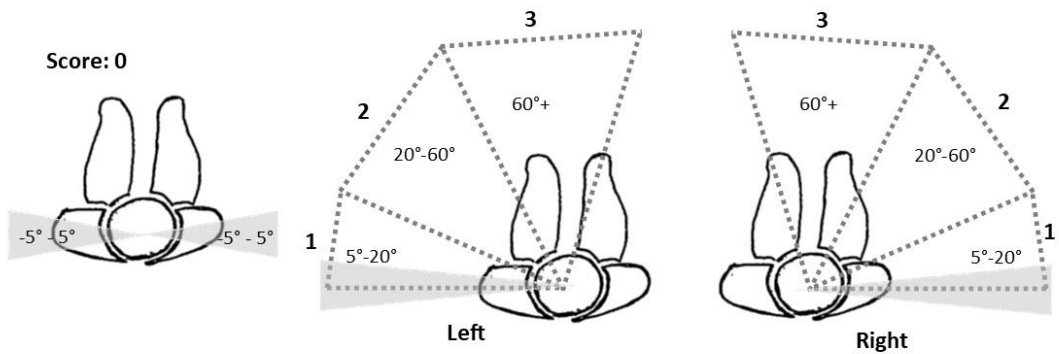

Section C: Pelvis analysis

Item 7: Locate Pelvis alignment (posterior / anterior tilt)

Position of the individual's pelvis from the side. Item scores the pelvis position from 0-3.

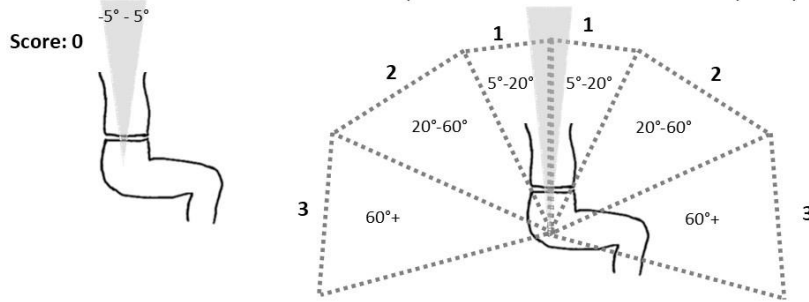

Item 8: Locate Pelvis alignment (obliquity)

Position of the individual's pelvis from the front or back. Item scores the pelvis position from 0 - 3.

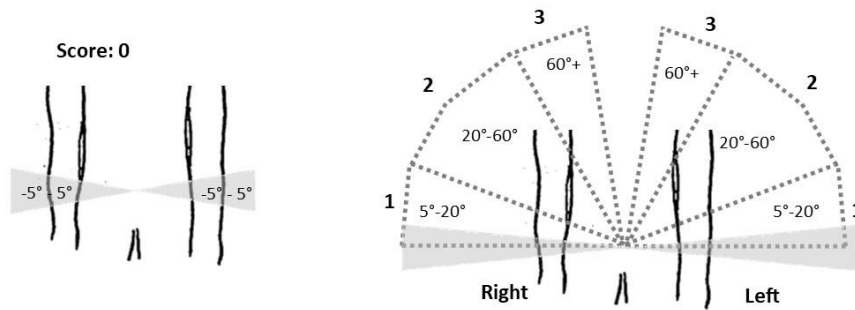

Item 9: Locate Pelvis alignment (rotation)

Position of the individual's pelvis from the transverse plane. Item scores the pelvis position from 0 - 3.

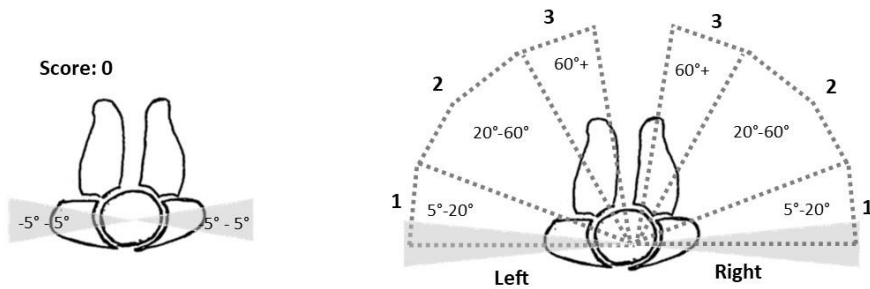

Section D: Arm Analysis

Item 10: Locate arm alignment (flexion / extension)

Position of the individual's arm alignment from the side. Item scores the arm position from 0—3.

Score: 0

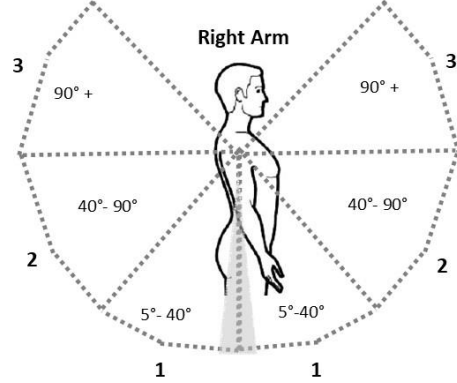
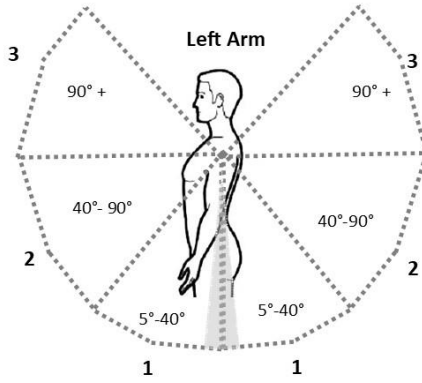

Item 11: Locate arm alignment (abduction / adduction)

Position of the individual's arm alignment from the front. Item scores the arm position from 0—3.

Score: 0

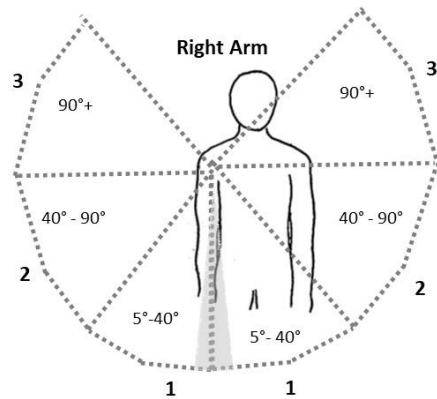
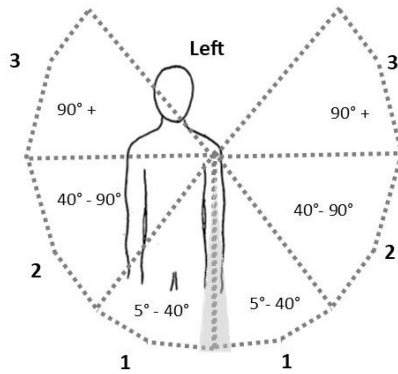
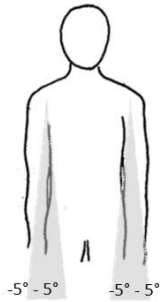

Section E: Leg position (standing or lying)

Item 12: Locate leg alignment (flexion / extension)

Position of the individual's leg from the side. Item scores the leg position from 0—3.

Score: 0

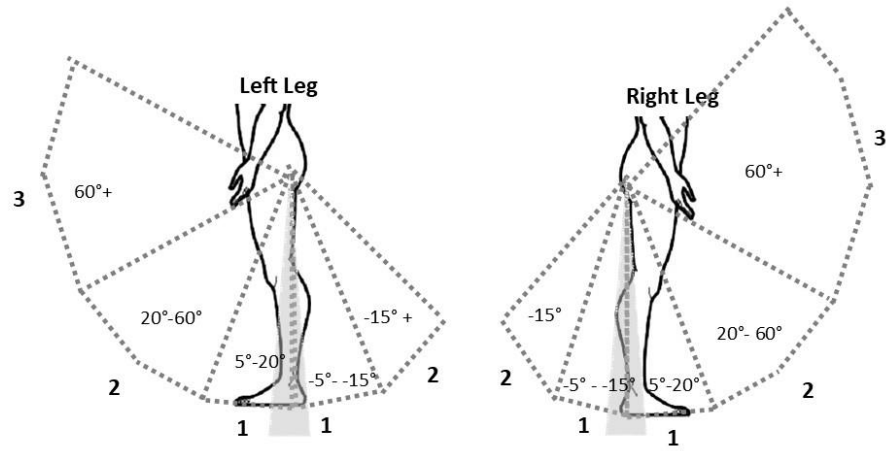

Item 13: Locate leg alignment (abduction / adduction)

Position of the individual's leg from the front or back. Item scores the leg position from 0—3.

Score: 0

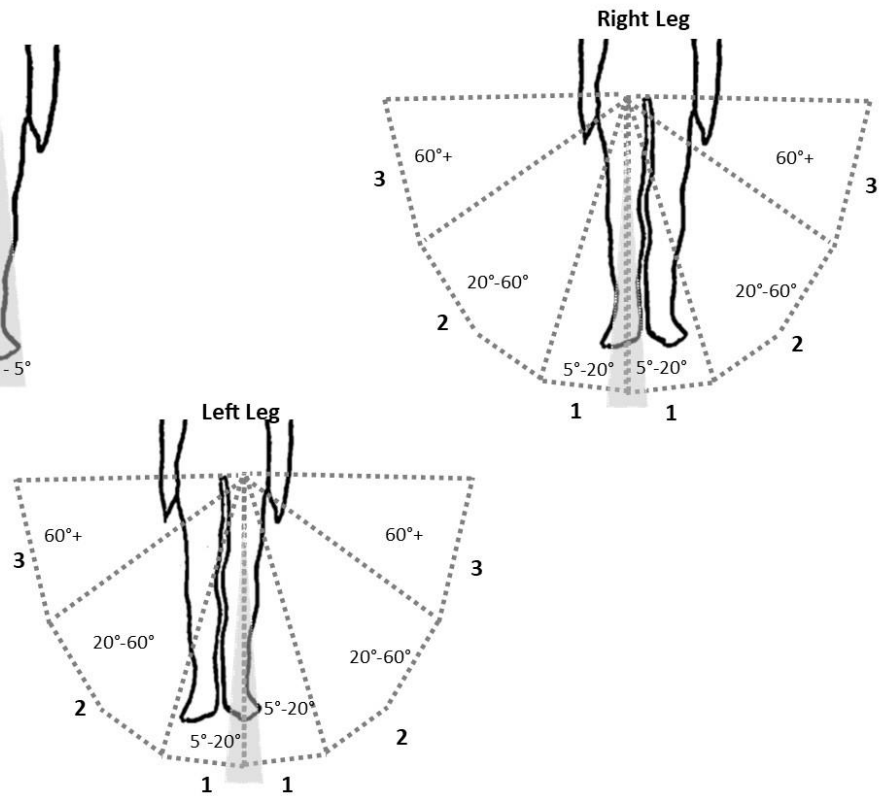

Section E: Leg position (standing or lying)

Item 14: Locate leg alignment (rotation)

Position of the individual's leg from the front. Item scores the leg position from 0—3.

Score: 0

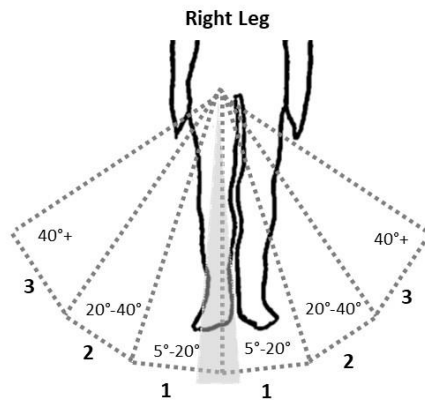
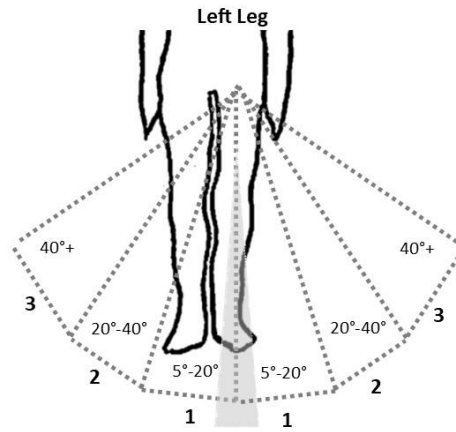

Section E: Leg position (sitting)

Item 15: Locate Upper leg alignment (flexion / extension)

Position of the individual's leg from the side. Item scores the leg position from 0—3.

Score: 0

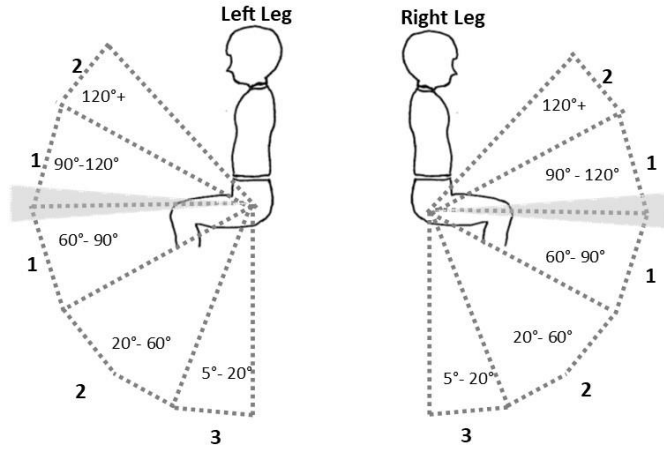
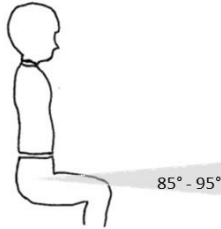

Item 16: Locate Lower leg alignment (flexion / extension)

Position of the individual's leg from the side. Item scores the leg position from 0—3.

Score: 0

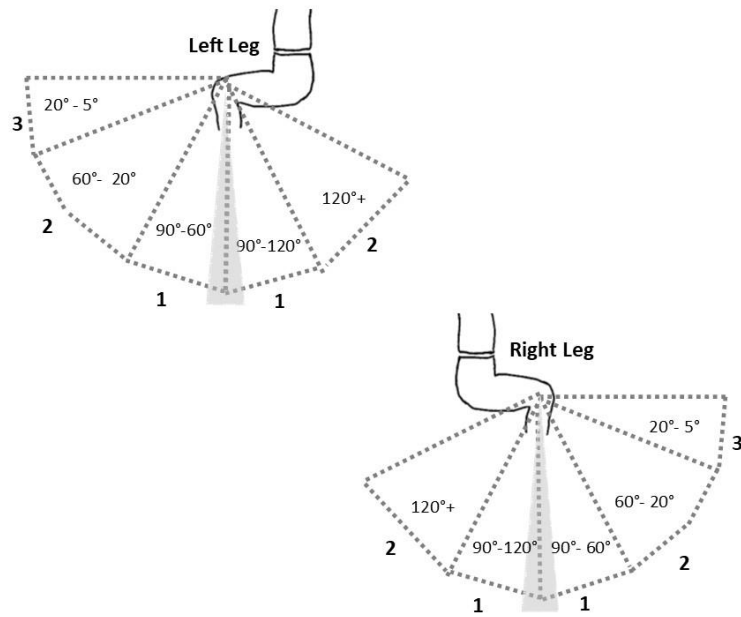

Section E: Leg position (sitting)

Item 17: Locate leg alignment (abduction / adduction)

Position of the individual's leg from the front or back. Item scores the leg position from 0—3.

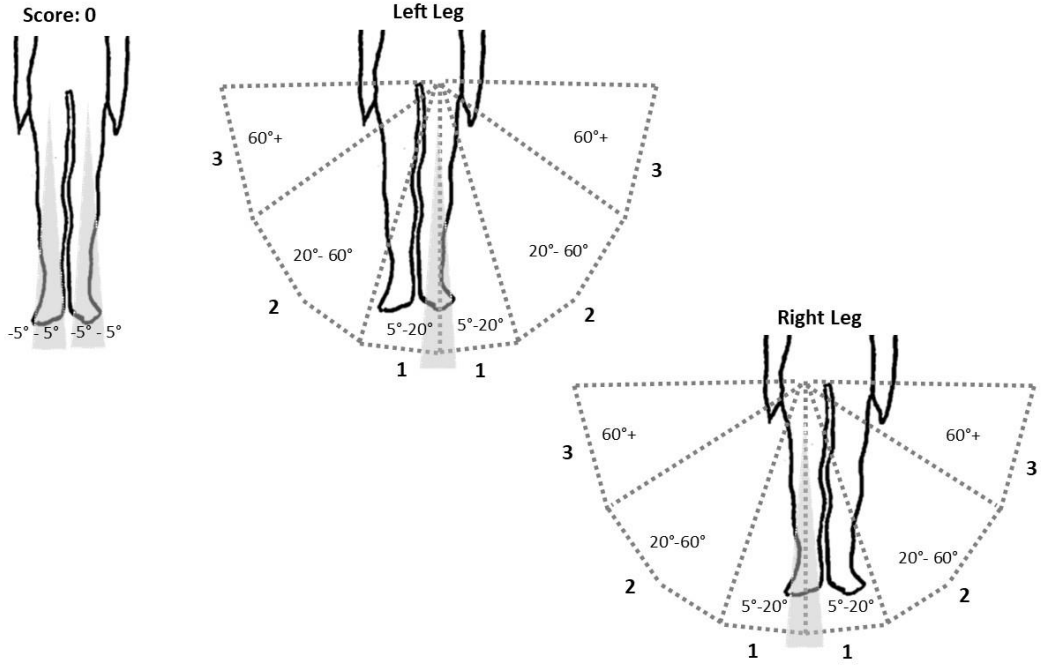

Item 18: Locate leg alignment (rotation)

Position of the individual's leg from the front or back. Item scores the leg position from 0—3.

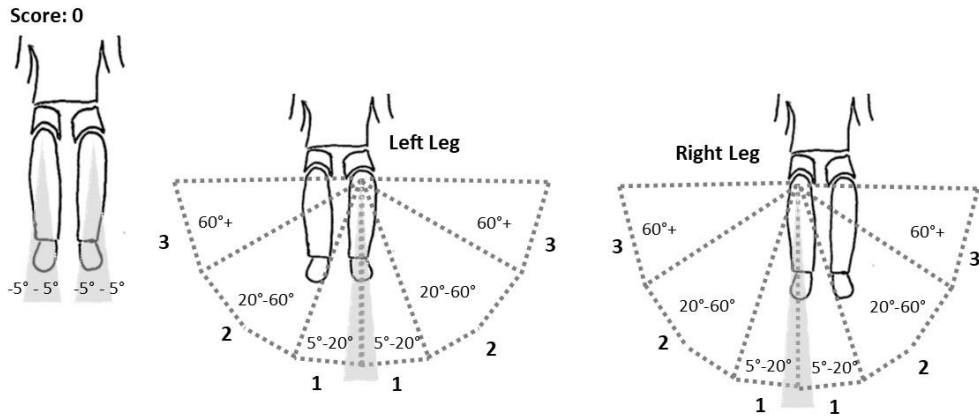

Section F: Foot position

Item 19: Locate foot alignment (inversion / eversion)

Position of the individual's foot from the front or back. Item scores the foot position from 0—3.

Score: 0

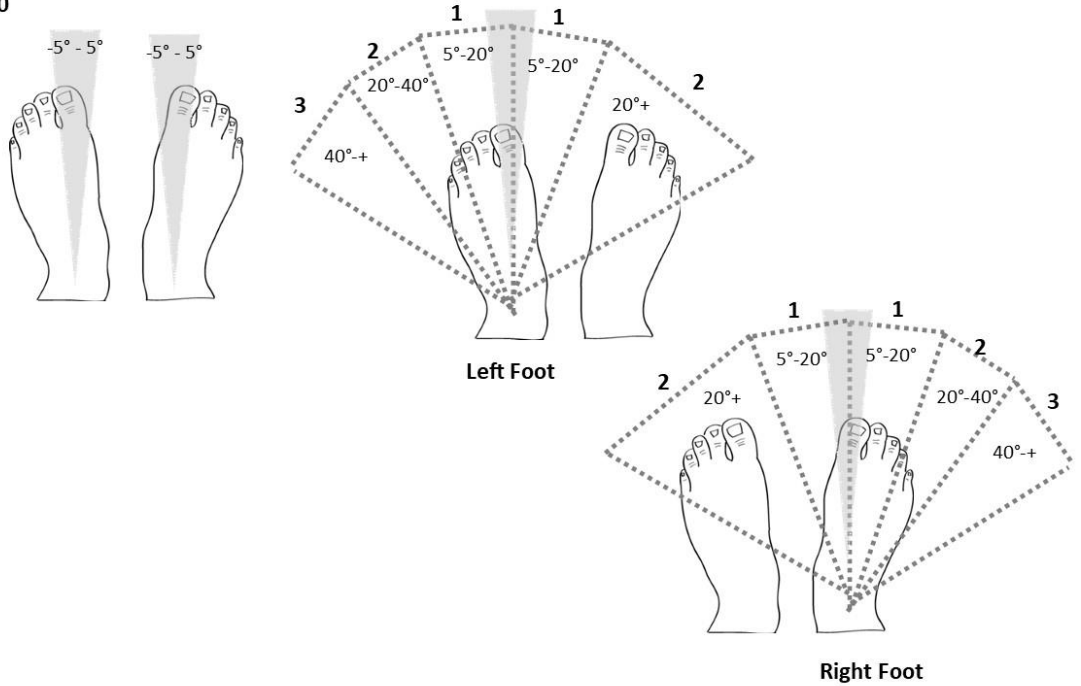

Item 20: Locate foot alignment (plantarflexion / dorsiflexion)

Position of the individual's foot from the side. Item scores the leg position from 0—3.

Score: 0

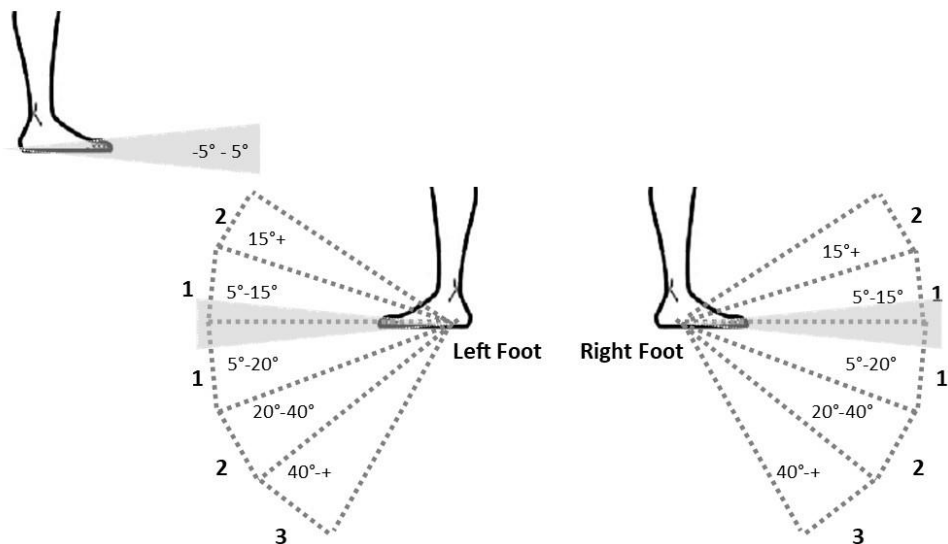

4.2.5 Procedure

The purpose of content validity is to assess whether the items on the CABA assessment adequately represent the construct of body alignment (Gotch, 2014). A consensus process and correlation design was employed. This followed the procedure whereby a panel of independent paediatric physiotherapy experts judged whether the CABA assessment items adequately represented the construct of body alignment.

The CABA items (see section 4.2.4.2) were sent out via an electronic survey using Qualtrics platform to APCP members (see appendix 5). To maintain participant anonymity, the survey was sent out through use of a gatekeeper, the APCP committee research lead. This meant that there was no direct contact between the researcher and possible participants. Participants were asked at the start of the survey to leave a 6-digit code using a combination of numbers and letters from their birthday and postcode. This created a unique and anonymous digital identifier to individual data responses, which participants could use should they wish to withdraw their data within a 60-day period of the survey launch.

Participants were asked to contribute if they worked within the field of posture / postural management with children with CP (see appendix 6). Participation was voluntary and consent was assumed through participants clicking on the survey link. Participant information was also provided on a separate link on the same email giving clarity on what was expected and the use of the data (see appendix 7).

Details of the full ethical application for this study are detailed in appendix 8. To evaluate the diversity within the participant' sample the participants were asked to answer 4 questions relating to ACPC region, years of experience, place of work and area of speciality. This allowed for analysis of how representative the sample was of the targeted users, paediatric physiotherapists.

Respondents were asked to consider and score the 20 items in relation to relevance to body alignment. One open ended question was also provided for respondents to state any other item of assessment that they felt should be included. Respondents

were also asked to consider and rate the importance of clinical utility attributes, which they felt would assist assessments' functionality in clinical practice. As the CABA is intended to be a clinically based assessment, ensuring it aligned with crucial attributes was an important consideration in its development. They were asked to rate items that have been identified as supportive of the clinical efficiency of an assessment including: training (formal); cost; time to administer; format (paper vs. electronic or both); environments applicable to assessment use; ease of administration (equipment, therapist stress, demand on child); transportability of the assessment; and ease of scoring analysis.

Within the instructions, the construct of interest, body alignment in children with CP, was clearly defined and the participants were provided with a structured framework for the matching of items. This ensured that all participants had a clear and consistent interpretation of the construct of body alignment.

4.2.5.1 Weighting of items to reflect importance

In the development of framework for matching items it was important to consider if items should be weighted to reflect importance. One common procedure is to assume that all the items are equal in value (Crocker and Algina, 2008). This viewpoint, however, is not universal. Katz (1973) suggested weighting or ranking items in terms of their importance, advocating ordering this using a 5-point scale.

It was important then to consider whether aspects of body alignment and items to be measured on the CABA should be weighted to reflect performance. Some aspects of performance could be viewed as more critical than others. In therapy assessments, sometimes all aspects of a construct (body alignment) are of equal value. For example, in undertaking an assessment of body alignment, the assessment of the trunk and legs is no more or less important than assessment of the head and arms. Therefore, the CABA assessment items were rated as either matching or not to the construct of body alignment.

However, in asking physiotherapists' view of clinical utility items importance relating to the CABA, some aspects of performance could be viewed as more critical than others. For example, in undertaking an assessment of body alignment within a clinical setting, the assessment's ease of use and cost may be of greater importance than the assessment format (paper or electronic) or environments the assessment can be applied to. Therefore, the CABA clinical utility items were rated in terms of importance using a 5-point scale (1=essential, 2= Important, 3= Acceptable, 4= marginally relevant, 5= not relevant). In using this approach, it was important to provide participants with a common definition of importance to avoid participants developing their own idiosyncratic definitions. For example, in judging importance of an objective one physiotherapist might consider the amount of function related to it, while another might define importance in terms of its relationship to future deformities. The common definition of importance provided was 1=essential defined as 'item is essential and must be included to ensure the assessment has clinical utility'. To exclude this would mean that the assessment had an extremely high risk of not being able to be used in everyday clinical settings. 5= not relevant defined as 'this item would never impact on the assessment being used within everyday clinical practice'.

4.2.5.2 Framework for matching items

The respondents were instructed to read through the presented CABA items. Respondents were given clear descriptions of the items to be considered for matching to the construct of body alignment. Each body segment to be assessed was clearly titled; each corresponding body alignment item relating to the specific body segment was outlined underneath the titled section. For example, see figure 4.1:

The CABA assessment items were rated as matching (yes / no) to the construct of body alignment. Clinical utility items were rated in terms of importance to the rater using a 5-point Likert scale (1=essential, 2= important, 3= acceptable, 4= marginally relevant, 5= not relevant).

Section A: Head Analysis

Item 1: Locate head alignment (flexion / extension)

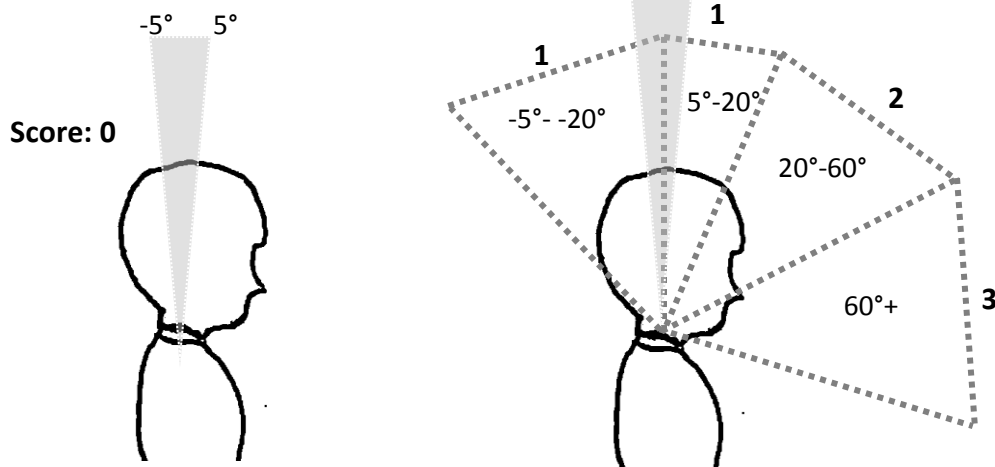

Fig 4.1: Position of the individual's Head. Item scores the head position from 0 - 3.

4.2.6 Data analysis

Content validity is a non-statistical type of validity that involves the degree to which the content of the assessment matches a content domain associated with the construct (Gotch, 2014). Content related evidence typically involves subject matter experts (SME's) evaluating test items against the test specifications (Rothstein, 1985).

An assessment measure has content validity built into it by careful selection of which items to include (Anastasi and Urbina, 1997). Items are chosen so that they comply with the assessment specification, which is drawn up through a thorough examination of the subject domain. Foxcroft et al (2004) noted that the use of a panel of experts to review specification of a test's specifications and item selection improved the content validity of a test. Therefore, item matching is a more qualitative approach than quantitative.

Each participant was assigned a unique reference number and the questionnaire responses were extracted from Qualtrics into the IBM Statistical Package for the Social Science (SPSS version 25). Data analyses were conducted using IBM Statistical Package for the Social Science (SPSS version 25).

Characteristics of clinicians who returned partial versus complete questionnaires were analysed using a Chi-squared test. The Chi-squared test is used on nominal (categorical) data (Bowling, 2014). This is when data has no clear ordering, such as area of speciality or place of work. The Chi squared test was used to determine if there was an association between the two variables of partial and completed responses and the characteristics of the clinicians.

Matching items to the attribute of body alignment was quantified by calculating the percentage of agreement to each item. Items with a high agreement score (>70%) were judged to be a 'good match', indicating a strong agreement and representation of the construct (Benson and Clark, 1982). Responses to the open-ended question responses were analysed. Responses which occurred frequently were considered to be a possible important component of the construct of body alignment and were sent back out to the expert panel to rate.

To assess the overall agreement of importance for the identified clinical utility attributes, percentage agreement, means and SD were calculated for each attribute. Standard deviation is the measure of the spread or extent of variability of a set of data scores around the mean (Field, 2013). It reflects the degree of homogeneity of responses in relation to each clinical utility item of the assessment (Hickson, 2013). A large standard deviation score indicates that the scores obtained scatter far from the mean, while a small standard deviation score indicates that the scores are clustered closely around the mean (Field, 2013). The degree of relevance was quantified by items with a low mean and standard deviation score and were judged to be highly relevant to the clinical utility of assessment. These were taken into consideration with the development of the CABA.

Respondent inter-rater reliability was assessed using the Fleiss' Kappa statistic to measure the extent to which the different clinicians (raters) gave the same responses to the rating questions (Fleiss et al., 2003) The Fleiss Kappa is an extension of the more common Cohen's Kappa used in cases where there are multiple raters. The Kappa statistic ranges from -1 to +1. A score of zero or less

shows that there is no agreement between raters; scores greater than zero can be graded using the bands proposed by Fleiss (Fleiss et al., 2003), 0.75 – 1.00 very good, 0.41 – 0.75 fair to good, < 0.40 poor.

4.3 Results

4.3.1 Response:

In total, 2,196 physiotherapists were contacted via electronic survey. Participants were invited to contribute if they worked within the field of posture / postural management with children diagnosed with CP. Two hundred and eighty-three (283) questionnaires were returned for a response rate of 13%. Fourteen participants completed the screening element only; 185 partially completed the questionnaire and 84 respondents completed the full questionnaire (table 4. 5).

Table 4.5: Completion of the questionnaire.

Questionnaire returns	Questions completed	Respondents (% of total sample)
Descriptive only	Q1 thru Q5 only	14 (5%)
Partial questionnaire	Q1 thru Q5 plus some ratings	185 (65%)
Complete questionnaire	All questions	84 (30%)

The descriptive data relating to respondents' characteristics (N=283) were collectively analysed and grouped by region, years of experience, place of work and area of speciality (table 4.6).

Table 4.6: Key characteristics of all respondents (N=283).

Characteristics	Dimension of characteristics	Respondents (% of total)
APCP area	<i>England (South)</i>	100 (39%)
	<i>England (Midlands)</i>	46 (18%)
	<i>England (North)</i>	57 (22%)
	<i>Scotland</i>	32 (13%)
	<i>Wales</i>	32 (13%)
	<i>Northern Ireland</i>	7 (3%)
Time in profession	<i>Up to 10 years</i>	43 (17%)
	<i>11 to 20 years</i>	76 (29%)
	<i>>20 years</i>	139 (54%)
Place of work	<i>NHS</i>	217 (83%)
	<i>Private practice</i>	23 (9%)
	<i>Education</i>	21 (8%)
Area of specialty	<i>Musculoskeletal</i>	31 (11%)
	<i>Neonatal</i>	22 (8%)
	<i>Neurodisability</i>	216 (76%)
	<i>Management</i>	28 (10%)
	<i>Respiratory</i>	26 (9%)
	<i>Orthopaedic</i>	25 (9%)
	<i>Community</i>	153 (54%)
	<i>Acute ward</i>	19 (7%)

Respondents came from all 4 nations of the UK and from all regions of England. Over half of respondents, 54%, had been in the profession for 20 years or more. The majority, 83%, worked in the NHS with 9% in private practice and 8% in education. Three quarters, 76%, worked in neurodisability and 54% worked in the community. Fifty-eight per cent of respondents worked in multiple areas of the 8 listed specialties.

A brief analysis was undertaken to determine if there were any differences between the respondents who completed a full questionnaire and those who provided only partial details across area, place of work and time in professions (see table 4.7).

Table 4.7: Key characteristics of respondents of partial and completed responses.

Characteristics	Dimension of characteristics	Partial data	Completed
APCP area	<i>South</i>	61 (35%)	39 (48%)
	<i>Midlands</i>	39 (23%)	7 (9%)
	<i>North</i>	38 (22%)	19 (24%)
	<i>Scotland</i>	20 (12%)	12 (15%)
	<i>Wales</i>	4 (2%)	3 (4%)
	<i>Northern Ireland</i>	11 (6%)	1 (1%)
Time in profession	<i>Up to 10 years</i>	30 (17%)	13 (16%)
	<i>11 to 20 years</i>	57 (33%)	19 (23%)
	<i>>20 years</i>	88 (50%)	51 (61%)
Place of work	<i>NHS</i>	149 (84%)	68 (81%)
	<i>Private practice</i>	16 (9%)	7 (8%)
	<i>Education</i>	12 (7%)	9 (11%)
Area of specialty	<i>Musculoskeletal</i>	25 (13%)	6 (7%)
	<i>Neonatal</i>	14 (7%)	8 (10%)
	<i>Neurodisability</i>	*143 (72%)	*73 (87%)
	<i>Management</i>	22 (11%)	6 (7%)
	<i>Respiratory</i>	19 (10%)	7 (8%)
	<i>Orthopaedic</i>	15 (8%)	10 (12%)
	<i>Community</i>	105 (53%)	48 (57%)
	<i>Acute ward</i>	11 (6%)	8 (10%)

* significant difference at 5% significance level.

A significant difference ($\chi^2(5)=12.2$, $p=0.032$) in respect to APCP area was noted between the partial data and complete respondents. Respondents completing the questionnaire in full are more likely to be in the South (London, South East and South West) and less likely to be from the Midlands. There are no differences in place of work ($\chi^2(2)=1.2$, $p=0.549$) or time in profession ($\chi^2(2)=3.2$, $p=0.205$). Neurodisability specialists are more prevalent in the sample who completed the full questionnaire compared to those who gave partial data ($\chi^2(1)=7.4$, $p=0.007$).

4.3.2 Content validity (item agreement)

The level of agreement amongst clinicians regarding item affiliation to body alignment was calculated using percentage agreement (table 4.8). The proportion of respondents who indicated that the 20 CABA items matched body alignment varied from a low of 65% for leg internal/external rotation to high of 94% for head flexion/extension. Among the participating clinicians, all items, except number 14,

were identified as highly related to body alignment with an agreement level of greater than 70%. Item 14 (leg internal/external) was the only item below with an agreement of 65%. In 14 out of the 20 items the agreement was >80%, indicating a consensus that these items strongly relate to the construct of body alignment.

Table 4.8: Percentage agreement that the CABA item matches body alignment.

Item	Description	Yes – this matches body alignment	No – this does not match body alignment
1	Head flexion / extension	77 (93.9%)	5 (6.1%)
2	Head side flexion	77 (92.8%)	6 (7.2%)
3	Head rotation	64 (77.1%)	19 (22.9%)
4	Trunk flexion / extension	74 (89.2%)	9 (10.8%)
5	Trunk Side flexion	74 (89.2%)	9 (10.8%)
6	Trunk rotation	61 (74.4%)	21 (25.6%)
7	Pelvis anterior / posterior tilt	73 (89.0%)	9 (11.0%)
8	Pelvic obliquity	66 (79.5%)	17 (20.5%)
9	Pelvis rotation	66 (80.5%)	16 (19.5%)
10	Arm Flexion / extension	68 (81.9%)	15 (18.1%)
11	Arm Abduction / adduction	68 (81.9%)	15 (18.1%)
12	Leg flexion / extension	62 (76.5%)	19 (23.5%)
13	Leg abduction / adduction	69 (83.1%)	14 (16.9%)
14	Leg internal / external rotation	54 (65.1%)	29 (34.9%)
15	Upper leg flexion / extension	68 (81.9%)	15 (18.1%)
16	Lower Leg flexion / extension	68 (87.9%)	15 (18.1%)
17	Leg Abduction / adduction	69 (83.1%)	14 (16.9%)
18	Leg internal / external rotation	70 (85.4%)	12 (14.6%)
19	Foot inversion / eversion	64 (78.0%)	18 (22.0%)
20	Foot plantar flexion / dorsiflexion	70 (86.4%)	11 (13.6%)

95% confidence intervals (CI) were calculated for the proportion of clinicians who agreed that the item matched body alignment (table 4.9).

Table 4.9: 95% CI for matched CABA items to body alignment.

Item	Description	% Yes (95% CI)
1	Head flexion / extension	93.9% (89%, 99%)
2	Head side flexion	92.8% (87%, 98%)
3	Head rotation	77.1% (68%, 86%)
4	Trunk flexion / extension	89.2% (82%, 96%)
5	Trunk Side flexion	89.2% (82%, 96%)
6	Trunk rotation	74.4% (65%, 84%)
7	Pelvis anterior / posterior tilt	89% (82%, 96%)
8	Pelvic obliquity	79.5% (71%, 88%)
9	Pelvis rotation	80.5% (72%, 89%)
10	Arm Flexion / extension	81.9% (74%, 90%)
11	Arm Abduction / adduction	81.9% (74%, 90%)
12	Leg flexion / extension	76.5% (67%, 86%)
13	Leg abduction / adduction	83.1% (75%, 91%)
14	Leg internal / external rotation	65.1% (55%, 75%)
15	Upper leg flexion / extension	81.9% (74%, 90%)
16	Lower Leg flexion / extension	81.9% (74%, 90%)
17	Leg Abduction / adduction	83.1% (75%, 91%)
18	Leg internal / external rotation	85.4% (78%, 93%)
19	Foot inversion / eversion	78% (69%, 87%)
20	Foot plantar flexion / dorsiflexion	86.4% (79%, 94%)

In 15 of the CABA items the 95% CI lower range was >70%. Four of the CABA (items 3, 6, 12, 19) showed a 95% CI >65% and one item (14) >55%. The CI values of item 1 (head flexion/extension) were greater than CI values for item 14, indicating that clinicians felt item 1 was a better indicator of body alignment than item 14 (leg internal/external). No additional items were reported frequently from the open-ended question (N=13 responses). Of these, 4 responses related to body linkages, whilst others responses (N=7) related to a broad range of issues not directly related to body position such as; environmental, muscle tone and task demand.

4.3.3 Respondent inter-rater reliability

Fleiss' Kappa was used to assess inter-rater reliability among all respondents for matching of each of the CABA items to the construct of body alignment. Each individual respondents' response, yes or no, for each item (1 to 20) was analysed and the results showed moderate agreement across all items that they matched the

construct of body alignment, ($K = .422$, 95% CI, .33 to .51, $p < .005$). In addition, inter-rater reliability was also assessed within clinician subgroups (based on years of experience and workplace description) (See table 4.10).

Table 4.10: Fleiss' Kappa measure of respondents' inter-rater reliability.

Subgroup (valid cases)	Fleiss' Kappa
In profession >20 years (n=51)	0.51
In profession <= 20 years (n=29)	0.33
NHS (n=66)	0.40
Not NHS (n=14)	0.53
Work in community (n=46)	0.36
Not in community (n=34)	0.47

Agreement between raters was higher for those who have been in the profession for more than 20 years compared to those with fewer years served. Agreement was higher amongst non-NHS clinicians (those in private practice or education) and for those who do not work in the community.

4.3.4 Clinical Utility

The clinical utility attributes the respondents were asked to rate are listed in table 4.11. This table also presents the combined totals of essential/important scores for each attribute, percentage agreement among respondents and the mean scores and standard deviation for each attribute. The ratings were based on a 5-point Likert scale; a score of one indicated a rating of essential/important., while a score of 5 indicated not relevant. The rating of essential was highest (76%) for 'overall ease of use' with 'time to complete', 'usable in different environments' and 'ease of analysis' rated as essential by greater than 50% of the respondents. Format (paper vs. electronic or both) was least important, receiving a rating of essential from only 20% of the respondents.

Table 4.11: Net scores of essential/important, mean and standard deviations of attributes.

Item	Description	Net essential and important	Mean score	Standard deviation
1	Formal training	63 (76%)	2.0	1.0
2	Informal training	64 (77%)	1.9	0.8
3	Cost	58 (70%)	2.2	1.0
4	Time to complete	76 (93%)	1.6	0.7
5	Format - electronic	42 (53%)	2.4	0.9
6	Format - paper based	28 (35%)	2.8	1.0
7	Format - paper based and electronic	47 (58%)	2.4	1.0
8	Usability in different environments	79 (95%)	1.5	0.6
9	Ease of use	80 (98%)	1.3	0.5
10	Requirement of equipment to conduct assessment	42 (51%)	2.4	1.1
11	Demand on the child	72 (88%)	1.7	0.8
12	Transportability	73 (89%)	1.7	0.8
13	Ease of analysis	78 (96%)	1.5	0.6

The total combined essential ratings ranged from a low of 35% (format paper) to 98% (ease of use) (See table 4.11). The rating of essential was highest (76%) for 'overall ease of use' with 'time to complete', 'usable in different environments' and 'ease of analysis' rated as essential by greater than 50% of the respondents. Format (paper vs. electronic or both) was least important, receiving a rating of essential from only 20% of the respondents. Four attributes had a combined score >90%; ease of use, time to complete, ease of analysis and usable in different environments. The greatest variation is noted in the attribute 'requirement of equipment'. Ease of use has the smallest variation. There is no significant level of agreement between the respondents' rating levels all as a whole (Fleiss' Kappa $K = .21$ 95% CI, .11 to .31, $p < .005$).

Respondents were presented in total with 13 attributes relating to the use and implementation of the measure and asked to rate the importance of each attribute on a five-point Likert scale where 1='essential' to 5='not relevant'. Table 4.12 compares the breakdown of responses across all levels of importance ratings.

Table 4.12: All responses (n=84) of rating of importance across all attributes.

Item	Description	Essential	Important	Acceptable	Marginally relevant	Not relevant
1	Formal training	26 (31.1%)	37 (44.6%)	13 (15.7%)	5 (6%)	2 (2.4%)
2	Informal training	29 (34.9%)	35 (42.2%)	18 (21.7%)	1 (1.2%)	0 (0%)
3	Cost	21 (25.3%)	37 (44.6%)	16 (19.3%)	7 (8.4%)	2 (2.4%)
4	Time to complete	42 (51.2%)	34 (41.5%)	5 (6.1%)	1 (1.2%)	0 (0%)
5	Format - electronic	15 (18.8%)	27 (33.8%)	31 (38.3%)	5 (6.3%)	2 (2.5%)
6	Format - paper based	7 (8.8%)	21 (26.3%)	40 (50%)	6 (7.5%)	6 (7.5%)
7	Format - paper based and electronic	15 (18.5%)	32 (39.5%)	25 (30.9%)	5 (6.2%)	4 (4.9%)
8	Usability in different environments	44 (53%)	35 (42.2%)	4 (4.8%)	0 (0%)	0 (0%)
9	Ease of use	62 (75.6%)	18 (22%)	2 (2.4%)	0 (0%)	0 (0%)
10	Requirement of equipment to conduct assessment	19 (22.9%)	23 (27.7%)	31 (37.3%)	5 (6%)	5 (6%)
11	Demand on the child	33 (40.2%)	39 (47.6%)	9 (11%)	0 (0%)	1 (1.2%)
12	Transportability	33 (40.2%)	40 (48.8%)	6 (7.3%)	3 (3.7%)	0 (0%)
13	Ease of analysis	43 (53.1%)	35 (43.2%)	3 (3.7%)	0 (0%)	0 (0%)

Ease of use has the highest proportion of 'essential' ratings (76%) with 'time to complete', 'usable in different environments' and 'ease of analysis' all having the majority of clinicians (greater than 50%) rating as essential. Format (paper based, electronic or both) was less important with less than 20% of clinicians rating these attributes essential.

4.3.5 Respondent Inter-rater reliability (clinical utility attributes)

Fleiss' Kappa was run to determine if there was agreement between the clinicians' ratings on the importance of the 13 attributes. There was low agreement between clinicians' ratings, $K = .21$ (95% CI, .11 to .31), $p < .005$. Furthermore, inter-rater reliability was run to determine the levels of agreement by different clinician

subgroups (table 4.13). Agreement between respondents was higher for those who have been in the profession for more than 20 years compared to those with less years served. Agreement was higher amongst non-NHS clinicians, those in private practice or education, and higher for clinicians who work in the community.

Table 4.13: Fleiss' Kappa measure of inter-rater reliability for 13 attributes by time in post, NHS/non NHS, Community/non-community.

Subgroup (number of respondents)	Fleiss' Kappa
In profession >20 years (n=51)	0.19
In profession <= 20 years (n=29)	0.25
NHS (n=66)	0.20
Not NHS (n=14)	0.27
Work in community (n=46)	0.22
Not in community (n=34)	0.18

4.4 Discussion

4.4.1 Response

Responses to this study covered a wide spectrum of APCP areas, speciality and level of experience in the profession. This produced a strong representative sample of physiotherapists working with children with CP and as such reduces sampling bias. Although a significant difference between partial and complete responses was noted for APCP region ($p=0.032$) and speciality ($p=0.007$), the sample of complete responses remains a representative sample.

4.4.2 Content validity (item agreement)

Content validity for the CABA item development was supported by the high percentage agreement of items matching the construct of body alignment. The level of agreement amongst clinicians regarding item affiliation to body alignment was calculated using percentage agreement along with 95% confidence intervals (table 4.9). The 95% CI indicates that while all items, except one (item 14), were highly representative of body alignment, there were differences in the magnitude of agreement between individual items. While four of the CABA items (items 3, 6, 12, 19) had a lower 95% CI range score below 70%, overall, the agreement

percentage by respondents was high, signifying that these items matched the domain of body alignment.

The lowest agreement was within one item (item 14: Leg internal/external), which scored a lower percentage agreement (65.1%) and 95% CI range (55%, 75%) compared to the rest of the items. The reason for this is unclear; this discrepancy could be attributed to the movement direction being assessed by this item when set in the context of clinical assessment of body alignment. However, the movement direction analysed by this item has important implications to overall body alignment with previous research having established a relationship between hip position and alteration in postural orientation (Porter et al., 2008; Scrutton, 2008; Porter et al., 2007). Assessment and management of hip position is clinically important in preventing wider postural deformities (Martinsson and Himmelmann, 2011). Limitations in hip rotation result in leg position shift away from midline and can result in pelvic obliquity and spinal scoliosis (Porter et al., 2007). Monitoring and assessing hip position is crucial to support alignment, prevent postural deformities and enhance comfort and function for a child with CP (Macias-Merlo et al., 2016; Martinsson and Himmelmann, 2011) This demonstrates the important role leg position and hip rotation has within the assessment of body alignment. Given the significance of assessing hip position and that the percentage agreement was close to the threshold of 70%, the decision was made not to exclude item 14 from the assessment.

The analyses above indicate that 19 of the 20 CABA items are highly representative of the construct of body alignment measurement, whilst 1 item is moderately representative. Content validity often involves subject matter experts evaluating the degree to which test items match the test specifications domain (Crocker and Algina, 2008). Most studies investigating psychometric properties of body alignment measurements have utilised expert opinion in their test construction process (Rodby-Bousquet et al., 2014; Barlett and Purdie, 2005; Pountney et al., 1999; Fife et al., 1991). The existing accounts on test construction give a brief description of development with little published data to allow quantifiable analysis

on expert level of agreement in relation to test items and their construct. As such, comparison of item relevance and validity cannot be made between published research and those of this study.

4.4.3 Respondent inter-rater reliability

Inter-rater reliability between respondents in relation to item agreement was fair to good ($\kappa = .422$) (Fleiss et al., 2003), in matching CABA items to the domain of body alignment. A higher agreement was seen in those with >20 years clinical experience. This could be a reflection that the highest percentage of respondents to this study had >20 years' experience (n=88). Posture and body alignment in children with CP are a post graduate skill, therefore clinicians working in this field and area are likely to have more experience in the assessment of body alignment.

In addition, there was higher agreement reliability between respondents who are non-NHS clinicians, those working in private practice or education (k= 0.53) compared to those who work in the NHS (k= 0.40). No reports could be found on specific areas of clinical work and working environment. Therefore, it could be speculated, that non-NHS clinicians are more likely to work frequently within specialist areas such as postural management, compared to those who work in the NHS. Results from this study suggest that this hypothesis could be substantiated.

Inter-rater reliability between respondents in relation to clinical utility items was low (K = .21) in rating attributes level of importance to clinical usability. Inter-rater reliability between different clinician subgroups (table 4.11) showed greater agreement between respondents with >20 years' experience (n=51), those who worked in private practice (n=7), education (n=9) and community settings (n=46). A possible explanation for this maybe that those with greater years' experience have a more comprehensive understanding of attributes which make an assessment applicable to clinical settings. Also, most respondents, 61% had greater than 20 years' experience. With regards to place of work private practice, education and community had fewer number of responses when compared to NHS, given that the NHS is a large employer of paediatric physiotherapists across the UK, this result was

not surprising. However, whilst respondents who work in the NHS (n=66) and those who worked in neurodisability (n=73) gave higher responses, they were less likely to agree. This is difficult to explain, but it may be related to differences in work environments leading to differing priorities in the attributes of clinical utility items. These findings raise intriguing questions regarding the properties and usability of the CABA, in order for it to be applicable across various clinical settings. In simple terms, the more clinical utility attribute the CABA relates strongly to, the more usable it is likely to be across place of work and area of speciality.

4.4.4 Clinical Utility

Clinical utility refers to how applicable an assessment is within clinical settings (Fawcett, 2013). It relates to attributes, which influence functionality and usefulness of an assessment, such as time and ease of use (Crocker and Algina, 2008). The time it takes to administer an assessment and the complexity of completing it may determine how usable an assessment is within day-to-day assessments (Fawcett, 2013). The longer and more complex an assessment is, the less likely it is to be selected by therapists within day-to-day clinical practice (Roach, 2006). Four attributes relating to the clinical utility of clinical assessments had a net importance score of >90%, between respondents, indicating they are significant to assessment's functionality within clinical practice. These attributes were ease of use, time to complete, ease of analysis and usable in different environments. This is not surprising, given that assessments like the CABA may need to be applied in a variety of settings with multiple individuals. Failure to recognise critical components of a measures clinical utility, such as cost and application, can result in the measurement being impracticable within the clinical environment (Roach, 2006).

Field and Livingstone (2013) undertook a systematic review of 19 clinical tools to measure posture in children with motor impairments. This review concluded that while some authors comment on the clinical usefulness, there was little objective evidence. To date, this area has received scant attention in research literature investigating body alignment measurements, with existing studies omitting recognition and discussion on the practicalities of clinical application. Although the

level of agreement between respondents was low, we propose that the CABA, as a clinically usable tool, needs to align with the utility attributes identified as being important to be applicable and accessible to clinicians.

4.4.5 Benefits of the CABA

The CABA construction has shown a high level of content validity to the domain of body alignment with a high level of agreement and good reliability in response from experts within the field of CP and posture. The CABA has been developed as an easy, inexpensive and low-burden way to measure postural alignment in children with CP. To the authors knowledge there are no other clinical measures for children with CP that demonstrate detailed content validity and item construction to assess total body segment alignment across any postural position while also allowing differentiation between left and right sides of the body. Current assessments, such as the PPAS (Rodby-Bousquet et al., 2016; Rodby-Bousquet et al., 2014), have only focused on one of these elements. This study has shown the CABA encompasses important components of body alignment assessment. With 19 items matched to a high level of agreement to assess body alignment across sitting, standing and lying positions, the CABA allows degrees in postural misalignment to be measured and demarcation between sides of the body to be clinically assessed. As the intent of the CABA is to succinctly measure overall body alignment, it can be broken down into subscales associated with aspects of body alignment e.g., trunk alignment, allowing for analysis of total body alignment but also separate body segments.

This allows for detailed body alignment analysis not only by body segment but also by individual body segment movements. Consequently, a therapist can summarise the overall body alignment of a child and identify specific areas where alignment is problematic. This could refer to a particular body segment, a side of the body or an individual item on the CABA, providing the therapists with a comprehensive and detailed assessment of body alignment from which to inform therapy interventions.

4.4.6 Limitations of the CABA

Within this study we acknowledge that assumptions were made in developing the assessment, these include that therapists would understand and be familiar with the terminology and posture categorisation in use, and the sample size used to validate this was small.

The response rate of 13% could be viewed as low, however, this was not unexpected. The APCP covers a wide field of expertise across paediatrics, inclusive of CP and it is highly likely that some members have limited or no involvement with CP or posture as part of their practice and, therefore, would not have responded to the study request. Currently the CABA only demonstrates content validity, further psychometric properties require investigation. Future studies examining construct validity of the CABA against a sample of children with CP of various functional abilities, would determine whether the items represent a valid construct to that of CP. Reliability, both inter- and intra-rater, of the CABA use with clinicians also needs to be completed. An examination of the CABA's responsiveness and sensitivity to change in children with CP after posture management interventions focusing on improving postural alignment would be beneficial prior to the assessment being used as an outcome measure.

Within this study it is acknowledged the recruitment approach for paediatric physiotherapists is open to self-selection bias. Self-selection bias is whereby those who participated differed in clinical characteristics than those who did not (Tripepi et al., 2010). In some respects this was expected, as only those who worked in posture and children with CP were asked to participate. However, it is acknowledged that those who self-selected to participate were only a selection of those who could have. In total 283 initial responses were received, 269 partially / fully completed the survey with only 14 completing the screening section only. Although self-selection is a threat for internal validity, it can be argued that with 95% of those who chose to participate completing some or all of the survey, the sample obtained was representative and showed diversity in respondent characteristics across experience, place of work, speciality and region which

minimised the impact of this potential bias. Future studies examining the application of the CABA against a larger sample of physiotherapists working with a wider spectrum of children with neurological disabilities in clinical settings would further support the generalisability of the results of this study.

At present how to interpret the CABA's raw scores is unknown and additional studies in typically developing children and those with CP are needed to develop scoring cut-offs and norms for this scale. This will be explored in further investigations as part of the development process of this assessment. Finally, research on the measure in children with other medical diagnoses to neurological disabilities is warranted. The analysis of the construct validity, reliability and responsiveness in children with CP is discussed in the following chapters (chapter 5 and 6).

4.5 Conclusion

Content validity of the CABA items has been examined and supported. This was the first step towards examining validity of the CABA items. Clinical utility attributes important to therapists in everyday practice have been explored and the CABA development has been informed by these.

Examination of the CABA's reliability and construct validity has been undertaken in the next chapter (chapter 5). This forms the second phase of the investigation into the psychometric properties of the CABA in children with CP. The focus of the next chapter will examine construct validity against all GMFCS levels of CP children and inter-rater / intra-rater reliability carried out by physiotherapists across sitting, lying and standing positions. This is required to determine if the CABA is a standardised measure of body alignment usable by physiotherapists.

CHAPTER 5:

RELIABILITY AND CONSTRUCT VALIDITY

5.1 Introduction

This chapter gives an overview of the second phase of the investigation into the psychometric properties of the clinical assessment of body alignment in children with CP. The recently developed CABA (chapter 4) is the only known clinical assessment tool designed to assess graded changes in total body alignment deviation in children with CP; denoting left and right sides of the body, across 3 positions; lying, sitting and standing. As demonstrated in chapter 4 the CABA is based on clinically derived postural items, which were developed and revised by the clinical expert opinions of 283 paediatric physiotherapists who specialised in paediatric postural assessment. The CABA has shown to have good content validity (percentage agreement >70%) with clinician's overall agreement fair to good ($k=.422$).

This chapter examines the reliability of the CABA through a study whereby paediatric physiotherapists observed a sample of children with CP via an electronic survey. This study considers intra-rater reliability and inter-rater reliability using a test-retest design. To evaluate construct validity, the sample of children with CP from the reliability study which represented a child at each level of GMFCS was used. The assumption was made that body alignment was likely to deviate more from optimal in children at lower levels of motor function, such as GMFCS IV and V. Throughout the chapter the methodology and data analysis are discussed in relation to the CABA's worth as a clinical measure of body alignment in children with CP. A final section looks at limitations and implications for clinical practice.

5.1.1 Reliability in clinical measures

Whenever an assessment is administered, assurance that the results could be replicated if the same individuals were tested again under similar circumstances is important in health (Roach, 2006). This desired consistency or reproducibility of assessment scores is termed reliability and can be interpreted by how stable the scores are between different users and across time (Fawcett, 2013). Dunn (2002, p.59) defines reliability as:

“the consistency of scores obtained under the theoretical concept of repeated testing of the same individual on the same test under identical conditions (including no changes to the individual). This could never be done, and various estimates of reliability are obtained in practice”.

Frequently, therapists are required to evaluate the effectiveness of interventions that manage body alignment, such as the use of postural equipment. Reliability should be examined at the assessment development stages, particularly if it is to be used by several therapists and/or intended to provide an outcome measure (Fawcett, 2013). Establishing the degree of reliability informs therapists how accurately the assessment scores reflect the true alignment of individuals being measured (Hinojosa, 2002). It is, therefore, of critical importance that in development of the CABA reliability is considered, ensuring that the changes in a body alignment on the assessment are not affected by time interval or rater.

Reliability reflects not only the correlation but also agreement between measures (Koo and Li, 2016). Ideally, if an assessment was totally reliable the therapist should be able to obtain the same score each time the assessment is undertaken within the same conditions (Fawcett, 2013). The majority of obtained assessment results vary across administrations due to random errors as discussed in chapter 4 (section: 4.1.2). The extent of measurement error in a set of observations is a concern for every responsible assessment developer and user (Crocker and Algina, 2008). Whenever an assessment is undertaken the scores represent a limited sample of what is being measured (Pynsent, 2001); in relation to the CABA this is the

presentation of body alignment in children with CP as measured by therapists. Consequently, scores obtained under assessment are fallible and subject to errors of measurement (Tripepi et al., 2010) which are described in chapter 2.

An important consideration is how closely the true scores of the CABA are to the observed scores. This can be expressed through examining absolute reliability and the standard error of measurement (Koo and Li, 2016). Therefore, consideration will be given in examination of the CABA's reliability to understand, minimise and explore possible error. As this study is part of a wider investigation into the clinical assessment of body alignment in children with CP as part of a PhD programme of research, the aim of this second phase of the project was to examine the reliability of the Clinical Assessment of Body Alignment (CABA) and its construct validity. This chapter represents the second phase in the psychometric investigation of the CABA assessment in children with CP.

The purpose of this chapter was to firstly, investigate the inter-rater, intra-rater reliability of the CABA items and secondly, to evidence the construct validity of the CABA in relation to the GMFCS through a study whereby paediatric physiotherapists used CABA items to measure body alignment in children with CP GMFCS I to V.

5.2 Methods

Approval for this study was obtained from the Ethics Review Board of York St John University, UK; REF: 069011429_George_22092017 (appendix 9).

5.2.1 Reliability

It is acknowledged that there is no gold standard for conducting reliability studies, methodology and sample sizes vary widely across reported studies (Bruton et al., 2000). Some developers evaluate the reliability between therapists for both the administration of the assessment and scoring, whereas others consider reliability of the scoring of the assessment only (Fawcett, 2013). In observational assessment where therapists are not required to administer set test requirements, such as the

CABA, a two-way reliability evaluation is superfluous, therefore, assessment of the scoring of the assessment only was examined in relation to the CABA's reliability.

Methodology varies depending on the type of reliability being examined (Traub and Rowley, 1991). It is important to understand the differences in the types of reliability, and judge whether the cited reliability is adequate for the context of clinical practice (Roach, 2006). The main types of reliability of relevance to therapists are: test-retest reliability, inter-rater reliability and intra-rater reliability (Fawcett, 2013), as defined in chapter 3 (section: 3.1). This formed the basis of the investigation into the CABA and its reliability.

As part of the development of this new assessment tool, this study aimed to explore the reliability of the CABA items in paediatric physiotherapists. This study aimed to obtain as larger a sample of raters as possible. This not only would improve transferability of the findings to the paediatric physiotherapy population but also strengthen the statistical analysis of the reliability between physiotherapists in their use of the CABA.

5.2.2 Construct validity

As identified in chapter 3, there is no established clinical measure of body alignment to make an independent comparison with. Hence, for situations where no criterion or gold standard can be identified then validity of the construct the assessment refers to is required (Kimberlin and Winterstein, 2008). This will enable therapists to draw inferences from the CABA scores assessing body segment position, the CABA items can be grouped under the label of the intended construct being measured, body alignment.

In examination of the CABA's validity further examination of the construct validity is required. Whilst content validity examined the CABA items relevance to the domain of body alignment, construct validity examined the CABA in relation to the construct of CP classification. As there is currently no gold standard clinical measurement of body alignment, construct validity was determined through

examining the CABA in relation to the GMFCS used to grade severity of CP. Current studies examining construct validity of postural assessment in children with CP have used GMFCS levels as a standard comparison measure to examine construct validity (Rodby-Bousquet et al., 2016; Rodby-Bousquet et al., 2014; Bartlett and Purdie, 2005). The use of this within this study means that it is relatable within the current field of research.

5.2.3 Study design

A clinical measurement design was used to examine the reliability of scoring items in a non-clinical setting and construct validity of the CABA. In the examination of reliability, more than one type of reliability study may be required (Bruton et al., 2000). In examination of the CABA's item scoring reliability both intra-rater and inter-rater reliability were investigated as a test-retest design.

5.2.3.1 Participants

A purposeful sample of members of the APCP, a special interest group within the field of paediatric physical therapy was undertaken.

5.2.3.2 Instrument to determine psychometric properties

A sample of children, one representing each GMFCS level (n=5), would equate to 71 scores per child resulting in a total each rater would have to give 355 scores. Increasing the number of children at each GMFCS level would significantly increase respondent burden and reduce participation. Hence 5 children in total, one at each GMFCS level was decided upon, with photographs being used for each child.

An electronic questionnaire was devised in a survey format using Qualtrics comprising of photographs of each child and the CABA scoring items. This use of electronic questionnaire software was selected for convenience of use for respondents and to reach a greater sample size and distribution. In addition, respondents were asked to provide information on their years of experience, geographic location and general professional information. The use of electronic format meant that it enabled the survey to be sent out to the identified sample

participants only, allowed for an expiration date to be set so that the survey could no longer be available or accessible after a defined date.

All children were photographed in sitting, lying and standing positions, in 5 views; anterior, posterior, left, right and transverse. Children wore vests and shorts to enable body alignment to be observed. Photographs of each child were placed alongside the corresponding CABA scoring items in an electronic survey format, the GMFCS Level of each child was anonymous to all but the primary researcher (See section 5.2.3.3 for child recruitment and consent details).

Postural evaluation scientifically is a difficult task. Whilst there is very good quantitative evaluation of the use of technologies, such as MRI (Cargill et al., 2007) and CT (Alta et al., 2012), to accurately measure posture, these remain expensive and have extremely limited clinical applicability to therapists' everyday practice. This is supported by do Rosário (2014) who reviewed the literature surrounding biomechanical assessment of human posture, identifying that simpler approaches to assessment such as photographs and goniometry had merit for clinical based assessment, yet advanced technologies have most evidential support.

The use of photographs in assessment of posture has been used in several studies (Fortin et al., 2011; Akel et al., 2008; Perry et al., 2008; Normand et al., 2007; Dunk et al., 2005; McEvoy and Grimmer, 2005; Dunk et al., 2004), with a consensus that measurement of body angles taken from photographs may be the most comprehensive and rapid way to assess posture. Digitally capturing and quantifying total alignment posture through use of photographs requires multiple angles and views to be captured to improve reliability (Lowe et al., 2014). Photographs capture a precise moment, and as such, do not allow raters to judge or determine alignment over an observed period of time (Juul-Kirstensen et al., 2001). As therapists regularly use their observational skills to observe and judge body alignment (do Rosário, 2014), other digital methods, such as video, may reflect current everyday practice to a greater degree. However, the occurrence of random errors from both rater and the child are also increased with this method (Lowe et

al., 2014). The use of photographs minimises the amount of random error likely to occur (Dunk et al., 2005). For the purpose of this study, photographs enabled error from the child to be minimised, enabling the examination of rater (physiotherapist) error only. This made it possible to identify any CABA items which had limited reliability between physiotherapists and, therefore, likely to be exacerbated when used in a clinical setting.

As this study involved over 355 ratings in total per respondent, ease of scoring was an important consideration to improve response rate and reduce burden to respondents. Techniques used to improve rater reliability involved having photographs in all movement planes, anterior, posterior, lateral and sagittal, and the use of a grid imposed onto the photograph improved rater reliability in scoring body segment position (Fortin et al., 2011). As this study was examining the reliability of scoring the CABA items, photographs with a grid in front of the photographs were used to assist respondents in their scoring of body segment alignment within this study. Whilst the use of a grid minimises errors in scoring allowing for any systematic errors to be identified within the CABA items (Tripepi et al., 2010), it does limit the applicability of the reliability results to clinical practice where a grid may not be used in scoring.

When using photographic data for posture analysis, it is important that researchers systematically control parallax errors in data collection (Lau and Armstrong, 2011). Parallax errors occur when the viewing angle is not aligned with the joint axis and affects how the position of the joint is viewed (Paul and Douwes, 1993). Parallax errors occur more commonly when observing a moving posture, such as video recording (Lau and Armstrong, 2011; Juul-kristensen et al., 2001). To minimise any effect of parallax posture should be viewed from multiple angles and with as little movement of the subject as possible (Lowe, 2004). Paul and Douwes (1993) propose a model to quantify parallax introduced during photographic recording of posture. This identifies the ideal viewing angle to be in line with the plane of movement and axis of rotation which produces minimal to no perspective distortion or parallax. To minimise parallax effects in this study several strategies

were put in place when taking and displaying the photographs. Firstly, the use of photographs eliminated errors of movement in relation to viewing angle. Secondly, each body segment was photographed from 5 camera angles which covered all axis of the body across anterior, posterior, lateral (both sides) and sagittal views aligned with joint axis, or where this should be in an optimal posture. Finally, only camera views of each joint were displayed to the respondents, these were those which aligned directly with the joint axis and plane of motion were selected and shown to the participants to reduce error.

As reported in the previous chapter, the CABA assessment form is a clinical assessment tool which has been rigorously developed to measure body alignment. The CABA is designed to score deviations in body alignment in sitting, standing and lying. Body alignment is graded across 20 items head, trunk, pelvis, legs, arms and feet across all positions and left and right sides of the body. The CABA posture classifications used a 0-3 scoring system to rank the alignment with 0 indicating a position within 5 degrees, either side of optimal alignment, and three indicating the most significant deviation away from optimal alignment. All CABA items are based on this scoring system with the exception of four items, which score on a 0-2 scale in one movement direction, due to the limited joint range from optimal. The CABA has strong clinical utility properties, can be carried out online or on paper, meaning it is highly applicable to everyday clinical practice.

5.2.3.3 Description of children evaluated

A stratified random sample of (n=5) children with CP (4-16 years in age) one at each GMFCS level was recruited from a local special school. All children had a confirmed diagnosis of CP and GMFCS level by a consultant paediatrician, no surgical procedures within the previous 6 months, no injection of botulinum toxin type A within the previous 6 months. Invitation letters and written information was given to the families through the school's communication system. Written consent was gained from all families who agreed to participate. Children who met the inclusion criteria were grouped into GMFCS levels. A child from each group was then

randomly selected and invited consecutively until there was a child at each of level I-V of the GMFCS.

The Children were identified by the primary researcher from a local special school. Gate keeper permission from the head teacher and school board of governors was sought to approach parents for informed consent in the study (see appendix 10). The primary caregivers were contacted through home schoolbooks, the schools established and preferred method of communicating with parents. Participant information (see appendix 11), consent forms (see appendix 12) and a return envelope were sent to parents of identified children, this asked parents to respond only if they wished for their child to participate. No parent or caregiver was directly contacted by the lead researcher as part of the recruitment process.

As children with CP are a group of individuals often unable to give consent due to their severe learning impairments, parent consent to participate in the study was sought. However, children were also given information about the study; taking into consideration the complex learning and communication needs of the children, it was important that creative, multi-method, flexible approaches were adopted, which could be tailored to the needs of those involved (see example appendix 13). It is particularly important to note there was likely to be a range of needs and abilities, therefore tools needed to be adapted to suit the individuals not the group as a whole. Again, such decisions were informed by consulting relevant experts, for example, parents, practitioners and support workers, and it was necessary to work alongside parents and support workers once consent to participate had been received, when undertaking data collection.

Alternative communication methods were used to explain the study, this took on the form of three main strategies to cover a range of understanding levels of the children and could be tailored to individual needs. Strategies included firstly, pictorial information supported by verbal and key words (see appendix 13); secondly, the showing of objects that directly related to the activity, for example clothing (shorts and vest) and camera; and thirdly the placing of objects in the

child's hand. Each child had a school pupil profile (see example appendix 14), which clearly described body responses the child displays when they are happy and unhappy, when they like or dislike something. These profiles are created by consultation with caregivers and professionals who know the child well. Body responses were observed and taken as the child assenting to participate in the study. If a child was able to give a verbal response this was also included alongside observation of body response. Caregivers were given a copy of the child participation information tailored to the individual child's needs, so that this could be shared with their child prior to photographs being taken.

Photographs were taken of the five children in a sitting, lying and standing position. Four photographs of each child were taken in each position to enable body alignment assessment, this involved an anterior, posterior, side and horizontal view. Children were supported into optimal body alignment for each position, followed by a period of two minutes to allow the children to adopt a typical or natural posture prior to the photographs being taken. For those children at higher levels of the GMFCS adult support was required to support sitting or standing positions, this was given as minimal as possible and did not correct body alignment. The photographs were taken within a paediatric therapy room within a community school setting. This was selected as it is familiar and comfortable to the children. Children wore shorts and vest tops to enable physiotherapy participants to observe and score body alignment. Each photograph had the face blanked out to avoid identification of the child. Photographs were taken against a neutral background to avoid identification of the location.

5.2.4 Procedure

The devised survey was sent out electronically using Qualtrics platform to all ACP members via their mailing list (see appendix 15). To maintain participant anonymity, the survey was sent out through use of a gatekeeper, the ACP committee research lead. This meant that there was no direct contact between the researcher and possible participants. Participants were asked at the start of the survey to leave a 6-digit code using a combination of numbers and letters from

their birthday and postcode. This created a unique and anonymous digital identifier to individual data responses which participants could use should they wish to withdraw their data within a 60-day period of the survey launch.

Respondents were asked to contribute if they worked within the field of posture / postural management with children with CP (see appendix 16). Participation was voluntary and consent was gained through participants clicking on the survey link and consent question. Participant information was also provided on a separate link on the same email giving clarity on what was expected and the use of the data (see appendix 17). Careful thought was given regarding the ethical considerations in undertaking this study to minimising child distress (see section 5.2.3.3). This involved communicating and involving with those who knew the child best, such as parents and careers throughout the study. Using child My Day profile (see appendix 18), which outlined clearly how the child communicated, how they reacted when they were happy or sad. Consideration was also given to gate keeper information and permission, data storage and participant anonymity. Details of the full ethical application for this study are detailed in appendix 19, with supporting information in appendix 10 to 13.

To evaluate the diversity within the participant sample the participants were asked to answer 4 questions relating to ACPC region, years of experience, place of work and area of speciality. This allowed for analysis of how representative the sample was of the targeted users, paediatric physiotherapists. Respondents were asked to observe each child's body alignment 3 times, once in sitting, once in lying and once in standing using the CABA scoring system. This produced 3 independent observations of each child. All participation was voluntary and anonymous with consent given through submission of the document after the study debrief.

The initial survey was open to APCP members for 1-month April 2019 – May 2019. Respondents were given the opportunity to participate in a repeat of this survey 1 month later by leaving their contact email address. In this case they were informed that anonymity was not possible due to the repeat participation. Respondent's data

for the repeated scores were matched using the individual unique reference number. The repeat survey was open to respondents for 1 month from June 2019 – July 2019.

5.2.5 Data Analysis

Each participant was assigned a unique reference number and the questionnaire responses were extracted from Qualtrics into the IBM Statistical Package for the Social Science (SPSS version 25) for data analysis. Only responses from therapists who returned complete questionnaires were analysed. Mean scores and standard deviation for the overall ratings of each body segment, each child and each position are reported due to the large volume of ordinal ratings that were taken.

For reliability, intra-class correlation coefficients (ICC) with 95% confidence interval were used to evaluate inter-rater and intra-rater reliability to determine the level of absolute agreement between raters of each CABA dimensions, and of the total scores. One commonly accepted analysis of reliability in therapeutic research is the use of intra-class correlation coefficients (Ottenbacher and Tomcheck, 1993).

An ICC $\geq 90\%$ generally accepted as the level required for a clinical decision-making tool (Koo and Li, 2016). Investigations into sample size requirements to support ICC power remain scarce for reliability studies (Shoukri et al., 2004). Different theories exist in the literature regarding determining sample size in reliability studies. Some authors advocate a predetermined rule of a sample of at least 30 and involve at least 3 raters (Koo and Li, 2016); whilst others have been more general suggesting gaining as large a sample of raters as possible (Field and Hole, 2002). Others have highlighted that this is not as straight forward or simple arguing a broader perspective is required in determining sample size; this is dependent on the number of observations and required power value of the ICC, meaning that the actual sample size for estimating ICC power is small (Bujang and Baharum, 2017; Walter et al., 1998).

Based on Bujang and Baharum (2017) with each rater carrying out a minimum of 3 observations per child ($n=5$); there is a power value of greater than 0.8 to detect an ICC greater than 0.9, statistical significance at a p value of 0.05. For interpretation of the results with a sample size of 5 children the following assessment of the strength of the reliability was adopted. ICC values less than 0.5 are indicative of poor reliability, values between 0.5 and 0.75 indicate moderate reliability, values between 0.75 and 0.9 indicate good reliability, and values greater than 0.90 indicate excellent reliability (Koo and Li, 2016).

Absolute reliability was determined by calculating the standard error of measurement (SEM). It is recommended that ICC's are not to be the only statistical measure for use as an indicator of agreement in reliabilities, the use of SEM supports analysis of high levels of agreement (Bujang and Baharum, 2017). The SEM serves in a complementary role to the reliability coefficient. The SEM is the standard deviation of measurement errors and is used to determine the effect of measurement error on individual results in the assessment tool.

Reliability data is used to provide an index of the amount of measurement error in an assessment. The body alignment aspects of children with CP evaluated by therapists are open to many variables, which may act as so-called errors during assessment. Pynsent (2001) lists 4 types of errors; error from the rater; error from the instrument itself; error from the patient; and random error. Both random and systematic errors are a source of concern in score interpretation. Thus, assessment developers have a responsibility to demonstrate reliability of scores obtained from assessments. Error scores, or errors of measurement, are the discrepancy between an examinee's or examiner's observed score and their true score. No measurement is perfectly accurate, but it is accurate within specific error margins. The lower the error margin, or SEM, the more confidence can be placed in the measure. The higher the score the more consideration should be given to whether the right problem is being addressed.

The confidence interval represents the range of scores within which you can be highly confident that the rater's true scores lie (Field and Livingstone, 2013). In order to calculate the confidence interval, the standard error of measure should be known (Field and Hole, 2002). Reliability coefficients are used to indicate the extent to which an assessment is a stable instrument that is capable of producing consistent results. Reliability is usually expressed as a correlation coefficient and varies between 0 and 1 (Pynsent, 2001). Correlation is the term used to describe a measurement of association, which indicates the degree to which two or more sets of observations fit a linear relationship, expressed as a numerical index (Field and Livingstone, 2013). When the test is completely unreliable, the standard error of measurement is at its maximum and is equal to the standard deviation of the observed scores (Field and Hole, 2002). The standard error of measurement is a function of both the standard deviation (SD) of observed scores and the reliability of the test (Roach, 2006). The calculation formula for the SEM was: $SEM = SD \sqrt{1-r}$ and the ICC was used to determine the value of r in this study. The closer the SEM is to zero the higher the degree of reliability. The SEM in this study were reported in a complementary role to the reliability of ICC's to support interpretations of levels of agreement.

For construct validity, the mean of sum rater scores was used based on GMFCS level. This assumed that body alignment is likely to be more severe, the higher a child with CP is classified, such as GMFCS level IV and V. A one-way between subjects' ANOVA was conducted to compare the rater's assessments of each position and the child's overall severity level to determine if the average ratings of children differ by the level of GMFCS severity. Post hoc comparisons using the Tukey HSD test were used to examine differences between pairs of each of the children at all GMFCS level to determine if the CABA can differentiate between each GMFCS level; for example, can the CABA distinguish between GMFCS level 2 and 5, or GMFCS level 4 and 5, or GMFCS level 1 and 3 etc.

5.3 Results

In total, 2,196 physiotherapists were contacted. Participants were invited to contribute if they worked within the field of posture / postural management with children diagnosed with CP. Responses were received from n=167, 20% of respondents (n=33) partially completed survey, with 9% (n=15) completing fully the rating of all 5 children in all 3 positions (table 5.1).

Table 5.1: Response breakdown of total number of responses (n=167).

Type of respondent	Cases (%)
No information recorded	8 (5%)
Descriptive only (no ratings)	123 (74%)
Partial ratings	21 (12%)
Complete ratings	15 (9%)

Respondents who completed partial ratings varied in the amount of the assessments they completed. The smallest amount of partial data completed was by one respondent who completed the first three items for one of the children in just one position. Whereas the largest amount of partially completed data was from one respondent who completed all ratings in four out of the five children in one position (standing). Within the partial ratings no respondent completed all the ratings on all of the children in a set position. Therefore, as there was no clear cut off for the partial rating data, analysis was run on the completed data set only.

The descriptive data relating to respondents' characteristics (N=15) were collectively analysed and grouped by region, years of experience, place of work and area of speciality.

Respondents came from all regions within England as well as other nations in the UK, with 7% of respondents (N=1) coming from overseas (table 5.2).

Table 5.2: Respondents by regions (n=167).

Region	All respondents	Completes
East Midlands	n=4 (3%)	
Eastern	n=13 (9%)	
London (including Greater London)	n=26 (17%)	
North East	n=13 (9%)	
North West	n=13 (9%)	
Scotland	n=6 (4%)	n=1 (7%)
South East	n=17 (11%)	n=3 (20%)
South West	n=10 (7%)	
Wales	n=7 (5%)	n=1 (7%)
West Midlands	n=25 (17%)	n=6 (40%)
Yorkshire & Humberside	n=8 (5%)	n=2 (13%)
Northern Ireland	n=2 (1%)	n=1 (7%)
Overseas	n=5 (3%)	n=1 (7%)

Just under half of respondents, 40% (n=4), had been in the profession for 11 - 20 years or more. More than half of respondents, 60%, worked in the NHS with 23% in education and 7% in private. The majority, 93%, worked in neurodisability and 7% worked in the musculoskeletal speciality area (table 5.3).

Table 5.3: respondent characteristics of time in job, area of expertise and area of work (n=167).

Dimension	All respondents	Completes
<i>Time in Job</i>		
1-5 years	n=12(8%)	n=2 (20%)
6-10 years	n=7 (5%)	n=2 (20%)
11-20 years	n=50 (33%)	n=4 (40%)
more than 20 years	n=82 (54%)	n=2 (20%)
<i>Area of expertise</i>		
Community	n=26(16%)	
Musculoskeletal	n=14 (9%)	n=1 (7%)
Neonatal	n=10 (6%)	
Neurodisability	n=109 (69%)	n=14 (93%)
<i>Area of work</i>		
Education	n=10 (6%)	n=3 (23%)
NHS	n=120 (77%)	n=9 (60%)
Private	n=26 (17%)	n=1 (7%)

5.3.1 Inter-rater reliability

We had complete responses from n=15 clinicians. Each therapist rated each of the 5 children in all 3 positions; 23 alignment ratings in the lying and standing position and 25 ratings in the sitting position. In total, 355 individual ratings by each rater were received producing a data set of 5,325 measurements.

ICC estimates and their 95% confidence intervals were calculated using SPSS based on a mean rating (k=15), absolute-agreement. Using a 2-way random-effects model ICC(2,15). A 2-way random-effect model was used because ratings were collected from a sample of 15 raters from the clinicians that were invited to take part in the study and the findings could be generalised to all clinicians who work with children with CP.

Results are presented as mean and standard deviations or total scores. Mean scores represented the total mean score of all raters (k=15 intra-rater, k=11 inter-rater) per the dimension being analysed e.g., Position; with the standard deviation showing the variation in values around the mean score. Total scores are the sum total of all raters CABA scores (n=355 ratings per rater) for different dimensions such as body segments. Total scores are used in the analysis of ICCs, 95%CI, and SEM.

The inter-rater reliability mean and SD for each child across all the measurements in each position increased in line with the level of GMFCS severity (table 5.4). The mean and SD values of GMFCS Level I were lower than Mean and SD values for GMFCS Level V, indicating that the higher the GMFCS classification the further body alignment deviates from optimal. The Mean and SD values were greater in standing and lowest in lying, with the exception of GMFCS level V indicating that at GMFCS levels I-IV alignment deviated greater from optimal the more upright they were against gravity. In GMFCS Level V Mean and SD values across standing, sitting and lying differed little, ranging from 1.63 (SD=0.38) to 1.87 (SD=0.56), indicating that their body alignment deviated greatly from optimal irrespective of standing, sitting or lying position.

Table 5.4: Inter-rater reliability Mean scores and Standard deviation of the CABA for GMFCS level and position given by 15 raters.

GMFCS	Standing	Sitting	Lying	Across all positions
Level	Mean (standard deviation)	Mean (standard deviation)	Mean (standard deviation)	Mean (standard deviation)
I	0.69 (SD=0.47)	0.35 (SD=0.16)	0.27 (SD=0.23)	0.43 (SD=0.36)
II	0.86 (SD=0.41)	0.45 (SD=0.22)	0.28 (SD=0.19)	0.53 (SD=0.37)
III	0.87 (SD=0.47)	0.55 (SD=0.31)	0.4 (SD=0.21)	0.61 (SD=0.39)
IV	1.39 (SD=0.39)	1.29 (SD=0.49)	1.23 (SD=0.37)	1.31 (SD=0.42)
V	1.63 (SD=0.38)	1.7 (SD=0.49)	1.87 (SD=0.56)	1.73 (SD=0.49)

Closer inspection of table 5.4 shows close mean scores between children at GMFCS level II and III in standing and sitting. This trend is apparent in fig 5.1, where no clear increase in scores is illustrated indicating little difference in body alignment deviation between these levels.

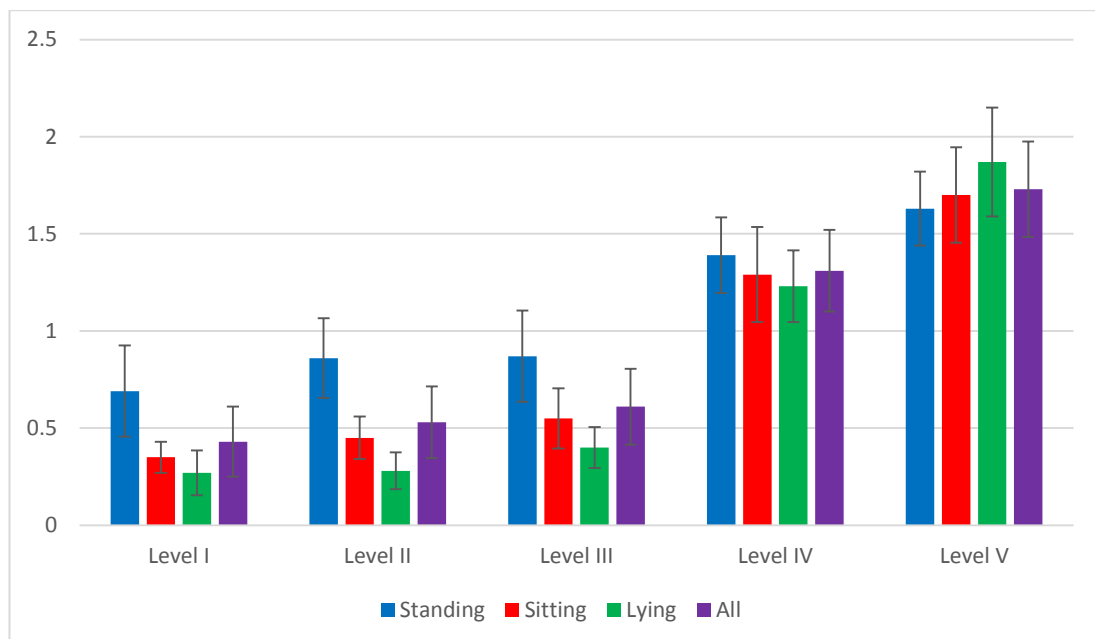

Figure 5.1: Mean Rating scores of alignment by position and GMFCS Level.

Further analysis was undertaken to determine whether these similarities related specifically to the GMFCS level or particular body segments within the CABA. The

results obtained from the preliminary analysis of inter-rater CABA scores across dimensions of position and body segments are presented in table 5.5.

Table 5.5: Inter-rater reliability Mean scores of the CABA by body segment for GMFCS level II and III given by 15 raters scores at test 1 (k=15) across sitting and standing.

Mean scores at test 1	Standing		Sitting	
	GMFCS Level II	GMFCS Level III	GMFCS Level II	GMFCS Level III
Head	0.78	0.79	0.62 [^]	0.62 [^]
Trunk	0.60*	0.47	0.33	0.67
Pelvis	0.51	0.74	0.26	0.40
Arm	1.15*	0.75	0.34*	0.29
Leg	0.67	0.80	0.48	0.67
Foot	1.39	1.57	0.57 [^]	0.57 [^]

* Denotes higher scores for GMFCS II than III. [^] Scores where the same between GMFCS levels.

In standing 4 out of the 6 body segments demonstrated a difference between the ratings given at GMFCS level II and III, with the smallest difference being noted at the head. Two of the body segments, arm and trunk scored higher for GMFCS level II indicating that these items may have lower inter-rater reliability between these levels. Similarly, for sitting, arm position scored higher for GMFCS level II with no difference in scores demonstrated for foot and head. Interestingly, only arm scores were higher at GMFCS level II for both standing and sitting, signifying that arm alignment may have reduced reliability across these positions and between GMFCS levels II and III.

Overall inter-rater reliability was excellent across all positions of sitting, lying and standing (ICC [2,15] 0.93 95% CI 0.918-0.941) and for all body segments ICC (2,15) 0.93 (95% CI 0.918, 0.941). The values given across individual positions and body segments showed excellent reliability for sitting, lying, head, trunk and pelvis. The ratings for standing, arm, leg and foot had reported lower range 95% confidence intervals from 0.847 (Foot) to 0.898 (Leg), demonstrating good to excellent agreement between raters (table 5.6).

Table 5.6: Inter-rater and intra-rater reliability of the CABA total score (N=355 ratings per rater) for different positions and body segments of children with CP.

Dimension	Inter-rater (K=15)			Intra-rater (K=11)		
	ICC (2,15)	95% CI	SEM	ICC (2,15)	95% CI	SEM
<i>Position</i>						
Standing	0.900	(0.868, 0.926)	0.17	0.902	(0.888, 0.914)	0.28
Sitting	0.931	(0.912, 0.942)	0.17	0.895	(0.864, 0.917)	0.27
Lying	0.953	(0.939, 0.966)	0.16	0.930	(0.920, 0.939)	0.23
Total	0.930	(0.918, 0.941)	0.17	0.910	(0.895, 0.921)	0.26
<i>Body segment</i>						
Head	0.947	(0.917, 0.968)	0.16	0.94	(0.929, 0.95)	0.21
Trunk	0.944	(0.917, 0.966)	0.15	0.924	(0.908, 0.937)	0.22
Pelvis	0.951	(0.926, 0.97)	0.16	0.936	(0.919, 0.949)	0.21
Arm	0.896	(0.847, 0.933)	0.16	0.891	(0.871, 0.908)	0.25
Leg	0.923	(0.898, 0.943)	0.17	0.876	(0.836, 0.904)	0.30
Foot	0.895	(0.847, 0.933)	0.21	0.903	(0.883, 0.919)	0.31
Total	0.930	(0.918, 0.941)	0.17	0.910	(0.895, 0.921)	0.26

The inter-rater and intra-rater ICCs when examining children classified by 5 GMFCS levels overall were >0.910 (table 5.7). All of the ICC values for inter-rater reliability were excellent for GMFCS levels III to V and good for Level II. Children at GMFCS I had an ICC (2,15) of 0.731, indicating moderate agreement.

Table 5.7: Inter-rater and intra-rater reliability of the CABA total score (N=355 ratings per rater) across GMFCS level.

GMFCS Level	Inter-rater (K=15)			Intra-rater (K=11)		
	ICC (2,15)	95% CI	SEM	ICC (2,11)	95% CI	SEM
I	0.731	(0.629, 0.833)	0.19	0.784	(0.712, 0.833)	0.28
II	0.865	(0.825, 0.905)	0.14	0.86	(0.785, 0.913)	0.24
III	0.903	(0.856, 0.95)	0.12	0.825	(0.797, 0.849)	0.26
IV	0.907	(0.872, 0.942)	0.13	0.885	(0.865, 0.902)	0.22
V	0.932	(0.905, 0.959)	0.13	0.909	(0.885, 0.931)	0.21
Total	0.930	(0.918, 0.941)	0.17	0.910	(0.895, 0.921)	0.26

5.3.2 Intra-rater reliability

The follow up re-test was completed 1 month later by n=11 of the raters. The re-test consisted of the same 355 individual ratings provided from the intra-rater data set and a second set from the retest data resulting in a data set of 7,810 measurements.

ICC estimates and their 95% confidence intervals were calculated using SPSS based on a mean rating (k=11) at two time points, absolute-agreement. Using a 2-way mixed-effects model ICC(2,11). A 2-way mixed-effect model was used because we collected and analysed multiple scores given by each rater. Absolute-agreement is the standard measure used for intra-rater, or test-retest studies since it is an agreement that is being measured (Koo and Li, 2016).

Overall intra-rater reliability was good to excellent across all positions of sitting, lying and standing and for all body segments (ICC [2,11] 0.910 95% IC 0.895-0.921). The ratings for positions sitting, standing and body segments arm, leg and foot had reported lower range 95% confidence intervals from 0.883 (leg) to 0.888 (standing), demonstrating good to excellent agreement between raters (table 5.6). The ICCs and 95% CI values given across lying, head, trunk and pelvis were >0.908, indicating excellent intra-rater reliability.

Examining inter-rater reliability for children classified by 5 GMFCS levels the ICC values were good to excellent for GMFCS levels II to V and moderate for Level I. On consideration of the 95% confidence interval scores children at GMFCS IV and V demonstrated good to excellent reliability, whereas GMFCS level I to III demonstrated moderate to good reliability for (table 5.7).

5.3.3 Examination of the change in scores between test 1 and test 2

It can be seen from the data in figure 5.2 that the second test scores tend to be lower than the first.

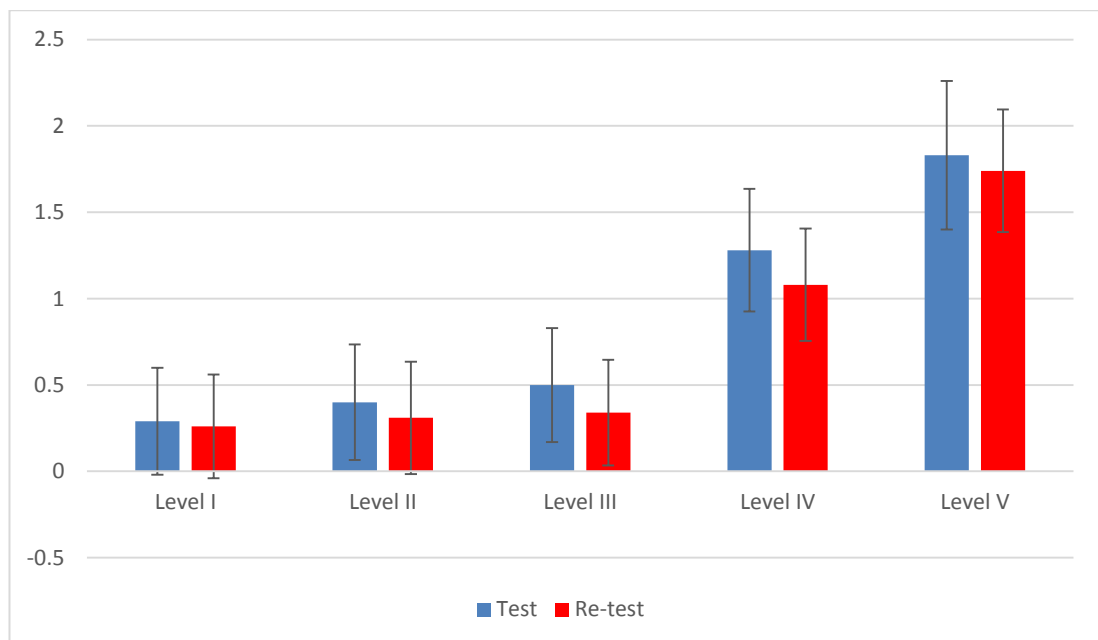

Figure 5.2: mean test-retest rating of alignment by GMFCS Level.

Closer inspection of the data (table 5.8) shows that this finding is consistent across all GMFCS levels, indicating that clinicians are more likely to spot misalignment or rate it as more severe on the first rating.

Table 5.8: Mean and standard deviation (SD) ratings given at test 1 and test 2 by the k=11 raters for each GMFCS level.

GMFCS Level	Test 1 Mean (SD)	Test 2 Mean (SD)
I	0.29 (SD=0.62)	0.26 (SD=0.6)
II	0.4 (SD=0.67)	0.31 (SD=0.65)
III	0.5 (SD=0.66)	0.34 (SD=0.61)
IV	1.28 (SD=0.71)	1.08 (SD=0.65)
V	1.83 (SD=0.86)	1.74 (SD=0.71)
Total	0.86 (SD=0.93)	0.74 (SD=0.87)

The test and retest ratings were more likely to be equal when rating GMFCS Level I. The greatest difference between test and retest ratings were noted for GMFCS level IV or V. Table 5.9 provides an overview of score changes between test 1 and test 2, examining the percentage of scores which scored higher or remained equal. The top of the table shows scoring between GMFCS level, whilst the rest examines dimension of the CABA in relation to positions and body segments.

Overall, 73% of scores remained equal at test 1 and test 2 across all GMFCS levels. Children at GMFCS level I had the lowest percentage change in scores between test 1 and test 2 with 87.5% of scores remaining equal compared to children at GMFCS level V which had the highest changes (62.9%).

Table 5.9: Percentage of scores which increase and stay the same between test 1 and 2 for the k=11 raters across GMFCS levels, positions and body segments.

Dimensions	% Test 1 scored higher	% Scores were equal	% Test 2 Scored higher
<i>GMFCS Level</i>			
I	8.1%	87.5%	4.5%
II	12.9%	81.8%	5.2%
III	23.9%	70.2%	5.9%
IV	28.7%	62.6%	8.7%
V	23.0%	62.9%	14.1%
Total	19.3%	73.0%	7.7%
<i>Position</i>			
Standing	20%	70%	10%
Sitting	23%	71%	6%
Lying	15%	78%	6%
Total	19%	73%	8%
<i>Body Segment</i>			
Head	9.9%	83.0%	7.1%
Trunk	13.7%	80.0%	6.3%
Pelvis	14.5%	81.4%	4.0%
Arm	17.0%	74.7%	8.3%
Leg	27.5%	64.0%	8.5%
Foot	23.1%	67.1%	9.8%
Total	19.3%	73.0%	7.7%

Scores across all dimensions of the CABA, positions and body segments, showed high levels of consistency with scores >70% remaining equal between test 1 and 2. Scores in the lying position were more likely to have equal scores (78%) compared to those in standing (70%). Whilst scores examining foot had lower equal scores (64%) compared to those examining head (83%). A decrease in scores between test 1 and test 2 was noted across all GMFCS levels, positions and body segments, indicating that on the retest misalignment was recorded as less severe.

Overall, the biggest difference was between test 1 and test 2 for GMFCS level IV and V. Further analysis revealed that scores of the head were the most stable with 75.3% remaining unchanged, whereas scores of the leg (51.7%) and foot (51.7%)

demonstrated greatest degrees of change (table 5.10). This indicates that CABA items relating to the leg and foot at GMFCS level IV and V may have greater variability in test-retest situations.

Table 5.10: Percentage of scores between test 1 and 2 (k=11 raters) for the CABA dimension of body segment across GMFCS levels IV and V.

Body Segment	% Test 1 scored higher	% Scores were equal	% Test 2 Scored higher
Head	12.6%	75.3%	12.1%
Trunk	19.2%	73.7%	7.1%
Pelvis	23.7%	70.2%	6.1%
Arm	25.8%	63.3%	11.0%
Leg	35.9%	51.7%	12.4%
Foot	26.2%	57.1%	16.7%

5.3.4 Rater variability

In addition, Intra-class correlation coefficients along with their 95% confidence interval were used to determine the level of absolute agreement between a raters score (k=11) on the first and second test of the same children, one month apart (table 5.11, figure 5.3). Overall rater agreement across GMFCS levels, positions and body segments were excellent (ICC(2,11) >0.90).

Table 5.11: Intra-rater reliability tests assessed by 11 Raters (N=355 ratings) across GMFCS level, positions and body segments.

Dimension	ICC(2,11)	95% CI
<i>GMFCS level</i>		
I	0.784	(0.712, 0.833)
II	0.86	(0.785, 0.913)
III	0.825	(0.797, 0.849)
IV	0.885	(0.865, 0.902)
V	0.909	(0.885, 0.931)
Total	0.910	(0.895, 0.921)
<i>Position</i>		
Standing	0.902	(0.888, 0.914)
Sitting	0.895	(0.864, 0.917)
Lying	0.930	(0.920, 0.939)
Total	0.910	(0.895, 0.921)
<i>Body Segment</i>		
Head	0.94	(0.929, 0.95)
Trunk	0.924	(0.908, 0.937)
Pelvis	0.936	(0.919, 0.949)
Arm	0.891	(0.871, 0.908)
Leg	0.876	(0.836, 0.904)
Foot	0.903	(0.883, 0.919)
Total	0.910	(0.895, 0.921)

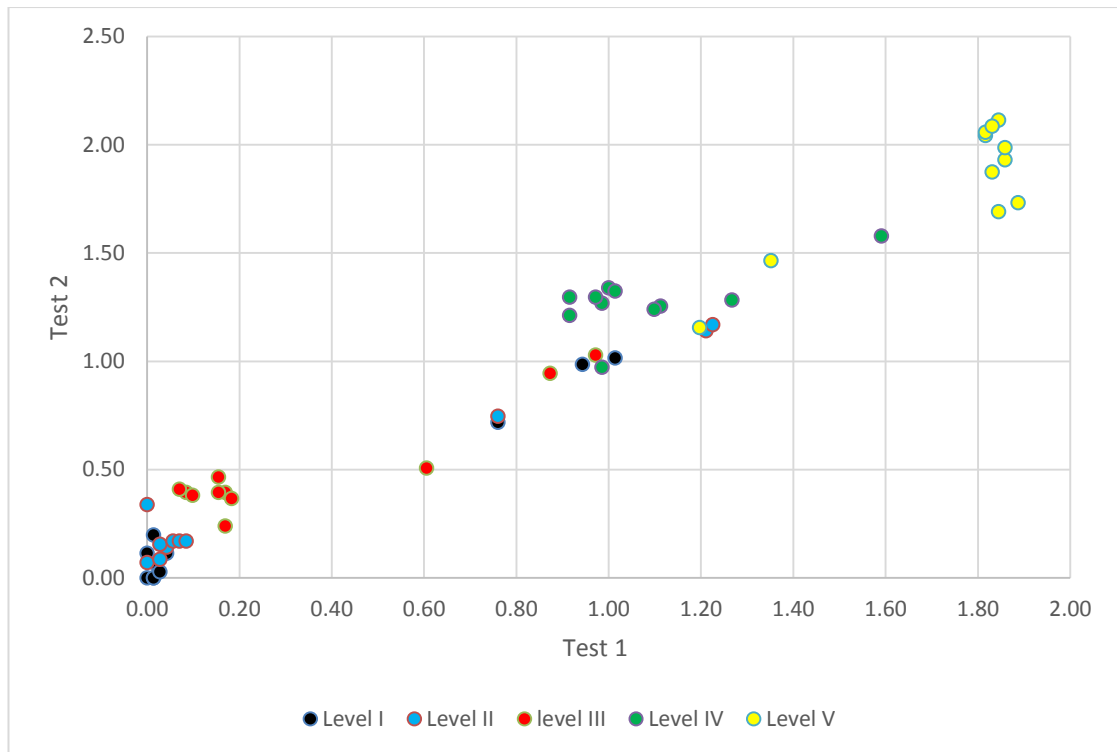

Figure 5.3: Distribution of Mean CABA scores at each GMFCS level for test and retest scores by each rater (k=11).

The results of the correlation analysis for raters test and retest scores are presented in figure 5.3. This shows a strong correlation of agreement between raters with little deviation from the line of best fit. Raters scores are grouped low and collectively for GMFCS levels I and II. Scores for GMFCS level III, can be clearly determined but lie close to levels I and II, whereas scores for GMFCS level IV and V are clearly grouped in separate clusters with level V being scored higher than level IV.

Significant deviation in raters test-retest scores occurs mainly at GMFCS level I, II and III. Whilst there is some discrepancy in the raters score of misalignments between GMFCS levels, the scoring for each rater remains consistent between test 1 and test 2. This can be demonstrated through examination of two example raters (figure 5.4). For example; rater A (black circle) has scored high for GMFCS level I. This score is grouped with most of the GMFCS level IV scores, indicating that in scoring across GMFCS this rater has scored misalignment high compared to others.

However, scoring is consistent with test 1 and test 2 having a mean score of 1.00. Similarly, rater B (red circle) presents the same, scoring high for misalignment at GMFCS level compared to the other raters, yet consistent in their score between test 1 (1.60) and test 2 (1.52).

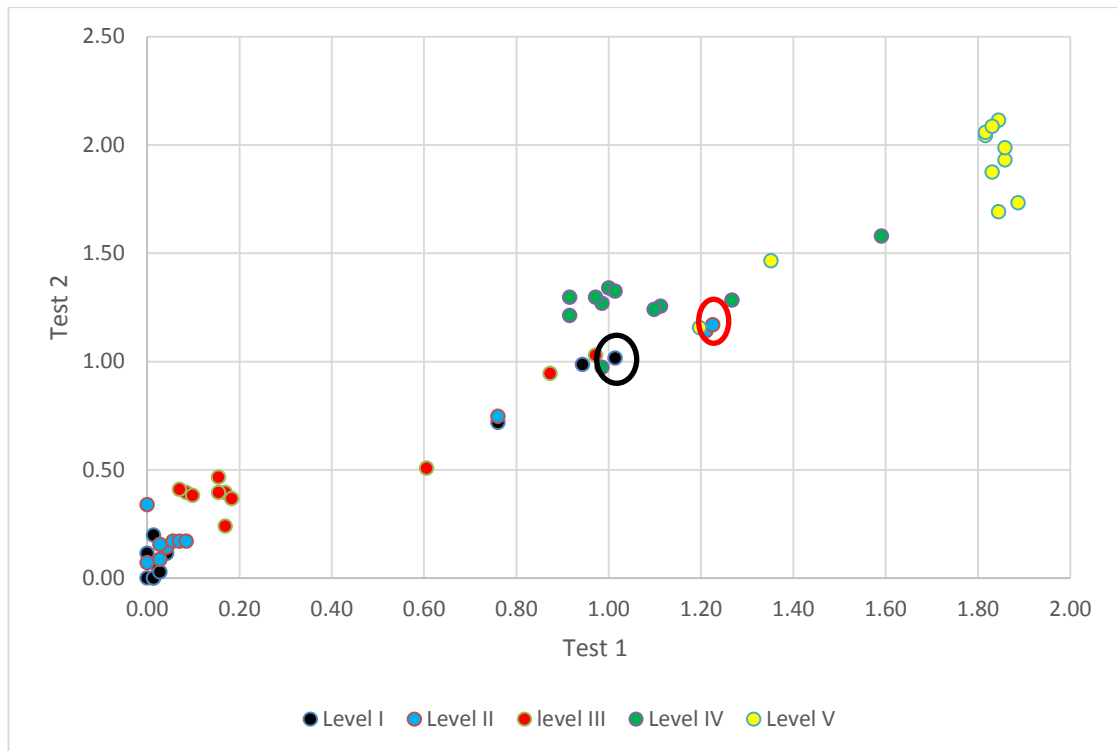

Figure 5.4: Outlier rater examples* for test-retest rater reliability.

*Examples are marked with a different colour circle, black = rater A, red = rater B.

From this correlation of agreement for rater test-retest reliability we can see close grouping and discrepancies in outlier scores between GMFCS levels I to III (figure 5.4). Data from this chart can be compared with the data in tables 5.4 and 5.5 which shows limited discrepancies of the raters scores between GMFCS levels I and II and Levels II and III, indicating that raters were less likely to determine body alignment between these paired levels.

Individual rater (K=11) ICCs across all measurements ranged from 0.858 to 0.933, with 6 of the 11 raters (55%) having an ICC > 0.9 (table 5.12). This indicates that all raters had a high level of agreement in individual ratings for the test and retest

situation using the CABA. Since all raters demonstrated high levels of intra-rater reliability, investigation into the impact of other factors such as the raters' level of experience or their area of expertise was not required.

Table 5.12: Intra-rater reliability tests for each individual rater.

Rater ID	ICC(2,1)	95% confidence interval	SEM
1	0.883	(0.856, 0.905)	0.28
2	0.872	(0.843, 0.896)	0.32
3	0.858	(0.826, 0.885)	0.28
4	0.882	(0.847, 0.909)	0.30
5	0.923	(0.902, 0.939)	0.24
6	0.893	(0.862, 0.917)	0.27
7	0.924	(0.897, 0.943)	0.23
8	0.933	(0.892, 0.955)	0.21
9	0.911	(0.865, 0.938)	0.25
10	0.928	(0.885, 0.951)	0.22
11	0.914	(0.869, 0.94)	0.23

5.3.5 Construct Validity

The mean score across all measures for all raters at the first test increase in line with GMFCS severity level from an average rating of 0.43 for level I children to an average rating of 1.73 for level 5 children (table 5.4).

A one-way between subjects' ANOVA was conducted to compare the raters' assessments of each position and the child's overall severity level. There was a significant effect of the ratings given across the different GMFCS severity levels [$F(4, 350) = 137.4, p < 0.001$]. Post hoc comparisons using the Tukey HSD test indicated that the mean score for each of the severity levels was significantly different to other severity levels with the exception of Levels II and III ($p=0.770$) and Levels I and II ($p=0.663$) where no significant difference was detected (table 5.13). The Tukey HSD test is specifically developed to account for multiple comparisons and maintains experimental-wise alpha at the specified level of 0.05 (Lee and Lee, 2018). It has good power and tight control over the type I error rate (Field and Hole, 2002); therefore, it was not necessary to correct for multiple comparisons in this data set.

Table 5.13: Construct validity pairwise comparisons between each GMFCS level based on raters scores at test 1 (k=15).

GMFCS Level	Paired comparisons to GMFCS Levels	Test 1 (k=15)		Test 2 (k=11)	
		Significance level	mean difference	Significance level	mean difference
I	II	0.66	-0.09	0.03	-0.05*
	III	0.02	-0.17*	0.03	-0.08*
	IV	0.00	-.87*	0.00	-0.82*
	V	0.00	-1.30*	0.00	-1.48*
II	III	0.77	-0.08	0.86	-0.03
	IV	0.00	-.77*	0.00	-0.77*
	V	0.00	-1.20*	0.00	-1.43*
III	IV	0.00	-.69*	0.00	-0.74*
	V	0.00	-1.12*	0.00	-1.40*
IV	V	0.00	-.42*	0.00	-0.66*

* The mean difference is significant at the 0.05 level.

Construct validity was repeated using the retest data set (k=11) to see if it improved for the raters who were more experienced in using the CABA, having done so twice. Values showed no change in significant effect at different GMFCS severity levels [$F(4, 3900) = 799, p < 0.001$], indicating that having experience of scoring with the CABA made no difference on construct validity (table 5.13).

5.4 Discussion

5.4.1 Respondent base

There were diverse characteristics across respondents who completed the full questionnaire. This demonstrates that the respondent base was diverse across years of experience, speciality, areas of work and areas of the UK. Non-response is a major source of potential bias in reliability studies (Bowling, 2014). A lack of diversity in the characteristics of respondents may reduce the effective sample size, introducing bias into the results. Whilst response rate could be interpreted as low (n=15), the sample size and diverse array of characteristics is a strength of this study. The sample encompasses a broad range of characteristics, which are applicable to the wider physiotherapy population. The yield in respondent sample

diversity in this study was higher compared to those of other studies, who have only used 1 or 2 therapists.

In this study, 2196 physiotherapists were contacted, 20% of respondents gave partially completed responses and only 9% gave fully completed responses. The APCP covers a wide field of expertise across paediatrics, inclusive of CP, and it is highly likely that some members had limited or no involvement with CP or posture as part of their practice and, therefore, would not have responded to the study request. However, these results are not consistent with the previous research finding into the content validity of the CABA (chapter 4), which received more initial responses (n=283) compared to this study (n=167). Furthermore, comparison of those who initiated a response and went onto fully complete the survey differs; this reliability study had only 9% (n=15) of those who initiated a response compared to 30% (n=84) of those who initiated in the content validity (chapter 4: section 4.3).

Whilst factors, such as the different times of year the research was conducted at, annual leave and workload pressures likely to fluctuate across different times, could well have impacted on responses this is an assumption and cannot be substantiated with any validated clinical data. A possible explanation for this reduced response rate could be the length of the survey. This involved scoring of 5 children across each CABA items and positions of lying, sitting and standing, resulting in 355 responses from each respondent. Whilst the scoring for each child was estimated to take approximately 10 minutes, 50 minutes in total to assess all 5 children and no more than 1 hour in total. This may have resulted in respondents not having enough time to complete the survey and may explain why responses tailed off within the first position scoring of all 5 children and partial respondents did not give a complete score for a child in the first position.

This is a limitation of this study and could suggest the scale of the project was too large. Therefore, future studies may focus on collection of more data through use of parts of the CABA separately as required by clinical need such as standing and specific GMFCS levels.

Whilst this limitation is acknowledged it was important that a stratified sample across all GMFCS was used to create construct validity. In addition, photographs were selected over clinical application to limit systematic and random errors, which may occur in clinical observation of children with CP. This approach enabled a robust analysis of the CABA's preliminary reliability and construct validity, which can be further explored by use of this in the clinical field.

5.4.2 Reliability

The results based on ICCs and 95% confidence intervals showed excellent overall inter-rater and intra-rater reliability for the CABA for children with CP across all GMFCS levels. Individual ICCs for both inter-rater and intra-rater were good to excellent for all GMFCS levels with the exception of GMFCS Level I, which indicated moderate (ICC (2,15) 0.731, ICC (2,11) 0.784). The reason for this is unclear; there may be different explanations for this including the presentation and order of the ratings with the child at GMFCS Level I always being the first rated and, as such, the benchmark case. Order effects refer to the differences in research participant responses that results from the order in which the materials are presented (Lowe et al., 2014). In the case of the CABA reliability study this effect was minimised by having pictures of all five children in one question. However, the order of the photos was in GMFCS grading meaning that the child at GMFCS level I was always the first in the order of the photos displayed in each question. The SEM for both inter-rater and intra-rater were highest for GMFCS level I, 0.19 and 0.28 respectively, yet when viewed collectively with the range of SEM scores for inter-rater (0.12 – 0.19) and intra-rater (0.21 – 0.28) this difference is marginal. It remains unclear as to the reason why GMFCS level I scored lower. Whilst order effect cannot be completely ruled out, the CABA demonstrated moderate to excellent inter-rater and intra-rater reliability across all GMFCS levels.

Furthermore, this discrepancy could also be attributed to some raters expecting to see misalignment, although overall rater variability was low. Respondents were not given any information about the children's GMFCS grading, nor an explanation that each of the five levels would be depicted. They were simply termed child 1 – child 5

(See Appendix 15). An assumption could be made that respondents assumed there would be alignment issues to observe. The increase in SEM scores at this level could indicate that GMFCS level I, being the first case scored, resulted in a greater margin of error due to an expected alignment deviation from 0. This theory is supported further in the rater test-retest scores, which showed outlier's for GMFCS level I – III, with levels I and II showing the greatest shift in outlier scores. These outliers demonstrate that whilst consistent, some respondents scored greater degrees of deviation from optimal in body alignment for those children in which most respondents found minimal deviation in alignment. This indication that one or two respondents scored children at GMFCS levels I and II higher than most could have skewed the results, causing a reduced level of reliability for GMFCS level I.

In addition, it is possible that the child made an active postural adjustment prior to the photograph being taken. Children at GMFCS level I and II have good postural alignment and function in walking and postural adjustments (Rosenbaum et al., 2007). Although children were positioned in optimal alignment, it is possible small active postural movement may have occurred prior to the photo being taken. In fig 5.4 there is a clear trend of GMFCS I and II scoring close to 0 for body alignment, clustered closely together indicating that respondents found their body alignment similar. This is not a surprising result as GMFCS level I and II children are able to control their body alignment in an optimal position against gravity and make adjustments within their base of support. Therefore, reliability of the CABA in children with GMFCS level I may be slightly lower and is an important consideration when using the CABA in clinical practice.

In terms of inter-rater and intra-rater total reliability for the dimensions of position and body segments the CABA demonstrated excellent reliability (ICC >0.910). Individual ICCs for both inter-rater and intra-rater were good to excellent for each of the specific positions and body segments, indicating that the CABA has substantial reliability across all its dimensions.

Rater variability overall scores were excellent ICCs (2,11) >0.90, indicating that all raters had a high level of agreement in test and retest situations and the CABA is fit for purpose. Scores for each individual rater who completed the test twice demonstrated high levels of test-retest reliability (ICC range 0.858 to 0.933), with 6 of the 11 raters (55%) having an ICC higher than 0.9 showing excellent levels of reliability. Surprisingly, all raters had high levels of intra-rater reliability. Indicating that rater's clinical experience, their place of work and specialty had little impact on their ability to reliably use the CABA. A possible explanation for this is the extensive content validity process undertaken in the CABA's development, with contribution from over 280 paediatric physiotherapists (chapter 4: section 4.3.1). The CABA was developed to be a clinically usable tool which can be easily applied to clinical practice, with low user demand. Other postural assessments require training and experience in using the assessment to produce consistent reliable results (Rodby-Bousquet et al., 2016; Goldsmith and Goldsmith, 2009; Pountney et al., 1999).

Clinical postural assessments of body alignment have been identified and critically analysed in chapter 3. Of the seven assessments identified only two, The PPAS (Rodby-Bousquet et al., 2016; Rodby-Bousquet et al., 2014) and SAROMM (Bartlett and Purdie, 2005), were supported by published studies which demonstrated good to excellent validity and reliability in samples which include children with CP, in addition to established evidence for construct validity. Both of these assessments used raters with considerable experience in using the tool, had training or required a manual to follow. The PPAS psychometric properties were supported with raters who had special training and long-term experience in using the assessment (Rodby-Bousquet et al., 2016). The SARROM provided all eight raters with a manual for administering the assessment, along with a study outline. Six of the raters were involved in the development and revision of the assessment items and, therefore, had considerable knowledge and experience in application of the SARROM, whilst all raters were aware of the study purpose. Consequently, the recruitment strategy opens the results up to biases across sample, measurement and the application of the assessment. As the raters were mostly involved in the development of the tool and all were aware of the study's aim, there was limited independent or blinded

evaluation, meaning that the results could be favourable towards the intended outcome.

The strength of the CABA is that it is able to be used reliably with minimal instruction and across varied levels of experience, work-place and specialty in children with CP.

5.4.3 Examination of the change in scores between test 1 and test 2

It can be seen from the data in figure 5.2 that the second test scores tend to be lower than the first. Closer inspection of the data (table 5.8) shows that this finding is consistent across all GMFCS levels, indicating that clinicians are more likely to spot misalignment or rate it as more severe on the first rating.

The test and retest ratings were more likely to be equal when rating GMFCS Level I. The greatest difference between test and retest ratings were noted for GMFCS level IV or V. Table 5.9 provides an overview of score changes between test 1 and test 2, examining the percentage of scores, which scored higher or remained equal. The top of the table shows scoring between GMFCS level, whilst the rest examines dimension of the CABA in relation to positions and body segments.

Overall, 73% of scores remained equal at test 1 and test 2 across all GMFCS levels. Children at GMFCS level I had the lowest percentage change in scores between test 1 and test 2 with 87.5% of scores remaining equal compared to children at GMFCS level V that had the highest changes (62.9%).

Scores across all dimensions of the CABA, positions and body segments, showed high levels of consistency with scores >70% remaining equal between test 1 and 2. Scores in the lying position were more likely to have equal scores (78%) compared to those in standing (70%), whilst scores examining foot had lower equal scores (64%) compared to those examining head (83%). A decrease in scores between test 1 and test 2 was noted across all GMFCS levels, positions and body segments, indicating that on the retest misalignment was recorded as less severe.

The difference between scores at test 1 and 2 could be attributed to a reduction in error rate with repeated exposure to the same image. This is in accord with recent studies; Andrews et al (2012) showed that error rate reduced with repetition when scoring body alignment based on posture categories. As a result, the results could be interpreted as a more accurate or 'true' score on the test 2 rather than a reduction in severity of alignment. However, as the majority of the scores (>70%) remained unchanged between test 1 and test 2 it raises the possibility that the CABA has a high accuracy of scoring with a low error rate.

Regarding individual body segments, the foot had the greatest variance between test 1 and 2. The foot scored items from 0-2, having less posture categories compared to the other CABA items, such as head, due to the reduced actual full range of movement expected at the joint, as explained in detail in chapter 4. It has been suggested that fewer posture categories can result in an increase in misclassification errors (Andrews et al., 2012; Van Wyk et al., 2009). These results support previous research into posture category boundaries and error rates (Andrews et al., 2012; Van Wyk et al., 2009; Andrews et al., 2008a).

Overall, the biggest difference is between test 1 and test 2 for GMFCS level IV and V. Further analysis revealed that scores of the head had the least number of classification errors with 75.3% remaining unchanged, whereas scores of the leg (51.7%) and foot (51.7%) demonstrated greatest number of misclassification (table 5.10). This indicates that CABA items relating to the leg and foot at GMFCS level IV and V may have greater variability in test-retest situations.

In terms of magnitude of errors between test 1 and 2 these were minimal, there were no significant interactions on respondents' scores between GMFCS level, body segment and position. Observer error is inherent in the use of observation-based assessment tools (Andrews et al., 2008a); the challenge remains a trade-off between magnitude of classification errors and the number of classification errors. According to the data present in this study it can be inferred that the CABA has good to excellent reliability, however, it is important to bear in mind the possible

errors which may impact on items with reduced posture categories, such as the foot.

5.4.4 Rater variability

The results of the correlation analysis for raters' test and retest scores are presented in figure 5.3. This shows a strong correlation of agreement between raters with little deviation from the line of best fit. Raters scores are grouped low and collectively for GMFCS levels I and II. Scores for GMFCS level III, can be clearly determined but lie close to levels I and II, whereas scores for GMFCS level IV and V are clearly grouped in separate clusters with level V being scored higher than level IV.

The results from this study are consistent with previous research into CP classification (Palisano et al., 2008) and intervention guidelines (Gericke, 2006). The observed groupings between GMFCS level I – V reflect the classification criteria for the GMFCS. While children at levels I -II have limitations with walking long distances and balances, all are typically able to walk and sit without needing support to maintain body posture (Rosenbaum et al., 2007). The distinction, in regards to body alignment, becomes clear between GMFCS III and IV, as children in Level IV function usually require external support in sitting (Palisano et al., 2008). Clinical recommendations for supporting body alignment clearly outline that posture interventions should start as early as possible for those children at GMFCS level IV and V (Gericke, 2006), indicating that these children due to the severity of their neurological impairment are more at risk of body misalignment.

From this correlation of agreement for rater test-retest reliability close grouping and discrepancies in outlier scores between GMFCS levels I to III (figure 5.3) can be seen. Data from this chart can be compared with the data in tables 5.4 and 5.13 which shows limited discrepancies of the raters scores between GMFCS levels I and II and Levels II and III, indicating that raters were less likely to determine body alignment between these paired levels.

The results of this study indicate that the scoring 'fits' in with the classification of CP and in terms of alignment. It remains debatable how much misalignment will be present across levels I to III, despite the heterogeneity within each classification strand, significant misalignment in body posture is not expected within these subgroups compared to levels IV and V. This means that the CABA needs to be able to clearly distinguish between these two groups, which is clearly demonstrated in the results presented (figure 5.3). Further development is required to explore the CABA's sensitivity to detect changes in alignment to enable early detection and ongoing monitoring of both positive and negative alignment deviation.

5.4.5 Construct validity

Construct validity for the CABA was evaluated through its ability to differ between known GMFCS levels in children with CP. Overall the CABA demonstrated statistically significant ability to differentiate between all GMFCS levels ($p < 0.001$). Further post hoc examination into paired differences between each of the GMFCS levels showed each paired comparison was significant with the exception of GMFCS Level I and II and GMFCS Level II and III, meaning that raters were less likely to determine a difference in body alignment between these specific pairs of children.

Construct validity was also repeated with $k=11$ raters to see if experience of using the CABA improved construct validity, however, no statistical difference was found, indicating that the CABA demonstrated good construct validity and experience did not impact on this.

The CABA was designed to measure body alignment and deviation from optimal at all levels of GMFCS. The GMFCS describes the primary differences between children at Level I and II and II and III relates to mobility (Palisano et al., 2008). In terms of body alignment support there is little difference described between these pairs (Rosenbaum et al., 2007), indicating that the findings are consistent with the GMFCS grading system. Whilst other postural assessments have only examined psychometric properties from GMFCS Level II (Rodby-Bousquet et al., 2014), the

CABA examined and is able to identify graded deviations in body alignment across all GMFCS levels.

In addition, mean score increased with GMFCS severity showing that the raters scored children at GMFCS level I as having more optimal alignment (mean score 0.43) compared to those at GMFCS Level V (mean score 1.73). These results are consistent with the GMFCS classifications which outline more support being required to support body alignment the higher the child is graded e.g., Level IV and V (Palisano et al., 2008; Rosenbaum et al., 2007). Our results also showed that deviation from optimal was greater in positions which were more upright against gravity, sitting and standing. These findings are in line with previous studies, which have explored postural alignment and gravity as a cause of deformity (Porter et al., 2008; Scutton et al., 2008; Fulford and Brown, 1976). These findings, while preliminary, suggest that the CABA is responsive to determining differences in alignment across the construct of CP and postural management.

Early identification and monitoring of body alignment asymmetry are important aspects of managing a child's posture and function (Gericke, 2006). The ability to determine changes in body alignment early can prevent the development of musculoskeletal complications (Hagglund et al., 2014; Porter et al., 2008; Scutton, 2008) and assist in the effectiveness of posture management interventions such as, the provision of supportive postural equipment in sitting, standing and lying (Pountney et al., 2009; Farley et al., 2003). The CABA is able to reliably detect changes in body alignment from optimal, providing a clinical assessment which is consistent in monitoring a child's postural alignment by either the same or multiple therapists.

5.4.6 Study Limitations

This was a first stage reliability study, which examined the reliability of scoring the CABA items, from photographs using a grid. Whilst the use of the grid assisted in minimising rater error it is acknowledged that this is not indicative of usual clinical practice. As such it has limitations in relation to the use and reliability of the CABA in clinical settings. Furthermore, this study examined scoring of items only, not administration of the CABA. A study on administration of the CABA and how physiotherapists place children into the positions required to score and whether they need a grid to view through would improve reliability of the CABA in clinical settings. Further studies which examine the scoring reliability both with and without a grid in clinical and none settings would provide further detail on the CABA's reliability and its application in clinical practice.

This study used photographs to capture body alignment and for therapists to score from. Any digital approach to capturing and quantifying total alignment posture, such as photographs, requires multiple angles and views need to be captured to improve reliability (Lowe et al., 2014). A standardised format is required regarding how to position of the child and set up of the camera to support reliability (Dunk et al., 2004). Whilst, a standardised protocol and positioning procedure improves photograph analysis of posture alignment, this may limit its transferability into everyday real life clinical assessment (do Rosario, 2014). Whilst it can be argued that the use of photographs maybe less reflective of therapists' current everyday practice (Perry et al., 2008), photograph acquisition is fast, easy to do, and accessible for the majority of physiotherapists working in clinical settings (Fortin et al., 2011). Whilst this study used photographs to minimise error, it could also offer another dimension of the CABA as clinical measurement (Fortin et al., 2011). Further studies which examine the scoring of the CABA from photographs using a positioning protocol would provide further support the generalisability of the result of this study.

As part of the development of this new assessment, this first stage study aimed to explore the reliability of scoring the CABA items. As such, having a higher number of

raters was beneficial, strengthening the statistical analysis of the reliability between physiotherapists in their use of the CABA. The use of photographs of children with CP minimised the amount of random error likely to occur from the child and enabled examination of rater error. This resulted in the ability to identify any CABA items which had limited reliability between physiotherapists and, therefore, likely to be exacerbated when used in a clinical setting. Other studies exploring psychometric properties of postural assessment have used a limited range of 2-3 raters.

In terms of the group of CP children evaluated it could be argued that this may have impacted on the significance of results obtained, limiting application to clinical practice at present. However, in the conduct of preliminary reliability studies, only a small sample size is required especially when a very high value of ICC is set for result significance (Bujang and Baharum, 2017). This study demonstrated that the CABA had excellent reliability with ICC value >0.90 across 11+ raters.

The response rates for this study indicated that a large number of clinicians started the questionnaire but did not fully complete. This could suggest the scale of the project with only 5 children was potentially too large. Therefore, further data collection focusing on one part of the CABA within children with CP as required by clinical need, would improve response rate. Consequently, further studies which examine elements of the CABA such as sitting, in a set cohort of children at a specific GMFCS level in clinical practice may provide further detail on the psychometric properties and recruit a larger sample of clinicians and children. Evaluation of the tool's use is on-going to assist with refinement of its clinical usability.

Within this study, it is acknowledged that there may be some bias through the recruitment strategy for therapists. The relatively small heterogeneous group of children with CP may as a result, limit the generalisability of the findings, whilst the recruitment approach for paediatric physiotherapists is open to self-selection bias. In terms of the recruitment strategy for paediatric physiotherapists; self-selection

bias is whereby those who participated differed in clinical characteristics than those who did not (Tripepi et al., 2010). In some aspects this was expected as only those who worked with posture and children with CP were asked to participate. However, it is acknowledged that those who self-selected to participate were only a selection of those who could have. In total 167 initial responses were received but only 15 participated fully in the study. There are several possible reasons for this, but in terms of selection bias it could be argued that those who participated were perhaps different in their experience and specialities. Although self-selection is a threat for internal validity of the study, a diverse respondent diversity which showed respondent characteristics varied from experience, to speciality and region minimised the impact of this potential bias. Future studies examining reliability of the CABA against a larger sample of children with CP and neurological disabilities in clinical settings would further support the generalisability of the results of this study.

5.5 Conclusion

The CABA shows excellent intra-rater and inter-rater reliability across all dimensions of body segments and positions of lying, sitting and standing. It demonstrates overall statistically significant construct validity to differentiate between all GFMCS levels. The CABA is able to detect deviations in body alignment by raters with varied experience and without training, suggesting it is a tool which can be practically applied into everyday clinical practice.

Further examination of the CABA's responsiveness to changes in body alignment will be undertaken in Chapter 6. This will form the third phase of the investigation into the psychometric properties of the clinical assessment of body alignment in children with CP. The focus of the next chapter will examine the CABA's effective measurement of body alignment in the context of posture managing interventions, specifically the provision of positioning equipment. This is required to determine if the CABA is an evaluative outcome measure in clinical practice.

CHAPTER 6:

RESPONSIVENESS TO CHANGE IN BODY ALIGNMENT

6.1 Introduction

This chapter reports on the third phase of the investigation into the psychometric properties of the clinical assessment of body alignment in children with CP. The recently developed CABA (chapter 4 & 5) is the only known clinical assessment tool designed to assess graded changes in total body alignment deviation in children with CP; denoting left and right sides of the body, across 3 positions; lying, sitting and standing. As demonstrated in chapter 4 the CABA is based on clinically derived postural items, developed and revised by the clinical expert opinion of 283 paediatric physiotherapists who specialised in paediatric postural assessment. The CABA has shown to have good content validity with clinician's overall agreement fair to good (See chapter 4). As established in chapter 5 the CABA demonstrated excellent inter-rater and inter-rater reliability across all dimensions of body segments and positions of lying, sitting and standing. Construct validity was supported by a significant difference in mean values between GMFCS Levels (chapter 5).

A responsiveness study was carried out with a paediatric physiotherapist observing a sample of children with CP GMFCS IV and V. The responsiveness study considers external and internal responsiveness using an experimental clinical design. Two frames of reference for determining responsiveness were used: immediate change in and out of posture management equipment and CP classification criterion. External responsiveness was determined by comparing all CABA scores obtained in and out of postural equipment, at the two GMFCS Levels. The hypothesis was made that children with CP will have improved body alignment when using postural equipment. In order to evaluate internal responsiveness the CABA scores for each child in and out of postural equipment were compared across three contexts: 1)

Ability to detect change across all positions and body segments; 2) the level of change detected; and 3) ability to detect change at both GMFCS IV and V.

Throughout the methodology and data analysis are discussed in relation to CABA's worth as a clinical measure of body alignment in children with CP. A final section looks at limitations and implications for clinical practice.

6.1.1 Responsiveness in clinical measures

To be useful to clinicians and researchers, assessment measures should demonstrate adequate psychometric properties in relation to responsiveness, reliability and validity, to allow the interpretation of a change in result to have clinical meaning (Fawcett, 2013). Responsiveness is becoming a criterion for selection of outcome measures (Beaton et al., 2001). Responsiveness is defined as the ability to detect change in the concept being measured (Finch et al., 2003). An assessment's ability to demonstrate responsiveness has become of great interest in rehabilitation (Field and Roxborough, 2011). Clinicians are becoming more critical of their assessment choices as they tailor intervention strategies to adopt an evidence-based approach (Majnemer and Mazer, 2004). Funding sources want to know that their resources are being effectively used (Lenker et al., 2005). Research is being more specific in their criterion for measures selected to explore treatment effectiveness and evaluation of programmes (Beaton et al., 2001).

Responsiveness is a context specific characteristic of an assessment, it can only be evaluated when the measure is used for a particular purpose and with a particular group of individuals (Roach, 2006). The current literature on assessing responsiveness divides this into two frames of reference. Internal responsiveness is the ability to detect clinically important change based on changes due to intervention and/or time effect, while external responsiveness is the ability to detect meaningful change based on external criterion such as patient groups or professionals (Terwee et al., 2003; Roach, 2002; Husted et al., 2000). Three axes underlie this classification system: the 'who' axis is who is being analysed, individuals / groups, the 'which' axis relates to which scores are being compared over time or at one point in time and finally the 'what' axis type of change being

quantified as is this general change or clinically important (Beaton et al, 2001). As responsiveness is a highly contextualised attribute of an instrument, despite there being a lack of clarity around the methodology, by applying this set of indices researchers are able to clearly describe their methodological approaches in examining this concept in relation to context, patient group and outcome being measured by the identified assessment.

Establishing the responsiveness informs therapists on the effectiveness of their interventions (Fawcett, 2013). Evaluative measures need to be responsive to both the type and amount of change that is desired as a result of the intervention (Roach, 2006). The CABA has been developed as having clinical meaning and being interpretable by the user as it was based on the ICF (WHO, 2007). The ICF defines body function as the physiological and psychological functioning of the body systems, inclusive of the skeletal alignment (WHO, 2007). The alignment scales of the CABA measures the body structure component of the ICF. Body alignment in lying, standing and sitting are areas targeted by therapists in the provision of postural management equipment (Hong, 2005; Farley et al., 2003). It is, therefore, of critical importance that in the development of the CABA responsiveness is considered. This investigation ensures that this measurement tool can detect clinically meaningful change in body alignment in the use of posture management equipment. As this study is part of a wider investigation into the clinical assessment of body alignment in children with CP as part of this PhD research project, the aim of this third phase of the project was to examine the Clinical Assessment of Body Alignment (CABA) responsiveness to detect change in body alignment in children with CP GMFCS IV and V. This chapter represents the third and final stage of the psychometric investigation of the CABA assessment in children with CP.

The purpose of this chapter was to examine the CABA's responsiveness to detect immediate change in body alignment through a study whereby a paediatric physiotherapist used the CABA to score alignment of children with CP GMFCS IV and V in and out of posture management equipment across lying, sitting and standing positions.

6.2 Methods

Approval for this study was obtained from the Ethics Review Board of York St John University, UK; REF: 069011429_George_22092017 (appendix 9).

6.2.1 Responsiveness

It is acknowledged that there is no gold standard for conducting responsiveness studies. Methodology is based on frames of reference criterion and underpinning sub-classifications which provide indices from which responsiveness can be determined (Terwee et al., 2003).

As part of the development of this new assessment tool, this study aimed to explore the responsiveness of the CABA in children with cerebral palsy GMFCS IV and V. This study aimed to examine responsiveness using two frames of reference: immediate change in and out of posture management equipment, and CP classification criterion examining both external and internal responsiveness. The sub-classifications described by Beaton et al, (2001) which underpinned the reliability indices was used to examine responsiveness: the 'who' axis refers to the groups of children with CP at GMFCS IV and V, the 'which' axis relates to the CABA scores compared over immediate change with and without postural equipment and finally the 'what' axis is the change in body alignment.

Experimental methodology designs are often used to determine cause and affect relationships (Field and Hole, 2002). Whether these are true of quasi designs depend on the control the researcher has over the dependent and independent variables. In terms of this study an independent variable is the use of positioning equipment (cause) and the dependent variable is the measurement of body alignment (effect).

In order for this study to be a true experimental design it would have to have a control group of children who did not use positioning equipment at all. In practice there are obvious ethical reasons why this cannot be done. Instead, this study has selected a group of children with CP who use positioning equipment for sitting,

standing and lying, however, also spend time out of equipment. This criterion was set as it reflects typical, real life settings in the use of positioning equipment in children with CP. Children with CP do not use positioning equipment across all the hours of the day (Gough, 2009). Posture management is an integrated approach combining techniques which minimise postural misalignment (Farley et al., 2003); while the use of positioning equipment is the primary approach with this accompanied by movement-based activities (Gericke, 2006). Children with CP also use movement experiences and time out of equipment to support development and their quality of life. In everyday situations it is typical for children to spend time without their equipment. While this study is examining immediate change of body alignment between use of positioning equipment and both variables can be controlled. There might be small differences in terms of time spent in and out of equipment on a daily, weekly or yearly basis for each child. As the variable of body alignment is not wholly under our control, a quasi-experimental design method is used (Field and Hole, 2002).

6.2.2 Study design

A quasi-experimental study design was used to examine the responsiveness of the CABA. In the examination of responsiveness, more than one type and context of responsiveness study may be required (Beaton et al., 2001; Husted et al., 2000). External responsiveness was determined by comparing all CABA scores obtained in and out of postural equipment, at GMFCS Level. The hypothesis for this part is that children with CP will have improved body alignment when using postural equipment. Consequently, the null hypothesis was that children with CP will have no improvement in body alignment when using postural equipment.

Internal responsiveness was determined by comparing the CABA scores for each child in and out of postural equipment across three contexts: 1) Ability to detect change across all positions and body segments, 2) The level of change detected and 3) ability to detect change at both GMFCS IV and V.

6.2.2.1 Participants

To evaluate the responsiveness of the CABA one physiotherapist, the primary researcher, evaluated a random stratified sample of (n=10) children with CP GMFCS Level IV (n=5) and V (n=5). The primary researcher was the sole physiotherapist within the school, this was selected as the children were both used to the environment and lead researcher, therefore, having minimal impact on the children's mood, wellbeing and clinical presentation. Random measurement errors can affect scores and can occur in either the assessor (physiotherapist) or the individual (child with CP) affecting an individual's score in either a positive or negative direction (Crocker and Algina, 2008) (See chapter 4: section 4.1.2). As random errors reduce both the consistency and the usefulness of the assessment scores, it is important to adopt approaches within research which minimise these (Mcdowell and Mcdowell, 2006). The selection of the sole researcher aimed to minimise both assessor and individual errors.

Children with CP can become unsettled when meeting new people and this can affect their body alignment through a change in tone. The primary researcher knew the children well and interacted regularly within the clinical context of the research, assessment of body alignment in everyday practice. This meant that the children were familiar with the physiotherapist assessing posture both in and out of equipment as part of their therapy sessions. The primary researcher was also familiar with the CABA assessment, having been the initial developer of the assessment. This meant that random errors related to misreading items or misinterpreting the scores were limited. Had other physiotherapists been recruited to examine the sample of children, there was a likelihood that this would have increased random errors and skewed the results.

6.2.2.2 Description of children evaluated

A random stratified sample of (n=10) children with CP GMFCS Level IV (n=5) and V (n=5) were recruited from a local special school. All children had a confirmed diagnosis of CP and GMFCS level by a consultant paediatrician, used postural equipment across sitting, lying and standing, had no surgical procedures within the

previous 6 months, no injection of botulinum toxin type A within the previous 6 months. Invitation letters and written information was given to the families through the school's communication system. Written consent was gained from all families who agreed to participate. Children who consented were grouped by GMFCS level and randomly invited until there were five children at each of GMFCS level.

This sample of children, five representing each GMFCS level IV and V (n=10 in total), this equated to 3 observation assessment per child across positions of lying, sitting and standing. With a score being taken twice for each position once without equipment and once with giving 142 scores per child resulting in a total each GMFCS group of 710 scores.

6.2.3 Procedure

A convenience sample of one physiotherapist who worked at the special school scored each child's (n=10) body alignment using the CABA. Each participant's body alignment was scored with and without equipment across lying, sitting and standing. For the baseline assessment, without equipment, the children were scored on a firm matt on the floor for lying, on a wooden block for sitting and on a firm flat surface for standing. With equipment, the children were scored in their own postural equipment they used across lying, sitting and standing.

A local special school was selected as it was an environment where children use posture management programmes frequently, and where posture assessments are a frequent part of a child's therapy. This was important as the children were both used to the environment and posture assessment, therefore, minimising any impact on individual clinical presentation reducing random measurement error. Some children required support to maintain positions such as sitting, without equipment. Adult support, from a teaching assistant was, therefore, given if required to support safety, but not correct or change alignment. The same teaching assistant was used for all children to keep continuity. Each child was allowed 2 minutes within each position before measurements were taken to allow them to adopt a typical

alignment more representative of how the child's posture would be both with and without equipment.

The children were identified by the primary researcher from a local special school. Gate keeper permission from the head teacher and school board of governors was sought to approach parents for informed consent in the study (see appendix 20). The primary caregivers were contacted through home schoolbooks, the school's established and preferred method of communicating with parents. Participant information (see appendix 21), consent forms (see appendix 22) and a return envelope were sent to parents of identified children, this asked parents to respond only if they wished for their child to participate. No parent or caregiver was directly contacted by the lead researcher as part of the recruitment process. The information to caregivers made it very clear that participation was voluntary and that refusal or withdrawal would not influence the therapy support either they or their child receive for postural management, and any other therapy intervention.

As discussed in chapter 5 (section 5.2.3.3) children with CP are a group of individuals often unable to give consent due to their severe learning impairments, therefore, parental consent to participate in the study was sought. However, children were also given information about the study. Taking into consideration the complex learning and communication needs of the children, it was once again important that creative, multi-method, flexible approaches were adopted, which could be tailored to the needs of those involved (example in appendix 23). It is particularly important to note there was likely to be a range of needs and abilities, therefore tools needed to be adapted to suit the individuals not the group as a whole. Again, such decisions were informed by consulting relevant experts (for example, parents, practitioners and support workers) and it was necessary to work alongside parents and support workers once consent to participate had been received, when undertaking data collection.

Alternative communication methods were used to explain the study, this took on the form of three main strategies to cover a range of understanding levels of the

children and could be tailored to individual needs. Strategies include firstly; pictorial information supported by verbal and key words (See appendix 23), secondly the showing of objects that directly related to the activity for example; equipment and camera; and thirdly the placing objects in the child's hand. Each child had a school pupil profile which clearly described body responses the child displays when they are happy and unhappy, when they like or dislike something. These profiles are created by consultation with caregivers and professionals who know the child well. Body responses were observed and taken as the child assenting to participate in the study. If a child was able to give a verbal response this was also included alongside observation of body response. Caregivers were given a copy of the child participation information tailored to the individual child's needs, so that this could be shared with their child prior body alignment assessment. Caregivers were also given the option to be present during the assessment if they wished (see appendix 21). For the purpose of maintaining participant anonymity, children were classified by GMFCS and age (mean, SD and range) only.

Careful thought was given regarding the ethical considerations in undertaking this study to minimising child distress. This involved communicating and involving with those who knew the child best, such as parents and careers throughout the study. Use of each child's My Day profile (see appendix 18), enabled individuals communication methods to be used and assent gained by observing each child's body response throughout their participation in the study. Consideration was also given to gate keeper information and permission, data storage and participant anonymity. Details of the full ethical application for this study are detailed in appendix 19, with supporting information in appendix 20 to 23.

Each participant's body alignment was observed and scored unsupported and again supported in their adaptive equipment used to correct the child's body alignment such as seating / stander / lying supports. It was recognised that some of the children may require adult support in some unsupported positions particularly sitting or standing, this was given as minimal as possible and did not correct body alignment.

6.2.4 Data Analysis

Each participant was assigned a unique reference number and the CABA scores inputted into the IBM Statistical Package for the Social Science (SPSS version 25) for data analysis.

The null hypothesis was that there is no difference in CABA scores between with and without equipment. Assumptions of the distribution of the data were examined using Kolmogorov Smirnov test, to determine whether parametric tests or non-parametric tests should be calculated. Two frames of references have been used in this methodology, internal responsiveness based on changes due to intervention and/or time effect and external responsiveness based on external criterion of GMFCS groups and individual children with CP.

For external responsiveness Pearson correlation coefficient was used to examine the correlation of scores with and without equipment. Pearson correlation coefficient is displayed using an r score range of -1 to $+1$ value (Husted et al., 2000). A score of 0 means there is no association, a negative value indicates a negative association that is as one value goes up the other goes down for example; a child with good alignment without equipment will have more deviated alignment with equipment. Whereas a positive correlation would indicate children with less body alignment deviation without equipment also equated to less alignment deviation in equipment. For interpretation of the results we adopted the following assessment of the strength of the responsiveness; r value less than 0.3 indicates poor correlation, values between 0.3-0.5 indicate moderate correlation and values greater than 0.6 indicate a strong correlation (Evans, 1996).

For analysis of the CABA's internal responsiveness summed scores were used for all measurements, for positional criterion of each position, body segment and GMFCS level. The focus of this analysis was to identify and quantify improvements in body alignment. The difference in raw alignment scores for each measurement was calculated and all differences where the CABA score with equipment was lower (closer to optimal alignment) than the score without equipment were identified as

improvements. The summed improvement score percentage, mean and standard deviation (SD) of measurements in which an improvement in alignment is noted were calculated. Examining the statistically significant changes of scores with postural equipment compared to without. The measurement taken without equipment was set as the baseline measurement, to enable comparison of the CABA's responsiveness to change. The paired sample t-test was used to determine if any difference in scores across positions and body segments, with and without equipment, were of statistical significance. This is a statistical procedure used to establish whether two means collected from the same sample and related observations differ significantly (Field, 2013). Independent sample t-test compared between GMFCS IV and V.

In the examination of the CABA's internal responsiveness the number of statistical comparisons is greater than one. Four variables are compared: with and without equipment; across positions; between body segments; and between GMFCS levels. To account for the possibility of type 1 errors (rejecting the null hypothesis, when in fact it was true) due to the number of correlations examined, the α level was adjusted. The usual α level is 0.05, in order to account for the number of tests carried out a Bonferroni correction was carried out (Field, 2013). The typical α level was divided by 4 (for the 4 variables) to give a new α level of 0.012. Values were deemed significant at $p < 0.01$ (Field, 2013).

6.3 Results

In total, 142 measurements were collected for each child GMFCS IV ($n=5$) and V ($N=5$) aged 3 to 12 years (mean 5yr 4mth); 71 CABA measurements with equipment and 71 corresponding CABA measurements without postural equipment.

6.3.1 Sum scores for normality

The Kolmogorov-Smirnov test results for the summed scores of all measurements and all measurements taken in each of the 3 positions were analysed. Each case demonstrates a non-significant finding meaning the null hypothesis is rejected of

the K-S test and the data is normally distributed, supporting the use of the parametric tests in the analysis (See appendix 24).

6.3.2 External responsiveness - correlation of body alignment with and without equipment

There were complete measures for each child $n=10$. Each child had a total of 142 measurements; 71 measurements taken with body alignment positioning equipment and 71 corresponding measurements taken without equipment.

Pearson correlation coefficients were calculated using SPSS comparing CABA scores with equipment to without equipment across GMFCS level. The measurements for each child with and without were strongly correlated ($r=0.769$, $p=0.002$), indicating that a child with good posture without equipment is likely to also have good posture in equipment.

6.3.3 Internal responsiveness

6.3.3.1 CABA's responsiveness to change in body alignment

There were complete measurements from $n=10$ children. In total, 71 measures with equipment; 23 alignment ratings in the lying and standing position and 25 ratings in the sitting position. The measures were repeated without equipment providing a comparable 71 measures resulting in a data set of 142 measurements per child.

Out of the 71 different measures with equipment for each child ($n=10$), the percentage of CABA measures showing an improved alignment with equipment ranged from 48% to 85%. The CABA scores body alignment on a 0 -3 scoring system; a score of 0 indicates optimal alignment, whereas a score of 3 indicates significant alignment deviation from optimal. In total, 70.3% of all measurements showed an improvement in alignment with equipment compared to without (figure 6.1). There is a statistically significant difference, $t(9)=24.5$, $p<0.001$ (table 6.1) across positions and body segments of the CABA.

Table 6.1: Internal responsiveness summed percentage, mean, standard deviation and paired t tests of the CABA for positions and body segments.

Dimension	Improvement in alignment % (mean, SD)	Paired t tests
<i>Positions</i>		
Lying	59.6% (mean=13.7, SD=2.4)	p<0.001
Standing	84.3% (mean=19.4, SD=2.7)	p<0.001
Sitting	67.2% (mean=16.8, SD=3.2)	p<0.001
<i>Body Segments</i>		
Head	57.8% (mean=5.2, SD=3.3)	P<0.001
Trunk	85.6% (mean=7.7, SD=1.3)	p<0.001
Pelvic	84.4% (mean=7.6, SD=1.7)	p<0.001
Arm	48.3% (mean=5.8, SD=2.8)	p<0.001
leg	85.0% (mean=17, SD=1.4)	p<0.001
Foot	55.0% (mean=6.6, SD=1.8)	p<0.001
<i>All measures</i>		
Total:	70.3% (mean=49.9, SD=6.4)	p<0.001

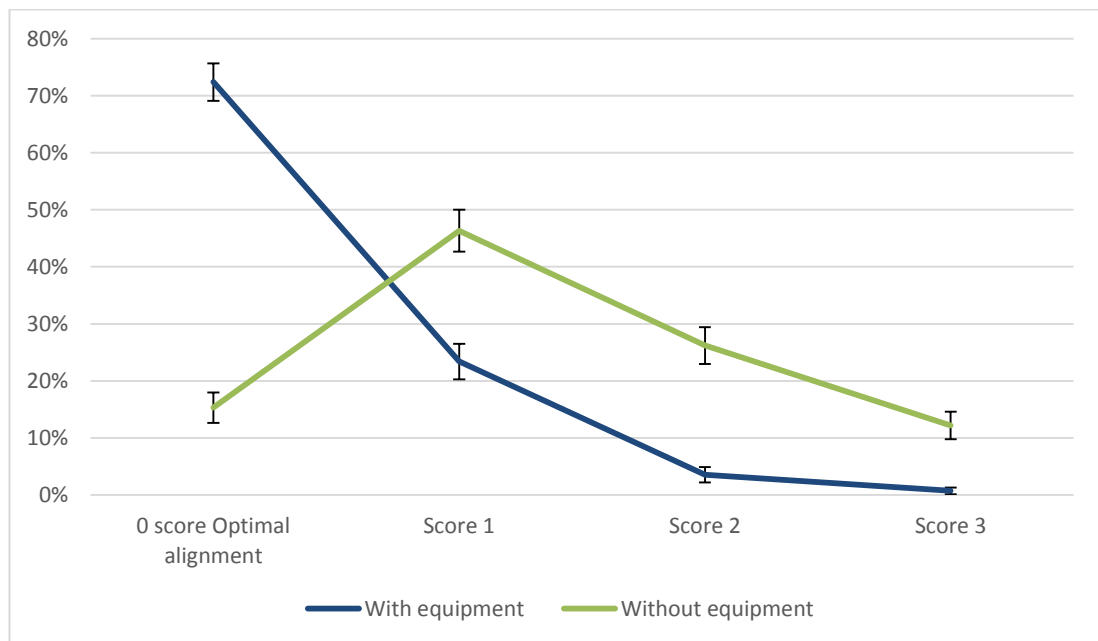

Figure 6.1: Total percentage scores of all measures with and without equipment.

The percentage scores were highest in standing (84.3%, p<0.001) and lowest in lying (59.6%, p<0.001), indicating that equipment had a greater improvement in body alignment the more upright the child was against gravity. Across all children

the mean and SD values across standing, sitting and lying differed little, ranging from 13.7 (SD=2.4) to 19.4 (SD=2.7) indicating that the CABA was able to detect change in body alignment indiscriminative of position.

Overall, the CABA's responsiveness to detect change in body alignment was statistically significant across all its postural body segments categorisations ($p < 0.001$), indicating that equipment improved total body alignment. The percentage scores were highest in trunk (85.6%, $p < 0.001$) and lowest in arms (48.3%, $p < 0.001$), indicating that postural equipment had a reduced effect on upper limbs and the CABA was responsive to detect alignment change across all body segments.

The analysis was repeated to see if there were any cases where the CABA scores showed a worsening in alignment with equipment compared to without. As shown in table 2.6, 70.3% of all measurements taken show improvement when in equipment compared to the baseline measurement of the alignment without equipment. The table below illustrates the breakdown of changes in CABA scores comparing measures which showed no improvement to those which remained the same and those which scored higher in equipment indicating a worsening in body alignment (table 6.2).

Table 6.2: percentage of measurements which changed within equipment compared to the baselines measure without equipment across positions.

Position	Improvement CABA score %	No change in score %	Worsening CABA score %
All positions	70.3%	29.7%	0%
Lying	59.6%	40.4%	0%
Standing	84.3%	15.7%	0%
Sitting	67.2%	32.8%	0%

There were no cases where measurements in equipment scored higher on the CABA scale, indicating a worsening of body alignment. Simply, no CABA score in equipment was higher, indicating a worsening of body alignment with equipment compared to without.

Interestingly 29.7% showed no change in score between with and without equipment. Further examination of those measurements that showed no change in CABA scores between baseline measures without equipment to the measures taken with equipment are illustrated in table 6.3.

Table 6.3: Percentage of measures which showed no change, broken-down into each scoring category of the CABA across positions.

Position	% of measurements in each Score category where scores remained the same			
	Score 0	Score 1	Score 2	Score 3
All positions	54%	39%	7%	1%
Lying	63%	28%	8%	2%
Standing	57%	37%	6%	0%
Sitting	44%	49%	6%	0%

It can be seen from the data in table 6.3 that 93% of measures which showed no change in alignment were scored between 0 and 1 on the CABA across all positions. Just over a half (54%) of all measurements where no change in CABA score were noted between with and without equipment were already optimal alignment (score 0). Less than 10% of measurement that did not see any improvement was for positions with level 2 (7%) or 3 (1%) misalignment. Overall, these results indicate that the CABA is consistently sensitive to changes in alignment and is able to detect no change as well as a change in body alignment. No increase in CABA score was found between with equipment to without, indicating that equipment maintained or improved alignment in all cases.

6.3.3.2 Level of change in CABA scores

The focus of this analysis was to identify and quantify the level of change in CABA scores and consequently in body alignment. The mean improvement in alignment was calculated by taking the difference in alignment scores between the measurement in equipment and the corresponding measurement without equipment (table 6.4).

Table 6.4: Mean improvement score (standard deviation) and the statistical significance for each position, body segment and overall.

Dimension	Mean improvement score (SD)	Paired t -tests
<i>Position</i>		
Lying	0.8 (SD=0.28)	p<0.001
Standing	1.4 (SD=0.49)	p<0.001
Sitting	0.9 (SD=0.36)	p<0.001
<i>Body segment</i>		
Head	0.8 (SD=0.64)	p<0.003
Trunk	1.4 (SD=0.53)	p<0.001
Pelvic	1.2 (SD=0.36)	p<0.001
Arm	0.6 (SD=0.29)	p<0.001
Leg	1.3 (SD=0.39)	p<0.001
Foot	0.7 (SD=0.28)	p<0.001
<i>All measures</i>		
Total:	1.0 (SD=0.29)	p<0.001

Overall, the level of change noted between CABA scores with and without equipment demonstrated a mean improvement in alignment of 1.0 ($t(9)=11.3$, $p<0.001$) across all measures (table 6.4); an increase of exactly one level on the CABA scoring scale indicating that the CABA's posture classifications are sensitive to change in body alignment.

Paired t-tests found statistically significant sensitivity across all positions ($p<0.001$). The Mean and SD values across standing, sitting and lying differed little, ranging from 0.8 (SD=0.28) to 1.4 (SD=0.49), indicating that the CABA scoring categories were responsive to change in body alignment indiscriminative of position.

Further statistical analysis revealed statistically significant sensitivity across all six body segments ($p<0.001$). The Mean and SD scores across body segments also varied little with the greatest in trunk, 1.4 (SD=0.53) and the smallest in arm 0.6 (SD=0.29), indicating that the CABA is able to identify change in alignment across all its postural body segments categorisations.

6.3.3.3 CABA's responsiveness to change at GMFCS IV and V

Independent t-tests were calculated using SPSS based on comparisons between children at GMFCS IV (n=5) and V (n=5). The sum percentage mean CABA scores for each GMFCS level across all measures, and comparison of the difference in improvement scores between these two GMFCS groups are presented in table 6.5.

Overall, the CABA demonstrated responsiveness to change in body alignment when equipment was used at GMFCS level IV ($t(4)=20$, $p<0.001$) and V ($t(4)=44$, $p<0.001$). No statistical difference between the two groups' overall improvement scores was evident ($t(8)=1.5$, $p=0.17$), indicating that the CABA was able to detect change accurately at both GMFCS IV and V.

Table 6.5: Internal responsiveness for GMFCS IV and V summed percentage and Independent t tests of the CABA for positions and body segments.

Dimension	GMFCS IV	GMFCS V	Comparison IV and V
	Improvement in alignment % (Independent t-test)	Improvement in alignment % (Independent t-test)	Results of independent t test between IV and V
<i>Position</i>			
Lying	57.4% ($p<0.001$)	61.7% ($p<0.001$)	$p=0.54^*$
Standing	80.0% ($p<0.001$)	88.7% ($p<0.001$)	$p=0.26^*$
Sitting	61.6% ($p<0.001$)	72.8% ($p<0.001$)	$p=0.17^*$
<i>Body Segment</i>			
Head	33.3% ($p=0.114$)*	82.2% ($p<0.001$)	$p=0.025^*$
Trunk	77.8% ($p<0.001$)	93.3% ($p<0.001$)	$p=0.08^*$
Pelvic	75.6% ($p=0.002$)	93.3% ($p<0.001$)	$p=0.15^*$
Arm	58.3% ($p=0.001$)	38.3% ($p=0.04$)*	$p=0.20^*$
Leg	86.0% ($p<0.001$)	84.0% ($p<0.001$)	$p=0.68^*$
Foot	50.0% ($p<0.001$)	60.0% ($p=0.002$)	$p=0.31^*$
Total	66.2% ($p<0.001$)	74.4% ($p<0.001$)	$p=0.17^*$

*= Denotes non-significant result

Independent t-tests found statistically significant sensitivity at GMFCS IV and V across all positions ($p<0.001$). Percentage improvements in scores across standing, sitting and lying were slightly higher for GMFCS V (range 61.7% to 88.7%) compared

to GMFCS IV (range 57.4% to 80.0%), indicating that body alignment improved less with equipment with greater severity of CP classification. Overall, comparison between GMFCS groups showed that none of these differences reached statistical significance, indicating that the CABA is sensitive to changes in body alignment across positions at both GMFCS levels.

Further statistical analysis revealed statistically significant sensitivity at GMFCS IV and V across all body segments ($p < 0.001$), with the exception head alignment for GMFCS IV ($t(4)=2$, $p=0.114$) and arm alignment for GMFCS V (38.3% ($t(4)=3$, $p=0.04$)). Percentage improvements in scores for head alignment were higher for GMFCS V (82.2%) compared to GMFCS IV (33.3%), indicating little improvement in head alignment at GMFCS IV when equipment was used. Whilst score for head alignment were higher for GMFCS IV (58.3%) compared to GMFCS V (38.3%). Comparison between GMFCS groups showed no statistical significant difference at head ($t(8)=2.8$, $p=0.025$) or arm ($t(8)=1.4$, $p=0.20$) alignment scores, indicating that the CABA is responsive to change in head and arm alignment at GMFCS IV and V. No other significant differences between GMFCS IV and V groups were noted.

The mean scores of measurements of all children at each GMFCS level IV ($n=5$) and V ($n=5$) increase in line with the CABA scoring criteria towards more optimal alignment with equipment compared to without, across all positions and body segments (figure 6.2). This indicates that at GMFCS IV and V the CABA is responsive to immediate change in body alignment with equipment across posture categorisations and scoring criteria set out in the CABA.

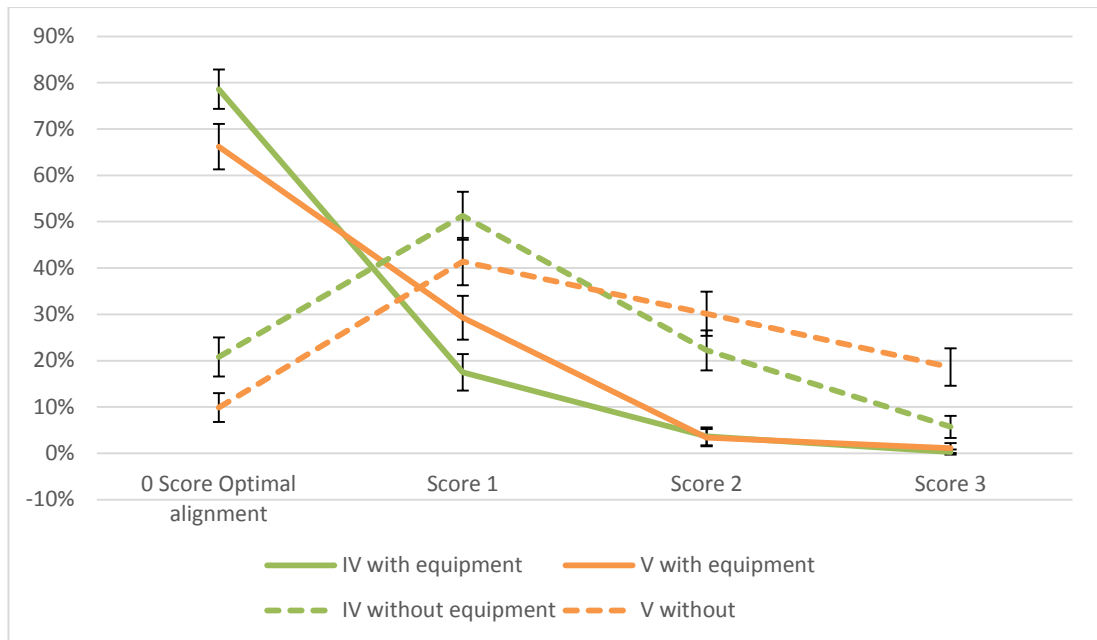

Figure 6.2: Percentage scores of all measures at GMFCS Level IV and V with and without equipment.

6.4 Discussion

6.4.1 External responsiveness correlation of body alignment with and without equipment

The primary hypothesis was that there would be a strong correlation between CABA scores with and without equipment ($r > 0.60$). The results, based on Pearson correlation coefficient demonstrated strong positive correlation ($r=0.769$, $p=0.002$), indicate that the CABA was able to detect differences in body alignment with and without equipment and disprove the null hypothesis. In terms of clinical importance, the CABA shows good external responsiveness to change in body alignment as a result of the use of postural equipment in children with CP. This is demonstrated by a strong positive correlation that a child with good posture without equipment is likely to also have good posture with equipment. Conversely a child that has very misaligned posture without equipment, for example a CABA score of 3 might be less likely to achieve good posture in equipment compared to a child who has only slightly misaligned posture without equipment, for example a CABA score of 1. It can, therefore, be suggested that the change in body alignment

measured by the CABA is meaningful as an important change in clinical presentation (Husted et al., 2000).

Correlations are often used to identify a potential association or relationship between two variables such as body alignment with and without positioning equipment (Connelly, 2012). In addition to the presence of a relationship, the correlation coefficient reveals two important aspects of this: the magnitude or strength, and direction of the relationship (Spearman, 2010). Pearson's correlation coefficient is commonly used to demonstrate linear relationships; however, correlation does not imply causation (Lovie and Lovie, 2010). The correlation is an index, rather than an actual measurement scale. Values can be assigned to determine the strength of the correlation with >0.70 representing a high correlation (Evans, 1996), but these should be reported alongside the p value significant level to assist in determining the strength of the relationship (Monge and Williams, 2001).

Correlations, whether significant or non-significant can be equally revealing in terms of clinical implications and in questioning long-standing practices (Pin et al., 2019). The use of positioning equipment is a long-standing established practice in the management of posture (Gericke, 2006; Hong, 2005). Prior studies, up to now, have been descriptive in nature on the impact body alignment correction may have on posture and function (Pountney et al., 2009; Porter et al., 2008; Scrutton, 2008; Fulford and Brown, 1976). The CABA reported a strong and significant correlation ($r=0.769$, $p=0.002$) meaning that there can be confidence in the relationship between body alignment and positioning equipment.

As discussed in chapter 3 (section 3.4.3), only one of the assessment tools which measure body alignment in children with CP examined the criterion of responsiveness. The seated postural control measure demonstrated fair to moderate significant correlation ($r=0.44$, $p<0.01$) for change in alignment (Field and Roxborough, 2011). This assessment only applies to a seated posture, hence its generalisability to wider posture management approaches is limited. The paucity of

an assessment of body alignment means there has been few empirical investigations into body alignment significance in posture management programmes. Although a causation between positioning and equipment cannot be determined solely by correlation (Connelly, 2012), it does confirm that the provision of positioning equipment is important in posture management approaches. The significance of this relationship is supported by the examination of the CABA's responsiveness to the effects of positioning on equipment on body alignment in children with CP which is discussed below.

6.4.2 Internal Responsiveness

6.4.2.1 CABA's responsiveness to change in body alignment.

The results, based on paired t-tests and percentage means showed that the CABA demonstrated statistically significant responsiveness to changes in body alignment for children with CP across all positions and body segments ($t(9)=24.5$, $p<0.001$). In total, 70.3% of all measurements showed an improvement in alignment with equipment compared to without.

The CABA demonstrated statistically significant differences using the posture categorisations to detect change in alignment across all positions ($p<0.001$). The greatest improvement was found in standing (84.3%), followed by sitting (67.2%) and the smallest in lying (59.6%). The relationship between improved alignment and positions may be explained by body alignment correction requiring more support the more upright against gravity the position. Standing requires a smaller base of support and increased postural control to maintain an upright alignment against gravity (Shumway-Cook and Woollacott, 2007). As such it is the most challenging position for a child with CP GMFCS to achieve and maintain (Carlberg and Hadders-Algra, 2005). Without support from postural equipment alignment is significantly deviated from optimal, therefore a greater change in body alignment would be expected between alignment with and without equipment (Pope, 2007). These findings are in line with previous studies which have explored the association between gravity, postural deviation and deformity in children with CP (Dewar et al.,

2015; Pountney et al., 2009; Shumway-Cook and Woollacott, 2007; Gericke, 2006; Carlberg and Hadders-Algra, 2005; Farley et al., 2003; Pountney et al., 2002). In terms of the CABA's responsiveness to changes in body alignment for the dimension of body segments, the CABA demonstrated statistically significant change across all six body segments, ($p < 0.001$). Individual body segments demonstrated a change in body alignment ranged from 48.3% - 85.6%, all changes indicated either an improvement or no change. The smallest improvement was noted for arm alignment (48%), though this difference is less than 50% it still showed a statistically significant improvement ($t(9) = 6.5$, $p < 0.001$).

This result may be explained by the fact that postural equipment aims to provide a stable and energy efficient position from which a child can function from (Pope, 2007). The principles of this relate to maintaining individuals centre of gravity within their base of support (BoS), support is provided to central body segments such as the head, trunk, pelvis and legs which form the BoS and improve stability and function (Dusing and Harbourne, 2010; Harris and Roxborough, 2005). Activity and participation are an integrated aspect of posture management; a collective aim is to prevent body alignment deformity whilst promoting functional skills (Gericke, 2006). The possible inference of restricted arm movement from equipment and participation cannot be ruled out. Direct restriction of arm movement by use of posture equipment would undoubtedly impact on functional benefits. Therefore, it is not a surprising result that arm measures show the smallest changes in alignment.

Further repeated analysis into CABA scores determined that there were no cases where a worsening in alignment with equipment compared to without was shown. These results showed that 29.7% of scores showed no change when compared to the baseline measurement without equipment. Just over half of these measures (54%) scored body alignment as optimal both with and without equipment. The greatest level of no change in score was found in lying (40.4%), followed by sitting (32.8%) and the smallest in standing (15.7%). This finding was not unexpected and indicates that children at GMFCS IV and V for some CABA items could achieve and

maintain fairly optimal body alignment both with and without equipment, dependent on positional demand.

These results are consistent with the GMFCS classifications which outline more support is required to support body alignment against gravity at both GMFCS IV and V (Rosenbaum et al., 2008). Whilst the classification does differentiate between the levels, children at GMFCS V are at greater risk of more body misalignment as they have significantly restricted voluntary control of movement and the ability to maintain antigravity postures (Palisano et al., 2008). The heterogeneous presentation of CP means that the border lines between classifications is not definite (Rosenbaum et al., 2008). This variability can mean that whilst on paper the classification seems separate, it is more ambiguous. Individual presentations can mean that a child maybe functioning at the higher or lower range within the classification description, resulting in some overlap between grade borders (Palisano et al., 2008; Morris and Bartlett, 2004). The results showed that for a small percentage of scores optimal alignment was more consistent or showed no change between GMFCS levels in positions which were less upright against gravity, lying and sitting.

Clinical recommendations for supporting body alignment outline a graded approach to positioning reflective of positioning demands and development, with lying being the first followed by sitting and then standing (Gericke, 2006). Early intervention is an important aspect of managing a child's posture in line with typical development milestones (Pope, 2007). The ability to determine body alignment changes across positions can prevent the development of secondary complications and assist in the effectiveness of posture management interventions as positions more upright against gravity are introduced (Hagglund et al., 2014; Gough, 2009; Farley et al., 2003). These findings demonstrate that the CABA is responsive to determining immediate change in body alignment across its postural categorisations, and responsive to change across gravity demands aligned with posture management approaches.

6.4.2.2 Level of change in CABA scores

The CABA demonstrated an average change in alignment score of 1.0, an increase of exactly 1 level increase on the CABA's scale. Overall, the CABA demonstrated statistically significant ability to differentiate of its 0-3 scoring scale across all posture categorisations ($p < 0.001$).

Paired t-tests (table 6.1) found statistically significant sensitivity across all positions and body segments ($t(9)=24.5$, $p<0.001$). Mean and SD (table 6.4) values differed little across positions ranging from 0.8 (SD=0.28) to 1.4 (SD=0.49) and body segments ranged from 0.6 (SD=0.29) to 1.4 (SD=0.53). The results show that all changes in CABA scores were <1.5 of an increment in the CABA scoring scale, indicating that the CABA scale is an accurate measure of a change in alignment (table 6.4). The challenge in measures responsiveness is ensuring it has the ability to detect real change over measurement error (Roach, 2006).

Responsiveness is closely linked to reliability; characteristics which can affect measurements sensitivity are associated with their construction (Evans, 1996). The number of scoring categories can significantly influence responsiveness; too few or too many can result in the measure being unresponsive to change and increase errors (Husted et al., 2000). The challenge for responsiveness in measurements is that the change should be large enough to be statistically significant whilst precise enough to reflect increments of change that are of clinical value (Stratford et al., 2002).

The CABA is an observational measure of body alignment that includes items dealing with graded change in alignment from 0 - 3 in 1-point increments. This scoring system is applied across all body segments expected to change as a result of neurological and movement impairment. As discussed in chapter 4 (section 4.2.3) a robust approach to posture categorisation was undertaken in development of the CABA. Border errors associated with observational assessment of body alignment have shown errors to increase the greater the number of categorisations there are (Andrews et al., 2008a). The smaller the scoring categories are the more likelihood

error will occur. There is a trade-off between magnitude of error and the number of errors (Andrews et al., 2012). Scores which fall closer to the margin of a posture category have greater likelihood that a rater will score the posture as more severe, giving a higher score (Van Wyk et al., 2009). In relation to the CABA this would mean that if scores were >1.5 in level of change it may indicate a greater error margin in posture categorisation and might indicate that the number and size of the posture categorisations might need adjustment. However, the CABA has shown to have excellent inter-rater reliability and rater (test-retest) reliability (chapter 5: sections 5.3.2 and 5.3.4). These results show that all changes in CABA scores are within <1.5 and therefore more likely to accurately measure a change in alignment.

A strength of the CABA's is that its scoring system is responsive to measuring real and clinically meaningful change of body alignment as part of posture management in children with CP.

6.4.2.3 CABA's responsiveness to change at GMFCS IV and V

Since it can be expected that children at GMFCS IV and V will have different postural severity, separate analysis was performed for both groups to detect whether the CABA is sensitive to change across both these classification levels. The differences between mean improvement scores for each of the GMFCS level IV and V were examined (table 6.5). The primary hypothesis under scrutiny here was that the CABA is responsive to body alignment change at both GMFCS IV and V, little difference was expected between the two groups. No statistical difference was found between the scores of both groups, GMFCS IV and V, supporting the hypothesis.

The results, based on independent t tests showed statistically significant improvements in alignment at both GMFCS IV and V ($p < 0.001$), indicating that the CABA is able to detect change in alignment across both groups. Individually GMFCS IV and V were statistically significant for each specific position ($p < 0.001$) with summed percentages showing GMFCS V scored slightly higher than GMFCS IV, however, comparable statistical significance was not shown.

Posture management studies have rarely used assessments of body alignment to determine the effectiveness of this approach (Farley et al., 2003). So far, only one alignment assessment demonstrating responsiveness properties has been identified (chapter 3). The Seated Postural Control Measure measures sitting alignment as a sub-section as it primarily is an assessment of movement (Field and Roxborough, 2011). This study did not stratify the sample of children with CP, instead it analysed them as a collective group. Consequently, the classification range of CP is undetermined meaning responsiveness at different GMFCS levels was not examined. Body alignment issues present more significantly the higher the classification of CP, GMFCS levels IV and V, due to the inability to attain antigravity postures (Palisano et al., 2007). Assessment examination must, therefore, determine sensitivity to changes at different classification levels.

Clinical assessments of body alignment have not critically analysed responsiveness to changes in body alignment (chapter 3). Sensitivity to determine differences in body alignment for those children with the most complex postures, GMFCS IV and V, has not been reported. As children with CP at these levels are most likely to require positioning equipment to support body alignment (Gericke, 2006) it is of critical importance that assessments are sensitive at both these levels. A strength of the CABA is that it is sensitive to changes of body alignment at both GMFCS IV and V. In terms of responsiveness to change at GMFCS levels for the dimension of body segments, individual GMFCS IV and V were statistically significant for each body segment with the exception of head GMFCS IV ($p=0.114$) and arm GMFCS V ($p=0.04$). These discrepancies could be attributed to specific body segments and CP classification.

Whilst these results suggest that the CABA is responsive to changes in alignment at GMFCS IV and V across all its dimensions, the adjusted α level may have resulted in type 2 errors. Therefore, these results need to be interpreted with caution. Type 2 errors are a result which is not significant when it in fact is. This would mean that while no statistical difference between the comparison of GMFCS levels IV and V was found, there may have been a difference. Had a standard α ($p=0.05$) value been

used without any correction this would have resulted in head alignment being statistically significant in comparisons of improvement scores between GMFCS IV and V ($p=0.025$). This is in keeping with the GMFCS classification with head alignment being a more established skill at GMFCS IV and, therefore, alignment expected at optimal (Palisano et al., 2008). Given that no other score would have shown a significant difference, the risk of these results being affected by type 2 errors is low. Hence the CABA remains sensitive to changes in body alignment at both GMFCS IV and V across all positions and body segments, however, head alignment should be interpreted with caution.

6.4.3 Study Limitations

Within this study there are limitations in the small sample size used to examine the responsiveness of the CABA. The sample size of children used ($N=10$) may mean that the results lack some generalisability and the results of this study should be viewed in the context of the small sample.

The results were also carried out by one therapist who is the developer of the CABA, observing body alignment. The use of one physiotherapist, the main researcher, was selected due to ethical considerations and managing the risk of distress to the children. As the lead researcher was a known physiotherapist to the children, this ensured that the children remained relaxed and in their 'typical' therapy routines. This minimised the children presenting with altered alignment presentation that would have occurred with unfamiliar therapists and multiple raters. The lack of independent evaluation means there is a risk of researcher bias, whereby the researcher may have favourably influenced the results. Whilst it is important to recognise this area of potential bias, it reflects real life and it attempted to ensure the assessment of body alignment was as close to typical everyday practice as possible. Further studies examining the responsiveness of the CABA across a wider sample of therapists would further support the generalisability of the results of this study.

It is acknowledged that there may be some bias through the recruitment strategy and observational approach, this study does demonstrate responsiveness to immediate change in body alignment in children with CP GMFCS IV and V. Future studies examining reliability of the CABA against a larger sample of children with CP and in children with other medical diagnoses of neurological disabilities would further support the generalisability of the results of this study. It would also be of use to explore the CABA's responsiveness to monitor change in body alignment over a period of time as this could further support the responsiveness of the CABA as a clinical outcome measure of body alignment. Evaluation of the tool's use is ongoing to assist with refinement of its clinical usability.

6.4.4 Implications for clinical practice

Despite the recognition that posture management involves assessment of total body alignment, there is paucity in evaluative studies that utilise clinical assessments that measure body alignment in posture management (Hong, 2005; Farley, 2003). The CABA was designed to measure specific body segments of body alignment that are expected to change from the use of postural equipment as part of posture management interventions across lying, standing and sitting (chapters 4 and 5).

The third phase of this investigation has indicated the CABA to be a responsive measure in children with CP GMFCS levels IV-V, measuring immediate change of body alignment. Collectively these findings alongside those of validity and reliability examined in chapters 4 and 5, demonstrate that the CABA has foundations as a standardised clinical assessment. Further research examining the CABA's psychometric properties in larger scale studies would be beneficial in supporting its use as a clinical outcome measure.

6.5 Conclusion

The CABA is responsive to immediate change in body alignment when posture management equipment is used. It demonstrates overall statistically significant

ability to differentiate between changes in body alignment across all positions and body segments in children with CP GMFCS IV and V.

Mean change in alignment was identified as being within 1 point of the CABA scale, indicating that the posture categorisations are responsive to detecting real change in body alignment in children with CP. The CABA is responsive to immediate change in body alignment for children at both GMFCS IV and V, suggesting it can be used to measure the impact of posture management equipment provided by therapists. Further studies examining the CABA's responsiveness to change in body alignment over time would be beneficial. Longitudinal research studies would further support the use of the CABA as an evaluative outcome measure of body alignment.

The implications of these findings, alongside those identified in chapters 3, 4 and 5 will be collectively discussed in chapter 7. This final chapter will bring together the main discussion points arising from this PhD programme of research. It presents a synthesis of the findings and discusses the implications of these in relation to the primary research question and objectives set out in chapter 1. It concludes this research project, identifying scope for future research as part of wider post-doctoral projects.

CHAPTER 7:

SUMMARY, DISCUSSION AND CONCLUSION

7.1 Introduction

This programme of research was driven from a clinical perspective, principally the questioning of posture management and the effectiveness of this approach. As a therapist working within this field, I was acutely aware of the 24-hour gold standard aimed for in provision of posture management, but also of the difficulties in implementing this and the variability of provision between services at both a local and national level. With very little research evidence into the benefit of 24-hour posture management (Farley et al., 2003) and some research stating this could have a negative impact (Gough, 2009), an interest developed in exploring this topic further.

There were several clinical questions at the forefront of this exploration: what was the difference in impact on posture between 24-hour posture management versus a more variable approach representative of typical clinical practice? Was posture management more effective in a certain position, such as sitting? Could posture management strategies be priorities depending on presentation and condition in terms of what was most effective? Whilst therapists regularly use their observational skills to judge body alignment (do Rosário, 2014), this approach lacks standardisation (chapter 2: section 2.10). Current measures of posture whilst reporting some aspects of psychometric testing have not been evaluated to meet all criteria for instrumental development (Pavao et al., 2013). By determining the amount of change in body alignment in everyday clinical practice, therapists are able to make observational, subjective judgements on the impact of a particular posture management approach (Hong, 2005). Consequently, the questions which have an important role within clinical practice could not start to be addressed without an assessment of body alignment which was applicable across everyday

therapy practices. Hence this programme of research was begun to explore how body alignment was assessed and, in the absence of a standardised assessment, (chapter 3) to develop one.

The purpose of this research project was to construct an assessment instrument to identify and assess body alignment difficulties in children with CP. In exploring body alignment assessment in children with CP this thesis focused on identification, development and psychometric testing of a body alignment measure. This research has addressed several important issues in test development and generated an innovative assessment in the measurement of body alignment for use in clinical practice.

The need for valid, reliable and responsive measures has been justified and explored at a clinical level among physiotherapists, and commonly used measures of body alignment for children with CP have been evaluated. The developed CABA has the potential to be a measure used in practice and research to explore in detail the impact of posture management in a wide variety of conditions across a wide variety of settings. This is the first step in a much broader project to examine and develop our understanding of the impact posture management practices can have across several clinical contexts. The findings and limitations of each research study contributing to this thesis (chapters 3, 4, 5, 6) have been interpreted and discussed in the relevant chapters. This chapter will present a synthesis of the evidence accrued to address the objectives identified in chapter one. It will discuss the implications the CABA may have on clinical and national approaches. The final section of the chapter considers the next steps and future research recommendations.

7.2 Summary of findings

Posture management programmes typically utilise positioning equipment to support body alignment to prevent musculoskeletal deformity and promote function. Available standardised clinical assessments of body segment alignment for children with CP have been found to be limited (See chapter 3). To be useful to

clinicians and researchers, assessment measures should demonstrate adequate psychometric properties to have clinical meaning. The objectives of this programme of research were to undertake a robust method of developing and examining the psychometric properties of a clinical measure of body alignment in children with cerebral palsy: The Clinical assessment of Body alignment (CABA).

The CABA is a standardised assessment designed for physiotherapists to observe and measure a change in a child's body alignment as part of posture interventions in everyday clinical practice. It has been developed as a standardised assessment that has undertaken a robust and clear method of examining its psychometric properties. This programme of research has demonstrated detailed and robust methods in its construction and examining of the CABA's psychometric properties. In the development of a standardised assessment, it is important to consider the process and framework followed (Crocker and Algina, 2008). This thesis has provided a clear framework forming a strong foundation on which items reflect the construct of body alignment.

The focus of the CABA is how a child's body alignment deviates from optimal containing items which can be observed by physiotherapists. Psychometric testing measures of validity, reliability of scoring items and responsiveness for the CABA were obtained (See chapters 4, 5 and 6). The studies undertaken as part of this programme of research have demonstrated the CABA to have excellent validity, reliability and responsiveness properties and is a clinically applicable assessment within everyday therapy practice so is a useful tool for measuring postural alignment in clinical and research settings.

The CABA is the only assessment to have validity, reliability of scoring items from photos with grids and responsiveness examined. The limitations and challenges of each study have been addressed in the relevant chapters and a summative overview given (see section 7.5). Despite an extensive search of several large electronic databases and references only seven assessments and ten articles were identified that examined or supported psychometric testing of body alignment

measures (chapter 3: section 3.3.3). Only two assessments were found which demonstrated good to excellent psychometric properties. The PPAS supported by two published research articles (Rodby-Bousquet et al., 2016; Rodby-Bousquet et al., 2014) and the SAROMM supported by one (Bartlett and Puride, 2005), suggesting that there has been limited research exploring this topic. Aspects of psychometrics of the PPAS (Rodby-Bousquet et al., 2014) that have been investigated to some extent are construct validity, internal consistency, intra-rater and inter-rater reliability. The SAROMM (Bartlett and Puride, 2005) has been partially investigated for construct validity, test-retest and inter-rater reliability. Neither measurement had been investigated for measurement error, content validity, responsiveness or sensitivity as an outcome of changes in body alignment. Gaps in knowledge have been identified in chapter 3 (section 3.5). The programme of research undertaken within this thesis has addressed the identified shortcoming in assessment development and psychometric evaluation.

The CABA offers clinicians and researchers a rigorously developed clinical tool to practically measure body alignment in children with CP. To the author's knowledge the CABA is the only assessment to detail and outline an in-depth construction process. The CABA item construction and posture categorisation was then examined through expert opinion of 283 paediatric physiotherapists to determine its relation to measuring the construct of body alignment. Decisions on posture category size in observation-based methods are important in optimising observation-based analysis and minimising observer error (Andrews et al., 2012). The construction of the CABA outlined in detail how the development of its posture classifications took into account ergonomic posture assessment literature, needs of CP and posture management intervention; for the purpose of reducing observer error and assessment time (Andrews et al., 2008). The CABA is designed to score graded deviations in body alignment in sitting, standing and lying using a 0-3 scoring system. This not only improved accuracy and sensitivity in scoring as detailed in chapter 5 and 6, it also improved the clinical usability and applicability into everyday clinical practice.

The focus on a clear framework for assessment construction and item development in this thesis was of particular importance as measures, which fail to undertake a robust development approach risk entrenching systematic errors making the assessment unsuitable to evaluate the intended aspect of clinical practice (Mcdowell and Mcdowell, 2006). As identified in chapter 3 few validated measures of body alignment in children with CP are available; two of the seven identified assessments had published research on assessment development and the psychometric property of content validity, with the majority of current assessments providing limited, imprecise or no detail on the development and validity of the assessments content. This means that clinicians and researchers are unable to determine, with clarity and conviction, the consistency and accuracy of the assessments results.

The clinical, national and research implications which arise from this programme of research are discussed in the following sections. This outlines the importance of the CABA and its wider potential in the world of posture management through translating the theoretical frameworks, which underpin clinical interventions in practice. Thus, enabling therapists to assess, evaluate and justify their approaches of body alignment and its management in everyday clinical settings. The use of the CABA to measure alignment accurately may prevent further deformity and pain (Scrutton, 2008; Pope, 2007), improving a child's participation in activities which are important to them such as school and interaction in family life (Novak et al., 2020). Ensuring the correct positioning needs of a child are met has a significant impact on a child's quality of life, indicating the importance the CABA has in regards to clinical practice, national guidance and service provision.

7.3 Clinical Implications

Despite a renewed interest in management of body alignment during the last 10 years (PHE, 2018; NICE, 2012; Mansell, 2010), there has been to date a limited number of assessments available to enable therapists to approach this area within the context of everyday clinical practice. An examination of the current literature on posture management illustrates limitations in range and content, impacting on

the exploration of topics such as impact and effectiveness. As noted earlier in chapter 3, the lack of standardised clinical assessments which assess total body alignment in children with CP is a contributing factor to this deficient evidence base to guide clinical practice.

7.3.1 Assessment

Paediatric rehabilitation has seen an increase in the measurement tools used clinically (Dewar et al., 2015). Whilst measures used frequently in rehabilitation evaluate a broad spectrum of postural abilities such as segmental trunk control (Argetsinger et al., 2019), postural ability (Rodby-Bousquet et al., 2016), spinal alignment along with joint range (Barlett and Purdie, 2005) and motor function and postural ability (Pountney et al., 1999), they lack sensitivity or inability in measuring total body alignment and detecting changes within specific dimensions of this (Butler et al., 2010; Dusing and Harbourne, 2010). Assessment of body position is often determined through observation of a child's postural alignment and whether this improves in regard to specific interventions such as the use of adaptive equipment (Hong, 2005). This approach remained subjective and unsubstantiated by clinical data assessment lacking meaning, credibility and limiting therapists' abilities to evaluate and justify their approaches (Fortin et al., 2011).

Therapists regularly use their observational skills to quantify body alignment (do Rosário, 2014), however, without a specified framework for measuring, defining and describing this becomes a complex phenomenon resulting in confusion and disparity between therapists (Stokes, 2011). The lack of a standard procedure to quantify the construct of body alignment and substantiate this within clinical contexts limits clinical decisions and evaluation of outcomes (Finch et al., 2003). This process is required in order for therapists to be able to accurately and consistently identify early changes in body alignment and evaluate the impact of interventions such as adaptive equipment use. This ensures that a child is positioned correctly at the outset, improving their comfort, function and participation (Novak et al., 2020). The CABA provides a clear framework from which therapists are able to numerically score body alignment and compare changes in an

individual child's score as either no change, a higher CABA score indicating a deterioration, or a lower CABA score indicating an improvement.

The CABA's ability to quantify observational assessment of body posture enables changes to be determined accurately and quickly as an integral part of a child's day-to-day function, instead of in a one-off specific position, setting or task (Goldsmith et al., 2009). For assessments to be meaningful, relevant and effective they need to be standardised and demonstrate good performance in psychometric characteristics of validity, reliability and responsiveness (Finch et al., 2003; Terwee et al., 2003). The CABA provides a consistent method for physiotherapists to identify, describe and evaluate body alignment of a child at a particular point in time. The research undertaken in chapter 4, 5 and 6 established excellent to good performance of the CABA as a valid, reliable and responsive clinical measurement of body alignment. The construction of the CABA devised a strategy for collecting and recording observations of body alignment in children with CP in a standardised format applicable to posture management therapy interventions. To the author's knowledge there are no other clinical measures for children with CP that demonstrate detailed content validity and item construction to assess total body alignment across any postural position while also allowing differentiation between left and right sides of the body. Current assessments, such as the PPAS (Rodby-Bousquet et al., 2016) have only focused on one of these assessment criterions.

This programme of research developed the CABA to encompass important components required to assess the construct of body alignment. With 19 items matched to a high level of agreement to assess body alignment across sitting, standing and lying positions, the CABA allows degrees in postural misalignment to be measured and demarcation between sides of the body to be clinically assessed. This enables physiotherapists to observe, categorise and group body alignment and deviation from optimal in children with CP. By accurately describing body alignment and reliably determining the amount of change in body alignment, therapists are able to make a clear judgement on the body alignment posture and areas of need for an individual child.

Whilst the overall intent of the CABA is to succinctly measure overall body alignment, it can also be segmented into subscales related to individual body segments. The CABA enables clinicians to break down alignment issues in relation to specific body parts for example head / trunk / pelvis, differentiate between left and right side of the body and precise movement directions. This means that clinicians can identify specific areas where alignment is problematic and immediately analyse whether the posture management strategies they are using, such as positioning equipment, are effective at correcting alignment. This enables analysis not only of overall body alignment, but also detailed and specific identification of body segment alignment. This allows the demands the child faces in maintaining their body alignment to be targeted, optimising their stability and improving their proficiency at completing the desired movement (Dusing and Harbourne, 2010; Pope, 2007). The more symmetrically body segments are aligned the lower the risk of significant long-term complications and fixed deformities (Goldsmith et al., 2009; Graham, 2002). This specificity within the CABA means that it can be associated with the biomechanical assessment of posture such as range of movement and wider aspects of postural control e.g., Trunk stability, having a direct and relevant role within a holistic therapy approach to posture and motor development.

The CABA has expanded the therapists' tool kit in the assessment of posture. This assessment focuses on body linkages and the difficulties or restrictions a child might have. This enables therapists to quantify body alignment issues and directly relate this with other methods such as restriction in joint range. When analysing constraints on posture, physiotherapists must also consider biomechanical factors such as the specific muscle strength and the range of motion (ROM) resulting in limitations in body positions, fixed or postural deformities (Carlberg and Hadders-Alga, 2005; Hong, 2005; Butler and Major, 1992) (chapter 2: section 2.12). The CABA allows therapists to not only quantify problems with body alignment but also relate this to restrictions in joint range and how this impacts posture. One example of this is a child who has no issues with joint range or muscle shortening, however, when sat is unable to achieve optimal alignment, thus indicating the equipment set

up is not appropriate and likely to need reassessment. Furthermore, for a child who has muscle shortening and a fixed trunk side flexion of 10° from optimal, when sat in a postural chair, a CABA score of for 1 trunk side flexion would be expected. A score lower than this would indicate the equipment is under correcting, failing to achieve optimal alignment. Conversely, a score higher than this may indicate overcorrection, and it is likely that this would show alignment problems at other body components such as pelvic obliquity. As discussed in chapter 2, the patterns of deformity are linked and consequently overcorrecting a shortened muscle will result in misalignment at other connecting body segments, such as the pelvis.

The CABA expands a therapist's assessment to quantify and analyse alignment in direct relation to the posture management strategies used. Whilst the provision of positioning equipment takes into consideration a limitation in hip flexion, this ultimately results in an obliquity of the pelvis, or a shortening in lateral trunk muscles can lead to a fixed trunk side flexion. Unsupportive or incorrect positioning can result in a child experiencing pain and discomfort and possibly develop fixed deformities (Goldsmith et al., 2009). Ensuring positioning equipment is correctly set up for the specific postural needs of an individual child supports and maintains their movement and function (Scrutton, 2008). Being able to build upon joint range assessment allows for more in depth and practical observational assessment of posture within everyday clinical settings.

It is important that assessments are able to be used flexibly by therapists within clinical practice (Sarathy et al., 2019). The CABA enables clinicians to assess body alignment across lying, sitting and standing positions, positions which are highly relevant to posture management practices, either combined or separately. This aligns to the collaborative holistic framework advocated by the International Classification of Functioning, Disability and Health (ICF) (WHO, 2007). A dynamic interaction between contextual factors and health conditions places emphasis on assessments which measure individual abilities in different environmental contexts (Odom et al., 2007). This is important for body alignment and CP children as they

make up a highly heterogeneous population, with clinical assessment occurring across diverse environmental settings and contexts (Sarathy et al., 2019).

Overall, the CABA enables accurate assessment of body alignment to support correct and effective intervention in the provision of equipment to manage body alignment. Ultimately this has a wider impact on a child's overall development and their ability to play, engage in and explore their environment (Hadders-Algra, 2013; Pope, 2007). As discussed in chapter 2, body alignment is a fundamental component of postural control and motor skills (Pavao et al., 2013; Shumway-Cook and Woollacott, 2007; Pountney et al., 2004). Assessing and supporting alignment means that a child's posture has stability from which to move and function from efficiently (Carlberg and Hadders-Algra, 2005; White, 1999). Children with CP whose individual constraints are such that they are unable to maintain alignment against gravity, means they are unable to achieve postural orientation, a critical component of postural control (Pavao et al., 2013; Shumway-Cook and Woollacott, 2007) (chapter 2: section 2.5).

The provision of positioning equipment permits a therapist to adapt the environment in which a child with CP can function in, by ensuring that this equipment is providing an optimal support of body alignment, improving functional movement, stability and motor control efficiently (Scrutton, 2008; Vekerd, 2007; Pountney et al., 2002). Assessment of body alignment is important at all GMFCS levels; however, the treatment strategies a therapist selects will vary dependent on the level of classification (Palisano et al., 2007) (chapter 2: section 2.11). This enables therapists to analyse and evaluate their approach to manage body alignment alongside other fundamental clinical priorities such as motor skills and functional engagement. The therapist's ability to ensure that the provision of the equipment is achieving the intended body alignment correction and support is an important component of wider therapy provision for children with CP.

7.3.2 Measurement of outcome

The lack of adherence to sound practices in body alignment assessment development may in part account for the conflicting and ambiguous results of research pertaining to posture management in children with CP. Research has often attempted to demonstrate the effectiveness and outcome of posture management interventions, by using poorly standardised or unrelated measures. This has produced inconsistent and inaccurate results, meaning that clinicians and researchers are unable to determine, with clarity and conviction, whether postural interventions were effective; or the measurements were so imprecise that the true effects of the intervention went undetected. This research highlights that the CABA's close adherence to the principles for sound assessment construction and content validation, make it a measure which can be utilised in future experimental investigations improving the overall quality of research in physiotherapy, CP body alignment and posture management.

Measuring outcomes at a clinical level has been an established practice for some time (Stokes, 2011). As discussed in chapter 2, physiotherapists must be able to assure the quality of their practice; this includes gathering qualitative and quantitative data and using appropriate outcome measures to evaluate interventions to ensure they meet individual needs (HCPC, 2016; DoH, 2010). The CABA is designed for physiotherapists to observe and measure a change in a child's body alignment as part of posture interventions in everyday clinical practice. By comparing data collected from the CABA relating alignment scores before and while using positioning equipment, a measurement of clinical outcome can be obtained.

Standardised assessments are essential in ensuring clinicians can evidence the effectiveness and outcomes of their interventions (Fawcett, 2013). The CABA, by virtue of the psychometric properties examined in this thesis, is an effective measure in identifying clinically meaningful change of body alignment in children with CP. The CABA allows physiotherapists to identify and examine specific areas where change in alignment has occurred, offering a comprehensive summary and comparison of results to previous assessment. This enables clinicians to measure

the effectiveness of their posture management strategies in terms of managing body alignment.

Effective outcome measurement is an important driver of clinical practice (WCPT, 2019). Being able to demonstrate a therapy approaches true benefits to individuals, can influence health policies and political priorities (Fawcett, 2013). Evidence based research is fundamental in providing a platform to champion the highest standard of health provision (Dean et al., 2014). Clinically relevant research which utilises standardised assessment is critical to support therapists, service providers and health policy maker's advocate effective therapy interventions (WCPT, 2019). The CABA provides researchers and clinicians the ability to accurately measure changes made to a child's body alignment through the provision of positioning equipment. This allows the impact and effectiveness of postural interventions, in terms of alignment to be evaluated, using clinically relevant methods. This would identify, with precision and accuracy, the efficacy of posture management interventions, informing clinical guidelines and cost-effective practices. The CABA could broaden opportunities for researchers and clinicians to examine the efficacy of posture management interventions, not just in CP, but in other conditions where posture management is needed.

The CABA provides an additional clinical dimension to the assessment of posture. Designed as a simple and clinically functional assessment it can support findings of more established, infrequent, standardised lab-based tests typically used to measure effect of posture such as x-rays. This would enable physiotherapists to quantify with meaningful consistency the results of the provision of positioning equipment, justifying clinical judgements on the impact and effectiveness this has on supporting and correcting body alignment. Commissioners and service planners have increasingly included outcome measurement in their service and treatment specifications, becoming a routine element in clinical governance and service redesign (CSP, 2012; DoH, 2010) (chapter 2: section 2.10). Consequently, standardised assessment and outcome measurement have an important role in enabling physiotherapy services to demonstrate their cost effectiveness, impact

and justify use of clinical resources. This is particularly pertinent to posture management in CP, where there is a paucity of standardised assessments to enable therapists to evaluate and measure the outcome their approach has on body alignment. The CABA as a standardised measure for clinical practice, could enable clinicians and researchers to examine the efficacy of accurate equipment provision. Justification on the provision of most appropriate piece of equipment to service providers would support health providers and funding sources to develop policies and practical procurement guidance based on clinically relevant evidence based practice.

7.3.3 Procurement of equipment

Therapists are increasingly required to justify the provision of equipment from a clinical perspective not only in terms of patient outcomes, but also from a funding perspective regarding provision and purchasing of positioning equipment (PHE, 2018; Robertson et al., 2018; Lenker et al., 2005). With funding sources wanting evidence that their resources are effective in their use (Lenker et al., 2005), therapists are becoming more critical of their assessment choices, tailoring intervention strategies to adopt an evidence-based approach (Majnemer and Mazer, 2004). It is recognised that research into the potential cost effectiveness of postural care services is required (PHE, 2018). However, as noted in chapter 3, research which attempted to demonstrate the effectiveness of posture management interventions used poorly standardised or unrelated measures. The paucity of a standardised clinical assessment of body alignment has meant that accurately providing evidence for posture interventions has been a challenge. The CABA can accurately assess body alignment and evaluate effectiveness of equipment provision. This could support more targeted and appropriate equipment being prescribed, improving outcome for the child and their families (section 7.3.2), making better use of available funding and develop an evidence base for posture management therapeutic interventions.

Equipment provision can include sleep systems, standing frames and specialist seating, with numerous versions available within each specialist area (Rennie, 2007;

Goldsmith, 2000; Pountney et al., 2009). As a result, it can be difficult for therapists to articulate and quantify the difference between various makes and models of positional equipment. Often the biggest difference is the alignment that is achieved and maintained, however, up until now there have been no assessments therapists can use to quantify this in a standardised format. The research undertaken in chapter 6 demonstrated statistically significant ability of the CABA to differentiate between changes in body alignment, signifying its responsiveness as clinical measurement of immediate change in body alignment when using positing equipment. This aids therapists in identifying which pieces of equipment are most effective at correcting body alignment. This means the correct, most appropriate piece of equipment can be provided and that clinical decisions can be justified to funding sources.

There is not only an economic impact to correct equipment provision but also a health consequence. Inappropriate provision of equipment means body alignment is poorly managed, resulting in asymmetrical postures, postural deformities and development of subsequent secondary complications such as surgery (chapter 1: section 1.1). Deterioration in body alignment means that equipment needs are constantly changing resulting in an on-going cost implication. As outlined in chapter 2 (section 2.12) providing equipment which correctly supports body alignment and reduces secondary health complications, could recover the economic costs of the equipment (BHTA, 2014). The cost of secondary complications has significant impact not only on health services but also on the child and their family. Posture management is not a short-term intervention, rather a lifestyle approach which requires constant review and adaption to meet the needs of the child. As discussed in chapter 2 (section 2.6.1) recognising a child's and family's goals are important in guiding appropriate and successful postural intervention and priorities (Pope, 2007). Following a system model framework which considers a child's individual, task and environmental needs maximises a child's ability to participate (Shumway-Cook and Wollacott, 2007) and improves equipment use (McDonald et al., 2007). Having a child's and family's goals at the forefront of postural interventions means

the most appropriate and usable piece of equipment is provided reducing the risk, both short-term and long-term, of secondary health implications for the child.

Accurate, effective assessment and clear clinical rationale on the appropriate provision can reduce immediate and long-term health and economic costs. The CABA has the potential to provide physiotherapists with an accurate, standardised assessment of body alignment supporting a sound clinical rationale for equipment provision. Accurate assessment is more likely to result in the correct positioning equipment being prescribed on assessment and reduce the possibility of equipment having to be altered or changed (McDonald et al., 2007; Hong, 2005). As such, being able to provide the correct piece of equipment straight away means the need for several assessments, purchasing of additional parts or a different piece of equipment are reduced. This would provide early correct positioning, reduce costs of clinical resources such as a therapists time, and mean funding could be more accurately directed.

Early identification, accurate assessment and effective intervention strategies have the ability to minimise secondary complications, maintaining body shape and ultimately reduce the prevalence of complex postures which requires more complex individualised equipment. Successful equipment provision incorporates multiple factors and is a complex undertaking (Collins, 2007; McDonald et al., 2007; Hong, 2005; Taylor-Cookson and Mitchell, 2001). The CABA offer therapists a clinical method for determining body alignment accurately and quickly as an integral part of a child's day. Having a standardised clinical measure that is applicable within everyday therapy practice and evaluates equipment provision enables the child's needs to be met from the outset, ensuring optimal positioning is implemented as early as possible. Furthermore, by being able to identify which area of alignment requires the most support therapists are able to adopt a tailored individualised approach to provision, rather than the all-encompassing 24-hour approach. Therapists would be able to use their time and staff resources to optimise engagement with therapy programmes and improve outcomes for individual children and their families.

7.3.4 Clinical utility

If an assessment is to be a functional and relevant measurement it should be applicable to the various settings and strategies, and easily tailored to individual everyday therapy practice (Fawcett, 2013; Crocker and Algina, 2008). The CABA was constructed as a functional and useful everyday clinical measure, which ensured clinical utility properties were fundamental within its development process (chapter 4). Children with complex neurological problems, such as CP, frequently have problems with fatigue resulting in a low tolerance for lengthy assessments (Baxter et al., 2007; Harris and Roxborough, 2005). In addition, undertaking posture management means a therapist assesses body alignment in a wide range of settings, such as children's homes, schools, clinics, community settings, hospices and respite care. Part of this development process involved 283 paediatric physiotherapist rating clinical utility properties required of a body alignment measure. This highlighted that usability, time and applicability were important for the CABA's use in everyday practice, with particular emphasis on time to complete and usability in different environments as essential components to the assessment's clinical functionality (chapter 4: section 4.5.4). Therefore, a clinical assessment needs to be usable without the requirement for large spaces and /or specialist equipment in order to complete. The development and refinement of the CABA aimed to reduce clinical and respondent burden by being an easy, inexpensive and low-burden measure of body alignment in children with CP. Further studies examining the CABA's clinical utility would support the initial findings within this programme of research.

Failure to recognise critical components of a measure's clinical utility, such as cost and application, can result in the measurement being impracticable within the clinical environment (Fawcett, 2013; Roach, 2006). The CABA is a quick assessment, taking 10 minutes to complete. Within the context of the studies, it has shown to be effectively applied by paediatric physiotherapists with varied experience. The research undertaken in chapter 5 (section 5.3) showed the CABA items were able to be reliably scored from photographs using a grid, across physiotherapists with varied levels of experience, from different work-places and areas of specialty in

children with CP. Other assessments of body alignment identified in chapter 3, required training and experience to produce consistent reliability results (Rodby-Bousquet et al., 2016; Goldsmith and Goldsmith, 2009; Pountney et al., 1999). Psychometric studies of these assessments used raters with considerable experience in using and /or developing the tool, had training or required a manual to follow (Rodby-Bousquet et al., 2016; Rodby-Bousquet et al., 2014; Goldsmith and Goldsmith, 2009; Bartlett and Purdie, 2005; Pountney et al., 1999). The CABA has the potential to be an assessment which requires no experience, training or instruction in its use to produce reliable and valid measurements of body alignment (chapter 4 and 5). Further studies into the CABA's clinical utility to evaluate its usability and psychometric properties when used in clinical settings by a range of therapists would support its use as low demand, accessible and practical assessment.

Posture management supports and corrects body alignment across all postures a child adopts within their day and night, typically these involve all or a combination of lying, sitting and standing positions (Gericke, 2006). The CABA can be applied across lying, sitting and standing, with the intent to succinctly measure body alignment as part of posture management. As such it can be divided into subsections of positions associated with posture management for example, lying. This allows for a comprehensive analysis of body alignment across all or separate body positions and a comprehensive measure of body alignment encompassing the posture management world, whilst also allowing for analysis and review of specific positions. This means that a therapist can complete the whole assessment across lying, sitting and standing to give an overarching picture of a child's alignment. However, they can also select the section of the CABA most relevant to their immediate assessment, for example review of seating. Thus, providing the therapist with a flexible approach to assessment of body alignment, which can be easily adapted to meet individual needs of each child. Being a functional and relevant assessment of all positions used in posture management strategies, makes the CABA highly applicable to everyday practice and easily tailored to individual therapy assessment.

A particular point to note in regard to the clinical usability of the CABA was the context in which the responsiveness was evaluated (chapter 6: section 2.6). Responsiveness is context based, dependent on the nature of change that measures are based on, and on whom (Beaton et al, 2001). The research undertaken in chapter 6 demonstrated the CABA is responsive, measuring immediate change of body alignment across all positions, in children with CP GMFCS levels IV-V. Consequently, assessment of change in body alignment has only been examined within this context and for this set group of children which limits its generalisability. Children with CP at GMFCS IV and V are most likely to require positioning equipment to support body alignment (Gericke, 2006), therefore, it is of critical importance that assessments are responsive to immediate change at both these levels. Sensitivity to determine differences in body alignment for this cohort of children has not been reported (chapter 3). A strength of the CABA is that it is a measure which is sensitive to immediate changes of body alignment at both GMFCS IV and V.

7.3.5 Wider context

Management of body alignment involves several clinical services and is applied within various environmental settings, illustrating the therapeutically diverse reality of assessing body segment alignment and implementing posture management in daily practice (WHO, 2007; Farley et al., 2003; Humphreys and Pountney, 2006). A range of clinical services and professionals are involved in the provision of equipment within CP. The CABA has applicability to support alignment across all health disciplines involved in posture management and the provision of positioning equipment. Posture management utilises the provision of equipment across all environments a child interacts within. This crosses a range of disciplines from wheelchair services in the provision of wheelchair seating, occupational therapy for provision of home seating and bathing equipment such as a bath seat, physiotherapy in terms of sleep systems and standers. The CABA is an assessment which enables a child's body alignment to be identified and assessed across all these areas and can be applied within various settings such as home, therapy clinics and schools.

The CABA provides a standardised approach that can outline a child's individual alignment needs and ensure posture management strategies are uniform across multi-professional services. This not only improves the outcome for the child in terms of maintaining alignment, improving function and comfort, it also improves the effectiveness of equipment provision. As each child has individual presentations in regards to their body alignment, meaning there is no generic approach, instead, it requires all professions working with that child to have a universal view of their postural needs and understating of intervention strategies and intended outcomes. In the absence of a standardised assessment this has meant those in each discipline within services and wider are utilising their own approach to assessing and determining posture (chapter 2: Section 2.12). This inconsistency in use of positioning equipment increases the risk of alignment worsening along with the associated health and economic impact as discussed in section 7.3.3.

The CABA is a highly accessible, easy to use assessment with qualities which make it stand out as a functional standardised assessment for use as part of physiotherapy practice. Whilst this programme of research has focused on children with CP, the assessment of body alignment has applicability across a wide range of health services and professions. The link between posture and motor control in this thesis has focused specifically on the impact body alignment has on functional movement in CP (chapter 2). The provision of positioning equipment aims to support optimal alignment creating a stable base from which function is enhanced (Shumway-Cook and Woollacott, 2007; Harris and Roxborough, 2005). This poses the hypothesis that the CABA, as a measure of body alignment, has potential to be of benefit to any individual who requires support of body alignment or uses some form of positioning equipment.

CP is not the only condition that involves posture management. It is utilised across a range of conditions and ages from stroke and dementia from birth to the elderly population. Research has raised the importance of posture alignment and its management within complex conditions such as stroke (Chatterton et al., 2001; Jones et al., 1998) and multiple sclerosis (Chan and Heck, 1999). The NSF for long

term conditions outlines care, treatment and service provision for individuals with a wide range of neurological conditions, such as brain injury, epilepsy, motor neurone disease and Parkinson's (DoH, 2005). It recognises the physical and movement difficulties individuals may have and advocates the provision of effective positioning equipment to prevent deterioration of posture and development of subsequent secondary complications. More recently, Public Health England (2018) published guidance on postural care in people with learning disabilities, identifying accurate measurement of body alignment as fundamental to evaluating outcomes of posture management interventions. Both these guidance papers signify the importance accurate assessment of body alignment has in evaluating the effectiveness of postural therapeutic strategies across a wider variety of conditions and presentations than CP. The CABA has the potential to develop and direct posture management treatment and service provision across a wide range of conditions.

7.4 National guidance and service provision

Despite increased recognition of the role posture management programmes have within physiotherapy rehabilitation (PHE, 2018; NICE, 2012), the research to date has little high-quality data available on posture management effectiveness in correcting body alignment in children with CP (Pavao et al., 2013; Farley et al., 2003). The approach to posture management interventions in terms of supporting and correcting body alignment lacks specificity (NICE, 2012), meaning currently posture management interventions and equipment provision vary on a local and national context. The CABA, as a standardised measure of alignment and posture management strategies may assist in overcoming these challenges at both a local, regional and national service provisions. The CABA has the potential to provide the means for therapists and researchers to examine the impact positioning equipment has on body alignment at a clinical level. This means that a particular position such as standing or a particular group of individuals such as children with CP GMFCS V could be evaluated comprehensively, informing current and future best practice posture management approaches.

The current evidence base surrounding posture management is limited (Farley et al., 2003). Clinical guidelines lacking specificity (PHE, 2018; NICE, 2012; Mansell, 2010; Gericke, 2006) and assumed best practices are unvalidated by clinical data (chapter 2: section 2.9). The focus needs to be on clinically based research which examines body alignment and evaluates, with specificity, the effectiveness of posture management interventions. Whilst clinical guidelines clearly state that services should focus on protection of body shape, the details of how this is carried out, the current strategies in place and assessment processes are lacking (NICE, 2012; Mansell, 2010). Standardised assessment tools are vital to provide quality information and guide clinical decisions (Terwee et al., 2018; Roach, 2006). The current clinical guidelines on posture management either lack detail of an assessment process or recommend an assessment with little to no psychometric properties (PHE, 2018; NICE, 2012; Mansell, 2010; Gericke, 2006). Public Health England (2018) makes recommendations for using The Goldsmith Indices of Body Symmetry (Goldsmith et al., 1992) as an assessment, however, evidence to support it as a standardised outcome measure is lacking in the guidance (PHE, 2018). Furthermore, the research undertaken in chapter 3 (section 3.3.3.) found this assessment to have poor psychometric properties, finding no evidence reporting on either its validity or reliability. The CABA fills this current gap in clinical assessment.

Whilst research recognised that posture should be managed by CP classification, its specificity is limited (Gericke, 2006), it does not specify which positions are a priority in terms of effectively supporting body alignment outcomes for children at differing levels of severity. Consequently, clinical guidelines lack specificity, with recommendations for practice referring to classification groups of children with CP and collective posture management interventions (PHE, 2018; NICE, 2012; Mansell, 2010; Gericke, 2006). The lack of differentiation between presentation of CP and types of posture management limits directed prioritised interventions (Farley et al., 2003). Equipment selection which is specific to a child and their family's needs can improve acceptance and use (Collins, 2007; Taylor-Cookson and Mitchell, 2001), supporting alignment more effectively and improving outcome for the child (McDonald et al., 2007). Currently physiotherapists have general all-encompassing

guidance, which fails to recognise the individualised constraints a child with CP can present with (Carlberg and Hadders-Algra, 2005). This is unrepresentative of everyday clinical practice whereby therapists use comprehensive assessment to identify the correct piece of equipment (Hong, 2005), taking into consideration practicalities within family life (Castle et al., 2014).

Whilst there is a general consensus that a 24-hour posture management approach is the gold standard (NICE, 2012; Hill and Goldsmith, 2010; Pountney et al., 2009; Gericke, 2006), this assumption has not been validated with clinical data. As discussed in chapter 2 (section 2.9), practices in reality are often not a 24-hour approach (Castle et al., 2014; Maher et al., 2011; Gough, 2009). Guidance and advice on which aspects of posture management, such as sitting, offer the most benefit to body alignment correction would be of benefit to therapists and service providers. It may also reduce the burden on families having to implement a 24-hour approach on a daily basis, and improve compliance on targeted postural interventions (Gough, 2009). The CABA has the ability to provide clinical data and guidance on specific and priority areas of alignment and therefore assist in prioritisation of postural intervention. As the CABA is relevant to all GMFCS of CP it would not only assist therapists in prioritising their therapy goals but also evaluating the outcome of equipment effectiveness, supporting an evidence-based approach and improving treatment outcomes.

The lack of clarity and detail in clinical guidance and evidence means current posture management interventions and equipment provision vary. Having a standardised approach to measuring body alignment means that assessment, treatment and service provision is standardised. The CABA can expand the options for therapists and researchers to evidence the efficacy of posture management practices and assist in developing guidance with more clarity and specificity.

7.5 Limitations of the project

This programme of research was intended to be a thorough investigation and development of a tool, but still some limitations are present. For instance, the

responsiveness study examined the CABA in the context of detecting immediate change in alignment by the primary researcher (chapter 6). As responsiveness is context based, dependent on the nature of change being measured based and on whom (Beaton et al., 2001), the results are limited to the framework that responsiveness was investigated in. Whilst the use of one therapist, the author and developer of the CABA, could be seen as a limitation, it reflects real life practice. Therapists see children they know frequently. It is not typical practice to have several unknown therapists observing a child. Furthermore, the CABA's ability to detect change in body alignment over time or its application to other neurological conditions which require positioning equipment (Chatterton et al., 2001; Chan and Heck, 1999; Jones et al., 1998), are limited without further studies. It would have been preferable to have investigated with a wider population of neurological issues across adults and children. Limitations and challenges of each study have been addressed in the relevant chapters, and summaries below.

The content validity study (Chapter 4) involved 269 physiotherapists, who partially/fully completed the survey, scoring items of matching or not to the domain of body alignment. Whilst the CABA items demonstrate good content validity, how to interpret the CABA's raw scores is unknown at present. Additional studies in typically developing children and those with CP are needed to develop scoring cut-offs and norms for this scale. This should be explored in further investigations as part of the development process of this assessment.

The first stage reliability study (Chapter 5) examined the reliability of scoring CABA items, from photographs, using a grid. Whilst the use of the grid assisted in minimising rater error it is acknowledged that this is not indicative of usual clinical practice. As such this has limitations in relation to use and reliability of the CABA in clinical settings. Furthermore, this study examined scoring of items only, not administration of the CABA. A study on administration of the CABA in clinical settings could investigate how physiotherapists place children into the positions required for scoring and whether a grid to view the positions through is required. Further studies which examine the reliability of scoring both with and without a grid

in clinical and non-clinical settings would provide further detail on the CABA's reliability and its application in clinical practice.

As part of the development of this new assessment, the first stage reliability study (chapter 5) aimed to explore the reliability of scoring the CABA items. As such, the use of photographs of children with CP minimised the amount of random error likely to occur from the child and enabled examination of rater error. This resulted in the ability to identify any CABA items which had limited reliability between physiotherapists and, therefore, likely to be exacerbated when used in a clinical setting. The use of photographs has limited applicability to real life clinical assessment; photographs require a procedure for positioning a child, in order to photograph and analyse the posture from this (do Rosario, 2014). Whilst photographing posture is not currently reflective of therapists' approach to everyday posture assessment (Perry et al., 2008), photograph acquisition is fast, easy to do, and is accessible for the majority of physiotherapists working in clinical settings (Fortin et al., 2011). Further studies exploring the reliability of scoring in clinical settings with and without the use of photographs would further support the use of the CABA as an assessment in clinical everyday practice.

The responsiveness study (Chapter 6) results were carried out by one therapist who is the developer of the CABA, observing body alignment. This was selected due to ethical considerations and managing the risk of distress to the children. As the lead researcher was a physiotherapist known to the children, this ensured that the children remained relaxed and in their 'typical' therapy routines. The lack of independent evaluation means there is a risk of researcher bias, however, it reflects real life and attempted to ensure the assessment of body alignment was as close to typical everyday practice as possible. Further studies examining the responsiveness of the CABA across a wider sample of therapists would further support the generalisability of the results of this study.

There are two main limitations affecting the overall conclusion of the thesis. Firstly, the sample frames of self-selection for both the development, content and

reliability studies in chapters 4 and 5 may not represent the views of all physiotherapists working within CP and posture, potentially impacting on the internal validity of the study (Tripepi et al., 2010).

In terms of the recruitment strategy self-selection bias was expected, as only those who worked with posture and CP were asked to participate. However, it is acknowledged that those who self-selected to participate were only a selection of those who could have. In terms of selection bias, it could be argued that those who participated differed perhaps in their experience and specialities. Although self-selection is a threat for internal validity of the study, the impact of this bias can be minimised through diversity in respondent characteristics (Tripepi et al., 2010). As the respondents in both the validity and reliability studies demonstrated diverse respondent characteristics across experience, speciality and region, which minimised the impact of this potential bias.

Secondly, and more significantly, the sample size for the reliability study in chapter 5 was considerably smaller than desired and this had implications specifically for reliability testing and interpretation of the findings. The sample size did meet the requirement according to the power calculation for repeated testing and from a statistical perspective was high. In total 167 initial responses were received but only 15 participated fully in the study, suggesting the scale of the project in examining children at each GMFCS across all positions was potentially too large (chapter 5). Data collection focusing on one part of the CABA for children with CP at a specific GMFCS level, could also improve response rate. Therefore, further studies investigating smaller focused areas of alignment assessment within posture management clinical practice, for example standing in GMFCS levels IV and V, would recruit a larger sample of clinicians and children providing further detail on the psychometric properties. The methodological approach to examine reliability, the use of photographs, whilst minimising the amount of random error likely to occur and enabling examination of rater error, could be viewed as limiting in terms of clinical application. Further reliability testing should take place in clinical settings

to provide detail on the scoring reliability properties in clinical face to face scenarios.

7.6 Recommendations for future research

The CABA's close adherence to the principles for sound assessment construction and content validation, make it a measure which can be utilised in future experimental investigations improving the overall quality of research in physiotherapy, CP body alignment and posture management.

This is the first step in a much broader project to examine and develop understanding of the CABA's role in posture management practices across various clinical contexts. The research studies contributing to this thesis (chapters 4, 5, 6) has shown the CABA to have excellent to good validity, reliability and responsiveness properties. Whilst this is an important foundation in examining the CABA's psychometric properties, a natural progression of this work is to further analyse the psychometric testing and development of the CABA.

What is now needed is a cross-national clinical study involving therapists working with a wider range of CP children. This would produce greater clinical data in terms of its validity, reliability, responsiveness and the generalisability of results from this thesis. The Covid-19 pandemic interrupted a feasibility study to examine psychometric properties of the CABA with physiotherapists in clinical practice assessing standing alignment in children with CP. This research, would have addressed some of the limitations identified within this thesis; however, the circumstances at the time prevented it from being conducted.

Expanding the examination of the CABA's psychometric properties would be the logical next step following on from this programme of research. Investigating the CABA in terms of clinical utility and face validity, would provide greater detail on the CABA's clarity and usefulness as an assessment for clinical practice. Exploring the CABA's reliability in clinical settings and in the administration of the CABA as

well as scoring would be beneficial to conduct to support its use as a clinical measure.

It would be interesting to compare CP classification level and the effectiveness of positioning in terms of correcting alignment. This may assist therapists in prioritising their interventions. While it was noted in chapter 6 that sitting achieved better alignment compared to the other positions, lying and standing, caution must be exercised in the interpretation of this finding. The context of this research (chapter 6) involved only children with CP GMFCS IV and V, therefore, further work is required which examines this across all GMFCS levels as it may be beneficial in supporting a targeted equipment choice.

Further research which examines the CABA's ability to detect change in body alignment over time would be worthwhile. Whilst the posture categorisations of the CABA are able to detect immediate change in alignment, in relation to use of positioning equipment, it has yet to be determined if these are sensitive to detect changes in alignment over time. This could expand the CABA role in clinical practice as an identification measure of postural change. The ability to frequently monitor and identify early change in alignment from clinical presentation, prior to the need for radiographs which are invasive and infrequent, is an important area for future research.

More broadly, research is also needed to determine the CABA's usability across a range of conditions, adults and children and use by different professionals such as occupational therapists, wheelchair therapists, education staff and parents to broaden its clinical use. A greater focus on this within future research could establish better understanding of posture management benefits at a clinical and national level. A future impact study using the CABA to examine posture management interventions and their effectiveness, could guide and change clinical practice and priorities to improve outcomes for children with postural needs.

A shortfall within current guidance in offering specific recommendations, established on a relevant and appropriate evidence-base, limits optimising health and economic benefits. There remains a paucity in research literature which explores the effectiveness of positioning equipment according to specific positions, clinical presentation and subsequent application. Consequently, several key clinical questions remain at the forefront of posture management practices. What is the difference in impact on alignment following a 24-hour posture management approach versus a more typical variable one? Is posture management more effective in a certain position such as sitting? Can posture management strategies be priorities depending on presentation and condition in terms of what is most effective? Whilst these questions are not small, their importance to clinical practice is significant. The development of the CABA, as a clinical tool for therapists and researchers, is the first step towards exploring these important clinical questions, further developing and informing evidence-based practice and national guidance.

7.7 Thesis conclusion

All objectives have been addressed and explored within the possibilities afforded by the sample size, and the research has been conducted scientifically and rigorously. Preliminary investigation of this new assessment of body alignment is promising. The first steps of identifying construct and content validity, reliability and responsiveness provides a platform for further revision and examination of the CABA in clinical settings.

This PhD research programme of psychometric investigation, as undertaken in chapters 4, 5 and 6 is an important foundation in examining the CABA's psychometric properties within clinical settings. In a sense, this is only the 'tip of the iceberg' in terms of the CABA as a clinical outcome measure of body alignment. The applicability of body alignment is a problem associated with various neurological conditions crossing both the adult and child population (Mansell, 2010; Chatterton et al., 2001; Chan and Heck, 1999; Jones et al., 1998). Body alignment and interventions to manage posture have been established across a wide scope of conditions that result in movement problems, resulting in difficulty maintaining and

adjusting static position against gravity (chapter 2). Ensuring appropriate assessment, services and support for posture management should be a priority for those who have body alignment problems. The findings from this thesis have important implications for future practices. The CABA has the potential to be an assessment utilised by clinicians and researchers across various health service provisions to evaluate body alignment and the effectiveness of posture management approaches.

References

- Adams, J.A., 1971. A closed-loop theory of motor learning. *Journal of motor behavior*, 3(2), pp.111-150.
- Akel, I., Pekmezci, M., Hayran, M., Genc, Y., Kocak, O., Derman, O., Erdoğan, I. and Yazici, M., 2008. Evaluation of shoulder balance in the normal adolescent population and its correlation with radiological parameters. *European Spine Journal*, 17(3), pp.348-354.
- Alotaibi, M., Long, T., Kennedy, E. and Bavishi, S., 2014. The efficacy of GMFM-88 and GMFM-66 to detect changes in gross motor function in children with cerebral palsy (CP): a literature review. *Disability and rehabilitation*, 36(8), pp.617-627.
- Alta, T.D., Bell, S.N., Troupis, J.M., Coghlan, J.A. and Miller, D., 2012. The new 4-dimensional computed tomographic scanner allows dynamic visualization and measurement of normal acromioclavicular joint motion in an unloaded and loaded condition. *Journal of computer assisted tomography*, 36(6), pp.749-754.
- Anastasi, A. and Urbina, S., 1997. *Psychological testing*. 7th ed. Prentice Hall/Pearson Education: New York.
- Andrews, D.M., Fiedler, K.M., Weir, P.L. and Callaghan, J.P., 2012. The effect of posture category salience on decision times and errors when using observation-based posture assessment methods. *Ergonomics*, 55(12), pp.1548-1558.
- Andrews, D.M., Arnold, T.A., Weir, P.L., Van Wyk, P.M. and Callaghan, J.P., 2008a. Errors associated with bin boundaries in observation-based posture assessment methods. *Occupational Ergonomics*, 8(1), pp.11-25.
- Andrews, D.M., Holmes, A.M., Weir, P.L., Arnold, T.A. and Callaghan, J.P., 2008b. Decision times and errors increase when classifying trunk postures near posture bin boundaries. *Theoretical Issues in Ergonomics Science*, 9(5), pp.425-440.
- Argetsinger, L.C., Trimble, S.A., Roberts, M.T., Thompson, J.E., Ugiliweneza, B. and Behrman, A.L., 2019. Sensitivity to change and responsiveness of the Segmental Assessment of Trunk Control (SATCo) in children with spinal cord injury. *Developmental neurorehabilitation*, 22(4), pp.260-271.
- Avery, L.M., Russell, D.J., Raina, P.S., Walter, S.D. and Rosenbaum, P.L., 2003. Rasch analysis of the Gross Motor Function Measure: validating the assumptions of the Rasch model to create an interval-level measure. *Archives of physical medicine and rehabilitation*, 84(5), pp.697-705.

Barela, J.A., Focks, G.M.J., Hilgeholt, T., Barela, A.M., Carvalho, R.D.P. and Savelsbergh, G.J., 2011. Perception–action and adaptation in postural control of children and adolescents with cerebral palsy. *Research in Developmental Disabilities*, 32(6), pp.2075-2083.

Bartlett, D. and Purdie, B., 2005. Testing of the spinal alignment and range of motion measure: a discriminative measure of posture and flexibility for children with cerebral palsy. *Developmental Medicine & Child Neurology*, 47(11), pp.739-743.

Bate, P., 1997. Motor Control Theories—Insights for therapists. *Physiotherapy*, 83(8), pp.397-405.

Baxter, P., Morris, C., Rosenbaum, P., Paneth, N., Leviton, A., Goldstein, M., Bax, M., Colver, A., Damiano, D., Graham, H.K. and Brien, G.O., 2007. The definition and classification of cerebral palsy. *Developmental Medicine and Child Neurology*, 49(s109), pp.1-44.

Baxter, P., 2004. ICF: health vs disease. *Developmental medicine and child neurology*, 46(5), pp.291-291.

Beaton, D.E., Bombardier, C., Katz, J.N. and Wright, J.G., 2001. A taxonomy for responsiveness. *Journal of clinical epidemiology*, 54(12), pp.1204-1217.

Benson, J. and Clark, F., 1982. A guide for instrument development and validation. *American Journal of Occupational Therapy*, 36(12), pp.789-800.

Bernstein NA., 1976. *The coordination and regulation of movements*. New York: Pergamon.

Beaton, D.E., Bombardier, C., Katz, J.N. and Wright, J.G., 2001. A taxonomy for responsiveness. *Journal of clinical epidemiology*, 54(12), pp.1204-1217.

Beith, I.D. and Harrison, P.J., 2004. Stretch reflexes in human abdominal muscles. *Experimental brain research*, 159(2), pp.206-213.

Bigongiari, A., e Souza, F.D.A., Franciulli, P.M., Neto, S.E.R., Araujo, R.C. and Mochizuki, L., 2011. Anticipatory and compensatory postural adjustments in sitting in children with cerebral palsy. *Human movement science*, 30(3), pp.648-657.

Bodkin, A.W., Robinson, C. and Perales, F.P., 2003. Reliability and validity of the gross motor function classification system for cerebral palsy. *Pediatric Physical Therapy*, 15(4), pp.247-252.

Bowling, A., 2014. *Research methods in health: investigating health and health services*. McGraw-hill education (UK).

- Breniére, Y. and Bril, B., 1998. Development of postural control of gravity forces in children during the first 5 years of walking. *Experimental brain research*, 121(3), pp.255-262.
- Brennan, R.L., 2010. Generalizability theory and classical test theory. *Applied Measurement in Education*, 24(1), pp.1-21.
- British Healthcare Trades Association (BHTA), 2014. The economic benefits of better provision of equipment for disabled and terminally ill children. *Report for the British Healthcare Trades Association: Centre for Economics and Business Research*
- Brogren, E., Hadders-Algra, M. and Forssberg, H., 1998. Postural control in sitting children with cerebral palsy. *Neuroscience & Biobehavioral Reviews*, 22(4), pp.591-596.
- Bujang, M.A. and Baharum, N., 2017. A simplified guide to determination of sample size requirements for estimating the value of intraclass correlation coefficient: a review. *Archives of Orofacial Science*, 12(1), pp.1-11.
- Burns, YR. 1996. *Physiotherapy and the Growing Child*. London: Saunders
- Burtner, P.A., Woollacott, M.H., Craft, G.L. and Roncevalles, M.N., 2007. The capacity to adapt to changing balance threats: a comparison of children with cerebral palsy and typically developing children. *Developmental Neurorehabilitation*, 10(3), pp.249-260.
- Burtner, P.A., Qualls, C. and Woollacott, M.H., 1998. Muscle activation characteristics of stance balance control in children with spastic cerebral palsy. *Gait & posture*, 8(3), pp.163-174.
- Bruton, A., Conway, J.H. and Holgate, S.T., 2000. Reliability: what is it, and how is it measured?. *Physiotherapy*, 86(2), pp.94-99.
- Butler, P., Saavedra, M.S., Sofranac, M.M., Jarvis, M.S. and Woollacott, M., 2010. Refinement, reliability and validity of the segmental assessment of trunk control (SATCo). *Pediatric physical therapy: the official publication of the Section on Pediatrics of the American Physical Therapy Association*, 22(3), p.246.
- Butler, P.B. and Major, R.E., 1992. Biomechanics of postural control and derived management principles. *Physiotherapy Theory and Practice*, 8(3), pp.183-184.
- Cacciatore, T.W., Gurfinkel, V.S., Skoss, R., Cordo, P.J. and Horak, F.B., 2004. Control of tonic activity in human axial musculature. In *Neuroscience Abstracts* (Vol. 30).

Cano-De-La-Cuerda, R., Molero-Sánchez, A., Carratalá-Tejada, M., Alguacil-Diego, I.M., Molina-Rueda, F., Miangolarra-Page, J.C. and Torricelli, D., 2015. Theories and control models and motor learning: clinical applications in neurorehabilitation. *Neurología (English Edition)*, 30(1), pp.32-41.

Cappelleri, J.C., Lundy, J.J. and Hays, R.D., 2014. Overview of classical test theory and item response theory for the quantitative assessment of items in developing patient-reported outcomes measures. *Clinical therapeutics*, 36(5), pp.648-662

Carlberg, E.B. and Hadders-Algra, M., 2008. Postural control in sitting children with cerebral palsy. *Clinics in Developmental Medicine*, 74(1), pp.74-96.

Carlberg, EB. Hadders-Algar, M., 2005. Postural Dysfunction in Children with Cerebral Palsy: Some Implications for Therapeutic Guidance. *Neural Plasticity*, 12, (2-3), pp.221-228

Cargill, S.C., Pearcy, M. and Barry, M.D., 2007. Three-dimensional lumbar spine postures measured by magnetic resonance imaging reconstruction. *Spine*, 32(11), pp.1242-1248.

Carr, J.H. and Shepherd, R.B., 2006. The changing face of neurological rehabilitation. *Brazilian Journal of Physical Therapy*, 10(2), pp.147-156.

Case – Smith, J., 2001. *Occupational therapy for children*. St Louis: Mosby

Castle, D., Stubbs, B., Clayton, S. and Soundy, A., 2014. A 24-hour postural care service: Views, understanding and training needs of referring multidisciplinary staff. *International Journal of Therapy and Rehabilitation*, 21(3), pp.132-139.

Chan, A. Heck, CS., 1999. The effects of Tilting the Seat Position of a Wheelchair on Respiration, Posture, fatigue, Voice Volume, and Exertion Outcomes in Individuals with Advanced Multiple Sclerosis. *Journal Rehabilitation Outcome Measure*, 3(4), pp.1-14

Charter Society of Physiotherapy (CSP)., 2012. *Quality assurance standards for physiotherapy service delivery*. Chartered Society of Physiotherapy, Bedford Row London: UK

Chatterton, HJ. Pomeroy, VM. Gratton, J., 2001. Positioning for stroke patients: a survey of physiotherapists' aims and practices. *Disability and Rehabilitation*, 23, (10), pp.413-421

Cherng, R.J., Lin, H.C., Ju, Y.H. and Ho, C.S., 2009. Effect of seat surface inclination on postural stability and forward reaching efficiency in children with spastic cerebral palsy. *Research in Developmental Disabilities*, 30(6), pp.1420-1427.

- Cherng, R.J., Su, F.C., Chen, J.J.J. and Kuan, T.S., 1999. Performance of Static Standing Balance in Children With Spastic Diplegic Cerebral Palsy Under Altered Sensory Environments¹. *American journal of physical medicine & rehabilitation*, 78(4), pp.336-343.
- Chia, H.S. and Howard, L. 2000. *Occupational therapy in childhood*. London: Whurr.
- Clarke, A.M. and Redden, J.F., 1992. Management of hip posture in cerebral palsy. *Journal of the Royal Society of Medicine*, 85(3), p.150.
- Clark, L.A. and Watson, D., 1995. Constructing validity: Basic issues in objective scale development. *Psychological assessment*, 7(3), p.309.
- Collins, F., 2007. The JCM Moonlite Sleep system: Assisting in the provision of 24-hour postural management. *International Journal of Therapy and Rehabilitation*, 14, (7), pp.36-40
- Connelly, L.M., 2012. Correlations. *Medsurg Nursing*, 21(3), p.171.
- Corrêa, J.C., Corrêa, F.I., Franco, R.C. and Bigongiari, A., 2007. Corporal oscillation during static biped posture in children with cerebral palsy. *Electromyography and clinical neurophysiology*, 47(3), p.131.
- Crocker, L. and Algina, J., 2008. *Introduction to classical and modern test theory*. CENGAGE Learning, 5191 Natorp Boulevard, Mason, Ohio 45040.
- Cumberworth, V.L., Patel, N.N., Rogers, W. and Kenyon, G.S., 2007. The maturation of balance in children. *The Journal of Laryngology and Otology*, 121(5), p.449.
- Curtis, D.J., Holbrook, P., Bew, S., Ford, L. and Butler, P., 2018. Functional change in children with cerebral palsy. *arXiv preprint arXiv:1811.12490*.
- Curtis, D.J., Butler, P., Saavedra, S., Bencke, J., Kallemose, T., Sonne-Holm, S. and Woollacott, M., 2015. The central role of trunk control in the gross motor function of children with cerebral palsy: a retrospective cross-sectional study. *Developmental Medicine & Child Neurology*, 57(4), pp.351-357.
- Dean, E., Dornelas de Andrade, A., O'Donoghue, G., Skinner, M., Umereh, G., Beenen, P., Cleaver, S., Afzalzada, D., Fran Delaune, M., Footer, C. and Gannotti, M., 2014. The Second Physical Therapy Summit on Global Health: developing an action plan to promote health in daily practice and reduce the burden of non-communicable diseases. *Physiotherapy theory and practice*, 30(4), pp.261-275.
- Department of Health (DoH)., 2010. *Equity and excellence: liberating the NHS* (Vol. 7881). The Stationery Office.

Department of Health (DoH)., 2005. National Service Framework for long term conditions [online] Available at: http://www.dh.gov.uk/en/Publicationsandstatistics/Publications/PublicationsPolicyAndGuidance/DH_4105361 [Accessed 4 march 2020]

Dewar, R., Love, S. and Johnston, L.M., 2015. Exercise interventions improve postural control in children with cerebral palsy: a systematic review. *Developmental Medicine & Child Neurology*, 57(6), pp.504-520.

Diamant, RB., 1992. *Positioning for play: home activities for parents with young children. Therapy Skills Builder*. Arizona: Tuscan

do Rosário, J.L.P., 2014. Biomechanical assessment of human posture: a literature review. *Journal of bodywork and movement therapies*, 18(3), pp.368-373.

Donker, S.F., Ledebt, A., Roerdink, M., Savelsbergh, G.J. and Beek, P.J., 2008. Children with cerebral palsy exhibit greater and more regular postural sway than typically developing children. *Experimental brain research*, 184(3), pp.363-370.

Dunk, N.M., Lalonde, J. and Callaghan, J.P., 2005. Implications for the use of postural analysis as a clinical diagnostic tool: reliability of quantifying upright standing spinal postures from photographic images. *Journal of manipulative and physiological therapeutics*, 28(6), pp.386-392.

Dunk, N.M., Chung, Y.Y., Compton, D.S. and Callaghan, J.P., 2004. The reliability of quantifying upright standing postures as a baseline diagnostic clinical tool. *Journal of manipulative and physiological therapeutics*, 27(2), pp.91-96.

Dunn, W., 2002. *The Infant/Toddler Sensory Profile manual*. TX: The Psychology Corporation: San Antonio.

Dunn, W., 2000. *Best practice occupational therapy: In community service with children and families*. Slack Incorporated.

Dusing, S.C. and Harbourne, R.T., 2010. Variability in postural control during infancy: implications for development, assessment, and intervention. *Physical therapy*, 90(12), pp.1838-1849.

Evans, J.D., 1996. *Straightforward statistics for the behavioural sciences*. Thomson Brooks/Cole Publishing Co.

Farley, R. Clark, J. Davidson, C. Evans, G. Maclennan, K. Michael, S. Morrow, M. Thorpe, S., 2003. What is the evidence for the effectiveness of postural management? *International Journal of Therapy and Rehabilitation*, 10, (10), pp.449-455

Fawcett, A.L., 2013. *Principles of assessment and outcome measurement for occupational therapists and physiotherapists: theory, skills and application*. John Wiley & Sons.

Ferdjallah, M., Harris, G.F., Smith, P. and Wertsch, J.J., 2002. Analysis of postural control synergies during quiet standing in healthy children and children with cerebral palsy. *Clinical Biomechanics*, 17(3), pp.203-210.

Field, A., 2013. *Discovering statistics using IBM SPSS statistics*. Sage.

Field, A. and Hole, G., 2002. *How to design and report experiments*. Sage.

Field, D. and Livingstone, R., 2013. Clinical tools that measure sitting posture, seated postural control or functional abilities in children with motor impairments: a systematic review. *Clinical rehabilitation*, 27(11), pp.994-1004.

Field, D.A. and Roxborough, L.A., 2011. Responsiveness of the Seated Postural Control Measure and the Level of Sitting Scale in children with neuromotor disorders. *Disability and Rehabilitation: Assistive Technology*, 6(6), pp.473-482.

Fife, S.E., Roxborough, L.A., Armstrong, R.W., Harris, S.R., Gregson, J.L. and Field, D., 1991. Development of a clinical measure of postural control for assessment of adaptive seating in children with neuromotor disabilities. *Physical Therapy*, 71(12), pp.981-993.

Finch, E., Brooks, D., Stratford, P.W. and Mayo, N.E., 2003. Physical rehabilitation outcome measures: a guide to enhanced clinical decision making. *Physiotherapy Canada*, 55(1), pp.53-54.

Finnie, NR. (1997) *Handling the young child with cerebral palsy at home*. 3rd ed. London: Butterworth Heinemann.

Fleiss, J.L., Levin, B. and Paik, M.C., 2013. *Statistical methods for rates and proportions*. 3rd ed. John Wiley & Sons.

Fortin, C., Ehrmann Feldman, D., Cheriet, F. and Labelle, H., 2011. Clinical methods for quantifying body segment posture: a literature review. *Disability and Rehabilitation*, 33(5), pp.367-383.

Foxcroft, C., Paterson, H., Le Roux, N. and Herbst, D., 2004. Psychological assessment in South Africa: a needs analysis: the test use patterns and needs of psychological assessment practitioners: final report. July.

Fulford, GE. Brown, JK., 1976. Position as a cause of deformity in children with Cerebral palsy. *Development Medical Child Neurology*, 18, pp.305-314

Gericke, T., 2006. Postural management for children with cerebral palsy: consensus statement. *Developmental Medicine and Child Neurology*, 48(4), pp.244-244.

Gibson, E.J. and Pick, A.D., 2000. *An ecological approach to perceptual learning and development*. Oxford University Press, USA.

Girolami, G.L., Shiratori, T. and Aruin, A.S., 2011. Anticipatory postural adjustments in children with hemiplegia and diplegia. *Journal of Electromyography and Kinesiology*, 21(6), pp.988-997.

Goldsmith, S. (2000) 'Postural Care at Night within a Community Setting'. *Physiotherapy*, 86, (10), pp.528-534

Goldsmith, J. and Goldsmith, L., 2009. Goldsmith Indices of Body Symmetry: Protecting Body Shape. *European Seating Symposium*, pp.122-124.

Goldsmith, J., Goldsmith, L., Hill, S., 2009. Working together to protect body shape. *Posture and Mobility*, 26(2), pp.9-13.

Goldsmith, E., Golding, R.M., Garstang, R.A. and MacRae, A.W., 1992. A technique to measure windswept deformity. *Physiotherapy*, 78(4), pp.235-242.

Gotch, C.M., 2014. Frontiers of Test Validity Theory: Measurement, Causation, and Meaning. *Journal of Educational Measurement*, 12;51(4), pp.463-467.

Gough, M., 2009. Continuous postural management and the prevention of deformity in children with cerebral palsy: an appraisal'. *Developmental Medicine and Child Neurology*, 51, (2), pp.105-110

Graaf-Peters, V.B., Blauw-Hospers, C.H., Dirks, T., Bakker, H., Bos, A.F. and Hadders-Algra, M., 2007. Development of postural control in typically developing children and children with cerebral palsy: possibilities for intervention?. *Neuroscience & Biobehavioral Reviews*, 31(8), pp.1191-1200.

Grant, M J., Booth, A., 2009. A typology of reviews: an analysis of 14 review types and associated methodologies. *Health Information and Libraries Journal*, 26 (2), 91-108

Graham, H.K., 2002. Painful hip dislocation in cerebral palsy. *The Lancet*, 359(9310), pp.907-908.

Graham, J.V., Eustace, C., Brock, K., Swain, E. and Irwin-Carruthers, S., 2009. The Bobath concept in contemporary clinical practice. *Topics in stroke rehabilitation*, 16(1), pp.57-68.

- Gurfinkel, V., Cacciato, T.W., Cordo, P., Horak, F., Nutt, J. and Skoss, R., 2006. Postural muscle tone in the body axis of healthy humans. *Journal of neurophysiology*, 96(5), pp.2678-2687.
- Haas, G., Diener, H.C., Rapp, H. and Dichgans, J., 1989. Development of feedback and feedforward control of upright stance. *Developmental Medicine & Child Neurology*, 31(4), pp.481-488.
- Hadders-Algra, M., 2013. Typical and atypical development of reaching and postural control in infancy. *Developmental Medicine & Child Neurology*, 55, pp.5-8.
- Hadders-Algra, M., 2010. Variation and variability: key words in human motor development. *Physical therapy*, 90(12), pp.1823-1837.
- Hadders-Algra, M. and Carlberg, E.B., 2010. *Postural control: A key issue in developmental disorders*. Mac Keith Press.
- Hadders-Algra, M., 2005. Development of postural control during the first 18 months of life. *Neural plasticity*, 12(2-3), pp.99-108.
- Hägglund, G., Alriksson-Schmidt, A., Lauge-Pedersen, H., Rodby-Bousquet, E., Wagner, P. and Westbom, L., 2014. Prevention of dislocation of the hip in children with cerebral palsy: 20-year results of a population-based prevention programme. *The bone & joint journal*, 96(11), pp.1546-1552.
- Hankinson, J. Morton, R.E., 2002. Use of a lying hip abduction system in children with bilateral cerebral palsy: a pilot study. *Developmental Medicine and Child Neurology*, 44, pp.177-180
- Hanna, S.E., Bartlett, D.J., Rivard, L.M. and Russell, D.J., 2008. Reference curves for the Gross Motor Function Measure: percentiles for clinical description and tracking over time among children with cerebral palsy. *Physical therapy*, 88(5), pp.596-607.
- Harris, S.R. and Roxborough, L., 2005. Efficacy and effectiveness of physical therapy in enhancing postural control in children with cerebral palsy. *Neural plasticity*, 12(2-3), pp.229-243.
- Health and Care Professions Council (HCPC), 2016. Standards of conduct, performance and ethics: Health & Care Professions Council. [online] Available at: <https://www.hcpc-uk.org/standards/standards-of-proficiency/physiotherapists/> [Accessed 23 April 2018]
- Hickson, M., 2013. *Research handbook for health care professionals*. John Wiley & Sons.
- Hill, S. and Goldsmith, J., 2010. Biomechanics and prevention of body shape distortion. *Tizard Learning Disability Review*, 15(2), p.15.

Hill, CM. Parker, RC. Allen, P. Paul, A. Padoa, K., 2009. Sleep quality and respiratory function in children with severe cerebral palsy using night-time postural equipment: a pilot study. *Acta Paediatrica*, 98, pp.1809-1814

Hinojosa, J., 2002. Best Practice Occupational Therapy: In Community Service With Children and Families. *American Journal of Occupational Therapy*, 56(4), pp.477-478.

Hodges, P.W., Gurfinkel, V.S., Brumagne, S., Smith, T.C. and Cordo, P.C., 2002. Coexistence of stability and mobility in postural control: evidence from postural compensation for respiration. *Experimental brain research*, 144(3), pp.293-302.

Hof, A.L., Gazendam, M.G.J. and Sinke, W.E., 2005. The condition for dynamic stability. *Journal of biomechanics*, 38(1), pp.1-8.

Hong, C.S., 2005. Assessment for and provision of positioning equipment for children with motor impairments. *International Journal of Therapy and Rehabilitation*, 12(3), pp.126-131.

Humphreys, G. Pountney, T., 2006. The development and implementation of an integrated care pathway for 24-hour postural management: a study of the views of staff and carers. *Physiotherapy*, 92, pp.233-239.

Howe, T. Oldam, J., 2001. Posture and Balance. Chapter 2 pp.105-117. In Trew, M. Everett, T. *Human Movement An Introductory Text*. London: Churchill Livingstone.

Hsue, B.J., Miller, F. and Su, F.C., 2009. The dynamic balance of the children with cerebral palsy and typical developing during gait. Part I: Spatial relationship between COM and COP trajectories. *Gait & posture*, 29(3), pp.465-470.

Husted, J.A., Cook, R.J., Farewell, V.T. and Gladman, D.D., 2000. Methods for assessing responsiveness: a critical review and recommendations. *Journal of clinical epidemiology*, 53(5), pp.459-468.

Jones, A. Carr, EK. Newham, DJ. Wilson-Barnett, J., 1998. Positioning of stroke patients: Evaluation of a teaching intervention with Nurses. *Journal of the American Heart Association*, 29, pp.1612-1617

Ju, Y.H., Hwang, S. and Cherng, R.J., 2012. Postural adjustment of children with spastic diplegic cerebral palsy during seated hand reaching in different directions. *Archives of physical medicine and rehabilitation*, 93(3), pp.471-479.

Juul-Kristensen, B., Hansson, G.Å., Fallentin, N., Andersen, J.H. and Ekdahl, C., 2001. Assessment of work postures and movements using a video-based observation method and direct technical measurements. *Applied ergonomics*, 32(5), pp.517-524.

- Katz, M., 1973. *Selecting an Achievement Test: Principles and Procedures*. Educational Testing Service. Princeton: New Jersey.
- Kelso, J.S. and Tuller, B., 1984. A dynamical basis for action systems. In *Handbook of cognitive neuroscience* (pp. 321-356). Springer, Boston, MA.
- Kenyon, L.K. and Blackinton, M.T., 2011. Applying motor-control theory to physical therapy practice: a case report. *Physiotherapy Canada*, 63(3), pp.345-354.
- Khan, Y. Underhill, J. (2006) 'Identification of sleep problems by questionnaire in children with severe cerebral palsy'. *Developmental Medicine and Child Neurology*, 37, pp.449-455.
- Kimberlin, C.L. and Winterstein, A.G., 2008. Validity and reliability of measurement instruments used in research. *American journal of health-system pharmacy*, 65(23), pp.2276-2284.
- Kim, D.H., An, D.H. and Yoo, W.G., 2018. Changes in trunk sway and impairment during sitting and standing in children with cerebral palsy. *Technology and Health Care*, 26(5), pp.761-768.
- Koo, T.K. and Li, M.Y., 2016. A guideline of selecting and reporting intraclass correlation coefficients for reliability research. *Journal of chiropractic medicine*, 15(2), pp.155-163.
- Kyte, D.G., Calvert, M., Van der Wees, P.J., Ten Hove, R., Tolan, S. and Hill, J.C., 2015. An Introduction to patient-reported outcome measures (PROMs) in physiotherapy. *Physiotherapy*, 101(2), pp.119-125.
- Larin, H.M., 1998. Motor learning: a practical framework for paediatric physiotherapy. *Physiotherapy Theory and Practice*, 14(1), pp.33-47.
- Lau, M.H. and Armstrong, T.J., 2011. The effect of viewing angle on wrist posture estimation from photographic images using novice raters. *Applied ergonomics*, 42(5), pp.634-643.
- Law, M., 2004. OUTCOME MEASURES RATING FORM GUIDELINES. *Can Child: McMaster University*. Hamilton.
- Law, M., Stewart, D., Letts, L., Pollock, N., Bosch, J. and Westmorland, M., 1998. Guidelines for critical review of qualitative studies. *McMaster University occupational therapy evidence-based practice research Group*.
- Lee, S. and Lee, D.K., 2018. What is the proper way to apply the multiple comparison test?. *Korean journal of anesthesiology*, 71(5), p.353.

- Lenker, J.A., Scherer, M.J., Fuhrer, M.J., Jutai, J.W. and DeRuyter, F., 2005. Psychometric and administrative properties of measures used in assistive technology device outcomes research. *Assistive Technology*, 17(1), pp.7-22.
- Letts, L., Wilkins, S., Law, M., Stewart, D., Bosch, J. and Westmorland, M., 2007. Critical review form—qualitative studies (version 2.0). *McMaster University*.
- Levine, D.N., 2007. Sherrington's "The Integrative action of the nervous system": A centennial appraisal. *Journal of the neurological sciences*, 253(1), pp.1-6.
- Levy, P., 1995. Charles Spearman's contributions to test theory. *British Journal of Mathematical and Statistical Psychology*, 48(2), pp.221-235.
- Liao, H.F. and Hwang, A.W., 2003. Relations of balance function and gross motor ability for children with cerebral palsy. *Perceptual and motor skills*, 96(3_suppl), pp.1173-1184.
- Liu, W.Y., Zaino, C.A. and McCoy, S.W., 2007. Anticipatory postural adjustments in children with cerebral palsy and children with typical development. *Pediatric Physical Therapy*, 19(3), pp.188-195.
- Lovie, S. and Lovie, P., 2010. Commentary: Charles Spearman and correlation: a commentary on 'The proof and measurement of association between two things'. *International journal of epidemiology*, 39(5), pp.1151-1153.
- Lowe, B.D., 2004. Accuracy and validity of observational estimates of wrist and forearm posture. *Ergonomics*, 47(5), pp.527-554.
- Lowe, B.D., Weir, P. and Andrews, D., 2014. Observation-based posture assessment: review of current practice and recommendations for improvement. *National Institute for Occupational Safety and Health: Department of health and Human Sciences*.
- Löwing, K., Arredondo, Y.C., Tedroff, M. and Tedroff, K., 2015. Introduction of the gross motor function classification system in Venezuela—a model for knowledge dissemination. *BMC pediatrics*, 15(1), pp.1-8.
- Macias-Merlo, L., Bagur-Calafat, C., Girabent-Farrés, M. and A. Stuberg, W., 2016. Effects of the standing program with hip abduction on hip acetabular development in children with spastic diplegia cerebral palsy. *Disability and rehabilitation*, 38(11), pp.1075-1081.
- Maher, C.A. Evans, K.A. Sprod, J.A. Bostock, S.E., 2011. Factors influencing postural management for children with cerebral palsy in the special school setting. *Disability and Rehabilitation*, 33, (2), pp.146-158

Majnemer, A. Mazer, B., 2004, March. New directions in the outcome evaluation of children with cerebral palsy. In *Seminars in Pediatric Neurology* (Vol. 11, No. 1, pp. 11-17). WB Saunders.

Mansell, J., 2010. *Raising our sights: Services for adults with profound intellectual and multiple disabilities*. MENCAP: London.

Martinsson, C. and Himmelmann, K., 2011. Effect of weight-bearing in abduction and extension on hip stability in children with cerebral palsy. *Pediatric Physical Therapy*, 23(2), pp.150-157.

Massion, J., 1998. Postural control systems in developmental perspective. *Neuroscience & Biobehavioral Reviews*, 22(4), pp.465-472.

McDonald, R.P., 2013. *Test theory: A unified treatment*. psychology press.

McDonald, R. Surtees, R. Wirz, S. (2007) 'A comparative exploration of the thoughts of parents and therapists regarding seating equipment for children with multiple and complex needs'. *Disability and Rehabilitation: Assistive Technology*, 2, (6), pp.319-325

Mcdowell, I. and Mcdowell, I., 2006. The Theoretical and Technical Foundations of Health Measurement: Psychophysics and Psychometrics. In *Measuring Health: A Guide to Rating Scales and Questionnaires* (pp. 617-800). New York: Oxford University Press.

McDowell, I. and Newell, C., 2006. Measuring health: a guide to rating scales and questionnaires: Oxford University Press. *New York*, pp.520-703.

McEvoy, M.P. and Grimmer, K., 2005. Reliability of upright posture measurements in primary school children. *BMC musculoskeletal disorders*, 6(1), p.35.

Miller, L.A. and Lovler, R.L., 2018. *Foundations of psychological testing: A practical approach*. Sage Publications.

Moher, D., Liberati, A., Tetzlaff, J., Altman, D.G., Altman, D., Antes, G., Atkins, D., Barbour, V., Barrowman, N., Berlin, J.A. and Clark, J., 2009. Preferred reporting items for systematic reviews and meta-analyses: the PRISMA statement (Chinese edition). *Journal of Chinese Integrative Medicine*, 7(9), pp.889-896.

Mok, N.W., Brauer, S.G. and Hodges, P.W., 2004. Hip strategy for balance control in quiet standing is reduced in people with low back pain. *Spine*, 29(6), pp.E107-E112.

Mokkink, L.B., Prinsen, C., Patrick, D.L., Alonso, J., Bouter, L.M., de Vet, H.C., Terwee, C.B. and Mokkink, L., 2018. COSMIN methodology for systematic reviews of patient-reported outcome measures (PROMs). *User manual*, 78, p.1.

Mokkink, L.B., Terwee, C.B., Patrick, D.L., Alonso, J., Stratford, P.W., Knol, D.L., Bouter, L.M. and De Vet, H.C., 2010. The COSMIN checklist for assessing the methodological quality of studies on measurement properties of health status measurement instruments: an international Delphi study. *Quality of life research*, 19(4), pp.539-549.

Monge, P. and Williams, F., 2001. Reasoning with statistics: How to read quantitative research.(5th ed.) Fort worth, TX: Harcourt college publishers

Morris, C., 2007. Definition and classification of cerebral palsy: a historical perspective. *Developmental Medicine & Child Neurology*, 49, pp.3-7.

Morris, C. and Bartlett, D., 2004. Gross motor function classification system: impact and utility. *Developmental medicine and child neurology*, 46(1), p.60.

National Institute for Clinical Excellence (NICE)., 2012. *Spasticity in under 19s: Management*. London: Department of Health.

Newman, C. J., 2005. The chailey approach to postural management, 2nd edition. *Archives of Disease in Childhood*, 90(6), 656.

Normand, M.C., Descarreaux, M., Harrison, D.D., Harrison, D.E., Perron, D.L., Ferrantelli, J.R. and Janik, T.J., 2007. Three dimensional evaluation of posture in standing with the PosturePrint: an intra-and inter-examiner reliability study. *Chiropractic & osteopathy*, 15(1), p.15.

Novak, I., Morgan, C., Fahey, M., Finch-Edmondson, M., Galea, C., Hines, A., Langdon, K., Mc Namara, M., Paton, M.C., Popat, H. and Shore, B., 2020. State of the evidence traffic lights 2019: systematic review of interventions for preventing and treating children with cerebral palsy. *Current neurology and neuroscience reports*, 20(2), pp.1-21.

Novak, I., 2012. Evidence to practice commentary: the evidence alert traffic light grading system. *Physical & occupational therapy in pediatrics*, 32(3), pp.256-259.

Odom, S.L., Horner, R.H., Snell, M.E. and Blacher, J., 2007. The construct of developmental disabilities.

Østensjø, S., Carlberg, E.B. and Vøllestad, N.K., 2005. The use and impact of assistive devices and other environmental modifications on everyday activities and care in young children with cerebral palsy. *Disability and Rehabilitation*, 27(14), pp.849-861.

Ottenbacher, K.J. and Tomchek, S.D., 1993. Reliability analysis in therapeutic research: practice and procedures. *American Journal of Occupational Therapy*, 47(1), pp.10-16.

Pai, Y.C., Maki, B.E., Iqbal, K., McIlroy, W.E. and Perry, S.D., 2000. Thresholds for step initiation induced by support-surface translation: a dynamic center-of-mass model provides much better prediction than a static model. *Journal of biomechanics*, 33(3), pp.387-392.

Pai, Y.C. and Patton, J., 1997. Center of mass velocity-position predictions for balance control. *Journal of biomechanics*, 30(4), pp.347-354.

Palisano, R.J., Rosenbaum, P., Bartlett, D., Livingston, M.H., 2008. Content validity of the expanded and revised Gross Motor Function Classification System. *Developmental Medicine & Child Neurology*, 50(10), pp.744-750.

Palisano, R., Rosenbaum, P., Bartlett, D., Livingston, M., 2007. Gross motor classification system expanded and revised. *CanChild* centre for childhood disability research, McMaster University, Canada.

Palisano, R.J., Cameron, D., Rosenbaum, P.L., Walter, S.D. and Russell, D., 2006. Stability of the gross motor function classification system. *Developmental Medicine & Child Neurology*, 48(6), pp.424-428.

Palisano, R., Rosenbaum, P., Walter, S., Russell, D., Wood, E., Galuppi, B., 1997. Development and reliability of a system to classify gross motor function in children with cerebral palsy. *Developmental Medicine & Child Neurology*, 39(4), 214-223.

Paul, J.A., Douwes, M., 1993. Two-dimensional photographic posture recording and description: a validity study. *Applied ergonomics*, 24(2), pp.83-90.

Pavão, S.L., Silva, F.P.D.S., Savelsbergh, G.J., Rocha, N.A.C.F., 2015. Use of sensory information during postural control in children with cerebral palsy: systematic review. *Journal of motor behavior*, 47(4), pp.291-301.

Pavao, S.L., Dantos, A.N.D., Woollacott, M.H., Cicuto, N.A., Rochaa, F., 2013. Assessment of postural control in children with cerebral palsy; a review. *Research in Developmental Disabilities*, 34, pp. 1367-1375

Pazos, V., Cheriet, F., Song, L., Labelle, H. and Dansereau, J., 2005. Accuracy assessment of human trunk surface 3D reconstructions from an optical digitising system. *Medical and Biological Engineering and Computing*, 43(1), pp.11-15.

Perry, M., Smith, A., Straker, L., Coleman, J. and O'Sullivan, P., 2008. Reliability of sagittal photographic spinal posture assessment in adolescents. *Advances in Physiotherapy*, 10(2), pp.66-75.

Pin, T.W., Butler, P.B., Cheung, H.M. and Shum, S.L.F., 2019. Relationship between segmental trunk control and gross motor development in typically developing infants aged from 4 to 12 months: a pilot study. *BMC pediatrics*, 19(1), p.425.

Piper, M.C., Pinnell, L.E., Darrah, J., Maguire, T. and Byrne, P.J., 1992. Construction and validation of the Alberta Infant Motor Scale (AIMS). *Canadian journal of public health*, 83, pp.S46-50.

Piscitelli, D., Ferrarello, F., Ugolini, A., Verola, S. and Pellicciari, L., 2021. Measurement properties of the Gross Motor Function Classification System, Gross Motor Function Classification System-Expanded & Revised, Manual Ability Classification System, and Communication Function Classification System in cerebral palsy: a systematic review with meta-analysis. *Developmental Medicine & Child Neurology*.

Pollock, A.S., Durward, B.R., Rowe, P.J., 2000. What is balance. *Clinical Rehabilitation*, 14, (4), pp.402-406

Pope, P.M., 2007. *Severe and Complex Neurological Disability: management of the Physical Condition* Edinburgh: Elsevier Butterworth-Heinemann, 2007.

Porter, D., Michael, S., Kirkwood, C., 2008. Is there a relationship between preferred posture and positioning in early life and the direction of subsequent asymmetrical postural deformity in non-ambulant people with cerebral palsy? *Child: Care, health and development*, 34, (5), pp.635-641

Porter, D., Michael, S., Kirkwood, C., 2007. Patterns of postural deformity in non-ambulant people with cerebral palsy: what is the relationship between the direction of scoliosis, direction of pelvic obliquity, direction of windswept hip deformity and side of hip dislocation? *Clinical Rehabilitation*, 21, pp.1087-1096

Pountney, T.E., Mandy, A., Green, E., Gard, P.R., 2009. Hip subluxation and dislocation in cerebral palsy – a prospective study on the effectiveness of postural management programmes. *Physiotherapy Research International*, 14, (2), pp.116-127

Pountney, T.E., Green, E.M., 2006. Hip Dislocation in cerebral palsy'. *British Medical Journal*, 332, pp.772-775

Pountney, T.E., Mulcahy, C.M., Clarke, S.M., Green, E.M., 2004. *The Chailey Approach to Postural Management*. 2nd ed. East Sussex: Chailey Heritage

Pountney, T., Mandy, A., Green, E., Gard, P., 2002. Management of hip dislocation with postural management. *Child: Care, Health and Development*, 28, (2), pp.179-185

Pountney, T.E., Cheek, L., Green, E., Mulcahy, C. and Nelham, R., 1999. Content and criterion validation of the Chailey Levels of Ability. *Physiotherapy*, 85(8), pp.410-416.

Pountney, TE. Mulcahy, C. Green, E., 1990. Early Development of Postural Control. *Physiotherapy*, 76, (12), pp. 799-802

Public Health England (PHE), 2018. Postural Care and People with learning disabilities: Guidance [online] Available at: <https://www.gov.uk/government/publications/postural-care-services-making-reasonable-adjustments/postural-care-and-people-with-learning-disabilities> [Accessed 17 June 2020]

Pynsent, P.B., 2001. Choosing an outcome measure. *The Journal of bone and joint surgery. British volume*, 83(6), pp.792-794.

Raine, S. and Twomey, L., 1994. Attributes and qualities of human posture and their relationship to dysfunction or musculoskeletal pain. *Critical Reviews in Physical and Rehabilitation Medicine*, 6, pp.409-409.

Rennie, J., 2007. *Learning Disability Physical therapy Treatment and Management*. 2nd ed. West Sussex, John Wiley & Sons Ltd.

Roach, K.E., 2006. Measurement of health outcomes: reliability, validity and responsiveness. *JPO: Journal of Prosthetics and Orthotics*, 18(6), pp.P8-P12.

Robertson, J., Baines, S., Emerson, E. and Hatton, C., 2018. Postural care for people with intellectual disabilities and severely impaired motor function: A scoping review. *Journal of applied research in intellectual disabilities*, 31, pp.11-28.

Rodby-Bousquet, E., Persson-Bunke, M. and Czuba, T., 2016. Psychometric evaluation of the Posture and Postural Ability Scale for children with cerebral palsy. *Clinical rehabilitation*, 30(7), pp.697-704.

Rodby-Bousquet, E., Ágústsson, A., Jónsdóttir, G., Czuba, T., Johansson, A.C. and Hägglund, G., 2014. Interrater reliability and construct validity of the Posture and Postural Ability Scale in adults with cerebral palsy in supine, prone, sitting and standing positions. *Clinical rehabilitation*, 28(1), pp.82-90.

Rodby-Bousquet, E., Czuba, T., Hägglund, G. and Westbom, L., 2013. Postural asymmetries in young adults with cerebral palsy. *Developmental Medicine & Child Neurology*, 55(11), pp.1009-1015.

Rodby-Bousquet, E. and Hägglund, G., 2010. Sitting and standing performance in a total population of children with cerebral palsy: a cross-sectional study. *BMC Musculoskeletal Disorders*, 11(1), pp.1-8.

Roebroeck, M.E., Harlaar, J. and Lankhorst, G.J., 1993. The application of generalizability theory to reliability assessment: an illustration using isometric force measurements. *Physical Therapy*, 73(6), pp.386-395.

- Roncesvalles, M.N., Woollacott, M.W. and Burtner, P.A., 2002. Neural factors underlying reduced postural adaptability in children with cerebral palsy. *Neuroreport*, 13(18), pp.2407-2410.
- Rose, J., Wolff, D.R., Jones, V.K., Bloch, D.A., Oehlert, J.W. and Gamble, J.G., 2002. Postural balance in children with cerebral palsy. *Developmental Medicine & Child Neurology*, 44(1), pp.58-63.
- Rosenbaum, D.A., 2009. *Human motor control*. Academic press.
- Rosenbaum, P.L., Palisano, R.J., Bartlett, D.J., Galuppi, B.E., Russell, D.J., 2008. Development of the Gross Motor Function Classification System for cerebral palsy. *Developmental Medicine & Child Neurology*, 50, pp.249-253.
- Rosenbaum, P., Paneth, N., Leviton, A., Goldstein, M., Bax, M., Damiano, D., Dan, B. and Jacobsson, B., 2007. A report: the definition and classification of cerebral palsy. April 2006. *Developmental Medicine and Child Neurology Supplement*, 109(suppl 109), pp.8-14.
- Rosenbaum, P.L., Walter, S.D., Hanna, S.E., Palisano, R.J., Russell, D.J., Raina, P., Wood, E., Bartlett, D.J. and Galuppi, B.E., 2002. Prognosis for gross motor function in cerebral palsy: creation of motor development curves. *Jama*, 288(11), pp.1357-1363.
- Rothstein, J.M., 1985. Measurement and clinical practice: therapy and application. *Measurement in physical therapy*, 7, pp.1-46.
- Russell, D.J., Rosenbaum, P., Wright, M. and Avery, L.M., 2002. Gross motor function measure (GMFM-66 & GMFM-88) users manual. London: Mac Keith Press.
- Saavedra, S.L. and Woollacott, M.H., 2015. Segmental contributions to trunk control in children with moderate-to-severe cerebral palsy. *Archives of physical medicine and rehabilitation*, 96(6), pp.1088-1097.
- Saavedra, S., Woollacott, M. and Van Donkelaar, P., 2010. Head stability during quiet sitting in children with cerebral palsy: effect of vision and trunk support. *Experimental brain research*, 201(1), pp.13-23.
- Sarathy, K., Doshi, C. and Aroojis, A., 2019. Clinical examination of children with cerebral palsy. *Indian journal of orthopaedics*, 53(1), p.35.
- Schmidt, R.A., Lee, T.D., Winstein, C., Wulf, G. and Zelaznik, H.N., 2018. *Motor control and learning: A behavioural emphasis*. Human kinetics.

- Schmidt, R.A., 1976. The schema as a solution to some persistent problems in motor learning theory. Chapter 2 pp.41-65. In Stelmach, G.E. *Motor control: Issues and trends*. New York: Academic Press.
- Scrutton, D., 2008. Position as a cause of deformity in children with cerebral palsy (1976). *Developmental Medicine & Child Neurology*, 50(6), 404-404.
- Shepherd, R.B., 2001. Exercise and training to optimize functional motor performance in stroke: driving neural reorganization?. *Neural plasticity*, 8(1-2), pp.121-129.
- Sheridan, M.D., 1980. *From birth to five years: children's developmental progress*. Hong Kong: NFER-NELSON
- Sherrington, C.S., 1906. Observations on the scratch-reflex in the spinal dog. *The Journal of physiology*, 34(1-2), pp.1-50.
- Shevell, M., 2009. Concepts and definitions in neurodevelopmental disability. *Neurodevelopmental Disabilities: Clinical and Scientific Foundations*, p.1.
- Shi, W., Yang, H., Li, C.Y., Zhou, M.Q., Zhu, M., Wang, Y. and Qian, X., 2014. Expanded and revised gross motor function classification system: study for Chinese school children with cerebral palsy. *Disability and rehabilitation*, 36(5), pp.403-408.
- Shore, B. Spence, D. Graham, H.K., 2012. The role of hip surveillance in children with cerebral palsy. *Current Rev Musculoskeletal Medicine*, 5, pp. 126-134.
- Shoukri, M.M., Asyali, M.H. and Donner, A., 2004. Sample size requirements for the design of reliability study: review and new results. *Statistical Methods in Medical Research*, 13(4), pp.251-271.
- Shumway-Cook, A. and Woollacott, M.H., 2007. *Motor control: translating research into clinical practice*. Lippincott Williams & Wilkins.
- Siddaway, A.P., Wood, A.M. and Hedges, L.V., 2019. How to do a systematic review: a best practice guide for conducting and reporting narrative reviews, meta-analyses, and meta-syntheses. *Annual review of psychology*, 70, pp.747-770.
- Silva, D.B., Pfeifer, L.I. and Funayama, C.A., 2013. Gross motor function classification system expanded & revised (GMFCS E & R): reliability between therapists and parents in Brazil. *Brazilian journal of physical therapy*, 17, pp.458-463.
- Skoutelis, V.C. and Dimitriadis, Z., 2016. The evolution of physiotherapy in the clinical management of children with cerebral palsy: A functional approach. *Arch Hell Med*, 33(4), pp.532-541.

- Spearman, C., 2010. The proof and measurement of association between two things. *International journal of epidemiology*, 39(5), pp.1137-1150.
- Stratford p, spadoni G, Kenedy D, Wesaway MD, Alcock GK. 2002 Seven point to consider when investigating a measure's ability to detect change. *Physiotherapy Canada*, 54, pp.16-24
- Stokes, E.K., 2011. *Rehabilitation outcome measures* (pp. 27-32). Edinburgh: Churchill Livingstone.
- Sugden, D. W.,M., 2013. *Typical and atypical motor development*. London: Mac Keith Press.
- Sugden, D. and Dunford, C., 2007. Intervention and the role of theory, empiricism and experience in children with motor impairment. *Disability and rehabilitation*, 29(1), pp.3-11.
- Sutherland, C.A., Albert, W.J., Wrigley, A.T. and Callaghan, J.P., 2008. A validation of a posture matching approach for the determination of 3D cumulative back loads. *Applied ergonomics*, 39(2), pp.199-208.
- Taylor-Cookson, J. Michelle, J., 2001. Seating for children and adolescents with special needs. *British Journal Therapy Rehabilitation*, 8, (6). pp.228-33
- Terwee, C.B., Prinsen, C.A., Chiarotto, A., Westerman, M.J., Patrick, D.L., Alonso, J., Bouter, L.M., De Vet, H.C. and Mokkink, L.B., 2018. COSMIN methodology for evaluating the content validity of patient-reported outcome measures: a Delphi study. *Quality of Life Research*, 27(5), pp.1159-1170.
- Terwee, C.B., Mokkink, L.B., Knol, D.L., Ostelo, R.W., Bouter, L.M. and de Vet, H.C., 2012. Rating the methodological quality in systematic reviews of studies on measurement properties: a scoring system for the COSMIN checklist. *Quality of life research*, 21(4), pp.651-657.
- Terwee, C.B., Dekker, F.W., Wiersinga, W.M., Prummel, M.F. and Bossuyt, P.M.M., 2003. On assessing responsiveness of health-related quality of life instruments: guidelines for instrument evaluation. *Quality of life research*, 12(4), pp.349-362.
- Thelen, E., 2005. Dynamic systems theory and the complexity of change. *Psychoanalytic dialogues*, 15(2), pp.255-283.
- Thelen, E., Kelso, J.S. and Fogel, A., 1987. Self-organizing systems and infant motor development. *Developmental Review*, 7(1), pp.39-65.
- Terzi, L., 2005. Beyond the dilemma of difference: The capability approach to disability and special educational needs. *Journal of philosophy of education*, 39(3), pp.443-459.

- Thonnard, J. and Penta, M., 2007. Functional assessment in physiotherapy. A literature review. *Europa medicophysica*, 43(4), p.525.
- Traub, R.E. and Rowley, G.L., 1991. Understanding Reliability: An NCME Instructional Module on. *Educational measurement: Issues and practice*, 10(1), pp.37-45.
- Tripepi, G., Jager, K.J., Dekker, F.W. and Zoccali, C., 2010. Selection bias and information bias in clinical research. *Nephron Clinical Practice*, 115(2), pp.c94-c99.
- Turvey, M.T., 1977. Preliminaries to a theory of action with reference to vision. *Perceiving, acting and knowing*, pp.211-265.
- Tyson, S.F. and DeSouza, L.H., 2003. A clinical model for the assessment of posture and balance in people with stroke. *Disability and rehabilitation*, 25(3), pp.120-126.
- Van Balen, L.C., Dijkstra, L.J., Bos, A.F., Van Den Heuvel, E.R. and Hadders-Algra, M., 2015. Development of postural adjustments during reaching in infants at risk for cerebral palsy from 4 to 18 months. *Developmental Medicine & Child Neurology*, 57(7), pp.668-676.
- Van Wyk, P.M., Weir, P.L., Andrews, D.M., Fiedler, K.M. and Callaghan, J.P., 2009. Determining the optimal size for posture categories used in video-based posture assessment methods. *Ergonomics*, 52(8), pp.921-930.
- Vekerdy, Z., 2007. Management of seating posture of children with cerebral palsy by using thoracic-lumbar-sacral orthosis with non-rigid SIDO frame. *Disability and Rehabilitation*, 29(18), 1434-1441.
- Walter, S.D., Eliasziw, M. and Donner, A., 1998. Sample size and optimal designs for reliability studies. *Statistics in medicine*, 17(1), pp.101-110.
- White, E., 1999. Wheelchair users and postural seating: A clinical approach. *British Journal of Occupational Therapy*, 62(7), 333-334.
- Wood, E. and Rosenbaum, P., 2000. The gross motor function classification system for cerebral palsy: a study of reliability and stability over time. *Developmental Medicine & Child Neurology*, 42(5), pp.292-296.
- Woollacott, M.H. and Shumway-Cook, A., 2005. Postural dysfunction during standing and walking in children with cerebral palsy: what are the underlying problems and what new therapies might improve balance?. *Neural plasticity*, 12.
- Woollacott, M.H., Burtner, P., Jensen, J., Jasiewicz, J., Roncesvalles, N. and Sveistrup, H., 1998. Development of postural responses during standing in healthy children and children with spastic diplegia. *Neuroscience & Biobehavioral Reviews*, 22(4), pp.583-589.

World Confederation for Physical Therapy (WCPT)., 2019. Evidence-based practice: Policy statement. World Confederation for Physical Therapy. [online] Available at: <https://world.physio/sites/default/files/2020-04/PS-2019-Evidence-based-practice.pdf> [Accessed 16 February 2020].

World Health Organisation (WHO), 2013. *World Health Organization. How to use the ICF: A practical manual for using the International Classification of Functioning, Disability and Health (ICF)*. Exposure draft for comment. October 2013. Geneva: WHO

World Health Organisation (WHO), 2007. *International Classification of Functioning, Disability, and Health: Children & Youth Version: ICF-CY*. World Health Organization.

Wright C., 2011. Posture, How it develops and why standing is important. [Online] available from: <https://www.leckey.com/media/1437/leckey-clinical-posture-how-it-develops-and-why-standing-is-important.pdf> [accessed 23.06.2019].

Wulf, G., McNevin, N. and Shea, C.H., 2001. The automaticity of complex motor skill learning as a function of attentional focus. *The Quarterly Journal of Experimental Psychology Section A*, 54(4), pp.1143-1154.

Young, N.L., Wright, J.G., Lam, P., Rajaratnam, K., Stephens, D., Wedge, J.H., 1998. Windswept Hip Deformity in spastic quadriplegic Cerebral Palsy. *Pediatric Physical Therapy*, 10, pp.94-100

Appendices

Appendix 1: Permission to use Images White (2011)

From: Marketing
Sent: 06 August 2015 15:25
To: Frances George
Subject: Re: request for permission to use images

Good afternoon Frances,

Thank you for your request.

We are happy for you to use the images you require. If you need any PDF's of the images, please let us know.

Kind Regards,
The Marketing Team!

From: Frances George [REDACTED]
Sent: 06 August 2015 15:11
To: Info <[REDACTED]>
Subject: request for permission to use images

To whom it may concern

I am a PhD student who is undertaking research into posture management and children with cerebral palsy. I am writing to seek your permission, as I am wanting to use some of your images from the below document in my PhD thesis:

Posture, How it's developing and why standing is important.

I accessed this off the internet, and am wanting to use images 1, 2 and 3 from this document. I will of course reference this work to yourselves.

Yours Sincerely

Frances George

Highly Specialised Physiotherapist MSc BSc HPC MCSP

[REDACTED]

Tel: [REDACTED]

Email: [REDACTED]

Appendix 2: Ethical approval letter- Content Validity

4th March, 2017

Nathalie Noret

Chair of Faculty of Health &
Life Sciences Research
Ethics Committee

Direct Line [REDACTED]

E-mail: [REDACTED]

Dear Frances,

**RE: Development and content validity of the Clinical Assessment of
Body Alignment for children with cerebral palsy.**

REF: 069011429_George_04032017

The research ethics committee has approved, without reservation, the above research ethics submission of 16th January 2017.

Yours sincerely



Appendix 3: Example of initial CABA items- arm alignment

Section D: Arm Analysis

Item 17: Locate arm alignment (flexion right arm)

Position of the individual's arm alignment from the side. Item scores the arm position from 0—3.

Score: 0

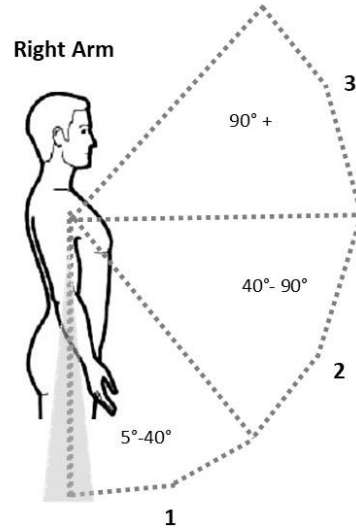

Item 18: Locate arm alignment (flexion left arm)

Position of the individual's arm alignment from the side. Item scores the arm position from 0—3.

Score: 0

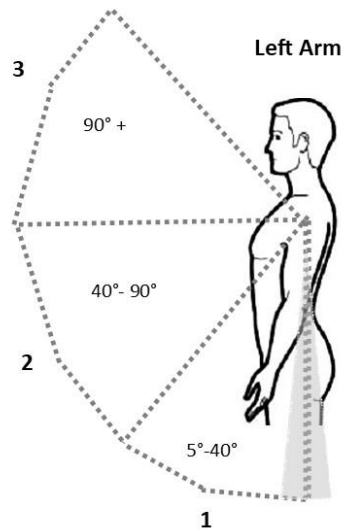

Item 19: Locate arm alignment (extension right arm)

Position of the individual's arm alignment from the side. Item scores the arm position from 0—3.

Score: 0

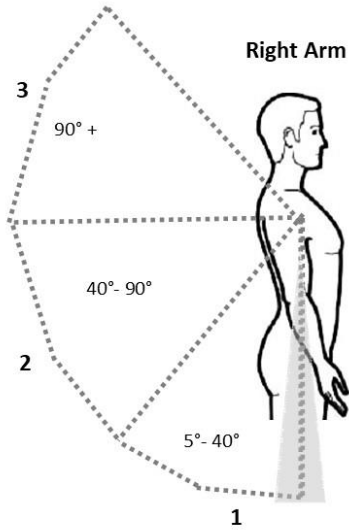

Item 20: Locate arm alignment (extension left arm)

Position of the individual's arm alignment from the side. Item scores the arm position from 0—3.

Score: 0

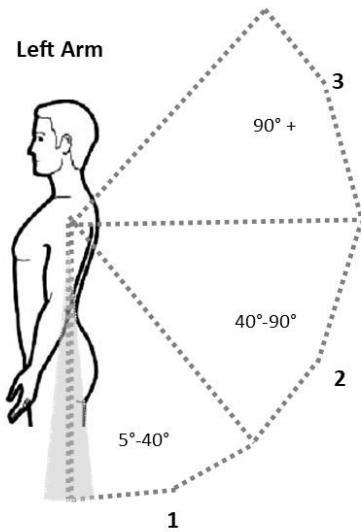

Appendix 4: Example of revised CABA items- arm alignment

Section D: Arm Analysis

Item 10: Locate arm alignment (flexion / extension)

Position of the individual's arm alignment from the side. Item scores the arm position from 0—3.

Score: 0

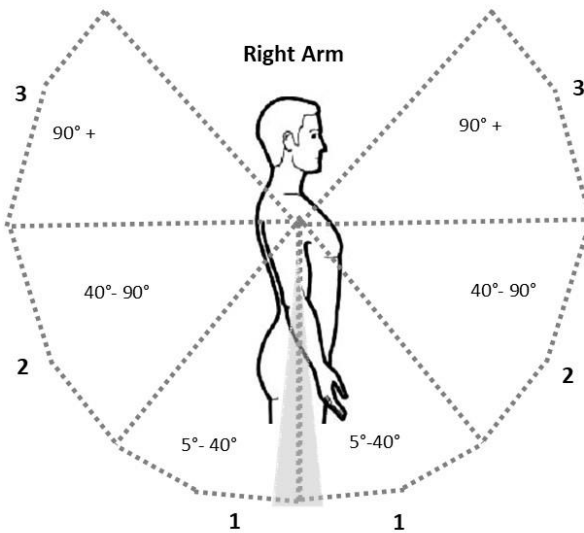
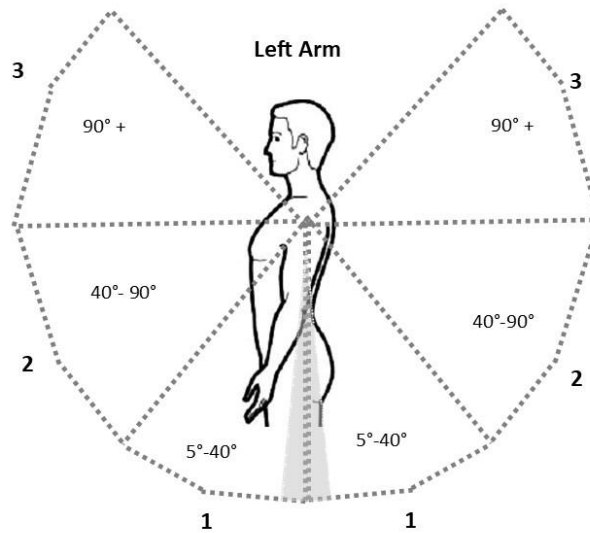

Appendix 5: Electronic Survey – content validity

Clinical Assessment of Body Alignment - CABA

Start of Block: General Info

Q1 This questionnaire is anonymised using a coded system. Please provide the last 3 digits of your postcode and the last 3 digits of your date of birth.

Providing this code is optional. However if you wish to withdraw from this survey before the closing date, this code can then be provided to the researcher and enable your responses to be discarded from the research project.

Q2 Of which APCP region are you a member of?

Q3 How many years have you been working as a qualified physiotherapist?

Q4 Which of the following best describes your area of speciality? If you have more than one area, please tick all that apply.

- Musculoskeletal (1)
 - Neonatal (2)
 - Neurodisability (3)
 - Management (4)
 - Respiratory (5)
 - Orthopaedic (6)
 - Community (7)
 - Acute ward (8)
-

Q5 Which of the following best describes your place of work?

If you work across more than one of these areas, please tick your primary area of work.

- NHS (1)
- Private practice (2)
- Education (3)
- General Practitioners practice (4)

Start of Block: Assessment items

Q6 PART 2

For the following questions please use the operational definitions of body alignment & body segment:

Body alignment: The position of body segments in relation to one another and their orientation in space.

Body segment: The position of the head, trunk, pelvis, arms, legs and feet.

The following questions will ask you to rate if each of the following assessment items matches the definition of body alignment.

Q7 Section A: Head position

Item 1: Locate head alignment (flexion / extension) Position of the individual's head from the side. Item scores the head position from 0 - 3.

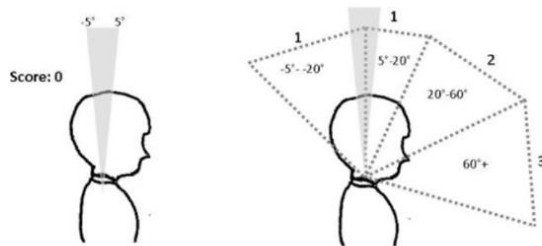

Q8 Does the above item match body alignment?

▼Yes (1) ... No (2)

Q9 Item 2: Locate Head alignment (side flexion). Position of the individual's head from the front or back. Item scores the head position from 0 - 3.

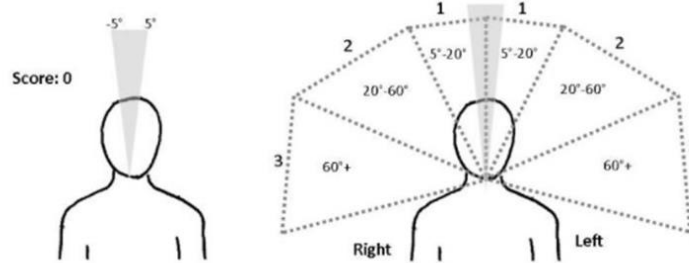

Q10 Does the above item match body alignment?

▼Yes (1) ... No (2)

Q11 Item 3: Locate head alignment (rotation) Position of the individual's head in the transverse plane. Item scores the head position from 0 - 3.

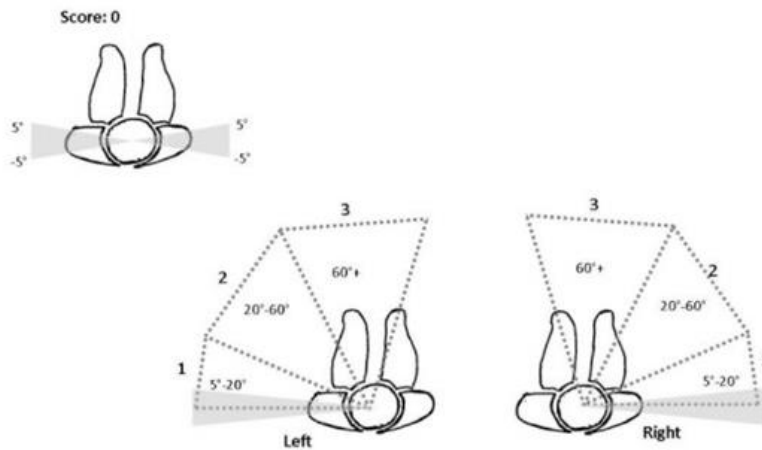

Q12 Does the above item match body alignment?

▼Yes (1) ... No (2)

Q13 Section B: Trunk Analysis

Item 4: Locate trunk alignment (flexion / extension) Position of the individual's trunk from the side. Item scores the trunk position from 0 - 3.

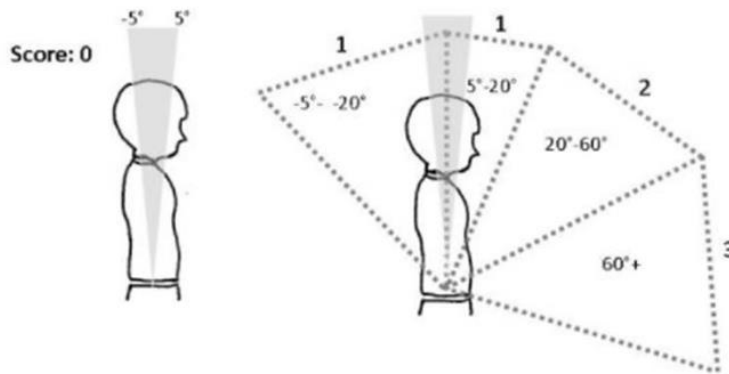

Q14 Does the above item match body alignment?

▼Yes (1) ... No (2)

Q15 Item 5: Locate trunk alignment (side flexion). Position of the individual's trunk from the front or back. Item scores the trunk position from 0 - 3.

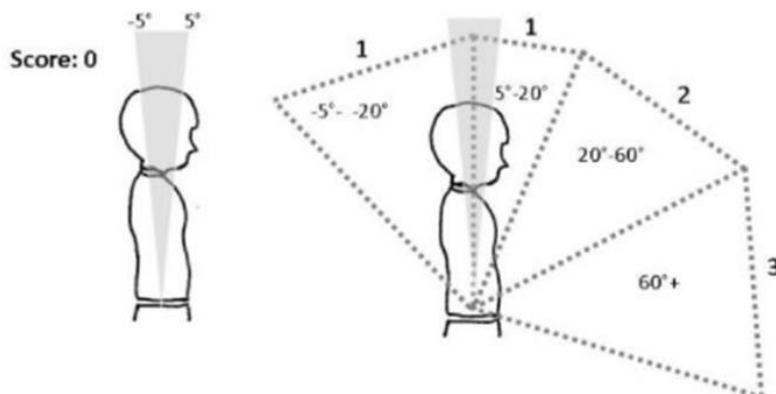

Q16 Does the above item match body alignment?

▼Yes (1) ... No (2)

Q17 Item 6: Locate trunk alignment (rotation). Position of the individual's trunk in the transverse plane. Item scores the trunk position from 0 - 3.

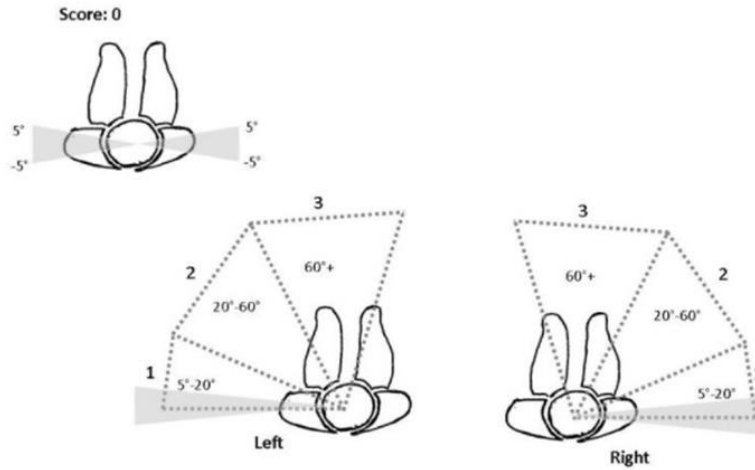

Q18 Does the above item match body alignment?

▼Yes (1) ... No (2)

Q19 Section C: Pelvis analysis

Item 7: Locate Pelvic alignment (posterior / anterior tilt). Position of the individual's pelvis from the side. Item scores the pelvic position from 0-3.

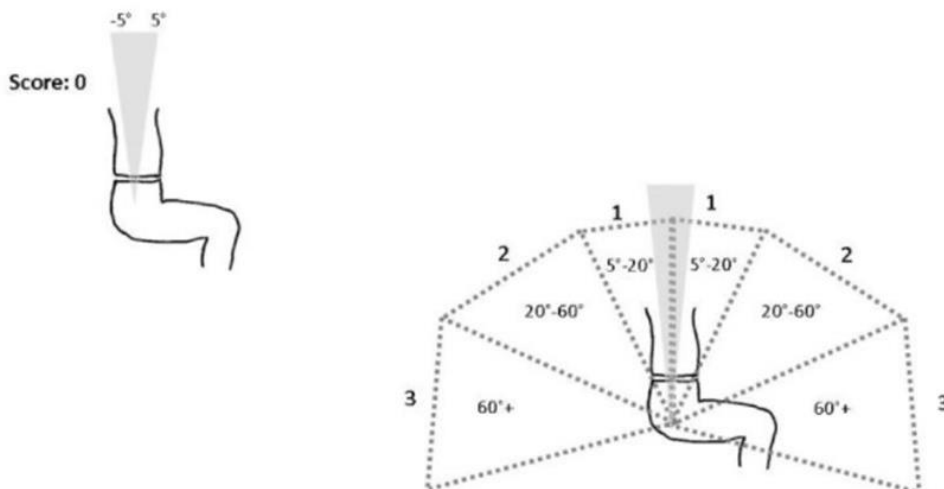

Q20 Does the above item match body alignment?

▼Yes (1) ... No (2)

Q21 Item 8: Locate Pelvic alignment (obliquity). Position of the individual's pelvis from the front or back. Item scores the pelvic position from 0 - 3.

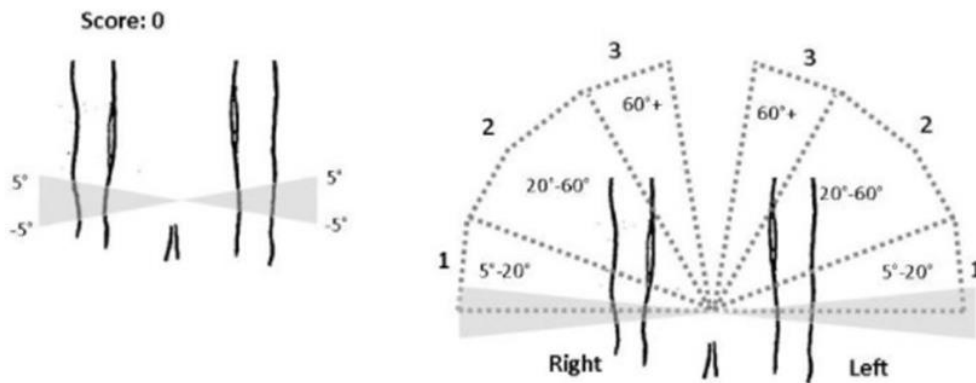

Q22 Does the above item match body alignment?

▼Yes (1) ... No (2)

Q23 Item 9: Locate Pelvic alignment (rotation). Position of the individual's pelvis from the transverse plane. Item scores the pelvic position from 0 - 3.

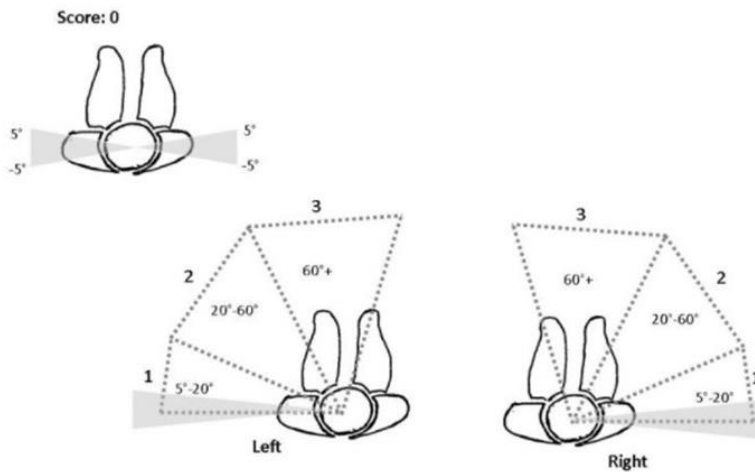

Q24 Does the above item match body alignment?

▼Yes (1) ... No (2)

Q25 Section D: Arm Analysis

Item 10: Locate arm alignment (flexion / extension). Position of the individual's arm alignment from the side. Item scores the arm position from 0—3.

Score: 0

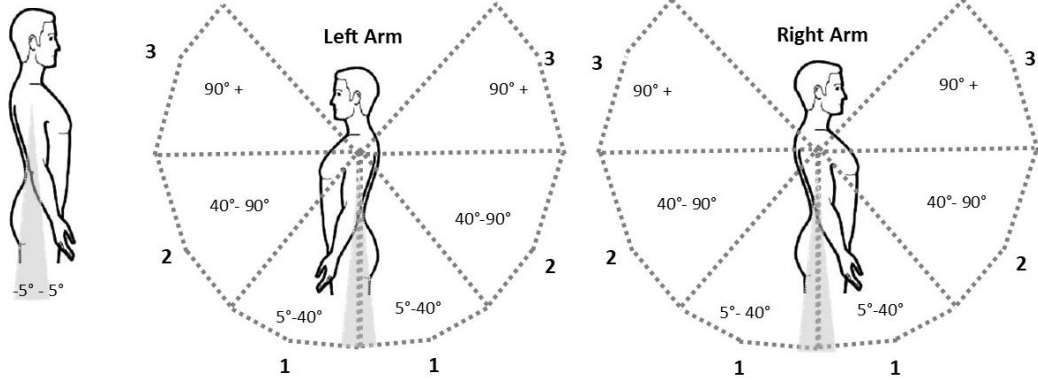

Q27 Does the above item match body alignment?

▼Yes (1) ... No (2)

Q26 Item 11: Locate arm alignment (abduction / adduction). Position of the individual's arm alignment from the front. Item scores the arm position from 0—3.

Score: 0

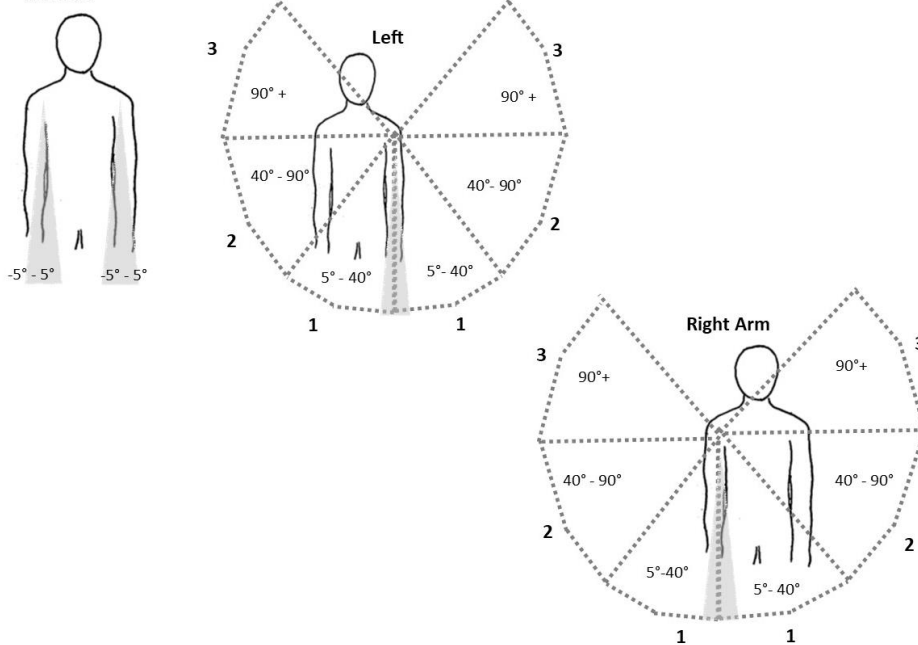

Q27 Does the above item match body alignment?

▼Yes (1) ... No (2)

Q28 Section E: Leg position (standing or lying)

Item 12: Locate leg alignment (flexion / extension). Position of the individual's leg from the side. Item scores the leg position from 0—3.

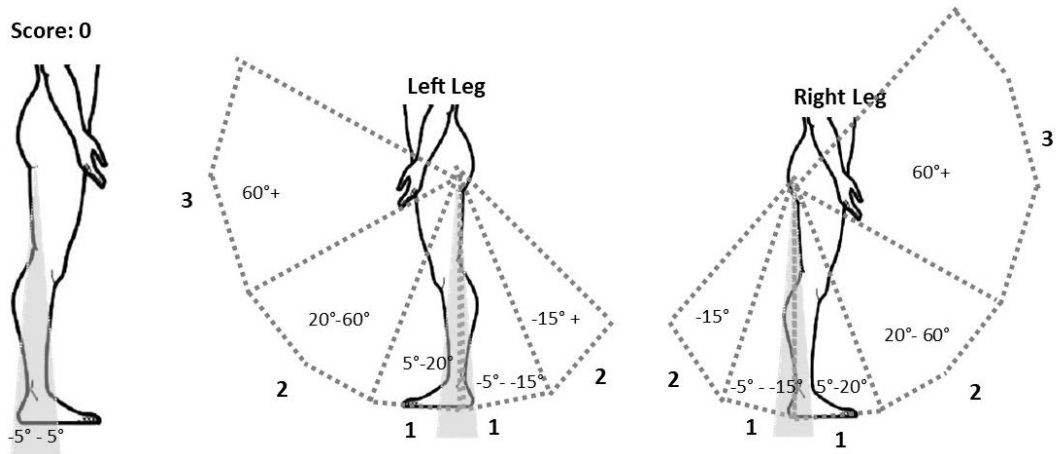

Q29 Does the above item match body alignment?

▼Yes (1) ... No (2)

Q30 Item 13: Locate leg alignment (abduction / adduction). Position of the individual's leg from the front or back. Item scores the leg position from 0—3.

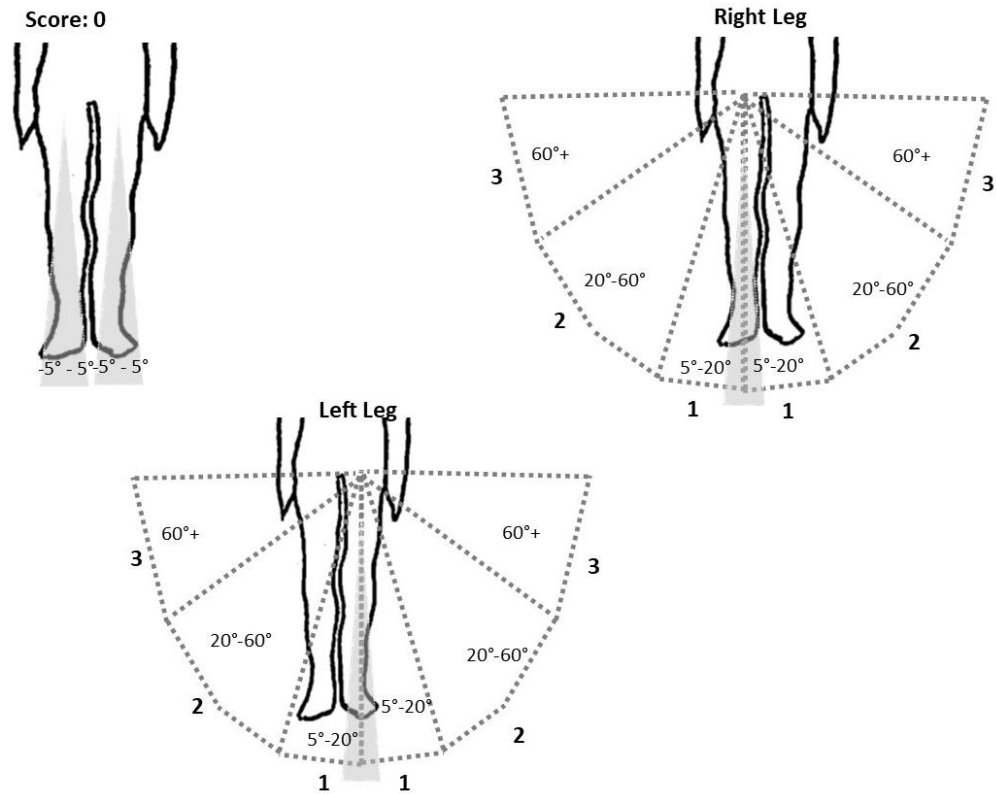

Q31 Does the above item match body alignment?

▼Yes (1) ... No (2)

Q32 Item 14: Locate leg alignment (rotation). Position of the individual's leg from the front. Item scores the leg position from 0—3.

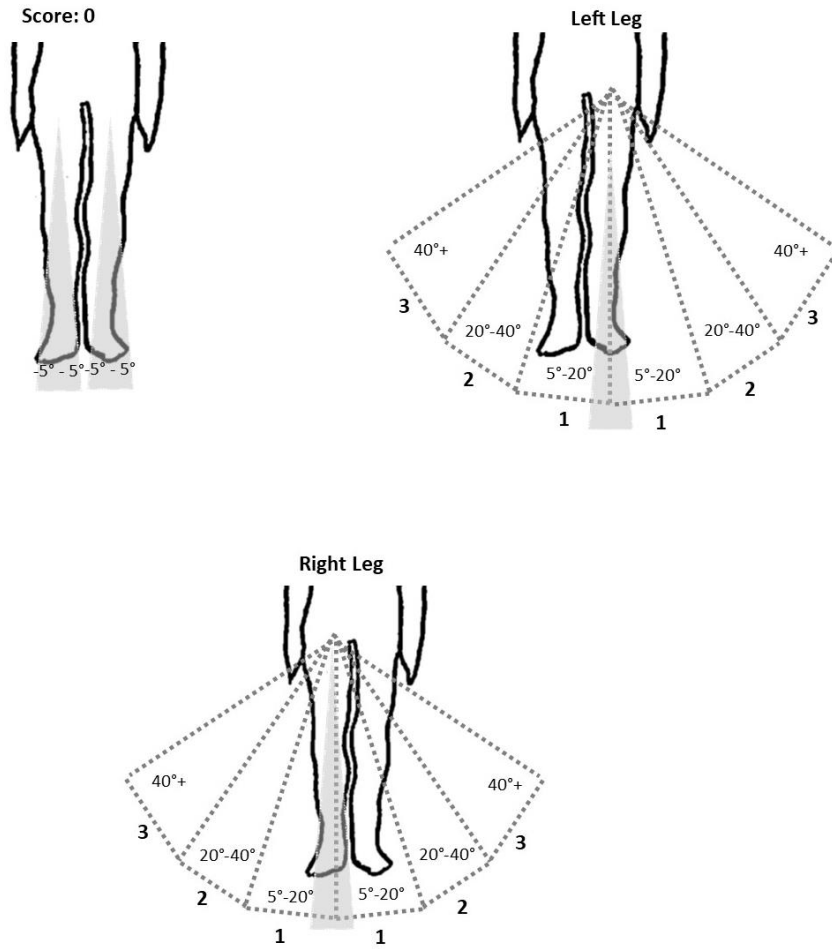

Q33 Does the above item match body alignment?

▼Yes (1) ... No (2)

Q34 Section E: Leg position (sitting)

Item 15: Locate Upper leg alignment (flexion / extension). Position of the individual's leg from the side. Item scores the leg position from 0—3.

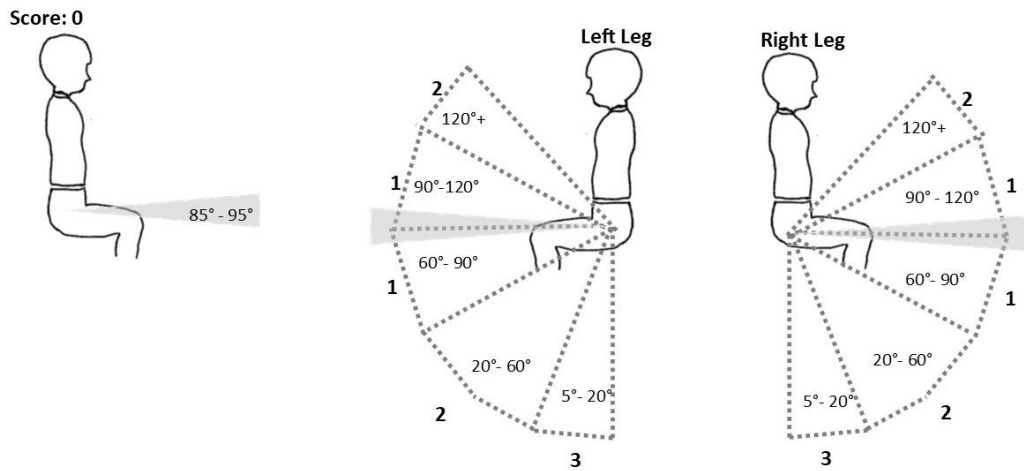

Q35 Does the above item match body alignment?

▼Yes (1) ... No (2)

Q36 Item 16: Locate Lower leg alignment (flexion / extension). Position of the individual's leg from the side. Item scores the leg position from 0—3.

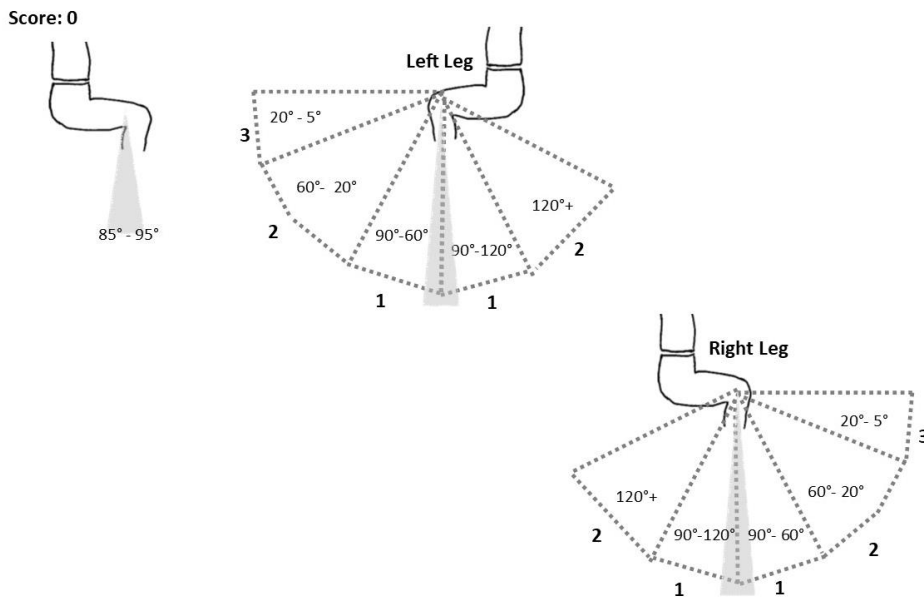

Q37 Does the above item match body alignment?

▼Yes (1) ... No (2)

Q38 Item 17: Locate leg alignment (abduction / adduction). Position of the individual's leg from the front or back. Item scores the leg position from 0—3.

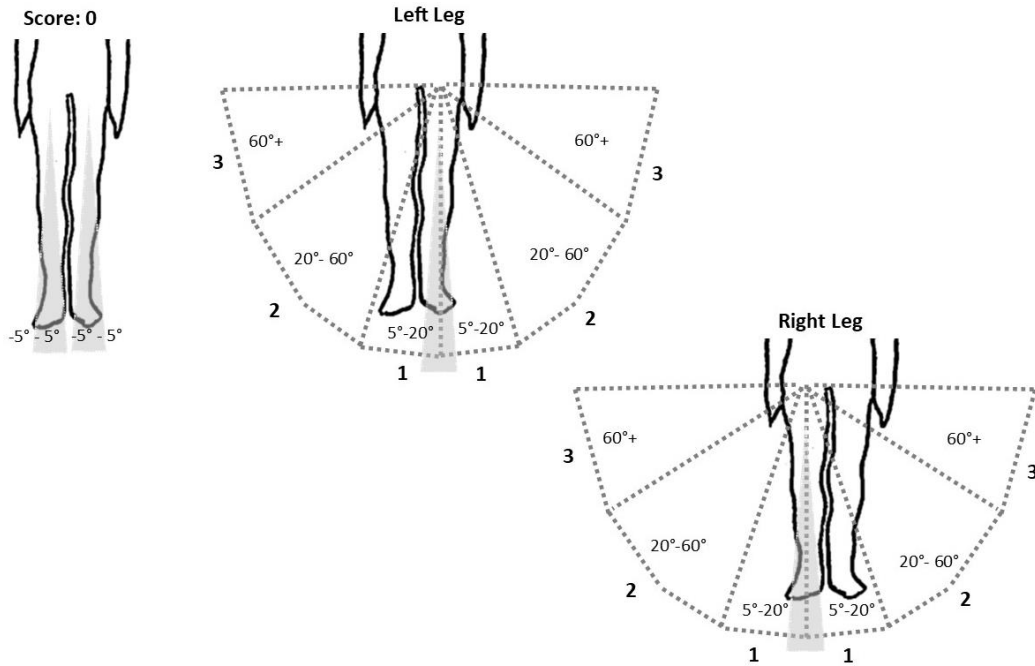

Q39 Does the above item match body alignment?

▼Yes (1) ... No (2)

Q40 Item 18: Locate leg alignment (rotation). Position of the individual's leg from the front or back. Item scores the leg position from 0—3.

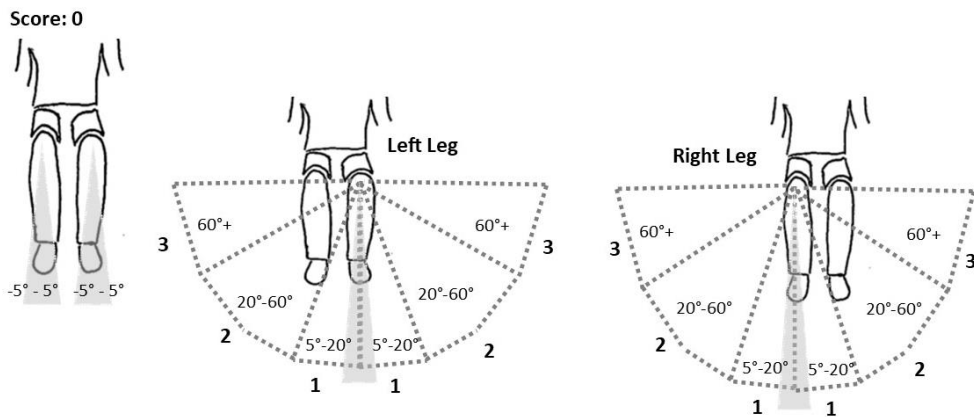

Q41 Does the above item match body alignment?

▼Yes (1) ... No (2)

Q42 Section F: Foot position

Item 19: Locate foot alignment (inversion / eversion). Position of the individual's foot from the front or back. Item scores the foot position from 0—3.

Score: 0

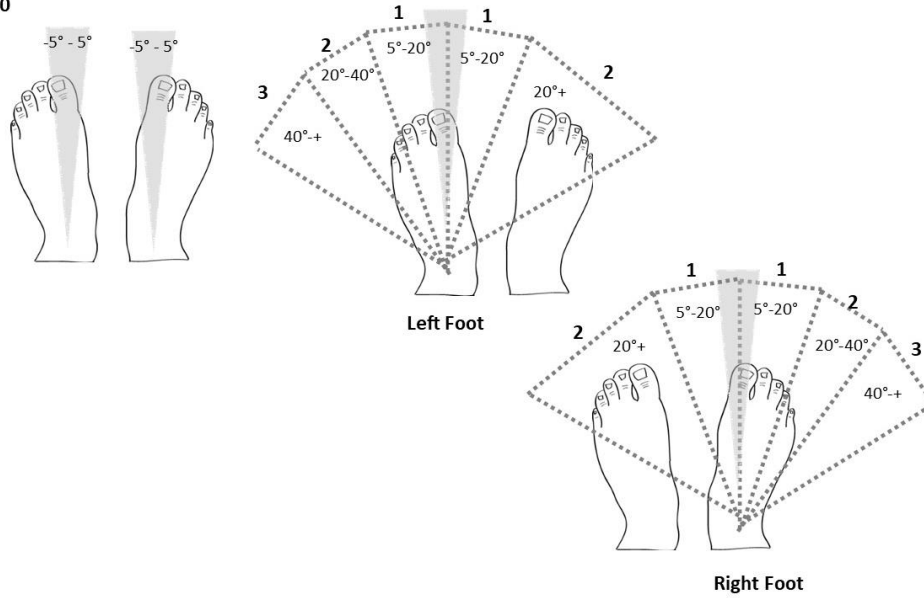

Q43 Does the above item match body alignment?

▼Yes (1) ... No (2)

Q44 Item 20: Locate foot alignment (plantarflexion / dorsiflexion). Position of the individual's foot from the side. Item scores the leg position from 0—3.

Score: 0

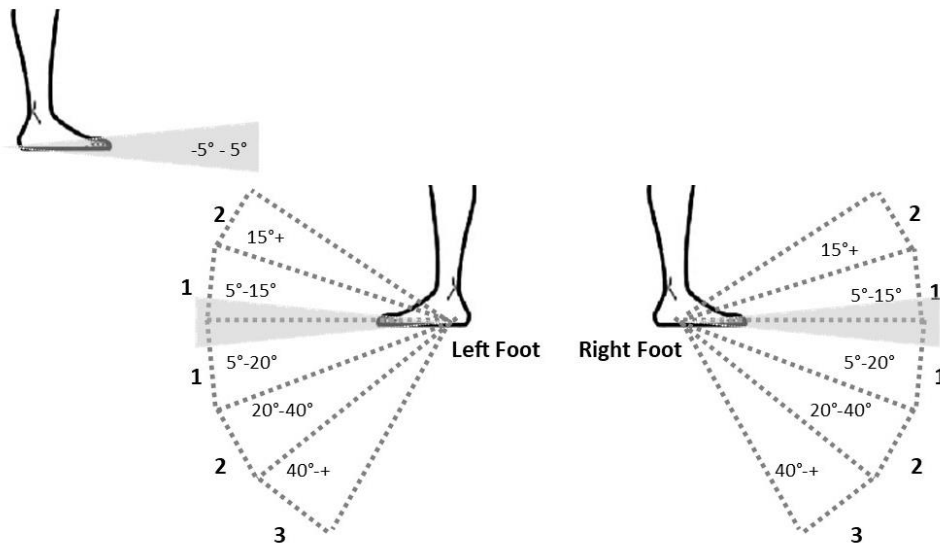

Q45 Does the above item match body alignment?

▼Yes (1) ... No (2)

Q46 Please state any other item which you feel should be included in an observational assessment of body alignment.

End of Block: Assessment items

Start of Block: clinical utility

Q47 PART 3

For the following question, please use these operational definitions of essential and not relevant:

Essential: item is essential and must be included to ensure the assessment has clinical utility. To exclude this would mean that the assessment had an extremely high risk of not being able to be used in everyday clinical settings.

Not relevant: this item would never impact on the assessment being used within everyday clinical practice



Q48 How important are the below items for using the CABA within clinical practice?

	Essential (4)	Important (5)	Acceptable (6)	Marginally relevant (7)	Not relevant (8)
Formal training (1)	<input type="radio"/>	<input type="radio"/>	<input type="radio"/>	<input type="radio"/>	<input type="radio"/>
Informal training (2)	<input type="radio"/>	<input type="radio"/>	<input type="radio"/>	<input type="radio"/>	<input type="radio"/>
Cost (3)	<input type="radio"/>	<input type="radio"/>	<input type="radio"/>	<input type="radio"/>	<input type="radio"/>
Time to complete (4)	<input type="radio"/>	<input type="radio"/>	<input type="radio"/>	<input type="radio"/>	<input type="radio"/>
Format - electronic (5)	<input type="radio"/>	<input type="radio"/>	<input type="radio"/>	<input type="radio"/>	<input type="radio"/>
Format - paper based (6)	<input type="radio"/>	<input type="radio"/>	<input type="radio"/>	<input type="radio"/>	<input type="radio"/>
Format - paper based and electronic (7)	<input type="radio"/>	<input type="radio"/>	<input type="radio"/>	<input type="radio"/>	<input type="radio"/>
Usability in different environments (8)	<input type="radio"/>	<input type="radio"/>	<input type="radio"/>	<input type="radio"/>	<input type="radio"/>
Ease of use (9)	<input type="radio"/>	<input type="radio"/>	<input type="radio"/>	<input type="radio"/>	<input type="radio"/>
Requirement of equipment to conduct assessment (10)	<input type="radio"/>	<input type="radio"/>	<input type="radio"/>	<input type="radio"/>	<input type="radio"/>
Demand on the child (11)	<input type="radio"/>	<input type="radio"/>	<input type="radio"/>	<input type="radio"/>	<input type="radio"/>
Transportability (12)	<input type="radio"/>	<input type="radio"/>	<input type="radio"/>	<input type="radio"/>	<input type="radio"/>
Ease of analysis (13)	<input type="radio"/>	<input type="radio"/>	<input type="radio"/>	<input type="radio"/>	<input type="radio"/>

End of Block: clinical utility

Appendix 6: Email information – content validity

We invite you to take part in this questionnaire as part of the research study: ‘what is the content validity of the Clinical Assessment of Body Alignment in children with CP?’

This study is being done as part of PhD research project by lead researcher Frances George from York St John University. You are invited because you are a health professional working with children with cerebral palsy.

The survey should take you no more than 5 minutes to complete.

We want to gain as many people’s views as possible. The questions are very simple. Apart from confirming your APCP region, years of experience and area of specialty, you will be asked to rate the assessment items as either being relevant or not by ticking a yes or no box. The final part of the questionnaire has 1 question looking at how important clinical usability of an assessment is, using a 5 point scale and only 1 question requires a written answer, but this is optional to fill in. Please fill in as much as you can – your ideas are very important to us.

You may not directly benefit from this research. Your participation will inform future research, and hopefully will improve postural management for children with cerebral palsy. Your answers will be used to produce a PhD thesis, publication report but individual comments will remain anonymous.

You do not need to give us any contact information.

Taking part is your choice and you can withdraw at any time within 60-days of the survey.

If you have questions about this project or if you have a research-related problem, you may contact:

Frances George: [REDACTED]

Dr Lynne Gabriel: [REDACTED]

Please note this survey will close in 50 days from the date of the email.

Appendix 7: Participant Information – content validity

Participant Information Sheet: Development and content validity of the Clinical Assessment of Body Alignment for children with cerebral palsy.

What is the purpose of this study?

You have been invited to take part in a research project which aims to develop a tool to assess body alignment, and to examine the content validity of this new scale.

The study involves the development of a Clinical Assessment of Body Alignment (CABA). This assessment is to be used by physiotherapists as part of their clinical practice in the assessment of body alignment, as part of posture management interventions with children with cerebral palsy.

This study is part of a PhD project exploring the assessment of posture management in children with cerebral palsy. Before you decide if you would like to participate we would like to explain the study and what we would expect from you. You may talk to others about the study before you decide if you would like to participate. Please do not hesitate to contact us if you have any questions, contact details are below.

Why have I been invited?

You have been invited as you have been identified as being a member of the APCP special interest group, and have experience within the field of paediatric physiotherapy.

What is expected of me if I take part?

If you chose to participate in the study you will be involved in completing the online questionnaire which is attached to this email.

The questionnaire has N questions set out in three parts.

- Part one asks you to answer questions relating to your APCP region, years of experience and area of specialty.
- Part two asks you to rate each assessment item as either being relevant or not by ticking a yes or no box.

This section also has one open question where you can state any other items you feel would be beneficial in the assessment of body alignment.

- Part 3 asks you to rate the degree of importance of items which relate to the clinical usability of the assessment, using a 5 point scale.

You may be contacted a second time to if additional items are found from the first round of open ended responses. Only new items will be circulated electronically in a second round and you will be asked to rate if the new items do or do not match the attribute of body alignment by ticking a yes or no box.

The first questionnaire should take no more than 25 minutes to complete. It is envisaged that the second questionnaire (if needed) would take a shorter amount of time, but no longer than 25 minutes.

The data collected from responses will be analysed and summarized as part of the PhD Project.

Consenting and Taking part?

If you wish to consent to being part of this study then please complete the attached questionnaire and submit.

The questionnaire will be open and accessible for 1 month from the date of the email.

If you do not wish to take part then please delete this email.

Do I have to take part?

Your decision to take part is completely voluntary. You may refuse to participate or withdraw from the survey at any point.

Each questionnaire will be anonymised using a coding system. Participants will be asked to provide the last three digits of their postcode and their date of birth. This code can then be provided to the researcher if you wish to withdraw.

Expenses and payment

You will not be paid for taking part in this study.

What are the possible disadvantages and risks of taking part?

We expect no serious risks.

What are the possible benefits of taking part?

Participants will be able to contribute to this research; this may then lead to further research as part of this PhD project regarding postural management and children with cerebral palsy. Participants may find participation an opportunity to contribute and share their knowledge, assisting in shaping future clinical assessments which are clinically applicable to practice.

Who can I contact about the project?

If you have any queries or questions please contact:

Principal Investigator: Frances George Email: [REDACTED] Phone: [REDACTED]

School of Health Sciences, York St John University

Alternatively you can contact my supervisor: Lynne Gabriel Email: [REDACTED]
Phone: [REDACTED]

If you have any concerns regarding how the research has been conducted, please contact [REDACTED], chair of the cross schools research ethics committee at [REDACTED], or by phone at [REDACTED].

Will my taking part in this study be kept confidential?

The questionnaires will be anonymous, at no point will you be asked to state your name and individual questionnaires cannot be traced back to an identified individual. Names will not be used in the final publication, so that you will not be identifiable.

The questionnaire will then be kept securely, with access by the principal research only, for as long as may be needed in the future.

Please retain this document for your records. If you have any questions or queries please do not hesitate to contact the principal researcher.

How will the information be used?

This research is part of a PhD study into posture management with cerebral palsy, and the results of this study may be used in the following ways:

- As part of a PhD study
- Part of a series of publications / conference presentations / book.
- Within further research.
- Informing best practice guidelines, government input.
- Teaching / training / education.

Appendix 8: Ethical Application – content validity

Please indicate which route you wish your application to follow:

Route 1 Ethical approval is not required

Route 2 Approval by expedited review

Route 2 ▼

Route 3 Approval without full ethical review

Route 4 or 5 Full ethical review required

STEP ONE: Provide an outline of the project

Everyone must complete this brief outline that shows the Research Ethics Committee what the project entails.

Where will you get your research material?

Documents:

Unpublished:

Published:

Existing databases:

Other (specify):

Online or social media:

Blogs:

Chat rooms:

Webpages:

Other (specify):

From people by:

Interviews:

Focus groups:

Questionnaires:

Other (specify):

Biological, medical or social data from:Animals: Members of the public: Medical patients: Social care clients: **Other research material:**

Specify:

If human participants are involved are they:Under 16: Adults able to give consent: Adults unable to give consent **Briefly describe your project****Outline**

Body alignment is the position of body segments in relation to one another and their orientation in space. Body segments are defined as the position of the head, trunk, pelvis, arms, legs and feet. These are connected together through the spinal joints, hips, shoulders, knees, and wrist and ankle joints, known as the body linkages. Impairments in body alignment have been documented in children with CP, and is important for enabling effective functional movement. A valid, reliable and clinically feasible assessment measure of body alignment is important for describing when and how body alignment is impaired and monitoring change in children's body alignment. This should lead to amelioration as much as possible via specific interventions, prominently posture management programmes.

There is a paucity of available standardised clinical assessments of body alignment for children with CP that include assessment of the head, trunk, pelvis, arms, legs and feet.

Aims:

The aim of this study is to describe the creation of the Clinical Assessment of Body Alignment (CABA) and examine its content validity.

The primary research question is: Does the CABA have content validity?

Methods

To evaluate construction of the CABA and its content validity, a consensus process and expert panel review design will be employed.

Through consensus, 3 researchers (primary researcher and 2 members of the PhD supervision team) will select an initial pool of items to create the CABA.

Content validity will be examined through expert opinion; a purposeful sample of Physiotherapists who are members of the Association of Paediatric Chartered Physiotherapists (APCP), a special interest group consisting of experts within the field of paediatric physiotherapy will be contacted.

The list of items will be sent out electronically to all APCP members. Respondents will be asked if they want to participate, a month period will be given for responses to be made. Respondents will be asked to review the CABA items scoring them as either matching or not to the domain of body alignment. One open Question will be provided for respondents to state any other assessment item they think should be included, these responses will be tallied. If additional items are found from the first round of responses, these will be circulated electronically in a second round and respondents will be asked to rate if the new CABA items do or do not match the attribute of body alignment.

Respondents will also evaluate the clinical utility of the CABA, scoring items relating to clinical utility in terms of importance using a 5 point scale.

STEP TWO: Initial Screening Checklist

Please complete the initial screening checklist by clicking either 'Yes' or 'No' in EACH row:

Subject area

If the research involves matters of social, political or personal sensitivity you need to be aware of the boundary between legitimate academic enquiry and unnecessarily offensive or illegal behaviour.

1. **Will the research require the collection of primary source material that might possibly be seen as offensive or considered illegal to access or hold on a computer?** Examples might be studies related to state security, pornography, abuse or terrorism. Check the [Prevent Duty Guidance for Higher Education](#).

OR

Does your research concern groups which may be construed as terrorist or extremist?

 No

If your answer to this question is “Yes”, you must complete and submit the supplementary form available as an appendix to your Research Ethics approval form. **You will also need to complete Appendices A and B at the end of the form to ensure secure data storage for security-sensitive information.**

2. **Will the study involve discussion or disclosure of information about sensitive topics?**

 No

This may involve legal issues that are nonetheless sensitive (e.g. sexual orientation, or states of health), or topics where illegal behaviour could be revealed (e.g. abuse, criminal activity, under-age drinking or sexual activity).

Participants: recruiting and consent

If the research involves collecting data from people you need to be aware of issues related to ensuring that they are able to give informed consent to participate where appropriate. This means being aware of how people are recruited, and whether they understand what information is being collected and why. In some cases data collection has to be covert, or informed consent is not possible from the participants themselves. These require particular attention.

3. **Will the study require the co-operation of a gatekeeper to give access to, or to help recruit, participants?**

 No

Examples include head teachers giving access to schools, ministers giving access to congregations, group leaders publicising your research.

4. **Will it be necessary for participants to take part in the study without their knowledge or consent at the time?**

 No

Examples might be studies of group behaviour or the use of data that was not intentionally collected for research.

5. **Will the study involve recruitment of patients through the NHS?**

 No

There are particular issues and procedures required if the research will involve

NHS users.

6. **Will inducements be offered to participants?**

This could include direct payments, the offer of being entered in a prize draw, or, for students, the offer of course credit for participation. It does not include the payment of legitimate expenses.

 No

7. **Does the study involve participants who are particularly vulnerable or unable to give informed consent?**

You must answer 'yes' if any participants are under 18. Adults with learning disabilities, the frail elderly, or anyone who may be easily coerced due to lack of capacity is considered vulnerable. If you teach and you wish to research your own students, they should be classed as potentially vulnerable.

 No

Data collection

Where the collection of data involves more than trivial risk to participants researchers must weigh carefully the necessity of the procedure, the level of possible harm, and the benefits of the research.

8. **Will the study require participants to commit extensive time to the study?**

Single-session interviews or completing questionnaires once or twice would not be considered excessive, but long-term studies with multiple sampling, intensive data gathering over a day or more, or long interviews and questionnaires that take some hours to complete might fall into this category.

 No

9. **Are drugs, placebos or any other substances to be administered to participants, or will the study involve invasive, intrusive or potentially harmful procedures of any kind?**

Even simple procedures such as tasting sessions might be dangerous if participants have allergies, so tick yes if the research involves any substance trials.

 No

10. **If there are experimental and control groups, will being in one group disadvantage participants?**

Examples might be testing new teaching methods where pupils without the trial procedure may be disadvantaged, or trying a new procedure where the outcomes are uncertain.

 No

11. **Is an extensive degree of exercise or physical exertion involved?**

If participants are unused to such exercise it could put them at risk, so it is important for researchers to be aware of this and communicate it to volunteers.

 No

12. **Will blood or tissue samples be obtained from participants?**

These procedures require specialist training and are covered by particular ethical

 No

codes.

13. **Is pain or more than mild physical discomfort likely to result from the study?**

No

14. **Could the study induce psychological stress or anxiety or cause harm or negative consequences beyond the risks encountered in normal life?**

This might be because the subject area is sensitive, the nature of task (e.g. decision-making under pressure), or the participants are particularly vulnerable to stress or anxiety (e.g. those with a history of poor mental health).

No

Date (dd/mm/yy):

01/12/16

Researcher: Enter your name here to confirm you have answered all the questions on the checklist:

frances george

When you have completed the checklist click here to see what to do next

Appendix 9: Ethical approval letter- Reliability and construct validity

Nathalie Noret

Chair of Faculty of Health &
Life Sciences Research
Ethics Committee

22nd September, 2017

Direct Line [REDACTED]

E-mail: [REDACTED]

Dear Frances,

RE: A study into the inter and intra-rater reliability and usability of the Clinical Assessment of Body Alignment (CABA) in children with cerebral palsy.

REF: 069011429_George_22092017

The research ethics committee has approved, without reservation, the above research ethics submission of 22nd June 2017.

Yours sincerely



Appendix 10: Gate Keeper Letter – Reliability Study

Dear

I am writing to you regarding a study which aims to develop a clinical assessment of body alignment, and to examine the validity and reliability of this new Assessment. The study involves the development of a Clinical Assessment of Body Alignment (CABA). This assessment is to be used by physiotherapists as part of their clinical practice in the assessment of body alignment, as part of posture management interventions with children with complex needs.

This study is part of a PhD project exploring the assessment of posture management in children with cerebral palsy in order to better understand the current practice and inform future service development for within this field.

The study will take the form of survey to Paediatric physiotherapists who are members of the Association of Paediatric Chartered Physiotherapists (APCP), a special interest group consisting of 2,200 experts within the field of paediatric physiotherapy in the UK. Physiotherapists will be asked to assess the body alignment of 5 children with cerebral palsy, using the CABA assessment.

Each child will have 4 photographs taken in sitting, lying and standing. Photographs will be taken from 4 different body angles - front, back, side and horizontal. Each child will wear shorts and vest tops in the photographs to enable physiotherapy to observe and score body alignment. The photo session occurs once and will take no more than 20 minutes; it is recognised that children with complex postures may take longer but no more than 30 minutes in total. Each photograph will have the child's face blanked out to avoid identification and will be taken against a neutral background to avoid identification of the school and location.

Photographs will be stored on an encrypted USB data stick. They will be disseminated in a survey. The survey will be sent out to 2,200 paediatric physiotherapists who are members of a special interest groups APCP; who will be able to access the survey for a 1 month period. If a poor response is obtained after 1 month then the survey accessibility will be extended for a further 1 month period. The survey will be accessible for a maximum of 2 months, after which it will expire.

Children will be identified by the primary researcher and their parents contacted individually using the schools established and preferred method of communicating with parents; the use of home school books. Parents will not be approached directly by the lead researcher for consent to participate in the study. The information to caregivers will make it very clear that participation is voluntary and that refusal or withdrawal will not influence the therapy support either they or their child receive for postural management, and any other therapy intervention. Parents will be sent a letter and provided with detailed information regarding the study. Parents will be provided with a return envelope and asked to return a consent form to school for the attention of the primary researcher if they consent to their child participating in this study.

Children will also be given information about the study; taking into consideration the complex learning and communication needs of the child participants, it is important that these approaches are tailored to the needs of those involved. It is particularly important to note there is likely to be a range of needs and abilities, therefore tools may need to be adapted to suit the individuals not the group as a whole. Such decisions will be informed by consulting relevant experts (for example, parents, practitioners and support workers) and it may well be necessary to work alongside parents or support workers when taking the photographs. Body responses will be observed and taken as the child assenting to participate in the study, each child's individual pupil profile will be used to inform body responses displayed when they are happy and unhappy. If a child is able to give a verbal response this will also be included alongside observation of body response. Caregivers will be given a copy of the child participation information so they can share this with their child. Signed consent forms for participation will be obtained from the caregivers of all included children participants.

Postural management has become part of the recommended treatment for some children with cerebral palsy and can help improve quality of life through maintaining physiological function, whilst also promoting participation and interaction.

Currently there is no standardised assessment regarding the analysis of body alignment and provision of postural management programmes, and therefore a variable level of service is being provided both locally and across the country. Hence, the information gained from this study aims to examine the validity and reliability of this new assessment. This may prompt further research into posture management in the longer term, helping to form a base of knowledge for the development of a standardised service framework.

I would greatly appreciate your help in both allowing children with cerebral palsy from your school to participate in the study. Parents of identified children will be contacted individually and provided with more information regarding the study, and asked if they would be willing for their child to participate.

If you have any questions or queries please do not hesitate to contact me.

Yours faithfully

Frances George (Principal researcher)

Appendix 11: Caregiver participation Information – Reliability

Caregiver Participant Information Sheet: Inter-rater and intra-rater reliability of the Clinical Assessment of Body Alignment for children with cerebral palsy.

What is the purpose of this study?

Your child has been invited to take part in a research study. Before you decide if you would like your child to participate we would like to explain about the study and what we would expect your child to do. You may talk to others about the study before you decide if you would like to participate. Please do not hesitate to contact us if you have any questions, contact details are below.

This research study is part of a PhD project exploring the assessment of posture management in children with cerebral palsy. It aims to develop an assessment of body alignment Clinical Assessment of Body Alignment (CABA), and to examine how reliable this is when used by physiotherapists as part of posture management interventions for with children with cerebral palsy.

Why has my child been invited?

Your child has been invited as they have been identified as having a diagnosis of cerebral palsy.

Does my child have to take part?

The decision for your child to take part is completely voluntary. You may refuse to participate or withdraw from the study at any point. Your refusal to participate or wish to withdraw from the study will not influence the therapy support you or your child receives for postural management or any other therapy intervention.

What is expected of my child and me if I take part?

If you chose for your child to participate in this study they will be have 4 photographs taken in sitting, on a wooden box / plinth, lying on a mat and standing for use in a physiotherapy survey. If your child struggles to sit or stand without support then an adult will support them.

Photographs will be taken from 4 different body angles - front, back, side and horizontal. Each child will wear shorts and vest tops in the photographs to enable physiotherapy to observe and score body alignment. The photo session occurs once and will take no more than 20 minutes; it is recognised that children with complex postures may take longer but no more than 30 minutes in total.

Each photograph will have the child's face blanked out to avoid identification and will be taken against a neutral background to avoid identification of the location.

You as a caregiver do not need to do anything or have any involvement in this study. However, if you want, you are more than welcome to be present for the photographs. You will receive a copy of your child's photograph prior to them being placed in the survey.

Storage and dissemination of Photographs:

Photographs will be stored on an encrypted USB data stick. They will be disseminated in a survey. The survey will be sent out to 2,200 paediatric physiotherapists who are members of a special interest groups APCP; who will be able to access the survey for a 60 day period. The survey will be repeated a second time 1 month after the first survey has finished, it will be sent to physiotherapists who have indicated they want to be involved from the first survey. This survey will be accessible for a maximum of 60 day period, after which it will expire.

Consenting and Taking part?

If you wish to consent to your child being part of this study then please complete the attached consent form and return it in the envelope provided to school in your child's home-school book. .

If you do not wish to take part then please ignore this letter.

What are the possible disadvantages and risks of taking part?

We expect no serious risks. However we have identified some potential areas of risk which we have taken steps to minimise the impact of these.

The following steps will be taken to ensure confidentiality of the children being photographed.

1. No children's names or personal details such as name, DOB or address will be included in any part of the research.
2. The location and name of schools used will not be disclosed in the research.
3. Children's faces will be blanked out to avoid identification.
4. Photographs will be done against a blank background so the location will not be identifiable.

The following steps will be taken as the lead researcher is a physiotherapist at the special school:

1. Caregivers will not be approached directly by the lead researcher for consent to participate in the study.
2. Caregivers will be contacted using the schools established and preferred method of communicating with parents; the use of home school books.
3. The information to caregivers will make it very clear that participation is voluntary and that refusal or withdrawal will not influence the therapy support either they or their child receive for postural management, and any other therapy intervention.

What are the possible benefits of taking part?

Participants will be able to be a part of this research; this may then lead to further research as part of this PhD project regarding postural management and children with cerebral palsy. Participants may find participation an opportunity to develop knowledge, assisting in shaping future clinical assessments which are clinically applicable to practice and import to children with cerebral palsy.

Expenses and payment

You or your child will not be paid for taking part in this study.

Who can I contact about the project?

If you have any queries or questions please contact:

Principal Investigator: Frances George Email: [REDACTED] Phone: [REDACTED]

School of Health Sciences, York St John University

Alternatively you can contact my supervisor: Lynne Gabriel Email: [REDACTED]

Phone: [REDACTED]

If you have any concerns regarding how the research has been conducted, please contact

[REDACTED], chair of the cross schools research ethics committee at

[REDACTED], or by phone at [REDACTED],

Will my taking part in this study be kept confidential?

Children photographed will be described in terms of their GMFCS & age only. No children's names or personal details such as name, DOB or address will be included in any part of the research. The location and name of school used will not be disclosed in the research. Children's faces will be blanked out to avoid identification. Photographs will be done against a blank background so the location will not be identifiable.

The photographs will then be kept securely, with access by the principal research only, for as long as may be needed in the future.

Please retain this document for your records. If you have any questions or queries please do not hesitate to contact the principal researcher.

How will the information be used?

This research is part of a PhD study into posture management with cerebral palsy, and the results of this study may be used in the following ways:

- As part of a PhD study
- Part of a series of publications / conference presentations / book.
- Within further research.
- Informing best practice guidelines, government input.
- Teaching / training / education.

Appendix 12: Caregiver consent form – Reliability

RESEARCH CONSENT FORM

Name of Researcher(s) <i>(to be completed by the researcher)</i>
Frances George
Title of study <i>(to be completed by the researcher)</i>
Inter-rater and intra-rater reliability of the Clinical Assessment of Body Alignment for children with cerebral palsy.

Please read and complete this form carefully. If you are willing to participate in this study, ring the appropriate responses and sign and date the declaration at the end. If you do not understand anything and would like more information, please ask.

- I have had the research satisfactorily explained to me in verbal and / or written form by the researcher. YES / NO
- I understand that the research will involve: my child having 4 photographs taken of them wearing shorts and a vest top. The photos will take no longer than 30 minutes. These photographs will be sent out in a survey to paediatric physiotherapists who are members of a special interest group - the APCP. The survey will be accessible for 60 days and repeated 1 month later. YES / NO
- I understand that I may withdraw my child from this study at any time without having to give an explanation. This will not affect my future care or treatment. YES / NO
- I understand that all information about my child will be treated in strict confidence and that my child will not be named in any written work arising from this study. YES / NO
- I understand that any photographed material of my child will be used solely for research purposes and will be destroyed on completion of your research unless I have given my consent for other use. YES / NO
- I understand that you will be discussing the progress of your research with others Dr Lynne Gabriel, Dr Charikliea Sinai and Dr Alex Benham at York St John University YES / NO
- I consent for the photographs of my child to be used in the instructions and guidelines which will accompany of this assessment. YES / NO











I freely give my consent for my child to participate in this research study and have been given a copy of this form for my own information.

Childs Name:

Signature:

Date:

Appendix 13: Child participant info example – Reliability

<p>research</p> 						
<p>posture</p> 						
<p>Frances</p> 						
<p>vest and shorts</p> 	<p>vest and shorts</p> 					
<p>camera</p> 						
<p>sitting</p> 	<p>lying</p> 	<p>standing</p> 				
<p>physios</p> 						

Appendix 14: CABA Score sheet

CABA Scoring Sheet - Overview

Childs Name:

Date of Assessment:

DoB:

Therapist:

Assessment criteria:

Out of equipment (on a flat surface, wooden block, floor mat, plinth)

In equipment – provide details of equipment (Make, model, support)

Overview: By body segment and position

Body Segment	Sitting	Lying	Standing
Head			
Trunk			
Pelvis			
Leg			
Arm			
Foot			
Total Score = All body segment scores			

CABA Score Sheet

Childs Name:

DoB:

Therapist:

Date of Assessment:

Position Assessment:

In or out of equipment:

		Score	Left	Right
Section A: HEAD				
1	Flexion / extension			
2	Side flexion			
3	Rotation			
Section B: TRUNK				
4	Flexion / extension			
5	Side flexion			
6	Rotation			
Section C: PELVIS				
7	Anterior			
	Posterior			
8	Obliquity			
9	Rotation			
Section D: ARMS				
10	Flexion			
	Extension			
11	Abduction			
	Adduction			
Section E: LEG – STANDING / LYING				
12	Flexion			
	Extension			
13	Abduction			
	Adduction			
14	Internal rotation			
	External rotation			
LEG - SITTING				
15	Flexion (upper leg)			
	Extension (upper leg)			
16	Flexion (Lower leg)			
	Extension (Lower leg)			
17	Abduction			
	Adduction			
18	Internal rotation			
	External rotation			
Section F: FOOT				
19	Inversion			
	Eversion			
20	Plantarflexion			
	Dorsiflexion			

Total Scores for each section

Head Score	<input type="text"/>
Trunk Score	<input type="text"/>
Pelvis Score	<input type="text"/>
Arm Score	<input type="text"/>
Standing Leg Score	<input type="text"/>
Sitting Leg Score	<input type="text"/>
Foot Score	<input type="text"/>

Total CABA Score

Appendix 15: Electronic Survey – Reliability

Reliability of the Clinical Assessment of Body Alignment - CABA

Consent question:

By clicking on “I agree” to the questionnaire on this page you are indicating that have read and understood the participant information and agree to participate in this research study.

I have read and understood the participant information regarding this survey.

- I agree to continue and complete the questionnaire
- I do not wish to continue with the questionnaire

[Participant information](#)

Start of Block: Part 1: Introduction

Q1 This questionnaire is anonymised using a coded system. Please provide the last 3 digits of your postcode and the last 3 digits of your date of birth.

Providing this code is optional. However if you wish to withdraw from this survey before the closing date, this code can then be provided to the researcher and enable your responses to be discard from the research project.

Q2 Of which APCP region are you a member of?

Q3 How many years have you been working as a qualified physiotherapist?

Q4 Which of the following best describes your area of speciality? If you have more than one area, please tick all that apply.

- Musculoskeletal (1)
- Neonatal (2)
- Neurodisability (3)
- Management (4)
- Respiratory (5)
- Orthopaedic (6)
- Community (7)
- Acute ward (8)

Q5 Which of the following best describes your place of work?

If you work across more than one of these areas, please tick your primary area of work.

- NHS (1)
 - Private practice (2)
 - Education (3)
 - General Practitioners practice (4)
-

Q6 Thank you so much for participating in our study. Here is some more information about what the study involves.

If you wish to view it please click on the link. You do not have to view this to move onto the next section.

End of Block: Part 1: Introduction

Start of Block: Part 2 Main survey

Q7

PART 2

For the following questions will ask you to observe and rate each child's body alignment using the CABA across lying, sitting and standing positions.

You will be asked to give a score of 0 - 3. Photographs are shown with the corresponding CABA assessment item making it quick and easy for you to score.

The specific body alignment component being observed for each photo and a description of how this is rated is given at the top of each question.

Lets get started.

The images in this survey are copyrighted. Please do not copy any images.

End of Block: Part 2 Main survey

Start of Block: Lying

Q8 Position: Lying

Q9 Item 1: Head Flexion / Extension

Item 1: Locate head alignment (flexion / extension)

Position of the individual's head from the side. Item scores the head position from 0 - 3.

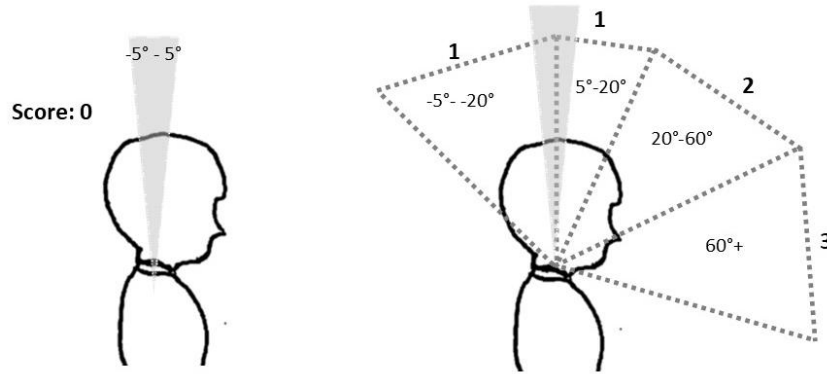

Child 1



Child 2



Child 3



Child 4



Child 5

	Child 1	Child 2	Child 3	Child 4	Child 5
	Answer 1 (1)	Answer 1 (1)	Answer 1 (1)	Answer 1 (1)	Answer 1 (1)
Score 0 (1)	<input type="radio"/>	<input type="radio"/>	<input type="radio"/>	<input type="radio"/>	<input type="radio"/>
Score 1 (2)	<input type="radio"/>	<input type="radio"/>	<input type="radio"/>	<input type="radio"/>	<input type="radio"/>
Score 2 (3)	<input type="radio"/>	<input type="radio"/>	<input type="radio"/>	<input type="radio"/>	<input type="radio"/>
Score 3 (4)	<input type="radio"/>	<input type="radio"/>	<input type="radio"/>	<input type="radio"/>	<input type="radio"/>



Q10 Item 2: Head Side flexion

Item 2: Locate Head alignment (side flexion)

Position of the individual's head from the front or back. Item scores the head position from 0 - 3.

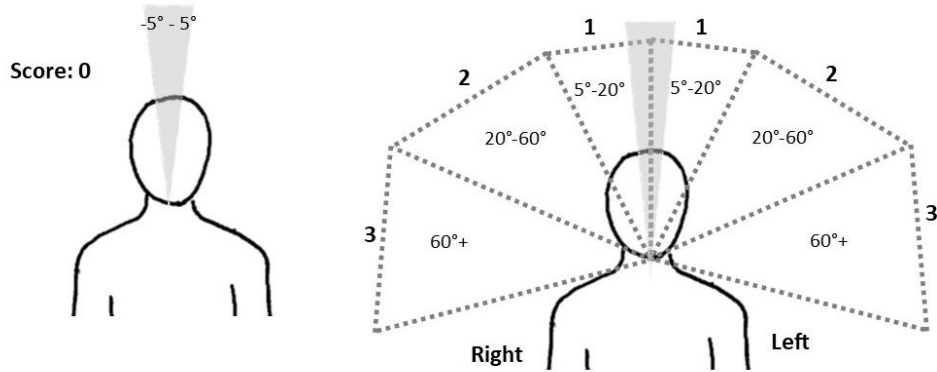

	Child 1	Child 2	Child 3	Child 4	Child 5
	Answer 1 (1)	Answer 1 (1)	Answer 1 (1)	Answer 1 (1)	Answer 1 (1)
Score 0 (1)	<input type="radio"/>	<input type="radio"/>	<input type="radio"/>	<input type="radio"/>	<input type="radio"/>
Score 1 (2)	<input type="radio"/>	<input type="radio"/>	<input type="radio"/>	<input type="radio"/>	<input type="radio"/>
Score 2 (3)	<input type="radio"/>	<input type="radio"/>	<input type="radio"/>	<input type="radio"/>	<input type="radio"/>
Score 3 (4)	<input type="radio"/>	<input type="radio"/>	<input type="radio"/>	<input type="radio"/>	<input type="radio"/>

Q11 Item 3: Head Rotation

Item 3: Locate head alignment (rotation)

Position of the individual's head in the transverse plane. Item scores the head position from 0 - 3.

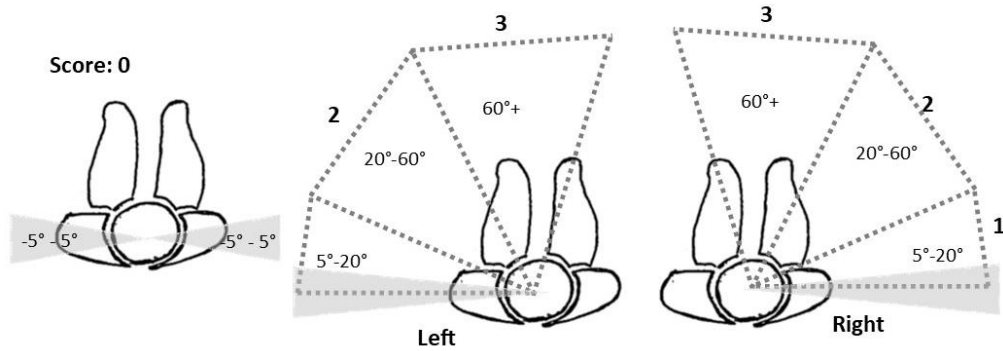

	Child 1	Child 2	Child 3	Child 4	Child 5
Answer 1 (1)	Answer 1 (1)	Answer 1 (1)	Answer 1 (1)	Answer 1 (1)	Answer 1 (1)
Score 0 (1)	<input type="radio"/>	<input type="radio"/>	<input type="radio"/>	<input type="radio"/>	<input type="radio"/>
Score 1 (2)	<input type="radio"/>	<input type="radio"/>	<input type="radio"/>	<input type="radio"/>	<input type="radio"/>
Score 2 (3)	<input type="radio"/>	<input type="radio"/>	<input type="radio"/>	<input type="radio"/>	<input type="radio"/>
Score 3 (4)	<input type="radio"/>	<input type="radio"/>	<input type="radio"/>	<input type="radio"/>	<input type="radio"/>

Q12 Item 4: Trunk Flexion / Extension

Item 4: Locate trunk alignment (flexion / extension)

Position of the individual's trunk from the side. Item scores the trunk position from 0 - 3.

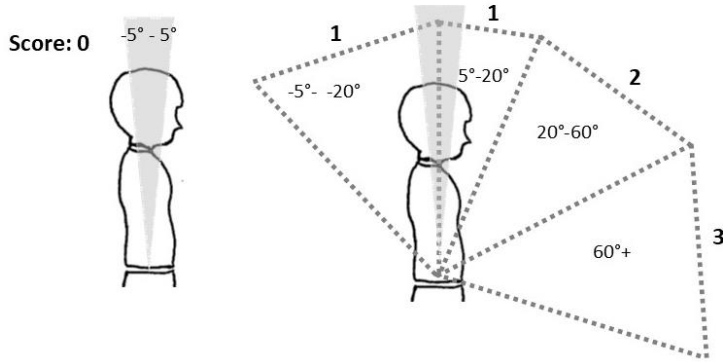

Child 1



Child 2



Child 3



Child 4



Child 5

	Child 1	Child 2	Child 3	Child 4	Child 5
	Answer 1 (1)	Answer 1 (1)	Answer 1 (1)	Answer 1 (1)	Answer 1 (1)
Score 0 (1)	<input type="radio"/>	<input type="radio"/>	<input type="radio"/>	<input type="radio"/>	<input type="radio"/>
Score 1 (2)	<input type="radio"/>	<input type="radio"/>	<input type="radio"/>	<input type="radio"/>	<input type="radio"/>
Score 2 (3)	<input type="radio"/>	<input type="radio"/>	<input type="radio"/>	<input type="radio"/>	<input type="radio"/>
Score 3 (4)	<input type="radio"/>	<input type="radio"/>	<input type="radio"/>	<input type="radio"/>	<input type="radio"/>

Q13 Item 5: Trunk Side Flexion

Item 5: Locate trunk alignment (side flexion)

Position of the individual's trunk from the front or back. Item scores the trunk position from 0 - 3.

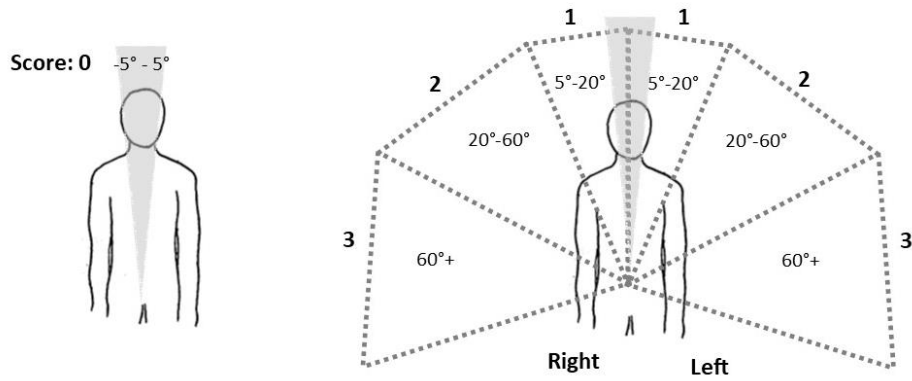

	Child 1	Child 2	Child 3	Child 4	Child 5
	Answer 1 (1)	Answer 1 (1)	Answer 1 (1)	Answer 1 (1)	Answer 1 (1)
Score 0 (1)	<input type="radio"/>	<input type="radio"/>	<input type="radio"/>	<input type="radio"/>	<input type="radio"/>
Score 1 (2)	<input type="radio"/>	<input type="radio"/>	<input type="radio"/>	<input type="radio"/>	<input type="radio"/>
Score 2 (3)	<input type="radio"/>	<input type="radio"/>	<input type="radio"/>	<input type="radio"/>	<input type="radio"/>
Score 3 (4)	<input type="radio"/>	<input type="radio"/>	<input type="radio"/>	<input type="radio"/>	<input type="radio"/>

Q14 Item 6: Trunk Rotation

Item 6: Locate trunk alignment (rotation)

Position of the individual's trunk in the transverse plane . Item scores the trunk position from 0 - 3.

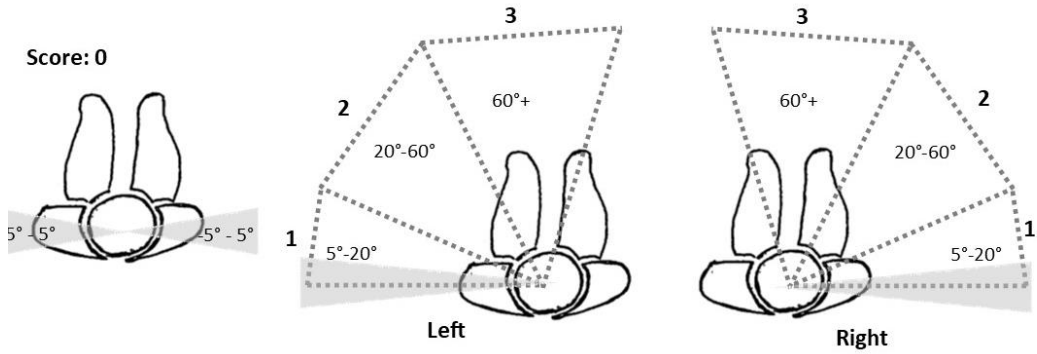

	Child 1	Child 2	Child 3	Child 4	Child 5
	Answer 1 (1)	Answer 1 (1)	Answer 1 (1)	Answer 1 (1)	Answer 1 (1)
Score 0 (1)	<input type="radio"/>	<input type="radio"/>	<input type="radio"/>	<input type="radio"/>	<input type="radio"/>
Score 1 (2)	<input type="radio"/>	<input type="radio"/>	<input type="radio"/>	<input type="radio"/>	<input type="radio"/>
Score 2 (3)	<input type="radio"/>	<input type="radio"/>	<input type="radio"/>	<input type="radio"/>	<input type="radio"/>
Score 3 (4)	<input type="radio"/>	<input type="radio"/>	<input type="radio"/>	<input type="radio"/>	<input type="radio"/>

Q15 Item 7: Pelvis Posterior / Anterior Tilt

Item 7: Locate Pelvis alignment (posterior / anterior tilt)

Position of the individual's pelvis from the side. Item scores the pelvis position from 0-3.

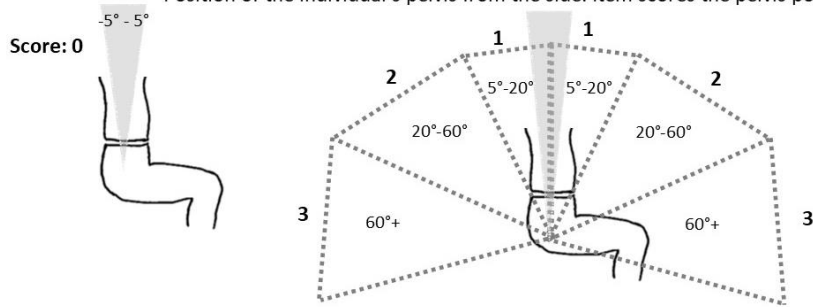

Child 1



Child 2



Child 3



Child 4



Child 5

	Child 1	Child 2	Child 3	Child 4	Child 5
	Answer 1 (1)	Answer 1 (1)	Answer 1 (1)	Answer 1 (1)	Answer 1 (1)
Score 0 (1)	<input type="radio"/>	<input type="radio"/>	<input type="radio"/>	<input type="radio"/>	<input type="radio"/>
Score 1 (2)	<input type="radio"/>	<input type="radio"/>	<input type="radio"/>	<input type="radio"/>	<input type="radio"/>
Score 2 (3)	<input type="radio"/>	<input type="radio"/>	<input type="radio"/>	<input type="radio"/>	<input type="radio"/>
Score 3 (4)	<input type="radio"/>	<input type="radio"/>	<input type="radio"/>	<input type="radio"/>	<input type="radio"/>

Q16 Item 8: Pelvic Obliquity

Item 8: Locate Pelvis alignment (obliquity)

Position of the individual's pelvis from the front or back. Item scores the pelvis position from 0 - 3.

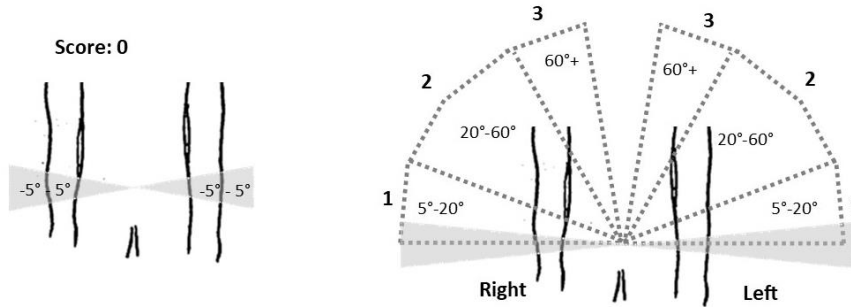

Child 1



Child 2



Child 3



Child 4

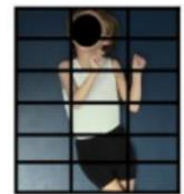

Child 5

	Child 1	Child 2	Child 3	Child 4	Child 5
	Answer 1 (1)	Answer 1 (1)	Answer 1 (1)	Answer 1 (1)	Answer 1 (1)
Score 0 (1)	<input type="radio"/>	<input type="radio"/>	<input type="radio"/>	<input type="radio"/>	<input type="radio"/>
Score 1 (2)	<input type="radio"/>	<input type="radio"/>	<input type="radio"/>	<input type="radio"/>	<input type="radio"/>
Score 2 (3)	<input type="radio"/>	<input type="radio"/>	<input type="radio"/>	<input type="radio"/>	<input type="radio"/>
Score 3 (4)	<input type="radio"/>	<input type="radio"/>	<input type="radio"/>	<input type="radio"/>	<input type="radio"/>

Q17 Item 9: Pelvic Rotation

Item 9: Locate Pelvis alignment (rotation)

Position of the individual's pelvis from the transverse plane. Item scores the pelvis position from 0 - 3.

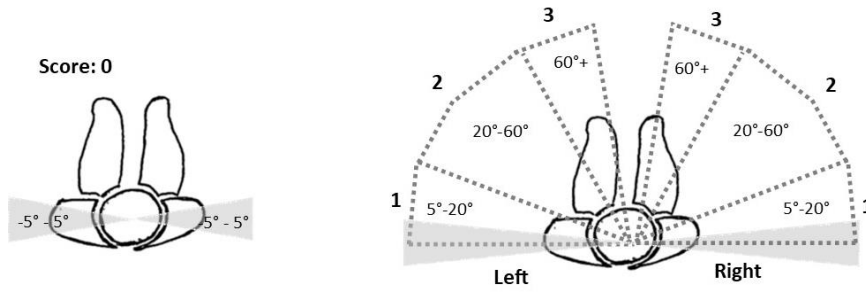

Child 1



Child 2



Child 3



Child 4



Child 5

	Child 1	Child 2	Child 3	Child 4	Child 5
	Answer 1 (1)	Answer 1 (1)	Answer 1 (1)	Answer 1 (1)	Answer 1 (1)
Score 0 (1)	<input type="radio"/>	<input type="radio"/>	<input type="radio"/>	<input type="radio"/>	<input type="radio"/>
Score 1 (2)	<input type="radio"/>	<input type="radio"/>	<input type="radio"/>	<input type="radio"/>	<input type="radio"/>
Score 2 (3)	<input type="radio"/>	<input type="radio"/>	<input type="radio"/>	<input type="radio"/>	<input type="radio"/>
Score 3 (4)	<input type="radio"/>	<input type="radio"/>	<input type="radio"/>	<input type="radio"/>	<input type="radio"/>

End of Block: Lying

Start of Block: Sitting

Q25 Position: Sitting

Q26 Item 1: Head Flexion / Extension

Item 1: Locate head alignment (flexion / extension)

Position of the individual's head from the side. Item scores the head position from 0 - 3.

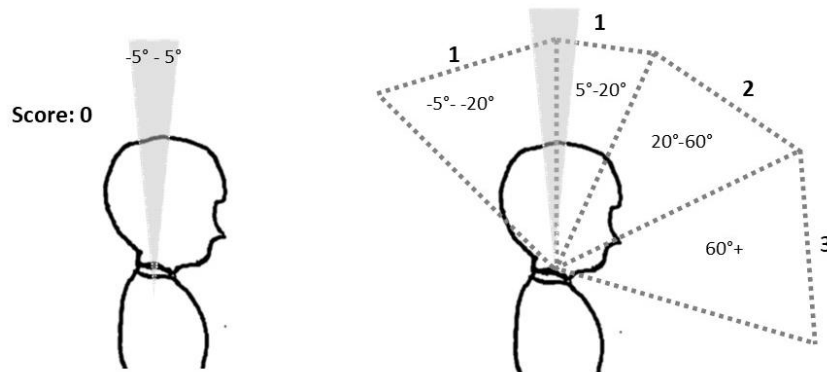

	Child 1	Child 2	Child 3	Child 4	Child 5
	Answer 1 (1)	Answer 1 (1)	Answer 1 (1)	Answer 1 (1)	Answer 1 (1)
Score 0 (1)	<input type="radio"/>	<input type="radio"/>	<input type="radio"/>	<input type="radio"/>	<input type="radio"/>
Score 1 (2)	<input type="radio"/>	<input type="radio"/>	<input type="radio"/>	<input type="radio"/>	<input type="radio"/>
Score 2 (3)	<input type="radio"/>	<input type="radio"/>	<input type="radio"/>	<input type="radio"/>	<input type="radio"/>
Score 3 (4)	<input type="radio"/>	<input type="radio"/>	<input type="radio"/>	<input type="radio"/>	<input type="radio"/>

Q27 Item 2: Head Side Flexion

Item 2: Locate Head alignment (side flexion)

Position of the individual's head from the front or back. Item scores the head position from 0 - 3.

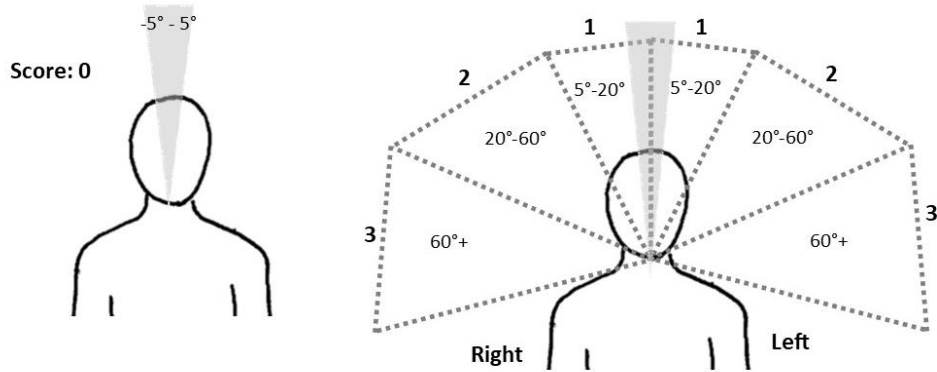

Child 1



Child 2



Child 3



Child 4



Child 5

	Child 1	Child 2	Child 3	Child 4	Child 5
	Answer 1 (1)	Answer 1 (1)	Answer 1 (1)	Answer 1 (1)	Answer 1 (1)
Score 0 (1)	<input type="radio"/>	<input type="radio"/>	<input type="radio"/>	<input type="radio"/>	<input type="radio"/>
Score 1 (2)	<input type="radio"/>	<input type="radio"/>	<input type="radio"/>	<input type="radio"/>	<input type="radio"/>
Score 2 (3)	<input type="radio"/>	<input type="radio"/>	<input type="radio"/>	<input type="radio"/>	<input type="radio"/>
Score 3 (4)	<input type="radio"/>	<input type="radio"/>	<input type="radio"/>	<input type="radio"/>	<input type="radio"/>

Q28 Item 3: Head Rotation

Item 3: Locate head alignment (rotation)

Position of the individual's head in the transverse plane. Item scores the head position from 0 - 3.

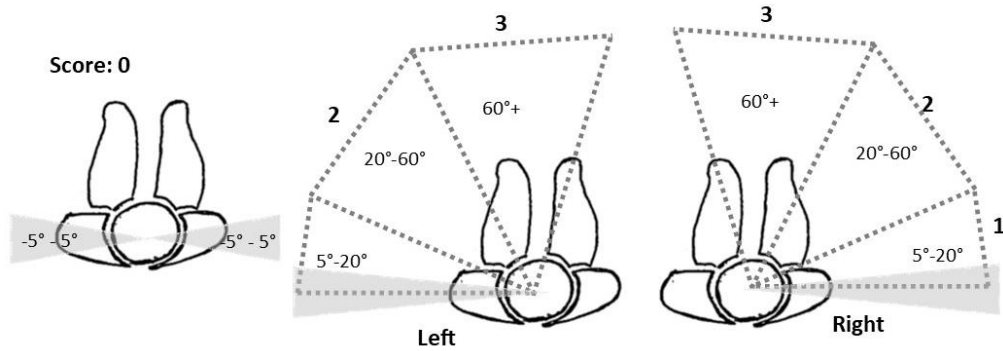

Child 1



Child 2



Child 3



Child 4



Child 5

	Child 1	Child 2	Child 3	Child 4	Child 5
	Answer 1 (1)	Answer 1 (1)	Answer 1 (1)	Answer 1 (1)	Answer 1 (1)
Score 0 (1)	<input type="radio"/>	<input type="radio"/>	<input type="radio"/>	<input type="radio"/>	<input type="radio"/>
Score 1 (2)	<input type="radio"/>	<input type="radio"/>	<input type="radio"/>	<input type="radio"/>	<input type="radio"/>
Score 2 (3)	<input type="radio"/>	<input type="radio"/>	<input type="radio"/>	<input type="radio"/>	<input type="radio"/>
Score 3 (4)	<input type="radio"/>	<input type="radio"/>	<input type="radio"/>	<input type="radio"/>	<input type="radio"/>

Q29 Item 4: Trunk Flexion / Extension

Item 4: Locate trunk alignment (flexion / extension)

Position of the individual's trunk from the side. Item scores the trunk position from 0 - 3.

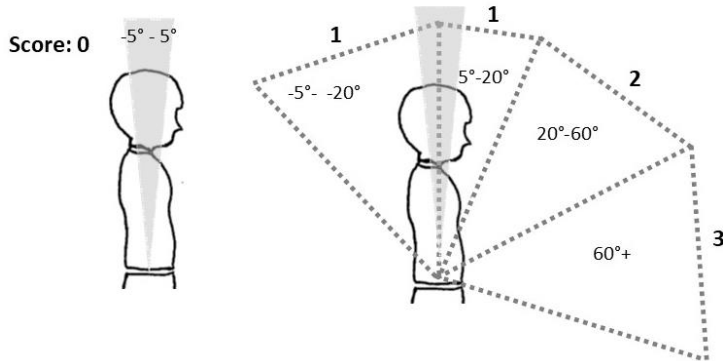

Child 1



Child 2



Child 3

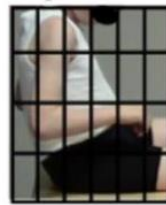

Child 4



Child 5

	Child 1	Child 2	Child 3	Child 4	Child 5
	Answer 1 (1)	Answer 1 (1)	Answer 1 (1)	Answer 1 (1)	Answer 1 (1)
Score 0 (1)	<input type="radio"/>	<input type="radio"/>	<input type="radio"/>	<input type="radio"/>	<input type="radio"/>
Score 1 (2)	<input type="radio"/>	<input type="radio"/>	<input type="radio"/>	<input type="radio"/>	<input type="radio"/>
Score 2 (3)	<input type="radio"/>	<input type="radio"/>	<input type="radio"/>	<input type="radio"/>	<input type="radio"/>
Score 3 (4)	<input type="radio"/>	<input type="radio"/>	<input type="radio"/>	<input type="radio"/>	<input type="radio"/>

Q30 Item 5: Trunk Side Flexion

Item 5: Locate trunk alignment (side flexion)

Position of the individual's trunk from the front or back. Item scores the trunk position from 0 - 3.

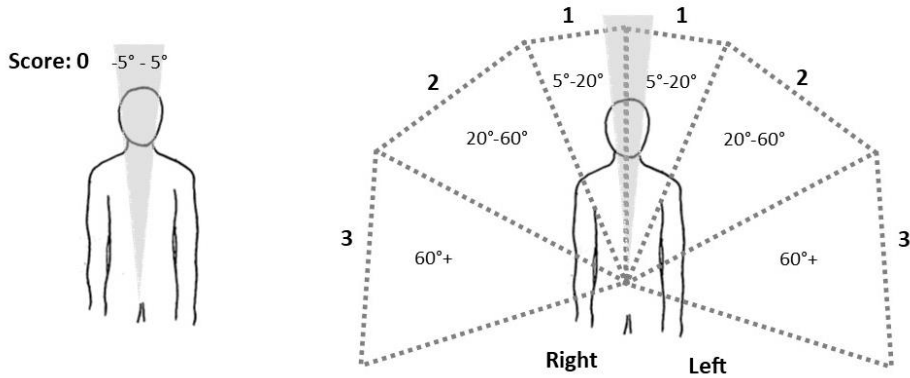

Child 1



Child 2



Child 3



Child 4



Child 5

	Child 1	Child 2	Child 3	Child 4	Child 5
	Answer 1 (1)	Answer 1 (1)	Answer 1 (1)	Answer 1 (1)	Answer 1 (1)
Score 0 (1)	<input type="radio"/>	<input type="radio"/>	<input type="radio"/>	<input type="radio"/>	<input type="radio"/>
Score 1 (2)	<input type="radio"/>	<input type="radio"/>	<input type="radio"/>	<input type="radio"/>	<input type="radio"/>
Score 2 (3)	<input type="radio"/>	<input type="radio"/>	<input type="radio"/>	<input type="radio"/>	<input type="radio"/>
Score 3 (4)	<input type="radio"/>	<input type="radio"/>	<input type="radio"/>	<input type="radio"/>	<input type="radio"/>

Q31 Item 6: Trunk Rotation

Item 6: Locate trunk alignment (rotation)

Position of the individual's trunk in the transverse plane . Item scores the trunk position from 0 - 3.

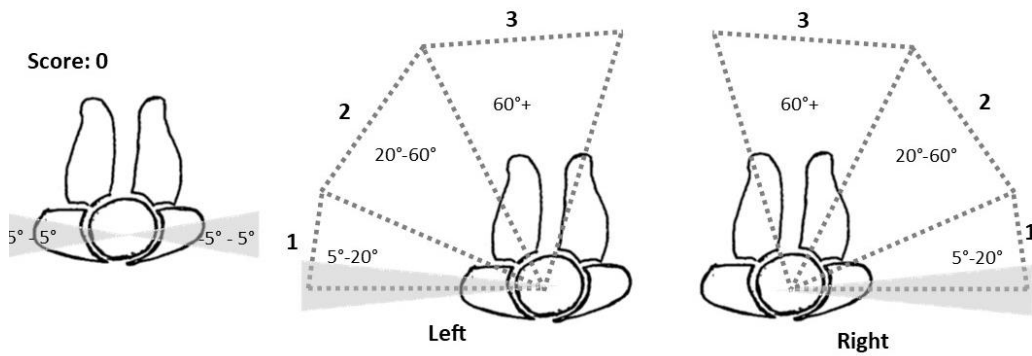

Child 1



Child 2



Child 3



Child 4



Child 5

	Child 1	Child 2	Child 3	Child 4	Child 5
	Answer 1 (1)	Answer 1 (1)	Answer 1 (1)	Answer 1 (1)	Answer 1 (1)
Score 0 (1)	<input type="radio"/>	<input type="radio"/>	<input type="radio"/>	<input type="radio"/>	<input type="radio"/>
Score 1 (2)	<input type="radio"/>	<input type="radio"/>	<input type="radio"/>	<input type="radio"/>	<input type="radio"/>
Score 2 (3)	<input type="radio"/>	<input type="radio"/>	<input type="radio"/>	<input type="radio"/>	<input type="radio"/>
Score 3 (4)	<input type="radio"/>	<input type="radio"/>	<input type="radio"/>	<input type="radio"/>	<input type="radio"/>

Q32 Item 7: Pelvic Anterior / Posterior Tilt

Item 7: Locate Pelvis alignment (posterior / anterior tilt)

Position of the individual's pelvis from the side. Item scores the pelvis position from 0-3.

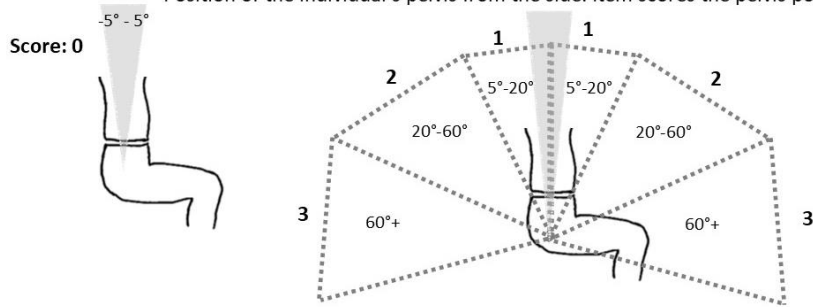

Child 1



Child 2



Child 3



Child 4



Child 5

	Child 1	Child 2	Child 3	Child 4	Child 5
	Answer 1 (1)	Answer 1 (1)	Answer 1 (1)	Answer 1 (1)	Answer 1 (1)
Score 0 (1)	<input type="radio"/>	<input type="radio"/>	<input type="radio"/>	<input type="radio"/>	<input type="radio"/>
Score 1 (2)	<input type="radio"/>	<input type="radio"/>	<input type="radio"/>	<input type="radio"/>	<input type="radio"/>
Score 2 (3)	<input type="radio"/>	<input type="radio"/>	<input type="radio"/>	<input type="radio"/>	<input type="radio"/>
Score 3 (4)	<input type="radio"/>	<input type="radio"/>	<input type="radio"/>	<input type="radio"/>	<input type="radio"/>

Q33 Item 8: Pelvic Obliquity

Item 8: Locate Pelvis alignment (obliquity)

Position of the individual's pelvis from the front or back. Item scores the pelvis position from 0 - 3.

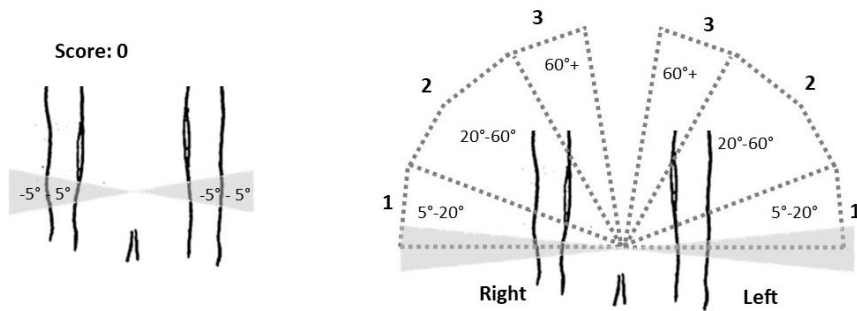

Child 1



Child 2



Child 3



Child 4



Child 5

	Child 1	Child 2	Child 3	Child 4	Child 5
	Answer 1 (1)	Answer 1 (1)	Answer 1 (1)	Answer 1 (1)	Answer 1 (1)
Score 0 (1)	<input type="radio"/>	<input type="radio"/>	<input type="radio"/>	<input type="radio"/>	<input type="radio"/>
Score 1 (2)	<input type="radio"/>	<input type="radio"/>	<input type="radio"/>	<input type="radio"/>	<input type="radio"/>
Score 2 (3)	<input type="radio"/>	<input type="radio"/>	<input type="radio"/>	<input type="radio"/>	<input type="radio"/>
Score 3 (4)	<input type="radio"/>	<input type="radio"/>	<input type="radio"/>	<input type="radio"/>	<input type="radio"/>



Q34 Item 9: Pelvic Rotation

Item 9: Locate Pelvis alignment (rotation)

Position of the individual's pelvis from the transverse plane. Item scores the pelvis position from 0 - 3.

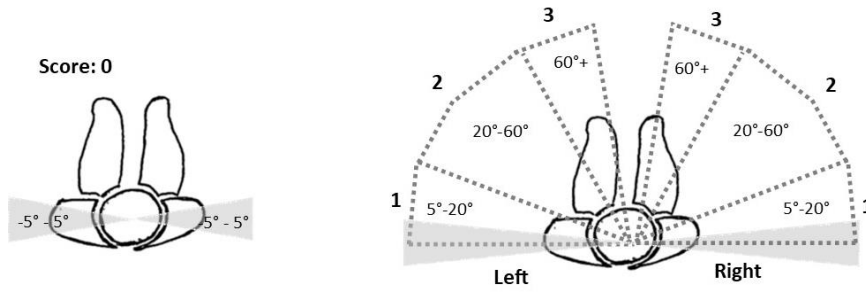

Child 1



Child 2



Child 3



Child 4

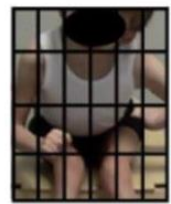

Child 5

	Child 1	Child 2	Child 3	Child 4	Child 5
	Answer 1 (1)	Answer 1 (1)	Answer 1 (1)	Answer 1 (1)	Answer 1 (1)
Score 0 (1)	<input type="radio"/>	<input type="radio"/>	<input type="radio"/>	<input type="radio"/>	<input type="radio"/>
Score 1 (2)	<input type="radio"/>	<input type="radio"/>	<input type="radio"/>	<input type="radio"/>	<input type="radio"/>
Score 2 (3)	<input type="radio"/>	<input type="radio"/>	<input type="radio"/>	<input type="radio"/>	<input type="radio"/>
Score 3 (4)	<input type="radio"/>	<input type="radio"/>	<input type="radio"/>	<input type="radio"/>	<input type="radio"/>

Q40 Item 18: Leg Rotation

Item 18: Locate leg alignment (rotation)

Position of the individual's leg from the front or back. Item scores the leg position from 0—3.

Score: 0

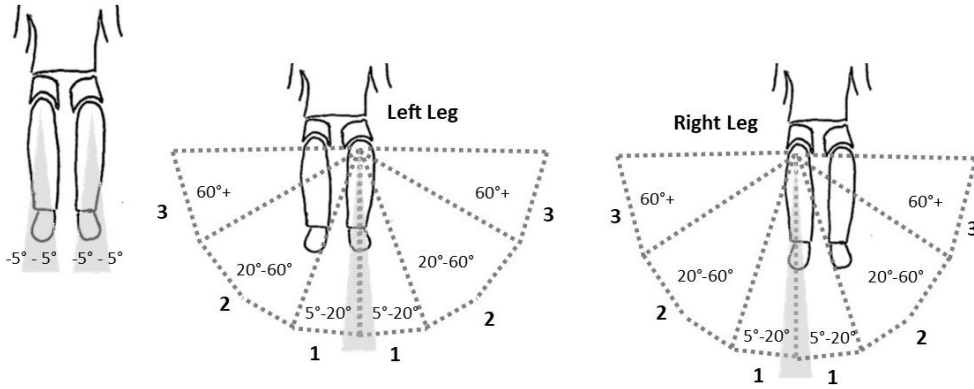

Right **Child 1** Left



Child 2



Child 3



Child 4



Child 5

	Child 1		Child 2		Child 3		Child 4		Child 5	
	Left (1)	Right (2)	Left (1)	Right (2)	Left (1)	Right (2)	Left (1)	Right (2)	Left (1)	Right (2)
Score 0 (1)	<input type="radio"/>	<input type="radio"/>	<input type="radio"/>	<input type="radio"/>	<input type="radio"/>	<input type="radio"/>	<input type="radio"/>	<input type="radio"/>	<input type="radio"/>	<input type="radio"/>
Score 1 (2)	<input type="radio"/>	<input type="radio"/>	<input type="radio"/>	<input type="radio"/>	<input type="radio"/>	<input type="radio"/>	<input type="radio"/>	<input type="radio"/>	<input type="radio"/>	<input type="radio"/>
Score 2 (3)	<input type="radio"/>	<input type="radio"/>	<input type="radio"/>	<input type="radio"/>	<input type="radio"/>	<input type="radio"/>	<input type="radio"/>	<input type="radio"/>	<input type="radio"/>	<input type="radio"/>
Score 3 (4)	<input type="radio"/>	<input type="radio"/>	<input type="radio"/>	<input type="radio"/>	<input type="radio"/>	<input type="radio"/>	<input type="radio"/>	<input type="radio"/>	<input type="radio"/>	<input type="radio"/>



End of Block: Sitting

Start of Block: Standing

Q43 Position: Standing

Q44 Item 1: Head Flexion / Extension

Item 1: Locate head alignment (flexion / extension)

Position of the individual's head from the side. Item scores the head position from 0 - 3.

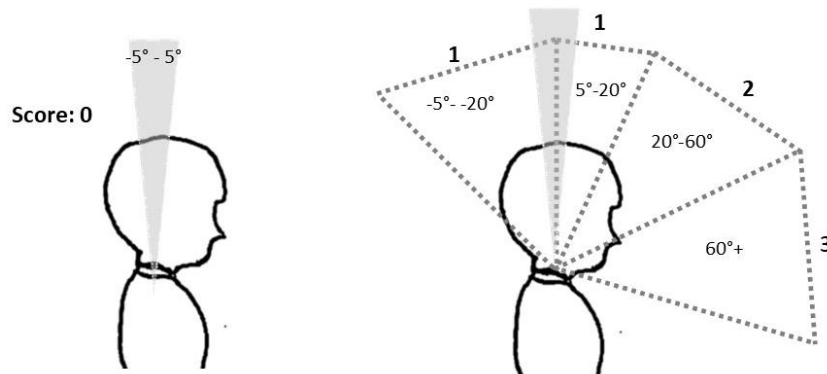

	Child 1	Child 2	Child 3	Child 4	Child 5
	Answer 1 (1)	Answer 1 (1)	Answer 1 (1)	Answer 1 (1)	Answer 1 (1)
Score 0 (1)	<input type="radio"/>	<input type="radio"/>	<input type="radio"/>	<input type="radio"/>	<input type="radio"/>
Score 1 (2)	<input type="radio"/>	<input type="radio"/>	<input type="radio"/>	<input type="radio"/>	<input type="radio"/>
Score 2 (3)	<input type="radio"/>	<input type="radio"/>	<input type="radio"/>	<input type="radio"/>	<input type="radio"/>
Score 3 (4)	<input type="radio"/>	<input type="radio"/>	<input type="radio"/>	<input type="radio"/>	<input type="radio"/>

Q45 Item 2: Head Side flexion

Item 2: Locate Head alignment (side flexion)

Position of the individual's head from the front or back. Item scores the head position from 0 - 3.

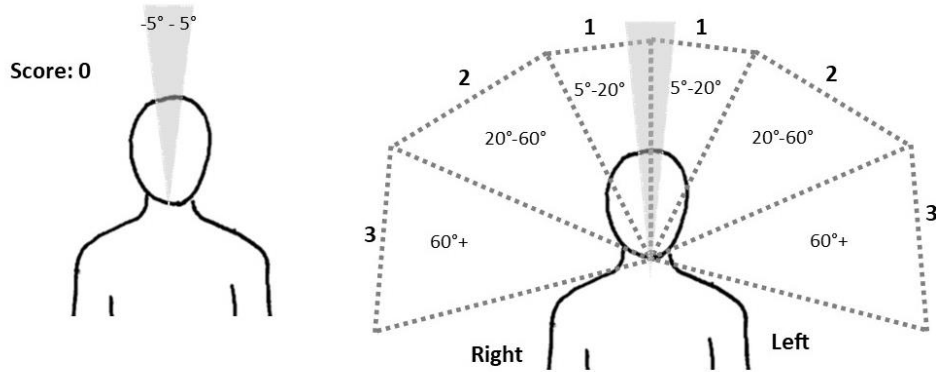

Child 1



Child 2



Child 3



Child 4



Child 5

	Child 1	Child 2	Child 3	Child 4	Child 5
	Answer 1 (1)	Answer 1 (1)	Answer 1 (1)	Answer 1 (1)	Answer 1 (1)
Score 0 (1)	<input type="radio"/>	<input type="radio"/>	<input type="radio"/>	<input type="radio"/>	<input type="radio"/>
Score 1 (2)	<input type="radio"/>	<input type="radio"/>	<input type="radio"/>	<input type="radio"/>	<input type="radio"/>
Score 2 (3)	<input type="radio"/>	<input type="radio"/>	<input type="radio"/>	<input type="radio"/>	<input type="radio"/>
Score 3 (4)	<input type="radio"/>	<input type="radio"/>	<input type="radio"/>	<input type="radio"/>	<input type="radio"/>

Q46 Item 3: Head Rotation

Item 3: Locate head alignment (rotation)

Position of the individual's head in the transverse plane. Item scores the head position from 0 - 3.

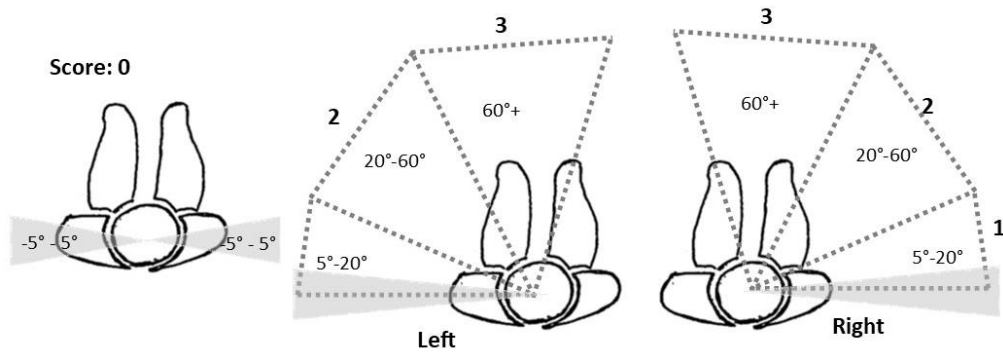

Child 1



Child 2



Child 3



Child 4



Child 5

	Child 1	Child 2	Child 3	Child 4	Child 5
	Answer 1 (1)	Answer 1 (1)	Answer 1 (1)	Answer 1 (1)	Answer 1 (1)
Score 0 (1)	<input type="radio"/>	<input type="radio"/>	<input type="radio"/>	<input type="radio"/>	<input type="radio"/>
Score 1 (2)	<input type="radio"/>	<input type="radio"/>	<input type="radio"/>	<input type="radio"/>	<input type="radio"/>
Score 2 (3)	<input type="radio"/>	<input type="radio"/>	<input type="radio"/>	<input type="radio"/>	<input type="radio"/>
Score 3 (4)	<input type="radio"/>	<input type="radio"/>	<input type="radio"/>	<input type="radio"/>	<input type="radio"/>



Q47 Item 4: Trunk Flexion / Extension

Item 4: Locate trunk alignment (flexion / extension)

Position of the individual's trunk from the side. Item scores the trunk position from 0 - 3.

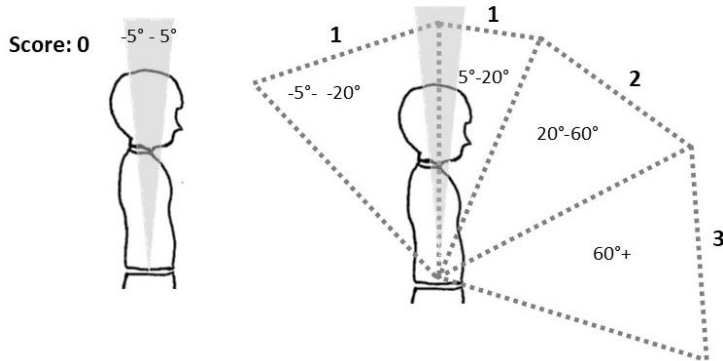

Child 1



Child 2



Child 3



Child 4



Child 5

	Child 1	Child 2	Child 3	Child 4	Child 5
	Answer 1 (1)	Answer 1 (1)	Answer 1 (1)	Answer 1 (1)	Answer 1 (1)
Score 0 (1)	<input type="radio"/>	<input type="radio"/>	<input type="radio"/>	<input type="radio"/>	<input type="radio"/>
Score 1 (2)	<input type="radio"/>	<input type="radio"/>	<input type="radio"/>	<input type="radio"/>	<input type="radio"/>
Score 2 (3)	<input type="radio"/>	<input type="radio"/>	<input type="radio"/>	<input type="radio"/>	<input type="radio"/>
Score 3 (4)	<input type="radio"/>	<input type="radio"/>	<input type="radio"/>	<input type="radio"/>	<input type="radio"/>

Q48 Item 5: Trunk Side Flexion

Item 5: Locate trunk alignment (side flexion)

Position of the individual's trunk from the front or back. Item scores the trunk position from 0 - 3.

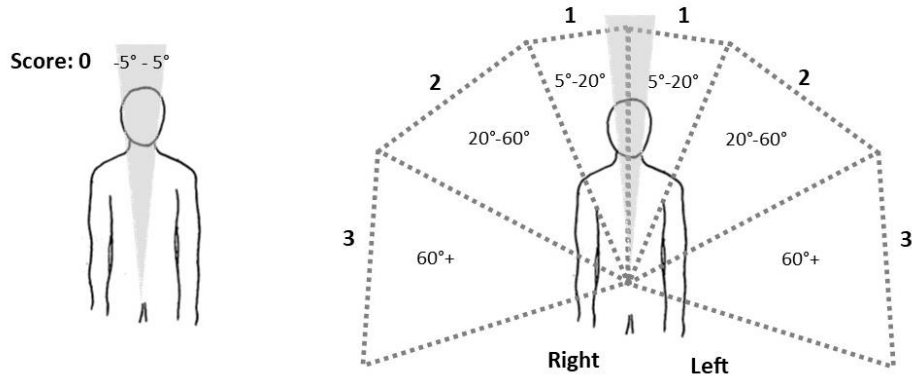

Child 1



Child 2



Child 3



Child 4



Child 5

	Child 1	Child 2	Child 3	Child 4	Child 5
	Answer 1 (1)	Answer 1 (1)	Answer 1 (1)	Answer 1 (1)	Answer 1 (1)
Score 0 (1)	<input type="radio"/>	<input type="radio"/>	<input type="radio"/>	<input type="radio"/>	<input type="radio"/>
Score 1 (2)	<input type="radio"/>	<input type="radio"/>	<input type="radio"/>	<input type="radio"/>	<input type="radio"/>
Score 2 (3)	<input type="radio"/>	<input type="radio"/>	<input type="radio"/>	<input type="radio"/>	<input type="radio"/>
Score 3 (4)	<input type="radio"/>	<input type="radio"/>	<input type="radio"/>	<input type="radio"/>	<input type="radio"/>

Q49 Item 6: Trunk Rotation

Item 6: Locate trunk alignment (rotation)

Position of the individual's trunk in the transverse plane . Item scores the trunk position from 0 - 3.

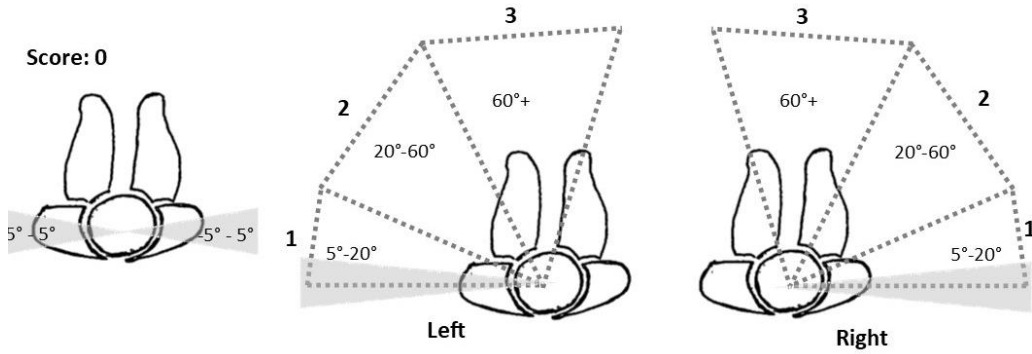

Child 1



Child 2



Child 3



Child 4



Child 5

	Child 1	Child 2	Child 3	Child 4	Child 5
	Answer 1 (1)	Answer 1 (1)	Answer 1 (1)	Answer 1 (1)	Answer 1 (1)
Score 0 (1)	<input type="radio"/>	<input type="radio"/>	<input type="radio"/>	<input type="radio"/>	<input type="radio"/>
Score 1 (2)	<input type="radio"/>	<input type="radio"/>	<input type="radio"/>	<input type="radio"/>	<input type="radio"/>
Score 2 (3)	<input type="radio"/>	<input type="radio"/>	<input type="radio"/>	<input type="radio"/>	<input type="radio"/>
Score 3 (4)	<input type="radio"/>	<input type="radio"/>	<input type="radio"/>	<input type="radio"/>	<input type="radio"/>

Q50 Item 7: Pelvis Posterior / Anterior Tilt

Item 7: Locate Pelvis alignment (posterior / anterior tilt)

Position of the individual's pelvis from the side. Item scores the pelvis position from 0-3.

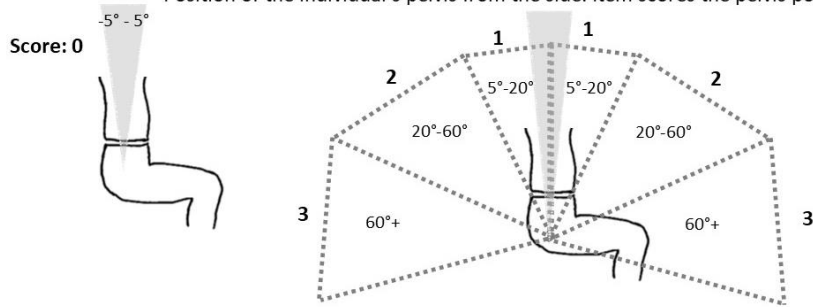

Child 1



Child 2



Child 3



Child 4



Child 5

	Child 1	Child 2	Child 3	Child 4	Child 5
	Answer 1 (1)	Answer 1 (1)	Answer 1 (1)	Answer 1 (1)	Answer 1 (1)
Score 0 (1)	<input type="radio"/>	<input type="radio"/>	<input type="radio"/>	<input type="radio"/>	<input type="radio"/>
Score 1 (2)	<input type="radio"/>	<input type="radio"/>	<input type="radio"/>	<input type="radio"/>	<input type="radio"/>
Score 2 (3)	<input type="radio"/>	<input type="radio"/>	<input type="radio"/>	<input type="radio"/>	<input type="radio"/>
Score 3 (4)	<input type="radio"/>	<input type="radio"/>	<input type="radio"/>	<input type="radio"/>	<input type="radio"/>

Q51 Item 8: Pelvic Obliquity

Item 8: Locate Pelvis alignment (obliquity)

Position of the individual's pelvis from the front or back. Item scores the pelvis position from 0 - 3.

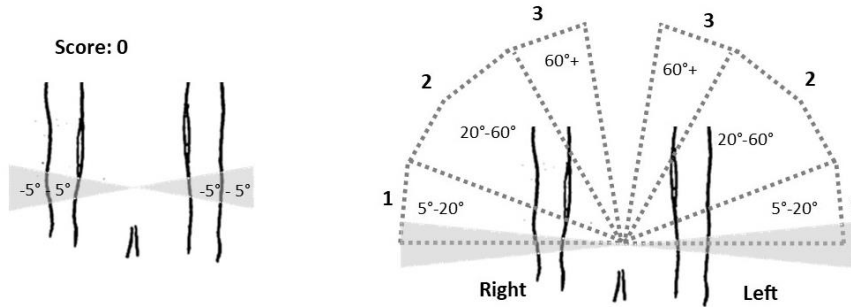

Child 1



Child 2



Child 3



Child 4



Child 5

	Child 1	Child 2	Child 3	Child 4	Child 5
Answer 1 (1)	Answer 1 (1)	Answer 1 (1)	Answer 1 (1)	Answer 1 (1)	Answer 1 (1)
Score 0 (1)	<input type="radio"/>	<input type="radio"/>	<input type="radio"/>	<input type="radio"/>	<input type="radio"/>
Score 1 (2)	<input type="radio"/>	<input type="radio"/>	<input type="radio"/>	<input type="radio"/>	<input type="radio"/>
Score 2 (3)	<input type="radio"/>	<input type="radio"/>	<input type="radio"/>	<input type="radio"/>	<input type="radio"/>
Score 3 (4)	<input type="radio"/>	<input type="radio"/>	<input type="radio"/>	<input type="radio"/>	<input type="radio"/>

Q52 Item 9: Pelvic Rotation

Item 9: Locate Pelvis alignment (rotation)

Position of the individual's pelvis from the transverse plane. Item scores the pelvis position from 0 - 3.

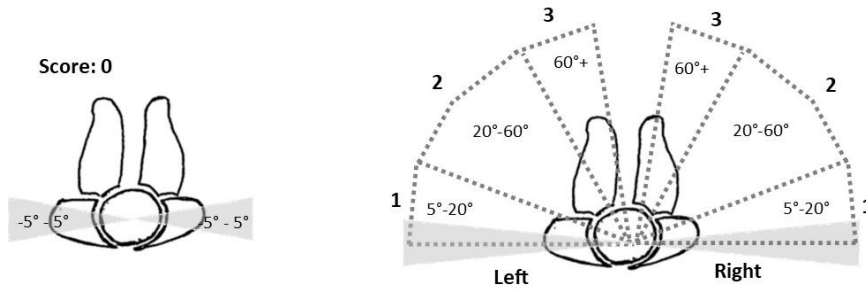

Child 1



Child 2



Child 3

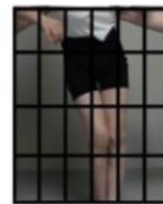

Child 4

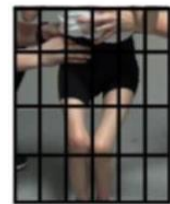

Child 5

	Child 1	Child 2	Child 3	Child 4	Child 5
	Answer 1 (1)	Answer 1 (1)	Answer 1 (1)	Answer 1 (1)	Answer 1 (1)
Score 0 (1)	<input type="radio"/>	<input type="radio"/>	<input type="radio"/>	<input type="radio"/>	<input type="radio"/>
Score 1 (2)	<input type="radio"/>	<input type="radio"/>	<input type="radio"/>	<input type="radio"/>	<input type="radio"/>
Score 2 (3)	<input type="radio"/>	<input type="radio"/>	<input type="radio"/>	<input type="radio"/>	<input type="radio"/>
Score 3 (4)	<input type="radio"/>	<input type="radio"/>	<input type="radio"/>	<input type="radio"/>	<input type="radio"/>

End of Block: Standing

Start of Block: Part 3 Intra rater reliability

Q61 Last Little thing

If you want to participate in the intra-rater reliability part of this study please leave an email address in the box below.

You will then be resent the survey and asked to rate the same photographs again. This will be done at some point after you have completed this survey.

You are in no way obliged to complete the second survey when you received it.

This is optional you no not need to leave an email address.

Q62 Thank you very much for completing this survey, your time and support is very much appreciated.

End of Block: Part 3 Intra rater reliability

Appendix 16: Email information – reliability study

We invite you to take part in this questionnaire as part of the research study: ‘what is the intra-rater and inter-rater reliability of the Clinical Assessment of Body Alignment in children with CP?’

This study is being done as part of PhD research project by lead researcher Frances George from York St John University. You are invited because you are a health professional working with children with cerebral palsy.

You may have already taken part in this study by completing the first questionnaire, in the validity of the assessment.

We want to gain as many people’s views as possible. The questions are very simple; you will be shown a picture of a child with CP; from your observation of their posture you then score their body alignment using the corresponding assessment item. You will then be asked if you want to be contacted about the intra-rater reliability study and complete the survey a second time. If you want to be contacted about the option of participating in this study, please provide a contact email at the end of the survey

You may not directly benefit from this research. Your participation will inform future research, and hopefully will improve postural management for children with cerebral palsy. Your answers will be used to produce a PhD thesis chapter and published report but individual comments will remain anonymous.

You do not need to give us any contact information. Please see participant information sheet for further information about this study.

Taking part is your choice and you can withdraw at any time within 60-days of the survey.

If you have questions about this project or if you have a research-related problem, you may contact:

Frances George: [REDACTED]

Dr Lynne Gabriel: [REDACTED]

Appendix 17: Participant Information – reliability study

Physiotherapy Participant Information Sheet: Inter-rater and intra-rater reliability of the Clinical Assessment of Body Alignment for children with cerebral palsy.

What is the purpose of this study?

You have been invited to take part in a research project which aims to develop a tool to assess body alignment, and to examine the reliability of this new scale.

The study involves the development of a Clinical Assessment of Body Alignment (CABA). This assessment is to be used by physiotherapists as part of their clinical practice in the assessment of body alignment, as part of posture management interventions with children with cerebral palsy.

This study is part of a PhD project exploring the assessment of posture management in children with cerebral palsy. Before you decide if you would like to participate we would like to explain the study and what we would expect from you. You may talk to others about the study before you decide if you would like to participate. Please do not hesitate to contact us if you have any questions, contact details are below.

Why have I been invited?

You have been invited as you have been identified as being a member of the APCP special interest group, and have experience within the field of paediatric physiotherapy.

Do I have to take part?

Your decision to take part is completely voluntary. You may refuse to participate or withdraw from the survey at any point.

Each questionnaire will be anonymised using a coding system. Participants will be asked to provide the last three digits of their postcode and their date of birth. This code can then be provided to the researcher if you wish to withdraw.

If you wish to withdraw your data please send the digit code you provided on the survey to:

Principal Investigator: Frances George Email: [REDACTED]

You will then receive an email reply confirming your request to withdraw data has been received and that your data has been removed from the research.

What is expected of me if I take part?

If you chose to participate in the study you will be involved in completing the online questionnaire which is attached to this email.

The questionnaire has 23 questions set out in three parts.

- Part one asks you to answer questions relating to your APCP region, years of experience and area of specialty.
- Part two asks you to rate each 5 children's body alignment using the CABA assessment giving a score of 0-3.
Each child has 4 photographs showing anterior, posterior, side and horizontal views. The corresponding CABA assessment item is shown above the relevant photograph angle to make it quick and easy to score.

In total there are 20 photographs to view.

- Part three asks if you want to be contacted again to participate in the intra-rater reliability study. You will be asked at the end of the survey to leave an email address if they want to be contacted about the next trial. This involves you being sent the same survey and asked to rate the same photographs again. This will be done 1 month after the first survey study has been completed.
This is optional you do not need to leave an email address.

The first survey should take no more than 50 minutes to complete. It is envisaged that the second survey would take a shorter amount of time, but no longer than 50 minutes.

The data collected from responses will be analysed and summarized as part of the PhD Project.

Consenting and Taking part?

If you wish to consent to being part of this study then please complete the attached survey and submit.

The survey will be open and accessible for 60 days, you will be sent a reminder email 1 month from the date of the email.

If you do not wish to take part then please delete this email.

Expenses and payment

You will not be paid for taking part in this study.

What are the possible disadvantages and risks of taking part?

We expect no serious risks.

What are the possible benefits of taking part?

Participants will be able to contribute to this research; this may then lead to further research as part of this PhD project regarding postural management and children with cerebral palsy. Participants may find participation an opportunity to contribute and share their knowledge, assisting in shaping future clinical assessments which are clinically applicable to practice.

Who can I contact about the project?

If you have any queries or questions please contact:

Principal Investigator: Frances George Email: [REDACTED] Phone: [REDACTED]

School of Health Sciences, York St John University

Alternatively you can contact my supervisor: Lynne Gabriel Email: [REDACTED]
Phone [REDACTED]

If you have any concerns regarding how the research has been conducted, please contact Nathalie Noret, chair of the cross schools research ethics committee at [REDACTED], or by phone at [REDACTED].

Will my taking part in this study be kept confidential?

The questionnaires will be anonymous, at no point will you be asked to state your name and individual questionnaires cannot be traced back to an identified individual. Names will not be used in the final publication, so that you will not be identifiable.

The questionnaire will then be kept securely, with access by the principal research only, for as long as may be needed in the future.

Please retain this document for your records. If you have any questions or queries please do not hesitate to contact the principal researcher.

How will the information be used?

This research is part of a PhD study into posture management with cerebral palsy, and the results of this study may be used in the following ways:

- As part of a PhD study
- Part of a series of publications / conference presentations / book.
- Within further research.
- Informing best practice guidelines, government input.
- Teaching / training / education.

Appendix 18: My Day template example

MY DAY

NAME _____

ACTIVITY	ASSESSMENT	INITIAL PRIORITY OBJECTIVES
Eating/Drinking		
Dressing		
Life Skills		
Social Interaction		
Communication		
Independent Occupation		
Out and About		
Sleep		
Personal Hygiene		
Toileting		
WELL BEING		COMMUNICATES BY:-
<u>Happy/Content</u> <u>Unhappy</u> <u>Agitated</u> <u>Angry</u> <u>Pain</u> <u>Sleep</u>		Mode - Access -

Appendix 19: Ethical Application – Reliability and responsiveness studies

Please indicate which route you wish your application to follow:

Route 1 Ethical approval is not required

Route 2 Approval by expedited review

Route 5

Route 3 Approval without full ethical review

Route 4 or 5 Full ethical review required

STEP ONE: Provide an outline of the project

Everyone must complete this brief outline that shows the Research Ethics Committee what the project entails.

Where will you get your research material?

Documents:

Unpublished:

Published:

Existing databases:

Other (specify):

Online or social media:

Blogs:

Chat rooms:

Webpages:

Other (specify):

From people by:

Interviews:

Focus groups:

Questionnaires:

Other (specify):

observation of body alignment in and out of unsupported

Biological, medical or social data from:Animals: Members of the public: Medical patients: Social care clients: **Other research material:**

Specify:

If human participants are involved are they:Under 16: Adults able to give consent: Adults unable to give consent **Briefly describe your project****Outline:**

Available standardised clinical assessments of body alignment for children with CP that include assessment of body segment alignment (the head, trunk, pelvis, arms, legs and feet) are few. Assessments are either sections of developmental motor diagnostic tests such as The Chailey Levels of Ability, or tests focused specifically on trunk and leg posture such as the Spinal Alignment and Range of Motion Measure (SAROMM) or Goldsmith indices. These current assessments either lack psychometric properties or responsiveness and selectively to measure body alignment.

Based on a systemised review of the literature, there was found to be an absence of a measure that adequately examines body alignment in children with CP and which is applicable within everyday clinical practice settings.

A research project is already underway to establish the validity of a developed assessment - Clinical Assessment of Body Alignment (CABA). The purpose of this proposal is to examine the reliability, usability and responsiveness of this new assessment.

Aims:

- To examine the inter-rater and intra-rater reliability of the CABA.
- To evaluate the CABA's usability as a measure in evaluating posture management programmes for CP children.
- To examine the CABA's responsiveness & specificity to changes in body alignment.

The primary research questions are:

1. Does the CABA have inter-rater and intra-rater reliability?
2. Is the CABA useable in a clinical setting and able to evaluate posture management programmes with CP children?
3. Is the CABA able to detect changes in body alignment as part of a posture management programme?

Methods:

PART 1: To evaluate the CABA's construct validity and its reliability, a clinical measurement design will be employed.

A purposeful sample of Physiotherapists who are members of the Association of Paediatric Chartered Physiotherapists (APCP), a special interest group consisting of 2,200 experts within the field of paediatric physiotherapy in the UK. Description of sample will be given in terms of:

- APCP region
- Years of experience
- Area of speciality

These clinical experts will evaluate a representative sample of (n=5) children with CP aged 3-17 years. Inclusion criteria for this representative sample is a confirmed diagnosis of CP, no surgical procedures within the previous 6 months, no injection of botulinum toxin type A within the previous 6 months. CP classification will be determined using the Gross Motor Function Classification System (GMFCS) from minimal impairment (Level I) to most severely impaired (Level V). The sample will contain a participant at each level of the GMFCS. The enrolled participants will be classified as:

- GMFCS.
- Age (mean, SD and range)

All caregivers of the children will be fully informed of the procedures and the purpose of the study – see attached participation information sheet. Children will also be given information about the study; taking into consideration the complex learning and communication needs of the child participants, it is important that creative, multi-method, flexible approaches are adopted, which can be tailored to the needs of those involved. It is particularly important to note there is likely to be a range of needs and abilities, therefore tools may need to be adapted to suit the individuals not the group as a whole. Again, such decisions will be informed by consulting relevant experts (for example, parents, practitioners and support workers) and it may well be necessary to work alongside parents or support workers when undertaking data collection. Alternative communication methods will be used to explain the study, this will take the form of three main strategies to cover a range of understanding levels of the children and can be tailored to individual needs. Strategies include firstly; pictorial information supported by verbal and key words – see attached child participant information, secondly the showing of objects which directly relate to the activity (Clothing – shorts and vest and camera) and thirdly the placing objects in the child's hand. Each child has a pupil profile; this clearly describes body responses the child displays when they are happy and unhappy, when they like or dislike something. These profiles are created by consultation with caregivers and professionals who know the child well. Body responses will be observed and taken as the child assenting to participate in the study. If a child is able to give a verbal response this will also be included alongside observation of body response. Caregivers will be given a copy of child participation information tailored to the individual child's needs, so they can share this with their child. Signed consent forms for participation will be obtained from the caregivers of all included children participants – see attached caregiver consent form.

Instrument used: The CABA assessment form – see attached assessment.

Procedure: Photographs will be taken of the 5 children in a sitting, lying and standing position. 4 photographs of each child will be taken in each position to enable body alignment assessment – this involves an anterior, posterior, side and horizontal view. For those children at higher levels of the GMFCS adult support may be required to support sitting or standing positions. The photographs will be taken within a paediatric therapy room within a community school setting. This was selected as it is familiar and comfortable to the children. Children will wear shorts and vest tops to enable physiotherapy participants to observe and score body alignment. Each photograph will have the face blanked out to avoid identification of the child. Photographs will be taken against a neutral background to avoid identification of the location.

Storage and dissemination of Photographs:

Photographs will be stored on an encrypted USB data stick. They will be disseminated in a survey format using Qualtrics; this enables the survey to be sent out to the identified sample participants only, allows for an expiration date to be set so that the survey is no

longer available or accessible after a defined date. The survey will be accessible by physiotherapy participants for a 60 day period.

All 2,200 ACP physiotherapists will be sent an email with information about the study and a link to the survey. Clear instructions will be given that if they wish to participate they can use the link to completing the survey, a 60 day period will be given for responses to be made. A reminder email will be sent out after 1 month – see attached Physiotherapy participant information

To determine inter-rater reliability, ACP physiotherapy participants will independently score each child's (n=5) body alignment using the CABA in sitting, lying and standing. All raters will be given a copy of the CABA assessment and administration guidelines. All items on the CABA will be scored for each child's assessment. The scoring for each child will take approximately 10 minutes, 50 minutes in total to assess all 5 children. The total time for participants to complete the inter-rater no more than 1 hour in total. To determine intra-rater reliability, participants will be asked at the end of the survey to leave an email address if they want to be contacted about the next trial. The survey will make clear that this is optional. Physiotherapists who leave an email address will be contact 1 month after the first survey has been completed; those wanting to participate will be sent a link to a second duplicate survey and asked to re-score the same photographs of children (n=5) using the CABA. The total time for participants to complete the intra-rater no more than 1 hour in total.

Construct validity will be determined by comparing the scores obtained by participants to the GMFCS levels of each child.

PART 2: To evaluate usability and responsiveness of the CABA to detect changes in body alignment as part of a posture management programme a clinical measurement design will be employed.

The primary researcher will evaluate a representative sample of (n= 10) children with CP GMFCS level IV (n=5) and V (n=5) aged 3-17years. Children will be recruited from a local special school at which the primary researcher works as a physiotherapist. A special school was selected as it is an environment where children use posture management programmes frequently, and where posture assessments are a frequent part of a child's therapy. This was also selected as the children are both used to the environment and lead researcher, therefore having minimal impact on their mood and clinical presentation. Inclusion criteria for this representative sample is a confirmed diagnosis of CP GMFCS IV or V, no surgical procedures within the previous 6 months, no injection of botulinum toxin type A within the previous 6 months. CP classification was determined using the GMFCS, children at levels IV

and V where selected as it is this cohort of CP children who require posture management programmes. Participants will be classified by GMFCS and age (mean, SD and range).

All caregivers of the children will be fully informed of the procedures and the purpose of the study – see attached participation information sheet. Children will also be given information about the study; taking into consideration the complex learning and communication needs of the child participants, it is important that creative, multi-method, flexible approaches are adopted, which can be tailored to the needs of those involved. It is particularly important to note there is likely to be a range of needs and abilities, therefore tools may need to be adapted to suit the individuals not the group as a whole. Again, such decisions will be informed by consulting relevant experts (for example, parents, practitioners and support workers) and it may well be necessary to work alongside parents or support workers when undertaking data collection. Alternative communication methods will be used to explain the study; this will take the form of three main strategies to cover a range of understanding levels of the children and can be tailored to individual needs. Strategies include firstly; pictorial information supported by verbal and key words – see attached child participant information. Secondly the showing of objects which directly relate to the activity (equipment and camera) and thirdly the placing objects in the child's hand. Each child has a pupil profile; this clearly describes body responses the child displays when they are happy and unhappy, when they like or dislike something. These profiles are created by consultation with caregivers and professionals who know the child well. Body responses will be observed and taken as the child assenting to participate in the study. If a child is able to give a verbal response this will also be included alongside observation of body response. Caregivers will be given a copy of the child participation information tailored to the individual child's needs, so they can share this with their child. Signed consent forms for participation will be obtained from the caregivers of all included children participants – see attached consent forms.

The primary researcher will independently score each child's (n=10) body alignment using the CABA. Each participant's body alignment will be scored unsupported and again in adaptive equipment currently used to support the child's body alignment such as seating / stander / lying support. The scoring for each child will take approximately 10 minutes in each position, a maximum of 30 minutes in total per child, as it is recognised that not all children will have adaptive support in all 3 positions (Sitting, lying, standing) therefore scoring will only occur in the positions for which the child has equipment in place to support body alignment.

Data Analysis: The Statistical Package for Social Sciences (SPSS) will be used for statically data analysis for all data collected. This will be stored on an encrypted USB data stick and backed up onto YSJU network drive 'My Docs'.

The data will be stored for the duration of the PhD research project and no longer than six years following collection, in line with YSJU Policy on safeguarding research data.

STEP THREE: If you answered “yes” to any of the questions on the initial screening checklist (and these responses were all coloured blue), you must complete the Decision Tree

When you click the button below, the only rows that will show are those where you clicked a blue 'YES' in the initial checklist. You then need to decide if a full ethics proposal might still be required by looking at the criteria and clicking the Yes or No response in the remaining rows as appropriate.

Click here to set up the decision tree according to your checklist

Reset Decision Tree

If you answered YES response to this Question:

- 1 Will the research require the collection of primary source material that might possibly be seen as offensive or considered illegal to access or hold on a computer? Will this material be security-sensitive, as defined by the Counter-Terrorism and Security Act (2015) or similar legislation?
- 2 Will the study involve discussion of, or the potential disclosure of, information about sensitive topics?
- 3 Will the study require the co-operation of a gatekeeper to give access to, or to help recruit, participants?
- 4 Will it be necessary for participants to take part in the study without

A Full Ethics Proposal is required if:

Required under all circumstances

- Participants include children.
- Subject matter relates to illegal activities.
- Gatekeepers are overseas.

Required under all circumstances

Full Ethics proposal required?

their knowledge or consent at the time?

5 Will the study involve recruitment of patients through the NHS?

Required under all circumstances

6 Will inducements be offered to participants?

Payments of more than £5 per person or prizes of more than £100. Any reward related to students gaining credit or marks for participation.

7 Does the study involve participants who are particularly vulnerable or unable to give informed consent?

Any adults are unable to give their own consent.

8 Will the study require participants to commit extensive time to the study?

Participants will be under observation for more than 8 hours in any session or required to give over 24 hours in total.

9 Are drugs, placebos or any other substances to be administered to participants, or will the study involve invasive, intrusive or potentially harmful procedures of any kind?

Any drug or invasive procedure such as injection.

10 If there are experimental and control groups, will being in one group disadvantage participants?

There is no evidence to show how experimental group will fare, or there any evidence that they may be disadvantaged.

Any procedure where untreated group would remain at risk of significant harm or disadvantage compared with experimental group.

11 Is an extensive degree of exercise or physical exertion involved?

Participants include likely vulnerable groups (e.g. those with history of heart problems, strokes, obesity etc.)

- | | | | |
|----|--|---|--------------------------|
| 12 | Will blood or tissue samples be obtained from participants? | Required under all circumstances | <input type="checkbox"/> |
| 13 | Is pain or more than mild physical discomfort likely to result from the study? | Required under all circumstances | <input type="checkbox"/> |
| 14 | Could the study induce psychological stress or anxiety or cause harm or negative consequences beyond the risks encountered in normal life? | Required under all circumstances | <input type="checkbox"/> |

When you have completed the decision tree, click here to see what to do next

*If you have answered NO to all the questions, a full ethics proposal is NOT required. However, you must complete the **Research Ethics Mitigation Form** and submit this with your application for ethical approval to the relevant ethics committee in order to show how you will mitigate the ethical issues identified in the checklist.*

*If you answered "YES" to any questions in the decision tree, your research must undergo a full ethical review, so go straight to **STEP FOUR***

STEP FOUR: Research proposal to be considered by means of a full ethical review

You must complete this part of the form if either:

- *You answered a 'red' **YES** in the Initial Screening Checklist in Part One of this form.*
OR
- *You gave one or more non-red YES answers in the Initial Screening Checklist and the Decision Tree indicated that a full proposal was required.*

You have to complete this form because what you propose to do raises substantive ethical issues. This proposal will be considered by the Research Ethics Committee supporting your cognate area, who will want to know clearly and precisely what you are proposing to do and how you will ensure that you follow best ethical practice. Make sure that you address how you propose to manage all potential ethical issues, specifically those identified in the checklist and/or decision tree

Objectives / Research Questions:

A few bullet points to indicate what questions you want to answer.

- To examine the inter-rater and intra-rater reliability of the CABA.
- To evaluate the CABA's usability as a measure in evaluating posture management programmes for CP children.
- To examine the CABA's responsiveness & specificity to changes in body alignment.

The primary research questions are:

4. Does the CABA have inter-rater and intra-rater reliability?
5. Is the CABA useable in a clinical setting and able to evaluate posture management programmes with CP children?
6. Is the CABA able to detect changes in body alignment as part of a posture management programme?

Rationale:

Please provide a brief justification of your proposed research project:

How it relates to previous research, why the questions are important, and what benefits might it offer. This helps to demonstrate that the research is worthwhile, even if it raises some ethical questions.

Body alignment is the position of body segments in relation to one another and their orientation in space. Body segments are defined as the position of the head, trunk, pelvis, arms, legs and feet. These are connected together through the spinal joints, hips, shoulders, knees, and wrist and ankle joints, known as the body linkages (Pope 2007). Impairments in body alignment have been documented in children with CP. Depending on the gross motor function classification scale (GMFCS) level of CP, children may show primary impairments in body alignment due to stability and postural control, functional movement abilities and musculoskeletal structures, and environmental forces and demands. Body alignment requires the individual to have voluntary antigravity movements, enabling selective positioning of body segments relative to stability, motor task and environment. Hence children at higher GMFCS levels (IV and V) exhibit the most significantly impaired movement and body alignment (Palisano et al 1997).

The relationship between body alignment, postural control and motor development has been implied in many research studies, yet remains underexplored. As body alignment becomes more controlled and established, base of supports used for function becomes smaller and selective to the task in hand (Pope 2007, Rosenbaum et al 2007). Movement is controlled both within and outside the selected base of support as postural control skills become refined and embedded (Pavao et al 2013). To accomplish motor development, postural control must be present and develop (Dusing & Harbourne 2010). Resultantly the relationship between postural control and movement is well studied and established (Carlbergh & Hadders-Algar 2005, Pavao et al 2013, Van Balen et al 2015). A precursor to both these skills is the ability to achieve body segment alignment. In its absence a child's stability, efficiency, movement and function are impaired against gravity (Pope 2007). Movement and postural control critically hinge on the ability to achieve body segment alignment. Given the importance of body alignment for functional movement in children with CP, a valid, reliable and clinically feasible assessment measure of body alignment is important for describing when and how body alignment is impaired and monitoring change in children's body alignment. This should lead to amelioration as much as possible via specific interventions, prominently posture management programmes.

For a larger study to identify determinates of body alignment, stability, motor function and deformity, a clinically feasible observational assessment measure of body alignment is needed, that is valid for children across all GMFCS levels. Available standardised clinical assessments of body alignment for children with CP that include assessment of the head, trunk, pelvis, arms, legs and feet, are few. The assessments are either sections of developmental motor diagnostic tests such as The Chailey Levels of Ability, or tests focused specifically on trunk and leg posture such as the Spinal Alignment and Range of Motion Measure (SAROMM) or Goldsmith indices. Available evidence to support these assessments have shortcomings in sensitivity, accuracy and psychometric properties.

Body alignment assessments that are evaluative, specific and discriminative are critical for identification, management and intervention effects of posture management in children with

CP. In particular, valid, reliable and responsive body alignment assessment is necessary for any further clinical investigations where body alignment is either an outcome or an intervention. There is a need for further research to establish the evidence for the development and use of a clinical assessment of body alignment for children with CP.

References:

Carlberg EB, Hadders-Algra M. Postural dysfunction in children with cerebral palsy: Some implications for therapeutic guidance. *Neural Plast* 2005;12(2-3):221-228.

Dusing SC, Harbourne RT. Variability in Postural Control During Infancy: Implications for Development, Assessment, and Intervention. *Phys Ther* 2010 12;90(12):1838-1849.

Palisano R, Rosenbaum P, Walter S, Russell D, Wood E, Galuppi B. Development and reliability of a system to classify gross motor function in children with cerebral palsy. *Dev Med Child Neurol* 1997 04;39(4):214-223.

Pavao SL, dos Santos AN, Woollacott MH, Rocha NACF. Assessment of Postural Control in Children with Cerebral Palsy: A Review. *Research in Developmental Disabilities: A Multidisciplinary Journal* 2013 05/01;34(5):1367-1375.

Pope PM. Severe and complex neurological disability: management of the physical condition. Edinburgh: Elsevier Butterworth-Heinemann, c2007; 2007.

Rosenbaum P, Paneth N, Leviton A, Goldstein M, Bax M. A report: the definition and classification of cerebral palsy April 2006. *Dev Med Child Neurol* 2007 02/02;49:8-14.

Van Balen LC, Dijkstra L, Bos AF, Van DH, Hadders-Algra M. Development of postural adjustments during reaching in infants at risk for cerebral palsy from 4 to 18 months. *Dev Med Child Neurol* 2015 07;57(7):668-676.

Please provide details of the proposed sample or research material:

Is this a random sample, or will you be recruiting only certain sorts of people or accessing certain sorts of material. If the sample comprises vulnerable people, or the material is particularly sensitive, identify how you will deal with the ethical issues this raises.

If you research involves security-sensitive material you MUST consult the [Prevent Duty Guidance for Higher Education](#). You must also complete Appendices A and B at the end of this form to ensure that your data is stored securely.

PART 1: To evaluate the CABA's construct validity and its reliability.

A purposeful sample of Physiotherapists who are members of the Association of Paediatric Chartered Physiotherapists (APCP), a special interest group consisting of 2,200 experts within the field of paediatric physiotherapy in the UK. Description of sample will be given in terms of:

- ACP region
- Years of experience
- Area of speciality

These clinical experts will evaluate a representative sample of (n=5) children with CP aged 3-17 years. Inclusion criteria for this representative sample is a confirmed diagnosis of CP, no surgical procedures within the previous 6 months, no injection of botulinum toxin type A within the previous 6 months. CP classification was determined using the Gross Motor Function Classification System (GMFCS) from minimal impairment (Level I) to most severely impaired (Level V). The sample will contain a participant at each level of the GMFCS. The enrolled participants were classified as:

- GMFCS.
- Age (mean, SD and range)

All caregivers of the children will be fully informed of the procedures and the purpose of the study – see attached participation information sheet. Children will also be given information about the study; taking into consideration the complex learning and communication needs of the child participants, it is important that creative, multi-method, flexible approaches are adopted, which can be tailored to the needs of those involved. It is particularly important to note there is likely to be a range of needs and abilities, therefore tools may need to be adapted to suit the individuals not the group as a whole. Again, such decisions will be informed by consulting relevant experts (for example, parents, practitioners and support workers) and it may well be necessary to work alongside parents or support workers when undertaking data collection. Alternative communication methods will be used to explain the study, this will take the form of three main strategies to cover a range of understanding levels of the children and can be tailored to individual needs – see attached child participant information. Strategies include firstly; pictorial information supported by verbal and key words, secondly the showing of objects which directly relate to the activity (Clothing – shorts and vest and camera) and thirdly the placing objects in the child's hand. Each child has a pupil profile; this clearly describes body responses the child displays when they are happy and unhappy, when they like or dislike something. These profiles are created by consultation with caregivers and professionals who know the child well. Body responses will be observed and taken as the child assenting to participate in the study. If a child is able to give a verbal response this will also be included alongside observation of body response. Caregivers will be given a copy of the child participation information tailored to the individual child's needs, so they can share this with their child. Signed consent forms for participation will be obtained from the caregivers of all included children participants.

PART 2: To evaluate usability and responsiveness of the CABA.

The primary researcher will evaluate a representative sample of (N=10) children with CP GMFCS level IV (n=5) and V (n=5). Children will be recruited from a local special school at which the primary researcher works as a physiotherapist. A special school was selected as it is an environment where children use posture management programmes frequently, and where posture assessments are a frequent part of a child's therapy. Inclusion criteria for this representative sample is a confirmed diagnosis of CP, no surgical procedures within the previous 6 months, no injection of botulinum toxin type A within the previous 6 months. CP classification was determined using the Gross Motor Function Classification System (GMFCS). Participants will be classified by GMFCS. And age (mean, SD and range). All caregivers of the children will be fully informed of the procedures and the purpose of the study – see attached participation information sheet. Signed consent forms for participation will be obtained from all included participants.

Children with CP will be recruited from a local special school and permission will be sought from the head teacher and governors (Gatekeepers) to approach caregivers for consent for their child to participate in the studies – see letter to head teacher and governors.

As the Special school is also a place where the lead researcher works, parents will not be approached directly by the lead researcher. Instead caregivers will be contacted using the schools established and preferred method of communicating with parents; the use of home school books. Participant information, consent forms and a return envelope will be sent to parents, this asks caregivers to respond only if they wish for their child to participate in the study. The information to caregivers makes it very clear that participation is voluntary and that refusal or withdrawal will not influence the therapy support either they or their child receive for postural management, and any other therapy intervention.

Describe how the proposed sample will be recruited:

Indicate if you will be recruiting directly, or if you will use a 'gatekeeper'. If the latter, how will they be trained, informed or instructed?

PART 1: To evaluate the CABA's construct validity and its reliability, a clinical measurement design will be employed.

A purposeful sample of Physiotherapists who are members of the Association of Paediatric Chartered Physiotherapists (APCP), a special interest group consisting of 2,200 experts within the field of paediatric physiotherapy in the UK.

All 2,200 APCP physiotherapists will be sent an email with information about the study and a link to the survey. Clear instructions will be given that if they wish to participate they can use the link to completing the survey, a 60 day period will be given for responses to be made. To

determine intra-rater reliability, participants will be asked at the end of the survey to leave an email address if they want to be contacted about the next trial. The survey will make clear that this is optional. Physiotherapists who leave an email address will be contact 1 month after the first survey has been completed; those wanting to participate will be sent a link to a second duplicate survey and asked to re-score the same photographs of children (n=5) using the CABA.– see attached Physiotherapy participant information

PART 2: To evaluate responsiveness of the CABA

Children with CP GMFCS IV and V will be recruited directly through the primary researcher at a local special school. Gatekeeper permission will be sought to approach parents for informed consent, no other involvement will be needed by the gatekeeper.

Caregivers will be contacted using the schools established and preferred method of communicating with parents; the use of home school books. Participant information, consent forms and a return envelope will be sent to parents, this asks parents to respond only if they wish for their child to participate in the study. Caregivers will not be approached directly by the lead researcher.

Please provide details concerning what your participants will be required to do:

Include an indication of the time they will need to give to the study, and whether or not the activities required might be physically or psychologically stressful. How will you deal with this if it is likely to happen?

PART 1: To evaluate the CABA's construct validity and its reliability, a clinical measurement design will be employed.

To determine Inter-rater reliability, ACP physiotherapy participants will complete the survey. This requires them to independently score each child's (n=5) body alignment from photographs displayed in the survey using the CABA. To determine intra-rater reliability, participants who want to be contacted for a second survey, will be asked to complete the survey a second time 1 month after the first survey; they will re-score the same Photographs. All raters will be given a copy of the CABA assessment and administration guidelines. All items on the CABA will be scored for each child assessment. The scoring for each child will take approximately 10 minutes, 50 minutes in total to complete assessments on all 5 children. The total time for participants to complete the inter-rater and intra-rater study in total is 2 hours.

Photographs will be taken of the 5 children in a sitting, lying and standing position. 4 photographs of each child will be taken to enable body alignment assessment from all angles – this involves anterior, posterior, side and horizontal views. For those children at higher levels of

the GMFCS adult support may be required to support sitting or standing positions. The photographs will be taken within a paediatric therapy room within a community school setting. This was selected as it was familiar and comfortable to the children. Children will wear shorts and vests to enable physiotherapy participants to observe and score body alignment. The photo session occurs once and will take no more than 20 minutes; it is recognised that individuals with complex postures may take longer but no more than 30 minutes in total.

Construct validity will be determined by the primary researcher comparing the scores obtained by participants to the GMFCS levels of each child.

PART 2: To evaluate responsiveness of the CABA

To evaluate responsiveness of the CABA the primary researcher will evaluate a representative sample of (n=10) children with CP GMFCS IV (n=5) and V (n=5). The primary researcher will independently score each child's (n=10) body alignment using the CABA. Each participant's body alignment will be observed and scored unsupported and again in adaptive equipment used to support the child's body alignment such as seating / stander / lying support. The scoring for each child will take approximately 10 minutes in each position (both supported and unsupported), a maximum of 30 minutes in total per child. It is recognised that not all children will have adaptive support in all 3 positions (Sitting, lying, standing), therefore scoring will only occur in the positions for which the child has equipment in place to support body alignment. The scoring for each child will be undertaken within school setting as part of the child's daily therapy routine when moving in and out of equipment.

Specify how the consent of participants will be obtained. Please include within this a description of any information which you intend to provide the participants:

If the participants fall into the 'vulnerable' category, or there is a question whether informed consent is possible, you need to justify why you should be doing research on such participants, and show that what you want them to do is in their best interests, or the best interests of society.

APCP physiotherapists

All 2,200 APCP physiotherapists will be contacted through email with information about the study and a link to the survey. Clear instructions will be given that if they wish to participate they can use the link to complete the survey, a 60 day period will be given for responses to be made. A reminder email will be sent out after 1 month. Consent will be obtained by the physiotherapist through their choice to access and complete the survey.

- See initial email and participant information

Gatekeepers

Permission will be sought from the head teacher and governors (Gatekeepers) to approach parents for consent for their child to participate in the studies. A copy of the full detailed research proposal will be provided. Formal written consent will be gained for this research to take place.

- See letter to head teacher and governors.

Children with CP

These are a vulnerable group of individuals, often unable to give informed consent due to their severe learning impairments. Therefore parental consent to participant in the study will be sought.

All caregivers of the children will be fully informed of the procedures and the purpose of the study. Children will also be given information about the study; taking into consideration the complex learning and communication needs of the child participants, it is important that creative, multi-method, flexible approaches are adopted, which can be tailored to the needs of those involved. It is particularly important to note there is likely to be a range of needs and abilities, therefore tools may need to be adapted to suit the individuals not the group as a whole. Again, such decisions will be informed by consulting relevant experts (for example, parents, practitioners and support workers) and it may well be necessary to work alongside parents or support workers when undertaking data collection. Alternative communication methods will be used to explain the study, this will take the form of three main strategies to cover a range of understanding levels of the children and can be tailored to individual needs – see attached child participant information. Strategies include firstly; pictorial information supported by verbal and key words, secondly the showing of objects which directly relate to the activity (Clothing – shorts and vest and camera) and thirdly the placing objects in the child's hand. Each child has a pupil profile; this clearly describes body responses the child displays when they are happy and unhappy, when they like or dislike

something. These profiles are created by consultation with caregivers and professionals who know the child well. Body responses will be observed and taken as the child assenting to participate in the study. If a child is able to give a verbal response this will also be included alongside observation of body response. Caregivers will be given a copy of the child participation information tailored to the individual child's needs, so they can share this with their child. Signed consent forms for participation will be obtained from the caregivers of all included children participants.

Caregivers will be contacted using the schools established and preferred method of communicating with parents; the use of home school books. Participant information, consent forms and a return envelope will be sent to caregivers, this asks caregivers to respond only if they wish for their child to participate in the study. Caregivers will not be approached directly by the lead researcher.

- See attached participation information sheet & consent forms.

It is this group of vulnerable children who are at most risk of developing body alignment posture issues. Their severe impairment both physically and cognitively means they are solely reliant on the support of families and therapists to adjust and support their position across their day. Few clinical measurements of body alignment demonstrate psychometric properties or specificity in the assessment of body alignment. Meaning that therapist's abilities to accurately and objectively identify and evaluate posture management approaches is impaired. Currently local posture management services and equipment provision lack credibility; provision is often dependent on local therapists' knowledge and experience, and local budgetary priorities and capacity.

Indicate any potential risks to participants and how you propose to minimize these:

Confidentiality of Children being photographed. This will be minimised using several steps:

5. No children's names or personal details such as name, DOB or address will be included in any part of the research.
6. The location and name of schools used will not be disclosed in the research.
7. Children's faces will be blanked out to avoid identification.
8. Photographs will be done against a blank background so the location will not be identifiable.

Lead researcher working at special school. This impact will be minimised using several

steps:

4. The lead researcher will not directly approach caregivers for consent to participate in the study.
5. Caregivers will be contacted using the schools established and preferred method of communicating with parents; the use of home school books.
6. The information to caregivers will make it very clear that participation is voluntary and that refusal or withdrawal will not influence the therapy support either they or their child receive for postural management, and any other therapy intervention.

Describe the procedures you intend to follow in order to maintain the anonymity or confidentiality of the participants:

You may not be able to collect data anonymously (e.g. in longitudinal studies) and in some cases participants may not wish what they contribute to be either anonymous or confidential. You need to show you are aware of these issues and have thought how to deal with them.

APCP physiotherapists

Participants will be asked to provide details of their:

- ACP region
- Years of experience
- Area of speciality

This information will be used to describe the collective sample of participants.

Each questionnaire will be anonymised using a coding system. Participants will be asked to provide the last three digits of their postcode and their date of birth. This code can then be provided to the researcher if participants wish to withdraw.

Gatekeepers

School or location will not be disclosed, it will be indicated that the school is a UK based special school. Photographs will be done against a blank background so the location will not be identifiable.

Children with CP

Samples will be described in terms of their GMFCS & Age (mean, SD and range). Photographs will blank out the child's face, no personal details such as name, DOB or address will be used in the research.

How will the data be handled and stored:

This is particularly important if there is a possibility of individuals being identified from the

records you keep. See YSJU policy on data storage for guidance.

<http://www.yorks.ac.uk/documents/directory/university-policies/registry/idoc.ashx?docid=8a4ec4d5-0403-4fdf-bee7-e28c5f51500e&version=-1>

Storage of Photographs:

Photographs will be stored on an encrypted USB data stick. This will only be accessible by the primary researcher. The encrypted USB will be stored in a locked cabinet. Photographs will be disseminated in a survey format using Qualtrics which will be accessible by APCP physiotherapy participants for a 60 day period. Physiotherapists who want to be contacted about the completing a second duplicate survey will be contact 1 month after the first survey has been completed; those wanting to participate will be sent a link to the second duplicate survey, this will be accessible for a 60day period.

Data Analysis: The Statistical Package for Social Sciences (SPSS) will be used for statically data analysis. This will be stored on an encrypted USB data stick and backed up onto YSJU network drive 'My Docs'.

The data will be stored for the duration of the PhD research project and no longer than six years following collection. In line with YSJU Policy on safeguarding research data.

Appended documents

List here the material you have appended to the end of this form. This might include letters to gatekeepers, examples of informed consent sheets, copies of questionnaires, interview schedules, participant screening tools etc). If you cannot easily append this material, email it as an attachment to your faculty research administrator.

PART 1:

Physiotherapy email

Physiotherapy participant information

Caregiver participation information sheet

Child participant information sheet

Caregiver consent forms

Letter to Gatekeepers: head teacher and governors.

PART 2:

Letter to Gatekeepers: head teacher and governors.

Caregiver participation information sheet.

Child participant information sheet

Caregiver consent forms

CABA assessment form

Appendix 20: Gate Keeper letter – Responsiveness Study

Dear

I am writing to you regarding a study which aims examine the usability and responsiveness of a newly developed clinical assessment of body alignment for children with cerebral palsy. The study involves investigating the Clinical Assessment of Body Alignment (CABA) ability to detect changes in posture as part of a posture management programme. This assessment is to be used by physiotherapists as part of their clinical practice in the assessment of body alignment, as part of posture management interventions with children with cerebral palsy.

This study is part of a PhD project exploring the assessment of posture management in children with cerebral palsy in order to better understand the current practice and inform future service development for within this field.

The study involves the primary researcher observing the body alignment of a representative sample of 10 children with CP at GMFCS level IV and V. The primary researcher will independently score each child's (n=10) body alignment using the CABA. Each child's body alignment will be scored unsupported and then supported in adaptive posture management equipment used to support body alignment. The scoring for each child will be undertaken within school setting as part of the child's daily therapy routine when moving in and out of equipment. The observation of body alignment will take approximately 10 minutes, 30 minutes in total per child.

School or location will not be disclosed in any part of the research, it will be indicated that the school is a UK based special school. Children participating will be described in the research in terms of their GMFCS & Age, no personal details such as name, DOB or address will be used in the research.

Postural management has become part of the recommended treatment for some children with cerebral palsy and can help improve quality of life through maintaining physiological function, whilst also promoting participation and interaction.

Parents of identified children will be identified by the primary researcher and contacted individually using the schools established and preferred method of communicating with parents; the use of home school books. Parents will not be approached directly by the lead researcher for consent to participate in the study. The information to caregivers will make it very clear that participation is voluntary and that refusal or withdrawal will not influence the therapy support either they or their child receive for postural management, and any other therapy intervention. Parents will be sent a letter and provided with detailed information regarding the study. Parents will be provided with a return envelope and asked to return a consent form to school for the attention of the primary researcher if they consent to their child participating in this study.

Currently there is no standardised assessment regarding the analysis of body alignment and provision of postural management programmes, and therefore a variable level of service is

being provided both locally and across the country. Hence, the information gained from this study aims to examine the validity and reliability of this new assessment. This may prompt further research into posture management in the longer term, helping to form a base of knowledge for the development of a standardised service framework.

I would greatly appreciate your help in allowing children with cerebral palsy from your school to participate in the study, and parents to be contacted.

If you have any questions or queries please do not hesitate to contact me.

Yours faithfully

Frances George (Principal researcher)

Appendix 21: Caregiver participation Information – Responsiveness

Caregiver Participant Information Sheet: To evaluate usability and responsiveness of the CABA to detect changes in body alignment as part of a posture management programme for children with cerebral palsy.

What is the purpose of this study?

Your child has been invited to take part in a research study. Before you decide if you would like your child to participate we would like to explain about the study and what we would expect your child to do. You may talk to others about the study before you decide if you would like to participate. Please do not hesitate to contact us if you have any questions, contact details are below.

This research study is part of a PhD project exploring the assessment of posture management in children with cerebral palsy. It aims to investigate the Clinical Assessment of Body Alignment (CABA) ability to detect changes in posture as part of a posture management programme.

Why has my child been invited?

Your child has been invited as they have been identified as having a diagnosis of cerebral palsy and use posture management equipment to support their body alignment.

Does my child have to take part?

The decision for your child to take part is completely voluntary. You may refuse to participate or withdraw from the study at any point. Your refusal to participate or wish to withdraw from the study will not influence the therapy support you or your child receives for postural management or any other therapy intervention.

What is expected of my child and me if I take part?

If you chose for your child to participate in this study; the primary researcher Frances George will observe the body alignment of your child using the CABA. Your child's body alignment will be scored unsupported and then supported in adaptive posture management equipment that they currently use to support their body alignment. The scoring for your child will be undertaken within their school setting as part of the child's

daily therapy routine when moving in and out of equipment. The observation of body alignment will take approximately 10 minutes in each position, 30 minutes in total per child.

You as a caregiver are not required to have any involvement in this study. However, if you want, you are more than welcome to be present for the assessment.

Consenting and Taking part?

If you wish to consent to your child being part of this study then please complete the attached consent form and return it in the envelope provided to school in your child's home-school book. .

If you do not wish to take part then please ignore this letter.

What are the possible disadvantages and risks of taking part?

We expect no serious risks. However we have identified some potential areas of risk which we have taken steps to minimise the impact of these.

The following steps will be taken to ensure confidentiality of the children:

9. No children's names or personal details such as name, DOB or address will be included in any part of the research.
10. The location and name of schools used will not be disclosed in the research.

The following steps will be taken as the lead researcher is a physiotherapist at the special school:

7. Caregivers will not be approached directly by the lead researcher for consent to participate in the study.
8. Caregivers will be contacted using the schools established and preferred method of communicating with parents; the use of home school books.
9. The information to caregivers will make it very clear that participation is voluntary and that refusal or withdrawal will not influence the therapy support either they or their child receive for postural management, and any other therapy intervention.

What are the possible benefits of taking part?

Participants will be able to be a part of this research; this may then lead to further research as part of this PhD project regarding postural management and children with cerebral palsy. Participants may find participation an opportunity to develop knowledge, assisting in shaping future clinical assessments which are clinically applicable to practice and import to children with cerebral palsy.

Expenses and payment

You or your child will not be paid for taking part in this study.

Who can I contact about the project?

If you have any queries or questions please contact:

Principal Investigator: Frances George Email: [REDACTED] Phone: [REDACTED]

School of Health Sciences, York St John University

Alternatively you can contact my supervisor: Lynne Gabriel Email: [REDACTED]
Phone: [REDACTED]

If you have any concerns regarding how the research has been conducted, please contact [REDACTED], chair of the cross schools research ethics committee at [REDACTED], or by phone at [REDACTED]

Will my taking part in this study be kept confidential?

Children will be described in terms of their GMFCS & Age only. No children's names or personal details such as name, DOB or address will be included in any part of the research. The location and name of school will not be disclosed in the research.

The data will then be kept securely, with access by the principal research only, for as long as may be needed in the future.

Please retain this document for your records. If you have any questions or queries please do not hesitate to contact the principal researcher.

How will the information be used?

This research is part of a PhD study into posture management with cerebral palsy, and the results of this study may be used in the following ways:

- As part of a PhD study
- Part of a series of publications / conference presentations / book.
- Within further research.
- Informing best practice guidelines, government input.
- Teaching / training / education.

Appendix 22: Caregiver consent form – Responsiveness

RESEARCH CONSENT FORM

Name of Researcher(s) <i>(to be completed by the researcher)</i>
Frances George
Title of study <i>(to be completed by the researcher)</i>
To evaluate usability and responsiveness of the CABA to detect changes in body alignment as part of a posture management programme for children with cerebral palsy.

Please read and complete this form carefully. If you are willing to participate in this study, ring the appropriate responses and sign and date the declaration at the end. If you do not understand anything and would like more information, please ask.

- I have had the research satisfactorily explained to me in verbal and / or written form by the researcher. **YES / NO**

- I understand that the research will involve: my child’s body alignment being observed by the named researcher (Frances George) in both unsupported and supported positions. This will take no longer than 30 minutes and will be carried out in the school setting. **YES / NO**

- I understand that I may withdraw my child from this study at any time without having to give an explanation. This will not affect my future care or treatment. **YES / NO**

- I understand that all information about my child will be treated in strict confidence and that my child will not be named in any written work arising from this study. **YES / NO**

- I understand that you will be discussing the progress of your research with others Dr Lynne Gabriel, Dr Charikliea Sinai and Dr Alex Benham at York St John University **YES / NO**

















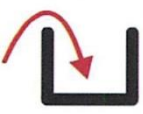

I freely give my consent for my child to participate in this research study and have been given a copy of this form for my own information.

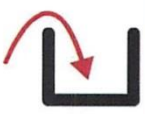
Childs Name:

Signature:

Date:

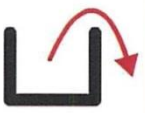
Appendix 23: Child participant info example – Responsiveness

<p>research</p> 						
<p>Frances</p> 						
<p>looking</p> 						
<p>sitting</p> 	<p>lying</p> 	<p>standing</p> 				
<p>in</p> 	<p>pacer</p> 	<p>in</p> 	<p>standing frame</p> 	<p>in</p> 	<p>walker</p> 	
<p>out</p> 	<p>pacer</p> 	<p>out</p> 	<p>standing frame</p> 	<p>out</p> 	<p>walker</p> 	

Appendix 24: Kolmogorov Smirnov test results

Positions	Kolmogorov-Smirnov test	Decision/interpretation
Lying	K-S(9)=0.227, p=0.155 Non-significant	Reject the null hypothesis – the data is normally distributed
Standing	K-S(9)=0.182, p=0.200 Non-significant	Reject the null hypothesis – the data is normally distributed
Sitting	K-S(9)=0.182, p=0.200 Non-significant	Reject the null hypothesis – the data is normally distributed
Total	K-S(9)=0.183, p=0.200 Non-significant	Reject the null hypothesis – the data is normally distributed