

**“Bed-blocking”: an Evaluation of the Role of
Financial Incentives in the Community Care (Delayed
Discharges etc.) Act 2003**

Ana Manzano-Santaella

Submitted in accordance with the requirements for the degree of
PhD

The University of Leeds
School of Sociology and Social Policy

November, 2008

The candidate confirms that the work submitted is his/her own and that appropriate credit has been given where reference has been made to the work of others.

This copy has been supplied on the understanding that it is copyright material and that no quotation from the thesis may be published without proper acknowledgement.

ACKNOWLEDGEMENTS

I would like to thank the Economic Research Council for the award that supported me during my three years of research. This work would not have been possible without the generous disposition of the many research participants: patients and staff at both the social services department and the hospital who helped moved this research forward. Confidentiality agreements prevent me from mentioning their real names but I will never forget them; the time they found for this research in their hectic working lives or at the vulnerable time of acute illness. I also wish to express my gratitude to my principal supervisor, Prof. Ray Pawson who was abundantly helpful and offered invaluable wisdom, generosity, support and guidance throughout the research project. Gratitude is also due to my second supervisor, Dr. Geof Mercer without whose knowledge and attention to detail this study would not have been possible.

I would like to gratefully acknowledge the enthusiastic encouragement of Dr. Teela Saunders for suggesting the idea of undertaking the Phd at the University of Leeds. I would furthermore like to acknowledge the help of Helen Rayfield and Belinda Goode for their technical advice on 'writing with style'. My fellow PhD students Mark Monaghan, Rachael Dobson and Sarah Kingston have also been fundamental, not only for their practical proof reading support but for the priceless conversations about methods, references, thesis structure, etc. I am also grateful to my friends Silvia, Gemma, Javi, Rosa, Bea and Alison for their continued moral and practical support, care and kindness. I feel a deep sense of gratitude for my social work ex-colleagues, Montserrat Roig i De Mariana and Charo Cuesta Alvarez, who taught me all I know about hospital social work practice and who believed in me before I did (*Moltes gràcies! Us porto sempre al cor!*).

Finally, I am forever indebted to my two favourite English men: my husband, Mark Wright, who failed to marry a doctor but who was relentlessly determined when helping to transform his wife in one of them. And my son, Sam, whose understanding and endless love were a gift and never a hurdle throughout the duration of my studies.

ABSTRACT

This study contributes to the evaluation of the role of financial incentives in achieving the reduction of hospital delayed discharges attributed to the implementation of the Community Care (Delayed Discharges etc.) Act 2003. This policy imposes financial penalties for social services departments in England unable to provide the community care services required to discharge patients within set timescales. Once a multidisciplinary team decides that patients are safe to be transferred out of the hospital, social services are given three days to organise the discharge. If patients do not leave on the third day, a fine is imposed to social services of £100/120 per day and per person. This programme aims to resolve the issue of ‘bed-blocking’, the loaded term used to describe patients whose discharge from hospital is not timed within the speed desired by the institution.

This thesis performs a theory-driven evaluation, analysing the theoretical basis underpinning this complex policy following the realist framework. The use of a case study approach based on multiple methods of data collection in ‘real-time’ helps unravel the complexities of this multi-agency initiative. Fourteen patients were followed through their hospital stay to identify flows and blockages in the programme. This data was compared with knowledge gained from other evaluations as a means to generalise the findings. The analytical process demonstrates that the Delayed Discharges programme is an amalgam of multiple innovations which includes financial incentives. Some of these other measures intertwined with the fines to create mechanisms that, planned or unplanned, reduce delays or avoid fines. Sometimes they do it at the same time, but on occasions they do it in isolation. Consequently, mechanisms are embedded in the designed programme theory that allow for fines to be avoided without delays being necessarily reduced.

TABLE OF CONTENTS

ACKNOWLEDGEMENTS.....	ii
ABSTRACT.....	iii
TABLE OF CONTENTS.....	iv
LIST OF FIGURES AND TABLES.....	vii
ABBREVIATIONS	ix
INTRODUCTION	1
1. THE CONCEPTUALISATION OF DELAYED DISCHARGES: PRECURSORS AND INTERPRETATIONS	5
1.1 Introduction.....	5
1.2 Delayed Discharges and the Contemporary Health and Social Policy Trends....	5
1.3 ‘Bed-Blocking’ or ‘Delayed Discharge’: A Contested Concept.....	8
1.3.1 Reducing Length of Stay to Improve Hospital Efficiency.....	13
1.3.2 The Measurement of Delayed Discharges: Tensions and Challenges	15
1.3.3 Most Common Reasons for Delayed Discharge.....	18
1.4 Patients in Blocked Beds: Who Are They?.....	21
1.5 Summary	23
2. THE POLICY RESPONSES: FINES TO REDUCE SOCIAL SERVICES DELAYED DISCHARGES.....	25
2.1 Introduction.....	25
2.2 Policy Responses to Delayed Discharges Problem: A Historical Overview	26
2.3 Delayed Transfers of Care: A Performance Indicator	29
2.3.1 Exploring the Relationship Between the NHS Financial Reform and the Fines to Social Services Departments.....	36
2.4 Cross-Charging Schemes in the Scandinavian Countries.....	41
2.5 An Overview of the Community Care (Delayed Discharges etc.) Act 2003	44
2.5.1 Innovations Made Statutory by the Delayed Discharges Act	45
2.5.2 Evaluations to Date	62
2.6 Summary	67
3. EVALUATION STRATEGY: METHODOLOGY AND METHODS	69
3.1 Introduction.....	69
3.2 A Focus on Programme Theory: Understanding How Financial Incentives Work	70
3.3 Realist Strategy to Evaluate a Multi-Agency Programme.....	71
3.4 Case Study Research.....	74
3.4.1 Selection of the Research Site.....	75
3.4.2 Sampling Relevant Discharge Events.....	77
3.4.3 Sampling Hospital Patients	78
3.5 Multiple Methods for Data Collection in Real-Time Research	80
3.5.1 Case Recording and Data Management.....	83
3.5.2 Participant Observations and Documentary Analysis.....	86
3.5.3 Qualitative Interviews	88
3.6 Analytical Strategy: Generalisation From a Reduced Number of Cases	90
3.7 Research in NHS Premises and Ethical Considerations	95
3.9 Summary	97
4. SURFACING THE PROGRAMME THEORY OF THE DELAYED DISCHARGES ACT	98

4.1 Introduction.....	98
4.2 Programme Theory and Social Systems	98
4.3 Discussions Around the Complexity of the Delayed Discharges Programme	100
4.3.1 The Macro-Social Phenomena.....	104
4.3.2 The Meso-Social Phenomena	108
4.3.3 The Micro-Social Phenomena.....	110
4.4 The Fines: A Complicated Solution.....	112
4.5 The Local Interpretation of the Nationally Designed Programme Theory	115
4.6 Summary	118
5. CONTEXTUAL CIRCUMSTANCES OF THE RESEARCH SITE.....	120
5.1 Introduction.....	120
5.2 Context and Programme Evaluation	121
5.3 Contextual Circumstances of the Local Healthcare Services: A Financial Imbalance	123
5.3.1 The Foundation Trust Hospital	124
5.3.2 The Primary Care Trust	128
5.4 Local Contextual Features of Social Care: Lack of Money and Lack of Fines.....	130
5.4.1 Social Services Financial Situation.....	131
5.4.2 Residential and Nursing Care Provision	134
5.4.3 Domiciliary Care Services	137
5.4.4 Housing Capacity	139
5.5 The Health and Social Care Multi-Agency Arrangements	140
5.5.1 Intermediate Care Services	141
5.5.2 NHS Continuing Healthcare	144
5.6 Summary	146
6. PRIMARY ADJUSTMENTS: MECHANISMS AND CORE PROGRAMME OUTCOMES.....	147
6.1 Introduction.....	147
6.2 Mechanisms and Outcomes	147
6.3 Significant Reduction of Delayed Discharges: Outcome Achieved	149
6.4 Total Absence of Fines: Outcome Achieved	151
6.5 Working towards ‘Seven Days Discharges’: an Unnecessary Mechanism	156
6.6 Multidisciplinary Team Decisions: Instant Reduction of Delayed Discharges	159
6.7 Weekly Census of Reasons for Delayed Discharges: an Easy Way Out.....	161
6.8 The Conceptual Construction of a New ‘Social Services Patient’	165
6.9 Interim Beds, Planned Mechanisms to Reduce Delays	169
6.5 Summary	172
7. THE CASE STUDIES: HOSPITAL DISCHARGE JOURNEYS UNDER THE REALIST MICROSCOPE.....	173
7.1 Introduction.....	173
7.2 Living Outcomes.....	174
7.2.1 Case Study 1: Mrs Ackroyd.....	177
7.2.3 Case Study 3: Mr Catford	184
7.2.4 Case Study 4: Mr Derwick.....	187
7.2.5 Case Study 5: Mrs Edington	191
7.2.6 Case Study 6: Mrs Falshaw.....	194
7.2.7 Case Study 7: Mrs Grange	197
7.2.8 Case Study 8: Mrs Hanslow.....	200
7.2.9 Case Study 9: Mrs Ianson	203

7.2.10 Case Study 10: Mrs Jones.....	206
7.2.11 Case Study 11: Mr Kingsley.....	209
7.2.12 Case Study 12: Mrs Leachman.....	212
7.2.13 Case Study 13: Mr Marshall.....	216
7.2.14 Case Study 14: Mrs Naylor.....	218
7.3 Summary.....	221
8. RESISTANCE, SECONDARY ADJUSTMENTS AND REALIGNMENTS.....	223
8.1 Introduction.....	223
8.2 The Context-Mechanism-Outcome Configurations.....	223
8.3 The Fines: an Absent Deterrent?.....	225
8.4 How did the Fines Work for Cases that Were Delayed?	228
8.4.1 The Self-funders: a Difficulty Created or Reinforced by the Programme?	229
8.4.2 The In-betweens: Cases with Complex or Specific Needs	235
8.5 How Did the Fines Work for the Cases that Were Not Delayed?	239
8.5.1 Outcomes for Intermediate Care Cases: the Contextual Difference between ‘Rehabilitation’ and ‘Recuperation’	239
8.5.2 Cases that Could Be a Potential Fine: Tacit Alteration of Mechanisms to Reduce Delays	241
8.6 Summary.....	250
9. RECAPITULATION AND RECOMMENDATIONS.....	251
9.1 Introduction.....	251
9.2 Thesis Overview	251
9.3 Reflections on Findings	256
9.4 Reflections on Methods	258
9.5 Policy Recommendations.....	260
REFERENCES	263
APPENDIX.....	283
Interview with Social Services Care Manager	283

LIST OF FIGURES AND TABLES

Chapter 2:

Figure 2.1: Delayed Discharges Contextualised in the Hospital Performance Indicator Map	32
Table 2.1: Delayed Transfers of Care as a Performance Indicator for Acute Care (Source: Healthcare Commission, 2006)	33
Table 2.2: Delayed Transfer of Care as a Performance Indicator for Social Care (Source: Commission for Social Care Inspection, 2005a)	35
Figure 2.2: The Purchaser/Provider Roles in Acute Care before and after the Delayed Discharges Act	39
Figure 2.3: Process Map of Discharge Planning after the Delayed Discharges Act....	46
Table 2.3: Innovations Made Statutory by the Delayed Discharges Act.....	47
Table 2.4: Reasons for Delay according to SitReps Guidance	54

Chapter 3:

Table 3.1: Example of Systematic Case Study Data Recording	84
Table 3.2: Activities per Case	85
Figure 3.1: Evaluative Research in Adaptive Systems	91
Figure 3.2: How to Bank Contexts	93
Figure 3.3: How to Bank Mechanisms and Outcomes.	94

Chapter 4:

Figure 4.1: Social Contexts in Which the Fines are Embedded	102
Figure 4.2: Main Stakeholders in Discharge Planning Decision-Making Process	112
Figure 4.3: Logic Model of the Delayed Discharges Programme	114
Table 4.1: Local Interpretation of the Main Programme Strategies	117

Chapter 5:

Table 5.1: List of Contexts.....	123
Figure 5.1: Main Institutional Relationships in Healthcare according to National Policy	124
Figure 5.2: Local Progress in Achieving the Target for the Performance Indicator 'Delayed Transfers of Care'	127
Table 5.2: Comparisons of FACS Needs Funded by Neighbouring Councils in 2006 (from Confidential Reference 8, 2006).....	132

Chapter 6:

Figure 6.1: Number of Lost Bed Days Due to Delayed Discharges in the Local Hospital (Source: Hospital Discharge Liaison Team Performance Data Collection)	151
Figure 6.2: Amount of Fines Paid by the Social Services Department in the Research Site from 2003-2008 (Source: Reimbursement Office, Local Social Services Department)	152

Figure 6.3: The Construction of the 'Social Services Patient' before and after the Delayed Discharges Act.....	168
--	-----

Chapter 7:

Table 7.1: Table of Contexts, Mechanisms and Outcomes	176
Figure 7.1: CMOs for Case Study 1: Mrs Ackroyd	177
Figure 7.2: CMOs for Case Study 2: Mrs Beamont.....	181
Figure 7.3: CMOs for Case Study 3: Mr Catford	185
Figure 7.4: CMOs for Case Study 4: Mr Derwick.....	188
Figure 7.5: CMOs for Case Study 5: Mrs Edington	192
Figure 7.6: CMOs for Case Study 6: Mrs Falshaw.....	195
Figure 7.7: CMOs for Case Study 7: Mrs Grange	198
Figure 7.8: CMOs for Case Study 8: Mrs Hanslow.....	201
Figure 7.9: CMOs for Case Study 9: Mrs Ianson	204
Figure 7.10: CMOs for Case Study 10: Mrs Jones	206
Figure 7.11: CMOs for Case Study 11: Mr Kingsley	210
Figure 7.12: CMOs for Case Study 12: Mrs Leachman.....	213
Figure 7.13: CMOs for Case Study 13: Mr Marshall	216
Figure 7.14: CMOs for Case Study 14: Mrs Naylor.....	219

Chapter 8:

Table 8.1: Reasons for Inclusion or Exclusion from the Reimbursement Scheme and whether Cases were Delayed	228
Table 8.2: Relationship between Social Services Participation in Discharge Decisions and Programme Eligibility Criteria.....	231
Table 8.3: Relationship between Choice and Promotion of the Independence in Self-funders.....	233

ABBREVIATIONS

CRAM: Capacity Risk Assessment Meeting

FACS: Fair Access to Care Services

GP: General Practitioner

MDT: Multidisciplinary Team Meeting

NHS: National Health Service

OT: Occupational Therapist

PbR: Payment by Results

PCT: Primary Care Trust

RNCC: Registered Nursing Care Contribution

SDD: Social Services Department

SitReps: Situational Report

UK: United Kingdom

*'Hospitals are places where you have to stay in for a long time, even if you are a visitor. Time doesn't seem to pass in the same way in hospitals as it does in other places. Time seems to almost not exist in the same way as it does in other places'.
Pedro Almodovar*

'A hospital bed is a parked taxi with the meter running'. Groucho Marx

INTRODUCTION

Different people may judge identical lengths of time to be passing at different rates, with some philosophers even doubting the claim that time can ever be measured. Time perception can be affected by space, by culture and age. But time also has another social constructed meaning: it has been given economic value.

The obsession of public health institutions to provide accountability on the basis of efficient management of their resources has resulted in the usage of time as evidence of effectiveness. Targets in hospital have been often constructed as time related measures: waiting lists, waiting times in A&E, patient length of stay. In this institutional and political context, 'bed-blocking' emerged as a loaded term used to describe patients whose discharge from hospital was not effected with the speed desired by the institution. The term started to gain public exposure in the 1990s, though it was rejected as being disrespectful to patients in 2001, and it was replaced with the terms, 'delayed transfers of care' or 'delayed discharges'. The Delayed Discharges Act 2003 had the difficult task of allocating a time related financial penalty for bed-blocking, a concept that has struggled with its operationalisation since its conception. In actuality delayed discharges are the product of objective forces and subjective meaning resulting in a range of intended and unintended consequences. For instance, after programme implementation, increased rates of hospital re-admissions and residential care admissions were observed (Commission for Social Care Inspection, 2004).

In contrast to initial Governmental evaluations based on simple, macro outcome measures concentrating on time of discharge to measure efficiency, this research was performed using a theory-driven, realist framework. In an attempt to get to grips with the totality of mechanisms affecting discharge, the thesis also operates at the micro-level. Fourteen patients were followed through their hospital stay using a case study approach that identified flows and blockages in the programme. Following up each case as they developed, in 'real-time' and with a mix-method approach, revealed the

particular circumstances in which the programme operated and facilitated rigorous testing of the programme theory.

The research literature on delayed discharges indicates that the causes of delay are complex and multi-factorial with health and social needs struggling to fit into the administrative framework categorising peoples' needs. The isolation of the financial incentives from the other nine innovations implemented concurrently proved an impossible task. It is also impossible to isolate them from the local contextual circumstances in which the programme was implemented. Therefore the present project evaluates the ensemble of measures as they were applied in a detailed local context.

With this challenge in mind, Chapter One of the thesis starts with a brief overview of contemporary health and social care policy trends that culminated in the introduction of the Community Care (Delayed Discharges etc.) Act 2003. The quasi-market reform in public services in the 1990's maintained the conceptual and administrative divide between health and social care (Lewis, 1999). Within this context, New Labour initiatives introduced after 1997 combined an approach that promoted inter-agency collaborations but, at the same time, forced them to compete for cost-efficiency savings. To better understand this challenge, the chapter describes how the delayed discharges problem was constructed as a consequence of the adoption of a specific economic theory.

In Chapter Two, the development of policy responses to reduce delayed discharges in the UK is examined, with special reference to how the performance indicator 'delayed transfers of care' was created and developed. The reasons why the Government chose a financial instrument to achieve the target of reducing delayed discharges to a minimum are also explored, focusing on the links with the contemporaneous national health reform (Payment by Results). The second part of the chapter describes how the policy idea germinated via the influence of similar programmes implemented in Scandinavian countries in the 1990's. These, significantly, had claimed a rapid decrease in delayed discharges numbers. The main features of the Delayed Discharges Act are explained concentrating on how a package of other innovations was introduced simultaneously with the fines. Finally, a brief review of the evaluations to

date of the Act is introduced, highlighting the need for a closer assessment of the successful outcomes reported by previous studies.

Chapter Three presents the methodology chosen for this study. The realist framework is introduced, providing a background approach which helps in developing adequate methods to untangle the programme theory behind the policy. The way in which data is collected and information analysed are then explained in detail; the use of 'real-time' data collection methods allows attention on relatively unexplained features of the Act. Patients were followed through their hospital plans as they developed. Meetings were observed and interviews with key actors, including the patients, were performed in situ or soon after decisions were made and contingencies emerged.

In Chapter Four delayed discharges are conceptualised as a multifaceted issue and some of its complexities are analysed. These are located in the multiple levels of the programme intervention: the large-scale macrostructure, the institutional agencies involved and the individual characteristics of patients and staff. The detailed theories of how the programme was expected to achieve change at the local level are explained, giving priority to the ten statutory innovations under the Delayed Discharges Act and how the local staff adapted their working practices to achieve them.

Chapter Five concentrates on examining the contextual factors that characterise the locality where the fieldwork took place and how these circumstances affected the impact of the fines. Key features of the health and social care agencies involved in discharge planning such as the local foundation trust hospital, primary care trust and social services department are identified. These provide the opportunity to identify contextual factors significant for the operation of delayed discharges.

Chapter Six identifies mechanisms that could produce two of the most relevant outputs for this investigation: 'reduced delays' and 'reduced fines'. It seems that the local implementation has achieved a rapid and sustained decrease of delayed discharges figures, without the social services department receiving, at the time of the fieldwork, significant fines. This could be explained by the redefinition of key

concepts for delayed discharges data collection like the interpretation of when patients are 'safe to transfer' and the definition of causes and agencies responsible for delays.

In Chapter Seven, the fourteen patients followed during their discharge plans are described. These case studies contain process data that evidence the local mechanisms generated to avoid the fines and the consequences for the patient. The outcomes for the individuals, whose lives were propelled into the programme, are identified to increase understanding of the relationship between process and outcomes, under local contextual constraints. The programme theories described in the previous chapters are tested in the micro-contexts of the individuals to gain an insight into how the intervention works when confronted with real people, their illnesses and their social circumstances.

In Chapter Eight, the analysis is brought together to demonstrate how fines are constrained by the local circumstances of the programme implementation. Some outcome patterns are elicited and refined generating transferable middle range theories about the causal powers of the fines. The comparison across the case studies illustrates how, although fines are not issued, delayed discharges still exist for some patients with well defined circumstances. From this evidence, the chapter moves into explaining the reasons why different cases progress at a different pace.

In conclusion, the thesis challenges the finding that fines have produced simple, significant and successful outcomes as claimed in some quantitative evaluations. The Delayed Discharges programme is an amalgam of multiple innovations which includes fines. All these measures interrelate to generate mechanisms that allow for fines to be avoided without delays being necessarily reduced. The realist evaluation approach helps unravel the complexities of this multi-agency initiative demonstrating how key contextual blockages are at the root of the delayed discharges. Finally, recommendations for future research and policy are presented in the light of the main findings.

The reader should note that as well as the usual bibliography and appendices, some of the references used are kept confidential as they could compromise the confidentiality agreements established with the research site.

1. THE CONCEPTUALISATION OF DELAYED DISCHARGES: PRECURSORS AND INTERPRETATIONS

1.1 Introduction

This chapter provides an overview of the concept of delayed discharges in order to assist the reader in contextualising the evaluation performed in this thesis. I begin with a brief description of the historical accounts that framed the emergence of delayed hospital discharges as a phenomenon. By placing policy developments in their historical context, it is possible to identify the key issues and assumptions that tend to remain invisible when evaluating recent policy initiatives.

In order to investigate the rival interpretations affecting the topic of bed-blocking, three key features of the concept are described: the reduction of patients' length of stay as a management tool to improve efficiency; the intrinsic methodological difficulties of measuring hospital delays; and the most common reasons for delayed hospital discharges. The chapter closes with a description of the characteristics of the patients frequently labelled as delayed discharge, their common traits and how these have been examined by previous research.

1.2 Delayed Discharges and the Contemporary Health and Social Policy Trends

Over the last thirty years, most western nations, influenced by neoliberal ideologies, embarked on healthcare reforms that are often characterised as 'decentralisation' and 'devolution' (Smith and Crome, 2000). The shift of responsibility away from the state through the introduction of market forces extended to all aspects of governance. Throughout the development of British welfare policy, the state was responsible for finance, ownership and supply of healthcare and social care. Founded in 1948, the National Health Service (NHS) was seen as a triumph of socialist ideology, inspired by egalitarian ideas as it institutionalised the principle of allocating resources

according to need. However, as in many other areas of welfare, as time went by, the NHS attracted criticisms typical to such large public organisations: inefficiency, slow to change and a persistent waste of tax-payers money. Consequently, under the Conservative Government of the late 1980's and early 1990's, de-institutionalisation, privatisation of care homes and decentralisation were key strategies underlying health reforms which culminated in the introduction of the NHS and Community Care Act 1990.

The purchaser-provider system now operating in the NHS was a central part of this legislation. This reform represented the greatest change in the organisation of NHS funding and health planning since its conception. State provision for health and social care was targeted for replacement with a quasi-market oriented approach to welfare service delivery. Such a system is not considered a 'complete' market because central government raises the funds for purchasing services, which are then distributed to agents who purchase these services on behalf of consumers. Consequently, the state retains control of finances but provision of services is left to independent profit, and non-profit providers, hoping that efficiency will be enhanced (Propper and Le Grand, 1997). In other words, the construction of internal markets was based on the belief that healthcare in the purchaser-provider system would generate increased cost awareness and hence encourage more efficient use of resources. Financial efficiency was to be achieved not with increased funds but through better performance management, delegating responsibility for the delivery of healthcare to local level. Several other changes in the administration of health and social care were precipitated by these reforms but the most significant to this thesis was the shifting of care from publicly run institutions to the community.

Before the 1990 reforms, the state was a provider of social care for much of its population: funding, purchasing and providing care services. After the reorganisation, local authorities were given a lead agency role for social care and they took on the characteristics of purchasers. The emergence of a management-oriented approach to community care planning meant that the state was supposed to enable social care, setting the emphasis on managing packages of care for people in the community rather than matching peoples' needs to services. Voluntary and private organisations

(and families) undertook the provision of social care on behalf of the council, and social workers were given the role of 'care managers'.

The relocation of care from institutions to the community meant a transfer of the cost of care from the state to other social care actors: users, their carers and families, voluntary sector organisations and for-profit organisations. The early discharge of people from hospital or care institution also increased the financial burden upon social services departments and primary healthcare services. Furthermore, the constant development of initiatives that reduced hospital-based NHS care represented the relocation of free care at the point of delivery to community services, which are means-tested and incur charges for the population. In other words, the redefinition of some acute and continuing care as 'social care' had an economic consequence for the end users of services that should not be ignored.

The 1990 NHS and Community Care Act continued the historical division between health and social care (Lewis, 1986 cited in Lewis, 1999). Eligibility criteria for free NHS continuing care and the appropriateness of discharging vulnerable patients from hospital became major political issues during the 1990s. Within this framework, in 1997, New Labour proposed 'The New NHS', a ten year plan for the NHS. While preserving many features of the internal market, this was intended to shift the focus of services from competition to cooperation. Government emphasis turned to 'integrated care' and 'partnerships' (Department of Health, 1997a). In this context, the old divisions between health and social care were identified as creating particular obstacles to the planning and delivery of 'seamless' services tailored to individual needs (Bywaters and McLeod, 2001).

The concepts of 'partnership' and 'collaboration' are rarely defined in detail by governmental agencies and hence they are difficult to put to empirical test (Lymbery, 2006). Nevertheless, in most understandings, partnerships seem to refer to joint systems of inter-professional and inter-organisational collaboration. Some examples of established partnership schemes, which meant a significant improvement from past organisational restructures of the interface between health and social care agencies were: joint budgets, intermediate care services and the single assessment process. Bevir (2005) explained that New Labour seemed to promote joined-up governance

‘using the tools championed by the new institutionalists with their appeals to social embeddedness and networks. These tools, New Labour suggests, can create a public sector that is flexible, entrepreneurial, and efficient – a public sector that is in tune with the new knowledge-based economy’ (p.49).

Other commentators (Lewis, 1999:336) described how the trend for seamless services ‘tends to draw a veil’ over the intellectual rationale that justified the boundaries between health and social care. The unbalanced policies on funding health and social care remain still problematic (Bywaters and McLeod, 2001).

In 2003, another initiative that attempted to reduce hospital based care was introduced: The Community Care (Delayed Discharges etc.) Act 2003. This policy meant that local authorities were made financially responsible for the accommodation costs (hotel services) that patients with social needs receive whilst in acute care. This figure was calculated in a daily tariff equal for all patients (£100 per day), with the exception of localities in the South East of England (£120 per day). As a consequence, administratively, social services departments were treated as purchasers of a service (acute care) for ‘their clients’, provided by the hospitals. As in Sweden with the similar Ädel reform,

‘the main steering mechanism of the reform was not only the introduction of financial incentives but also the division of the process of illness into an acute, short-term period and conditions lasting for longer periods and subsequently requiring long-term care’ (Andersson and Karlberg, 2000:7).

In this policy, the partnership ethos collided with the need for efficiency, which was constructed under a concept emblematic of that division: the problem of bed-blocking or delayed discharges. The phenomenon is deep-seated within the problematic administrative, financial and professional division of health and social care.

1.3 ‘Bed-Blocking’ or ‘Delayed Discharge’: A Contested Concept

Cultural, social, economic and organisational contexts influence how the patient group of the so-called ‘bed-blockers’ could be defined (Styrborn, 1994). There are rival conceptions and interpretations of this term which could thus be considered to

come under the rubric of an 'essentially contested concept' (Gallie, 1956). Bed-blocking is an internally complex term, open-ended and based on qualitative notions. Interpretations of the concept are disputed with particular lines of thought being sustained by different standpoints. In brief, the presence of delays in a health system may be considered as an indicator of two possible system inefficiencies: a failure in the discharge planning process, which generally blames social services for not ensuring timely services; or a shortage of alternative forms of care for this group of patients.

The term 'blocked bed' originated in the UK in the late 1950's and it was traditionally used to imply 'that regular patient or client through-put with regard to that particular bed has stopped' (Rubin and Davies, 1975: 142). Synonymous expressions like 'back-up', 'backlogs', 'long-stays', 'outliers' and 'delayed discharges' were used in the USA and Canada (Styrborn, 1994) and had similar meanings despite the contextual differences. They all referred to the fact that average bed use was interrupted by patients who stayed in hospital for longer than expected. Whatever the words used to describe this group of patients, similar terms were and still are applied not only to acute hospital beds but also to beds in psychiatric, geriatric and other health and social care institutions.

The beginning of the bed-blocking phenomenon cannot be separated from the changing role of hospitals in respect of geriatric patients. Originally, 'bed-blocking' concerns were driven by hospital clinicians becoming increasingly perturbed with their limited availability of beds. In the UK between 1961 and 1967, there was a 14 per cent rise in the elderly population but the number of hospital beds assigned for their use remained practically the same (Lewis, 2001). Apparently, there was 'intense competition over hospital space within the medical profession which led to a desire on the part of some hospital doctors to exclude care of the elderly sick from major hospitals' (Martin, 1995 in Bridgen, 2001: 511). Hall and Bytheway (1982) suggested that hospital doctors followed the prevailing 'acute ideology' in medicine and used phenomena like bed-blocking to restrict older people's entry to hospital. Therefore, not surprisingly, early investigations into the 'bed-blocking' phenomenon relied on the opinion of consultants for the reasons why patients stayed in hospital longer than necessary (MacPhail and Bradshaw, 1967; Rosin, 1970; Butler and Pearson, 1970).

Doctors' research tended to focus on the failure of social care to develop the services needed to facilitate discharges. For this reason, some authors argue that the concept of 'bed-blocking' is another example of the medical dominance that intrudes into policies and the daily administration of health institutions:

'At the interface between medical and social systems of care, medical decisions often determine the extent to which non-medical services may be provided to meet the complex mix of social and medical care necessary to alleviate the problem to be addressed. This is particularly important in geriatric care since declining biological and bodily functions can in part be compensated by the provisions of social services whose purpose is to support elderly persons in their current environments through procedures which compensate for declining bio/social abilities' (Gill and Ingman, 1994: 5).

In other words, doctors decide whether hospital treatment is completed without considering the holistic processes associated with individuals and the institutions where they receive their care. This approach is based on a medical model that locates the problem within the person and disregards the social context of people's lives:

'Since the late 1950s hospital doctors have repeatedly complained that their acute beds are 'blocked' by elderly patients, whom they suggest require social rather than health care. Local authorities, on the other hand, have protested that they are having to care for individuals with ever-greater degrees of infirmity. Meanwhile, as interest groups for elderly people have pointed out, individual service users have been caught in the middle of these disputes' (Bridgen and Lewis, 1999:10).

In the 1990's, with the drive for efficiency that dictated healthcare institutions, the term 'bed-blocking' was borrowed by health economists who used it as an example of the failure of efficient systems in hospitals. Indeed, in the debate over 'bed-blocking', economists tended to side with hospital doctors and blame inadequate local authority provision: reducing the boundaries of acute care had the potential to suit both cost conscious policy makers and the professional inclinations of many hospital doctors.

In 1994, Styrborn argued that 'bed-blocking', despite its common use, was not to be accepted as a medical term but as an administrative concept that was part of an economic control system 'coined by health economists' (Styrborn, 1994: 32). He explained that the term implied that the patient was situated in the wrong location in the spectrum of care. Later on, following a similar approach, Wimo et al. (1999)

referred to the ‘misplacement’ of people who are situated at the ‘wrong caring level’. This notion included the need for diverse care alternatives:

‘The position of a person in the care organisation depends on several factors which impact on each other in a complicated way. The need for help is of course fundamental as well as the number of resources available. The demand of care from caretakers or other family members and the financial system linked to the care also contribute to the complex situation’ (p.228).

Styrborn and Wimo et al.’s approach focuses on defining the bed-blocking problem as the need for a different place or site where patients could be located. Reasons for relocating patients range from administrative decisions and political policies to changes in patients’ health status. Most importantly, this type of conceptual explanation leads to solutions to the problem that were based on increasing the availability of ‘locations’, sites, or spaces for these patients.

In the recent years, the use of the adjective ‘bed-blocker’ to refer to patients has been considered inappropriate in the UK. It was argued that this term insinuated that patients themselves were responsible for their situation: ‘The whole notion of bed blocking seems to imply that older people enter hospital and then wilfully continue to occupy a bed which, in the views of staff, they no longer require’ (Victor, 1991: 123). The term was considered politically incorrect, deemed offensive for patients and rejected by the Health Select Committee (Department of Health, 2002a). Instead, the expressions ‘delayed transfer of care’ or ‘delayed discharge’ were proposed to replace them. In April 2001, the Department of Health issued a standard definition:

‘A delayed transfer occurs when a patient is ready for transfer from a general and acute hospital bed but is still occupying that bed. A patient is ready for transfer when: a clinical decision is made that the patient is ready for transfer; a multi-disciplinary team decision has been made that the patient is ready for transfer; and the patient is safe to discharge/transfer’ (Department of Health, 2002a).

Since then, the expression ‘delayed discharges’ has been widely adopted in the governmental and research literature. Although it has been considered a ‘more neutral term’ (Glasby, 2003: 5), the newly coined expression supports a clear theoretical position. It implies a shift from focusing on macro economic factors to micro organisational systems. The exclusive focus on the time component of the discharge

process shifted the debate from the availability and suitability of the next location (space), to the institutional process of discharge (time). Beds are not blocked but patients' discharges are delayed, which implies that somebody (social services departments) should work at a faster pace to avoid those delays.

In addition, when redefining the need for relocation of patients into the need for speeding up the discharge process, attention is diverted not only from the availability of other forms of care but also from other significant aspects of the transitions between hospital and discharge destinations. Some of these issues are the long-term outcomes (for the state and for the patient) as a consequence of rapid discharges; the quality and adequacy of the new environment to which patients are transferred; the involvement of the individuals and their families in the discharge process. Although there are indications of the cost-effectiveness that discharge planning programmes offer when they result in decreased lengths of stay and readmission rates (Schmitt et al., 1988; Naylor, 1990; Pleasant, 1991), these calculations do not consider the expense of additional community services and specialist staff 'nor do they include the cost to families who are rapidly becoming unpaid givers of complex care' (Jackson, 1994: 497).

Indeed, the speedy discharge of patients is not considered by all commentators as the best care model. Delayed transfers of care are particularly associated with older patients with complex needs and geriatric medicine often purposely decelerates the process of discharge to achieve better long-term results:

'Successful discharges have to be planned. Planning takes time; when discharging an elderly sick person to their own home I often deliberately slow down the process in order to achieve success. [...] I delay discharge until a few days after I think the patient might be able to cope. In this way I aim to ensure a successful landing, for the goal of geriatric medicine is to return the disabled person to independent living in their own homes' (Millard and McClean, 1994:15).

These authors explain that reduced stays cannot be used as measure for efficiency in all patients. Gains made in the efficiency of treating the acute care patients faster do not necessarily imply improvements in their long-term outcomes. These gains may even be made at the expense of pushing a larger fraction of the patients into permanent care (Harrison et al., 2003). In summary, the reduction of length of stay to

improve hospital efficiency is a management choice that is not always supported by clinical evidence in all patients. Some authors (Glasby et al., 2004) argue that in hospital discharge planning, health and social care agencies operate with competing notions of good practices. Health agencies focus on speeding up the process for the sake of resource efficiency and social care emphasising choice and empowerment. This conflictive vision of inter-professional and inter-agency working when dealing with hospital discharge framed the introduction of the policy that penalised social services departments with a funds transfer to hospitals.

1.3.1 Reducing Length of Stay to Improve Hospital Efficiency

The phenomenon of ‘delayed discharges’ may thus be understood in the terms of organisational management choice. Healthcare planners, confronted with an increased number of potential users, choose to ensure a rapid patient flow as a new tool to improve efficiency. Millard and McLean (1994) used the analogy of a toy train to explain how an acute hospital works and Ivatts and Millard (2002) further elaborated the problem of delayed discharges. The hospital was compared with a 24 hour train circling a track at constant speed. To improve the passenger carrying performance several choices were given:

- a) To add more carriages (i.e. more beds)
- b) To stop passengers getting on board (programmes to reduce admissions in the over 75’s)
- c) To stop passengers staying overnight (increase day services like day surgery and other treatments)
- d) To persuade the passengers to get off the train earlier and continue their journey elsewhere (early discharge, intermediate care and transfer to social care homes).

Although in the UK, the number of hospital admissions keeps growing, the possibility of increasing the number of beds seems always omitted from the equation. Moreover, the number of acute beds in England has been consistently reduced and solutions along the lines of b) c) and d) are the ones frequently used by the programmes implemented subsequent to the NHS plan (Department of Health, 2000). Other

possible solutions outside the logic that the circular track represents are also rejected. The performance target is simplified to the fact that patients can only enter hospital if other patients leave and therefore, once patients are in, they should be processed out of the system as fast as possible. The reduction *ad absurdum* of this linear thinking is that no beds will eventually be needed to treat patients (Ivatts and Millard, 2002). Furthermore, it has been argued that schemes to reduce patients' length of stay are often management tools to justify bed closures (Health Committee, 2003; Hopper, 2007).

When reduction of length of stay schemes are in place, two different categories of patients are generated: patients who need to enter or stay in hospital and patients who need to exit. The first are welcome, the latter are not welcome in hospital anymore. People change status as time goes by. The transformation from welcome to unwelcome patients, however, is not straightforward. There are important debatable concepts attached to this issue, such as who decides that patients should exit the hospital, how this decision is made and, in summary, when are patients' exits appropriate (Vetter, 2003). Those unwelcome patients are the so-called 'delayed discharges', a by-product of adopting economic theories that recommend decreasing length of stay to improve hospital efficiency. Furthermore, the change of status from welcome to unwelcome also affects the level of patient care received. When dealing with patients ready to leave the hospital, the consultants and their teams pass by, the therapists move on to more rewarding patients and the nurses still tend but they no longer actively encourage self-help (Ivatt and Millard, 2002).

The UK Government made the choice of selecting reduction in length of stay as a tool for efficiency, stating that it was one of its six dimensions of performance (Department of Health, 1997a). Despite the official choice to use length of stay as a measure for efficiency, the causal relationship between length of stay and quality of care is not straightforward. Traditionally, much of the literature in this area explains that health outcomes are not affected by shorter stays and that extended stays are linked to increase morbidity. However, authors like Clarke and Rosen (2001) expose the lack of evidence of the association between shorter length of stay and poorer health outcomes. They explain how tensions between reducing stays in order to increase patients' throughput and maintaining the appropriateness of care are rarely

appreciated by those keen to see stays reduced as a marker of efficiency. In addition, reduction in the length of patients' stay has also the potential to increase the complexity of the discharge process (Henwood et al., 1997). Healthcare work is frequently highly problematic due to the unexpected and often difficult to control contingencies, stemming not only from the illness itself, but also from a host of work and organisational sources as well as from biographical and life-style sources pertaining to patients, relatives and staff members (Strauss et al., 1985). The shortening of hospital stays could add to that complexity with the potential of more contingencies occurring due to the lack of time healthcare workers have to familiarise themselves with the patients' circumstances.

The need for recognition of the interrelationship between economic and social policy is suggested in this section. The economic theories of reducing hospital length of stay to improve hospital financial efficiency are adopted and then translated in 'delayed discharges' schemes.

1.3.2 The Measurement of Delayed Discharges: Tensions and Challenges

The methodological literature studying delayed discharges raises serious questions related to core conceptual issues about what constitutes a hospital 'delay'. This lack of consensus is illustrated by four main tensions in the definition of 'delays':

- a) The first approach defines 'delay' as the time period established by a hospital discharge planner which is measured by the time difference between a patient being medically ready for discharge and the actual time of discharge (Falcone et al., 1991). Consequently, the resulting figure is a period of time defined subjectively by researchers, medical practitioners, health and social care staff (Bryan et al., 2006) or, in some cases, a panel of 'experts' (Armitage and Kavanagh, 1996). This approach is a more refined derivation of the traditional arbitrary approach used by consultants in the 1960s but it still seems to privilege opinion over evidence. For instance, McDonagh et al. (2000) in a systematic review of the methods used to assess the appropriateness of acute bed use explain how physicians opinion tend to prevail upon other members of the multidisciplinary team, referring to it as the 'gold standard':

'In an effort to quantify the amount of inappropriate use of hospital beds, research in this area originally included asking various health professionals to classify patients as appropriate or inappropriate for occupying an acute hospital bed. Occasionally a definition of 'inappropriate' is provided for guidance. Physician opinion is generally considered the gold standard. However, in such research, the decision of 'appropriateness' may largely depend on whose opinion is being asked. For instance, asking the physician responsible for the patient in a concurrent survey may lead to biased results. Additionally, several authors have suggested variability in results depending on physician seniority and whether the physician panel was made up of GPs or specialists. Nevertheless, the tools have been largely tested by comparison to the gold standard of physician opinion, although sometimes also against each other' (p. 159)

- b) The second conceptual framework establishes that a hospital delay can be numerically quantified in an objective manner. In an attempt to overcome the subjectivity of the first approach, delays are defined with the construction of a mathematical norm. This statistical calculation is generally based on the individual length of stay for a particular age group, consultant and condition which is greater than a standardised threshold for mean length of stay by the respective consultant and condition derived for the whole population (Audit Commission, 1992; Holland et al., 2003). However, this type of single average measure relies on length of stay as an appropriate measure of performance. This has been disputed by some health analysts who argue that single averages of bed occupancy, bed emptiness and average length of stay do not represent hospital activity. Instead, they propose the use of mixed exponential distributions as a better way of understanding bed usage. This means that patients flow through medical care following different time streams according to the complexity of their illnesses, psychological and social circumstances. 'Thus the distributions of the times that cohorts of in-patients occupy beds must be represented as a sum of two or three exponential terms, called a mixed exponential distribution' (Harrison et al., 2003: 147). These types of criticism highlight also the use of mean duration of stay as misleading when dealing with geriatric or rehabilitation patients because a small number of patients with very long stays can skew the distribution (Findlay et al., 2001).
- c) A variation of the single average system is the use of standard measurement instruments which list clinical reasons why a patient should stay in hospital and

later on, these factors are scrutinised in the patients' medical records. Examples of these instruments are the Intensity-Severity-Discharge Review System with Adult Criteria (Coast et al., 1995), and the Oxford Bed Study Instrument (Anderson et al., 1988). It seems that few of the existing tools have been tested for reliability and validity (McDonagh et al., 2000). The best validated tool, known as the Appropriateness Evaluation Protocol (AEP) (Gertman and Restuccia, 1981), was originally developed in the United States and later adapted in Switzerland for use in Europe. The validity and reliability of AEP for specific European countries has been questioned (Smeets et al., 2000). Although studies which used validated tools tend to be considered the most evidence-based, Vetter (2003) found that all measurement tools are poor, lacked validity and reproducibility. They also tend to be applied retrospectively and, most significantly, they still rely on subjective interpretations of delays and take no account of local circumstances or the availability of alternative services to the hospital bed (Glasby et al., 2004).

- d) The fourth approach is the one of authors highlighting the lack of consensus in defining delays and therefore, the difficulty in comparing research findings. They accept that establishment of who and when hospital patients are delayed is an essentially subjective task. They exhibit the methodological limitations of the decision criteria employed by discharge planners, clinical practitioners or researchers. For instance, Carter and Wade (2002) acknowledge how:

'It is difficult to define precisely when a patient is 'ready for discharge' or 'no longer in need of our medical/ surgical expertise'. We simply relied on the opinion of the clinical team responsible for the patient; they no longer felt responsible for the patient's management. [...] it was not easy to establish the reason for delay. We simply relied upon clinical judgement, identifying the one factor that seemed most important, but in practice there were often several inter-related reasons' (p. 319).

Styrborn and Thorslund (1993) consider local circumstances as decisive for the definition of delays and for any attempted solutions. They also explained that 'when comparing over time, it is important to have a consistent definition of the bed-blocker concept. Since the decision is a subjective one made by a physician, it should be carefully studied with regard to when and on what grounds different patients are listed as being a bed-blocker' (p.168). Vetter (2003) reinforces the above argument and

deems the assessment of inappropriate bed usage as being 'beset by problems of lack of definition' and 'dominated by subjectivity'. Glasby et al. (2004) follow the same line and they also emphasise the importance of local contexts and history in different areas for the study of delayed discharges.

All the four tensions identified above face not only the problem of lack of a common definition of delay but also concerns about the accuracy of the related numerical data that is collected for performance purposes (House of Commons Health Committee, 2002; National Audit Office, 2003). The Department of Health started collecting data on delayed discharges in 1997 but a standard definition of delayed discharges was only issued in 2001. Although this represents a step towards common measurement, it does not guarantee it. Definitions can also have ambiguous elements, be misinterpreted, misapplied or not followed. In 2003, the National Audit Office reported that only 27 per cent of hospitals surveyed were following the 2001 definition in full (National Audit Office, 2003). Discrepancies between data reported by acute hospitals and data provided by primary care trusts were also noted.

Another significant difficulty with the way in which delayed discharges data is collected is the focus on acute and general beds and the exclusion of other non-acute, mental health and community beds (House of Commons Committee of Public Accounts, 2003). Finally, with some exceptions, literature related to delayed discharges often fails to include patient and carer perspectives (Glasby et al., 2006).

1.3.3 Most Common Reasons for Delayed Discharge

As previously explained, delayed discharges can be considered as an indicator of a shortage of alternative forms of care or they can be seen as a consequence of inefficiencies in the discharge planning process. Interestingly, the second standpoint dominated research on delays through the 1980's and 1990's with discharge planning receiving most of the attention. Research on the causes for delayed discharges concentrated on which organisation was to blame for the problem, social services or hospitals. This was a potential distraction that moved attention away from the macro problems that created resource shortages or even the reasons why bed-blocking was constructed as a problem. Micro-level concerns drove research on assessing discharge

planning procedures and schemes. Moreover, one of the limitations of research on discharge planning is that it does not normally spotlight the reasons for delays but the ways of improving internal organisational processes.

The origin of the bed-blocking phenomenon is in part responsible for the main assumptions embedding the research studying causes for delayed discharges. Clearly, the first doctors in the 1960s who conducted bed-blocking studies believed that some patients were staying in hospital longer than necessary, for reasons other than medical. Indeed, delays were generally perceived to be the responsibility of social services departments. This medical standpoint is present in the research on this topic mainly because it was driven and performed by the clinicians themselves. Typically, investigations concentrated on identifying predictors for delay (age, illness, etc) and costs generated by these patients' delays due to their social care needs. In the 1990's, with the introduction of health management theories and performance indicators as a form of governance, cost efficiency analysis drove research into clinical pathways and why patients, with or without social need, were delayed. The scrutiny of the internal clinical systems revealed that hospital organisational factors were the cause of a significant proportion of delayed discharges (Houghton et al., 1996; Fenn et al., 2000; Armstrong et al., 2001). Patients waiting for results of investigations, consultants input, assessment from specialist health staff, transport or pharmacy were typical efficiency or provision failures.

Significantly, studies that examine delays from the social standpoint seem to also reproduce the historical divisions between health and social need. Roberts and Houghton (1996: 28) conceptualise delays as been caused by the hospital, social services or 'delays beyond control of either agency'. In the research literature common reasons why delays were allocated to social services were: delays in allocating social workers, complexity of assessment criteria, delays in allocating funding. It seems that, in general, the research on causes for delays concentrates on who to blame instead of accepting the complex and multi-faceted nature of factors contributing to delayed transfer (Glasby et al., 2006). This perspective is a continuation of the historical preoccupation of both social and health sectors, to focus on 'who' (should provide services, whose fault is it?, etc.) more than on 'what' they should provide (Lewis, 1999).

Between 2000 and 2004, four systematic reviews from randomised controlled trials of discharge processes were conducted in the UK (Hyde et al., 2000; Parker et al., 2002; Parker et al., 2004; Sheppard et al., 2004). These reviews looked at randomised control trials that investigated the effects of supported hospital discharges as opposed to routine discharges. Typical outcomes reviewed were length of stay, mortality, morbidity, readmission rates and costs. Other research in the UK had evaluated the effectiveness of dedicated discharge planning staff, scrutinising measures of outcome similar to the above (Houghton et al., 1996). Research also looked at the impact of multidisciplinary teams in post-discharge outcomes (Bull and Roberts, 2001). Jackson's review on this issue concluded that

'interdisciplinary teams seem to result in fewer bureaucratic delays. However, the more inclusive the team is of other disciplines the greater the number of referrals to rehabilitation, nutrition and speech services. Such referrals may increase the length of hospital stay thereby increasing the cost of patient care' (Jackson 1994: 498).

Other distinctive researched topics are communication between the hospital and the community, education, prescriptions and follow-up arrangements (McKenna et al., 2000; Pearson et al., 2004; Cahill, 2005). In general, it seems that discharge planning does generally reduce the length of hospital stay, increase patient satisfaction, and reduce the number of patients experiencing a delay. However 'Hospital at Home' schemes, also called 'Early Supported Discharge' schemes, are also linked with lower carer satisfaction and increases in overall length of care (Hubbard et al., 2004).

From the patients' perspective, Fisher et al. (2006) performed a synthesis of the evidence of older people's experiences and perceptions of their discharge process. This type of review tends to look at involvement in decision making, empowerment and patient satisfaction. Similarly, there are studies that look at the impact of discharge on carers and patients' families. For instance, Waters et al. (2001) looked at the increasing role of the family in supporting older people in the UK from the 1980's to the 1990's, exploring rates of involvement, information and the carer's preparation for the patient's discharge. Victor et al. (2000) explored retrospectively the relationship between absence of family carer and delayed discharges.

Interestingly, only two literature reviews concentrated on studies of rate and cause of delayed discharges. Glasby et al. (2004) reviewed 21 documents on reasons for delays between 1993 and 2003. They concluded that causes for delayed discharges are extremely diverse but they identified three main reasons for delays: a) internal hospital factors as a prime cause such as waiting for another opinion, a planned investigation or a decision from another consultant; b) lack of rehabilitation services; c) other factors, such as waiting for social care assessments or funding, issues related to patients and carers, or factors such as housing. Similarly, Hubbard et al. (2004), in a review of studies published between 1984 and 2005, concluded that there was no conclusive evidence to demonstrate that delayed discharges were caused by problems in any one part of the care system, and they argued that a combination of factors contribute to the problem. Problems in health and social care settings associated with delayed discharges identified were: lack of home support; unavailability of convalescent or rehabilitation facilities; delays in community care needs assessments or homecare packages.

There are significant local variations in the rate (Healthcare Commission, 2004a) and reasons (Glasby et al., 2004) for delays. In 2002 the overall figures for delayed discharges revealed 'significant regional variation. London and the South are particularly affected, whereas the problem is generally less pronounced in the north of England' (House of Commons Committee of Public Accounts, 2003:5). However, research in this area tended to ignore local historical and administrative contexts (Vetter, 2003; Glasby et al., 2006). Instead, patient's characteristics attracted much more attention. These individual factors are explored in the following section.

1.4 Patients in Blocked Beds: Who Are They?

Whatever the term chosen to describe them, bed-blockers are people. They are hospital patients admitted into wards due to illness. These people may be considered problematic by the hospital because the administrative jungle of institutional responsibilities and specialisations categorised them as been in the wrong location at some specific time. If we, however, accept that delayed discharge is an administrative

and not medical term, then the bed-blockers are likely to be different sort of ‘people’ depending on the locality and the hospital where they are admitted:

‘Although the phenomenon is widespread, the conditions prevailing in each country in the form of social policy, health care organization and legislation will be decisive for whether it becomes a problem and for the character of attempted solutions’ (Styrborn and Thorslund, 1993: 156).

Significantly, Glasby et al. (2004) pointed out that causes for delay vary substantially from area to area as do the delayed discharges rates. Although some studies have examined the social care market situation, hospital factors and patients’ characteristics (Falcone et al., 1991), research on ‘inappropriate’ hospital stays has a tendency to focus on micro individual characteristics of patients. Studies generally aim to generate patients’ profiles, analyse mainly demographic, socio-economic factors and clinical characteristics of patients like age, gender, living arrangements prior to hospitalisation, dependency for daily living activities, etc. However, attention on the individual characteristics of people with prolonged stays may attribute the institutional need for relocation to patient’s circumstances. The objective of most research concentrating on population characteristics is to establish predictors of delay, regardless of how delay is conceptualised.

Consensus seems to be achieved in the literature identifying specific group of patients that generate more obstacles for a faster hospital discharge than the general population. This is the case for older people who seem to make more inappropriate use of hospital beds, demonstrating higher delay rates than the rest of the general population (McDonagh et al., 2000). These delays are generally caused by higher levels of hospital admissions in older people, increased disability and related social needs in that section of the population. Other identified groups who are often thought to block acute care beds more frequently include patients with chronic illnesses and people with mental health illness or cognitive impairments. This population seems to create more delays due to lack of appropriate community facilities that could meet their needs (McDonagh et al., 2000; Glasby and Lester, 2004).

Although delayed discharges are generally stereotyped as older or/and disabled people because they statistically represent the bigger group of users of acute care, patients

who are outside this bigger group may still block beds. Moreover, many short delays from the elderly population may be less costly than one single case of a younger person who stays in hospital for a long time. From those limitations, people labelled as delayed discharges are generally described with similar words to those used in a Swedish study conducted by Styrborn (1994):

‘The results showed that bedblockers were fragile, dependent persons who needed help from others for their daily living activities. Diseases affecting functional ability such as stroke and musculoskeletal diseases were prominent causes of bedblocking reports due to the need for rehabilitation or further care in a nursing home. These patients often had a multiple medical history which made them vulnerable to acute illness. Additionally, medically relevant symptoms appeared in half of the bedblockers after their being listed as medically ready for discharge’ (p. 32).

Frailty and multiple illnesses seem to be common characteristics of people who are delayed in hospitals. Hubbard et al. (2004) explain that although older people, those with multiple pathologies and those with some specific clinical conditions (such as neurological deficit and stroke) might be most at risk of delayed discharge, it is not a clinical condition *per se* which causes the delay but the ways in which organisations are managing or providing services to care for people with these clinical conditions.

1.5 Summary

In this chapter I have explained how the problem of delayed discharges was constructed in the historical administrative division between health and social care. In the UK, this problem became more apparent in the late 1990’s when New Labour adopted a strong management approach to improve NHS efficiency. This approach had to be combined with the ethos of partnership and collaboration between agencies promoted by the Government. In order to understand this conflict of interests, the chapter analysed in detail the conceptual definitions of delayed discharges. Rival conceptions and interpretations of this phenomenon are apparent and in need of investigation. The analysis of how delays are measured showed a lack of consensus which affected many of the studies that sought to measure initiatives to ameliorate the problem. The literature typically concentrated on exploring improvement and effectiveness of the discharge planning process with little attention given to the

reasons for delayed discharges. Finally, the chapter argued that the focus on the individual characteristics of patients with prolonged stays placed undue emphasis upon patients' circumstances for the institutional need for relocation. From this foundation, the explanatory quest for the policy responses to delayed discharges can be developed in Chapter Two.

2. THE POLICY RESPONSES: FINES TO REDUCE SOCIAL SERVICES DELAYED DISCHARGES

2.1 Introduction

This chapter is divided into two main sections. The first part offers a general overview of the use of financial incentives to reduce social services delayed discharges. It starts with a brief historical outline of the policy responses to hospital delays in the UK. Then, the chapter examines how the performance indicator 'delayed transfer of care' may have influenced the Government choice of a strong response like the Community Care (Delayed Discharges etc.) Act 2003. The reasons why a form of economic incentive was the chosen policy instrument for social delays are explored in detail. It is argued that contextual factors, like the imminent introduction of the 'Payment by results' financial reform in the NHS, could explain why economic incentives are preferred to other possible approaches to the delayed discharges phenomenon.

The second part of the chapter introduces the Community Care (Delayed Discharges etc.) Act 2003. Initially, the rationale for the transfer of the 'policy idea' from the Scandinavian countries to the United Kingdom is discussed, exploring some of the outcomes of these implementations. The objective is to ascertain contextual differences and some of the main outcomes achieved by those policies that could help in further understanding the English implementation. The focus of the chapter then turns on the Act itself, describing it in more detail and explaining how it was intended to create change at the different stages of discharge planning. Ten main innovations are identified and described as the 'theories of change' anticipated by the policy. The final part of the chapter examines the ways in which the programme has been evaluated to date. It concludes that there is a need for the assessment of the role of fines in the development of post-implementation outcomes.

2.2 Policy Responses to Delayed Discharges Problem: A Historical Overview

Some incentives-based approaches are supported by legislation, others are not. Vedung (1998) explained that the discourse on public policy instruments is a discourse of political power. Governments can choose different ways to exercise their political power and one of these choices is 'doing nothing'. Transfer of financial liability for delayed discharges could be considered a form of economic control. The inter-institutional transfer of funds could be considered another operational tool to effect changes in healthcare utilization with the objective of enhancing financial outcomes (Styrborn, 1994).

In Britain, concerns about social delays in hospitals materialised for the first time in 1963 when the Government issued a circular to all hospital and local authorities emphasising some good practice guidance on discharging patients (Ministry of Health, 1963, cited in Glasby, 2003: 15). There was then a 26 year gap in updating official guidance on hospital discharge practices, with the next circular issued in 1989. This new circular came at a significant time because it was distributed just prior to the NHS and Community Care Act 1990, which itself introduced the community care reforms that had significant consequences for discharge processes. However, the Act made no direct reference to the circular (Glasby, 2003).

Five years later, the Department of Health published a workbook with a framework for good practice in hospital discharge (Henwood, 1994) and then, in 1995, official guidance to replace the old 1989 circular (Department of Health, 1995). This reiterated the role of consultants in deciding the adequate time and services for patients' discharges. Also, most significantly and for the first time, it referred explicitly to patients not having the right to occupy NHS beds indefinitely. In the same year, the Carers (Recognition and Services) Act 1995 made explicit reference to the rights and needs of carers during hospital discharge (Department of Health, 1996). In summary, since its conception as a significant problem worthy of Government guidance in the 1960's, the official response to hospital discharge delays was scarce and peripheral up to the 1990's.

In 1997, with the arrival of New Labour, the importance of updating hospital discharge guidance was recognised immediately (Department of Health, 1997b) but no official documentation was issued until 2003 (Department of Health, 2004a). Before this, in 2001, the Government expressed its intention to ‘eliminate widespread bed blocking’ (Department of Health, 2001a). With this objective in mind, the Department of Health initiated the process of managing social delays in hospital with the allocation of £300 million to be distributed over two years to ‘tackle bed blocking’ (Department of Health, 2001a). Then, in 2002, the Government announced a 7.5% annual increase in the NHS budget for five years and a 6% annual increase in social care over three years. The increase in funding for both institutions was accompanied by the introduction of a ‘cross-charging’ policy to deal with bed-blocking. This was inspired by previous experiences in Sweden and Denmark (Department of Health, 2002b).

This ‘give-and-take’ form of packaging economic policy instruments that preceded the Delayed Discharges Act was described by Van der Doelen in the following terms:

‘Levies arouse too much resistance and are therefore used only sparingly. Increasing the benefits of certain courses of conduct by providing subsidies appears to lessen the resistance to a given policy. By taking with one hand, through the levy, and giving back with the other, through the subsidy, the authorities can increase the feasibility and effectiveness of a policy’ (Van der Doelen, 1998: 139).

The subsidy, in this case in the form of significant budget allocations, worked as a ‘kind of tranquilizer’ (Van der Doelen, 1998: 138) and enhanced the feasibility of policy acceptance. In summary, although delayed hospital discharges were conceptualised as a problem for the NHS for several decades, historically the Government response has been reduced to occasional and, at times, opportunistic service development guidance. Innovatively, the Community Care (Delayed Discharges etc.) Act 2003 was the first exclusive policy response to the problem of delayed discharges in the form of statutory law in Britain.

After the Government announcement of their intention to use fines to reduce social delays in hospitals, numerous critics opposed this measure. The Bill faced opposition from charities (i.e. Age Concern England and Help the Aged) and from social services

directors who accused the Government of potentially making matters worse by tackling only part of the problem. The Local Government Association and the NHS Confederation warned that the measures could put huge financial strain on local councils and damage local partnerships. The British Medical Association and the King's Fund also voiced concerns about the plans (Moore, 2003). During the passage and early implementation of the Act, opinion was strongly divided as to the likely impact of the legislation. The common arguments against the scheme referred to the risk of inadequate discharges, increased tension between health and social care institutions, the administrative burden, and the likelihood of transferring monies from already chronically under-funded social services departments. The legislation was finally passed by Parliament on the April 8 2003. After the debate, some amendments to the proposed arrangements were made in response to the concerns. Extra money in the form of a Delayed Discharge Grant of £100K for each year of programme operation was allocated. A dedicated team (The Change Agent Team) was designated to support public institutions with the implementation of the new system. A 'shadow phase' of the programme was implemented from October 2003 to allow time for localities to adjust their processes to the changes. This meant that although the systems and procedures were in place, cross-charging did not take place until January 5 2004, when the programme was fully implemented in England. The original proposal was to extend the scheme to Wales but the relevant provisions have not started to date and there are currently no plans for commencement (Department of Health, 2007a).

In 2001, the Government announced a broad package of measures to improve services for older people. A sample of those services inspired by the National Service Framework for Older People (Department of Health, 2001b) includes: the emphasis on intermediate care services to prevent unnecessary hospital admissions and facilitate hospital discharges; the single assessment process for older people to unify assessments from health and social care agencies; the new care trusts which provided health and social care; and the creation of four new regional directors of health and social care. Then, in 2003, as the Delayed Discharges Act, was being implemented the Government promoted other significant initiatives for older people. Some of the new measures were: the promotion of direct payments to enable people to purchase their own care; carers grant to double by 2006; abolition of charges for some key

equipment necessary to support people at home (hand rails, hoists, etc.); and expansion of rehabilitation services and sheltered housing. Therefore multiple measures to enhance health and social care services that had direct or indirect impact on delayed discharges were introduced at a similar time to the Act. This makes the evaluation of the effectiveness of the fines a difficult task because of the potential impact of those other programmes implemented at the same time, creating the classic 'attribution problem'.

2.3 Delayed Transfers of Care: A Performance Indicator

When evaluating the role of the financial incentives used in the Delayed Discharges programme, the link between these and the performance indicators on which health and social care organisations were routinely assessed at the time of the fieldwork needed to be explored. Performance indicators are one of the consequences of governance by targets. Bevan and Hood (2005) define them as a:

‘version of homeostatic control in which desired results are specified in advance in measurable form. Some system of monitoring measures performance against that specification, and feedback mechanisms are linked to measured performance’ (p. 5).

When using a reduced number of indicators to represent overall performance of an institution, some aspects of the reality are preferred (the targets) while others are implicitly rejected in that selection. On top of that, once the area is selected, this is reduced even more by identifying certain numerical outputs that represent the whole of the domain (Bevan and Hood, 2005). Each target is accompanied by a large set of performance indicators which generate more targets once interpreted by each institutional department. Linking financial incentives to performance is a traditional management system to ensure compliance in the achievement of the targets. The theory of linking financial incentives to performance indicators is, at its most basic, ‘What gets measured (and rewarded) gets done’. This idea builds on the economic theory of ‘change the financial reward and the behaviour will be changed’ (Fetter et al., 1976).

Closely aligned to the system of financial incentives is the public reporting of target results. With the 1997 White Paper, 'The New NHS: modern dependable', a new framework for managing and assessing the performance of the NHS was set out: the provision of quantitative information in the form of a new National Performance Framework. From then onwards, health targets started to be fruitful, multiply and self-reproduce (Hood, 2006). In 2001, public sector hospitals and other public health-delivery organisations were awarded 'star ratings' scoring from zero to three, according to their performance on key national targets. The star ratings seemed a simplistic reward system that offered star shaped stickers to the best hospitals and did not escape criticism. Bevan and Hood (2005: 25) explained that, in such a system, it was possible for 'three-star Trusts to have within them a scandalously poor clinical service, and zero-star Trusts an excellent service'. Rowan et al. (2004) found no relationship between performance and star ratings and the clinical quality of adult critical care provided by hospitals. Whatever their real impact, those stars revealed sharp points because they were linked to budget allocation, financial penalties or incentives. All these were related to each other in forms that escape the mind of anybody who is not a hospital manager. Coye (2001) summarised this situation with the following sentence:

'The complex and extraordinarily contradictory incentives operating within and among health care organizations are so pervasive and pernicious that they boggle the imagination. Within each, attempts to change patterns of care trigger a cascading of negative and positive incentives, each provoking actions that reinforce or impede the success of the effort'(p. 53).

This governance system was the one in place when the Delayed Discharges Act was designed and implemented. The relevant performance indicator for this thesis was called in 2001 'delayed discharges' and then, in the financial year 2002/2003 was re-named 'delayed transfers of care'. This measure of efficiency reflected the Governmental objective to reduce levels of delayed discharges:

'In December 2002 (the latest figures available), the number of delays for all ages on any given day fell to 4,600 (5,400 in September) and for people over 75 to 3,500 (4,100 in September). [...] The Department interprets its commitment to end "widespread" delayed discharge by the end of 2004 to mean a reduction to "about 3,000" delays of all ages, with a further reduction to 2,000 to 2,500. The Department sees this as a minimum level below which further improvement is not practicable, because it believes there will always be some patients awaiting a

suitable placements and delays in the system' (House of Commons Committee of Public Accounts, 2003:5).

Targets were set for 2004 and after that and up to the time of writing, the target remained defined as reducing delayed transfers of care to 'a minimal level' in the threshold of $\leq 3.5\%$ (Healthcare Commission, 2007).

Performance indicators are constantly under reconstruction; they are regularly changed and modified depending on the latest political targets. A year into the implementation of the Delayed Discharges Act, in 2005, the Healthcare Commission, which was the body responsible for inspections and performance assessments in health, launched a new approach to assess healthcare organisations in England: 'The Annual Health Check'. The annual health check was the system in operation for hospitals at the time when the empirical data was collected for this study. The new system consisted of scores based on a four-point scale: weak, fair, good and excellent. This assessment removed some of the old performance indicators and created new ones. 'Delayed transfers of care' was maintained as an indicator of effectiveness in the category called 'Existing national targets'. This category grouped a total of twelve indicators, all of them numerical equations mainly reporting waiting times for clinical inputs.

'Delayed discharges' is a performance indicator managed by financial incentives (through the Delayed Discharges Act) but it is also embedded in a group of performance indicators which are managed by another tool for target compliance: public reporting. Figure 2.1 highlights other performance indicators that are directly related to delayed discharges. For instance, one of the core standards explicitly demands health and social care institutions to work in partnership to manage patients' needs efficiently, which means that discharges should not be delayed. Another acute care performance indicator which relates to delayed discharges is the number of patients following emergency admission multiplied by length of stay. The higher the number of delayed transfers of care, the further away that hospitals are from achieving this target.

Figure 2.1: Delayed Discharges Contextualised in the Hospital Performance Indicator Map

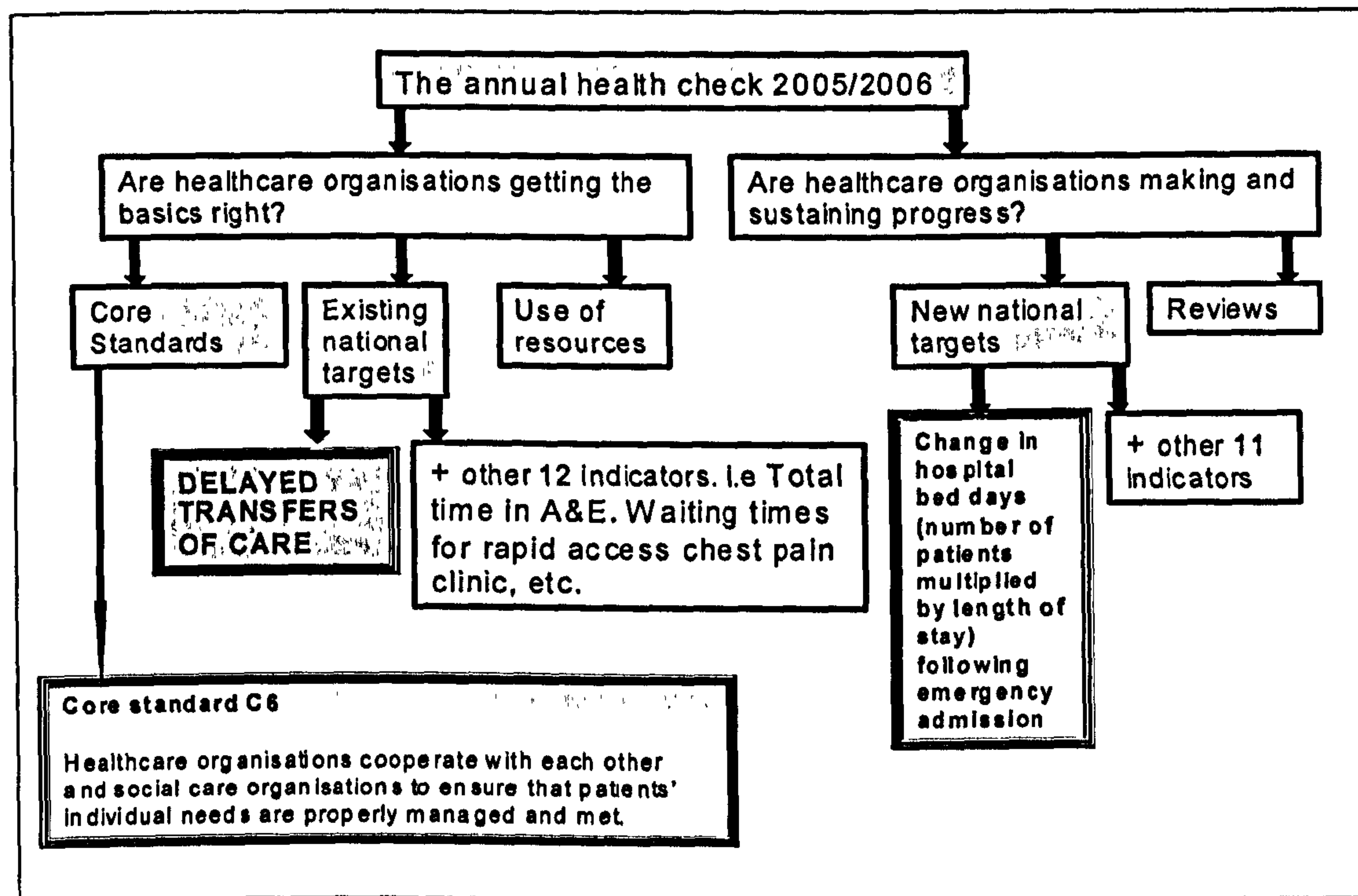

The indicator 'delayed transfers of care' is monitored in health institutions at two levels: acute care and primary care. Table 2.1 shows how the indicator is constructed for acute care. The target to achieve was the reduction of delays to a minimum by 2006 and that 'minimum' was calculated as $\leq 3.5\%$ of the total hospital stays. The rationale for the target mentioned the Delayed Discharges Act and referred to the impact of community care in facilitating the discharges. The primary care trusts (PCT), assessed by the same tool, shared the performance indicator based on the same national target of reducing delayed discharges to a minimum level by 2006. The official rationale was identical to the one used for acute care. The numerical construction of the indicators was the same but the data was obtained from a different source: 'LDPR standard collection'. The Local Delivery Plan Return (LDPR) was a data collection undertaken by the Department of Health to monitor the progress of NHS achievements against the Local Delivery Plan targets. In the past, when delayed discharges information collected from PCTs and acute care were contrasted, significant discrepancies were evidenced (National Audit Office, 2003). However, the data requested is managed by the acute trust on a daily basis, so PCTs can only record it by attending the SitReps meeting or by receiving reliable returns from the hospitals.

Table 2.1: Delayed Transfers of Care as a Performance Indicator for Acute Care (Source: Healthcare Commission, 2006)

ACUTE CARE	
TARGET:	Delayed transfers of care to reduce to a minimal level by 2006 ($\leq 3.5\%$)
RATIONALE:	‘This indicator measures the impact of community-based care in facilitating timely discharge from hospital, the quality of service received in hospital and the mechanisms in place within the hospital to facilitate timely discharge. People should receive the right care in the right place at the right time and primary care trusts must ensure, with acute trusts and social services partners, that people move on from the acute environment once they are safe to transfer. The Community Care (Delayed Discharges, etc) Act 2003 facilitates joint working with social services and requires partners to identify the causes of delay, and the actions required to tackle delays within their local system. Although this is an all-adult indicator the vast majority of those delayed are patients aged over 75 years. As a result of investment in extra capacity and the introduction of the new Act, delayed transfers of care should be reduced to a minimal level by 2006’.
DATA SOURCE:	SitReps
NUMERICAL CONSTRUCTION OF THE INDICATOR:	<p>Numerator: The number of patients occupying an acute bed whose transfer of care was delayed.</p> <p>Denominator: The number of patients occupying an acute bed summed across all 52 weeks of the financial year.</p> <p>Indicator: The number of patients occupying an acute bed whose transfer of care was delayed divided by the number of patients occupying an acute bed summed across all 52 weeks of the financial year. Expressed as a percentage.</p>

A completely different and separate system of monitoring performance was in place for local authorities at the time of the fieldwork: the Comprehensive Performance Assessment (CPA). Although, according to their creators, social services star ratings were designed to be compatible with performance information for both the NHS and other Local Government services, the fragmentation in the monitoring of public

institutions performance also reflects the historical divisions between health and social care. This is a process devised by the Audit Commission and introduced in 2003 by which every council is judged on a star rating scale from zero to four stars. The social services star rating judgements contribute to the Local Government CPA. Social care for adults is one of the sections reviewed with its own performance indicators, which are monitored by the Commission for Social Care Inspection. There are 27 performance indicators for adult social care provided by the local authorities and one of them is called, as in healthcare, 'delayed transfers of care'. This indicator sits in a category grouped as 'NHS interface indicators'. The relationship between delayed discharges and some of the other 27 performance indicators is based on how other outcomes like days for assessment, days for service provision or number of admissions into nursing or residential care affected the smooth provision of services for hospital patients (See Table 2.2).

The first significant difference between the definition of 'delayed transfers of care' for health institutions and the one for social care is that social services departments only counted as delays patients who are over 65 years of age, while NHS institutions refer to it as an 'all-adult indicator'. The source for both data is the same SitReps return. The quasi-market in social care meant that, apart from the assessment which is performed by social services staff, all services needed to discharge hospital patients are generally provided by external care providers, which have, once again, their own performance framework. At the time of the fieldwork, in England, all registered adult care service providers like care homes and homecare agencies were legally required to complete an Annual Quality Assurance Assessment. None of these providers' indicators are explicitly directed to offering timely services to hospital patients and no explicit reference is made to hospital discharges.

Table 2.2: Delayed Transfer of Care as a Performance Indicator for Social Care (Source: Commission for Social Care Inspection, 2005a)

SOCIAL CARE	
INDICATOR:	Delayed transfers of care
DEFINITION:	The number of delayed transfers of care per 100,000 population aged 65 or over.
DATA SOURCE:	SitReps
NUMERICAL CONSTRUCTION OF THE INDICATOR:	<p>Numerator: The average number of delayed transfers of care (all ages) in a week taken over the year from April 2006 to March 2006. A delayed transfer of care occurs when a patient is ready for transfer from an acute hospital bed, but is still occupying such a bed. A patient is ready for transfer when (a) a clinical decision has been made that the patient is ready for transfer AND (b) a multi-disciplinary team decision has been made that the patient is ready for transfer AND (c) the patient is safe to discharge/transfer. Reasons for delayed transfers are: Awaiting completion of assessment for <7 days, Awaiting completion of assessment for >7 days, Awaiting public funding, Awaiting further (non-acute) NHS care (including intermediate care, rehabilitation services etc), Awaiting residential/nursing home placement or availability, Awaiting domiciliary package (including adaptations and equipment), Patient or family choice, Other reason (e.g. disagreements, family/patient arranging care).</p> <p>Denominator: Population aged 65 or over / 100,000</p> <p>Indicator: The number of delayed transfers of care per 100,000 population aged 65 or over.</p>

In summary 'delayed transfers of care' lies in the jungle of targets and standards that assesses the overall performance of acute hospitals. There is a complexity within the performance indicators which shapes and potentially disguises the attribution of causality with regard to fines. Fragmentation occurs between health and social care organisations themselves with different audit bodies and assessment tools for each agency. The indicator 'delayed transfers of care' is more relevant for some institutions than for others and it could conflict or contradict in a more or less intensive manner with other performance incentives in the operation. Data gathering for regulatory purposes is collected, managed and analysed by different institutions, which can

potentially increase the recognised problems with data quality in healthcare regulation (Attride-Stirling et al., 2006). Two systems of performance run in parallel but they are united by a common financial incentive. The contextual circumstances in which incentives are applied could determine their effectiveness (Dudley et al., 2004) and the performance indicator *jeux* described above reflected some of the difficulties when evaluating the impact of one single measure like the fines.

2.3.1 Exploring the Relationship Between the NHS Financial Reform and the Fines to Social Services Departments

This section examines some of the economic characteristics of the implementation of the Delayed Discharges programme that will further clarify the circumstances in which fines were introduced. The main objective of the analysis is to explore why an economic tool was chosen as the appropriate policy response to deal with delayed discharges.

The use of financial incentives to influence behaviour has been extensively analysed in the literature of multiple disciplines. Within healthcare in the last decade, attention turned to the way they could improve efficiency in publicly funded health systems. Incentives are normally structured with the objective of decreasing health utilisation. Within this context, the impact of financial incentives on providers' behaviour, focusing on quality of care is a frequent subject of analysis. The research on 'Payment for Performance' schemes is prolific and in constant transformation, with papers on this area being published monthly (Roland, 2008). In hospital care, financial incentives are a common management tool to reduce patients' length of stay. The constant fight to confront all obstacles to early discharge theories made it only a matter of time before the generation of specific incentives for social services patients' delays.

'Payment by Results' (PbR) is the new NHS financial regime, which was first announced in 2002 and it was planned to be fully implemented before April 2008. This new system moves away from locally negotiated block contracts with providers, which paid them a fixed amount irrespective of activity, towards paying providers a nationally fixed price for each individual case treated. Initially this single national

tariff concentrated on acute care but the plan is that, eventually, it would cover all financial transactions within the NHS. Payment by Results proposes a large transformation of the healthcare financing system. The technical features of PbR are numerous and complex. One of its key attributes is that it encourages providers (hospitals) to reduce patient's length of stay. The reform makes a direct link between activity and income: the higher the number of patients treated, the greater the financial rewards. Evidence from other countries reported shorter waiting times and lengths of stay in hospital: 'Experiences with similar activity-based payment systems suggests that hospital react to such incentives, for example, by reducing excessive lengths of stay' (Maybin, 2007:3).

The policy designers of PbR tried to anticipate unexpected financial side-effects of the reform and devised some technical solutions to counteract them. One of these was the introduction of 'long stay outlier' payments to enable risk-sharing between purchasers and providers, for patients who had clinically appropriate long stays. In other words, if patients stayed in hospital for longer than a standard average, hospitals would still be reimbursed if there was a clinical reason for it. In this context of fear of unplanned financial consequences, patients with social needs who had their hospital stay delayed over an average 'trim point' (length of stay) were seen as an economic risk. Significantly, the risk of receiving no payment for patients delayed for non-clinical reasons was minimised by the possibility of charging social services departments. This was explained by Epstein and Mason when they examined the structure of PbR:

'Some patients, especially the elderly, may be fit to leave hospital but their discharge is delayed by problems with the provision of residential or home care. In these cases, the cost of delayed discharge passes to the local authority social services who reimburse the healthcare provider' (Epstein and Mason, 2006: 235).

The risk that patients with unmet social need meant for the system was already a concern when Payment by Results was still at the design stages. In fact, in the national consultation for this programme, the NHS posed the following question to the general public: 'Should there be an adjustment to the national tariff for inpatient activity with very long lengths of stay, and on what basis should the adjustment be made?' This question acknowledged that longer stays than the average were likely and that some sort of monetary adjustment may be needed to balance the financial

transactions between providers and purchasers. The answer of the Association of Chartered Certified Accountants (ACCA) exemplified how delays caused by social services were conceptualised by health policy advisers as another source of income for hospitals. Their reply was clear: 'There should be no adjustment to the national tariff. If social services cause the delay then they should reimburse the NHS Trust' (ACCA, 2003).

Later on, once the health reform was out for implementation, the Department of Health, confirmed the financial connections between PbR and the Delayed Discharges programme when they repeatedly (Department of Health, 2005, 2006a) warned PCTs that hospitals should not be reimbursed for the same patient twice:

'If a patient is deemed fit for discharge and fines have been imposed on local authorities under the Delayed Discharge arrangements then PCTs should not be liable for any further outlier payment' (Department of Health, 2005: 16).

All the services excluded from fines in the Delayed Discharges Act are, interestingly, also excluded from the scope of the mandatory tariff implemented with PbR (Department of Health, 2003c; 2006). Although both policies intended to eventually extend to other areas of care, to date none of the tariffs applies to community health services, mental health services, learning disabilities services, critical care, rehabilitation or continuing and intermediate care services. In fact, both in Sweden (Ädel reform) and Norway (ABF, Activity based funding) where fines to social services have also been introduced, they were constructed as part of a national health funding reform similar to PbR.

Therefore, the fines in the delayed discharges programme are not only tools to reduce delays, but they are also planned solutions for some of the financial gaps in the new macro economic health structure for the NHS. In the new financial regime, the fines to social services were interpreted, if not designed as the solution to the economic threats posed by patients with social needs staying for longer than the agreed length of stay. Three immediate consequences of the relationship between these two tariffs are identified and described as follows:

a) **Further Division between Health and Social Need.** By establishing a clear division of health and social need with the threat of financial sanction, the Delayed Discharge programme supported models that represent a view of health and illness that divides health into separate components (e.g. physical, emotional, and social). With the introduction of the Delayed Discharges Act, a further fragmentation within health and social care is established. Local authorities are made financially responsible for the accommodation costs (also called 'hotel services') that patients with social needs receive while in acute care. Administratively, social services departments are treated as purchasers/commissioners of a service (acute care) that 'their clients' are provided for by the hospitals. When PbR considered social services departments as purchasers of acute care, a new split was created in an already endlessly divided health and social care system (Lewis, 2001).

Figure 2.2: The Purchaser/Provider Roles in Acute Care before and after the Delayed Discharges Act

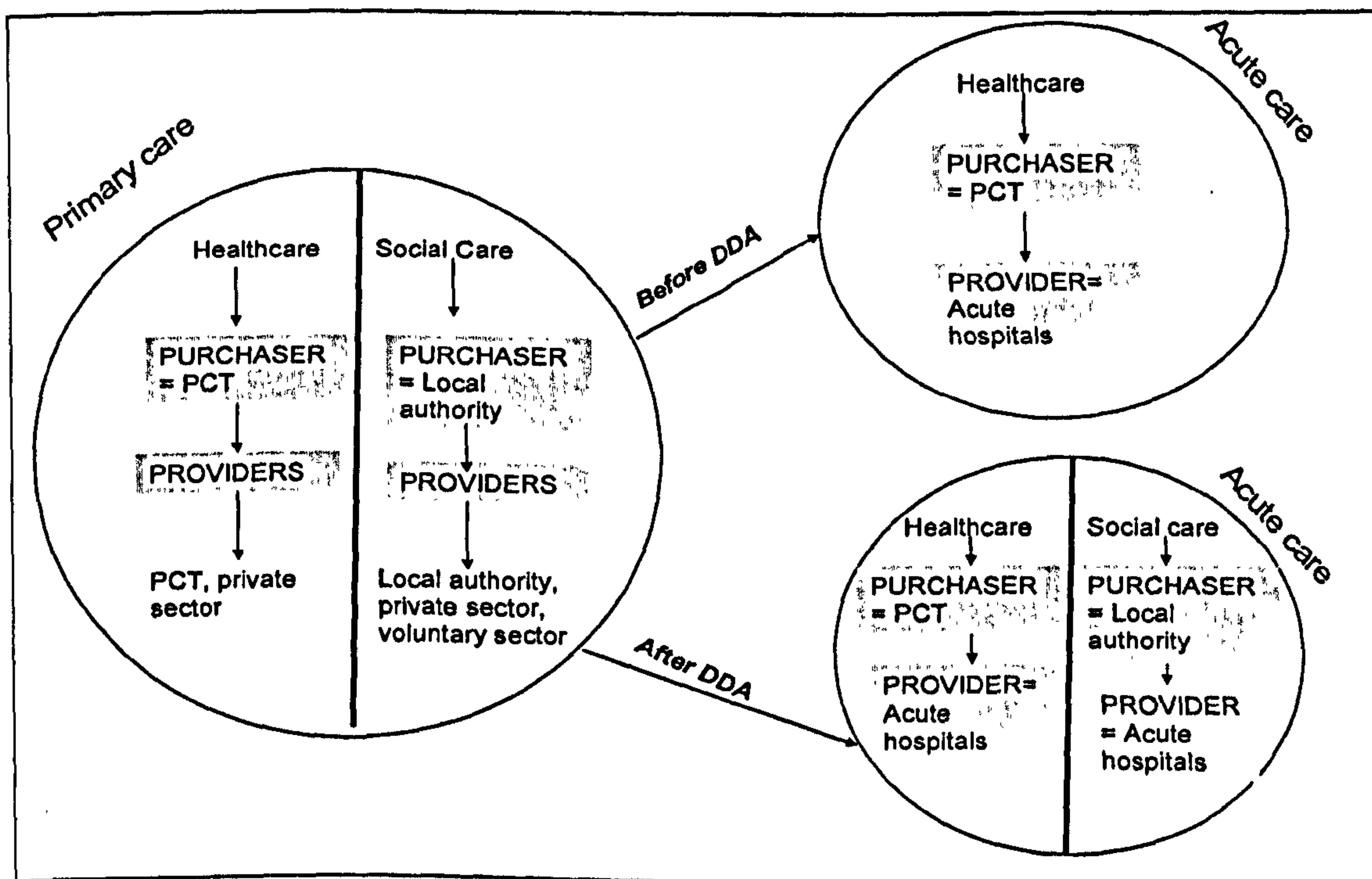

Primary care divides social and healthcare administratively, with PCTs providing healthcare and local authorities providing social care (See Figure 2.2). Before the introduction of the Delayed Discharges Act, acute care was considered a health need that was provided by hospitals and PCTs paid for it.

Since the Delayed Discharges Act and, in the context of PbR reform, acute care is further divided in health and social need. PCTs pay for the health needs of patients and local authorities are supposed to pay for the social needs of the same patients when patients overstay the standard length of stay with no clinical reasons.

- b) Lack of Sophistication in the Conceptualisation of Social Need.** The internal market between health providers was reformed with PbR, establishing a new set of rules base on case mix adjustments. Health Resource Groups (HRG) were created to cost average days and conditions. These are groupings of individual cases that are clinically similar and require similar treatment, based on international categories of diagnosis. HRGs take into account procedures, complications and co-existing illnesses (Fairbairn, 2007). Consequently health conditions are conceptualised in a complex way with numerous diagnoses costed at different prices. Social need, however, is treated in a more simple way. Local authorities are just allocated three days for assessing and discharging patients; one flat rate is allocated for all its users, independent of the complexity of their social care needs. The complexity of health need is legitimated by a set of ostensibly technical rules and differences, while social needs are conceptualised as uniform and straightforward, and as not being affected by concurrent health needs. Furthermore, the added difficulty of market forces and means-tested eligibility criteria in social care are not acknowledged as part of that complexity.
- c) Fines to Social Services: a Tool to Generate Income?** The conceptualisation of the fines to social services as revenue generator for hospitals faces tensions when contrasted with the reality that fines have hardly been issued in a high proportion of the English hospitals that decided to follow the most punitive side of the Delayed Discharges Act (McCoy et al., 2007a; Godfrey et al., 2008). Cross-charging is a measure designed with the objective of reducing delays, following the hypothesis that the fear of that measure would generate mechanisms to reduce delays. Since implementation of the Delayed Discharges programme, the number of delays dropped nationally, but fines are uncommon. Fine avoidance mechanisms are expected consequences of linking

financial incentives to performance indicators and the Delayed Discharges Act implementation design allowed for enough ways to avoid the fines. For this reason, fines for social delays cannot be expected to be sources of income that fill designed gaps of wider health financial reforms like PbR.

The dissection of illness treatment into quantitative measures (days and money) conflicts with social aspects of health and well being. It is not clear whether the Delayed Discharges Act was deliberately designed as an incentive to reduce length of stay or as a tool to approach the unintended consequences of larger NHS financial reform. However, the relationship between these two policies, although never made clearly explicit, was present in implementation documentation. With the implementation of the Delayed Discharges Act, the complicated process of discharging patients at the interface of health and social need was linked to fines. But these fines were constructed as simple and uniform solutions. The relationship between Payment By Result and the Delayed Discharges Act has proven to be a more complex one than originally constructed by the health reform designers.

2.4 Cross-Charging Schemes in the Scandinavian Countries

The literature in the area of 'policy transfer' refers to cross-national experiences as having an increasingly influential impact upon decision-makers within the private, public and third sectors of different countries. Those working on policy diffusion challenged the logic of 'policy choice' and they referred to 'policy processes' (Radaelli, 2000). This perspective goes beyond the logic of a simple mechanical transfer model. In particular, 'policy transfer' and 'lesson-drawing' are considered a dynamic process where knowledge about policies is used across time or space in the development of initiatives elsewhere (Stone, 2001). In the case of the Delayed Discharges Act, the Government made explicit reference to the Scandinavian experiences in their policy design. This influence was claimed as a form of legitimisation: fines worked in Sweden and Denmark and that was why the system was brought into England. In 2001, the UK Cabinet funded a study about social and healthcare in developed countries where the author recommended as one of the 'interesting lessons which are worth examining' the Swedish system of 'imposing a penalty on local authorities if patients are not discharged promptly from hospital'

(Minford, 2001:177). In April 2002, the Wanless Report commissioned by the Treasury to look at health trends and challenges also recommended that the Government explore the benefits of incentives like those used in Sweden to reduce bed-blocking (Wanless, 2002). In the same month of 2002, the Government announced the introduction of fines based on the Swedish system, skipping the recommendation of 'examining the merits' of the system. This hasty response following the Wanless advice has been interpreted as hurdling the implementation process:

'The failure of the Government to follow its own mantra of adopting an evidence-based approach to policy and practice when these proposals had not been the subject of any piloting or evaluation, added further to the hostility with which the announcement was received' (Henwood, 2006a: 401).

Fines were introduced to reduce social services delays in the three Nordic countries where they were implemented in the 1990's: Denmark (Colmorten et al., 2004), Sweden (Styrborn and Thorslund, 1993) and Norway (Health Committee, 2004). The first country to implement the fines was Denmark. In a pilot project in the region of North Jutland, local authorities were required to accept patients discharged from hospital within five days of notification, beyond which they had to pay the hospital for each extra day of care (Saltman, 1992). Then, from 1993 onwards, all local authorities had to pay a fee per day for patients in hospital who had finished their treatment, with some municipalities formally agreeing notifications at least three days before a patient's discharge (Leichsenring, 2004). While Danish accounts confirmed that reimbursement was successful in reducing the number of delays, there were disagreements between hospitals and community services as to when patients were ready for discharge or what services they needed. The perception was that community services were increasingly and inappropriately taking on more of the responsibilities of hospitals. There were also reports of inadequate notice of discharge and inaccurate information about patients' needs (Colmorten et al., 2004).

In Sweden, Uppsala council was the first health authority to introduce a transfer in the financial liability for delayed discharges in January 1987. Other areas like Gothenburg and Stockholm created similar payment systems within the county sector. Then, in 1988 a commission was created to develop a better way of coping with the growing

population of older people and they proposed that responsibility for the care of the aged should be transferred from the counties to the municipalities (Twaddle, 1999). As a result of this consultation, four laws decentralised responsibility for the care of older and disabled people, including nursing homes and long-term medical care, from the counties to the municipalities. Twenty one per cent of total county council healthcare expenditure was transferred to the municipalities (Lindgren, 1995). The Care of the Elderly and Disabled Act (the Ädel reform) was implemented in 1992 and gave the local authorities (municipalities) the main responsibility for all care of the elderly including long-term care. The local government became liable for payment for patients who remained in hospital for more than five days after having been reported as social services' delays. The cost debited per bed-day was the estimated average cost for a bed-day at the time (Health Committee, 2004). The reputed success of the innovative Ädel reform to resolve bed-blocking was a further inspiration for the design of the Community Care (Delayed Discharges etc.) Act 2003. Swedish municipal authorities - which unlike their UK equivalents own and run nursing homes (Lister, 2005) - were also required by law to accept patients deemed ready for discharge.

In Norway, cross-charging was implemented in 1996 and it gave local authorities initially fourteen days to find alternative accommodation for hospital patients. This timeframe was reduced to seven days in 1997 (Health Committee, 2004), although some commentators refer to a ten day limit in 1998 (Holmas et al., 2007: 2). As in Sweden, if the local authorities did not set up alternative care arrangements, patients were discharge directly into short stay units, funded by the local authorities: 'These units had a maximum period of occupancy of three weeks and grants were switched from hospitals to the urban district to reflect the cost of the transfer in responsibilities' (Health Committee, 2004: 5).

In all three countries, the reforms were deemed sufficiently successful by policy analysts. Bed closures and lower average length of stays were reported as the main outcomes of success. Nevertheless, the accounts were not always positive. A sharp reduction of delayed discharges after the Ädel reforms was reported as soon as 1993 but, almost immediately, reports of decreasing quality of care surfaced. Despite the lack of systematic data evaluating the changes in the quality of care, Harrison (2004:

114) explained how hospital nurses perceived that the quality of nursing care may have actually improved in internal acute medicine, because it 'relieved nurses of the heavy responsibility of caring for terminally ill geriatric patients'. The transfer of those responsibilities to municipalities meant, however, that the supply of nursing facilities did not keep pace with demand, and serious deficiencies occurred in the quality of geriatric care out of hospital (Twaddle, 1999). Municipalities, overwhelmed by the demand, rationed care, rather than guaranteeing patient choice (Harrison, 2004)

A significant media debate in Sweden in the 1990's concentrated on the problems of 'bed-blocking patients' who were sometimes discharged on dubious grounds. Because readmissions within seven days to departments of internal medicine increased in patients aged 75 and older (Styrborn, 1994), the cash transfers were assessed by some commentators as 'economically advantageous for municipalities in the short term but unduly expensive in the long run' (Fotaki and Boyd, 2005: 239). Deficiencies were also reported in the discharge information communicated to district nurses and also in the opportunities for patient participation in their discharge plans (Eriksson, 1993; Lundvall et al., 1993 both cited in Styrborn, 1994).

2.5 An Overview of the Community Care (Delayed Discharges etc.) Act 2003

The Community Care (Delayed Discharges etc.) Act 2003 introduced, among other initiatives, financial penalties for English social services departments unable to discharge patients from acute hospitals within set timescales. Due to variance of healthcare policy across the NHS in the devolved countries of the United Kingdom, the Act was only implemented in England. This programme established a timeframe for discharge equal for every patient irrespective of their personal circumstances or illnesses. Social services departments are given a minimum of two days to assess and arrange services. Then, once the hospital multidisciplinary team decides that the patient is ready to leave, social services are given 24 hours to organise the patient's discharge. If the patient is not discharged on the third day, the local authority must pay the acute hospital £100 per day (£120 in the South East of England). The basic assumption of the programme's theory is that local authorities would be prompted to assess and transfer patients quickly out of hospital because of the threat of financial penalties.

This reimbursement policy applies to all acute adult patients (over 18 years old) who qualify for community care services under the NHS and Community Care Act 1990. The Act specifies that cross-charging only applies to beds that are counted administratively as acute. Acute care is defined by the policy as:

‘intensive medical treatment provided by or under the supervision of a consultant which is for a limited time after which the patient no longer benefits from that treatment. The following types of care are not regarded as acute care -

- (a) maternity care, that is, care of expectant and nursing mothers;
- (b) mental health care within the meaning of article 2 of the Delayed Discharges (Mental Health Care) (England) Order 2003;
- (c) palliative care;
- (d) intermediate care;
- (e) care provided for the purposes of recuperation or rehabilitation.’ (Department of Health, 2003a:1)

The scope for extending the arrangements to other beds and services in the future was clearly stated at the time but it has not happened to date.

2.5.1 Innovations Made Statutory by the Delayed Discharges Act

The Delayed Discharges Act dictates a standard system to plan discharges for all acute hospitals. This new system generates significant practice implications for discharge planning procedures which are summarised in Figure 2.3. Patients with planned admissions are those who are given a specific day to access a hospital bed because of elective surgery, treatment or investigations. According to the new policy, these patients must be assessed by the NHS for likelihood of needing social services and, if that is the case, a notification must be sent to social services not earlier than eight days before patients’ admission. Before giving this notice, the NHS must consult the patient and the carer. This is to prevent assessments that are not required but also to inform the patient that the Act applies to their hospital stay. Unplanned admissions are those of patients who access hospital through the emergency departments due to unexpected acute illnesses. In this phase, patients likely to need social care input on discharge are screened and referred to their local social services department following the procedure described in Section 2.5.

Figure 2.3: Process Map of Discharge Planning after the Delayed Discharges Act

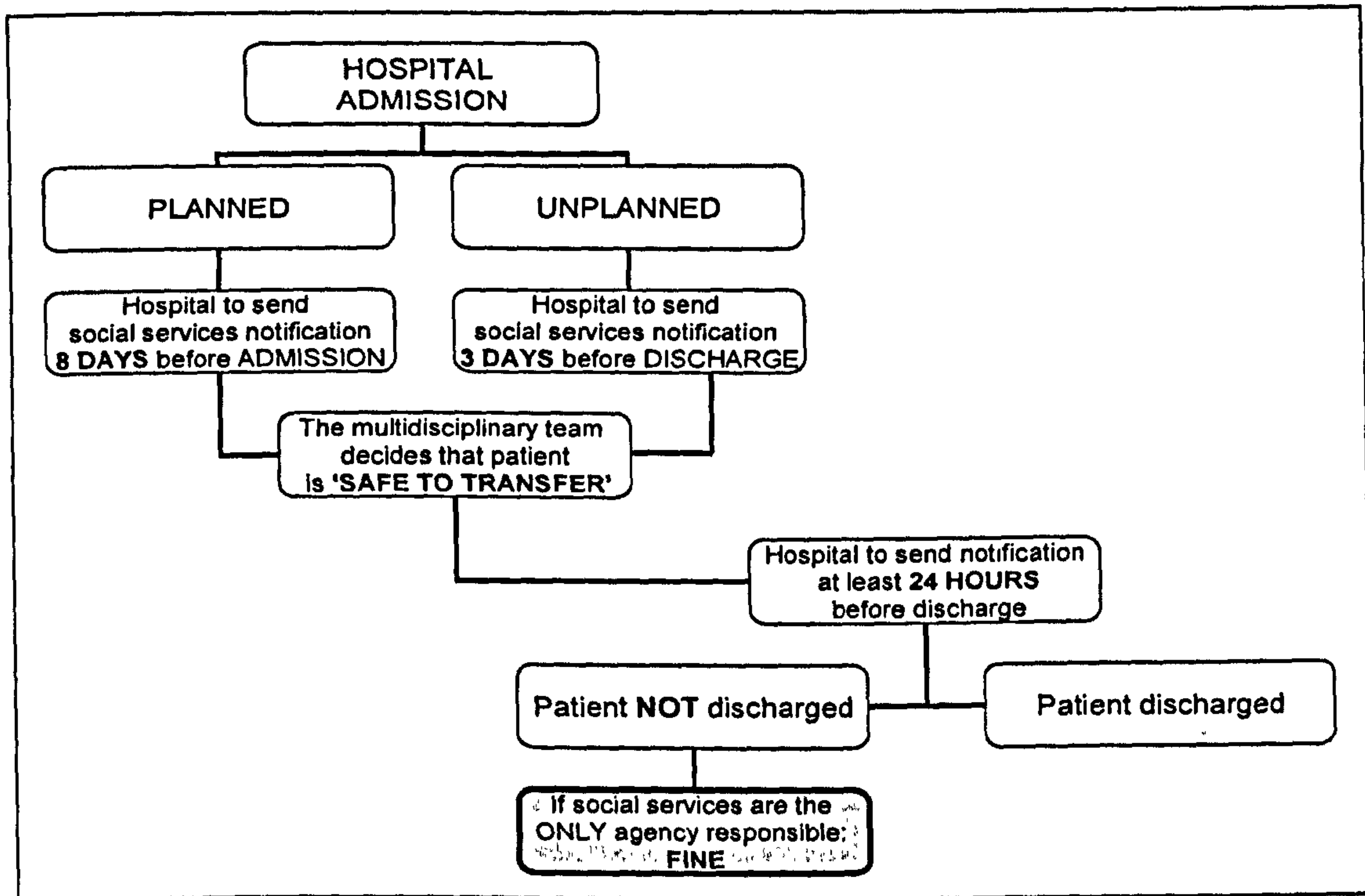

Beyond the controversial fine scheme, and the significant increased funding to tackle delayed discharges described in section 2.2., some of the best practices identified in the literature on discharge planning (Henwood, 1994; Rudd and Smith, 2002; Pearson et al., 2004) are also formalised by this programme. Ten key innovations were introduced with the Delayed Discharges Act and are summarised in Table 2.3 below.

Table 2.3: Innovations Made Statutory by the Delayed Discharges Act

TEN INNOVATIONS MADE STATUTORY BY THE POLICY:
1. Common definition of “delayed transfer of care”.
2. Safe to discharge, a multidisciplinary team decision.
3. NHS statutory duty to notify councils of any patients with likely need for community care.
4. Minimum time intervals for assessment and discharge.
5. Set reasons for delayed transfers of care.
6. Weekly census (SitReps) and monitoring of discharges.
7. Seven days extended services in discharge planning.
8. Duties and responsibilities for the NHS in the discharge process.
9. Free personal care and community equipment for a maximum of six weeks.
10. Fines linked to reasons for delayed transfers of care which are defined as been caused exclusively by social services.

Although the mechanics of financial incentives seem to be more appealing to policy makers, all the innovations above are conceptually and practically interrelated to each other. There is the risk that only the fines are deemed responsible for the success or failure of the programme but the evaluation of the fines cannot be separated from all the innovations. These are analysed in more detail in the following sections:

2.5.1.1 Common Definition of ‘Delayed Transfer of Care’

One of the concerns expressed with the implementation of this policy is that people would be transferred out of hospital before it was safe to do so. The Reimbursement Implementation Team published their own definition of ‘medical stability’ and ‘safe to transfer’ to try to avoid inappropriate discharges as a consequence of the fines scheme. According to the Department of Health guidance, a hospital patient is considered ‘safe to discharge’ when the following stages are all simultaneously addressed:

- a. 'A clinical decision has been made that a patient is ready for transfer AND
- b. A multi-disciplinary team decision has been made that a patient is ready for transfer AND
- c. The patient is safe to discharge / transfer' (Department of Health, 2003b: 1).

For the first time ever, hospitals were given a statutory standard definition of delays and this was very different from other definitions used in the past by clinicians and researchers. Three main components form the rationale of delays. First, the consultant has to establish that the patient is medically ready to go. Secondly, all members of the team (which includes a social services representative) must agree that the patient is ready to leave the hospital. This compulsory involvement of the multidisciplinary team in discharge decisions is a major innovation that is analysed separately in the next section. Finally, a third stage is required (c.) and clarified in the guidance as follows:

'In the acute setting assessment relates to the diagnostic and treatment process and the decision that the patient is safe to transfer. Multi-disciplinary teams need to be very clear about what else they need to know before they can make this decision. For example, the team may decide that a home visit by an OT with the patient is essential to determine whether the patient is safe to transfer. Where it has not been possible to run this in parallel with the other aspects of the assessment, the patient cannot be regarded as a delayed transfer because the multi-disciplinary team decision cannot yet be made. However, this should not be allowed to cause delays of any significance' (Department of Health, 2003b: 3).

In other words, the team cannot make the decision that patients are ready for transfer until they are certain that their discharge destination is a safe place. In practice, this means that pre-discharge home visits need to be performed and that care homes need to assess patients before patients can be deemed 'delays'. The requirement for these three stages: clinician decision, team decision and discharge location makes the new definition for delays very different from the previous one, when only clinicians' views were taken into account. As a consequence, quantitative accounts post-implementation of this definition have to reflect, inevitably, a lesser number of delays. The process to call patients 'delayed transfers of care' becomes more complicated and, consequently, the number of 'appropriate' stays according to the definition increases.

2.5.1.2 Safe to Discharge, a Multidisciplinary Team Decision

The central role of the multidisciplinary team is reinforced with this policy. The decision on when a patient is ready to leave the hospital is taken away from the medical staff in order to achieve a more holistic remit. A team, which includes nursing and other health and social care professionals caring for the patient, have to establish when the patient is ready and safe to transfer out of hospital. The policy designers were aware of the fact that they were introducing significant changes in hospital discharge practices with this requirement as the next sentence from the guidance illustrates:

‘In some cases we are told the process consists almost entirely of the consultant deciding a patient is medically fit for discharge, followed by referral to social services. Hence the multi disciplinary input to the decision making process is minimal and –in extreme cases- non-existent’ (Department of Health, 2003b:1).

In both Sweden and Norway (Lundh and William, 1997; Minford, 2001), after the introduction of the fines, reports followed of patients discharged from hospital before they were safe to leave. Consequently, in those countries, new regulations were introduced so that care plans had to be signed by all agencies responsible for the patients’ care and not only the consultants (Health Committee, 2004). In Sweden, a commonly accepted definition of ‘medically completed treatment’ was not established. It was a subjective doctor’s decision, where explicit criteria were not defined. This situation generated uncertainty about the adequacy of resources and time consuming conflicts at the organisational level (Styrborn and Thorslund, 1993; Andersson and Kalberg, 2000). In Denmark disagreements about when patients had finished treatment due to different institutional understandings of central discharge concepts were also reported (Felbo and Soland, 1996 cited in Colmorten et al., 2004). In England, before the Delayed Discharges Act, doctors were generally deciding whether patients were fit to leave hospital, basing that decision on medical grounds. The English designed programme probably intended to avoid the above tensions and it endorsed an innovative national definition of patient ‘safe to transfer’.

Therefore, the central role of the multidisciplinary team is a legally binding requirement introduced with this policy. This shift in practice, not without tensions,

has contributed to a positive outcome for patients. Accounts of premature discharges after programme implementation have been generally described as ‘anecdotal’ (Commission for Social Care Inspection, 2004; Henwood, 2004; Godfrey et al., 2008). This new and more holistic definition also accounts for another ‘success’ of the policy. It holds a hidden form of reducing delays. Before the introduction of the fines, delays were decided exclusively on the doctor’s judgement. After the Act, delays are decided based on the multidisciplinary team’s judgement. Subsequently ‘delays’ before and after the Delayed Discharges Act are conceptualised differently. Now, the whole team need to have their assessment done and agreed discharge plans in weekly meetings before patients can be called ‘delays’. The consequence of this new approach again has implications for the quantitative accounts of delays which have to show a smaller number of delays because team decision-making processes are longer than individual doctors’ decisions.

In addition, the involvement of the multidisciplinary team, while essential for effective discharge planning can potentially generate other intrinsic problems. Communication deficits are more likely to happen as the number of professionals involved increases. These professionals are not necessarily a ‘named person’. In the 24 hour world of hospitals, only the patients stay the same. Hospital staff change with shifts, weekends and holidays. Teams tend to have formal weekly meetings to make decisions but the information and circumstances referring to a particular patient vary on a daily and sometimes hourly basis. Information flows 24 hours a day while the discharge planners only work 9-5, Monday to Friday. Although there is a time and place established for this meeting, decisions are either made outside the meeting or delayed to wait for the weekly session.

2.5.1.3 NHS Statutory Duty to Notify Councils of Any Patients with Likely Need for Community Care

Planning for discharge as soon as possible during hospital stays is made a legal requirement for NHS staff when the Delayed Discharges Act makes statutory that hospitals must give at least three days for social services to assess and facilitate patients’ discharges. The prediction of the likelihood of patients’ need for community care service is not, however, straightforward. Bull and Roberts (2001) describe the

need of ongoing, honest communication with the patient and family at this stage as vital for the planning of proper discharge. In addition to this, information from the community services (GP, District Nurses, social workers, etc.) is also fundamental.

Despite following the above procedures, identifying the best time to refer patients to social services is not a simple task. Acute patients' conditions are extremely changeable and the unpredictability and contingencies related to illness make this phase a guessing exercise. Patients' medical condition fluctuates on a daily basis and this affects their psychological and social needs. One of the assumptions of delayed discharge procedures is that people who enter hospital are at their worst on admission and gradually improve through their hospital stay. However, the reality is that during their stay, patients may experience new and worsened functional impairment that improves at a much slower rate than the acute illness that caused them to be admitted. The Delayed Discharges programme anticipated these situations and tried to approach them by allowing for withdrawal of notifications if patients became medically unstable.

Another limitation to the early referral is patients changing their mind about what assistance they may require on discharge. Rudd and Smith (2002) explained that patients who have in-depth assessment of needs in the pre-operative assessment clinic often decline social services' referrals and the associated support, but then demand a referral at the point that discharge home is confirmed. This unanticipated contingency requires an alternative line of action that could most probably generate a delay in the expected trajectory of the discharge plans (Strauss et al., 1985). Often, it is also assumed that clinical staff are able to understand social need, identify it as a separate entity at the early stages of the admission and pass it to the right agency. Less and Holmes (2005: 42) explained how the 'majority of medical teams tend to be unaware of which members of the multi-disciplinary team they should refer patients to, when and why'. It seems that in the wards, social care input is undoubtedly perceived as the demarcation from medical care but it is a concept that is not clearly defined and consequently understood.

2.5.1.4 Minimum Time Intervals for Assessment and Discharge

The Delayed Discharges Act allocates a minimum time interval of two working days (excluding Sundays and public holidays) to make an assessment of a patient likely to need post-discharge social care. The hospital also must allow a minimum of 24 hours notice of the patient's discharge date before the acute bed can be classified as a 'delayed transfer of care' and social services could be fined for it. A set timeframe for discharge is one of the key innovations introduced alongside the fines. The three days' notice, specifically, has been considered to be insufficient, particularly for complex cases (Baumann et al., 2007). There is no rationale in the documentation guidance of why 'three' is the number of days thought to be adequate for discharge planning. In Denmark and Sweden five days were allowed while in Norway the number of days varied from fourteen to ten to seven days (Health Committee, 2004).

Discharges are affected by multiple factors, apart from social services interventions: not only the unpredictability of the medical situation, but also factors such as medication, transport, personal and family issues are not under the control of social services staff. Less and Holmes (2005), in a pilot study on estimating a date of discharge, explained how clinicians were openly sceptical about prescribing dates when patients could leave hospital. They identified some prior internal management issues to be addressed before establishing a date that would be more of a form filling exercise than an accurate prediction.

On the other hand, the specific time allocations are peculiar to social input. The Act officially separates the social care assessment from the others done since admission. A fixed time stipulation does not apply to any other professionals internal or external to the hospital institution. It is stated in the implementation guidance that there should be local agreement on 'what is reasonable in terms of response times' by other discharge actors and that the guidance designed for social services should be used as 'a useful benchmark for the other professions' (Department of Health, 2003b: 3). This recommendation, however, has not developed in any set timeframes for the other professionals involved in patients' discharges.

2.5.1.5 Set Reasons for Delayed Transfers of Care

The Delayed Discharges Act conceptualised ten set reasons for delayed transfers of care and only some of those would generate fines for social services departments. To establish that a delay was the sole responsibility of social care agencies was to assume that their input could be easily separated from that of the other disciplines. This relates conceptually to a model of health that is not dynamic but linear, where there is clear and sequential demarcation between physical capabilities and social and personal circumstances. The practice implication of this directive had to confront the challenge to isolate reasons for delay when dealing with unique individuals. In weekly 'SitReps' meetings, the management of the acute hospital and social services discussed the individual cases using written information passed by their staff and they agreed the fines. The following information is recorded for performance purposes and then forwarded to the Department of Health:

- a) Council responsible for each delayed patient. This information refers to the fact that, although the majority of patients admitted in the hospital are residents of the local authority where the hospital is located, a percentage of admissions could be from patients out of the area.
- b) Number of patients whose discharge is delayed – subdivided by the responsible council. This data reflects all delays per area without differentiating reasons or agency responsible for the delays.
- c) Number of reimbursable days – subdivided by responsible council. This figure informs on the total numbers of fines, although these are counted per day and not per patient.
- d) Agency responsible for the delay (NHS, social services, or both). It has to be noted here that the only agency mentioned as responsible for a delay, apart from the NHS is social services. NHS institutions are considered as a whole, without differentiating between PCTs, community hospitals, mental health institutions, etc.
- e) Reason for delay. Recognised causes of delay for reporting purposes are codified in the following categories:

Table 2.4: Reasons for Delay according to SitReps Guidance

CODE	REASON FOR DELAY
A	Awaiting completion of assessment
B	Awaiting public funding
C	Awaiting further (non acute) NHS care (including intermediate care, rehabilitation services, etc.)
D (i)	Awaiting residential home placement or availability
D(ii)	Awaiting nursing home placement or availability
E	Awaiting care package in own home
F	Awaiting community equipment and adaptations
G	Patient or family choice
H	Disputes
I	Housing – patients not covered by the NHS and Community Care Act

For performance monitoring purposes, reasons for delay are reduced to ten categories (See Table 2.4), and then, further reduced to the selection of only one possible choice. The guidance established that ‘a patient should only be counted in ONE category of delay, this category should be the one most appropriately describing their reason for delay’ (Department of Health, 2003c: 18). In the consultation on the reimbursement scheme, the NHS Confederation, the Association of Directors of Social Services and the Local Government Association all opposed focus on a single cause for delay. They jointly said that ‘the current proposals focus on only one element of a complex and interdependent system. There is however no single cause for delays in discharge and no one sector can deliver a solution’ (Roll and Wright, 2003: 44).

2.5.1.6 Weekly Census (SitReps) and Monitoring of Discharges

In 2000, the Department of Health introduced a new system for collecting performance-related data from hospitals - SitReps (Situation Reports). This system collected data on delays in discharge as well as performance data on ambulance services, emergency admissions, elective care, cancelled operations and critical care. Then, in 2003, the SitReps return was modified when the shadow mode of the Delayed Discharges Act was implemented. The ten causes of delay described in the

previous section were also introduced at this point. Now, each hospital has to collect data on all patients, whose discharge is delayed, recording also the number of bed days occupied by these patients.

The policy designers considered that rigorous management information systems would be necessary to make the reimbursement system work. The quantitative performance information which relates to hospital delays has to be collected daily by the acute hospital and then sent off weekly to the Department of Health. The Delayed Discharges programme enforces a weekly census to count delays, as opposed to the one day quarterly census system used in the past. For many years, data for hospital delays was collected every three months using a 'one-day' census of hospital bed use. Data was presented in terms of the number and proportion of delayed patients on a given day by quarter, with a further breakdown for elderly patients (Department of Health, 2006b). Interestingly, the Swedish evidence that highlighted the success of the fines was collected using a monitoring system based on one day annual census. This annual collection is also used in Scotland but has been deemed more vulnerable to gaming activities with agencies trying to fast discharge patients in the weeks immediately prior to the one day of monitoring (Godfrey et al., 2008).

This rigorous monitoring provided the impetus for weekly interagency meetings between health and social care management staff to discuss delays and fines frequently called 'SitReps meeting'. These meetings normally occur across English hospitals on Thursday mornings before data is sent to the Department of Health. This type of meeting has been associated with hospital sites that have low figures of delayed transfers of care (Baumann et al., 2007).

2.5.1.7 Seven Days Extended Services in Discharge Planning

Another of the innovations of this policy is the move towards seven days extended services in discharge planning. For cross-charging purposes, Saturdays are considered working days and originally it was intended to extend it to Sundays and Bank Holidays by April 2005, although this has not materialised at the date of writing. The Reimbursement Change Agent Team explained that the intention of this change was that:

'both NHS and Social Services should be working towards 7 day, extended hour services and that patients should not remain in hospital over the weekend due to the unavailability of either NHS or Social Services assessment or provision. For example, patients may be unable to leave (or even make arrangements to leave) hospital for several days over a bank holiday, to the detriment of their health. In addition, where discharge services close down over the weekend, problems may be created for Monday admissions, often affecting other important NHS targets' (Department of Health, 2003c: 5-6).

Discharge planning research identified poor discharge practices on Friday because the people responsible to facilitate discharge traditionally only worked Monday to Friday from 9 to 5. This refers not only to social workers but also to hospital staff like therapists, discharge coordinators and consultants. In hospitals, Fridays are the most common day to discharge patients; decreased staffing levels at weekends seem to be the reason for this (Van Walraven and Bell, 2002). However, poor outcomes for patients discharged on Fridays are common. Not only social care but community healthcare support services do not work to full capacity at weekends. Increasing the turnover of hospital beds by modifying this practice is a common argument, with some studies blaming restricted weekend services for delays (Varnava et al., 2002).

2.5.1.8 Duties and Responsibilities for the NHS in the Discharge Process

A formal structure of notifications for social services is a major innovation of this policy and this new discharge procedure implied obligations for the NHS that have never been statutory before. Once the hospital has formally referred a patient to social services, the Act introduces the following 'duties' for the hospital:

- a) The Act makes statutory the consultation with social services to avoid patients being discharged at their risk, which give patients a significant legal protection against premature or unsafe discharges. The hospital 'must consult the Social Services authority before deciding which services it will make available upon discharge' (Department of Health, 2003d sect. 5).
- b) The policy introduces the compulsory communication to social services of any change in the patients' circumstances: 'Social Services authority should be informed as soon as possible by the NHS body of circumstances which change

the proposed discharge date, so that the Social Services authority can make corresponding changes to their arrangements to provide services. This ensures clarity of communication between the NHS and Social Services authority leading to better joint planning' (Department of Health, 2003d: sect.5).

- c) The policy also regulates the form, content and manner of issuing and withdrawal of discharge notices. The aim of formalising this process is primarily to ensure that the social services departments receive fair warning of the intention to discharge or of changes to this decision. The formal system of referral aims to prevent disputes about when notices could be regarded as given or received.
- d) A legal requirement for NHS trusts to assess patients for eligibility for NHS continuing healthcare funding before they leave hospital.
- e) The implementation guidance establishes a sequenced order of patients' assessments: Continuing healthcare assessment must be completed before referral to social services. Registered Nursing Care Contribution (RNCC) assessments and confirmations of NHS funding also have to be in place before social services can be held financially responsible for patients' delays.

These new duties and responsibilities for the NHS are an explicit recognition of the joint responsibility for ensuring timely discharges (Henwood, 2004).

2.5.1.9 Free Personal Care and Community Equipment for a Maximum of Six Weeks

Part II of the Community Care (Delayed Discharges etc.) Act 2003 introduces a significant innovation that is hardly mentioned in the impact evaluations of this programme. From June 9 2003, certain community care and carers' services provided through intermediate care had to be provided free of charge for a maximum of six weeks to the disabled or older person and carer. Intermediate care is defined as 'a qualifying service which consists of a structured programme of care provided for a limited period of time to assist a person to maintain or regain the ability to live in his home' (Department of Health, 2003e: sect. 2). According to this definition, all patients who are discharged from hospital are now entitled to a maximum of six free weeks of community care services: recreational facilities, personal care, day care,

occupational therapies, home helps, laundry services, rehabilitation services, and any carers' service provided under section 2 of the Carers and Disabled Children Act 2000 (CarersUK, 2003). Aids and house adaptations must assist with nursing at home or help with daily living. Minor adaptations are defined as those costing £1,000 or less, including the costs of buying and fitting the equipment. This guidance also makes clear that the equipment might also be provided as a carer's service. The councils retained the discretion to charge for equipment where the costs exceed this amount.

In summary, with this innovation local authorities' power to charge for certain services provided through intermediate care is removed. The elimination of mean-tested procedures for hospital patients in need of these services is intended to remove bureaucracy and patients' resistance to pay that could delay discharges. Even more, if those services are not ready on discharge, it is considered a delay caused by the NHS, because intermediate care services are conceptualised by the policy as a health need excluded from the reimbursement policy.

2.5.1.10 Fines Linked to Reasons for Delayed Transfers of Care which Are Defined as Being Caused Exclusively by Social Services Departments

The system of reimbursement by social services to the relevant NHS hospital for delays is the most controversial innovation of the Delayed Discharges Act. Initially, it was also the most announced feature by their supporters. Consequently, opponents to the scheme focused on this feature. During implementation, attention was intended to be shifted towards other benefits of the programme:

'Significantly, the implementation guidance uses a language that is careful to avoid any talk of 'blame', 'fines' or 'penalties' such as characterised much of the early discussion of these issues. Nonetheless, such terminology had become embedded in much of the reporting of the Bill, and in debate of its provisions in parliament. Shedding these negative associations for more neutral language is taking time to gain acceptance' (Henwood, 2004: 10).

The theoretical literature of the effectiveness of financial incentives refers to the characteristics of the incentive itself as determinant of success. Dudley et al. (2004) argue that there are financial and non-financial characteristics of the incentives which need to be taken into consideration when evaluating this type of programme:

a) Financial Attributes of the Incentives

The main financial attributes are whether the incentive is directed to the optimal recipient (individual provider, provider groups, or even community organisations) and whether the performance measures were within providers' scope of control. The recipients of the financial incentives used in the Delayed Discharges Act are individual providers (social services departments). However, due to the mixed market that characterises social care, social services departments depend on other providers to achieve the goal demanded (fast discharge). Furthermore, social services and the providers that they depend on are not intrinsically motivated by the same financial structure: social services are a public service and some of their providers are for profit corporations. According to this structure, scope of control of the performance measure is reduced to coordination with the rest of providers who are not directly affected by the reimbursement fines.

The next financial attribute which could determine the likelihood of effectiveness is the potential impact on revenue. This is based on the magnitude of the incentive and the proportion of patients to which it applies. As previously explained, financial incentives for social delays were introduced in England following the 'give-and-take' model (Van der Doelen, 1998). Before the Delayed Discharges Act was implemented, a significant cash subsidy was given to local authorities to help them build up the necessary infrastructure to reduce delayed transfers of care. However, social services departments are chronically under funded and current lack of capacity is a well known characteristic of care in the community. The way in which each local social services department spent their grant cash would impact on the way in which they responded to the threat of a financial penalty. McCoy et al. (2007b) in their analysis of the impact of the reimbursement scheme in two London Boroughs describe the availability of the Delayed Discharges Grant as a fundamental factor that had an impact in the reduction of delays.

On the other hand, Roll and Wright explain how the figure of £100/120 was calculated by the Government following details of the proposal contained in a consultation document:

'The charge would be daily and should be high enough to provide an incentive for social services authorities to provide more suitable care but not so large that it was an incentive for hospitals to prematurely identify patients as ready for discharge in order to maximise their income. The document suggested that the reimbursement fee might be £100 day, and £120 in London and the Southeast. It explained that this was arrived at by using the costs of treating patients in a nursing-led facility, estimated at £168 per inpatient day. Removing capital costs, medical input, special nursing and indirect overheads reduced this to about £100 per patient day, or £700 a week. It said that this figure was likely overstate the cost of a delayed discharge because the level of nursing care in a nurse-led unit would be more intensive than that given to nursing home residents. But in the absence of more accurate information, the maximum level at which the payment should be set appeared to be about that amount' (Roll and Wright, 2002: 25).

The main rationale of choosing that particular daily tariff was to reduce it to the hotel costs of the hospital stay. Significantly, the cost per week of paying the fine is more expensive than the cost of transferring the patient to a nursing establishment. This aspect means that before a possible delay, social services departments find it cheaper to pay for nursing home places than to pay for fines.

The next financial characteristic to consider is the cost for the institution of complying with the performance measure. The Delayed Discharges Act allowed flexibility through the creation of local protocols that could define the specific local nature of the financial arrangement between social services departments and their main acute hospital providers. In other words, hospitals could choose whether to fine or not to fine social services. Pollock and McCoy (2006) found three main types of interagency relationships developed for the reimbursement programme:

- a. The hospital is reimbursed and keeps the money as a source of income.
- b. Arrangements where the hospital does not earn income from delays in discharge. An example of this is Waltham Forest's London Borough and PCT, with the local hospital (Whipps Cross University Hospital Trust). These three organisations decided the best approach was not to pay any fines and used the Government grant to establish a Whole Systems Reimbursement Implementation Team, creating a fines amnesty and getting the three organisations to work together to reduce discharge delays (Mathieson, 2004).

- c. The arrangement is either a mix of the earlier two categories, or it is unclear from their data collection.

Considering their freedom to choose arrangements, the issue is then why some localities decided to choose a more coercive model than others, and how the circumstances in which that decision was made might impact on the effectiveness of the programme.

b) Non Financial Attributes of the Incentives

According to Dudley et al. (2004), non-financial attributes of financial incentives are more numerous and subtle. Some of those attributes are the chosen approach to the reinforcement (e.g. positive versus negative reinforcement) and the perceived attainability of the performance goals set to be achieved by the incentive. The acceptability of those goals, their congruence with professionalism, altruism and intrinsic motivation and with provider preferences for domain of performance measured are also significant attributes to take into consideration. McGraw (1978) explained that incentives have a detrimental effect on performance when two conditions are met:

‘First, when the task is interesting enough for subjects that the offer of incentives is a superfluous form of motivation; second, when the solution to the task is open-ended enough that the steps leading to a solution are not immediately obvious’ (p. 34).

Discharge planning of acute patients is definitely an open-ended task with steps to success depending on contingencies. The fine imposed on Social Services departments by the Delayed Discharges programme is a collective punishment based in the work place. It is not addressed to the salaries of the individual staff but to the organisation budget. The more fines, the less money in the budget. The less money in the budget, the more difficult the job for frontline staff. However, the managers are the only ones with ownership of the budget and this fact makes them the direct target of the policy. In the Delayed Discharges programme, the targets are managerial sanctions linked to reputational incentives. Therefore they are linked to managerial

sanctions for non-performance. Publicly recorded performance is an important aspect of NHS and social services managers' career concerns.

Financial incentives are never introduced in isolation (Van der Doelen, 1998; Chaix-Couturier et al., 2000). This section explained how nine other significant innovations were implemented by the same programme at the same time as the fines. These were designed organisational changes, which also aimed at reducing patients' length of stay, transforming discharge practices and improving quality of decision-making and care. All these ten innovations are linked to each other and to evaluate one is to evaluate all of them. They have similar objectives and they generate similar outcomes. To untangle the intricate links that unite all of them is not only a difficult task, but most possibly an unattainable one.

2.5.2 Evaluations to Date

This section reviews the evaluations of the Community Care (Delayed Discharges etc.) Act 2003 published at the time of writing so as to establish how the impact of the financial incentives has been previously assessed. Some of these evaluations are 'quantitative accounts' provided by the Department of Health. Based on internal audits, this type of evaluation shows a significant reduction in delayed discharges since the implementation of the programme. The first account was given on May 17 2004, five months into the full implementation, when the Department of Health published a press release with the title 'Dramatic Fall in Delayed Discharges'. The Health Secretary informed that there were 4000 less delayed discharges than before the start of the 'Cash for Change' programme in 2001. This was interpreted as a 'massive reduction in delayed discharges (and it) was the equivalent of adding eight extra hospitals to the NHS' (Department of Health, 2004b: 1). The document clarified that the figure of eight hospitals was based on a typical general hospital having around 500 beds. The simplification of the mathematics of patient flow and hospital cost analysis were obviously the preferred method for the purpose of explaining the success of the policy. Later on, data reported in 2006 showed a 64% reduction in delayed transfers of care from acute hospitals between 2001 and September 2005 (Secretary of State for Health, 2006). The last official announcement was in November 2007, when the Government released official figures showing an overall

decline in delayed bed days from 776,101 to about 733,000 in England for the year from 2005/6 to 2006/7 (Brindle, 2007).

The Commission for Social Care Inspection (2004) performed two evaluations on the effects of the Delayed Discharges Act. The first evaluation was in October 2004 and it looked at the initial months of implementation in seven local authorities. They examined 151 case records and interviewed 70 people a few weeks after their discharge. Although key concerns like premature discharges or institutional conflicts were not discussed, some of their findings reflected concerns previously expressed by the critics of reimbursement. Their data indicated marked variations (from 8% to 50%) in the rate of hospital re-admissions within a few months of discharge. They explained that up to a third of older people were moved directly into care from the wards (site variation was 4% to 35%), highlighting the short-term focus of the interventions. In this last aspect, lost opportunities of rehabilitation potential undermined by the need to achieve faster discharges were reported. In some councils, 'self-funders' clients, not eligible for social services financial assistance, were at a disadvantage in terms of active help and information about rehabilitative options.

Their second report (Commission for Social Care Inspection, 2005b), was a follow-up exercise a year later in which they re-interviewed the same people as in 2004. Their objective was to explore the long-term outcomes achieved by their original sample. Of the 70 people interviewed in 2004, 11 had died and 12 were too ill or unable to be interviewed. They recruited 23 new people to replace those missing participants. The findings of this new report, which were in general very positive, need to be contrasted with the fact that 23 potential complex cases were excluded from the original sample. Even so, almost a third of the people had experienced readmission, some of them on more than one occasion. Rehabilitation services varied across the localities, and admissions into residential care had become permanent. This evaluation claimed to explore how the reimbursement policy was affecting people, a year on. This statement assumed, however, that positive (or negative) outcomes found in participants a year later from their admission were caused by the way their hospital discharge was planned twelve months before. Not only new hospital episodes but also the multiple services that they had been receiving in the community must have had an influence in

their present well-being. Neither of these two reports directly evaluated the specific role of the fines generating discharge outcomes.

Henwood (2004), in a discussion paper for the Integrated Care Network, considered the arguments around the introduction of the reimbursement scheme and then examined the implemented changes. She explains that the phased implementation of the policy had been helpful, and that the work of the Change Agent Team helped to overcome a number of early difficulties and that the policy as a whole has contributed to focus on delays. Later, the same author (Henwood, 2006a) analysed the Delayed Discharges Act as an example of effective partnership working. The paper argued that the apparent success in reducing delayed discharges numbers also delivered improved outcomes both for services and patients. However, months later the same author published a newspaper article with the subheading 'I'm an expert on the theory of health and social care for older people but it did not prepare me for the reality of my mother's treatment'. In this article, she explains how her mother was discharged home after hip surgery at short notice with no discussions with the patient or relatives and no discharge plans. Having to ring social services once her mother was at home and finding out that she had not been referred to rehabilitative or intermediate care services, she reports important administrative difficulties in obtaining help for bathing her mother. Henwood concludes:

'I had genuinely believed that routine hospital discharge practice was much improved in recent years, that there were fewer delays and more 'joining up' of health and social care. To find that the day-to-day reality for many patients is still so poor was at best disturbing, and at worst made me wonder about the point of all the research and policy development I've been engaged in over the past couple of decades' (Henwood, 2006b: 2).

The contrast between the policy theory and statistics and the 'day-to-day' reality of the patient and relatives experiences of fast discharges is clearly explained by Henwood's own personal contact with the programme. Despite her doubts, her previous research is still valuable but her remarks highlight the need for closer examination of the flows and blockages that the programme encounters, how staff resolve them and how this affects patients and their carers.

The Economic and Social Research Council funded an evaluation based on the use of mixed-methods: a survey of all social services departments to determine level of reimbursement, analysis of SitReps, and Hospital Episode Statistics data (Godden et al., 2007; McCoy et al., 2007a, McCoy et al., 2007b; McCoy et al., 2007c). The study also undertook a qualitative case study in two London Boroughs interviewing key stakeholders. Their findings showed that, in most cases, hospitals and social services chose to avoid the fines. Concerns over the validity of official data on delayed discharges, specifically the one collected from SitReps returns were reported. The authors concluded that 'further qualitative research would be required to look at the effect of financial incentives and cross-charging between the NHS and social services departments on hospital discharge practices' (McCoy et al., 2007c: 6). This research was a necessary account where quantitative data was complemented with qualitative information from stakeholder's perspectives.

The Department of Health commissioned a study (Baumann et al., 2007) before the announcement of the Delayed Discharges Act intending to fill the evidence gap regarding solutions to delays. To achieve this, the study analyses sites performing 'exceptionally well' with regards delayed discharges and it draws general knowledge from their practices. Six 'high performing' sites were selected, using a statistical model to shortlist authorities:

'The model used a range of data from 1998 to 2000 to predict rates of delays. The model found that population needs, social services expenditure, health resources, local wage rates and house prices explained around 20% of variation in rates. Those that performed best with respect to rates of delays, when these factors were held constant, were short-listed. Secondly, the authors examined rates of delays and emergency re-admissions data for these sites over a longer period (1998–2002) to ensure sustained high performance. To maximise the chances of selecting sites that were all-round high performers, these results were cross-referenced with joint review reports by health and social care inspectorates. Subsequently, star ratings and delayed discharge performance data for hospitals and PCTs within the short-listed authorities were examined to ensure that hospitals also performed well. Finally, the authors ensured that selected sites represented a mix of geographical locations and local authority types' (Baumann, et al. 2007: 297-298).

This comprehensive statistical model is, however, relying on statistical data prior to 2002, when the common definition of delays was issued and systematic recording for delayed discharges was standardised. The site selection therefore is based on some of

the conceptual assumptions described in Chapters One and Two. Interviews were held with health and social services staff to identify key features of their sites. Although interviews with patients were part of their research proposal, they reported unsuccessful efforts to recruit sufficient patients after contacting 164 people. Therefore, patients' accounts were not collected in their investigation. Key features of the sites were identified, suggesting that they had all addressed three relevant issues: capacity, internal hospital efficiencies and interagency efficiencies. The study concluded:

'The reimbursement scheme appears to have been largely helpful in the study sites, prompting efficiency-driven changes to the organisation of services and discharge systems, but further focused research is required to provide clear evidence of its impact nationally, and in particular, how it impacts on staff, and patients and their families' (Baumann et al., 2006: 295).

Based on organisational changes and outcomes, this study did not specifically concentrate on the innovations brought about by the Delayed Discharges Act. It did, however, include characteristics of the local areas and examined existing local organisational arrangements.

Another study commissioned by the Department of Health was a longitudinal multi-site project carried out in three hospitals in England and two hospitals in Scotland (Godfrey et al., 2008; Cornes et al., 2008). Two different approaches to tackling delayed discharges are compared in this research: the English reimbursement scheme and the Scottish Joint Action Planning adopted in 2002. Using a multi-method approach, researchers examined documents, observed meetings and practices and interviewed stakeholders, staff and service users and their carers. The contextual delimitations of discharge practices make comparative research of this type a difficult task. This study of the Delayed Discharges Act is the only one that has successfully incorporated the views of frail elderly patients about their discharge. It also offers a comprehensive analysis of some of the innovations brought in by the Act. However, the authors expressed their difficulty in drawing 'any clear conclusions about the role played by the 'stick' of reimbursement i.e. fines imposed on the local authority for reimbursable delays' (Godfrey et al., 2008: 39).

All these evaluations are small pieces of the puzzle that the Delayed Discharges Act represents. Each of them explains how the programme works from different perspectives. Some offer simple outcome measures concentrating on volume and time periods of discharge to measure efficiency. Others, using a greater range of methods, examine some of the organisational changes that occurred after implementation. The evaluation performed in this thesis presents a new onset from the previous ones. It tries to fill the gap for an evaluation that could explain how the financial incentives achieved the proposed changes. By concentrating more specifically on the role that the fines played in the successful outcomes and unintended consequences of the programme, certain features of the fines become more attainable. The challenge ahead is how to explain them and how to claim causality between the incentives and outcomes. In understanding this, it is necessary to accept the inability to separate some of the components of the programme.

Because of its micro-level approach, my research is located in one locality and it follows a small group of patients in detail. It does so in 'real time', whilst the programme is applied to them. The idea is to capture that 'day-to-day reality' that Henwood mentioned (Henwood, 2006b). As processes occur, accounts are collected from the key agents involved in their discharge, including the patients. Theories are built from all the other evaluations explained above and from the body of literature summarised in Chapter One and the first part of Chapter Two. Then these theories are tested and refined with the evidence collected from the case studies. Finally common general patterns are established that could inform the overall knowledge of how the use of fines to reduce delayed discharges could impact other social systems.

2.6 Summary

This chapter presented an initial theoretical background for the in-depth empirical work that followed. Starting with an overview of previous policy responses to deal with delayed discharges, the chapter progressed with a detailed analysis of 'delayed transfer of care' as a performance indicator. The reasons why a financial incentive was the chosen policy instrument for delayed discharges were explored, focusing on the relationship between Payment by Results and the Delayed Discharges Act. After reviewing the influence of previous similar programmes in the Nordic countries to the

one evaluated, the second part of this chapter provided an initial analysis of the theories of change brought about with the Act. Nine key innovations join the fines in their journey towards reducing delays. All were significant reforms alongside the financial incentives, and they need to be taken into consideration when assessing the success of the programme in reducing delays.

Finally, previous evaluations of the programme were explored, explaining briefly how they accumulated the knowledge to ground the theories examined in this research. Some of the features of my research were outlined, by way of a preview of the research design and methodology described in Chapter Three. In summary, with a thorough conceptualisation of the programme anatomy, the examination of the role of the fines may progress.

3. EVALUATION STRATEGY: METHODOLOGY AND METHODS

3.1 Introduction

Choices which underpin the design and conduct of the empirical work are presented in this chapter, with realist evaluation providing the broad logic of enquiry. Although, as a theory-driven study, methodological issues are present throughout the thesis, this section justifies the specific choices to explore how fines work to reduce delayed discharges. Initially, the research objectives and questions are explained. Since these questions are concerned with policy development and implementation, this study is identified as evaluative research. Then, the choice of a ‘theory-driven’ approach is proposed as the optimal method to establish how financial incentives operate to resolve the problem of delayed discharges. Many different methodological strategies may be used within the realist framework; case study research is the one employed here. This method helps to ascertain how the broad programme theory (‘fines reduce delayed discharges’) works in practice and to explore the local processes in which it is developed.

Issues pertaining to the sampling strategy are also discussed, identifying three levels of case study selection: ‘research site’, ‘relevant discharge events’ and ‘hospital patients’. The chapter goes on to describe the use of multiple methods of data collection in ‘real-time’, meaning that discharge planning activities are followed as they occur, observing them and then asking the actors to reflect on them. Participant observations, documentary analysis and qualitative interviews are the main techniques used to capture the immediacy of the decision-making processes.

An issue in this thesis is the ever-present challenge of how it is possible to generalise from limited case studies. Of note in this respect is the usage of the above methods within an attempt to extract middle-range generalisations, rather than in the more descriptive, interpretative approach in which qualitative methods are usually located.

The analytical strategy used to do so is described, focusing on how contextual differences and mechanisms to reduce delayed discharges are identified and generalisation constructed around these. Finally, the chapter turns attention to the process of gaining ethical approval from both the local NHS hospital and the local authority, reflecting separately on the main ethical issues underlying research with staff and patients.

3.2 A Focus on Programme Theory: Understanding How Financial Incentives Work

Delayed discharges are an issue surrounded by rival interpretations on how and why hospital delays occur and the way in which they are measured. A policy attempt to resolve the problem of delayed discharges is to fine social services departments for the delays caused by them. This system was implemented through a national strategy (The Community Care (Delayed Discharges etc.) Act) for all English local authorities in 2003. This thesis focuses on exploring one of the several innovations introduced with this Act: the fines. With that purpose, the empirical work was designed around unravelling the inner workings of the fines. Accepting that fines reduce delays, the question to answer is ‘how and why does it happen?’ To elucidate the internal dynamics of how programmes work, the main broad objectives of this research are:

- To elicit the theory in which the financial incentives are embedded and to compare that theory with the actual practice.
- To produce an analysis of the process and context in which financial incentives are applied.
- To explore how the financial incentives reduce the number of delayed transfers of care.
- To provide feedback that could contribute to the reduction of unwanted effects in the practice of the policy and highlight areas of uncertainty.

Specifically, this enquiry aims to explore the course of action in which fines are issued in a specific location. The combination of underlying programme mechanisms and contexts generate outcome patterns that help answer the question ‘why does the programme work in here?’ The main research question becomes ‘How do fines

actually work to reduce delays?', which is then broken down in two specific questions:

- How do fines reduce the numbers of delayed transfers of care?
- How do fines influence the practice of hospital discharge planning?

The organised efforts to intervene (with fines) for the purposes of solving a problem (delayed discharges) are assessed with these questions (Chen, 1990). Consequently, the research questions that this thesis seeks to answer are evaluative questions. Evaluation research utilises many of the strategies and techniques used in traditional social research with the distinction that evaluation takes place within a political and organisational context. For the purposes of this research, evaluation is considered:

‘the systematic assessment of the operation and/or the outcomes of a program or policy, compared to a set of explicit or implicit standards, as a means of contributing to the improvement of the program or policy’ (Weiss, 1998: 4).

Approaches to evaluation differ in their objectives and their use of methods and theory. Theory-driven as opposed to method-driven perspectives have as a central argument that programme theory has to be integrated into evaluation processes and that programme evaluation should not be perceived as a range of data collection techniques. ‘Programme theory’ is generally defined as ‘a set of interrelated assumptions, principles, and/or propositions to explain or guide social actions’ (Chen, 1990: 40). The unravelling of these theoretical premises is necessary to understand how programmes are working, through the examination of the linkages between the intervention and the results.

3.3 Realist Strategy to Evaluate a Multi-Agency Programme

In the Delayed Discharges Act, the complexity of the hospital discharge planning is handled with the implementation of a multi-agency programme involving both acute hospitals and social services departments. This situation poses several evaluation and methodological challenges. El Ansari et al. (2001) explain the complexity of evaluating multi-agent programmes since ‘its enquiries will exhibit similar features and will have different meanings for each and every participant group. Each

constituency will want to ask different questions about whether, how and why it works' (p.223). The challenge of this evaluation thus is to grasp the complexity of a collaborative scheme that deals with objectives for two organisations which, although they may have the same long-term goals, in practice have very diverse immediate aims. Judge et al. (1999) note that traditional evaluation approaches could fail to reflect the complexities of collaborative government, arguing instead for the adoption of methodologies based on models of 'realistic evaluation' (Pawson and Tilley, 1997) and 'theories of change' (Connell et al., 1995).

In the area of policy evaluation, Pawson and Tilley have developed a set of methodological principles to evaluate programmes following the realist strategy to research (Pawson and Tilley, 1997; Pawson, 2002; Pawson et al., 2005). These principles are based on the 'theory-driven' (Chen and Rossi, 1980; Chen, 1990) or 'theory based' (Weiss, 1997) approaches but rooted in the tradition of scientific realism, concerning the nature and operation of causal forces in the social world. These are assessed through configurations of contexts, mechanisms and outcomes. The real (mechanisms), the causal (events which may or may not be observable) and the empirical (evidence of experiences and observable events) are elicited with the objective of describing the relationship, if any, between them.

The use of a realist research strategy seeks to unravel most of the complex relationships between national and local policy contexts and the organisational dynamics that characterise multi-agency initiatives. Theory-led evaluations have recently become increasingly popular approaches to partnership evaluations in an attempt to open up the 'black box' of evaluation, and so be able to attribute outcomes to specific processes (Dickinson, 2006). However, some authors (Barnes et al., 2003) dispute whether approaches based on the realist paradigm can embrace the contested meanings amongst multiple actors and dismiss the contribution that social constructivism can make to theory and the notion of the existence of multiple kinds of knowledge. This criticism was countered by the later development of the realist synthesis methodology (Pawson, 2006a) which in turn has been criticised for accepting as valid too many sources of knowledge (Van der Knapp et al., 2008).

This thesis joins that debate in a practical way and supports an approach based on the inspection for/of theories of change to understand which ideas work for whom, in what circumstances and why. The separation of mechanisms from contexts is a key contribution of the realistic methodology that informs this study. The Delayed Discharges programme was launched through national guidance but with enough laxity for local authorities to adapt their implementation to local circumstances. With rates and reasons for delayed transfers of care showing great local variation, the possibility of realising an analytical separation of context, helps understand the interlinkages between programme theory and local circumstances. The choice of the theory-oriented perspective is an overt attempt to be sensitive to the political, historical and organisational contexts where the programme is implemented. Glendinning (2002) provides support for the idea of isolating contextual circumstances when dealing with joint programmes between health and social care agencies:

‘Because of the wide application of the term ‘partnership’, local priorities and interests are likely to shape the organisational framework of any partnership, the objectives of the partnership, and the ways in which the partner organisations set out to achieve these objectives’ (p.118).

The ‘histories of past encounters’ will affect the partnership objectives and associated implementation strategies (Glendinning, 2002) and therefore, these should be revealed and analysed. Nevertheless, the concept of ‘context’ as it is applied by Pawson and Tilley has been criticised as difficult to conceptualise (Calnan and Ferlie, 2003) or under-conceptualised (Dahler-Larsen, 2001). Other authors report difficulties in differentiating contexts from mechanisms (Byng et al., 2005) and some propose further developed solutions (Dickinson, 2006). The underlying theme in all these critiques is the insufficient conceptualisation of the three components of the equation (contexts, mechanisms and outcomes). Chapter Eight engages with this debate and shows how these components are not fixed entities trapped in methodological cages. In other words, elements that are called contexts, mechanisms or outcomes, in one combination, can be reconfigured in the next one, because their role is interchangeable as health systems mature and evolve. A process referred to by Archer (1998) as ‘morphogenesis’.

3.4 Case Study Research

To map the programme theory in which programme outcomes develop, case study methods are used including a combination of both within-case analysis and comparisons across a small number of cases. A careful examination of the contextual factors of the research site is a parallel step because comparisons need to be 'contextualised' (George and Bennett, 2005). The use of case study field investigations has been recommended for the evaluation of partnership programmes in contrast to using more traditional methodologies (Gray et al., 2003). In the case of delayed discharges policy, an advantage of this approach is their ability to accommodate complex causal relations. Case study research investigates a phenomenon in a natural setting when the boundaries between the phenomenon and its context are not clear, using multiple sources of evidence (Yin, 1994).

Hammersley (1992) formulates the following definition of 'case study':

'What I mean by the term 'case' here is the phenomenon (located in space/time) about which data are collected and/or analysed, and that corresponds to the type of phenomena to which the main claims of a study relate. Examples of cases can range from micro to macro, all the way from an individual person through a particular event, social situation, organisation or institution, to a national society or international social system' (p. 184).

Goode and Hatt (1953) regard case studies as a way of organising social data which have as its focus a single social unit. If that social unit is a person, the focal point of data can be a set of relationships or processes which are relevant to the problem being investigated. George and Bennett (2005) reinforce the need of clearly defining the events, situations or interactions that the cases constituted. In this thesis, three major selections are made that represent three different levels in which case study strategy is used:

- a) A single case study. The focal point is located in one setting: an acute hospital.
- b) A few case studies in the form of events and interactions related to the process of hospital discharge are analysed, selecting a number of organisational meetings where decisions about discharge take place.

- c) Multiple individual case studies consisting on observing the discharge pathways of fourteen hospital patients. These processes are defined within the time period comprising when a referral is sent to social services for an acute patient and finishing when that person leaves the hospital.

These three levels of case study selection are explained in the following three subsections focusing on the reasons why these choices were made.

3.4.1 Selection of the Research Site

A purposive (also called 'theoretical') approach was adopted in the selection of the research site. This type of approach intentionally chooses settings where the processes under study are more prevalent (Silverman, 2001). The acute hospital selected had a poor rate of delayed discharges when the programme was implemented, hence its selection but, it must also be conceded that the site selection had an element of convenience. In a previous occupation, I taught the practicalities of the Delayed Discharges Act in this locality, and I was employed by the local authority delivering multi-agency training to hospital and social care staff. This role was assumed to facilitate access for the two key institutions involved: the social services department and the acute hospital itself.

Evaluation approaches tend to be described as dichotomies: internal-external or 'in-house/ out-house'. These distinctions are based on whether people in or outside the programme collect the evaluation data themselves. Commentators criticise this dichotomy in terms of advantages and disadvantages and talk about the feasibility of combining both approaches (Patton, 1982). However, evaluators' circumstances cannot always be easily conceptualised as either 'inside' or 'outside' the institutions or programmes they are going to evaluate. According to Elias (1956), people have a capacity for greater or lesser detachment and involvement and this varies on a continuum depending on the situation and on the individual. In my case, with a hospital social work background and extensive experience as a discharge planning practitioner, I described my condition in the field as an 'ex-insider': no longer working for the institution but being acknowledged by staff as 'one of them'. This meant that more than being perceived as somebody from either social services or the

NHS, I was identified as somebody who has worked for a local public sector institution. Weiss (1998) described the advantages of evaluations performed by insiders on the grounds that:

‘knowledge of what is going on in the program is vital for evaluation staff. They need to know both the real issues facing the agency and the real events that are taking place in the program if their evaluation is to be relevant. It is here that in-house staff chalk up points. Because they usually sit close to the action, they are likely to hear a great deal about what goes on. They hear the gossip, they know quickly about any cataclysmic event, and they see the faces of clients and staff’ (p. 38).

This was exemplified during one of the team meeting observations, when a doctor stopped the meeting I was observing and said that she was worried that I could be writing down her words ‘literally’. Before I could start to reply, the care manager attending the meeting (an ex-colleague) came to my defence and explained to the doctor that she should not ‘worry’ about me and that I would not report her exact words in a hostile manner. Her comment calmed the doctor down and the meeting proceeded as normal.

These advantages need to be balanced against potential detrimental factors like insiders being more likely to take positions when caught in the middle of tensions between competing groups and perspectives. In this respect, Patton suggests that ‘it is impractical to expect to have the same kind of relationship -close or distant- with every group or faction. Fieldworkers, human beings with their own personalities and interests, will be naturally attracted to some people more than others’ (Patton, 2002: 319). Conversely, outsiders are able to exercise more autonomy and take a wider perspective. As an ex-insider I was able both to ‘sit close to the action’ as Weiss described it but, because I was no longer employed by the institution, this helped build up some distance from the programme and participants.

3.4.2 Sampling Relevant Discharge Events

Within the hospital, two wards were selected for the fieldwork: one medical, the other surgical. The theoretical sense behind this purposive sampling was to look at the challenges that patients with different illnesses represent for the programme, assuming as a simple starting point that the surgical ward would deal with less complex cases than the medical one. Several formal and informal meetings took place with key local stakeholders to discuss the most adequate wards. The eligibility criteria were to include wards where discharge planning practice was considered adequate and where routine multidisciplinary team meetings were taking place. This decision followed the rationale that wards with low incidence of delayed discharges would have in place more mechanisms to reduce delays. Although it is not possible to estimate population parameters using a non-probability sample, it was decided to work towards achieving the same number of cases in each ward to facilitate comparisons. Because data collection could potentially yield information that was both institutionally and personally sensitive, it was decided not to name the hospital and local authority where the fieldwork took place.

Detailing the sequence of events leading to patients discharge (process mapping or process tracing) is primarily concerned with the need to ascertain the internal dynamics of the scheme that allows for the number of delayed discharges to be reduced. It is not possible, however, to follow every minute of process carried out in patients' discharge planning and map a precise copy of the reality. Therefore, another selection is made of significant events where key actions occurred. In the medical ward, each consultant leads a weekly multidisciplinary meeting (MDT) where his/ her patients' progress and discharge plans are discussed. Two out of the three MDTs held in this ward were chosen for their convenience (avoiding time overlaps). In the surgical ward, there is only one MDT where all patients are discussed. It is nurse-led and consultants do not attend. This meeting was observed weekly while the research participants were admitted in the ward and their progress and discharge plans were discussed in them.

Finally, twice a week social services management and the discharge liaison officers meet to discuss all delays and it is in this meeting (called 'SitReps meeting') where fines are discussed and agreed. One day a week, the meeting was observed while the participants were admitted in hospital until the week they left.

3.4.3 *Sampling Hospital Patients*

This evaluation intended to deliver findings on the inner workings of the fines that could be generalisable and for that reason tried to select cases that covered the whole range of programme participants. The use of non-probability purposive sampling permits the selection of case studies based on the judgement about the extent to which they represent a population or a significant group of people (Blaikie, 2000). Statistical sampling was discarded because a probabilistic sample could never be representative of the larger population of programme participants. The main reasons being that this policy only applies to a relatively small number of patients with 'unmet' social needs (McCoy et al., 2007a) and the complexity and interpretation of such a definition would make the probabilistic sampling impossible. In other words, random sampling could never identify the variation of programme participants because the intervention has unexpected processes that cannot be predicted *a priori* for statistical purposes.

At the level of individual patients, fourteen case studies documenting outcomes were pursued. Purposive sampling can be based on different criteria and of these, the need to 'maximize variability so as to discover whether the program succeeds across a whole spectrum of sites' (Weiss, 1998: 164) drove the sampling of participants. Cases were discussed with ward managers, discharge liaison officers and social services staff to make sure they would help the development of working theories about the fines. In addition, general criteria for participant inclusion mirrored those set out in the Community Care (Delayed Discharges etc.) Act 2003. These are:

- Patients receiving acute care.
- Over 18 years of age.
- A notification of /referral to social services has been formally issued (Section 2 form faxed and acknowledged).

Although sampling was informed by theoretical considerations, it was, however, also framed by the practical difficulties of sampling delayed discharges. One of the reasons to use purposive sampling is to deal with situations where it is complicated to identify the targeted population. This sampling strategy proved difficult to implement. Patton explains how:

‘the logic and power of purposeful sampling lie in selecting information-rich cases for study in depth. Information-rich cases are those from which one can learn a great deal about issues of central importance to the purpose of the inquiry’ (Patton, 2002:230).

The assumption here is that an information-rich case can be selected *a priori*. The original evaluation design intended to recruit the patients referred to social services as they first entered the system, to avoid self-selection and the self-prescription that could threaten the inspection of programme theories. Unlike other similar studies which sampled cases already categorised as delays by the hospital (Godfrey et al., 2008), my rationale was that, to explore how fines operate, cases need to be observed from the start of social services input, when nobody knows if they are going to be delays or not. If fines work to reduce delayed discharges, by excluding the patients who are not delayed, the opportunity to observe how they manage to succeed could be missed.

Following the assumption that patients’ progress through hospital in a linear way, the empirical design followed the programme theory. This is: patients are referred to social services (Section 2), then discharge notices are sent (Section 5) and then patients get discharged, sooner or later. However, as Strauss et al. (1985) explained, multiple unpredictable contingencies happen to acute patients, diverting cases from that linear model. Consequently, numerous possible participants were ‘lost in contingencies’. After Section 2s were sent, cases disappeared from the ward because they were transferred to other wards, intensive care, discharged without social services involvement or they died. Effectively, not everybody referred to social services, ended up being actively managed by them. This process of sampling, while exhausting and frustrating, is a useful exemplification of the pathways that the programme documentation follows when confronted with acutely ill patients. Withdrawals of Section 2s forms were frequent and patients were leaving the wards or

the hospital without staff being informed. Accordingly, some attempts to further refine the sampling to focus on working hypotheses were unsuccessful. The lesson learned here is that, when sampling for hospital delayed discharges, researchers are not always in control over choosing a theory-driven sample due to the practical difficulties in accessing the ideal desired population.

Buchanan et al. (1988: 54) stated that when negotiating organisational access 'in the conflict between the desirable and the possible, the possible always win'. The inability to recruit participants with mental health needs was further confirmation of the lack of control over theoretical sampling. Ward staff reluctance about consent frustrated continuous attempts to approach these patients. Therefore, the study could not analyse how the process works with this particular population. Recent studies share the difficulty of drawing specific attention to this population (Glasby and Lester, 2004) and, since the Government plans to extend this programme to mental health inpatient services, the importance of studying the impact of the introduction of fines for people with mental health illnesses is significant.

In summary, the gate-keeping role of staff combined with the unpredictability of discharge processes for acutely ill people transformed the sampling strategy into 'quasi-purposive'. The sample obtained, however, was still informed by theoretical considerations but it was also limited by accessibility issues.

3.5 Multiple Methods for Data Collection in Real-Time Research

The Delayed Discharges Act had been in place for three years when the fieldwork took place. To explore how the fines function, the research design intends to study the social activity as it occurs, observing it and then asking the actors to reflect on it. Researching 'patients discharges' in real-time is a choice made following the notion that unplanned contingencies continuously impact on discharge processes and have the effect of changing their direction. In real-time methods, information on how the fines work is experienced firsthand by the researcher, not as an ethnographer gaining insight into individual meanings and interpretations but as an observer trying to interpret the mechanisms perceived, with the help of the main actors. In other words, although sharing the same data collection methods as ethnography, the focus of the

present study is to understand patterns so as to produce generalisable information that could inform future programmes.

The strengths and weaknesses of the use of qualitative methods versus quantitative have been examined extensively in the research literature (Sayer, 1992; Mason, 2002). The selection of multiple qualitative methods to study the inner workings of the fines supports the position that ‘when a program reaches the stage that it is appropriate to discuss and assess impacts, qualitative research provides a window on the program that is simply not available in any other way’ (Rist, 2003: 632). A qualitative approach is deemed to help in the identification of contextually-grounded explanatory mechanisms which could be difficult to obtain using only quantitative methods (Sayer, 1992). The main methods of generating qualitative data employed in this thesis are observations and interviews; with policy related documents also being used as tools to refine theories. The observations took place in the natural setting with meetings that are part of everyday discharges processes being observed. The semi-structured interviews were conducted in a semi-natural setting, a few days later, when staff were asked to reflect on the processes observed affecting particular cases. Blaikie (2000) clarified the distinction between these two research settings:

‘Research conducted in a *natural setting* involves the researcher entering an area of social activity and studying people going about their everyday lives. In a *semi-natural setting*, individuals are asked to report on their activities that occur in natural settings, while an *artificial setting*, social activity is contrived for experimental or learning purposes’ (p.187).

The combination of diverse research environments offers the benefit of contrasting perceptions of staff from institutions with competing interests. Observations and interviewing focus on different levels of analysis and tend to produce different types of findings (Gerson and Horowitz, 2002). In this thesis, however, they are not conceptualised as two completely separate methods. While presented here as individual sections, observations and interviews are related to each other in various aspects. During fieldwork, the researcher arrived to the interviews as somebody who had observed the meetings and was knowledgeable of what happened in the natural setting. Interviewees also knew that the researcher would enquire about the same phenomena to other staff who may have competing perspectives. Patton (2002)

described this situation as interviews filling in the gaps of knowledge missed by other research methods, in particular part-time observations:

'The interviews appear in retrospect to have been a necessary tool of the part-time observer. Bit by bit team members filled in holes in my information and their repeated references to particular situations and conditions reinforced for me what were sometimes at best only vague perceptions.[...] The interviews also helped me become aware of misconceptions on my part caused by seeing only part of the picture, due to time constraints'(p. 317).

This 'gap-filling' feature is, however, as significant for the observations. Both methods complement each other because data collection and reflection does not follow a sequential order. Theories constructed in the interviews were refined against the observational data and vice versa, both methods having a 'conceptual refinement function' (Pawson and Tilley, 1997: 167).

Finally, central to real-time methods for hospital patients is the contention that, if interviewed retrospectively, participants not always remember discharge planning as a separate event in their hospital admissions (Manzano-Santaella, 2005). Acute patients' accounts of their discharge planning have been previously described as unfocused and not presenting a coherent picture of events' (Pearson et al., 2004). So as to overcome this difficulty, where possible, interviews with patients took place while the process of discharge planning was still happening. Many acute patients are very frail and some may have communication difficulties and the immediacy of the events helped patients recall conversations and thoughts. The possibility of identifying staff by their own names in the interviews, of mentioning days of the week and times of the day when key events have taken place, helps with the data collection because respondents are asked to reconstruct from immediate short-term memories in many cases, recall a few hours before.

In summary, understanding patients' organisational environment creates opportunities for obtaining an insight into how patients are experiencing their present situations, reflecting on the anxieties and uncertainties about their impending discharges. The presence of the researcher in this setting, from the initial conversation to obtain consent, to the casual greeting when speaking to other patients, to the last interview a day before they leave the ward 'qualified' the researcher as an 'insider' of the

institution and of their personal circumstances. Older people have been reported to be passive in relation to discharge planning and exhibit apparent willingness to accept arrangements made by others (Social Care Institute for Excellence, 2006). Real-time research offers the possibility to examine how institutions involve patients in their discharge taking into account contextual organisational and personal circumstances. However, this methodology proved an extremely difficult task. I learned that fast discharge practices require a fast and flexible evaluator. The narratives of the case studies in Chapter Seven described how discharge dates were not always planned in advanced and people were given on some occasions a few hours warning before they departed. Accordingly, some patients' interviews had to be arranged at the weekend, in the evenings and in a few cases, days after being discharged.

3.5.1 Case Recording and Data Management

The process of following case studies through their hospital discharge planning generates multiple sources of evidence in different time periods. The practical consequence of investigating each case within its real-life context is that data emerged from formalised observations and interviews but also, spontaneously, from comparison with other cases, casual comments or participant willingness to provide more information once people had already been discharged from hospital. The need to organise the material by patient and not only chronologically is addressed by inputting the data by case using a tailor made database designed with the software FileMaker Pro9. This system of recording and information management is a strategy designed to respond to one of the major criticisms of case studies: the production of unmanageable amounts of data.

Although this criticism tends to be based on the confusion between case study methodology and ethnography in general (Blaikie, 2000: 218), it does highlight the challenge of organising case study data in a manageable manner. The system also facilitates the location of the many kinds of evidence identified in the case study process, thus helping with the principle of transparency in presenting data for detailed analysis. Table 3.1 is an example of the way in which activities were systematically recorded for individual cases. Firstly, all cases were numbered following the time sequence in which they were initially sampled. Then, field notes were dissected case

by case, transferring relevant sections of information to the patient file, dating it, classifying it by activity type and identifying the informant who provided it. This system produced an amount of 'leftover' data on the process and practice of data collection in general. These data were used at the end of the theory building process to further refine the findings and to examine and reflect on the methodological approach.

Table 3.1: Example of Systematic Case Study Data Recording















Patient no: 3				
				
Activity no	Date	Who	Type	
 3	28/11/2006	Pt	inf.conversation	
 23	28/11/2006	SS	inf.conversation	
 24	28/11/2006	OT	inf.conversation	
 25	30/11/2006	SS	inf.conversation	
 26	30/11/2006	MDT	Observation	
 35	04/12/2006	SS	T/C	
 36	05/12/2006	Pt	Interview	
 37	08/12/2006	DL	inf.conversation	
 41	12/12/2006	SS	T/C	
 56	21/12/2006	SS	T/C	
 89	25/01/2007	SS	Interview	
 185	12/12/2006	DL	Interview	

Table Abbreviations: Pt (patient), SS (social services staff), OT (occupational therapist), MDT (multidisciplinary team meeting), DL (discharge liaison officer), inf. (informal), T/ C (telephone call).

Once the data were sorted and ordered, the activities performed by case could be extracted for analytical purposes. Table 3.2 shows the number of activities per case, focusing on the semi-structured interviews and the observations. The total amount of semi-structured interviews was 39; participant observations 73; but there were also 93 activities during fieldwork which included informal observations and conversations, telephone calls, access to medical notes and emails.

Table 3.2: Activities per Case

CASE	SEMI-STRUCTURED INTERVIEWS	PARTICIPANT OBSERVATIONS	OTHER ACTIVITIES	TOTAL ACTIVITIES
CASE 1	2	1	8	11
CASE 2	3	13	8	24
CASE 3	3	1	8	12
CASE 4	3	13	10	26
CASE 5	3	4	3	10
CASE 6	3	6	2	11
CASE 7	3	2	5	10
CASE 8	3	8	8	19
CASE 9	3	9	9	21
CASE 10	2	4	4	10
CASE 11	3	7	5	15
CASE 12	3	2	6	11
CASE 13	3	2	6	11
CASE 14	2	1	11	14
TOTAL	39	73	93	205

Of the 39 interviews, 13 were with patients, 12 with hospital staff and 14 with social services staff. The formal participant observations were divided in two settings: 37 multidisciplinary team meetings and 36 SitReps (management) meetings. Interview transcripts were transcribed verbatim (See Appendix for an example) and observations and other activities were also transcribed with added reflexive comments, which were an initial 'on site' attempt to codify data as possible mechanisms, context and outcomes. The initial hypotheses were then confirmed, modified or abandoned with the post-fieldwork analysis.

3.5.2 Participant Observations and Documentary Analysis

Participant observation has been defined as ‘the circumstance of being in or around an on-going social setting for the purpose of making a qualitative analysis of that setting’ (Lofland and Lofland, 1971: 93). This refers implicitly to the fact that multiple data collection strategies are used simultaneously while experiencing being ‘in or around’ the setting. The decision to undertake participant observations was based on the premise that social relations in fieldwork are more complex than those accounts that could be recalled in interviews. This is particularly relevant for the study of the Delayed Discharges programme because it involves staff from two institutions with conflicting interests.

Immersion in the field was partial with structured participant observations of planned programme activities. These normally occurred three days a week, in the formal settings of two MDT meetings and one SitReps meeting. The original research proposal intended to include ‘social services patients’ assessments’ as another observational setting. The researcher would be present while social services staff discussed discharge options with patients. When in the initial discussions with a ward manager about my research methods, I explained that I was going to observe ‘social services assessments’; she laughed and said ‘You’ll have to observe telephone calls!!’ This prediction was right and, although some of the care managers did see the patients in hospital, their visits were limited or reduced to conversations with relatives. When they did visit the patients, meetings were arranged spontaneously and at short notice, which made it very difficult to observe because immersion in the field was only partial. It soon became obvious in the first two case studies that it was impossible to use the observation of these assessments as a standardised method for all the cases and this method was discarded.

Patton explained that for evaluators the field is the programme being studied (Patton, 2002: 262) and, on this basis, several unplanned informal observations occurred. They were events that took place between and around the selected programme activities: ‘Observations can be informal, too, embodying a look-around-and-see perspective. The evaluator watches the implementation of the program in a variety of settings over

a period of time. She takes notes and records what she sees' (Weiss, 1998: 153). Informal interviews and informal observations were all part of this 'being around', gathering information in order to secure understanding of how the programme operated from as many angles as possible.

Participant observation occurs in the natural setting and gaining entry into that setting is part of that process. Patton (2002:311) differentiated between the entry process in sociological research and the entry process for evaluation purposes because of the negative connotations that the word 'evaluation' have for many people. Participation can be seen as a way of establishing rapport (Bogdewic, 1992) and it is clear that this method demands some sort of ongoing relationship between the researcher and the people being studied. During fieldwork, in the observations, informal access had to be negotiated for two different meetings with different staff from health and social care agencies. Gerson and Horowitz (2002) clarified that 'unlike interviews, which are short term and private, participant-observation involves a web of relationships that, like any set of relationships, involves negotiation and change' (p. 213). In a way, informal access had to be re-negotiated weekly because, although the key people attending meetings tended to be the same, new staff were frequently joining in (Humphrey et al., 2003).

Finally, in terms of documentary analysis, several documents of varying status were used as sources of data: institutional annual reports and accounts, minutes of board meetings, census and Government statistical data, records of performance assessments, inspections reports, national and local programme guidance, press releases, etc. These documents are in the public domain and are widely accessible on the internet. Patton explained (2002) that:

'in contemporary society, all kinds of entities leave a trail of paper and artefacts, a kind of spoor that can be mined as part of fieldwork [...] Organizations of all kinds produce mountains of records, both public and private. Indeed, an often intriguing form of analysis involves comparing, official statements found in public documents (brochures, board minutes, annual reports) with private memos and what the evaluation observer actually hears or sees occurring in the program' (p. 293).

Documents were not analysed systematically in search for general themes or cross-comparisons. Following a pragmatic approach, they were used instead as tools to ascertain or/and refine theories. This was a valuable method in the detailed examination of the contextual factors embedding the research site but it was equally important for the development of the programme theory key to the whole process of analysis.

3.5.3 Qualitative Interviews

The different players in the Delayed Discharges programme were identified in the literature review and three main stakeholders were selected for the interviews: patients, social services care coordinators and hospital discharge coordinators. These individuals were considered, on the grounds that they are the ones with more quality information regarding the underlying programme theory. Because practitioners translate programme theories into practice, evaluation of partnership programmes needs to accommodate the multiplicity of aims and the diversity and variety of stakeholder and beneficiary groups (Thomas and Palfrey, 1996). There are, however, a larger number of professionals involved in discharge planning during post hospitalisation. This research excluded community health and social care staff i.e. GPs, district nurses, homecare, etc. because they do not tend to be involved in the hospital discharge planning process whilst it is happening. They are, however, recipients of the consequences of the work done in hospital and frequently see themselves as ‘picking up the pieces’ following discharge (Pearson et al., 2004).

Interviews were semi-structured, containing exploratory questions based on the individual cases but acting as instruments to draw out the themes of the general inquiry. Three different topic guides were devised for each group of interviewees. The topics covered reflected the objectives of the study as a whole, and concerned the provision of information around care services, specific care arrangements, and other relevant process issues. They were designed around patients’ awareness and experiences of assessment and discharge planning, including the extent of their involvement in these processes. Conversations with staff were guided with the help of the specificities of the individual cases, and from there, they were directed into the general use of fines. ‘On the theory-driven model the researcher’s theory is the subject

matter of the interview, and the subject is there to confirm or falsify and, above all, to refine that theory' (Pawson, 1996: 209). The following extract from an interview in Case 3 illustrates how in the fieldwork, individual cases were used as prompts to redefine general programme theories:

'Researcher: Why do you think it was a nursing home the chosen destination for Mr Catford? Do you think he could have gone to...?

Discharge liaison nurse: Do I think he would have gone to...his own home?

Researcher: His own home, instead of a nursing home. And I am saying this because one of the theories about this policy is that it is sending people into...

Discharge liaison nurse: Into care...

Researcher: ...Into care homes too soon. Right?

Discharge liaison nurse: Umm, ummm...I think at the time he could have been managed with a care package, which it would have had to be quite a big package...Say three times in the day say.... Three to four and once in the night time. I think, what's triggered it for him, is that he'd been in hospital for a long time and he was scared about being on his own. Plus he had some medical issues which needed monitoring. And I think, possibly, it was peace of mind (the reason why he was transferred into care)' (Interview with discharge liaison nurse, Case 3).

In this case, the researcher was trying to explore the mechanism to transfer people into long-term care to avoid fines and the interviewee refined it, adding that patients consider care homes a safer option after a period of acute illness. As the example showed, theories are identified by their own names and exposed to the interviewees, using their expertise as tools for hypotheses refinement. Then, as the number of cases cumulates, comparisons are made with all participants and with data generated by observations. In the realistic approach, although stakeholders are not key members of the evaluation team, they play an important role in the development of theories. Not as mere 'researcher's subjects' (Patton, 1999) but as key informants with the power of their knowledge about how the programme is really operating.

Interviews also occurred in less formal situations in the form of conversations about the programme occurring in more casual settings. These informal conversations complemented the theory refinement feature of the interview method. Wallen and Fraenkel (2001) explained that:

'Informal interviews are much less formal than structured or semi-structured interviews. They tend to resemble casual conversations, pursuing the interests of

both the researcher and the respondent in turn. They are the most common type of interview in qualitative research. They do not involve any specific type or sequence of questions or any particular form of questioning. The primary intent of an informal interview is to find out what people think and how the views of one individual compare with those of another' (p.441).

The strength of casual conversation method is that 'it allows the interviewer to be highly responsive to individual differences and situational changes. Questions can be individualized to establish in-depth communication with the person being interviewed and to make use of the immediate surroundings and situation to increase the concreteness and immediacy of the interview questions and responses' (Patton, 1982: 162). The weakness of this type of interview is the risk of imposing interpretations on the situation by the structure of the questions. However, when this method is combined with others, this risk can be overcome by triangulation.

3.6 Analytical Strategy: Generalisation From a Reduced Number of Cases

This study confronts the challenge to establish generalisation from a small number of case studies while evaluating a complex programme; it cannot, however, be considered a 'one-off' project because it is built from learning about previous studies. The Delayed Discharges Act is a national initiative inspired in a broad programme theory ('fines work to reduce delayed discharges') designed and used somewhere else before (Scandinavian countries) and at the same time in every single English local authority. Consequently, this locally transformed programme theory is tested overtime and worldwide locations and each of those local designs are testing exercises from which lessons are learned. Evaluations of those local programmes are also performed at different times and spaces. Some of them are able to evaluate the theory in a variety of sites (spaces) or longitudinally (times). Others, like this one, can only reach a small amount of data in a specific location but it stills feeds from all the others evaluation schemes.

This knowledge construction process is illustrated in Figure 3.1. The core programme theory is defined by two perpendicular directed lines (the x-axis and the y-axis). These represent the coordinates 'time' and 'space' in which evaluations occur across diverse locations and at different times of programme implementation. The shaded

rectangle frames the instrumentation of programme theory into a programme. Evaluation studies (illustrated with grey circles) are in single or multiple locations and in one or several periods of time. The present evaluation (highlighted in a bold circle) is not marooned in singular description because it uses the knowledge gained from all the other studies. Consequently, the findings from this local implementation will state something about the broad programme theory ('fines work to reduce delayed discharges') as a general theory of change, thus, a number of transferable lessons can be learned from everybody and for everybody.

Figure 3.1: Evaluative Research in Adaptive Systems

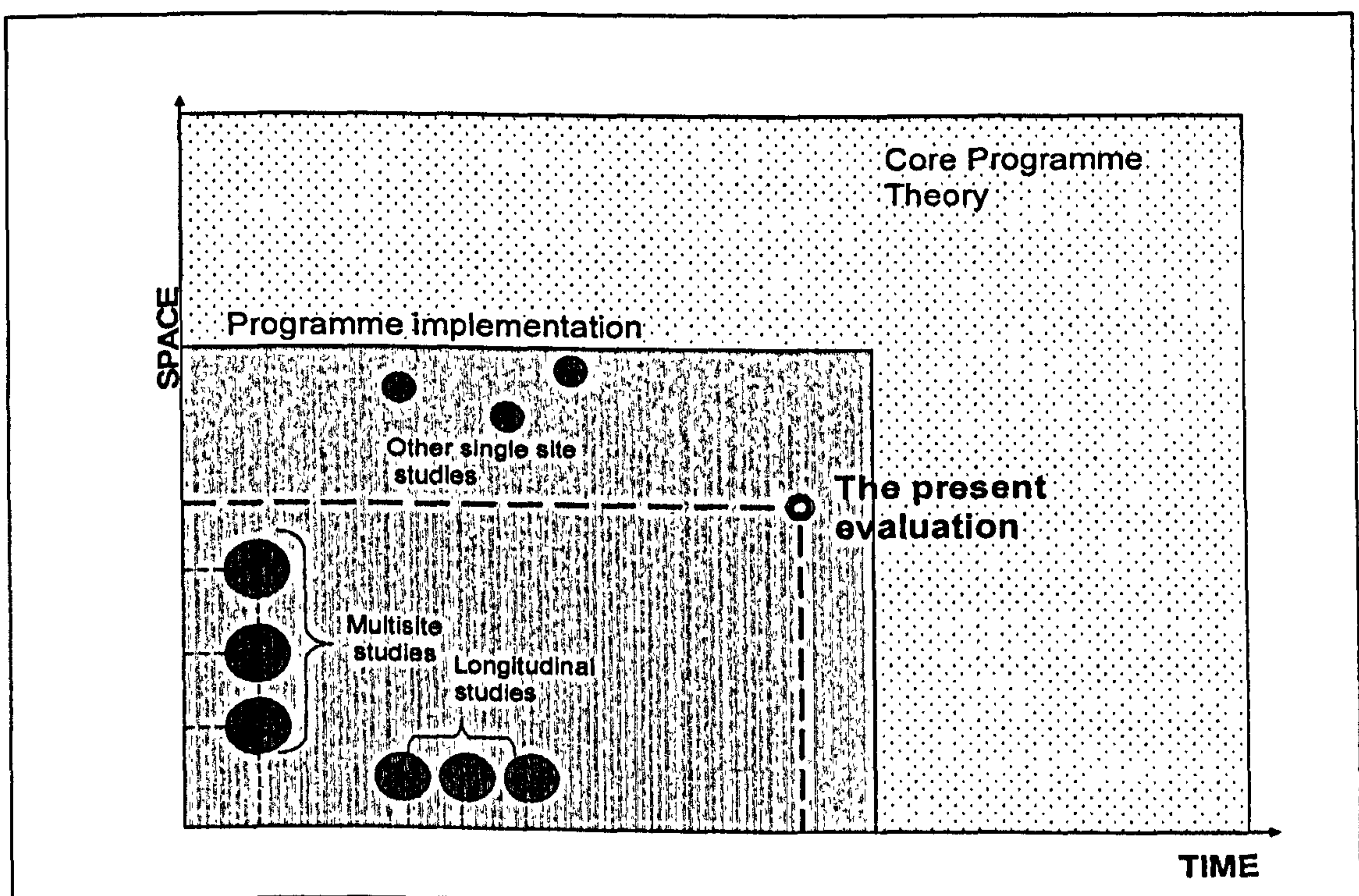

The question here is how can all this previous knowledge be accumulated and brought to bear on the investigated; how can it be 'banked' to assist the process of creating generalisable findings? The answer is that the analytic strategy intends to work through programme complexity examining data at different levels (macro-meso-micro). Surfacing the local design of the programme theory is a first step (Chapter Four) that builds from the literature review on the problem (delayed discharges) and attempts to solve it (Chapter One); while performing at the same time, a detailed examination of the national policy (The Community Care (Delayed Discharges etc.) Act 2003) described in Chapter Two. The assessment of the contextual framework of

the research site educates the analysis of the key macro and meso structures influencing the programme (Chapter Five). The micro and the meso-levels of analysis extracted with the help of the fourteen case studies help the interpretation of the mechanisms used locally to avoid the fines. Then, these are compared with other similar mechanisms used elsewhere (Chapter Six and Seven). Afterwards, secondary readjustments to all these working hypothesis are made (Chapter Six and Eight) to finally abstract some middle range propositions applicable to any future implementations of the same programme theory (Chapters Eight and Chapter Nine).

More specifically, the banking of the data extracted from contextual circumstances is described in Figure 3.2. Although the implementation evaluated here has unique local circumstances, this will be the case in any other location. The task embarked on is to explore how different contextual challenges enhance or weaken the basic programme theory. In Figure 3.2, outcomes of other evaluations are defined by 'contexts', which can be located at the macro or meso-level of the programme. For instance, the case study that experienced the longest delay in the sample (Case 4) has a significant micro-contextual characteristic. The patient needed re-housing in a council property to be able to leave the hospital. Consequently, references to public housing structures were searched for in the other evaluations. In this case, the Swedish implementation of delayed discharges, unlike the English one, was accompanied by a large investment in housing facilities in a country already praised by their shelter housing infrastructure (Minford, 2001). Consequently, the context 'housing capacity' was established as an element that can disable or unable the mechanisms to reduced delayed discharges.

Figure 3.2: How to Bank Contexts

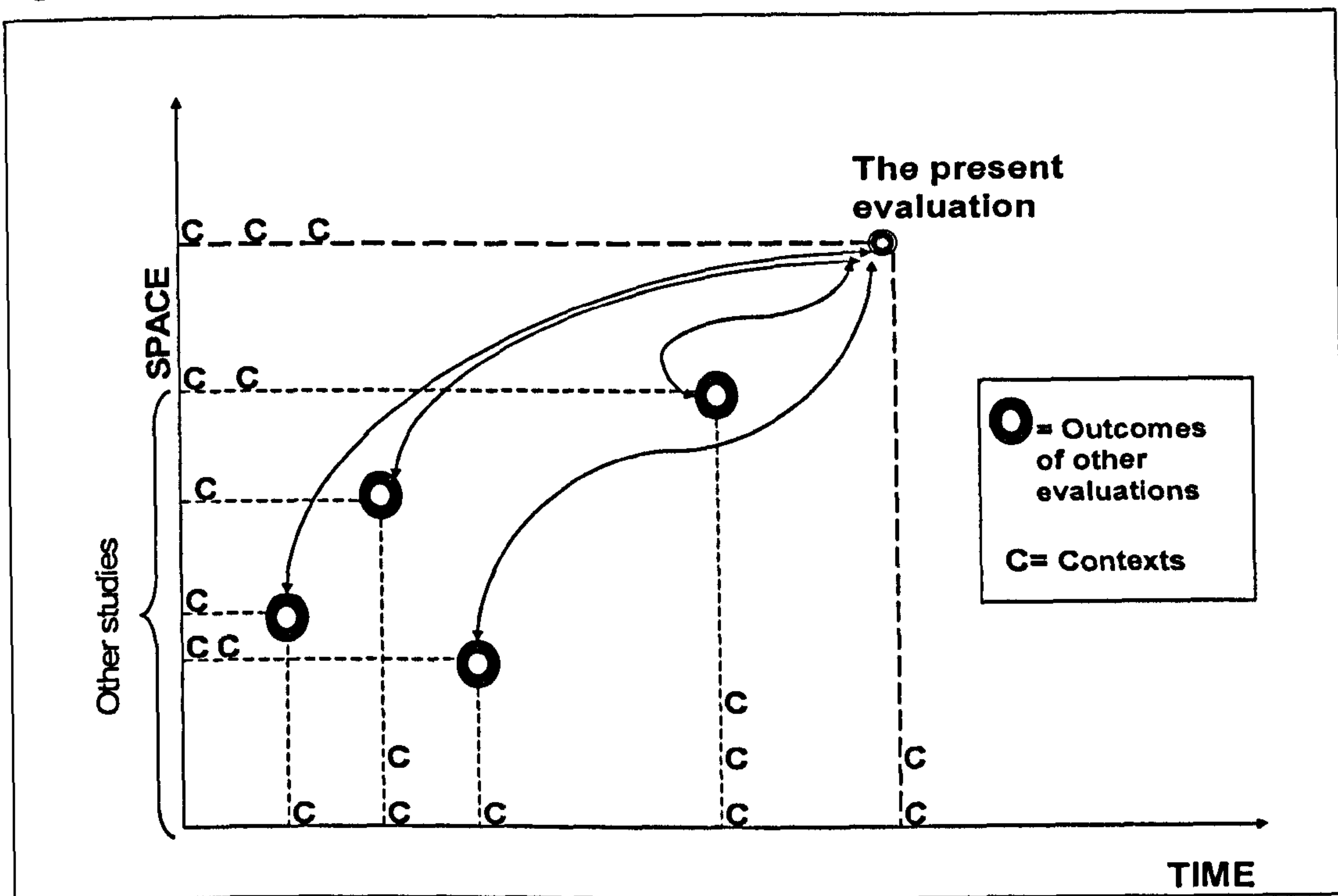
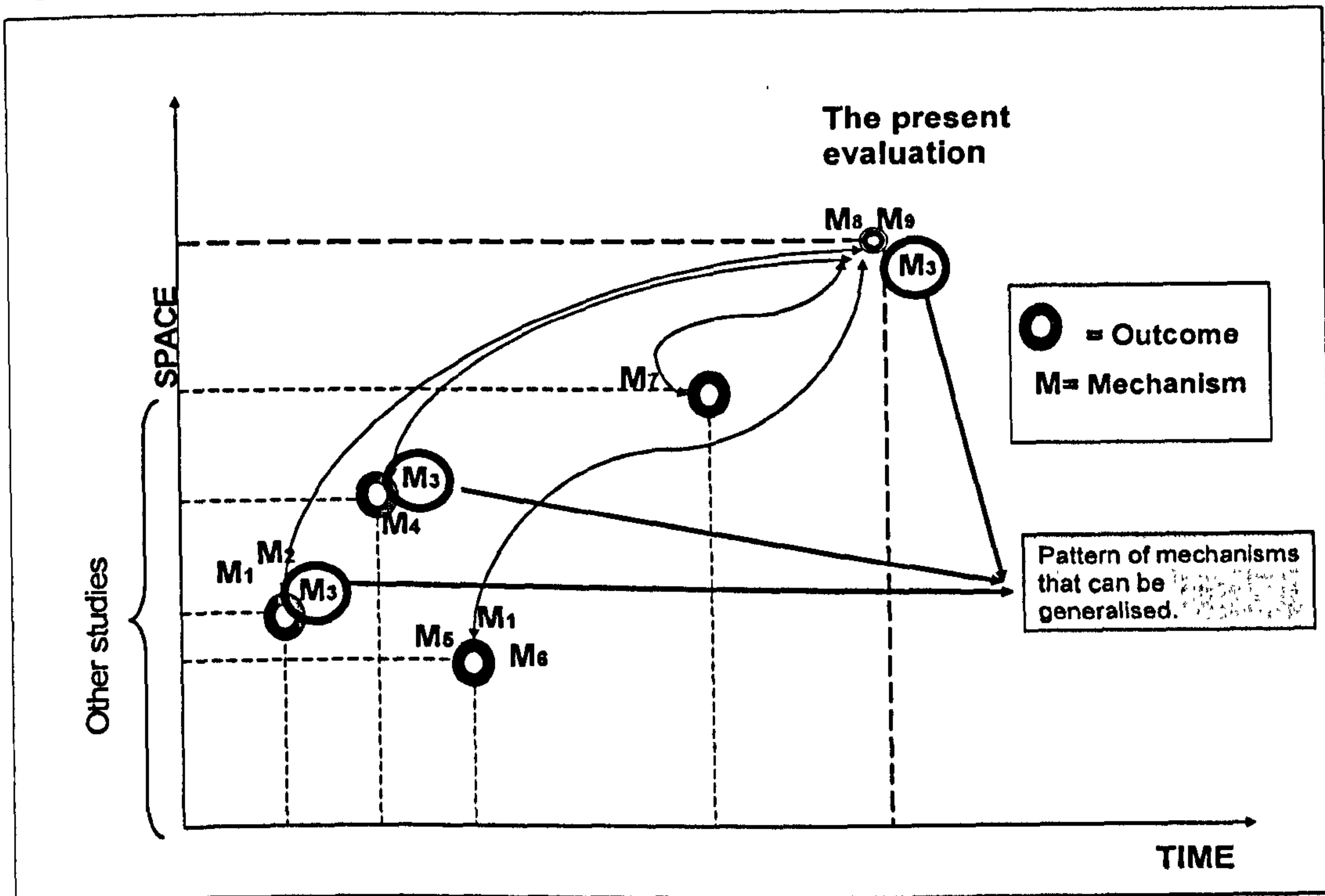

Figure 3.3 represents schematically the process of 'banking' or cumulating mechanisms, which are the local strategies to reduce delays (or avoid fines). Patterns of success or failure (the outcomes) were noticed and then a hypothetical explanatory mechanism emerged. Further investigation revealed whether this causal relationship could hold and which were the contexts that facilitated or prevented their association. These could be institutional, individual contexts or those derived from the macrostructure where the programme is embedded (like the example of the public housing infrastructure explained above). All of these were 'cumulated' together and contrasted with contexts learned from other implementations of the same programme theory. This was the way of aggregating knowledge: moving from one specific case to general theories, back to the next case and once again to review the theories. For example, the use of weekly monitoring of delays with formal meetings between health and social care staff as opposed to the simple quarterly collection of quantitative figures was established as a mechanism to reduce delays in the research site. Examples of the same mechanisms were found in other English local authorities described in Baumann et al. (2007) and Godfrey et al. (2008) and this helped to consolidate this theory.

Figure 3.3: How to Bank Mechanisms and Outcomes.



In order to facilitate the multiple sub-group comparisons across the heterogeneity of the micro individualities of the fourteen cases, some features of Qualitative Comparative Analysis (QCA) are used as a refining extension of the analysis strategy. This system of comparative analysis is widely used in comparative historical methodology and it is useful to present comparisons based on case-oriented research where the aim is not only to make sense of each case separately, but to gain knowledge about cross-case patterns (Ragin, 1987). Both QCA and realistic evaluation have significant features in common: the understanding of causality, the existence of components that can or cannot activate change and the recognition of the key role of the contextual circumstances surrounding the programme. The complementary combination of realistic evaluation and QCA has been recognised: 'Perhaps the greatest added value that QCA can bring to realistic evaluation is this power to extend the transfer of ideas among up to several cases, so as to enlarge the empirical support of theory' (Befani and Sager, 2006: 284). Once configurations are generated through the realistic paradigm, as shown with the example above, QCA helps to compare them across cases and build up generalisation.

The QCA tables (called 'truth tables' by Ragin) were used to correlate the causal configurations. These are codified as 'present' or 'absent' and then compared across in a matrix. Several 'truth tables' can be found in Chapter Eight and an example of their use is the correlation of 'reasons for exclusion or inclusion from the fines' to whether cases were delayed or not. This table showed that all the patients who self-funded a nursing or residential home to leave hospital (and were therefore excluded from the fines scheme) were delayed. Then, this pattern was looked for in other studies with the Commission for Social Care Inspection (2004) evaluation referring to the same phenomenon. The road to generalisation of this finding is related to the use of linking financial incentives with performance indicators and how performances that are not incentivised can decrease (Bevan and Hood, 2005) and, consequently, overall institution objectives are not met. In this case, delays are shifted from people needing social services funding to be discharged, to people needing to pay for the care establishments where they need to be discharged.

3.7 Research in NHS Premises and Ethical Considerations

In the UK, the process of gaining NHS ethical approval (Wald, 2004) and, in general, the Research Governance Framework (Howarth and Kneafsey, 2005) have attracted criticism in the research literature over concerns at the balance between the benefits and the gate-keeping effect of research governance. The criticisms over the bureaucracy associated with the Framework are illustrated in this research project with duplicated application forms and delays associated with studying two public institutions. Researching a partnership programme seems to have similar logistical difficulties as its implementation. The complications of dealing with two institutions are amplified by the fact that the steps towards access are separate but interrelated and interdependent. Consequently, slow progress with one will slow the process with the other one and, consequently, the general access to the field.

The processes of applying for ethical approval and negotiating access to study sites are closely interwoven (Hannigan and Allen, 2003) and the relationship between ethics and access is transformed into a complex exercise. Approvals from both the NHS Research Ethics Committee and the NHS Research and Development Alliance Unit are needed for any UK study that includes NHS patients, staff or premises. If the

applicant does not work for the NHS, apart from the Research Development approval, the regional unit has to issue the researcher with a 'NHS honorary contract'. The formal process of applying and getting access granted is lengthy and research proposals need to adjust to general applications forms that have been primarily designed for clinical trials. This has the potential to discreetly limit the methodological freedom of the researcher. In addition, multi-agency research designs do not conform to these general standards either. Since this research design includes interviews with social services staff who are local authority employees, a separate Research Governance application form had to be submitted to the relevant council. General access was finally obtained in October 2006, eleven months after the process was first initiated.

With regards to the overall ethical issues, the researcher followed the recommendations of the Statement of Ethical Practice for the British Sociological Association (2002). The ethical challenges in this particular project were addressed according to the Ethics Committee recommendations in the following way: The identities of the hospital and local authority are kept anonymous; case study subjects were identified in consultation with the hospital multidisciplinary team in order to confirm that their clinical situation was stable and participation in the research was not potentially damaging for their well-being. With regards to adults deemed unable to give consent, information was provided according to their capacity to understand, and this was checked with their named nurse. The views of their next of kin and or carer were also sought. Written consent was signed following detailed verbal explanation and a summary information sheet was provided 24 hours in advance. Respondents were given assurances regarding confidentiality and the decision whether or not to participate in the research project would not affect the quality of the care received. It was also explained that they were free to withdraw at any stage without providing a reason. Copies of the information sheet and consent forms were given to the participants and stored in their hospital file.

With regards to staff, it was explained that the participation in the study was voluntary; that they were free to withdraw from the study at any time; and that the decision not to take part in it would not affect them in any way. Any information collected was confidential and had their name and work place removed. If a patient

decided to participate in the study, and any of the staff involved in their discharge planning refused to participate in the research, this situation was recorded and the specific data related to that particular member of staff was not collected or pursued. Transcripts were coded to avoid identification of personal circumstances and identifying information was stored separately from these data.

3.9 Summary

This chapter examined the methodological decisions undertaken in this research project. The search for an overall approach that could account for the process embedding the financial incentives led to the adoption of the realist evaluation framework. Consideration was then given to the methods for selecting the research site and the reasons why the use of case studies was considered the most appropriate tool to untangle the inner workings of the financial incentives used to speed up discharges. Although methodological issues are present throughout the thesis, the logic of theory development and refinement was aided by the use of various methods of data collection. These are outlined in the context of evaluating a programme in real-time, while it is being applied to the participants. In addition, some of the main ethical issues underlying research in the NHS with hospital staff and patients were reviewed.

Finally, in this section it was explained how the theory-driven research design tried to mirror the complexity of the discharge process but aiming at a holistic view of the patient as case. The logic is to construct data from a variety of perspectives and compare them with knowledge gained from other evaluations as a means to generalise the findings.

4. SURFACING THE PROGRAMME THEORY OF THE DELAYED DISCHARGES ACT

4.1 Introduction

The importance of the relationship between evaluations and the theoretical underpinning of programmes has emerged as one of the major themes in the evaluation literature (Weiss, 1998; Pawson, 2002; Donaldson, 2007; Rogers, 2007). If theories are embedded in programmes then the evaluation would have to identify those theories first; examine them in detail; test them; and finally refine them. This is what this chapter intends to do: elicit the theoretical framework behind the use of fines to reduce delayed discharges.

With this objective, the chapter starts with a reflection on the most common definitions of 'programme theory' and the degree to which interventions are characterised by programme designers and their evaluators as complex entities. This leads to the discussion about the conceptualisation of delayed discharges as a multifaceted issue and the analysis of some of its complexities, which are located in the multiple levels of the programme intervention: the large-scale macrostructure, the institutional agencies involved and the individual characteristics of patients and staff.

Finally, after exposing the broad theoretical framework in which the fines for delayed discharges are located, a logic map of the programme is used to facilitate the extraction of the detailed theories of change implemented locally. Priority is given to the ten statutory innovations under the Delayed Discharges Act and how the local staff adapted their working practices in the attempt to achieve them.

4.2 Programme Theory and Social Systems

Since 'programme theory' is the central feature of theory-driven evaluations its meaning must be clarified from the outset. Perhaps surprisingly, multiple definitions and debates about the characteristics of programme theory are found in the literature.

Some authors (Wholey, 1987; Patton, 1989) believe that programme theory is the one that is elucidated through programme stakeholders' views. Others like Chen and Rossi (1980; 1992) claim that only social science theory should be taken into consideration for evaluation purposes, but subsequently accepted that both the stakeholders' views and social science knowledge are necessary to construct theory. They also argue that stakeholder's views on causative theory are not detailed and comprehensive enough and therefore the use of a social science approach is needed to frame their input. Even more, it must be taken into consideration that social science theories may well be in direct opposition to the working assumptions of policymakers.

Chen's later definition of programme theory is 'a specification of what must be done to achieve the desired goals, what other important impacts may also be anticipated, and how these goals and impacts would be generated' (Chen, 1990: 43). However, this definition includes some common basic assumptions about the way in which policy is formulated and implemented and about the way in which policies generate change in social systems. These assumptions relate to linear and sequential causality and they assume that there is stability and symmetry in the relationship between variables (Sanderson, 2000). These suppositions are, first, that we know how to change social systems to achieve desired ends and that these 'ends' can be clearly and consensually defined. Secondly, that we actually have the capacity to change social systems because much public policy is based upon the belief of an implicit competence in influencing the behaviour of individual agents through programmes.

Before we attempt to change social systems, first we need to be able to understand how they operate, a difficult enterprise if they are considered open systems (Pawson, 2002). With the objective of gaining understanding of these systems, Stame (2004) suggests two characteristics of a system that is to be considered complex: 'It is stratified, and actors are embedded in their own contexts; and each aspect that may be examined and dealt with by a programme is multi-faceted' (p. 63). This makes the task of evaluating whether a single input (in the case of the Delayed Discharges programme, a financial incentive) causes a given output (the reduction of delays), a lost cause before we can even start. Because, inputs are operating in conjunction with a variety of other inputs that could never be totally isolated from their contexts for the

sake of hypothesis testing (evaluation). This could mean that all social programmes must be considered complex.

Programme theories and their interventions, though, vary considerably in terms of complexity (Donaldson, 2007). How complex is the problem of ‘delayed discharges’ and is the level of complexity reflected in the intervention designed to solve it (the fines scheme)?

4.3 Discussions Around the Complexity of the Delayed Discharges Programme

Rogers (2008) explained that complex problems tend to be those developed through networks and partnership governance. Delayed transfers of care are a problem located on the borders of both health and social systems and the Delayed Discharges Act is a policy solution based on partnership governance. However, this solution confronts the challenge of a multi-faceted and multi-agency topic:

‘Given the diversity of the causes of delayed discharge, it is clear that this is a multi-faceted issue with a wide range of contributing factors. These include factors within the control of social services, factors within the control of the NHS and factors outside the control of either health or social care (such as housing or issues relating to individual service users and their carers). As a result, we believe that any response to delayed hospital discharges needs to be equally multi-faceted and diverse, adopting a whole systems approach to what is clearly a whole systems issue’ (Glasby et al., 2004: 1193).

Glouberman and Zimmerman (2002) argue that healthcare systems are complex and, wrongly, most attempts to treat healthcare problems are merely ‘complicated’. This discrepancy between the conceptualisation of the problem and that of the solution could be blamed for the unsuccessful attempts to improve systems. According to them, complicated problems ‘contain subsets of simple problems but are not merely reducible to them’ (Glouberman and Zimmerman, 2002: 1). Their complicated nature relates to issues of coordination or specialised expertise. The key difference is that, with adequate planning, coordination and skill, complicated problems can be managed with a greater degree of control. However,

‘complex problems can encompass both complicated and simple subsidiary problems, but are not reducible to either (Goodwin, 1994) since they too have

special requirements, including an understanding of unique local conditions (Stacey, 1992), interdependency (Holland, 1995) with the added attribute of non-linearity (Lorenz 1993), and a capacity to adapt as conditions change (Kauffman, 1995; Kelly, 1994)' (Glouberman and Zimmerman, 2002: 1-2).

In summary, complex problems have four main characteristics. They are defined by unique local circumstances, they are interdependent, non-linear and they fluctuate as they can adapt to the rest of the contextual factors in which they are embedded. The complexity of healthcare is built on the many players who operate at different levels, with different funding mechanisms, goals, performance measures, contexts and changing relationships between agents. The internal market for social care is also characterised by complexity hence, the question is whether delayed discharges, a problem sitting at the interface of these two complex systems must be conceptualised as a complicated or as a complex subsidiary problem.

Chapter One explained how the 'problem' of delayed discharges could be constructed as located in the macrostructure of the health and social care systems or as situated in the meso-organisational structure of the hospital and the local social services departments and the micro-characteristics of hospital patients. In other words, when delayed transfers of care are treated with micro-solutions based on improvements of discharge planning practices, they are been conceptualised as merely a 'complicated problem'. These complicated solutions are initiatives like financial incentives, patient pathways, dedicated discharge planning staff or other mechanisms to coordinate discharge processes. In all of these, the assumption is that coordination can be mastered through the renewed procedures and then, the problem of delayed discharges would be sorted. However, these efforts have been considered 'to be tinkering with the discharge relationships and processes and not tackling the nature of the problem' (Arundel and Glouberman, 2001: 4).

Against this standpoint, the complexity of delayed discharges is described in the following sections. The multiple levels of the nature of the Delayed Discharges programme are identified in this section as different interconnected layers of the social reality of the programme where the multiple aspects affecting discharge processes rest. Blaikie (2000: 187) explains social settings involving three main levels of analysis: micro-social phenomena, meso-social phenomena, and macro-social

phenomena. These categories, which resemble Layder's (1993) stratified model of society, have numerous components and the relationships between all of these components intertwine. Components can interact within the same level but they can also interfere with components within other levels. Figure 4.1 represents the 'embeddedness' of the fines for delayed discharges programme in the wider range of social processes representing the stratified nature of social reality (Pawson and Tilley, 1997). This figure illustrates how the programme depends on nested territorial levels of decision-making which become more complicated in the context of complex overlapping networks.

Figure 4.1: Social Contexts in Which the Fines are Embedded

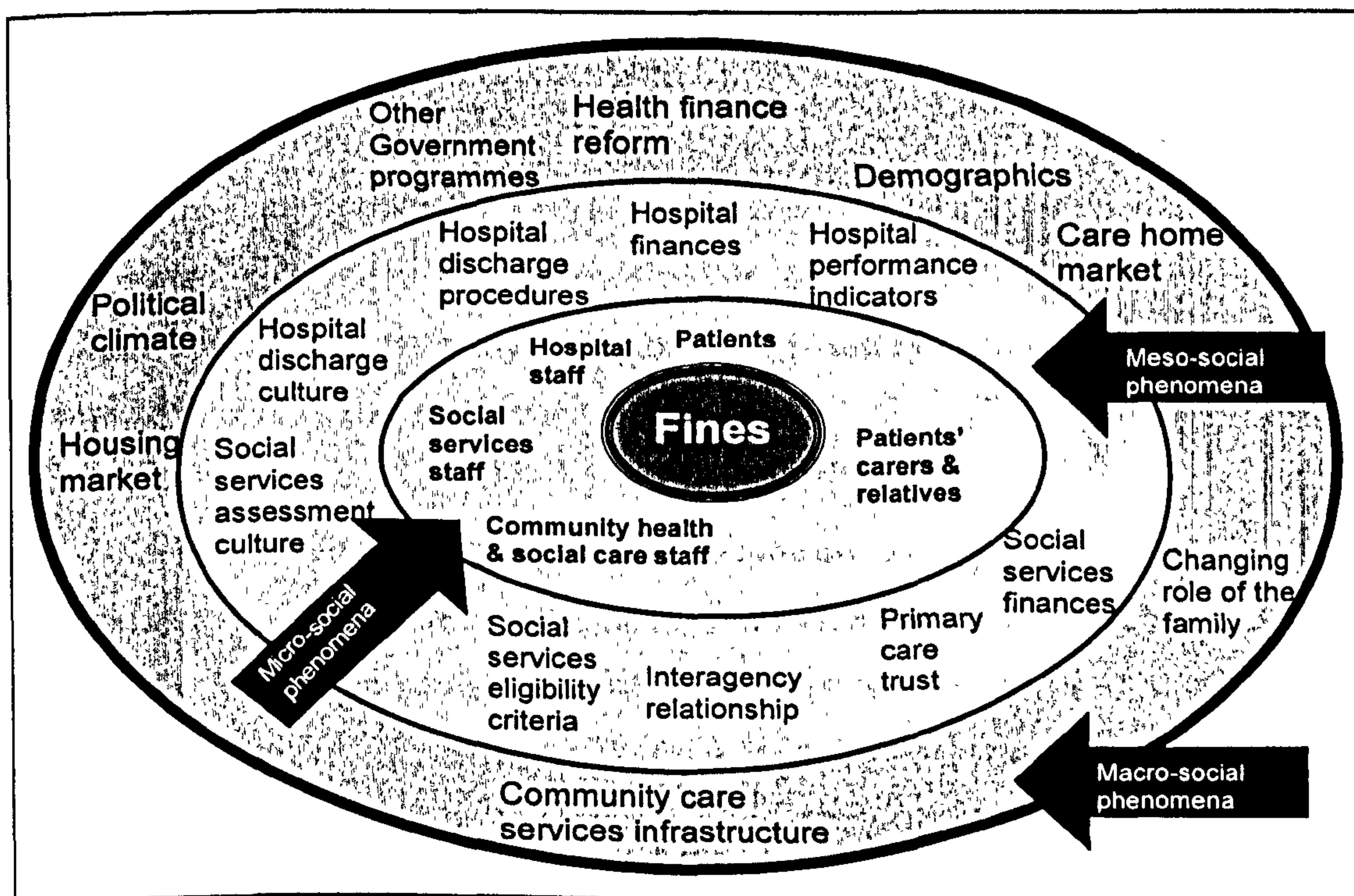

It becomes clear then that the effective deployment of the fines scheme depends upon the multiple elements located at the different levels illustrated in Figure 4.1. For example, the successful discharge of patients in the community depends as much on the prompt availability of resources like council housing or care homes, as on the inter-agency discharge planning procedures to manage the micro-characteristics of individual patients. Consequently, the difficulty of evaluating this programme remains in the detailed interaction between the various agencies and the identification of the connections and outcomes of individual actors which are embedded in their own

institutional, historical and political specificities. Shifting power relations, uneven capacities and political opportunities need to be taken into account when addressing how programme theories are shaped.

Commentators who distinguish between complicated and complex problems (Glouberman and Zimmerman, 2002; Rogers, 2008) say that the same type of problem requires the same type of solutions: to resolve complex problems, complex programmes are needed. For complicated problems, complicated programmes should be designed. If a mismatch occurs, the programme will encounter a greater amount of difficulties to achieve change. Hence, if delayed discharges are conceptualised as a complex problem, this would require a complex solution, which would include a macro-level approach. Nevertheless, Cilliers (2000) argues that any 'perfect' representation of these systems must be as complex as the system itself, and this is an impossible task. In building representations of open systems, we are forced to leave things out, and since the effects of these omissions are nonlinear, we cannot predict their magnitude. In summary, because complex changes are non linear, they cannot be understood through linear analysis. Consequently, solutions to these problems would always be imperfect and, at the most, complicated.

Accordingly, attempts to approach the complexity of delayed discharges should include interventions (theories of changes) in the three levels in which phenomena are located. The next three sub-sections will further analyse these three levels, exploring how the fines implemented with the Delayed Discharges Act interact with some of the key phenomena located in the different layers drawn in Figure 4.1. This study however could not analyse every single element located in these layers. Priority is given to the aspects that interact more closely with the discharge planning processes that the fines try to modify; analysing closely how those theories of change may operate when a disparity of complexity between problems and solutions occur. To initiate the search for programme theories, an initial exercise is performed which consists of describing the different layers composing the social system where the programme is introduced. In the next three sub-sections, an overview of the relationships within these layers is offered. These are barriers that the theories of change constructed for the Delayed Discharges Act encounter in their journey to

modify outcomes. Barriers have three sizes (macro-meso-micro) but these are all as difficult to overcome.

4.3.1 The Macro-Social Phenomena

The Department of Health issued a national policy that, among other innovations, implemented fines for all social services departments in England. The rules of how the system was going to operate were first made law (The Community Care (Delayed Discharges etc.) Act 2003), and then the national guidance on how to implement was disseminated on the Department of Health website, within internal documents and a dedicated Change Agent Team were created to promote the departmental guidance and answer frequently asked questions. Afterwards, the local agencies involved (PCT, acute hospitals, social services departments and housing departments) were expected to meet to create their own specific regulations (local discharge protocols) based on the original guidance which allowed for some flexibilities that could be adapted to the local needs. In other words, goals were set at the higher level, objectives were articulated and public resources allocated; but means or ways of attaining the results were not yet fully anticipated. Objectives were designed and decided at the Department of Health level and implemented at the local level. In summary, at this juncture, the system consisted of a macro-level intervention attempting to change national systems providing guidance to the meso-level structure.

In Chapters One and Two, some of the key components of the macro-social phenomena related to delayed discharges were explained. In this section, some of the contemporaneous governmental programmes to the Delayed Discharges are identified as elements that can potentially interact upon the system when evaluating the role of the fines in achieving outcomes. It is not unusual for a wide range of other programmes to be operating prior to and during the implementation of a new initiative because policy interventions are always embedded in a larger 'policy landscape'. The difficulty of dealing with complex policy environments is related to the impossibility of isolating the effects of the new approaches, because new initiatives often complement or extend pre-existing services and programmes, rather than replacing them entirely (Sanderson, 2000).

Although programmes are addressed to specific institutions, in real life they interact, overlap and intermix with some of the other institutional players. These collisions can act as 'change stoppers', route diversions that the theories of change have to follow. In the case of the fines, some programmes come into contact more closely than others in the daily practice of patients with social needs. Below, three initiatives that interact with the financial incentives to reduce delays are briefly analysed:

a) **Fair Access to Care Services (FACS)**. In April 2003, English councils were given four bands for prioritising peoples' needs (low, moderate, substantial and critical). Every council has the freedom to set its eligibility threshold according to its finances (Department of Health, 2002c). For example, depending on how healthy their finances are, one council may fund only critical need; but the neighbouring council may decide to fund all needs from low upwards. Basically this programme is a new rationing system for funding social care which is not based exclusively on means-testing but also on people's needs. Councils do not fund services but people's needs. For instance, help for shopping can be considered a 'low need' for somebody who is independent for all the activities of daily living, but it could also be a 'critical need' for somebody who has a clinical depression and would not eat unless meals are provided for them.

The difficulty with FACS is that is based on such abstract and ambiguous concepts that professional judgement is the core component of its successful operation (Cestari et al., 2006). The degree of professional interpretation and exercise of judgement needed to put FACS in practice generated infrastructures to promote consistency of funding approvals within the local authorities. These also try to prevent a key unintended outcome: thanks to that ambiguity, staff could easily 'inflate the level of need in order to ensure that a service was received' (Cestari et al., 2006: 479). The challenge confronted by the attempts to integrate FACS and the Delayed Discharges Act theories of change is to combine activities aimed at fast discharges with systems created for the rationing of services.

Infrastructures created to ration services have the potential to impact discharge processes and both systems cannot be separated from each other. For example, the review of post-discharge services (two weeks after being in place in the research

site) has as an objective of reducing services as soon as they are not needed but this fast reduction could affect readmissions. Funding-approval panels run by middle managers like the Capacity and Risk Assessment Meeting (CRAM) in the research site may also slow down the discharge process. This funding approval meeting existed before reimbursement, to control the quota of local authority care home admissions approved. Then, in 2003, it was redesigned as CRAM to fast track funding approvals to avoid the fines. The same year, however, FACS was also implemented and the CRAM meeting was the location used by managers to screen FACS eligibility. At the time of the fieldwork, CRAM was deciding on every single community care service allocation:

‘CRAM makes the decisions, you see, regarding who goes where. Everybody now. It used to be that we would decide, that the two care managers here [based in the hospital] would decide who went where when. But not now, CRAM makes all decisions about everything’ (Interview with care manager Case 11).

It is difficult to differentiate whether the changes described by this front-line worker have been brought up by FACS or by the reimbursement scheme because both programmes were implemented at the same time and CRAM combines both objectives (rationing and avoiding fines). The process to access post-discharge resources is indeed controlled by the managers in this meeting and whether services are considered ‘critical’ is decided by a panel of senior social care staff who, most probably, have never met (and will never meet) the patient or their carers.

b) The National Guidance on Choice Directive. This guidance intends to ensure that when social services departments place people in care homes, within reason, individuals are able to exercise genuine choice over where they live (Department of Health, 2007b). Although this directive establishes the right for patients to select a care establishment of their choice, patients have not the right to remain in hospital once treatment is completed to wait for that bed of their choice. These two policies can come into conflict when patients need to be admitted into care from their hospital beds. Not only to look for and choose a care home takes time but, most importantly, the preferred establishment most probably will not have an instantly available vacancy, with the most popular homes having long waiting lists. The use of interim

beds (short-term transfers into care until preferred homes are available) was an instrument promoted by the Delayed Discharges Act implementation guidance as the main mechanism to fast discharge patients without compromising their right to choose the care establishment.

The right to choose a care home for a short-term stay is not only limited to the number of interim beds contracted locally but also to the vacancies available when patients are ready to be discharged. As the following quote, summarises, people who are transferred into care from hospital whether for short-term (interim beds) or long-term stays have their choice restricted by the resource availability: the homes that have beds available at the time are the only ones that they could select:

‘Tricky. See what you are saying to that person is: ‘We are lending you the money to go wherever you [want to] go but you can’t go wherever you want because you have to go where there are vacancies’. So while they have a choice, it is only a choice of one, in a pre-dictated place’ (Discharge liaison officer, Case 2).

- c) Registered Nursing Care Contribution (RNCC).** The primary care trust (PCT) in which a nursing home is located is responsible for meeting the cost of care provided by registered nurses employed by the home. To assess how much the NHS will pay for nursing care, a PCT nurse determines the ‘Registered Nursing Care Contribution’ (RNCC) (Department of Health, 2007c). This is a significant assessment because, for people paying for their own care, it represents the only money that they will receive from the Government towards funding the nursing home. In practice, the requirements of the RNCC means that if hospital patients need to be admitted into a nursing home, a PCT nurse needs to assess them before social services could be fined for their delay. This review is also used in practice to ascertain if a person requires admission into a nursing home or a residential home (a cheaper option for the patient). As a result, these assessments are now completed in hospital (they used to be done once patients had been discharged) and consequently, needs are assessed at times when patients are only a few days away from being acutely ill.

The risk is that, if these assessments are done too early so as to accelerate discharges, patients’ needs are higher and people could be transferred into nursing

homes unnecessarily and/or paying for more). One of the registered nurses that assess RNCC in the research site refers to these inconsistencies in one of the interviews:

‘The whole reimbursement agenda suggests that you shouldn’t be assessing people in acute beds. And the Registered Nursing Care Contribution automatically means that you are assessing them for a care home, temporary or permanent, in an acute bed when they have got 24/7 cover of nurses and doctors. I know we are not talking about RNCCs but I do sometimes feel that we assess them as high need and they are reviewed in three months time and if they’ve plateaued or stabilised I would imagine the needs would probably go down’ (Discharge liaison officer, Case 3).

These three examples illustrate how contemporary programmes affect other layers of the social system in which the fines are embedded. Different interventions designed by the Department of Health before, during or after the Delayed Discharges Act overlap with some of the core theories of change of the latter.

4.3.2 The Meso-Social Phenomena

At the meso-level, institutions implement national programmes under their own interpretation, with their own resources and with their own political scene. Then, staff juggle about those programmes trying to fit the specific individual to a large group of regulations that most probably, at some point would contradict each other. The local capability to implement national innovation policies like the Delayed Discharges programme is intrinsically linked to the macro-structures for policy-making in which local governments are embedded but it is also framed by their own specific local circumstances. When dealing with delayed transfers of care for acute patients, it has been argued that:

‘different health and social care communities are facing different pressures and that delayed hospital discharges can be caused by a different combination of factors in different areas. To us this suggests that responses to delayed discharges need to be equally localized, based on a detailed understanding of local services, the local context and the history of local agencies’ (Glasby et al., 2004:1193).

The Delayed Discharges programme is placed by the national designers into a local context which is intrinsically systemic. Innovation takes place at different spatial

scales and policy implementations and practices are negotiated at multiple territorial tiers even at the local level. This complex architecture is not fixed or stable but dynamic; it varies over time and across practices. These players are mutually dependent on each other. The primary care trusts provide healthcare in the community and they also pay the hospital for the acute medical treatment that they provide to patients in their community. Local social services departments make sure that those acute patients who have social needs have them met promptly so they can leave the hospital as soon as possible after their medical treatment is finished. But to do so, social services need to commission social care services from a variety of providers in the community. In other words, local authorities remain accountable for the quality of service relying on private and/or not for profit organisations but these exercise considerable autonomous authority in providing the services contracted. The presence of a diversity of institutional stakeholders embedded in the local context brings up as many opportunities for collaboration as for coordination conundrums. The chain of mutual dependency between actors with different interests is sensitive enough to be broken at any time by any of the players because of the complexity of their own institutional processes.

The basic programme theory of the reimbursement scheme is clear: fines will be issued when social services are the only responsible agency for the hospital delay. From then, numerous exceptions follow which are good illustrations of all the other possible reasons for delays. These reflect the major difficulty in attributing outcomes related to hospital discharge to one agency when so many institutional players are involved in the process. The local protocol of implementation of the programme listed nine explicit reasons for delays that will not result in reimbursement for social services:

‘There will be no liability for re-imburement from Social Services for the following:

- Lack of non-acute health services.
- Lack of primary and community health care services.
- Patient choice.
- Where appropriate alternative services, which take account of the patients views, have been offered and active encouragement given to the patient to transfer but they unreasonably refuse to move to the alternative.
- The absence of intermediate care if it is assessed that the person could benefit from such a service.

- Where individuals choose to have no involvement with Social Services during their hospital stay and go on to fund their own care home placement or domiciliary care package.
- Where a patient is clear that they do not want the involvement of Social Services and they will not accept services put in place for them.
- Where the hospital invites staff from Social Services to provide advice to patients even though they subsequently go on to arrange their own care.
- The commissioning of services for patients cared for under the Community Critical Care Scheme' (Confidential Reference 1, 2004:14).

These reasons for delay are adapted from the Delayed Discharges Act implementation guidance and are not the only ones for which social services departments are not liable: others like self-funding patients and all those who are not considered to receive acute care (i.e. maternity care, palliative care, etc.) are also excluded. The list above is not only an enumeration of other reasons (rather than social services) why patients' discharges can become delayed but it is also a preliminary list of the bargaining mechanisms or negotiation opportunities used at the management meetings to avoid the fines. These have the name of different stakeholders attached to them (the PCT, the patient or family, etc) which account for particular contextual factors. In addition, these excluded causes for delays are also significant innovations introduced by the programme: delays that before reimbursement were considered social services responsibility are now counted in performance returns as caused by other agencies. The consequence of this change in accountability will be further explained in Chapters Six and Eight.

4.3.3 The Micro-Social Phenomena

From a sociological perspective, the Delayed Discharges programme is based on the model that has long driven the human services, that is, on defining the individual in need of help as the source of the problem (Darling, 2000). The practitioner's task, in this model, is to change the individual, to adjust the individual to society, or to bring the individual into line with more normative standards. A patient 'blocking' a bed could be seen as the problem to confront, and not the social organisation that creates the difficulties for the person. The opposite model is to link individuals with social structure and recognise that people, their behaviours and their problems are expressions of the social worlds in which they are embedded. In this case, a patient does not block beds, but it is the health and social care infrastructure that fails to

provide for them because there are not instantly accessible services to cater for their needs.

For financial incentives to work as policing mechanisms, within the framework of the macro-infrastructure and the institutions, they need the cooperation of the micro-context of the individuals. The specific characteristics of the patients and staff could obstruct or facilitate the outcome patterns intended by the programme theory. At the micro-social layer are individuals who, in this case, are frontline staff in the hospital, social services departments, patients and their carers. All these people are constrained and framed by the specific hospital institution with its discharge culture, its own local discharge protocol; all of these embedded in a larger macrostructure.

The fines for delayed discharges are not only a multi-agency but also a multi-subject programme. Figure 4.2 below groups the main stakeholders involved in decision-making processes surrounding hospital delayed discharges. With the implementation of the Delayed Discharges programme, although the decision-making responsibility of discharge is given to all multidisciplinary staff; the fine if not achieving timely discharge is only applied to one of the institutional players, social services, which is represented at front-line level by the care managers. It is important to note that these staff have little decision-making capabilities in comparison with all the other stakeholders in Figure 4.2, as funding and placements decisions in social services departments need previous approval from their management team.

Figure 4.2: Main Stakeholders in Discharge Planning Decision-Making Process

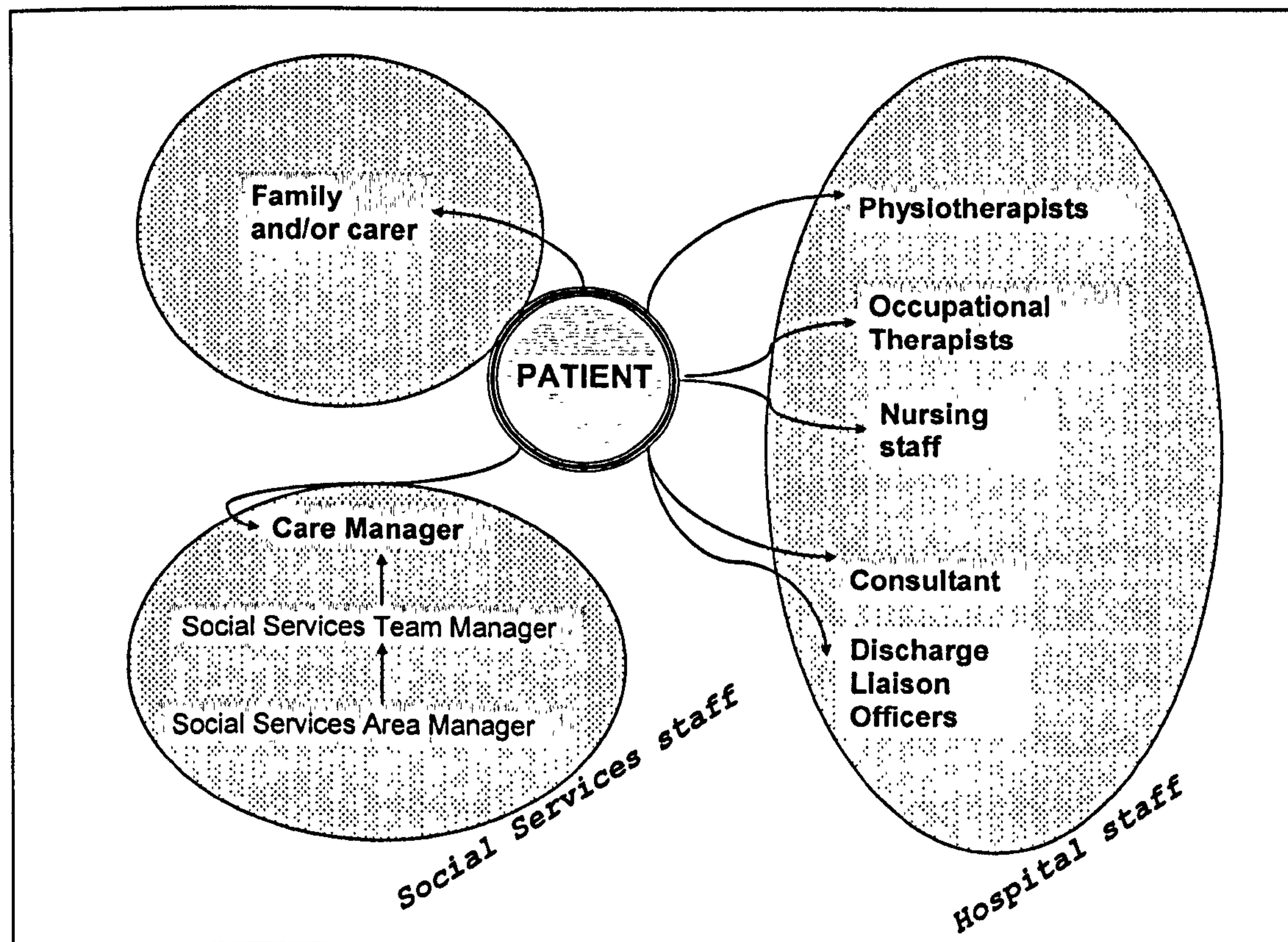

Hospital patients are left in the middle of this jungle of interests and regulations, themselves having their own embeddeness framed in their illnesses and their social circumstances. Chapter Seven explores in detail these micro characteristics and how they influence people's discharge planning pathways. A small taster of what is to come to illustrate this point at this stage is the situation experienced by Case 1, Mrs Ackroyd, who was discharged to an interim bed through an agreement made in a CRAM meeting between discharge liaison officers and the social services team manager. This transfer took place without consulting the patient or her care manager, and against the multidisciplinary team decision that she should have waited to be transferred for a period of convalescence into the local PCT community hospital.

4.4 The Fines: A Complicated Solution

A logic model is a visual representation of the relationships between the various components of the programme. Traditionally, these components include inputs, actions, intermediate goals and overall outcomes. Logic models have been suggested

by several researchers (Weiss, 1997; McLaughlin and Jordan, 1998) as the key tool for better understanding the theories and mechanisms of change for programme evaluation. They bring to the surface the programme's theories of change by exposing the links between the inputs and the intermediate goals and between the intermediate goals and the outputs.

The programme designers generate the official programme theory with their examples of logical diagrams of expected impacts, which can later on be compared to the theory that 'is really going on'. The map in Figure 4.3 illustrates how the financial penalty is subordinated to discharge planning theories. The fines are positioned in the middle of numerous outputs and inputs. In the logic map, there are missing feedback loops and emergent outputs, which determine whether the programme achieves the planned outcomes. The vastness of all these programmes theories could not be attained because they never remain constant (Barnes et al., 2003) and they could never be all evaluated because the only way to 'get to grips with complexity is to prioritize' (Pawson, 2006b: 231). In this case, the prioritisation concentrates on the fines firstly, because they are the most 'advertised' feature of the programme. Secondly, to fill the gap acknowledged by previous evaluations of the programme that referred to the need of clarifying the specific role of the fines in achieving the reduction of delays (Baumann, et al., 2007; McCoy et al., 2007a; Godfrey et al., 2008).

Figure 4.3: Logic Model of the Delayed Discharges Programme

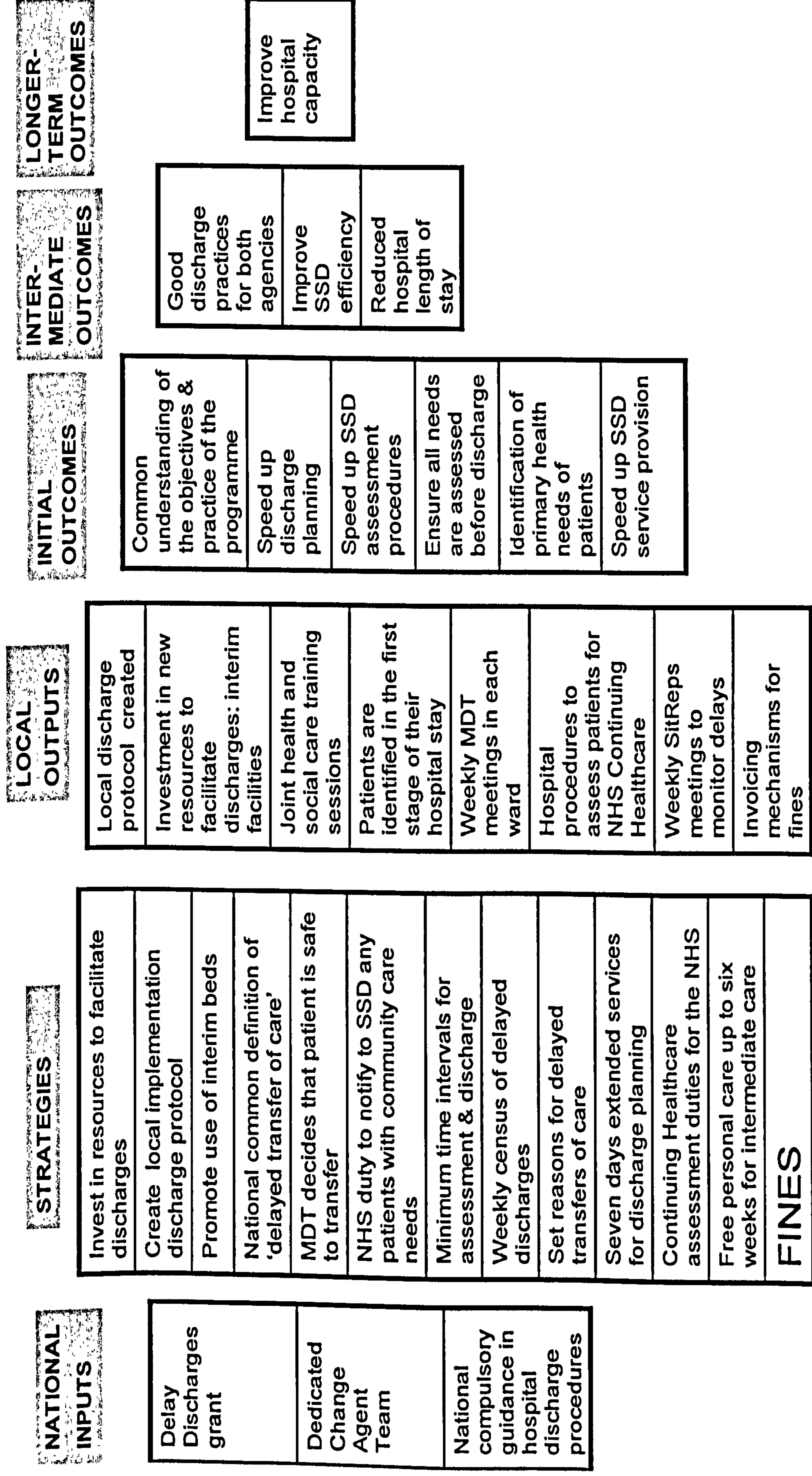

Figure 4.3 illustrates how change is supposed to be achieved by all the innovations introduced with the programme. In Chapter Two, it was explained how the Delayed Discharges Act brought about ten main innovations, including the fines, which cannot be artificially divided for the purposes of evaluation. This logic map reflects how the challenge of this research project is to be able to grasp the interlinkages of outputs in a collaborative programme which dealt with objectives for two organisations that, although they may have the same long-term goals, in practice have very diverse immediate goals.

Logic maps have been criticised by some authors for not been able to reflect complexity:

‘While ToC (Theories of Change) are useful in understanding where the architects and implementers of a programme *think* they are going and how they expect to get there, the linear logic implied by a ToC approach, which requires pre-specification of how actions will lead to outcomes, cannot embrace the way complex systems actually work’ (Barnes et al., 2003: 277).

This criticism is based on the concept of ‘emergence’ developed by complexity science theorists, which refers to the fact that in open systems there are feedback loops and radical changes that cannot be anticipated with a diagram that assumes step progress. But does the complexity lies in the problem or in the solution? If the complexity of the delayed discharges problem is addressed with a merely complicated programme (like the fine scheme), then a complicated logic map should be a good enough tool to represent it (Rogers, 2008).

4.5 The Local Interpretation of the Nationally Designed Programme Theory

It is not infrequent to picture programme theory as a shielded block of ideas that is created somewhere and later on transported, intact, from programme designers, to implementers and from these, once again, to programme practitioners. Theory is considered a uniform, linear and static concept, assuming that in the designing and implementation stages there is a ‘consensus of theories and values’ (Conrad and Miller, 1987). However, if we take a different approach, assuming that there is no real

theoretical consensus between the multiple agents involved in the process of a programme's life; its theory could be considered as a dynamic and malleable element that is altered prior to and during programme implementation and practice. Furthermore, even if a great level of consensus was achieved, ideas and values are abstract entities which allow for enough laxity to be significantly modified by the next group of agents. The reason for this abstraction can be related not only to the inherent definition of what ideas are, but also to the fact that abstraction could be a deliberate choice. Bickman (1987: 6) explains how 'often the objectives, goals, and theory underlying the program may be purposely ambiguous because of political concerns; that is, it may be kept intentionally vague in order to gain support from different groups'. Consequently, programmes could have their theory explicitly described and, at the same time, ambiguously not described, leaving enough room for new theory generation. This view leads to the notion of a modifiable programme theory, which needs to be tracked down at different physical and temporal locations in the life of a programme.

When the Delayed Discharges programme was first announced, the local health and social care managers met to re-define the nationally defined theories into a local practice that was the most convenient for their services. In other words, the theories of change proposed by the national organisation (Department of Health) were organised locally by middle managers. The comparison between the national guidance and the local implementation illustrates the first group of theories of change (see Table 4.1). The ten main innovations of the programme were translated locally into outputs which were introduced at the beginning of the programme implementation. Three year later, some have withdrawn and others have consolidated. Patton described this situation as the natural development of all programmes: 'In reality, development usually occurs in fits and starts, some upward or forward progress, then backsliding or consolidation' (Patton, 2002: 167).

In Table 4.1, the outputs created locally to achieve the nationally designed innovations are listed. These local outputs are activities to implement each of the changes dictated by the Delayed Discharges programme. Activities have multiple forms: training, control meetings, staff recruitment, protocols, invoices, etc. To design and create all these activities is no easy task. Long et al. (1985) explained how:

'problems of implementation are legion, ranging from ambiguity in policy aims and responsibilities, the problems of relating general guidance (for example on priorities) to particular cases, enforcement, changing financial and manpower assumptions or conditions, and differing time horizons of actors (the planners versus the health practitioners) and organisational and political factors' (p. 231).

Reflecting these implementation difficulties, Chapters Six, Seven and Eight analyse the way in which these activities were developed locally and how they interact with each other to generate specific outcomes for delayed discharges.

Table 4.1: Local Interpretation of the Main Programme Strategies

STATUTORY INNOVATIONS	LOCAL OUTPUTS	OUTCOME	IN PLACE AT THE TIME OF FIELDWORK
1. Common definition of 'delayed transfer of care'	Training to both agencies, local protocol	Implemented	In place
2. Safe to discharge, a multidisciplinary team decision	Social Services staff to attend all MDTs	Implemented	In place
3. NHS statutory duty to notify councils of any patients with likely need for community care	Section 2 forms in all wards	Implemented	In place
4. Minimum time intervals for assessment and discharge	Section 5 forms in all wards	Implemented	Not followed as described
5. Set reasons for delayed transfers of care	Both agencies must agree reasons for social services patients	Implemented	In place
6. Weekly census of discharges	Weekly StReps meeting	Implemented	In place. Meeting increased to twice a week
7. Seven days extended services in discharge planning	One member of social services staff to work on Saturdays	Implemented temporarily	Suspended. Not in place
8. NHS continuing healthcare assessment duties	All patients to be assessed for NHS continuing health care eligibility	Implemented	In place
9. Free personal care up to six weeks for intermediate care needs	Joint budget, needs CRAM approval	Implemented	In place
10. Fines for delayed transfers of care defined as been caused exclusively by social services	Invoicing mechanisms in place	Implemented	In place

Programme dynamics should be taken into consideration when evaluating these in real-time, as they are still active. At the moment of the fieldwork, nearly three years after its implementation the Delayed Discharges programme was in the 'middle phase' of its life cycle: it is established and predictable, with a permanent budget and an organisational function, and the programme tasks have become part of the work routine. However, in this phase 'one should expect to see the emergence of resistance to change' (Hunter, 1999: 9). At this stage of the programme, the degree to which intermediate outcomes are achieved can be assessed. Table 4.1 illustrates how the majority of the local outputs were still in place at the time of the fieldwork. Some,

however, have been modified or have disappeared. This is the normal evolution of all programmes because some characteristics of the final phase of the programme may be starting to show as participants' stamina is declining and it seems to be the time to renew, revise, or redefine activities. These alterations to the initial plans will be explained in Chapter Six, where the local mechanisms to reduce delays are analysed in detail.

Lipsky (1980) considered practitioners as policy makers. They are the ones that deal with programme innovations and adapt its theories of change to their own working practices. According to him, practitioners are able to 'make policy' thanks to two interrelated characteristics of their role: discretion and relative autonomy: 'The policy derived by street-level bureaucrats is most often immediate and personal. They usually make decisions on the spot (although they some times try not to) and their determinations are focused entirely on the individual' (p.8). The capacity for practitioners to modify programmes is, however, limited to the other micro and meso-phenomena happening at different levels of the intervention. In the case of the Delayed Discharges programme the fines are directed at the managers' budget and not to staff wages. How practitioners modify the theories of change proposed by the managers is tested with the empirical work and explained in the following chapters. The identification of the pre-existing social contexts in which the programme is introduced helps to elicit its flows and blockages. These contexts are specific to each local implementation. The combination of underlying programme mechanisms and contexts generated outcome patterns that help answer the question 'how does the programme work?'

4.6 Summary

This chapter has followed the theory-driven premise of surfacing the main programme's theories of change. The description of how the programme is expected to achieve change was initiated with a reflection of the meanings and uses of programme theory. Then, the chapter progressed into further understanding of the embeddeness that surrounded the fines as a public policy instrument. The different layers of the programme interventions were explained in detail, pointing out that aspects were overlapping and mismatches could occur.

In the second part of the chapter, the general theoretical framework where the fines are located was articulated. This was followed by the extraction of the main programme theories of change, which were identified with the help of a logic model. This exploration tool illustrates the position of the fines in the middle of numerous outputs and inputs that are expected to generate intermediate and long-term impacts. Finally, the local interpretation of the main ten innovations that the policy introduced was described. These materialised in the forms of activities like training activities, control meetings, joint protocols, etc that were still in place or had been withdrawn at the time of the fieldwork. As an initial description of what really 'goes on' in the programme, practitioners' ability to adapt the programme's theories of change into their practices and consequently, modify the expected outcomes was explained. In the next four chapters, this ability will be analysed, describing their efforts to reduce the numbers of delayed discharges and to avoid fines.

5. CONTEXTUAL CIRCUMSTANCES OF THE RESEARCH SITE

5.1 Introduction

Hospitals do not work in isolation. Many different organisations besides social services departments, such as primary care trusts, independent and voluntary sector providers need to work in cooperation with acute hospitals to reduce delayed discharges. This chapter draws on the importance of local circumstances in determining how barriers or facilitators of change operate in any setting. This standpoint supports the premise that hospital performance on delayed discharges depends on the range and capacity of discharge resources available. In addition, it acknowledges that the discharge options available are subordinate to the relationship between all the institutions involved. Following this argument, this chapter analyses the local context in which the Delayed Discharges Act was introduced in the locality chosen to evaluate. Patton (1987) explained how local implementation of national programmes involves adapting the programme to local circumstances:

‘Programs are adapted to local needs and circumstances and show considerable differences in kind –different in content, in process, in goals, in implementation, in politics, in context, in outcomes and in program quality’ (p. 28).

Consequently, when evaluating a programme locally, we have to draw a picture that captures ‘the unique diversities and contrasts that mark local programs and to understand how and why programs deviate from initial plans and expectations’ (Patton, 1987: 28). This chapter focuses on the meso-level of the intervention, the institutional layer illustrated in Figure 4.1 of Chapter Four; acknowledging from the start that it is an impossible task to capture all its components.

Some of the features of the hospital chosen as the research site are explored and its relationship with the primary care trust is analysed as an opportunity to identify contextual features significant to the impact of the reimbursement programme. Afterwards, the local social care situation is explored focusing on the overall financial

situation and relevant resources for discharges including the care home market, domiciliary care services and availability of council housing. To complete the chapter, the contextual characteristics of the formal partnership arrangements between local health and social care agencies are examined. Agreements with regard to intermediate care services and NHS continuing healthcare procedures are highlighted as key initiatives that could have an influence in the way the fines worked in this locality.

5.2 Context and Programme Evaluation

The success of programmes is conditional to local factors. Contextual constraints enable or disable the mechanisms engineered with the programme theory. One of the strengths of Pawson and Tilley's (1997) methodology is their emphasis on the identification of contextual differences of programme implementations:

'The other difference between Pawson and Tilley and other versions of program theory is their emphasis on analyzing differences between particular groups of clients and between particular program sites. For example, one might seek to explain why a project succeeds at one site but not at another through exploring differences in management support, community conditions, or other contextual variables. One might also seek to explain why a project succeeds with certain clients and not with others through exploring differences in individual client attributes. Pawson and Tilley's argument for these types of explanation are, in my view, their single biggest contribution and may go some way toward countering the common obsession in other evaluation theory and practice with answering whether programs "work" in some meaningless average way' (Rogers, 1999: 382).

Rogers summarises in this above quote that 'particular programme' sites and particular groups of clients perform differently according to their peculiar features. This chapter concentrates on analysing the key features of the research site that may have influenced the results obtained by the reimbursement scheme in the locality under study. Chapter Seven of the thesis will analyse the differences between diverse groups of clients that affect programme outcomes.

Social programmes are always introduced into a set of pre-programme social circumstances. Programmes do not start from a blank sheet; they begin from a colourful sheet previously encrypted with organisational relationships, hundreds of micro and macro structural factors and other overlapping programmes. The

Department of Health attempted to structure a contractual relationship between the NHS and social services departments, enforcing a policy which compels the latter to perform a service for the NHS in a prearranged form. The limitations that this sort of system encounters in practice are multiple; one of these is the character of each party, and another, the characteristics of their relationship (Christianson et al., 2006). Therefore, the local health and social care context and their partnership arrangements need to be described in detail to understand how they shaped programme development. The challenge of identifying the contextual relationships and structures that can generate causal outcomes in a particular programme is dealt within a theory-driven approach informed by the literature review and researcher's prior knowledge as a discharge practitioner.

The in-depth examination of these local circumstances facilitated background knowledge that informed the modification, emergence or elimination of the 'contexts' that were to be part of the final causal configurations. The final list of these 'context codes' is summarised in Table 5.1. These contextual factors refer to particular groups of clients (micro-level of the intervention) but they are defined by this 'particular programme site' (macro and meso-level of the intervention). For example, a person with housing needs will encounter more or less obstacles to leaving hospital depending on the resources available locally that could meet his/her particular needs. In the following sections of this chapter, some of the contexts on the list are explained in detail. Others will be further explained or referred to in the subsequent chapters of the thesis.

Table 5.1: List of Contexts

	Context	Type
C1	Recuperation needs	Micro
C2	Social care needs are self-funded	Micro
C3	Housing needs	Micro
C4	NHS continuing healthcare needs	Micro
C5	Social services funded care needs	Micro
C6	Rehabilitation needs	Micro
C7	Family challenges MDT team recommendation	Micro
C8	Financial situation is not assessed before discharge	Meso
C9	Discharge destination is not negotiated at MDT	Meso
C10	Ignorance of codes in social services staff	Meso
C11	Patient is clearly NOT involved in discharge planning decisions	Meso
C12	Patient (or family) involved in discharge planning decisions	Meso
C13	Health needs exclude patient from reimbursement	Macro
C14	Financial needs exclude patient from reimbursement	Macro
C15	'Choice' excludes patients from reimbursement	Macro
C16	Other needs like housing exclude patient from reimbursement	Macro
C17	Patient could incur a fine	Macro
C18	Patient is not informed of discharge date in advance	Meso

Finally, a specific amount of time is necessary for a cause to have an impact or effect. The assessment of a programme in a particular point in time of its life-cycle generates the observation of specific outcome patterns. That is, 'timing of programme evaluation' is considered an overall contextual factor that shaped the configurations observed in the interval of time when the evaluation took place.

5.3 Contextual Circumstances of the Local Healthcare Services: A Financial Imbalance

Two main health institutions are considered significant in framing the local healthcare context: the foundation trust hospital and the primary care trust. Traditionally, research on delayed discharges concentrates on the characteristics of the acute hospital where the delays occurred. Figure 5.1 illustrates how the hospital is financially affiliated with other public and private institutions due to the fragmentation of responsibilities generated by the internal market in health and social care. This relationship is dictated by the macro-social phenomena of national legislation which established how these organisations must be administratively related to each other. The PCT is the institution that holds the budget to pay for the health treatment of its population (commissioning services) and consequently, they pay

hospitals for the acute treatment they provide to their residents. Social services departments are a direct provider of social care but they also pay (commission) to other for profit or not for profit agencies to supply social care to the population.

Figure 5.1: Main Institutional Relationships in Healthcare according to National Policy

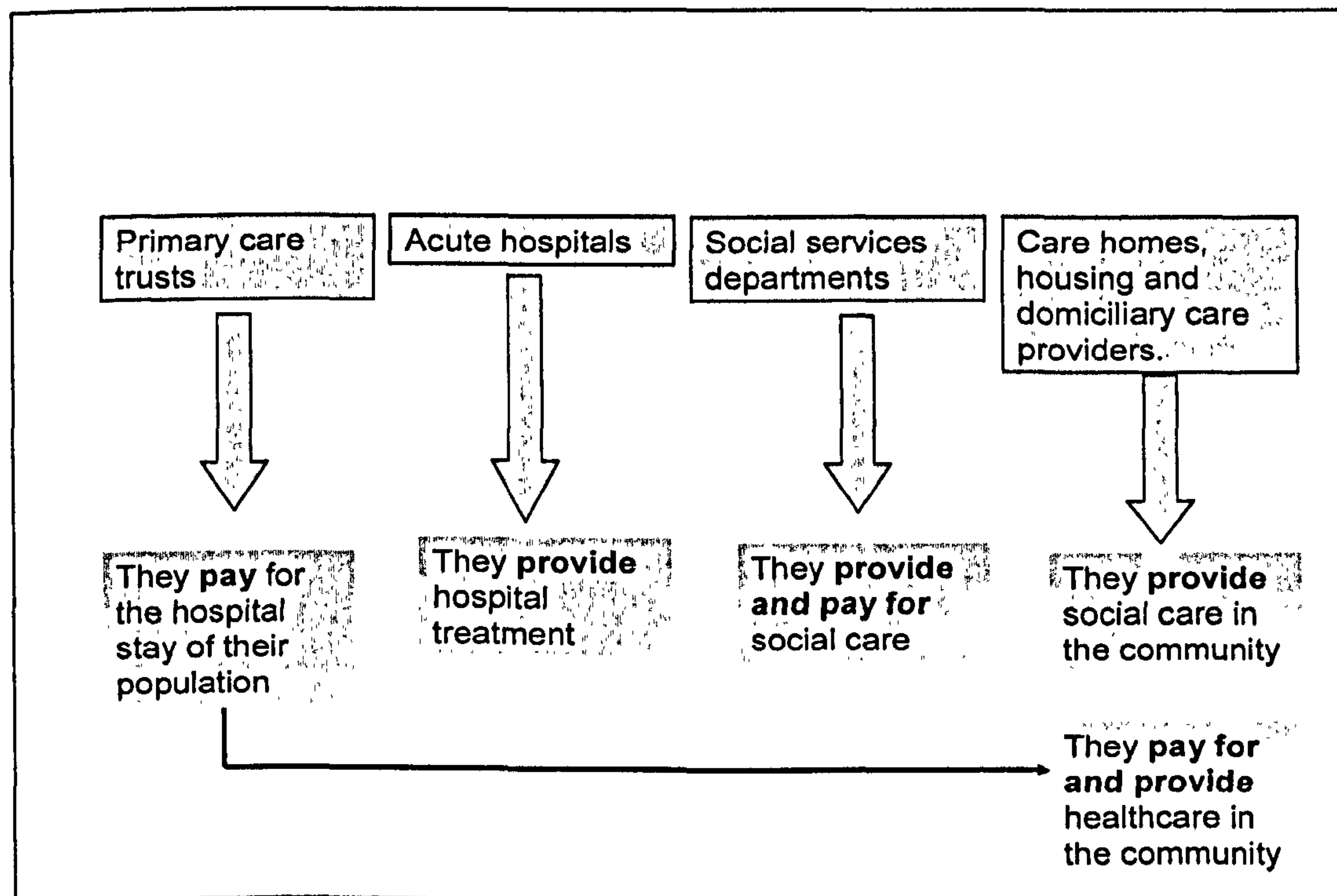

The administrative relationship between all these institutions is the same for all English localities. However, decentralisation and flexibilities brought in by the quasi-market means that they relate to each other in singular ways that are explored below.

5.3.1 The Foundation Trust Hospital

This local hospital serves over 170,000 people, the majority of them residents of the local authority under study. However, as the hospital borders with a neighbouring metropolitan borough with city status, this hospital admits a considerable number of patients from the North East of the city. Significantly, in their interviews, hospital staff were able to compare the resources of both local authorities (their own and the neighbours) and this comparison informed the construction of some of the contextual local features. In January 2005, the hospital was successful in becoming one of the 32 NHS foundation trust hospitals in the country. Only high performing hospitals can

apply for foundation trust status, and this was the case of this local hospital, which was awarded three stars in 2003, just before it expressed interest in becoming a foundation trust. The hospital has continued to perform well, not only against the Department of Health performance indicators, but also financially, as it was stated in its annual accounts: 'The outturn income and expenditure position for the NHS Foundation Trust for 2005/2006 was one of financial balance' (Confidential Reference 2, 2006: 14).

Foundation Trusts are independent not-for-profit entities ('public benefit corporations'), part of the NHS but outside the direct control of the Department of Health and the Secretary of State for Health, managed locally rather than nationally. The key differences between foundation trust hospitals and existing NHS trusts are:

- 'The board comprises local people, patients and staff as elected members;
- They have more freedom to invest and dis-invest coupled with the right to work with private partners from any industrial sector.
- They can retain surpluses for investment in the development of services.
- They have some advantages in recruiting and retaining staff' (Boyle, 2005: 1).

Although the Government argued that the introduction of foundation trust hospitals would improve the provision of healthcare at the local level, critics stated that they were just another step towards the privatisation of the acute hospital sector. They also pointed out the risk of inequalities between areas and the danger of favouritism towards hospital provision at the expense of primary and community care (Walshe, 2003; Boyle, 2005). In other words, competition is based on losers and winners. As Figure 5.1 illustrates, the finance of other institutions is linked to that of the hospitals. If hospitals are trying to 'earn money', that money could in some circumstances be earned at the expense of the institutions that pay for their services: i.e. the PCTs and social services departments (with the introduction of the Delayed Discharges Act). In 2006, in the locality where the empirical work took place, the institutions providing primary care (PCT) and community care (social services) had significantly overspent budgets; while the acute care provider (foundation trust hospital) had balanced finances.

As discussed in Chapter Two, the reduction of delayed discharges has been a national target for acute hospitals since 2001. Consequently, when evaluating the impact of the fines for social delays in this local foundation trust hospital, the number of delayed discharges is a key contextual feature that must be looked at in detail. The indicator 'delayed transfer of care' is the performance indicator against the existing national target that consisted of reducing the number of delayed discharges to a minimal level by 2006. This performance indicator is defined as 'the number of patients occupying an acute bed whose transfer of care was delayed divided by the number of patients occupying an acute bed summed across all 52 weeks' (Healthcare Commission, 2006). If the resulting figure is less than or equal to 3.5%, the hospital achieves the target. In 2006, the hospital under study scored 2.67% and therefore it met the national target. However, the hospital's previous scores for this indicator were significantly worse and this could explain their sensitivity towards this problem. The local process in achieving the national target for this performance indicator is summarised below and illustrated in Figure 5.2.

- In 2002/2003, the first year after this performance indicator was created, the local hospital scored 7.5%, being classified as 'below average'. The lowest score was defined as 'significantly below average' at greater than 8.5% (Healthcare Commission, 2003).
- In 2003/2004, the year when the Delayed Discharges Act was implemented, the local hospital scored in 'Band 1 poor'; with a score greater than 6.3%. 'Band 5 good' was defined at less than or equal to 0.9% (Healthcare Commission, 2004a). This was the only indicator where the hospital had a poor performance.
- In 2004/2005, the local hospital scored 'Band 2' which was now re-defined as less than or equal to 5.0% and greater than 3.5% (Healthcare Commission, 2005). The hospital scored 5.0% at the edge of scoring in 'Band 1 poor', which was now decreased to greater than 5.0%. Again, this was the indicator in which the hospital had the lowest score, having an overall high performance that gave them the maximum award of three stars.
- Finally, in 2006 the local hospital achieved the national target ($\leq 3\%$) reporting a percentage of delayed discharges at 2.67%.

Figure 5.2: Local Progress in Achieving the Target for the Performance Indicator 'Delayed Transfers of Care'

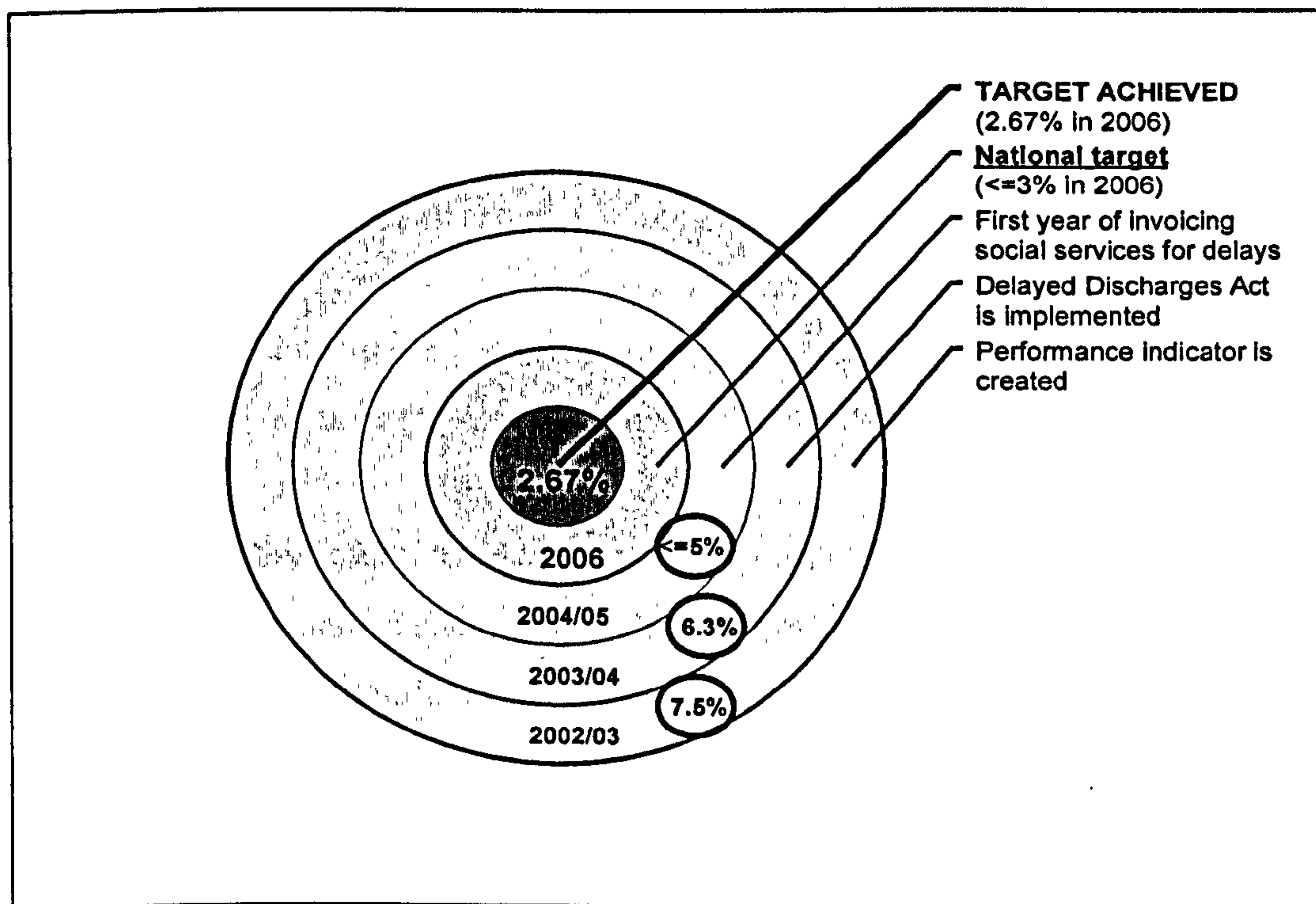

In summary, when the fines were implemented the local hospital already demonstrated an unsatisfactory performance in managing delayed discharges. Furthermore, this indicator was the only one on which they had a poor performance and consequently, the hospital chose to make full use of the 'fines scheme', a choice possibly attributable to their poor performance in this one indicator. In Chapter Two, it was explained how the Act allows for other types of inter-agency arrangements that do not involve formal fine and invoicing structures. In response other areas did not use the fines as mechanisms to reduce the number of delayed discharges. Acute hospitals are the institutions dictating how the reimbursement contractual relationship is defined and this hospital chose the most robust version of that relationship. Three years later, they had achieved the national target. Therefore, a first simple quantitative analysis shows that the fines worked fast to reduce delayed discharges. The number of delayed discharges had been slowly decreasing since 2002 but it halved in 2006. The figures reveal a large reduction but, later on in the thesis, it will be shown how this quantitative achievement does not reflect all the outcomes produced by the fines.

5.3.2 The Primary Care Trust

Primary care trusts (PCTs) are local health organisations responsible for ‘securing the provision of primary care, community health, mental health and acute secondary care services, personal medical services, medical, dental, pharmaceutical and optical services and emergency ambulance and patient transport services’ (Baggot, 2004: 163). They receive funding from the NHS, providing some services themselves or commissioning them from providers, such as acute care from hospitals.

In October 2006, four PCTs in the area where the fieldwork took place were reorganised into one unified PCT. This is geographically the largest in England covering 3,200 square miles, and the third largest in population terms at 765,000. This reorganisation created one institution with a major deficit in its finances. In November 2006, the newly created PCT announced a forecast of £24.5 million overspend at the end of March 2007, with the plan to save £42.4 million in 2006/2007 (Confidential Reference 3, 2006). However, in March 2007, the PCT announced that, at the end of January 2007, with a budget of £877m it had a deficit of £31.2m and was forecasting an end of year deficit of £37.7m (Confidential Reference 4, 2007). The trading position on a number of contracts showed significant overspends. The most notable of these involved five acute hospitals, one of which was the foundation trust hospital in the locality of the study. Critically, the PCT stated that they continued to have no agreement in terms of the contractual position of three key providers and again the foundation trust hospital in our locality was one of them. This is significant because the financial performances of both organisations are linked because most of the hospital services are commissioned by the PCT. The hospital recognised this in its annual accounts, establishing the financial position of the PCT as a factor that influenced its financial performance (Confidential Reference 2, 2006).

Therefore, the main local healthcare institutions have conflicting financial interests highlighted by the strong economic performance of one against the weak performance of the other. Nevertheless, this situation is obviously intrinsic within the theory of quasi-markets in healthcare and a consequence of the purchaser/provider split. In this case, though, an overstretched PCT has to buy acute services from a hospital with a

healthy financial position. This is significant in terms of delayed discharges because in the event of joint working being necessary to facilitate complex discharges, both organisations look after their own financial interests. A significant 'context' ('C6 recuperation needs') emerged from these particular circumstances. The PCT owns and funds the only NHS facility in the area that provides 'recuperation' for patients who have been in hospital and need a convalescence period before going back home. In 2006, a cost analysis report of this facility (a community hospital) stated that:

'Under the current rules the only income received from patients transferred to the community hospital comes from excess bed days. Patients who are transferred to the community hospital before a normal trim point provide no income' (Confidential Reference 5, 2006: 16).

This financial imperative was translated in a rule that meant that the community hospital did not accept patients until they had been admitted in the acute hospital for 35 days because, only at that point, their stay is considered 'excess bed days'. Only after that point the community hospital will be making a financial gain by admitting patients transferred from the local foundation trust hospital.

This equation is a significant contextual characteristic which affected the patients who had 'recuperation needs'. This contextual characteristic caused delays in two of the fourteen case studies, to be discussed in the final chapters of the thesis. Patients waited in hospital several weeks until they were accepted by the PCT community hospital. Moreover, observations of the multidisciplinary team meetings showed how they continuously expressed their inability to contact the community hospital before patients had been on the acute wards for at least 35 days. In this locality, the community hospital was the only option for patients who need to be transferred to a 'recuperation' establishment and therefore they were routinely delayed in the wards.

These recuperation needs are, however, excluded from the local implementation of the reimbursement policy, meaning that if the patient requires convalescence, the fines would not apply. Despite this exclusion, the financial incentive had a significant importance in the development of this contextual feature. In this locality, before the implementation of the fines these patients were placed in nursing homes funded by a joint budget between the local PCT and the social services department. When the

finances were announced, social services decided to withdraw their money for 'recuperation patients' and re-invest it in resources for those patients at risk of incurring fines. This phenomenon has been defined in the sociology of organisations for more than half a century, recognizing that the incentivisation of performance is likely to lead to 'goal displacement'. This is linked to one of the most common assumptions underlying the theory of governance by targets: the part on which performance is measured can adequately represent performance of the whole, and that distribution of performance does not matter. But because performance outside the domain incentivised is assigned less importance, it can decrease. In other words, patients in need of a period of convalescence who were smoothly discharged from hospital before the fines existed; after the fines were implemented, created significant internal delays. These delays, for performance purposes, were now allocated to the NHS. This phenomenon has also been referred to as 'synecdoche' (Bevan and Hood, 2005); 'hitting the target but missing the point', 'tunnel vision' (Smith, 1993), 'parochialism' (Jacobs and Manzi, 2000); or 'what's measured is what matters' (Marshall et al., 2000; Bevan and Hood, 2005).

5.4 Local Contextual Features of Social Care: Lack of Money and Lack of Fines

The local social services department was considered the key institutional actor in the management of delayed discharges and this is why it was the exclusive direct target of the fines. After the 1990's Community Care reforms, local authorities became commissioners of services and reduced their role as direct providers. A mixed economy for social care was stimulated by promotion of the 'purchaser/provider' split. Local authorities purchase social care services and private institutions provide them. Besides the financial situation of the local social services department, three key social care resources required to discharge people from hospital are considered important contextual characteristics in the local implementation of the Delayed Discharges programme. These are: local demand and supply of residential and nursing care, provision of domiciliary care services and appropriate council housing capacity. The local social services financial situation and the three specific resources mentioned above are analysed in the next four subsections.

5.4.1 Social Services Financial Situation

It is commonly assumed that one of the main reasons behind inefficiencies in the use of hospital beds is the lack of social care resources to provide support for patients following discharge. The levels of social care services purchased are 'dependent, among other things, on the budgetary constraints faced by local authorities and on the input prices faced by providers of the services' (Fernandez and Forder, 2002: 45). Therefore, the financial capacity of the main social services department providing social care to the patients is a key contextual feature that may influence programme outcomes. In 2005-06, gross current expenditure on personal social care by councils with social services responsibilities in England was £19.3 billion, an increase of 6 per cent in cash terms (4% in real terms) from the previous year; and 10 per cent in real terms since 2003-04 (The Information Centre, 2007). However, social services departments are considered to be chronically underfunded (Social Policy Aging Information Network, 2001; Wanless, 2006) and continue to overspend their allocated budgets. This is the case for the council in our study, which overspent their social care budget by £1.4m in 2005-2006. This expenditure was explained by the high level of capital directed at care home funding: 'due particularly to costs of adult and older people placements' (Confidential Reference 6, 2006: 7).

Overspent budgets appear to be the norm in English social services departments, and consequently this phenomenon could not be taken as the sole indicator when assessing the finances of the local department. Instead, the Fair Access to Care Services (FACS) national framework for adult social care eligibility criteria was considered a significant indicator of the financial situation of the researched council. As summarised in Chapter Four, in April 2003, English councils were given four bands for prioritising individuals' needs (low, moderate, substantial and critical), based on the seriousness of the assessed risk to people's independence if problems were not addressed. These four bands are based on standardised definitions and they apply to all social services departments across England, though each council sets its eligibility threshold according to its current financial position and make public its choice of threshold. In other words, each council decides which bands they can afford to meet and they maintain it for all adult services. In 2003, the research site started funding services to meet the substantial needs of their residents; but in April 2005, they

decided to change from substantial needs to fund only critical needs (Confidential Reference 7, 2005). They continued to fund only people assessed in the critical band until March 2007 (during all the fieldwork), when they reverted to the funding of substantial needs again. Table 5.2 showed how, in comparison with ten other neighbouring councils, the research site was the only one that limited its resources to funding critical needs (Confidential Reference 8, 2006: 9).

Table 5.2: Comparisons of FACS Needs Funded by Neighbouring Councils in 2006 (from Confidential Reference 8, 2006)

COUNCIL	CRITICAL NEED	SUBSTANTIAL NEED	MODERATE NEED	LOW NEED
RESEARCH SITE Council	√			
Council 1	√	√	√	√
Council 2	√	√	√	
Council 3	√	√	√	
Council 4	√	√	√	
Council 5	√	√	√	
Council 6	√	√	√	
Council 7	√	√		
Council 8	√	√		
Council 9	√	√		
Council 10	√	√		

In 2006, there were waiting lists for services even for people assessed as critical and the number of complaints to the council had increased (Confidential Reference 8, 2006). This may have had an impact on the delayed discharges rates as argued by Fernandez and Forder (2002: 46) 'Richer local authorities are able to purchase higher levels of services and face, results suggest, lower delay discharges rates'. When these authors discuss 'richer' local authorities, they refer to authorities with high budget allocations for social care. Localities richer in housing stock or household incomes are not necessarily richer in social services budget. The Commission for Social Care Inspection referred to the way eligibility criteria had restricted services in this council:

'The inspection found that services to disabled people and their carers were relatively under-developed in (name of the county council). There had been no

clear strategy and no clear planning process, and there had been very limited use of Health Act flexibilities and joint commissioning. There was no obvious leadership for the services to give them focused attention and drive improvement. This situation had been exacerbated by the decision to restrict eligibility for services in the face of budget pressures. (Name of the County Council) was a relatively low spender on services to disabled people compared to similar councils and supported a relatively low number of disabled people. The staff groups that worked with people with sensory impairments were very thinly spread and there was inconsistency in levels of service available across the county in relation to these and other services' (Confidential Reference 9, 2005c: 1).

Consequently, the local social services department, with overstretched finances, have to confront the risk of fines that could potentially drain their finances even more. This fear was expressed by local stakeholders before the implementation of the Delayed Discharges Act. They feared that 'the Local Authority could experience serious financial pressures and quickly become unable to meet current commitments for older peoples' services' (Confidential Reference 10, 2002: i). These financial circumstances drove the action of the local social services department to closely control all funding decisions through a weekly panel called the Capacity and Risk Assessment Meeting (CRAM). This panel is used as 'budget balancing factor' (Confidential Reference 8, 2006:9) with the following objectives directly quoted from the Delayed Discharges local implementation protocol:

- a) 'to review all placements agreed through the previous week
- b) monitor budgets
- c) ensure consistency of eligibility criteria
- d) prioritise needs of all applications including those people in the community or occupying non-acute beds
- e) ensure interim facilities are fully and effectively utilised and continue to meet the needs of the people using them' (Confidential Reference 1, 2004: 15).

The immediate consequence of this funding panel is that managers rather than front-line staff who have the direct knowledge about the patient needs, decide on the allocation of services. Misunderstandings, outdated information about patient or family issues and unclear communication channels are key factors that can potentially affect the effectiveness of such panels (See Case 1 in Chapter Seven for an example of miscommunication between CRAM and front-line staff). Secondly, decisions on funding for services following discharges are made only weekly, when the CRAM meeting takes place. This arrangement has the potential of generating a slow reaction

time for decisions, although exceptions to this timeframe were reported in 'urgent' cases.

5.4.2 Residential and Nursing Care Provision

The relationship between delayed discharges and care home provision is frequently mentioned by research. Some evaluators of delayed transfers of care have assumed that increased delayed discharges are caused primarily by a reduction in the number of care home vacancies (National Audit Office, 2003; Healthcare Commission, 2004b). The financial analysis of the care home markets tends to conclude that demand for residential care depends, in part, on the availability of other service alternatives to long-term admissions, generally domiciliary care (Fernandez and Forder, 2002). This means that, if the number of homecare services increases, there would be less demand for care establishments.

The past history of this locality as a retirement destination generated an accumulation of care homes. Locally, during 1984, the number of private nursing home beds had risen from 275 in 1981, to over 600, with 38.8 per cent of the residents having their last permanent address outside the district (McGlennon, 1984). However, between 1985 and 2001, a decline in the number of care establishments was observed, although provision was still high, it was no longer considered exceptional (Confidential Reference 11, 2002). Nevertheless, the increase in the number of care home admissions in the 1980s was a national trend generated by changes in social security regulations (Glasby and Henwood, 2005).

In the UK since the 1990s, the care home market has largely been left to the private sector to develop with the result that provision is patchy across the country and left to market forces. A common assumption in this area of financial analysis is that local authorities are the main commissioners of publicly subsidised residential and nursing care, and therefore, they have a role in keeping down the market prices in their localities. However, in this area, with 75.4% of owner-occupied households, the majority of older people going into care would have enough assets to be considered self-funders. Therefore, the power of the local authority in controlling prices is not necessarily significant. These local factors help the development of the context 'C2

self-funding population' which refers to patients who, when they are means-tested by social services, have to self-fund the resources needed to facilitate their discharge. Self-funder patients are excluded from the reimbursement policy and this locality has a great number of those. This was evidenced by the significant number of self-funders (eight) that emerged in the fourteen case studies.

A second significant contextual characteristic is that this local authority, with little control over the local care market prices decided to buy in bulk beds to transfer patients who could incur fines. That is, a number of beds are pre-purchased annually at a lower cost than the market price and used exclusively to reduce hospital delayed discharges. Patients are expected to stay in these establishments from four to six weeks and then move back to their own homes with the services needed or into another long-term facility of their choice. This practice is not exclusive to this local authority. With the implementation of the fines for social services delays, local authorities across England decided to consolidate the practice of purchasing blocks of beds in private care establishments at a reduced price. These beds, called 'interim, transitional or step-down' beds, are offered across the nation to patients awaiting capacity or service of their choice in care homes or in their homes with domiciliary support.

Interim beds were also used in the Scandinavian countries that implemented the fines in the 1990s. For instance, in Norway patients were transferred to short-stay units where they could stay a maximum of three weeks and the cost of the stay was funded by social services (Health Committee, 2004). A significant contextual difference between countries was that, in England social care is means-tested and the transfer to interim bed was administratively conceptualised as social care. The Department of Health implementation guidance to local authorities supported this practice and it established that:

'depending on the particular service and local arrangements interim care may or may not be subject to a charge. Services provided by the NHS are free of charge. Where intermediate care is provided by social services, this is free for six weeks. Social services are required to charge for residential care but have discretion not to charge for eight weeks and have discretion in relation to community based services' (Department of Health, 2003c: 6).

Interim beds were devised nationally as key mechanisms to facilitate faster discharges and therefore to avoid fines, but they are embedded with local contextual characteristics. The variety of costing criteria permitted under the national guidance allowed local authorities discretion on whether or not to charge. In 2004, when the Delayed Discharges programme was implemented, the social services department in the research site offered transfers to interim accommodation free of charge for a maximum of four weeks. Eventually, they decided to means test patients on transfer to interim accommodation in private homes and, at the time of the fieldwork, patients were means-tested from day one of the transfers. In other localities, social services paid for two weeks and, afterwards, patients were charged (Godfrey et al., 2008). In this local authority, transfer to these beds is subject to management approval obtained in the weekly CRAM meeting.

Before reimbursement this locality used 'pre-placement beds' which were jointly funded by health agencies and social services with no charge to the person. Anyone who needed a temporary placement could be transferred to these beds whether they were self-funding or not. However, with the implementation of the fines scheme, this facility was withdrawn and self-funders were excluded from the possibility of temporary transfers. Local provision of interim accommodation to facilitate discharges increased significantly after the Delayed Discharges Act, but it is still quite limited in comparison with other social services departments with higher number of social services funded patients. The local provision of interim facilities at March 2007 was:

- Seven beds in a local authority residential home.
- One bed in a local authority residential home for elderly mentally ill patients.
- Eight beds in private nursing homes.
- Flexible use of residential beds in a local authority home that was closing down (around five beds at the time of the fieldwork).
- Two 'extra care' housing apartments with homecare service (free of charge for the first two weeks).

The number of transitional care homes available for patients to choose is an important characteristic because a high proportion of people refuse the transfer to interim beds.

Crotty et al. (2005) reported that more than a third of the patients in their sample refused to be transferred to interim accommodation. Refusal happened because patients either thought that the home offered was too far from relatives and friends, or they only wanted one transition from hospital to long-term care. Interim facilities are bought in block in specific care homes and can be located considerably further away from the patients' home than the hospital. This is of crucial importance in this locality because the social services department serves a big rural community with no interim facilities in more remote areas and older relatives and friends of patients have to be reliant on infrequent public transport to visit them. Although the local authority could also draw individual contracts (called 'spot contracts') with other care establishments, these homes could charge more for their beds than the local social services department could afford.

In summary, the smaller the range of interim beds offered, the higher the likelihood of the interim beds being rejected. The choice available in this locality was reduced to a small number of homes that could be far away from the patients' home and for which they have to pay. These facilities cannot be offered to people who are assessed as having to self-fund their admission into long-term care establishments.

5.4.3 Domiciliary Care Services

Homecare services have been identified as 'the most cost-effective alternative for reducing delays' (Fernandez and Forder, 2002: 47) and this is why an understanding of homecare provision in the research site provides vital contextual information necessary to understand the efficiency of the financing system. In England, between September 2001 and September 2005, the number of homecare hours provided by social services increased by 24% while the number of households receiving services decreased by 7%. This suggests that more intensive services are being provided for a smaller number of service users, continuing a trend observed nationally over the last 10 years (National Statistics, 2006).

However, this local social services department covers a considerable rural area and there is a well known problem of the lack of capacity to provide personal care services in remote country areas. The significant growth of independent sector

providers of domiciliary care exacerbates capacity problems. Private agencies have increasing difficulties in recruiting staff and they also struggle to run cost efficient services because of the need to cover large and sparsely populated areas, which raises the unit costs (Roderick, 1999; Wenger, 2001). In the research site, according to the latest inspection report (Confidential Reference 6, 2006), the percentage of older people helped to live at home has increased from the previous year but it is still lower than the national average. The costs for homecare in the area rose above the group average: 'the impact on the market particularly for home care, may adversely affect the implementation of the council's strategy to promote choice for people to remain living in the community' (Confidential Reference 6, 2006: 7). Although the council wishes to enable people to live independent lives, the restriction in eligibility for social care services is making it more difficult for this objective to succeed. In the context of severe resource constraints, there is limited scope for real choice to be offered to many service users and carers. These limitations were explained by social services staff:

'The rural areas are difficult. What tends to happen in the rural areas, if you're lucky enough to be able to get the care package, you can't necessarily get the timings that you want. So people have to.., you know, they might like to get up at 7 o'clock in the morning but you've got an agency that can do the call, but can't call in until 10 o'clock. Because you do try to explain that you don't always get the times that people want and may have to start off with something a bit later and then move when the vacancy occurs. And they are pretty good at saying, 'Well Ok then, to start off with then I'll accept a 10 o'clock call', or whatever' (Interview with social services care manager, Case 10).

Nevertheless, these contextual characteristics did not operate as an obstacle for discharges in any of the cases of the sample. The innovation of free personal care provided through intermediate care for a maximum of six weeks for all hospital patients introduced with the Delayed Discharges Act helped to facilitate homecare packages for patients. In the discharge of Mrs Edington (Case 5, more information on this case can be found in Chapter Seven, section 7.2.5) a person who lived in a rural area and needed a package of care, none of the homecare agencies commissioned for that area had staff available to provide the service at the time of discharge. However, social services staff asked the local intermediate care team to provide homecare temporarily and the person was discharged on time.

5.4.4 Housing Capacity

In this locality, the social services department is administratively dependent on the county council but it is managed locally. The area is a borough under the administrative control of a county council which is divided into a number of local districts. Its location had a population of approximately 152,000 people in 2001, 17% of the local population was over 65 years of age which is well over the national average (Census, 2001). With a 98.4% white population and a large urban centre, there are also extensive rural areas. A popular retirement destination in the past, the main town continues to be strongly associated with medical and social care, which accounts for 17.5% of jobs compared with 11% in the region (Confidential Reference 11, 2002).

High property prices and lack of affordable and council housing are also characteristics of this locality, where 75.4% of the households are owner-occupied and only 6.1% are rented from a local authority (Census, 2001). There is an acute shortage of council properties with long waiting list (Confidential Reference 12, 2007). The lack of council housing in the town framed the emergence of another key contextual feature of the implementation of the Delayed Discharges Programme (C3 'housing needs'). Prompt access to adequate housing was a difficulty identified before implementation of the Delayed Discharges programme (Department of Health, 2003c). Cultural and organisational divides between housing departments, social services and health were recognised as limiting effective joint working. Besides the requirement of multi-agency agreements, the need to secure a variety of housing options for discharging patients, in many localities would have meant a significant increase in the stock of affordable, supportive housing. Critically, the Swedish fine scheme was accompanied by the increase of the housing alternatives available and the improvement of the quality housing facilities for older and disabled people. Nonetheless, even though the Swedish housing system is praised for its high quality 'special housing' infrastructure (Minford, 2001), insufficient services and care being available on demand were still reported as problems. The fundamental contextual difference in the English implementation is evident especially in localities like the one in this study, with historical shortages of affordable housing.

Significantly, the Delayed Discharges policy designers anticipated patients with housing needs as another point of conflict. Initially, they intended to fine social services for the delays caused by patients waiting for appropriate housing but, after receiving feedback in the early stages of implementation, they decided to exclude these patients from the reimbursement scheme (Department of Health, 2003c: 21). Their concern was correct: hospital patients who needed re-housing struggled to find a smooth way out of hospital. In this locality, there is not only a shortage of local housing resources but also there is a historical lack of a working relationship between the local housing department and all the other institutions dealing with hospital discharges. This contributed to the lack of involvement of the housing department in the preparatory agreements (local protocol) for the Delayed Discharges Act. Consequently, when re-housing services are required for hospital patients, staff have to deal with an agency without systems in place to facilitate fast discharges.

The lack of resources and relevant multi-agency schemes with the local housing department added yet another level of complexity to discharge procedures. First, patients had long waits to be allocated a council property and then if required, suitable alterations had to be undertaken in the flat. This was the situation observed in Case 4 of the sample, which was a young person who had a stroke, lived in a third floor council flat without a lift and was unable to climb stairs. In section 7.2.4 of Chapter Four, this case is explained in detail but, the most relevant point for this argument is that this patient experienced the longest delay in all of the cases observed.

5.5 The Health and Social Care Multi-Agency Arrangements

‘When a program involves cooperation between two or more organizations, interorganizational processes become complicated and may condition implementation processes and program consequences’ (Chen, 1990: 282). The divide between health and social care systems characteristic of the English system, with conflictive incentives, different structures and financial cycles, and even different geographical boundaries (Lewis, 2001) shaped the implementation choices of the fining system that characterised the Delayed Discharges Act. In other countries where fine schemes for hospital delays have been used, different levels of integration between health and

social care agencies apply (Andersson and Karlberg, 2000; Minford, 2001; Colmorton et al., 2004).

In the UK, the 1990s Community Care reforms recognised the need of health and social care to work together but it was a decade later that Section 31 of the Health Act 1999 introduced optional financial flexibilities which allowed NHS and local authorities to use 'pooled budgets' for specific services. The objective of this legislation was to promote partnerships and integration between health and social care agencies. However, the national historic difficulties described above, in conjunction with complicated local relationships, generated a slower than expected use of these flexibilities:

'Implementation has not always been easy, however, and some barriers to local partnerships remain. Some of these barriers, such as different financial planning systems and performance management systems for the NHS and local government, need to be addressed by central government. Others, such as those rooted in cautious local relationships require greater effort from local policy and provider networks' (Glendinning et al., 2002: VI).

In 2006, the council administratively dependent of the research site was described as an authority where 'there had been very limited use of Health Act flexibilities and joint commissioning' (Confidential Reference 9, 2005c:1). For the purposes of this research, two aspects of the relationship between the local health and social care agencies are selected as possible influences on the outcomes of the Delayed Discharges programme: the development of intermediate care services and the arrangements for NHS continuing healthcare patients.

5.5.1 Intermediate Care Services

Nationally, there is no general consensus on the definition of 'intermediate care' (Melis et al., 2004). The term was introduced in the UK with the NHS Plan (2000) and refined in the National Service Framework for Older People (Department of Health, 2001b) but differing local interpretations of the term were born from differing contexts (Godfrey et al., 2005). A comprehensive definition of the term is offered by Cowpe (2005):

'Intermediate care, when fully developed, comprises networks of local health and social care services, which deliver targeted, short term support to individual patients or clients, in order to prevent inappropriate admission to NHS acute inpatient or continuing care, or long-term residential care, facilitate earlier discharge from hospital, and most importantly, maximise people's ability to live independently within their communities' (p. 3).

In the research site, 'intermediate care' was defined locally as:

'a whole system approach to a range of multi-disciplinary, multi-agency services designed to promote, improve and maintain independence, health and well-being by:

- reducing avoidable admissions to acute hospitals;
- facilitating timely discharge from acute hospitals; minimising premature or avoidable dependence on long term care in institutional settings; promoting effective rehabilitation and recuperation opportunities' (Confidential Reference 13, 2005: 110).

The reimbursement regulations exclude from the fines scheme people with intermediate care or rehabilitation needs; nevertheless, this is still a significant group of hospital patients. Most significantly, intermediate care needs are not always clear when people are referred to social services for assessments and, in addition, the local services do not always provide a comprehensive choice of facilities to meet these needs.

The existence of great national variations in the level of investment in intermediate care services embeds these resources with local contextual characteristics. In this locality, there is evidence of an early development of a range of intermediate care facilities using Section 31 of the Health Act 1999. However, 'in the main they are services not initially designed, or designated as intermediate care but subsequently relabelled as such' (Confidential Reference 13, 2005: 107). Although 'recycling' schemes does not necessarily affect the quality of their services, it can frame the resulting products. In 2000/2001, the following services were funded by pooled (health and social care) budgets in this local area: rapid response beds, recuperation/step-down beds, rehabilitation beds, community based-support, rehabilitation services and overnight support in peoples' own homes.

The services listed above are divided into those that offer residential accommodation and those provided in the people's own homes. In a residential care home owned by

the county council, a rehabilitation unit with eight beds is the dedicated residential accommodation resource for people with rehabilitation needs. The home is located in a large suburb to the east of the town centre, well linked with public transport for people travelling from the town but not for those travelling from the rural areas of the district. The geographical position of the only rehabilitation beds offered by this local authority is significant because there is a lack of provision of this sort of establishment for the rural population. A community rehabilitation team helps to discharge people back to their own homes after their stay in the rehabilitation unit. These teams 'tend to provide a comprehensive range of services, including equipment as well as therapy, not just specific to intermediate care. They provide living aids, bath aids, home based occupational therapy, exercise programmes for people with arthritis and falls prevention programmes' (Roe, 2005:70).

Before the Delayed Discharges Act, this locality also offered 'recuperation/step-down beds'. These had the objective of 'providing care to recover 'fitness' to return home and where the user would not benefit at this stage from a rehabilitation programme' (Godfrey et al., 2005: 131). Patients could stay in those beds for up to six weeks and they were used mainly to provide a period of convalescence for people discharged from hospital. However, with the arrival of the fines scheme, the local authority decided to stop providing this service, concentrating on the provision of interim care and leaving a significant gap in the services yet to be filled. As previously explained in section 5.3.2 of this chapter, now the PCT have to provide the resource for patients with 'recuperation needs'. The only establishment in the area available to transfer these patients is the PCT community hospital. But this facility has its own contextual characteristics: patients need to stay in the acute hospital 35 days before they can be admitted there and patients who are not heavily dependent are preferred due to reduced staffing levels. Equally important, the facility is located 12 miles away from the acute hospital. For older people reliant on public transport, a transfer there could mean isolation from friends and relatives.

With regard to intermediate care services for people in their own homes, two joint health and social care teams (one for the urban area and one for the rural area) were developed with the introduction of the Delayed Discharges Act. The aim of this service is to 'prevent avoidable hospital admissions, facilitate early discharge and

provide out of hours skilled nursing care, thus enabling service users to maintain an optimum level of independence within their own home or care setting'. This initiative has been used by the Reimbursement Change Agent Team as an example of a 'bright idea' to improve discharges (Confidential Reference 14, 2004c). However, these are small teams run with limited personnel. Therapy staff in the research site confirmed that intermediate homecare services in a neighbouring city are 'far superior. Rehabilitation visits are up to four times a day in (Name of neighbouring town), once a flood in here. There is no comparison' (Interview with hospital therapist, Case 6).

5.5.2 NHS Continuing Healthcare

Guidance on NHS responsibilities for continuing healthcare is under constant review. In October 2007 a National Framework for NHS continuing healthcare and NHS-funded nursing care was implemented. People with NHS continuing healthcare needs are defined as those whose health needs are 'primary'. This is assessed according to four indicators (Department of Health, 2007c):

- 'nature – the type of condition or treatment required and its quality and quantity
- complexity – symptoms that interact, making them difficult to manage or control
- intensity – one or more needs which are so severe that they require regular interventions
- unpredictability – unexpected changes in condition that are difficult to manage and present a risk to you or to others'(p. 4).

The package of services identified for these patients must be arranged and funded by the NHS. Continuing healthcare is free at the point of service, unlike social care for which a charge may be required depending on people's finances. This, however, is a highly contested policy area. In the last years, it has been the subject of two critical reports from the Health Ombudsman and one from the Health Select Committee (Samuel, 2006). Citizens have legally challenged decisions of refused funding with some important successes that have modified future policies and guidance. Examples of these are the 'Coughlan case' (Luxton, 2003) and the 'Grogan case' (ADSS, 2006).

Individual PCTs currently interpret national guidelines very differently and consequently there is great local variance in the allocation of NHS continuing care funding (Jerome, 2007). The PCT studied in this research, as of 31 March 2007, was awarding 211 people continuing care, which represents a ratio of 2.47 people per 10,000. This compares with the PCT that approved the highest level of funding in England (for 826 people – a rate of 41.75 per 10,000 people (Age Concern, 2007)).

In addition to variation in funding, local PCTs also have diverse assessment procedures based on a national assessment framework. This guidance establishes that the decision for eligibility for NHS continuing healthcare must be done in collaboration with the local authority. Although some PCTs organise weekly panels of senior staff to determine eligibility using their strategic health authority criteria (Vindlacheruvu and Luxton, 2006), this local PCT employs two designated officers to decide eligibility for funding. In practice, at the time of fieldwork, two people (one PCT nurse and one senior social care officer) make decisions about eligibility for NHS continuing care based on an application form (assessment tool) completed jointly by health and social care staff. If the needs of a person meet the NHS continuing healthcare eligibility criteria, the application is submitted to the designated officers and they judge on paper if funding should be allocated. This procedure has not been designed to resolve cases with the immediacy required for hospital discharge and days pass until decisions are formally communicated to families and professionals involved.

Patients with continuing healthcare needs are excluded from the reimbursement scheme. Nevertheless, their complex circumstances and administration of their needs are factors that interact with the clear division and sequence between health and social needs in which the reimbursement programme is based. One of the patients followed during fieldwork in this research (Case 2) demonstrates how the sequence imposed by the programme (first NHS continuing care assessment, then request a social services assessment) conflicts with illness contingencies. Case 2 was an old woman with continuing healthcare needs who was drawn into social services procedures. Although she was actually entitled to NHS continuing healthcare funding, she was discharged from hospital thinking that she may have to sell her house to pay for a nursing home. The local administration of the continuing healthcare application form was not

flexible and prompt enough to avoid the distress for this person and her relatives. More details of this case are described in section 7.2.2 of Chapter Seven.

5.6 Summary

This chapter describes some of the contextual circumstances relevant to delayed discharges that operate in the research site. Institutional factors located at the meso-level of the programme intervention determine the choices and journeys of programme participants. Features of the local hospital, primary care trust and social care services generate contexts that influenced the way in which fines work in this locality. The most significant factors have been analysed in this chapter; some others will be explored in the following chapters. More factors exist but they are not described in this thesis because they were not significant for the discharge journeys of the fourteen case studies. This is the case of local mental health services (Koffman et al., 1996) and resources for ethnic minorities (Glasby et al., 2006).

Although characteristics of the organisations targeted for financial incentives programmes are significant, patient personal circumstances could also be as important (Dudley, 2005). How the contextual factors of this particular research site, in combination with individual patients' characteristics shapes the success of the programme is the task that the following chapters seek to explain.

6. PRIMARY ADJUSTMENTS: MECHANISMS AND CORE PROGRAMME OUTCOMES

6.1 Introduction

The detailed examination of complex interrelationships between structural causes, individual behaviour and health and social care needs is a difficult task for both programme designers and evaluators. Evaluators have the advantage, though, of observing them *a posteriori*. Rossi's (1987) 'iron law' of evaluation states that the expected value of any impact assessment of any large scale social programme inclines to zero. In other words, when complex programmes are evaluated in detail, success and failure often strike a balance and little outcome change ensues.

In the previous chapter the constraining circumstances that could frame the development of local mechanisms to reduce the numbers of delayed discharges were examined. The analysis now progresses into the generation of theories about the local mechanisms that, enabled or disabled by those contextual factors, produce two of the most relevant outcomes for this investigation: 'reduced delays' and 'reduced fines'. With this objective, the chapter starts with a clarification of the meaning of 'mechanisms' and 'outcomes' according to the realist framework. The chapter progresses with an in-depth analysis of the mechanisms that could either reduce or avoid fines and it concludes that some of the changes in reduction of delays are based on redefinition of key concepts for delayed discharges like 'safe to transfer' and causes and agencies responsible for delays.

6.2 Mechanisms and Outcomes

All programmes contain resources and mechanisms to generate change that were not present prior to implementation. Mechanisms are the engines behind change; they are the driving force of the possible patterns. They are 'what it is about a program which

makes it work' (Pawson and Tilley, 1997: 66). Mechanisms are the logical chain from resources (the inputs) to reasoning. These resources may be material, emotional, social, etc. and they tend to have the form of 'sticks' (regulation), 'carrots' (economic means) and/or 'sermons' (information) (Vedung, 1998). Mechanisms are internalised by some actors (stakeholders) who take them on and become responsible for them. Nevertheless, mechanisms can also follow their function against the programme logic. In the case of the fines, for example, 'fine avoidance mechanisms' are generated that may not resolve delayed discharges and could even increase delays.

In brief, mechanisms may be intentional or unintended. Consequently, outcomes may be planned or unanticipated by the programme. In other words, intended mechanisms are what the programme theory believes could bring about the desired changes. If everything goes to plan, an intended mechanism will generate an intended outcome. However, stakeholders' choices are not just directed by the mechanisms, they are also influenced by factors external to the programme (for example, other programmes, specific characteristics of local services, etc.). Consequently, contextual circumstances may disturb the planned cause-effect reaction and unplanned mechanisms and outcomes may emerge. The evaluator must be prepared to track both routes.

The fines schemes for social services delays appear to have left an international footprint of rapid decrease of delayed discharges figures and overall reduction of hospital length of stay. In the research site, delays have been significantly reduced since implementation of the programme; this reduction persisted until 2006/2007, when the fieldwork took place. How do they do it? Mechanisms to achieve these outcome patterns are those described by the programme guidance (see Chapter Two for the ten programme innovations) but there are also mechanisms not always explicit in the implementation documentation.

Outcome patterns are the 'beginnings of causal explanation' (Pawson, 2006a: 23). When the Department of Health announced that the fines scheme is a success because delays have been reduced (Outcome), the need emerged to ascertain what it is about the Delayed Discharges programme which works (Mechanisms) for whom and in what conditions (Contexts). Two main core outcomes of the programme are analysed

in this chapter: reduction of delays and fines issued. Using them as a starting point, mechanisms are elicited as initial explanations of those outcomes. Some of them are voiced by staff at the local social services department; others are voiced by the hospital staff who plan patients' discharges. Examples of these mechanisms are found throughout the thesis but in this section the ones that relate to the innovations are described. Later on, in Chapters Seven and Eight the remainder of mechanisms will be explored. The main assumption for the explanation to come is that to study the mechanisms generated to avoid fines, fines do not need to be observed. Even more, the less number of fines, the larger the amount of fine avoidance mechanism in the system.

6.3 Significant Reduction of Delayed Discharges: Outcome Achieved

Fines appeared to work to reduce delays in the three Nordic countries where they were implemented in the 90s: Sweden (Styrborn and Thorslund, 1993), Norway (Health Committee, 2004) and Denmark (Colmorten et al., 2004). Reductions have also been the norm in England (McCoy et al., 2007a) and, interestingly, as happened in Sweden (Styrborn and Thorslund, 1993; Socialstyrelsen, 1993 cited in Twaddle, 2002), the largest decrease of delays was experienced in the first year of implementation (McCoy et al., 2007a). Therefore, one characteristic of the way in which fines work is that they appear to have a fast impact on the system. Nonetheless, there are other functions of the fines that should be considered aside from rapidly reducing delays. One of these is their ability to influence hospital length of stay. In other words, patients who may never be counted as delays get processed out of the hospital faster (Health Committee, 2004; McCoy et al., 2007a).

The reduction in overall length of stay is of significant importance for hospital managers. After decreasing length of stay, they can potentially close hospital beds and improve their overall efficiency, increasing activity with fewer expenses. Indeed, this is what happened in the Nordic countries that implemented fines for delayed discharges (Minford, 2001; Health Committee, 2004; Colmorten et al., 2004). And, without the intention of trying to infer causation, but spurred by the correlation, a year after the implementation of the Delayed Discharges Act, it is interesting to note

that in 2005/2006 bed numbers figures in England 'fell more steeply, by 5,300 in one year' (Wanless et al., 2007: 119).

Another relevant characteristic of the fines is that, in Sweden and in England, delayed discharges had already been decreasing before fines were implemented (Styrborn and Thorslund, 1993; McCoy et al., 2007a). Again, alternative mechanisms must be contemplated. This could mean that other measures to improve this problem were already in operation and were working well. For instance, in England increased investment in intermediate care services is a significant policy change in the years immediately before the implementation of the Delayed Discharges Act (Cowpe, 2005). In summary, in systems where delays are already decreasing, fines appear to further reduce the official figures and, moreover, they seem to do so rapidly and to simultaneously reduce overall hospital length of stay. The association of all these factors is potentially pleasing to policy makers but the causal relationship between all of them is not clear and needs to be explored.

The research site evaluated in this thesis followed the national trend and the number of delayed discharges was significantly reduced following the implementation of the Delayed Discharges Act in 2004. Figure 6.1 illustrates how the number of lost bed days to delayed discharges fell sharply after the Act was implemented, and most significantly they have continued to do so. This is a local characteristic that does not follow national trends. Apparently, in the rest of the country, total lost bed days have shown little variation since the first big drop in 2004 (Godden et al., 2007).

Figure 6.1: Number of Lost Bed Days Due to Delayed Discharges in the Local Hospital (Source: Hospital Discharge Liaison Team Performance Data Collection)

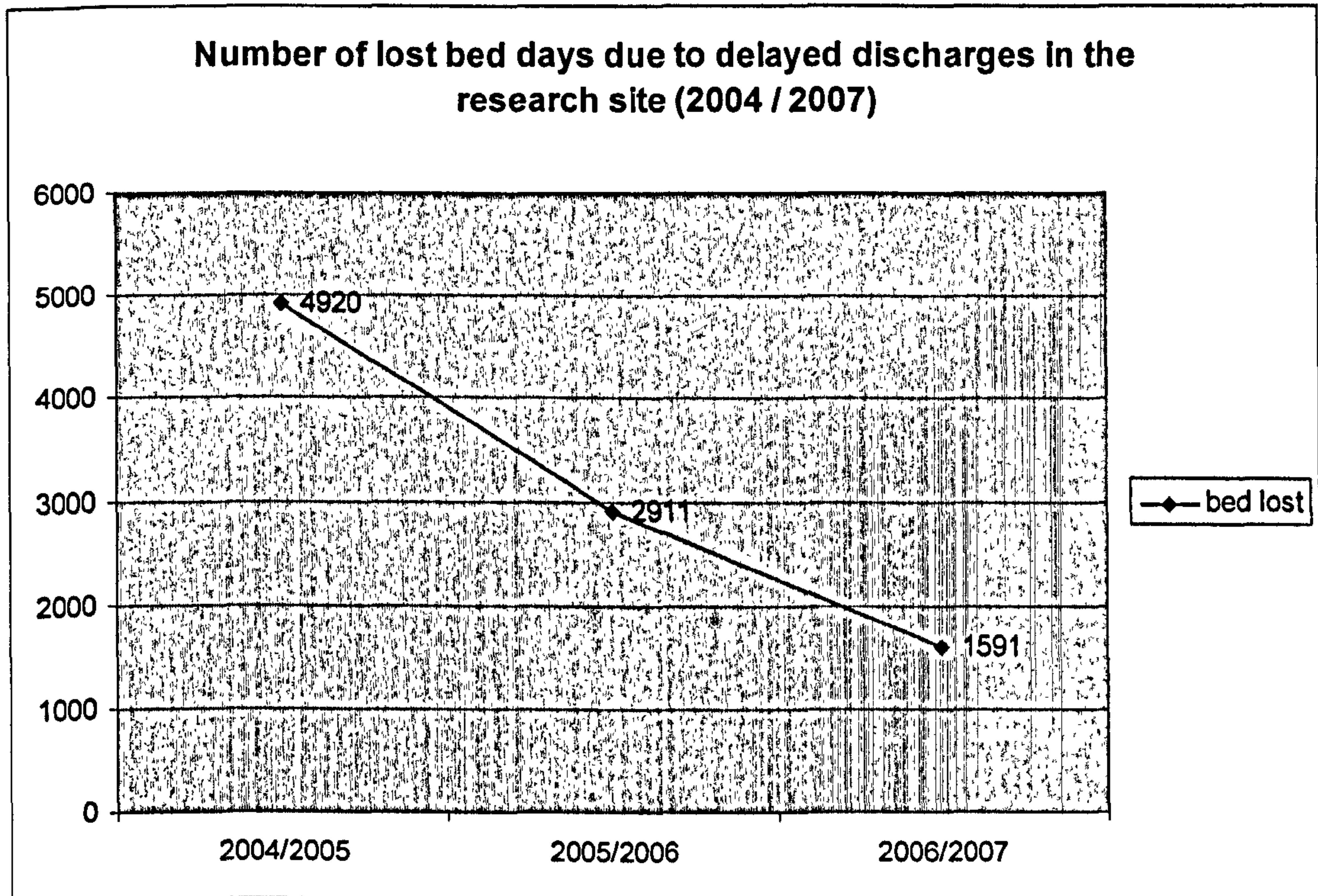

Consequently, if such a drastic drop followed the implementation of the Act, it is assumed that mechanisms (whether planned or unplanned) followed and these generated the sharp and continuing reduction in the number of delays observed in the quantitative data collections. The number of fines, however, must also be examined so as to compare it with the number of delays and initiate the process of hypothesis testing with regards to possible planned or unplanned mechanisms that helped achieved these outcomes. In summary, local outcomes for 'delays' and outcomes for 'fines' are interrelated. Teasing out the reasoning for this relationship should reveal the key mechanisms to tackle.

6.4 Total Absence of Fines: Outcome Achieved

The most significant observation of this chapter is that, in the locality of the study, fines are hardly ever issued. As fieldwork progressed and none of the initial case studies had generated a fine, I started asking staff general questions about the number

of fines in their previous cases but they could not recall any. The following quotation represents the typical answer that social services staff gave:

‘Researcher: Have you had any fines lately for your patients?’

Care manager: For me, personally?’

Researcher: Yes.

Care manager: No. [Bangs on table] Touch wood. I mean, I haven’t had many fines at all, really, since we started the reimbursement. Obviously, team managers and area managers know how it goes. So they will try to provide the services that you need or look at alternatives or provide interim placements if packages of care aren’t available’ (Interview with social services care manager, Case 10).

As a result of this unexpected situation, half way through the fieldwork, I asked the local social services department for a copy of the number of fines that they have paid since the implementation of the Delayed Discharges programme in 2004. As Figure 6.2 illustrates, the fact that none of the fourteen cases of this study generated a fine is simply a reality based on statistical probability. The lack of fines is so palpable that it can be considered an extinction of the financial incentive:

Figure 6.2: Amount of Fines Paid by the Social Services Department in the Research Site from 2003-2008 (Source: Reimbursement Office, Local Social Services Department)

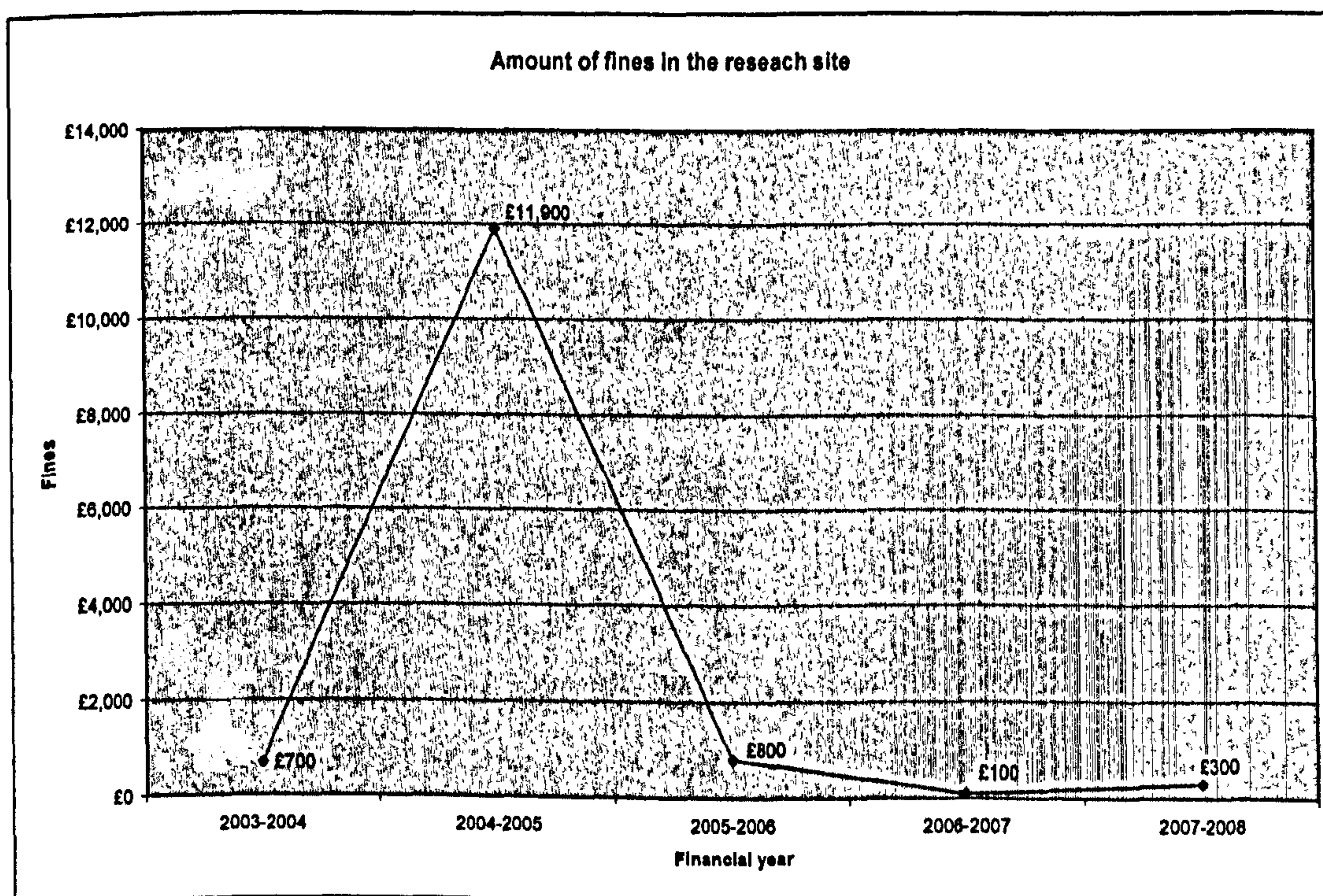

The local Reimbursement Office that provided the information collected in Figure 6.2 did not record amounts paid per patient. Consequently, as it happens with the national data collection on delays, it is not possible to establish how many patients generated these fines and only the number of bed days lost that the local authority was financially responsible for is provided. In the first year of the implementation of the programme (2003-2004), £11,900 was paid to the hospital, of which £11,700 was paid in the first month. After that initial leap, the social services department learned to deal with the new policy in a way that resulted in fine avoidance. In the financial year 2006-2007, the one in which the majority of the fieldwork took place, only £100 of fines were paid to the hospital. This equates to only one patient and for one day delayed in hospital because of social services. Therefore, it was hardly surprising that I was not able to locate that patient in my sample!

As explained in Chapter Two, under The Delayed Discharges Act regulations, hospitals could choose whether to fine social services departments for their delays. Although the research site chose the most punitive side of the programme and invoicing was in place at the time of the fieldwork, they only managed to charge social services for the first month of implementation. Nevertheless, absence of fines must be balanced by the fact that, in these same years, the local hospital reported significantly reduced numbers of delayed discharges. The logical next questions are ‘What did they do or learn in that month that had such a quick and persistent impact?’ ‘How have they reduced the delayed discharge numbers without incurring fines?’ Or in realist terms: ‘What are the mechanisms used locally to achieve the outcome ‘no fines’ and the outcome ‘reduced delays’?’

The first hypothesis considered was that the fines issued during that first month had such a ‘deterrent power’ that the system changed immediately and this had long lasting effects, which are present three years later. In other words, practitioners followed the mechanisms designed by the programme to avoid the fines and these work. But this theory is contradicted by studies about implementation fatigue, which explain that, at this point of the intervention, fines ‘deterrent power’ should have diminished. Nevertheless, another set of hypothesis were pursued: The Delayed Discharges programme designed ‘delays reduction mechanisms’ but did they inadvertently design ‘fine avoidance mechanisms’ that had no real impact on how fast

discharges are processed? Or are these 'fine avoidance mechanisms' generated by practitioners that have as a first priority to avoid the fines and not to speed up the discharge process? In one of the interviews with members of the hospital discharge liaison team, they explained that their department had been audited by the foundation trust hospital while the fieldwork took place and their team were 'told off' for not generating enough fines. In informal conversations, they mentioned that perhaps they had signed the local protocol too soon, before realising how social services were going to 'escape' fines. Therefore, their perception was that social services found 'ways around the fines' without delays being resolved and that the formal local agreements signed in the protocol contained 'fine avoidance' mechanisms. The examination of the local protocol, however, showed that the local interpretation of the programme did not differ from the national guidance. Mechanisms of to avoid the fines were defined broadly in the Delayed Discharges Act and the local protocol summarises and adapts them to the local context.

The application of fines was also scarce in the similar programme implemented in Sweden (Health Committee, 2003), and in a goodly proportion of the English hospitals that chose to implement the penalty system (McCoy et al., 2007c). However, this is still a paradoxical finding for the investigator because fines were a key issue in all fieldwork conversations with staff. Fines appear to operate in an invisible way, rather than a reality. The threat of the fine was constant in conversations with social services frontline staff but then, none of their clients had ever resulted in a fine. Two possible ways of achieving that perception are described as follows:

- a) Fines have changed the form and shape of the discharge process for patients who are referred to social services. 'Fine-driven' structures drive the discharge planning procedures from the beginning to the end. At referral and discharge points, the reimbursement administration process is totally consolidated in the wards. The legal obligation to use the two forms associated with the fine have strengthened the use of the Section 2 and the Section 5 forms. These forms are a constant reminder of the potential fine for all patients; so powerful that hospital staff transformed them from nouns to verbs: 'I am going to 'sectionfive' her', said one ward manager when she referred to patients who are ready for discharge. Although this sentence could be considered just a 'way of talking', it could also be

interpreted as a reflection of the authority that hospital staff have been given to inflict the fines and social services staff are very aware of that power. Also, fine-driven structures are constantly present in the decision making processes like the social services attendance to all MDTs, the requirement to wait for social services managers to approve funding (CRAM meeting) and the SitReps (management) meetings where patients delayed are constantly monitored (twice a week). For the purposes of this meeting, all care managers have to report back to their managers weekly updated information on their clients, justifying why they are in hospital and reasons for any delays in assessments or service provision.

- b) The threat of possible fines is maintained by the relative ignorance of front-line staff of which patient's circumstances could generate fines. The complexity of the implementation guidance, which excludes patients from reimbursement for multiple specific health or financial situations, creates a 'programme knowledge challenge'. Significant training was provided to staff at the implementation stages, but at the time of fieldwork, three years later, front-line staff in social services do not tend to know if they are going to be charged or not for a delay in a specific patient. Front-line staff ignorance of the reimbursement eligibility criteria is evident in some of the case studies followed in this thesis. This is illustrated in the following quote from a hospital discharge liaison nurse. In interview, she explained how social services front-line staff lack knowledge of the reimbursement criteria (the 'codes') and due to that ignorance, they treat all patients with the same speed:

'But the care managers don't always know what codes do apply. So while the hospital social services team are very familiar with, [name of social services team leader] particularly is, as a team leader. She is very familiar with the codes. All the other care managers aren't familiar. So, automatically, it makes them think 'Oh, I better get going!' And also they are pushed by their team leaders, to act anyway regardless of the code'.

Middle managers appear to approach their inability to ensure staff knowledge of reimbursement by retaining ownership of that knowledge and execute it mainly in the SitReps meeting where reasons for delays are discussed. The positive aspect of this practice is that managers, aware of the potential financial dangers of front-line staff ignorance of the codes, recommended them to provide equal service for

everybody. The difficulty in grasping all the 'rules and nuances' of the reimbursement programme is also described by Godfrey et al. (2008). This is attributed to high turnover of staffing hospital wards and social services departments. Despite the potential influence of the wide range of current policies affecting human resources in the NHS (Humphrey et al., 2003) and of the existence of national (Eborall and Emerson, 2001) and research site (Confidential Reference 15, 2005) shortages of social work staff with low retention levels and high use of agency workers, other issues must be taken into consideration when attributing these factors to the lack of programme knowledge. Equally relevant issues could be the quality and frequency of multi-agency training, management commitment to continuous professional development, etc. In summary, although difficulties in recruiting and retaining social care staff are frequently referred as a factor impinging on the implementation of Government policies, it is argued here that the intricacy of the programme design and how it is transmitted to staff must also be considered when looking for disabling factors.

Social services staff initially (at the point of referral) deal with everybody similarly, because exclusions from reimbursement cannot be ascertained until patients' health or financial needs are assessed. This is reflected with my own sampling experiences. The inability to recruit more patients funded by social services was related to the same timing problem: by the time staff found out that patients were social services responsibility, it was so late in the discharge process that very few activities could be observed. In summary, although fines are not issued, the presence of the 'possible fine' is reflected in staff working practices.

6.5 Working towards 'Seven Days Discharges': an Unnecessary Mechanism

The Delayed Discharges programme implemented the seven days a week monitoring of delays. This is a designed mechanism that assumes that if delayed bed days counted as possible fines from Monday to Saturday, social services departments would increase their operational hours to seven days a week to avoid the fines; consequently reduction of delays will follow. To reinforce this, although initially only Monday to Saturday counted, the implementation literature suggested that the policy would soon be extended to counting Sundays. This threat has not materialised to the

date of writing, five years from the original announcement. Nonetheless, the logic of the implementation theory did not square with the fact that fines are avoided in several other effective ways without the need to extend operational hours of social services departments. The job of avoiding fines is done Monday to Friday, in the meetings, with the offers of interim beds and so on.

The social services department in this study did initially invest in one care manager and administrative staff to receive the hospital referrals working on Saturdays. However, this service was quickly regarded as unnecessary and it was cancelled subsequently. This demonstrated that other mechanisms to avoid fines were working well enough and no further investments were needed to avoid them. In an interview with the only care manager who used to work in this locality on Saturdays at the beginning of the implementation of the policy, she explained the reasons why the service was suspended:

Researcher: So there is nobody in, on Saturdays.

Care manager: And I think the reason for that is that we are actually manipulating the system to work Monday to Friday.

Researcher: And you manage to do it Ok?

Care manager: And we do it OK. Yes, yes... [...]

Care manager: The difficulty was... The difficulty is that people do expect this service currently to be Monday to Friday, 9 to 5 service. So at the weekends and on an evening there is like the emergency duty team. And there is nothing else really. And that's how generally people see the service. So even picking stuff up, picking up referrals via customer relations [the local authority department that deals with referrals], who hardly ever got any. Because they were in, as well.

Researcher: Yes. Are they in now or not?

Care manager: No, no. They stopped doing that.

Researcher: So it wasn't only you, somebody from customer relations...?

Care manager: Yes, customer relations were in as well because reimbursement took into account Saturdays.

Researcher: Could you access homecare?

Care manager: I never did anything.

Researcher: No...

Care manager: I didn't have a thing to do!

In the research site, initially social services made the decision to provide a six day service with some staff working on Saturdays. This reduced input was not enough to change their five day working culture and they soon returned to their original practice. This member of social services staff alluded to the fact that hospitals themselves do

not fully work seven days a week and that's why she did not have discharges to facilitate.

'Discharge liaison nurse: Is the whole thing about working with five days service. You know, the reimbursement counts for a seven day week. And the bulk of the services only work-operate Monday to Friday.

Researcher: Yes, but reimbursement tried to change that, from social services point of view, but it hasn't changed it...

Discharge liaison nurse: The way has changed it is we count more days.

Research: You count more days, yes. But it hasn't actually...

Discharge liaison nurse: We count a seven day week, we count weekends as bed lost days which they are not. But there is no more money put into resources...

Researcher: ...over the weekend...

Discharge liaison: Over the weekend

Researcher: No staff working over the weekend?

Discharge liaison nurse: No, no. It is bare minimum [...]

Discharge liaison nurse: There is an on call physio and an occupational therapist. I don't think they do anything out of hours at all in hospital [...]

Discharge liaison nurse: In [neighbouring town] they do. But in here they have a duty manager who works with people in the hospital, they don't do delays. They don't do...

Researcher: So it hasn't worked.

Discharge liaison nurse: No, no. And I think all that would have achieved is processing the section 2 forms quicker. But there is nothing in place to say the people can then go out on Saturday or Sunday' (Interview with discharge liaison nurse, Case 11).

As explained in Chapter Two, at weekends hospitals have decreased staffing levels and community health and social care support services also do not work to full capacity. To expect social services to change their practice without modifying the whole system appears to be an insufficient mechanism. As the above interviewee said, it changed performance data because 'we count more days' but it did not change their practices. Neighbouring localities to the research site, however, run higher health and social care coverage and consequently, the lack of a whole system approach to the seven days discharge practices appears to be a contextual factor that disempowers the fines power to consolidate the mechanism. Thus far, none of the other studies of the Delayed Discharges Act commented on the impact of the seven days monitoring on discharge figures or practices.

Although more days are counted now than before implementation, numbers of delays continue to be low. If this innovation did not progress, there have to be other

mechanisms used locally, which are so powerful that transformed the 'six or seven days working' theory of change into an unnecessary expense.

6.6 Multidisciplinary Team Decisions: Instant Reduction of Delayed Discharges

A significant mechanism which was not purposely designed to avoid fines related to an integral characteristic of the English introduction of fines for delayed discharges: the reinforcement of multidisciplinary assessment for hospital discharges. The English implementation tried to avoid tensions that occurred in the Nordic countries and it endorsed an innovative national definition of when a patient is 'safe to transfer' (See Chapter Two, section 2.2.1.2). This new definition established that, besides the clinical decision that a patient is ready for transfer, a multidisciplinary team decision must be made, agreeing that a patient is ready and safe for transfer out of the hospital. The 'safe to transfer' requirement means that the whole team need to have their assessment done and discharge plans agreed in weekly meetings before patients can be labelled as 'delays'. With this new definition, instantly, the numbers of days that people are 'not safe to transfer' are likely to increase for two reasons:

a) Group versus individual decision-making. A decision made by a team tends to take longer than a decision made by one professional (the doctor). The standard definition implemented refers to three sequential stages that are conditional on patients being considered safe for discharge (Department of Health, 2003b). A first step is that the doctor decides that the patient is medically stable for transfer. Secondly, all other members of the multidisciplinary team (which include therapists and social services staff) decide that the patient is ready to leave the hospital. Finally, 'the patient is safe to transfer', which is explained in the section b) below. Before the Delayed Discharges Act, decisions in general were made only in one step (consultant decision), now generally the team has as greater say as the consultant. The follow observation illustrates how doctors will consult the team:

'Consultant: Is she ready for discharge?

Ward manager: No, she is making progress. She needs more time.

Consultant makes a comment about the amount of time the patient has been in the ward. Ward manager says: 'She is getting better. Leave her alone! [laughs]'
(Notes from MDT observation, Case 2).

In Case 4, however, there was disagreement about discharge plans between ward clinical and therapy staff and social services (more details of this case can be found in Chapter Seven, section 7.2.4). The social services team manager attended the MDT and confrontation was evident:

'[Social services] team manager is quick to say that this issue cannot be resolved in hospital. And she makes a comment about the patient being 'privileged' for being in hospital for so long. To what the consultant and the ward manager reply that he has been treated like everybody else. Ward manager says: 'We've given him the same priority as anybody who hasn't got a house'. Team manager says something like: 'This is not the message I've been given in SitReps. I have been said, he has been a delay for about three to four weeks'. Discharge liaison nurse keeps quiet. Team manager says 'He could now go to a hostel or B&B because he has no care needs. This is an option now' (Notes from MDT observation, Case 4).

Therefore, in the research site, decisions with regards to whether patients are safe to leave the hospital are, in general, made jointly by the whole of the team. Sometimes disagreements occur between the consultant and the rest of the team, sometimes between social services and ward staff. Other times, decisions are quickly agreed and patients flow through the system quicker. This slower pace is most probably beneficial for the patient outcomes but, most significantly, it modifies the times when people are classified as delays. Before implementation of the Delayed Discharges Act, people were called 'delays' at an earlier stage because this decision was based on the judgement of one professional. By the time four or five professionals have agreed that somebody is a delay, days and weeks can pass.

b) 'The patient is safe to discharge / transfer'. The ambiguity of the third step mentioned in the 'safe to transfer' definition was clarified by the implementation guidance. The team could not make the decision that the patient was ready for transfer until they could be certain that the discharge destination was a safe place for the patient to be transferred. In practice this means, for example, that trial home visits have to be performed to make sure that the patient can be discharged home safely before patients are considered delays. Locally, this third step was converted in another 'fine avoidance' mechanism. If a social services patient (a possible fine) needs transfer to a care home (interim or long-term), the manager of the chosen care home has to go to the ward, visit the patient and make sure the care home can meet his

needs, before this patient can be called a 'delayed transfer of care', and therefore a possible fine could apply. A member of the local discharge liaison team explained how this 'third' step removes the 'power' that the programme design gave to the Section 5 forms, that is, to generate a fine for the social services department:

'And that's the frustrating thing about the Section 5s. Health can never send them... We can send them all the time, but we can never send them, in the confidence that they won't be rejected. Because there is always that 'But we haven't got whatever is needed'. And therefore is not 'safe for transfer', so it is not a delay. But they are always delayed in hospital waiting for that 'safe to transfer'!' (Interview with discharge liaison nurse)

As a direct consequence of these two attributes of the new definition of 'delayed transfers of care' introduced at the same time as the fines, days that used to be called 'delayed days', now are not called delays because members of the team are still making their assessments, or they are waiting for their weekly meetings, or they are waiting for trial home visits, etc. Consequently, quantitative comparisons prior to and post introduction of the fines will always show a reduction of 'delayed days'. Not only reduction of the delays caused by social services, but also of NHS delays. If all hospital delays are monitored through MDT and SitReps meetings, the same instant mechanism would reduce overall delays figures. In the research site and in others in the country (Godfrey et al., 2008), the reimbursement infrastructure is used to monitor all hospital delays. Therefore, the performance related 'delayed transfer of care' definition, which is applied to all hospital patients that have a referral to social services - independently of which agency ended up being financially responsible for the delay- have intrinsic attributes to reduce delayed discharges figures for all agencies without necessarily reducing patients' length of stay.

6.7 Weekly Census of Reasons for Delayed Discharges: an Easy Way Out

The Delayed Discharges programme established a weekly census to count delays, as opposed to the one day annual census system used in the past. As previously explained in Chapter Two, the Swedish evidence that claimed the success of the fines was collected using the one day annual census. The locality evaluated in this thesis, like others around the country, established a weekly management meeting, including hospital and social services senior staff, to discuss delays and fines (SitReps meeting)

before data are sent to the Department of Health. This type of interagency meetings is associated with hospital sites that have low figures of delayed discharges (Baumann et al., 2007). In parallel, there is the Capacity and Risk Assessment Meeting (CRAM), which was constituted by local social services managers with the objective of accelerating funding decisions, when reimbursement was implemented.

A similar type of weekly funding allocation meeting is present in all three sites in the Godfrey et al. (2008) study. In those hospitals, like in the one analysed in this thesis, the system for allocating the funding of the packages of care is rapid, with decisions made normally within a week. This mechanism seems to decrease the amount of delays caused by social services due to waiting for their funding. Godden et al. (2007) concluded that waiting for funding scored as the smallest percentage of patients delayed because of social services reasons. This is significant because waiting for social services funding is one of the common reasons for delayed discharges identified in the research literature. Consequently, weekly allocation panels to speed up funding decisions appear to cause a reduction in delays because they formalise weekly systems to approve funding, which did not exist before the implementation of the fines. The close and structured joint monitoring of delays by both agencies is a mechanism that reduced delays. Later on, in Chapter Eight, with the comparisons across case studies, it is demonstrated how this managerial move to monitor delays is conducive of some associated contingencies for the patients and for the speed of discharges.

But what do managers actually do in those meetings? How are causes for delay agreed? And most significantly, how can social services avoid the fines? The guidance is clear: to fine social services they have to be the 'sole' responsible agency for the delay. This responsibility was defined nationally by the compulsory classification by agency of quantitative performance information which records delayed discharges into set categories. Reasons for delay are codified in the nine categories (labelled A to D) illustrated in Table 2.4 (Chapter Two). The misinterpretation of these defined categories has been reported elsewhere (Godden et al., 2007). The artificial simplification of one single reason for delay worked well for straightforward cases, which, most probably, would not get delayed or, if they did, not for long. However, complex cases tend to be delayed for multiple reasons and the

choice of categories becomes a struggle or a casual decision made for the purposes of form filling. In the sample, the patient with the longest delay could have been an E, F, G, H or I code. During fieldwork, it was never clear why some codes were chosen in preference of others and, when I asked a member of the discharge liaison team, she said 'It does not look very good if we have many delays of one code'. This comment reflected one of the accusations from social services managers about data manipulation.

Social services cannot practically detect any wrong doing in the cases in which they have not been involved. But in the cases where they have a partial involvement (i.e. self-funders, providing advice only, etc.), they mentioned lack of consistency in recording delays. Discharge liaison department's reasons for choosing codes are questioned by their social services colleagues as much as they are questioned about the recording of the delays of people with no involvement or follow-up from the local authority. Specifically in the case of the self-funders, notifications of discharge forms (Section 5) are not routinely sent to social services and this is, apparently, a way to avoid the official recording of delays used by the discharge liaison department which has as a general target reducing the number of overall hospital delays. This was apparent in some of the self-funders in my sample, but not in all of them. This issue will be further explained in Chapter Eight.

The detailed analysis of the reasons for delays that could incur a fine for social services identifies them as clear mechanisms to avoid the fines. Only four out of the nine codes could generate a fine to social services with the rest being delays allocated to other agencies or stakeholders (non-acute NHS, family, housing and inter-agency disputes). A further inspection of those four codes (A, B, D and E) explains how they could be effortlessly transformed into 'fine avoidance' mechanisms:

Code A. Awaiting completion of assessment. Hospitals used to refer patients to social services departments and days and weeks could pass without them visiting the wards and assessing patients' social needs (National Audit Office, 2000; Glasby et al., 2004). After the introduction of the Delayed Discharges Act, with the standard definition of delays, the multidisciplinary decision required before calling patients 'delays' needs to include a social services representative. In practice, this means that a

patient cannot be deemed a delay before the social services assessment is done and consequently, this code will never be applied to one single delay. In the research site, when wards send Section 5s forms (giving them 24 hours to discharge or a fine will be issued) for patients who have not been assessed by social services, these forms are not accepted and are sent back on the grounds that social services have not been part of the 'safe to transfer' decision.

Code B. Awaiting public funding. Another common reason of social services delays is that patients wait in the wards until funding is released for them to be transferred into long-term care (Bryan et al., 2006). In the research site, after the introduction of the Delayed Discharges Act, if somebody needs long-term care and requires social services funding, they are routinely offered temporary interim accommodation that they need to pay for themselves. Public funding for the long-term bed is approved 'in principle' in the CRAM meeting, but it will not be released until the moment the person leaves the interim bed for their final destination. If the interim bed is rejected, the reason for delay would shift to Code G (patient or family choice) which is classified as an NHS delay and consequently is not reimbursable. The use of the mechanism interim bed transforms this code into virtually extinct.

Code D. (i, ii) Awaiting residential or nursing home placements. Finding a suitable care home 'is time-consuming and requires good knowledge of local facilities and their current availability' (Audit Commission, 1992: 22). This reason for delay refers to the situation when social services funding has been released for a care home placement but patients still wait in the ward because their families are still seeking a suitable home or they are waiting for a vacancy in their home of choice (Audit Commission, 1992; National Audit Office, 2000; Bryan et al., 2006). These codes are only used if people are going directly into care, which is not the case for social services funded patients because they are routinely transferred into interim accommodation first. This code could only be used if there was no availability of the interim placements contracted in bulk. When that has occurred, managers approved to fund a bed temporarily in any other private establishment that has a vacancy. But, again, once any interim bed available is offered, if the patient refuses it, the delay becomes a Code G (patient or family choice), and therefore, not reimbursable, which makes this code another impossible way of issuing fines for social services clients.

Code E. Awaiting care package in own home. Discharges can be delayed because the packages of domiciliary care patients require to leave the hospital safely cannot be arranged in time. Problems with arranging homecare services have been blamed for much of these delays (Audit Commission, 1992; National Audit Office, 2000). The second part of the Delayed Discharges Act - innovation nine of Table 2.4 in Chapter Two - conceptualised the community care services needed to maintain or regain ability to live at home after hospital discharge as 'intermediate care services'. They are now services free for up to six weeks and, most importantly, they are conceptualised as a health need excluded from the reimbursement policy. In the research site, the local authority seemed to have enough homecare provision to facilitate a prompt service to hospital services, with more difficulties in the rural areas. However, if they would not have the care package available at the time of discharge, social services could not be charged for the delay because it is an 'intermediate care need' and therefore, none reimbursable.

In summary, micro-mechanisms are bespoke within the designed programme theory that can generate the outcome 'lack of fines' without having to reduce delays. These are so powerful they instantly explain why fines in the research site are anecdotal. Nevertheless, the ways in which delays are reduced still need to be explored.

6.8 The Conceptual Construction of a New 'Social Services Patient'

Before reasons for delays are even discussed, under the new rules of the Delayed Discharges Act, large categories of patients are excluded from reimbursement. Unlike the Swedish system, the English excludes from the reimbursement scheme a high number of patients because of their care or financial needs. Patients are clearly not included in the fines system because of health reasons (rehabilitation, recuperation, mental health, maternity, intermediate, critical and continuing care), financial reasons (self-funders) and other various reasons (housing and learning disabilities).

The most significant exclusion criteria from the reimbursement scheme is through 'patient or family choice', which referred to the right of patients to refuse the resources offered to organise their discharge from hospital. Although patients who

have finished their acute medical treatment do not have the right to stay in the ward indefinitely, patients exercising statutory right of choice over which residential or nursing home to enter are identified as a frequent cause for delayed discharge (ISD Scotland, 2000 cited in Glasby, 2003: 99). The National Assistance Act 1948 (Choice of Accommodation) Directions 1992 and the guidance that followed were intended to ensure that, when councils offered placements in care homes, people were able to exercise genuine choice, within reason, over where they chose to live.

Nevertheless, discharge from hospitals is frequently delayed when the patients' preferred accommodation is not readily available by the time they are ready to leave the hospital. The implementation of this direction is problematic in a hospital setting. If patients refuse to accept interim placements, hospitals can only either 'convince' patients to leave, or they can start legal proceedings against them. Hospitals know that the latter would only delay even more the patient's stay and it has the potential of unwanted media attraction. Interestingly, the Swedish evidence dismissed the 'patient choice' factor as a possible way to avoid fines because 'though they [patients] are not bound to, in practice, patients take what is offered' (Health Committee, 2004: 3). In fact, this comment reinforces critics of the Swedish reform who report that older people lacked information about their care and that they were regarded as passive receivers of care. Because their opinions were not recognised, it was suggested that they became more dependent on care services, which, in turn, increases overall care costs (Henriksen et al., 2003).

Godfrey et al. (2008) referred to 'patient choice' as a mechanism to avoid fines generated because of a 'loophole' in the programme. I argue, however, that this exclusion should not be considered merely a gap or loophole in the programme theory because it was consciously designed as a legitimate exclusion. 'Patient choice' is, on one side, a factor inevitably linked to local availability of post-discharge resources. The more alternatives for discharge offered to patients, the bigger the likelihood that they would accept any of them. But, on the other side, 'patient choice' also relates to the national Government stance to enhance citizenship. It is not clear whether the English policy designers miscalculated the impact that excluding the reason for delay 'patient choice' from reimbursement could have in the fines efficiency; or whether, informed by the Swedish experience, it was decided to exclude 'choice' in the best

interest of the patient. But the exclusion is explicit and this situation is best described not as a technical error but as a conscious design feature that generates an unexpected output: it avoids fines but does not reduce delays.

With this complicated scenario of exclusions in mind, the policy guidance explicitly constructs a new meaning of 'social services delays'. This construction, based on the assumption of a clear definition between social need and other needs, reduces once again the number of patients that could be fined (See Figure 6.3). In other words, less patients than before are now labelled as 'social services patients'. Not only the quantitative data produced by the Department of Health, but studies like Godden et al. (2007) and McCoy et al. (2007a), which reported a reduction in social services delays since the fines have been implemented, do not appear to consider the different conceptual construction of 'social services delays' prior and post implementation of the fines.

This is one of the reasons why the English fines rapidly reduced social services delays. They created a 'conceptual reduction of delays' by the means of redefining what social services delays signify in a way that official figures decreased instantaneously. Now, a whole collection of conditions are not reimbursable if they are attached to social needs and social services patients are considered only those who have those reimbursable needs. In other words, the Delayed Discharges programme administratively defined social services delays in a way that was never done before.

Figure 6.3: The Construction of the 'Social Services Patient' before and after the Delayed Discharges Act

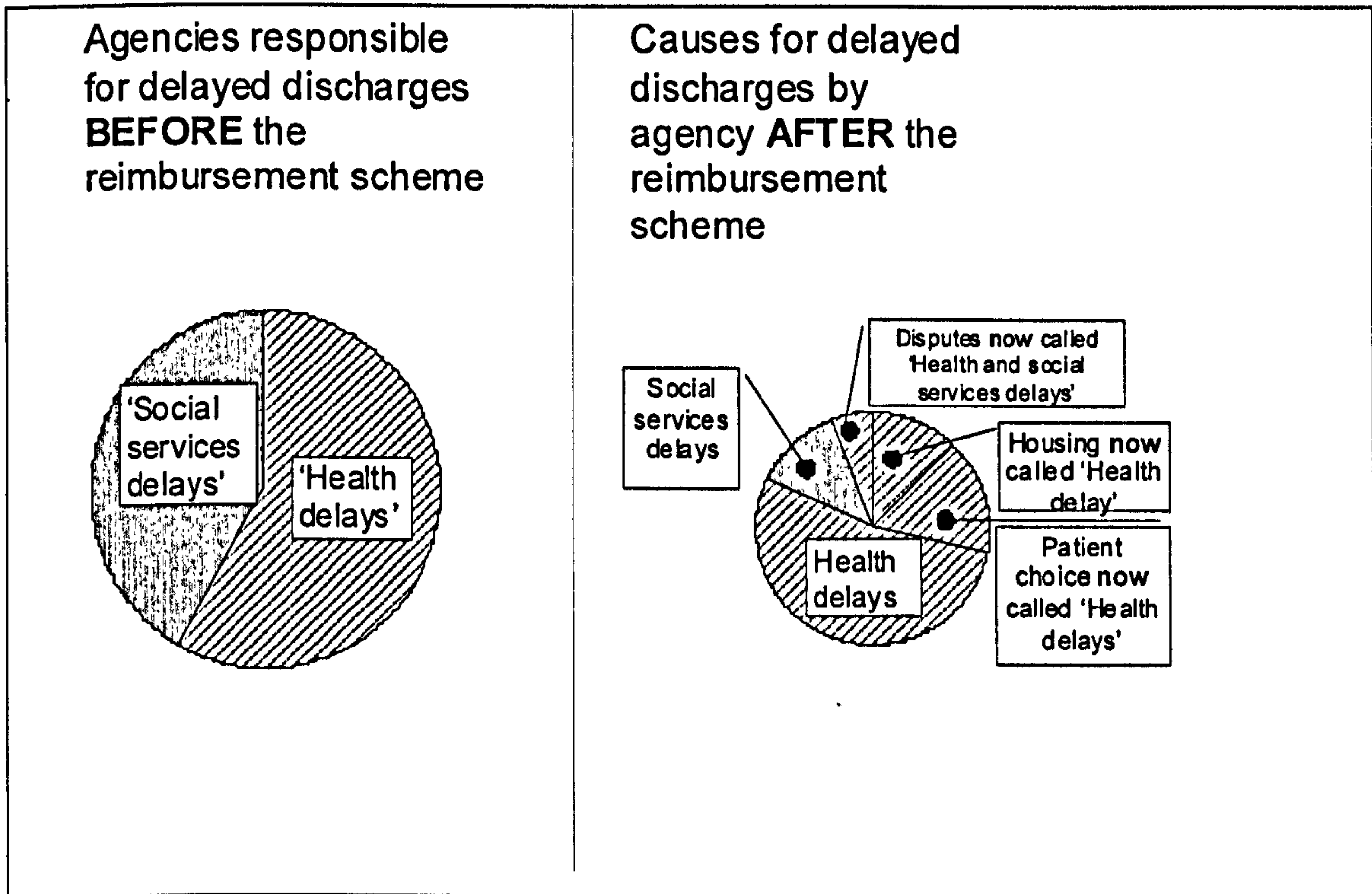

Figure 6.3 illustrates broadly, with a diagram comparison, what happened to the causes for delays after programme implementation. Before the Delayed Discharges Act (diagram to the left), there was no standard definition of causes for delays and hospitals reported numbers of delayed discharges based on patients who remained in hospital for whatever reasons other than medical ('social services delays' versus 'health delays'). After the Act was implemented (diagram to the right), typical 'ex-social services needs' like patient choice (all the self-funders are included in this category) or housing are renamed as causes attributed to the NHS.

This blame shift could explain Godden et al. (2007) findings when they examined the total number of delayed bed days by quarter and by agency (NHS or social services) using SitReps returns. The longitudinal comparison between 2003/04 and 2005/06 showed

'a steep reduction in the number of delayed discharge bed days attributed to social services between the first and second quarters, after which there is a slowing down and cessation of further reductions. It also shows a shallower and more gradual reduction in delays attributed to the NHS' (Godden et al., 2007: 13).

The larger reduction in social services delays was between October 2003 and March 2004 but then, 'from March 2004, the further reduction in social services delayed discharge bed days began to slow down and virtually stopped, leaving a residue of on-going delays in discharge that appear to have been resistant to change' (Godden et al., 2007: 21). The NHS delays also have a core group of reasons for delays that have not decreased through the years of programme stability: housing needs and patient choice.

In summary, it appears that the establishment of set national criteria for reimbursement exclusion and the redefinition of the reasons why agencies are responsible for delays could have contributed to the development of the outcome 'reduced delays' for social services. The new conceptual construction of the social services patient ruled out immediately a large number of delays that they used to be 'blamed for'.

6.9 Interim Beds, Planned Mechanisms to Reduce Delays

Transfers to beds called 'interim, transitional, holding or step-down' beds are designed mechanisms to both reduce delays and avoid fines clearly prescribed in the implementation guidance of the Delayed Discharges programme. The idea is that patients should be transferred into temporary residential or nursing homes to wait for the services that are holding them from being timely discharged. The transfer of hospital patients to temporary accommodation is not an innovation brought in by the Delayed Discharges programme. In 2002 and 2003, several public institutions advised hospitals on patient's rights to choose their post-discharge destination, but emphasised that they did not have the right to stay in hospital indefinitely (House of Commons Health Committee, 2002; Department of Health, 2002b; National Audit Office, 2003). Agencies were encouraged to use interim accommodation for patients whose care home of choice was unavailable at the time of being safe for discharge. Later on, these temporary stays were extended to any patients waiting for further social assessment. Several authors (Allen et al., 2002; Black and Pearson, 2002; Crotty et al., 2005) support this option as the solution for delayed discharges:

'Rather than having to make binding decisions about future packages of care a client will require at the point of discharge, what is actually needed for all people

is a period of adjustment and accommodation during which decisions might be made about whether care at home is feasible and what adaptations would be required to make it possible' (Allen et al., 2002: 416).

Nevertheless, the use of interim beds to facilitate early hospital discharge is regretted by some commentators. This practice has been criticised as another example of fragmentation of care, where healthcare is partitioned between several sites without taking into consideration the benefit or harm for the patient or effect in overall cost of care (Coleman, 2003; Boockwar et al., 2004). Despite these risks, interim beds are generally explained to patients in positive terms. The transfer to interim beds is justified to hospital users with three main arguments, which are summarised in the policy guidance as follows:

'Hospital is not the ideal place to be while waiting for arrangements for care to be put into place. Hospitals make people more dependent; there is also an increased risk of them acquiring infection. Whilst they are away from home, older people's care networks can break down' (Department of Health 2003b: 5).

The assumption here is that interim facilities could provide a solution to those three stated risks: infection, loss of independence and reduced social support.

With regards to infections, the statement in the introduction of the policy guidance represents a frequently used justification given in hospital wards when patients or relatives dispute the timing of discharge, especially the possible risk of infection. As one ward manager mentioned in one of my observations: 'I will tell them about all the bugs they may catch in here if they stay for longer'. So hospital bugs are only stated as a problem when the length of stay is deemed inappropriate; when 'appropriate', the hospital is proud to announce their multiple infection control procedures. The next assumption is that the interim places to which patients are transferred do not involve an increased risk of infections. However, on a couple of occasions during fieldwork, the main local care home contracted for interim placements was closed due to infections, with the consequent worries of social services managers who saw their regular way out for possible delayed patients blocked.

The statement that hospitals 'make people more dependent' relates to the fact that acute staff cannot dedicate the time that recovering patients need to improve their independence. In hospital wards, the amount of therapy is limited and chores tend to be done for patients rather than asking or teaching them, which is not unreasonable

when dealing with people at the most vulnerable time of their illnesses. Two issues require consideration when analysing the relationship between promotion of independence and transfer to interim facilities:

- a) **The extreme frailty of acute patients likely to be delayed.** With this programme, interim beds are offered early in the process to people in acute wards. If patients are assessed as needing long-term care, interim accommodation is the mechanical suggestion made by social services. However, with length of stay being shortened, these transfers are offered so early in the hospital stay that frequently patients assessed to be transferred into interim die before the moves took place. This happened to a couple of possible participants during fieldwork. The routine use of the mechanism 'interim bed' is confronted with the reality that people needing long-term care and therefore, likely to be delayed are generally very frail. This was also the experience of the Godfrey et al. (2008) study: 'Patients in our sample represent core NHS service users. Many were very old and had chronic health conditions, many were frail and often in the last years of their lives' (p. 94).
- b) **Service provision characteristics'.** Whether interim accommodation makes people less dependent than hospital could depend on the care plans that are put in place while they are admitted in those temporary care homes. These establishments tend to be privately run care homes catering for long-term residents and they only allocate a small section of their beds for short-term stays. Their care plans are not traditionally based on the promotion of independence.

Finally, in the research site interim facilities are bought in bulk in specific care homes and can be located considerably further away from the patients' homes than the hospital. As explained in Chapter Five, there is also a lack of interim facilities in the rural areas with older relatives and friends relying on infrequent public transport to visit them. Consequently, temporary transfers to interim facilities could be sometimes more detrimental for patients support than the hospital admission.

The above three arguments question the programme theory that supports the use of interim beds for the patient's best interest. But do the mechanism 'interim bed' achieve both the 'outcome no fine' and the 'outcome no delay'? Although this will be

further explored with the detailed case studies of Chapter Seven and the generalisations explained in Chapter Eight, it must be reiterated that an 'offer' of interim bed does immediately avoid the fine while the patient could still remain delayed in hospital.

6.10 Summary

In the research site, delays were significantly reduced after the introduction of the Delayed Discharges Act. The redefinition of performance data intrinsic to the reimbursement system generated an interesting local consequence: the near absence of fines. The fines for social services are a threat more than a financial reality. The system allows for ways of avoidance without major confrontation with the acute hospital and, most importantly, without reducing delays.

This chapter examined emerging mechanisms that either reduced delays or avoided fines. On some occasions they act simultaneously, at other times they are thrown out of kilter. Some of the ten innovations introduced at the same time of the fines intertwined in unexpected ways that tend to avoid fines. The detailed analysis showed how some of the changes in reduction of delays are simply based on re-definition of key concepts for delayed discharges like 'safe to transfer', causes for delays, and, in summary, how the 'social services patient' is constructed differently before and after the programme. Finally, the planned use of transfers to interim beds for social services was analysed in detail, exploring the three main assumptions behind the need of temporary transfer: infection, loss of independence and reduced social support.

7. THE CASE STUDIES: HOSPITAL DISCHARGE JOURNEYS UNDER THE REALIST MICROSCOPE

7.1 Introduction

In order to focus on outcomes for individuals under the remit of the Delayed Discharges programme, fourteen patients were followed through their hospital discharge planning. Chen explained that 'the immediate environment surrounding the participants may hinder or facilitate implementation processes or condition program consequences' (Chen, 1990: 284). Following this argument, the chapter explores that 'immediate environment' as a form to demonstrate how these cases are not capricious tales of chance encounters in the hospital wards. They are strategically patterned by the implementation of decisions uncovered in all the previous chapters. The case studies are examples of the living outcomes that result when all the layers of the programme intervention collide with the real circumstances of the patients.

The cases are dealt with, initially, as narratives; as stories with a beginning and an end that happened to real people admitted to hospital. To help the reader, narrative is used as an instrument for the description of the individual sequence of events; but these are formalised using CMOs as a form of explanation. While, periodically, stopping to formalise and codify them by conceptualising what actually happened to individual people into contexts, mechanisms and outcomes, the factuality of the patients' journeys is explained. In other words, these case studies contain process data which illustrate the mechanisms used locally to avoid fines, the obstacles or facilitators encountered by these mechanisms and the consequences these have for the patient and for the programme outcomes.

7.2 Living Outcomes

The basic programme theory for use of fines to reduce delayed discharges concentrates on outcomes and not on the process. The main policy hypothesis is that for all patients referred to social services, if a fine is used as a measure, 'fine avoidance' mechanisms would follow. These mechanisms will simultaneously reduce delays. By contrast, the national programme implementation tried to give attention to the process of discharge by describing the ideal discharge pathway which would avoid outcome oriented interventions. The contradictory combination of outcome measures and process guidance is made evident in all the case studies.

The fourteen discharge stories of the patients provide some detail of their lives before admission into hospital and then describe the process of their discharge, using quotes which refer mainly to patients' experiences. Codes categorised as mechanisms, contexts and outcomes are allocated to parts of their individual discharge process. A figure with a summary of the most relevant codes per case is drawn for each one, with contexts grouped into three different categories: individual contexts and institutional contexts belonging to either the meso or the macro-levels. Mechanisms are also collated in three groups: mechanisms to avoid the fine used by social services; mechanisms to reduce delays, used by the hospital wards; and other mechanisms used by both institutions and which are defined as those that do not have a performance orientated purpose but are meant to preserve good joint working relationships. The outcomes are divided into individual and institutional outcomes with the latter referring to results at the meso-level.

All the codes were created using practitioner's experience, literature review and new knowledge gained during fieldwork. They were refined during the analysis of each individual case and finalised after completion of the categorisations per case (See Table 7.1). Later on, as described in the next chapter, these codes will be aggregated for generalisation. Consequently, Table 7.1 should be used as a reference guide that helps with the initial generalisations extracted from the individual cases. While reading what happened to people (outcomes), common patterns are found and categories formed. These categories lay out the foundation for the cross-case

comparisons from which general lessons about how fines achieve reduction in the number of delayed discharges will be extracted.

Table 7.1: Table of Contexts, Mechanisms and Outcomes

CONTEXTS	MECHANISMS	OUTCOMES
C1. Recuperation patient	M1. Social services managers to make discharge decisions through weekly meetings	O1. Possible fine avoided
C2. Self-funding patient	M2. To offer transfer to interim bed	O2. FINE
C3. Housing needs	M3. To use patient choice as an automatic way to avoid fine (even if it was never going to result in a fine)	O3. Patient delayed and recorded
C4. NHS continuing healthcare patient	M4. To offer minimum involvement for patients who are not a possible fine (no contact with patient or family)	O4. Patient delayed and not recorded
C5. Social services funded patient	M5. Care manager in the MDTs has an active role in discharge discussions	O5. Patient not delayed
C6. Rehabilitation patient	M6. To use the same pathway offered by the policy for patients clearly excluded by the policy	O6. Expressed inter agency conflict
C7. Family challenges team recommendation	M7. To use the resource that discharges the patient sooner but which is not necessarily the most suitable one	O7. Formal complaint
C8. Financial situation is not assessed before discharge	M8. To use social services resources to discharge sooner patients with primary health needs	O8. Patient leaves with unresolved medical issues
C9. Discharge destination not negotiated MDT	M9. Not to officially record a delay.	O9. Patient pays for more
C10. Ignorance of codes in social services staff	M10. To adapt discharge planning to social services rhythm	O10. Unexplored independence/rehabilitation potential
C11. Patient is clearly NOT involved in discharge planning decisions	M11. To offer some sort of involvement for patients excluded by the policy	O11. Choice of destination not fulfilled
C12. Patient (or family) is involved in discharge planning decisions	M12. To offer full involvement for patients excluded by the policy	O12. Independence or rehabilitation potential explored
C13. Health needs exclude patient from reimbursement.		O13. Choice of destination fulfilled
C14. Financial needs exclude patient from reimbursement		
C15. 'Choice' exclude from reimbursement		
C16. Housing needs exclude from reimbursement		
C17. Patient could incur a fine		
C18. Patient not informed discharge in advance		

7.2.1 Case Study 1: Mrs Ackroyd

Mrs Ackroyd is an 87 year old woman who was admitted to hospital due to several fractures caused by a fall. Before admission, she lived alone and was independent in all the activities of daily living (Mahoney and Barthel, 1965). In a fall at home, she broke three bones: in her leg, a rib and right wrist. After surgery, she was fitted with a long plaster cast on her leg, which was above her knee, and she was not allowed to put weight on it for 12 weeks. She could not hold a Zimmer frame or a stick because she also had a plaster cast on her right wrist, which left her unable to mobilise independently or with the use of equipment. These circumstances made her dependent on help for nearly all the activities of daily living, including washing, dressing, walking, meal preparation, etc. The following figure summarises the codes identified in this case:

Figure 7.1: CMOs for Case Study 1: Mrs Ackroyd

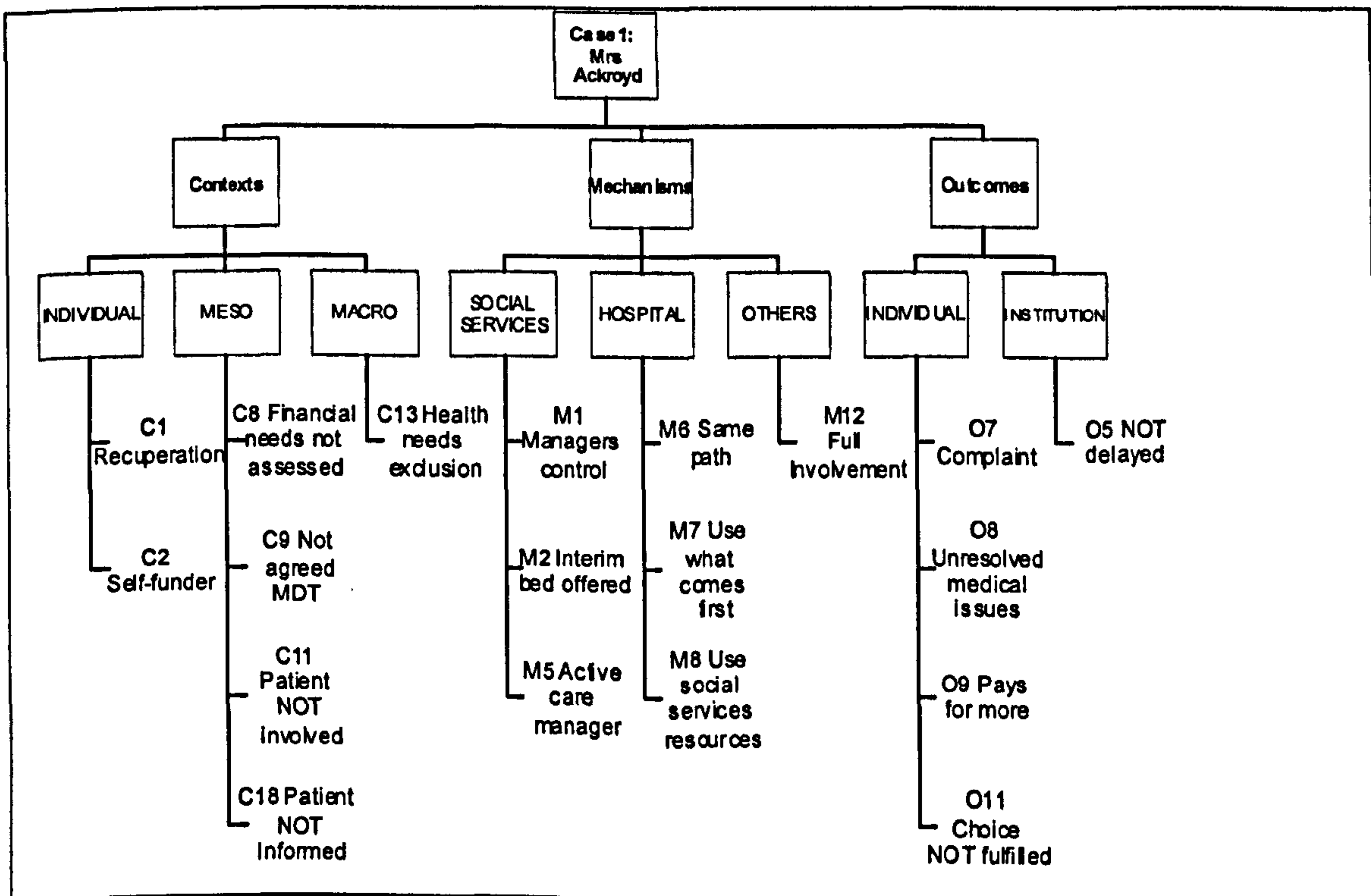

When Mrs Ackroyd's discharge was discussed in the multidisciplinary team meeting (MDT), it was stated that she was a suitable candidate for a transfer to the local PCT community hospital, where she could convalesce until she could start her

rehabilitation treatment. Consequently, she was a patient with 'recuperation needs'(C1), that is, somebody who needs rehabilitation after they complete a period of convalescence, recovery or recuperation. In this case, this would happen after six weeks, once she could put weight on her leg. The reimbursement scheme conceptualised these needs as 'health needs' and they exclude social services from any responsibility (C13) in these discharges.

Chapter Five explained how in the research site, before the introduction of the Delayed Discharges programme, the social services department had a budget allocated for recuperation patients. With the introductions of the fines, however, it was decided to leave this 'health need' as an NHS responsibility and money was diverted to other initiatives. Locally, the only NHS resource where these patients can be transferred is the PCT community hospital, which has a significance performance rule: patients are only accepted after they have been hospitalised in an acute ward for at least 35 days (See Chapter Five, section 5.3.2). Significantly, Mrs Ackroyd had only been in hospital for around 20 days when she was ready to leave the ward, which meant that she had to wait in an acute bed for at least 15 days before she could be transferred to this facility.

According to the reimbursement rules, Mrs Ackroyd did not need to be referred to social services because she was an 'NHS patient'. Nevertheless, the hospital still referred her (M6) because they did not have an NHS facility available for at least 15 days. In other words, they asked for social services' help, in order to facilitate a more prompt resource. After the care manager reinforced the need to transfer the patient to the NHS facility, the Tuesday MDT concluded by saying that Mrs Ackroyd would be placed on the waiting list for the community hospital. However, without any other multidisciplinary meeting, on Monday morning of the following week, Mrs Ackroyd was transferred to an interim bed in the residential home where social services have a block contract of seven beds. Therefore her transfer was not agreed at the MDT (C9) because decisions were made outside the meeting. The following quote from the social services care manager summarises how Mrs Ackroyd's discharge happened:

'Mrs Ackroyd is very upset. Because she is being transferred from an acute ward, she didn't know she was going to [name of the residential home]. Because nobody

had spoken to her. And, when, she's asked the nursing staff... The ambulance have come to get her! [They said:] 'Right you are going to [name of the residential home]. Pack your things!' And the nurse that told her, she didn't know where [name of the residential home] was, what was it all about or anything. And she didn't know about the cost implication. She actually wasn't given a chance to voice her opinion' (Interview with social services staff).

Mrs Ackroyd had been in hospital 27 days when the mechanism interim bed (M2) was used to facilitate her fast discharge from hospital. She found out that she was going to a residential home because the ambulance man told her. Therefore the patient was not involved in her discharge plans (C11), because these being discussed, agreed and implemented 'behind her back'. She was not consulted or informed in advance of the time or place of her discharge (C18). The following day, the social services care manager visited her for the first time. When discussing Mrs Ackroyd's finances, she realised that she was a 'self-funder' (C2) and, consequently, she would have to bear the full cost of the bed (£365.90 per week). The circumstances in which the transfer was carried out made the process of discharge too fast for the care manager to assess Mrs Ackroyd's finances before she left the ward (C8). In interview, the care manager explained that social services happened to have seven empty beds in the home where they had contracted interim beds in bulk. They had to fill them and therefore they transferred this lady to one of them. The mechanism activated here was 'use what comes first' (M7), which refers to the fact that the hospital use the resource that gets the patient out of the hospital sooner, instead of the resource that is most adequate for the individual's needs.

Another mechanism identified in this case was called 'manager control' (M1). Social services managers, who meet weekly to look at the list of patients ready to leave hospital, decided to transfer this patient without checking the information with the frontline staff, who had decided not to suggest an interim bed. This situation relates to the three other mechanisms identified in Mrs Ackroyd's case: the presence at the MDT of a care manager who had an active role in discharge planning discussion. This (M5) was a mechanism designed to reduce social services' delays. In this case, however, the care manager provided full involvement for a patient who was excluded from the policy (M12). From the point of view of the hospital, the mechanism used to reduce delays was to use social services resources to discharge earlier patients with

primary health needs (M8) for whom they should offer non means-tested NHS resources.

The main institutional outcome of this discharge process was that the patient was not delayed (O5) and therefore, the key policy output was achieved. A possible 15 days delay categorised as caused by the NHS was avoided. However, the coexisting individual outcomes for Mrs Ackroyd were a different story. To start with, the patient left the ward with unresolved medical issues (O8), including an unexplored chest pain and unclear direction of how her rehabilitation exercises should progress. This was explained by the care manager a few days later after the discharge:

‘She has got chest pain. She said that she had chest pain all time while in hospital. So I said, ‘What did they say [in the hospital ward]?’ ‘It’s just because of my fall’. She has very severe chest pain, going right through the middle of the chest, and it comes and goes. So when I went to the MDT yesterday afternoon, I said to them: ‘Can I just clarify that the chest pain that Mrs Ackroyd was having since the fall had been investigated fully?’ And they said they didn’t know anything about this chest pain. So now we had to get the GP out, to [name of the residential home] to have a look at this chest pain. The consultant said that she could partially weight bear, so I told them at [the residential home] that she could partially weight bear. But because the community rehabilitation team have got involved... They said ‘No, she can’t [partially weight bear]’... The lady has now lost her confidence in [the residential home]. She thinks ‘What the hell is going on here?’ (Interview with social services staff)

Mrs Ackroyd, days after this conversation with her care manager, decided to self-discharge from the interim bed and chose to admit herself to a private nursing home of her choice. This decision has been used as evidence of the outcome ‘choice of accommodation not fulfilled’ (O11), because when she realised that she did have a choice, she decided to go elsewhere, a private nursing home costing £800 per week. Mrs Ackroyd was actually entitled to free care in an NHS facility, but the circumstances in which her discharge developed made her pay privately for nursing care. She was compelled to a situation where she was paying more money for services that she did not require (O9) because she could have been managed in a residential home with some occasional nursing input. Although it is unknown to the researcher how her rehabilitation process progressed once out of the NHS system, months later Mrs Ackroyd wrote a formal complaint (O7) against the hospital for the way her discharge had been handled.

7.2.2 Case Study 2: Mrs Beamont

Mrs Beamont was an 87 year old woman who was admitted into hospital due to breathing difficulties caused by a chronic respiratory illness (bilateral pulmonary embolism). She also had multiple long-term pain conditions. She was registered blind and before admission, she lived alone, mobilising with a Zimmer frame. She had a care package of four homecare visits a day which was set up five months before, following a previous hospital admission. Homecare were preparing all her meals and drinks. They were helping her with personal care but she was still transferring independently from the chair and using the stair lift. The following codes are identified for this case.

Figure 7.2: CMOs for Case Study 2: Mrs Beamont

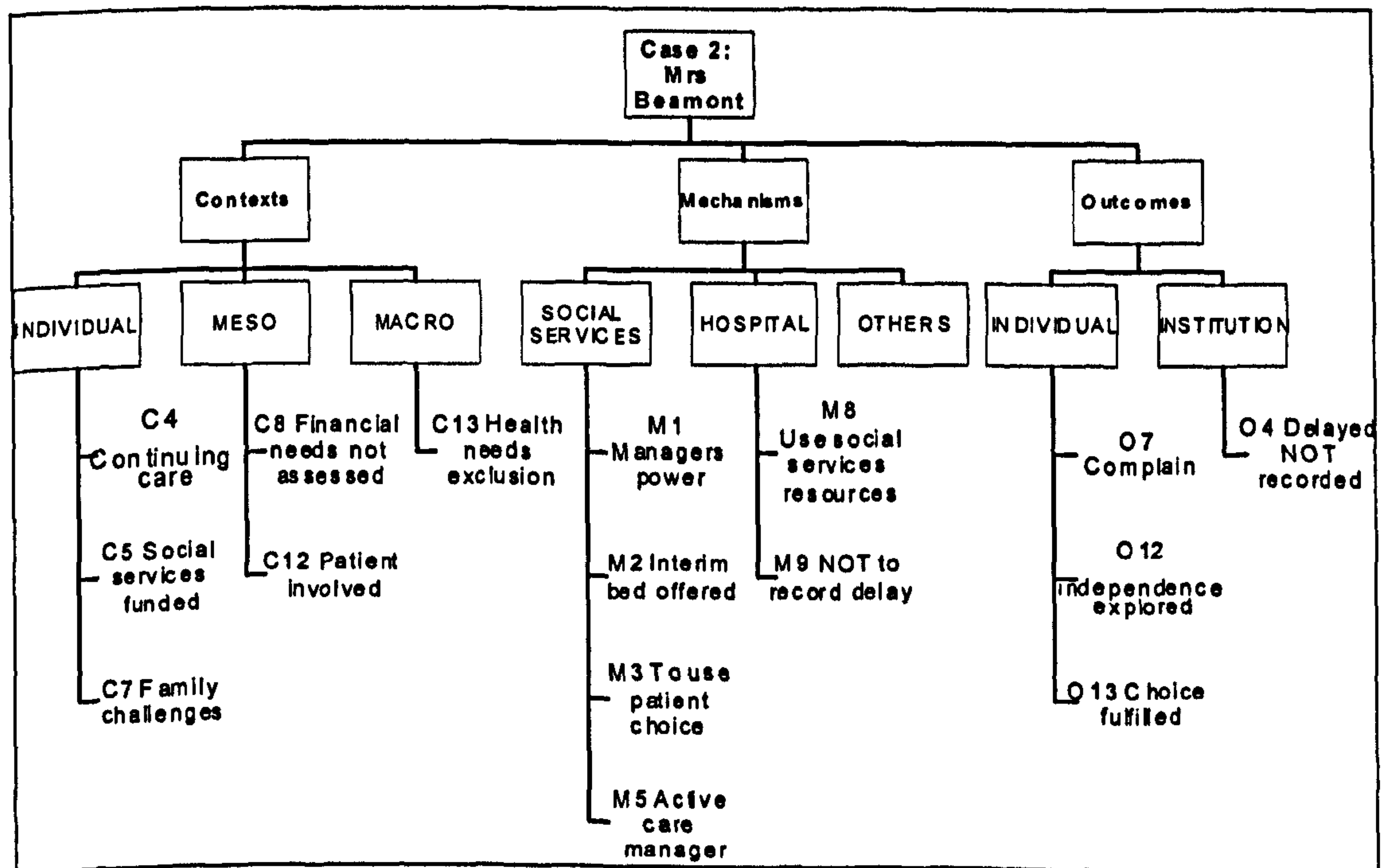

When Mrs Beamont was referred to the social services department, the intention was for her to return home and to re-start the original care package. She explained this to me in our first conversation:

‘In the information interview, Mrs Beamont explains that she lives on her own, with homecare four times a day. She asked me if she is going to have those services again so she can go back home. She sees homecare as part of her

independence, she wants to go back home. She likes to go out in the garden and look at the distance, listen to her audiotapes' (Fieldwork notes).

However, as the weeks and months went by, Mrs Beamont did not appear to reach medical stability and she had several infections. The multidisciplinary team recommended permanent transfer to a nursing home as the adequate discharge destination for the patient. Although, the patient's family initially did not want her to go into a nursing home, Mrs Beamont understood and accepted the change in plans, as the best option for her:

'Mrs Beamont says she is going to a nursing home tomorrow. She mentions the name of the home and asks me if I know of it. She mentions another nursing home they liked and the fact that they had 14 people on the waiting list. She went to visit a friend in there years ago. She is very pleased to leave the hospital. She has been in it since October [four months ago], she says. She explains how she originally wanted to go back home but she does not want to be 'a burden to her kids'. She gets a bit emotional at this point. She thinks that to go home would mean to be dependent on her daughter. She explains how her daughter was happy to support her at home, but Mrs Beamont thinks that to go into a nursing home is the best solution. She explains how she gets bored in the ward. She cannot listen to her tapes or the radio. Also she gets frustrated with her eyesight and not being able to see at a distance' (Notes from interview with patient).

Although Mrs Beamont owned a property, she was entitled to some social services funding for her placement because her savings were just below the threshold. This means that social services are obliged to fund her nursing home fees for 12 weeks, at which point she would be expected to sell her property. For this reason, she was considered a 'social services patient' (C5), and therefore somebody who could incur a fine (C17). When it was decided that she needed to go into care, social services offered a transfer to one of the interim nursing beds contracted in block in a private establishment (M2).

Mrs Beamont's family rejected the interim bed on three grounds. First, they did not like the private nursing home that they were offered. Second, they did not want Mrs Beamont to be moved twice: once to the interim bed and then to the final long-term home. Finally, they did not want her to be moved to a different room once she was in the nursing home. Interim beds bought in block are used exclusively for hospital discharges. Once the six weeks passed, even if she was staying in that home, she would need to move to a different bedroom. Mrs Beamont was blind and all these

moves would have been unsettling and disorientating. All these reasons were a mixture of the circumstances in which 'interim beds' were defined locally and the patient's micro-characteristics. The rejection of the offer from social services meant that she would be categorised as a delay due to 'patient or family choice' and social services would not be fined for it (C7). Nobody in the multidisciplinary team queried how beneficial the offer of a temporary transfer was for somebody so frail. The mechanism 'interim bed' was used automatically and routinely. The MDT meeting recommended she was 'for placement, in her best interest'. They did not, however, question if the temporary placement was the most appropriate solution for a medically frail patient. The following notes from one of the meeting observations reflected this frailty and how much staff were aware of it:

'Doctor to have another conversation with the patient on their own. Risk of sudden death because of multiple illnesses. Doctor to have X-ray meeting. Discharge liaison nurse thinks she needs a palliative care bed. She is worried that she may die with the transfer 'I don't want to put her in an ambulance', she said. She has questions about how the nursing home is going to manage her breathing. She asked the social services care manager: 'Palliative care, they can do at [name of the nursing home], can they? She needs symptom management' (Notes from MDT observation).

Mrs Beamont had an unstable health condition and needed palliative care. Her health needs meant that she could be considered a 'continuing healthcare patient' (C4). That is, somebody with a primary unstable health need who is excluded from the reimbursement policy (C13) and who is entitled to non means-tested NHS healthcare. In other words, the NHS is legally obliged to fund the nursing home placement because the patient's health needs are unpredictable and/or unstable therefore, they are considered as the total financial responsibility of the NHS. The need to submit an application for this NHS funding was not mentioned in the MDT meetings.

Days after rejecting the interim bed, Mrs Beamont's family found a vacancy in a nursing home of their choice. Because social services had to fund that stay for 12 weeks, her case needed to be discussed in the social services' CRAM meeting to approve the funding (M1). It was only a few days before Mrs Beamont's discharge to her chosen nursing home, that the discharge liaison nurse and the social services care manager decided to complete the application form for NHS continuing care funding.

They both explained in interview that they could not have done that funding application before because Mrs Beamont was never 'stable enough'. Significantly, unstable condition is the key qualifying criteria for NHS continuing healthcare funding (Department of Health, 2007c).

Mrs Beamont spent 101 days in hospital and died a month after being discharged. The individual outcomes for this case offered a mixed scenario. The family sent a formal complaint to the social services department (O7) because Mrs Beamont was discharged from hospital thinking that she may have to sell her house (C8) and without knowing that she was entitled to NHS continuing care funding. However, she was discharged to the nursing home of her choice (O13) and the discharge planning team considered other solutions which could promote her independence (O12), like going home which was not a feasible option due to her medical condition. Her discharge was delayed for a few days due to the fact that the family had to find a suitable home but this was never recorded officially (O4).

7.2.3 Case Study 3: Mr Catford

Mr Catford is an 89 year old man who lived independently in a sheltered flat. He used to be part of the Royal British Legion and before admission he was still giving talks in schools about Remembrance Day and his experiences in the war. Mr Catford was admitted in hospital due to cancer of the colon. He had a couple of operations until he refused to have another surgery. After these operations, he had a colostomy bag fitted, which is a removable bag to dispose of bodily wastes from the intestines. While in the wards, he also contracted several hospital acquired infections. When he was ready for discharge, he was walking independently with a Zimmer frame. However, because Mr Catford's medical condition had been so acute, ward staff told the family to terminate the contract on his rented flat, thinking that he may never recover enough to be independent. They did so and therefore when he, unexpectedly, improved he was homeless. The following codes are identified for this case:

Figure 7.3: CMOs for Case Study 3: Mr Catford

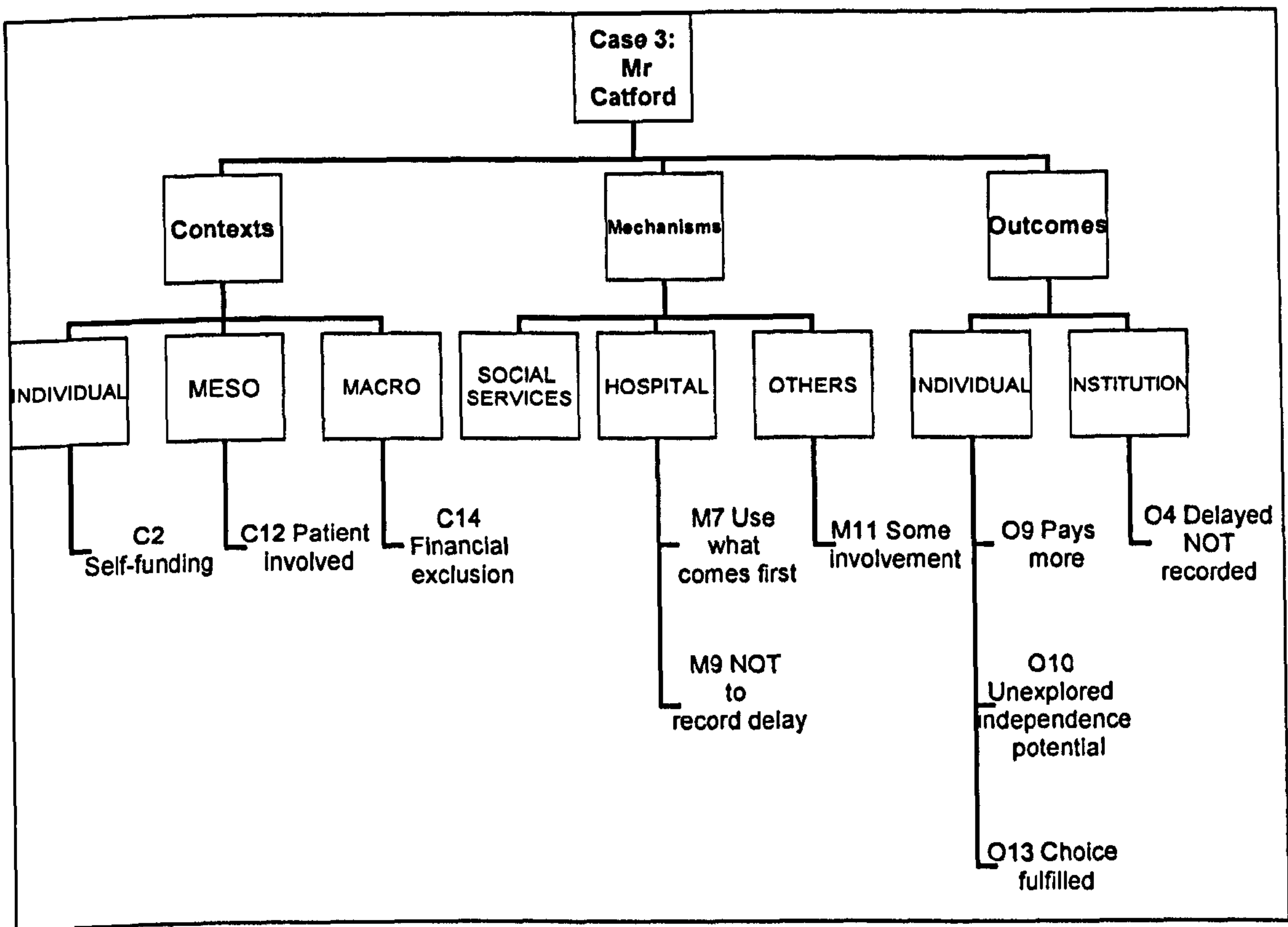

Mr Catford had savings over the social services threshold and was therefore considered a self-funder (C2). However, he would only be able to self fund for a year, if he needed to pay for a placement in a care home. In the first MDT observed, it was mentioned that his family were looking for homes. In my initial information interview with the patient, he was quick to mention that he now needed '24 hour care'. Mr. Catford was discharged after 57 days in hospital into a local home which provides long-term care for ex-service men. As a private client, he paid £625 per week for a nursing care bed of which £87 was paid by the NHS due to his nursing needs.

Mr Catford was a self-funder, and the reimbursement rules state that social services are only responsible for assessing his care needs but not for his discharge. This means, to advise him on whether he should go home and what packages of care are available, or whether he needed a residential or a nursing home. Once that discussion has taken place, the patient could not be incurring a fine. The social worker allocated to Mr Catford's case spoke on the phone with his family and gave them a list of nursing

homes available in the area. However, it was not clear whether the social worker visited him while in hospital. Initially, she said that she did not have the time to visit him while in hospital but, weeks later, in the interview, she reported a visit before he was discharged. Without questioning this discrepancy, what is significant is that she reported visiting Mr Catford just before he was discharged and thinking ‘You could go home! You know, with a bit of help’. The perception that Mr Catford’s needs could have been managed either at home or in a residential home was confirmed when she visited him at the nursing home two weeks after his admission:

‘Uff [sighs]... He is walking about... He’s had a fall because he lost his balance when he was drawing his curtains because he didn’t use his stick. He is dressing himself, he is washing himself and he could be... I’ve asked them to re-assess him’ (Interview with social services staff).

When asked if she meant he should actually be paying only for residential care, she agreed. This explains how the potential for independence of this patient was not explored before his discharge (O10) and social services, whether they visited him in hospital or not, went along with helping the family with the transfer into care without questioning if this was the best resource for the patient. The relationship between the outcome ‘unexplored independence potential’ and the context ‘self-funder’ was explored in the interview with her care manager. She explained how, if the patient had been funded by social services, the outcome for him would have been different:

Researcher: If he was social services funded, do you think they would have tried him in the community like [name of an interim sheltered facility] or...?

Care manager: The state he was in when I saw him? Yes, I do. I believe that he would have gone home in a trial or into interim and...

Researcher: And another sheltered...

Care manager: And the rehabilitation team working on him for his mobility, you know, to make sure he got the right equipment. And I think he would have been fine. I don’t think he would have come to nursing or residential’ (Interview with social services staff).

A similar answer was given by the discharge liaison nurse when asked the same question, which strengthened this finding. However she explained that, unlike social services funded patients, self-funders have the option to ‘choose’ to pay and they frequently do. It is not clear how informed those choices are:

'I think the difficulty with self-funders is that they can pretty much go wherever they want. They may not necessarily need to go where they are sent. And they can sometimes opt for something that is provided with more support than they need. But a bit of me thinks, you know, he had a diagnosis that means he was exhausted and anaemic all the time. He wasn't going to get any better. He had a hell of a time with his surgery. It must have knocked him sideways. And I think he did his absolute best to say 'I'd like to try home but I don't know if my heart is in it'. I think he was scared' (Interview with hospital discharge liaison nurse).

A frequent subsequent outcome for self-funders, who do not have their independence maximised, is that they pay for more services than they require (O9), and this is the case of this patient. In the case of Mr Catford, a return home was not an option given to him from the beginning. However, he might have managed in a residential bed in the same home, which would be considerably cheaper. The tentative explanation here is that because this patient was a self-funder (C2) and not reimbursable (C14), the case lacked an active involvement from social services (M11). Consequently, his independence was not maximised (O10), which meant that he ended up paying for more services than he needed (O9).

Nevertheless, social services did offer support to the family, they did review his post-discharge outcomes (M11) and Mr Catford had his choice of accommodation fulfilled (O13). With regard to institutional outcomes, Mr Catford's hospital stay was identified as a delay during the discharge planning (O4) when his consultant said in the MDT meeting: 'He should have gone last week'. Although the patient ended up leaving six days after that comment was made, Mr. Catford's stay was not recorded as a delay (M9). This was confirmed by the fact that the Section 5 form, which is the one that highlights the delays in the hospital figures was never sent to social services.

7.2.4 Case Study 4: Mr Derwick

Mr Derwick is a 40 years old man who was totally independent before being admitted in hospital with a stroke. This left him with right side weakness in his body which caused impairment in his speech, and reduced mobility. He could walk independently but had a tendency to fall and it was difficult for him to manage stairs. He also needed some assistance with meal preparation. Before the stroke, he lived alone in a third floor council flat without a lift. When the patient was considered fit for discharge, he

could not go back to his old apartment because he could not safely go up and down the three flights of stairs to get to his flat. His family was not able to give him shelter or practical support. Mr Derwick left hospital after 122 days to be re-housed in a bungalow in a neighbouring town. The following CMO combinations are elucidated in his discharge planning:

Figure 7.4: CMOs for Case Study 4: Mr Derwick

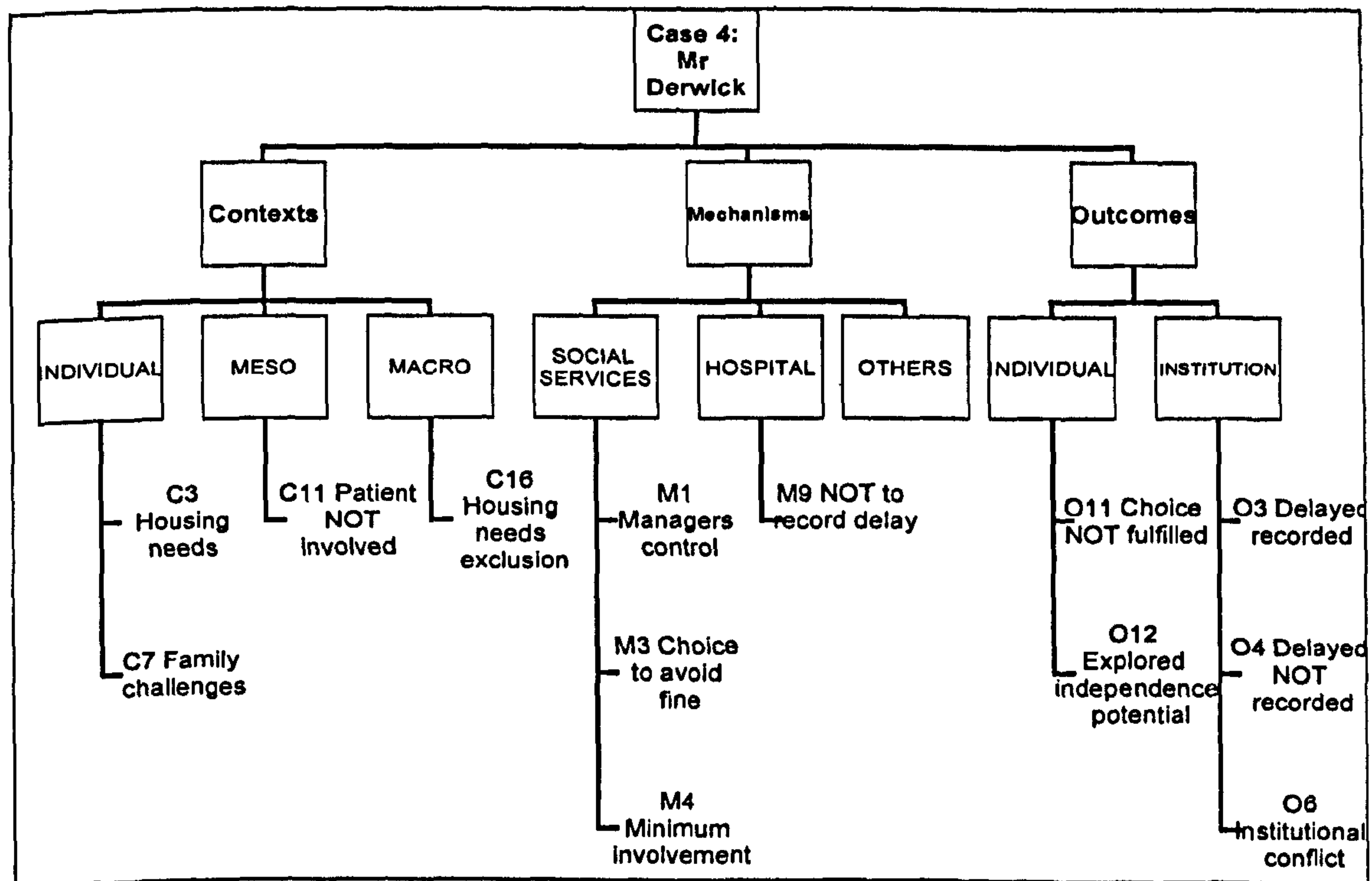

When Mr Derwick was ready for discharge, his main need was 're-housing' (C3) which is a social need excluded by the reimbursement policy (C16). Therefore, social services could not be charged for a delay in his discharge.

Chapter Five explained how in this locality there is a significant shortage of council properties. Consequently the likelihood of Mr. Derwick being allocated a suitable council property within a few days was much reduced. Social services offered the hospital minimum support for this case (M4). Firstly, a social services care manager was only allocated to the case two months after his admission to hospital. The case was allocated at a late stage to somebody that was in a planned sick leave, indicating no urgency to facilitate his discharge. Secondly, the social services representative who attended the MDT meetings did not show active involvement when Mr Derwick's

case was discussed. Difficulties in finding accommodation for the patient were reported week after week, but she did not participate in developments or decisions. It was the discharge liaison nurse who was left with the task of communicating with the housing department, filling in the application form for re-housing and urging them to quickly resolve the problem. Social services input for this patient was reduced to management recommendations (M1) through the weekly SitReps meetings. This was confirmed in an interview with the social services manager:

'But from a management point of view, it was only sort of the latter end that myself got involved, didn't I? When you think for how long he'd been in hospital... You know, he was just left sailing along and, you know, nobody was saying: 'Oh, you manager get him sorted out! Get him allocated! Get him do this! Or, you know, get the care manager to be more proactive!' It was only in the last few weeks, when it became apparent that maybe social services had delayed him in a way. Because they haven't maybe being proactive as they should have been' (Interview with social services manager).

She was blaming the hospital team for letting this patient 'sail along' in the wards. But the hospital ward strongly felt social services were showing an unusual lack of interest in the case. In fact, before reimbursement, this social need would have most probably been dealt with by social services staff. The Delayed Discharges Act removed this responsibility from social services and allocated it in the performance returns as caused by the NHS.

The development of this case created an open dispute between social services and the hospital team (O6). This conflict was observed in meetings and in informal conversations with staff from both institutions, with the wards considering writing a formal complaint against the social services department. When the local housing department informed the discharge liaison nurse that there were no immediate vacancies in the area of Mr Derwick's choice, the discharge liaison nurse went back to the social services manager for help. The manager advised that the patient return to his previous accommodation and wait for a vacancy to be available. The hospital team and the patient's family did not agree with that solution:

'Discharge liaison explains the outcome of the SitReps meeting to the rest of the team. She starts saying that the hospital social services team manager was on holiday and this other team manager came in and suggested that he should go back to his old flat. Discharge liaison uses a tone of voice that makes clear that

she does not agree with this suggestion. The occupational therapists and the physiotherapist disagree with the suggestion. Discharge liaison says that she hasn't had anymore news from housing. She makes comments like 'Not that I know the system!' and a very interesting one: 'social services is not helping one bit!!' (Notes from MDT meeting observation).

Mr Derwick's departure was delayed for weeks, some of those recorded (O3) and others not recorded officially. The hospital said that he was not MDT fit for discharge as they could not assess his needs until he was assessed by the therapists in the new property (O4). In an MDT observation done 20 days before he left the hospital, the consultant explained that 'There is not a lot we can do now' referring to improving the patient's health and the ward sister explained that 'They are giving him little jobs in the ward like tidying up the staff room'. Although, according to SitReps guidance, he was not a delay because he was waiting for a health assessment, in interview the discharge liaison explained how the patient was ready to leave the hospital two months before he actually went. Social services blamed the discharge liaison team for not wanting to send a Section 5 form (notification of discharge) for this patient because they knew he would be counted as an NHS delay.

In effect, social services could not offer their resources to assist the hospital in the case of Mr Derwick, as they do with older people (See Case 2), because they do not have any immediate resources contracted for younger patients. At some point during the weeks of trying to find a suitable accommodation for this patient, the discharge liaison team tried to recapture the punitive side of fines. They informed social services management that 'some new guidance' was out which could mean that they would be fined for this delay. One of the mechanisms that helped social services to avoid fines was instantly suggested. They informed the hospital that they would use 'patient choice' to avoid the fine (M3). They would recommend that he either returned to his previous accommodation or to be discharged to a Bed and Breakfast. If the family opposed that solution, it was due to personal choice and the fine would be avoided. The patient's family strongly opposed the patient going back to his old accommodation and threatened to go to their MP if the hospital was not able to offer a better solution (C7).

Finally, Mr Derwick was clearly not involved in the discharge discussions (C11). In one of the SitReps meeting observations, when the discharge liaison team were reporting the family's opposition to the patient going back home, I asked what was Mr Derwick's opinion about that possibility. The discharge liaison nurse said 'He doesn't have an opinion. He is passive'. Although the use of advocacy service was suggested, it never materialized. Mr Derwick was finally discharged to a bungalow in a neighbouring town, after spending 122 days in hospital. In the interview, he explained how he was not pleased with the area where he was going to be re-housed because it was too far out from his family and friends to visit (O11).

7.2.5 Case Study 5: Mrs Edington

Mrs Edington is an 82 years old woman who lived alone independently in a bungalow before being admitted into hospital due to a fracture in her leg, caused in a car crash where she was the driver. Her initial recovery was slow due to anxiety and depression but, in the last week before discharge, she started improving. One of the hospital therapists described in interview how this happened:

'For the first few weeks, she had her face to the wall. She didn't want to talk to anybody. She didn't want visitors. She didn't want to know anything. And then her wheelchair arrived. And I said to her 'We need to have a trial! We have to go out onto the corridor'. She was very reluctant to go out into public in a wheelchair but when I got her into the corridor, she asked me if I had more time to spend with her. And then she wouldn't get out of the wheelchair! She was going up and down the corridor. She went up and down the corridor three or four times on the first day! And you could see the emotional baggage lifting of her shoulders, and her face. And she was smiling for the first time in her admission and it was just very good!' (Interview with hospital therapist).

The following codes are identified in Mrs Edington's case:

Figure 7.5: CMOs for Case Study 5: Mrs Edington

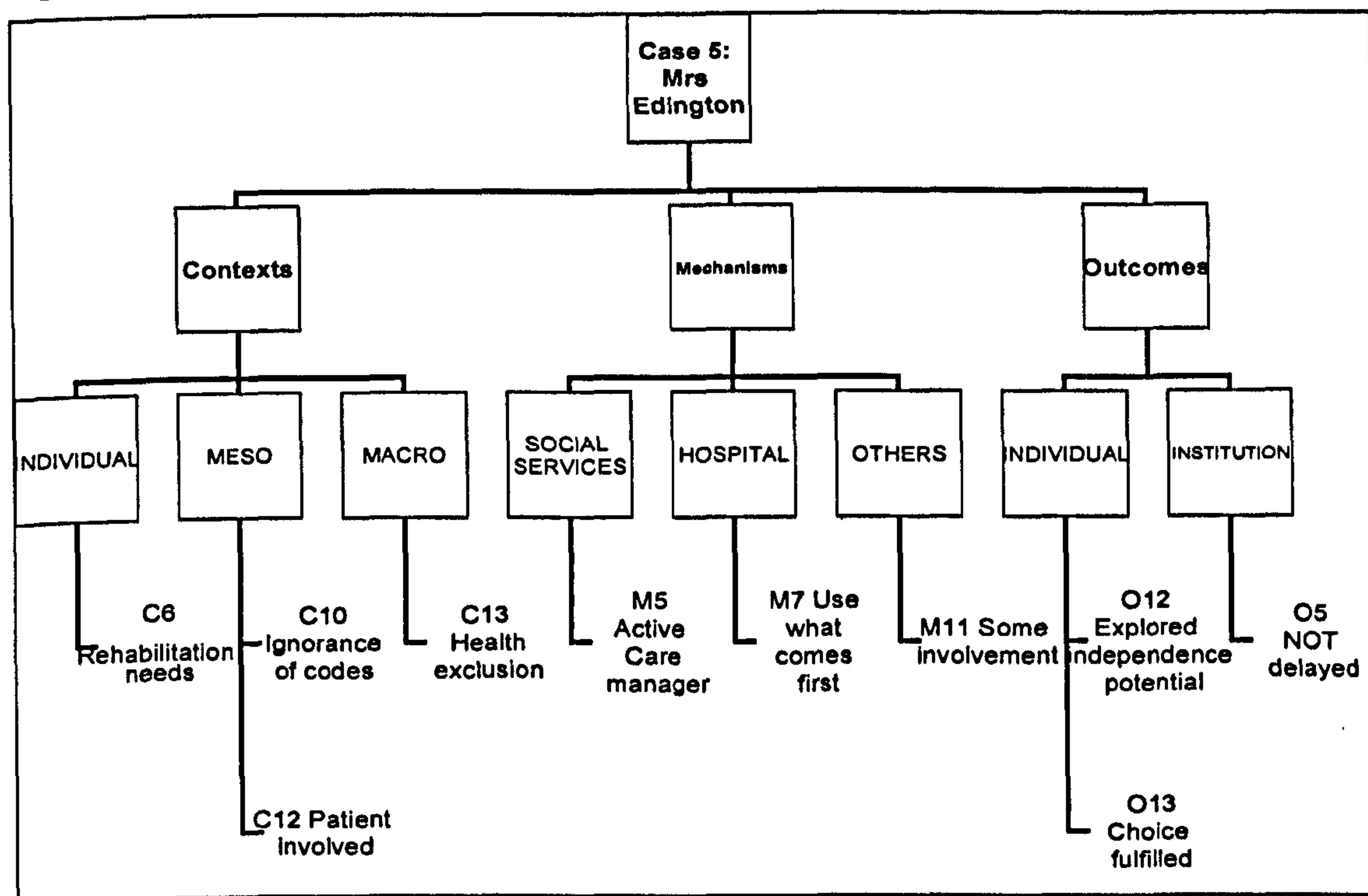

Although Mrs Edington had a plaster cast on her leg and she could not put weight on it and therefore she had only convalescence or recuperation needs for a few weeks, she developed a good degree of independence and was soon considered for rehabilitation treatment (C6). At the time of discharge she was mobilising for long distances with a wheelchair, and she only needed supervision while walking with a Zimmer frame. She also required help with meals and supervision with personal care. Once the plaster cast came off, she would be able to move up to the next level of more intense rehabilitation exercises.

In the MDT meeting, the team explained that Mrs Edington was going to be proposed for transfer into a nursing home but then, she started to improve and was able to do start some mild rehabilitation treatment. A discussion took place about the possibility of transferring her to the PCT community hospital but she still had 14 days to go for the 35 days target (See Chapter 5, section 5.3.2). They then suggested a transfer to a rehabilitation ward in the same acute hospital. Only if she was not accepted in another ward (these internal transfers need to be approved by a consultant), they would try to discharge her back to her own home. Therefore, the mechanism to reduce delays used here was the use of the resource that came first (M7) because home was considered as

a discharge destination only when the other two options were not feasible. Two weeks later, a home visit was organised and she was discharged home needing a rehabilitation homecare package (2-3 homecare visits a day) and input from the community rehabilitation team.

Mrs Edington lives in a rural area where packages of care are typically more difficult to arrange and when she was ready for discharge, social services did not have the homecare package available. However, her discharge was not delayed (O5) because social services contacted the local intermediate care team to ask them to temporarily help the patient while they found a private homecare agency that could do it. Mrs Edington's discharge could have never been a fine because she was entitled to intermediate care services to regain her ability to live at home after a hospital discharge which are excluded from the fines because they are considered a 'health need' (C13).

After a couple of days of helping her at home, the intermediate care team withdrew their services completely because the patient was able to manage on her own. Consequently, it seemed that Mrs Edington achieved her maximum level of independence (O12) when she was discharged home, to the destination of her choice (O14) and the one that would best help her recovery:

'If she would have gone somewhere else, I think she would have felt that she was a failure. I think she gained so much by the planning of going home and organising the family. It gave something for her to focus on, rather than her injuries. Because of the background to her accident in the first place and the guilty feelings that she had; having something else to focus on, I think, it made the difference for her. I think, if she'd gone to an interim placement or she'd gone to [rehabilitation care home] and the whole process would have been so much longer. I don't think, psychologically, it would have helped her' (Interview with hospital therapist).

Mrs Edington spent 33 days in hospital. Although, the MDT meeting made decisions about the most appropriate discharge destination, the consultant's perception of the time she should spend in hospital still played an important role. Although this case was never a delay (O5), hospital staff explained how, under the care of another consultant, this same patient might have been considered a delay:

'We were very fortunate that her consultant wasn't pushing either. Some other consultant may have said, 'We've done the medical treatment. Get her out of the bed!' While her consultant wasn't like that' (Interview with hospital therapist).

Although Mrs Edington was excluded from the reimbursement scheme, social services offered some involvement in this case (M11) with the care manager having a proactive role in the discharge discussions and setting up the services needed for a fast discharge. However, in the interview she explained how she feared she could have been fined for the patient's delay, when I reminded her that Mrs Edington stay was excluded from the reimbursement scheme. This confirmed another of the tentative hypothesis of social services staff lacking knowledge of the complex rules of the Delayed Discharges programme (C10) which, in general, facilitated a more equal management of the cases. However, Mrs Edington's post-discharge outcomes were not actively reviewed, as the care manager explained in the interview:

Care Manager: I spoke to Mrs Edington because I didn't go out and do a review because we didn't put a care package in.

Researcher: Yes...

Care Manager: I spoke with [the intermediate care team] and they assured me that she was fine. She didn't need anything. So I thought, 'Well, I'll just leave it'. And then before my holiday, I thought, 'Well, I'll ring her to close the file'. I just wanted to make sure that she was alright. And she was a bit...She actually felt that she was managing but she was still struggling. When I asked her to specify in what ways [she wasn't managing], she couldn't specify what she was struggling with. So I did say, when I go back from holiday, I will give her a ring and I'll go out and see her if necessary. But I don't think there is anything, really, that we would put a care package in for. It's just the fact, I think, she thought because we talked about having a care package up to six weeks' (Interview with social services staff).

The need of actively reviewing post-discharge services seem to be ignored for some patients if there are no services commissioned by social services that needed checking on or that could be offered.

7.2.6 Case Study 6: Mrs Falshaw

Mrs Falshaw is a 90 year old woman who lived alone and was independent before admission into hospital. However, she was not managing well at home and this seemed to be the reason that created the symptoms for admission: not eating and

incontinence issues, which were described by the hospital team as self-neglect. When she was ready to be discharged, she walked independently with a Zimmer frame but needed some supervision. At night, she needed help to get in and out of bed and she used a commode with assistance of one person. In the first MDT observed, it was assumed that the patient was going to be discharged home with some support. A week later, in the observation of the SitReps meeting, discharge liaison said: 'Family dictating residential home, case conference needed'. In the following MDT, when a case conference with the patient and family was suggested by a member of the team, the ward manager said 'Why do we need a case conference? She has agreed to go into care!' And nobody challenged this. In the next MDT, it was said that she was a self-funder and she was going to be discharged into a private residential home. The following codes are identified for this case:

Figure 7.6: CMOs for Case Study 6: Mrs Falshaw

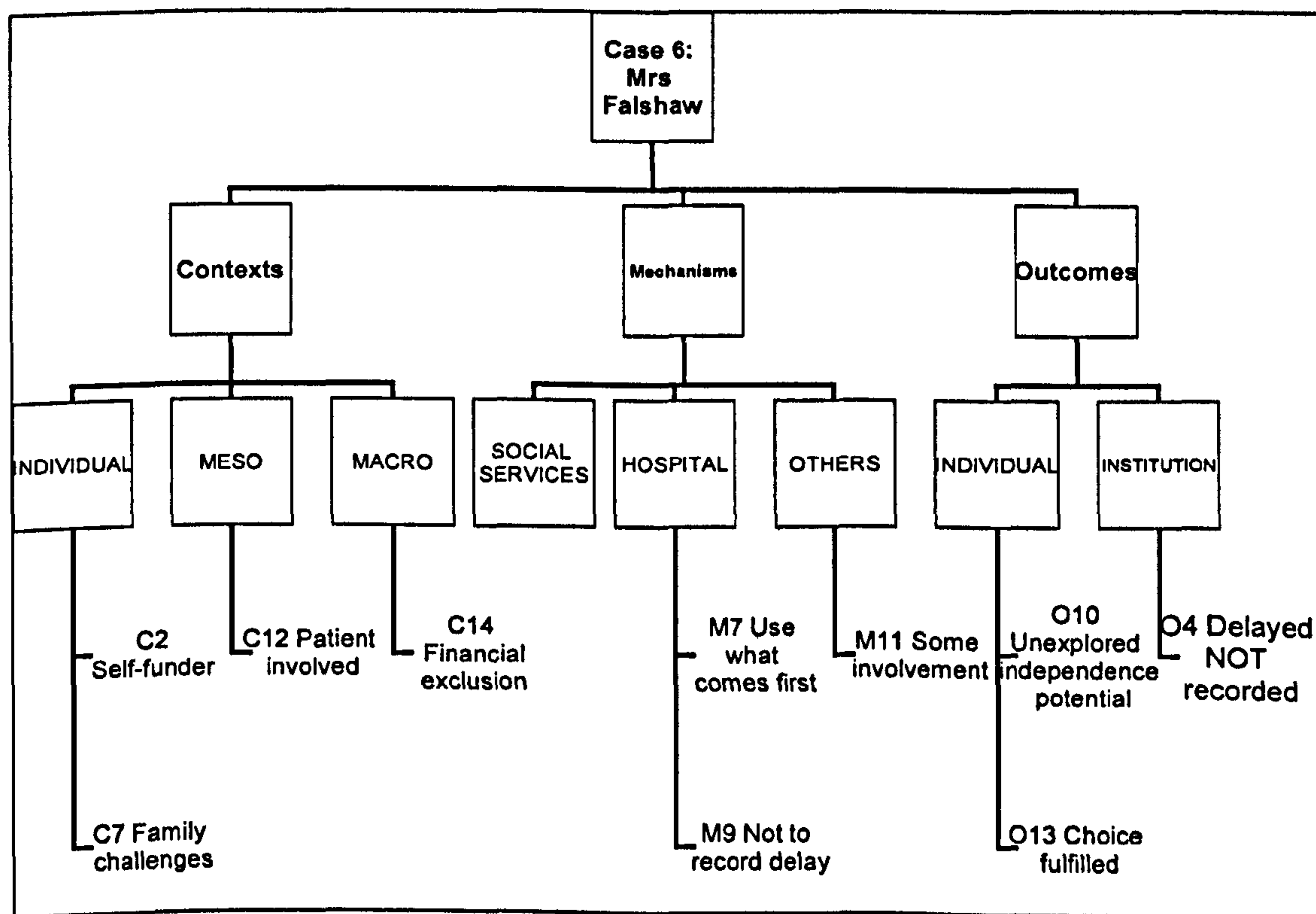

Mrs Falshaw was a self-funder (C2) and therefore excluded from the reimbursement policy because of her financial circumstances (C14). Although this patient had no previous care services at home before admission into hospital, Mrs Falshaw's family asked for her to be transferred into a care home. This was against the team

recommendation (C7), who thought she should go home with a package of care. However, nobody from either social services or the ward challenged this decision and a transfer to a private care home was facilitated with the guidance of the care manager. The mechanism used by the hospital to facilitate this discharge was the use of the resource that would discharge the patient first (M7), because to organise a care conference with the patient and family would have delayed the process.

Despite the situation described above, Mrs Falshaw was pleased with the transfer to a care home (O13), which she knew of through her son (C12) as she described in interview:

'Mrs Falshaw explains that her son has organised everything and she is happy with it. She thinks she is going there [to the care home] on Sunday. I asked her about her involvement in discharge planning. She says: 'In the hospital they just tell you when you have to leave and then you have to make your own arrangements and my son has done it for me'. She has been very happy in the ward. She did not get bored. She was happy to be in but she is happy to leave as well. She has no worries about discharge' (Interview with patient).

Social services had some involvement in the case (M11). Although the care manager did not take an active role in the MDT discussions, she did meet with the patient's family and spoke on the phone with them a couple of times. However, the potential of Mrs Falshaw's independence was never explored (O10) in the way it would have been done if the patient was not self-funding her own care. This theory was confirmed in the interview with the allocated care manager:

'Researcher: If she would have been social services funded, how do you think the case would have been different?

Care manager: She had not had any care at home...any significant care at home prior to been admitted in hospital. So what we would probably have looked at, it would have been an interim [bed] for further assessment and then possibly home with a package of care.

Researcher: Tried her home first...

Care manager: Yes, yes... But obviously taking on board what she wanted and what the family wanted. Because they were concerned about her neglect at home. They really felt, she'd gone down hill' (Interview with social services staff).

Consequently, the care manager explained that if this patient had been 'social services funded', first she would have used the interim bed as a routine mechanism and then,

she would have tried to help the patient to go back home. When I asked why she did not confront the family's decision to admit Mrs Falshaw into care, as she would have done for a social services patient, she explained that they do not take that approach with self-funders:

'You don't. No, you don't challenge their decision, really at the end of the day. No, because, you know, they can fund it. They have that choice. I've written to the son. Sent him the leaflet that says if the savings get to £20,000 you should contact social services. But it wouldn't look as if this lady would meet that. She is very self-funding without selling the property' (Interview with social services staff).

Mrs Falshaw stayed in hospital 57 days, when she was discharged to a private residential home that she had to pay for. Apparently, she was never recorded as a delay although her consultant in an MDT meeting said about her: 'She is happily sitting there. She does not need to be here'. The patient left the hospital eleven days after that comment was made (O4). The Section 5 form that records delays was never sent to social services for this patient (M9), which is a mechanism used to avoid recording delays

7.2.7 Case Study 7: Mrs Grange

Mrs Grange is a 77 years old woman who was admitted into hospital due to a fracture in her leg caused by a fall at home. She lived alone and was fully independent before the fall. She used to live in the area, but she moved to another town to be closer to her only daughter. She did not settle there and, 16 months later, she moved back into the area in a rented flat, having a house to sell in the previous town. She had only been in her new flat four days when she had the fall. The codes identified for this patient are described in the figure below:

Figure 7.7: CMOs for Case Study 7: Mrs Grange

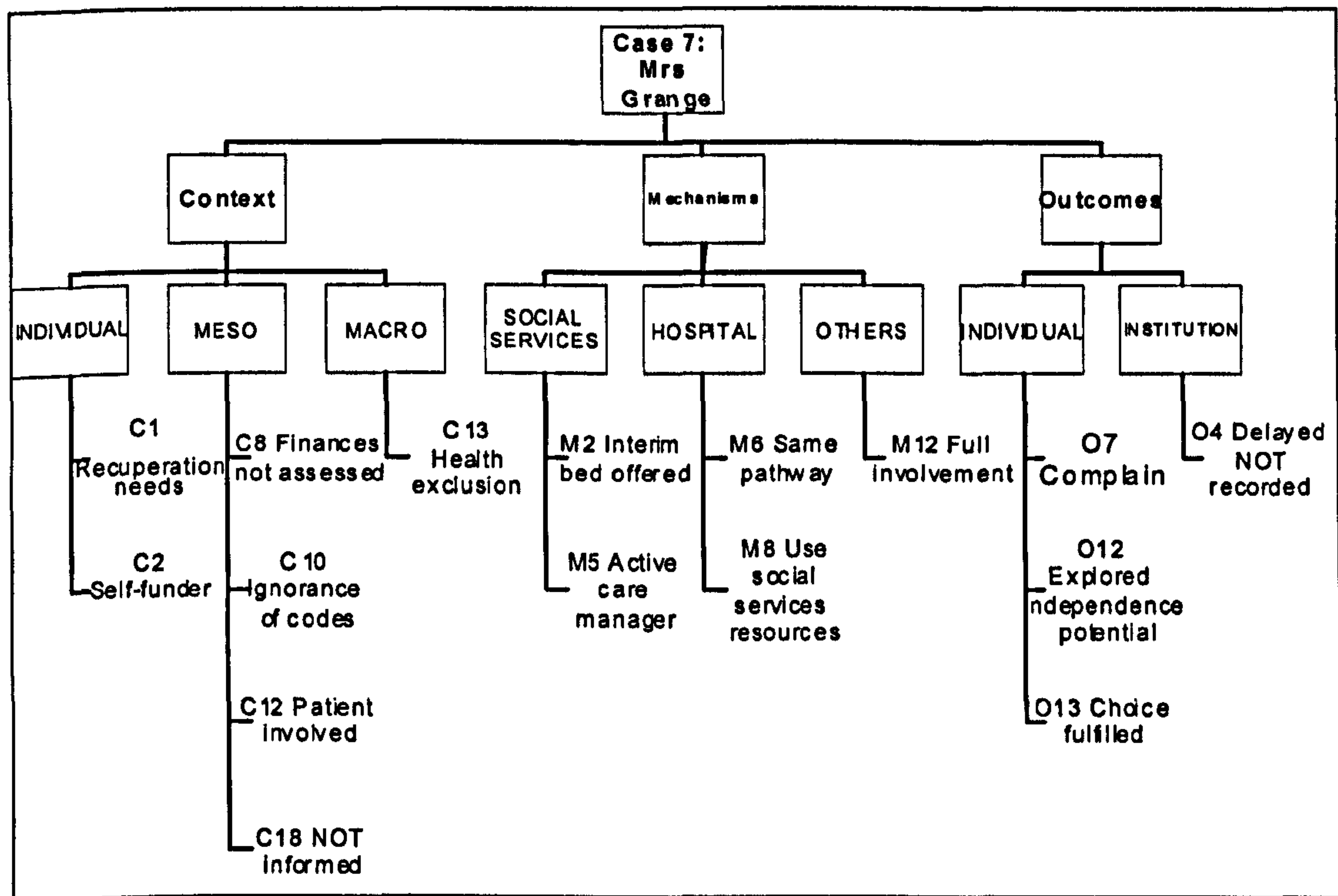

Mrs Grange required a period of convalescence (recuperation) before she could start the rehabilitation treatment (C1) and therefore she was excluded by the reimbursement policy because of this health need (C13). Initially, a home visit was organised with the idea of setting up a homecare package but Mrs Grange struggled to mobilise and she was not considered by the hospital therapists to be safe at home. Therefore, her independence potential was explored (O12) and she was involved in the decisions about her discharge plans (C12). When the home visit failed, she was offered an interim bed in the residential home where social services have the block contract and she accepted:

‘Initially, she did say she’d come here [name of the residential home], but they were full. And the other option would have been [name of the community hospital]. But she didn’t want to go there, because she wanted her friends to get to visit her. And then, literally on the home visit, I found that morning that somebody had died, and somebody has gone in the hospital. So, suddenly, they had two beds. So I rang [name of social services manager], and explained ‘Look the home visit is a bit of a disaster, and [the residential home] has got a couple of beds’. And it was a Thursday, so CRAM were actually meeting. So she said ‘Right, yes’. She went back to hospital after the visit but then we were able to get her a bed [in the residential home]’ (Interview with social services staff).

Social services provided a full involvement for this case (M12), with the care manager playing an active part of the discussions at the MDT, offering transfer to an intermediate care facility that the patient refused, attending the trial home visit organised by the hospital, facilitating her transfer into an interim bed (M2) and reviewing post-discharge outcomes. Although, this patient was excluded from the fines because of her health needs, the hospital managed to discharge this patient earlier using the availability of social services resources (M6).

In this locality, interim beds are not offered to self-funded patients. However, the process of officially assessing patients' finances is slower than the hospital discharge process. Another council department has to visit patients while they are at home, review proof of their financial assets and then determine whether they are entitled to financial help from the local authority. Therefore, hospital care managers can only ask initial triage questions to decide whether patients are self-funders. Typically, they ask 'Do you own a property? Do you have savings over £20,000?' to ascertain if patients are able to self-fund. Financial situations, however, can be more complicated than this. When Mrs Grange left hospital, she had not been assessed by the council's financial department (C8) and she thought that she would not have to pay for the full cost of the interim bed:

'Mrs Grange: She [social services care manager] did say it was means-tested. And I said 'I have nothing because my property is not sold over in Manchester area'. And she said: 'Well, then you don't have anything to worry about'. I said: 'What kind of a fee are we talking about?' Well, she started off at £350! I thought 'Oh, my god, what am I doing!' But she said it'll come down drastically. And I think, they haven't means-tested me, you see. So I think that's why they have delayed it [the transfer to the interim bed]. Because she did say they would have to do the means test. So, whether that is delaying it, I don't know. Like I say, it's a lack of communication [...]

Researcher: The prices are shocking, aren't they?

Mrs Grange: Well, you know, I just can't afford it. It's as simple as that. I haven't got the money!' (Interview with Mrs Grange).

The care manager, thinking that the patient would be funded by social services, offered transfer to the interim bed for two weeks until the cast was removed from her leg. Then she would have rehabilitation needs (C6) and could stay in the same home but in a different room where she could remain for up to six weeks fully funded by the

NHS. She stayed in the interim bed three weeks but, when she was finally financially assessed, she was considered a self-funder (C2) and had to pay for the first three weeks of her stay. She formally complained against social services for this reason (O7).

Mrs Grange's choice of accommodation was fulfilled (O13). Her hospital stay was delayed but never recorded as such because the team could argue that she was waiting for a health assessment (the trial home visit) (O4). Although this patient's delay could not have been reimbursable because of her health need of recuperation, her social worker showed confusion in the interview when trying to ascertain if the reimbursement codes applied (C10). During Mrs Grange's discharge planning, it was never stated that she was a delay.

Mrs Grange stayed 30 days in hospital. The patient was not informed of the discharge date in advance (C18). Although I was informed on the Friday that she would be going the next Monday, when I visited her on the ward the day before her departure (on Sunday afternoon), nobody had told her that she was going the next day.

7.2.8 Case Study 8: Mrs Hanslow

Mrs Hanslow is an 85 year old woman who lived with her husband of a similar age. In the past, she had a small stroke which left her with a lack of grip in both her hands (difficulty writing and holding walking equipment). She lived independently in a bungalow with her husband as the main carer and with help from other relatives. She was admitted into hospital due to a fall at home in which she fractured both legs. Initially, she had two plaster casts fitted, but while in hospital they removed one. Due to her previous stroke, she could not push with her arms and had to be hoisted to get out of bed. When she was ready to be discharged, Mrs Hanslow remained fully dependent for all the activities of daily living:

Figure 7.8: CMOs for Case Study8: Mrs Hanslow

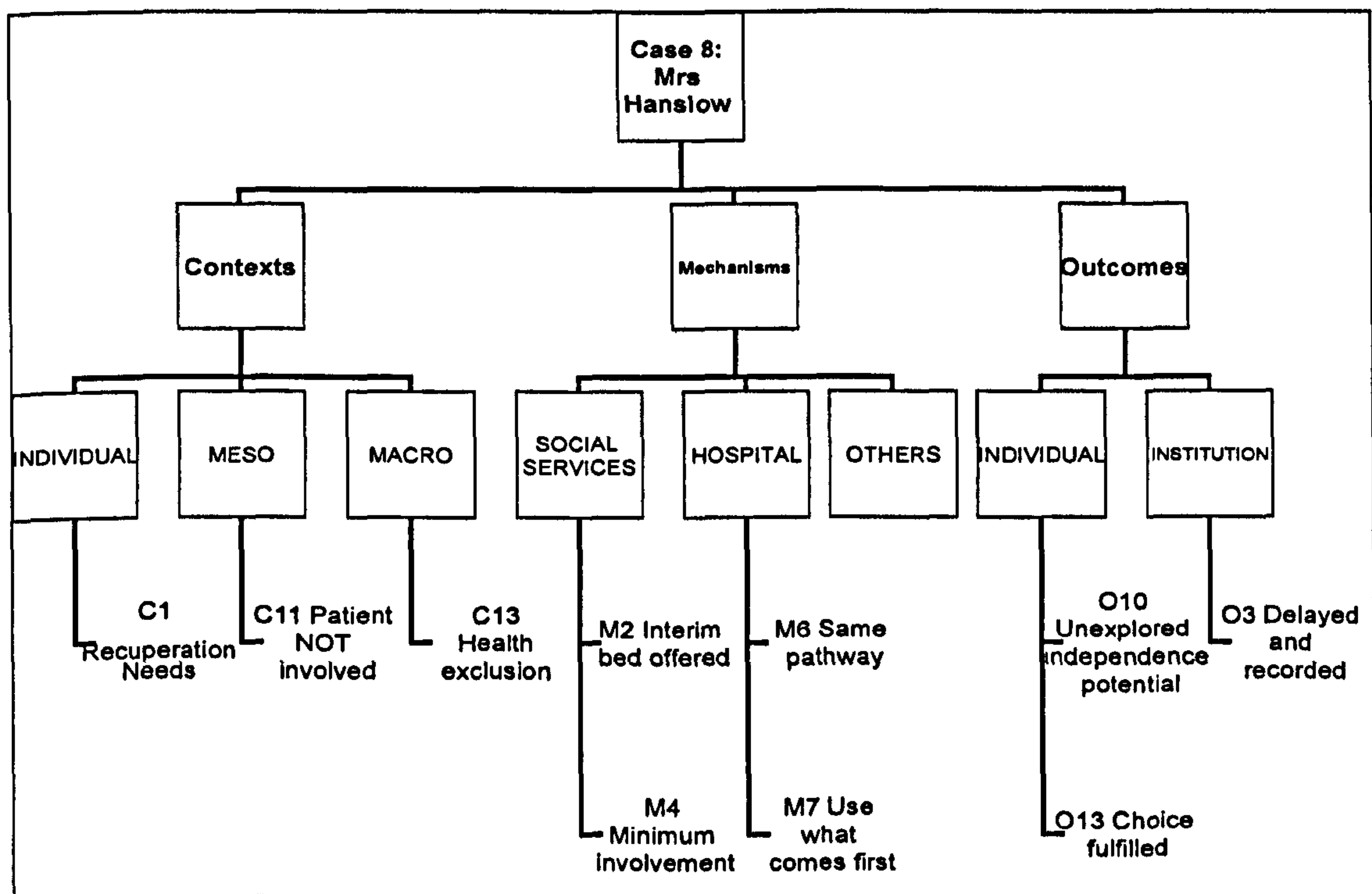

Mrs Hanslow was in need of a convalescence or recuperation period (C1) because she could not start rehabilitation until the other cast, which was above her knee, came off. Therefore she was excluded from the reimbursement policy because of her health need (C13).

In the first MDT observed, the social services care manager explained that the patient had been proposed for transfer to an interim bed. When in a SitReps meeting, social services queried why Mrs Hanslow was not transferred to the community hospital, the answer was that 'They do not 'do' non-weight bearing patients'. In other words, her nursing needs were greater than the community hospital would be willing to accept. The weeks passed and the ward sister at the MDT kept saying that Mrs Hanslow was 'waiting for an interim bed'. A Section 5 form was formally issued and the patient's stay became a delay (O3) and recorded as such. Social services could not be fined for her stay because of her recuperations needs and this delay was conceptualised by the programme as being the NHS fault.

Then, in the management meeting where delays are discussed (SitReps meeting), I asked if Mrs Hanslow had been offered an interim bed, and the three members of the

team, which included a social services manager answered at the same time with an emphatic 'No!'. It was only after the patient left the hospital and her care manager was interviewed that this mechanism was clear. Although the care manager said in the MDT that she had put the patient's name down for an interim bed (M2), this was only a mechanism to 'keep the peace' and to be seen as being proactive, more than a reality:

Researcher: Then they said that the care manager, you, had proposed this patient for an interim bed, so was that right?

Care manager: That was right. But it is because... I mean, to be honest with you... We actually didn't think she was... Because she didn't have any use in her arms or legs. So we said 'put her on the waiting list for an interim. But she is not going to get one' [...] It was the hospital responsibility, because she couldn't walk. And they were saying at that time she couldn't use either of her hands. So, she needed proper nursing.

Researcher: She needed hoisting and everything?

Care manager: Yes. She wasn't actually ready for an interim bed, really...'
(Interview with social services staff).

Social services offered minimum involvement to help facilitate her discharge (M4), the care manager did not visit this patient while in hospital and although she said she had put her name on the list for interim beds, this had not been done. Consequently, with no practical help from social services, the hospital had to wait for a bed to become available in the PCT community hospital once the patient had stayed in for 35 days. The weeks passed and she started weight bearing. Then the MDT team started to discuss the possibility of discharging her home instead of to the community hospital because there were no beds available in the near future. However, a day after the possibility of discharging Mrs Hanslow home was discussed; the patient was transferred to the community hospital with only a few hours warning. A bed became available and the transfer was a faster option than organising her discharge home directly from the ward (M7):

'Ward manager explains that Mrs Hanslow can now weight bear [not clear if fully or partially]. It has been a surprise because today she has walked to the corridor with a Zimmer frame. Sister asked Carer's Resource to check whether a referral has been made to them, as they are thinking of discharging home instead of to the community hospital because there seem to be no beds in the near future. Very supportive family. Patient had arthritis before admission. Sister-in-law was doing the laundry and husband, the shopping. They live in a bungalow in [name of the

town]. One shallow step into the house. She has electric riser chair. To do referral to the community rehabilitation team.

Ward manager says: To ask [name of the person who deals with admissions in the community hospital] if there are beds in the near future [...]. The occupational therapist asked when should they do the home visit if going home. Ward manager says: 'Early next week, you think? But see what the community hospital says' (Notes from MDT observation).

The day after this MDT meeting the patient was transferred to the PCT community hospital, after staying in hospital a total of 48 days. This was the preferred destination of the patient as it was closer to home than the acute hospital (O13). Mrs Hanslow, however, was not involved in the discharge discussions (C11), although she was informed that she was 'on the [waiting] list' to go to the community hospital:

'Researcher: Were any other options ever mentioned to you about leaving hospital? Nothing else was mentioned?

Mr Hanslow: Nothing else was mentioned.

Mrs Hanslow: Only by this person who came and we don't know who she was. She was talking about meeting somebody [...]

Mr Hanslow: Oh, this lady she said 'Would you like to get her out?' I said 'Certainly'. And she said it would be better for me and 'I'm sure it would be better for Mrs. Hanslow'. But that was as much as was said. She said 'Well, what I'll do, I'll put you on top of the list'. And I said 'Well, I'll be pleased about that'. And like three or four weeks later, she just appears. She says 'You are going to [name of the community hospital]. I said 'Never!' And that was the same day' (Interview with patient and her husband).

Her stay was delayed and recorded as such (O3). Whether Mrs Hanslow's independence potential was explored or not is hard to ascertain, as the patient was very dependent on help from carers and a discharge home would have been difficult. However, the patient did express in the interview that she did not feel they were been proactive with her rehabilitation while in the acute hospital. Indeed, the possibility of the patient going home was never explicitly explored (O10) in any of the meetings observed, apart from the last one, or explained to the patient and her family.

7.2.9 Case Study 9: Mrs Ianson

Mrs Ianson is a 69 year old woman who lived alone independently and she was in active employment as a medical secretary in a private hospital. She had a daughter who lived abroad. Mrs Ianson was admitted in to hospital due to a stroke which left

her with a weakness in the left side of her body. At the time of discharge she was walking with a stick and needed help with her personal care and with meal preparation. The following codes are identified for this case:

Figure 7.9: CMOs for Case Study 9: Mrs Ianson

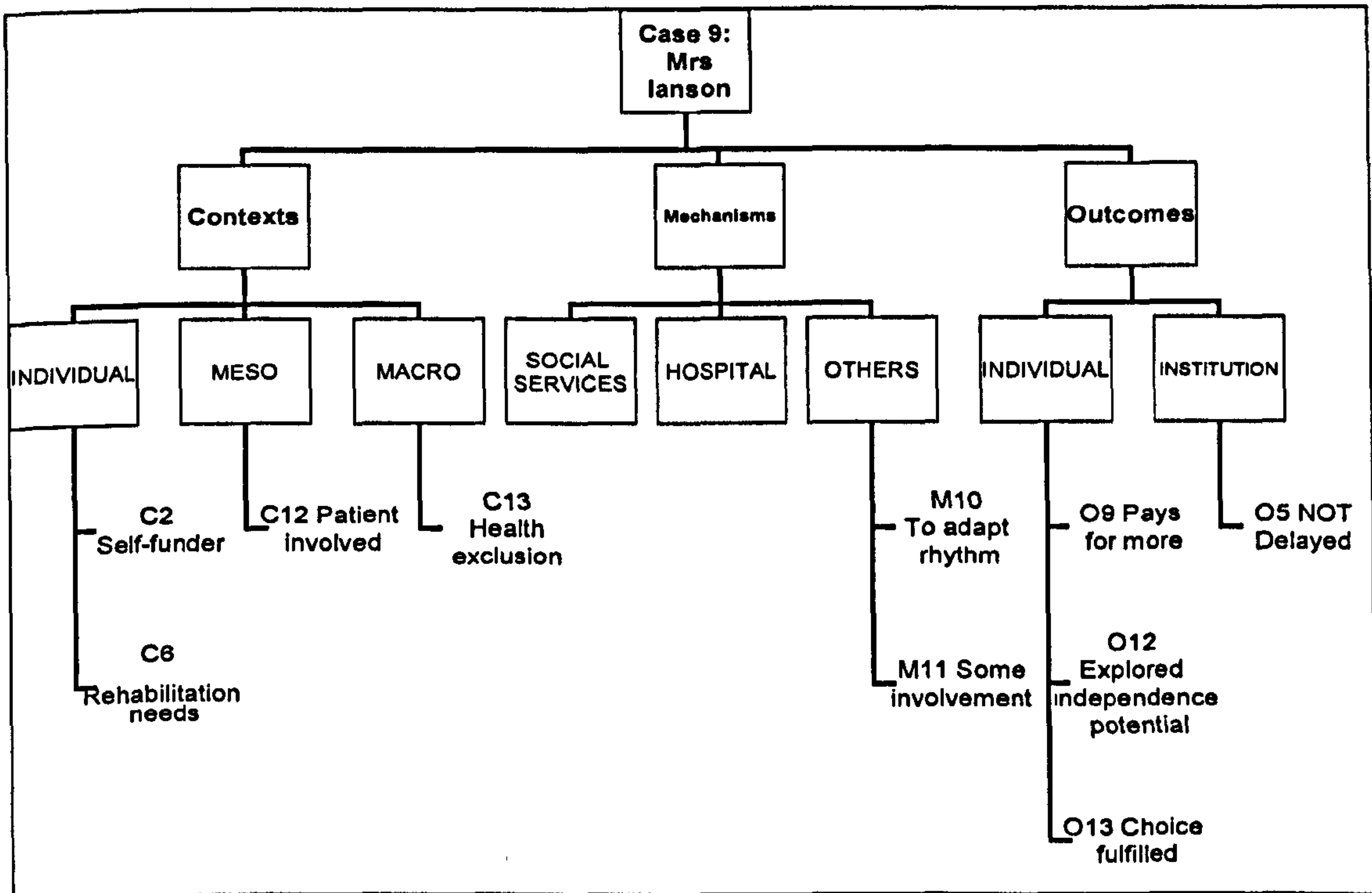

Mrs Ianson was considered a rehabilitation patient (C6) because she needed to learn to do everything with one hand and therefore, her primary health need excluded her from the reimbursement policy (C13). The multidisciplinary team suggested transfer to a rehabilitation care home until she learned how to be more independent. Although Mrs Ianson's family would have preferred this temporary resource, she wanted to go back to her own home directly. A trial home visit was organised to further assess the patient's mobility in her own environment and the family decided to pay privately for a live-in carer to stay at home with her 24 hours.

Even though Mrs Ianson was a self-funder, social services offered some involvement in this case. The allocated care manager attended the trial home visit and met with the patient and her family. Yet, her post-discharge outcomes were not reviewed and the social services representative in the MDT never took an active role in the discharge discussions (M11).

Mrs Ianson was entitled to up to six weeks free package of homecare introduced by the Delayed Discharges Act but she did pay for more care than she needed (O9). Whether this was a personal choice or a lack of information about her rights was explored in the interview with her care manager:

Care manager: We were looking at a package of care. People coming in the morning, lunch time, etc. And they [the family and the patient] decided that they will feel more comfortable if somebody was living on the premises, for at least a while. So they employed an agency to stay with her. So the family met up with them and they agreed a programme. Initially they were looking for a month, with a view to continue as necessary. And as far as I am aware, that went very well indeed. [...]

Researcher: At that point the family decides, although she would be ok with three visits a day, we want to pay. So it is their choice in a way...

Care manager: We discussed people coming in. Their concern was that they would be long periods when she'll be on her own. And they wanted peace of mind, really. Because it's Italy that they live in. So they could go back home and know that there was going to be somebody around 24 hours. What they were just worried about was that, God forbid, she had another stroke or she fell or whatever. And even with the pendant [alarm], she wouldn't be able to raise the alarm. So their choice to have somebody living in was purely for peace of mind. She could have managed quite sufficiently with care going in' (Interview with social services staff).

From the start, Mrs Ianson was involved in her discharge plans (C12) and her independence potential was explored to the maximum (O12). This was not only evidenced by the fact that she was supported to go back home, against her families initial wishes; but also because, when the team heard that she was going to have a live-in carer, it was decided that the team therapist would write to the private agency explaining that she needed 'enabling care and that she needs only supervision', their worry was that if everything was done for her at home, she would not regain independence. In this case, that was clearly not social services responsibility, the team mentioned that they needed to wait for the CRAM meeting to approve her care package (M10). This was not needed because she was paying for her own care but the team still, routinely, adapted their way of timing the discharge to social services meetings.

Mrs Ianson spent 72 days in hospital and was never reported as a delay (O5). Her choice of accommodation was fulfilled (O13). She was discharged home with a

privately funded carer and the support of the community therapist team to work on improving her mobility.

7.2.10 Case Study 10: Mrs Jones

Mrs Jones is a 69 year old woman who lived alone before admission into hospital. She was registered blind and lived independently with the informal help of family and friends. She was previously known to social services because, on a couple of occasions, some help at home had been set up for her, but days later she always decided to cancel it. Mrs Jones was admitted into the acute hospital due to a stroke, which caused her a mild left side weakness that made her unsteady when mobilising. At the time of discharge she needed help with meal preparation and personal care in the evening. The following codes are established for Mrs Jones' case:

Figure 7.10: CMOs for Case Study 10: Mrs Jones

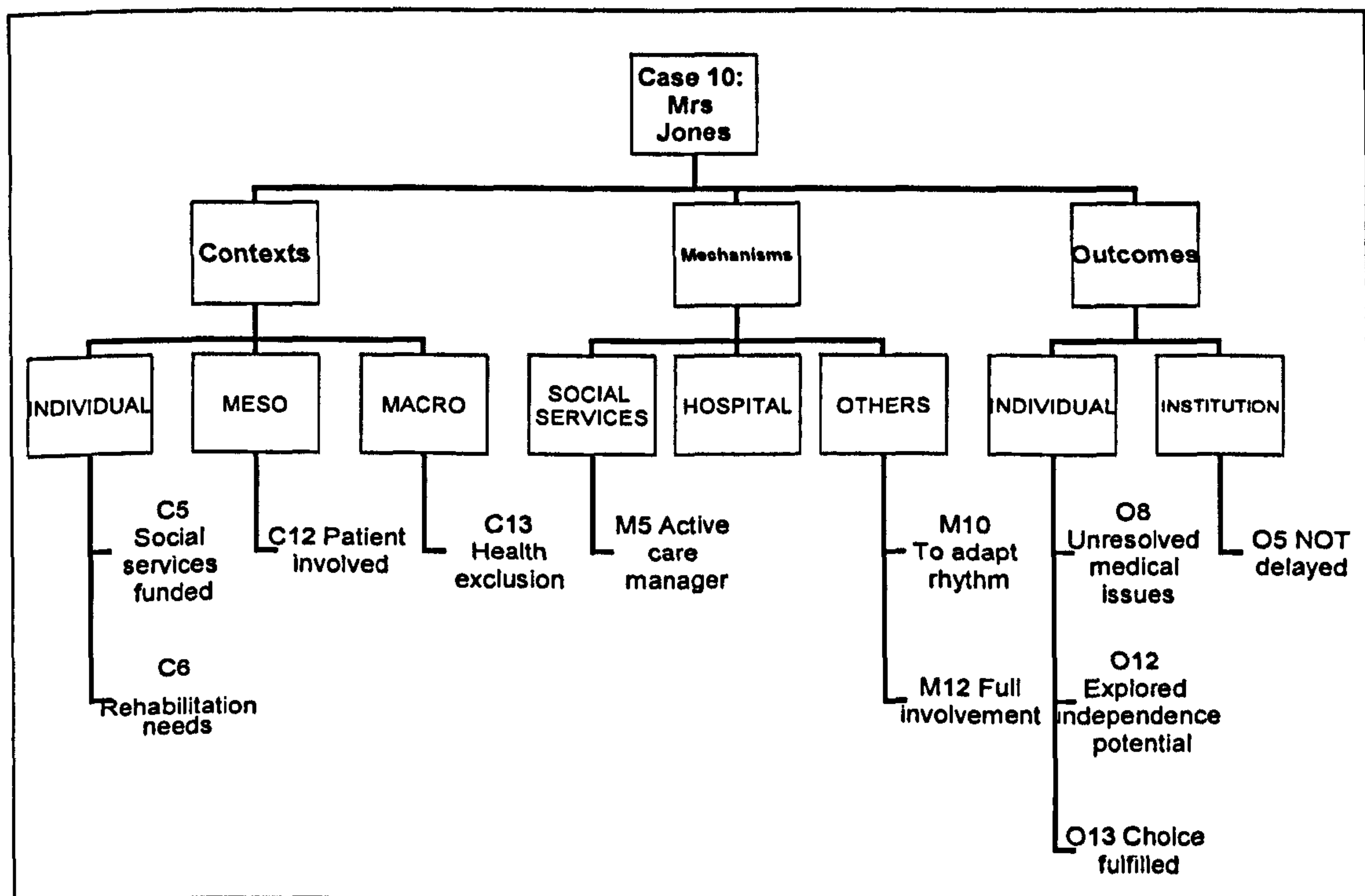

Mrs Jones was a rehabilitation patient (C6) and, as such, she was automatically excluded from the reimbursement policy because of her primary health needs (C13). However, she was known to social services as a previous service user (C5), which would have entitled her to social services funding, if needed. Mrs Jones was very

proud of being independent and she wanted to go back to her own home. Her family worried about her safety, especially knowing that she had rejected homecare in the past. The allocated care manager explained the family's position when she recalled a conversation with the patient's daughter in the trial home visit that the hospital organised:

'I have spoken to the daughter who was very anxious about her mum. Again, at the home visit, I arrived before they [the patient and hospital staff] arrived and talking to the daughter, she was very anxious and very concerned. But she did realise that her mum is a very independent lady and she does want to do what she wants to do, when she wants to do it! And, again, we reiterated that if that's what she chooses to do, then we couldn't make her do anything other than that, but she agreed to a care package for discharge' (Interview with social services staff).

This patient was clearly involved in the discharge planning discussions (C12). Mrs Jones herself explained in the interview how her family supported her choice of going back home (O13) but only after convincing her to accept formal homecare from social services:

'Mrs Jones: My family are right. I've managed on my own for long enough, I think. Now I need help.

Researcher: Did they ask your opinion, then?

Mrs Jones: They asked my daughter's opinion. [They asked] what was she most concerned about. And my son. And they both agreed the concern was they only get to know about things when it is too late, like been rushed into hospital' (Interview with Mrs Jones).

Mrs Jones' independence potential was explored to the maximum (O12). She was provided with two homecare visits a day: one for meal preparation and another in the evening to help her get ready for bed. Social services offered full involvement in this case (M12), performing an active role in the MDT meeting, attending the home visit that the hospital organised and, once she left hospital, reviewing the post-discharge outcomes. They also organised a visit from the local specialist assistive technology worker, with the objective of providing Mrs Jones with specialised equipment that would help her live at home independently.

As Mrs Jones had intermediate care needs (C6), she was entitled to a rehabilitation care package which is free for up to six weeks and this was implemented when she went home. Although these packages are funded by a joint health and social care

partnership, the budget is managed by social services. This means that the service needed to be approved by the CRAM meeting. After the six weeks of free homecare had passed, social services would review her needs and if she still requires some long-term care, she would have to be assessed financially and the package approved again by the CRAM meeting. In interview, her care manager explained how the patient's discharge date was planned to happen after the CRAM meeting, once her application for homecare went through (M10). Consequently, the MDT meeting adapted Mrs Jones' discharge plans to the social services managers' meeting dates.

Mrs. Jones stayed in hospital 27 days and her stay was never described by any member of the team as a delay (O5). However, she was discharged home with unresolved medical issues (O8). Whether these could have been avoided with a longer stay, is difficult to ascertain:

Researcher: So what do you make of this discharge? Was it quite straightforward in the end?

Care manager: Well, it wasn't actually... We need to step back a bit, again. Everything was in place for the discharge. I had received the Section 5 and returned it. On that particular day I went up to the ward to do the MDT and I was informed that the ward was closed because they had D&V [hospital acquired infection that causes vomiting and diarrhoea]. So I said, 'Well, that will mean that Mrs Jones is not going home at the moment?' 'Oh, she is in a bay that is not affected', I was told. So she would be discharged. So the discharge was to go ahead as planned. She went home, as planned, and I spoke to her again on the 10th of April, which was after Easter to discover that she had contracted the sickness? [...] So she's actually contracted this D&V over the weekend. Actually she was very ill over the weekend [that she was discharged] and she had to get the GP out. So it wasn't really, I mean, it would have been a safer discharge to have kept her in.

Researcher: Maybe doing some sort of a test to see if she had it before leaving. You'd think that would be standard procedure...

Care manager: But the problem is that if they're discharging them home, it's not an issue. If they're discharging them to a nursing home, it would be an issue. But if they're going home ... But, that doesn't take into account, that we've got carers going in there and then they're going to be visiting other people.

Researcher: So you can say it's not such a big public health issue. Although, from an infectious point of view or, as you say, you got the carers. But then, it's an issue for the person because that can very easily frustrate the discharge and they can end up coming back again [into hospital], so she was lucky that....

Care manager: Her symptoms had been that bad that she did have to call the GP. But the GP did not feel it was necessary to re-admit her. But she could

very well have been re-admitted, if her symptoms were that bad' (Interview with social services staff).

To discharge this patient with a possible infection was increasing the risk of readmission in a frail patient; fortunately it did not happen. Also the risk of spreading the infection to the homecare staff was not considered when deciding to discharge the patient home. However, to confirm that the infection was present in her, and then, to wait until it was cleared, would have delayed her hospital departure.

7.2.11 Case Study 11: Mr Kingsley

Mr Kingsley is an 84 year old man who lived in a bungalow with his son who was his main carer before admission into hospital. At home he was walking independently with the help of two sticks and was preparing meals. However, he struggled and had frequent falls due to mobility problems caused by arthritis in his knees and pain in his shoulders. He was admitted to hospital due to his poor mobility but he stayed in hospital six months after contracting several infections. At the time of discharge, he needed the help of one person for transferring into a chair or bed and he was considered to have rehabilitation potential. The codes described below are identified for this case:

Figure 7.11: CMOs for Case Study 11: Mr Kingsley

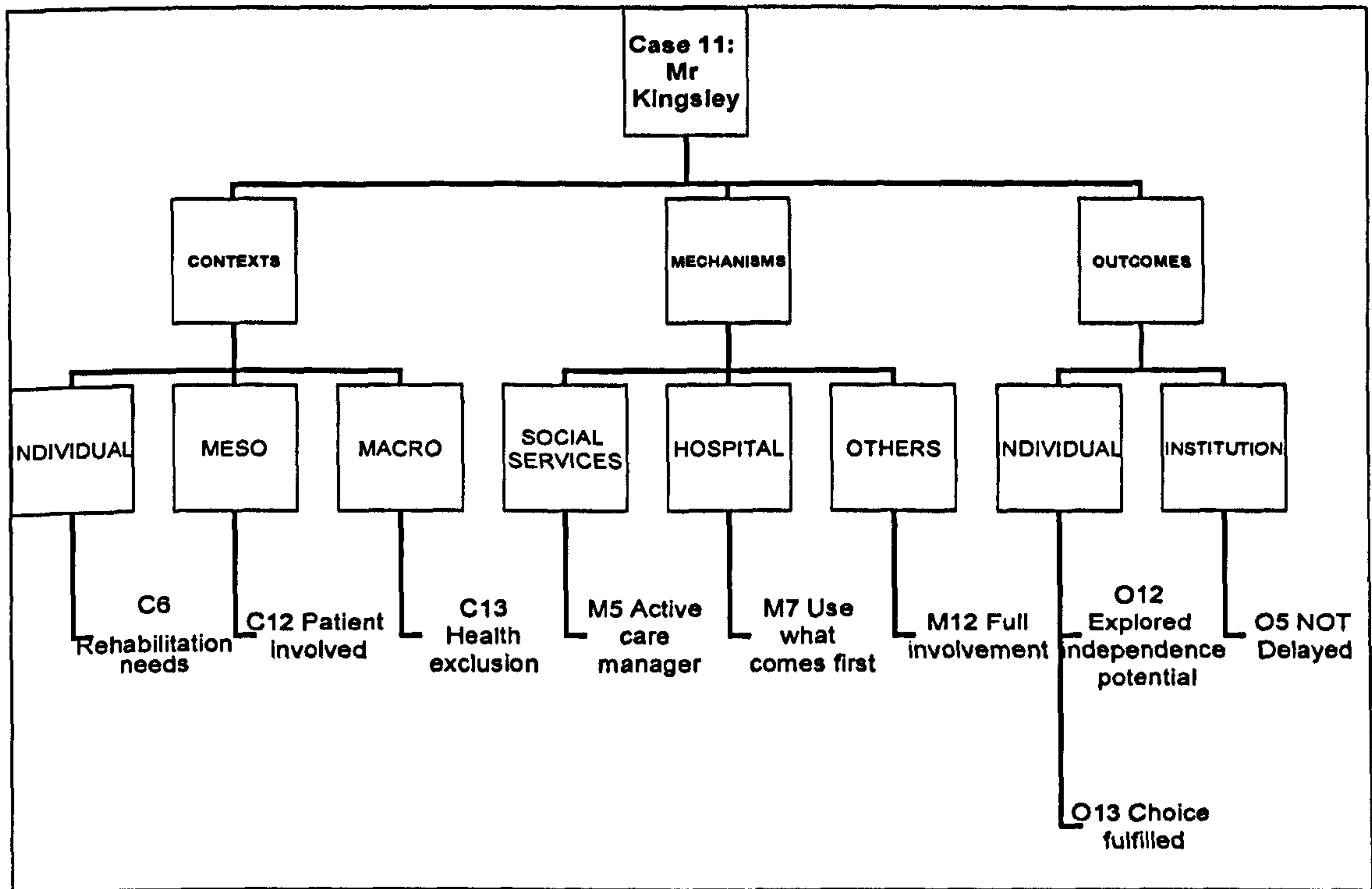

Mr Kingsley needed rehabilitation treatment (C8) and this health need excluded him from the reimbursement policy. He did not want to go into long-term care and wished to go back to his own home. The hospital team had to work hard with him to support his choice (O13) because he needed lots of prompting when mobilising and he was very anxious and frightened of falling. His independence potential was explored to the maximum (O12), this was evidenced by the post-discharge outcomes (he eventually went back home) and also in the MDT observations:

‘It was said that he needs transfer with one person to be accepted at the rehabilitation home. The consultant asks: ‘He’ll stand up with one?’ Physio: ‘At times’. Occupational therapist: ‘He’ll stand up but he’s not happy when he is up and he says he is falling’. Physio: ‘If he stands, he still falls’.
At home he was walking with two sticks and was preparing meals. Son doesn’t feel he is OK to go back home. Patient wants to go back home. Consultant: ‘He’ll need to do better than this’. For the rehabilitation home, he needs to be able to stand with one. ‘We need to put that to him’ [...] Consultant: ‘It is a bit of an ultimatum. If he is not able to do this by this date, he won’t be able to go home’ (Notes from MDT observation).

And the ultimatum worked. Mr Kingsley was clearly involved in his discharge plans (C12) but he was not able to identify this in the interview when asked about it:

'Patient is happy with everything. He said he was physically and mentally ready to leave the hospital. When I asked about his participation in discharge plans he said 'You just do as you are told. People from the medical profession know best'. He can't remember if he was given choices. Although he thinks he was' (Notes from the interview with Mr. Kingsley).

The ward supported his wish to going back home, but specific goals were set up for him to be able to achieve his choice of destination. Mr Kingsley achieved this goal and he was accepted into the rehabilitation home from where, weeks later, he was successfully discharged home with only a temporary lunch time visit from homecare to help with meal preparation. Social services offered full involvement in this case (M12), with the care manager having an active role in the MDTs meetings (M5), and then reviewing post-discharge outcomes once the patient had left the hospital. The possibility of discharging Mr Kingsley directly to his own home with a rehabilitation care package was discussed at the team meetings but rejected because to organise it would have taken longer than to transfer him to a care home (M7). So the resource used was the one that would discharge him sooner, as observed in one of the MDTs:

'Patient doing a bit better. Lady from the rehabilitation home has been. He understands where he is going. Transferring with one. He can go now. Care manager says 'He is on the list'. Ward sister asked: 'How long is the list?' Care manager: 'Not long'. Physiotherapist says that he'll be ready to go Tuesday or Wednesday. Consultant asked: 'What about getting him home?' Physiotherapist answers: 'If he was going to go home, he'll need to be here for a few more weeks. He is not independent, is he? Did he have any services before?' 'No' (Notes from MDT observation).

Mr Kingsley stayed 179 days in hospital, the longest of the entire sample but this was never described as a delay (O5). However, the discharge liaison nurse explained how, especially in his last week in hospital, discharge was adapted to MDT meetings times:

'Discharge liaison nurse: I am picking up your point. There is no reason why, technically, the Section 5 couldn't have gone. Because we could have got the consultant to agree [that the patient could leave] before the MDT, with the therapists. Send the Section 5 on Thursday with a target discharge date on the Friday.

Researcher: Yes. And then is up to them to assess whenever.

Discharge liaison nurse: Yes. And then it would have been a delay from the Friday until whenever they [rehabilitation home] assessed and accepted it. I mean, they can assess and take on the same day. But he hadn't been assessed. He has been on the waiting list but he hasn't been assessed up to that point. You could say that he was MDT fit. But

[social services manager] would have argued that he wasn't safe to transfer because he hasn't been assessed. There was nowhere we could transfer him to' (Interview with hospital staff).

Because Mr Kingsley had rehabilitation needs, if he had been considered a delay, he would have been an 'NHS delay'. When it was suggested to the discharge liaison nurse that he could have gone earlier, and therefore he could have been considered a delay at least for the last week, she answered with the same mechanism that social services use to avoid fines. The definition 'safe to transfer' implies that patients are not delayed discharges until they have been assessed in the place they are going to be transferred to, in this case the rehabilitation home. Until a manager from this home comes to the ward to visit patients and confirm that the home is a suitable place for them, patients cannot be counted as delays.

7.2.12 Case Study 12: Mrs Leachman

Mrs Leachman is aged 68 years and lived alone before admission. She had asthma, which made it difficult mobilising long distances, so she had a scooter to go out and friends offered her some informal support. Mrs Leachman was admitted into hospital after having a fall at home, where she fractured her ankle. When she was ready to be discharged, she had a plaster cast on her ankle which made her unable to walk independently. The following codes are identified in this case:

Figure 7.12: CMOs for Case 12: Mrs Leachman

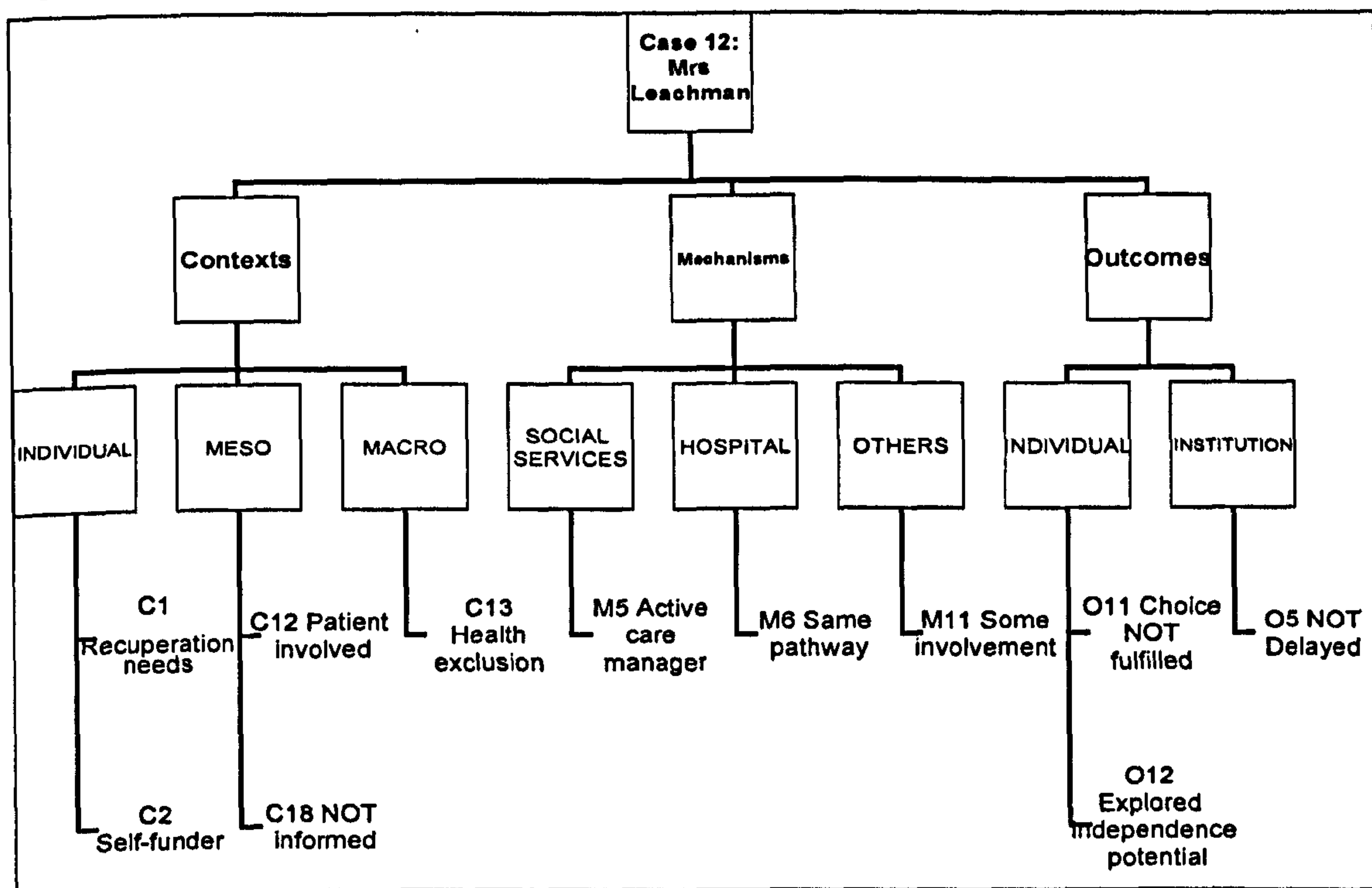

Mrs Leachman was considered a patient with convalescence or recuperation needs (C1) when she was first referred to social services because she could not put weight on the leg with the broken bone. As days passed by, she was allowed to put weight on it, but due to her anxiety and previous mobility problems her rehabilitation potential was predicted to be slow. One of the problems of discharging her back home was that her council property was due to undergo major building work. The independence potential of this patient was explored (O12) with the occupational therapist contacting the builders to try to bring the work forward to enable discharging the patient directly to her home, but they were unable to do so. The recuperation needs of this patient excluded her from the reimbursement policy (C13) but social services were still asked to assess the patient (M6) and they did offer some involvement in this case (M11). The care manager had an active role in the MDT advocating for the patient's interests and she did meet with her and her friend to explain the possible alternatives to the hospital ward:

'Care manager: She wasn't like somebody with good mobility. You break your leg, you're going home and you kind of manage by hopping around. She can't do that, she was just non weight bearing. So that's kind of how it all progressed. I started the assessment with her, and we talked about interim beds. I said a rehabilitation bed is not appropriate until at least she is

weight bearing. But the thing with an interim bed then was that she was self-funding so she had to go somewhere private. And it would have cost her £400-500 a week. So I talked to the ward about that and, quite rightly, discharge liaison was saying 'That's not fair' [...] So I also met up with Mrs Leachman. She's got a friend who goes in. So I had a chat with her. Just to let her know that I quite happily would help her to find somewhere for her to go private. But the implications were that it is going to be like £500 a week. And the ward couldn't insist [on her going] because, while she is not weight bearing, she is a medical responsibility.

Researcher: So how did you explain that to either the patient or the...? Do you say she could either go to [name of the community hospital] for free or she can pay privately for somewhere in [name of the town]?

Care manager: Yes, I am just honest to them and say...

Researcher: You actually say 'You have the right to go to [name of the community hospital]'.

Care manager: Yes. But I say: 'It is a health responsibility. So if you are not happy to pay this money, then you have to say to the ward staff 'I am not going, I'm your responsibility'. Yes, yes, I don't fudge it to them. I think it is their right to know, isn't it?

Researcher: I am not sure the wards tell them that...

Care manager: I don't think the wards tell them that [laughs]. No, I don't think they do' (Interview with social services staff).

So in this case, unlike others in the sample, the patient was informed of her rights and options for discharge. She was involved in the available plans to leave hospital (C12), which could have had an impact in the individual outcomes because she was a self-funder (C2). It must be noted here that social services did not offer a block contracted interim bed as they did in Case 1 and Case 7. Mrs Leachman's recovery was going to be slow and that meant that she would block one of their beds for too long. Instead, the care manager offered to help her find a temporary bed in a private establishment that she had to fund at full market price. This is the reason why 'interim bed' has not been coded as a mechanism for this case.

As in the other cases of patients with recuperation needs, Mrs Leachman was left with the only option of being transferred to the PCT community hospital. However, in this case, the patient was not happy to go there because she felt it was too far out for her friends to visit her; and she had never heard of anybody being admitted there. It was not her choice (O11) but accepted it because she looked at it as another step to go back home (her final choice). However, she was worried about the transfer. In the interview she defined her worries as 'the fear of the unknown'. Her anxiety was not helped by the fact that she was not informed in advance of the discharge date (C18).

When I visited her, the day before her discharge, she had still not been told that she was going to go the next day, when I knew about it three days before:

‘Arrived to the ward on Monday morning. On the board, next to the patient’s name says that ambulance has been booked for Tuesday a.m. to go to the community hospital. I spoke with staff nurse and told her that I was going to speak to Mrs Leachman and she says ‘She is going to the community hospital tomorrow’. I said ‘Yes, I know’. Visited patient at around 11.30 a.m. Started saying that I have been told that she is going tomorrow, and she answers ‘Am I? Good!’ I asked if she didn’t know anything about it and she says she didn’t. Nobody has said anything. I am totally shocked as I found out on Friday morning [today is Monday] when I was at the social services office, because somebody [discharge liaison officer] rang social services to tell them. Also somebody wrote on the ward board that she was going tomorrow. But today is Monday and the patient hasn’t been informed yet. I told the patient if it’s OK I could come back at around 1 p.m. for the interview, they’ll probably talk to her this morning. She agrees. I went to the nursing station and talked to the nurse in charge. I explained that I went to see the patient and she didn’t know that she is going tomorrow. She said ‘Yes, I know, I haven’t had time to speak to her yet’. I explained that I am going to talk about her discharge plans and it’ll be good if she had the information of when she is going before I talk to her today at 1 p.m. [never mind just because she needs to know!]. She said yes, she’ll talk to her.

I come back to the ward at around 1.15 p.m. Patient sat on her chair (as previously) reading a book. I asked if it is OK to have the interview now and she agrees, although she tells me that nobody has been to talk to her about her discharge yet. I asked if she’d rather me come tomorrow morning and she says she prefers to talk to me now, if she is going to go tomorrow. We have a long chat. I leave at around 2.10 p.m. and nobody has been to talk to her. Nurses may now go into handover and I wondered if anybody will ever talk to her, as it happened in this ward with Mrs. Ackroyd [Case 1] who was informed by the ambulance man that she was going to the rehabilitation home’ (Notes from interview with the patient).

Mrs Leachman stayed in hospital 18 days before she was transferred to the community PCT hospital. In this case, the performance rule of having to wait for 35 days was not followed. Whether this was because they had empty beds could not be ascertained. However, in one of the management meetings the previous week, it was mentioned that the community hospital was not admitting patients due to infection. It may have happened that once the infection was cleared, they had several beds to fill. Mrs Leachman’s hospital stay was never described as a delay (O5).

7.2.13 Case Study 13: Mr Marshall

Mr Marshall is an 80 year old man who lived independently in sheltered accommodation. He struggled to mobilize long distances and used a scooter to go out. He was admitted to hospital due to a knee injury after a fall. He was transferred to the PCT community hospital for convalescence and in there, they X-rayed further up his leg and they discovered he had a fracture, so they transferred him back to the acute hospital. While in the acute hospital it was established that he did not have rehabilitation potential and could not go back to the community hospital. The codes below are identified in this case:

Figure 7.13: CMOs for Case Study 13: Mr Marshall

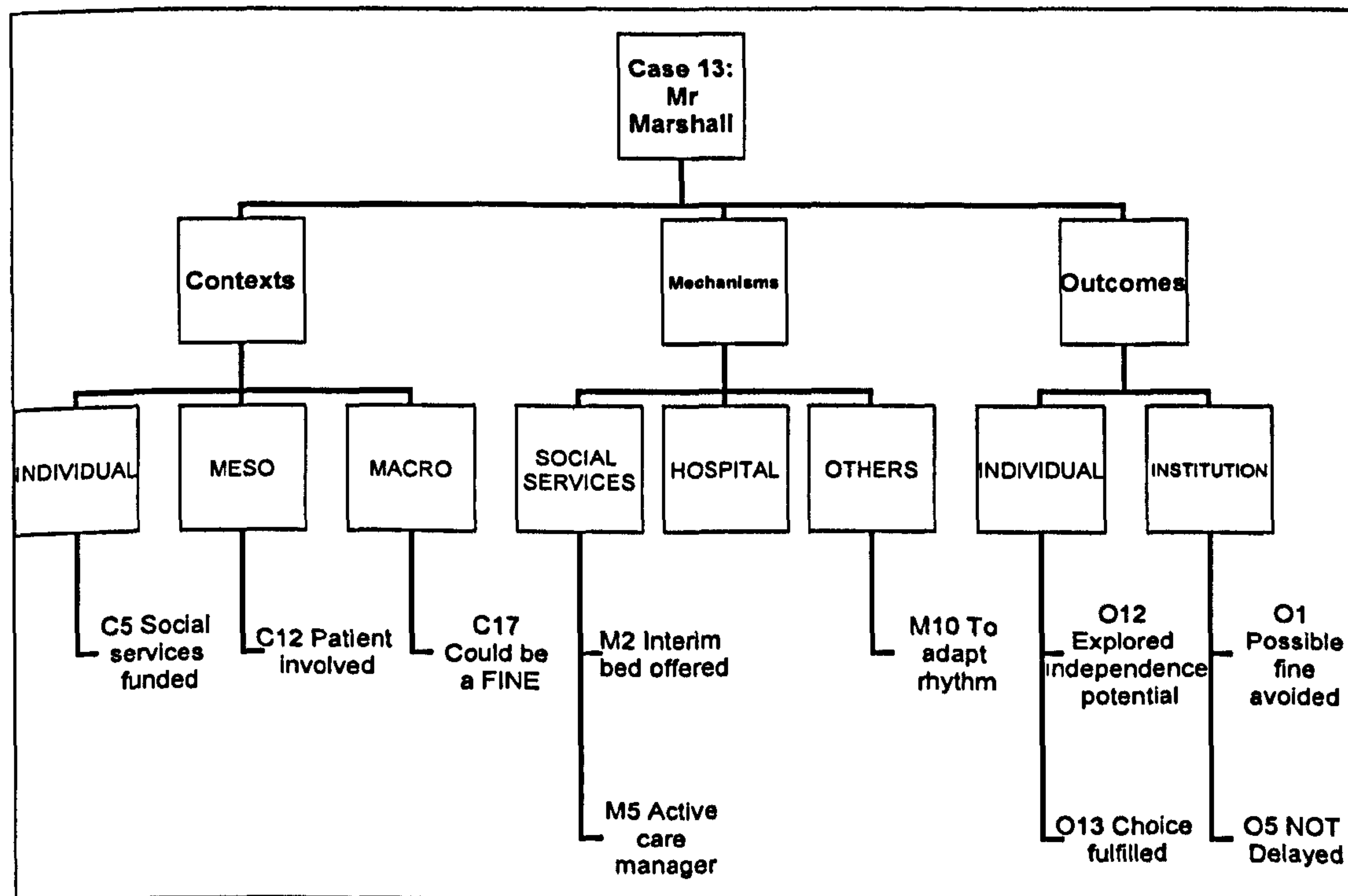

Mr Marshall was not progressing well mobilising, he needed hoisting for all transfers (chair, bed and commode) and he was not likely to improve. He was entitled to social services funding (C5), and without any significant primary health need, his case could have incurred a fine if delayed (C17). The mechanism 'interim bed' was offered to him automatically (M2). His independence potential was explored in different ways. First, when the care manager, having an active role in the MDT discussions (M5),

confronted the team when they said he needed nursing care. She clarified that he did not have any nursing needs and only mobility issues and therefore could be managed in a residential bed (also a cheaper option). The care manager also explored the possibility of going back home in conversations held with the patient while in the interim bed (O12):

Researcher: When you went to see him the second time to tell him he was going to go to [the interim bed], how did he take it?

Care manager: A bit of acceptance, I think. He was disappointed but he kind of said 'Well, umm... OK!' He does that. He thinks if his daughter is in agreement... He will say what he is thinking. He is not someone who will be pushed around, because he's not stupid. He has got poor short term memory. He is not stupid and he knew that, if he was going to go home, he'd be glad. In fact, at the latest review I said to him. 'I know you want to go home, but if you do go home you are going to have to wait for the carers to come and I don't think you will wait. I think you will be trying to get up and walk and he said 'I will!'

Researcher: [Laughs] That is quite nice, isn't it?

Care manager: Yes, he said 'I will. If I am left on my own, I won't just sit there. I will try and get up'. Of course he can't get up, so...' (Interview with social services staff).

Mr Marshall's choice of going home was limited to the package of care that social services could provide. Generally, this is a maximum of four visits of homecare per day. In between those visits, he would have to wait sat on a chair for the next visit to come and help him. If he would not wait and tried to walk on his own, he would most probably fall and hurt himself.

In the interview, Mr Marshall was clearly pleased with the temporary transfer (O13) because the residential home where he was transferred to is located below the flat that he used to live in. However, when I asked him if he was given a choice, he said 'No, I was just told'. When I explained his answer to his care manager, she reflected on it:

'I think they are probably right, actually. When you think about it. Because you can only go and say 'You're not managing bla dee bla. You need hoisting, therefore we think you need to...' Yes, so we do, in a way. It almost puts an ultimatum, doesn't it?' (Interview with social services staff).

Another important consequence of the local characteristic of the mechanism interim bed is that the residential home where the council had the interim beds contracted, is

only used for temporary accommodation. Mr Marshall would have wanted to remain in that residential home because he knew the area and the staff there. But a second move was always part of the plan. As it happens, he deteriorated while in that home, and ended up having to be transferred to an establishment that could provide nursing care.

The mechanism of the hospital adapting to the social services discharge rhythm (M10) was observed in this case. Although Mr Marshall's delay could have been a fine, the ward still gave social services a few days to find him a bed. They were also happy to wait for the CRAM meeting (M11), as the care manager explained to me in informal conversation when I asked if he was going to be transferred before the next MDT meeting (on a Tuesday). Her answer was: 'No, because CRAM is today [Thursday, to approve funding]. Tomorrow I am on annual leave, Monday is bank holiday, so I won't find out if the funding is approved until Tuesday'. On that same Tuesday, the ward had an MDT meeting in which social services were given two more days, so the patient actually left a week after his funding was approved:

'Discharge liaison says 'Can we agree a Section 5 [form that activates the fine] then? Thursday?' Care manager says: 'Yes, that gives them two days. Yes, that's fine'. Discharge liaison to sister: 'Is that OK?' 'Yes', sister answered' (Notes from MDT observation).

Mr Marshall was in hospital for 18 days and his stay was never described as a delayed discharge (O5) and therefore a possible fine was avoided (O1). He was transferred to an interim bed where he remained for three and a half months until he was transferred to a long term bed in a nursing home.

7.2.14 Case Study 14: Mrs Naylor

Mrs Naylor is an 88 years old woman who lived with her son who was her main carer. She was admitted in to hospital due to a fracture caused by a fall. While she was having the operation for the fractured bone, she had a heart attack and her health condition deteriorated. When she was ready to be discharged form the ward, Mrs. Naylor could not stand independently and the team decided she needed long term care and referred her to social services. The following codes are identified for this case:

Figure 7.14: CMOs for Case Study 14: Mrs Naylor

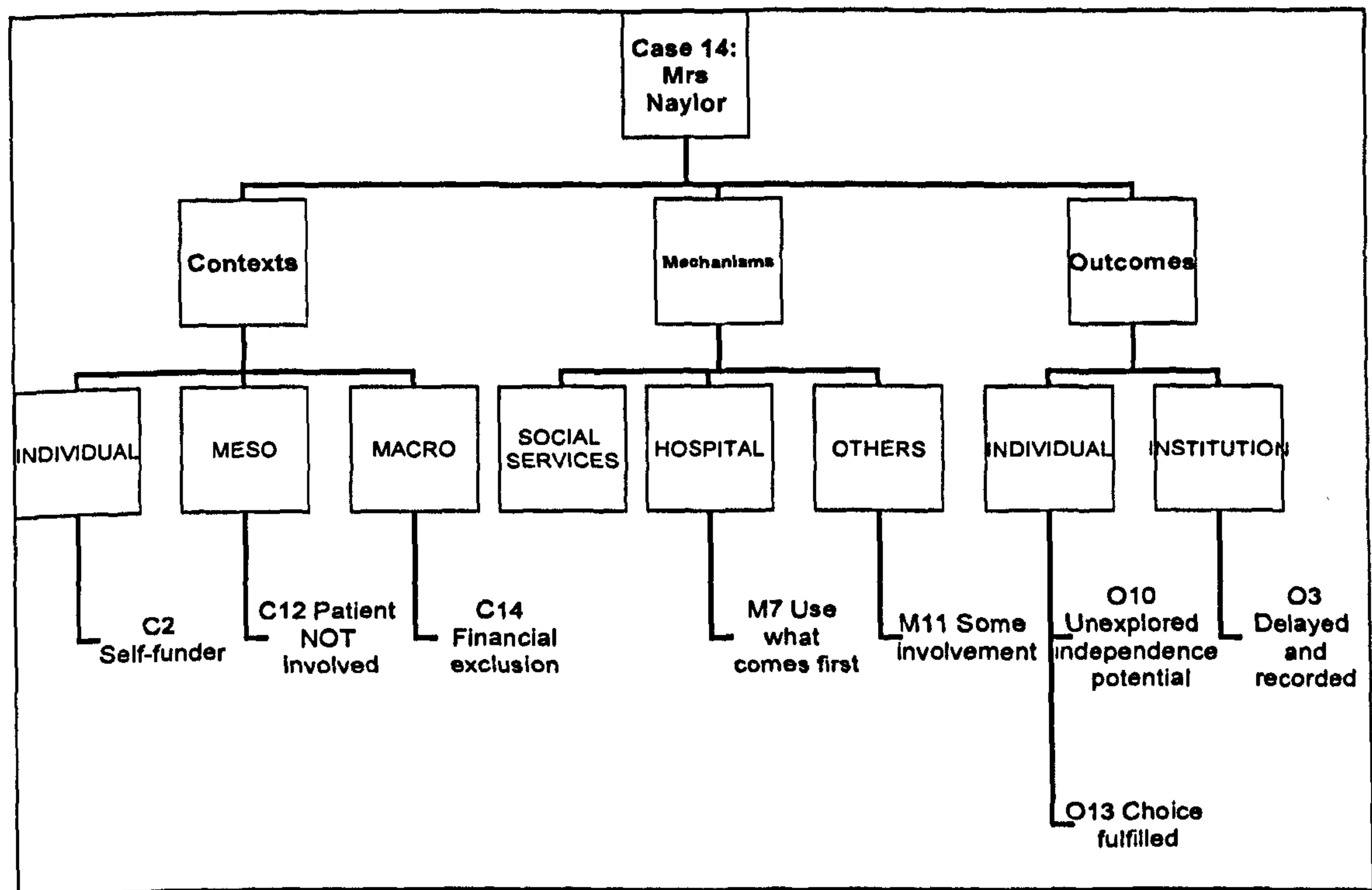

Mrs Naylor was a self-funder (C2) and therefore she was excluded from the reimbursement policy due to her financial situation (C14). Although the care manager informed that Mrs Naylor was going to be transferred to a nursing home, in the MDT meeting, the ward sister reported a 'problem':

'Ward sister explains that there has been 'a problem'. Patient asked the doctor 'Can I go home?' and the doctor said 'Yes, if you do well with physio'. Physio explains how patient doesn't stand or can't stand. Sister says it maybe 3-4 months before patient could go back home. Physio asked care manager if the patient is 'very self-funder?' Care manager says 'Yes', that when she spoke to the son and referred to the limit of savings, he said 'She is well over that figure' (Notes from MDT observation).

So it was not clear, how the decision was made for the patient going into care, but it seemed that the MDT supported the idea of transferring her to a long-term establishment. The meaning of the concept 'very self-funder' mentioned in the MDT and why that question was asked in relation with Mrs Naylor independence potential was asked to the care manager in interview:

Researcher: Why will it make a difference if she wasn't self-funder?

Care manager: Well, it shouldn't, should it? But they often want them out, don't they? Out of the way...

Researcher: I still don't understand what she meant! Do you want to translate it?

Care manager: I think what she is getting at is, if she wasn't self-funding, they'll be saying 'Well, maybe rehabilitation', either move her up to a ward or...

Researcher: Ah! OK. Yes. But if self-funder...

Care manager: If they go self-funding. If they get her going there, brilliant. If not, well, she can't stay there. Which isn't really fair to her! Because maybe she is not getting, you know...' (Interview with social services staff).

Therefore, the mechanism that the hospital used to reduce delays was to use the resource that could discharge the patient sooner and not the most beneficial for the patient (M7). Thus her independence potential was unexplored (O15) because discharging her into a nursing home would speed up the process of her discharge. Although Mrs Naylor was not directly involved in her discharge planning (C12), in the interview she explained that she was very pleased to go to the nursing home that her family had chosen for her (O13):

'I asked Mrs Naylor about leaving. She knows that she is going this afternoon and she mentions the name of the nursing home where she is going. I asked if she is happy to go there and she explains that she has been in hospital for three weeks and she is delighted to leave the hospital. She sees it as a way out from the hospital. I asked how she achieved that decision. She explains that her daughter in Dorset is the one that made the decision and she agrees with it. She says the hospital helped her to get discharged to the nursing home and she is happy to be leaving now' (Notes from Mrs. Naylor's interview).

Social services provided some involvement for this patient (M11). The care manager met with her son and she did an assessment of the patient's needs. She did not meet with her because 'she was too frail' and the care manager did not challenge the team's decision of suggesting transfer to a nursing home.

Mrs Naylor stayed in hospital for 61 days. The ward sent a Section 5 form to social services on the 24th of August and the patient did not leave until seven days later. Her discharge was unexpectedly delayed for a few days when her daughter told the ward that 'they were discharging her too soon'. Nobody from social services or discharge liaison dealt with this situation and the ward ended up discharging her to the nursing home several days later. Therefore, she was a delay (O4) and it was formally recorded

as such with the use of the Section 5 form, which is the one that highlights delays for the hospital database.

7.3 Summary

In this chapter, the case studies were analysed individually as primary data, which built up as the number of cases increased. Each case study was scrutinised for evidence which supported, modified or contradicted the programme theory. Each case illustrated only a small section of the theory and they were all considered not only as tools to refine the theories but also as generators of new fragments of theory that contributed to the overall evaluation of the role of the fines in the programme.

These case studies illustrate how the micro-context of patients' characteristics has an impact on the achievement of the programme objectives. They also demonstrate that macro and meso contextual circumstances play an equal role in enabling fast discharges. To locate the 'inappropriateness' of delayed discharges in the patient and not in the hospital processes or in the health and social care infrastructure (Vetter, 2003) is, therefore, to miss a significant part of the reasons that lead to delays. It is, however, equally important, not to focus the analysis on how good or poor individual practices of health and social care professionals for these discharge journeys are. As with patients, to locate the inappropriateness of delayed discharges in individual members of staff is to overlook the importance of agency and structure in front-line staff working practices.

Since the community care reforms and the performance driven public services, front-line care services staff conduct their daily practices in new working environments; having now highly regulated and standardised relationship with clients. They perform less direct work and more 'gatekeeping and policing services'. In the case of social care staff, they assess whether those who are referred to social services meet the ever higher eligibility criteria and then commission the required services in an atmosphere of endemic organisational change (Jones, 2001). In the case of ward staff, with limited time to provide clinical input to patients, discharge planning is not seen as a priority (Atwal, 2002). In addition, clinical staff struggle with concepts of cost-effectiveness in an increasingly complex healthcare market (Jones, 1994).

Finally, although the in-depth comparison across cases is left for the next chapter, this section presented some of the key findings described later. Firstly, the intricacy of establishing how and when patients are delayed; secondly, people outside the definition of the 'social services funded' patients are still largely referred to and managed by social services (with some of them having significant delays). Consequently, although the Delayed Discharges programme is addressed to social services, it does affect those excluded from it. Finally, none of the fourteen case studies generated a fine for the local social services department.

8. RESISTANCE, SECONDARY ADJUSTMENTS AND REALIGNMENTS

8.1 Introduction

This chapter completes the analytic strategy of the thesis by constructing relevant configurations which generate outcome patterns informing the main findings. In this section, abstraction takes place with the intention of extracting out of the individual cases, the generalisable regularities which could be formed in similar contexts through similar mechanisms. This provides a closer inspection of the evidence that steered away from the details and started building abstractions into the inner workings of the financial incentives in the Delayed Discharges programme. This exercise produces middle range theories (Merton, 1968) on how and why the interventions perform when contrasted with the complex reality of the social world.

With the absence of fines as a starting point, configurations are shaped, seeking not to generate universal cause-effect truths but to establish patterns of programme behaviour in which particular cases lead to particular effects. Although the fourteen case studies reveal no fines, a significant pattern of delays is also observed. Consequently, from this confirmation that the absence of fines does not cause absence of delays, theories are generated on how contextual characteristics of the cases determined the outcomes. Then, the implicit ways of eluding the fines while using mechanisms designed by the programme are explored. Unplanned ways of avoiding the fines generated some unexpected outcomes for specific configurations, which are described in detail.

8.2 The Context-Mechanism-Outcome Configurations

The first challenge of using the realist analytic framework is the overwhelming substantiation of the complexity of social interaction. Configurations are infinite and CMO equations are not formed of single components. The exercise of selecting some

of those configurations is made, not only on a practical basis, but also with a theory driven approach (Chen, 1990). In this exercise, programme theory is used as a background safety net which tries to avoid the analysis drifting into the universe of infinite possible configurations. In other words, when trying to choose what configurations are relevant to the research questions, the rationale of identifying what could be considered patterns and what could not, is not based on statistical supremacy. The theory-driven choice is made out of the knowledge gained from significant patterns identified by other evaluations of the Delayed Discharges Act or of the financial incentives to reduce social services delayed discharges.

Once patterns that better represent the structural constraints of delayed discharges are found, similar events are grouped together. These are not, however, exact clones; it is through abstraction that theories are developed according to causally significant common properties (Sayer, 1992). These abstractions follow the path of the designed programme theory and the diversions where this expected behaviour does not occur. The main hypothesis to test in the Delayed Discharges programme is that, by introducing a fine as a measure for patients funded by social services, mechanisms would follow which result in the reduction of patients delayed in hospital. The assumption here is that these mechanisms, which are generated to avoid fines, would have a double role, reducing delays, as well.

To evaluate this hypothesis, the first step of this part of the analysis is to scrutinise outcomes which relate to fines and delays. Then, all codes labelled as outcomes are grouped together by looking at their numerical significance. This is based on the two extremes: codes that have high numbers of repetition and codes that are low or non-existent. Once that first choice of significant outcomes is made, for each identified outcome, correlation of contexts, mechanisms and simultaneous outcomes are accumulated. Then, a new juxtaposition takes place, which shows configurations most repeated per outcome. Those configurations look like linear equations with two coefficients (Context + Mechanism) and where the constant is the outcome (Context+ Mechanism= Outcome). The fact that all elements of the equation could have more than one variable, for example: $(C_1+C_2) + (M_3+M_4) = (O_5+O_6)$, allows for some of this complexity and permits the possibility of studying concurrent outcomes, which also helps in exploring unintended consequences of each main configuration.

Therefore, the logic of this configurational puzzle is linear; using aggregation and combination of the components, but also allowing for emergence and for 'morphogenesis' (Archer, 1998). In other words, elements that are called contexts, mechanisms or outcomes in one combination can be called something different in the next one, because their role can shift under a different structure in the same system. To code data in more than one way is intrinsic to the analysis of qualitative sources. Weiss (1998) explains how 'the same data can be coded in more than one way. The evaluator can construct theoretical codes and codes based on the evidence for the same response' (p. 169). The analytic prioritisation when searching for matched cases is theory dependent, based on trying to answer the research questions: How do fines reduce delays? How do fines influence the patient's experience of discharge? To do so, Ragin's (1987) 'truth tables' are used as initial tools to illustrate CMOs correlations where conditions are simple presence/absence dichotomies (represented as two variables: score of 0 indicates absence and score of 1 indicates presence). The format of the table is an instrument to show how contexts, mechanisms or outcomes are interrelated across cases. This interrelation is then triangulated with the evidence from generalisations derived from interviews and observations, alongside the review of the current relevant policy documentation and literature. This systematic examination of data facilitates the generation of middle range theories relating to findings of how financial incentives used in the Delayed Discharges Act worked to achieve the programme objectives.

8.3 The Fines: an Absent Deterrent?

In the search for explanations of how the fines work, it has been documented that, during fieldwork stages, fines were hardly issued in the research site. Chapter Six explained how this is not an exclusive characteristic of this area, but apparently a trend in a high proportion of the English hospitals (McCoy et al., 2007a; Godfrey et al., 2008) that decided to follow the more punitive side of the Delayed Discharges Act. Since implementation of the reimbursement programme, the number of delays dropped nationally. Consequently, the assumption is that fines are working as an effective deterrent for social services to speed up the discharges of their clients. Consistent with this information, none of the fourteen cases in this study incurred a

fine for social services. Fines, however, do not need to exist to do their job. It is fear of the possible fine that makes them effective. In this specific town, fines performed their deterrent attributes in the first month of implementation of the reimbursement scheme, when the local social services department were charged and invoiced with £11,800. Fines on this scale have never happened again. From then onwards, the number of fines have been so small that they look more like accidents than embedded problems of a system in need of such a strong measure. Considering the complexity of hospital discharge (see Chapter One) and for a hospital with a weak performance in delayed discharges (see section 5.3 of Chapter Five), this is an amazing achievement. This is particularly significant because the local social services department is underfunded and only providing community care services to people who have 'critical needs' (see section 5.4 of Chapter Five).

Hence, it is expected that mechanisms are generated locally to avoid the large invoicing to re-occur. This part of the analysis has as an objective to ascertain how the fines were avoided for these fourteen cases and if, in doing so, delays were also reduced. Two main questions result from the evidence of the case studies. Could any of the fourteen cases have ever been a potential fine? And if so, what mechanisms were used to avoid that potential fine? The answer to the first question is that eleven of the fourteen case studies are clearly excluded from the reimbursement scheme, because of either health or financial needs. In other words, the designed eligibility criteria for the programme excluded the majority of the sample. This represents a high proportion considering that all the cases were referred to social services through the reimbursement procedures. This confirms the theories of designed fine avoidance explained in Chapter Six; specifically, the redefinition of the newly constructed 'social services patient'. Only one patient (Case 13, Mr Marshall) of the fourteen followed was a clear case that could have generated a fine to social services, if the resources needed for his discharge had not been processed at the speed dictated by the programme. Only two other cases (Case 2, Mrs Beamont and Case 4, Mr Derwick) could have created some doubts over reimbursement responsibility because of their complex or specific needs.

In effect, the new programme characterisation of what cases should be dealt with by social services meant that eleven out of the fourteen patients could have never been a

fine, even if the local social services department had not changed a single procedure following implementation of the Delayed Discharges Act. The strict eligibility criteria of the English version of the reimbursement programme exclude from the fines a large group of patients that could still become delayed in hospital. Moreover, these patients are still managed with more or less involvement by social services departments. This is reflected in the sampling difficulties experienced during fieldwork. Initially, patients referred to social services were sampled assuming that all of them could be potential fines. When, half way through the cases, it was noticed the lack of patients who could potentially incur fines for social services, I tried to specifically sample for them. But that search became an impossible task. When a patient was referred to social services, weeks of MDT meetings could pass until the patient was stable enough to be visited to social services staff, only to find out at the end that they were, for example, self-funders or that health needs excluded them from the fines scheme.

In Table 8.1, cases' contextual circumstances are correlated to whether their discharges were delayed, demonstrating that half of the fourteen cases stayed in hospital for longer than expected. Significantly, the reduction in delays does not follow the same sharpness as the absence of fines. This suggests that mechanisms which avoid fines do not have that double role and reductions of delays do not follow, confirming that there is no direct causality between non existence of fines and outcome 'not delayed'.

Table 8.1: Reasons for Inclusion or Exclusion from the Reimbursement Scheme and whether Cases were Delayed

CASE	EXCLUDED (HEALTH)	EXCLUDED (FINANCIAL)	UNCERTAIN	INCLUDED (SOCIAL)	DELAYED
#14	0	1	0	0	1
#2	0	0	1	0	1
#3	0	1	0	0	1
#4	0	0	1	0	1
#6	0	1	0	0	1
#7	1	0	0	0	1
#8	1	0	0	0	1
#9	1	0	0	0	0
#10	1	0	0	0	0
#11	1	0	0	0	0
#12	1	0	0	0	0
#13	0	0	0	1	0
#5	1	0	0	0	0
#1	1	0	0	0	0

(Score 0 means absence, score 1 means presence)

Pattern 3: Patients not clearly excluded or included from the programme were delayed

Pattern 2: All self-funders were delayed

Pattern 1: Cases excluded because of health need did not tend to be delayed

Three main patterns emerge from the comparisons showed in Table 8.1: firstly (Pattern 1), cases with health needs (intermediate care) were not generally delayed; secondly (Pattern 2), all patients excluded from the reimbursement for financial reasons (the self-funders) were delayed; and finally (Pattern 3), the two cases with uncertain eligibility for the fines because of their complex needs were delayed. From these initial findings, the analysis will explore the following questions: how did the fines influence the discharges of the cases that were delayed (self-funders and complex cases)? And how did the fines influence the discharge of cases that were not delayed (patients with intermediate care needs)?

8.4 How did the Fines Work for Cases that Were Delayed?

To avoid as much as possible the subjectivity of referring to cases as 'delayed' (especially if they had not been officially recorded as such), the same definition of 'delayed transfer of care' introduced by the Delayed Discharges Act (see Chapter

Two, section 2.5.1) is followed. Cases allocated the outcome 'delayed' are those which, according to the definition introduced by the policy, still remained in hospital after being considered 'safe for transfer'. The correlation of all the contextual characteristics of the seven cases that were delayed shows three significant patterns. All self-funders were delayed, half of the patients in need of a period of convalescence ('recuperation needs') were delayed and all the cases with complex or specific needs were delayed. The next two sections will analyse how the fines operate for self-funders and patients with complex needs. The case of patients with recuperation needs is examined later, in section 8.5.1, where general outcomes for intermediate care cases will be discussed.

8.4.1 The Self-funders: a Difficulty Created or Reinforced by the Programme?

Analysis of the seven cases considered 'delayed' revealed one strong individual contextual characteristic based on maximum repetition possible for the context 'self-funder'. But were these delays a new outcome that the reimbursement scheme had created? Apparently this was not the case in the research site as hospital staff reported that 'self-funders pre-reimbursement were delayed for a very long time, so they get some help now' (Interview with discharge liaison nurse). Consequently, it appears that the discharges of self-funders have improved under the new programme but that the fines scheme still does not resolve their sometimes lengthy delays. Hospital staff feels that the local social services department treats them differently from social services funded patients. Self-funders do not seem to be guided through their discharges in a way that could reduce their lengthy hospital stays:

'I don't think social services do anything with self-funders other than identify whether they are self-funding or not. The minute that is made clear -They won't necessarily admit it- but they will withdraw their services in that: They won't ring up the family; they won't chase them; they won't give them vacancies. They only give them a list, if they ask for it. They won't give them bus routes; they won't tell them where the places are [...]' (Interview with discharge liaison nurse).

This assertive quote reflects hospital staff perceptions of the working practice of social services with self-funders: once they confirm that patients have money, they give them a list of care homes in the area and the hospital are 'left on our own' with the coordination of the discharge of the patient. If self-funders' discharges are left to

the family to sort out, patients stay in hospital for longer. Clinical staff intervene to accelerate discharges but they are overwhelmed by the practical difficulties of discharge coordination. This feeling of being left alone with 'a problem' was a constant theme in the general 'corridor conversations' about self-funding patients during fieldwork. The explicit omission from the fines scheme of this population reinforced this feeling.

Research carried out before and after the implementation of the Delayed Discharges programme blames social services departments for dedicating less input to self-funders (Wright 2003; Commission for Social Care Inspection, 2004; 2008). Managers in the research site are aware of these accusations. When asked about social services position with regards self-funders, one of the care managers interviewed said: 'We have to be seen as doing the same for self-funders'. Consequently, the practice with these patients is described more as a 'make-up operation' than a 'real' practice based on the principle that clients should not be discriminated by their financial situation. Conversely, in the majority of the cases, when hospital staff refer a patient to social services, they do not know their financial situation. Also in general, when social services receive a referral from the hospital, their staff have no means to know whether patients are self-funders until they visit them. Consequently, self-funding patients cannot be totally excluded from social services involvement, because staff need to, at the least, talk to the patients or their relatives in order to ascertain how much money they have in the bank and if they own a property, before they can put them in the 'self-funder' category.

In the search for ways in which the fines scheme could affect this population, some of the individual outcomes of the self-funder cases are correlated with mechanisms and outcomes in Table 8.2. Two strong patterns emerge from this correlation: firstly (Pattern 1), in the self-funders cases, social services staff did not actively participate in the decision-making discussions occurring at the weekly MDTs; secondly (Pattern 2), in the case of patients with health needs, social services staff participated in the discharge decisions which took place in the MDTs. Therefore, the idea that unequal outcomes for patients are dependent on their financial circumstances can be confirmed in the cases observed in the sample.

Table 8.2: Relationship between Social Services Participation in Discharge Decisions and Programme Eligibility Criteria

Case	Excluded (health)	Excluded (financial)	Uncertain	Included (social)	Active participation of social services in MDT	DELAYED
#14	0	1	0	0	0	1
#8	1	0	0	0	0	1
#3	0	1	0	0	0	1
#4	0	0	1	0	0	1
#6	0	1	0	0	0	1
#9	1	0	0	0	0	0
#2	0	0	1	0	1	1
#7	1	0	0	0	1	1
#10	1	0	0	0	1	0
#11	1	0	0	0	1	0
#12	1	0	0	0	1	0
#13	0	0	0	0	1	0
#5	1	0	0	0	1	0
#1	1	0	0	0	1	0

Pattern 2: Social services staff tended to actively participate in discharge discussions of patients with health needs

Pattern 1: Social services staff did not actively participate in discharge discussions of self-funders

(Score 0 means absence, score 1 means presence)

The local social services department, however, allocates staff to facilitate self-funders discharges and they all visit the patients and/or their relatives but the management of these discharges can be executed with different levels of involvement. This is explained in the two subsections below:

a) Care Manager's Ownership of the Cases in Multidisciplinary Discussions

The attendance of a social services member of staff in all ward MDTs is one of the mechanisms used locally to avoid fines. But the care manager who attends the MDT meetings is not necessarily the allocated one for the case discussed. When patients are admitted into hospital and they already have an allocated care manager, the 'MDT care manager' only acts as an information collector from the meeting to the allocated care manager and to the social services management team. In practice, the information collected in the meeting is written down and passed in the form of 'MDT minutes' to their team managers.

When during fieldwork, 'MDT care managers' were asked about discharge plans of cases discussed in the MDT they attended, but not allocated to them, they tend to respond: 'He/she is not one of mine, ask the team manager'. This suggests that they do not always hold ownership of the cases that are not directly allocated to them. In the MDTs, however, they are supposed to participate in discussions regarding these patients. 'Active involvement or participation' is defined here as staff contributing towards the discussions with regards to patients discharge plans, suggesting adequate services, and clearly advocating their opinions in the best interest of the patients, even when they are contrary to the rest of the team.

MDT care managers' lack of active participation in discharge decisions showed a strong pattern for the self-funders, whether they were allocated to that care manager or not. Table 8.2 illustrates how the social services representatives attending the weekly MDT meetings did not participate actively in the multidisciplinary discussions where self-funders' future was decided. They were in the meetings but remained quiet. The following MDT observation for Mrs Falshaw (Case 6, a self-funder admitted into long-term care directly from the ward) exemplifies their behaviour:

'Somebody says 'We need a case conference!'. And the ward manager says 'Why do we need a case conference? She has agreed to go into care' And nobody answers her back [...] The care manager kept quiet. It will be interesting to see if this patient is self-funder because she did not have previous care services at home' (MDT observation Case 6).

In all three self-funder cases, discharge decisions were made by the other members of the team but not by the social services staff. They took that decision as a given and then advised families on vacancies and general procedures for admission into care.

b) Lack of Independence Promotion

Unnecessary admissions into care (Netten and Darton, 2003) and an increased number of unmet social needs for individuals who are not state funded have been reported (Forder, 2007). As a high rate of self-funders' long-term care admissions take place directly from hospital (Netten et al., 2002), the hypothesis was that their health encounters are also different from those of the patients funded by social services. The

emergence of the undesired outcome of 'unexplored independence potential' in the self-funders cases in the sample leads to further exploration of the way causality operates in this configuration (See Table 8.3).

Table 8.3: Relationship between Choice and Promotion of the Independence in Self-funders

CASE	Self-funder	Maximum independence potential explored	Choice of destination fulfilled	Delayed
#6	1	0	1	1
#14	1	0	1	1
#3	1	0	1	1

(Score 0 means absence, score 1 means presence)

It appears that in practice, self-funders are not actively encouraged to return to their homes and recover previous levels of independence. Table 8.3 also illustrates how self-funders were delayed because they waited in hospital until a bed in their preferred nursing or residential home became available. In this configuration, the outcome 'choice fulfilled' is transformed into a mechanism which causes delays. In other words, because self-funders are relieved from the resource constraints that frame social services clients, they can choose the care homes where they want to go and they wait in the wards for vacancies in that particular home. Hospital staff know that self-funders are more likely to get delayed and they use the resources that could discharge them first and not necessarily the ones that promote patients' independence, concerned that the latter would lengthen their stays even more.

Case 14, (Mrs Naylor) exemplifies the above findings. She was a self-funder patient who was transferred directly into a nursing home. When at some point during her

discharge planning process, she expressed the wish to go back home, the physiotherapist asked the care manager in the MDT if the patient was 'very self-funder' before assessing if she should be transferred to a rehabilitation ward. When the answer was positive, the possibility of offering her acute rehabilitation treatment was discarded. This finding has further economic implications because health inequality can also lead to social inequality. That is, if rehabilitation treatment is not always offered to self-funders, and to this is added the lack of advocacy from social services, this could explain why self-funders have an increased number of unnecessary admissions into care from the hospital wards (Netten et al., 2002). On the contrary, the local social services department requires (before releasing funding for long-term care) that their care managers provide evidence that all options for support at home have been explored. This evidence is discussed in the weekly CRAM meeting and only then admissions into care are approved.

Related to lack of promotion of independence for self-funders are the restrictions in the use of interim transfers for this population. As explained in Chapter Five, in this locality, a number of interim beds are bought in bulk annually and they are 'expected' to be used exclusively for social services clients. Unlike in other parts of the country, only patients whose social care needs are funded by social services are transferred into these interim beds. One of the care managers interviewed recalled being 'told off' for transferring a self-funder to one of the interim beds:

'Researcher: Have you ever had a case where a self-funder has gone to an interim bed?

Care manager: They can't.

Researcher: They can't...

Care manager: I once did. Not realising she was a self-funder. And I had to move her out, when I realised [...] I had to move her out, which was a bit embarrassing, really. So I've learned my lesson. So they can't. They have to pay' (Interview with social services staff).

Self-funders who need long-term care have only two options: to go directly into care or to wait for the home of their choice in the hospital beds. It appears that the fines scheme did not directly cause the unequal treatment of self-funders because this inequality existed before the Delayed Discharges programme was implemented. However, some of the mechanisms used locally to avoid fines for other groups of

patients excluded self-funders and consequently, the previous unequal treatment was reinforced. A motivation displacement takes place when a task is incentivised. The objective is not really to succeed at the task at all (in the sense of doing it well); it is to succeed at avoiding the fine. Marshall and Harrison (2005) call this situation 'spill over' effect referring to the impact of incentives on behaviours other than those incentivised because what is not measured may not matter as much as the incentivised tasks. With regards to self-funders, it must be noted that this motivator displacement was not reported in the countries where the fines for social delays had been implemented before. However, a key local contextual characteristic comes into place here, as in Sweden, nursing care is not means-tested and therefore the concept 'self-funder patient' does not exist with the same meaning.

8.4.2 The In-betweens: Cases with Complex or Specific Needs

The patients' stories narrated in Chapter Seven showed the complexities of hospital discharge cases. Interplay between medical and social factors has to fit into multiple programmes operating side by side with the reimbursement policy. Sometimes, cases fit in and they are discharged smoothly but sometimes, patients have lengthy and complicated pathways out of hospital. Two of the case studies of the sample (Case 2 and Case 4) had lengthy delays, whether these were always officially recorded or not. These are described as 'in-between cases' because their needs, for different reasons, did not fit the health and social needs structure and divide created for the purposes of this policy. The programme theory for the Delayed Discharges policy does not approach the possibility of patients with cross-cutting or unclear needs or the difficulty in categorising needs at the time of planning discharges. The latter was the problem in Case 2 (Mrs Beamont) who was excluded from the policy because of her continuing healthcare needs. However, this was not clear to the team when they started planning her discharge.

Following the Delayed Discharges Act national implementation guidance, the local hospital protocol established that patients should first be assessed for continuing care needs, which entitles a patient to free NHS services. Only when these needs are discarded, should the patient be referred to social services. But this programme theory assumes a linear sequence that does not represent illness and organisation related

contingencies characteristic of acute patients (Strauss et al., 1985). When Mrs Beamont was referred to the local social services department, she did not have continuing healthcare needs and consequently, social services put in place the mechanisms that they use for their clients. This did not help her discharge pathway because an interim bed was offered and rejected; unnecessary financial worries were imposed on a patient who was entitled to free NHS care and to an already stressed family, who expressed their discontent with how the discharge was planned, making a formal complaint to the social services department.

In the case of Mr Derwick (Case 4), the young man who needed re-housing, the administrative divide between social and housing needs for the purposes of the reimbursement programme, created the complexity. In Case 4, social services did not actively participate in generating solutions for maintaining the discharge of this patient, who was delayed for weeks. When there was an unsuccessful attempt by the discharge liaison team to classify the patient as reimbursable, in the hope this would generate more involvement from social services, they recommended discharge to his old flat (to be housebound) or B&B accommodation. Mr Derwick's family not only rejected this possibility, which would leave him housebound, but they expressed discontent with how the discharge was being planned by threatening to complain to their MP if the social services recommendation was executed.

In Case 4, when social services decided to take the route of not cooperating with his discharge, claiming that he was excluded from the policy, interagency conflict escalated and ward staff were openly unhappy with the local social services department. The Delayed Discharges policy anticipated disputes between organisations and established a procedure for resolving conflicts. The local discharge protocol included a dispute resolution guidance, which is based on the fact that 'should any dispute over the categorisation of a patient arise, the patient should be moved to the appropriate setting as soon as possible whilst attempts are made to resolve the dispute locally' (Confidential Reference 1, 2004: 16). In other words, the patient must be transferred out of the hospital first and then the dispute must be resolved. However, the disagreement in Case 4 was concerned with what constituted an 'appropriate setting' to transfer the patient; with the hospital team thinking that he should be re-housed and social services recommending return to his old flat or B& B.

Consequently, Mr Derwick waited in hospital for weeks until suitable accommodation was available. Interagency disagreements tend to be resolved (or not) informally because the priority is to 'get the job done' more than create formal conflict resolution processes. This was explained by the discharge liaison nurse who dealt with Case 4:

'I did phone the Strategic Health Authority for clarification and I said it was an unresolved dispute, really. But I didn't really want to put it down as that because we have been working fairly jointly together, but not with the outcome and the support that we needed' (Interview with hospital discharge liaison team, Case 4).

Therefore, in a sample of fourteen case studies, two patients had needs that did not fit the artificial programme categorisation of social need ('social services funded'). These two cases had lengthy and complicated discharges for the teams, the patients and their families. More evidence that the reimbursement scheme works least effectively with complex cases is the constant withdrawals of notifications for assessment and discharge (Section 2 and Section 5 forms) which these cases generate. This research and other evaluations of this programme (Commission for Social Care Inspection, 2004; Godfrey et al., 2008) reported discharge notifications being repeatedly issued and withdrawn in complex cases. The reimbursement programme not only did not help reduce this complexity but seemed to add to it, when mechanisms to avoid fines were unnecessarily used for both cases. The fact that financial incentives tend to work better with simple activities or mechanical tasks (in the Delayed Discharges Act, the cases that fit the simple categorisation of needs) is well documented (Marshall and Harrison, 2005). This arises because actors choose to approach the incentivised tasks with routine actions to avoid the fines (i.e. transfer to interim bed, etc). When these solutions come across a situation that does not fit the standard solution, not only do they not work, but they can add to the complexity. This is described by McGraw (1978) when he explains that if tasks incentivised are not managed with open-ended solutions, incentives could have a detrimental effect on performance.

Patients with unclear needs (health and social) have always been a challenge to any discharge planning policy or procedure. Discharges are difficult and, inevitably, these patients have lengthy hospital stays. These long stays tend to frustrate hospital staff who see themselves as providers of acute care and not support for those with chronic

illnesses (Strauss, 1985). The fines programme could not approach the complexity of these discharges and could not resolve these lengthy delays. In their evaluation, Godfrey et al. (2008: vii) report 'the continued existence of a group of patients with lengthy acute episodes whose often complex and multifaceted needs challenged the capacity and comprehensiveness of the service system to respond'. To ascertain whether the reimbursement programme makes these cases worse or better is a difficult task which is not supported by the quantitative collection of delays. Performance information records delays by days and not by patient and consequently it is impossible to know whether there are a small number of patients with long delays or many patients with short delays (McCoy et al., 2007a). This is significant because one complex case delayed for months is potentially as financially damaging to the system as lots of cases delayed for shorter periods of time.

Apparently, the Swedish version of the fines was also unsuccessful in the management of complex cases. Thorslund et al. (1997) explains how there was a lack of competence to care for very frail elderly patients: different areas of responsibility on care services for the elderly were poorly defined and lacked inter-agency coordination (Henriksen et al., 2003). Just as significant, in Sweden, the greatest reduction in delayed discharges was in departments of surgery and orthopaedic surgery (Styrborn and Thorslund, 1993). These departments generally admit people who have short length of stays due to occasional illnesses that require surgery (fractures, etc.) and where complexity is less frequent. This could mean that in Sweden patient throughput was speeded up thanks to the faster pace at which the less complex cases were processed, rather than improvement in the management of the complex cases. Although such data were not available in the English implementation at the time of writing, the two cases in the sample with in-between needs, which did not fit the programme categorisations, were both from medical and not surgical wards.

8.5 How Did the Fines Work for the Cases that Were Not Delayed?

Half of the patients followed in this study sailed through their hospital discharges without any blockages. Because this group of cases had achieved the two main programme outcomes (absence of fine and absence of delay), analysis of their characteristics is supposed to help ascertain 'what works' in this programme. These cases were divided into two further subgroups: patients with intermediate care needs and patients with needs funded by the local social services department.

8.5.1 Outcomes for Intermediate Care Cases: the Contextual Difference between 'Rehabilitation' and 'Recuperation'

The analysis of the seven cases that were considered 'not delayed' shows one strong individual contextual characteristic based on maximum repetition possible for the context 'rehabilitation'. In other words, four out of the total of four rehabilitation cases were 'not delayed'. To observe that patients with rehabilitation needs were not delayed in this hospital is a relevant finding because rehabilitation needs have been traditionally identified as a reason for delayed discharges (Carter and Wade, 2002; Brasel et al., 2002; Glasby et al., 2004). This is significant because, in the research site, local provision in intermediate care services have been identified as inferior to the ones offered in neighbouring localities (See Chapter 5, section 5.5.1). This positive result might be associated with local investment in intermediate care services that deal with rehabilitation patients and which took place simultaneously at the implementation of the Delayed Discharge programme. In addition, the positive result could also be related to the innovation brought about in the second part of the Act: entitlement to a maximum of six free weeks of community care services for patients who wish to return home. Two of the rehabilitation cases were transferred to the rehabilitation care home where seven beds are funded by joint monies from social services and the PCT; and the two other patients who went home had a package of care that was offered through this new free service.

In the group of six patients with health needs that were not delayed, there were two patients who needed a period of convalescence before starting their rehabilitation

treatment ('recuperation needs'). In early fieldwork stages it was learned that recuperation patients could become potential delays. Staff from both organisations referred to recuperation needs as a 'gap in the services'. Chapter Five explained that this gap was generated locally by the introduction of the reimbursement scheme. When the Delayed Discharges Act was implemented, the local social services department, which used to co-fund beds for these patients (who are excluded from the fines scheme), decided to pull out money from that service and invest it in targeting fine-avoidance resources. The local PCT provides the only establishment for this population but this is defined by contextual characteristics that could limit the smooth discharge of the patients with recuperation needs.

However, the clear goal displacement seen with the self-funders was not as strong for the recuperation cases. Firstly, not all recuperation patients were delayed and secondly, Pattern 2 in Table 8.2 illustrates how social services staff took ownership of these patients discharge plans, despite not being officially liable for them. Moreover, in half of the cases, they offered their own resources (pre-paid interim beds) to facilitate faster discharges. This pattern contradicts the financial incentive theory that social services would act only in cases where there is a risk of being fined (Casalino, 1999) and it illustrates how staff motivation is affected by other factors unrelated to the incentives programme (Marshall and Harrison, 2005).

There may be an ulterior motive in this 'altruist' help, though. This category of patient only uses social services resources for a short period of time; they are likely to quickly improve and, in a few weeks, return to their own homes. These are people with broken legs like Mrs Ackroyd (Case 1) or Mrs Grange (Case 7) with no other significant chronic illnesses that could block those resources for too long. In the cases where the expected convalescence period was longer (Mrs Hanslow, Case 8 and Mrs Leachman, Case 12), interim beds were not offered and consequently, if beds were not available at the local PCT community hospital, the cases were delayed for weeks (as happened to Mrs Hanslow, Case 8).

8.5.2 Cases that Could Be a Potential Fine: Tacit Alteration of Mechanisms to Reduce Delays

Throughout this thesis it has been explained how the programme construction of the 'reimbursable patients' reduced the number of social services delayed discharges. However, these patients still exist and social services successfully avoid the fines. The sample of patients who could be potential fines was small (Case 2 and Case 13) in order to establish significant generalisations for this specific group. Nonetheless, analysis of these cases provides opportunity to utilise information collected along all aspects of the fieldwork, reflecting tacit ways in which social services control discharge times. In general, the adopted approach is one of slight manipulation of the designed mechanism to generate new implicit mechanisms that can avoid fines without necessarily reducing delays. This behaviour is a victory of the softer approach over the initial confrontations that took the local social services department nowhere but to empty their budgets. Case 13, Mr Marshall, was the only one of the case studies with a clear possible fine from the beginning to the end of his discharge plans. Observation of his case confirmed staff behaviour that was observed through all the other cases. Three main mechanisms are explored: minimum intervals for assessment and discharge, decision-making meetings and interim beds.

8.5.2.1 Use of the Minimum Intervals for Assessment and Discharge

The Delayed Discharge Act introduced two statutory notifications to plan the discharge of patients in need of a community care assessment. The first one is the Section 2 notice, which provides a minimum of two working days for social services to complete their assessment. The second one is the Section 5 form, which gives social services one more day for the transfer of the patient out of the hospital. Implementation guidance suggested that the hospital should alert social services of possible candidates that may need their support before sending the Section 2 forms, implying that this alert would give social services departments more time than the prescribed three working days. Although staff interviewed reported a variety of practices, in both wards where the fieldwork took place, Section 2s are used as the old referrals, which existed before reimbursement. That is, as soon as the hospital is

aware of the likelihood of a patient needing social care, they fax the Section 2 form to the local social services department. As a result, Section 2s are sent days, weeks or months before the patient is ready for discharge, which is what wards used to do before reimbursement was introduced. In the fourteen case studies followed in this research, the smallest time difference between a Section 2 and a Section 5 is ten days and, in half of the cases, there is a time span difference of more than 28 days.

Consequently, in practice, the Section 2 form does not have the role of warning social services that the patient would be ready to leave the hospital in three days. That sort of information is gathered at the MDT by the care managers or it is a phone call, as prior to reimbursement. Resistance to this theory of change was explained by hospital staff as an attempt to 'keep the peace' between colleagues and protect good working relationships:

'And so the wards did try a couple of years ago, to do it, right, send it [the Section 2 form] and then, send a Section 5. And it caused so many arguments that it caused more disharmony. To the point where people were being really rude to each other and phone calls were really difficult. And nobody wanted to do anything for anybody' (Interview with hospital staff).

This intended mechanism did not survive local implementation and the discharge planning practices went back to their original ways prior to programme implementation. This finding of the Section 2 not being used as it was designed has also been identified by other studies across different research sites (Commission for Social Care Inspection, 2004; Godfrey et al., 2008). Therefore, although the form is used as a legal proof of referral it does not stick to the designed strict timeframe.

The other notification introduced by the Delayed Discharges Act is the Section 5 form. This gives social services 24 hours to facilitate discharges or they could be cross-charged. During fieldwork, it was clear that this form has multiple roles but the one role that it was designed for. Primarily, the timing of the Section 5 is agreed during the MDT meetings, giving social services more than the 24 hours prescribed by the programme. In one of the wards, on some occasions, the nursing staff took the initiative of sending the Section 5s without waiting for the agreement of the care managers. Then, social services would ring them and request that it be withdrawn.

Withdrawals are required on the basis that social services staff need to be part of the multidisciplinary decision and they had not agreed that the patient is safe to be transferred from the hospital. The adoption of this tacit approach of the compulsory set time for discharge is bi-directional because hospitals choose not to stick to the strict rules of reimbursement. They allow for flexibility based on common sense, though. This was explained by one of the occupational therapists interviewed:

‘Things like target discharge dates, they tend to be...a lot of times are negotiated with the care manager, rather than the ward just sending a Section 5. But that doesn’t always happen. There are occasions when we’ll decide: ‘No, they are ready for discharge’. If we’ve been waiting for two weeks for some information about funding... That happened today with another patient, yes, then we will send the Section 5’ (Interview with occupational therapist Case 9).

The need of social services care managers to attend the MDTs is used as an opportunity for negotiation, not only whether patients are safe to transfer but also to agree when is the most convenient time for Section 5s to be sent. Consequently, the need for social services representatives to attend MDTs to negotiate Section 5s consolidates a practice that removes another of the traditional reasons for delayed discharges identified in the literature; social workers failing to attend discharge planning meetings (Audit Commission, 1992). The following quotation demonstrates how more than one day -in this case, seven days- are routinely given to social services to discharge patients:

‘Then at the end of the conversation, the ward manager says very nicely and smiley ‘I have a Section 5 here’. Then the care manager says: ‘No problem’. And then she [care manager] says ‘Put next Tuesday down’ [this gives them seven days more]. And everybody is OK with it. Discharge liaison kept quiet during all the conversation’ (Notes from MDT observation, Case 5).

Consequently, the social services department had seven days more to organise this discharge. As a result, this patient would not count as a delay until those seven days have passed and most probably will never be a delay. This is significant as, in the research site, Section 5s notifications are also used as instruments to monitor all hospital delays and not only social services ones. In the MDTs, dates to write down in the forms are negotiated for all patients, whether or not social services is the only agency to blame for their delay. This role of the Section 5s to monitor all delays has two main implications:

- a) The use of the Section 5 form as the instrument to record all hospital delays also legitimises the re-categorisation of reasons for delays for all patients, including those who are not the responsibility of social services. In five of the fourteen case studies, outcomes were codified 'delayed but not recorded', which meant that outcomes were transformed from 'delayed' to 'not delayed' through the mechanism of not officially recording the delay (absence of Section 5 form). This could suggest the use of gaming to meet the performance target (Marshall et al., 2000; Marshall and Smith, 2003; Bevan and Hood, 2005; Young et al., 2005). In the research site, self-funders discharges are typically quoted in the accusations of not recording delays. Social services managers feel that discharge liaison team (the department in control of the performance indicator data related to delays) uses the fact that 'they are on their own' with the self-funders to manipulate the figures and hide self-funders' delays to meet their targets. As explained in Chapter One (section 1.3.2), the ambiguity that embeds the definition of delayed discharges allows for the possibility of not recording delays without the need of too much conscious gaming behaviour.
- b) The presence of the Section 5 forms speeds up social services involvement in the discharge process for all patients. The rules and exceptions of the reimbursement process are too complex for all staff to comprehend inclusion criteria. In practice, social services frontline staff do not always know if the patient could generate a fine or not and, consequently, the receiving of the Section 5 form acts as a trigger mechanism to instigate a sense of urgency in all cases. This was explained in Chapter Six with evidence from some of the interviews with staff. After implementation of the Delayed Discharges Act, delays in social services completing patients' assessment decreased nationally and some studies suggest that the use of the Section 2 form (notification of need of assessment) contributed to this change (Godden et al., 2007). In this research site, however, the Section 2 forms have not changed previous referral practices pre-reimbursement and it is only the Section 5 form that produced a modification in the practices established before the reimbursement scheme.

Three years on from the implementation of the Delayed Discharges Act, the legal notifications (Section 2s and Section 5s) that instigate fines have been 'domesticated'. Forms are still used but in such a way that the original 'punitive power' has been removed from them and, in general, they are a paperwork exercise. Section 2 forms are used as the old referrals, and dates for the Section 5 forms are negotiated with social services staff verbally who then write down the date in the notifications and fax them to social services central office.

8.5.2.2 Adapting Working Practices to Timeframes of Decision-Making Meetings

One of the change strategies that the local social services department adopted after implementation of the programme was for middle managers to take formal control of the fines. All acute hospital patients referred to social services are also processed through the SitReps meetings, with list of names discussed twice a week. Those who require funding from social services are also discussed in the CRAM meeting. During fieldwork stages, this meeting (SitRepS) was taking place twice a week (Tuesdays and Thursdays). Also on Thursdays, all social services area and team managers would meet to approve funding for services (CRAM meeting). The discharge plans of patients who are not included in the reimbursement programme still have to be approved by the management meetings, with the clear exclusion of the self-funder clients. Patients with clear health exclusions are also discussed in CRAM because locally, all rehabilitation packages are managed by social services and, although it is a joint budget with the PCT and the service is free for the end user, this expenditure still needs to be approved in the CRAM meeting.

In the research site, funding is regularly approved within the same week of being required and, in none of the cases in the sample that needed CRAM approval, was the funding refused or said to be unavailable. This change is significant because it does discard one of the traditional causes of delayed discharge for social services patients: waiting for social services funding to be approved or released (Glasby et al., 2004). However, this pattern is not consistent with national trends. General delays about decisions on the eligibility of public funding for post-discharge care seem to present an upward trend at the later stages of the implementation of the programme (Godden et al., 2007). This study, however, could not establish whether this rising tendency is

due to a growing number of disputes over eligibility for public funding, or because of delays in making funding decisions.

Social services staff are the only members attending the MDT meetings who cannot make professional decisions in situ because funding decisions in social services are made by a manager. When observing the MDT meetings, a frequent situation arose where the teams agreed that somebody needed a social care service (i.e. homecare, an interim bed, etc.), they all knew that the MDT care manager could not confirm their decision straight away. They had to wait for a funding decision from the CRAM meeting. As one consultant in the research site said 'We have to wait for that 'CRAP' meeting'. The slight modification of the meetings' name could be seen as a reflection of the artificiality of this 'decision displacement.

In summary, the problem here is that the clinical decision made at the hospital by the team has to be validated days later by the social services managers. There is, of course, the potential of delay in waiting for CRAM, which was always denied by the care managers interviewed who explained that, if the funding is urgent, they could have it passed by their team manager straightaway. This raises questions around which cases are considered urgent and which are not, who makes that decision and, if all hospital cases should be considered urgent. In practice, MDT members seem to know that the CRAM meeting happens on Thursdays and plan their discharges accordingly. Hospital staff accept the lower pace of the decision making system and they plan their discharges according to the times of these meetings, taking them into consideration, when agreeing Section 5s dates, as this care manager explained:

'I mean we do take into account, whenever we're agreeing Section 5s, that there is a Thursday CRAM meeting. That, we do take into account. Because everybody on the ward is now aware that CRAM meet on a Thursday and services are allocated then' (Interview with social services staff).

But the wards also find strategies to reduce waiting days even while accepting that they have to wait for social services managers' decisions. One of these is guessing care needs to avoid having to wait another week to have the funding approved, as the following MDT observation illustrates:

'Occupational therapist says that the patient will need a care package for washing and dressing. To set a day for discharge after the home visit. Care manager says the care manager allocated is [name] 'If you can let her know what she needs and she can put in the application [for funding]'. Then discharge liaison recommends putting the application in before Thursday because the CRAM meeting is on Thursday [that means that they are going to send the application form before having the information gathered in the home visit, which is needed to fill that application]. Physiotherapist tells the occupational therapists that they can probably guess what she needs before the home visit' (Notes from MDT observation, Case 9).

A significant outcome with regards to managers controlling decisions through weekly meetings is the potential for miscommunication. This happened in Case 1 (Mrs Ackroyd) who was sent to an interim bed after the team had agreed to wait for a transfer to the community hospital. Mrs Ackroyd's care manager described, how the decision she agreed at the MDT was overruled later by her managers in CRAM:

'So I've learned now...Because quite often... It just happens quite often that somebody will ring me and say 'Your lady is going to...' 'Hang on a minute. I didn't present it to CRAM! How come a decision has been made on this lady?' And it's always been made higher up. Which I think is very bad. It shouldn't be without the workers' input' (Interview with care manager, Case 1).

Although this situation could be described as anecdotal, the decision to transfer her was made by managers who were pressured by a high number of vacancies in their pre-paid residential interim beds (beds need to be filled otherwise the money already in them is not seen as having been spent cost-effectively). This is an example of how managers' financial priorities, combined with miscommunication and fast pace of discharges can override front-line agreements and patients involvement in their own discharge plans (Mrs Ackroyd was not consulted or informed in advance of her discharge destination).

8.5.2.3 Mechanical Use of Interim Beds

The practice of offering interim accommodation to social services funded patients who need to go into care had become established in the wards at the time of the fieldwork, and it was not questioned by health or social care professionals. The use of interim beds had three main implications that were evidenced in the analysis of the data. Firstly, 'transfer to interim bed' is the mantra repeated by social services when a

patient with care needs is social services funded. Of the two social services funded cases in my sample, both were offered an interim bed, one rejected it and the other one accepted it. But for the patients who were not social services funded, responses to the question 'How would this case be different if the patient was social services funded?' tended towards 'He would have gone to interim'. The threat of the fine embeds the practice of discharge by offering temporary transfers to all patients funded by social services, independently of this solution being adequate for the patient's wellbeing (Case 2) or even the most cost efficient for social services (Case 13). The risk of this stereotypic or repetitive approach to deal with financial incentives has been explained by Schwartz (1982). The organisation, threatened by the financial penalty, reacts with a repetitive solution to the problem, which, in the case of delayed discharges, is to mainly transfer to another care establishment all patients who could incur fines

The Delayed Discharges implementation guidance justified the use of interim beds as the main mechanism to speed up all discharges, based on the fact that the life changing decision of going into long-term care should not be made in hospital. Nevertheless, in the research site, only patients whose social care needs are funded by social services are transferred into interim beds (excluding self-funding patients from these transfers). The initial evaluation of the programme carried out by the Commission for Social Care Inspection (2004) evidenced that a large proportion of older people were moving into permanent care since reimbursement had been implemented. Of the fourteen case studies of the sample, three out of the four cases who were admitted directly from hospital into long-term care were self-funders. These patients were never offered interim beds because this is the administrative rule followed in this authority. However, they were offered to other patients excluded from the fines, like patients with recuperation needs. This demonstrates that the rationale to retain these beds for social services patients revealed some exceptions that are not always financially driven and possibly based on the objective of maintaining good working relationships between institutions. This finding confirms reports that suggest that interagency collaboration did not decrease but has improved since the implementation of the Delayed Discharges Programme (Commission for Social Care Inspection, 2004; Mc Coy et al., 2007b; Godfrey et al., 2008).

Pre-paid interim beds were offered in four cases of the sample. It is a significant finding that three of those four cases were the only cases in the sample that had as a concurrent outcome 'formal complaints', which were processed by patients or their relatives. When analysing the codes in those three cases, a strong pattern emerged: in all of them, financial needs were not assessed before their discharge took place. At the macro contextual level, the three cases had health needs excluded by the policy but social services resources (interim beds) were used to discharge patients who were entitled to free NHS funding. Other concurrent individual outcomes were 'independence potential explored' and 'choice fulfilled'. Consequently, the strong outcome pattern is related to the fact that the complaint appeared, not so much because the patients were not involved in the discharge plans (as happened with Case 1) but because of the financial implications of their fast discharges. All three complaints referred to financial assessments not been completed when the patients left the hospital. The Commission for Social Care Inspection (2004) evaluation of the initial impact of the Delayed Discharges programme did not detect any rise in complaints since implementation in their seven research sites. Other studies, however, reported the anxiety of families and patients confronted with the prospect of interim care for a range of reasons which included having to pay for it (Cornes et al., 2008). Evidence reported in this section highlights the problematical relationship between the contextual characteristics of the use of interim beds under the reimbursement programme and patient satisfaction with their discharge processes.

Finally, the only 'social services' patient (Case 13) that accepted the transfer to an interim facility stayed there for a significant amount of time (eleven weeks). These short-time stays may well not be as short as the implementation theory assumed. As the Commission for Social Care Inspection reported: 'While it was said that all residential placements were initially short term, there was little evidence from case files of people moving on' (Commission for Social Care Inspection, 2004: 29). Although this one case may not be enough to generalise, it is significant to illustrate the need of monitoring length of stay and costs of patients transferred to interim accommodation, as other studies have mentioned before (Godden et al., 2007; McCoy et al., 2007a). Interim beds have been traditionally assessed on their effectiveness to reduce hospital length of stay (Crotty et al., 2005) and they do seem to reduce delays (Baumann et al., 2007). However, there is need for evaluation on how this is achieved

with regards to patients' experience of discharge (Cornes et al., 2008) and whether overall length of stay and costs across the spectrum of care increases.

8.6 Summary

In this chapter, the evaluation of the role of financial incentives in the Delayed Discharges Act reached the point of highest theory development with the readjustment of some primary patterns. This helped the generation of middle range theories about causal powers of the fines. The cross-case comparison showed that eleven out of the fourteen cases were clearly excluded from the reimbursement programme, with only one case that could have been a potential fine. The analysis concentrated on examining the correlation of discharges that were delayed or not delayed with the different outcomes and contexts that emerged in the individual cases. From this evidence followed separate analysis of the characteristics of the group of delays and those that were not delayed. From the first group, a strong pattern of delays appeared in the self-funders and in cases that had needs which did not match the programme theory.

From the detailed examination of the second group (the cases that were not delayed), special attention was given to the rehabilitation and recuperation cases, examining reasons why they progressed through the system with total success (rehabilitation cases) or some blockages (recuperation patients). Finally, analysis of the small number of cases that could be potential fines provided opportunity to report how social services found implicit ways of controlling the time of discharges. These activities were non confrontational and used mechanisms prescribed by the programme design: the set times for assessment and discharge, the use of formal decision-making meetings and the mechanical use of interim beds. In the next and final chapter of the thesis, some of this knowledge will be converted into recommendations for practice and future construction of programme theory in the area of hospital discharge planning and financial incentives.

9. RECAPITULATION AND RECOMMENDATIONS

9.1 Introduction

Delayed hospital discharges are often blamed for interrupting the smooth operation of public hospitals adding to their pecuniary problems and the Community Care (Delayed Discharges etc.) Act 2003 introduced fines to social services departments to resolve this issue. Evaluations of this policy based on simple outcome measures reported high levels of success in the reduction of delays. Nevertheless, outcome evaluations are not always able to ‘identify which elements of the program “amalgam” are the essential ingredients for success implementation’ (Weiss, 1972, in Chen, 1990: 32). Conversely, programmes based on financial incentives tend to identify these incentives as the essential ingredient of the outcomes achieved.

This thesis, however, demonstrates firstly that the Delayed Discharges Programme is an amalgam of multiple innovations which includes fines and secondly, that mechanisms are embedded in the designed programme theory that allow for fines to be avoided without delays being necessarily reduced. These findings are obtained following the realist evaluation approach (Pawson and Tilley, 1997) which helps unravel the complexities of this multi-agency initiative. To further understand how these findings were constructed and to generate some recommendations, it is necessary to recapitulate on some of the key aspects of the previous chapters.

9.2 Thesis Overview

Chapter One started framing the Delayed Discharges Act into current UK health and social policy trends. In this chapter, it was argued that the programme evaluated in this thesis corresponded with the move towards managerial drive for efficiency and cost-effectiveness in the English National Health Service. The modernisation of the NHS, initiated by New Labour in 1997 reinforced the concept of internal market introduced with the NHS and Community Care Act 1990. Improving the performance of hospitals was high on the Government agenda and delayed discharges achieved

political exposure as part of another negative example of how public services are run. In the most recent decades, with a renewed management drive, the main economic incentive used in public hospitals to reduce expenditure is to minimize hospital bed use by reducing the length of stay of the patients. As a consequence, keeping people in hospital longer than necessary was constructed as an indicator of poor public performance. The construction of measures to analyse this indicator is challenged though, by the conceptual subjectivity of who, when, why and for how long people stay in hospital for longer than expected.

Chapter Two provided the structure for the analysis of the programme theory behind the policy. The historical overview of the policy responses to delayed discharges leads to the creation of the performance indicator called 'delayed transfer of care'. This indicator is part of a jumble of targets and other indicators linked to reputational performance for hospitals and local authorities. It is argued here that the choice of a financial instrument to deal with delayed discharges could be related to the contemporary introduction of Payment by Results, a national financial health reform. In the second part of the chapter, the ten innovations made statutory by the Delayed Discharges Act are described concluding that, although this study aimed to look at the fines, all innovations are interrelated to each other. Consequently, the surgical separation of impacts for the purposes of evaluation is a difficult exercise with an unattainable quest. Finally, the review of all the evaluations of the Act to the date of writing concludes that the specific role of the fines in achieving change (reduction of delays) is in need of further exploration.

Integral to the whole of the thesis is the use of the realist approach to inform the search for regularities that could inform how the financial incentives work. Chapter Three explained how this project was designed around case studies. The methods of data collection (interviews, observations and documentary analysis) are justified. They were selected to understand the relationship between the policy contexts, the mechanisms designed to achieve the policy outcomes and the intended and unintended consequences of these. It is also explained how the process of theory development and the designed methods are constrained by the practical difficulties of the fieldwork stages. Patients' discharge plans were observed as they developed, experiencing the 'life' contingencies, difficulties and choice constraints of the programme. Finally, the

pathway to generalisation from a small number of case studies while evaluating a complex programme is described. The Delayed Discharges Act is a national initiative inspired in a broad programme theory designed and used somewhere else before. Although this research reached a small amount of data in a specific location, it stills feeds information from all the others previous and contemporary evaluation schemes and contexts, mechanisms and outcomes are constructed with the help of all that other knowledge.

Chapter Four attempted to reveal the main programme's theories of change, while reflecting on the meanings and uses of programme theory for evaluation purposes. It is argued that the fines are a measure embedded by multiple social phenomena situated in different levels of the programme interventions. The main macro-social phenomena affecting the fines were described in the two initial chapters but, in this section, the focus is given to the contemporary Government programmes that intertwined with the Delayed Discharges Act. With regards the meso-social phenomena, the different institutional actors involved in the discharge of hospital patients are mentioned, but explaining that this level could only be analysed under the specific circumstances of the local implementation. Finally, staff and patients are located at the level of the micro-social phenomena where all the other layer components colluded. After exposing the broad theoretical framework in which the fines for delayed discharges are located, as the initial step of ascertaining what really 'goes on' in the use of fines, a logic map of the programme is used to facilitate the extraction of the detailed theories of change implemented locally. The focus is on the ten innovations made statutory by the Delayed Discharges Act and how the local staff adapted their practices to achieve them.

Chapter Five continued the process of analysis by examining the contextual factors that characterise the research site. This section reflected on the fact that many different organisations besides social services need to work in cooperation with acute hospitals to reduce delayed discharges. Hospital performance on delayed discharge depends heavily on the range and volume of discharge options available. And all those choices are subordinated to the relationships between all the institutions involved in facilitating the resources necessary to discharge patients from hospital. Local implementation of national programmes involves adapting the programme to

local circumstance and local differences are often large. This chapter drew a picture that captured that diversity, under the assumption that this would characterise the inner workings of the fines in the research site. Features of the local hospital, PCT and housing provision revealed some of the key 'contexts' used in the analysis, like the case of the patients in need of convalescence and the people with housing needs. The analysis of the local social services department showed an institution with high budgetary constraints that determine the way in which they manage the fines. The study of the local residential and nursing care provision exposed another significant characteristic of this locality: a high proportion of their residents will be considered self-funders when assessed by social services. This context is one of the key findings of the way in which the fines operate in this area. Other aspects like, the contextual characteristics of the partnership arrangements between local health and social care agencies were examined. This exercise demonstrated a lack of strong agreements with regards to intermediate care services and NHS continuing healthcare procedures that influence how the financial incentives for delayed discharges impact the research site.

Chapter Six explained that in the research site, delays were significantly reduced after the introduction of the Delayed Discharges Act. The local implementation achieved a rapid and sustained decrease of delayed discharges figures, without social services receiving practically any fines. The chapter examined how some of the other innovations introduced with the fines intertwined to create mechanisms that, planned or unplanned, reduced delays or avoided fines. Sometimes they did it at the same time, but on occasions they did it in isolation. The redefinition of performance data intrinsic to the reimbursement system allowed for ways of avoiding the fines without the need of major confrontations or major changes in their existing discharge practices. The conceptualisation of 'social services patients' and as a result, the delays attributed to social services is significantly different after the Delayed Discharges programme. Inevitably, this creates a disparity between quantitative data collected before and after implementation. But when inevitably, comparisons are made, they show a general reduction of hospital delays and a substantial immediate decrease of delays allocated to social services departments.

Chapter Seven analysed the circumstances surrounding the programme participants and how these micro-contextual characteristics impact with other layers of the

programme intervention to achieve the main programme outcomes ('reduced delays' and 'reduced fines'). The chapter specifically concentrates on describing the discharge journeys of the fourteen case studies. The detailed examination of each case, behind the figures of lost bed days due to delayed discharges has a double aim. Firstly, to use the cases as vehicles to describe patients' experiences. Secondly, patient' journeys are instruments to test the programme theories, gaining an innovative insight into how the programme works in real life. In this respect, it is shown that relevant contexts are constructed at the different levels of the intervention. The individual, meso and macro contextual levels interplayed with designed and unplanned mechanisms in different ways. People with their own individual stories are propelled into a system framed by a reduced catalogue of options and limited by local institutional constraints. Patients, the living outcomes of the programme, progressed through the jungle of rules, regulations and innovations of the programme with more or less success.

Finally, in Chapter Eight, middle range theories about causal powers of the fines were generated. From a study located in a research site with a total absence of fines, the analysis concentrates on how the reduction of delays was achieved. The cross-case comparison demonstrates that, although fines are not issued, delayed discharges still exist for some patients with well defined circumstances. Considerable patterns of delays were identified in the self-funders population and in complex cases that do not match the simplified programme theory. Nonetheless, patients with other characteristics progress smoothly through the system (rehabilitation cases) or with some blockages (people in need of convalescence). The analysis of the few cases that could have potentially incurred fines illustrates the tacit ways to escape the fines. Minimum intervals for assessment and discharge are not used strictly as they were designed with staff negotiating dates based on a softer common sense approach. Formal decision-making meetings not only exemplified the tight management control in which the local social services dealt with the fear of the fines but are now established mechanisms with decisions being timely framed to adapt to the dates in which these meetings take place. To conclude, the mechanical use of interim beds is exposed, not only as a way to reduce the likelihood of fines but as a practice that carries some unintended consequences detrimental to patients and families' experiences of hospital discharge procedures.

9.3 Reflections on Findings

From the 1940s, with the creation of the British welfare state, healthcare is mainly provided on a universalist basis, available to all who need it without exceptions. Other welfare provision, however, was born on a selectivist basis, only to be provided to certain categories of people who meet specific conditions. This is the case with social care, which is means-tested, provided to people according to their financial circumstances. Consequently, healthcare as a universalist benefit walks in parallel to social care, a selectivist benefit. When health and social care needs collide (and they are inevitably meant to collide), health needs have the potential to be also transformed in a selectivist benefit. As a result of this, the debate expands to whether welfare provision of health can be separated from welfare provision of social care.

As the extent of welfare state comes under increasing reductions, healthcare maintains (on the surface) its privilege position as the 'jewel of the crown' of the British welfare state (Jones, 1994). Within the NHS debates, the issue is not so much about expenditure as such but about efficiency and productivity: where and how should the money be spent. This is not the case in social care, however, as rationing of services according to need are added to financial exclusion criteria. Nonetheless, shortening acute patients' hospital stays has as a consequence that the universalist ethos of healthcare is reduced by transferring a large portion of it into the community and re-conceptualising it as social care, which is means-tested.

The growth of competitive tendering and contractualism within public services (the quasi-market) is related to the intrinsic belief that economic drive motivates human behaviour. Nowadays, in public services working practices and relationships of caring professions are highly regulated, standardised and incentivised. Although staff are likely to act altruistically (Titmuss, 1970), the employment of market mechanisms in the delivery of health and social care services does not come without dangers.

Finally, in sickness-focused services, hierarchies of organisational control are been transferred from the traditional 'medical power' to the more holistic 'team control' but most significantly, patients still remain relatively powerless.

The basic conceptual framework of the Delayed Discharges Act described above is widely shared by contemporary health and social care programmes. The use of performance indicators linked to financial incentives is a trend established by the New Labour Government in the last decade. Under the ethos of 'what counts is what works' incentives are extensively used as tools to increase efficiency in the public services quasi market. Because local policy tools are recycled and transferred internationally (Klein, 2006), the need to disentangle the real mechanisms operating in policies is imperative. In the case of the Delayed Discharges Act, a programme imported from the Scandinavian countries, the complex process of discharging patients at the interface of health and social need is linked to fines. Social measures, however, are not implemented in isolation. They are accompanied by a multitude of initiatives that can have as much power to change old practices. This thesis demonstrates how, in addition to the cash injection applied to the system and the multiple prior and parallel programmes, the Delayed Discharge Act introduced nine other innovations besides the fines that contain as much mechanisms of change as the more advertised financial incentives. The exploration of how all these elements are connected is a way of unravelling the inner workings of the programme as a whole, and by default, of the fines.

The delayed discharges problem is a complex fabrication, consequent upon the institutional separation of health and social needs. Fines for social services delays are constructed as complicated solutions but still following a sequential and unidirectional pathway of illnesses that does not reflect the processes of acute hospital patients. These two dissimilar starting points were likely to collide in complicated ways, and they did. The strong regulation of delayed discharges performance with the use of financial incentives located at the meso-level of the institution does not address the broader health and social care system (macro-level). The programme design, aiming to reflect the complexity of the social world that it is trying to improve becomes an intellectual exercise of inclusions and exclusions difficult to be attained by frontline staff and that does not fit the messy circumstances of real people who are acutely ill. Furthermore, effective discharge management cannot be assessed on simple quantitative measures. Although 'all tools used to gather information for regulation are inevitably imperfect' (Attride-Stirling et al., 2006: 207), the simplification for performance purposes of reasons and actors to blame for delayed discharges

reproduces and increases the administrative division of health and social care needs and does not reflect the real pathways of people who experience delays on discharge.

The main concern in monitoring the effect of the Delayed Discharges Act has been 'with the numbers of delayed discharges rather than with the effect of this on patients' (Henwood, 2006a: 407). This thesis demonstrates how evidence of poor outcomes for patients is not necessarily anecdotal because the scheme allows for structures that can generate risks of unwanted outcomes for specific groups of users. Which ones? It depends on the local circumstances. But it appears that the policy struggles to cope with people with complex or in-between needs and those excluded from it because of their financial situation. The reimbursement scheme works well for some cases, but it does not resolve complex and lengthy delays that existed before the programme was implemented. Moreover, the tendency to deal with complex discharges with routine fine avoidance mechanisms that work with 'simpler' cases, add new contingencies to these cases.

9.4 Reflections on Methods

In this study, the application of a theory-driven programme evaluation strategy provides the explanatory depth that such a complex multi-agency programme requires. This is highly relevant when evaluating policies that are designed nationally to be implemented locally. Since the influence of contextual factors needs to be taken into account because the same measure (the fines) is never an exact replica and consequently, the same effect will not be produced: 'Circumstances vary, meaning that responses to a measure at one time and place will not necessarily be the same as responses at another time and place' (Tilley, 2004: 256).

The concept of policy context is central to this thesis. It refers to the historical, political and legal settings, organisational structure, the character of markets, and the nature of issues related to the topic where programmes are implemented. Following the hypothesis that the nature of the issue to improve (delayed discharges in this case) and the institutional context largely determine the ways in which particular policy instruments operate. If that is the case, methods to evaluate these programmes should reflect those contextual differences. They should also be able to identify the elements

of the 'programme amalgam' before claiming causality. The threads hidden behind the tapestry of the Delayed Discharges programme are unravelled with the realist evaluation strategy. The application of the realist approach is a novel take on existing research that studied delayed discharges. This approach is a demanding task that added complexity at every stage of the analysis; it soon became apparent though, that the complexity is not in the method but in the real world, and specifically on the issues regarding hospital discharges.

The 'realist mindset' surrounded all aspects of the research project and it was not merely considered a method to be used at the analysis stage once all data is collected. Thinking in Context-Mechanisms-Outcomes terms starts in the literature review and embeds fieldwork and overall thought processes. Findings build up, slowly by watching what 'was going on' in the wards and constructing theories in the form of causal patterns. Then, those theories are tested with the cross-comparison of a small number of case studies, living outcomes of how the fines impact discharge practices. The resulting sets of theories are compared with findings from previous studies of financial incentives for delayed discharges with the objective of achieving generalisation. The construction of theories, however, is not a linear process with clearly divided phases. Knowledge gained is sequenced in consecutive thesis chapters to reproduce some sense of movement in order to facilitate the reader's comprehension.

The realist approach to evaluation embraces all methods of data collection but mostly researchers have used case studies as part of multi-method designs (Redfern et al., 2003). In this study, patients' discharge pathways were followed as case studies: collecting and observing views from patients and staff while the process of discharge negotiations was taking place. The difficulty of following these patients' discharges 'live', without been fully immersed in the field proved a complicated but comprehensive method to gain knowledge about discharge practices. Institutions offered conflicting views of why decisions are made and patients are not always aware of all the constraints and choices that surround them. The possibility of compounding a holistic view of the case with a qualitative mixed method approach was a key attribute that helped develop middle range theories based on evidence collected at different points, from different actors and in different ways.

The use of a small number of cases constructed with qualitative data has its own validity issues (Hammersley, 1992) that present themselves when trying to establish general patterns through the realist approach. This was dealt with by building on theories from previous findings, cumulating their knowledge as part of the theory refinement process. The extraction of patterns out of a very small number of cases to generate the CMO configurations was better explained through the use of 'truth tables' (Ragin, 1987). In general, the realist framework proved an adequate tool to understand causality for the different contextual levels in which fines operate and to unravel planned and unplanned mechanisms generated by the fear of the fines. It is hoped that this study contributed in a modest way to the development of the realist evaluation strategy.

9.5 Policy Recommendations

National policy is translated into local protocols, procedures and activities, and somewhere in that process the original programme theories of change are lost in translation. The whole system of innovations implemented with the reimbursement scheme reduces delays but they do so in unexpected ways that need to be considered when claiming their success. Recommendations to inform theory refinements or future designs of hospital delayed discharges programme theory are explained below. The recommendations take the form of a set of practical considerations targeted at the improvement of the workings of programmes in the broad area of discharge planning:

- Data collection with regards the quantitative information of delays for performance purposes should be theory informed and not exclusively based on 'time measures'.
- Reasons for delay should be studied in a holistic and qualitative manner. If for performance purposes, causes for delayed discharges need to be recorded in a numerical form; these should include the possibility of choosing several reasons for delay.
- The performance classification of reasons for delayed discharges should avoid the categorisation by agency. This could avoid 'gaming' strategies from one or other

agencies in the discharge process and it would reinforce whole system solutions for a whole system problem.

- Set timescales for assessment and discharge do not provide the flexibility required when assessing acutely ill people. Illness and social contingencies transform notifications in a bureaucratic exercise with multiple forms being sent backwards and forwards from hospitals to social services departments.
- Some innovations introduced at the same time of the fines significantly improve discharge practices and they also reduced traditional reasons for delay such as waiting for social care assessment or funding. This is the case of social services presence in multidisciplinary decision making, weekly health and social care funding panel allocations, weekly monitoring of delays and free personal care for people discharge from hospital.
- The routine and mechanical use of transfers to interim beds for patients with delayed discharges should be avoided. This practice has the potential of negative short and long-term outcomes for the patients, specially for those with complex needs. These transfers need to be monitored quantitatively (length of stay, cost for the patient) and qualitatively (opportunities for rehabilitation, clinical input, choice available, etc.).
- Policy instruments that deal with delayed discharges should be designed locally. These designs should analyse the contextual circumstances that generate delays in their communities and approach them accordingly.
- Fine avoidance mechanisms are unexpected consequences of linking financial incentives to performance indicators. Therefore, the likelihood of fines presence is limited. For this reason fines for social delays cannot be expected to be sources of income that fill designed financial gaps of wider health economic reforms like Payment by Result.
- Delayed discharges programme designs addressed exclusively to social services departments should consider unintended consequences for the populations excluded from these programmes.

In conclusion, the thesis has attempted to show that the concatenated world of health and social care interdisciplinary practice cannot be measured, explained or evaluated with simple cause-effect interpretations of events. This study demonstrates how

complex relationships between national and local policy contexts and the organisational dynamics that characterise health and social care programmes must be analysed before attributing outcomes to financial incentives.

REFERENCES

- ACCA, (2003). "Payment by Results Consultation - Preparing for 2005". Retrieved June 3, 2007 from http://www.acca.co.uk/publicinterest/activities/policy_papers/archive/public/1022459
- ADSS, (2006). "Social Care Leaders Urge Members to Re-examine Care Cost Cases". Press release. March 6, 2006. Retrieved May 16, 2008 from <http://www.adss.org.uk/pres/2006/reexaminecarecost.shtml>.
- Age Concern, (2007). "Official Care Figures Reveal True State of Postcode Lottery". July 7, 2007. Retrieved May 27, 2008 from <http://www.ageconcern.org.uk/AgeConcern/9DD582DA43F4474292F1F3F586790E73.asp>
- Allen, D., Lyne, P., Griffiths, L., (2002). "Studying complex caring interfaces: key issues from a study of multi-agency rehabilitative care for people who have suffered a stroke". Journal of Clinical Nursing(11): 295-305.
- Anderson, P., Meara, J., Broadhurst, S., et al., (1988). "Use of hospital beds: a cohort study of admissions to a provincial teaching hospital". British Medical Journal 297: 910-912.
- Andersson, G., Karlberg, I., (2000). "Integrated care for the elderly: the background and effects of Swedish care of the elderly". International Journal of Integrated Care 1(November): 1-10.
- Archer, M., (1998). "Realism and morphogenesis" in Archer, M., Bhaskar, R., Collier, A., et al. (Eds.) Critical Realism: Essential Readings. London, Routledge: 356-381.
- Armitage, S., Kavanagh, K., (1996). "The discharge liaison nurse at the interface of hospital and community nursing services". International Journal of Nursing Practice 2: 215-221.
- Armstrong, S. H., Peden, N. R., Nimmo, S., et al., (2001). "Appropriateness of bed usage for inpatients admitted as emergencies to internal medicine services". Health Bulletin 59(6): 388-395.
- Arundel, C., Glouberman, S., (2001). "Substudy 15: An analysis of blockage to the effective transfer of clients from acute care to home care". Canadian Policy Research Networks Inc., Ottawa
- Association of Chartered Certified Accountants, (2003). "Payment by Results Consultation - Preparing for 2005" Retrieved April 4, 2008 from http://www.acca.co.uk/publicinterest/activities/policy_papers/archive/public/1022459
- Attride-Stirling, J., Humphrey, C., Tennison, B., et al., (2006) "Gathering data for health care regulation: learning from experience in England and Wales". Journal of Health Services Research and Policy 11 (4): 200-210

- Atwal, A., (2002). "Nurses' perceptions of discharge planning in acute health care: a case study in one British teaching hospital". Journal of Advance Nursing 39(5): 450-458.
- Audit Commission, (1992). Lying in Wait: the Use of Medical Beds in Acute Hospitals. London, HMSO.
- Baggot, R., (2004). Health and Health Care in Britain. Basingstoke, Macmillan.
- Barnes, M., Matka, E., Sullivan, H., (2003). "Evidence, understanding and complexity: evaluation in non-linear systems". Evaluation 9(3): 265-284.
- Baumann, M., Evans, S., Perkins, M., et.al., (2007). "Organisation and features of hospital, intermediate care and social services in English sites with low rates of delayed discharge". Health and Social Care in the Community, 15(4), 295-305.
- Befani, B., Sager, F., (2006). "QCA as a tool for realistic evaluations: the case of the Swiss environmental impact assessment" in Rihoux, V., Grimm, H. (Eds.) Innovative Comparative Methods for Policy Analysis. New York, Springer.
- Bevan, G., Hood, C., (2005). "What's measured is what matters: targets and gaming in the English public health care system". Discussion paper series: No.0501. London, The Public Services Programme, ESRC.
- Bevir, M., (2005). New Labour: A Critique. Abingdon, Routledge.
- Bickman, L., (Ed.) (1987). Using Program Theory in Evaluation: New Directions for Program Evaluation. San Francisco, Jossey-Bass.
- Black, D., Pearson, M., (2002). "Average length of stay, delayed discharge, and hospital congestion". British Medical Journal 325: 610-611.
- Blaikie, N., (2000). Designing Social Research. Cambridge, Polity Press.
- Bogdewic, S.P.,(1992). "Participant observation" in Crabtree BF, Miller W (Eds.) Doing Qualitative Research. Newbury Park, CA, Sage Publications.
- Boockvar, K., Litke, A., Penrod, J., et al., (2004). "Patient relocation in the six months after hip fracture: risk factors for fragmented care". Journal of the American Geriatrics Society 52(11): 1826-1831.
- Boyle, S., (2005). What Foundation Trusts Mean for the NHS. Discussion paper number 18. London, LSE Health and Social Care, London School of Economics.
- Brasel, K., Rasmussen, J., Cauley, C., et al., (2002). "Reasons for delayed discharge of trauma patients". Journal of Surgical Research (107): 223-226.
- Bridgen, P., (2001). "Hospitals, geriatric medicine, and the long-term care of elderly people 1946-1976". Social History of Medicine. 14(3): 507-523.

- Bridgen, P., Lewis, J., (1999). Elderly People and the Boundary between Health and Social Care 1946-91: Whose responsibility? Nuffield Trust Grand Report No.1. London: The Nuffield Trust.
- Brindle, D., (2007). "Minister admits slip over NHS figures". The Guardian. Retrieved March 22, 2008 from <http://www.guardian.co.uk/society/2007/nov/09/nhs.longtermcare>
- British Sociological Association, (2002). "Statement of Ethical Practice". March 2002. Retrieved April, 19 2006, from <http://www.britsoc.co.uk>.
- Bryan, K., Gage, H., Gilbert, K., (2006). "Delayed transfers of older people from hospital: causes and policy implications". Health Policy 76(2006): 194-201.
- Buchanan, D., Boddy D., McCalman J., (1998). "Getting in, getting on, getting out and getting back" in Bryman, A. (Ed) Doing Research in Organizations. London, Routledge.
- Bull, M. J., Roberts, J., (2001). "Components of a proper hospital discharge for elders". Journal of Advance Nursing 35(4): 571-581.
- Butler, J. R., Pearson, M., (1970). Occasional Papers in Social Administration 34. London, Bell.
- Byng, R., Norman, I., Redfern, S., (2005). "Using realistic evaluation to evaluate a practice-level intervention to improve primary healthcare for patients with long-term mental illness". Evaluation 11(1): 69-93.
- Bywaters, P., McLeod, E., (2001). "The impact of New Labour health policy on social services: A new deal for service users' health?" British Journal of Social Work (31): 579-594.
- Cahill, K., (2005). "An audit of in-patient discharge communication and discharge summary prescribing". National Institute of Health Sciences Research Bulletin 3(1):1-2
- Calnan M., Ferlie, E., (2003). "Analysing process in healthcare: the methodological and theoretical challenges". Policy and Politics 31: 185-193.
- Carers UK, (2003). "Free Carers and Community Care Services Through Intermediate Care Community Care (Delayed Discharges etc.) Act 2003". Press Release. June 2003.1-4.
- Carter, N. D., Wade, D.T., (2002). "Delayed discharges from Oxford city hospitals: who and why?" Clinical Rehabilitation 16: 315-320.
- Casalino, L. P., (1999). "The unintended consequences of measuring quality on the quality of medical care". The New England Journal of Medicine 341(15): 1147-1150.
- Census. (2001). "Key Statistics for Local Authorities". Retrieved April 23, 2007 from <http://www.statistics.gov.uk/StatBase/Product.asp?vlnk=10150>

- Cestari, L., Munroe, M., Evans, S., et al., (2006). "Fair Access to Care Services (FACS): implementation in the mental health context of the UK". Health and Social Care in the Community 14(6): 474-481.
- Chaix-Couturier, C., Durand-Zaleski, I., Jolly, D., et al., (2000). "Effects of financial incentives on medical practice: results from a systematic review of the literature and methodological issues". International Journal for Quality in Health Care 12(2): 133-142.
- Chen, H., (1990). Theory-Driven Evaluations. Newbury Park, Sage Publications.
- Chen, H., Rossi, P., (1980). "The multi-goal, theory-driven approach to evaluation: a model linking basic and applied social science". Social Forces 59: 106-122.
- Chen, H., Rossi, P., (Eds.) (1992). Using Theory to Improve Program and Policy Evaluations. Westport, Greenwood Press.
- Christianson, J., Knutson, D., Mazze, R., (2006). "Physician pay-for-performance: implementation and research issues" Journal of General Internal Medicine 21(2): S9-S13 (1).
- Cilliers, P., (2000). "Knowledge, complexity and understanding". Emergence 2(4): 7-13.
- Clarke, A., Rosen, R., (2001). "Length of stay: how short should hospital care be?" The European Journal of Public Health 11(2): 166-170.
- Coast, J., Inglis, A., Morgan, K., et al., (1999). "The hospital admissions study in England: are there alternatives to emergency hospital admission?" Journal of Epidemiology and Community Health 49: 194-199.
- Coleman, E., (2003). "Falling through the cracks: challenges and opportunities for improving transitional care for persons with continuous complex care needs". Journal of American Geriatrics 51: 549-555.
- Colmorten, E., Clausen, T., Bengtsson, S., (2004). "Providing integrated health and social care for older persons in Denmark" in Leichsenring, K., Alaszewski, A. (Eds.) Providing Integrated Health and Social Care for Older persons: A European Overview of Issues at Stake. Aldershot, Ashgate Publishing.
- Commission for Social Care Inspection, (2004). Leaving Hospital: The Price of Delays. London, CSCI Communications.
- Commission for Social Care Inspection, (2005a). "Original Cover Letter and Performance Indicators for 2005-06: August 2005". Retrieved May 23, 2008 from http://www.csci.org.uk/professional/councils/performance_assessment/definitions/previous_years_definitions/performance_indicators_for_2-1.aspx
- Commission for Social Care Inspection, (2005b). Leaving Hospital – Revisited: A Follow-up Study of a Group of Older People who were Discharged from Hospital in March 2004. London, CSCI Communications.

- Commission for Social Care Inspection, (2008). The State of Social Care in England 2006-07: Executive Summary. London, CSCI Communication.
- Connell J., K. A., Schorr L. and Weiss C., (Eds.) (1995). New Approaches for Evaluating Community Initiatives: Concepts, Methods and Contexts. Washington DC, The Aspen Institute.
- Conrad, K., Miller, T., (1987). "Measuring and testing program philosophy" in Bickman, L. (Ed.) Using Program Theory in Evaluation: New Directions for Program Evaluation. San Francisco, Jossey-Bass.
- Cornes, M., Manthorpe, J., Donaghy, E., et al., (2008). "Delayed discharge from hospital: supporting older people to exercise choice". Working with Older People 12(1): 16-20.
- Cowpe, J., (2005). "Intermediate Care: Policy and Context" in Roe, B., Beech, R. (Eds.) Intermediate and Continuing Care: Policy and Practice. Oxford, Blackwell.
- Coye, M. J., (2001). "No Toyotas in health care: why medical care has not evolved to meet patients' needs". Health Affairs 20(6): 44-56.
- Crotty, M., Whitehead, C., Wundke, R., et al., (2005). "Transitional care facility for elderly people in hospital waiting for long term care bed: randomised controlled trial". British Medical Journal 331(1110): 1-5.
- Dahler-Larsen P., (2001). "From programme theory to constructivism: on tragic, magic and competing programmes". Evaluation 7: 331-349.
- Darling, R. B., (2000). The Partnership Model in Human Services: Sociological Foundations and Practices. New York, Kluwer Academic/Plenum.
- Department of Health, (1996). Carers (Recognition and Services) Act 1995: Policy Guidance. London, Department of Health.
- Department of Health, (1997a). The New NHS Modern and Dependable: A National Framework for Assessing Performance. Consultation document. London, Department of Health.
- Department of Health, (1997b). Better Services for Vulnerable People. EL(97)62, CI(97)24. London, Department of Health.
- Department of Health, (2000). The NHS Plan: A Plan for Investment, a Plan for Reform. London, The Stationery Office.
- Department of Health, (2001a). "£300 Million 'Cash for Change': Initiative to Tackle 'Bed-blocking'". Press release 2001/0464. London, Department of Health.
- Department of Health, (2001b). National Service Framework for Older People: Modern Standards and Service Models. London, Department of Health.

- Department of Health, (2002a). Services for Older People - 2002-3 Data Definitions London, Department of Health.
- Department of Health, (2002b). Delivering the NHS Plan: Next Steps on Investment, Next Steps on Reform. London, Department of Health.
- Department of Health, (2002c). Fair Access to Care Services: Guidance on Eligibility Criteria for Adult Care Services. LAC (2002)14. London, Department of Health.
- Department of Health, (2003a). The Delayed Discharges (England) Regulations 2003 Statutory Instrument 2003 No. 2277. London, The Stationary Office.
- Department of Health, (2003b). SITREPS Definitions and Guidance 2003-2004. Version 1 from 29 September 2003. London, Department of Health.
- Department of Health, (2003c). The Community Care (Delayed Discharges Etc.) Act Frequently Asked Questions on Reimbursement. London, Department of Health.
- Department of Health, (2003d). Explanatory Notes To Community Care Delayed Discharges Etc.) Act 2003. Chapter 5. London, Department of Health.
- Department of Health, (2003e). The Community Care (Delayed Discharges Etc.) Act (Qualifying Services) (England) Regulations 2003. Statutory Instrument 2003 No. 1196. London, Department of Health.
- Department of Health, (2004a). Achieving Timely 'Simple' Discharge from Hospital. London, Department of Health.
- Department of Health, (2004b). "Dramatic Fall in Delayed Discharges". Press release 2004/0196, 17 May. London, Department of Health.
- Department of Health, (2005). Implementing Payment by Results: Technical Guidance 2005/06. July 2005. London, Department of Health.
- Department of Health, (2006a). Implementing Payment by Results: Technical Guidance 2006/07: Executive Summary. January 2006. London, Department of Health.
- Department of Health, (2006b). Chief Executive's Report to the NHS: Statistical Supplement. June 2006. London, Department of Health.
- Department of Health, (2007a). "Cross-border arrangements for England and Wales". London, Department of Health. Retrieved June 16 2008, from http://www.dh.gov.uk/en/Healthcare/IntegratedCare/Delayeddischarges/DH_4067415
- Department of Health, (2007b). "Guidance on: National Assistance Act 1948 (Choice of Accommodation) Directions 1992 National Assistance (Residential Accommodation) (Additional Payments and Assessment of Resources) (Amendment) (England) Regulations 2001 (Consultation)". London, Department of Health. Retrieved June 9, 2007, from

http://www.dh.gov.uk/en/Publicationsandstatistics/Publications/PublicationsPolicyAndGuidance/DH_4069787

- Department of Health, (2007c). NHS Continuing Healthcare and NHS-funded Nursing Care: Public Information Booklet. London, Department of Health.
- Dickinson, H., (2006). "The evaluation of health and social care partnerships: an analysis of approaches and synthesis for the future". Health and Social Care in the Community 14(5): 375-383.
- Donaldson, S., (2007). Program Theory-Driven Evaluation Science: Strategies and Applications. New York, Lawrence Erlbaum Associates.
- Dudley, R. A., (2005). "Pay-for-performance research: how to learn what clinicians and policy makers need to know". Journal of American Medical Association 294(14): 1821-1823.
- Dudley, R. A., Frolich, A., Robinowitz, DL, et al., (2004). "Strategies to Support Quality-based Purchasing: A Review of the Evidence: Technical Review Number 10". Rockville, MD, Agency for Healthcare Research And Quality. Retrieved June 8, 2007 from <http://www.ncbi.nlm.nih.gov/books/bv.fcgi?rid=hstat2.chapter.11920>
- Eborall, C., Garmeson, E., (2001). Desk Research on Recruitment and Retention in Social Care and Social Work. August 2001. CO Communications for the Department of Health.
- El Ansari, W., Phillips, C., Hammick, M., (2001). "Collaboration and partnerships: developing the evidence base". Health and Social Care in the Community 9(4): 215-227.
- Elias, N., (1956). "Problems of involvement and detachment". British Journal of Sociology 7(3): 226-52.
- Epstein, D., Mason, A., (2006). "Costs and prices for inpatient care in England: Mirror twins or distant cousins?" Health Care Manage Science 9: 233-242.
- Eriksson, T., (1993). Patients Medically Ready for Discharge in Arvika Hospital, Värmland County Council. Stockholm, Socialstyrelsen.
- Fairbairn, A., (2007). "Payment by results in mental health: the current state of play in England". Advances in Psychiatric Treatment 13: 3-6.
- Falcone, D., Bolda, E., Crawford Leak, S., (1991). "Waiting for placement: an exploratory analysis of determinants of delayed discharges of elderly hospital patients". Health Services Research 26(3): 339-374.
- Felbo, O., Soland, A.M., (1996). Elderly and the Health System- How Can we Get Better? Copenhagen, Akademisk forlag.

- Fenn, A., Horner, P., Travis, S., et al., (2000). "Inappropriate bed usage in a district general hospital". Journal of Clinical Excellence 1(4): 221-227.
- Fernandez, J., Forder, J., (2002). "The Importance of Social Care in Achieving an Efficient Health Care System: The Case for Reducing Hospital Delay Discharge Rates". Discussion Paper Number 07. PSSRU. London, LSE Health and Social Care, London School of Economics.
- Fetter, R., Thompson, J., Mills, R., (1976). "A system for cost and reimbursement control in hospitals". Yale Journal of Biology and Medicine 49: 123-136.
- Findlay, P., Seymour, G., Primrose, W., et al., (2001). "Pictorial outcome measures for the hospital care of older patients - a suggested toolkit". Age and Aging 30: 27-32.
- Fisher, M., Qureshi, H., Hardyman, W., et al., (2006). Using Qualitative Research in Systematic Reviews: Older People's Views of Hospital Discharge. How knowledge works in social care, Report 9. London, SCIE.
- Forder, J., (2007). "Self-funded social care for older people: an analysis of eligibility, variations and future projections". PSSRU. London, Commission for Social Care Inspection
- Fotaki, M., Boyd, A., (2005). "From plan to market: a comparison of health and old age care policies in the UK and Sweden". Public money and management (August): 237-243.
- Gallie, W.B., (1956). "Essentially contested concepts". Proceedings of the Aristotelian Society 56 (1956): 167-198.
- George, A., Bennett, A., (2005). Case Studies and Theory Development in the Social Sciences. Cambridge, Mass., MIT Press.
- Gerson, K., Horowitz, R., (2002). "Observation and interviewing: options and choices in qualitative research" in May, T., (Ed.) Qualitative Research in Action. London, Sage.
- Gertmann, P. M., Rustuccia, J., (1981). "The appropriateness evaluation protocol; a technique for assessing unnecessary days in hospital care". Medical Care 18(8): 855-871.
- Gill, D., Ingman, S., (1994). Eldercare, Distributive Justice, and the Welfare State: Retrenchment or Expansion. New York, Sunny Press.
- Glasby, J., (2003). Hospital Discharge: Integrating Health and Social Care. Oxon, Radcliffe Medical Press.
- Glasby, J., Henwood, M., (2005). "Part of the problem or part of the solution? The Role of care homes in tackling delayed hospital discharges". British Journal of Social Work (December 13): 1-14.
- Glasby, J., Lester, H., (2004). "Delayed hospital discharge and mental health: the policy implications of recent research". Social Policy and Administration. 38(7): 744-757.

- Glasby, J., Littlechild, R., Pryce, K., (2004). "Show me the way to go home: a narrative review of the literature on delayed hospital discharges and older people". British Journal of Social Work (34): 1189-1197.
- Glasby, J., Littlechild, R., Pryce, K., (2006). "All dressed up but nowhere to go? Delayed hospital discharges and older people". Journal of Health Services Research & Policy 11(1): 52-58.
- Glendinning, C., (2002). "Partnerships between health and social services: developing a framework for evaluation". Policy and Politics 30(1): 115-27.
- Glendinning, C., Hudson, B., Hardy, B., et al., (2002). National Evaluation of Notifications for the Use of the Section 31 Partnership Flexibilities in the Health Act 1999: Final Project Report. Nuffield Institute for Health and National Primary Care Research and Development Centre.
- Glouberman, S., Zimmerman, B., (2002). Complicated and Complex Systems: What Would Successful Reform of Medicare Look Like? Discussion Paper 8. Commission on the Future of Health Care in Canada.
- Goode, W. J., Hatt, P.K., (1952). Methods in Social Research. New York, McGraw-Hill.
- Godden, S., McCoy, D., Pollock, A., (2007). Can We Tell if Government Policies Are Working? Interpreting Government Data on Delayed Discharges from Hospitals. Discussion Paper Series: No. 0703. The Public Services Programme, ESRC. Retrieved April 22, 2008, from <http://www.publicservices.ac.uk/wp-content/uploads/dp0703.pdf>
- Godfrey, M., Keen, J., Townsend, J., et al., (2005). An Evaluation of Intermediate Care for Older People: Final Report: September 2005. Leeds, Institute of Health Sciences and Public Health Research. University of Leeds.
- Godfrey, M., Townsend, J., Cornes, M., et al., (2008). Reimbursement in Practice: The Last Piece of the Jigsaw: A Comparative Study of Delayed Hospital Discharge in England and Scotland. Leeds, University of Leeds.
- Gray, A., Jenkins, B., Leeuw, F., (2003). "The implications of a new policy instrument" in Gray, A., Jenkins, B., Leeuv, F., et al. (Eds.) The Challenge for Evaluation: Collaboration in Public Services. New Brunswick, Transaction Publishers.
- Hall, D., Bytheway B., (1982). "The Blocked bed: definition of the problem". Social Science and Medicine 16: 1985-1991.
- Hammersley, M., (1992). What's Wrong with Ethnography? London, Routledge.
- Hannigan, B., Allen, D., (2003). "A tale of two studies: research governance issues arising from two ethnographic investigations into the organisation of health and social care". International Journal of Nursing Studies 40: 685-695.

- Harrison, M., (2004). Implementing Change in Health Systems: Market Reforms in the United Kingdom, Sweden and The Netherlands. London, Sage.
- Harrison, G., Ivatts, S., Millard, P., (2003). "Mathematical modelling: how and why". British Journal of Health Care Management 9(4): 144-150.
- Healthcare Commission, (2003). "Delayed Transfers of Care". London, Healthcare Commission. Retrieved 1 September 1, 2008 from <http://www.chi.nhs.uk/Ratings/Trust/Indicator/indicatorDescriptionShort.asp?indicatorId=1013>
- Healthcare Commission, (2004a). "Performance Ratings Methodology for 2003/04. 23rd July, 2004." London, Healthcare Commission. Retrieved September 1, 2008 from <http://ratings2004.healthcarecommission.org.uk/methodology.asp>
- Healthcare Commission, (2004b). State of Healthcare Report 2004. London, Healthcare Commission.
- Healthcare Commission, (2005). "Performance rating methodology for 2004/2005- PCT". London, Healthcare Commission. Retrieved September 1, 2008 from http://ratings2005.healthcarecommission.org.uk/Downloads/methodology_PCT.doc.
- Healthcare Commission, (2006). "Annual Health Check Ratings". London, Healthcare Commission. Retrieved November 2, 2006, from <http://annualhealthcheckratings.healthcarecommission.org.uk/annualhealthcheckratings.cfm>
- Healthcare Commission, (2007). "Performance indicator thresholds for existing national targets and new national targets 2007/2008". Healthcare Commission: 1-8. London, Healthcare Commission. Retrieved August 8, 2008 from http://www.healthcarecommission.org.uk/db/documents/ENTthresholds_210208.pdf
- Health Committee, (2003). Committee Visit to Norway and Sweden. Report Number 5, Director of Secretariat. London, Health Committee.
- Health Committee, (2004). Provision for the elderly in Norway and Sweden. A report on the Health Committee's visit to Norway and Sweden. London, Health Committee.
- Henriksen, E., Selander, G., Rosenqvist, U., (2003). "Can we bridge the gap between goals and practice through a common vision? A study of politicians and managers' understanding of the provisions of elderly care services". Health Policy 65(2): 129-137.
- Henwood, M., (1994). Hospital Discharge Workbook: A Manual on Hospital Discharge Practice. London, Department of Health.
- Henwood, M., (2004). Reimbursement and Delayed Discharges: Discussion Paper for the Integrated Care Network. Leeds, Integrated Care Network.

- Henwood, M. (2006a). "Effective partnership working: a case study of hospital discharge". Health and Social Care in the Community 14(5): 400-407.
- Henwood, M., (2006b). "The treatment gap". Society Guardian. May 31, 2006. Retrieved October 3, 2007 from <http://www.guardian.co.uk/society/2006/may/31/longtermcare.guardiansocietysupplement>
- Henwood, M., Hardy, B., Hudson, B., et al., (1997). Interagency Collaboration: Hospital Discharge and Continuing Care Sub-Study. Leeds, Nuffield Institute for Health.
- Holland, D., Harris, M., Pankratz, S., et al., (2003). "Prospective valuation of a screen for complex discharge planning in hospitalized adults". Journal of the American Geriatrics Society 51(5): 678-682.
- Holmas, T., Kjerstad, E., Kristiansen, F., et al., (2007). Long Term Care and Hospital Length of Stay for Elderly Patients. Working paper No. 09/07. Bergen, Institute for Research in Economics and Business Administration and Health Economics.
- Hood, C., (2006). "Gaming in target world: the targets approach to managing British Public services". Public Administration Review July- August 2006: 515-521.
- Hopper, A., (2007). "Reducing the LOS of emergency medical admissions". Health Services Journal Conference: 'Reducing Length of Stay. Practical strategies to improve patient flow and manage hospital beds days'. London, July 7, 2007.
- Houghton, A., Bowling, A., Jones, I., et al., (1996). "Appropriateness of admission and the last 24 hours of hospital care in medical wards in an east London teaching group hospital". International Journal for Quality in Health Care 8(6): 543-553.
- House of Commons Committee of Public Accounts, (2003). Ensuring the Effective Discharge of Older Patients from NHS Acute Hospitals: Thirty-third Report of Session 2002-03. HC 459. London, The Stationary Office.
- House of Commons Health Committee, (2002). Delayed Discharges, Third Report of Session 2001-2002: Volume 1. HC 627-I, para 168. London, The Stationery Office.
- Howarth, M., Kneafsey, R., (2005). "The impact of research governance in healthcare and higher education organizations". Journal of Advance Nursing 49: 675-683.
- Hubbard, G., Huby, G., Wyke, S., et al., (2004). Research Review on Tackling Delayed Discharge. Edinburgh, Scottish Executive Social Research.
- Humphrey, C., Ehrich, K., Kelly, B., et al., (2003). "Human resources policies and continuity of care". Journal of Health Organization and Management 17(2): 102-122.
- Hunter, D., (1999). "Program Life-Cycles". New York, Edna McConnell Clark Foundation. Retrieved February 26, 2007 from http://www.emcf.org/pdf/eval_lifecycles.pdf

- Hyde, C., Robert, I., Sinclair, A., (2000). "Systematic review. The effects of supporting discharge from hospital to home in older people". Age and Ageing 29 (3): 271-279.
- Ivatts, S., Millard, P., (2002). "Health care modelling: opening the 'black box'". British Journal of Health Care Management 8(7): 251-255.
- Jackson, M., (1994). "Discharge planning: issues and challenges for gerontological nursing: a critique of the literature". Journal of Advanced Nursing 19(3): 492-502.
- Jacobs, K., Manzi, T., (2000). "Performance indicators and social constructivism: conflict and control in housing management". Critical Social Policy 20: 85-103.
- Jerome, J., (2007). "NHS Continuing Health Care (CHC). Debate in House of Lords". ADSS Briefing Note Health Overview & Scrutiny. Appendix 1 (1-4). 5th February 2007: NHS Continuing Health Care. Retrieved May 5, 2008 from [http://www.shropshire.gov.uk/committee.nsf/0/6001F4174A3CC7F28025726E003FCBA4/\\$file/Appendix%201%20-%20NHS%20CHC%20Debate%20in%20House%20of%20Lord%20December%2006.pdf](http://www.shropshire.gov.uk/committee.nsf/0/6001F4174A3CC7F28025726E003FCBA4/$file/Appendix%201%20-%20NHS%20CHC%20Debate%20in%20House%20of%20Lord%20December%2006.pdf)
- Jones, C., (2001). "Voices from the front line: state social workers and New Labour". British Journal of Social Work 31 (4): 547-562.
- Jones, L., (1994). The Social Context of Health and Health Work. London, Macmillan.
- Judge K., B. L., Benzeval M., Barnes M., (1999). Health Action Zones: Learning to Make a Difference. Report submitted to Department of Health. Personal Service Research Unit, University of Kent.
- Klein, R., (2006). The New Politics of the NHS: from Creation to Reinvention. Abingdon, Radcliffe Publishing.
- Koffman, J., Fulop, N., Pashley, D., et al., (1996). "No way out: the delayed discharge of elderly mentally ill acute and assessment patients in North and South Thames regions". Age and Aging 25: 268-272.
- Layder, D., (1993). New Strategies in Social Research. Cambridge, Polity Press.
- Lees, L., Holmes, C., (2005). "Estimating date of discharge at ward level: a pilot study". Nursing Standard 19(17): 40-43.
- Leichsenring, K., (2004). "Developing integrated health and social care services for older persons in Europe". International Journal Integrated Care 4(Jul-Sep): 1-15.
- Lewis, J., (2001). "Older people and the health-social care boundary in the UK: half a century of hidden policy conflict". Social Policy and Administration 35(4): 343-359.
- Lewis, K., (1999). "The concepts of community care and primary care in the UK: the 1960s to the 1990s". Health and Social Care in the Community 7(5): 333-341.

- Lindgren, B., (1995). "Health Care in Sweden" in Alban, A., Christiansen, T. (Eds.) The Nordic Lights: New Initiatives in Health Care Systems. Odense, Denmark, University Press.
- Lipsky, M. W., (1980). Street-Level Bureaucracy: Dilemmas of the Individual in Public Service. New York, Russell Sage Foundation.
- Lymbery, M., (2006). "United we stand? Partnership working in health and social care and the role of social work in services for older people". British Journal of Social Work 36(7): 1119-1134.
- Lofland, J., Lofland, L., (1971). Analyzing Social Settings. Belmont, CA, Wadsworth.
- Long, A., Harrison, S., Mercer, G., (1985). "Comparative perspectives on performance" in Long, A., Harrison, S. (Eds.) Health services performance: Effectiveness and Efficiency. London, Croom Helm.
- Lundh, U., Williams, S., (1997). "The challenges of improving discharge planning in Sweden and the UK: different but the same". Journal of Clinical Nursing 6: 435-442.
- Lundvall, O., Sjöo, M., Tjernell, A., et al., (1993). The Department of Internal Medicine and the Elderly after the Ädel Reform. Stockholm, Socialstyrelsen.
- Luxton, T., (2004). "Continuing care: legal and 'Coughlan compliant'?" Age and Ageing 33(2): 98-99.
- Macphail, A. N., Bradshaw, D. B., (1967). "Delayed in hospital". Lancet ii: 89-91.
- Mahoney, F., Barthel, D., (1965). "Functional evaluation: the Barthel Index". Maryland State Medical Journal 14: 61-65.
- Manzano-Santaella A., (2005). "The Impact of the Community Care (Delayed Discharges, etc) Act 2003 in Hospital Patients". Masters Dissertation. University of Leeds.
- Marshall, M., Harrison, S., (2005). "It's about more than money: financial incentives and internal motivation". Quality and Safety in Health Care 14: 4-5.
- Marshall, M., Shekelle, P., Brook, R., et al., (2000). Dying to Know: Public Release of Information about Quality of Health Care. London, The Nuffield Trust.
- Marshall, M., Smith, P., (2003). "Rewarding results: using financial incentives to improve quality". Quality and Safety in Health Care 12: 397-398.
- Mason, J., (2002). Qualitative Researching. London, Sage.
- Mathieson, S., (2004) "Fine achievement". The Guardian. Retrieved February 23, 2007 from <http://www.guardian.co.uk/society/2004/nov/24/publicservicesawards9>
- Maybin, J., (2007). Payment by Results: Briefing. London, King's Fund.

- McCoy, D., Godden, S., Pollock, A., et al., (2007a). "Carrot and sticks? The Community Care Act (2003) and the effect of financial incentives on delays in discharge from hospitals in England". Journal of Public Health (29): 281-287.
- McCoy, D., Pollock, A., Bianchessi, C., (2007b). Managing the Discharge and Post-acute Care of Hospital Inpatients: Notes from Canden and Islington, London. Discussion Paper series: No. 0704. London, The Public Services Programme, ESRC.
- McCoy, D., Pollock, A., Bianchessi, C., et al., (2007c). "Survey on the Implementation of the Community Care (Delayed Discharges) Act (2003)". Discussion Paper Series: No. 0702. London, The Public Services Programme, ESRC.
- McDonagh, M. S., Smith, D.H., Goddard, M., (2000). "Measuring appropriate use of acute beds: a systematic review of methods and results". Health Policy 53: 157-184.
- McGlennon, M., (1984). "Private nursing home census: October 1984". Community Medicine 9(3): 307-312.
- McGraw, K., (1978). "The detrimental effects of reward on performance: a literature review and prediction model" in Lepper, M., Greene, D. (Eds.) The Hidden Costs of Rewards: New Perspectives on the Psychology of Human Motivation. Hillsdale, Erlbaum.
- McKenna, H., Keeney, S., Glenn, A., et al., (2000). "Discharge planning: an explanatory study". Journal of Clinical Nursing 9: 594-601.
- McLaughlin, J., Jordan, G., (1998). "Logic Models: A Tool for Telling Your Program's Performance Story". Retrieved December 5, 2006 from <http://www.pmn.net/library/Logic.htm>
- Melis, R., Olde Rikker, M., Parker, S., et al., (2004). "What is intermediate care?" British Medical Journal (329): 360-361.
- Merton, R., (1968). Social Theory and Social Structure. New York, Free Press.
- Millard, P. H., McLean, S. I., (Eds.) (1994). Modelling Hospital Resource Use: a Different Approach to the Planning and Control of Health Care Systems. London, Royal Society of Medicine Press.
- Minford, M., (2001). The Boundaries between Health and Social Care for Older People in Developed Countries. London, The Nuffield Trust.
- Moore, W., (2003). "NHS and local government try to stop introduction of "bed blocking" fines". British Medical Journal 326 (25 January): 184.
- National Audit Office, (2000). "Inpatient Admissions and Bed Management in NHS Acute Hospitals HC 254 Session 1999-2000". 24 February 2000. London, The Stationary Office.

- National Audit Office, (2003). Ensuring the Effective Discharge of Older Patients from NHS Acute Hospitals. HC 392. London, The Stationary Office.
- National Statistics, (2006). Community Care Statistics 2005: Home Care Services for Adults, England. London, Health and Social Care Information Centre.
- Naylor, M., (1990). "Comprehensive discharge planning for hospitalized elderly: a pilot study." Nursing Research 39(3): 156-161.
- Netten, A., Darton, R., (2003). "The effect of financial incentives and access to services on self-funded admissions to long-term care". Social Policy and Administration 37(5): 483-497.
- Netten, A., Darton, R., Cutis, L., (2002). "Self-funded admissions to care homes: Summary of findings", PSSRU. London. Retrieved August 2, 2008 from <http://www.pssru.ac.uk/pdf/rs022.pdf>
- Parker, S. G., Peet, S.M., McPherson, A., et al., (2002). "A systematic review of discharge arrangements for older people". Health Technology Assessment 6(4): 1-183.
- Parker, S. G., Lee, S.D., Faday Evatan, R., (2004). "Coordinating discharge of elderly people from hospital to community". Evidence Based Health Care and Public Health 8: 322-334.
- Patton, M. Q., (1982). Practical Evaluation. Newbury Park, Sage.
- Patton, M. Q., (1987). How to Use Qualitative Methods in Evaluation. Newbury Park, Sage.
- Patton, M. Q., (1989). "A context and boundaries for theory-driven approach to validity". Evaluation and Program Planning 12: 375-377.
- Patton, M. Q., (1999). "Realistic evaluation [Review of the book Realistic Evaluation]". American Journal of Evaluation. 20(2): 385-388.
- Patton, M. Q., (2002). Qualitative Research and Evaluation Methods. Thousand Oaks, Sage.
- Pawson, R., (1996). "Theorizing the interview". The British Journal of Sociology 47(2): 295-314.
- Pawson, R., (2002). "Evidence-based policy: in search of a method". Evaluation 8(2): 157-181.
- Pawson, R., (2006a). Evidence-based Policy: A Realist Perspective. London, Sage.
- Pawson, R., (2006b). "Simple principles for the evaluation of complex programmes" in Killoran, A., Swann, C., Kelly, M. (Eds.) Public Health Evidence: Tackling Health Inequalities. Oxford, Oxford University Press.
- Pawson, R., Tilley, N., (1997). Realistic Evaluation. London, Sage.

- Pawson, R., Greenhaigh, T., Harvey, G., et al., (2005). "Realist review - A new method of systematic review for complex policy interventions". Journal of Health Services Research and Policy 10 (Supplement to issue 3): 21-34.
- Pearson, P., Procter, S., Wilcokson, J. et al., (2004). "The process of hospital discharge for medical patients: a model". Journal of Advanced Nursing 46(5): 496-505.
- Pollock, A., McCoy, D., (2006). "Unblocking 'bed blocking'." ESRC Public Services Programme. Oxford. Retrieved December 19, 2006, from http://www.publicservices.ac.uk/our_research/Financial_Incentives_and_Discharging.asp.
- Propper C., Le Grand, J., (1997). Central Government and Quasi-Markets: The Case of Health Care. Discussion Paper No.6. London, LSE Health. The London School of Economics and Political Science.
- Radaelli, C., (2000). "Policy transfer in the European Union: institutional isomorphism as a source of legitimacy". Governance 13(1): 25-43.
- Ragin, C., (1987). The Comparative Method. Berkeley, University of California Press.
- Redfern, S., Christian, S., Norman, I., (2003). "Evaluating change in health care practice: lessons from three studies". Journal of Evaluation in Clinical Practice 9(2): 239-249.
- Rist, R., (2003). "Influencing the policy process through evaluation" in Denzin, N., Lincoln, Y. (Eds.) Collecting and Interpreting Qualitative Materials. Thousand Oaks, Sage.
- Roberts, P., Houghton, M., (1996). "In search of a block buster". Health Service Journal 5(December): 28-29.
- Roderick, P., (1999). "Health and health services" in Shucksmith, M., Murphy, C. (Eds.) Rural Audit: A Health Check in Rural Britain. Aberdeen, Arkleton Centre for Rural Development Research.
- Roe, B., (2005) "Service development and evaluation in intermediate care" in Roe, B., Beech, R. (Eds) Intermediate Care and Continuing Care. Policy and Practice. Oxford, Blackwell.
- Rogers, P., (1999). "Book review: Realistic Evaluation". American Journal of Evaluation. 2(20): 381-383.
- Rogers, P., (2007). "Theory-based evaluation: reflections ten years on". New Directions for Evaluation 2007(114): 63-67.
- Rogers, P., (2008). "Using programme theory to evaluate complicated and complex aspects of interventions". Evaluation 14(1): 29-48.
- Roland, M., (2008). Comment on 'Financial Incentives, Healthcare Providers and Quality Improvements'. London, The Health Foundation.

- Roll, J., Wright, K., (2002). The Community Care (Delayed Discharges Etc.) Bill: Bill 4 of 2002-03. Research Paper 02/66. London, House of Commons Library.
- Rosin, A. J., (1970). "Why were they in hospital so long?" Gerontologia Clinica 12(1): 40-48.
- Rossi, P. H., (1987). "The iron law of evaluation and other metallic rules". Research in Social Problems and Public Policy 4: 3-20.
- Rowan, K., Harrison, D., Brady A., et al., (2004). "Hospitals' star ratings and clinical outcomes: ecological study". British Medical Journal 328: 924-925.
- Rubin, S. G., Davies, G. H., (1975). "Bed blocking by elderly patients in general-hospital wards". Age and Ageing 4: 142-147.
- Rudd, C., Smith, J., (2002). "Discharge planning". Nursing Standard 17(5): 33-37.
- Saltman, R., (2002). "Regulating incentives: the past and present role of the state in health care systems". Social Science and Medicine 54: 1677-1684.
- Samuel, M., (2006). "Special report on Continuing Care: 17 February 2006". Community Care. Retrieved 17th May, 2008, from <http://www.communitycare.co.uk/Articles/2006/02/17/52865/special-report-on-continuing-care.html>.
- Sanderson, I., (2000). "Evaluation in complex policy systems". Evaluation 6: 433-454.
- Sayer, A., (1992). Method in Social Science: a Realist Approach. 2nd ed. London, Routledge.
- Schmitt M.H., Farrell. M. P., Heinemann G.D., (1988). "Conceptual and methodological problems in studying the effects of interdisciplinary geriatric teams". Gerontologist (28): 753-764.
- Schwartz, B., (1982). "Reinforcement-induced behavioural stereotypy: How not to teach people to discover rules". Journal of Experimental Psychology 111: 23-59.
- Secretary of State for Health, (2006). Our Health, our Care, our Say: A New Direction for Community Services. Cm 6737. London, The Stationary Office.
- Sheppard, S., Parkes, J., McClaran, J., et al., (2004). "Discharge planning from hospital to home". The Cochrane Database of Systematic Reviews 1(Art. No.: CD00313.pub2. DOI: 10.1002/14651858.CD000313.pub2).
- Silverman, D., (2001). Doing Qualitative Research: A Practical Handbook. London, Sage.
- Smeets, P., Verheggen, F., Pop, P. et al., (2000). "Assessing the necessity of hospital stay by means of the Appropriateness Evaluation Protocol: how strong is the evidence to proceed?" International Journal for Quality in Health Care 12(6): 483-493.
- Smith, P., (1993). "Outcome-related performance indicators and organizational control in the public sector". British Journal of Management 4: 135-151.

- Smith, A., Crome, P., (2000). "Relocation mosaic – A review of 40 years of resettlement literature". Clinical Gerontology 10: 81-95.
- Social Care Institute for Excellence, (2006). "Using qualitative research in systematic reviews: Older people's views of hospital discharge". *How Knowledge Works in Social Care. Report 09.* London, Social Care Institute for Excellence.
- Social Policy Ageing Information Network, (2001). The Underfunding of Social Care and its Consequences for Older People. London, Help the Aged.
- Stame, N., (2004). "Theory-based evaluation and types of complexity". Evaluation 10(1): 58-76.
- Stone, D., (2001). Learning Lessons: Policy Transfer and the International Diffusion of Policy Ideas. CSGR Working Paper No. 69/01. Retrieved July 3, 2008 from <http://poli.haifa.ac.il/~levi/res/stone-2000.pdf>
- Strauss, A., Fagerhaugh, S., Suczek, B., et al., (1985). Social Organization of Medical Work. Chicago, The University Of Chicago Press.
- Styrborn, K., (1994). "Geriatric decision-making: a study of medical organizational aspects of discharge planning". Uppsala, Sweden, Uppsala University. Doctoral thesis.
- Styrborn, K., Thorslund, M., (1993). "'Bed-blockers': delayed discharge of hospital patients in a nationwide perspective in Sweden". Health Policy 26: 155-170.
- Tawddle, A., (1999). Health Care Reform in Sweden, 1980-1994. Westport, Conn., Auburn House.
- Tawddle, A., (2002). "Ideology and interests: explaining Swedish medical care reform, 1991-1994: an overview" in Twaddle, A. (Ed.) Health Care Reform Around the World. Westport, Greenwood Press.
- The Information Centre Knowledge for Health and Social Care, (2007). "Statistics and data collection." London, Department of Health. Retrieved February 20, 2007 from <http://www.ic.nhs.uk/pubs/pssex0506>.
- Thorslund, M., Bergmark, A., Parker, M.G., (1997). "Difficult decisions on care and services for elderly people: the dilemma of setting priorities in the welfare state". International Journal of Social Welfare 6(3): 197-206.
- Tilley, N., (2004). "Applying theory-driven evaluation to the British Crime Reduction Programme: the theories of the programme and of its evaluations". Criminal Justice 4: 255-276
- Titmuss, R. M., (1970). The Gift Relationship. London, Allen and Unwin.
- Van der Doelen, F., (1998). "The "give-and-take" packaging of policy instruments: optimizing legitimacy and effectiveness" in Bemelmans-Vidéc, M., Rist, R., Vedung,

- E., (Eds.) Carrots, Sticks and Sermons: Policy Instruments and their Evaluation. New Brunswick, Transaction Publisher.
- Van der Knaap, L., Leeuw, F., Bogaerts, S., et al., (2008). "Combining Campbell standards and the realist evaluation approach". American Journal of Evaluation. 29(1): 48-57.
- Van Walraven, C., Bell, C., (2002). "Risk of death or readmission among people discharged from hospital on Fridays". Canadian Medical Association Journal. 2002 June 25; 166(13): 1672-1673.
- Varnava, A., Sedgwick, J., Deaner, A., et al., (2002). "Restricted weekend service inappropriately delays discharge after acute myocardial infarction" Heart 2002; 87: 216-219.
- Vedung, E., (1998). "Policy instruments: typologies and theories" in Bemelmans-Videc, M., Rist, R., Vedung, E., (Eds.) Carrots, Sticks and Sermons: Policy Instruments and their Evaluation. New Brunswick, Transaction Publisher.
- Vetter, N., (2003). "Inappropriately delayed discharge from hospital: what do we know?" British Medical Journal 326(7395): 927-928.
- Victor, C., (1991). Health and Health Care in Later Life. Milton Keynes, Open University Press.
- Victor, C., Healy, J., Thomas, A., Sargeant, J., (2000). "Older patients and delayed discharge from hospital". Health and Social Care in the Community 8(6): 443-452.
- Vindlacheruvu, M., Luxton, T., (2006). "NHS continuing care: reliable decisions?" Age and Ageing 35(3): 313-316.
- Wald, S., (2004). "Bureaucracy of ethics applications". British Medical Journal 329: 282-284.
- Wallen, N., Fraenkel, J., (2001.) Educational Research: A Guide to the Process. London, Lawrence Erlbaum Associates.
- Walshe, K., (2003). "Foundation hospitals: a new direction for NHS reform?" Journal of the Royal Society of Medicine. 96: 106-110.
- Wanless, D., (2002). Securing Our Future Health: Taking a Long-Term View: Final Report. London, HM Treasury.
- Wanless, D., (2006). Securing Good Care for Older People: Taking a Long-Term View. London, Kings Fund.
- Wanless, D., Appleby, J., Harrison, A., et al., (2007). Our Future Health Secured? A Review of NHS Funding and Performance. London, King's Fund.
- Waters, K., Allsopp, D., Davidson, I., et al., (2001). "Sources of support for older people after discharge from hospital 10 years on". Journal of Advanced Nursing 33: 575-582.

- Weiss, C., (1997). "How can theory-based evaluation make greater headway?" Evaluation Review 21: 501-524.
- Weiss, C. H., (1998). Evaluation: Methods for Studying Programs and Policies. London, Prentice-Hall.
- Wenger, C., (2001). "Myths and realities of ageing in rural Britain". Ageing and Society 21: 117-130.
- Wholey, J. S., (1987). "Evaluability assessment: developing program theory" in Bickman, L. (Ed.) Using Program Theory in Evaluation: New Directions for Program Evaluation. San Francisco, Jossey-Bass.
- Wimo, A., Ronnback, E., Larsson, B., et al., (1999). "Misplacement' of elderly people in the caring organisation: reasons and alternatives". Archives of Gerontology and Geriatrics (28): 227-237.
- Wright, F., (2003). "Discrimination against self-funding residents in long-term residential care in England". Ageing and Society 23: 603-624.
- Yin, R. K., (1994). Case Study Research: Design and Methods. Applied Social Research Methods, Vol. 5. Thousand Oaks, CA, Sage.
- Young, G., White, B., Burgess, J., et al., (2005). "Conceptual issues in the design and implementation of pay-for-quality programs". American Journal of Medical Quality 20(3): 144-150.

APPENDIX

Interview with Social Services Care Manager (Mrs Naylor's, Case 14)

Researcher: 7th of August 07. Will it say the admission date in here?

Care Manager (CM): Yes, 2nd of July.

Researcher: Did you ever get a Section 5?

CM: They didn't send me a Section 5. No [pause]. Oh, yes, I did get a Section 5! [Laughs with surprise].

Researcher: That's good because they don't normally do them...

CM: They don't. No...

Researcher: ...for self-funders. [Sights] Where does it say the date?

CM: [Reads from the form] 'Family looking for nursing home'. She wasn't...she hadn't chosen... They didn't know where she was going then.

Researcher: Ah...

CM: That's why I didn't know when she was going. I knew I didn't know when she was going...

Researcher: Will it have a...? Does it say...?

CM: They have to agree a transfer date, don't they?

Researcher: So agreed transferred date 29th of the 8th.

CM: Yes. But she didn't go on the 29th.

Researcher: No...

CM: That's just when they are saying she is ready to go. So we say 'Yes, we agree it but because she is self-funding we can't get charged'. Do you see what I mean?

Researcher: So the Section 5 was on the 24th, for her to go on the 29th. Is that the actual date that she went?

CM: I have no idea, they didn't tell me. I doubt it.

[Interruption]

Researcher: [Looking at her note]) No, she went on the Friday, so she went on the 31st.

CM: Right. Oh, that's good. I'll make a note about it, actually.

Researcher: [Laughs]

CM: 31st...Where did she go? Redgate?

Researcher: Redgate, Redgate Nursing Home

CM: Thank you very much.

Researcher: One of my questions, when we were discussing about the Section 5...Because in this case I am interested about the fact that she was self-funder and if it affected the way the discharge went and everything... The policy says that with self-funders, social services are only responsible for the assessment process. But what I have found out is really... the hospital doesn't sort of remember that, because if he is self-funding, it is sort of...just...

CM: Umm...Yes, they can just get on with it, go and do it.

Researcher: Yes...Self-funders are never a fine or anything...

CM: No...

Researcher: Because in this case, for example, what was your involvement? What sort of assessment did you do with her?

CM: I met with the son. I didn't meet with her, she was too frail. Did like an assessment really, asking about etc, etc. Because initially we thought she was going to go home, he was quite keen to have her home...

Researcher: Was he [referring to the patient's son] keen?

CM: Yes... But then from what the ward staff and the occupational therapists were saying, she wasn't mobilising at all. He agreed that yes, maybe care will be appropriate. So really was advice for him, so after doing the assessment...

Researcher: The assessment of the needs and you realised that she did need it...

CM: Yes...I checked out finances, explained what happens because she is self-funding. What the implications were of that. And then I got him a list of... Find out where the vacancies were. Gave them to the ward. And him and his sister just then got on and did it.

Researcher: So it was basically one conversation with the son.

CM: A couple of conversations on the phone and one actual meeting.

Researcher: Yes. And giving them the list and...

CM: Yes, that was it.

Researcher: So we can call that your assessment. So if you wouldn't have done that, by the time the Section 5 was sent, then...

CM: Let me have a look...

Researcher: The Section 5 was sent on the 24th, if you wouldn't have done all that before the section 5, you would have been liable.

CM: Oh right! Yes, yes.

Researcher: You know what I mean because is like social services are liable for the assessment.

CM: I did the assessment on the 21st

Researcher: On the 21st, yes

CM: Yes. And then the Section 5 on the 25th.

Researcher: But they wouldn't be able to tell that she is going before you do the assessment. So it is a bit of a funny one, isn't it?

CM: Yes, it is. Because it might have been that we would look for a package of care at home or we might have been helping fund for her to go somewhere.

Researcher: OK, I don't know if you remember in the MDT. I went to only one MDT for this lady. And the physio said, there was this confusion because the doctor...Because in the MDTS in this ward there are no consultants if you compare with others. So it is totally nurse driven the MDT, while in others is more like consultant driven...

CM: Women round him [laughs].

Researcher: Yes. But in here they are the sisters and all the therapists. So the physio was saying that they had a problem because the doctor, the consultant, had said to the lady that she could go home after...

CM: That's right, yes.

Researcher: That's interesting. Because the doctor is not in the MDT, he goes in a different direction than the rest of the team. More like the old fashioned way that they used to do. But then the physio was saying maybe in three or four months she'll be able to recover. And then she asked you 'Is she very self-funder?' And you said, 'Oh, yes, the son says she was quite over the limit'. So why do you think she was asking that? Why will it make a difference if she wasn't self-funder?

CM: Well, they shouldn't, should it? But they often want them out, don't they? Out of the way...

Researcher: I still don't understand what she meant! Do you want to translate it?

CM: I think what she is getting at is, if she wasn't self-funding, they'll be saying well... maybe a rehabilitation bed, either move her up to a ward or...

Researcher: Ah, OK. Yes... But if she is a self-funder...

CM: If they go self-funding, if they get her going there brilliant. If not, well, she can stay there. Which isn't really fair to her! Because maybe she is not getting...you know...

Researcher: In a different way, I've seen that in the past with some of other self-funders that I've done, not with you, with the other care managers, that the promotion of independence is a bit less than with social services patients. Because they tend to say 'The family is going to find a place and that place is ready. So they can go'. So in a way they, as you said, they know that they can get them out quicker.

CM: Yes, they can.

Researcher: What is a bit of a...Is not fair, isn't it?

CM: It's not, is it? No...

Researcher: Do you think that is something that reimbursement has created or is always been like that? I don't know if you worked before reimbursement?

CM: No, not directly doing hospital work, I didn't. I am sure it must have an effect, mustn't it? It must do. But I wasn't doing the work then so I can't say definitely.

Researcher: So from a care manager point of view, how would you have dealt with this case differently, if she wasn't self-funder?

CM: If she wasn't a self-funder?

Researcher: Yes...

CM: She would have gone to CRAM basically. She would have ended up going to an interim bed. So, I think, I don't know. I get a feeling they might well have moved her. She wouldn't have been suitable for rehabilitation in a residential home because she wasn't that.... So it would have been up to the ward whether or not they put her onto a rehabilitation ward. If they had done that, from there, if she had progressed maybe we would have looked at a rehabilitation residential home. But if they had said 'No, we want...she needs to go now, she is not suitable to go there', we would have looked at it. She would have probably gone to an interim bed. I would have applied to CRAM for funding. I can't imagine that would have come through straight away... And then the family would have obviously less time to look where there are vacancies and whether they [those homes] will take the local authority funding.

Researcher: So interim bed. Is that what you are saying, she would have gone to an interim bed first?

CM: She would have probably gone to an interim bed first and waiting for funding to move. Yes, yes...

Researcher: Is 'waiting for funding', waiting for the local authority to approve it or just waiting for the people to find a home that accepts...?

CM: They (the local authority) probably would have approved it in principle. But not actually released the money.

Researcher: Ah, OK.

CM: They would so that like if they go somewhere like if it was nursing and wait for the funding to be released and once it's released...

Researcher: I haven't heard of that before...

CM: Oh, haven't you heard that? Yes, yes...

Researcher: [Laughs] So it's like 'in principle'...

CM: You get your thing back from CRAM to say agreed in principle for her to go to interim until funding is actually released.

Researcher: Because people pay even if they are social services funded. They pay for the interim bed, don't they?

CM: Oh, Yes, yes.

Researcher: You get charged anyway so I did never understand why they had to go to CRAM. Is it because of that 'in principle funding'?

CM: It's all on different budgets, isn't it?

Researcher: Yes. I know. So have you ever had a case where a self-funder has gone to an interim bed?

CM: They can't...

Researcher: They can't.

CM: I once did and not realising she was a self-funder and I had to move her out when I realised.

Researcher: Oh, I remember you telling me that...

CM: I had to move her out. Which was a bit embarrassing really. So I've learned my lesson. So they can't, they have to pay. Well they've got to go somewhere. Because I kind of think in some ways an interim bed is a good idea if somebody is not sure just to get an idea of what care is like. Do you know what I mean? They may think 'Oh, I want to go home'. But if they want to do that, they are still going to have to pay for a trial stay, wherever they choose.

Researcher: It's the same thing. It's an interim bed that you can contract anywhere people can contract... Because it says in the policy 'nobody should make the decision to go into care directly from hospital' and that's one of the excuses social services use to transfer people into interim directly and they say 'You shouldn't make that decision because it is a life changing decision'. But then, obviously, that doesn't apply to self funders. That again is unfair isn't it?

CM: Yes, yes

Researcher: Last bit, discharge coordinator. In this case I couldn't find anybody from the hospital that felt they actually coordinated the discharge. This has happened to me before but never so clearly as in this one. I think it was because the self funders I have had in the past were in

another ward where the whole discharge planning is slower because it's a slower ward where patients stay for weeks and weeks and weeks. And I think people, maybe the sisters, get to know them better and everything. But she went on a Friday, I went to the MDT on a Tuesday and Redgate Nursing Home said they were already going to have her but they had to come to assess her. So at that point I started ringing the ward to see when she was going and... I think it was the ward clerk that said 'She was going to go today but she can't go because the daughter felt that we were rushing her out of the hospital'. So nobody knew what was happening to the point that I went on a Thursday night and it was sister Pam and sister Sally because they were talking ...and I was asking if they knew what was happening? And they were asking me 'Do you know if she is going?' [Both laugh together]

CM: Right...

Researcher: It was quite funny [laughs]. I was like 'No'.

CM: Hadn't they arranged the transport?

Researcher: Well, the ambulance was booked ages ago but still they had these messages about the family not being happy. But there was nobody that was talking to the family, and discharge liaison was not talking to the family. For me, I had the impression in this case... So then I went Friday morning and the ward clerk said 'Oh, She's going. The daughters rang me this morning I've booked the ambulance and she's definitely going today'. But there was nobody with knowledge of the patient that was dealing with this. If there was any anxiety with the family... Obviously you did your assessment once you gave them the list is that the end of your involvement?

CM: That's it really, yes. Unless anything goes on, or they want advice or... But generally that's it, yes.

Researcher: Are you not the one who calls them [the ward] to say she is going this day or the other day? Or do you leave the family to do it?

CM: I normally hope the ward will at least phone me to say 'This is the day she's going'. But if they don't...

Researcher: What about discharge liaison, would they be involved?

CM: Only if the family were blocking it [the bed] for too long. If the family was saying there was a problem. I am surprised if the family was saying there was a problem they didn't get involved actually...Because they were wanting her off the ward. That's normally when they come and they talk to the family and say 'What's the problem? Well this is what we have done...' And they explain the process they have gone through, from the hospital point of view to get to...

Researcher: I asked the ward sister about it. A couple of days ago I rang her and said, look can you explain to me, why has this happened? And she actually said 'Well, She hasn't really been a real problem. She ended up going'. So, I suppose if the family ends up negotiating a couple of days, that's acceptable isn't it?

CM: Yes.

Researcher: Nobody questions it and that's it. I suppose if they'd say 'She's not going' or it's not happening they will involve discharge liaison.

CM: Yes.

Researcher: OK, so you don't really normally tend to be the active discharge coordinator with the self-funders. Will you be it with the social services clients? Yes, you will. You will ring them...

CM: With social services clients? Yes. We dictate really, more or less, as long as they get home. We go and say 'Yes'. Then, we just check we have got the paperwork all done but...

Researcher: But you will ring them and say 'She's going this day' or whatever...

CM: Yes...But even then, sometimes if the home have gone to assess, they will go. Well, they (care establishment) have done the assessment and say 'Yes, she can come tomorrow'. And the ward don't always tell you.

Researcher: So the nursing home matron will tell the ward...

CM: Just say direct. As long as they know we've had funding. So sometimes, it depends who is on duty. Sometimes, you get a call to say...Another time you phone in to say 'When is she going?' 'Oh, she went this morning!'

Researcher: Have you ever sent somebody that is social services funded into a home directly now or do they always go through interim?

CM: Emm...I think I had...I don't think. Has anybody gone direct? [silence] I don't know... Nursing homes are more likely to...

Researcher: Is that because there are more vacancies in nursing homes?

CM: Yes, yes...But I can't think of the top of my head who, to be honest... So maybe, I haven't. You know what I mean? Oh, I don't know...I can't think of anybody...

Researcher: Is it more like an automatic process? You think "Oh, he needs to go into care: interim"...

CM: Yes.

Researcher: When I was working before the policy (I worked before and after reimbursement). And when I was working before reimbursement the process was to look at the vacancy list of the homes that accept local authority fees and then transfer them direct in to there. But I think that practice has changed, hasn't it? You just go 'interim' and then...

CM: Yes, when the funding is released, family then get a list of where there are vacancies. Warned them obviously about top ups and things and it is up to them to decide...

Researcher: Reviews, my last question.

CM: Reviews.

Researcher: With this lady would you do a review after two weeks?

CM: No, she is self-funding.

Researcher: She is a self-funder, so you don't have to...

CM: Close it down. If I hadn't been so stuffed out, it would have been closed by now

Researcher: Is it because she is self-funder and goes into a home? Because if she was going home you would review it, no?

CM: No, not necessarily. If they do go home, sometimes I might give her a call just to say 'Are you OK and are you definitely managing?' But we don't do reviews or anything, no.

Researcher: No. Is that something that comes from them [management] or is it something that you decide personally?

CM: What about?

Researcher: The review. Because I had another self-funder that the care manager was reviewing...

CM: There is no need. There is no service that we are paying for. So what is it to review? There is nothing to review. The only thing I may do is make a courtesy phone call.

Researcher: To see if they are happy...

CM: Yes or they may want... I always check with them did they want day care or did they need help with claiming attendance. So I don't mind, I go and do that kind of thing. But even with homecare, you see. Like, I have a chap going home today with two visits [of homecare] a day. Yes, he is self-funding but we still do pay a little bit towards that. So we are..., we did a contract and everything.

Researcher: That's what I thought. Maybe with homecare you are a bit more...

CM: Yes, so with that yes, I will have to review. Because they are paying the bulk of it, because he's got money, we are still paying contribution...

Researcher: And you are using an agency that is contracted through social services, isn't it? I suppose it would be different if it was a self-funder that decided to go...

CM: And they don't want...We don't need to be involved. We'll just sort it. That's it. Fine you do that and we just close it down.

Researcher: What happens if this lady? Sorry, still at the review. Because I had a case, he was a self-funder. He went from the ward to a nursing home. And the daughter was working in this GP surgery and I think, she was involving the care manager all the time although he was self-funder. And what happened at the review that gentleman actually wasn't nursing anymore, he was residential.

CM: Oh right...

Researcher: And the care manager was wondering about, you know, what do you do? Because in a way what I can see in the case of the self-funders is the fact that nobody advocates for their financial...I don't think it will happen with this lady, because she was very dependent. But, you know when sometimes, you are not very sure if they are nursing or residential and it can

Researcher: Have you ever sent somebody that is social services funded into a home directly now or do they always go through interim?

CM: Emm...I think I had...I don't think. Has anybody gone direct? [silence] I don't know... Nursing homes are more likely to...

Researcher: Is that because there are more vacancies in nursing homes?

CM: Yes, yes...But I can't think of the top of my head who, to be honest... So maybe, I haven't. You know what I mean? Oh, I don't know...I can't think of anybody...

Researcher: Is it more like an automatic process? You think "Oh, he needs to go into care: interim"...

CM: Yes.

Researcher: When I was working before the policy (I worked before and after reimbursement). And when I was working before reimbursement the process was to look at the vacancy list of the homes that accept local authority fees and then transfer them direct in to there. But I think that practice has changed, hasn't it? You just go 'interim' and then...

CM: Yes, when the funding is released, family then get a list of where there are vacancies. Warned them obviously about top ups and things and it is up to them to decide...

Researcher: Reviews, my last question.

CM: Reviews.

Researcher: With this lady would you do a review after two weeks?

CM: No, she is self-funding.

Researcher: She is a self-funder, so you don't have to...

CM: Close it down. If I hadn't been so stuffed out, it would have been closed by now

Researcher: Is it because she is self-funder and goes into a home? Because if she was going home you would review it, no?

CM: No, not necessarily. If they do go home, sometimes I might give her a call just to say 'Are you OK and are you definitely managing?' But we don't do reviews or anything, no.

Researcher: No. Is that something that comes from them [management] or is it something that you decide personally?

CM: What about?

Researcher: The review. Because I had another self-funder that the care manager was reviewing...

CM: There is no need. There is no service that we are paying for. So what is it to review? There is nothing to review. The only thing I may do is make a courtesy phone call.

Researcher: To see if they are happy...

CM: Yes or they may want... I always check with them did they want day care or did they need help with claiming attendance. So I don't mind, I go and do that kind of thing. But even with homecare, you see. Like, I have a chap going home today with two visits [of homecare] a day. Yes, he is self-funding but we still do pay a little bit towards that. So we are..., we did a contract and everything.

Researcher: That's what I thought. Maybe with homecare you are a bit more...

CM: Yes, so with that yes, I will have to review. Because they are paying the bulk of it, because he's got money, we are still paying contribution...

Researcher: And you are using an agency that is contracted through social services, isn't it? I suppose it would be different if it was a self-funder that decided to go...

CM: And they don't want...We don't need to be involved. We'll just sort it. That's it. Fine you do that and we just close it down.

Researcher: What happens if this lady? Sorry, still at the review. Because I had a case, he was a self-funder. He went from the ward to a nursing home. And the daughter was working in this GP surgery and I think, she was involving the care manager all the time although he was self-funder. And what happened at the review that gentleman actually wasn't nursing anymore, he was residential.

CM: Oh right...

Researcher: And the care manager was wondering about, you know, what do you do? Because in a way what I can see in the case of the self-funders is the fact that nobody advocates for their financial...I don't think it will happen with this lady, because she was very dependent. But, you know when sometimes, you are not very sure if they are nursing or residential and it can