

# Early medieval locks and keys in England and Scandinavia

Volume 2/2

Megan von Ackermann

PhD

University of York

Department of Archaeology

November, 2018

# Chapter 5 Locks and keys in Early Medieval Scandinavia: Birka

## 5.1 Introduction

The previous chapter used keys as a lens through which a greater understanding of the larger community could be inferred. Although a great deal of information about social structure and craft networks can be derived from the uncontexted data available through the PAS, a more complete picture can only be gained through the study of the objects within their communities. With this in mind, we begin with a brief discussion about the importance of locks and keys as carriers of cultural beliefs. Next, the broad theoretical setting in which this study was conducted is presented, discussing two central themes: gender, and the social contexts of mortuary construction. The identified difficulties and biases in artefact studies in general, and for locks and keys specifically in respect to these are examined, as well as a brief explanation of how these biases influenced the approach to data collection.

This is followed by the main case study, the trade centre of Birka, beginning with a discussion of the distribution of the type groups, identified in the previous chapter, of the keys found in Birka's cemeteries and settlement area, and how those distributions and types compare to sites in England and Northern Europe. The types and distribution of locks, and of boxes and caskets are then briefly discussed as this allows a better understanding of differences in construction methods and design choices seen in these objects.

The focus then turns to exploring the characteristics of graves containing locks and keys, how they compare with contemporary Scandinavian sites, and to what extent

they support traditional interpretations of their meaning. This includes an examination of the strength, extent, and nature of the connection between keys and gender, and a brief examination of other theories about key meaning in terms of identity, ritual practice, and ongoing interactions with (or responses to) the dead. In order to provide context for this section of the study, it is important to first establish the theoretical context in which it was carried out.

## 5.2 Locks and keys: belief, identity, and symbolism

The continued cultural investment in craft knowledge through the early Middle Ages indicates the importance placed on the ability to lock spaces, but the fact that there was an ongoing investment of scarce materials in lock and key construction is also significant for the deeper social meanings the objects may have carried. The consistent investment in not only sustaining but developing lock use and technology indicates that they could have been more than important practical objects, also being used to convey messages about status and identity and/or abstract symbolic concepts.

Early English texts give support to this idea. An analysis of 29 texts, including poetry, scripture, history, and narrative, found that locks, boxes, and keys are frequently used metaphorically, particularly in body-related metaphor. Hearts and minds are often literally locked, and the thoughts and feelings they contain are referred to as “hoards” (Christ III The Final Judgement, Cook 1900; Homelitic Fragments; Juliana, Bradley 1982). The body itself is a box containing life, blood, or soul. Weapons or illness act as keys, sometimes agents of plunder, sometimes of release (Elene, Kent 1891; Guthlac, Muir 1994; Juliana, Bradley 1982). Even Christ’s crucified body becomes both sanctuary and key in Christ I: “So the Prince of Angels, Dispenser of Life / locked you up behind him with his limb-key”. (Cook 1900, IV 9 v 10) There is also a consistent connection with knowledge and wisdom. Exeter riddle 42 twists the meaning of ‘lock’ so it is both the puzzle of the riddle and the secret knowledge of the riddler, while the key is the wit of the person who can guess the meaning:

*Hwylc þæs hordgates*

*cægan cræfte þa clamme onleac*

*Who can the hoard-gates unlock with the crafty key?*

*(Author’s translation)*

These usages, particularly the frequent combination with the idea of hoarding or protecting something precious so that it could be unlocked and distributed at the right moment to those who were deserving, emphasise the importance not just of locks but

specifically of locked boxes or chests. The role of locks in keeping the contents secure, and the importance of keys for the significant event of access is clear.

Not surprisingly, there is also evidence for the importance of the physical messaging of having and displaying a key. This begins in the Roman period where there are examples of decorative, or possibly amuletic, miniature keys (see figures 2.34 and 2.35, Chapter 2). However, as mentioned above, the practice was also well embedded in Germanic culture. Related object types are found in early medieval graves: key bundles in Scandinavia and girdle hangers in England (figures 5.1 and 5.2), and may also have been used in Merovingian Gaul (Steuer 1982). The fact that these objects share a reference but have such distinctive morphologies suggests that they have a common origin but diverged early enough to develop regional forms. This indicates that the cultural importance of keys, and particularly of highly visible keys, is deeply rooted. The assumption that both the role and the object types associated with it continued unchanged over such a significant period of time is considerable and should be used with caution. However, even more important is the question of what these objects actually meant both in belief and in practice, particularly when they are taken out of the recorded context of marriage, and placed in graves.

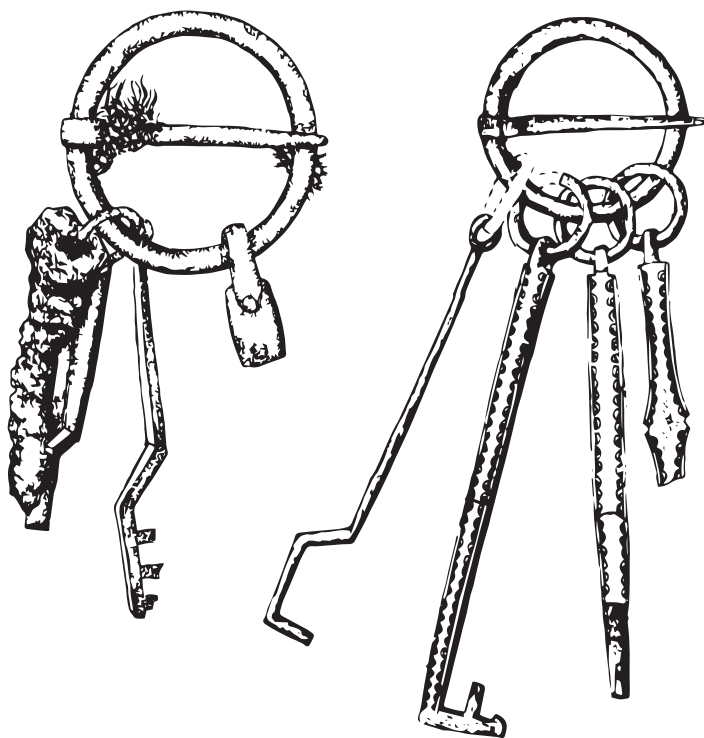

Figure 5.1 Migration era key bundles  
Bergen museum F77  
Drawing by Ellinor Hoff.



Figure 5.2 Girdle hangers  
British Museum 1893 0618

It is insufficient to suggest that an object contributes to identity construction without continuing to ask what that contribution consists of. Objects like brooches are recognised as containing messages of status and wealth, as well as possibly group allegiance, cultural sophistication, and/or family heritage. But objects like keys are more complex because of their multiple roles as tools, objects of display, symbols of authority, and possible carriers of

metaphorical or belief-based meanings and uses. This is particularly true when these objects are referential and symbolic rather than functional, a choice that sublimates the primary roles in preference for those of meaning and reference.

A housewife who had authority over the keys to secured valuables would, by carrying them, already clearly signal the messages central to that specific role and identity; for this purpose, the display objects are superfluous. The suggestion that key bundles and girdle hangers were made specifically for grave deposition as substitutes for the (valuable) household keys is contradicted by Karen Felder's work on girdle hangers (2012, 2015) which has shown that the objects very often had considerable sign of both wear and repair. It is possible that household keys were not normally worn and that therefore key bundles were used as a reference of symbolic authority over objects that were kept in common circulation. But there is both archaeological evidence showing that keys were often either worn suspended or kept in a girdle pouch (Owen-Crocker 2004), and literary evidence in Exeter Riddle 44, which describes a key as "hanging by a man's thigh":

*Wrætlic hongað bi weres þeo  
frea under sceate  
Glorious it hangs at a man's thigh  
under his cloak  
(author's translation)*

Another suggestion is that these non-functional objects had a use that referred to ideas about locking and unlocking without requiring a fully practical action. Possible contexts could include hospitality ("unlocking" the household for an honoured guest), knowledge exchange (referring to the idea of a "word hoard" referenced above), or birth or death events (unlocking the womb, unlocking the spirit from the body). In her examination of "Lady of the house" objects which she identifies as including textile tools and key bundles, Siv Kristoffersen (2004a, 296-97) discusses the possible cultic purposes of weaving swords, but does not examine how keys or key bundles may have also have such uses, instead suggesting that in graves they referred again quite simply to marriage.

Further (albeit negative) evidence for a possible belief-centred use for girdle hangers and key bundles is that during the middle Saxon period, discussed above as a time of expansion and shift in lock use and technology, these objects gradually disappear from grave assemblages. In England this may perhaps be interpreted in terms of the conversion to Christianity and shifts in ideology, but key bundles also disappear from grave constructions in Scandinavia (Kristoffersen 2004b). At the same time, the inclusion of functional keys in graves continued, which supports the idea that the two object types were connected but not identical in use and meaning and that they should not be conflated in interpretations of

assemblages until there is a greater understanding of the appearance and characteristics of keys in graves.

This includes a specific examination of whether there is a consistency in how keys are used. In their examination of the material culture (Sindbæk 2008) and burials (Svanberg 2003) of early medieval South Scandinavia, Søren Sindbæk and Fredrik Svanberg have discussed the marked diversity of the archaeological record. Sindbæk suggests that this diversity is evidence of underlying practices of group and individual identity construction, and that the characteristics of the diversity - showing clearly defined patterns, or blending and intermixing in various ways - suggests the ways in which people were negotiating social boundaries.

The nature, extent, and variation of the use of keys in the presentation of identity, particularly the female role of "Lady of the House" is, therefore, important to explore. If a strong and consistent connection can be demonstrated between keys and specific objects connected with female identity that provides an important and valuable point of reference for shared beliefs. Such a widely shared material practice is evidence of an equally widely shared set of social practices that underlie it, relating to the range of economic, social, even political activities that are supposed to be connected to the use of keys in the management and distribution of household goods. If, however, there is evidence for diversity in key use and appearance, it allows an opportunity to look for patterns that may suggest connections that are otherwise invisible. The proto-town of Birka is particularly well suited for just this sort of study.

## 5.3 Central themes and considerations

### 5.3.1 Gender in the study of objects in mortuary settings

The question of gender in relation to keys is of primary concern in this study. It is necessary to have an accurate understanding of how gender identities may have been related to or even expressed through the use of keys in grave assemblages. But the ability to achieve that understanding is necessarily limited not only by the available material evidence, but also by archaeological theoretical approaches to gender as it is expressed in that evidence. Therefore we now need to discuss the theories that have informed this study. Gender and biological sex are among the primary questions asked of grave constructions, but the process of finding answers is complicated not only by the fungibility of gender identity and its expression in the material record, but by the theories and ideologies about gender, sex, and identity that inform the research.

The importance to archaeology of the recognition that gender and gender constructions can be distinct from biological sex, and the understanding that gender is complicated, fluid, and multivalent, affected by social, cultural, and psychological factors is the subject of ongoing discussion (CF Whelan 1991, Arnold and Wicker 2001, Gilchrist 2012, Sørensen 2013). Navigating these complexities in practice in relation to objects also continues to be problematic. Not only is it difficult to recognise and avoid bias resulting from modern ideas about gender identity, Viking Age archaeology has the additional problem of a set of inherited assumptions about how objects are linked to gender roles, some of which have an ideological motivation underlying them (Arwill-Nordbladh 1991, 51-64). This has resulted in a largely binary view of gender with strictly defined social roles, a view that has been difficult to challenge.

This is illustrated by responses to an article (Hedenstierna-Jonson et al. 2017) announcing that osteological and genetic tests on remains from Birka grave 581 show that the individual was female. The rich assemblage in the burial contained objects considered distinctly, even exclusively male, including weapons, a set of game pieces, and the remains of two horses (figures 5.3, 5.4). Judith Jesch (2017) responded particularly strongly, challenging the way that the osteological analysis was presented, suggesting that the association of bones to grave numbers may have become muddled in the decades since the excavation, and implying that the authors of the study may have already been convinced of the results before carrying out the tests.

Her final, and most relevant point is that there are other explanations for the nature of this assemblage, a criticism that the authors fail to address in their an article expanding on their interpretation of the genomic findings (Price et al 2019). The authors specifically and clearly state that care should be taken in assuming that grave goods are the possessions or representations of the dead (191), but throughout the article they continually conflate objects with identity. They not only repeatedly map social roles on to object types but also assume a one-to-one relationship between identity and object: weapons are used by warriors, game pieces are associated with military leaders (184). In doing so they appear to take the use that archaeologists have traditionally made of burial assemblages (to understand and interpret the identity of the dead) and assign it as the intention behind their construction.

What's more, they suggest that objects not only express identity, they have the ability to create it. While admitting that the woman in BJ581 could have had a number of non-warrior roles and identities, they assert that the inclusion of weapons in the burial was both intended and able to override her own biography and construct instead what they term a "proxy identity" (192). In their interpretation, whatever this woman was in life, her association with weapons in death made her a warrior, and only a warrior. By assuming that the grave assemblage has the single purpose of either expressing or creating a single,

204

role-based identity, this interpretation has the unintended effect of elevating traditional archaeological ideas about objects above other, more nuanced considerations. By ignoring the possibility that objects in burials, singly and as an assemblage, could serve multiple

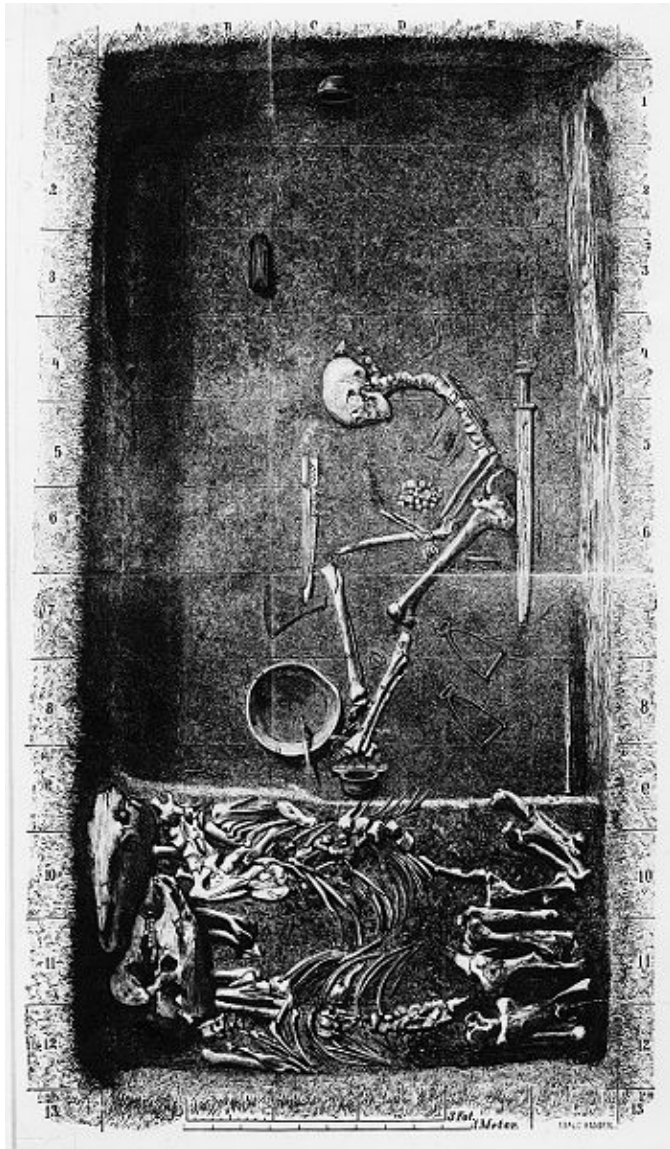

Figure 5.3 (left) Birka grave 581. Evald Hansen based on the original plan by excavator Hjalmar Stolpe, 1889. Historiska. Figure 5.4 (right) Reconstruction of BJ581. Neil Pierce 2017.

purposes, this study not only fails to challenge simplistic ideas of gender-object association, it tends to reinforce them.

Yet a basic examination of the strict assignment of gender associations to object types against what is known about some practices of Scandinavian people produces obvious problems. If many Viking Age men spent several months a year on expeditions away from their farmsteads, how were gender restricted tasks carried out at home? Were young boys and old men pressed into service to perform necessary tasks even if they lacked the experience, skill, or strength? And on these voyages, were men unable or unwilling to use their own textile tools to mend clothing and sails? Clearly in practice there would be a sharing of tasks and of knowledge, and there could not have been a sense of taboo when



the appropriate tools were used as needed. A visible gendered pattern of tool inclusion in graves, therefore, should not be taken as evidence of cultural beliefs about restricted gender roles in the living community.

This is particularly true because, as with the archaeological use of categorical groups, a circular pattern can develop with the use of objects in the identification of gender. Cultural and logical assumptions inform the original associations which are then reinforced as new studies rely on existing work and statistics, resulting in a biased record that can easily imply a stronger correlation than actually exists.

The argument for the preferential use of object-derived gender identification was clearly articulated by Mary Whelan (1991) who posited that the practice was necessary in order to maintain the distinction between gender and sex. She also referred to a 1972 study (Weiss) that showed that, when dealing with poorly preserved remains, researchers tended to misidentify female skeletons as male over 10% of the time, implying that in cases of juveniles, or where remains are fragmentary or significantly damaged, object-based gender identification may be the only option, a concept that somewhat diminishes the first point as it assumes gender can identify sex. Further, the use of objects to identify gender often has the practical effect of reinforcing the impression that 'male' is the default identification and that women have to be made present through objects. Because there are a limited number of objects that are considered 'female' (generally jewellery and textile tools), female identity, agency, and presence is similarly limited. It becomes, in fact, a literal objectification of women.

The emphasis on both gender and biological sex produces another problem in mortuary research. Because it is of such primary concern to archaeologists, there is a tendency for the question to act as a lens, creating a focus on the material evidence as though gender were the direct and primary factor in the characteristics of the grave, as opposed to treating it as a derived identification from associated, but not necessarily directly correlated, factors. This focus can perhaps be seen in Sam Lucy's (1998) exploration of the grave constructions with objects that contradict the biological sex, or containing both male and female objects. She suggests that this may reflect the concept of plural genders in the communities. But it is equally possible that these conflicting object associations could be a reflection of lax or flexible role assignments, or unusual, but socially acceptable, practices. A female skeleton with a spear in her assemblage may simply have been identified within her community as a woman who used a spear, either as a weapon or with some other function (Gardela 2013), rather than a person of a third gender. And of course, these possibilities aren't exclusive, but could both have been factors for different graves.

It is also unusual for a researcher to suggest that objects generally considered to be gender-associated might have additional uses or meanings in graves that do not carry gender associations and that may, therefore, appear in contexts that contradict

archaeological expectations. Instead the effort is to explain the anomaly in a way that aligns the object with received understanding. This can go to the lengths of suggesting the original presence of an additional burial, now entirely missing, of the appropriate gender (Grøn et al. 1994, 120–121, 136, Androshchuk 2005). But an object that had been owned by a woman may, for example, be used as a memento or a method of creating physical connection between that woman and a deceased man. Its appearance in the grave with a male neither masculinises the object nor feminises the man because the intention makes an alternate meaning prominent. It is important to note that, as stated above, other understandings remain active in the use of the object but are reshaped in their interpretation, just as they shape the interpretation of the salient meaning in this context. The femininity of the object adds poignancy to its use in the male grave.

This view maintains a balance in agentive power between the object and the individual, recognising that each may have the ability to create and shape identity in the other. It does not assume that the association with an object can impose a gender identity on the person who owns or interacts with it, a view that is implied in the tendency to insist on high conformity in a supposedly gendered object. Instead it supposes that these objects, loaded with pre-existing cultural conceptions, navigate individual relationships with those who own and use them, neither one dictating the gender assignment of the other, but instead adding nuance and colour to it. These new identifiers are additional to the already existing identities, interacting with them without necessarily negating them even when there are elements that are contradictory.

Although there is still considerable use of the approach, there are a number of studies that are trying to challenge the gender-centric identification of different object types. Evidence for female burials containing weapons is leading to a re-evaluation of the assumption that these objects were reserved for males (Jesch 1991, McLeod 2011, Gardela 2013, Hedenstierna-Jonson et al 2017). Joanne O'Sullivan (2015, 78) has shown evidence for a masculine practice of multiple bead use, and makes the important point that beads were neither necessary for the indication of masculine identity nor contradictory to it. This clarifies the idea that the gender associations of objects should not be considered fixed, but that the possible fluidity of identity that is recognised for people should also be recognised in objects. But the interpretation of the archaeological evidence of such fluidity remains contentious for many object types .

Harris et al's (2017) recent examination of a furnished Norse burial in Scotland deliberately avoids making any gender identification on the basis of objects, although the grave goods are consistent with traditional masculine classifications. Instead they use objects to discuss identity more broadly, evoking activities suggested by tools, a cooking pan, and a fire lighter. They discuss the materialisation of networked connections both in characteristics of grave construction, and in the setting within the landscape. In doing

this they allow a broader consideration of the implications of intentionality in the choices involved in planning, constructing, and living with the grave.

This approach may go some way to help mitigate ongoing issues that persist in gender research, a field that is still heavily influenced by inherited ideas about historic and prehistoric gender identities and norms. As discussed in Chapter 3, it has been recognised that efforts to support political and social goals, notably for Viking Age research in the 19th century (Arwill-Nordbladh 1991, 51-64), produced abstract archetypes that were considered appropriate for the idealised gender roles constructed by and for the contemporary society. Additionally, in interpretive writing there is often an uneasy combination of the projection of modern understandings of labour division and gender roles onto the past (Conkey and Spector 1984; Wylie 1991) and an inferred set of cultural differences that often assume less flexibility and nuance than are known and accepted in current cultures.

This ignores the difference between received concepts and enacted concepts, between the understood beliefs and the practice of those beliefs. Conceptual taboos are subject to subversion by a variety of exceptions - exception of person, exception of context, and exception of audience, any of which may allow a necessary flexibility and heterogeneity. Without a recognition of this possibility, interpretation of the physical evidence often leads to overly simplified ideas of object significance. The interpretation of keys as signalling the unspecific social role of 'housewife', for example, is often repeated without discussion of what that role might mean.

More subtly, and perhaps more insidiously, this over simplification is tinged with an unintentional implication that female roles and objects are not only exclusive to women, but that their feminine association is a contamination that makes them socially taboo for males. When a traditionally assigned female key occurs in a clearly male grave construct, it is explained away as an accidental inclusion in preference to considering that not only would men regularly use keys in their daily lives, but also there is a possibility that there was a particular aspect of the key use that had symbolic significance that prompted its inclusion in the grave (see for example Svanberg 2003, 64).

This problem stems perhaps not only from an over-reliance on modern understanding of social norms, but also on the disconnect between the questions asked by researchers of the archaeological evidence, and the intentions of the people who created that evidence. This is most clearly seen in grave constructions, both because they provide the greatest wealth of concentrated material evidence, and because they represent discrete and deliberate actions of object association. However, the two questions that archaeologists most commonly apply to cemetery data are not, arguably, issues that concerned the communities who built the graves: chronological dating, and gender identity.

Unlike many modern cultures, who traditionally record and display exact dates of death, there is no indication that Viking Age people had such concerns. Certainly on

surviving memorial stones (Zilmer 2005) inscriptions focus on genealogy, character traits, and major biographical events. This corroborates later evidence from the sagas where it is the family line of the main characters that is important, providing both a chronology and a shorthand explanation of the network of loyalties and bonds that exist within the community. Dates, therefore, appear to have been relative rather than universal, acquiring meaning from the people and events that provide anchor points of reference.

This point may seem overly simplistic, but it is, I feel, still worth reiterating. Research questions that look for precise dating evidence both for artefact seriation and for settlement or cemetery chronologies are approaching the data in a way that is disconnected from the concerns of the community itself. This is not of itself problematic, but it has the effect of exaggerating the importance of dating information in comparison with other information available. It also leads to a tendency to ignore observed anachronisms and anomalies in pursuit of a confident and consistent date.

A more difficult issue is the question of gender identification. As discussed above, there is already the problem of modern bias and imposed interpretation, but I believe it is worth asking whether, in creating a grave assemblage, gender identification was a consideration. That is not to say that gender was unimportant or did not have an influence on identity construction, but it seems worthwhile to point out that not only was that identity, like the genealogical information, already part of the context for the construction, but that the focus of the grave, the body, was likely sufficient to establish that identity, and assemblage objects were an elaboration on that already recognised base.

This is particularly important when dealing with graves that appear to violate gender norm rules as understood through interpretation of the archaeological record as alluded to above. There are numerous graves that contain both 'male' and 'female' objects in the same assemblage, or that have 'gendered' objects found with remains that have been osteologically identified as the opposite sex like Birka 581. These graves have at times been variously explained as examples of exceptional curatorial behaviour (Edwards 1998 14-17), unidentified double graves (Lauritsen and Hansen 2012) or even as deviant graves that are constructed around an individual who violated cultural rules with or without the tacit acceptance of the community (Sandquist 2012, 20). These explanations may all be applicable to individual instances, but together are still insufficient to explain the total number of anomalous assemblages.

Part of the difficulty may arise from the application of gender rules expressed in post-conversion written evidence, such as the Gragas prohibition against women dressing as men or carrying male weapons (Dennis et al 1980), or the episode in *Laxdaela* saga where a woman contrives her own divorce by having her husband wear an 'effeminate' shirt (Magnusson 1969). Not only is it unclear to what extent these taboos were also found in the pre-Christian communities, it is not reasonable to broadly apply those restrictions to

all objects assumed by researchers to be gendered. In the case of the 'effeminate' shirt, for example, the garment was male, not something that a woman would wear. It was the cut of the shirt that changed its gendering, not the type of object.

Of course, some objects were strongly associated with gender; artefacts that relate to and are a functioning part of styles of dress, such as oval brooches, are an obvious example. Role-related objects, such as tools, are more problematic. There is a sharp difference between tools that were normally used by one gender or another and tools that were culturally restricted to one gender or another. Assuming that a male grave containing textile implements is 'deviant' applies a value judgement derived from contemporary, post-conversion understanding that may or may not be relevant, and brings up the question of why such deviant graves often do not otherwise exhibit other evidence of social rejection or censure.

### 5.3.2 Intention and purpose of objects used in the funeral process

It is reasonable to assume that because cemeteries were often a significant and prominent part of the community landscape, burials were constructed to contribute to that landscape. Birka's densest cemetery areas were closely associated with the settlement, with some early burials even incorporated into the defensive walls. Kalmring et al (2017) have identified what they suggest is an important harbour northeast of the Black Earth, which would mean that the approach to the settlement was sometimes through the largest of these cemetery areas (map 5.1). This mirrors Kaupang, which was approached by land through a long cemetery field (Skre (2007a) and may have also had significant burial markers visible from the sea approaches (map 5. 2).

This association between burial grounds and roads leading to or past settlements is recognised as significant, one that has been argued to be a means of establishing and expressing a relationship with the landscape that is anchored in the past (Bukkemoen 2008). This relationship is complex, and arguably is not limited to simple ownership but extends into a sense of control over both the landscape and the actions of the people who transition through it (Lund 2009, 231). Both literary and archaeological evidence suggests that the dead were not seen as passive, but had agency (Price 2002, 168-169; Eriksen 2019, 219) and the construction of burials as well as their placement was likely an essential part of establishing a desirable relationship between the living, the dead, and the landscape. Assemblages in these burials are arguably, therefore, unlikely to be deviant in relation to accepted social norms of their makers. Instead that deviance may be in that their failure to conform to our expectations as researchers.



Map 5.1 Relationship of cemetery areas, settlement, and access routes at Birka

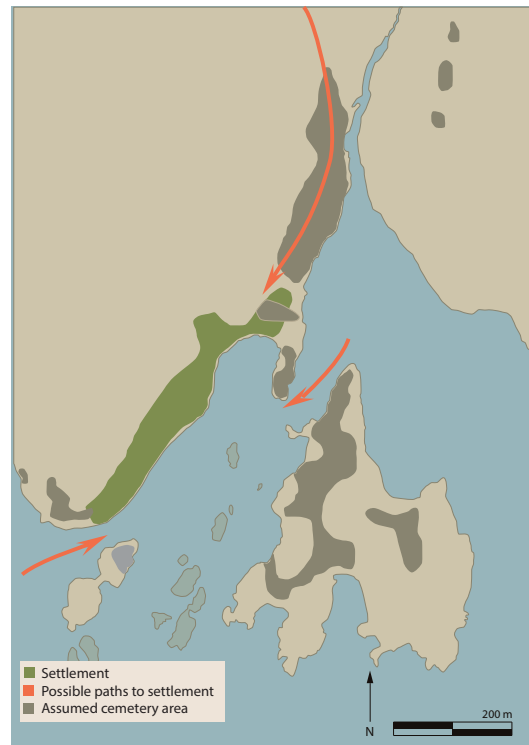

Map 5.2 Relationship of cemetery areas, settlement, and access routes at Kaupang

Studies in social psychology have suggested that when faced with mortality reminders, people become more conservative in their own identity expression and in their tolerance for the expressions of others (cf Solomon et al 1991). This includes a reinforcement of in-group association and out-group rejection, meaning that individual reaction tends to be echoed in group behaviours. In a context of high mortality salience, a group will adhere more strongly to cultural norms, a tendency that is reinforced by the fact that grave construction is a public performance that is socially and emotionally significant, adding multiple objective and subjective pressures for conformity (Morris et al., 2015; although see Burke et al 2010). Therefore, it seems reasonable to assert that grave constructions within accepted community cemetery settings are unlikely to violate normative ideas about identity construction and expression. Instead, those normative ideas provide parameters within which - or against which - the distortion of funerary expression exists.

There is also a range of acceptable construction variations within a community. Some of those variations may be only rarely accessed, under exceptional circumstances, but although unusual they still represent an appropriate response to those circumstances. Violent death, death in childbirth, or the death of a guest or stranger may all be unusual, but would still have occurred in the community's narrative history, if not in living memory, establishing the basis of a model for appropriate response. Similarly, people with exceptional biographies or status may be accorded burials that are outside of normal patterns but are still driven by community ideas about correctness.

To better understand the motives that may lay behind these expressions Heinrich Härke (2014) has produced a summary of the meanings most commonly suggested by archaeologists to explain the creation of grave assemblages. His list, in brief is:

1. Equipment for the afterlife
2. Inalienable property of the deceased
3. Potlatch or ostentatious display
4. Identity construction or expression
5. Biographical metaphor
6. Gifts to the deceased
7. Relicts of the funerary process
8. Disposal of polluted objects
9. Protection (of living, dead, or both)
10. Forgetting

Jeremy Huggett (1995) suggests a different schema where the primary motivations are based both on the relationship between those constructing the grave and the deceased, and on the shared belief systems that the living and the dead held about death and the afterlife (183). He then identifies five categories of what he terms stylistic aspects (table 5.1) which are either related to the larger group or are specific to the deceased individual.

Aspect	Description
Emblemic	group membership, community and kin identities
Assertive	individual identity or identities
Magico-religious	ideologies surrounding death and an afterlife
Intrusive	characteristics deriving from the group rather than from the deceased
Uncoordinated	unexplained features from peri- and post-burial activities

Table 5.1 Characteristics and motivations of grave constructions, Huggett (1993 183)

Härke’s list focuses on conscious, belief-based motivations, ideas that would have been openly expressed and shared. These are the answers that the communities themselves would, theoretically have provided if asked why a grave was being furnished. However, as he points out, these intentions are not singular. Instead cultural practice is a combination of many beliefs and motivations from which the most appropriate aspects are selected, given the conditions of a particular burial. Huggett’s model, on the other hand, does not look at specific beliefs but instead approaches belief generally and tries to classify the ways in which underlying conceptual structures are physicalised.

While both approaches have their strengths and can provide useful conceptual tools for examining the mortuary record, neither addresses the central point. This is that the foundational purpose of mortuary practice is to assist those who participate in them in processing the death of a community member. This process requires the renegotiation and re-imagining of relationships between that community and its members and the deceased (Giles 2017). This process is not culturally derived but is psychologically rooted. Research in the processes of bereavement indicates that grief is not something that is moved through but is instead a fundamental and permanent change of state that must be effectively incorporated into a newly formed reality (Rosenblatt 1996, Conant 1996, Kastenbaum 2012). The enactment of that need is culturally derived and may include apparently contradictory practices such as intentional forgetting or ritualistic effacement of identity (Taylor 1993).

For communities that practice commemoration, the process means the replacement of the living individual (Williams 2003). The identities of the living have both a locus and a focus in the embodied person and, by extension, in the landscape, objects, and people with whom they interact. After death that must be replaced with a new, constructed identity for which the grave may or may not act as the locus. The focus is then diffused, embodied in objects, graves, locations, and the narratives they represent. These physical anchors are time-travellers, carrying identity forward into the projected future of the community, and connecting that community with a commonly shared memory of the past. But they also provide a tangible centre that, through the physicality, creates a needed sense that the memory is equally tangible and therefore represents a shared reality. Memory creates identity for the living (Klein 2012) and the dead.

This sense of sharing is necessary because living identities are not singular, either in the understanding of the individual themselves, or in the experience of the community. Instead they are contextually derived, created relative to the relationships between individuals and the social setting in which interactions take place. Each person with whom an individual interacts consistently develops a sense of that individual's identity composed of factors such as their own relationship, the individual's position in the community, their particular skills or knowledge, and their physicality. The nature and composition of this perceived identity will shift over time. This plurality inevitably contains contradictions, which are possible to navigate because the perceived identity can continually be reinforced through interaction between individuals. Navigating the transition from a living, plural individual with a spectrum of identities to a memory of that individual whose identities must be both created and actualised through a physical process, either built or enacted is, therefore, complex and emotionally charged (figures 5.5 a, b, c below).

Further, different conditions of both the biography of the individual and the circumstances surrounding the death and funeral may have required different approaches



1 Sustained interaction with an individual, involving consistent contact over extended time produces a complex image of their social identity. Changes to this image happen gradually, but can be abrupt in moments of punctuated narrative (A) that are unusual or exceptional. These moments can produce narrative threads that persist through time (B).

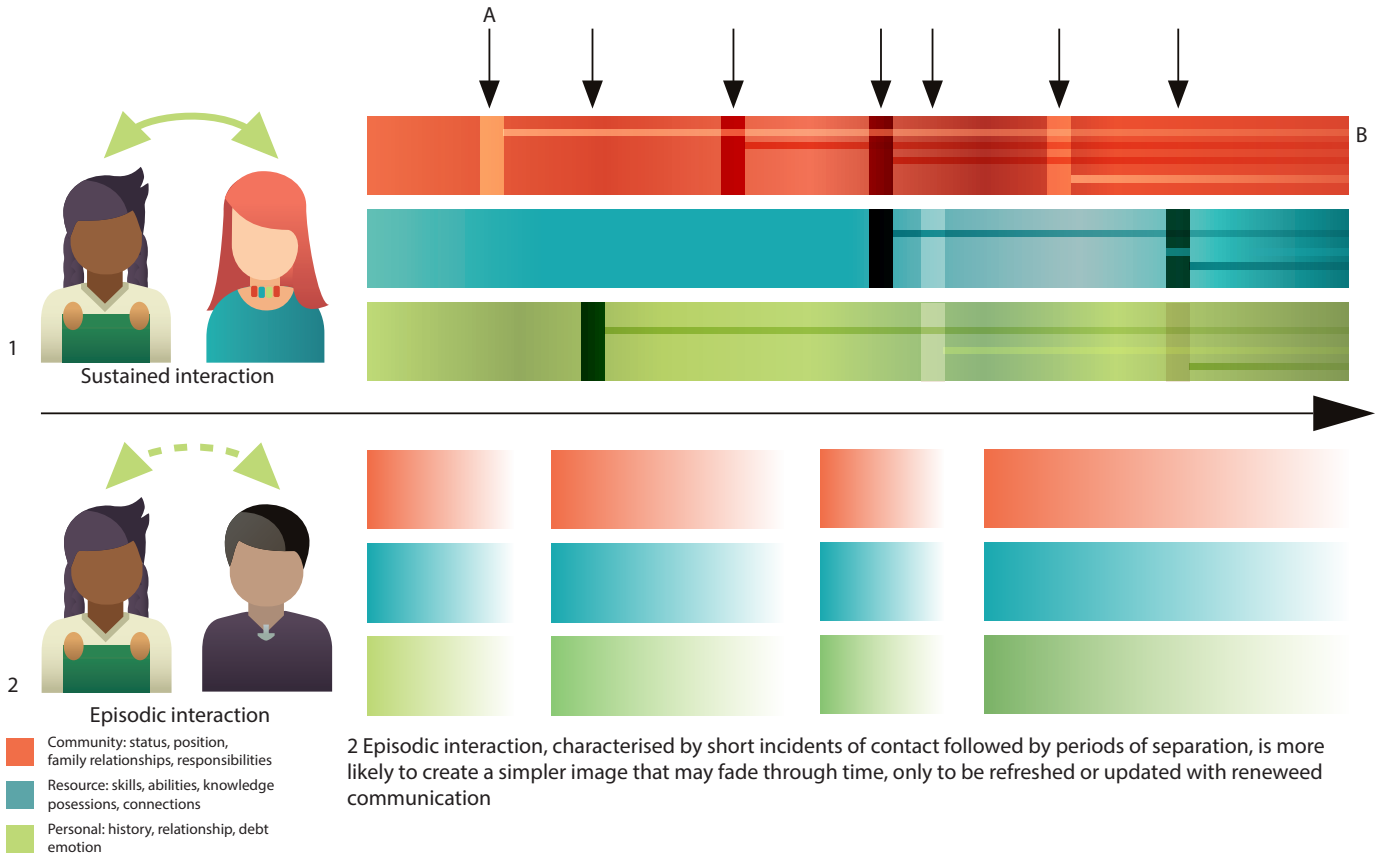

2 Episodic interaction, characterised by short incidents of contact followed by periods of separation, is more likely to create a simpler image that may fade through time, only to be refreshed or updated with renewed communication

### Social identity construction with living individuals

Figure 5.5a (above)  
Creation of a social identity concept over time

Figure 5.5b (below)  
Social identity concepts of an individual at a given moment in time

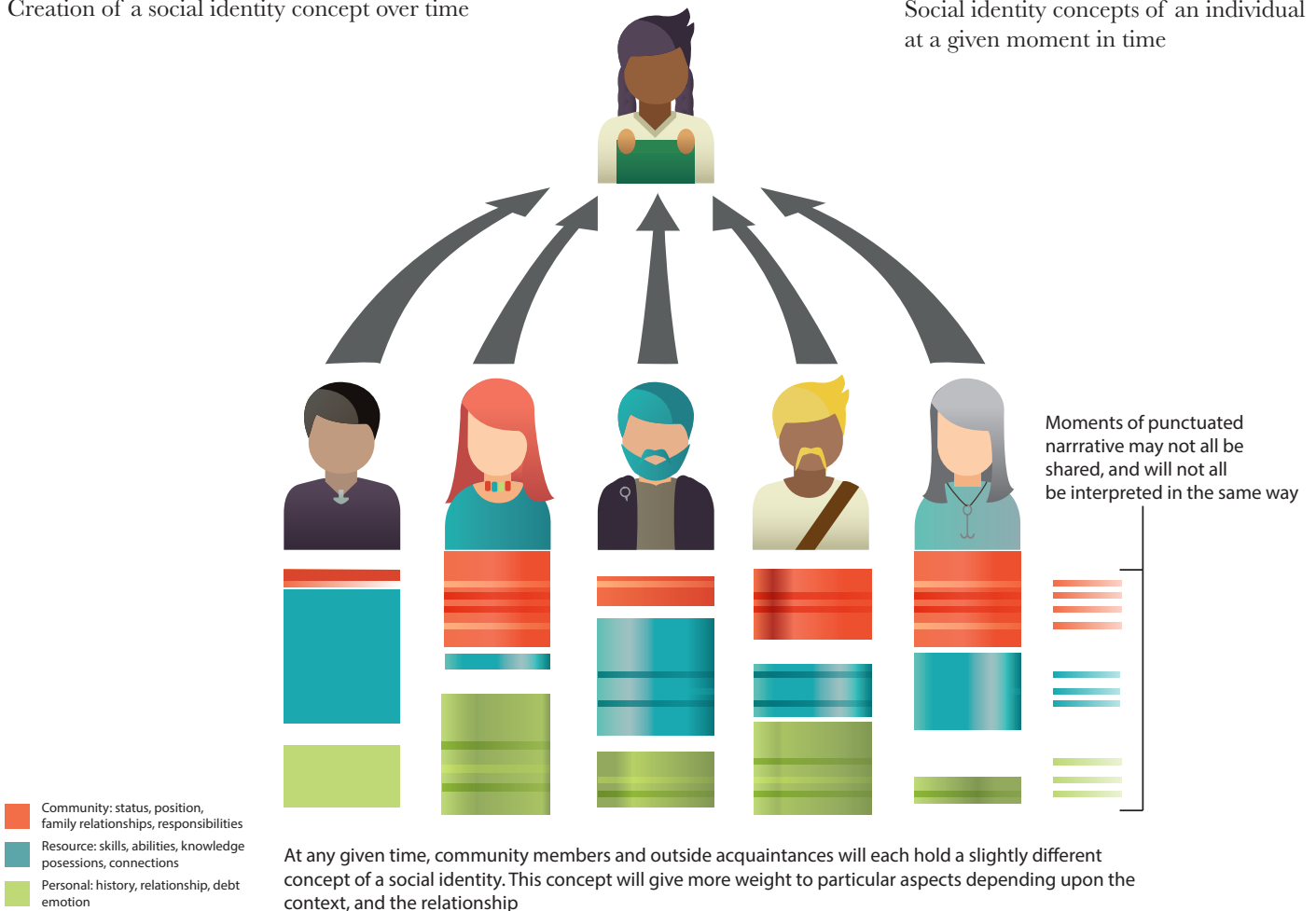

At any given time, community members and outside acquaintances will each hold a slightly different concept of a social identity. This concept will give more weight to particular aspects depending upon the context, and the relationship



### 5.5 c Creation of a communally shared social identity

to that navigation - maintaining more or less flexibility in the commonly created memory-identity. This is applicable to elites and non-elites alike: social influence, cultural trauma, exceptional circumstances in life or in death, all may contribute to an urge to maintain a certain amount of fungibility in that physicalised memory, including the opportunity, at need, to re-negotiate or re-write established norms.

The new, created identity is a communal construct and requires a certain amount of cooperation and agreement between community members. This is particularly true if the grave will be central to ongoing interaction with and performance of the new identity which will, at least in some part, be communal in nature. By necessity, therefore, that expression will be simplified and distilled, containing those elements that can be shared without conflict and that serve the needs of the community. Each individual will also have an independent internal memory-identity (figure 5.5c) which will be at least in part shaped by the communal memory as performed through narration and made material through the grave.

The need to successfully perform this relationship transition underpins the choices that are overtly informed by Härke's belief-based drives and shaped by the influences

identified by Huggett. The resulting construction carries a heavy ideological and psychological load, needing to successfully satisfy the complex, interwoven needs of the community as it incorporates the death into its relationships, and carries out the practices that are culturally required to appropriately and sufficiently acknowledge and negotiate that loss.

Mortuary activities, therefore, must not only be appropriate and effective, but also efficient. The unavoidable limitations of time, space, and material available with which to satisfy that ideological load mean that every element must contribute to the desired outcome. Because the inclusion of those elements requires a sacrifice in time or material on the part of the community, there may also be a preference to choose elements that can serve multiple purposes or invoke multiple meanings.

This leads to the relatively simple premise that every object in an assemblage is necessary to the purposes of that assemblage, and that the assemblage itself is sufficient for fulfilling that purpose. Every grave, therefore, theoretically represents the smallest possible investment necessary to satisfy the needs created by the context in which the death and the grave occurred. In other words, graves are constructed on a principle of parsimony.

An object placed in a grave is, in most circumstances, no longer available to the community as a practical resource for its original purpose. Even if the object is retrieved, it sustains a biographical shift (having left the living world and been interred), and acquires a different identity, although the difference may be one of quality or scale. They are, however, for the most part denied to the living community as usable objects. Therefore, any object represents an excess above need in the context of the possible return expected from that sacrifice.

The return could involve the satisfaction of spiritual or social needs or the processing of grief. But it could also be positively or negatively active. It may provision the active and interactive dead, or serve propitiatory or apotropaic purposes. Supplying necessary items to the dead may not only have allowed those dead a better afterlife, but gave them greater agency that might be to the benefit of the living community. Even the construction of a worthy and appropriate identity may provide greater status and security for the community both within their own living world and in the imagined world of the dead.

However, putting an object in the grave is not an end of its biography, instead it is a shift in its biographical category. It remains as an active, if unseen, presence in the community so long as the memory of the burial is continued. Ongoing interactions with burial assemblages, which could be destructive (Lia 2004, 302 from Lund 2013), subtractive, or additive (van Haperen 2010; Aspöck 2011) indicate that burials and the objects in them were not inert in the community landscape.

Given the assumption stated above of a principle of parsimony in grave construction, it is important to consider the implications of the existence of unfurnished graves, a form that is often omitted from statistical analysis. The relatively large number of such graves in early medieval cemeteries indicates that burial without any of the objects that regularly survive in the soil was, almost certainly, an acceptable, sufficient, and viable choice. Therefore, an unfurnished grave should be considered the 'null hypothesis' option, and each inclusion above that base state represents an additional active investment necessitated and justified by the context of the death.

There is surviving evidence of the inclusion of ephemeral goods such as food, as with the bread found in Birka grave BJ449. It is reasonable to assume that such objects were regularly included in graves and have simply not survived. It is also likely that ephemeral practices were part of the funeral, such as story-telling or singing as suggested by Neil Price (2010). However, it is arguable that some of the perceived sufficiency of practice in an unfurnished burial was the view that the presence of the body, whether cremated or inhumed, in itself satisfied the requirements of presence and identity in the absence of objects.

This is particularly germane when considering questions of characteristics such as age, gender, and sex. The people constructing graves were likely not principally concerned with demonstrating these features of the person being buried through the addition of objects, because those details were already well known to them and were established by the physical presence of the body itself, as mentioned above. In other words, although grave goods may have been used in part to express features of identity, the features being expressed were probably not primarily to do with characteristics inherently present in the body, as that was unnecessary. Instead that objectified identity is in addition to those characteristics (Table 5.2).

Embodied or persistent characteristics	Displayed or narrative characteristics
age	status
physical condition	knowledge/skills
appearance	relationships
biological sex	biography
gender (in cultures where gender and biological sex are tightly linked)	gender (in cultures where gender contradicts biological sex, or where it may be fluid and changed over time, in certain contexts, or through dress or object association)

Table 5.2 Embodied or persistent characteristics vs displayed or narrative characteristics

This may seem an obvious point to make, but since, as discussed above, archaeological research is often reversing this, asking as a primary concern whether objects

are linked to those common, embodied characteristics, it is worth emphasising. Although the observation that the dead do not bury themselves is self-evident, it is also true that the dead are an active presence in the burial and the construction and assemblage are shaped around and in reaction to them (Parker Pearson 1993; Williams 2004; Krmpotich et al 2010). Constructions and activities are, therefore inherently individual in nature in response to the individuality of the deceased, even when they may be restricted in physical expression by limited cultural norms. Support for this idea may possibly be found, if somewhat negatively, by burials where the body was not sufficient, and objects have apparently been added to make up for the lack.

The amount and stringency of restriction within the observed burial practice is also potentially important. In cultures with a highly prescribed mortuary tradition, such as that observed in late 20th century Japan (Fujii 1983), observable differences are likely to be in quality rather than in type and may be restricted in expression to only a subset of all required aspects. The type of object may be essential, but the material from which it is made can vary. For example an *ihai*, the memorial tablet essential in the enactment of memory in traditional Japanese mortuary practice, may be a relatively simple object of lacquered wood or an expensive, gilded, bespoke item (Irizarry 2014).

In contrast, in early medieval burials, which show such a relatively high rate of variation, it is arguable that this variation is itself an important and valued characteristic. This could be an indication of an awareness of and interest in maintaining the individuality of the deceased. It could also be evidence of the extension of living practice into the perceived world of the dead. Mike Parker Pearson (1993) has pointed out that the dead, and burials, have social value allowing for the manipulation of relationships, status, and position within the community. Literary evidence, although later than the period, indicates that the ability to create and exploit advantageous networks through the use of hospitality, gift exchange, and rhetoric was highly valued (cf Laxdaela saga). The flexibility afforded by the wide range of acceptable object and construction associations would allow the extension of that ability to funerary and mortuary activities and, possibly, enable the deceased to participate in this network creation in the afterlife.

Mel Giles (2017) has suggested that the inclusion in graves of objects that anticipate future action, such as whetstones which imply the need to sharpen knives and tools, can be taken as evidence of a cultural belief in the active dead: the dead as individuals with agency and perhaps an ongoing concern for the living. Those of the active dead who had, in life, been gifted in diplomacy and social negotiation may have been selected for grave constructions that would give them essential tools for continuing to use those skills on behalf of the community in a world of the dead that was parallel to and overlaid that of the living. In this case, the selection of objects would relate only indirectly to identity and biography and may be only tangentially indicative of status.

The dead may have also had the potential to be actively hostile to the living community. Draugrs appear in a number of sagas, including *Grettis saga*, *Landnámabók*, *Heimskringla*, and others. In these stories the revenant dead spread plague, kill people and animals, and cause insanity. An individual whose death or personality made them likely to become a draugr may have been buried with objects that could prevent that happening. Or the grave may need to be opened and objects added (Gardela 2013) or removed (Klevn 2016) to propitiate or destroy the malevolent dead.

In summary, the central concepts on which this study was based are:

- Although the gender identity of the deceased is an important aspect of the burial, the relationship between the objects in that burial and the gender identity is not necessarily strictly and absolutely defined.
- The motivations for the inclusion of objects are complex and there may have been multiple intentions and meanings involved in their use.
- These multiple meanings provided a necessary flexibility for the construction of burials that were incorporated into the shared community landscape.

## 5.4 Difficulties and challenges

### 5.4.1 Keys as object types

Some of these difficulties with understanding the significance of objects and their relationship with sex, gender, and social roles are particularly salient in studying keys. This is, in part, because of the previously mentioned traditional identification and associated ideological reduction of keys as serving as symbols of housewives. The uncritical acceptance of this idea has resulted in the use of their presence to confidently identify gender, sex, and social role, sometimes as the sole material evidence.

There are particular characteristics of keys that make their use for gender and role identification problematic, and that complicate some approaches to examining their appearance in the mortuary record. The first is that although they are considered highly gendered they do not comfortably conform to the characteristics of other similarly female gendered objects. These tend to be of two types: objects that are worn, such as oval brooches and other jewellery, and objects related to tasks like textile production, such as needles and needle cases, spindle whorls, loom swords, and smoothing stones. Although some keys were almost certainly worn, and some examples are certainly decorative, unlike the key bundles of the Migration era, or the girdle hangers from Anglo Saxon graves, they are also primarily functional (although see Härke 2014, 3). Further, although they are sometimes broadly identified as tools, they cannot be considered in the same class of tools as those that are used to make or maintain things such as spindle whorls and needles.

This problem of classification is another difficulty. Grouping keys broadly with jewellery and textile tools both actualises the assumption of gender association and reduces the diverse properties of the group to a single, shared characteristic of gender. In statistical analysis, this can have significant effects, both artificially inflating the group cohesion and masking other possible associations that individual objects or object types may have.

On the other hand, comfortably fitting keys into other categories is sufficiently difficult that no single approach has been taken in classifying them. In addition to identification as tools, they have been variously described as personal goods, fasteners and fittings (Rees et al 2008), and simply placed in the catch-all group 'miscellaneous' (Ward Perkins 1993). In archaeological reports they are often bundled with small finds or broadly with iron or other metal objects. Museum displays group them with ordinary household goods (as at the Museum of London), or sometimes blacksmithing tools and supplies (as in the British Museum's Roman room).

The most common response, however, is to keep them as a discrete category of their own (cf Biddle et al 1990). In the Pitt Rivers Museum, keys are placed together in a single display which resolves the difficulty of settling on a broad classification and allows a focus on the technology itself which was Pitt-River's passion. But when it happens at a site museum, like Vindolanda, visually presenting locks and keys in a separate display isolates them from their living context, effectively reducing their narrative to one of shape, function, and technology rather than the result of cultural beliefs and practices. These difficulties are not, I feel, trivial, but reflect the complex roles that keys as objects have historically filled and continue to fill in our own culture.

#### 5.4.2 Inherited biases: issues resulting from earlier artefact studies

A further significant issue is that in object research, studies necessarily rely on and react to previous work, and the earliest work was primarily focused on objects chosen not only for their morphological variability and their relatively good preservation, but for their aesthetic appeal and material value. The selective practice of collection used by the earliest antiquarians, who tended to save the most decorative or interesting objects, means that succeeding generations of archaeologists have far more examples of these objects available for study and far more previously produced data on them with which to work. The result is that artefacts seen as high status and therefore more socially important such as weapons and jewellery, and those that have recognisable diagnostic traits that allow them to be organised into typological series, have received attention out of proportion to their actual appearance in the record. A relative minority of object types have ended up carrying a considerable statistical weight.

This bias has carried through and arguably been reinforced so that 'diagnostic'

objects like swords and brooches remain the central artefact types examined (see for example Geake 1997, Ravn 2003, and Hines and Bayliss 2013). Other, less decorative objects are mentioned only in passing and often seem to drop out of the studies altogether. Not only is this problematic for the understanding of the archaeological record as a whole, it can tend to lead to the tacit impression that these research-significant artefacts were also dominantly significant to the cultures that produced them. For some situations and practices this could be true, but almost certainly it was not for the daily lives of the majority of people.

This disconnect between the assumptions and interests of the researchers and the experience of past peoples is also found in some of the biases that go into choosing the nature and direction of analysis. Nick Stoodley (1999, 29) may have shown some evidence for this when, in his study of Anglo-Saxon grave assemblages, he mentioned that he chose to look for gender patterning within the categories he identified rather than the clusters shown in his initial statistical analysis. Although the groups are, according to Stoodley, roughly the same, there are variations, and those variations may have provided additional useful information.

The difficulty seems to come from the application of observed statistical patterns to grave assemblages in a predictive rather than descriptive manner. The strength of the observed patterns becomes artificially inflated over time as graves that have not been osteologically identified, or that do not contain more confidently gender associated objects, are recorded as female or male on a probabilistic basis. In many studies, the number of unidentified graves is proportionally greater than those confidently sexed male or female. This large population, simply on the basis of numbers, holds the potential if not to overturn some of the gender associations, at least to change the composition of the patterning.

The problem is that statistics are produced from the remaining evidence of behavioural actions, but the picture that they give is inevitably limited, and somewhat distorted. When that distorted picture is then simplified in order to facilitate statistical analysis, its ability to accurately express the complexity of the archaeological record is compromised. Worse, there is a temptation to explain the archaeological evidence in a way to suit the statistical predictions rather than using observed anomalies to calibrate and adjust the model.

Statistical analysis takes objects out of their own context and sets them into the artificial context of the database, relating them to other artefacts in ways that have only a slight and theoretical relationship with the living world in which the objects were created and used. The knives from a single graveyard may have been a conceptual group for the people who used them, but they were not a single physical group, even in deposition. This means that this sort of study will always have limited use when applied to interpretation. But it does not mean that statistics are not useful in research into the social aspects of artefacts, instead it calls for an expansion of focus and methodological approaches. Rather than



isolating the artefacts from their context, the context itself should be studied in an artefact-centred way.

## 5.5 Data collection and recording



Map 5.3 Geography of the study areas

It was in consideration of these issues that the approach to data collection for this project was designed. I recorded all available information about a particular cemetery or grave rather than selectively excluding some data. In this way the process of reduction and clustering could be responsive and flexible rather than static. However, because the scope of

collection was large, time constraints meant that some concessions had to be made in terms of data sources.

In order to provide useful comparisons for the Birka material, it was important to include data from both a trade centre active in the same period and a set of rural communities that represented a more traditional way of life. Ideally this would include locations with a number of cemeteries within a relatively small geographical area that could show how much variation was within and among those inter-connected communities.

To balance the need for sufficient data with that for efficiency, I concentrated on published reports. Kaupang (Skre 2007) allowed for the comparisons of two trade centres, while Frederik Svanberg's 2003 compilation of cemeteries from south eastern Scandinavia allowed for more diverse settlement types (Map 5.3 above). Some comparison is also made to sites elsewhere in Scandinavia and in England, Germany, and France.

These data allowed a large-scale examination of the appearance of keys to understand how widespread their use was, and what, if any, patterns of that use are apparent. This required that the majority of the analysis focus on the 96 cemeteries that contain five or more excavated graves and that are in the eight areas that cover more than three such cemeteries (Birka, Bornholm, Bleckinge and Lister, Finnveden, Kaupang, Öland, Scania, and Varend).

## 5.6 Birka

Birka was a trading settlement located at the northern end of what is now the island of Björkö in Lake Mälaren, Sweden and was active from c 750 until the mid 10th century. Archaeological evidence has shown that Birka participated in an extensive trade network that ranged throughout northern Europe and into western Asia (Ambrosiani and Ambrosiani 2005) and involved a wide range of materials and crafts. The island was part of an immediate interlinked community, including the elite centre at Hovgården (map 5.4 - 5.6) As mentioned above, the settlement area and the fortifications are surrounded by extensive burial fields (map 5.7), containing at least 3,000, and possibly as many as 5,000 graves (Price et al 2018, 22) constructed by a diverse population.

This makes Birka a particularly rich site for examining the symbolic roles of keys in early medieval Scandinavia. Because it was not only a trade centre, but an important place of manufacture of a number of goods, including padlocks and decorative keys (Ambrosiani 2016), it was a place where varied ideas about craft, exchange, use, and deposition were not only coeval but concentrated, focused in a small, active and vibrant area. The settlement itself, and the wider network of exchange in which it participated, were diverse in cultural practice and in material objects. It is a place where ideas, both conceptual and physically represented, met and responded to each other.



Birka and its environs showing approximate sea levels:  
 Map 5.4 (above) Viking Age  
 Map 5.5 (right) Late 7th c. Dahlberg 1696  
 Map 5.6 (above right) Present day



Map 5.7 Locations and names of Birka cemetery areas

The burials, therefore, were built in an environment of richness in the availability of both material and cultural concepts. Together that produces particularly interesting and unusual conditions for the process of creating a grave. The choices that were made were, in general, less restricted by access to goods. But the context in which those choices were made had a greater complexity, with more possible practices to select, reject or respond to, more social relationships and roles to express, and a dense, layered landscape in which it all took place.

The number and variety of keys types found in Birka shows that the community had relatively easy access to the objects, and that therefore there was potential to create layers of meaning and effect through the selection of a particular type or even a specific key. To return to the concept of parsimony, because there were fewer difficulties in acquisition or replacement, keys could be more frequently included if desired. And because of the variety of types available, the range of purposes they may have served was, at least in theory, expanded.

Keys could be chosen not only because they were of the right kind of object, but the right type of key or even a particular key with strong associations. The amount of information an object in a burial carries increases in a direct correlation with the specificity in the choice of that object. A key that is selected because it is the necessary object of the right type, that has a known biography will bring to the assemblage a range of potential ideas compared to a key included because it was the easiest, or even the only option. Objects higher in specificity inherit the information available from those in lower levels, and add information that is of a higher order in terms of its possible significance (table 5.3).

Level of specificity	Example	Meanings and references
object group	weapon, jewellery, blacksmith tools	wealth, status, gender, role, affiliation
object type	sword, brooch, hammer	myths and shared history, specific skill, cultural identity
particular object	object with known biography, object made or acquired specifically for the burial	individual narrative, association and relationship within community,

Table 5.3 Example types of information available by level of specificity of an object

Birka's key assemblage, therefore, gives the opportunity to better understand how these objects were used in burials. It allows the exploration of whether they had a widely understood set of parameters that dictated how and with whom they were deposited, such as the proposed role of Lady of the House, but also other possible associations relating to craft, identity, and belief.

## 5.6.1 Birka locks and keys

We now turn to the analysis of the locks and keys found in the Birka cemeteries and settlement. For the first part of the analysis a total of 72 keys from the Back Earth that could be identified were given classifications. Although there are a significant number of keys and padlocks that have been excavated from the garrison area, these were not included in the distribution analysis. These keys represent objects made to the specialised set of requirements of the garrison community. They appear to have been used primarily within the limited area of the garrison terraces and were possibly even created in the garrison's own smithy (Gustaffson 2003), and do not appear to reflect the use patterns of the wider settlement.

Identification and classification of the cemetery keys came primarily from Holger Arbman's Birka reports (1940; 1943), supplemented by information from Historiska, the Swedish History Museum's online catalogue. Comparative examples were drawn from the dataset of English sites, Mathieu Linlaud's catalogue of medieval French keys (2014), and individual sites such as Haithabu, Kaupang, and Ribe.

## 5.6.2 Distribution of keys in Birka by type group

Of the 90 keys found in graves in Birka, 81 can be identified by type group. Seven survive only as handles and are either from group A or group E (table 5.4). A small majority are padlock keys. The distribution of key type groups from burials is broadly comparable with the distribution of keys found in excavations of the Black Earth. The most obvious divergence is in group A keys, which are more common in the settlement than in burials. If the seven unidentifiable keys are A type this divergence becomes smaller, but persists, and it is unlikely that all of these keys belong to the same type group (table 5.5).

Type group	Number of keys	Percent
A	10	11%
B	30	34%
C	22	25%
E	17	19%
G	1	1%
H	1	1%

Table 5.4 Distribution of type groups in keys from the Birka cemeteries

Type group	Number of keys	Percent
A	18	26%
B	16	24%
C	19	28%
E	10	15%

Table 5.5 Distribution of type groups in keys from the Birka Black Earth area

There are a higher proportion of group B keys in burials than in the settlement which may be significant. Mould impressions of both padlocks and padlock keys (Gustafsson 2005) show that both were being manufactured on site so a reasonably large number would be expected in both settings. The stronger numbers of padlock keys may be related to the high numbers of both locks and keys found concentrated in the garrison (Westerholm 2001; Gustafsson 2005), but as discussed below, the appearance of these padlock keys does not directly reflect some of the ideas that have been suggested for their meaning in within the garrison community. In the assemblage as a whole, most of the keys are relatively simple, suggesting that they were chosen from ordinary objects already in use rather than having been purpose made for deposition.

The distribution of type groups, with a roughly equivalent number of keys from groups A, B and C is in sharp contrast to that seen in English settlements, discussed in the previous chapter all of which have very low numbers of keys from group C. But as mentioned, there is a different distribution in English burials in or containing chests and boxes, where nearly 80% of locks use keys from group C. This distribution is partly due to the large group of 19 chest burials discovered in Thwing, all of which have group C bolts (Ottaway, ND). However even without this collection, nearly 70% of the locks are group C. As mentioned previously, Patrick Ottaway (1995, 12) has suggested that C group keys fell out of use sometime after the 9th century, although that estimate may reflect changes in burial practice rather than in lock manufacture and use in the living community. It does appear that group C keys continued in use into the 10th century in Birka; several occur in assemblages with type P51 oval brooches, dating approximately to 900-950 ad (Petersen 1928).

#### A. Group A keys

Over half of the Group A keys found in the Black Earth area, and all but two of those from burials (eight out of ten) have very simple rectangular bits without any signs of clefts. They would have been functional in this state, and three apparently un-cleft keys from Trelleborg (Nørlund 1948, XXI) suggest that some keys were left in this form (figures 5.6, 5.7). However it is also possible that these keys were blanks, either ready for export in an unfinished

condition, or intended for final shaping in the Birka workshops after the lock had been built, to ensure a working fit. All of the blanks that appear in burials share the same basic morphology, which is similar to the casket keys discussed in the previous chapter. There are no surviving rotary locks of the type that would relate to this key morphology from any of these burials, although there are two lock plates with appropriately shaped keyholes (figure 5.8 a-b). Unfortunately these plates have no recorded context (Arbman 1940) and may be chance losses. It is possible that these unfinished keys were never in use and were seen as an acceptable stand-in for practical keys that would be inconvenient or expensive to replace.



Figure 5.6 (left) Uncleft key, Birka Black Earth Historiska 107656

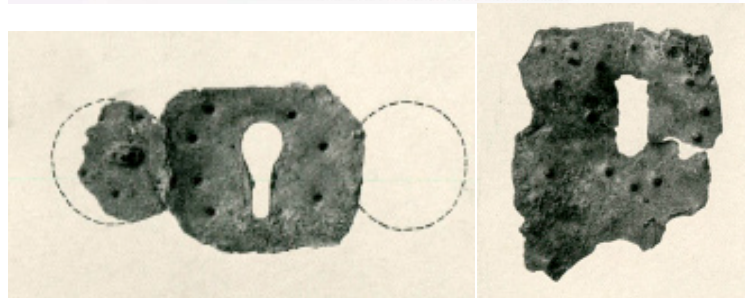
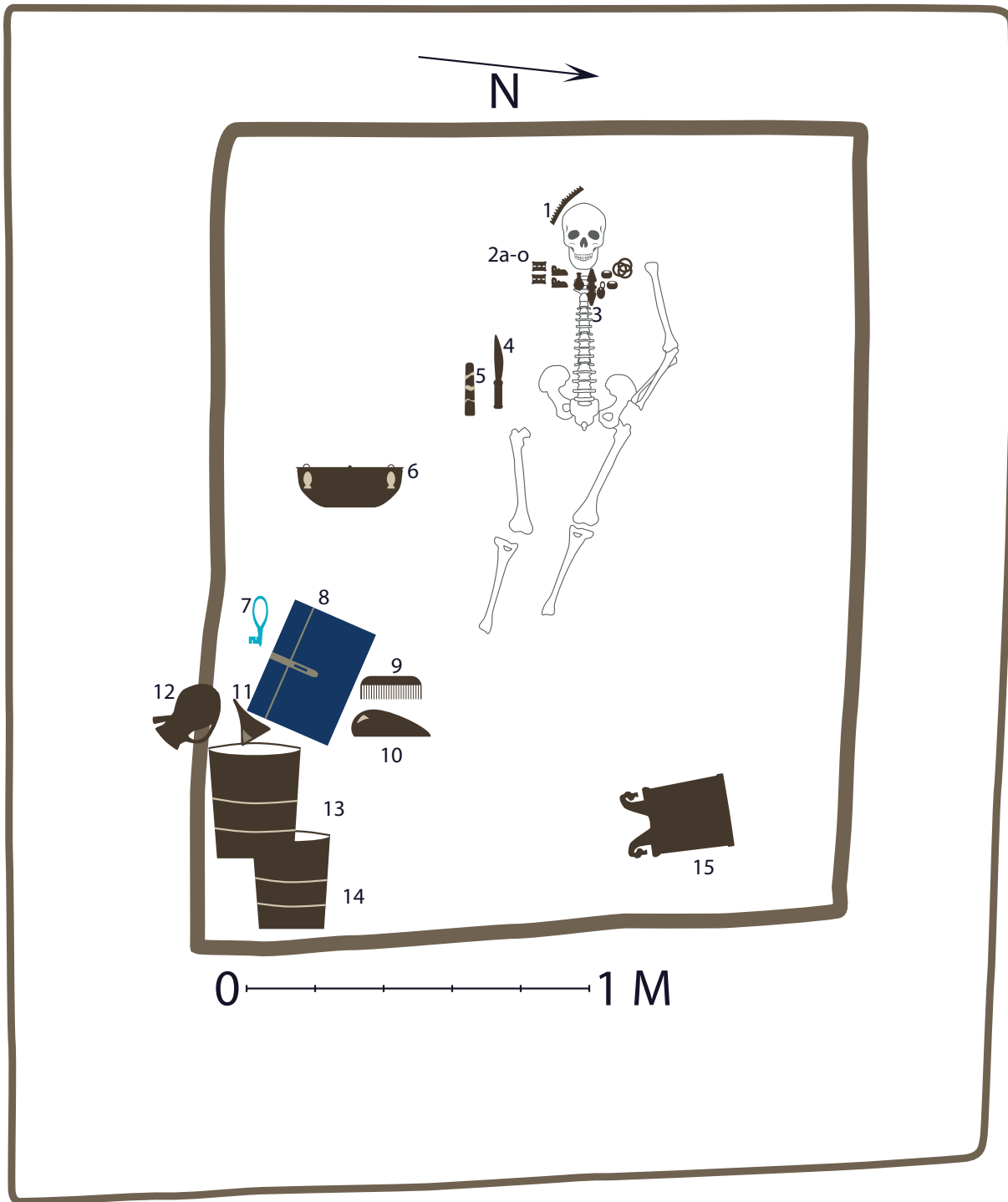

Figure 5.8 a,b Uncontexted lockplates from Birka cemetery areas (Arbman 1940, plate 262)



Figure 5.7 (below) Uncleft key, Trelleborg (Nørlund 1948 XXI: 1)

This suggests that, at least for some assemblages, these objects were not included because they had a strong personal connection with the dead, but instead because they served a more symbolic purpose. Some support for this may come from grave BJ854 (Arbman 1943 plate 264: 1, 2a, 2b). The key found in this burial is a group A key with two clefts, but the lock bolt and mechanism may not relate to it. The key was found at the foot of the grave on (rather than in) the casket (Arbman 1943, 327) so was clearly intended to be associated with the box and possibly the other objects near or in it: comb, jug, glass smoothing stone, bucket, and carved smoothing board (figure 5.9). If the key is not to the box it is possible that the original key to the box had been lost and a convenient substitution was made. But it also could be that the key was purposefully kept back, and the placement of a non-functional substitute served its own purpose.



- |                                 |                          |                              |
|---------------------------------|--------------------------|------------------------------|
| 1 silver band                   | 6 hanging bowl           | 11 glass beaker              |
| 2 a-o Beads, brooches, pendants | 7 KEY                    | 12 ceramic pitcher           |
| 3 equal armed brooch            | 8 casket fittings        | 13 large bucket              |
| 4 knife                         | 9 comb                   | 14 smaller bucket            |
| 5 whetstone                     | 10 glass smoothing stone | 15 whalebone smoothing board |

Figure 5.9 Grave plan of BJ854, after Arbman 1943, fig. 274

Two of the remaining keys from the Black Earth area are only tentatively classed as Group A. These keys have distinctive bits, shaped from a long, thin rod of iron rather than a rectangular or similarly shaped plate (figure 5.10-5.13). These keys could have been functional in a rotary lock. Because their form has a considerably wider “cleft” area than standard keys they may have worked as skeleton keys, opening rotary locks that have the



double-cleft structure discussed in the previous chapter, even if they varied somewhat in size and ward placement. A very similar key was found in Coppergate, York, as well as one slightly simpler version (Ottaway 1992, 670 fig 286: 3618, 3620).

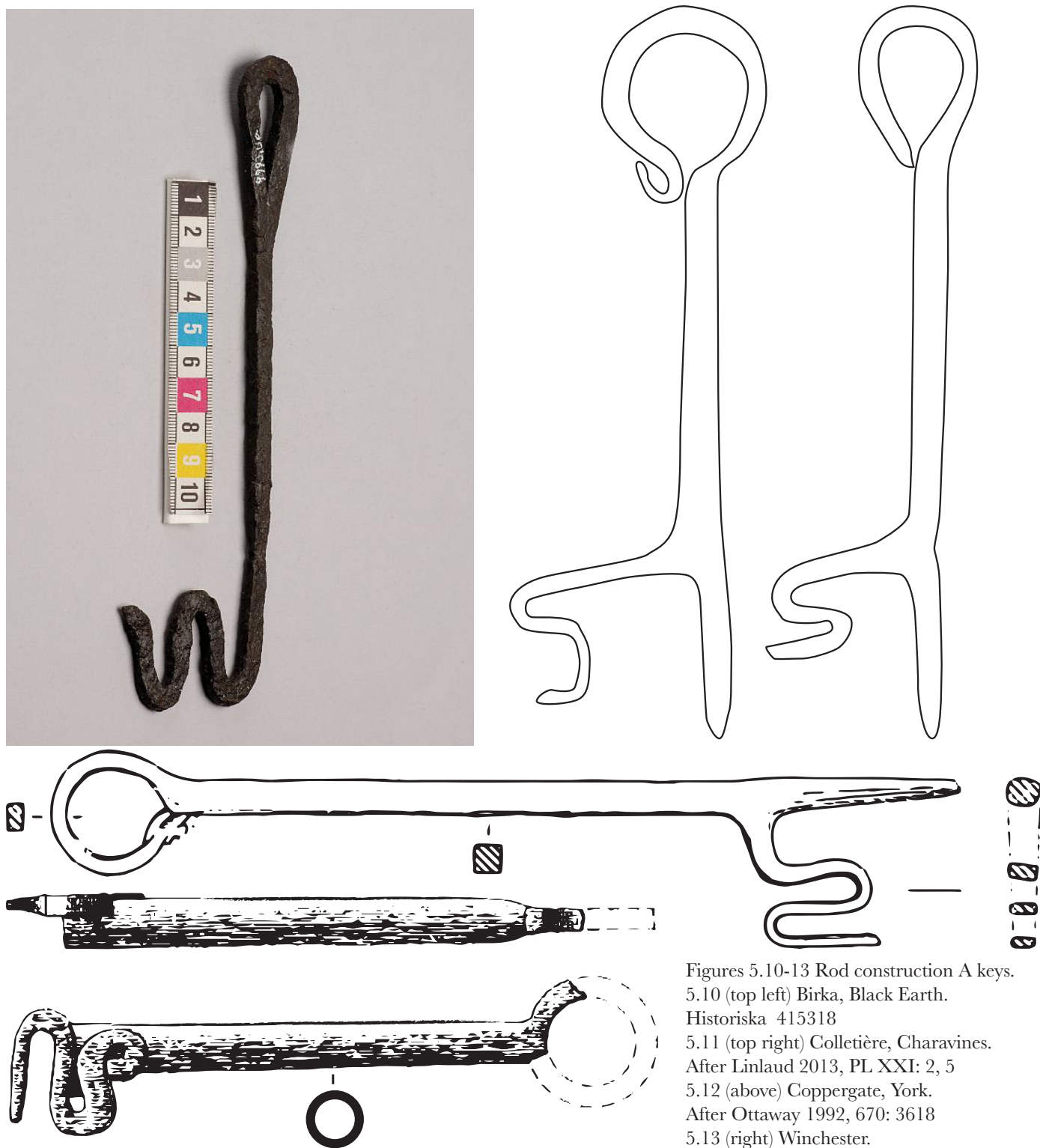

Figures 5.10-13 Rod construction A keys.  
 5.10 (top left) Birka, Black Earth.  
 Historiska 415318  
 5.11 (top right) Colletière, Charavines.  
 After Linlaud 2013, PL XXI: 2, 5  
 5.12 (above) Coppergate, York.  
 After Ottaway 1992, 670: 3618  
 5.13 (right) Winchester.  
 After Biddle et al 1990, fig 326.

It is also possible that this represents a separate construction practice that may relate to a different lock mechanism. Nine keys found in Colletière, Charavines (Linlaud 2014, 276 fig XXI: 2-10) have the same construction method but a different morphology. Linlaud (2014, Plate IV) has suggested a lock reconstruction that is a simplified version of standard rotary locks (figure 5.14), but with the basic elements in a

different orientation, however the morphology of the Birka keys does not suit this lock. This could mean that although sharing some superficial construction similarities, these keys are not related, and there may have been a different movement or system of warding for the Birka examples. There are no examples of this type in either the PAS or in MOLA, but a single key from Winchester found in a 10th century context has a bit morphology similar to the Colletière keys, but with a different method of manufacture (Biddle et al 1990, 1025). This amount of variation in such a small number of objects is interesting and may represent the spread and adaptation of practice from a single workshop or craft community.

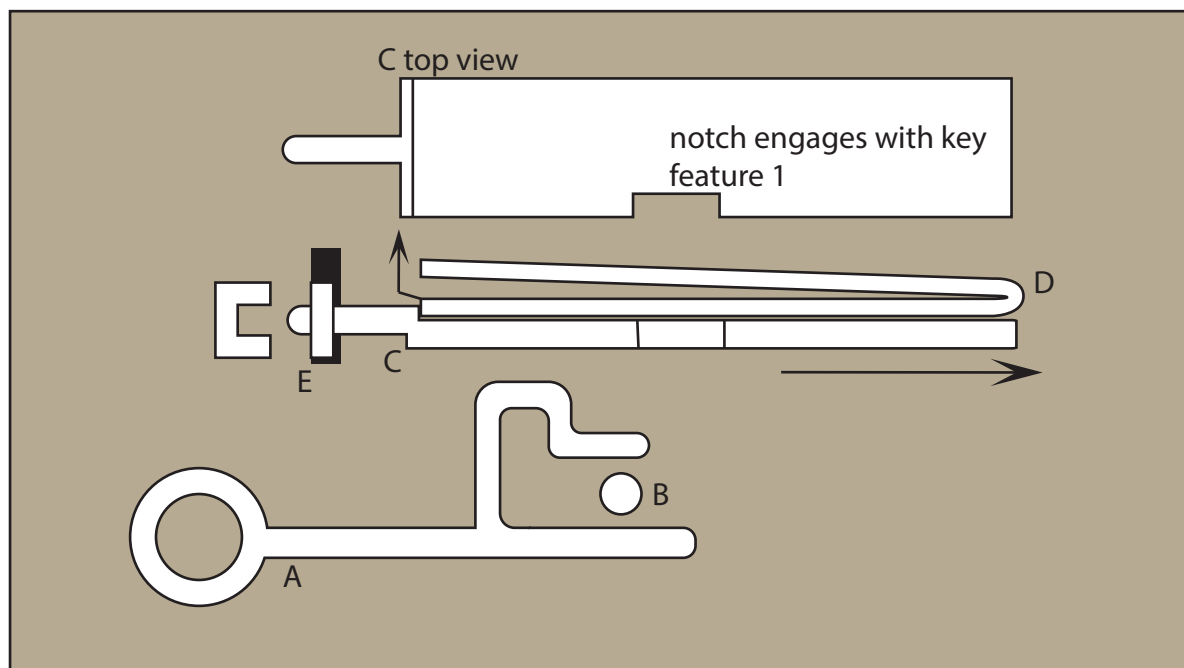

Figure 5.14 Schematic of Linlaud's (2013, plate IV) suggested lock mechanism for rod-constructed group A keys Key (A) rotates past ward (B), engages with the notch in bolt (C) compressing spring (D) to free the bolt which is then slid free of the hasp (E)

## B. Group B keys

Jan-Erik Tomtlund (1970, 1978) identified three padlock types in use in early medieval Scandinavia. Type 1, mentioned above, was opened by group E keys, but the other two types were related to keys from group B. As discussed in the previous chapter, there are two variations of these keys, related to the padlocks they opened. The first (group B:1), had a bit in-line with the stem. This group can be further subdivided into keys with closed rectangular bits with internal perforations (group B: 1a), those with rectangular bits with an opening at the terminal end (group B: 1b), and those with circular bits with internal

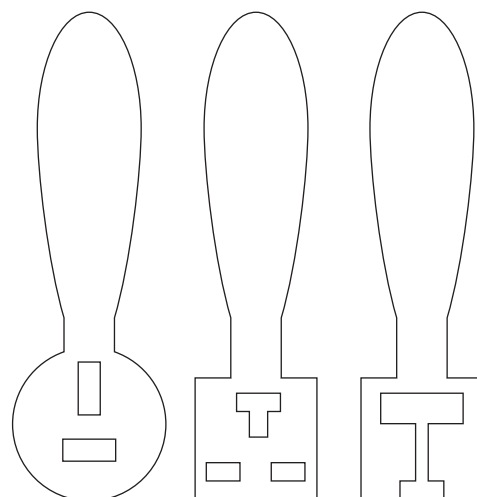

Figure 5.15 Group B: 1a-c

perforations (group B: 1c) (figure 5.15). The second (group B:2), with the bit at an angle to the stem, was used with barrel padlocks with the keyhole at one end. These padlocks are known from Roman sites (cf Birley 1997, 9, 37) and continued in use in both England as discussed in the previous chapter (cf Ottaway 1994, 676) and southern Europe (cf Linlaud 2014, 334). Only one of the identifiable group B keys at Birka was of this type (figure 5.16).

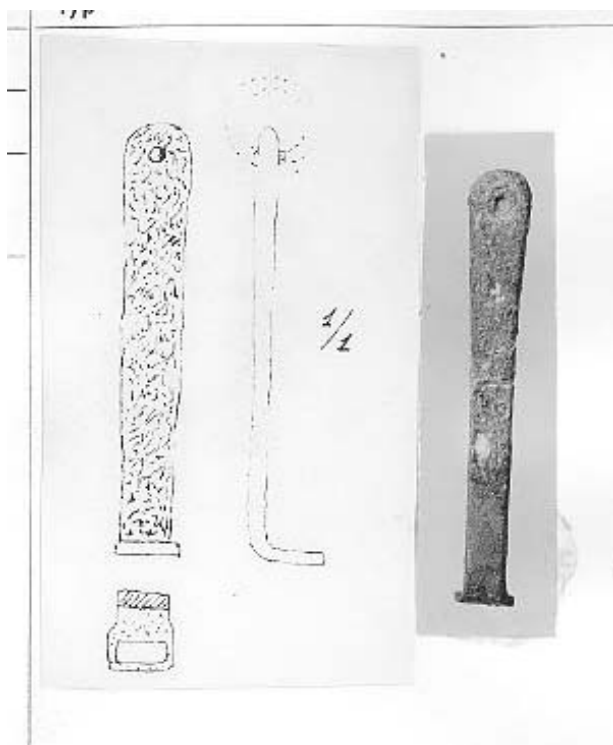

Figure 5.16 Group B:2 key from Birka's Black Earth SHM 5208: 179

Group B: 1a would have opened box padlocks with T-shaped keyholes on one side (Tomtlund Type II). Group B: 1b opened similar padlocks, but was also used on caskets that also incorporated flared-spring locks (fig 5.17 below). Group B: 1c opened barrel padlocks that had a slot along the length of the barrel.

As mentioned above, padlocks were manufactured in Birka. They may also have had some social significance, discussed below, so it is unsurprising that a number of group B keys were found both in burials and in the Black Earth excavation. But where two thirds of the keys in the Black Earth were from group B: 1b, two thirds of those in burials are from group B1: a. There are four padlock keys from the Black Earth that survive only as handles so this distribution should be viewed with caution.

Trelleborg also has a number of group B keys (Nørlund 1948, plate XXII: 5-8). Although the objects are damaged, it seems that there are two different B:1b bit shapes in the Trelleborg assemblage, with two keys of each shape (figure 5.18 below). These two shapes are also found in two keys from the Black Earth area (figures 5.19, 5.20 below). This amount of repetition within a relatively small number of objects suggests that although this key form would have been easy to individualise, instead there was a fairly small pool of commonly used shapes known to craftworkers in these areas. It is arguable that these objects are another example of a persistent form, and that they represent an interconnected

community of craftworkers who were able to successfully transmit and maintain the shared knowledge of specific forms and features of these keys.

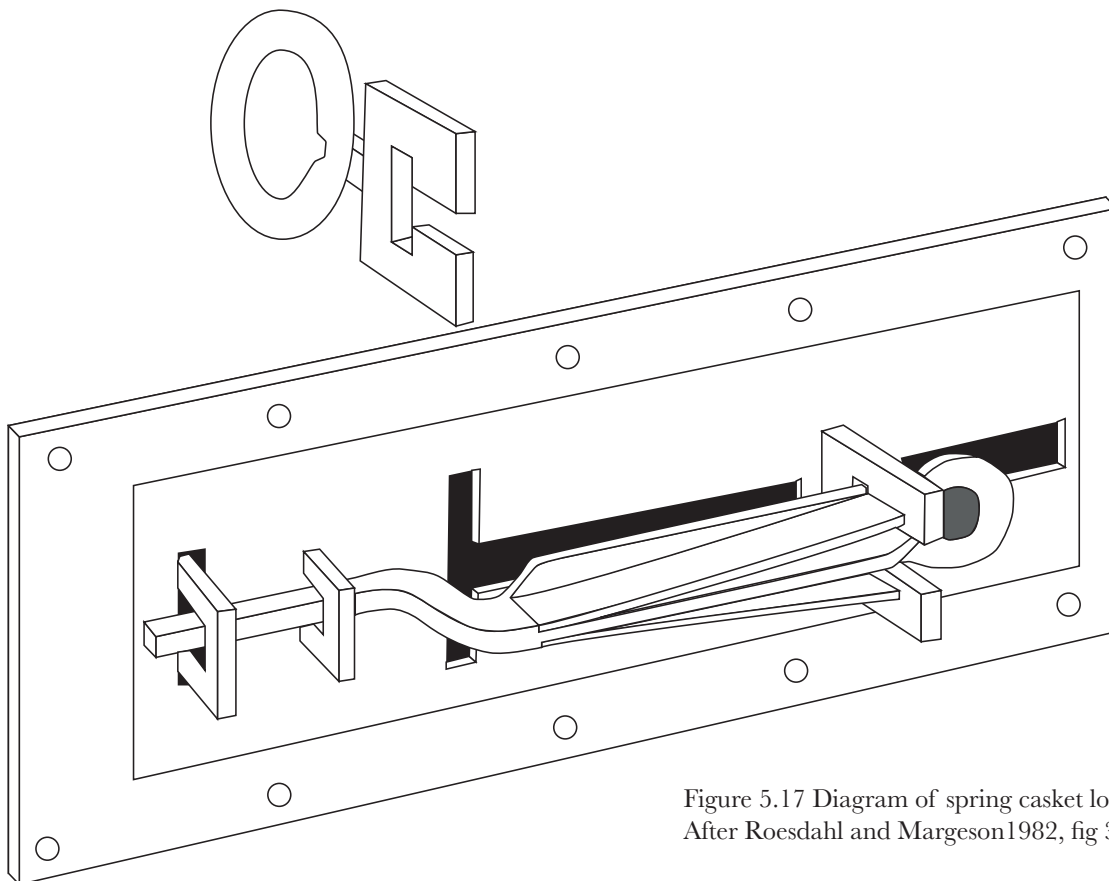

Figure 5.17 Diagram of spring casket lock from Fyrkat, Denmark. After Roesdahl and Margeson 1982, fig 31



Figure 5.18 Group B keys from Trelleborg



Figure 5.19 group type B1: b key. Compare with Trelleborg keys above. Historiska 415508



Figure 5.20 group type B1: b key. Historiska SHM 35000

The group B: 1a keys show an even greater amount of conformity (figure 5.21 a-f above). Of the 14 keys examined in this category, 10 have three perforations in the bit. In eight of those keys there is one T-shaped perforation and two rectangles. Four of these keys are from Birka, but the others are from Haithabu (Arents and Eisenschmidt 2010), Trelleborg (Nørlund 1948), and the MOLA collection. A key from Coppergate, York (Ottaway 1992, 677, fig 291) has three T-shaped perforations, and a key from a burial in Birka has two rectangular perforations, and a third that has been damaged. These keys are all clearly drawing from a similar tradition, sometimes directly replicated and sometimes varied, but with variations that also seem to have been repeated. An exact parallel to the Scandinavian model has been found in Gnëzdovo, Smolensk, and one to the MOLA key in Sarskoye, Gorodishche, demonstrating how far these objects travelled (Hedestierna-Jonson 2009, figs 91, 93).

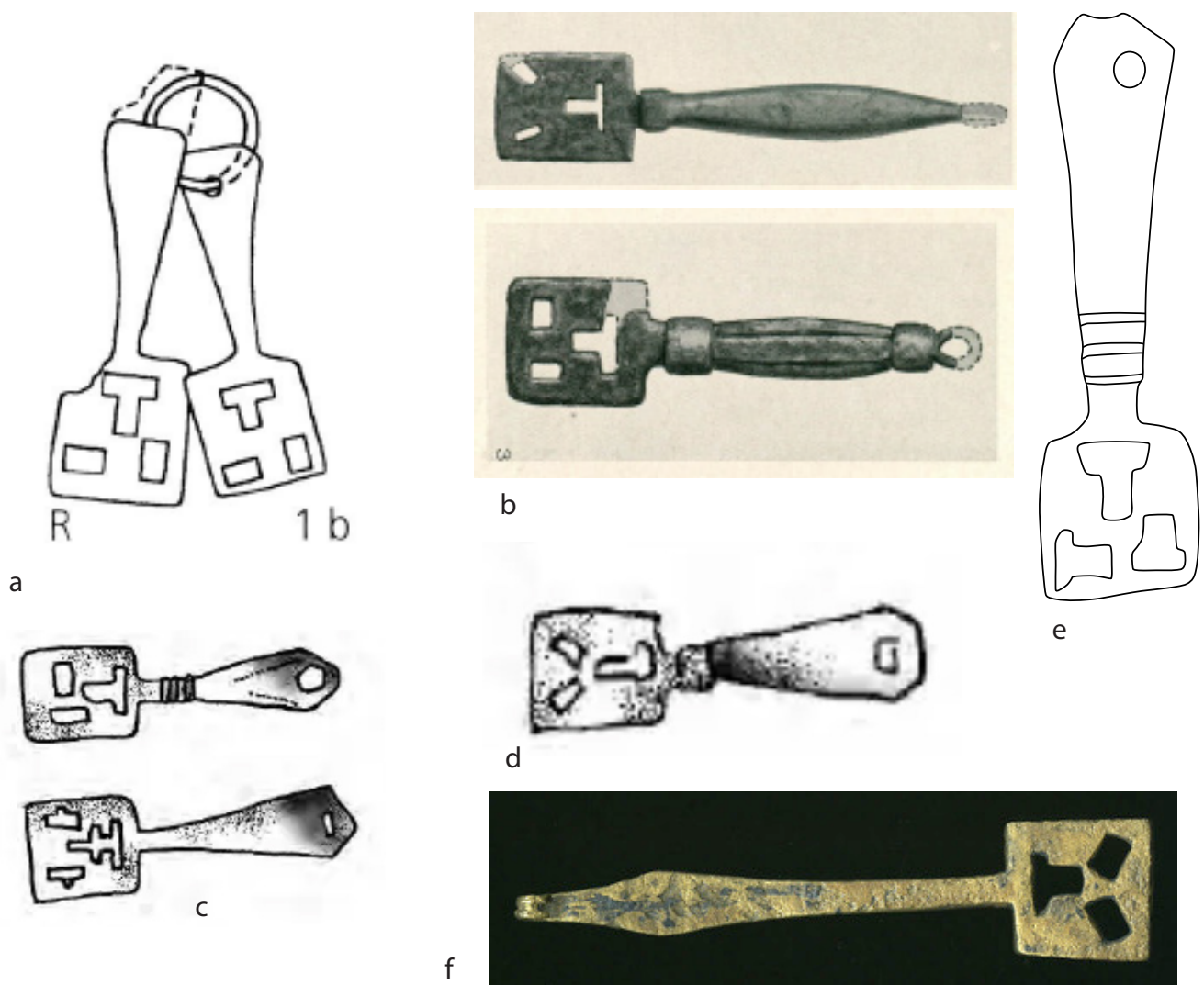

Figure 5.21 a-f Group B:1a keys with shared features. Note in particular the number and distribution of clefts and the repetition of the “t” shape in the same location in each key.

- a Haithabu, from Arents and Eisenschmidt 2010, 396, plate 98: 1012
- b Birka, from Arbman 1940, plate 274, 2, 3
- c Coppergate, York, from Ottaway 1992, 677, fig 291
- d Gnëzdovo (top key), from Hedestierna- Jonson 2009, 165 fig 93
- e Sarskoye from Hedestierna- Jonson 2009, 165 fig 91
- f England, MOLA 80.65/13.

The number of keys, the patterns of repetition and the degrees of variation all suggest that these keys may be useful objects for further study. Looking in greater detail about the conditions of their appearance could provide greater insight into the broader community of specialised craft workers who were engaging with this particular form. Where the persistent forms discussed in the previous chapter were used to examine craft stability and continuity, these keys could provide insight into the patterns of mobility and exchange by mapping the amount and degree of shared knowledge expressed in the morphology of the keys.

### C. Group C keys

There are 11 group C keys found in burials, 9 of them with a form variation that only occurs once in Early Medieval keys in the English dataset. The stem of these keys has a dog-leg type double bend. In the illustrated examples from Birka the angle of this bend varies somewhat (figures 5.22-24). In contrast to the distribution of C-group forms in the grave assemblages, of the 18 group C keys found in the Black Earth, five are too fragmentary to identify the complete form, two are T-form, and nine are L-form. Only one of these keys has the dog-leg double curved stem.

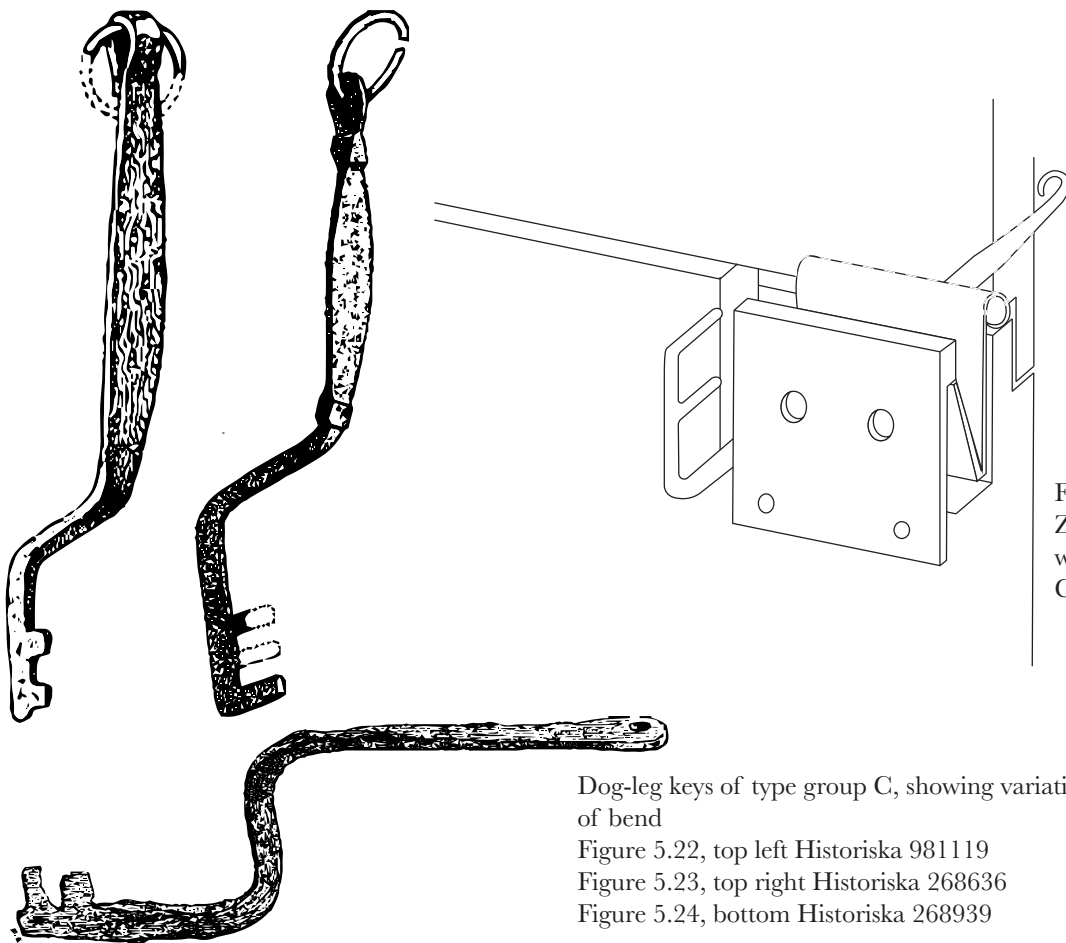

Dog-leg keys of type group C, showing variation in the angle of bend

Figure 5.22, top left Historiska 981119

Figure 5.23, top right Historiska 268636

Figure 5.24, bottom Historiska 268939

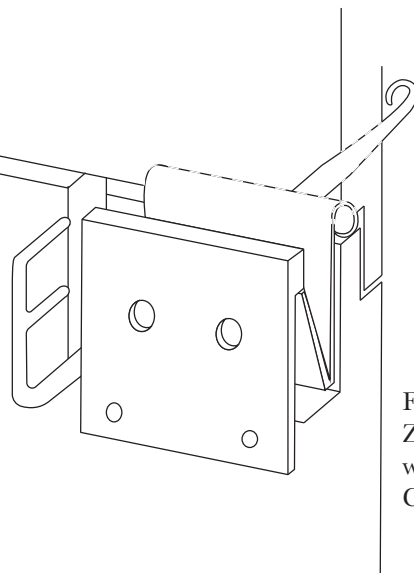

Figure 5.25 Schematic of the Z-spring catch lock associated with dog-leg form type group C keys

The lock mechanism assumed to be related to this key form is the simple Z-bend leaf spring with a catch described in Chapter 2 (Ottaway 1992, Fig 283 a and b). This lock is markedly different from those for the T- and L-form keys found in England, as will be discussed in greater detail below (figure 5.25 above). As mentioned above, because of the shape of the Z-bend catch, the lock could only have been used on caskets or chests, not structural doors.

Many of the Black Earth L-form keys have a proportionately longer distance between the inner tooth of the bit and the stem in comparison with the English examples which could mean they were also used with the leaf-and-catch lock mechanism. Although this longer span is not impossible for the T- and L- lock type found in England, this shape would put additional strain on both the teeth and the stem when the bolt was being shifted. The simpler, one directional movement of the catch lock in contrast would have had most of its stress at the point of the shaft bend, which could be fairly easily repaired. The form still does not seem ideal, but it is possible that the longer span meant the lock was moved further away from the keyhole, resulting in an increase in security.

Whether or not the L-form keys from the Black Earth were used for the same basic lock type as the dog-leg variation, the difference in key morphology is suggestive of greater experimentation and development in lock and key technology than is usually acknowledged. The implications of these variations are the focus of the discussion below examining patterns of both persistence and change in this type group.

#### D. Group E keys

In their analysis of Birka grave finds, Ulfhielm and Arwidsson (1989, 123-24) placed A and E keys into the same type groups (their types I and II are distinguished primarily by terminus type), but the lock mechanisms related to these groups are entirely different. Group E keys could open two different lock types: casket or chest locks with sliding bolts, or rotary padlocks with the same leaf-spring mechanism as that used with the dog-leg group C keys discussed above (Tomtlund Type I, 1978). There is not, at this point, a reliable means of identifying which lock type a key may have opened. Stem length, key size, terminus type, and bit morphology are all varied, and with the limited number of surviving locks, it was not possible to discover a consistent pattern. This is particularly unfortunate because, as will be discussed below, there may be a different significance placed on padlocks and padlock keys than that attached to box or casket keys.

There are roughly three bit variants in group E keys: rectangular bits with projecting teeth (E:1), triangular bits with three round pegs (E:2), and long narrow bits with a single tooth (E:3) (figures 5.26-5.28). In Birka there are approximately the same number of keys of

the first two variants, a distribution that is seen in both the cemetery and in the Black Earth. Only two keys of the third variant were found, one in a burial and one from the settlement.



Figure 5.26 (left) Type group e:1 with projecting teeth, SHM 35000

Figure 5.27 (centre) Type group e:2 with three pegs, SHM 5208

Figure 5.28 (right) Type group e:3 with single tooth bit, MOLA 10884

Although there are a fairly large number of group E keys in the PAS and in the MOLA collection, there are fewer from archaeological sites. Coppergate had a single example, and Flixborough only two. There were no recognisable keys of this type from Winchester, although a number of the early medieval keys had incomplete or missing bits so it is possible the type was in use there. Linlaud (2014) includes neither the padlock, nor the casket lock mechanism in his discussion of lock types, and there is only one possible E group key in his extensive catalogue so it may be that this lock variant was not used in early medieval France.

However in addition to the English examples, E group keys have been found in Ribe (Fevéille 2006, 434), Helgö (Holmqvist 1961, 121), and Haithabu (Arents and Eisenschmid, 2010), suggesting shared craft knowledge between England, Denmark, and Sweden. Five keys in particular, one from Ribe and four from England, have clear evidence of a common tradition. They all have triangular bits, a peg terminus, and a distinctive bow shape (figures 5.29-5.32 below). However there are enough differences among the examples to make it clear they were not produced from the same mould, and probably not by the same workshops.

There are considerably more of the third variant found in England, particularly in the PAS dataset, where they represent half of the group E keys. As mentioned, two of this variant were found in Birka, but only Helgö of the other Scandinavian sites examined produced an example. The English keys are widely distributed and show a fairly large amount of variation in handle design, supporting the idea that this variation was reasonably common and was made by a number of different craftworkers. It is interesting, however, that there is only one of these keys in the MOLA collection.





Figure 5.29 PAS NLM12376



Figure 5.30 PAS NLM12378

t



Figure 5.31 MOLA A12192

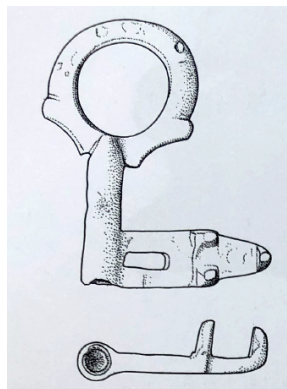

Figure 5.32 Ribe, Feveile 2006, 434 Pl 54: c

Type group E:2 keys with shared characteristics

### 5.6.3 Group distribution in Birka's cemetery areas

Keys with identifiable bits appear in twelve of the Birka cemetery areas, although six of those areas have only one key that can be assigned a group. The distribution shows little discernible pattern. There is approximately the same proportion of type C and E keys in the cemeteries as there is in the Black Earth area, but a few more group A in the settlement, and group B in the cemetery. Among the three cemetery areas with enough keys to make a comparison, there are some small differences, particularly in Hemlanden 1A which has slightly lower proportions of E and higher proportions of C keys than the other areas. Hemlanden 1B also has a slightly higher percentage of type B keys.

Although it is unsurprising that there are no discernible significant patterns in key groups on this scale, it is interesting that there is no evidence for a greater appearance of padlock keys in burials in and around the Borg where padlocks occur in exceptional numbers in the settlement area. Excavations on the terraces to the Northwest of the Borg fortification have uncovered a large building, interpreted as a great hall (Holmquist Olausson 2002) which appears to have had political and social significance. The armoury stored in the great hall is assumed to have been provided and administered by the central authority (Holmquist Olausson and Kitzler Åhfeldt 2002). Inside and around this hall a large number

of keys, including padlock keys, were found, along with 43 padlocks of varying sizes and designs. There was also evidence that padlocks were being made in the adjacent garrison smithy (Gustaffson 2005).

These padlocks occur in far greater numbers than in either the cemetery areas or in the Black Earth, and there is evidence that they had symbolic as well as practical significance. A padlock was found in one of two foundational deposits discovered in the central postholes, and it is possible that it is related to a key found during a re-excavation of the other posthole (Hedestierna-Jonson 2015, 81). Other padlocks, supposed to have been used to lock individual chests that stored garrison weapons and armour, appear to have been deliberately broken, probably during the destruction of the hall after what appears to have been a successful attack on the Borg. Although this could be the result of looting activity, the deposit of another broken padlock on the smithy cistern, which had been deliberately destroyed (Bergström 2013), could indicate that these locks were being used ritualistically (Gustafsson 2005, 23).

The garrison locks and keys have also been suggested to have been used to establish identity, both of the warriors who were part of what appears to be a professional cohort (Hedestierna-Jonson 2015, 73), and of the authority for whom they acted. Several particularly small locks have been suggested to be non-functional because of their size, and instead to have represented the controlling authority, possibly drawing on a similar visual rhetoric as used for brazed weights (Gustafsson 2005; Hedestierna-Jonson 2015).

An even stronger association has been suggested for particular padlock keys, brazed and decorated with stylised, stooping falcons (figure 5.33 below), 10 of which have been found in the garrison. Marita Westerholm (2001) felt that these keys were symbols of rank within the cohort, signalling authority through the double symbols of the key and the falcon. Charlotte Hedestierna-Jonson (2009; 2015) has taken this idea of identity creation further, suggesting that these icons (also found on brooches and sword-chapes, figure 5.34 below) were deliberately used to signal group affiliation, an affiliation that she connects with a polyethnic culture she identifies as the Rus' (2009 175).

The number of padlocks, and of these highly decorated keys certainly suggests that the objects were held in some importance. The large number of padlock keys of varied designs suggests that most if not all of the garrison warriors would have owned at least one, but although the significance of the keys, and particularly of the falcon-motif keys has been examined, less attention has been paid to the padlocks themselves and why this particular lock type was so visibly important to the garrison.

Fixed locks on chests and boxes are well known from the Birka cemeteries. These locks could be robust, and visually striking, indicating strength and security, but the keys of type group E could also produce powerful visual messages. The pear or tear-drop shaped

handles common in Birka would have been particularly well suited for the falcon motif. The shape is roughly similar to the sword-chapes so the falcon would need less modification than that seen on the padlock keys. The handles are also smaller, and are open-work which would emphasise the falcon, making it more striking and easily recognised.

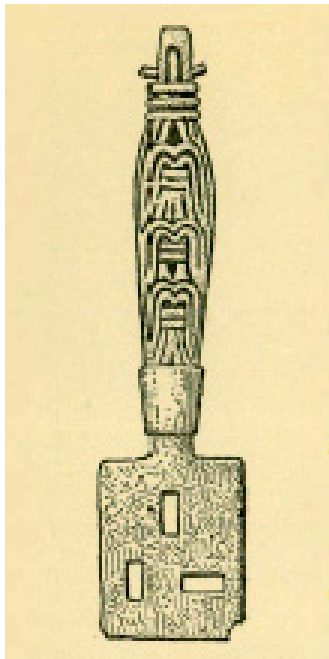

Figure 5.33 Falcon key and motif, after Arbman 1943, 187 fig 134



Figure 5.34 Falcon motifs from the Birka settlement, from Hedenstierna-Jonson 2006, 82: 4

But these fixed locks are physically and psychologically part of the chest itself. Ownership of the chest is also ownership of the lock, and through it the key. In contrast, padlocks are self-contained and mobile. Their application to a locked space is temporary, and this characteristic is essential to the nature of the lock - it is a desirable feature. Having the garrison members supply their own locks produces a sophisticated message through the disposition of lock, key, chest, and contents. The ownership of and authority over the latter two remain with the central authority, but the responsibility for the contents lies with the owner of the lock.

Ny Björn Gustaffson (2005, 22-23) has discussed this distinction, pointing out that possession of the key gave both the right to control access to the contents of the chest, but also responsibility for their safety and security. Gustaffson, and after him Hedenstierna-Jonson (2015, 81) has cited medieval Swedish provincial law to support this idea, pointing out that a distinction was made over the control of locks and keys during and after a theft. However I would argue that these important conditions of control and responsibility could be established with any type of key. The number and variety of padlocks and padlock keys, and the use of a padlock in the posthole deposit, indicate that there was significance and importance in this specific lock type and that the falcon motif is an elaboration of this significance.

Padlocks control the relationship of the space and the contents they secure to the community in which they are used. Because that control is temporary, they can be removed or even destroyed without changing the fundamental nature of the things controlled. But they are also mobile, and could be perceived to carry with them not only the significance of the authority (which can then be applied to other spaces and things), but the memory of that former relationship. The use of the padlocks reinforces the stability of the controlling authority and sovereignty represented by the boxes and the weapons in them, and also expresses the relationship of the individual warriors to that authority in a physical way.

The falcon-motif keys are, as has been argued (Westerholm 2001), possibly part of this complex system of object as metaphor, representing higher rank within the garrison and possibly opening the largest, most substantial padlocks (Gustafsson 2005, 23). But where the sword-chapes, brooches, and other falcon designs are clear and easy to read, the padlock handle is dense, more abstract, and importantly also distinctly different from other versions. Instead of a single falcon, the handle has three, tightly nested. Although substantial in size, and gilded, to be highly visible, unless already familiar with the design, it could only be interpreted and understood with close examination.

The symbols on this padlock key may, therefore, have been intended for an in-group audience, signalling not to the wider community but to the members of the garrison themselves. It could be that the multiple falcons also references a cohort rather than a single individual, and the owner was reinforcing their membership in that cohort. The focus of identity then, both through the type of key itself and through the decoration, is not necessarily on the individual carrying it, but on the warrior group and on the leader they served.

This may be why the falcon motif key, although appearing in high numbers in the garrison, is not well represented in the cemeteries. Only two of these keys, one of them only a suggested identification, have been found in burials. The clearly identified key appears in BJ562, a chamber grave located close to the garrison. Unfortunately there is no grave plan available for this burial, but according to Stolpe's description a padlock case was found at a depth of approximately 1/2 a metre next to the south wall (Arbman 1943, 182) with the falcon handled key next to it. The Swedish historical museum database lists a second key in the grave (object 559938), although this is not mentioned in Arbman. The grave also contained five knives, an arrowhead, some boat rivets, and a ploughshare, all scattered in the upper levels of the burial.

The position of the lock and the falcon key, above and removed from the body, indicate they were not included as personal belongings or to express identity. Instead it would seem that they had some other, possibly symbolic purpose in the grave. The padlock is incomplete, missing its bolt, and it is possible that it was deliberately damaged prior to deposition, but the key does seem to fit the lock (Tomtlund 1989, 132). This is the only

padlock found in a Birka burial that includes its key. The other grave goods also appear to have been included as something other than simple possessions, but they seem to have been physically separate from the lock and their use or meaning may not be connected.

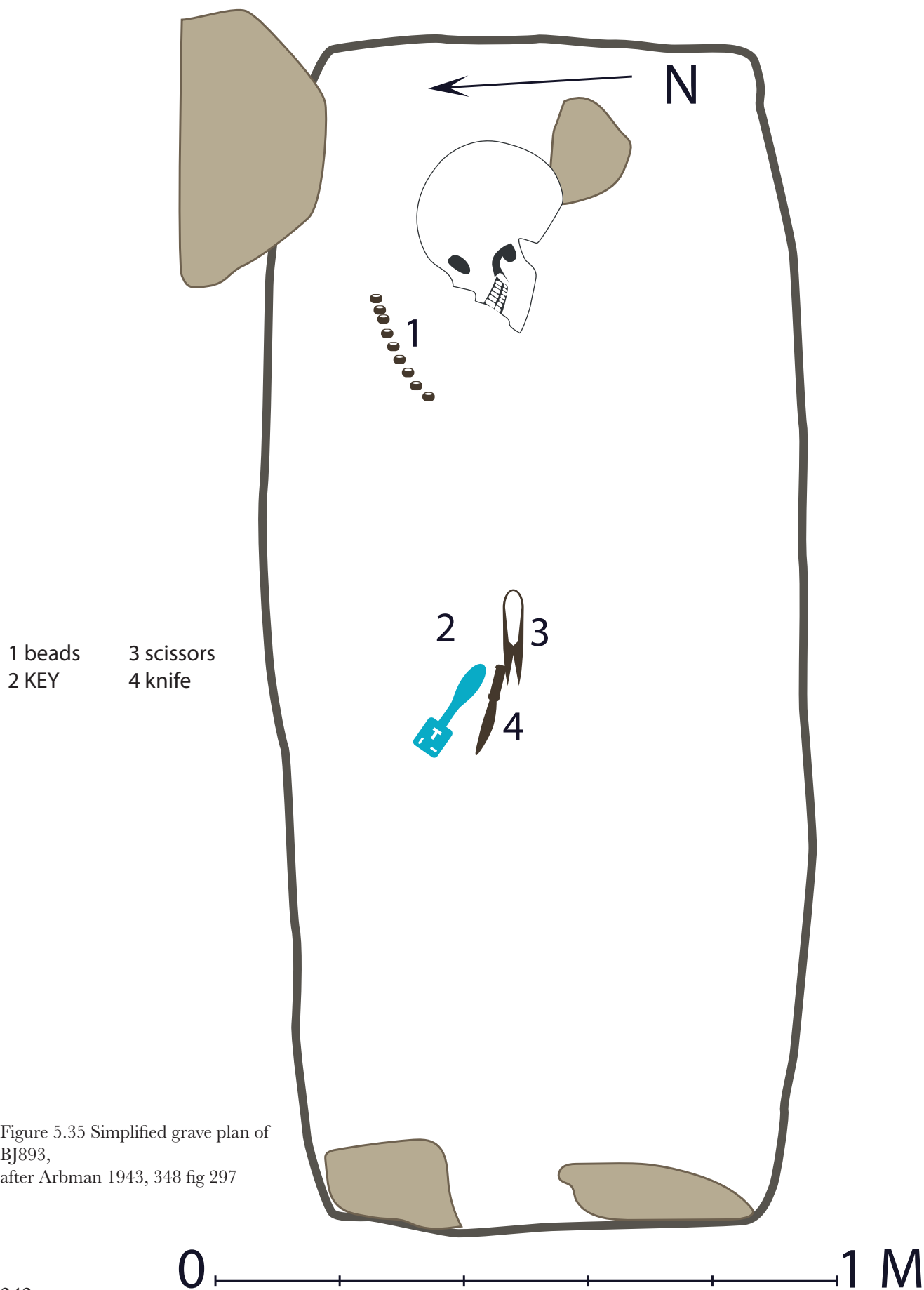

Figure 5.35 Simplified grave plan of BJ893, after Arbman 1943, 348 fig 297

The other grave possibly containing a falcon key (BJ893) is an inhumation located in Hemlanden 1B, fairly close to the fortifications. All of the grave goods appear to have been placed directly on the body approximately where they would have been worn in life (figure 5.35 above). The padlock key was grouped with the knife and scissors, apparently near the waist. The number of beads suggest that this was a female burial. No obvious additional significance is given to the key, and its placement with the other objects implies that they were the personal belongings of the individual. The identification of the key in this grave as a falcon-motif is not secure, but if it is of this design it may suggest that this key design was not exclusively used by the garrison.

Support for the idea that padlock keys more generally were important identity markers for some Birka warriors is scarce. There are eleven graves that contain both weapons and keys, and of those nine have no female jewellery. Nearly half of those keys are padlock keys - including BJ562 - and all of them are chamber graves. Two of the keys appear to have been placed in close association with the body (BJ985 BJ1125b) although one is probably not where it would have worn in life (see figures 5.87 and 5.68 below). BJ562 is the only grave close to the garrison location, the others are in Hemlanden 1A and 1B. Although it could be that these burials are of garrison warriors it is impossible to do more than suggest the possibility.

#### 5.6.4 Boxes and caskets in the cemeteries

For their study of boxes and caskets in Birka's graves, Greta Arwidsson and Håkan Thorberg (1989) relied on Thorberg's earlier work on the assemblage (1973 A and B in Arwidsson and Thorberg 1989). This work created a typology of four categories A-D (table 5.6). The first three categories were based on reconstructions of three boxes, one from each group. The authors state that group A also used fittings from a fourth box, from BJ832, but there is no record of such fittings either in Arbman (1943, 303-04) or in the Historiska database. There are a few minor errors in the text of this section so it is possible that the grave number was misreported.

Group A	Boxes with metal fittings and/or nails, without a lock
Group B	Boxes with metal bands and a lock
Group C	Boxes cased fully in sheet metal with a lock and slightly domed lids
Group D	Boxes made entirely of iron or wood with copper alloy fittings

Table 5.6 Arwidsson and Thorberg typology of Birka boxes and caskets

Attempting to accurately classify and describe an entire assemblage on the basis of

three partial examples can only produce a very broad system of organisation, and one that is prone to error. The primary characteristic used to create the categories (1989, 114) was whether or not there was evidence for a lock. Boxes without locks were all classified as type A. This approach, which supposed that a lack of surviving evidence means that there never was a lock, has clear flaws. Most of the surviving evidence for boxes is extremely fragmentary and it is clear that a significant number of iron objects have either left almost no trace or are so corroded they cannot be confidently identified. Eleven of the burials with boxes were cremations, and although two of them have surviving evidence for locks, it is possible that the cremation process in other burials may have destroyed some of the metalwork. Finally, there is the possibility that, prior to deposition, some of the more valuable or useful elements of a box may have been salvaged. There is no direct evidence mentioned in the reports for such a thing happening at Birka, and it is intended only as a suggestion.

Another fundamental problem with the definition of type A is that although in practice the classification is directed to differentiate boxes with or without fixed locks, in theory it appears to assert that type A boxes cannot be locked at all. This ignores entirely the use of a padlock on caskets and chests, in spite of the fact that the box on which this type is based from BJ639 (Arbman 1943, 218) has a well-preserved hinged latch and hasp that was clearly intended for a padlock (figure 5.36). On the basis of their classification, Arwidsson and Thorberg argue that women were buried with lockable boxes whilst men were not (1989, 114-15), a conclusion that can no longer be supported.

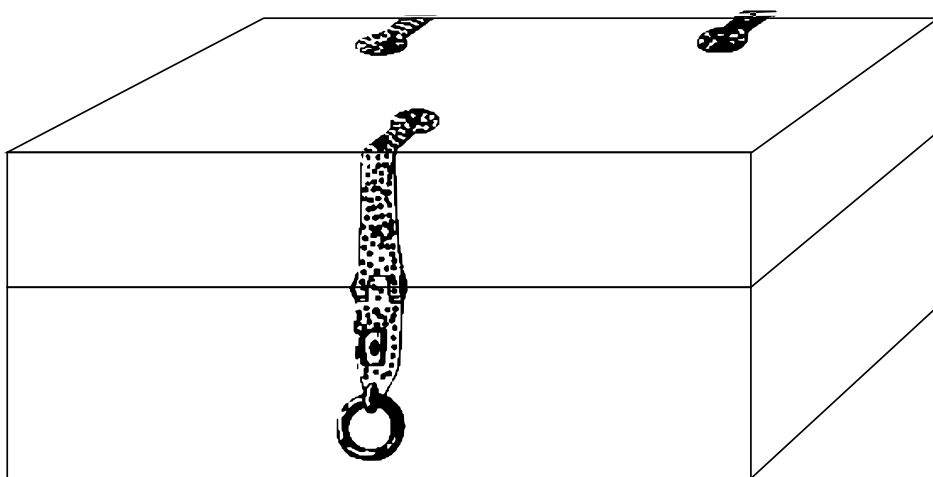

Figure 5.36 Reconstructed casket from BJ639 with hasp and staple for use with a padlock. After Arbman 1943, 218

## 5.6.5 Locks from the Birka cemeteries

The type of locks surviving in the Birka burials was not considered in Arwidsson and Thorberg, although they referred to an earlier published analysis (1989, 116, note 6). There is surviving evidence for at least three types of fixed locks: Z-bend leaf spring locks, which are identified by surviving springs with either two or three leafs; rotary locks with a large, rectangular lock plate and multiple hasps; rotary locks with a triangular or shield-shaped lock plate.

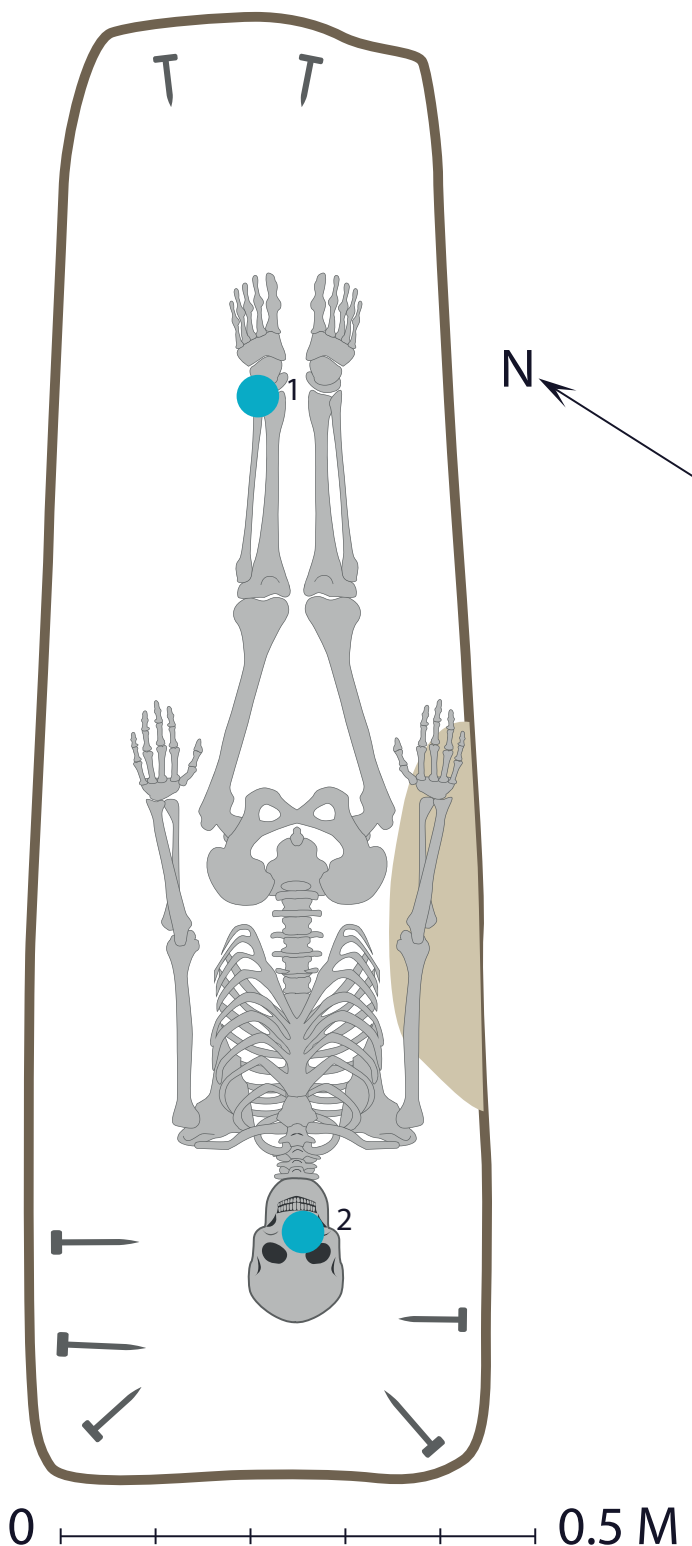

Figure 5.37 Simplified grave plan of BJ110. There were no surviving remains so this reconstruction is only a suggestion, based on the location of tooth enamel. The orientation of the grave reflects Arbman's grave plan (1943, 50 fig 34).

The padlock was the only object found in the burial



There are seven burials with Z-bend leaf spring locks in the Historiska database, and an additional burial (BJ399) found in Arbman (1943, 112-13) which may be a misidentification. Based on surviving springs and keys, two leafs appears to be the most common form. Locks to these boxes are more widely distributed than the associated keys, appearing in five different areas.

The two rotary lock forms cannot be confidently assigned to a key group. Few mechanisms survive, but those that do are of a multi-hasps type described below, and appear to have been opened by group E: 2 keys. There are eight examples of these locks, found in graves near the town ramparts and to the north of the Borg. There appear to be three shapes of key hole: rectangular, L-shaped, and a single example of the modern keyhole shape, but it is possible for any of the group E key forms to have been used with them.

In addition to the fixed locks, there are eight graves containing padlocks. The majority of these are Tomtlund type II box padlocks, but there are two rotary type I examples. In his analysis, Tomtlund (1989, 134) suggested that at least five of the padlocks may have been deliberately broken prior to deposit and that this lock type may have had a symbolic use in grave constructions. One of the padlocks was found in a of child's grave, and another was in the fill of the grave (BJ110, figure 5.37 above). The padlock from another grave BJ737B may have also been placed in the fill as it is not included on the grave plan (Arbman 1943, 262, fig 213) Only one of the graves, BJ562, discussed above, also contained a key. These graves are widely distributed geographically, but may still represent a commonly shared practice, possibly related to a need to lock or seal a particular grave either during or after the burial took place.

## A. Lock mechanisms

The bolt shape on the locks from graves BJ854 and BJ639 is distinctive, with a straight rod on one end and a u-curve on the other (figure 5.38). This allows a single action from the key to lock or unlock two hasps. These hasps are, by necessity of the design, external, which makes them vulnerable, as evidenced by the damaged chest from Haithabu discussed in the previous chapter. But it also gives the chest greater apparent security and is visually impressive.

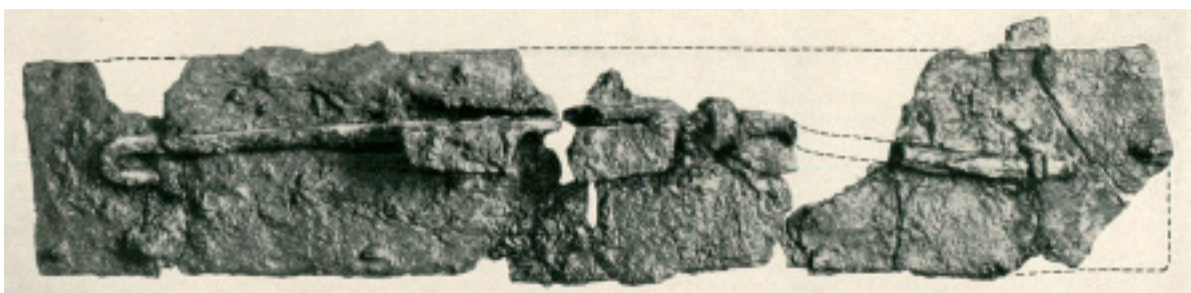

Figure 5.38 Lock bolt from casket in grave BJ854 from Arbman 1940 plate 264

The chest found with what appears to be a blacksmith's hoard in Mästermyr, Gotland (figures 5.39, 5.40) uses the same lock form. It originally had two hasps, and is suggested to have been opened with a three-peg key of group E: 2 (Arwidsson and Berg 1983, 8). Although the chest shows no sign of decoration, that does not necessarily mean that the lock was not a relatively expensive object. As a blacksmith, the owner would not only have been able to make a more elaborate and complex lock, but may have chosen to do so in order to demonstrate their skill and craftsmanship.

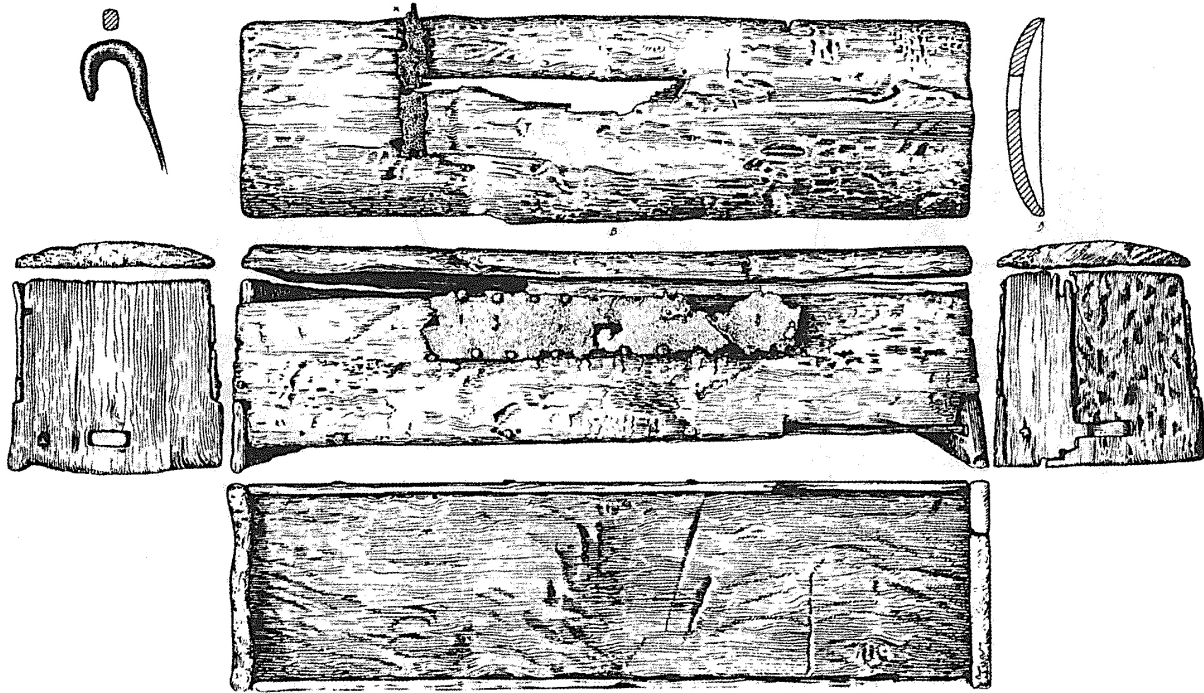

Figure 5.39 Mastermyr chest  
from Arwidsson and Berg 1983, plate 15

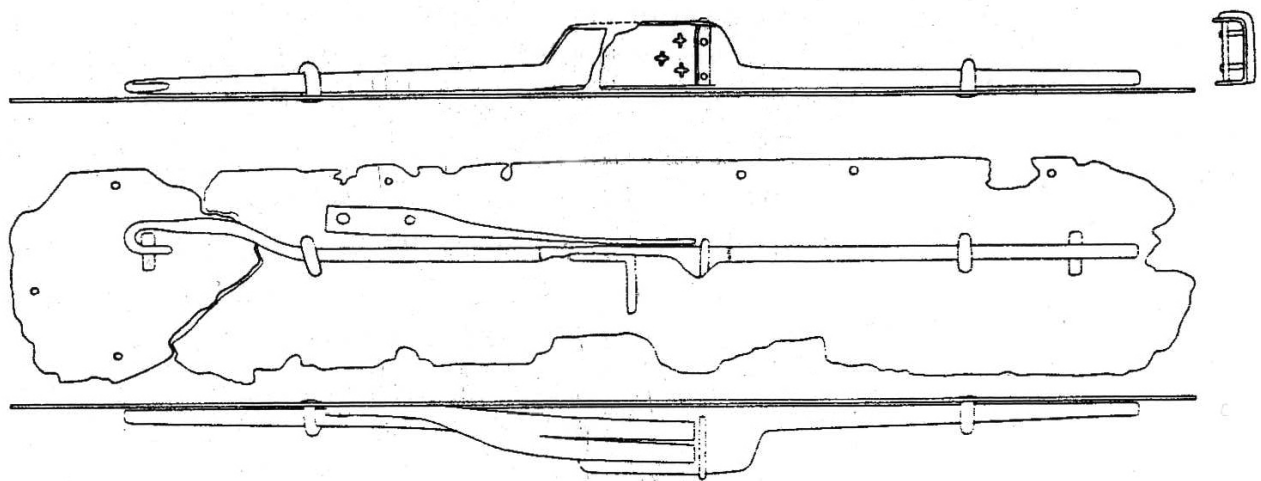

Figure 5.40 Lock from the Mastermyr chest  
from Arwidsson and Berg 1983, 8 fig 2

Although, as discussed above, there are some English examples of keys that may be related to this lock type, the locks themselves do not appear to have survived. Rotary locks that have survived in chest burials in York (Kjølbye-Biddle 1995 506) and Winchester (Biddle et al 1990 1018) are secured with a single hasp. Where the Scandinavian chests use leaf springs to hold the bolt in place, The English locks have a curved spring shaped out of a thin length of iron (figures 5.41, 5.42). Two locks from Seine-Saint-Denis have a very similar mechanism (Linlaud 2014 308, 309)(figure 5.43 below), suggesting that English and French craft workers were drawing from a shared knowledge base.

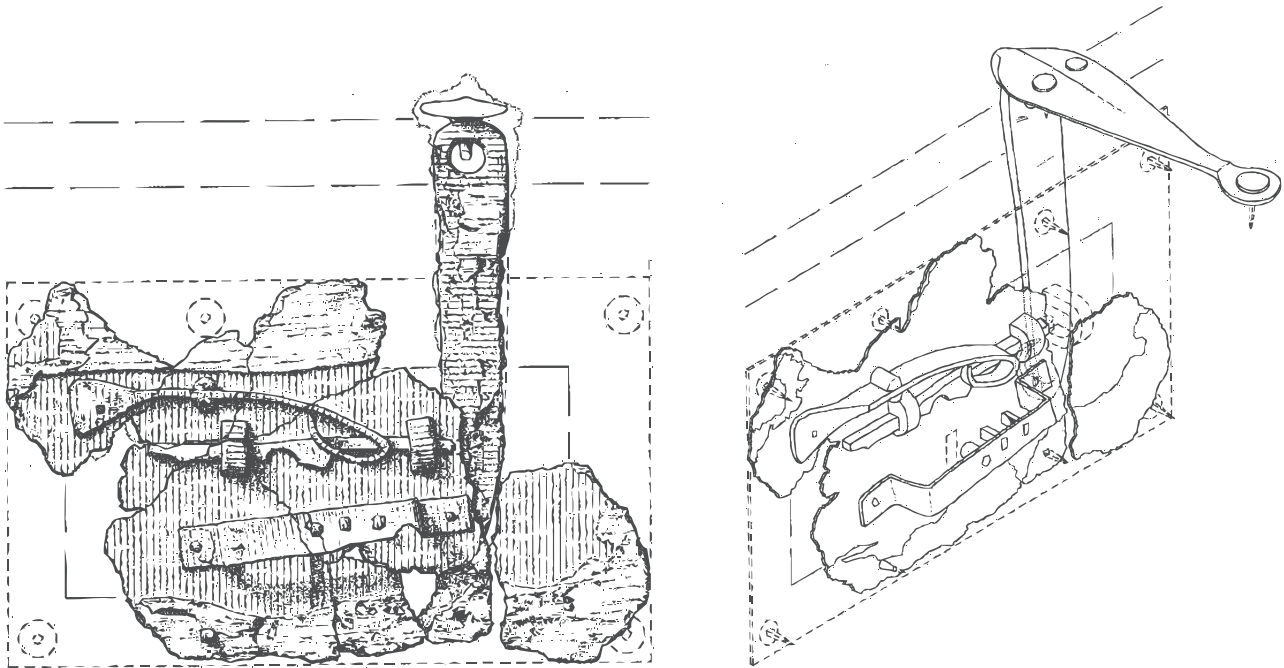

Figure 5.41 Lock from Gr105, York Minster after Kjølbye-Biddle 1995, 506, fig 176

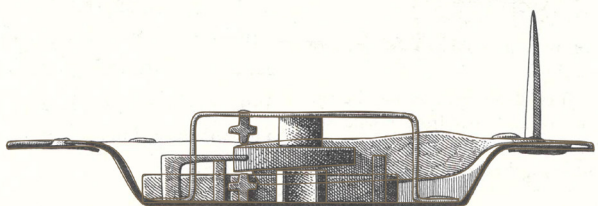
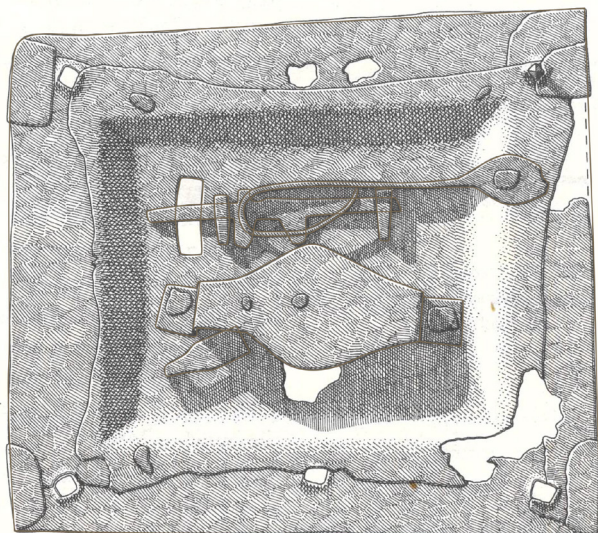

Figure 5.42 Lock from Winchester from Biddle 1990, 1018 fig 329

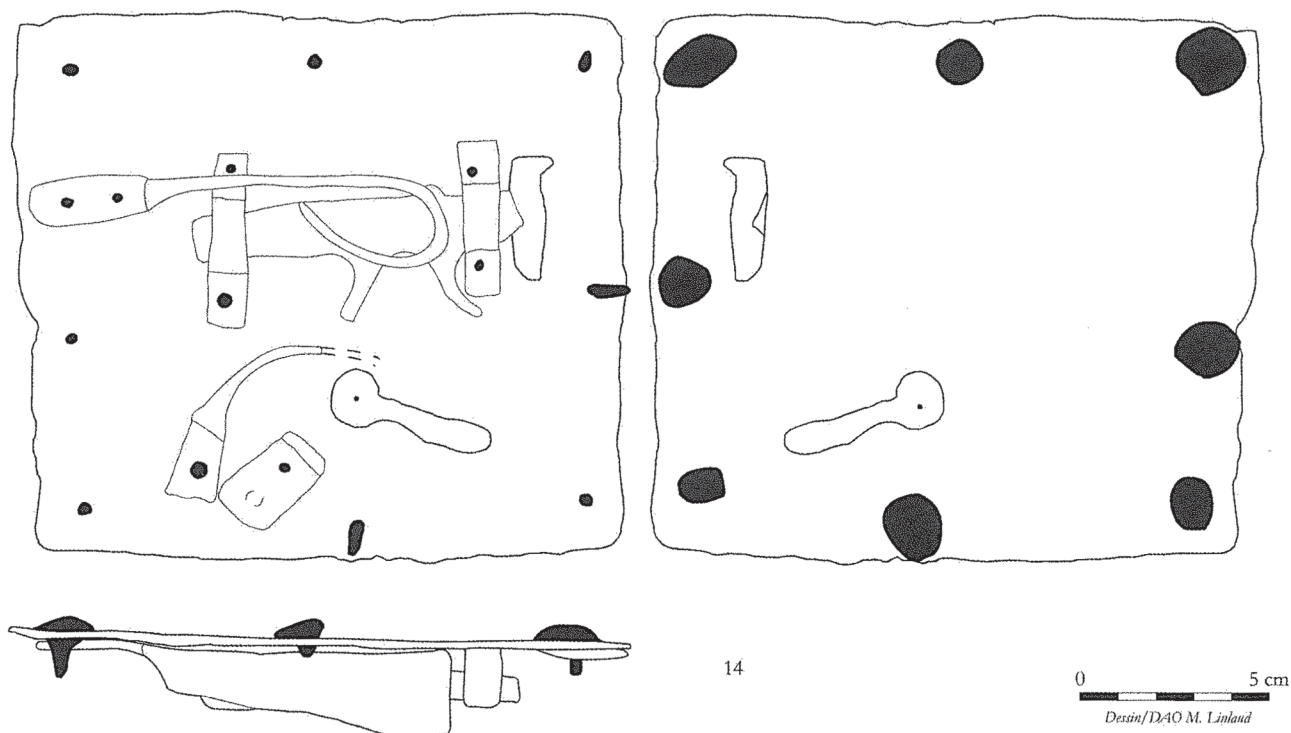

Figure 5.43 lock from Seine-Saint-Denis  
from Linlaud 2014 308, fig XLVII: 14

The fact that there is consistency in some of the key morphology although the mechanisms are distinctly different is intriguing. It suggests that the visual rhetoric of keys was important enough to remain stable while the function of the locks themselves could be adapted. It also suggests that there was both a consistent base of knowledge exchange that maintained fidelity of form in keys and also sufficient technical skill to allow for innovation and change.

More broadly, the differences in these mechanisms shows that although the essential basis for lock technology remained unchanged, relying on the same components of bolts, springs, and keys, there is also considerable variation in how these components are combined and used. These variations could help establish both a more specific timeline of lock development and a better understanding of the network of knowledge exchange among lock makers.

## B. Sea chests

Only a few of the boxes from the cemeteries were sufficiently well preserved to allow for reconstruction. Among them was one that is particularly striking. The box from BJ865 was covered with metal plating, held in place with diagonal rows of decorative dome-headed tacks, a form that is reminiscent of the construction of Roman *arca*, discussed in Chapter Two. The box was locked with three hasps with animal heads at the terminus. The domed lid had a single handle, although whether it could be used to transport what must have been

a relatively heavy box is unclear. Arbman's reconstruction (1940 plate 263: 1a) suggests that the box was splayed on the sides (figure 5.44).

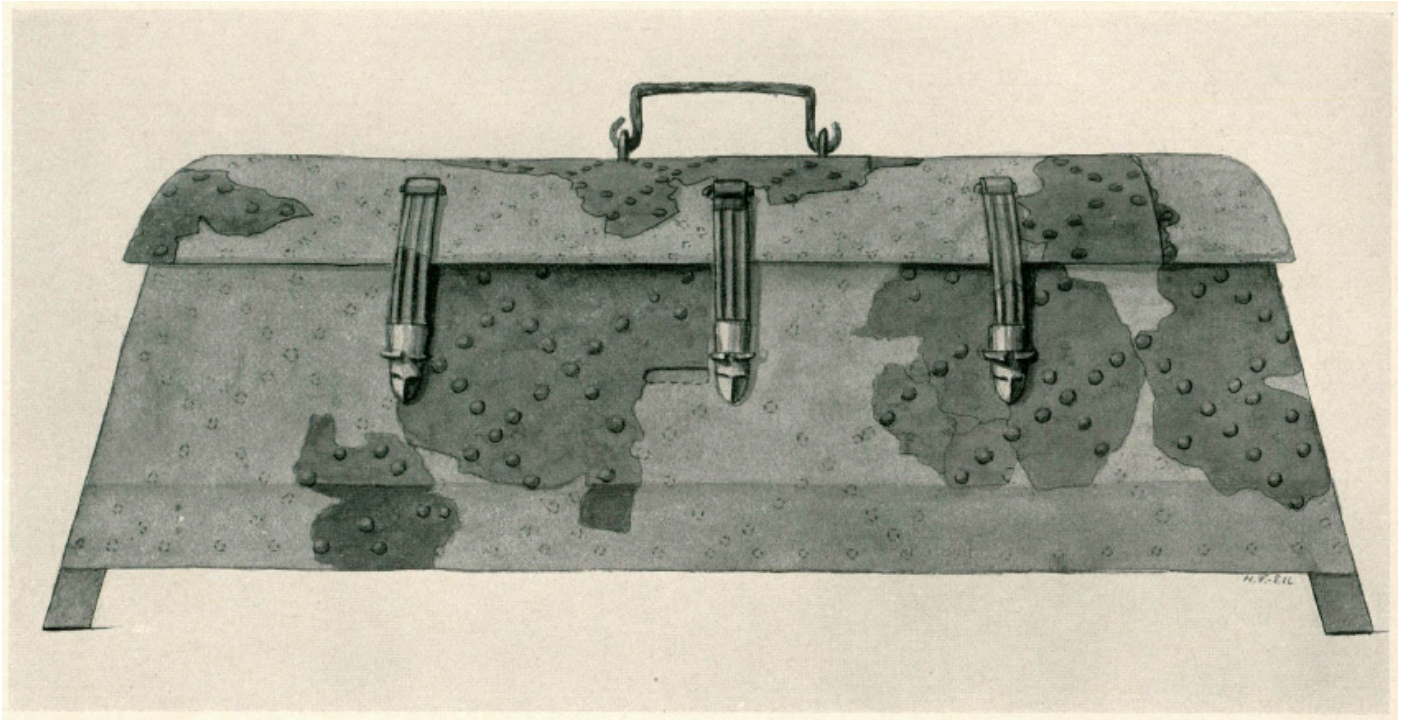

Figure 5.44 Reconstruction of the casket from BJ845. Arbman 1940, 263: 1a

This reconstruction was probably informed by the similar metal-clad chest found in the Oseberg ship burial (Christensen et al 1992, 91). Although the method of cladding and the dimensions of the chests differ, both objects are clearly referencing a shared sensibility in the three decorated hasps and the lavish use of metal (figure 5.45 below). A third chest, from Kammergrab 5 in Haithabu (Arents and Eisenschmidt 2010, 417) also draws on these distinctive characteristics. Its metal plating more closely parallels the Birka chest, although the stud pattern differs. The hasps are an interesting mix of elements seen in the Oseberg and Birka chests, suggesting that there was space for interpretation of the form (figures 5.46-5.49 below). This chest has a further elaboration not surviving on the other two - a keyhole guard that locks the central hasp in place (figure 5.50: A below) and has to be slid aside using a handle disguised as a stud (figure 5.50: B below) (pl 119: 24a; 251-57).

Like the Birka box, the Haithabu example has been reconstructed with the sides splayed, although the surviving metal fittings do not make it completely clear that this was the original form (416 pl 118). However given the close resemblance to the Oseberg casket, it is possible that two, if not all four, sides were angled.

The chest discovered in the Haithabu harbour mentioned in the previous chapter was also splay sided. Sven Kalmring (2010b, 433) has identified this form of box as being a sea chest, pointing out that it was sturdy enough to act as a seat, and that its stable base that helped keep it from tipping. The circumstances of the find support this identification as its location make it likely that it was thrown off a ship (Kalmring 2010a, 283).



Metal clad chests from the Oseberg ship burial (left) and Haithabu chamber grave 5 (centre). The relationship between the decorative hasps of Haithabu (bottom left), Birka (bottom centre), and Oseberg are clear

Figure 5.45 © Museum of Cultural History, University of Oslo/CC BY-SA 4.0/Svein Kojan og Morten Krogvold

Figure 5.46 Arents & Eisenschmidt 2010, 416 Pl 118

Figure 5.47 Detail of Arents & Eisenschmidt 2010, Pl 119: 24a

Figure 5.48 Detail of casket hasp from BJ845. Arbman 1940, 263: 1b

Figure 5.49 Detail of Oseberg hasp, Christensen et al 1993, 91

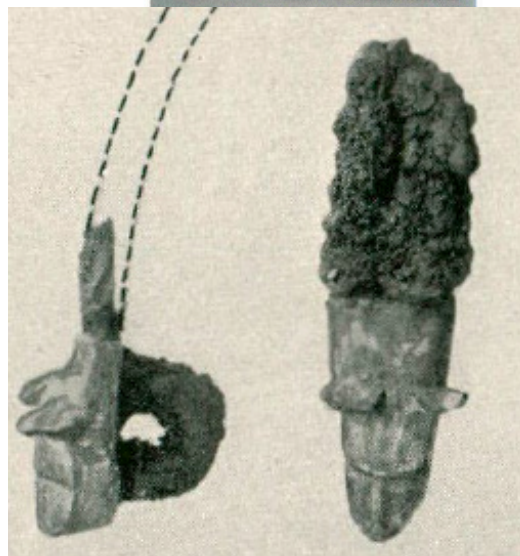
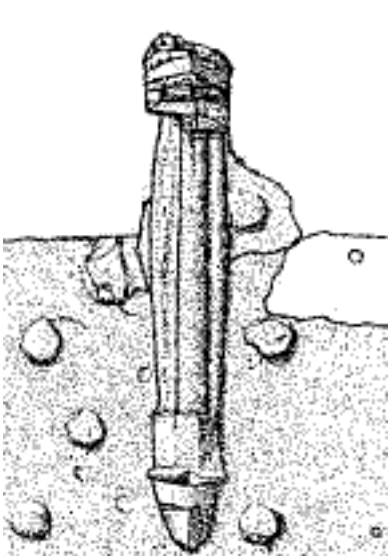
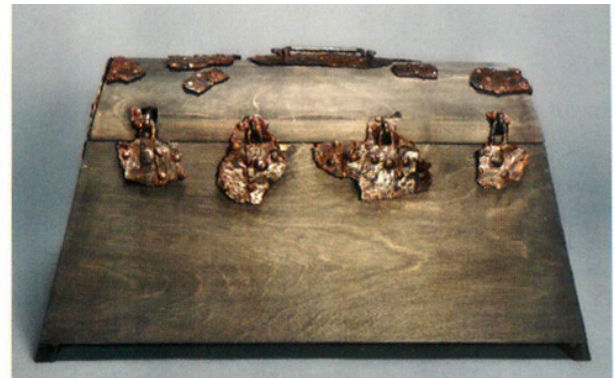
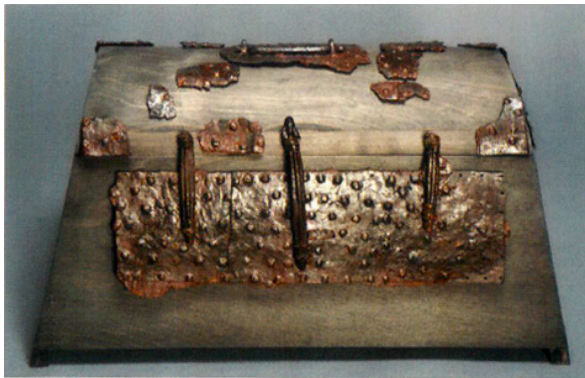

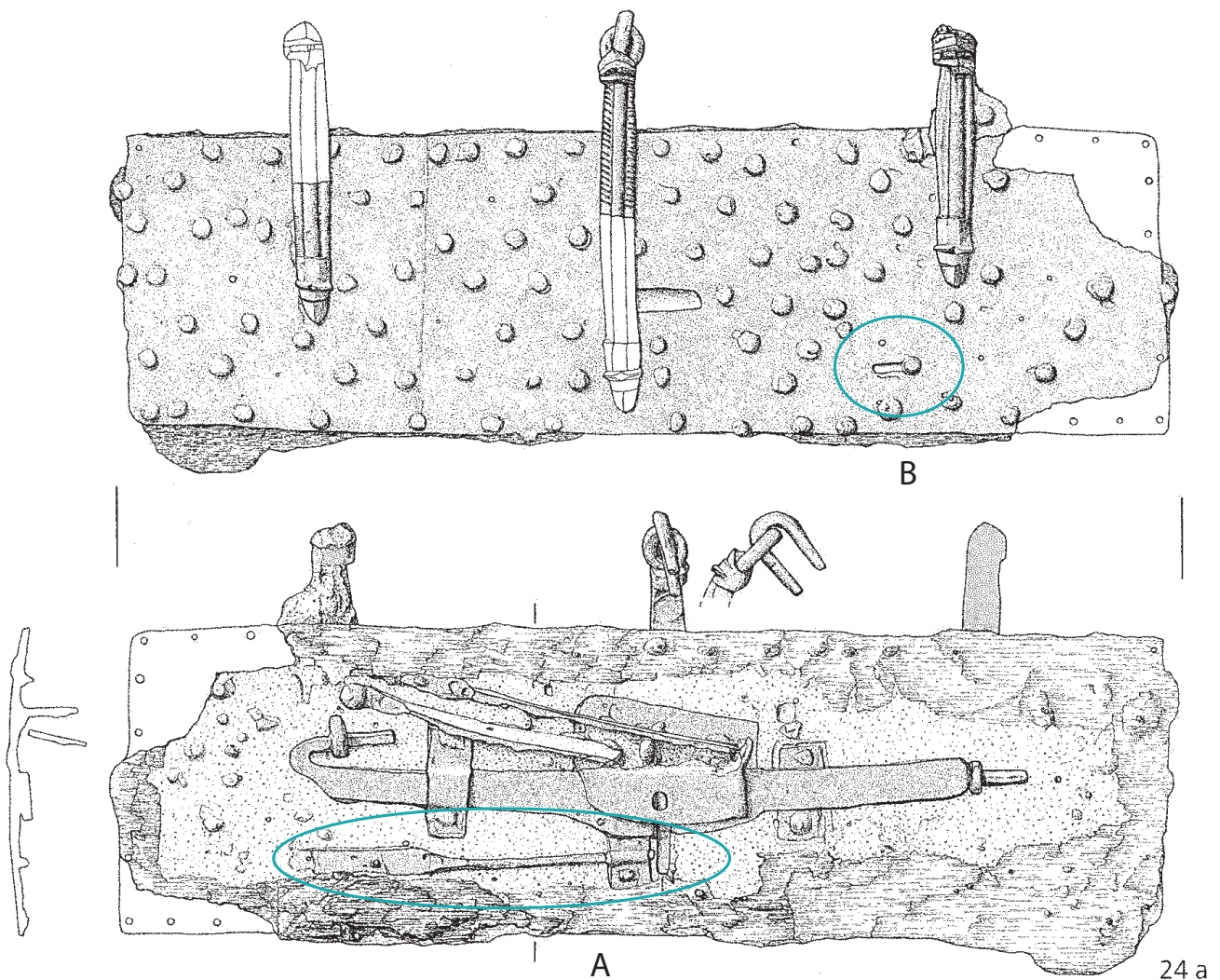

Figure 5.50 Lock mechanism and hidden keyhole guard from the casket in Haithabu chamber grave 5 after Arents & Eisenschmidt 2010, Pl 119: 24a

If the reconstructions of the Haithabu and Birka chests are accurate, it is possible that these also were sea chests, possibly used by wealthy traders. Or it could be that the form was referencing the simpler chest, but giving it heightened importance through the use of elaborate decoration. And possibly these three burials have a common link, not only in the form of the chests but in the symbolism they provided.

### 5.6.6 Discussion: Group C variants and distributions

The distribution of key types and the evidence from boxes and caskets in Birka show evidence of both persistence and innovation in form and technology. The evidence suggests a tendency towards persistence in form in key types, although variations are evident, combined with changes in lock technology, evidenced by the fact that keys of very similar form are used for a wide range of lock mechanisms. The material from Birka allows the opportunity to explore the characteristics of that phenomenon and to provide a possible reason that the practice of locking technology developed in this way.

As discussed in earlier chapters, group C keys, originating in the Roman period, appear in two primary forms: asymmetric L-form keys with the bit set at a right angle to one side of the stem, and symmetric T-form keys with teeth to either side of the stem. The dog-leg variation may also be from this period, but as mentioned above, it appears in the English dataset in only one example, from Coppergate, York (Ottaway 1992, 674).

Specific key forms, including the dog-leg variant, appear to have acquired cultural significance during Migration period. In Norway key bundles, the small sets of symbolic key forms, shifted from having multiple simple hooks (possibly versions of group G) to featuring several varied key forms including both the standard L-form, and the dog-leg variant (Kristoffersen 2004a, 292) (figure 5.1 above).



Figure 5.51 Hanging key from Sande, Norway from Vedeler et al 2018, 12 fig 5

Practical, although beautifully made dog-leg keys appear in late Migration era burials, sometimes with an accompanying casket, such as the 6th century grave from Sande, Norway (Vedeler et al 2018) (figure 5.51). It is possible that the relatively late appearance of the symbolic and the utilitarian forms indicates that this key and its accompanying lock(s) were imported at this time. However having both the symbol and the tool be adopted in such a short period is somewhat surprising; it seems more likely that the locks had already been in use, and that a cultural shift in practice or belief created an additional or heightened meaning to them that was expressed through the display of both the icon and the object.

The dog-leg form is sometimes assumed to be primarily late Migration era (Vedeler et al 2018, 11-13), found at a number of sites including Gotland (Stenberger and Klindt-Jensen 1955 1148), and Norway (Kristoffersen 2004a). However the evidence from Birka suggests that it had a much longer use life. The keys in the Birka burials appear to have been in use around the time of deposit as three of the keys were found with caskets with surviving locks that correspond to the key form (Arbman 1940, Pl 267-68). The same form is also found in burials in Ribe (Fevle 2006, 372, 434, 440), in three burials in Kaupang dated between 850-950 (Stylegar 2007, 104-126) and is one of the 21 identifiable keys from Trelleborg (Nørlund 1948, XXIII). It seems clear that



this particular form continued in active use in some areas of Scandinavia through the 10th and possibly into the 11th century (figures 5.52-5.54).

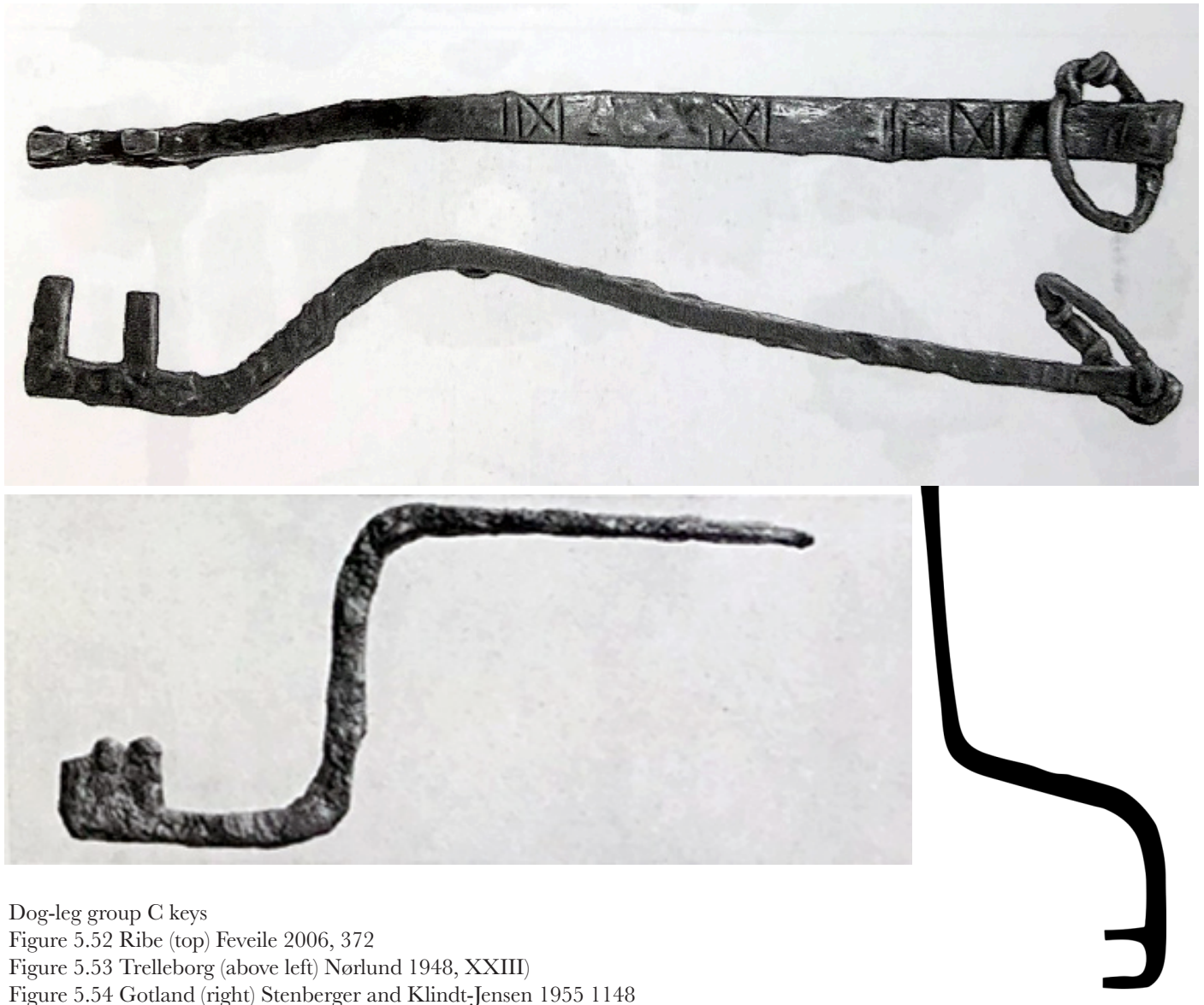

Dog-leg group C keys  
 Figure 5.52 Ribe (top) Feveile 2006, 372  
 Figure 5.53 Trelleborg (above left) Nørlund 1948, XXIII)  
 Figure 5.54 Gotland (right) Stenberger and Klindt-Jensen 1955 1148

The more standard L-form key from Birka, two in grave assemblages and at least eight from the settlement, appear to have two different variants, with a longer (A) or shorter (B) distance between the stem and the first tooth of the bit (the throat). Six of the settlement keys and one from the cemetery assemblages (BJ607) are of the A variant. Because these keys are individually made, a certain amount of variation is expected, but the difference is noticeable (figures 5.55-5.59 below).

To better understand this apparent difference, the Birka keys were compared to a set of L-form keys from England. Nineteen keys from the Roman period and ten from the early Middle Ages were measured, and the ratio of the length of the entire bit to the length of the throat was calculated and compared to those from Birka (figure 5.60 below). The Birka assemblage clearly has a different distribution, with a skew towards higher ratio values.

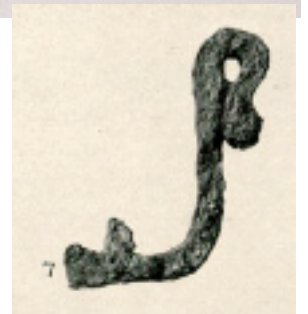
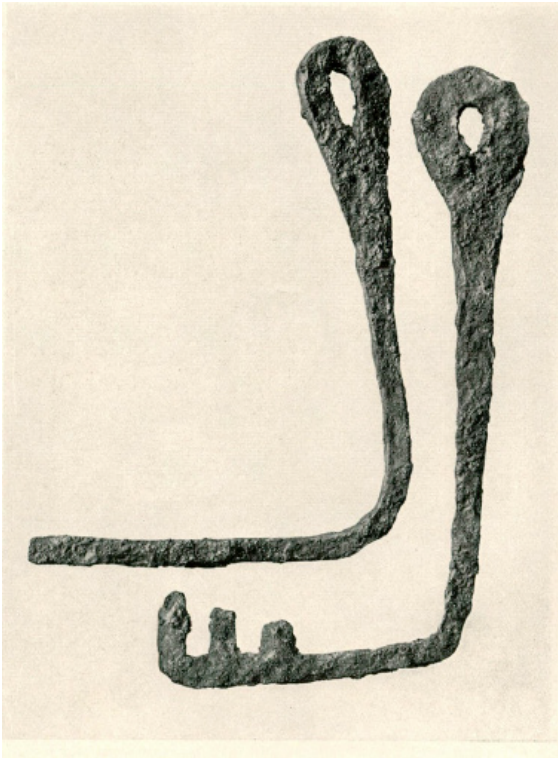

Examples of the varying throat depth (the measurement from the stem to the first tooth of the bit) of l-form group C keys found in Birka. Clockwise from top left.

Figure 5.55 Arbman 1940, Pl 275, 8-9

Figure 5.56 SHM 5208: 405

Figure 5.57 SHM 13921:10

Figure 5.58 Arbman 1940, Pl 275, 7

Figure 5.59 SHM 5208: 402

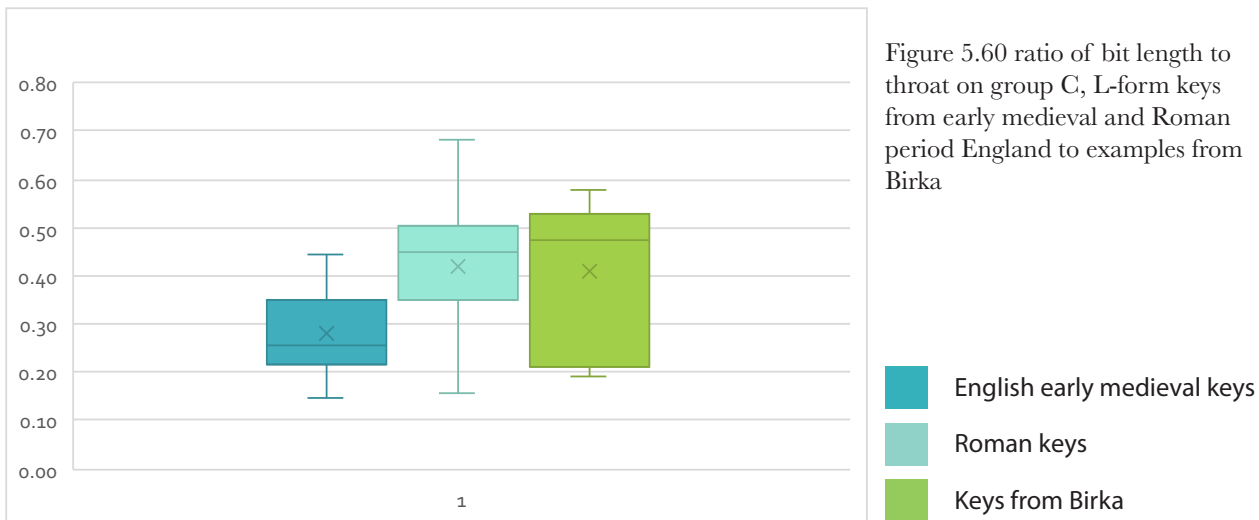

Figure 5.60 ratio of bit length to throat on group C, L-form keys from early medieval and Roman period England to examples from Birka

Obviously, the dataset is too small to definitively state that the suggested variants A and B are actual differences in shared practice. But the length of the throat in the key is related to the dimensions of the lock it fits, so rather than representing an accidental or unconsidered difference it is likely that this is an intentional choice informed by a sense of the correct or best practice.

The two T-form keys from the settlement are also varied. The first is a small, well made key that would have opened a box (figure 5.61), while the other is large, with four rather than the usual two teeth, and may have opened a door (figure 5.62). Almost certainly the lock mechanism for these two keys would have been different, so it is possible that the C-group keys in Birka represent at least three and possibly as many as five different lock technologies.



T-form group C keys from the Black Earth

Figure 5.61 (above) SHM 5208: 409

Figure 5.62 (right) SHM 5208: 410

As varied as these keys are, the variations all occur within set parameters. As with other key types, the stem and terminus are often altered, sometimes with elaborate decoration. The dog-leg keys vary in the angle of bend in the stem; several copper alloy examples from the Gotlands museum have sharp 90° angles (figure 5.63) while the Birka

examples, like the small key from Sande, are more gentle. There is clearly an interest in display and individuality, but the basic elements of the key - the distinctive bit with its large teeth - remains the same.



Figure 5.63 Example of extreme angles on a dog-leg form type C key. Gotlands Museum GFC271\_

The variety of locks that are used with these keys show that there is no lack of skill, knowledge or innovation among the craftworkers. A lock from a chest used in a burial in Lejre, Zealand (Andersen 1969) has elements of both the English and the Swedish mechanisms. The bolt for the lock is double ended for a two-hasps system like those from Birka and Haithabu used with group E keys, but is configured for use with a T-form key like those from England (figure 5.64). So there is evidence for the intermixing and development of ideas in lock mechanisms beyond slight variations. This could be useful for understanding the structure of knowledge exchange among craftworkers in Scandinavia.

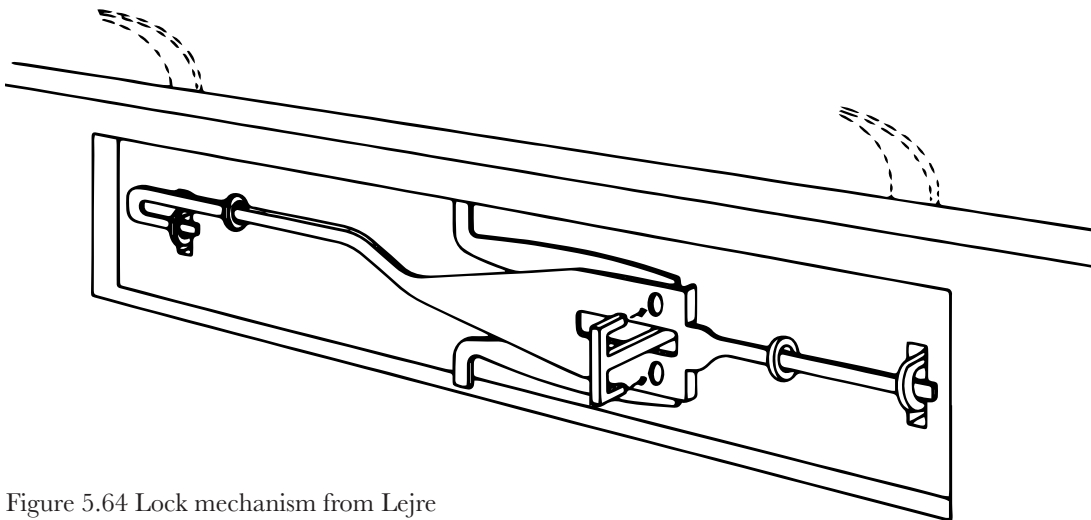

Figure 5.64 Lock mechanism from Lejre Gr1160 with a double hasp system comparable to Birka examples, but opened with a T-form group C key. After Andersen 1969, 74 fig 80

There is, then, evidence for both a considerable resistance to change in regards to the essential design elements of the keys and an interest in and ability for innovation and adaptation in the mechanism of the lock itself. The form of the key was shaping

and restricting the choices made about the technology of the lock. The apparent lack of development in lock technology was not due to a lack of craft skill but was a result of cultural pressures drawn from concerns that were external to basic pragmatic goals of greater security, efficiency, or economy.

Because the resistance to change is located in morphology, there are two factors that may have been involved: reference, and recognisability. Repeating a form that had been in use for centuries allows the object to participate in the narrative of that past and bring it into current use. Unlike the deliberate revival of past forms, such as Noël Adams's (2010) suggestion that the Sutton Hoo shoulder clasps were referencing elements of Roman design, these objects participate in, and through physical representation reinforce, the idea of an unbroken, extended past with all of the implications of authority and heritage that gives.

The recognisable shape also served as an effective and efficient means of establishing an environment of mutual understanding. In a community where, as Steve Ashby (2015) has argued, travel had significance above basic economic concerns, the successful navigation of contact between communities was essential. Among groups that participated in the same network of exchange, the use and display of objects with a shared design base did more than signal the identity of the owner. Through that action it also establishes the identity of the people and space around it in relation to the owner. These objects helped to establish a mutually understood context of roles, intentions, and expectations.

In addition to this social weight, there is the accrued symbolic weight that the keys and their locks develop. Some of that may be widely shared, including possible roles and identities such as the Lady of the House, but others will have emerged from smaller, local events and beliefs. In the characteristics of grave constructions, which is a product of both everyday beliefs and the exceptional practices demanded by the reaction to death, it may be possible to find evidence for the existence and expression of these additional meanings.

### 5.6.7 The Birka cemeteries

We now turn to an examination of the appearance of keys in the Birka cemetery areas, beginning with the general characteristics of each area. There are 1208 excavated burials recorded at Birka, although it is estimated that there may have at one time been over 3,000 burials. The extensive grave fields were primarily excavated by Hjalman Stolpe from 1871-1895, and it is these excavations that provide the boundaries and names of many of the cemetery areas (map 5.8).



Map 5.8 Cemetery areas of Birka

These areas are traditionally divided into seven large zones (Gräslund 1980):

1. Hemlanden (Homeland). East of the settlement; divided into Hemlanden A-F, and Hemlanden
2. North of Borg. Lying between the fort and the settlement; divided into A and B
3. Borg. Inside the fort
4. South of Borg. Extending south of the fort and divided into a number of sub-areas
5. Grindesbacka. South of Hemlanden
6. Kärrbacka. East of the South of Borg cemetery
7. Ormknös. Southeast of Hemlanden

Stolpe further subdivided these broad areas for convenience, producing fifteen named zones partially on the basis of land ownership at the time of his excavation. Later excavations have added another eight designations for a total of 23 in the Swedish History Museum database. Stolpe suggested at the time of excavation that the burials south of the Borg were not separate and that the settlement was entirely surrounded by a fairly continuous grave field. This suggestion is supported by recent LIDAR scans which, when overlaid with existing plots of the excavated burials (Gräslund 1980), begin to show the density of the original cemeteries, and provide some idea of the number of burials yet to be excavated (map 5.9 below).

How this field developed is not entirely clear, and the complexity of that development is evident from these scans. Several graves have been identified as likely dating from the Vendel period, prior to Birka's founding and were probably associated with established farmsteads (near Ormknös). These pre-existing burials would likely have acted as physical and conceptual landmarks which, along with the underlying topography, and the developing built environment, would have provided a structure for the evolution of the cemetery. However cultural ideas that may have influenced the choice of grave location, such as social role, family association, or belief affiliations, are not as easy to identify.

Of the 23 named areas, fifteen contain enough graves for statistical analysis. Although some of these areas have burials that tend to share common characteristics, others have significantly more diversity. The less diverse areas tend to be further away from the settlement (the Black Earth), the fort (Borg), and harbour, with the exception of Hemlanden 1B which lies directly next to the town rampart. The Hemlanden area has been identified by

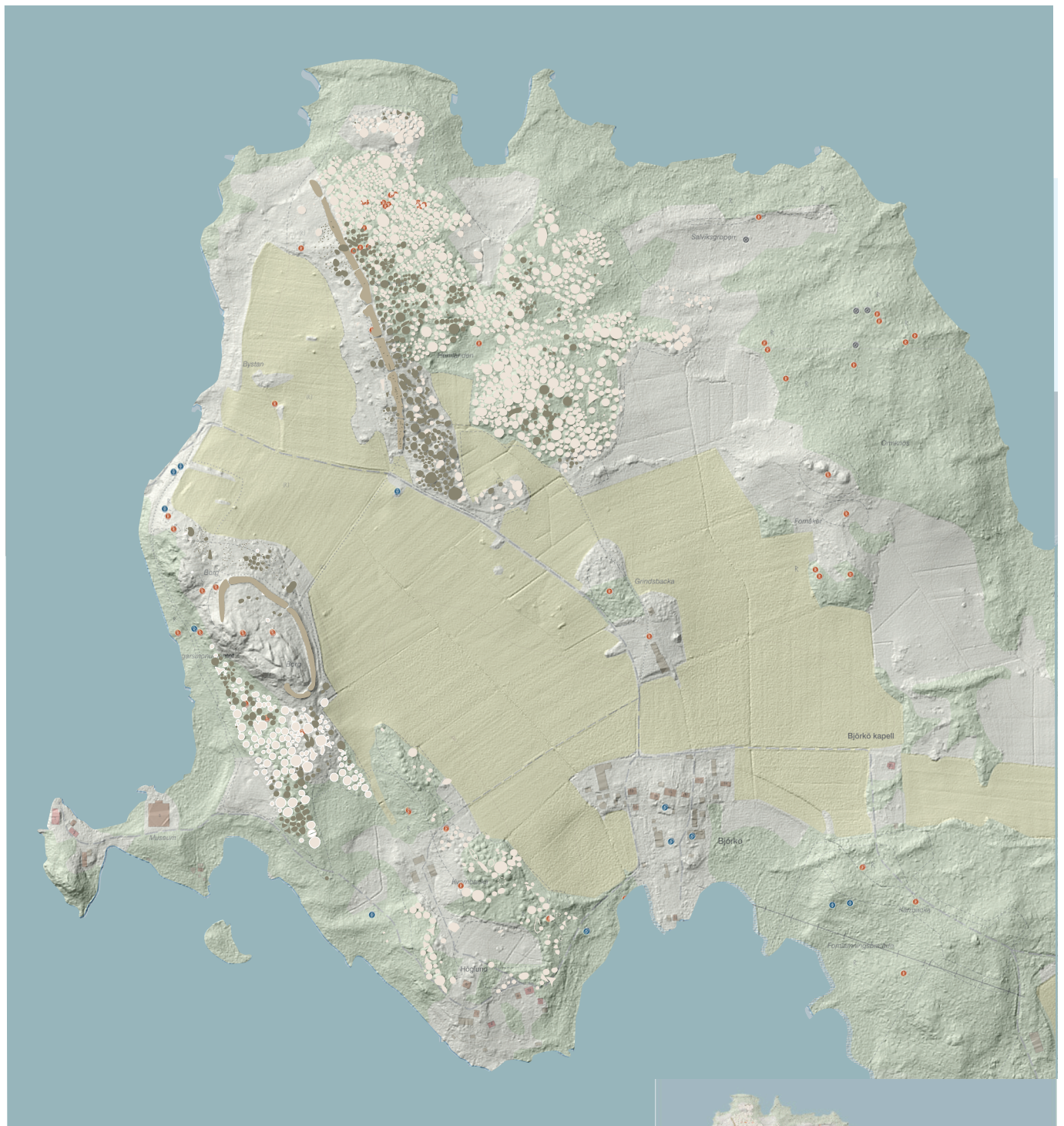

- Burials found in Graslund
- Burials with known identification
- Defensive structures

Map 5.9 Composite map of the island of Björkö (right) and the cemetery and settlement areas of Birka (above).

The map consists of three layers. A lidar map is the base layer, with a topographic map at reduced opacity laid over to show present day features and markers for recognised archaeological sites. These were made from maps available through the Riksantikvarieämbetet's Fornsök database (<https://app.raa.se/open/fornsok/>). These base maps were then overlaid with a trace of the defensive features and the excavated burials found in Graslund (1980).



Gräslund (1980) as attracting burials throughout Birka's active life, so over time and with a population containing and in contact with various cultures, these popular and significant areas naturally acquired a more diverse character, but this diversity itself is not evenly distributed. A full analysis of the range of these differences is beyond the scope of this project, but information about the basic characteristics of grave construction is discussed here to provide a basis for comparison between Birka's cemeteries and later the other sites used in this study. The use of gendered objects in assemblages is also discussed in order to understand the extent and nature of gender expression through objects, as it is traditionally understood.

The following descriptions of the Birka cemetery areas move roughly North to South, beginning with the outlying areas of Hemlanden and ending with the cemetery groups of Kvarnbacka 4A-D (map 5.8 above). Only cemeteries with at least one recorded key are discussed, and only those with more than five excavated burials.

### A. Hemlanden 1D

There are 51 excavated graves in Hemlanden 1D; 46 are mounds, 71% are cremations. There is only one chamber grave and one coffin recorded. This area has only a single key, from type group B, in an inhumation burial with a mound construction (BJ1044). There is no grave plan for this burial, but the key is reported as having been found .45 metres from the east end of the grave pit, which was 1.6m long. There were no other grave goods found (Arbman 1943, 435).

This area has very few burials with gender-associated objects; 78% of burials only have objects such as combs, knives, and whetstones. Arrows are the only male object type in this area, found in five burials (8%) while the female object types, in 12% of graves, are slightly more diverse, with both jewellery and textile tools, including a loom weight. Because the key from BJ1044 is the only one in the area, and because it is apparently the only grave good included, it can be argued that it served a symbolic purpose, perhaps locking the individual into the grave, or else allowing them to unlock and enter the world of the dead.

### B. Hemlanden 1E

Hemlanden 1E is a relatively large cemetery, with 130 excavated burials. 85% of those are cremations in mounds, but there are several graves containing both inhumations and cremations which may be a fluidity in practice, evidence of environmental factors effecting burial choice, or possibly the importation of previously cremated remains to include in a later burial. There are five burials identified as boat graves, but the vast majority of



constructions in this area are mounds without additional noted features. Four key graves occur in this area, two of them in cremation mounds (BJ916 and BJ935), but the other two in less common settings: a boat cremation (BJ96) and an inhumation in a coffin (BJ919).

As in Hemlanden 1D, 2/3 of the burials in this area contain no gender-associated objects. In the 1/3 that do, there is a wider range of male-assigned object types than in Hemlanden 1D, including a range of weapons as well as horse gear. Both jewellery and textile tools are also represented, found in 9 burials. Two of the keys are found with male-associated objects, one with a shield (BJ96) and one with horse gear (BJ916). Both are cremations, but the key was found in association with both the cremated remains and the other elements of the assemblage. Another cremation with a key included also had a needle and needle case (BJ935). The coffin burial had no strongly gendered objects (BJ919, figure 5.65).

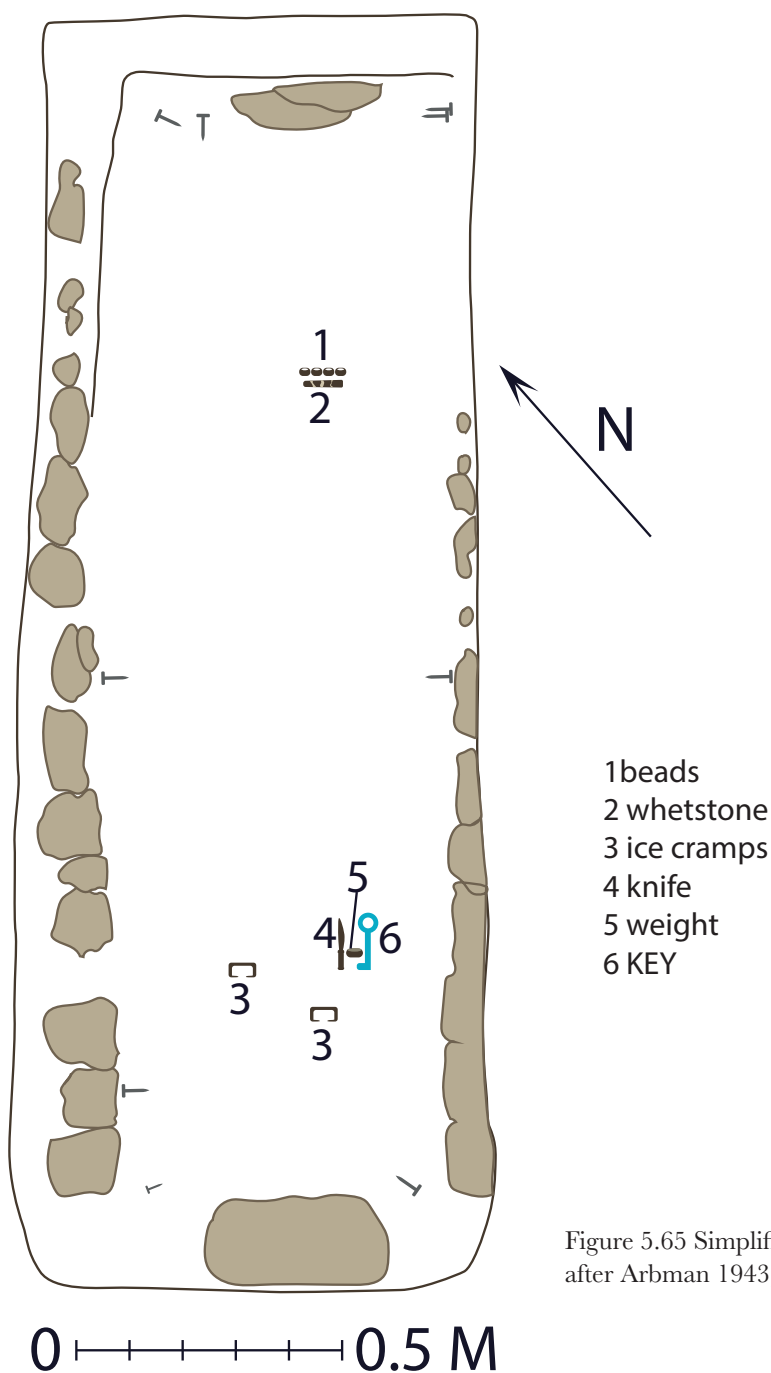

Figure 5.65 Simplified grave plan of BJ919, after Arbman 1943, 324, fig 272

## C. Hemlanden 1F

Hemlanden 1F has the fewest excavated burials of the six Hemlanden areas, with only 35 recorded graves. It is also the least diverse in burial type. Aside from BJ204, which was only tentatively identified as a grave by Stolpe (Arbman 1943, 82), all of the graves are cremations, and 97% of them are mounds. There is only one key in this area, from the only identified boat burial (BJ212).

There is a similar distribution of gender-associated objects as that seen in Hemlanden 1D with 5 burials containing jewellery and 3 containing arrows or shields. Only one grave had a textile tool, a needle case. The assemblage with the key included a single oval brooch and a box.

## D. Hemlanden 1A

This cemetery area clearly differs from the areas previously discussed, and from Hemlanden 1B below, in its distribution of burial types and grave constructions. Approximately 70% of the 151 excavated burials are inhumations, and only 40% of the graves have a mound as the primary construction, while the number of chamber tombs, over 20%, is striking. There are 17 graves with a total of 22 keys in Hemlanden 1A, two of them with two (BJ950 and BJ983), and one with four (BJ1083). Graves with keys in the assemblage include a considerably higher number of chamber tombs, almost 60%, and slightly more coffins. The burial type distribution is broadly that of the area as a whole.

71% of the key graves had female object types, including textile tools. One grave from the area has a key in an assemblage that has no female objects, and holds a bundle of arrowheads (BJ974). Unfortunately there is no location given for the key in this grave.

Another burial, BJ965 (figure 5.66 below), containing a box and two keys appears to be the grave of a female. However it also includes a horse with its harness, often considered indicative of a male burial, . Three other burials in the area also have both female and male object types as part of the assemblage, (BJ944, BJ958, and BJ943). The first of these is an extremely large chamber grave with a horse burial. Although the human skeletons have completely disappeared, it does look as though there may have been three bodies originally and perhaps one of them was female, although this is conjecture. The other two graves are single, with well preserved skeletons. So there is some evidence for burial assemblages that mix gender associations within one assemblage.

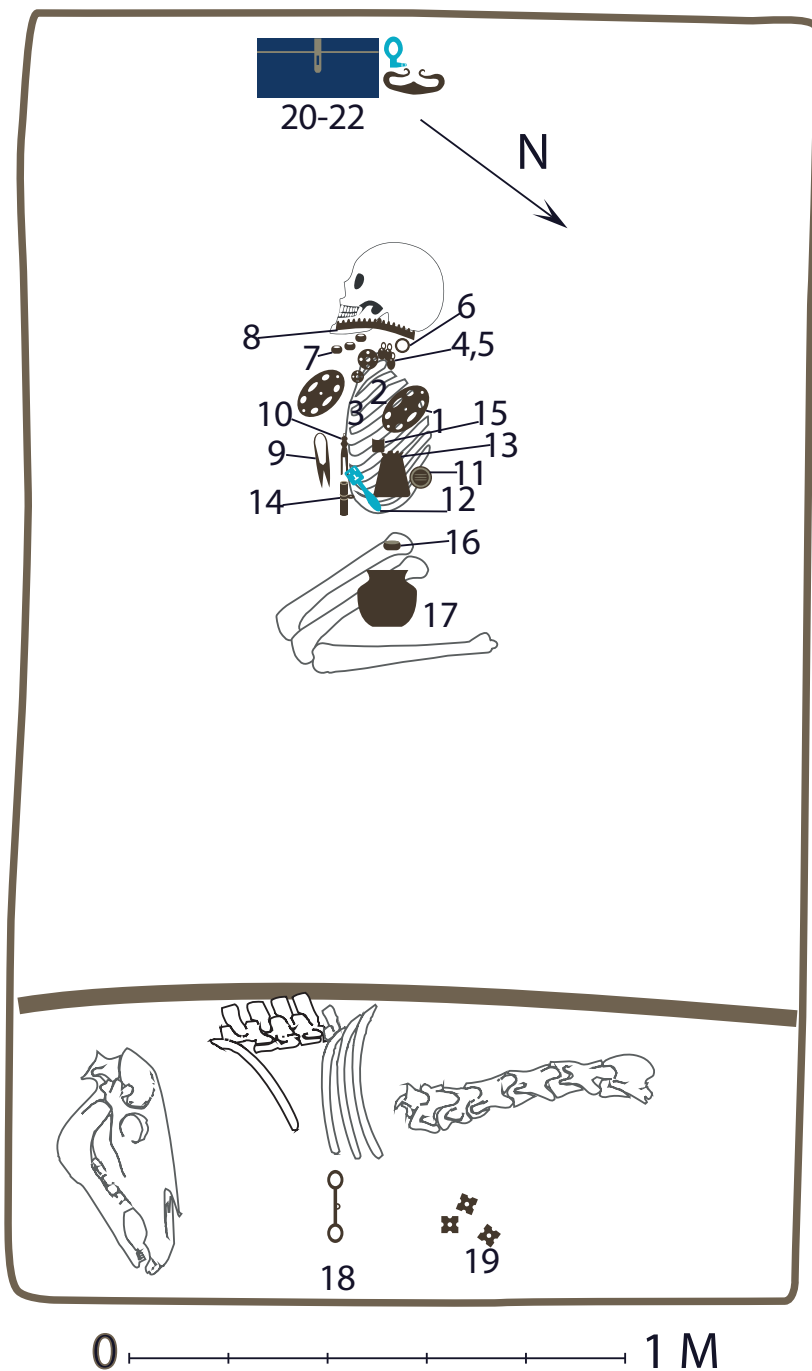

- 1 oval brooches
- 2 large round brooch
- 3 small round brooch
- 4, 5 pendants
- 6 silver ring
- 7 beads
- 8 silver band
- 9 scissors
- 10 tweezers
- 11 silver dirham
- 12 KEY
- 13 purse
- 14 needle case
- 15 barrel shaped sandstone
- 16 weight
- 17 ceramic pot
- 18 bridle
- 19 horse harness
- 20 box fittings
- 21 fire steel
- 22 KEY

Figure 5.66 Simplified grave plan of BJ965, after Arbman 1943, 390, fig 342

### E. Hemlanden 1B

In terms of grave constructions, this area as a whole broadly resembles the cemeteries that are further removed from the settlement areas. 75% of the 233 recorded graves are mounds and a similar percentage of burials that have an identified burial method are cremations. There are 14 graves with keys in Hemlanden 1B, about 6% of furnished burials in the area. The graves with keys show a striking difference to the distribution of the cemetery as a whole, with only 50% of them with a mound construction and only 43% being cremations. The difference is most striking in chamber graves. Keys are found in a third of all chamber graves in the area.

Eight of the grave assemblages with keys also had female-associated objects, including both jewellery and textile tools. There were two key graves with weapons, BJ850 and BJ1125B, and it is possible that they were related to each other in some way. Both are inhumations in chamber graves, both have arrows, spears, and shields in addition to the keys, and in both burials the keys are placed to the lower left of the body (figures 5.67 and 5.68 below). The keys were, however, of different types. The remaining five graves did not have any strongly gender associated objects.

There are a fairly large number of boxes in this area, four of them in graves that also have keys, and another eight without keys. The latter also have a lower percentage of cremations and of mound constructions than the rest of the area. Both the box graves and the key graves tend to have large assemblages, the richest being the four graves that have both objects, for which the average assemblage size is 14.5. In the area as a whole, furnished burials have an average of 4.5 objects and over 80% of them have three or fewer object types. Grave assemblages with keys are, in fact, among the largest in the area; even the grave with the fewest object types (BJ893) has a large collection of 84 beads.

## F. Hemlanden 1C

The distribution of burial types and grave constructions is roughly similar to that of Hemlanden 1A with 61% inhumations and 49% mound constructions found in the 168 recorded graves. Chamber burials are also high in number in this area, 18% of all constructions. There are 24 graves with keys in Hemlanden 1C, with a total of 29 keys. Graves with keys do not follow the general area distribution: there are far fewer mounds and far more coffins. Burial types also diverge, although less significantly, with more inhumations and fewer cremations.

About half of the key graves contained female object types with both jewellery and textile tools represented. Another third had assemblages without strong gender associations. One burial with only non-gendered and male object types (BJ714) was a cremation and, according to Stolpe (Arbman 1943, 248), the key was placed in the cremation vessel with the cremated remains. The key was from type group E. Grave BJ708 contained a shield and spear and a considerable amount of horse gear. Two keys were placed at the foot of the grave in association with a box (figure 5.69).

In terms of burials with both male and female associated objects, there are only two examples. Grave BJ750, which will be discussed in more detail below, was a double burial, and although the skeletal remains have not survived, the placement of jewellery and weapons make it reasonably certain that there was a woman placed on the left hand side of the grave and a man on the right. The key in this grave is, however, placed at the

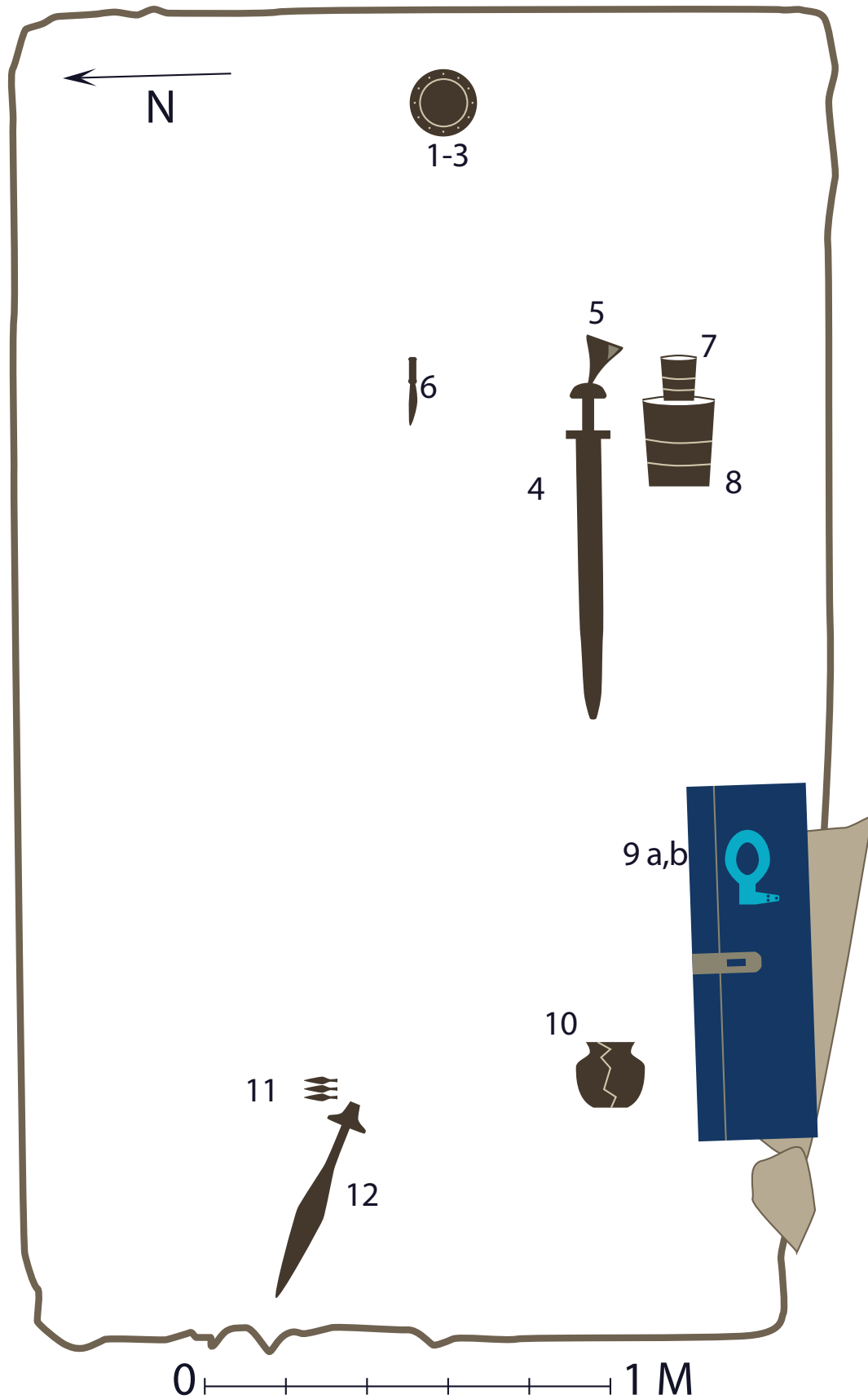

1-3 shield boss and fittings  
 4 sword  
 5 glass beaker  
 6 knife  
 7, 8 two nested buckets

9 a casket fittings  
 9 b key  
 10 pot sherds  
 11 arrowheads  
 12 spear head

Figure 5.67 Simplified grave plan of BJ850, after Arbman 1943, 324, fig 272

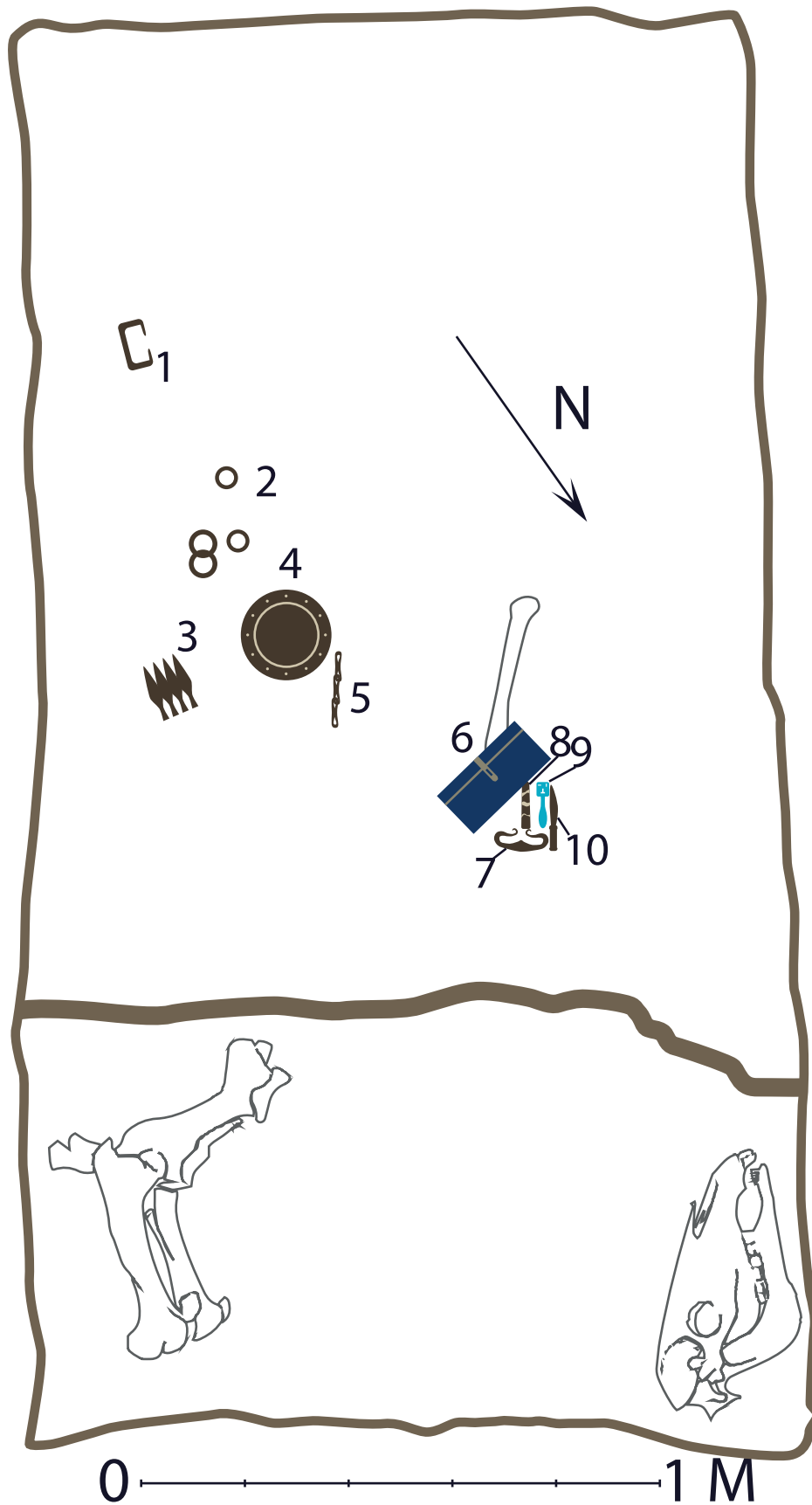

- 1 ice cramp
- 2 iron rings
- 3 arrowheads
- 4 shield boss
- 5 iron chain

- 6 casket fittings
- 7 fire steel
- 8 whetstone
- 9 padlock key
- 10 knife
- spearhead - placement un

Figure 5.68 Simplified grave plan of BJJ125B, after Arbman 1943, 465, fig 434

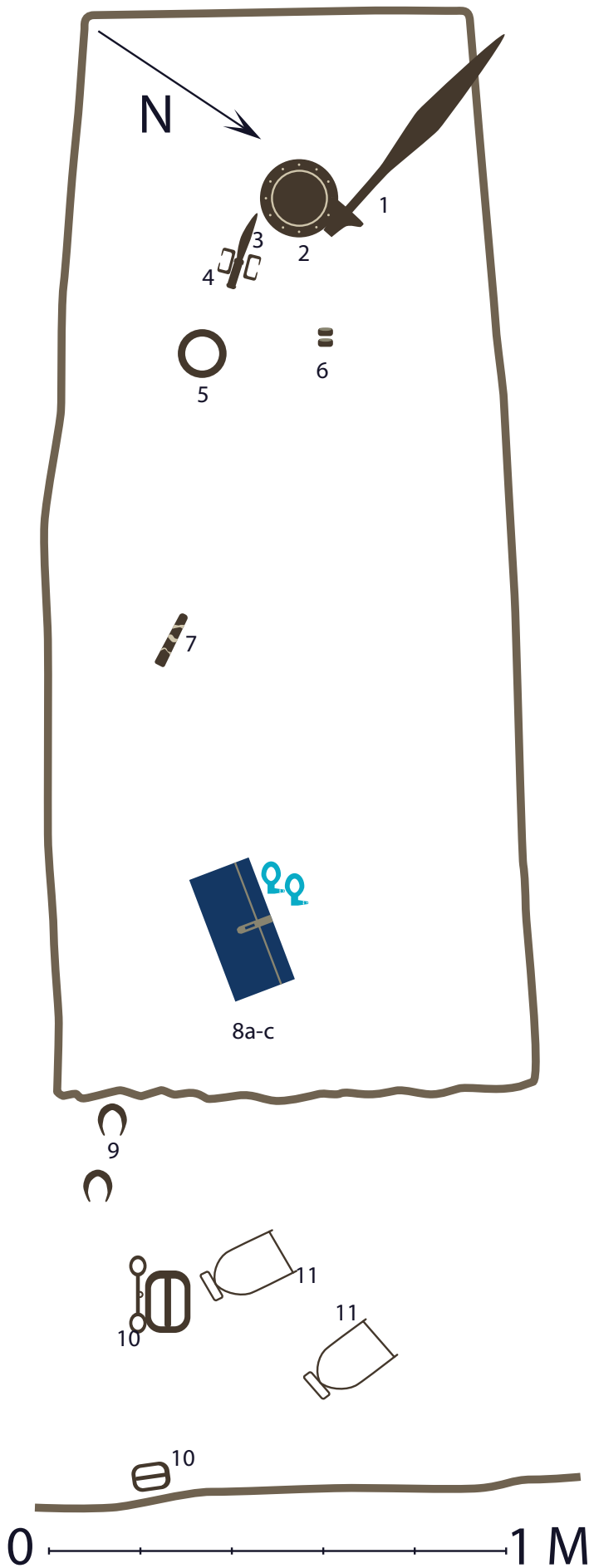

- 1 spear head
- 2 shield boss
- 3 knife
- 4 ice cramps
- 5 large iron ring
- 6 round weights
- 7 whetstone
- 8 a-c casket fittings and 2 keys
- 9 horse shoe nails
- 10 horse harness
- 11 stirrups

Figure 5.69 Simplified grave plan of BJ1708, after Arbman 1943, 243, fig 193

head of the chamber, on the right-hand side, and in association with a collection of tools which would suggest that it is part of the male assemblage. In Grave BJ823, a chamber burial that was later incorporated into the settlement defences, there are two apparently non-contemporary burials. One assemblage with male-identified objects is placed at the top edge of the grave along with a skull, while the second assemblage, containing female jewellery and a key among other objects, is directly associated with a fairly complete set of remains. The key is clearly part of an intentional construction (figure 5.70 below)

The distribution of gender-association in this area is different to that seen in Hemlanden 1A, with considerably more burials that have no gender associated objects and fewer graves with female objects. Most of the graves that do have such objects have a large number of them. Seven of the graves have scissors, multiple beads, and at least two oval brooches; a number of these have additional brooch types as well and many contain weights which are among the objects Emma Nordström has suggested may be involved in a particular social role she calls the Trading Lady of the House (2014). All of the keys that are in chamber graves are found with gender-associated objects, while those without such objects are in graves with a range of construction and burial types.

## G. North of Borg 2A

This area, with 132 excavated graves, is almost entirely inhumation burials (96%), with a large number of coffins and at least 29 chambers. The homogeneity of burial type in this area is striking, particularly in comparison with the other large cemeteries in Hemlanden, but it is interesting that there is a relatively even distribution of construction methods unlike the cemeteries situated somewhat further from the settlement fortifications. There are five graves with keys, all of them inhumations, with three different constructions noted, including a chamber burial.

Almost 40% of the graves in this area had female-associated objects. Oval brooches are particularly common, found in 44 graves, but there are also a large number of scissors - 27 from 24 graves. There are only about half as many burials with male object types but the majority of these held more than one weapon. A large number of the graves, 49, do not contain gender-linked objects.

In this area there are several graves that have both male- and female- identified object types but that do not appear to have been double burials. In many of these there is a distinction made between groups of objects with some being closely associated with the body and others placed at the perimeter of the grave, similar to BJ965 (figure 5.66 above) for example, but in others there is no difference made. The majority of these burials are in chambers and they would have been highly visible in the landscape both during and after the active period of construction. Three of the four graves that, based on the placement of



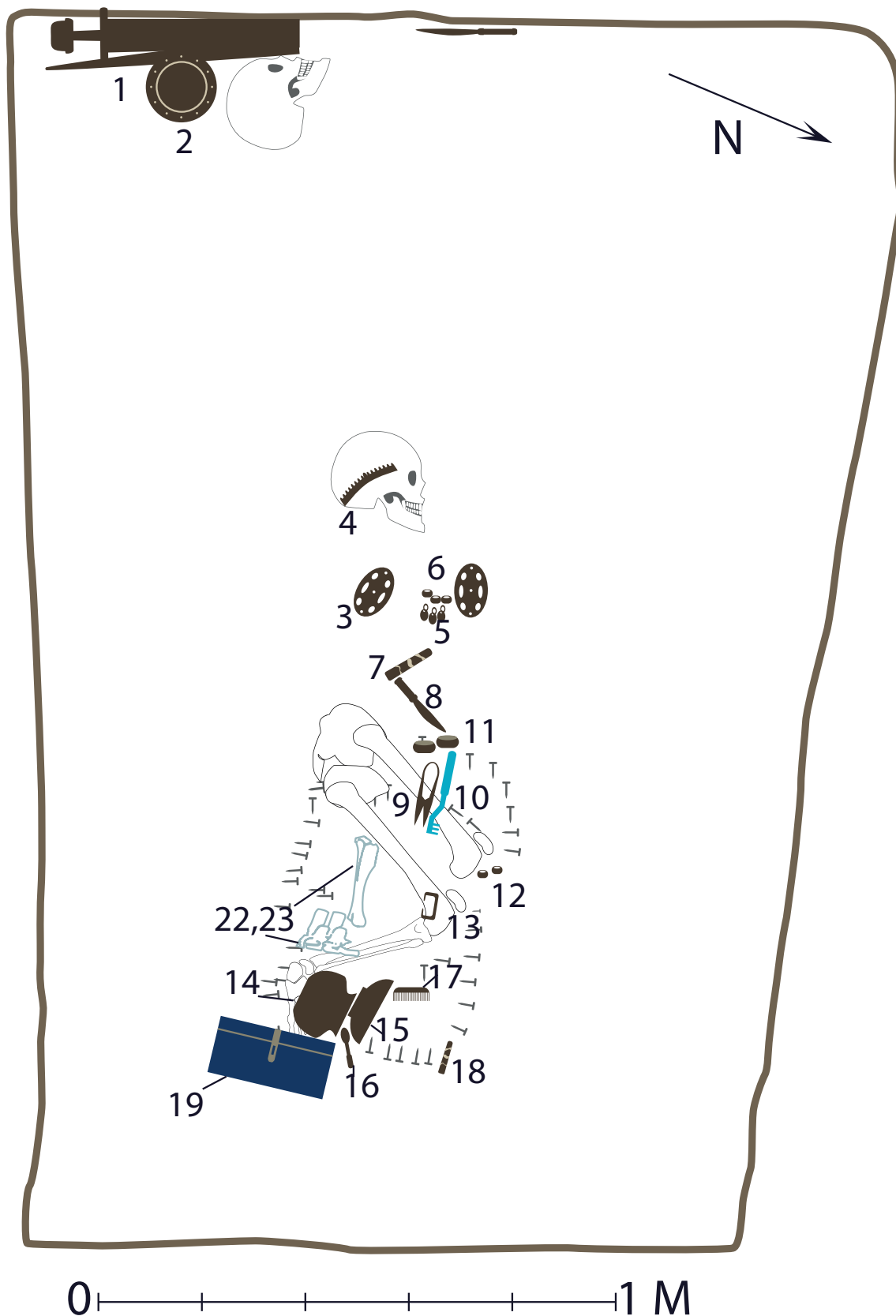

- |                 |                |                      |
|-----------------|----------------|----------------------|
| 1 sword         | 7 whetstone    | 13 ice cramp         |
| 2 shield boss   | 8 knife        | 14 pot               |
| 3 oval brooches | 9 scissors     | 15 bowl              |
| 4 silver band   | 10 group C key | 16 spoon             |
| 5 pendants      | 11 weights     | 17 comb              |
| 6 beads         | 12 beads       | 18 whetstone         |
|                 |                | 19 iron box fittings |

Figure 5.70 Simplified grave plan of BJ823, after Arbman 1943, 296, fig 245

brooches and other jewellery, appear to be female have a single arrow associated with them, a characteristic that is found in other burials and may be similar to the spears that Gräslund (1980 30-31) identified as having been driven into the grave walls, possibly as part of an Odinic ritual (Nordberg 2002). The fourth has a large set of gaming pieces and a padlock. It seems clear that in this area there were factors involved in the creation and disposition of objects that, under some circumstances, made the intermixing of object types desirable.

Of the five key graves, one was found in grave with both male- and female-associated objects (BJ504). Although the skeletal remains have not survived, the location of the assemblage suggests that the key was placed on the upper right of the body near an oval brooch and a pair of scissors; at the foot of the grave was a spear (figure 5.71 below). The assemblages of the other key graves all contain a pair of oval brooches, and three of them have large collections of beads.

## H. North of Borg 2B

The division between this area and North of Borg 2A is not clear, but there are some differences between the distribution of burial types and object types that may relate to choices the community made about where to site the graves. Of the 61 excavated graves 82% are inhumations, with 9 cremations. The most frequently seen construction type is a coffin. Chamber and simple flat graves appear at approximately the same rate. There is also a single boat burial. Of the four keys found in this area, three are in chamber graves, the fourth in a coffin burial.

19 assemblages had female-associated objects, and 8 had male object types. As in North of Borg 2A, there were a number of graves with intermixed assemblages containing objects from both gender associations. Object placement suggests that three of these are males, and one is female. There is, again, evidence for complex factors that shaped these constructions, of which gender may have been one but not necessarily the most important.

Three of the graves with keys in this area are found in the same approximate area, although not directly next to each other and two of them may be related, sharing a number of object types. In both of these graves (BJ585, BJ639) the key is associated with objects on the edge of the burial (figures 5.72, 5.73 below), but the positioning of both objects and remains is notably different. The fourth key grave in this area is the burial discussed above, BJ562, containing a falcon-type padlock key and padlock, with knives and an arrow dispersed in the fill.

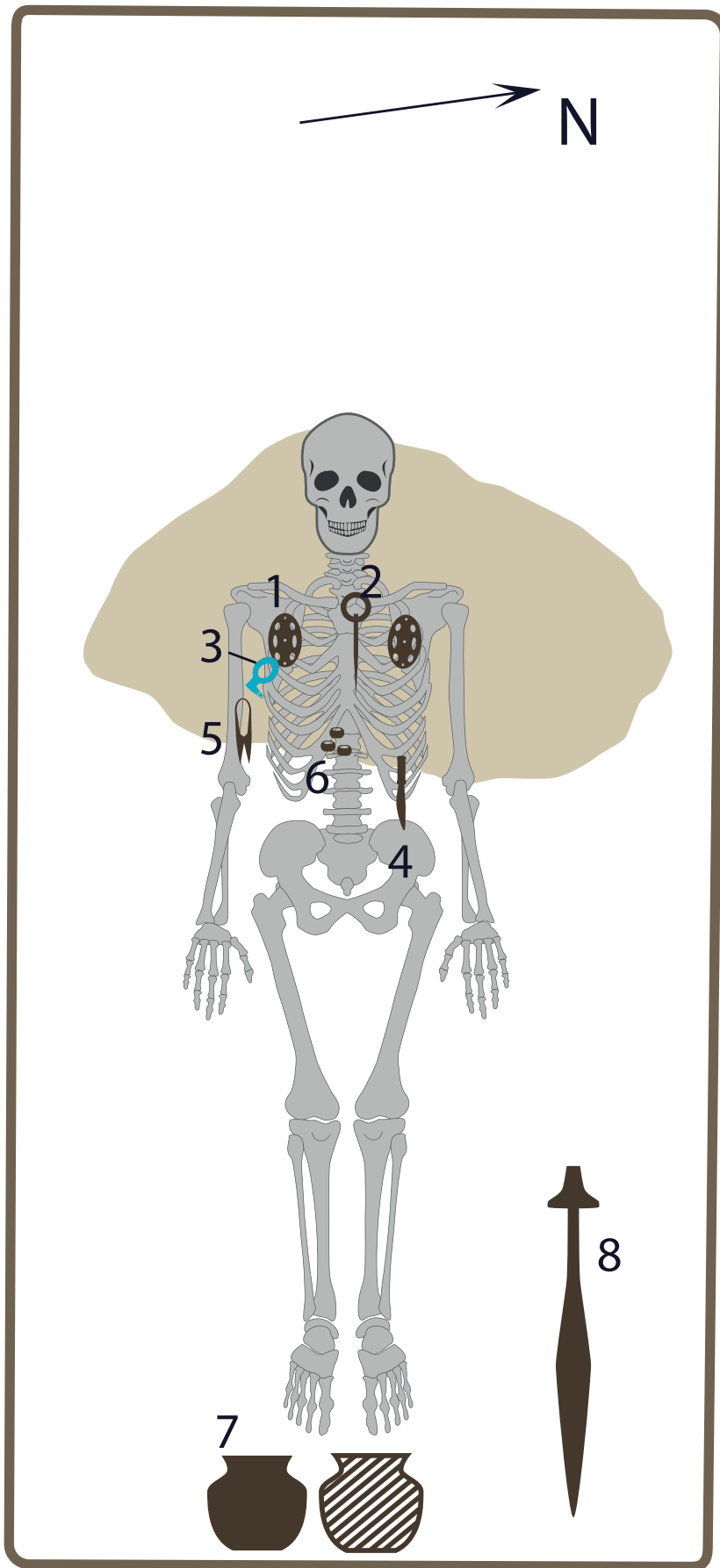

- |                 |                                  |
|-----------------|----------------------------------|
| 1 oval brooches | 5 scissors                       |
| 2 ring pin      | 6 beads                          |
| 3 KEY           | 7 ceramic pots (1 not in Arbman) |
| 4 knife         | 8 spear head                     |

Figure 5.71 Simplified grave plan of BJ504, after Arbman 1943, 246, fig 91

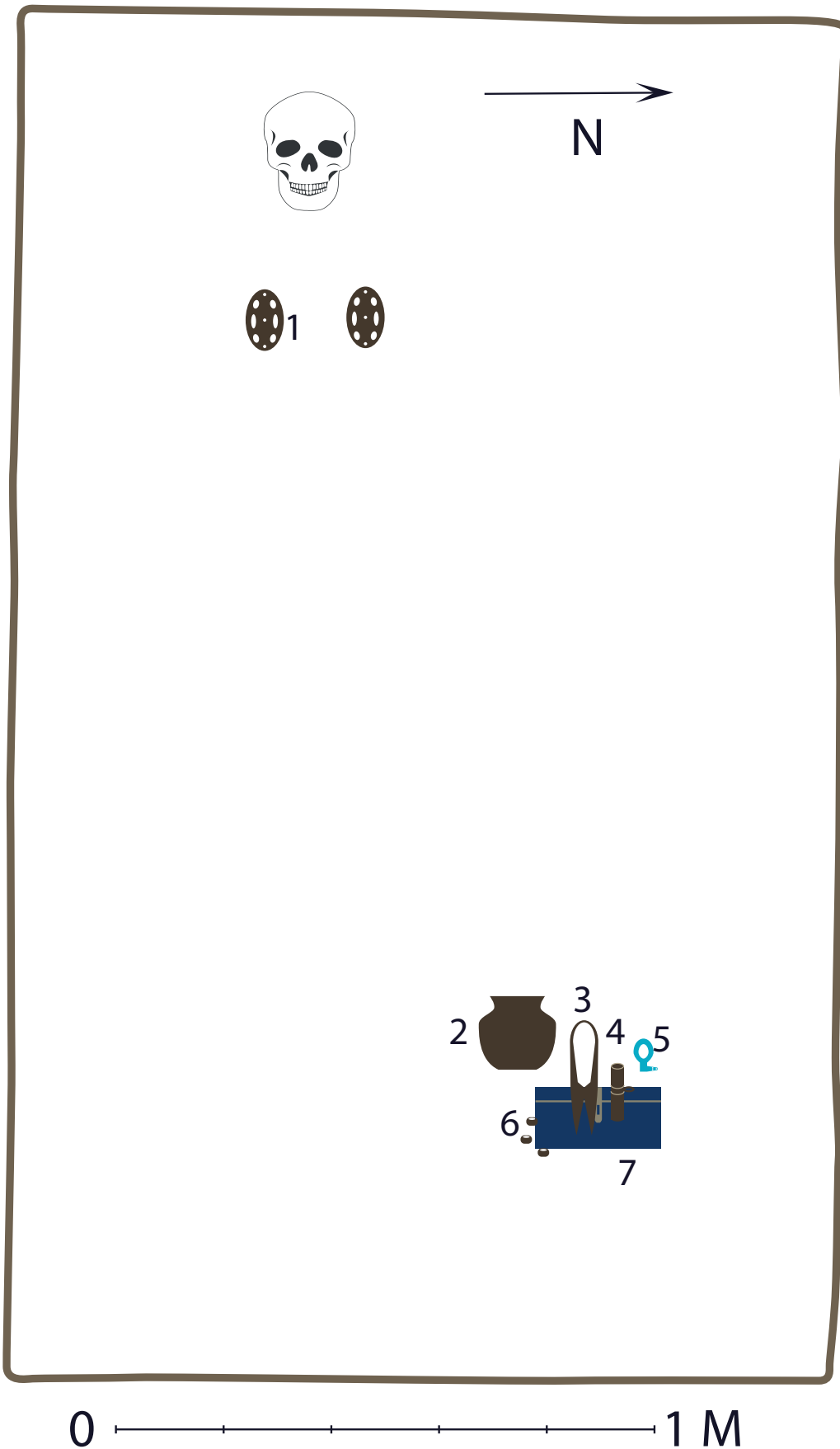

- 1 oval brooches
- 2 ceramic pot
- 3 scissors
- 4 needle case
- 5 KEY
- 6 beads
- 7 box fittings

Figure 5.72 Simplified grave plan of BJ585, after Arbman 1943, 144, fig 191

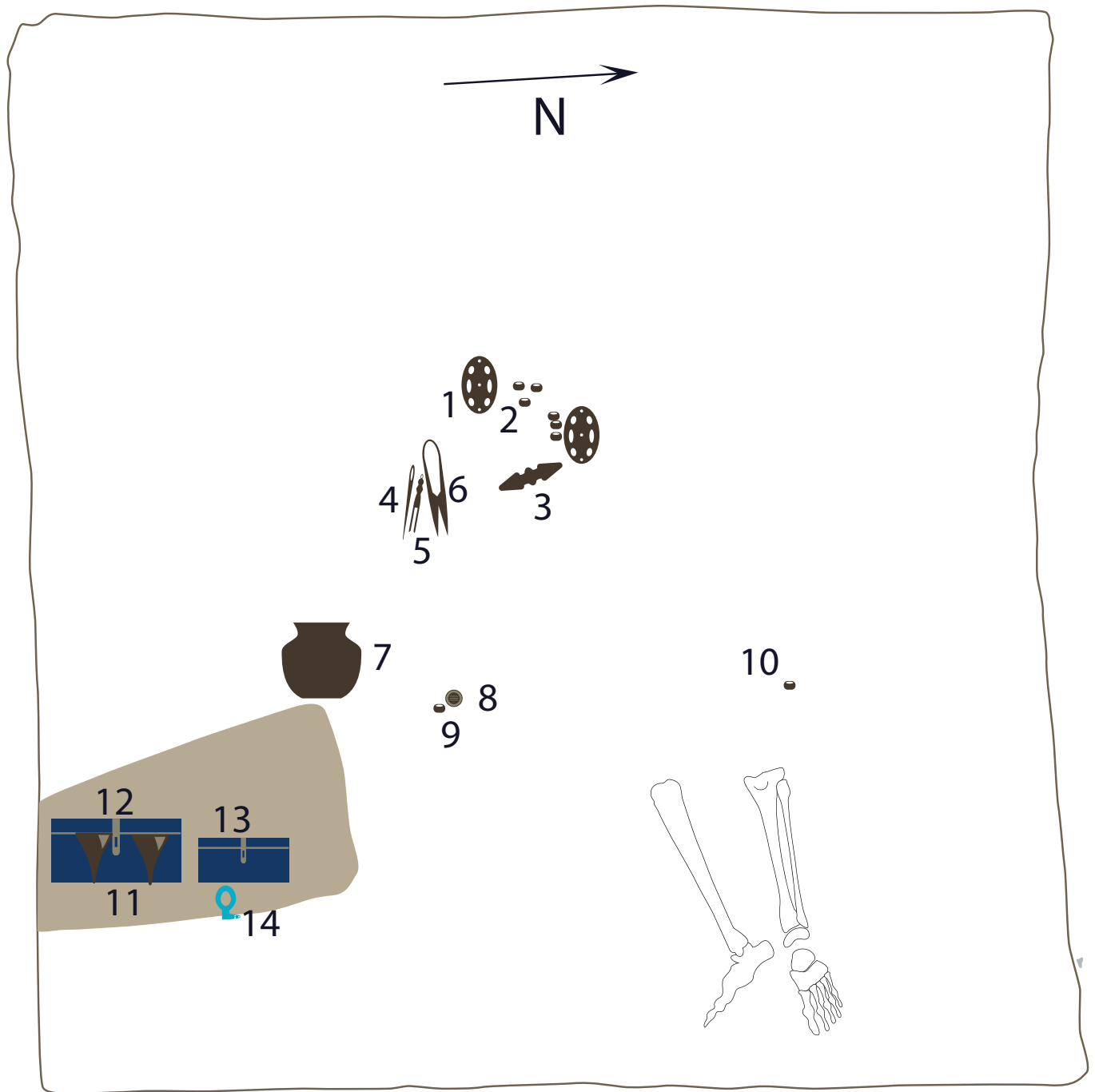

0 |-----| 1 M

- |                      |               |                     |
|----------------------|---------------|---------------------|
| 1 oval brooches      | 5 tweezers    | 10 sandstone "bead" |
| 2 bead               | 6 scissors    | 11 glass beakers    |
| 3 equal armed brooch | 7 ceramic pot | 12 large box        |
| 4 needle             | 8 silver coin | 13 small box        |
|                      | 9 bead        | 14 KEY              |

Figure 5.73 Simplified grave plan of BJ639, after Arbman 1943, 216, fig 174

I. Borg

Only nine burials were excavated from inside of the fort. The construction methods for these graves is unclear, but it is reasonable to assume that Stolpe would have mentioned evidence for chambers, boats, or coffins and it is most likely that these were all simple, flat

graves. Eight of the burials were cremations; one of them is the single key grave in this area.

Only two graves had male-associated objects, one with two arrows and another with a single game piece which, as has been mentioned, may not have had strict male associations in Birka. There are three graves with female jewellery, and one of these also has a needle case. The assemblage that includes the key has four oval brooches and an equal-armed brooch and may represent the cremation of more than one individual.

#### J. Borg Meadow 4A

Borg Meadow 4A covers the west and south perimeter of the Borg and extends southward. Of the 93 graves excavated in this area, 94% of them are cremations. There was not sufficient evidence to confidently identify the remaining six. Almost all of the graves were constructed with mounds, but there are also three boat graves. In this area there is only one key burial, a cremation mound.

Unlike graves to the north of the Borg, assemblages in this cemetery either contain female- or male-associated objects but not both. Most of the 14 graves with female object types contain jewellery, although there is not a single dominant type. There are no scissors among the assemblages, but there is a single needle case and several graves with at least one needle. There are only three male-associated object types: shields, swords, and spears. The most common of these are shields, found in eight of twelve graves. The burial containing the key had neither female nor male object types.

#### K. Kvarnbacka 4B

Fourteen burials have been excavated from this small cemetery area. In four cases the burial type could not be determined, although Arbman (1943, 101) tentatively suggested one (BJ355) may have been an inhumation. The remaining ten graves are cremations. Relatively few of the assemblages included gender-associated objects. Only two included a weapon, one with a shield and one with arrows. None of the graves in this area had textile tools, but two of them have a single oval brooch, and one of those also has 14 beads. This grave, BJ349, has the only key in the cemetery.

#### L. Kvarnbacka 4C

Of the 26 excavated graves in Kvarnbacka 4C, 23 are mounds and the remainder had boat burials. All of the burial types that can be identified are cremations. This cemetery area is unique for having only two gender-associated object types in the assemblages. One grave has a set of sixteen beads, and five graves have a shield. There are no textile tools found in this area, and no jewellery other than beads, and two amulets. The only key found here was

in a cremation mound (BJ96) that also contained a single game piece.

## M. Kvarnbacka 4D

There are twenty excavated graves in this cemetery, the majority of them mounds, with a single stone setting and two possible flat burials. All of the burial types that could be identified are cremations. Arrows are the only strongly male-associated object type among the assemblages, found in two burials, one of which (BJ 306B) also held 28 beads, and a key. There are two graves with oval brooches and bead collections, and one burial with a loom weight.

## 5.6.8 Discussion

The diverse characteristics of the Birka cemetery fields have long been recognised. But it is still not entirely settled whether the differences represent different communities or varying social identities within those communities (cf Graslund 1980, 77-78; Ambrosiani et al 1992, 20), or possibly are a result of changing beliefs over time, possibly with the conversion to Christianity (Steuer (1984, 344-48). But it is apparent that there is a greater variety of burial practice being expressed in Hemlanden 1A-1C and the cemeteries north of the Borg (the inner grave fields) than those in the outer grave fields.

Keys are one of the object types that reflect that difference. They are very rare in the outer fields; even in the larger burial area of Hemlanden 1E they appear in only 1% of graves. In the central area of the inner Hemlanden burial field, Hemlanden 2b, and in the cemetery to the north of the Borg they are somewhat more common, 5% overall, with the western area (2B) having a higher frequency than the eastern. But it is in Hemlanden 1A and 1C, the areas that flank the inner Hemlanden cemetery field, that most of the keys occur, in 11% and 14% of burials respectively.

The difference in practice is also visible in how often and in what way keys are found with gender associated objects. In all of the inner grave fields the majority of key burials could be identified as female through object association. But all five of the areas with more than one key grave also had keys in burials that could be identified as male, and there were a significant minority of burials throughout the cemetery that had no gender-associated objects in their assemblage. The distribution of female identified graves was also uneven. In Hemlanden 1A and North of Borg 2A that is the dominant construction pattern, but in the others, female identified assemblages account for just over half of the key graves.

The outer areas are even less strongly associated with female artefacts. Of the seven cemetery areas defined, four of them had no female objects in key graves. The area with the most key assemblages had a single burial that could be identified as female, but two

others contained male objects. The four remaining key graves from this area had no gender-associated objects.

The low rate of key appearance in these areas is also interesting. As a whole, the assemblages seen in these cemeteries have fewer object types per assemblage than in the inner area (table 5.6), but because of the large number of cremation burials it is possible that the surviving record does not accurately reflect the original composition. There are also relatively fewer objects that could be identified as high status, like swords, shields, and some jewellery, although this pattern varies among the areas (table 5.7).

Cemetery area	Average no. object types	No. of graves with keys
Hemlanden 1A	5.55	17
Hemlanden 1B	4.55	14
Hemlanden 1C	6.26	24
Hemlanden 1D	2.85	1
Hemlanden 1E	3.58	4
Hemlanden 1F	4.03	1
North of Borg 2A	2.15	5
North of Borg 2B	4.79	4
Borg	4.62	1
Borg Meadow 4A	3.89	1
Kvarnbacka 4B	3.9	1
Kvarnbacka 4C	3.9	1
Kvarnbacka 4D	4.22	1

Table 5.7 Average number of object types in assemblages and number of graves with keys by cemetery area

Cemetery area	No of graves w/ high status objects	% of furnished burials
Hemlanden 1A	68	49%
Hemlanden 1B	79	37%
Hemlanden 1C	76	48%
Hemlanden 1D	8	20%
Hemlanden 1E	38	31%
Hemlanden 1F	9	32%
North of Borg 2A	72	63%
North of Borg 2B	36	63%
Borg	6	75%
Borg Meadow 4A	23	28%
Kvarnbacka 4B	4	40%
Kvarnbacka 4C	7	33%
Kvarnbacka 4D	5	36%

Table 5.8 Number and proportion of grave assemblages with high status objects by cemetery area



Although wealth or status could be important factors in the characteristics of these grave assemblages, there is also evidence for differences in belief or practice. The extremely low occurrence of textile tools in the cemeteries south of the Borg, relatively common elsewhere in the grave fields, suggests a deliberate exclusion. Although the community using these cemeteries must have regularly used textile tools, they did not see them as appropriate for inclusion in burials, either in a passive sense of not requiring these objects or in an active sense of avoiding them.

Keys, with their potential additional symbolic weight may have also been objects that were seen in some communities as too potentially powerful to casually include in an assemblage. There are a few graves that may have some indications for the use of keys or locks in a ritualistic way (for example BJ607, where the key was found above the burial level in the fill), and for some groups those uses may have made these objects unsuitable for other purposes.

Within the Birka mortuary record then, there is evidence for a range of practices around the use of keys. This includes a clear connection with female identity, but also a number of appearances in male graves. Furthermore, the large number of burials that have no strong gender association should be considered. To better understand some of these practices it is worth looking at the wider context to see whether and how they may appear in other areas and other types of communities.

## 5.6.9 The wider context

### A. Kaupang

Kaupang was a trading centre in Vestfold Norway, on the Oslofjord. The settlement was active from the beginning of the 9th to the mid 10th century. Like Birka, there is evidence for connection to an extensive trade network, and an active community of craftworkers, although it appears that the range of objects made, and the complexity of work was not as great as in Birka (Pedersen 2009, 135).

There are only four cemeteries in Kaupang with enough graves to provide some comparison with Birka (map 5.10). Unfortunately, there are difficulties with the Kaupang data. The cemeteries, particularly Nordre Kaupang, have been significantly damaged due to ploughing. When Nicolay Nicolayson visited Nordre Kaupang in 1859 he wrote of the rapid and ongoing destruction of barrows due to cultivation and development (Skre 2007a, 36), damage that continued to take place.

Confidently describing the characteristics of this cemetery is, therefore, nearly impossible. Dagfin Skre (2007b) has pieced together a timeline of the destruction of some of the barrows using early maps and sketches in combination with aerial photographs in an attempt to understand something of the original extent of the burial ground. His conclusion,

which is necessarily tentative, is that there were probably originally between 200-300 barrows, and that they lined the track-way that led into the settlement. But it is impossible to know the composition of those burials and the assemblages they may have contained.

There is even uncertainty about the nature of some of the barrows that have been excavated and recorded. In Nicolayson's subsequent excavation of the cemetery he reported that a large number of the barrows contained no burial, the majority only producing charcoal, while eight appeared to be entirely empty. In his re-analysis of the Kaupang burials, Stylegar (2007, 69-70) suggests that these apparently empty barrows may have, in fact, been erected as monuments over inhumations that lay deeper than Nicolayson's excavations had reached. These two interpretations present fundamentally different impressions of the nature and purpose of the cemetery, and it is clear that no accurate understanding of the characteristics of this cemetery is possible. Discussion of the distribution of grave constructions in Kaupang, therefore, is limited to Bikjholberget and Lamøya and should be understood to represent only an approximation based on surviving evidence.

What can be stated confidently is that, like Birka, both cremation and inhumation were commonly practiced. There was a wide range of burial constructions in a single cemetery (Bikjholberget), including sleds, log coffins, and even a storage chest, and although the distributions are different, Stylegar (2007, 100) has compared this cemetery with the diverse and well-furnished burials in the area north of Borg. He also suggests that the pattern of division, with cremation mounds in one area and richly furnished inhumations in another, is not coincidental but is a reflection of some directing force common to both communities. Lamøya, although slightly less diverse, also contains both inhumations and cremations, and a variety of construction methods. The distributions of burial types and grave constructions are shown in (figure 5.74 below).

Unlike Birka, there is little clear evidence for the large-scale production of locks or keys in the settlement. This does not mean that these objects were not made for local use, but it is less likely that they were an object type that was part of trade export. This could mean that, although they were in use in the community, it may not have been as convenient to replace a lost or deposited key which could explain the slightly lower rate of key appearance to that of Birka. However, Kaupang would have had access to metalworkers capable of producing locks and keys for domestic use, so it must also be considered that keys were not as important in grave assemblages as in Birka or were not applied to as many conditions.

There are only 11 graves with keys in the cemeteries of Kaupang, an overall appearance rate of 8% of known furnished graves. As in Birka, keys tend to appear in highly varied assemblages with an average of 9.4 object types. Unlike the broad cemetery frequencies, the most commonly associated object is a knife (found in 9 of the 11 graves).

Approximately half of those graves contain female identified objects, five of them with oval brooches, but a few with larger collection of beads, and textile tools. An equal number of burials have weapons or horse gear. Two of these are among the richest graves in Norde Kaupang while another key grave from the same cemetery contains only the key and a ceramic pot, although because of the amount of disturbance it is unclear whether this represents the entire original assemblage.

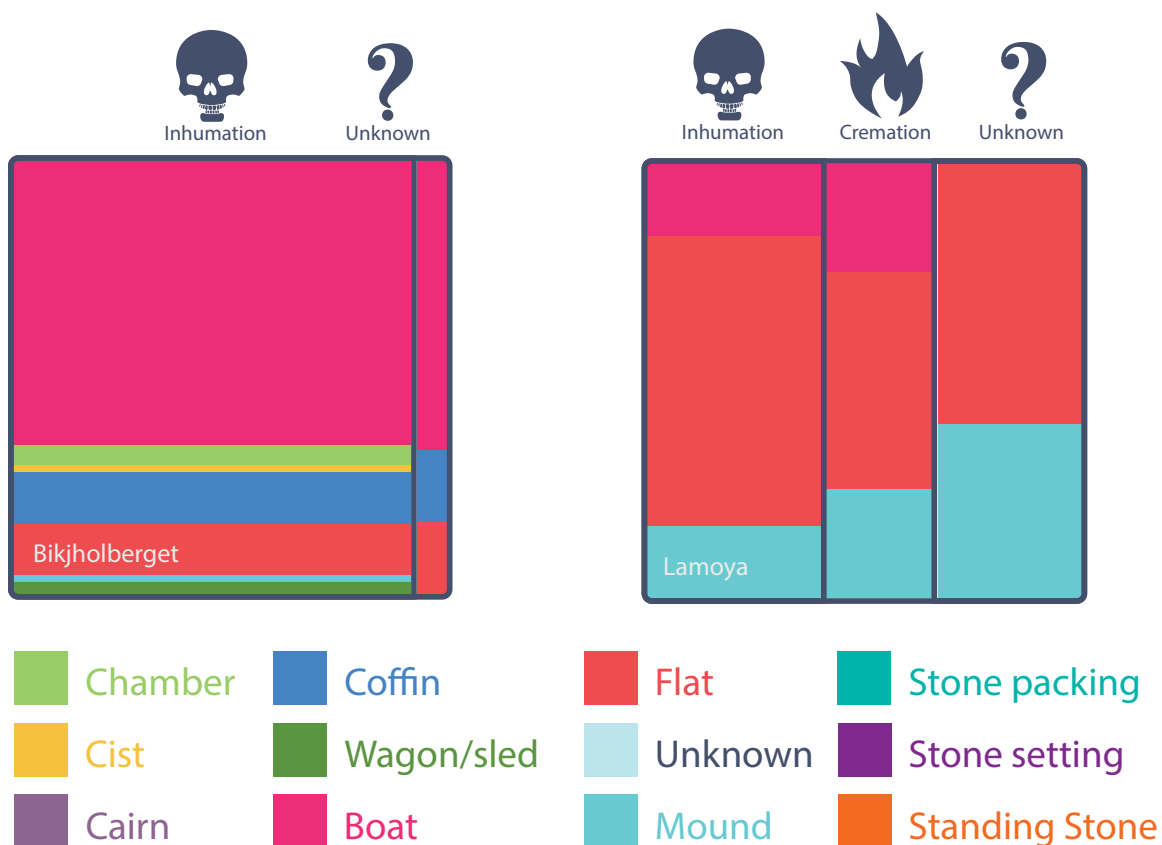

Figure 5.74 distribution of grave constructions showing the greater diversity in the excavated graves of Bikjholberget compared with Lamoya

Half of the Kaupang keys have not been identified by type. Of the remaining keys, three are group C, one is probably group A, and 2 group E. Stylegar's catalogue does not identify any padlock keys, but grave Ka 282 in Bikjholberget (120-121) contained a box padlock. A number of assemblages also included boxes, most of them with locks, some in graves with keys (table 5.8).

Grave number	Cemetery	Key	Box	Lock
GK0085	South Kaupang	x	x	x
GK0088	South Kaupang	x	x	
GK0083	South Kaupang	x		
GK0037	North Kaupang	x		
GK0004	North Kaupang	x		
GK0109	Lamoya	x		
GK0157	Bikjholberget		x	
GK0163	Bikjholberget		x	
GK0177	Bikjholberget		x	
GK0146	Bikjholberget	x	x	
GK0143	Bikjholberget		x	x
GK0118	Bikjholberget		x	x
GK0111	Bikjholberget	x		
GK0152	Bikjholberget	x		
GK0155	Bikjholberget	x		
GK0160	Bikjholberget	x		
GK0174	Bikjholberget	x		
GK0113	Bikjholberget			x
GK0131	Bikjholberget			x

Table 5.9 graves with keys, boxes, and locks in the Kaupang cemeteries

With the exception of one grave, a sled burial, key graves in Bikjholberget have assemblages that include at least one female-associated object type, four out of five of those including oval brooches. Instances of assemblages with male-identified objects are both with multiple burials, three individuals in Ka 285, and two in Ka 250. There is no reason to suppose that the keys were not associated with the other female objects in these burials. Lamoya's single key grave also contains no male-identified object types.

The keys from North and South Kaupang, in contrast, do not have any female-associated object types in their assemblages. Four of the five keys from these areas are in burials that contained swords, and there are also shields, spears, and arrows listed among the grave goods (table 5.9). Because of issues of preservation any conclusions must be tentative, but Styleger strongly suggests that at least the cemeteries of North Kaupang and Bikjholberget represent two different traditions if not two different communities and if Skre is correct in suggesting that the North Kaupang barrows were used by local elite and their retinue, it is at least possible that the male key graves in that area represent one of the burial practices that was specific to them.

Grave number	Cemetery	Arrow	Axe	Shield	Spear	Sword
GK0004	North Kaupang		x	x	x	x
GK0037	North Kaupang	x	x	x		x
GK0085	South Kaupang	x	x	x	x	x
GK0088	South Kaupang					x

Table 5.10 Graves with keys and weapons

## B. Finnveden

Finnveden (map 5.11 below) is in the northeast of the historical Swedish Province of Småland and is bordered by Scania to the south and Varend to the east. This area has the largest number of identified cemeteries among the study areas, of which 32 have enough graves to be included in the dataset. There are seven identifiable construction types, and graves with both inhumations and cremations, although the distribution is uneven. Only one cemetery containing inhumations (Korsabo, no 79) does not also have cremations, but the majority of cremation cemeteries (76%) are homogeneous in burial types. Similarly, non-mound constructions are limited to just 11 cemeteries (figure 5.75 below).

Fifteen cemeteries had burials with keys, Thirteen of them in the dataset. The number of key graves in each cemetery ranges from 1-3. They are not rare objects, found in about 6% of the recorded assemblages, but they occur at a far lower rate than the most common gender linked objects, arrows and oval brooches, both of which are found in 20% of furnished burials.

Key graves are unexceptional in terms of their construction. The majority of them are cremation mounds which is the majority construction for both the area as a whole and for most of the cemeteries where the keys appear. The exception is Villstad Prastgard, which is 80% cairn construction, but again the graves with keys follow the majority pattern. Assemblages containing keys tend to be larger on average than those of other graves in the cemeteries, but the difference is within statistical variation.

The key-grave cemeteries show similar patterns of gender-associated objects in assemblages as that seen in the area as a whole. Approximately the same number of burials have weapons, horse equipment or tools, as those with female jewellery or textile tools. In both data sets only 6% of graves have mixed male and female object types, and over 90% of those have arrows, which may relate to something other than identity expression, possibly a ritual associated with particular graves. The key graves, on the other hand, show a strong gender differentiation, with 73% of them containing only objects associated with females. A single grave in Prastgarden Skateberg (Gr4) had an arrow in it in addition to the key, a large collection of beads, and an arm ring. And one grave in Kallerstad (Gr8) held horse gear in addition to the key, two whetstones, and a single bead. The remaining graves, a total of five, had no gender-diagnostic objects.

The evidence supports the idea that the use of keys in Finnveden is an expression of local belief that is fairly widely spread, but not commonly practiced. In this area there is a strong association between women and keys, although a quarter of the burials do not follow this pattern and may indicate additional, but less common, practices.

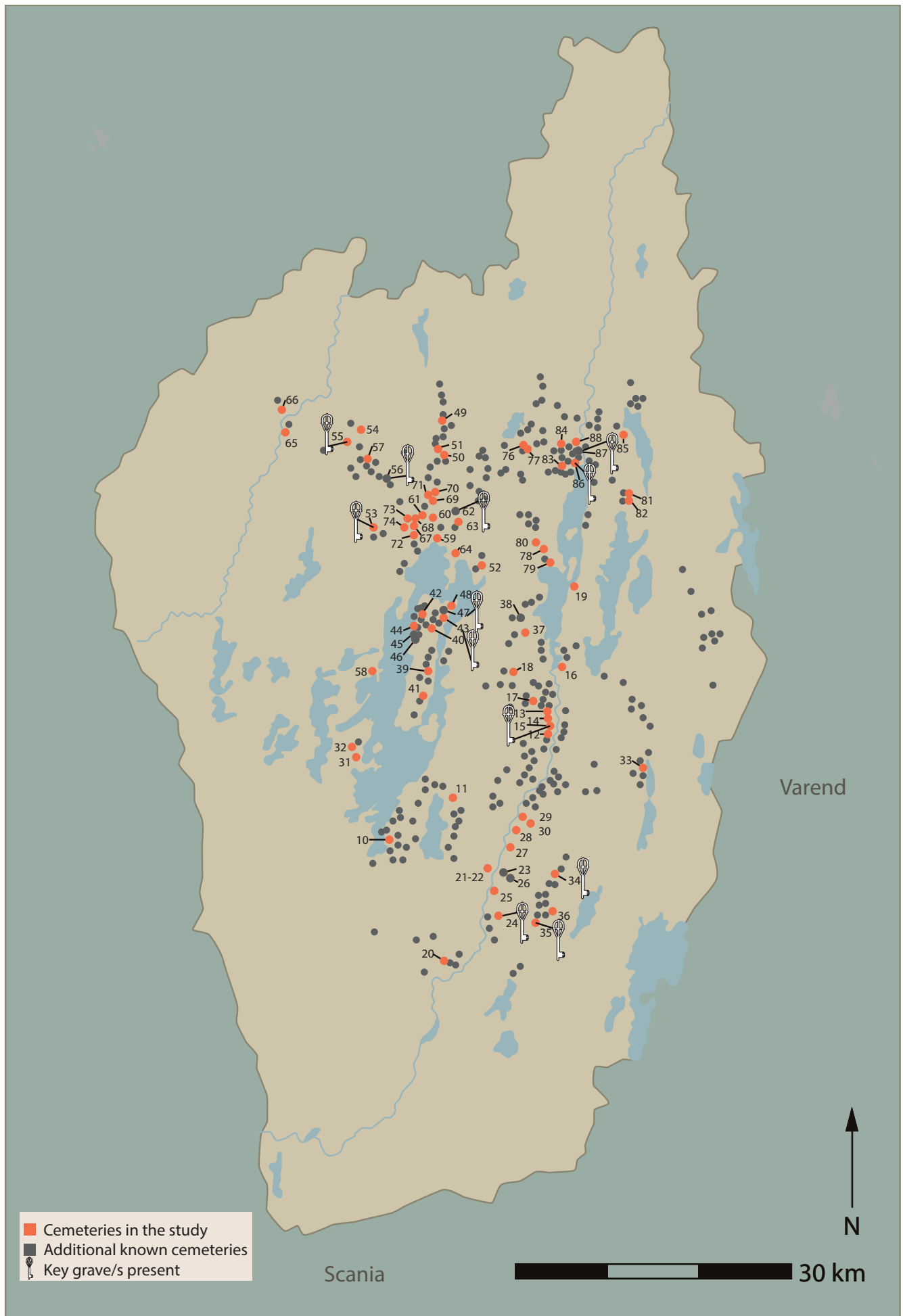

Map 5.10 Map of Finnveden showing known cemeteries, the distribution of cemeteries included in the study, and the location of burials with keys.

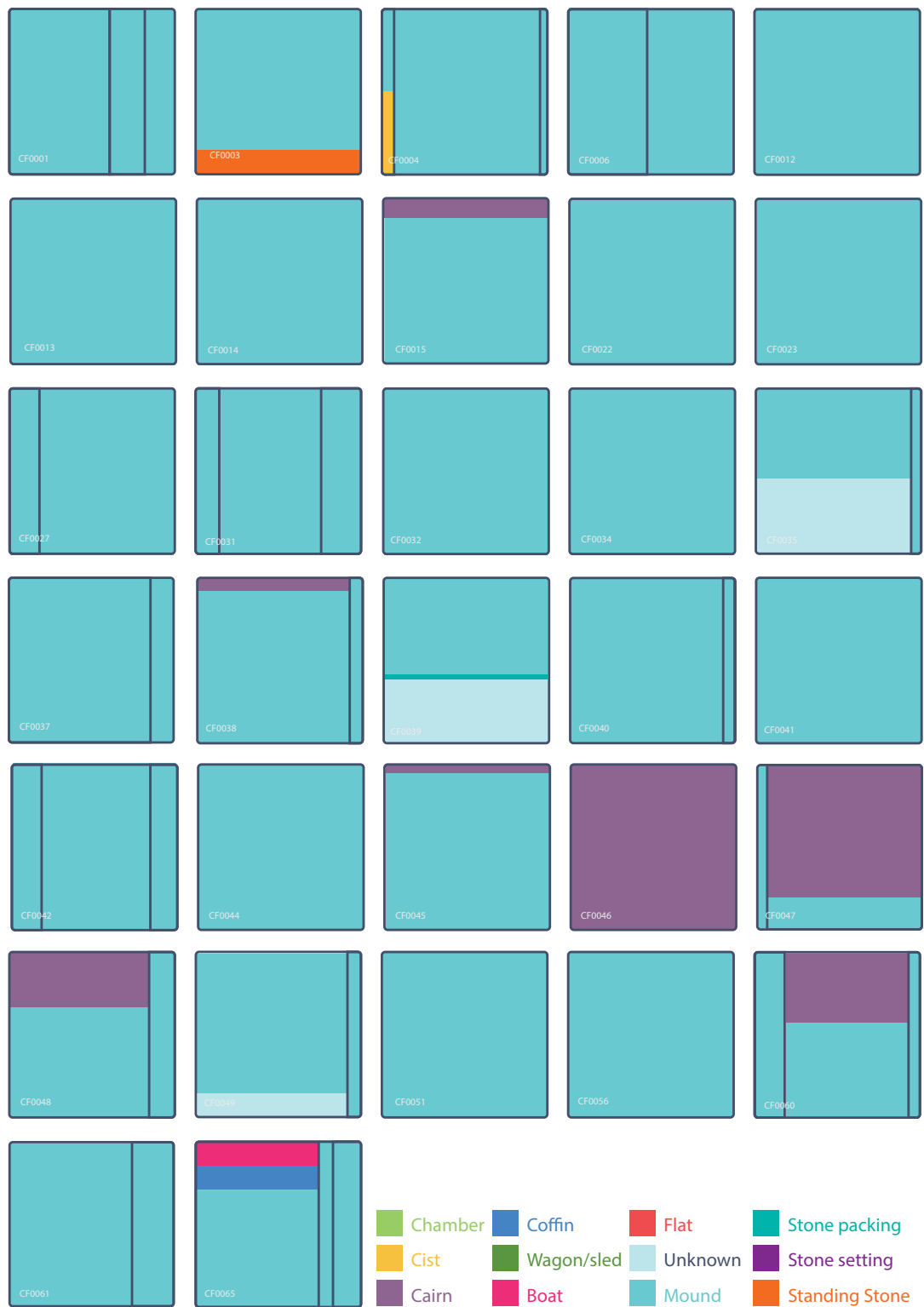

Figure 5.75 Distribution of grave constructions in Finnveden

### C. Scania

Scania lies on the southwest tip of Sweden (map 5.12 below). There are a large number of recorded burials in the areas, but the majority do not have an identified construction method listed in Svanberg's catalogue, making it difficult to fully characterise burial practices. For those that are known, most are coffin inhumations and within the dataset, inhumation is the most common form recorded. There are a range of construction types

in addition to coffins listed, but how widespread these practices were is impossible to tell (figure 5.76 below).

Burials throughout Scania have relatively small assemblages, and many cemeteries have a limited number of object types used overall. In spite of that, there is a good deal of variation in the objects used around the area, and little evidence for widely held beliefs. There are, for example, relatively few graves with gender-associated objects included. Only 3% of burials had male objects, and 9% had female - the latter mostly spindle whorls and other textile tools.

There are only five keys found in Scania, located in four cemeteries. Only one of these keys may have some female jewellery - a collection of 8 beads. But the rest of the objects found in the graves cannot be assigned a gender. This is in spite of the fact that these cemeteries did include a range of textile tools. There are three boxes in Scania burials; one of them was associated with a key (Gr 67 in Norrvidinge) but the other two, one in the same cemetery as Gr 67, were not. There is nothing in the Scania record to suggest a strong cultural connection between keys and female objects. The fact that no keys appear with textile tools may be significant, as will be discussed below.

#### D. Öland

The island of Öland lies off the southeast coast of mainland Sweden (map 5.13 below). Two recent studies (Wilhelmson and Ahlström 2015; Wilhelmson and Price 2017) have tried to establish the nature of immigration on Öland between the early and late Iron Age using isotope analysis. The first study, using strontium, established that there appeared to be an increase in the scale of migration, although the incomers seem to originate from similar, generally nearby, locations (Wilhelmson and Ahlström 2015, 38). The second study used oxygen ( $\delta^{18}O$ ) isotopes and included information about burial construction and grave goods. As the authors acknowledge throughout the study, there is a fundamental bias in their data as they can only work with samples from inhumed remains while the majority practice in this area in the late Iron Age was cremation.

They did present some evidence that, if supported by further work, presents valuable new information for mortuary studies. The first is that in the early period there was no apparent difference between immigrants and locals in terms of grave construction and orientation, but as immigration increased there was at least one group that maintained their own distinctive practice. Second, they found that in the late Iron Age material almost all of the women were immigrants (Wilhelmson and Price 2017, 192). Because the women came from varied locations the authors concluded that their presence indicates an increase in female mobility rather than a single practice such as spousal migration.



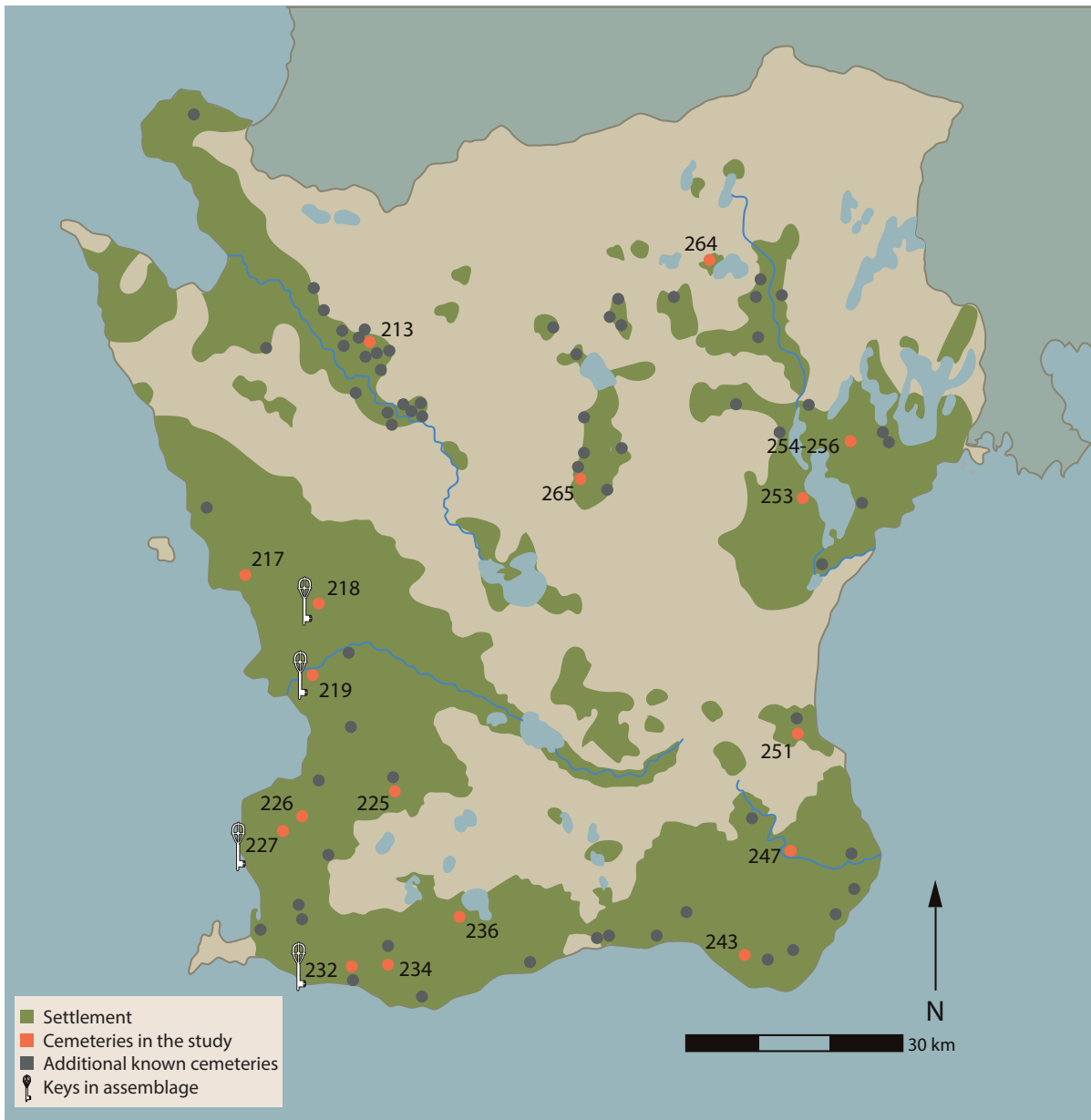

Map 5.11 Map of Scania showing known cemeteries, the distribution of cemeteries included in the study, and the location of burials with keys.

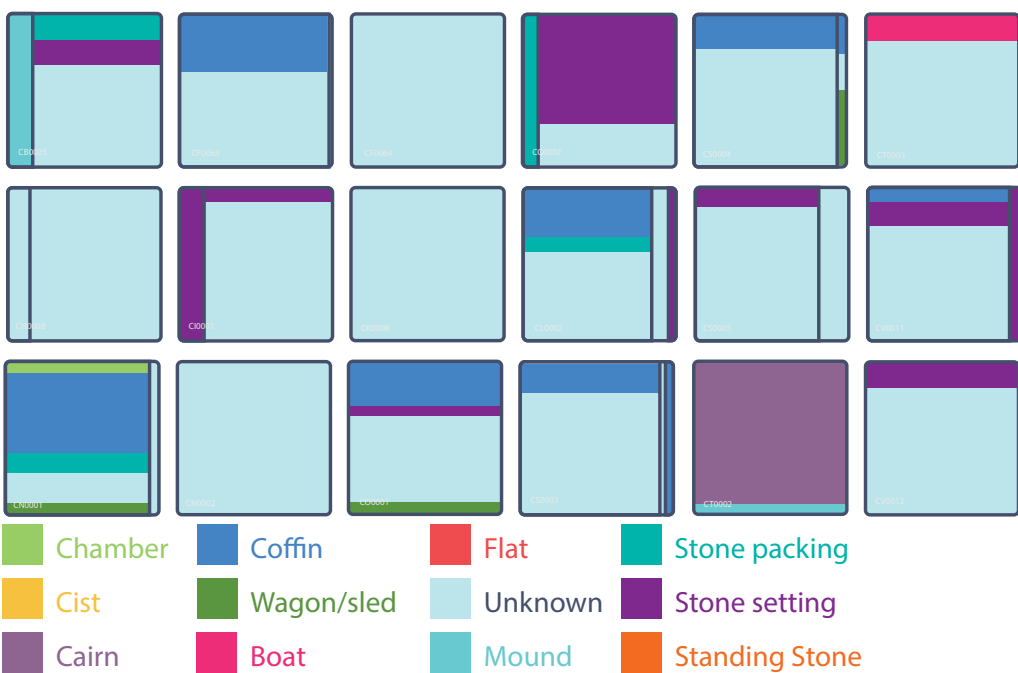

Figure 5.76 Distribution of grave constructions in Scania



Map 5.12 Map of Öland showing known cemeteries, the distribution of cemeteries included in the study, and the location of burials with keys.



Figure 5.77 Distribution of grave constructions in Öland

Öland has a more even distribution of burial types than the other areas outside of Kaupang and Birka (figure 5.77 above), and a fairly even distribution of construction types for inhumation graves. Obviously the high number of cremations without identified construction types makes it difficult to know how prevalent the use of stone-settings was, but it is a majority. As the mekko tiles show, the overall area diversity is reflected in many of the cemeteries, although the extent varies.

There are only three key graves on Öland, and none of them contain objects that can be given a secure date or provenance, so it is not possible to differentiate among them what may be local or non-local practice. What can be said of them is mostly negative evidence - none of the graves contain female jewellery or textile tools.

One grave is from a cemetery with only three known burials (Gardby, no catalogue numbers given for the graves) so has not been used in the wider dataset, but it is interesting that both of the other graves in the cemetery contain oval brooches and round brooches and both were marked with external monuments (a mound and a standing stone). One is an inhumation, the other unknown, but the key burial is a cremation which may be evidence of either a non-local burial or of the adoption of non-local practices. The only other object type in the key grave was a whetstone.

The other two key graves are from the large cemetery of Folkeslunda. Two thirds of the burials in this cemetery are inhumations, with either cists, stone settings, or stone packing as the construction method. The cremations graves include a single stone setting and one burial with a standing stone. The remainder are stone packing. The key graves both have stone packing constructions, but one (Gr18) is an inhumation and the other (Gr1) is a cremation. The inhumation also contains game pieces and some horse gear among other objects, suggesting a possible male burial. The key is the only object in the cremation burial.

There are several graves in the wider cemetery with large sets of beads, oval brooches, and/or needle cases (these seven graves are evenly distributed between cremations and inhumations), so these objects were available to the community. The key depositions may reflect two different practices, or two different purposes, but neither or them can be said to reflect a traditional female identity.

## E. Varend

Varend lies to the east of Finnveden, and has a large number of identified and probable cemeteries. Of those, only six of those in the source publication have more than five graves (Map 5.14 below). Most of the burials in this area are cremations, and within the cemeteries there is usually very little if any diversity in construction methods (figure 5.78 below). The assemblages throughout the area tend to be relatively small, and there is an unusually low number of knives which may reflect a regional practice.

There are three keys in Varend, found in three different cemeteries. The key graves are unremarkable within their own cemetery, sharing common burial constructions. Two of these have female objects in the assemblage: Gr4 in Inglestad, has a collection of 20 beads and a needle in the assemblage, and Gr3 from Vinninge has an equal-armed brooch. The third grave has only a single bead.

## F. Blekinge and Lister

Blekinge and Lister has just four cemeteries with more than five graves, and only forty-five graves in total (map 5.15 below). It is difficult to know how homogeneous burial practice was in terms of body treatment as a third of the graves are unidentified (figure 5.79 below). There is a single recorded inhumation, and the remaining 29 burials are cremations. The unknown burials have approximately the same distribution of construction type as those with known body treatments: nearly 1/3 mounds and 2/3 stone settings, but as the single inhumation was found in a mound it is not possible to say that all the unknown burials were cremations. As with Varend, there is some variation in construction methods and that variation is expressed in all of the cemeteries to some extent.

There is only a single key in the entire dataset of Blekinge and Lister, in the largest cemetery, Johannishus (no 279). The assemblage in which the key appears is essentially gender neutral although Johannishus has several graves with oval brooches, textile tools (including a loom which is a very rare object), and large bead collections.

## G. Bornholm

Bornholm is an island in the southern Baltic, southwest of the Swedish mainland. Svanberg's (2003) catalogue for Bornholm has relatively few identified cemeteries and only 79 excavated graves (map 5.16 below). There is evidence that Bornholm had extensive ties throughout the Baltic, and coin finds from hoards show contact with Britain through trading and/or raiding (Ingvardson 2012). It is unclear how much immigration Bornholm experienced, although changes in pottery techniques in the 11th century (Naum 2012) are abrupt enough to suggest an influx of craftworkers rather than an import of objects.

There is only one identified cremation in the Bornholm dataset. The remainder are inhumations. There are several construction methods, but within the cemeteries themselves there are only one or two in use. There is, at least in these characteristics, a reasonable amount of conformity (figure 5.80 above). There are relatively few graves with weapons or horse equipment, a total of seven in the entire area. None of those contain female object types. Seventeen burials had female object types, one of them a spindle whorl but the rest jewellery.

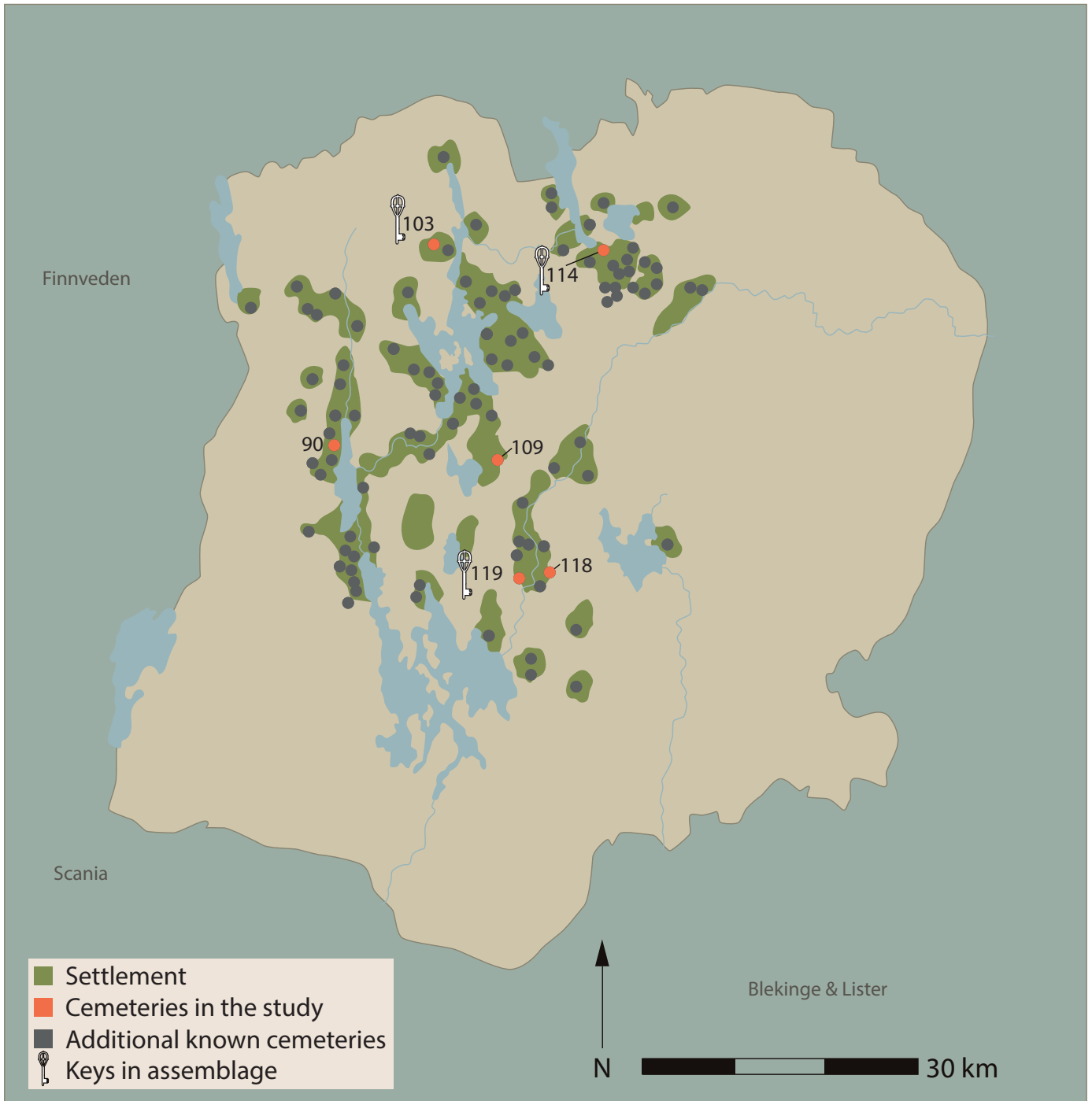

Map 5.13 Map of Varend showing known cemeteries, the distribution of cemeteries included in the study, and the location of burials with keys.

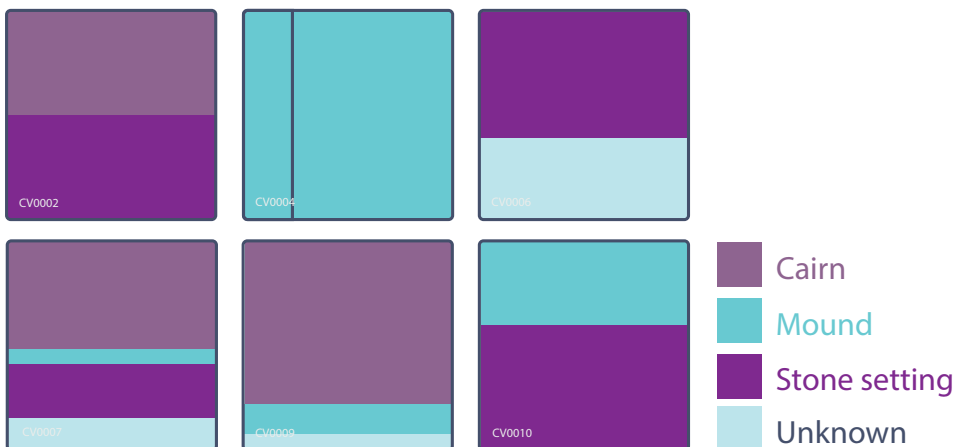

Figure 5.78 Distribution of grave constructions in Varend

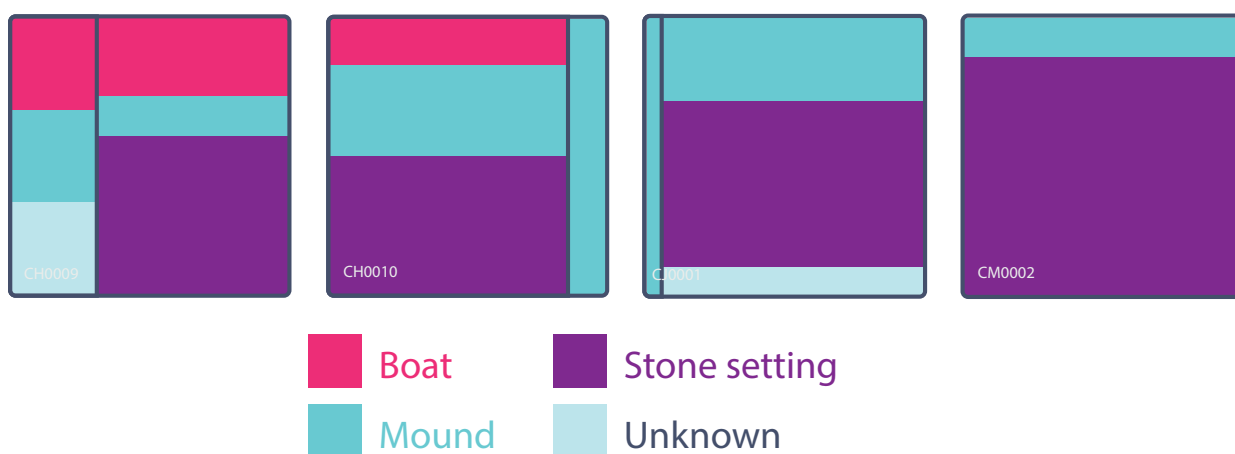
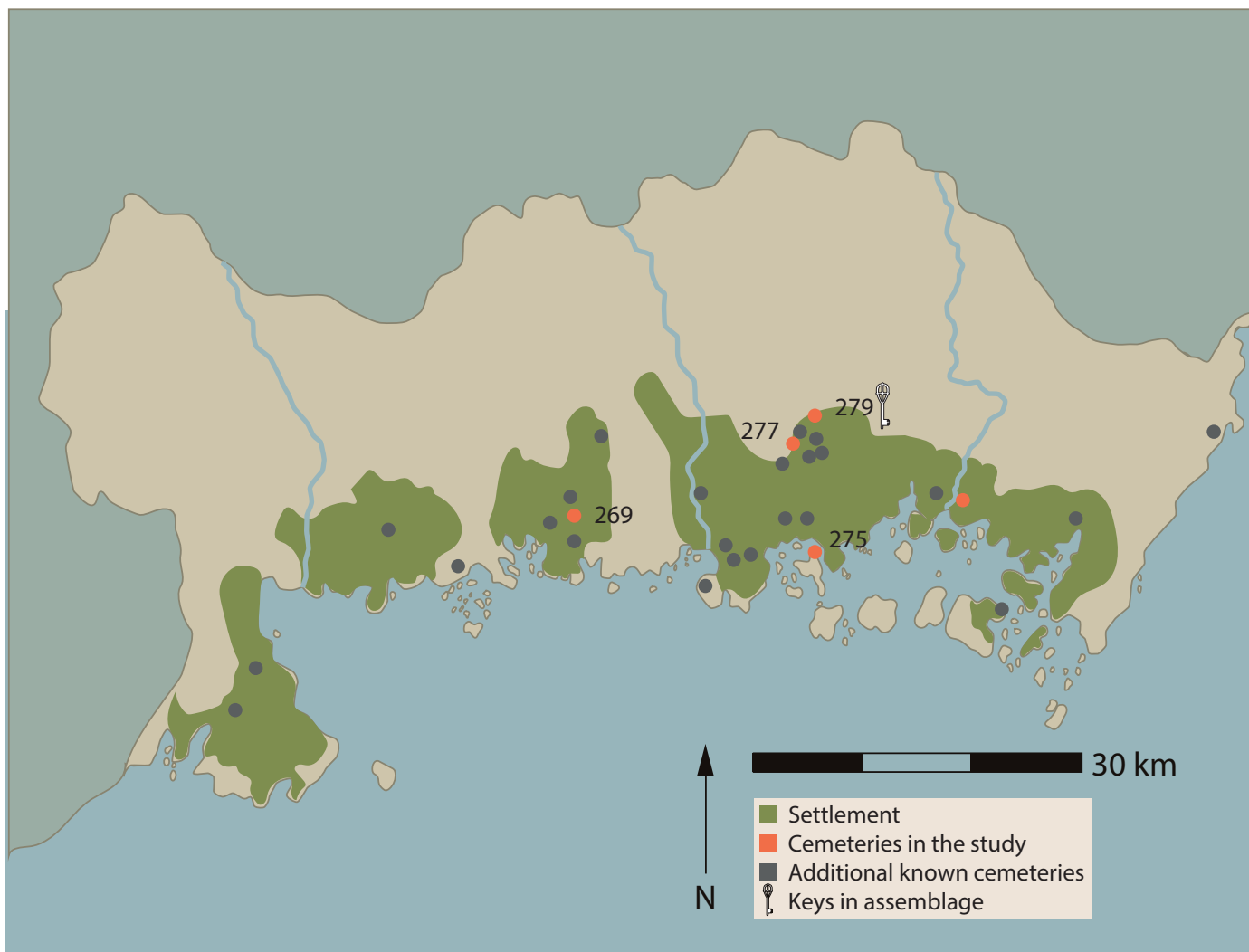

Figure 5.79 Distribution of grave constructions in Blekinge & Lister



Map 5.15 Map of Bornholm showing known cemeteries, the distribution of cemeteries included in the study, and the location of burials with keys.



Figure 5.80 Distribution of grave constructions in Bornholm

Bornholm is unique among the areas for having a cemetery, Lillevang, where keys are found in nearly half the furnished graves. These graves all also contain a knife (the cemetery average is 73%) and half of them have a single bead. Not only do keys in Lillevang not occur with oval brooches, there is a clear distinction, as graves with oval brooches do not contain knives. In contrast, the single other key grave in the area occurs in a cemetery where every excavated grave held oval brooches and beads. It seems clear that the two communities who created these cemeteries had very different ideas about the role keys play in grave constructions and, because of the high number of keys, that the community of Lillevang placed a particular significance on the use of keys in burials, one that is not found elsewhere in the dataset.

## 5.7 Analysis and discussion

### 5.7.1 Keys in female burials

The powerful but simplistic idea of keys representing an aspect of female identity, the Lady of the House role, has been fairly indiscriminately applied to the Northern European archaeological mortuary record. But, unsurprisingly, a recognisable, widely shared pattern of object use that can be linked to this identity is not clearly present in the dataset. Just as the distribution of gender associated objects varies from area to area, so does the distribution of those objects in relation to keys.

The most obvious difference is in the distribution of keys and textile tools. There are eight different textile tools in the dataset, and it is reasonable to assume that all of them would have been in active use in the communities. But they only appear in assemblages with keys in four of the areas in the study, Their uneven distribution in grave assemblages, therefore, suggests a deliberate exclusion based on local beliefs and practices (table 5.10). Table shows the percentage of graves with keys that also contain textile tools, and the number of occurrences of the different types of tool, broken down by area.

Area	% of key graves	Needle	Needle Case	Scissors	Spindle whorl	Other
Birka	42%	11	12	24		2
Finnveden	26%	1	1		5	
Kaupang	33%			2	5	1
Varend	33%	1				

Table 5.11 Patterns of association between keys and textile tools. Other tools: smoothing board and glass smoothing stone in a burial in Birka; loom sword in a burial Kaupang

Siv Kristoffersen's identification of the objects associated with the Lady of the House in the Migration Era specifically includes textile tools (particularly spindle whorls and loom



swords) in addition to keys or key bundles and jewellery (2004, 295). The persistence of the iconic morphology of migration era keys, demonstrated above, shows that there was a shared and consistent emphasis placed on the importance of keys that carried through into the early Middle Ages. But a strong identity associated with those keys, as signalled through the use of textile tools in burials, does not seem to have persisted, with the possible exception of part of the Birka community.

Looking more closely at the way in which the keys appear in the grave does provide some information. Fifty of the Birka keys come from inhumation burials where the grave plan is available. Of these keys, five are not found in close proximity to any other objects. Of the remainder, while many were placed next to jewellery, mostly collections of beads, they were most commonly placed close to a knife (table 5.11). This association pattern could suggest that knives, and less commonly scissors and whetstones, were symbolically linked with keys for the purposes of the assemblage construction. But as the objects are most often found directly on or next to the body, it is also possible that they were placed approximately where they were worn in life. In either case, the placement suggests that these keys were not primarily seen as objects of display and were instead considered tools.

Approximate placement	Jewellery	Scissors	Knife and/or whetstone
Upper left body	3	2	2
Upper centre body		1	2
Upper right body	1	2	4
Mid left body	1	2	2
Mid centre body		1	4
Mid left body	1	2	2
Lower right body			1
Foot of grave	2	2	3
Head of grave	1		1

Table 5.12 Location of keys in graves with most commonly associated object type

The uneven distribution and appearance of keys throughout Birka and the other areas in the study in relation to female object types makes it clear that they were not universally and solely seen as an essential part of individual female identity. Instead the evidence supports the idea that these objects had multiple meanings and uses, some of which were more commonly held than others. Although in some communities there was a strong association with women, in others that connection is less strongly expressed.

## 5.7.2 Keys in male burials

As with the female burials just discussed, the appearance of keys in male burials is unevenly distributed throughout the study areas and is primarily limited to the trade centres

of Kaupang and Birka. The majority of these burials in Birka are chamber graves, which means they represent both considerable investment and deliberation in their construction, and also significant visibility during that process. In other words, the keys in these burials must be assumed to have been intentionally included and to be acceptable in that setting. Specifically, it seems reasonable to conclude that the keys in these burials did not contradict the gender suggested by other objects in the assemblage. However the relative rarity of this use of keys suggests that the conditions for that use were exceptional - that it may have been a response to unusual circumstances.

Evidence for this may come from a burial from the winter camp of the Great Viking Army at Repton (Biddle and Kjølby-Biddle 1992, 2001). Found close to the Anglo Saxon church of St Wystan, (figure 5.81), grave 511 contained the remains of an adult male over 35 years of age (figure 5.82 below). Cause of death may have been either of two major injuries: a penetrating head wound above the left eye, and a sharp force trauma to the top of his left femur (figures 5.83, 5.84). The latter, it is suggested, would have likely mutilated the man's genitals (Richards 2003, 388). It is also possible that he was eviscerated and his feet deliberately damaged.

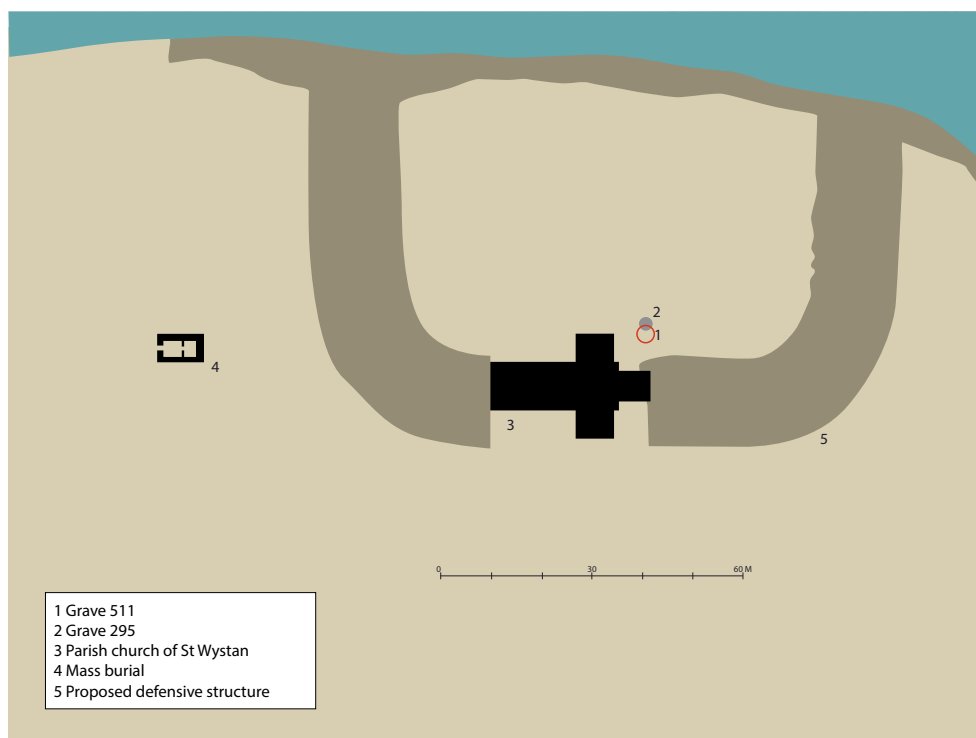

Figure 5.81 Location of Repton grave 511  
After Biddle and Kjølby-Biddle 1992, 39, fig 4.5

The furnishings provided for this burial appear to be, at least in part, a response to the circumstances of the death. In addition to his sword and other personal effects, placed approximately where he would have worn them in life, a jackdaw humerus, probably in a pouch, lay between his thighs, and a boar's tusk was placed just below his pelvis. On the northeast side of the body, just below the knee and approximately parallel with the sword, was a large iron key of type group A (figures 5.85, 5.86 below).



Figure 5.82 Grave 511 as excavated, looking north. Biddle and Kjøbye-Biddle 1992, 42, fig 4

Figure 5.83 Skull from grave 511 showing facial trauma. Richards 2001, 13:19.

Figure 5.84 Top of left femur from grave 511 showing sharp force trauma. Richards 2001: 15:14

The burial appears to have been placed in a prominent location (figure 5.81, 1), and was probably clearly marked as not only was a second burial added shortly afterwards (possibly a close male relation to the individual in 511. Jarmon 2019), but other burials constructed later continued to respect the grave cut. The number and type of grave goods in the burial suggest an individual of some standing in the community, and also appear intended to reinforce the masculine, warrior identity of that individual. It must be assumed that the key was in addition to and not contradiction of that constructed identity.

In my 2013 masters dissertation I suggested that the key could be a symbol of the man's position and role within the army. With the complexity of logistics involved in successfully maintaining the army in the field, it is at least possible that there were specific roles involved in the security and distribution of particularly valuable assets. For such a role, a key would be a reasonable symbol.

However, because the key is not placed in the position it would have been worn, I would now argue that its use is symbolic. It may be reinforcing the intention behind the use of the boar's tusk and the jackdaw humerus, but it could also have its own, additional purpose, perhaps giving the deceased access to a desired place in the afterlife. Another interpretation is that the key locked out or blocked unwanted interference, perhaps a preventative step necessitated by the context of the death.

Repton grave 511 provides one possible model of the symbolic use of keys in burials. One significant characteristic of this burial is the care and respect expressed. There are no evident signs of "deviance" in this burial in the archaeological sense. The position of the body, the location of the grave, and nature of most of the grave furnishings are indicative of status, but otherwise unexceptional. Although the circumstances of the death may have required additional steps, including the addition of a key, those steps appear to have been taken on behalf of the individual, rather than as a preventative measure.

Whether this sort of symbolic use of keys is a significant factor in grave constructions at Birka, particularly those with male-associated objects in the assemblage, is unclear. The burial that shows the most likely signs of the use of a key for a symbolic purpose is BJ562, discussed above. As with Repton 511, the conditions of this particular death may have demanded an unusual reaction, including the scatter of multiple knives in the fill of the grave. In this case, the key and its accompanying padlock may have been intended to "unlock" the way to the afterlife for the dead. Possibly the use of a padlock and padlock key also gave proof of this man's identity as a garrison warrior, serving as his credentials.

Of the other seven other graves that have both keys and male object types, three were cremations, and in another the location of the key was not given in Stolpe's original notes (BJ974) so there is a limited amount of information available about how the key may have related to the remains or to other objects. But in a third inhumation (BJ985) the key

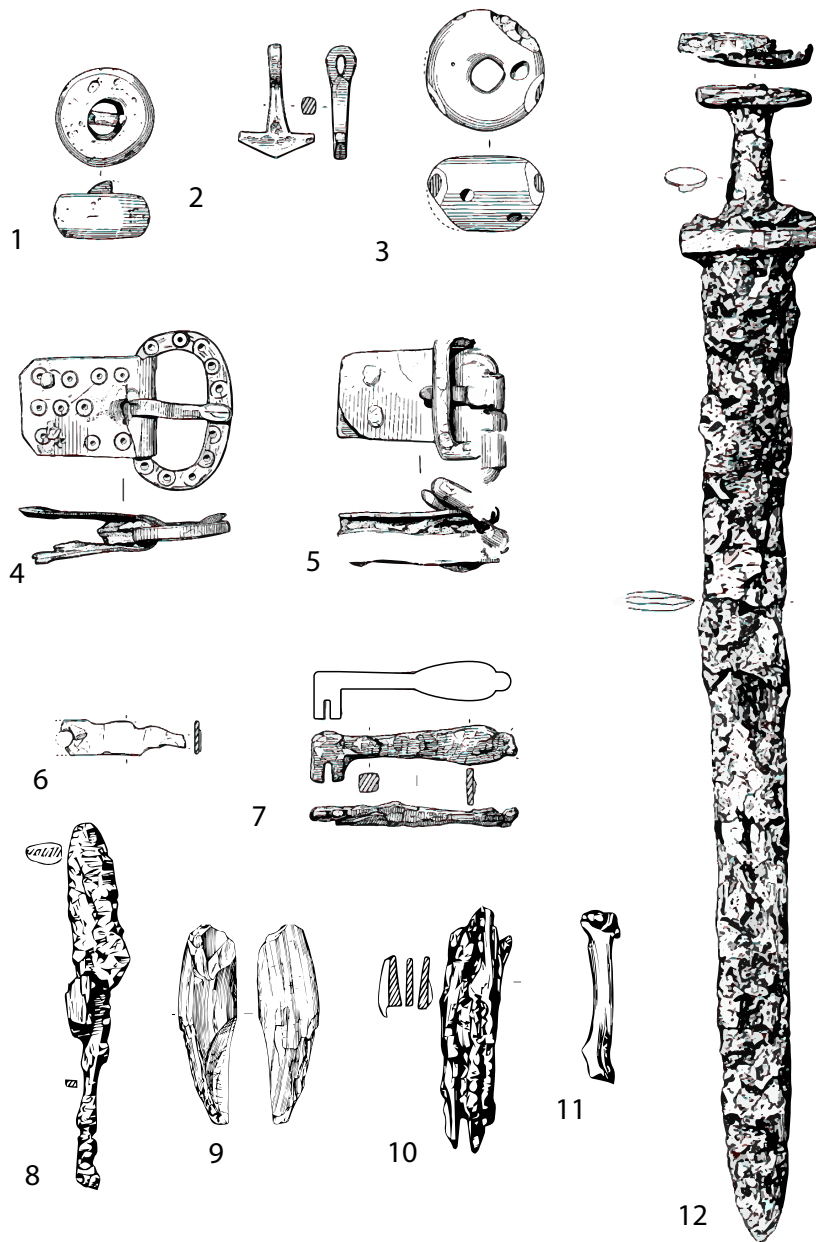
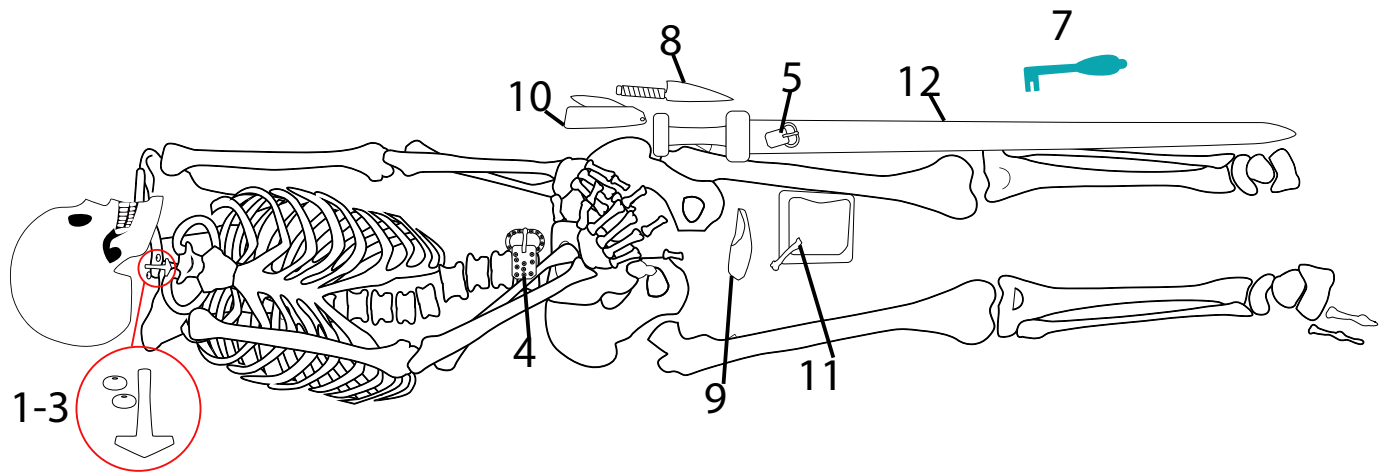

- 1 glass bead
- 2 silver Thor's hammer
- 3 glass bead
- 4 copper alloy buckle
- 5 sword harness
- 6 fastener
- 7 iron key
- 8 iron knife
- 9 boar's tooth
- 10 folding knife
- 11 jackdaw humerus
- 12 sword

Figure 5.85 (top) Grave plan of Repton 511  
After Biddle and Kjølbye-Biddle 1992, 42, fig 4

Figure 5.86 (left) Repton 511 burial assemblage  
After Biddle and Kjølbye-Biddle 1992, 43-44,  
figs 5-6

was directly on the upper left of the body, next to two knives and a whetstone. As this was a padlock key and was found in a grave with a shield and spear it is possible that this burial is associated with the garrison, in which case the key may have been intended to help signal that identity (figure 5.87 below).

In two other graves the key was found off of the body, in association with a box (BJ850 above and BJ750). The first of these is comparable to female burials with boxes and keys, and it seems reasonable to assume that these constructions may have had similar intentions behind them. As with most of the boxes in Birka's cemeteries, there is no surviving evidence of the original contents if there were any. Arwidsson and Thorberg (1989, 117) have suggested that, as with the Oseberg chest, these boxes originally held grain and other foodstuff. The other burial, BJ750, will be discussed in more detail in the next section.

In summary, although there are relatively few graves with keys that, from the artefact evidence, appear to be male, the variation within those graves makes it difficult to assign a single purpose behind the inclusion of the keys. A symbolic use appears to be likely in some constructions, but it also seems clear that, at least for some communities, there was no direct contradiction between male identity and the use of keys, and in some circumstances these objects could be included as personal possessions that were meaningful for or in relation to the individual.

### 5.7.3 Blacksmith graves and deposits

Grave BJ750 (figure 5.88 below) may reflect a specific and complex role that keys played in early medieval Scandinavia. This chamber grave is apparently a double inhumation, richly furnished with intimate personal belongings displayed on and near the remains, but also with a number of objects placed at the foot and head of the chamber. Among these, apparently once contained in a box (Arbman 1943, 272), are a number of tools and a type group C, dog-leg variant key (figure 5.89 below, objects 3-19). There is no surviving evidence of a lock on the box, so it is likely that the key is included as part of the tool deposit.

The identification and interpretation of "blacksmith burials" has been the subject of considerable discussion (cf Müller-Wille 1977). The significance of the number and type of tools (Pleiner 2006, 72-74), the importance of the location of the burial and how it may relate to the position of the smith within (or without) the community (Callmer 2002, Hedeager 2002) and whether the objects themselves signify socio economic identity (Härke 2014, 47) or are symbolic references to the Weyland myth and to secret craft knowledge (Andrén 1993, 49) remain topics of lively debate.

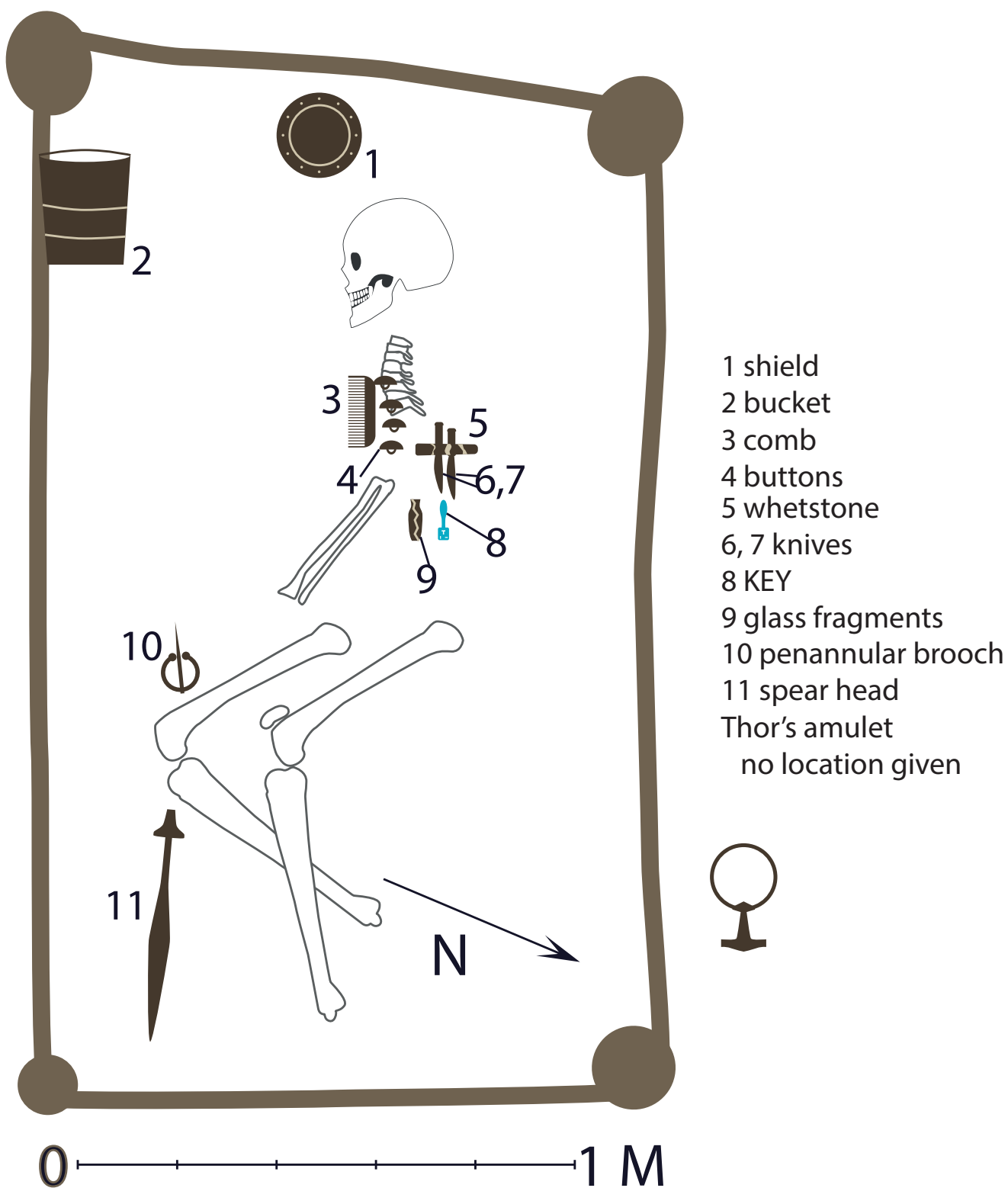

Figure 5.87 Simplified grave plan of BJ985, after Arbman 1943, 412, fig 365

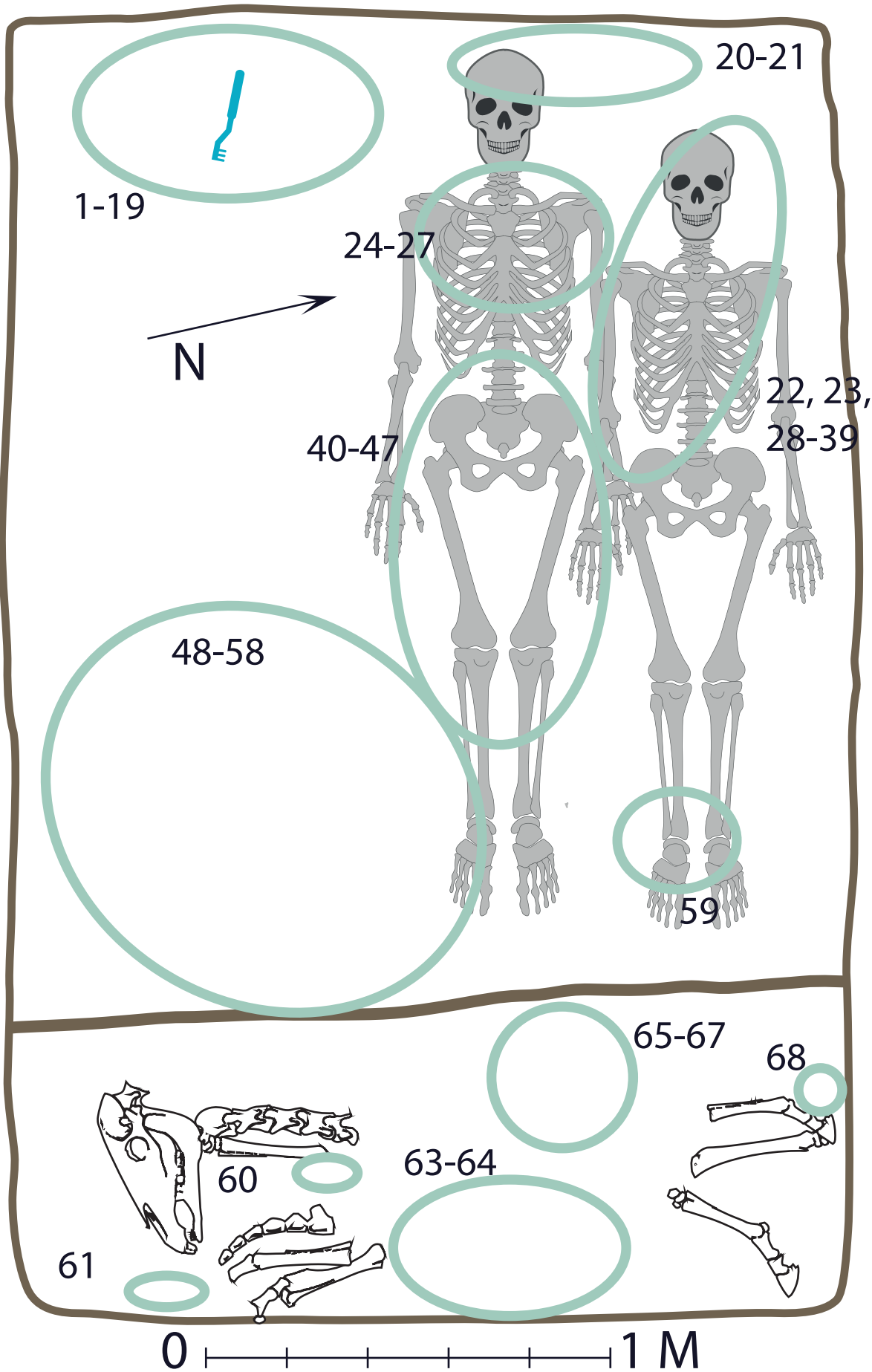
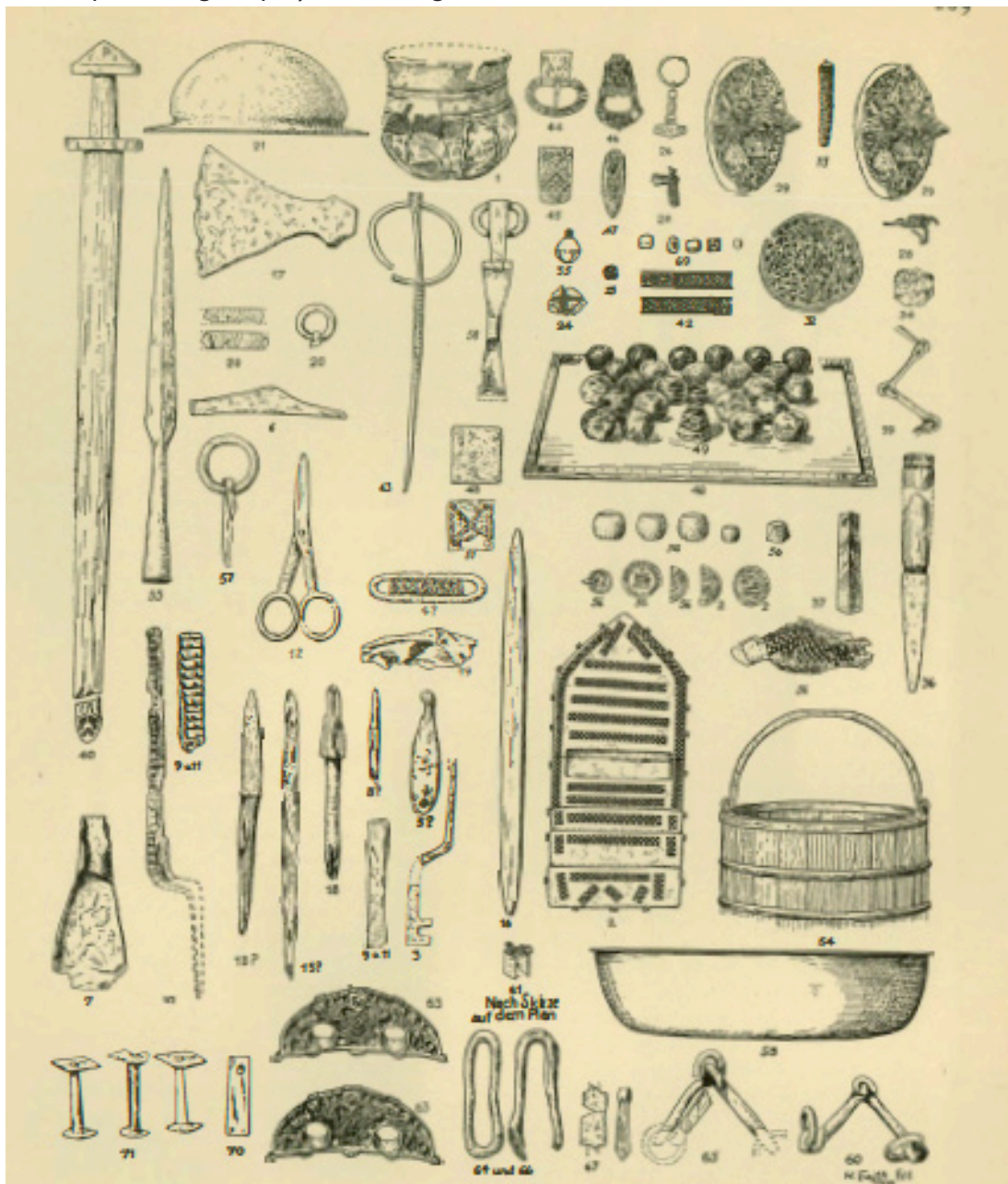

Figure 5.88 Simplified grave plan of BJ750, after Arbman 1943, 268, fig 217



- |                             |                                      |   |
|-----------------------------|--------------------------------------|---|
| 1 glass beaker              | 22 possible shield fitting           | 44-47 two silver buckles and strap ends |
| 2 leather bag               | 23 silver bead                       | 48 game board                           |
| 3 KEY                       | 24, 25, 27, 38, 41, 42, 59 gold band | 49 glass game pieces                    |
| 4 fire steel                | 26 silver Thor's hammer              | 50 arrowheads                           |
| 5, 8, 14, 15 box fittings   | 28 worked silver, silver band        | 51-52 box fittings                      |
| 6 hammer                    | 29 oval brooches                     | 53 copper alloy bowl                    |
| 7 unidentified iron object  | 30 fragments (iron)                  | 54 bucket                               |
| 9 wedge                     | 31 brush                             | 55 spear head                           |
| 10 rasp?                    | 32 round brooch                      | 56 leather bag                          |
| 11 rasp?                    | 33 needle case                       | 57 iron ring                            |
| 12 scissors                 | 34 glass mirror                      | 58 bow brooch                           |
| 13 knife                    | 35 copper alloy bell                 | 60-62, 56-67 horse harness              |
| 16 whetstone                | 36 knife                             | 63 decorative horse harness fittings    |
| 17 axe                      | 37 whetstone                         | 64 iron links                           |
| 18 drill                    | 39 iron chain                        | 68 horse ice cramps                     |
| 19 flint                    | 40 sword                             | 69 beads                                |
| 20-21 fittings, shield boss | 43 silver ring pin                   | 70 whetstone                            |
|                             |                                      | 71 rivets or nails                      |

From Historiska: bipolar weights, polyhedral weight, axe



In BJ750, as in other smiths burials (Müller-Wille 1977, 172), the tools are only one aspect of a complex grave construction. In addition to a horse with harness, this grave included weapons, objects possibly related to hospitality, and a full set of gaming pieces with a game board. From a strictly practical point of view, the objects represent a fairly extensive set of household equipment. The key may simply be part of that equipment, or it may reinforce the sense of ownership that the dead could claim to the objects themselves, and to the privileges that ownership represents.

It is also possible that, in addition to the mundane use, there were additional layers of meaning particularly attached to the presence of the box of tools and the key. Julie Lund (2006) has examined nine early medieval ritual deposits containing tools, weapons, and other metal objects in South Scandinavia and suggests that the keys found in three of these deposits (326-27) may not simply represent objects made by the smith, but could symbolise their control of the valuable materials and resources involved in their work. In the ritual deposits, their inclusion could signify the complete nature of the sacrifice - the relinquishment of any claim of ownership. In the burial that significance may shift somewhat, showing that the objects, and possibly the knowledge and skill that are attached to them, continue with the deceased and are not retained within the living community.

#### 5.7.4 Locks and keys as enchained objects

Although there is a clear link between keys and artefactually identified female burials, there are also a significant number of graves that have no clear gender identity. While it is possible that in some of these graves keys were intended to carry that identity in the absence of other objects, the evidence for the symbolic importance of these objects suggests that there may have been other beliefs involved in their inclusion.

Because keys are only half of a tool set they are by their very nature “enchained” objects (Chapman 2000), strongly linked to their associated lock. This link means that the presence of one invokes the presence of the other. In daily use this allows, for example, the signalling of the existence of valuable objects even when they are not present. It also gives a fixed object (a building with a lock on the door) the ability to “move” as the portable key is carried away from it, projecting itself from a distance. In a grave, it can form an active link between the world of the lock and that of the key, the world of the living and the dead. This link could be viewed as undesirable, in which case both objects could be present, or the link would have to be broken either through the destruction of the other object or through a ritualistic un-coupling. Or it could be desirable, perhaps alleviating the grief of loss by recreating broken bonds, allowing active contact with the world of the dead, or anchoring the dead to the world of the living.

This link is not unconsidered, but has psychological weight. There is archaeological evidence for the deliberate creation of enchainment objects for mortuary rituals through fragmentation, breaking a pot in order to inter only part of it (Chapman 2000) or using human remains themselves to link locations, worlds, or people (132-183). At Birka there is also evidence for the importance of enchainment objects in the living community. One of the foundation deposits found beneath a central posthole in the garrison great hall contained a large number of comb cases that had been deliberately damaged (Hedenstierna-Johnson 2015,77-78), but the combs themselves had apparently been retained by their owners. This act, using such intimately personal objects, must have been a powerful symbol of the tie between the warriors and their hall. It is unlikely therefore that the link potential would not be a factor in choices about the inclusion of a key in an assemblage. Examining how this enchainment appears in assemblages may provide some insight into whether its effect was fixed or could be manipulated to suit the specific needs of the individual burial.

Keys to buildings obviously must appear alone, and their appearance in a grave could indicate that the link was deliberate and desirable. It is possible that this link was ritually broken, but that would break the relationship between the key, the key holder, and the household, making the key a generic symbol, a reduction in its semiotic value. Which of these outcomes was intended for the inclusion of a building key is impossible to determine, but for keys to boxes or chests the evidence is available.

There are 43 graves with boxes in the focus group but only 14 of them also contain keys. This inconsistency could be explained by suggesting that the 29 remaining boxes either were not lockable, or had been locked with a padlock which was removed before the box was interred. However, there are also 7 graves that contain locks, only two of which appear with keys, and another two of which were accompanied by boxes. In other words, there is evidence that the link created by the entanglement between lock and key was both avoided and exploited in various settings – a fundamental contradiction in how these objects were used and how their link was perceived from use to use. This suggests that use and perception of objects were not fixed, but that there were multiple possible meanings and purposes that were decided in response to the specific context of each burial.

### 5.7.5 Locks, keys, and fluid object meanings

This concept of fluidity of object meanings provides additional nuance to the understanding of the range of variation in Scandinavian burials and in the tolerance for these variations seen in places like Birka. Certainly there is evidence in the pattern of key appearance to support the suggestion that there were important differences in beliefs and practices throughout Scandinavia. But literature and material evidence indicates there

was also a shared collection of ideas about cosmology and culture. A commonly held view of object fluidity would have provided an important means to navigate differences, maintaining a sense of group identity while easing communication between communities.

Both Martin Carver (1992, 1995) and Neil Price (2008, 2010) have discussed the performative nature of Viking Age funerals, specifically in reference to elite burials, using the metaphor of theatrical poetry which captures that idea the funeral was essentially and productively creative. However where Price refers to the process as the “performance of story” (2010, 137) it is perhaps more useful to see it as a narratively driven enactment of the transition of a living person to one of memory, and the reconstitution of the community around this new identity. Physical elements of this enactment, including the settings in which it took place and the objects that were used, serve as both the tools necessary for the process and as the lasting embodiment of the created identity which must, necessarily, be flexible (Schacter and Addis 2007).

The funerary process would have been multi-stage and involved objects for a variety of purposes, filling needs that ranged from the physical to the social, those that were rooted in the immediate time and place to those that looked backward, forward, or possibly even stepped out of time altogether, using memory as time travel (Klein 2012). These stages shift from a body-centric focus to one where the body and the landscape become co-focal. A broad list of these stages, which may not happen sequentially, includes:

- Body preparation: vigil; washing and purification; dressing; grooming
- Site preparation: selection, clearing, excavation, pyre construction, interior fitting
- Body transportation
- Body placement and arrangement
- Grave furnishing
- Grave closure and post-mortuary activities

Because of these multiple stages, it is necessary to look beyond the act of creating the grave assemblage in order to better understand object use and inclusion. Table 7.41 presents funerary object use in terms of three categories and describes some of the motivations they may lie behind them. Three object types are used to explore those motivations as they may relate to three common object types that have different practical functions: keys, combs, and ceramic pots. “Physical” refers to actions that are directed to the present time, that affect the people, objects, and landscape in which they perform the action. “Visual” refers to the signalling of messages that are not necessarily grounded in the present, but that may reach forward or backward, or even be timeless. “Symbolic” refers to

actions that are directed at people, objects, and landscape that are not immediately present. Obviously, these categories and actions can and do overlap, particularly as it can be argued that every action is also a signal.

	Motivation	Key	Comb	Ceramic vessel
Practical	Effectively move the body through the necessary phases of the funerary process	Open chests in which particular necessary objects are stored	Groom the body	Hold liquid for washing or drinking; contain the cremated body
Visual	Send messages of identity, correctness in practice, grief, and reassurance	Establish ownership and authority between the dead and the living; signal the wealth or role of the dead	Anchor memories Reaffirm intimate identity Signal previous processes	Signal previous processes Anchor memories
Symbolic	Affect the past or future Affect the gods or the afterlife Provide protection or security for the living	Lock or unlock worlds Lock or unlock the dead in their grave Lock or unlock an anticipated outcome	Replace or stand in for a cremated body (Williams 2003) Provide a tool for use of the dead	Replace or stand in for a cremated body Provide a tool for the use of the dead Hold tribute or gifts to the gods or the dead

Table 5.13 Categories of motivations for object inclusion in the funerary process

The spatial setting of these stages is an important consideration as it would change the nature and relationship of the people participating as well as the actual and perceived audience, expressed in the “visual” section of the table. If a body is prepared and dressed inside a building within the household compound, that action is experientially and socially distinct from the same activities carried out at the grave or pyre site.

If these preparations took place indoors it was probably in the longhouse, which Blanton (1995) has discussed as being the locus for shaping and defining social relationships. Body preparations occurring here would be a final negotiation in this setting, creating the foundation for the identity and relationship of the new member of the household, the remembered dead, with the cooperation and participation of household members, and with the dead as a physically present witness. The choice of objects that may be part of the funeral dress at this stage would be a response to this intimate setting but would also be chosen for effective display when the body was moved outside and seen by a wider audience.

There is evidence for the importance of display as part of the funeral, including signs that furnished graves were left open for a period after furnishing, as with the Oseberg ship burial (Gansum 2004). This means that object roles were dual, involving both affect and effect. The concept of parsimony in mortuary practice, discussed above, would imply that each object that remains in the grave or at the site fills as many of these requirements as possible. Because of the heightened social and cultural nature of mortuary ritual, even when objects are seen as filling a purely practical need, that action could acquire additional significance that may affect how the object is treated and situated after its use.

Finally, there is the point that object choice is shaped by the weight given to the identity of the object itself. At one extreme this may be entirely dislocated, allowing substitution of votive offerings such as the joss paper, spirit money, sacrificed to the newly dead in some Asian funeral practices (Adler 2002). At the other, only a specific object may be used, indicating a high degree of value or importance placed in object biography.

The range of assemblage size does show that richness in both number and variety was desirable. But the lack of strong evidence for consistent, broadly applied substitution of votive models in Viking Age Scandinavia, or of the inclusion of commonly available objects such as loom weights, discussed above, indicates that there was both a need for the richness of the burial to be direct rather than referenced, rooted in real-world objects, and for the objects to be suitable. Numbers, in other words, were not enough, and object choices were likely limited to those types or objects that were related specifically to the functions and messages required by the conditions of the context of the burial. The variation in object appearance and association indicates that the amount of weight given to the individuality of an object also varied, likely not only from grave to grave but, for larger assemblages, from role to role and object to object. The significance and meanings of an object may have shifted throughout the performance of the burial.

Fluidity of meaning and use in object types has two advantages, particularly in the burial of those who were of significance within their community but whose status and wealth meant that the extremely wide variety of object types was not available, because of either material or cultural restrictions. It amplifies the effectiveness of each object included, giving the potential for each inclusion to satisfy a number of needs or wants. And it multiplies the possible expressions available that would otherwise be limited by the relatively small number of objects that, due to access or cultural restrictions, were available for use.

To return to the analogy of the narrative poem, fluidity in objects is comparable to the use of complex kennings in Old Norse literature. Kennings are circumlocutions, producing meaning indirectly through a genitive phrase that consists of three parts: the base word, the determinant (that qualifies the base word), and the referent which is the unstated subject of the kenning (Frank 1978, 42). The single phrase can, then, carry at least

three connotations, provided by the three parts, but may also derive additional meanings by varying familiar kennings, multiplying meaning through reference. A complex kenning may replace the determinant or base word or both with a further kenning, sometimes extending the phrase into four or more elements.

This convoluted practice of layered reference and allusion could have resulted in complete incomprehensibility, but this was avoided by the imposition of traditional restrictions, referring, as a rule, only to particular subjects or themes and drawing on familiar stories and metaphors. The skill of the skald was in their ability to display originality, richness of meaning, and a depth of cultural knowledge, and those qualities may have been valued in funeral practice as well.

Kennings, therefore, not only folded multiple meanings and references into a single phrase, through metonymy they often served to create a network of links and entanglements. Objects, people, and nature become linked within the kenning itself in phrases such as *hron-rād*: whale-road, meaning ocean, or *vetrliði rastar*: bear of the current, meaning ship. But new stories and poems also were linked to established legends, providing both a foundation and rich context for the new constructions and a renewal of the old. These constructions also conflate mythical and factual worlds; gold may be Sif's hair or Freyja's tears, both referencing gods, or Kraki's seed, from the legend of *Hrólf Kraki*. (Byock 1998) This rhetorical melding of worlds involves not only the conceptual, but also the physical and temporal.

It is essential to emphasise that I am not suggesting that objects were seen and intentionally used as physical kennings. The analogy is instead intended to draw out similarities between the two that are the result of the underlying culture of verbal and non-verbal communication. In a similar way, theatricality in high status funerals was a characteristic of, rather than an intended product of, the activities that took place.

While recognizing that objects carry meanings, simply adopting Saussure's linguistic model of linguistic signs (1919) does not provide a useful model for physical objects (Williams and Young 1995). A strict linguistic approach obscures the equally important fact that objects also have practical purposes and that those purposes are inherently and inextricably linked with those meanings. Their relationship with the signified, although it may more or less direct, is still derived from and bound by the object's cultural history, personal narrative, and physical form and condition.

Hodder recognized (1992, 174-183) that the poly-significance of objects makes their insertion into the linguistic semiotic model problematic, but his further contention that this multiplicity of significance makes object meaning unknowable is, perhaps, overly pessimistic. Object meaning and significance is not arbitrary but is grounded in the physicality, use, mythology, and history of the object. These things provide parameters and structure for those meanings which, although not directly accessible or completely

knowable, may be indirectly inferred at least in terms of mode and type. There is still value in recognizing that objects can be and are used with the intention of invoking and expressing multiple meanings and in attempting to find ways to recognize such instances in the physical record. Focusing solely on the immaterial is as problematic as focusing on the material; objects must be studied holistically in order to understand their appearance in the physical record and to effectively exploit the information potential of that appearance.

The categories of references an object can make are: its own identity, the spatial setting, the position in time, people, and other objects. These categories can exist at different levels of removal from the immediate and as that conceptual distance grows, the specificity of the information provided through the reference can decrease. Because of the physical and temporal context in which it exists, an object used as a referent always inherently includes the reference set of its immediate setting, referring to this, here, now, these, which is usually the base context use of an object. The intentionality in use, however, may then reference some, many, or even all degrees of remove implied by: those, there, then (always/never), they. An object carries with it all of the potential references available to it through its own biography and through the type group to which it belongs. It is the context and the use of the object that decide which references are going to be salient and how much other, possibly contradictory, references are suppressed.

In summary, the contentions of the above discussion are:

1. that all objects are to a greater or lesser extent poly-referential
2. that the salience of states of the referential set will vary depending on context
3. that there is a reference 'base context' which represents the most frequently accessed state or set of reference state
4. that all contexts of object use include the base state of reference states [this, here, now, these]
5. that there is a distinction between conscious and unconscious access of additional reference states
6. that conscious divergence from the reference base context state is more likely to occur in contexts of heightened emotional, social, and or cultural importance
7. that the rate of both conscious and unconscious divergence may be related to the extent to which poly-referencing is accepted or even desired
8. that the degree to which objects may be perceived or used as poly-referential in a culture (the richness of reference states) is not identical with the range of practices, applications, and contexts for which the access of those states is perceived as acceptable. In other words, a culture with a great richness in reference states for objects may have strictly proscribed paradigms for the expression of those reference states.
9. that in such cultures, there will be a higher tendency towards pattern in the physical record



The sixth point in the above list refers to the specialised context of narrative, a context in which mortuary ritual, by its nature, takes place. This is not primarily because of the aspects of funeral practices that can create narrative, but because of the characteristics of the setting in which that enactment takes place. Narrative spaces create boundaries within which transgressive, subversive, or exceptional concepts can be enacted without violating cultural norms. They are settings in which time and space overlap and entangle without contradiction (Hones 2011; Kemp 2012).

Rituals surrounding death exist in linear, sequential, present time but also evoke a remembered past, and intentionally project into the future, making them simultaneously temporal and atemporal. The landscape in which these practices take place may be seen to contain the experienced material and at the same time the imagined immaterial in which the dead exist. Multiple references, meanings, and purposes of objects not only are reasonable within this context of overlapping times and worlds, they are active participants in the creation and interpretation of them.

How the intended meaning and effect were signalled is not clear. Spatial relationship to the body, the landscape, and other objects would allow meanings to be “read” repeatedly throughout the period when the furnished grave or pyre was displayed. This also anchors meanings and intentions physically, ensuring that they persist. The time of object use, and the person using it would also have added information. And, of course, spoken declarations could have reinforced and clarified this physical messaging, or replaced it entirely. Such performances would have given an active, powerful role to the living community but would also only be directly available at the discrete moment of the declaration, although they could be both revived and reinterpreted through later narrative.

### 5.7.6 Keys, doors and boundaries

If keys were not directly reflecting gender but were part of an enfolded, multi-referential construction, the question of their significance in graves becomes more interesting. The possibility of deliberate entanglement has been discussed above, but there are other potential uses or meanings that they keys may have carried. One possibility is related to the significance of doorways, boundaries and thresholds in early medieval Scandinavia.

This significance is dual. There is the social and political importance of the control of access and the delineation of inner and outer spaces (Hillier and Hanson 1984). But there is also the metaphorical significance which may have led to the use of doors and doorways in ritual (Andrén 1993; Arrhenius 1970; Beck 2010; Price 2010). Marianne Eriksen (2013, 2019) uses literary references, including Ibn Fadlan’s description of the Rús, and two poems from the Poetic Edda to suggest that doorways were seen as bridges between the world of the living and that of the dead, allowing communication and possibly transition.

Erikson also provides archaeological evidence for the physical connection of doorways to graves (2019). This includes both locating graves in doorways as in Storrsheia, Norway (Petersen 1933, 41–42) or in Birka in the “Elk Man” double burial (Holmquist Olausson 1990), and possibly building doorways at the grave site as in mound 30 at Helgö (Arrhenius 1970). These examples, however, are rare, and even if this were a widely spread practice detecting evidence for it is difficult. But it is possible that in some graves keys were included as a symbol of the doorway or threshold, standing in place of a built structure or reflecting a different expression of a shared belief in the importance of doorways in some burial rituals.

Although this is an intriguing possibility, it is important to note that keys are not mentioned in the instances of ritual doors in the literature. Further, in the Ibn Fadlan description, the vision of the world of the dead is achieved not through the doorway, but by looking over it, a concept that is repeated in an episode in *Völsa þáttr* str 13 (Heinrichs et al 1982) where a woman asks to be lifted up so she can look over the door lintel and locate a ritual object that has been lost. The significance is in the subversion of the ordinary use of a door, clearly making the approach special and different, and in this subversion a key is not only not required, it is useless.

Another possibility, discussed above, is that the key was intended to allow the dead access, “unlocking” the world of the dead. Reference to a door to Hel (*Valgrind*, *Nágrind* or *Helgrind*) is found in several Eddic poems (e.g, *Grimnesmál* 22, *Lokasenna* 63) and in the *Prose Edda Gylfaginning* (Sturluson 2006) which also describes the walls and gates that surround it. A death that was difficult, unusual, or unexpected, may have been seen as requiring additional help in order to access the world of the dead. That access may have been bi-directional, providing a portal that allowed the living community to access and communicate with the world of the dead. The key holder, in this interpretation, would be the agent through whose active intervention this communication could take place.

Alternatively the key may have been apotropaic, used to symbolically “lock” the unwanted or dangerous dead, such as the draugr *Glámr* in *Grettir’s Saga*, into their grave. A related practice is used by some groups in modern day Nigeria (Ugwuanyi 24 August, 2018 personal communication). The key prevents the dead from taking revenge or from acting on behalf of their family and represents a powerful and hostile spell that can only be reversed when the key is removed and neutralised. Eriksen (2013) suggests that doors may have been used as a barrier against the hostile dead, drawing on the description of the “door-court” in *Eyrbyggja saga* (Edwards and Pálsson 1989, 50–55)

Eriksen (2016) has further argued that buildings themselves were the subject of mortuary ritual. The practice has been variously interpreted as ancestor worship, (Baudou

1989, 35–36), commemoration of the landscape and structures of the past (Herschend 2009, 152) or territorial markers (Renck 2008). Kristian Kristiansen (2013, 242) suggests that in the Bronze Age, the practice was a particularly lavish example of equipping the dead, allowing the buried structure to be carried with the dead to the afterlife.

Eriksen, in contrast, draws a direct analogy between hall and body (2016, 2019), using literary references that refer to parts of the structure using anatomical terms. The relationship is found in the other direction as well; kennings for men and women refer to them both as trees (a complex reference that includes the idea of building material) and as poles or posts (structural elements) (Louis-Jensen and Wills 2007). In Eriksen's view the house and the body are not symbolically linked but should be seen as a distinct entity: the house-body (2016, 487) with agency and identity. Viewing the house-body as a meshwork as defined by Ingold (2006), she suggests that the social centrality of the hall meant that, under particular circumstances, a burial was necessary to allow the building to "die" formally. Although the practice is rare and appears most frequently in central Scandinavia (Eriksen 2016, 478), there may have been a more widely shared cultural belief about the intimate relationship between human bodies and houses, perhaps seen in the hogback tombs found in Scotland and England, a belief that could be expressed through the use of keys as a *pars pro toto* where the full internment was not possible or not practiced.

Although finding evidence for this sort of object use is, of course, extremely difficult, it is possible that those graves that do not associate with possible identity-expressing object types such as jewellery or weapons are examples of this practice. Unlike the group discussed above, non-gendered key graves appear in all eight areas, although the distribution is, unsurprisingly, uneven. Over half of these keys are found in Birka, a slight majority of them in group B, particularly in Hemlanden C.

The most common associations are with knives and with beads, both at approximately the same rate. It is tempting to either take a broad population distribution approach and suggest that approximately half of the non-gendered graves will be female, or to apply the observed distributions of graves with recognisable gendered object types, meaning that somewhere around 16% should be considered male. But neither approach is entirely satisfactory. In particular, the latter approach assumes that graves without gendered objects were using keys with the same intention and role or identity connection as those with recognisable gender.

As a whole these graves have smaller assemblages in terms of object types, and the range of types is smaller than for keys with gendered objects. Many of these graves tend to contradict ideas about keys relating to wealth or status; they are often not the richest or most diverse graves in the cemetery. But there are a number of graves that are very richly furnished, mostly found in Birka and Kaupang. These graves are notable for their inclusion of both weapons (often multiple types) and tools.

In geographic distribution, object association, and frequency of appearance, these key graves differ markedly from those associated with female jewellery or with textile tools. There is also no evidence for the inclusion of boxes in these graves, removing the idea that they are included as a practical object. Although it is possible that the keys in these graves still expresses a particular role or identity, that role is apparently substantially different in either expression, definition, or both. And the unusually high percentage of keys in the graves at Lillevang Bornholm mentioned above may suggest that there was some use of keys for symbolic or spiritual purposes, either to facilitate the successful transition of the dead, or to ensure the safety or well-being of the living community.

## 5.8 Conclusion

The focus on locks and keys in this study has produced insights into both the characteristics of the appearance of the objects themselves, and the utility of the methodology used to discover them. It has provided a better understanding of the complex nature of key use and also illuminated the value of establishing the regional characteristics of object inclusion against which an object type can be compared. It has also shown that in order to access some of the information potential of object types, they need to be evaluated in as much detail as is available in the archaeological record, using as high a granularity as possible for both the object and its context.

This includes the need to recognise and examine the range of appropriate construction types available to a given community, including unfurnished graves. The concept that burials are created on a principle of parsimony allows the recognition that every object intentionally included must have a meaning and purpose. Further, because there was a cultural appreciation of interlaced, complex messages expressed through poetry and art, it is reasonable to assume that each object could have been a physical kenning, performing multiple tasks both practical and symbolic.

The traditional association of keys with a single, gendered identity has obscured this multivalent nature of their use in burials. When examined more closely, on a smaller geographical area, the gendered association is neither as simple nor as absolute as the prevailing interpretation implies. It is these more complex characteristics that have the potential to provide significant insights into past cultures.

The variations in expression and association can be used to infer connections between areas that are geographically removed. Recognition that a strongly female gendered identity expression is not universal in Scandinavia allows the identification of the spread of the practice. There is a clear pattern of the appearance of keys with oval brooches and with large collections of beads, but that pattern is not found throughout the study area. There are also graves that vary from this pattern, many of which include male gendered

objects, or which do not appear to have an object-expressed gender. And the extent to which that practice is seen in different areas may give information about its place of origin, or the direction of spread.

Exploring the ways in which keys and locks are or are not associated with other object types can also imply variations in beliefs or practices. This is particularly evident in the patterns of association with textile tools. The clear geographic limits to the appearance of these object types with keys helps demonstrate the existence of network connections, but it also indicates that their appearance may also have meaning beyond the historically assigned role of expressing craft and gender. Further, that meaning may have been altered by the presence of keys. There is considerable scope for further investigation into the behaviour of keys with other common objects, and the nature and characteristics of textile tools in early medieval burials.

Finally, this study demonstrated the importance of common objects in the understanding of the past. Many understudied object types can provide a significant contribution when the questions asked of them are suited to their particular characteristics. By looking beyond questions of date or morphological style, information specific to their making, use, and appearance at deposition can give valuable insight into the structures and beliefs shaping the lives of the community.

## Chapter 6 Conclusion

This thesis has focused on the social aspects of Early Medieval locks and keys and has established a better understanding of the practices and beliefs that shaped the manufacture and use of the objects. In both the broad scale study in England, and the focused case study in Birka the idea of persistence was used to examine how cultural norms and needs can powerfully influence the retention of particular forms. By understanding that these concepts were rooted in the Roman period it is possible to see that many complex mechanisms were maintained even through times of considerable change. This demonstrates that the craftworkers who made these objects were able to adapt to changing conditions in terms of resource availability. But it also shows the social significance that locks and keys had in daily life, motivating the community at large to continue to invest in the technology, and giving additional symbolic weight to the objects, evidenced by their varied uses in grave assemblages.

These two qualities, the physical and the social have proven to be extremely useful in providing information about various conditions in the past that are otherwise invisible. Although much of that information must be inferred as it is not directly expressed, it is still possible to suggest a craft network that was capable of the necessary level of knowledge exchange within the community to sustain the specialised skills necessary to make the locks. This includes the *Chaîne opératoire* involved in the individual object types, as outlined in Chapter Four. But evidence was also presented of a more abstract understanding of the principles involved in the mechanisms, allowing the development of small but significant

differences in manufacture such as the casket locks discussed in Chapter Five.

This flexibility in the manufacture and design of the largely unseen mechanisms was, as seen in both studies, balanced by a strong tendency to preserve many of the visible forms. Some of that may be a deliberate archaism; possibly the metal-clad and studded boxes were harking back to a memory of socially significant Roman *arca*. Or it may be that the repeated forms served as a shared visual language, making communication among different groups easier. But it has also been shown that this conservatism was not directed at all key types, nor was it expressed in the same way in all of the areas of the study.

What does seem to be consistent in both studies is a strong demand for security, and particularly for security that was flexible and portable. The desire to be able to limit access to particular objects, and to exert that control in a way that was visible to the immediate community, appears to have continued through the upheavals of the end of the Roman period. It was apparently not limited only to elite sites or to more densely populated locations. Instead the picture developed from the PAS data suggests that even in some of the more rural areas there was an ongoing demand for locks, with an apparently rapid adoption – or re-acquisition – of additional key forms and mechanisms.

This combination of an intentional conservatism in certain forms with a willingness to adapt or abandon others suggests that there were additional factors involved. The power of locks and keys in terms of reshaping both the physical and the conceptual character of a space has been discussed, and with the evidence presented for complex, layered meanings ascribed to these objects it seems likely that it is this aspect rather than more mundane considerations of resource or economy that were responsible for this persistence. There may have been a shared idea that what a key *is* and what it *means* are closely linked. When making a new key, the appropriate form was necessary in order to ensure that it was suitable both for its physical and for its social tasks.

## 6.1 Summary of the studies

The PAS database allowed the opportunity to look at locks and keys outside of the elite sites and proto-towns and try to understand the nature of their distribution in the more rural areas. Because of the limitations relating to the nature of collection of the objects themselves, additional data from both traditional archaeological sources and from representations in various media was used. A timeline of key forms was constructed, illustrating the types of keys that are known to have been in use in the early middle ages. Comparing the distribution of these types to the date classification of similar types in the PAS and MOLA made it clear that the actual population of early medieval keys was larger than has been previously recognised.

Using these known key forms, and examples from securely dated art work, it was possible to develop a more accurate picture of the types of keys that were not only in use in specific locations, but were sufficiently well known to be used as visual reference in illustrations. This process also allowed the identification of two specific key types that indicate there was a high degree of accuracy in the replication of these forms over time.

The first of these forms, a relatively simple casket key, is very widespread and has a significantly long use life. It is found in Roman, early medieval, and medieval contexts and is the most common form in the PAS. The persistence of this type, arguably, is evidence of not only a wide spread desire for locks of this size and general type, but also an equally widely shared cultural concept of the appropriate form for that sort of key.

A second, more complex persistent form that can be securely dated to the Roman period, can be shown through artwork and later site evidence to have been in use after the early medieval period. This form is scarce in the PAS records, but appears with variations relatively frequently in MOLA. The suggestion is that it is evidence of re-introduction rather than persistence.

The study used these forms to support the idea that there was likely a robust community of experienced craft workers with specialised skills. This community was large enough and sufficiently networked to be able to successfully maintain and accurately transmit their knowledge. It was suggested that the apparent reduction of more complex key types early in the post-Roman period may indicate that keys were sometimes made locally while the more technologically challenging locks were created by specialists in productive centres. If true, these characteristics could be used to infer information about ways in which craft networks changed in response to the disruptions in trade that followed the end of the Roman period.

The survival of craft knowledge also provides insight into the wider communities. The consistent demand for locks, particularly during a time when access to material resources was restricted, indicates the importance these objects played in social life. Rather than relying entirely on earlier solutions for security, such as caching and hoarding, these communities continued to invest in technology that was more costly in resources, and that could be lost or broken. These communities must have had the assurance that, having acquired these objects, they could also have them repaired or replaced when necessary.

This implies that something in addition to a need for security was driving the survival of locking technology. The rhetorical importance of the use of a lock in visually and physically creating identity categories of people, object, and spaces, was also at play. The fact that locks were not only used in elite centres, but were more broadly distributed, indicates that the hierarchical structures and the cultural practices involving locking and unlocking were also wide spread and continued to have significance.

As stated, the study demonstrated the value of viewing persistence as a product of the same physical and social forces that produce technological change. Accurately and



reliably reproducing an object form, particularly for an object type that has considerable potential variation, requires a consistent investment of resources. That persistence of form implies that there was a stability in both the broad cultural idea of what the object should look like, and the specific knowledge necessary to make it.

By looking beyond questions of date, it is possible to use archives like the PAS to infer information about the social conditions that were in place when these objects were made and used. By applying this approach to other understudied object types, it may be possible to gain a better understanding of the ways in which craft workers and communities navigated the transitions of the early middle ages. In particular, it may give better insight into the ordinary, non-elite activities that can be obscured when object research is focused on object types that are not central to those activities.

The second study looked at keys and locks within their social setting. This began with an examination of the objects themselves. The keys from both the Black Earth and the burial assemblages were identified and classified by type and by comparing them to objects from other areas it was possible to see that while there was a great deal of diversity, there were also particular characteristics that were shared among communities. The distinctive forms of type C keys found in Birka showed that even these relatively simple objects carry evidence of cultural preferences.

Surviving evidence of boxes and caskets provided additional evidence of those shared preferences. But the lock types also showed that there was more innovation and specialisation in lockmaking that had previously been understood. Not only was the distribution of lock type different between Birka and England, but the components of the lock type are distinctive.

The focus then turned to keys within the context of the cemeteries and the burials. The general characteristics of the cemeteries were discussed in terms of the amount of variation in construction type that was present, and how, if at all, gender identity appeared to be important in the burials. Having compared the cemeteries around Birka, the additional data from the seven other sites in the study were similarly discussed.

Finally these data were analysed in terms of several different themes that have particular importance for locks and keys. First it was established that although in some of the cemetery areas keys did often appear in female burials, that distribution was not consistent in all of the areas around Birka, or in the other sites in the study. It is difficult to support the idea that keys were important in constructing an identity, such as the Lady of the House, certainly not as a practice that was widely shared.

Next the keys that feature in large and well furnished male burials were discussed. Although many of these keys were found with objects placed away from the body at the edge of the grave, some were closely associated with the remains. It was shown that

there was no apparent contradiction between the masculine identity seen through many of the objects in the assemblage and the presence of the key. Repton Grave 511 gave an interesting comparison, and introduced the idea that keys could also have symbolic meanings or uses beyond simple identity display.

Some of these potential symbolic meanings were explored, such as the connection between keys and blacksmiths. There is also a possibility that locks and keys were deliberately used as enchained objects to manipulate the connection between the living and the dead. The fact that both locks and keys appear alone may support this idea.

Then we examined two other ideas. The first compared objects in a burial construction to kennings, complex word play that layered multiple meanings into a single phrase through the use of reference. This view of the objects suggests that they could hold multiple meanings and perform multiple roles. Finally, we looked at the idea that the locks and keys could be used as they were in life – to control access to and change the nature of the space around them.

## 6.2 Further research

The foundation laid in this study has potential for further work. The type groups that were developed for this thesis are, of course, limited. But both studies have shown that the social pressure for persistent forms is directed at the morphology rather than the technology. This provides an opportunity to further explore the ways in which that persistence is expressed by adapting the present system to focus on those aspects. The classification method used for casket keys could be expanded and applied to other types, perhaps developing into a morphological grammar that will allow a more precise description of the particular elements of these objects that are either relatively stable or are subject to innovation and individual expression.

This would allow patterns of association, like that seen in the casket keys in Chapter Four, or the padlock keys in Chapter Five, to be recognised and possibly mapped. This would allow the identification of probable contact between locations or communities. And of course as more data are added, and with them more suggested connections, it could be possible to see evidence for the directionality of those exchanges.

This sort of work would exploit the advantages of locks and keys – their mobility, relatively morphological stability, and their cultural significance. But in order to realise the potential it will be necessary to expand the dataset considerably. Building on the English and the Scandinavian material already gathered, ideally the scope would be widened in two ways. The first is geographic, to include not only more of western Europe, but also the extended trade and exchange network. The second is to give more attention to locks which, other than padlocks, have been largely ignored.

The adaptations of common forms and mechanisms that were seen in the locks discussed in Chapter Six show that there was considerably more innovation in the craft than has been understood. Linlaud (2014) has begun to suggest a chronology for the development of some of these small changes in France and that provides an opportunity to begin to better explore the characteristics of that development.

One important aspect of this would be to experiment with physical models. There are several reasons for this. The first is that in order to properly study these objects as the product of physical and social forces, it is reasonable to try to understand as much as possible about the physical conditions that would have directed or constrained the choices made. Studying the effects of wear on components, for example, would give an idea of weak points and vulnerabilities, things that a household would likely be aware of and need to accommodate for.

Having a better idea of the ease or difficulty of making the components and then assembling the lock would also be valuable. The skills listed for each lock type in Chapter Four are based on experiments carried out previously (Gustafsson 2005) and on replicas made by reenactors as well as consultation with craft workers, but doing a systematic study to map out more completely the resources and the skills necessary to construct each lock type would provide a much more complete idea of the environment in which these objects were made.

There is also the fact that several of the lock forms discussed in this thesis are only conjecture, an effort to explain what evidence has survived. Although Linlaud (2014) has built 3-d models of some of the rotary locks in his dataset, a project to physically build and test these forms could add a considerably to the understanding of their functionality when in use. In particular, it would be worthwhile to work with the "keys" discussed in Chapter Four that found in Early Medieval English burials prior to the conversion. I have made the suggestion that these may not be functional keys, or that they may be some other sort of tool entirely.

Extending the study both through the expansion of the dataset and with the incorporation of experimental approaches will not only increase our knowledge about these particular objects, but also may prove useful for other object types and for other research questions. There is considerable potential in the approach used here. Viewing these objects in terms of their social context and framing the questions asked about them from that point of view has proved particularly useful for locks and keys, which have been difficult to study using more traditional methods. The information gained through this study is valuable not just because it provides a better understanding of the objects, but it is an understanding of the objects within their own world.

# Appendix One The development of the type groups used in the study

Although a system of organisation was clearly necessary for the analyses carried out in this thesis, it was never the intention to produce a formal typology of key forms for use outside of the study. Early in the process I was informed of another project on keys, focused in Scandinavia, one important aim of which was to create just such a typology. The projected timeline for this researcher's thesis meant that it would not be available for use in my own work. Rather than developing a second typology, which would create unnecessary confusion, my intention was to produce an organisational system that would facilitate the planned analysis, and as the researcher's typology became available, discuss how this system fits within her model. Unfortunately as of this writing this typology has not been made public.

The organisational system was designed, therefore, in relation to the project rather than with the intention of describing the chronological development of keys. As has been discussed in the thesis, the long use-life of many key forms makes such a chronology particularly difficult. The tendency has been to focus on specific characteristics, such as terminal types in rotary keys (Linlaud 2014), or decorative handles (Almgren 1950). These limited chronologies allow some keys to be roughly dated, although the geographical limitations are still not well established. But a chronologically focused typology that includes all of the known variants of bit type has not yet been established and doing so would be well beyond the scope of this project.

In order to create an organisational structure of keys for this project, three aspects of keys were identified as being central to the analytical focus: their morphology, their relationship to lock mechanisms, and their relationship to the space controlled by this lock. The first aspect is the foundation of most object typologies, including those mentioned above, and is an obvious place to begin to form classifications so from the beginning, this was the aspect that was the primary focus. However, the other aspects are also important and were evaluated.

As discussed in the thesis, there is not a one-to-one relationship between key type and lock type so this second aspect could not be used as the primary means of classification. However, because keys are part of a two-part tool set, it seems essential to consider the probable lock type insofar as it can be determined. Finally, the use to which these keys and locks was also important, not only for the value that information may have to the researcher, but because it is likely that this is the primary way that the keys were thought of by the people who owned and used them.

These three aspects all had some drawbacks and difficulties. The morphology of keys is complex as they are, as discussed, composed of multiple components all of which have variants. The difficulty with primarily considering lock types has just been mentioned, but a further issue is that many details of lock construction are unknown; building a classification system on conjectural reconstructions is, obviously, unsatisfactory. The third factor, the question of the secured space, appeared to have potential, but had not been thoroughly explored in previous typologies.

In order to evaluate whether or not this aspect would be viable as a basis for initial classification, particular characteristics of keys from groups A, C, and E were identified as possibly providing information about the dimensions of the lock to which they related (figure I.1). Table I.1 describes the location of the measurement and the dimension it relates to on a lock. A broad selection of keys from each of these groups from the dataset was then traced, and the measurements recorded (figure 1.2). Analysis on the distribution of these measurements, and on ratios of some of the measurements (table I.2) was done. Additionally, traces were made of surviving locks from chests and boxes.

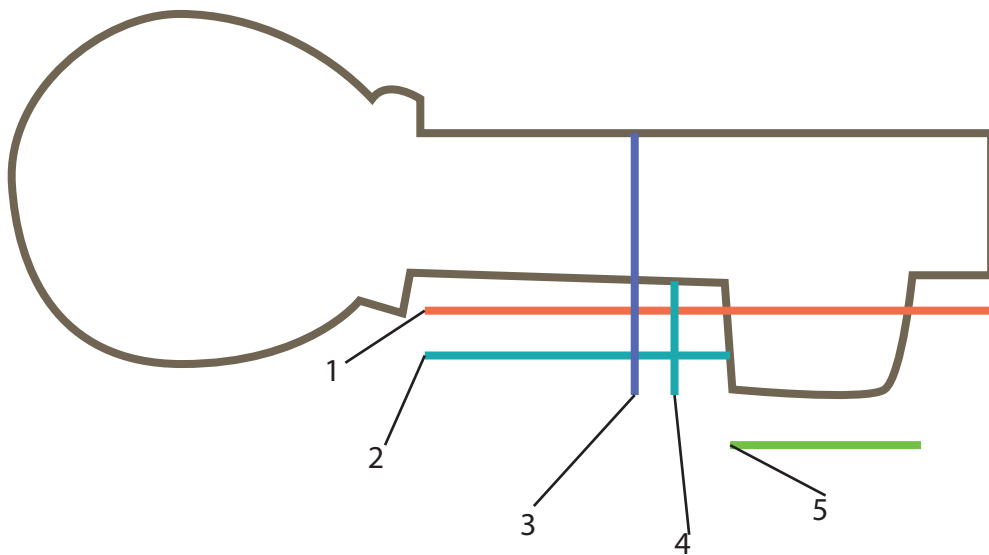

Figure I.1 Schematic of the five dimensions used to evaluate the possible relationship of key measurements to lock size

	Location	Possible relationship to use
1	length of full stem with bit	distance from face plate to back plate of lock
2	length of stem without bit	distance from outer face plate to inner surface (thickness of box wall)
3	depth of bit with stem	[for rotary keys] diameter of the movement area - the space the key rotates
4	depth of bit	distance between the pivot point and the point of contact with the bolt
5	length of bit	depth of the mechanism from faceplate to backplate

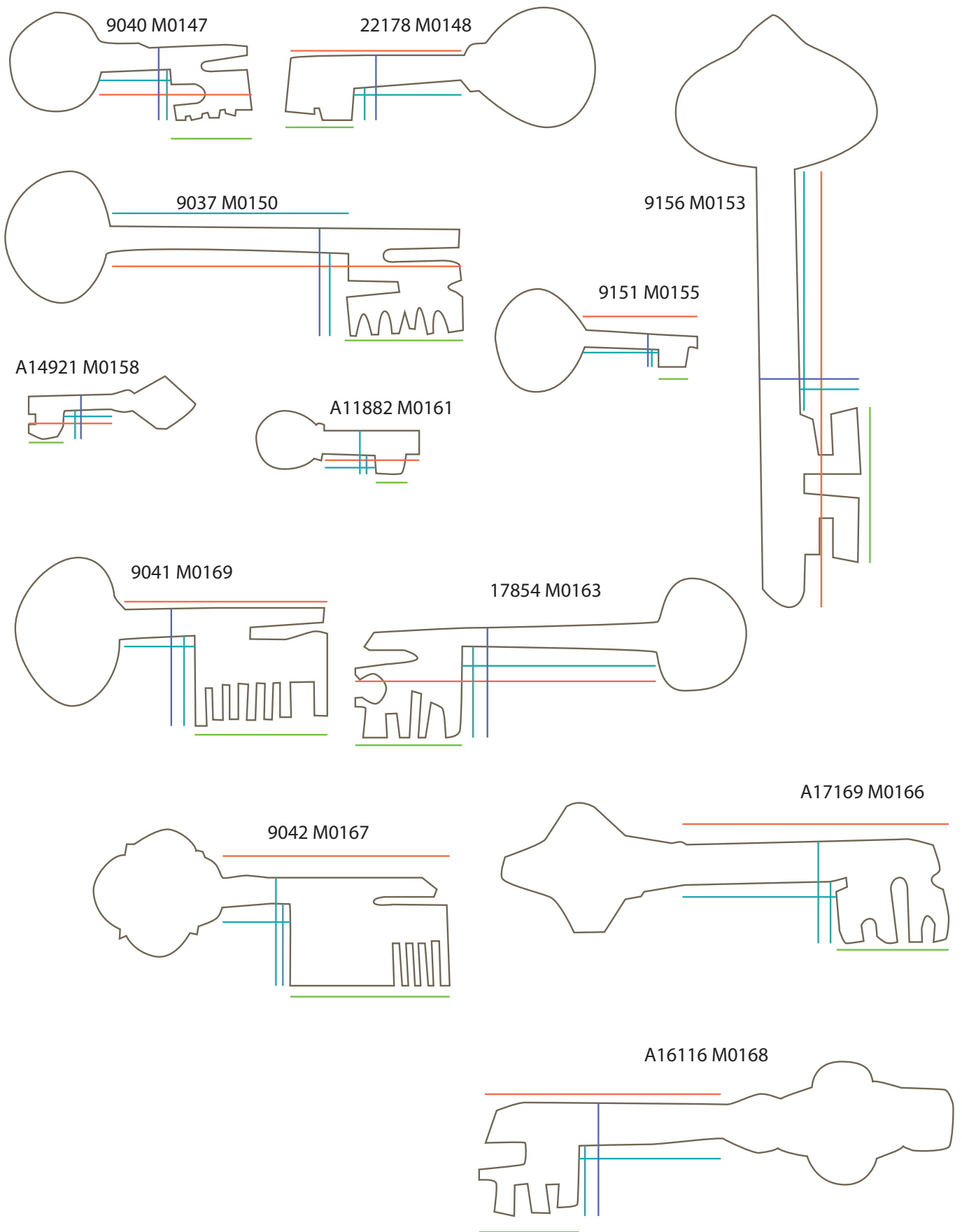

Figure I.2 Examples of traced keys

ID	Collection ID	Stem min	Stem max	Stem max rounded	Stem ratio	bit depth min	bit depth max	bit width	% of bit to max stem
3	763397	12.53	21.33	21	0.59	7.14	11.3	8.8	41%
4	763023	6.01	14.49	14	0.41	6.46	10.91	8.49	59%
29	753316	18.91	32.1	32	0.59	5.36	9.19	8.74	27%
31	752491	12.82	21.89	22	0.59	4.96	8.47	10.37	47%
56	740498	10.53	19.95	20	0.53	7.01	12.1	9.42	47%
80	730912	16.51	26.26	26	0.63	10.02	15.98	10.4	40%
83	729653	11.79	25.34	25	0.47	6.7	9.92	8.33	33%
122	423923	5.04	13.77	14	0.37	7.16	13.32	8.73	63%
148	726323	16.77	24.24	24	0.69	6.89	11.96	7.41	31%
162	718085	13.78	21.49	21	0.64	6.84	10.18	6.31	29%
175	713532	14.7	23.97	24	0.61	7.77	12.73	9.04	38%
199	707668	5.81	15.41	15	0.38	6.65	12.04	9.9	64%
208	703240	11.67	20.28	20	0.58	5.03	8.82	8.82	43%
210	702320	3.72	7.98	8	0.47	3.3	4.98	4.27	54%
252	648254	6.97	15.88	16	0.44	7.01	10.28	8.39	53%
278	639556	16.74	29.66	30	0.56	6.46	10.82	8.64	29%
303	628738	15.34	24.89	25	0.62	7.25	11.95	10.34	42%
324	621800	8.14	20.35	20	0.40	4.82	8.12	8.39	41%
327	619890	10.68	18.48	18	0.58	6.55	10.45	8.82	48%
338	610665	9.62	20.11	20	0.48	5.76	9.14	7.28	36%
342	609731	13.87	22.11	22	0.63	5.19	8.87	8.26	37%
377	599312	14.27	22.92	23	0.62	8.47	13.24	7.92	35%
396	593628	17.14	30.71	31	0.56	6.72	13.62	13.7	45%
464	571453	10.84	19.01	19	0.57	6.49	10.36	7.78	41%
489	563027	16.2	23.91	24	0.68	6.18	10.51	8.06	34%
497	559573	9.76	18.08	18	0.54	7.19	11.38	8.32	46%
533	552132	11.84	24.35	24	0.49	7.16	12.41	9.34	38%
563	536444	16.44	26.6	27	0.62	7.79	12.04	10.34	39%
592	525640	19.01	25.66	26	0.74	6.92	10.35	6.92	27%
635	503194	24.07	33.03	33	0.73	5.96	11.31	8.43	26%
646	500812	7.01	18.99	19	0.37	12.13	17.35	6.56	35%
679	489895	8.83	18.86	19	0.47	5.05	8.99	8.95	47%
682	489333	13.77	23.32	23	0.59	8.83	12.59	9.55	41%
694	485671	13.02	22.14	22	0.59	7.76	10.88	9.34	42%
772	462189	29.86	37.34	37	0.80	4.74	9.38	7.48	20%
778	460762	11.84	24.4	24	0.49	7.22	11.5	9.53	39%
795	456357	11.94	19.17	19	0.62	6.92	10.65	7.21	38%
888	430370	12.96	20.22	20	0.64	6.45	11.22	8.12	40%
1162	269148	8.21	15.16	15	0.54	8.8	12.7	9.67	64%
1512	185714	20.96	27.78	28	0.75	9.18	14.93	6.72	24%

Table I.2 Example measurements and ratios

The results did not produce recognisable clusters that could be used as the basis for a typology. In part this is because there are relatively few surviving locks where the dimensions of the box, chest, or door is known that could therefore be used as a control. The largest set are from chests used in burials, notably those from Winchester, York, Thwing, and Ailcy Hill, and the majority of the locks are associated with Group C keys. There is only one extant possible door lock from the period, from the Lloyd's Bank excavation in York, and that example had been removed from the door. Both the way in which the lock was fixed in place and the type of door on which it was used are unknown. It could have been used on either a structural door or a large cupboard. Similarly, there are very few surviving small box locks. However, while this small study failed to provide the basis for a workable typology, the approach shows promise in terms of understanding lock use, and further work on a larger scale could be useful.

Having eliminated size and dimensions as a meaningful basis for grouping keys, the next consideration was to use Ward Perkin's typology created for his catalogue of medieval objects at the Museum of London (1993). The MOLA collection is used within the study so using a typology developed in reference to it has obvious advantages. Further, this typology is often used as reference both in site reports in Britain and in the PAS. However there are also a number of problems with this system when applied to this study.

Ward Perkins limits himself to the discussion of what he identifies as door-keys and chest-keys (134), casket keys which includes small keys with a wide range of morphologies, and two sub-variants of padlock keys. The first group is divided into nine types (figure 1.3), although only seven of these are described in the text. Type I is keys from group E in this study, Types II - VIII are keys from group A, and Type IX is a variant of group B. The criteria used to create these divisions varies. Type II and Type III have the same basic form and are differentiated solely by their construction method; one is formed out of a single piece of iron and in the other the bit is made separately and then welded in place. Type IV and Type V are distinguished by their terminus: in the former a solid pin ending at the fore-edge of the bit, in the latter a solid pin extending past the bit. Type VI Ward Perkins identifies as a copper alloy form, with a thick bit and a solid stem that has been bored at the end to create a pipe. Type VII has a symmetrical bit, indicating that it could be used from either side of a door lock.

The two further types that lack descriptive text are somewhat problematic. Type VIII is apparently identical to Type IV, and without a description it is impossible to know why it is separately classified. All of the examples listed for Type IV are iron so it is possible type VIII was intended to describe copper alloy keys of this form. Type IX is a variant of Group B keys, with a spade shaped bit. This form known from Roman sites, and is also fairly common in late 18th-19th c Britain, variously known as a night latch key, or a French latch key (Monk 1999, 41-43). I have been unable to find any securely dated keys of this variant from the early or



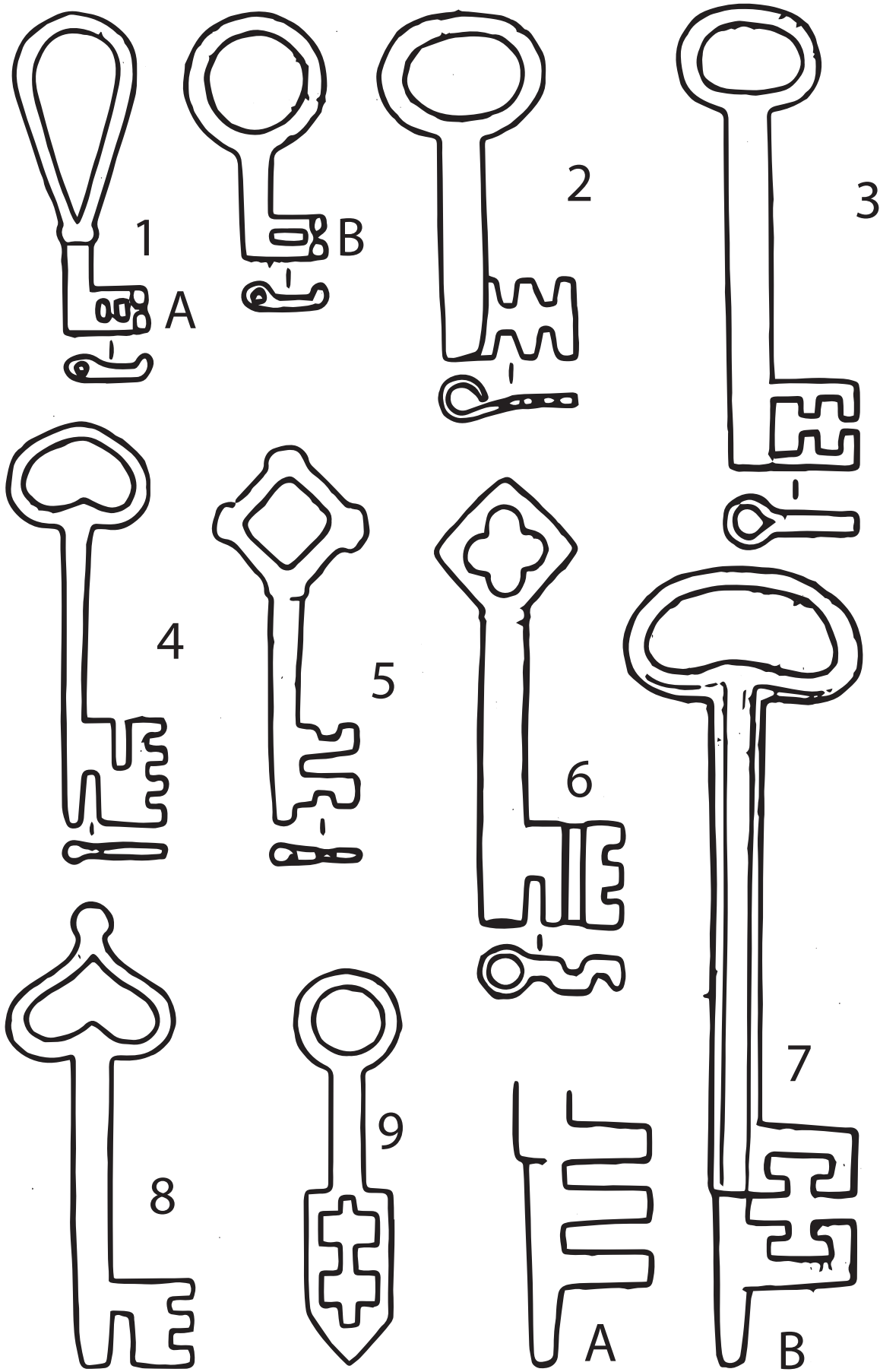

Figure I.3 Ward Perkins's nine types of medieval keys. After Ward Perkins 1993, fig 42  
326

later medieval periods.

Ward Perkins's typological model is unsatisfactory for the present study for two reasons. The first is that the typology is restricted to a small number of forms. This is not an insurmountable issue as key forms not mentioned could simply be appended. The second and more important issue is that the characteristics used by Ward Perkins to identify his types I - VII are widely varied in quality. The result is a set of types that can be described but that provide little meaningful information behind their physical form which makes them unsuitable for the distribution analyses used in this study.

It was decided, therefore, to create a new set of classifications primarily on the basis of the broad morphology of the keys, but with some consideration of the lock mechanism that they opened. A foundation for this classification comes from the organisation used by Patrick Ottaway (1992) in his discussion of the keys from Coppergate, York. The broad divisions he makes are: rotary keys (Group A), padlock keys (Group B), and "slide" keys (Group C).

This broad grouping was then extended and refined. Two forms that are not found in the Coppergate material, the Roman warded tumbler key (Group D) and the wood or bone tumbler keys (Group F) were added for completeness. Although sharing much of their basic morphology with type groups A and C, toothed rotary keys (Group E) and simple hook "latch lifters" (Group G) were given separate classifications because their related lock mechanisms were sufficiently distinct to represent a separate (although related) craft practice.

Group C keys, J and T forms, have a very similar construction method, and in England they were sometimes used for the same type of lock so it seemed reasonable to combine the forms into a single group. Group E keys are more problematic. As discussed in Chapter Five, there are at least three variants of these keys, and they open two (or maybe more) very different lock types: casket locks and padlocks. Unfortunately the lock mechanisms related to these keys have not been well studied so their relationship to those mechanisms isn't completely clear. Because these keys seem to have a similar chronology, being limited mostly to the mid- to late-early middle ages, I decided to keep them as a group but to describe the main variants. hopefully future research will help clarify their use.

The morphological approach is, obviously, arbitrary by nature and dependent on individual interpretation. It does not attempt to reflect the ideas and identities that the people who made and used them would have had. While this system was adequate for the needs of this study, hopefully a more complete typology that considers both locks and keys can be developed in the future.

# Appendix Two: Bit forms found in the dataset

## Group A keys

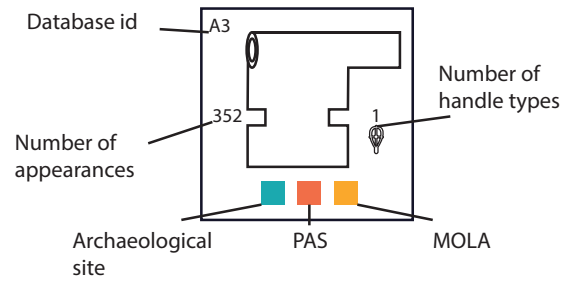



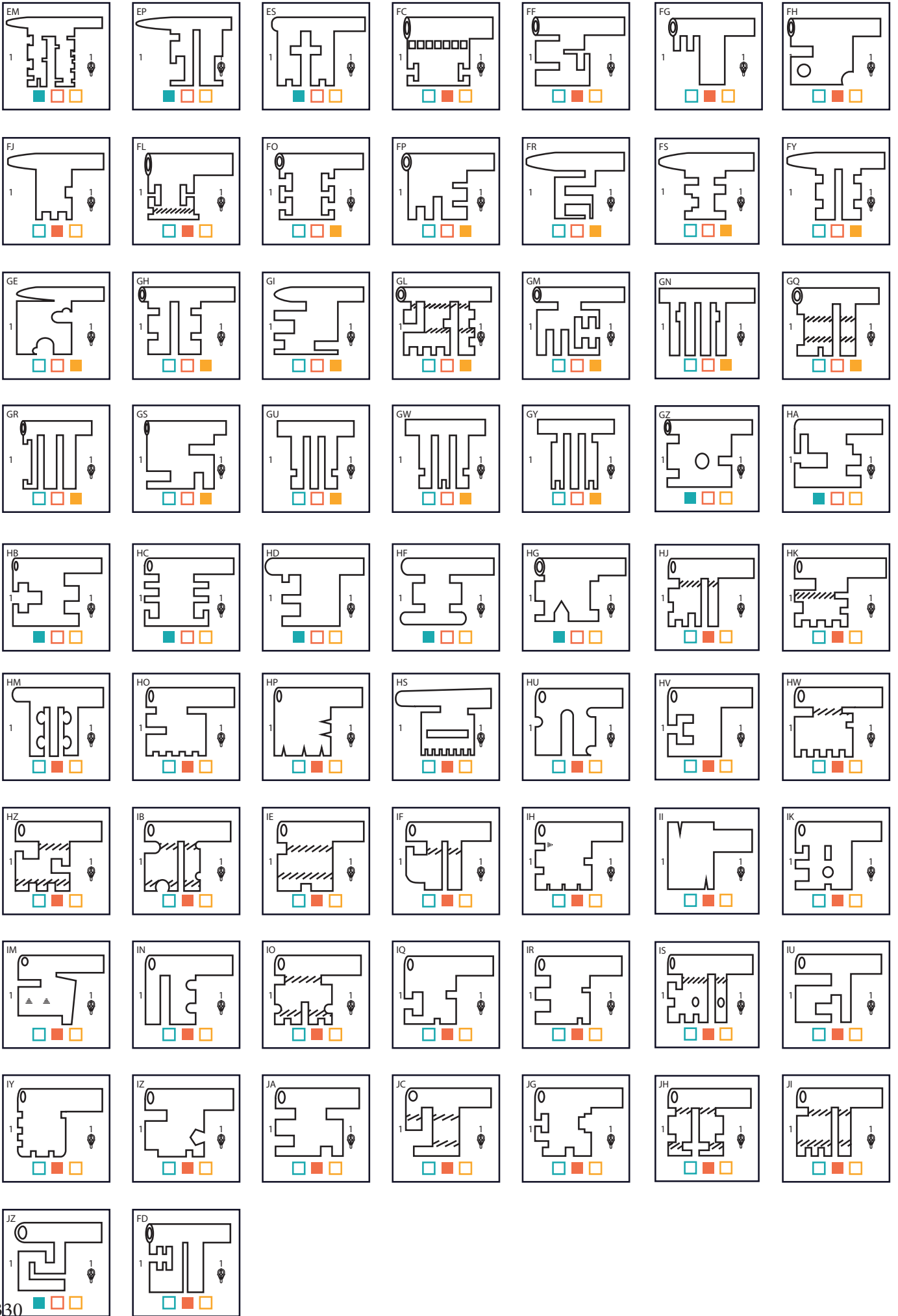

## Group B keys

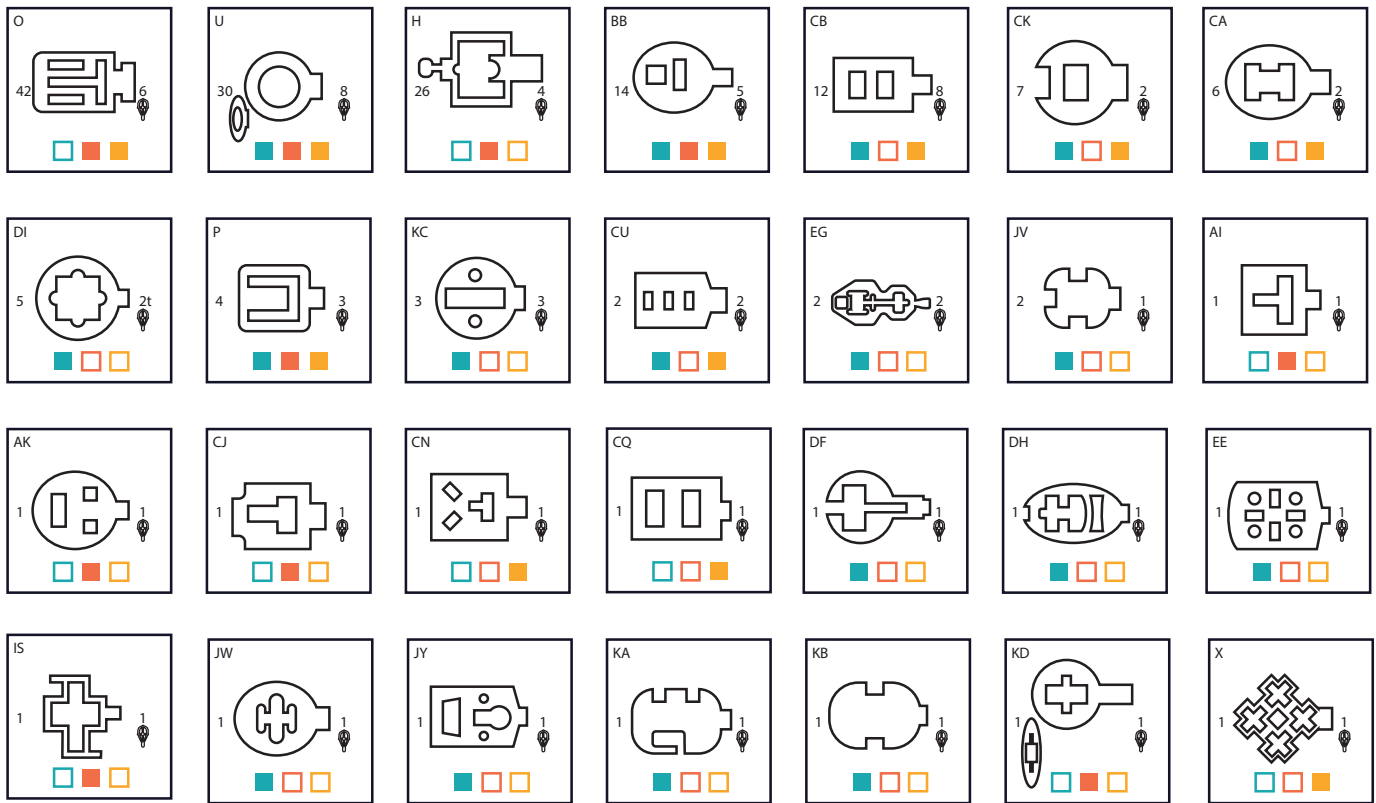

## Group E keys

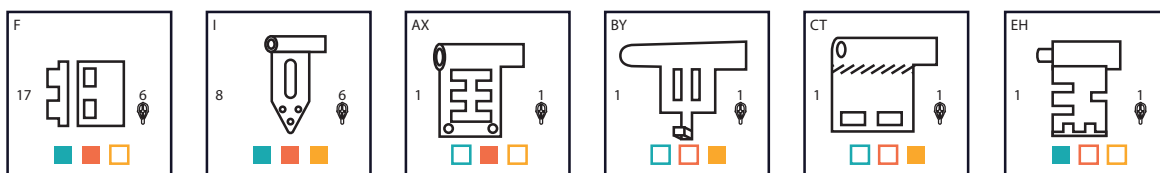

# Appendix Three: Bow or handle forms found in the dataset

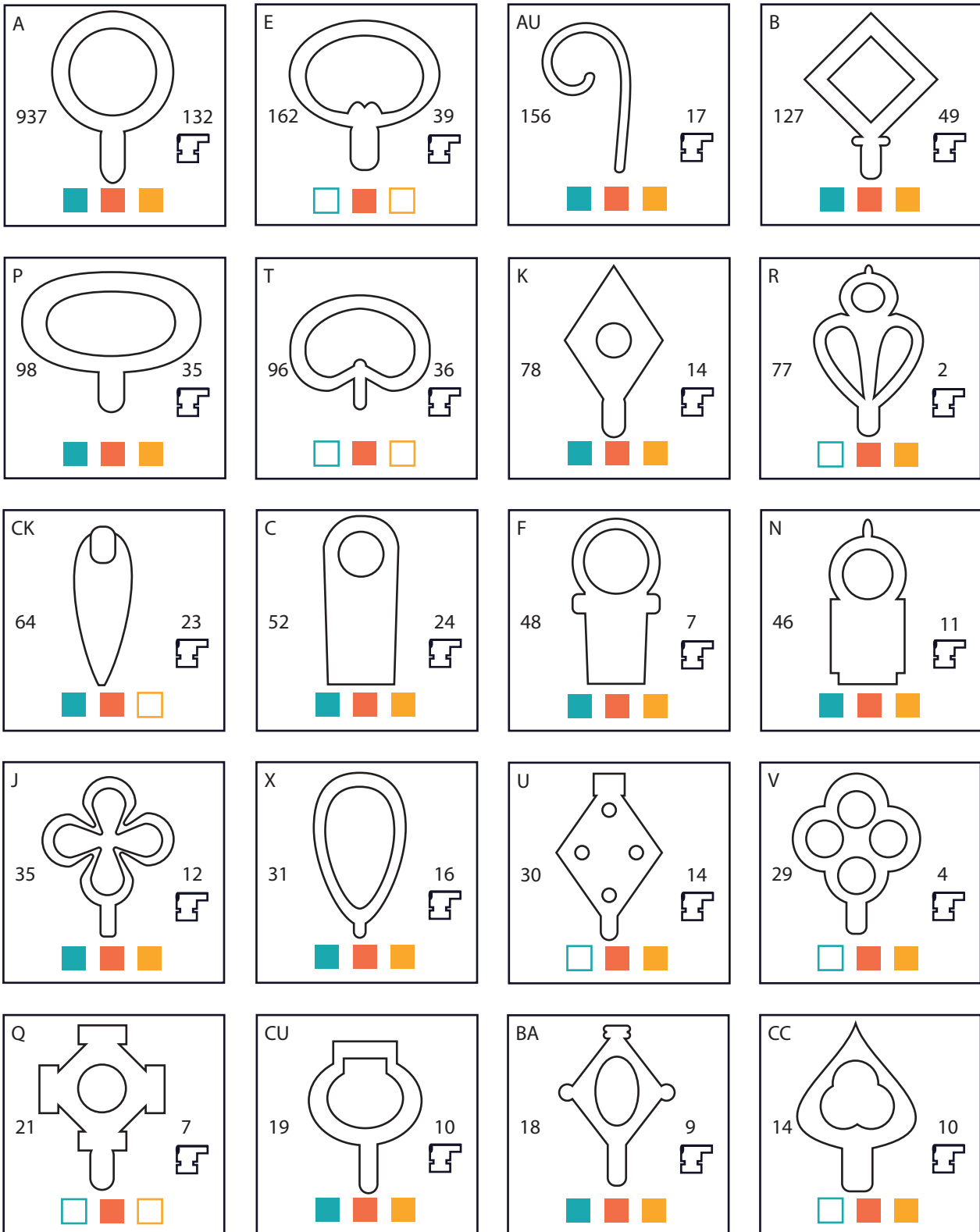
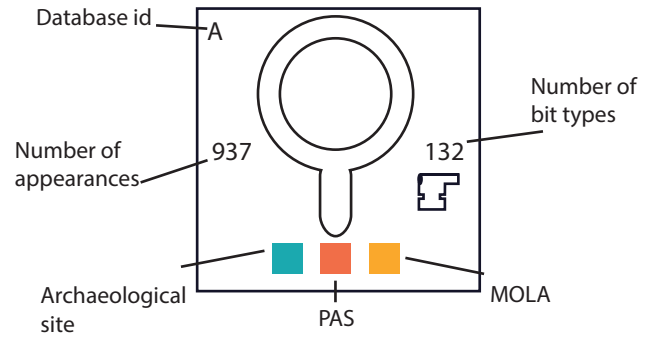

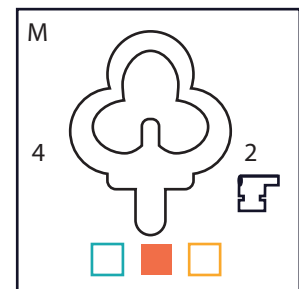
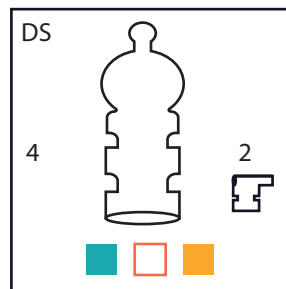
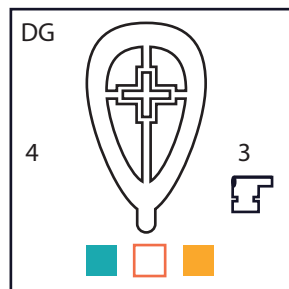
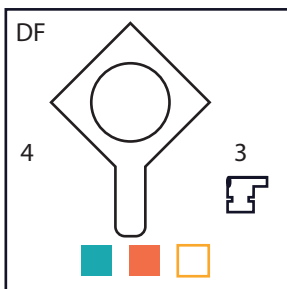
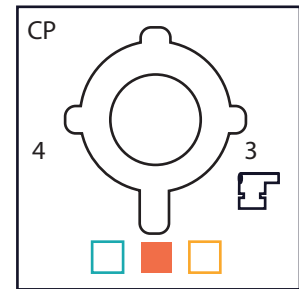
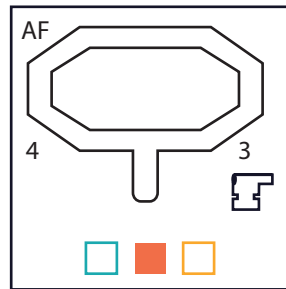
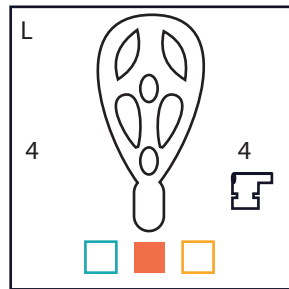
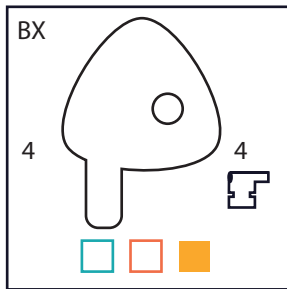
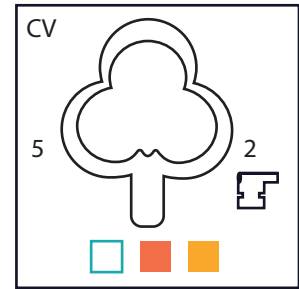
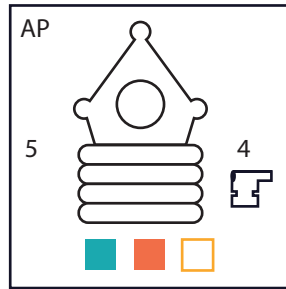
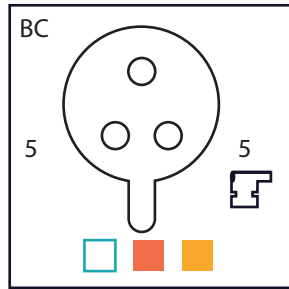
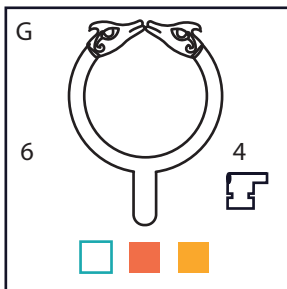
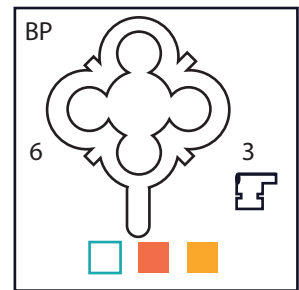
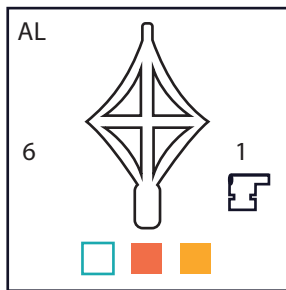
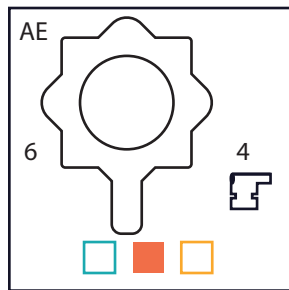
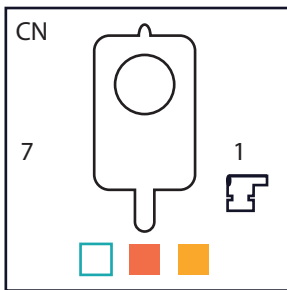
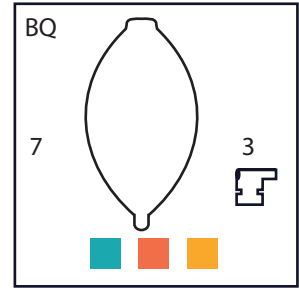
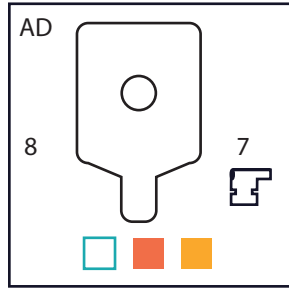
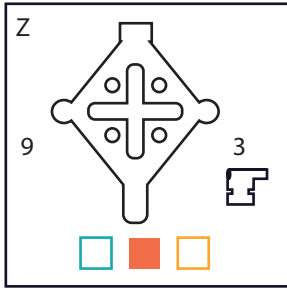
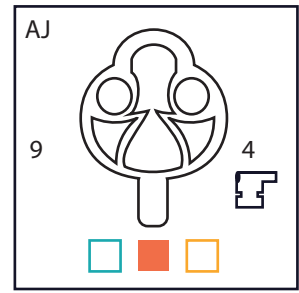
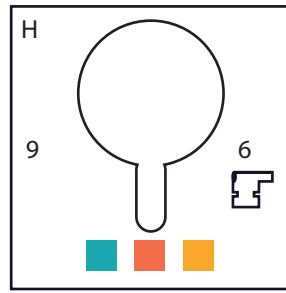
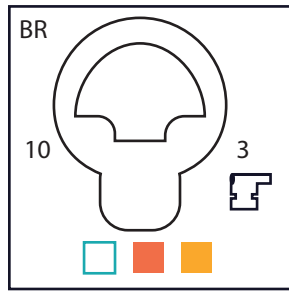
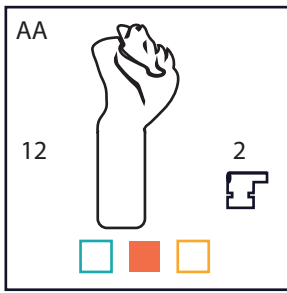



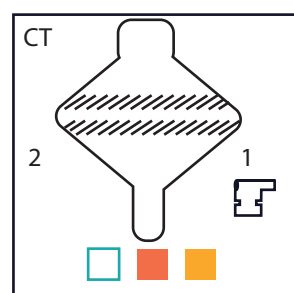
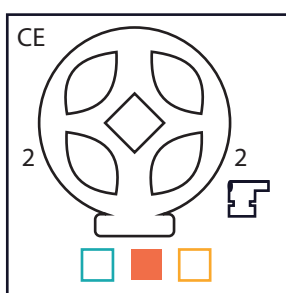
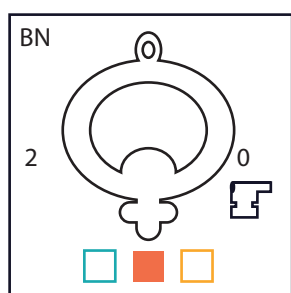
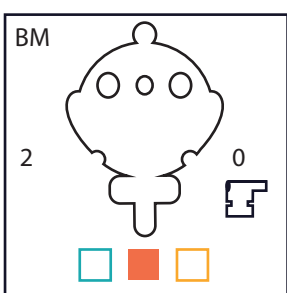
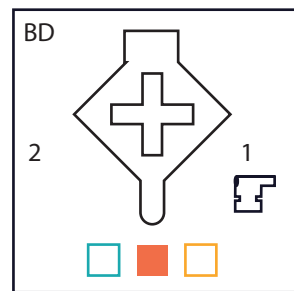
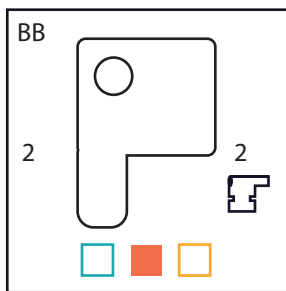
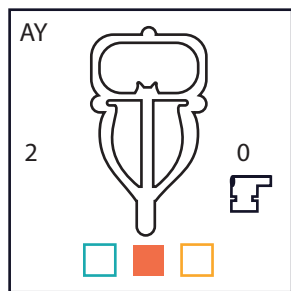
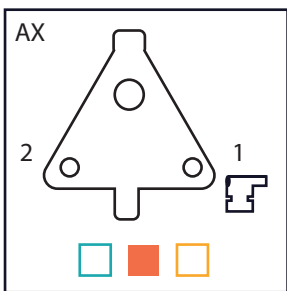
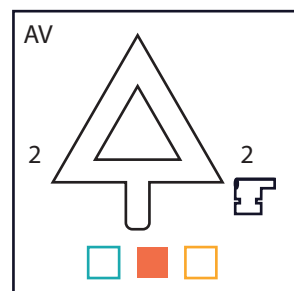
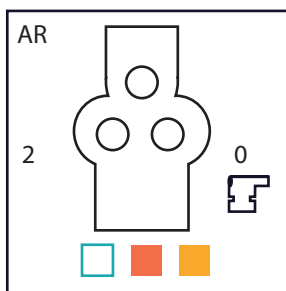
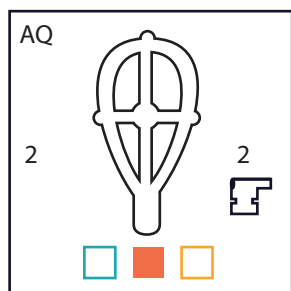
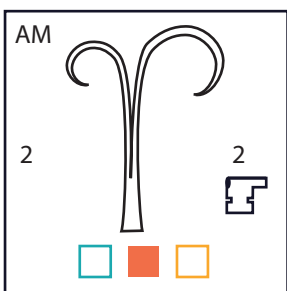
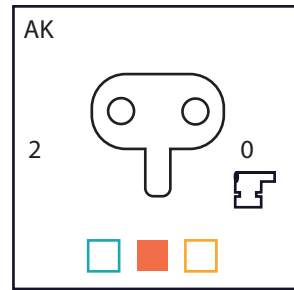
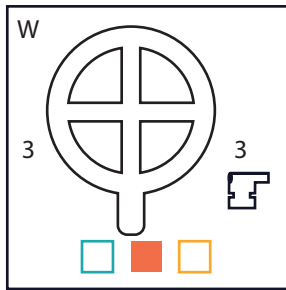
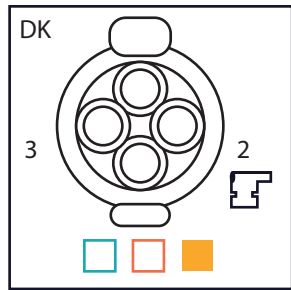
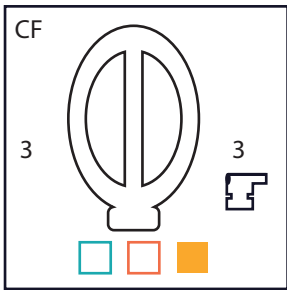
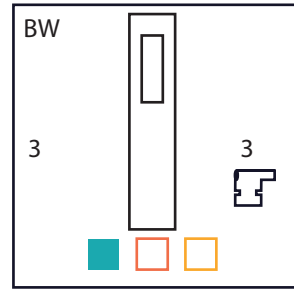
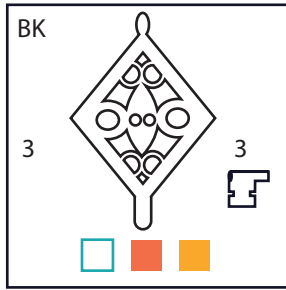
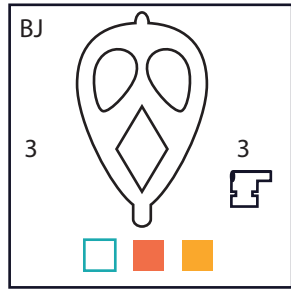
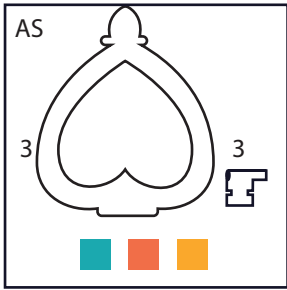
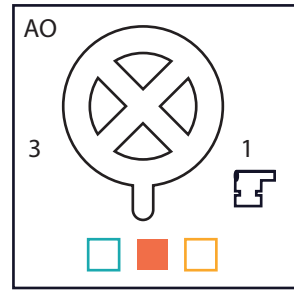
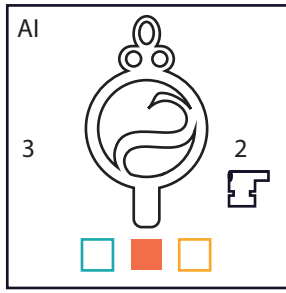
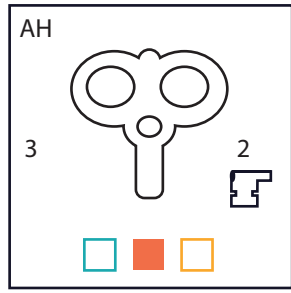
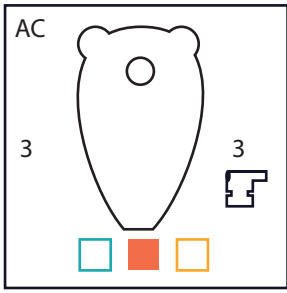

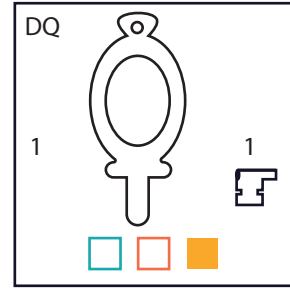
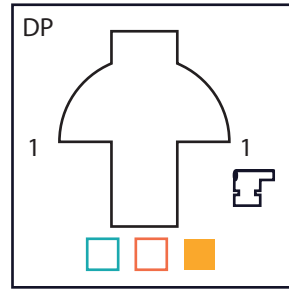
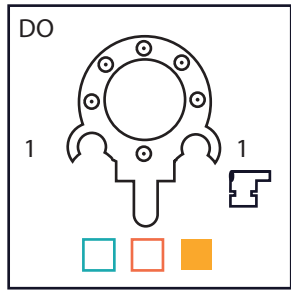
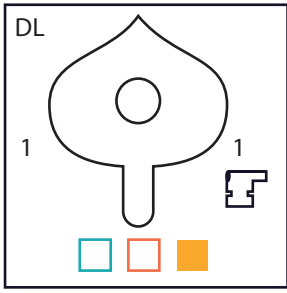
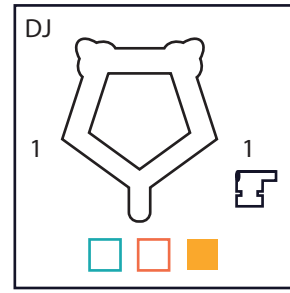
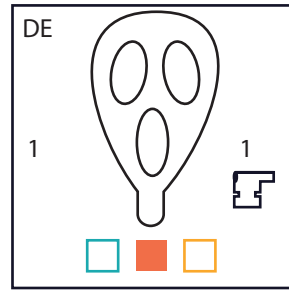
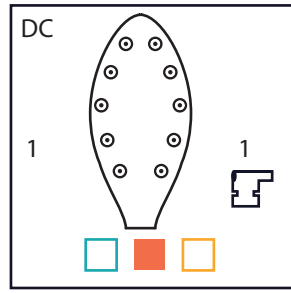
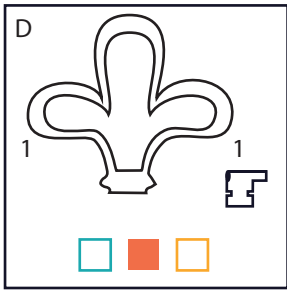
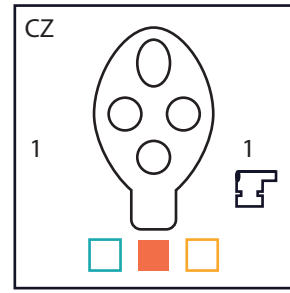
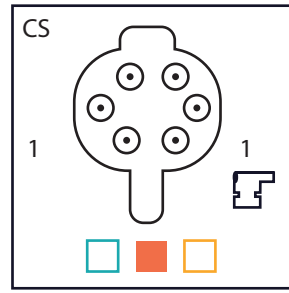
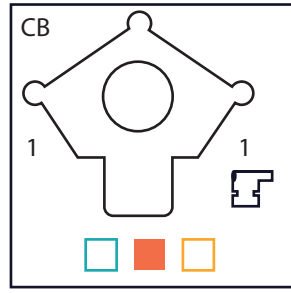
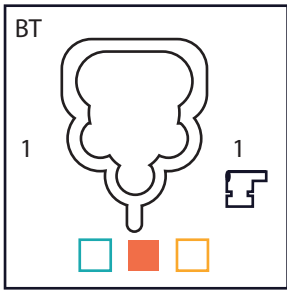
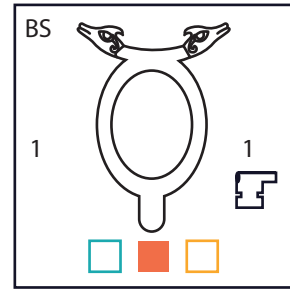
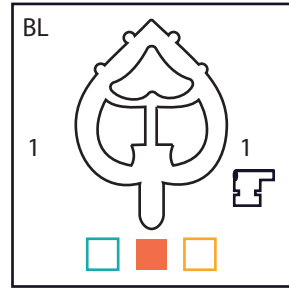
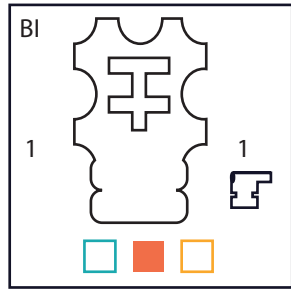
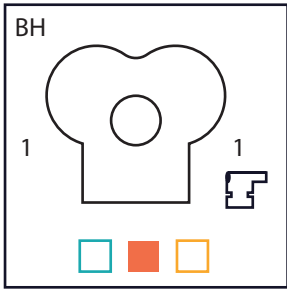
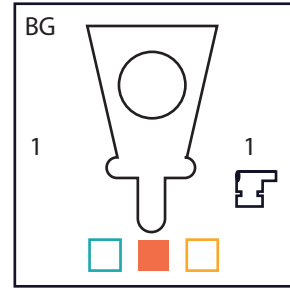
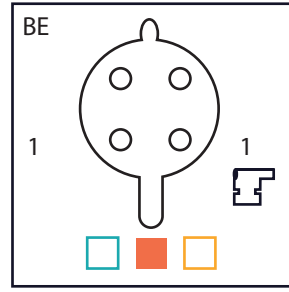
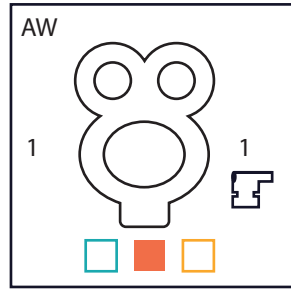
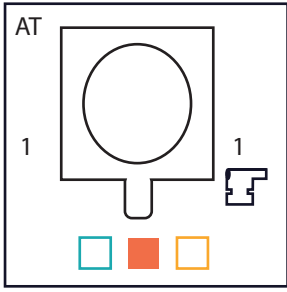
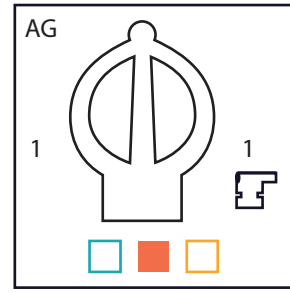
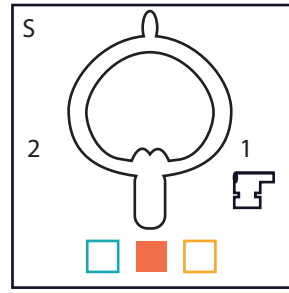
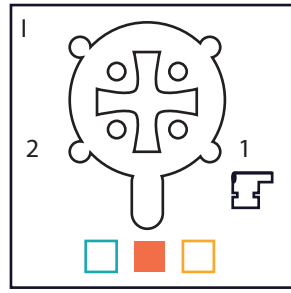
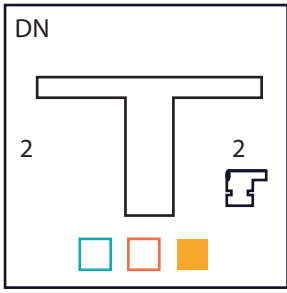

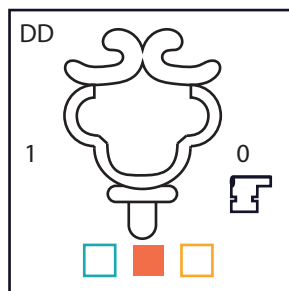
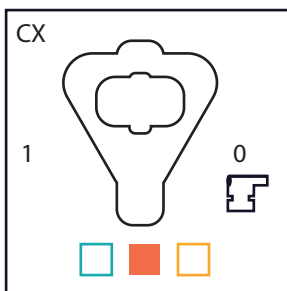
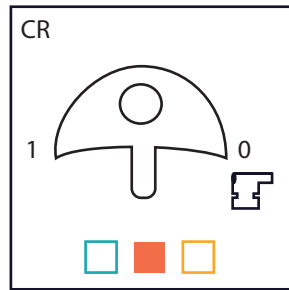
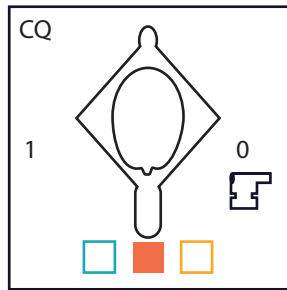
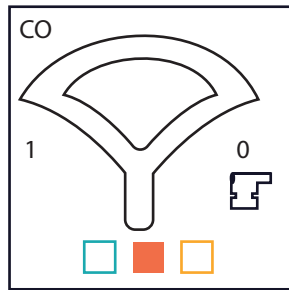
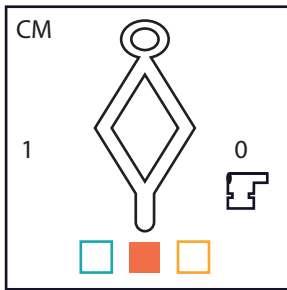
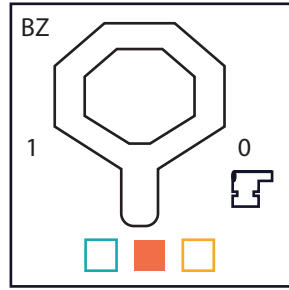
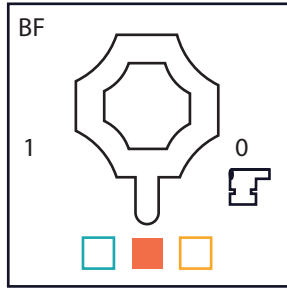
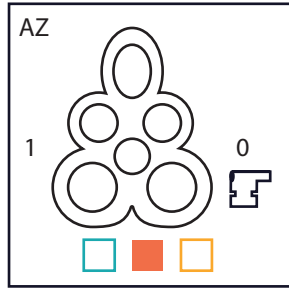
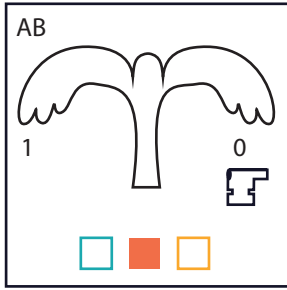
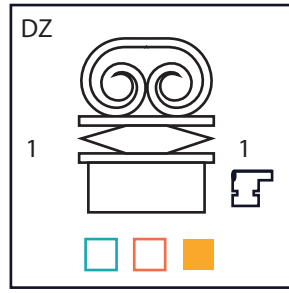
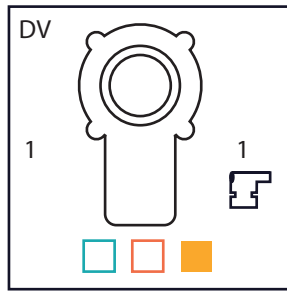
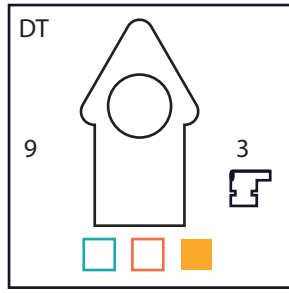
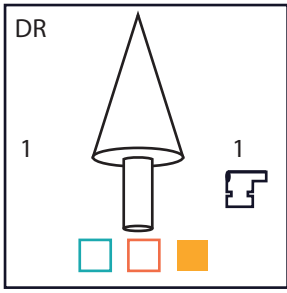

# Appendix Four: Archaeological sites used in the study

Site name	A	B	C	D	E	G	Box/lock
Ailcy Hill, Ripon							Yes
Baldock							Yes
Bekesbourne			1				
Bishophill and Skeldergate	2			1			
Bishopstone							Yes
Bloodmoor Hill		2	3				Yes
Bucklands, Dover			6				
Butt Road, Colchester	1						Yes
The Castle, Newcastle upon Tyne							Yes
Castledyke		8			1		
Chamberlain's Barn, Leighton Buzzard			2				Yes
Chartham Down			1				
Coppergate	31	32	1		1		
Cuxton			3				
Dorchester-onThames	1						
Fishergate, York	4	1					
Flixborough	31		14		2		
Garton II							Yes
Goltho	1	4					Yes
Great Chesterford			2				
Guilton			1				
Harford farm			6				Yes
Hod Hill		1				11	
Kingston Down			3				
Mucking		1	2			1	
Orpington	2						
Ozengill			2		1		
Quarrington						1	
Ramsbury, Wiltshire	1						
Riby Cross Roads			1				
Saltwood tunnel Kent		1	16			4	Yes
Sarre			11				
Silbertswold			7				Yes
Skeleton Green							Yes
Staunch Meadow, Brandon	1		2				
Swallowcliffe Down							Yes
Thetford	13	6	1				
Thwing	2		6				Yes
Wasperton			1				
Winchester	76	21	7				
Wraysbury		2					
Yeavinger			1				
York Fortress	3			2			
York Minster							Yes

## Appendix Five: Sources used for Early Medieval keys from art work

Title	location	date	media
Coffin of St Cuthbert	Durham	698 CEt	Wood
St Peter in the south wall	St Michael le Belfrey, York, South aisle	15th c?	Stained glass
Tympanum at Carennac	Church of St Pierre, Carennac France	12th c	Stone
Tympanum at Ste Foy Conques	Abbaye St Foye a Conques	1107	Stone
St Peter St Trophime	St Trophime Arles	1000-1200	Stone
Christ in Majesty	Tympanum Siddington Church, Glos	1066-1100	Stone
Conan passed out the keys	Bayeux tapestry	1066-1100	Textile
St Peter Apostolis	Cloister at Morissac	1100	Stone
St Peter	Frieze below tympanum, St Sernin, Toulouse	1080-1120	Stone
St Veronica between St Peter and St Paul - Durer	National Gallery of Art	1509	Engraving
Saint Sernin La Porte Miègeville Saint Peter	Frieze below tympanum, St Sernin, Toulouse	1080-1120	Stone
Grave slab	Bakewell parish church		Stone
St Peter Pierre Vienne	Vienne Isere	Unknown?	Stone
Apocalypse in prose	British Museum	14th c	Manuscript
Cotton MS Nero C IV	British Library	12th-13th c	Manuscript
Cotton MS Nero D I	British Library	1250-1259	Manuscript
Harley MS 76 f 7v	British Library	1020-1030	Manuscript
St Peter seal	British Museum	14th c	Seal
St Peter seal	British Museum	14th c	Seal
St Peter seal	British Museum	14th c	Seal
St Peter on capitol from Lewes Priory	British Museum	1125-1150	Stone
St Peter seal	British Museum	13th c	Seal
Grandisson Triptych	British Museum	1330-1340	Ivory
Benedictine	British Library	9th c	Manuscript

# Appendix Six: Casket key classification system

This classification system (discussed in Chapter 4, section 4.5.4) identified 211 different forms of casket key. Of these, 147 appear only once. The common form identified in Chapter four accounts for 30% of the keys that can be given a complete classification. The figures and tables below show how many variations of form are seen for each part of the key. Obviously some parts have considerably more scope for variation than others.

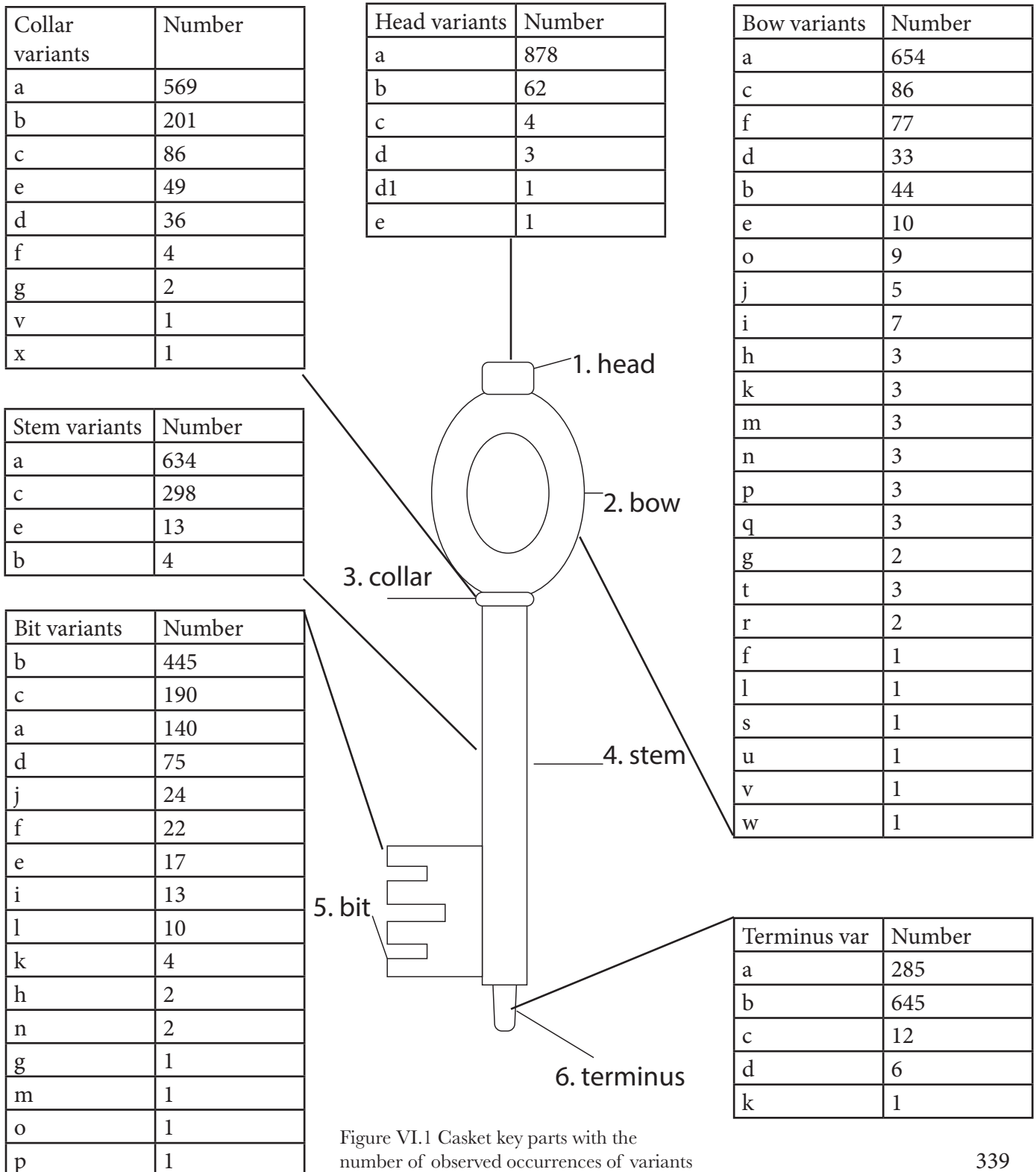

Figure VI.1 Casket key parts with the number of observed occurrences of variants

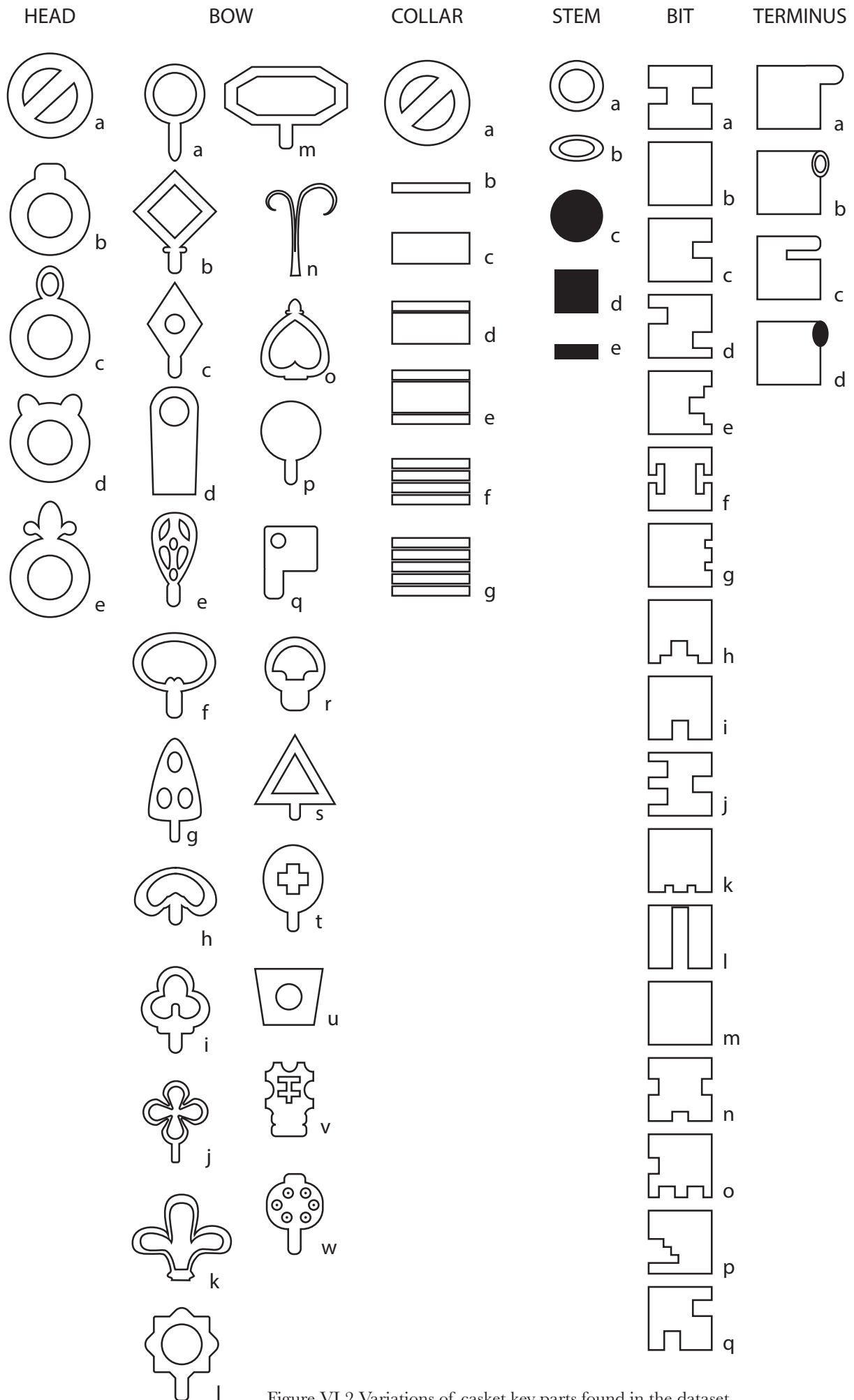

Figure VI.2 Variations of casket key parts found in the dataset

# Bibliography

## Primary sources

Anon (ND). *Benedictional of St. Æthelwold*. BL Add MS 49598. London: British Library

Anon (ND). *Liber Vitae of Newminster and Hyde*. BL Stowe 944 London: British Library.

Anon (ND). *Life of St Edward the Confessor*. University of Cambridge MS Ee.3.59. Cambridge: University Library.

Anon (ND). *Prayer book of Archbishop Arnulph II of Milan*. BL MS Egerton 3763 London: British Library.

Athanassakis, A and Wolkow, B (Trans). (2013). *The Orphic Hymns*. Baltimore: Johns Hopkins University Press.

Blume, F H (Trans), Frier, B W, Connolly, S, Corcoran, S, Crawford, M H, Dillon, J N, Kehoe, D P, Lenski, N E, McGinn, Thomas A J, Pazdernik, C F, and Salway, B (Eds). (2016). *The Codex of Justinian: a new annotated translation, with parallel Latin and Greek text based on a translation by Justice Fred H. Blume*. Cambridge; London: Cambridge University Press.

Bradley, S A J (Trans). (1982). *Anglo-Saxon Poetry*. London: Everyman's Library.

Byock, Jesse L, (Trans). (1998). *The Saga of Hrdlfr Kraki*. London: Penguin Books.

Cook, A S (Trans). (1900). *The Christ of Cynewulf; a poem in three parts: the advent, the ascension, and the last judgement*. Boston: Ginn & Company.

Cook, R (Trans). (2001). *Njal's Saga*. London: Penguin.

Cropp, M J (Trans.) (2002). *Euripides: Iphigenia in Tauris*. Oxford: Aris & Phillips.



- Crossley-Holland, Kevin (Trans). (2008). *The Exeter Book Riddles*. London: Enitharmon Press.
- Dennis, A, Foote, P, and Perkins, R (Eds). (1980). *Laws of early Iceland : Gragas, the Codex Regius of Gragas, with material from other manuscripts*. Winnipeg, Canada: University of Manitoba Press.
- Edwards, PG and Pálsson, H (Eds). (1989). *Eyrbyggja saga*. London: Penguin.
- Evelyn-White, H G (Trans). (1914). *Hesiod. The Homeric hymns. And Homerica*. London: W. Heinemann.
- Frank, R (Trans). (1978). *Old Norse court poetry: the Dróttkvætt stanza*. Ithaca; London: Cornell University Press.
- Ibn Fadlan, and Lunde, P (Trans). (2012). *Ibn Fadlan and the land of darkness: Arab travellers in the far north*. London: Penguin.
- Jóhannesson, J (Trans). (1956-58). *Íslendinga saga*. Reykjavik: Almenna Bokafelagid.
- Johnston, G (Trans). (1973). *The saga of Gisli*. London: Dent.
- Kent, CW (Trans). (1891). *Elene: an Old English poem*. Boston; London: Ginn & company.
- Magnusson, M (Trans). (1969). *Laxdæda Saga*. Harmondsworth: Penguin.
- Muir, BJ (Ed). (1994). *The Exeter Anthology of Old English Poetry*. Exeter: University of Exeter Press.
- Nicholson LE (Trans). (1991). *The Vercelli book homilies: translations from the Anglo Saxon*. London: University Press of America.
- Pausanias (1918) *Pausanias Description of Greece with an English Translation by W H S Jones, LittD, and H A Ormerod, MA, in 4 Volumes*. London: William Heinemann Ltd.
- Rogers, B B (Trans). (1930). *Aristophanes*. London: William Heinemann Ltd.
- Scudder, B (Trans). (2005). *The saga of Grettir the Strong*. London: Penguin.
- Sturluson S (2006). *The elder Eddas of Sæmund Sigfusson and the younger Eddas of Snorre Sturluson*. Teddington, Middlesex: Echo Library.
- Tacitus, C (1971). *The annals of imperial Roma*. Harmondsworth: Penguin.
- Thomas Aquinas (1947-48). *Summa Theologica*. New York: Benzinger Brothers.
- Thomas, T (Ed). (1994). *Hymns and initiations*. Frome: Prometheus Trust.

Porgilsson, A and Benediktsson, J (Eds). (1968). *Íslendingabók : Landnámabók*. Reykjavík: Hið Íslenska Fornritafélag.

## Secondary sources

Aannestad, H L (2004). En nøkkel til kunnskap - om kvinneroller i jernalder. *Viking*, 69-82.

Adams, N (2010). Rethinking the Sutton Hoo shoulder clasps and armour. In C Entwistle and N Adams (Eds). *'Intelligible Beauty': Recent Research on Byzantine Jewellery*. British Museum Research Publication v. 178. London: British Museum Press, pp 83-112.

Adams, S A (2013). *The first brooches in Britain : from manufacture to deposition in the Early and Middle Iron Age*. Unpublished: University of Leicester. PhD.

Addyman, P V (Ed). (1999). *Craft, industry and everyday life: bone, antler, ivory and horn from Anglo-Scandinavian and medieval York*. York: Council for British Archaeology.

Adler, J (2002). *Chinese religious traditions*. London: Laurence King Publishing, Ltd.

Alizadeh, A (2006). *The origins of state organisations in prehistoric highland fars, southern Iran: Excavations at Tall-E Bakun*. Chicago: Oriental Institute Publications.

Allen, M. L. 1997. 'The Keys of the Kingdom': Keys from Masada, *Brigham Young University Studies*, 39(3), 154-69.

Allison, P (2004). *Pompeian Households: An Analysis of the Material Culture*. Los Angeles: Cotsen Institute of Archaeology Press at UCLA.

Allison, P (2006). *The Insula of the Menander in Pompeii III: the finds, a contextual study*. Oxford: Clarendon Press.

Allison, P (2013). *People and space in Roman military bases*. Cambridge: Cambridge University Press.

Almgren, B (1950). *Bronsnycklar och djuronamentik*. Uppsala: Appelbergs Boktryckeri AB.

Ambrosiani, B (2016). Alsnöhus och den vikingatida hallen på Alsnö. *META 2016*, 7-24.

Ambrosiani, B and Ambrosiani, A (2005). Birka and Scandinavia's trade with the east. *Russian History*, 32(3/4), 287-296.

Ambrosiani, B, Clarke, H and Stolpe, H (1992). *Early investigations and future plans*. Stockholm: Birka Project.

Andersen, H (1969). Vikinger fra uvant synsvinkel. *Skalk 1969*, 1, 3-8.

- Anderson, C (2017). 'A female Viking warrior? Tomb study yields clues' The New York Times. 14 Sept 2017. [Online]. Available at: <https://www.nytimes.com/2017/09/14/world/europe/sweden-viking-women-warriors-dna.html?mcubz=0> [Accessed 14 September, 2017].
- Andrén, A (1993). Doors to other worlds: Scandinavian death rituals in Gotlandic perspectives. *Journal of European Archaeology*, 1(1), 33-56.
- Andrén, A (1998). *Between artefacts and texts: historical archaeology in global perspective*. New York: Plenum Press.
- Androshchuck, F (2005). En man i Osebergsgraven? *Fornvännen*, 100, 115-28.
- Anstee, J W (2001). The examination, interpretation, and replication of an iron lock from Lullingstone Roman Villa, Kent. *The Antiquaries Journal*, 81, 395-400.
- Appadurai, A (1986). *The social life of things: commodities in cultural perspective*. Cambridge: Cambridge University Press.
- Arbman, H (1940). *Birka I. Die Gräber. Tafeln*. Stockholm: Almqvist & Wiksell International.
- Arbman, H (1943). *Birka I. Die Gräber. Text*. Stockholm: Almqvist & Wiksell International.
- Arents, U and Eisenschmidt, S (2010). *Die Gräber von Haithabu*. Neumünster: Wachholtz Verlag.
- Arnold, B and Wicker, N L (2001). *Gender and the archaeology of death*. Walnut Creek: AltaMira Press.
- Arnold, C J (1984). *Roman Britain to Saxon England*. London: Croom Helm.
- Arrhenius, B (1970). Tür der toten. Sach- und Wortzeugnisse zu einer frühmittelalterlichen Gräbersitte in Schweden. *Frühmittelalterliche Studien*, 4, 384-94.
- Arwidsson, G and Berg, G (1983). *The Mästermyr find: a Viking Age tool chest from Gotland*. Stockholm: Almqvist & Wiksell International.
- Arwidsson, G and Thorberg, H (1989). *Die Kästchen*. In G Arwidsson (Ed). *Birka I: 1-3. Systematische Analysen der Gräberfunde*. Stockholm: Almqvist & Wiksell International, pp 112-117.
- Arwill-Nordbladh, E (1990). Nyckelsymbolik i järnålderns kvinnogravar. *Fornvännen* 85, 255-260.
- Arwill-Nordbladh, E (1991). The Swedish image of Viking Age women: stereotype, generalisation, and beyond. In R Samson (Ed). *Social approaches to Viking studies*. Glasgow: Cruithne Press, pp 53-64.

Ashby, S (2006). *Time, trade, and identity: bone and antler combs in Northern Britain, c. AD 700-1400*. Unpublished: University of York. PhD.

Ashby, S, (2011). The language of the combmaker: interpreting complexity in Viking-Age industry. In J Baron and B Kufel-Diakowska (Eds). *Written in bones: studies on technological and social contexts of past faunal skeletal remains*. Wroclaw, Poland: University of Wroclaw, pp 9-24.

Ashby, S (2013). Making a good comb: mercantile identity in 9th to 11th-century England. In L Ten Harkel and D Hadley (Eds). *Viking towns: social approaches to towns in England and Ireland c. 800-1100*. Oxford: Oxbow Books, pp 193-208

Ashby, S (2014). *A Viking way of life: combs and communities in early medieval Britain*. Stroud: Amberley.

Ashby, S (2015). What really caused the Viking Age? The social content of raiding and exploration. *Archaeological Dialogues*, 22(1), 89-106.

Ashby, S [forthcoming]. Technology. Making things in medieval Europe.

Aspöck, E (2011). Past 'disturbances' of graves as a source: taphonomy and interpretation of reopened early medieval inhumation graves at Brunn am Gebirge (Austria) and Winnall II (England). *Oxford Journal of Archaeology*, 30(3), 299-324.

Bamforth, DB and Finlay, N (2008). Introduction: archaeological approaches to lithic production skill and craft learning. *Journal of Archaeological Method Theory*, 15, 1-27.

Baudou, E (1989). Hög - gård - helgedom i Mellannorrland under den äldre järnåldern. *Arkeologi i norr*, 2, 9-43.

Beck, A S (2010). *Døre i vikingetidens langhus. Et forsøg på at indetænke mennesket i bebyggelsesarkæologien*. Unpublished: University of Copenhagen. MA .

Belousova, E (2002). The preservation of national childbirth traditions in the Russian homebirth community. *Folklorica*, VI(2), 50-77.

Berg, H L (2013). *Nøkkelpølse: østnorske jernaldernøkler som symbol og teknologi*. Unpublished: University of Oslo. MA.

Berg, H L (2015). "Truth" and reproduction of knowledge. Critical thoughts on the interpretation and understanding of Iron-Age keys. In M Eriksen, U Pedersen, B Rundgerget, I Axelsen, and H Berg (Eds). *Viking worlds: things, spaces and movement*. Oxford: Oxbow Books. pp 124-142.

Bergström, L (2013). *Hus och Hantverk: Arkeologisk undersökning av de övre terrasserna i Birka's Garnison. RAÄ 173, Björkö, Adelsö sn, Uppland, 2001-2004*. Stockholm: Riksantikvarieämbetet.

- Biasiotti, A, (2003). I meccanismi di riferma e chiusura della cassaforte. In A D'Ambrosio, P G Guzzo and M Mastroroberto (Eds). *Storie da un'eruzione: Pompei, Ercolano, Oplontis*. Milan: Electa, pp 172-173.
- Biddle, M, Goodall, I H and Hinton, D A (1990). *Object and economy in medieval Winchester*. Oxford: Clarendon Press.
- Biddle, M and Kjølbye-Biddle, B (1992). Repton and the Vikings. *Antiquity*, 66(250), 36-51.
- Biddle, M and Kjølbye-Biddle, B (2001). Repton and the 'great heathen army', 873-4. In J Graham-Campbell (Ed). *Vikings and the Danelaw: select papers from the Proceedings of the Thirteenth Viking Congress, Nottingham and York, 21-30 August 1997: 45-96*. Oxford: Oxbow.
- Birch, T (2011). Living on the edge: making and moving iron from the 'outside' in Anglo-Saxon England. *Landscape History*, 32(1), 5-23.
- Birley, A (1997). *Vindolanda Research Reports. New Series. Volume IV. The Small Finds Fascicule II. Security: The Keys and Locks*. Greenhead: Roman Army Museum.
- Birley, A (2002). *Garrison life at Vindolanda: a band of brothers*. Stroud: Tempus.
- Blakelock, E (2013). *The Early Medieval cutting edge of technology: An archaeometallurgical, technological and social study of the manufacture and use of Anglo-Saxon and Viking iron knives, and their contribution to the early medieval iron economy*. Unpublished: University of Bradford. PhD.
- Blakelock, E and McDonnell, G (2007). A review of metallographic analyses of early medieval knives. *Historical Metallurgy*, 41(1), 40-56.
- Blanton, R E (1995). The cultural foundations of inequality in household. In T D Price and G M Feinman (Eds). *Foundations of social inequality*. New York: Plenum Press, pp 105-127.
- Borg, R (2005). Pin tumbler locks in Sweden. *Historical locks*. [Online]. Available at: <https://www.historicallocks.com/en/site/h/other-locks/locks-of-wood-and-iron/pin-tumbler-locks-in-sweden/> [Accessed 18 January, 2017].
- Borrill H (1981). *Casket burials*. In C Partridge (Ed). *Skeleton Green. A Late Iron Age and Romano-British Site*. London: The Society for Promotion of Roman Studies, pp 304-308.
- Bray, L S (2006). *The archaeology of iron production: Romano-British evidence from the Exmoor region*. Unpublished: University of Exeter. PhD.
- Brindle, T (2013). Making the most of PAS data: macro- and micro- level studies of Romano-British settlement. *Landscapes*, 14(1), 73-91.
- Brindle, T (2014). *The Portable Antiquities Scheme and Roman Britain*. London: The British Museum Press.

Brøndsted, J (1965). *The Vikings*. Harmondsworth: Penguin Books.

Bukkemoen, G B (2008). Der ingen tilfeldighet råder: Anvendelse av gravanlegg i lokal kontekst . In K Chilidis, J Lund and C Prescott (Eds). *Facets of Archaeology: Essays in Honour of Lotte Hedeager on Her 60th Birthday*. Oslo Archaeological Series, Vol. 10. Oslo: Unipub, pp 465–474.

Burke, B L, Martens, A, and Faucher, E H (2010). Two decades of terror management theory: a meta-analysis of mortality salience research. *Personality and Social Psychology Review*, 14(2), 155-195.

Burmeister, S (2000). Archaeology and migration: approaches to an archaeological proof of migration. *Current Anthropology*, 41(4), 539-567.

Callmer J (2003). Wayland – an essay on craft production in the early and high Middle Ages in Scandinavia. In L Larsson and B Hårdh (Eds). *Centrality – Regionality. The Social Structure of Southern Sweden during the Iron Age*. Lund: Uppåkrastudier 7, pp 337–361.

Cantor, N (1991). *Inventing the Middle Ages*. New York: W. Morrow.

Carver, M O H (1992). *The age of Sutton Hoo: the seventh century in north-western Europe*. Woodbridge: Boydell Press.

Carver, M O H (1995). Boat burial in Britain: ancient custom or political signal? In O Crumlin-Pedersen (Ed). *The ship as symbol in prehistoric and medieval Scandinavia*. Copenhagen: National Museum of Denmark, pp 111-24.

Chapman, J (2000). *Fragmentation in archaeology: people, places and broken objects in the prehistory of south Eastern Europe*. New York: Routledge.

Chester-Kadwell, M (2009). *Early Anglo-Saxon communities in the landscape of Norfolk*. BAR British Series 481. Oxford: Archaeopress.

Childs, S T (1998). Social identity and craft specialisation among Toro iron workers in western Uganda. *Archaeological papers of the American Anthropological Association*, 8(1) 109-121.

Christensen, A E, Ingstad, A S and Myhre, B (1992). *Osebergdronningens grav : vår arkeologiske nasjonalskatt i nytt lys*. Oslo: Schibsted.

Collared, M, Kemery, M, and Banks, S (2005). Causes of toolkit variation among hunter-gatherers: a test of four competing hypotheses. *Canadian Journal of Archaeology*, 19(1), 1-19.

Conant, R D (1996). Memories of the death and life of a spouse: the role of images and sense of presence in grief. In D Klass, PR Silberman, and S Nickman (Eds). *Continuing bonds: new understandings of grief*. Philadelphia, PA: Taylor & Francis, pp 179-196.

- Condron, F (1997). Iron production in Leicestershire, Rutland and Northamptonshire in antiquity. *Transactions of the Leicestershire Archaeology and History Society*, 71, 1-20.
- Conkey, M W and Spector, J D (1984). Archaeology and the study of gender. In M B Schiffer (Ed). *Archaeological method and theory*. New York: Academic Press, pp 1-38.
- Conzémus, M (2013). *Private Security in Ancient Rome*. Pétange: Le Centre de gestion informatique de l'éducation.
- Costin, C L (1991). Craft specialization: issues in defining, documenting, and explaining. *Archaeological Method and Theory*, 3, 1-56.
- Costin, C L (2005). The study of craft production. In H Maschner (Ed). *Handbook of methods in archaeology*. Lanham, MD: Alta Mira Press, pp 1032-1105.
- Crummy, N (1983). *The Roman small finds from excavations in Colchester 1971-9*. Colchester: Colchester Archaeological Trust Ltd.
- Daubney, A (2010). The cult of Totatis: evidence for tribal identity in mid Roman Britain. In S Worrell (Ed). *A decade of discovery: proceedings of the Portable Antiquities Scheme Conference 2007*. BAR, 510, pp 105-116.
- Della Corte, M (1911). *Notizie Degli Scavi di Antichità*. Rome: Ed. Quasar.
- Della Corte, M (1914). *Notizie Degli Scavi di Antichità*. Rome: Ed. Quasar.
- Denon, V (1803). *Voyages dans la Basse et la Haute Egypte, pendant les campagnes de Bonaparte, en 1798 et 1799, Volume 1*. London: J&W Smith.
- Dereck, M and Boyd, R (2016). Partial connectivity increases cultural accumulation within groups. *Proceedings of the National Academy of Sciences*, 113(11), 2982-2987.
- Dereck, M, Beugin, M, Godell, B, and Raymond, M (2013). Experimental evidence for the influence of group size on cultural complexity. *Nature*, 503, 392-397.
- Dorst, J D (1983). Neck-Riddle as a dialogue of genres: applying Bakhtin's genre theory. *The Journal of American Folklore*, 96(382), 413-433.
- Drescher, H (1983). Metallhandwerk des 8.-11. Jh. in Haithabu auf grund der Werkstattabfälle. In H Jahnkuhn (Ed). *Das Handwerk in vor- und frühgeschichtlicher Zeit, II*. Göttingen: Vandenhoeck & Ruprecht, pp 174-192.
- Edwards, B J N (1998). *Vikings in north west England: the artefacts*. Lancaster: Lancaster University Press.

- Egan, G (1998). Security equipment. in G Egan (Ed). *The medieval household: daily living c. 1150-1450*. London: Stationary Office, pp 88-120.
- Egan, G (2010). *The medieval household: Daily living 1150-1410*. Woodbridge: Boydell Press in association with Museum of London.
- Eras, V J M (1957). *Locks and keys throughout the ages*. Schiedam: Interbook International.
- Ericsson, K (2003). The search for general abilities and basic capacities: theoretical implications from the modifiability and complexity of mechanisms mediating expert performance. In R Sternberg and E Grigorenko (Eds). *The psychology of abilities, competencies, and expertise*. Cambridge: Cambridge University Press, pp. 93-125.
- Ericsson, K (2004). Deliberate practice and the acquisition and maintenance of expert performance in medicine and related domains. *Academic Medicine*, 79(10), S70-S81.
- Ericsson, K, Krampe, R T, and Tesch-Romer, C (1993). The role of deliberate practice in the acquisition of expert performance. *Psychological Review*. 100(3), 363-406.
- Eriksen, M H (2013). Doors to the dead. The power of doorways and thresholds in Viking Age Scandinavia. *Archaeological Dialogues*, 20(02), 187-214.
- Eriksen, M H (2016). Commemorating Dwelling: The Death and Burial of Houses in Iron and Viking Age Scandinavia. *European Journal of Archaeology*, 19(3), 477-496.
- Eriksen, M H (2019). *Architecture, society and ritual in Viking Age Scandinavia*. Cambridge: Cambridge University Press.
- Evans, D H, Loveluck, C and Archibald, M (2009). *Life and economy at early medieval Flixborough, c AD 600-1000: the artefact evidence*. Oxford: Oxbow Books.
- Evans, G E (1956). *Ask the fellows who cut the hay*. London: Faber.
- Evison, V I (1987). *Dover: the Buckland Anglo-Saxon cemetery*. London: Historic Buildings and Monuments Commission for England.
- Faussett, B (1856). *Inventorium sepulchrale: an account of some antiquities dug up at Gilton, Kingston, Sibertswold, Barfriston, Beakesbourn, Chartham, and Crundale, in the county of Kent, from A.D. 1757 to A.D. 1773*. London: T. Richard.
- Felder, K (2014). *Girdle-hangers in 5th and 6th century England. A key to early Anglo Saxon identities*. Unpublished: University of Cambridge. PhD.
- Felder, K., (2015). Networks of meaning and the social dynamics of identity: an example from early Anglo-Saxon England. *Papers from the Institute of Archaeology*, 25(1), 1-20.
- Fell, C (1984). A friwif locbore revisited. *Anglo-Saxon England*, 13, 157-165.



- Feveile, C (2006). *Det ældste Ribe. Udgravninger på nordsiden af Ribe Å 1984–2000. Ribe Studier, vol. 1.2.* Højbjerg: Jysk Arkæologisk Selskab.
- Flad, R K and Hruby, Z X (2007). "Specialized" production in archaeological contexts: rethinking specialization, the social value of products, and the practice of production. *Archaeological papers of the American Anthropological Association*, 17(1), 1-19.
- Fleming, R (2012). Recycling in Roman Britain after the fall of Rome's metal economy. *Past and Present*, 217, 3-45.
- Foxhall, L. (2015). Introduction: miniaturization. *World Archaeology*, 47(1), 1-5.
- Frank, R (1978). *Old Norse Court Poetry: The Dróttkvætt Stanza. (Islandica, XLII.)*. Ithaca and London: Cornell University Press.
- Frantzen, A J and Niles, J D (Eds). (1997). *Anglo-Saxonism and the Construction of Social Identity*. Gainesville: University Press of Florida.
- Friedhoff, U (1991). *Der römische Friedhof an der Jakobstraße zu Köln (Kölner Forsch., Bd. 3)*. Mainz: Zabern.
- Fuchs, A (1998). *Die Annalen des Jahres 711 v. Chr. nach Prismenfragmenten aus Ninive und Assur, SAAS*. Helsinki: Neo-Assyrian Text Corpus Project, Department of Asian and African Studies, University of Helsinki.
- Fujii, M (1983). Maintenance and change in Japanese traditional funerals and death-related behavior. *Japanese Journal of Religious Studies*, 10(1), 39-64.
- Fülep, F (1977). *Roman cemeteries on the territory of Pees (Sopianae)*. Budapest: Akademiai Kiado.
- Fulford, M and Barnett, C [ongoing]. The Silchester Environs Project. Reading: University of Reading.
- Gansum, T (2004). *Hauger som Konstruksjoner — Arkeologiske Forventninger Gjennom 200 år*. Göteborg: Göteborg University.
- Gardela, L (2013). 'Warrior women' in Viking Age Scandinavia? A preliminary archaeological study. *Analecta Archaeologica Ressoiviensia*, 8, 273-309.
- Geake, H (1995). *The use of grave-goods in conversion-period England c. 600 - c. 850 A.D.* Unpublished: University of York. PhD.
- Geake, H (1997). *The use of grave goods in Conversion period England, c 600-c 850*. BAR British series, 261. Oxford: Archaeopress.

- Gilchrist, R (2012). *Medieval Life: Archaeology and the Life Course*. Woodbridge: Boydell and Brewer.
- Giles, M (2017). Grave goods: objects and death in later prehistoric Britain. Unpublished paper presented at York Seminar Series, 22 Feb 2017. York.
- Godfrey, E G (2007). *The technology of ancient and medieval directly reduced phosphoric Iron*. Unpublished: University of Bradford. PhD.
- Grahame, M (2000). *Reading space: social interaction and identity in the houses of Roman Pompeii*. BAR International Series 886. Oxford: Archaeopress.
- Gräslund, A-S (1980). *The burial customs: a study of the graves on Björkö*. Stockholm: Almqvist & Wiksell.
- Gräslund, A-S (2001). The Position of Iron-Age Scandinavian Women: Evidence from the Graves and Runestones. In B Arnold and N L Wicker (Eds). *Gender and the Archaeology of Death*. Cumnor Hill (Oxford): AltaMira Press, pp 84–86.
- Grøn, O, Hedeager Krag, A, and Bennike, P (1994). *Vikingetidsgrovpladser på Langeland*. Rudkøbing: Langelands Museum.
- Gustafsson, N B (2003). *Bultlås från Birkas Garnison – Analys och rekonstruktionsförslag*. Stockholm: Archaeological Research Laboratory.
- Gustafsson N B (2005). On Norse padlocks – production and use examples from the Birka garrison. *Journal of Nordic Archaeological Science*, 15, 19-24.
- Gustafsson N B and Söderberg A (2007). En senvikingatida metallverkstad i Fröjel. *Gotländskt arkiv*, 99–110.
- Hall, N (2018) Iron working in Anglo Saxon England: new evidence to show fresh iron smelting of ironstone ores from the 6th - 10th centuries CE. *Journal of Archaeological Sciences: Reports*, 344-351.
- Hall, R A and Whyman M (1996). Settlement and monasticism at Ripon, North Yorkshire, from the 7th to 11th centuries AD. *Medieval Archaeology*, 40, 62–150.
- Hall, R A, Allen, S J, Evans, D T, Hunter-Mann, K and Mainman, A J (2014). *Anglo-Scandinavian occupation at 16-22 Coppergate*. York: York Archaeological Trust.
- Hamerow, H (2002). *Early medieval settlements: the archaeology of rural communities in Northwest Europe, 400-900*. Oxford: Oxford University Press.
- Hamerow, H and Brennan, N (2015). An Anglo-Saxon great hall complex at Sutton Courtenay/Drayton, Oxfordshire: a royal centre of Early Wessex? *Archaeological Journal*, 172(2), 325-350.

Hammond, B and Murawski, P G (2014). *Benet's Artefacts of England & the United Kingdom*. Witham: Greenlight Publishing.

Härke, H (1989). Knives in Early Saxon burials: blade length and age at death. *Medieval Archaeology*, 33, 144-148.

Härke, H (2011). Anglo-Saxon immigration and ethnogenesis. *Medieval Archaeology*, 55(1), 1-28.

Härke, H (2014). Grave goods in early medieval burials: messages and meanings. *Mortality*, 19(1), 1-21.

Harrington, S and Brookes, S (2012). ASKED - the Anglo-Saxon Kent Electronic Database. *Journal of Open Archaeology Data* 1(p e2). [Online]. Available at: <https://openarchaeologydata.metajnl.com/articles/10.5334/4f33a7b040dd1/>. [Accessed 12 May 2017].

Harris, O J T, Cobb, H, Batey, C E, Montgomery, J, Beaumont, J, Gray, H, Murtagh, P, and Richardson, P (2017). Assembling places and persons: a tenth-century Viking boat burial from Swordle Bay on the Ardnamurchan peninsula, western Scotland. *Antiquity*, 91(355) 191-206.

Hedeager, L (2002). Scandinavian 'central places' in a cosmological setting. In B Hårdh and L Larsson (Eds). *Central places in the migration and Merovingian periods : papers from the 52nd Sachsensymposium, Lund, August 2001*. Stockholm: Almqvist & Wiksell International, pp 3-18.

Hedenstierna-Jonson C, Kjallström A, Zachrisson, T, Krzewińska, M, Sobrado, V, Price, N, Günther, T, Jakobsson, M, Götherström, A, and Storå, J (2017). A female Viking warrior confirmed by genomics. *American Journal of Physical Anthropology*, 164, 853–860.

Hedestierna-Jonson (2009). Rus', Varangians and Birka Warriors. In L Holmquist Olausson and M Olausson (Eds). *The martial society: aspects on warriors, fortifications and social change from the Bronze Age to the 18th century*. Stockholm: Archaeological Research Laboratory, Stockholm University, pp 159-178.

Hedestierna-Jonson (2015). To own and be owned: the warriors of Birka's garrison. In A Klevnäs and C Hedestierna-Jonson (Eds). *Own and be owned: Archaeological approaches to the concept of possession*. Stockholm: Postdoctoral Archaeological Group, pp 73-91.

Heinrichs, A, Janssen, D, Radtke, E, Rohen, H, and Sutrluson, S (1982). *Olafs saga hins helga: die "Legendarische Saga" uber Olaf den Heiligen (Hs. Delagard. saml. nr. 8II)*. Heidelberg: Carl Winter.

Henig, M (1984). A cache of Roman intaglios from Eastcheap, City of London. *Transactions of the London and Middlesex Archaeological Society*, 35, 11-15.

- Henrich, J (2004). Demography and cultural evolution: how adaptive cultural processes can produce maladaptive losses: the Tasmanian case. *American Antiquity*, 69(2), 197-214.
- Herschend, F (2009). *The Early Iron Age in south Scandinavia: social order in settlement and landscape*. Uppsala: Uppsala University.
- Hildebrand, H (1883). *The industrial arts of Scandinavia in the pagan time*. London: Chapman & Hall.
- Hillier, W and Hanson, J (1984). *The social logic of space*. Cambridge: Cambridge University Press.
- Hines, J and Bayliss, A (Eds). (2013). *Anglo-Saxon graves and grave goods of the 6th and 7th centuries AD: a chronological framework*. London: Society for Medieval Archaeology.
- Hirst, S and Clark, D (2009). *Excavations at Mucking: Volume 3, the Anglo Saxon cemeteries*. London: Museum of London Archaeology.
- Hjärthner-Holdar, E, Lamm, K and Magnus, B (2002). Metalworking and central places. In B Hårdh and L Larsson (Eds). *Central places in the Migration and Merovingian Periods. Acta Archaeologica Ludensia Series in 8°, No. 39*. Stockholm: Almqvist & Wiksell International, pp 159-183.
- Hodder, I (1992). *Theory and practice in archaeology*. London: Routledge.
- Holm, I, Innselset, S and Øye, I (Eds). (2005). 'Utmark' *The outfield as industry and ideology in the Iron Age and the middle ages*. University of Bergen: Bergen.
- Holmquist Olausson, L (1990). Älgmannen" från Birka. Presentation av en nyligen undersökt krigsgrav med människooffer. *Fornvännen*, 85, 175-182.
- Holmquist Olausson, L (2002). The fortification of Birka: interaction between land and sea. In A Nørgård Jørgensen (Ed). *Maritime warfare in northern Europe: technology, organisation, logistics and administration 500 BC–1500 AD: papers from an international research seminar at the Danish National Museum, Copenhagen, 3–5 May 2000*. Copenhagen: National Museum of Denmark. pp 159-167.
- Holmquist Olausson, L and Kitzler Åhfeldt, L (2002). *Krigarnas hus*. Arkeologisk undersökning av ett hallhus i *Birkas Garnison*. RAÄ 35, Björkö, Adelsö sn, Upplans 1998-2000. Stockholm: Stockholm Universitet Arkeologiska forskningslaboratoriet 2002.
- Holmqvist, W (1961). *Excavations at Helgö*. Stockholm: Almqvist & Wiksell.
- Hones, S (2011). Literary geography: setting and narrative space. *Social & Cultural Geography*, 12(7), 685-699.

- Huggett, J (1995). Numerical techniques for burial analysis. In J Huggett, and N Ryan, (Eds). *Computer applications and quantitative methods in archaeology—CAA94*. BAR International Series 600. Oxford: Archaeopress, pp 183-190.
- Hurst, S (2006). An analysis of variation in caching behavior. *Lithic Technology*, (31)2, 101-126.
- Ingold, T (1993). The reindeerman's lasso. In Lemonnier, P (Ed). *Technological choices: Toward an anthropology of technical systems*. Abingdon: Routledge, pp 108-124.
- Ingold, T (2006). *Rethinking the animate, re-animating thought*. *Ethnos*, 71(1), 9-20.
- Ingold, T (2007a). Materials against materiality. *Archaeological Dialogues*, 14(01), 1-16.
- Ingold, T (2007b). Writing texts, reading materials. A response to my critics. *Archaeological Dialogues*, 14(01) 31-38.
- Irizarry, JA (2014). Signs of life: grounding the transcendent in Japanese memorial objects. *Signs and Society*, 2(S1), S160-S187.
- Jarman, C (2019). "2/ With ancient DNA analysis we have found a first degree relationship on the paternal side between Graves 511 ("The Repton Warrior") and 295, who were buried side-by-side at the Great Army camp in Repton, Derbyshire, soon after 873 AD." *Twitter*. 21 April, 2019. Available at: <https://twitter.com/catjarman/status/1120056292956094465?lang=en>. [Accessed 21 April, 2019]
- Jesch, J (1991). *Women in the Viking Age*. Woodbridge: Boydell & Brewer.
- Jesch, J (2017). Let's Debate Female Viking Warriors Yet Again. 9 September 2017. *Norse and Viking ramblings: a gentle wander through the Viking world*. [Online]. <https://norseandviking.blogspot.com/2017/09/lets-debate-female-viking-warriors-yet.html>. [Accessed 10 September, 2017].
- Jochens, J (1995). *Women in Old Norse society*. Ithaca: Cornell University Press.
- Johns, C and Bland, R (1994). *The Hoxne late Roman Treasure*. *Britannia*, 25, 165-173.
- Johns, C (2010). *The Hoxne late Roman treasure : gold jewellery and silver plate*. London : British Museum Press.
- Kalmring, S (2010a). Of thieves, counterfeiters and homicides : crime in Hedeby and Birka. *Fornvännen*, 105(4), 281-290.
- Kalmring, S (2010b). *Der Hafen von Haithabu*. Neumünster: Wachholtz.
- Kalmring, S, Runer, J and Viberg, A (2017). At home with Herigar: a magnate's residence from the Vendel- to Viking Period at Korshamn, Birka (Uppland/S). *Archäologisches Korrespondenzblatt*, 47, 1-23.

- Kars, M (2011). *A cultural perspective on Merovingian burial chronology and the grave goods from the Vrijthof and Pandhof cemeteries in Maastricht*. Unpublished: Universiteit van Amsterdam. PhD.
- Kars, M (2012). (Re)considering the pre-burial life of grave goods: towards a renewed debate on early medieval burial chronology on the continent. *Medieval and Modern Matters, Archaeology and Material culture in the Low Countries*, 107-134.
- Kastenbaum, R (2012). *Death, society, and human experience*. New York: Routledge.
- Kellogg, R (2000). Introduction. In Ö Thorsson (Ed). *The sagas of Icelanders: a selection*, xv-liv. New York: Penguin Group.
- Kemp, S (2012). The inescapable metaphor: how time and meaning become space when we think about narrative. *Philosophy and literature*, 36(2), 391-403.
- Kiernan, P (2009). *Miniature votive offerings in the north-west provinces of the Roman Empire*. Wiesbaden: Harrassowitz.
- Klein, S B (2012). Memory and the Sense of Personal Identity. *Mind*, 121(483), 677-702.
- Kline, M A, and Boyd, R (2010). Population size predicts technological complexity in Oceania. *Proceedings of the Royal Society B*, 277(1693), 2559-2564.
- Klevn, A M (2016). 'Imbued with the essence of the owner': personhood and possessions in the reopening and reworking of Viking-Age burials. *European Journal of Archaeology*, 19(3), 456-476.
- Knappet, K (2007). Materials with materiality? *Archaeological Dialogues*, 14(01), 20-23.
- Krause, R. (1985). *The clay sleeps: an ethnoarchaeological study of three African potters*. Tuscaloosa: University of Alabama Press.
- Kristiansen, K (2013). Households in context: cosmology, economy and long-term change in the Bronze Age of northern Europe. In M Madella, G Kovács, B Kulcsarne-Berzsényi and I Briz-Godino (Eds). *The archaeology of household*. Oxford: Oxbow, pp 235-68.
- Kristoferssen, S (1999). Swords and brooches. Constructing social identity. In M Rundkvist (Ed). *Grave matters: eight studies of first millennium AD burials in Crimea, England and southern Scandinavia*. BAR International Series 781. Oxford: Archaeopress, pp 87-96.
- Kristoferssen, S (2004a). Bridal jewels - in life and death. In T Oestigaard, N Anfinset and T Saetersdal (Eds). *Combining the past and the present: archaeological perspectives on society* BAR International Series 1210. Oxford: Archaeopress, pp 31-37.

- Kristoffersen, S (2004b). Symbolism in rites of transition. In M Wedde (Ed). *Iron Age Norway. The Tenth Anniversary Symposium of the Norwegian Institute at Athens, 12-16 May 1999*. Bergen: The Norwegian Institute at Athens, pp 287-303.
- Krmpotich, C, Fontein, J and Harries, J (2010). The substance of bones: the emotive materiality and affective presence of human remains. *Journal of Material Culture*, 15(4), 371-384.
- Künzl, E (1994). Römische Ärztinnen. *Jahresbericht des Römisch-Germanischen Zentralmuseums. Forschungsinstitut für Vor-und Frühgeschichte*, 41(2), 623-626.
- Kyølbye-Biddle, B (1995). Iron-bound coffins and coffin-fittings from the pre-Norman cemetery. In D Phillips and B Heywood (Eds). *Excavations at York Minster, vol.1: from Roman fortress to Norman cathedral*. London: H.M.S.O, pp 489-521.
- Lanciana, R (1889). *Ancient Rome in the light of recent discoveries*. Boston: Houghton, Mifflin and company.
- Landeschi, G, Dell'Unto, N, Lundqvist, K, Ferdani, D, Campanaro, D M, and Leander Touati, A (2016). 3D-GIS as a platform for visual analysis: investigating a Pompeian house. *Journal of Archaeological Science*, 65, 103-113.
- Lang, A (1892). *The Green Fairy Book*. London: Longmans, Green and Co.
- Latour, B (2005). *Reassembling the social: an introduction to actor-network theory*. Oxford: Oxford University Press.
- Laurence, R (1994). *Roman Pompeii*. Routledge: London.
- Lauritsen, T and Hansen, O (2012). Transvestite Vikings?. *Viking Heritage Magazine*, 1(3), 14-17.
- Leahy, K (2013). A deposit of early medieval iron objects from Scraftoft, Leicestershire. *Medieval Archaeology*, 57(1), 223-237.
- Lemonnier, P (1986). The study of material culture today: Toward an anthropology of technical systems. *Journal of Anthropological Archaeology*, 5 (2), 147-186.
- Lemonnier, P (1993). Introduction. In P Lemmonier (Ed). *Technological choices: transformation in material cultures since the Neolithic*. London: Routledge, pp 1-35.
- Lia, Ø (2004). Vikingetidsgravenes rituelle kompleksitet. In L Melheim, L Hedeager and K Oma (Eds). *Mellom himmel og jord: foredrag fra et seminar om religionsarkeologi, Isegran, 31. januar–2. februar 2002*. Oslo: Institutt for arkeologi, kunsthistorie og konservering, Universitetet i Oslo, pp 292–319.

- Linlaud, M (2014). *Serrures médiévales (VIIIe-XIIIe siècle)*. Rennes: Presses universitaires de Rennes.
- Louis-Jensen, J and Wills, T (Eds). (2007). Anonymous Poems, Plácitusdrápa 23. In MC Ross (Ed). *Poetry on Christian Subjects. Skaldic Poetry of the Scandinavian Middle Ages 7*. Turnhout: Brepols, pp 196-204.
- Lucy, S (1998). *The early Anglo-Saxon cemeteries of East Yorkshire: an analysis and reinterpretation*. BAR British series 272. Oxford: Archaeopress.
- Lucy, S (2000). *The Anglo-Saxon way of death*. Stroud: Sutton Publishing.
- Lucy, S (2002). Burial practice in early medieval eastern Britain: constructing local identities, deconstructing ethnicity. In S Lucy and A Reynolds (Eds). *Burial in early medieval England and Wales*. London : The Society for Medieval Archaeology, pp 72-87.
- Lucy, S, Tipper, J, and Dickens, A (2009). *The Anglo-Saxon settlement and cemetery at Bloodmoor Hill, Carlton Colville, Suffolk*. East Anglian Report No 131. Cambridge: Cambridge Archaeological Unit.
- Lund, J (2005). Thresholds and passages: the meanings of bridges and crossings in the Viking Age and early Middle Ages. *Viking and Medieval Scandinavia*, 1, 109-135.
- Lund, J (2006). Vikingetidens værktøjskister i landskab og mytologi. *Fornvännen*, 101(5), 323-341.
- Lund, J (2009). *Åsted og vadested. Deponeringer, genstandsbiografier og rumlig strukturering som kilde til vikingetidens kognitive landskaber*. Unpublished: University of Oslo. PhD Thesis.
- Lund, J (2013). Fragments of a conversion: handling bodies and objects in pagan and Christian Scandinavia ad 800–1100. *World Archaeology*, 45(1), 46-63.
- Lycett, S (2015). Cultural evolutionary approaches to artefact variation over time and space: basis, progress, and prospects. *Journal of Archaeological Science*, 56, 21-31.
- MacDougall, H A (1982). *Racial myth in English history: Trojans, Teutons and Anglo-Saxons*. Montreal: Harvest House.
- Manning, W H (1985). *Catalogue of the Romano-British Iron Tools, Fittings and Weapons in the British Museum*. London: British Museum.
- Margeson, S (1993). *Norwich Households: Medieval and Post-Medieval Finds from Norwich Survey Excavations 1971-78*. Norwich: East Anglian Archaeology.
- McCreight, T (1991). *The Complete Metalsmith: Illustrated Handbook*. Worcester MA: Davis Publications Inc.



- McDonnell, G (1989). Iron and its alloys in the fifth to eleventh centuries AD in England. *World Archaeology*, xx, 373-382.
- McLeod, S (2011). Warriors and women: the sex ratio of Norse migrants to eastern England up to 900 AD. *Early Medieval Europe*, 19, 332–53.
- Meletinsky, E. (1998). *The Elder Edda and early forms of the epic*. Trieste: Parnaso.
- Meulengracht Sørensen, P (1983). *The unmanly man: concepts of sexual defamation in early northern society*. Odense: Odense University Press.
- Miller, D (2007). Stone age or plastic age? *Archaeological Dialogues*, 14(1) 23-27.
- Mols, S T A M (1999). *Wooden furniture in Herculaneum: form, technique and function*. Amsterdam: Gieben.
- Monk, E (2010). *Keys: their history and collection*. Oxford: Shire Publications Ltd.
- Montelius, O (1888). *Civilization of Sweden in heathen times*. London and New York: Macmillan and Co.
- Montgomery, J , Evans, J A, Powlesland, D and Roberts, C A (2005). Continuity or colonization in Anglo-Saxon England? Isotope evidence for mobility, subsistence practice, and status at West Heslerton. *American Journal of Physical Anthropology*, 126, 123-138.
- Moorhead, S (2013). *A history of Roman coinage in Britain: illustrated by finds in the Portable Antiquities Scheme*. Witham: Greenlight Publishing.
- Morris, M W, Hong, Y, Chiu, C and Liu, Z (2015). Normology: integrating insights about social norms to understand cultural dynamics. *Organizational behavior and human decision processes*, 129, 1–13.
- Müller (1971). *Römische Brandgräber mit Truhenresten aus Hackenbroich, Kreis Grevenbroich*. Dusseldorf: Verlagsbüro.
- Müller-Wille, M (1977). Die frühmittelalterliche Schmied im Spiegel skandinavischer Grabfunde. *Frühmittelalterliche Studien*, 11, 127-201.
- Mundal, E (2013). *Dating the sagas: reviews and revisions*. Copenhagen: Museum Tusulanum Press.
- Muthrukrishna, M, Shulman, B, Vasilescu, V and Henrich, J (2014). Sociality influences cultural complexity. *Proceedings of the Royal Society B*, 281, 1-8.
- Nagel, A and Wood, C S (2005). Toward a new model of Renaissance anachronism. *The Art Bulletin*, 83(3), 403-415.

- Naum, M (2012). Ambiguous pots: everyday practice, migration and materiality. The case of medieval Baltic ware on the island of Bornholm (Denmark). *Journal of Social Anthropology*, 12(1), 92-119.
- Nelson, H (1949). Certain Reliefs at Karnak and Medinet Habu and the Ritual of Amenophis I. *Journal of Near Eastern Studies*, 8(3), 201-232.
- Neuburger, A (1919). *Die Technik Des Altertums*. Leipzig: R. Voigtlander.
- Nilsson, B (2007). An archaeology of material stories. Dioramas as illustration and the desire of a thingless archaeology. *Archaeological Dialogues*, 14(01), 27-30.
- Nordberg, A (2002). Vertikalt placerade vapen i vikingatida gravar. *Fornvännen* 97, 15-24.
- Nordström, E (2014). The trading Lady of the House at Birka. In H Alexandersson, A Andreeff, and A Büntz (Eds). *Med hjärta ohh hjärna: en vänbok till professor Elisabeth Arwill-Nordbladh*. Gothenburg: Institutionen för historiska studier, pp 295-311.
- Nørlund, P (1948). *Trelleborg*. København: Nordiske Fortidsminder.
- O'Sullivan, J (2015). Strung along: re-evaluating gendered views of Viking-Age beads. *Medieval Archaeology*, 59(1), 73-86.
- Oates, D and Oates, J (2001). *Nimrud. An Assyrian imperial city revealed*. London: British School of Archaeology in Iraq.
- Oddy, A (1981). Gilding through the ages: an outline history of the process in the old world. *Gold Bulletin*, 14(2), 75-79.
- Ottaway, P (1992). *Anglo-Scandinavian ironwork from Coppergate*. Dorchester: The Dorset Press.
- Ottaway, P (1995). *Products of the blacksmith in Mid-Late Anglo-Saxon England*, 2. Unpublished paper. [Online]. Available at <https://www.pjoarchaeology.co.uk/docs/14/anglosaxon-ironwork-part-2.pdf> [Accessed 13 May 2014]
- Owen-Crocker, G R (2004). [1986]. *Dress in Anglo-Saxon England* (rev. ed). Woodbridge: Boydell Press.
- Pantmann, P (2011). The symbolism of keys in female graves on Zealand during the Viking Age. In L Boye (Ed). *The Iron Age on Zealand status and perspectives*. Copenhagen: The Royal Society of Northern Antiquities, pp 75-80.
- Parker Pearson, M (1993). The powerful dead: archaeological relationships between the living and the dead. *Cambridge Archaeological Journal*, 3(2), 203-229.
- Partridge, C (Ed). (1981). *Skeleton Green a late Iron Age and Romano British Site*. London: Society for the Promotion of Roman Studies.

- Pedersen, U (2009). Den ideelle og den reelle smed. In J Lund and M Lene (Eds). *Håndverk og produksjon. et møte mellom ulike perspektiver*. Oslo Archaeological Series, vol. 12. Oslo: Unipub : Institutt for arkeologi, konservering og historie, pp 129-146.
- Pernice, E. (1938). *Pavimenti und figürliche Mosaiken, Die hellenistische Kunst in Pompeji 5*. Berlin: Walter de Gruyter.
- Petersen, J (1928). *Vikingetidens Smykker*. Stavanger: Stavanger Museum.
- Petersen, J (1933). *Gamle gårdsanlegg i Rogaland fra forhistorisk tid og middelalder*. Oslo: H. Aschehoug & Co.
- Pfaffenberger, B (1992). Social anthropology of technology. *Annual Review of Anthropology*, 21(1), 491-516.
- Pitt-Rivers, F R S (1883). *On the development and distribution of primitive locks and keys*. London: Chatto and Windus.
- Pleiner, R (2006). *Iron in Archaeology: Early European Blacksmiths*. Prague: Archeologický ústav AV ČR.
- Pollard, A M, Bray, P, Gosden, C, Wilson, A and Hamerow, H (2015). Characterising copper-based metals in Britain in the first millennium AD: a preliminary quantification of metal flow and recycling. *Antiquity*, 89(345), 697-713.
- Potts, D (1990). Locky [sic] and Key in Ancient Mesopotamia. *Mesopotamia in Torino*, 25, 185-192.
- Price, N (2002). *The Viking Way: Religion and War in Late Iron Age Scandinavia*. Uppsala: Uppsala University.
- Price, N (2008). Dying and the dead: Viking Age mortuary behaviour. In S Brink and N Price (Eds). *The Viking World*. London: Routledge, pp 257-273.
- Price, N (2010). Passing into poetry: Viking-Age mortuary drama and the origins of Norse mythology. *Medieval Archaeology*, 541(1), 123-156.
- Price, N, Hedenstierna-Jonson, C, Zachrisson, T, Kjellström, A, Storå, J, Krzewińska, M, Günther, T, Sobrado, V, Jakobsson, M and Götherström, A (2019). Viking warrior women? Reassessing Birka chamber grave Bj.581. *Antiquity*, 93(367), 181–198.
- Price, T D, Naum, M, Bennike, P, Lynnerup, N, Frei, K, and Wagnkilde, H (2012). Isotopic investigation of human provenience at the eleventh century cemetery of Ndr. Grødbygård, Bornholm, Denmark. *Danish Journal of Archaeology*, 93-112.

Proffitt, B (2018). *Securitas et Claves Gabiorum: A Social and Proprietary Analysis of the Imperial Roman Keys Excavated at Gabii*. Unpublished: Texas Tech University. MA.

Radner, K (2010). Gatekeepers and lock masters: the control of access in the Neo-Assyrian palaces. In H D Baker, E Robson, and G Zolyomi (Eds). *Your Praise is Sweet: a memorial volume for Jeremy Black from students, colleagues and friends*. London: British Institute for the Study of Iraq, pp 269 - 280.

Ravn, M (2003). *Death ritual and Germanic social structure (c. AD 200-600)*. BAR: international series 1164. Oxford : Archaeopress.

Read, D (2008). An interaction model for resource implement complexity based on risk and number of annual moves. *American Antiquity*, 73(4), 599-625.

Rees, H, Crummy, N, Ottaway, P J, and Dunn, G (2008). *Artefacts and Society in Roman and Medieval Winchester. Small Finds from the Suburbs and Defences, 1971–1986*. Winchester: Winchester Museums Service.

Renck, A M (2008). Erövrat mark – erövrat släktskap. In M Olausson, (Ed). *Hem till Jarlabanke. Jord, makt och evigt liv i östra Mälardalen under järnålder och medeltid*. Lund: Historiska Media, pp 91–111.

Repovs, G and Baddeley, A (2006). The multi-component model of working memory: explorations in experimental cognitive psychology. *Neuroscience*, 139, 5-21.

Richards, J [BBC] (2001). Blood of the Vikings: invasion. [Online]. [Accessed 12 July 2013]. Available at: <http://www.youtube.com/watch?v=-2gXurOZuWA>.

Richards, J D (2003). Pagans and Christians at the frontier: Viking burial in the Danelaw. In M O H Carver (Ed). *The Cross Goes North: Processes of Conversion in Northern Europe, AD 300-1300*. York Medieval Press in association with Boydell & Brewer, York/Woodbridge, pp 383-395.

Richards, J D, Naylor, J, and Holas-Clark, C (2008). Overview. *The Viking and Anglo-Saxon Landscape and Economy (VASLE) Project [data-set]*. [Online] York: Archaeology Data Service [distributor]. Available at: <https://doi.org/10.5284/1000044>. [Accessed 9 October 2015]

Richards, J D and Naylor, J (2009). The real value of buried treasure. VASLE: The Viking and Anglo-Saxon Landscape and Economy Project. In S Thomas and PG Stone (Eds). *Metal detecting and archaeology*. Woodbridge: The Boydell Press, pp 167-79.

Richardson, H G and Sayles, G O (1966). *Law and legislation from Æthelberht to Magna Carta*. Edinburgh: Edinburgh University Press.

Robbins, K (2013). Balancing the scales: Exploring the variable effects of collection bias on data collected by the Portable Antiquities Scheme. *Landscapes*, 14(1), 54-72.

Robbins, K (2014). *A guide for researchers*. Portable Antiquities Scheme. [Online]. Available at: <https://finds.org.uk/documents/guideforresearchers.pdf> [Accessed 3 May 2015].

Roesdahl, E (1993). On keys. In H Bekker-Nielsen (Ed). *Twenty-eight papers presented to Hans Bekker-Nielsen on the occasion of his sixtieth birthday 28 April 1993*. Odense: Odense University Press, pp 217–224.

Roesdahl, E, Sindbæk, S, Pedersen, A and Wilson, D M (2014). *Aggersborg: the Viking-age settlement and fortress*. Højbjerg: Jutland Archaeological Society.

Rogers, N (2009). Copper alloy keys. In D H Evans and C Loveluck (Eds). *Life and economy at early medieval Flixborough, c. AD 600-1000: the artefact evidence*. Oxford: Oxbow Books, pp 193-195.

Rosenblatt, P C (1996). Grief that does not end. In D Klass, P R Silberman, and S Nickman (Eds). *Continuing bonds: new understandings of grief*. Philadelphia, PA: Taylor & Francis. pp 179-196.

Rubinson, S R (2010). *Iron technology: An examination of the quality and use of iron alloys in iron artefacts from Early Medieval Britain*. Unpublished: University of Bradford. PhD.

Sandquist, Siri (2012). *Making of a man: the hegemonic masculinity of the Viking age*. Unpublished: University of Glasgow. MLitt.

Saussure, F (1916). *Course in general linguistics*. London: McGraw-Hill Book Company.

Scatozza Horicht, L A (1989). *I monili di Ercolano*. Rome: "L'Erma" di Bretschneider.

Schacter, D L and Addis, D R (2007). The cognitive neuroscience of constructive memory: remembering the past and imagining the future. *Philosophical Transactions of the Royal Society*, 362, 773-786.

Schneider, W (2002). *So they understand*. Logan, UT: Utah State University Press.

Schrüfer-Kolb, I (2004). *Roman iron production in Britain: technological and socio-economic landscape development along the Jurassic ridge*. BAR 380. Oxford: Archaeopress.

Schulman J K (2007). "A Guest is in the Hall": women, feasts, and violence in Icelandic Epic. In S S Poor and J K Schulman (Eds). *Women and Medieval Epic. The New Middle Ages*. New York: Palgrave Macmillan, pp 209-233.

Sherlock, S J and Allen, S (2012). *A royal Anglo-Saxon cemetery at Street House, Loftus, North East Yorkshire*. Hartlepool: Tees Archaeology.

Sim, D. (1998). *Beyond the bloom: bloom refining and iron artefact production in the Roman World*. BAR International Series. Oxford: Archaeopress.

- Simon H A and Chase W G (1973). Skill in chess. *American Scientist*, 61, 394–403.
- Sindbæk, S (2007). Networks and nodal points: the emergence of towns in early Viking Age Scandinavia. *Antiquity*, 81(311), 119-132.
- Sindbæk, S (2008). The lands of Denemearce: cultural differences and social networks of the Viking Age in South Scandinavia. *Viking and medieval Scandinavia*, 4, 169-208.
- Sindbæk, S (2013). Market towns and long distance: Did the Viking era start in Ribe? in H Lyngstrøm and LG Thomsen (Eds). *Viking Age in Denmark: texts written to Joergen Poulsen on the occasion of the experimental and mediating archaeology practiced and developed by the Viking Village in Albertslund from 1992 to 2012*. Copenhagen: University of Copenhagen, pp 173- 176.
- Skre, D (2007a). Introduction. In D Skre (Ed). *Kaupang in Skiringssal: Kaupang excavation project publication series, volume I*. Aarhus: Aarhus University Press, pp 13-24.
- Skre, D (2007b). Exploring Skiringssal 1771-1999. In D Skre (Ed). *Kaupang in Skiringssal : Kaupang excavation project publication series, volume I*. Aarhus: Aarhus University Press, pp 27-43.
- Slocum, J, and Sonneveld, D (2017). *Romano-Celtic mask puzzle padlocks: a study in their origin, design, technology, and security*. Oxford: Archaeopress.
- Söderberg, A (2008). Metallurgical clay packages. In H Clarke and K Lamm (Eds). *Excavations at Helgö XVII*. Stockholm: Kungliga Vitterhets Historie och Antikvitets Akademien, pp 159-169.
- Söderberg, A (2014). The brazing of iron and the metalsmith as a specialised potter. *The Old Potter's Almanack*, 19(2), 23-29.
- Soldadi, R (2012). *The Antique Wooden Door locks of Italy*. [Online]. [Accessed 14 May 2016]. Available at: <https://www.youtube.com/watch?v=9zp2Xi5OnUM>.
- Solomon, S, Greenberg, J, and Pyszczynski, T (1991). A Terror Management Theory of social behavior: the psychological functions of self-esteem and cultural worldviews. *Advances in Experimental Social Psychology*, 24, 93-159.
- Sommella, M (1983). *Crepereia Tryphaena: un tesoro nascosto di 2000 anni fa : Museo di Milano*. Milano: Fabbri.
- Sørensen M L S (2013). Identity, gender and dress in the European Bronze Age. In A Harding and H Fokkens (Eds). *The Oxford Handbook of the European Bronze Age*. Oxford: Oxford University, pp 216-233.
- Spano, G. (1914). *Pompei - Scavi sulla via dell'Abbondanza durante il mese di giugno. Notizie degli Scavi di Antichità, Series 5, No. 11*. Roma: Accademia nazionale dei Lincei.

- Sparling, H H, Magnusson, E and Morris, W (1935). *Völsunga Saga: the story of the Volsungs and Niblungs*. London: W. Scott Publishing Co.
- Stead, I M and Rigby, V (1986). *Baldock: the excavation of a Roman and pre-Roman settlement, 1968-72, etc*. London: Society for the Promotion of Roman Studies.
- Stein W A (2016). *How to read medieval art*. New Haven, CT: Yale University press.
- Stenberger, M and Klindt-Jensen, O (1955). *Vallhalgar: a migration period settlement on Gotland, Sweden*. Copenhagen: Munksgaard Publishers.
- Steuer, H (1982). Schlüsselpaare in frühgeschichtlichen Gräbern. Zur Deutung einer Amulettbeigabe. *Studien zur Sachsenforschung*, 3, 185–247.
- Stöger, J J (2011). *Rethinking Ostia : a spatial enquiry into the urban society of Rome's imperial port-town*. Unpublished: Leiden University. PhD.
- Stoodley, N (1999). *The spindle and the spear : a critical enquiry into the construction and meaning of gender in the early Anglo-Saxon burial rite*. BAR: British series 288. Oxford: Archaeopress.
- Stylegar F (2007). The Kaupang cemeteries revisited. In D Skre (Ed). *Kaupang in Skiringssal : Kaupang excavation project publication series, volume I*. Aarhus: Aarhus University Press, pp 65-126.
- Suzuki, S (2008). *Anglo-Saxon button brooches: typology, genealogy, chronology*. Martlesham: Boydell & Brewer.
- Svanberg, F (2003). *Death rituals in south-east Scandinavia AD 800-1000 : decolonizing the Viking age 2*. Stockholm : Almqvist & Wiksell International.
- Swift, E (2012). Object biography, re-use and recycling in the late to post-Roman transition period and beyond: rings made from Romano-British bracelets. *Britannia*, 43, 167-215.
- Taylor, AC (1993). Remembering to forget: identity, mourning and memory among the Jivaro. *Man, New Series*, 28(4), 653-678.
- Tilley, C (1989). Interpreting material culture. In I Hodder (Ed). *The meaning of things*. London: Routledge, pp 185-194.
- Tilley, C (2007). Materiality in materials. *Archaeological Dialogues*, 14(1), 16-20.
- Tomtlund, J-E (1970). Hänglåsen från Helgö. *Fornvännen*, 65, 238–247.
- Tomtlund, J-E (1978). Locks and keys. In K Lamm and A Lundström (Eds). *Excavations at Helgö V: Workshop Part II*. Stockholm: Kungl. Vitterhets Historie och Antikvitets Akademien, pp 3–14.

- Tomtlund, J E (1989). Die Vorhängeschlösser. In G Arwidsson (Ed). *Birka II:3 Systematische Analysen der Gräberfunde*, Stockholm: Almqvist & Wiksell, pp 133–134.
- Toynbee J M C (1971). *Death and Burial in the Roman World*. Ithaca, NY: Cornell University Press.
- Tylecote, R F and Gilmour, B J J (1986). *The Metallography of Ferrous Edge Tools and Edged Weapons*. BAR British series 155. Oxford: Archaeopress.
- UKDFD (2005a). *About*. UKDFD. [Online]. Available at: <http://www.ukdfd.co.uk/pages/about.html> [Accessed 12 Sept 2017].
- UKDFD (2005b). *Guidelines for recording*. UKDFD. [Online]. Available at: <http://www.ukdfd.co.uk/pages/guidelines.html> [Accessed 12 Sept 2017].
- UKDN (nd). *Is there a Code of Conduct?* UKDN. [Online]. Available at: <http://www.ukdetector.net.co.uk/conduct.html> [Accessed 12 Sept 2017].
- Ulfhielm, A and Arwidsson, G (1989). Schlüssel. In G Arwidsson (Ed). *Birka II:3 Systematische Analysen der Gräberfunde*, Stockholm: Almqvist & Wiksell, pp 122-132.
- Ulmschneider, K (2013). Settlement, economy, and the 'productive' site: middle Anglo-Saxon Lincolnshire A.D. 650-780. *Medieval Archaeology*, 44(1), 53-79.
- van der Leeuw, S (1993). Giving the potter a choice. In Lemonnier, P (Ed). *Technological choices: transformation in material cultures since the Neolithic*. Routledge: London and New York, pp 238-288.
- van der Veen, M (2003). When is food a luxury? *World Archaeology*, 34(3), 405-427.
- van Haperen, M (2010). Rest in pieces: an interpretive model of early medieval 'grave robbery'. *Medieval and modern matters: Archaeology and material culture in the Low Countries*, 1, 1-36.
- Vedeler, M, Kristoffersen, E S and Røstad I M (2018). Dressed for ritual, dressed for life. A Migration-Period grave from Sande in Norway. *Medieval Archaeology*, 62(1), 1-27.
- von Ackermann, M (2013). *Lykill and skör: evaluating the archaeological potential of Viking Age keys*. Unpublished: University of York. MA.
- Walker, M (2005). *Hitchcock's Motifs*. Amsterdam: Amsterdam University Press.
- Ward Perkins, J B (1993). *London Museum medieval catalogue 1940*. Ipswich, Suffolk: Anglia Publishing.
- Wardle, K A and Wardle, D (2004). Glimpses of private life: Roman rock cut tombs of the first and second centuries AD at Knossos. *British School at Athens Studies*, 12, 473-480.



Wawn, A (2000). *The Vikings and the Victorians: Inventing the Old North in nineteenth-century Britain*. Cambridge: D.S. Brewer.

Weber, G W (1986). The decadence of feudal myth: towards a theory of riddarasaga and romance. In J Lindow, L Lönnroth, and GW Weber (Eds). *Structure and meaning in old Norse literature: new approaches to textual analysis and literary criticism*. Odense: Odense University Press, pp 415–54.

Weeber, K-W (2000). *Alltag im Alten Rom: das Leben in der Stadt. Ein Lexikon von Karl-Wilhelm Weeber*. Düsseldorf: Patmos.

Weiss, K (1972). On the systematic bias in skeletal sexing. *American Journal of Physical Anthropology*, 37, 239-250.

Welton, A J (2016). Encounters with Iron: An archaeometallurgical reassessment of early Anglo-Saxon Spearheads and Knives. *Archaeological Journal*, 173(2), 206-244.

Wendrich, W (2006). Entangled, connected or protected? The power of knots and knotting in ancient Egypt. In K Szpakowska(Ed). *Through a glass darkly: magic, dreams and prophecy*. Swansea: The Classical Press of Wales, pp 243-269.

Westerholm, M (2001). *Bronserade nycklar med fågelmotiv från Birkas garnison: Fyndpreparering och tolkning av ornamentik med hjälp av laserscanner*. Unpublished: Stockholm University. MA.

Westphalen, P (2002). *Die Eisenfunde von Haithabu*. Neumünster: Wachholtz.

Whelan, M (1991). Gender and historical archaeology: Eastern Dakota patterns in the 19th century. *Historical Archaeology*, 25(4), 17-32.

White, RH (1988). *Roman and Celtic objects from Anglo Saxon graves: a catalogue and an interpretation of their use*. BAR British Series 191. Oxford: Archaeopress.

Whiten, A, Horner, V, Litchfield, C A and Marshall-Pescini, S (2004). How do apes ape? *Learning Behaviour*, 32, 36-52.

Wilhelmson, H and Ahlström, T (2015). Iron Age migration on the island of Öland: Apportionment of strontium by means of Bayesian mixing analysis. *Journal of Archaeological Science*, 64, 30-45.

Wilhelmson, H and Price, T D (2017). Migration and integration on the Baltic island of Öland in the Iron Age. *Journal of Archaeological Science: Reports*, 12, 183-196.

Williams, H (2003). Medieval culture as memory: combs and cremation in early medieval Britain. *Early Medieval Europe*, 12(2), 89-128.

Williams, H (2004). Death warmed up: the agency of bodies and bones in early Anglo-Saxon cremation rites. *Journal of Material Culture*, 9(3), 263–291.

Williams, M A and Young, M J (1995). Grammar, codes, and performance: linguistic and sociolinguistic models in the study of vernacular architecture. *Perspectives in Vernacular Architecture*, 5, *Gender, Class, and Shelter*, 40-51

Wilson, D M (1959). Almgren and Chronology. *Medieval Archaeology*, 3(1), 112–119.

Wise, S (2007). *Childbirth Votives and Rituals in Ancient Greece*. Unpublished: University of Cincinnati. PhD.

Wolters, J (1981). The ancient craft of granulation: a re-assessment of established concepts. *Gold Bulletin*, 14(3), 119-129.

Wylie, A. (1991). Gender theory and the archaeological record: Why is there no archaeology of gender? In J M Gero and M Conkey (Eds). *Engendering archaeology*. Oxford: Basil Blackwell, pp 31-54.

Zettler, R (1987). Sealings as artefacts of institutional administration in ancient Mesopotamia. *Journal of Cuneiform Studies*, 39, 197-240.

Zilmer, K (2005). *“He drowned in Homer’s sea - His cargo-ship drifted to the sea-bottom, only three came out alive”*. Records and representations of Baltic traffic in the Viking Age and the Early Middle Ages in early Nordic sources. Unpublished: University of Tartu. PhD.