

# **The Antibacterial Effect of Honey and Tamarind-Notably Against MRSA- in Relation to Wound Treatment**

by

Amal Abdullah Sabour

MSc. King Saud University, Saudi Arabia

MPhil., University of Sheffield, England



**The  
University  
Of  
Sheffield.**

Thesis submitted to the Department of Molecular Biology and Biotechnology the University of Sheffield, England, in fulfillment of the requirements for the Degree of Doctor of Philosophy.

Department of Molecular Biology and Biotechnology,  
the University of Sheffield, England

2018

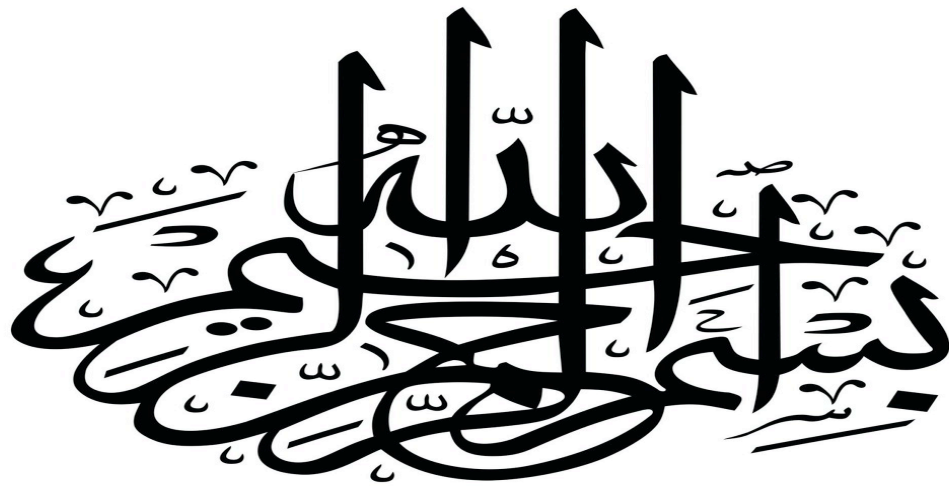

In the name of God, Most Gracious,  
Most Merciful

## **DEDICATION**

*This thesis is dedicated to my beloved father, my affectionate Mother. A special dedication to those who inspired me to the higher ideals of life, my husband Abdullah and my children Roaa, Yousef and Danah, my sisters and brothers, my relatives, friends and colleagues.*

## **ACKNOWLEDGMENTS**

All gratitude is to Allah (God), the beneficent and merciful; who blessed me with health, courage, enthusiasm and for giving me the power and endurance to complete this Thesis. My deepest thanks to my supervisor Professor (Hon Cardiff) Milton Wainwright for his devoted efforts, guidance, support, helpful advice and encouragement at all times given to me during this study and to complete the Thesis. I would also like to thank my supervisory committee members, Dr. D. J. Gilmour and Professor Jeffrey Green for their helpful advice and comments during my study. My thanks also extend to all in Prof Wainwright's laboratory members, particularly for my best friend Maha for our exchanges of knowledge and skills and for her help and encouragement. My special thanks are due to my family for their patience, support, continuous encouragement and enthusiasm throughout the period of my study. Finally, I would like to thank my sponsor, King Saud University for granting me a full scholarship which allowed me to carry out this PhD course at the University of Sheffield.

## ABSTRACT

The overall aim of this study was to find new and effective honeys and other natural plant products for potential use as alternatives to antibiotics. It involved a broad-ranging screening program aimed at finding the most effective antibacterial honeys, and to determining the antibacterial effects of: a) combinations of different honeys or Tamarind, b) mixtures of honey and a range of different antibiotics and c) different time periods of ultraviolet light exposure on bacteria. It also involved a study of the liberation of endotoxin from *E. coli* after being treated with honey or Tamarind. The ability of some pathogenic bacteria to resist antibiotics has increased, consequently, alternative antimicrobial agents are needed. Different types of honey can effectively kill or inhibit a wide variety of multi-antibiotic-resistant bacteria. Antibacterial activity was tested using 12 honeys as well as Tamarind against *Escherichia coli*, *Staphylococcus aureus* and methicillin-resistant *Staphylococcus aureus* (MRSA). The agar well diffusion assay was used to investigate the effectiveness of honey samples and Tamarind. Minimum Inhibitory Concentration (MIC) and Minimum Bactericidal Concentration (MBC) for honey and Tamarind were determined by using the broth macro-dilution method. Active honeys were tested for the presence of peroxide by treatment with catalase. The agar diffusion method was used to assess the effect of combining two honeys

together and honey mixed with Tamarind and also to assess synergistic interaction between antibiotics and honeys or Tamarind paste. Seven different types of honey were seen to be remarkably effective against tested bacteria, some having marked or moderate activity. The results showed that the lowest minimum inhibitory concentrations (MICs) were for Antibacterial Medical honey, Manuka 15+ and Tamarind, while Manuka 15+ and Tamarind produced the lowest MBC values. Manuka honey +24, Manuka honey +15 (which are produced from the botanical source *Leptospermum scoparium*) were shown to be non-peroxide honeys. Honey-effectiveness was significantly increased after mixing each different honey with Tamarind. A number of honey-antibiotic combinations were seen to interact positively to inhibit the growth of bacteria. The results of exposure of bacteria to UV showed that the inhibition zones were significantly increased after exposing the bacterial suspension to UV-B for all (each) tested periods for each different honey or Tamarind. Generally, longer UV-B exposure time resulted in an increase in the inhibition zone diameter except in some rare cases. Almost all honey samples showed negative results for endotoxin except Brezzo Italian Lemon honey which was the only one producing a positive effect.

## LIST OF CONTENTS

<b>Dedication .....</b>	<b>III</b>
<b>Acknowledgments .....</b>	<b>IV</b>
<b>Abstract.....</b>	<b>V</b>
<b>List of contents .....</b>	<b>VII</b>
<b>List of tables.....</b>	<b>XII</b>
<b>List of figures.....</b>	<b>XIII</b>

<b>Chapter One. General Introduction .....</b>	<b>1</b>
1. Introduction.....	2
1.1 Some important Pathogenic Bacteria.....	2
1.1.1. <i>Staphylococcus aureus</i> .....	3
1.1.2 <i>Escherichia coli</i> .....	5
1.2 Resistance to antimicrobial agents.....	6
1.3 The importance of finding alternatives to antibiotics .....	9
1.4 Apitherapy (Honey therapy) .....	11
1.5. Tamarind.....	17
1.6 Research objectives .....	18

<b>Chapter Two: Studies on the Antibacterial Activities of a Range of Commercially Available Honeys and Tamarind.....</b>	<b>19</b>
2.1 Introduction .....	20
2.2 Materials and methods .....	22
2.2.1 Honey samples and Tamarind .....	22
2.2.2 Samples preparation.....	22
2.2.3 Test organisms .....	22
2.2.4. Turbidity standard for inoculum preparation.....	23
2.2.5 Agar well Diffusion Assay .....	23
2.2.6 Minimum Inhibitory Concentrations (MIC).....	24

2.2.7 Minimum Bactericidal Concentrations (MBC).....	24
2.2.8 The autoclaving of honey and Tamarind to detect the effectiveness of antimicrobial activity.....	25
2.2.9 Determination of pH .....	26
2.2.10 Peroxide test .....	26
2.2.11 Catalase treatment .....	26
2.2.12 Statistical analysis .....	27
2.3 Results.....	28
2.3.1. Agar well Diffusion assay.....	28
2.3.2. Minimum Inhibitory Concentration (MIC) and Minimum Bactericidal Concentration (MBC) .....	36
2.3.3. The effect of autoclaving of honey and Tamarind to detect the effectiveness of antimicrobial activity.....	41
2.3.4. Determination of pH.....	45
2.3.5. Determination of the role of peroxide in the antibacterial activity of honeys using the peroxidase strip test.....	46
2.3.6. Catalase treatment.....	48
2.4. Discussion.....	50
2.5. Conclusion.....	51

<b>Chapter Three: The effect of combining two honeys together, honey mixed with Tamarind and combining honey with antibiotics.....</b>	<b>52</b>
3.1. Introduction .....	53
3.2. Materials and Methods .....	57
3.2.1 Honey samples and Tamarind .....	57
3.2.2. Samples preparation .....	57
3.2.3. Test organisms.....	57
3.2.4. Turbidity standard for inoculum preparation .....	57
3.2.5. The effect of combining two honeys together and honey mixed with	



Tamarind.....	58
3.2.6. The effect of combining honey with antibiotics.....	59
3.2.7 Statistical Analysis.....	60
3.3. Results .....	61
3.3.1. The effect of combining two honeys together and honey mixed with Tamarind; comparison of the results with those of the effect of individual honey and Tamarind.....	61
3.3.2. The effect of combining honey with antibiotics.....	70
3.4. Discussion and conclusion.....	77

**Chapter Four: The effect of ultraviolet light exposure on bacteria after  
has been treated with honey or Tamarind .....79**

4.1. Introduction.....	80
4.2. Materials and Methods.....	86
4.2.1 Honey samples and Tamarind .....	86
4.2.2. Samples preparation .....	86
4.2.3. Test organisms.....	86
4.2.4. Turbidity standard for inoculum preparation .....	86
4.2.5. Exposure of bacterial suspensions to ultra-violet radiation .....	87
4.2.6 Statistical Analysis.....	88
4.3 Results and Discussion.....	89
4.3.1. Microbial inactivation as a result of UV light treatment in combination with honey or Tamarind paste.....	89

**Chapter Five: The detection of liberation of endotoxin from *E. coli*  
after being treated with honey or Tamarind.....96**

5.1. Introduction .....	97
5.2. Materials and Methods .....	102

5.2.1 Honey samples and Tamarind .....	102
5.2.2. Samples preparation .....	102
5.2.3. Turbidity standard for inoculum preparation.....	103
5.2.4. Reagent preparation.....	103
5.2.5. Preparation of Limulus Amebocyte Lysate (LAL) solution....	103
5.2.6. <i>E. coli</i> endotoxin standard.....	103
5.2.7. Test procedure.....	104
5.3. Results and Discussion.....	105
<b>Chapter Six: Final Discussion.....</b>	<b>109</b>
6.1. Final Discussion.....	110
6.2. Suggestions for future work.....	117
<b>References.....</b>	<b>119</b>
<b>List of Appendices .....</b>	<b>132</b>
Appendix 1. Peroxide test.....	133
Appendix 2. Manufacturer information of UV lamps.....	134
Appendix 3. Manufacturer information of Gel Clot Endotoxin Assay.....	138

<b>List of Tables</b>	<b>Page</b>
Table No. 1: The effect of different concentrations of selected honeys from different origins and Tamarind against <i>Staphylococcus aureus</i> determined by agar diffusion assay.	32
Table No. 2: The effect of different concentrations of selected honeys from different origins and Tamarind against <i>Escherichia coli</i> determined by agar diffusion assay.	33
Table No. 3: The effect of different concentrations of selected honeys from different origins and Tamarind against MRSA determined by agar diffusion assay.	34
Table No. 4: pH of honeys and Tamarind.	44
Table No. 5: Hydrogen peroxide content of honey.	46
Table No. 6: The catalase effects on honey activity.	48
Table No. 7: Effect of combination of antibiotics and honey or Tamarind on <i>S. aureus</i> .	72
Table No. 8: Effect of combination of antibiotics and honey or Tamarind on <i>E. coli</i> .	73
Table No. 9: Effect of combination of antibiotics and honey or Tamarind on MRSA.	74
Table No. 10: The presence of endotoxin in honeys and Tamarind.	104

<b>List of Figures</b>	<b>Page</b>
Figure 1: Chemical structures of the methylglyoxal (MGO).	16
Figure 2: Well diffusion assay for Manuka honey 24+ at different concentration (100%, 80% and 60%); showing zone of inhibition of growth of different bacteria.	30
Figure 3: Well diffusion assay for Manuka honey 15+ at different concentration (100%, 80% and 60%); showing zone of inhibition of growth of different bacteria.	30
Figure 4: Well diffusion assay for New Zealand Rewarewa Ogilvy's Honey at different concentration (100%, 80% and 60%); showing zone of inhibition of growth of different bacteria.	31
Figure 5: Well diffusion assay for Tamarind at different concentration (100%, 80% and 60%); showing zone of inhibition of growth of different bacteria.	31
Figure 6: Minimum inhibitory concentration (MIC) of Manuka 15+ honey for MRSA; with no visible growth from 6.25%.	36
Figure 7: Minimum inhibitory concentration (MIC) of Manuka 24+ honey for <i>S. aureus</i> ; with no visible growth from 12.5%.	36
Figure 8: Minimum inhibitory concentration (MIC) (% v/v) by broth macro-dilution method and minimum bactericidal concentration (MBC) of different honey and Tamarind paste against <i>S. aureus</i> .	37
Figure 9: Minimum inhibitory concentration (MIC) (% v/v) by broth macro-dilution method and minimum bactericidal concentration (MBC) of different honey and Tamarind paste against <i>Escherichia coli</i> .	38

Figure 10: Minimum inhibitory concentration (MIC) (% v/v) by broth macro-dilution method and minimum bactericidal concentration (MBC) of different honey and Tamarind paste against MRSA.	39
Figure 11: The antibacterial activity of autoclaved and non autoclaved different honey and Tamarind by against <i>Staphylococcus aureus</i> determined by agar diffusion assay.	41
Figure 12: The antibacterial activity of autoclaved and non autoclaved different honey and Tamarind by against <i>E. coli</i> determined by agar diffusion assay.	42
Figure 13: The antibacterial activity of autoclaved and non autoclaved different honey and Tamarind by against MRSA determined by agar diffusion assay.	43
Figure 14. QUANTOFIX® Peroxide 25 test strips.	46
Figure 15: Effect of combining honey and Tamarind against <i>S. aureus</i> determined by agar diffusion assay.	61
Figure 16: Effect of combining honey and Tamarind against <i>E. coli</i> determined by agar diffusion assay.	62
Figure 17: Effect of combining honey and Tamarind against MRSA determined by agar diffusion assay.	63
Figure 18: Effect of different honey type in combination with Manuka honey 24+ (M24), against <i>S. aureus</i> determined by agar diffusion assay.	64
Figure 19: Effect of different honey type in combination with Manuka honey 24+ (M 24+) against <i>E. coli</i> determined by agar diffusion assay.	65
Figure 20: Effect of different honey type in combination with Manuka honey 24+ (M 24+) against MRSA determined by agar diffusion assay.	66

Figure 21: Effect of different honey type in combination with New Zealand Rewarewa Ogilvy's Honey (O) against <i>S. aureus</i> determined by agar diffusion assay.	67
Figure 22: Effect of different honey type in combination with New Zealand Rewarewa Ogilvy's Honey (O) against <i>E. coli</i> determined by agar diffusion assay.	68
Figure 23: Effect of different honey type in combination with New Zealand Rewarewa Ogilvy's Honey (O) against MRSA determined by agar diffusion assay.	69
Figure 24: Effect of UV-B light treatment in combination with different honey types and Tamarind paste against <i>S. aureus</i> .	91
Figure 25: Effect of UV-B light treatment in combination with different honey types and Tamarind paste against <i>E. coli</i> .	92
Figure 26: Effect of UV-B light treatment in combination with different honey types and Tamarind paste against MRSA.	93
Figure 27: The detection of endotoxin in honey samples.	105

# **Chapter 1**

## **General Introduction**

## **1. Introduction**

A number of pathogenic bacteria have recently shown increasing resistance to antibiotics, a fact which has attracted significant attention from healthcare and medical practitioners as well as governments and the media. Several bacteria have been reported to be resistant to antibiotics, including species of Staphylococci, Enterococci and Mycobacteria (Zainol *et al.*, 2013). Such antibiotic-resistant bacteria obviously pose a major threat to public health and as a result, alternative antimicrobial agents are urgently needed.

A range of honeys can inhibit numerous multi-resistant bacteria, including multi-resistant strains of *Pseudomonas aeruginosa* and vancomycin-resistant Enterococci (VRE). Honey possesses a number of advantages over antibiotics: it has never been reported to show any toxicity or side effects, it is locally available and reasonably cheap and bacteria do not develop or pass on resistance to it; all of which make honey a potentially promising alternative to antibiotics (Zainol *et al.*, 2013).

### **1.1. Some important pathogenic bacteria**

Although most bacteria are harmless and often beneficial, many are pathogenic, for example, wound infections are caused by methicillin-resistant *Staphylococcus aureus* (MRSA) and urinary tract infections are



caused by *Escherichia coli*.

### **1.1.1. *Staphylococcus aureus***

*Staphylococcus aureus* is a Gram-positive coccus which occurs in grape-like clusters under the microscope. In 1882, Scottish surgeon Sir Alexander Ogston named the clustered micrococci "staphylococci". Although it is often a pathogen, this bacterium is regarded as a human commensal as it asymptotically colonizes the anterior nares of 30% of non-institutionalized individuals (Rigby and DeLeo, 2011).

*Staphylococcus aureus* is responsible for hospital acquired infections occurring in long-term care facilities throughout the world (Baquero, 1997). It is endemic in hospitals (Tiwari and Sen, 2006), while approximately 30–50 % of individuals carry the organism on the skin and on their mucosal surfaces (Sowash and Uhlemann, 2014). *Staphylococcus aureus* causes a wide spectrum of diseases including carbuncles, food poisoning, wounds infections, bacteremia, necrotizing pneumonia and endocarditis (Holden *et al.*, 2004), skin and soft tissue infections (SSTI) and osteomyelitis (Sowash and Uhlemann, 2014). *Staphylococcus aureus* produces the following enzymes: 1. Catalase (which is able to break down hydrogen-peroxide to water), 2. Coagulase (an enzyme which enables the conversion of fibrinogen to fibrin, this results in clotting of the blood;

fibrin clots may protect the bacterium from phagocytosis). Bacterial resistance to antibiotics has developed rapidly and *S. aureus* has a particularly marked ability to acquire such resistance (Pantosti, 2012). Historically, within a year of the first use of penicillin a number of strains of *S. aureus* had become resistant (Croft *et al.*, 2007). Resistance to penicillin in *S. aureus* strains is attributed to the ability to produce  $\beta$ -lactamase (Baquero, 1997). Methicillin-resistant *Staphylococcus aureus* (MRSA) first appeared in 1961 (Pantosti, 2012) and MRSA is now the main nosocomial bacterium capable of causing infections in hospitals and long-term care centres (Baquero, 1997). MRSA isolated in 1997 from a 64-year-old female was found to be resistant to penicillin, erythromycin, ciprofloxacin, and methicillin although sensitive to rifampicin, fusidic acid, tetracycline, trimethoprim, amikacin and gentamicin (Holden *et al.*, 2004). Now, *S. aureus* is resistant to most antibiotics such as: aminopenicillins, oxacillin, macrolides, aminoglycosides, lincosamides, tetracyclines, quinolones, carbapenems, trimethoprim, cephalosporins, sulphonamides (Baquero, 1997), linezolid and glycopeptide antibiotics such as vancomycin (Holden *et al.*, 2004; Tiwari and Sen, 2006; Choo and Chambers, 2016). Such increased resistance of MRSA to multiple antibiotics (multidrug resistance) obviously makes such infections difficult and sometimes impossible to treat (DeLeo *et al.*, 2010).

There are two types of MRSA, namely community-acquired MRSA (caMRSA) and hospital acquired MRSA (haMRSA). The earliest reported caMRSA infection occurred in the 1980s in Detroit and in the Kimberley region of Western Australia (Sowash and Uhlemann, 2014; DeLeo *et al.*, 2010). HaMRSA infections occur in situations where individuals are at primary risk, including when undergoing surgery. In contrast to haMRSA, caMRSA infections often occur in healthy individuals who are not exposed to such risk factors (DeLeo *et al.*, 2010).

### **1.1.2 *Escherichia coli***

In 1885, Theodor Escherich isolated slender short rods from an infant stool, and the organism was subsequently named after him (Croxen *et al.*, 2013). *Escherichia coli* is a Gram-negative, oxidase-negative, rod-shaped bacterium which can grow under both aerobic and anaerobic conditions and can either be non-motile or motile, with flagella. It is a harmless commensal in the gastrointestinal tract in warm-blooded animals. *Escherichia coli* can, however, be pathogenic by acquiring genes from another source (Croxen *et al.*, 2013). Although the presence of *E. coli* can be important in the gastrointestinal tract, it can also cause a broad range of significant human diseases including diarrhea, urinary tract infections (UTIs), bloodstream and central nervous system diseases (Croxen *et al.*, 2013) such as meningitis and septicemia (Jafari *et al.*, 2012); some strains

can also cause fatal diseases in humans (Jafari *et al.*, 2012).

## **1.2. Resistance to antimicrobial agents**

Antibiotics are chemicals produced by microorganisms which have the ability to inhibit bacteria and other microorganisms. They are selective in their effect on different microorganisms and they vary in chemical structure. Before the discovery of antibiotics, infections were treated with antiseptics, arsenicals, silver compounds and surgical drainage (Zinner, 2007). Penicillin was the first antibiotic discovered by chance by Sir Alexander Fleming while working with *Staphylococcus aureus*. From near the outset, Fleming cautioned that resistance to penicillin might soon appear although it was widely thought that the total control of infectious disease was possible. Since these early days, antibiotics have been improved and at least 17 different classes have now been produced (Croft *et al.*, 2007). Nevertheless, many resistant strains have emerged to varying degrees; some strains became multiple drug resistant (MDR), i.e. being resistant to three or more drugs, a fact which has led to treatments becoming complex and expensive, and also to higher mortality rates (Croft *et al.*, 2007). Antibiotics must exhibit selective toxicity, that is be able to kill pathogens without adversely affecting the host in any major way; they may be bactericidal (capable of killing) or bacteriostatic (capable of inhibiting) and antibiotics that kill bacteria are referred to as being

"bactericidal", while antibiotics which inhibit bacterial growth are termed "bacteriostatic".

Some antibiotics act on Gram-positive bacteria, while others inhibit only Gram-negative ones. The cell wall of Gram-negative bacteria acts as a permeable barrier because it consists of inner and outer membranes; the bacterial cell produces outer membrane proteins (porins) which allow for the movement of essential compounds through the outer membrane. Porins allow molecules, including antibiotics, to diffuse into the cytoplasm and if outer membrane proteins are changed by mutations in relation to their structure, cell wall impermeability will be affected and access of the antimicrobial agents to their active site is likely to be impeded (Mulvey and Simor, 2009). Antibiotics work by interacting with specific bacterial targets, the target site varying depending on the class of antibiotic so that any changes occurring in the target organisms structure are likely to result in the antibiotic being unable to bind to its target and therefore being ineffective (Mulvey and Simor, 2009). Since for the antibiotic to be effective it must reach and bind to its bacterial target site, such binding can inhibit cell-wall synthesis, protein synthesis or nucleic acid replication (Mulvey and Simor, 2009).

Two types of bacterial resistance to antimicrobial agents exist, namely natural and acquired resistances. In the case of the natural form, casual

genetic mutation occurs to the organism conferring on the organism the ability to adapt and resist the action of an antibiotic. In the case of acquired resistance, the organism acquires resistant properties through the transfer of genetic material from other bacteria by transformation or conjugation or transduction (Croft *et al.*, 2007).

Bacteria acquire resistance due to factors such as overuse or misuse of antibiotics in the treatment of disease, and the use of antibiotics in agriculture. However, misuse of antibiotics is not confined to the general public; some physicians for example, prescribe antimicrobials for virus infections although it is well known that antibiotics are ineffective against such infections (Croft *et al.*, 2007).

There are three general mechanisms by which bacterial resistance works:

1. Bacteria produce specific proteins, i.e. enzymes which alter or denature the innate structure of an antibiotic and as a result inactivate it, e.g. beta-lactamases, which hydrolyze the beta-lactam ring of penicillins (Mulvey and Simor, 2009).
2. The second mechanism is efflux using a protein pump efflux which pumps the antibiotic back out of the bacterium (Croft *et al.*, 2007).
3. The third mechanism is to change the target of the antibiotic by chemical modification or mutation so that the antibiotic is unable to bind with the

target (Croft *et al.*, 2007).

*Staphylococcus aureus* was the first bacterium to become resistant to antimicrobial agents, as predicted by Fleming, and the first known resistance of *Staphylococcus aureus* to penicillin occurred in the 1940s. *Neisseria gonorrhoeae* and *Haemophilus influenzae* developed resistance to penicillin in the 1970s. Many other species then developed resistance, such as *E. coli*, *Salmonella sp.*, *Shigella sp.*, *Klebsiella pneumoniae*, *Vibrio cholerae*, *Acinetobacter baumannii* and *Pseudomonas aeruginosa*. In the late 1970s and 1980s, multi-drug resistant *Mycobacterium tuberculosis* and methicillin-resistant *Staphylococcus aureus* (MRSA) were discovered. Today, strains of *Staphylococcus aureus* and Enterococci have become resistant to vancomycin; in addition, *Streptococcus pneumoniae* has developed resistance to penicillin and *Streptococcus* strains have developed resistance to macrolide antibiotics (Croft *et al.*, 2007).

### **1.3. The importance of finding alternatives to antibiotics**

There are many reasons why alternatives to antibiotics are urgently required, notably, of course, the fact that the appearance of resistant bacteria to a varied range of antibiotics continues to increase and the rate of development of new antibiotics has fallen off markedly (Allen *et al.*, 2014). Such problems have led to a reassessment of natural therapeutic agents

such as plants, plant products, and honey. A number of negative aspects of antibiotic treatment exist including:

1. Antibiotics reduce beneficial gut microbes (Allen *et al.*, 2014).
2. Hypersensitivity can result from their use (Manten, 1981).
3. Antibiotics may cause fatal sensitivity and toxicity to humans and this may cause changes in tissues or organs, or their functioning (Manten, 1981).
4. Resistance of pathogens is increasing as a result of overuse (Croft *et al.*, 2007).



#### **1. 4. Apitherapy (Honey therapy)**

Honey is a mixture of nectar which has been collected and processed by honey bees. It is well known for its high nutritional and medicinal value (Alam *et al.*, 2014) and is composed of at least 181 components. It is basically a solution supersaturated with sugars, the most important being fructose (38%) and glucose (31%). It contains about 17.7% moisture; total acidity in honey is about 0.08%; and ash constitutes 0.18%. It also contains numerous minor components including phenolic acids, ascorbic acids, organic acids, amino acids, proteins, flavonoids, carotenoids, and  $\alpha$ -tocopherol, and some enzymes such as glucose oxidase and catalase (Viuda-Martos *et al.*, 2008).

Honey has been used from ancient times in most cultures for both nutritional purposes and in folk medicine (Miorin *et al.*, 2003; Al-Naama, 2009; Deb Mandal and Mandal, 2011; Al- Waili *et al.*, 2012). Historically, honey has been used to treat wounds and prevent infection (Sufya *et al.*, 2014; Deb Mandal and Mandal, 2011). Recently, medical properties of honey have been rediscovered, leading to the development of an alternative medical subject, called apitherapy. Apitherapy involves the medical use of honey and other bee products against many diseases, notably bacterial infections (Deb Mandal and Mandal, 2011). As a result, the use of the antimicrobial activity of honey is increasingly being accepted for use in

modern medicine (Irish *et al.*, 2011) and as a result it is now widely used in hospitals throughout the world to treat topical infections, most notably burns and wounds (Al-Naama, 2009). The antibacterial activity of honey was first recognized scientifically, in 1892, by van Ketel (Al-Naama, 2009). Since then, many researchers have shown that honey is effective against a wide range of bacterial pathogens and food spoilage bacteria (Deb Mandal and Mandal, 2011). Honey has been reported to have an inhibitory effect on many species of bacteria including Gram-positives and Gram-negatives, aerobes and anaerobes. Honey also exhibits antifungal action against some yeasts and filamentous fungal species *Penicillium* and *Aspergillus* (Al-Naama, 2009). Honey has a wide range of properties related to the variety of the components it contains, all of which contribute to its effectiveness as an antimicrobial substance (Irish *et al.*, 2011). Al-Waili *et al.* (2012) notes that honey has been used to treat diarrhea, gastric ulcers, infected leg ulcers, measles, earache, eye diseases, coughs and sore throats (Al-Waili *et al.*, 2012). Numerous reports have appeared of honey being very effective as a dressing for use in treating wounds, skin ulcers, as well as burns and inflammations. Honey-related healing properties speed up the development of new tissue which leads to effective wound healing, an effect which can be ascribed mainly to its antibacterial activity and to the fact that it can accelerate the development of new tissues which aid wound healing. Honey can also heal wounds that fail to respond to

conventional therapy (Deb Mandal and Mandal, 2011).

Honey's antibacterial effect can result from a number of factors: a naturally low pH, osmotic effect and the production of hydrogen peroxide (Alam *et al.*, 2014). Brudzynski and Lannigan (2012) state that "Despite progress in determining the compounds that are involved in growth inhibitory and bactericidal actions of honey, the mechanism underlying these activities remained unknown". The most important characteristic in antimicrobial activity in honey is the possession of two important enzymes, namely bee-derived glucose oxidase and floral-originating catalase. These enzymes determine the level of peroxide activity in honey which lies behind antibacterial potency (Zainol *et al.*, 2013). Hydrogen peroxide is the end product of the glucose oxidase system (Al-Naama, 2009). Small amounts of this antiseptic product, effectively inhibit or kill pathogenic bacteria (Al-Naama, 2009) and control bacterial colonization (Zainol *et al.*, 2013); they also play a role in stimulating the activity of peripheral blood lymphocytes and phagocytes (Al-Naama, 2009). Hydrogen peroxide ( $H_2O_2$ ) is produced when glucose is hydrolyzed by active glucose oxidase to  $H_2O_2$ . In contrast, a high catalase level together with a high antioxidant capacity will destroy  $H_2O_2$  (Zainol *et al.*, 2013). Although, many researchers think that  $H_2O_2$  is the main antibacterial active component of honey, Brudzynski and Lannigan (2012) showed that this molecule is a weak oxidant and needs to

be present in large amounts before it can exert any cytotoxic effect and instead they point to the involvement of phenolics in honey's antibacterial activity. Very high osmotic pressures coupled with high acidity are the two major factors which contribute to the antibacterial properties of honey (Zainol *et al.*, 2013).

The pH of honey is low (between 3.2 and 4.5) due to the presence of gluconic acid formed by the oxidation of glucose to gluconic acid by the enzyme glucose oxidase. However, the low pH alone is significant factor in the inhibition of many pathogenic bacteria (Al-Naama, 2009).

The low water activity of honey also inhibits growth of most bacteria and many yeasts and fungi (Al-Naama, 2009; Irish *et al.*, 2011). In addition, honey can draw moisture out of the environment and cause dehydration of bacteria (Deb Mandal and Mandal, 2011). Zainol *et al.* (2013) consider glucose oxidase to be activated in diluted honey and thereby produce hydrogen peroxide and at this juncture, so the antibacterial activity of honey will slowly change from osmotic- and pH-dependent to peroxide-dependent activity (Zainol *et al.*, 2013).

Some types of honey (e.g. Manuka honey) exhibit antibacterial activity which is unrelated to peroxide, and these types of honey contain numerous non-peroxide constituents that are responsible for their antibacterial action,

which in the main include phenols, peptides which exhibit antibacterial activity, flavonoids, methylglyoxal, methyl syringate, and other trace components (Zainol *et al.*, 2013). Researchers have determined that the main compound responsible for non-peroxide activity in New Zealand Manuka honey is methylglyoxal, which is derived from dihydroxyacetone (Irish *et al.*, 2011; Liu *et al.*, 2015). The main advantage of non-peroxide honey is that it is not destroyed by catalase present in body fluids. Furthermore, it is unaffected by gamma irradiation, allowing this kind of honey needs to be sterilized for medicinal use when used as a topical antimicrobial and as a wound dressing (Irish *et al.*, 2011).

Manuka honey is effective against pathogenic bacteria such as *Staphylococcus aureus* (*S. aureus*) and *Helicobacter pylori* (*H. pylori*) allowing this kind of honey to be used in the treatment of wounds or stomach ulcers (Deb Mandal and Mandal, 2011). In addition, there are other factors which contribute to antimicrobial activity such as the low protein content in honey, high ratio of carbon to nitrogen, a redox potential which is low as the result of presence of large amounts of reducing sugars, the presence or development of an anaerobic environment, and the viscosity of other chemical agents and phytochemicals (Al-Naama, 2009). Some flavonoids and phenolic substances have also been found in honey, including cinnamic acid derivatives (Miorin *et al.*, 2003).

The differences in antimicrobial activity level in honey are associated with their floral source and type of processing used in their production (Irish *et al.*, 2011, Al-Naama, 2009). However, variations in this activity also occur among honeys from within the same floral species (Irish *et al.*, 2011). Such variations result from differences in the presence and activity of enzymes and to other antimicrobial agents being present (e.g. methylglyoxal) (Fig. 1) all of which are derived from the flower (Sufya *et al.*, 2014). Whereas, honeys derived from *Leptospermum* species for example, have non-peroxide antimicrobial activity; such activity has also been found to a lesser extent in a limited number of so-called non-*Leptospermum* honeys (Irish *et al.*, 2011).

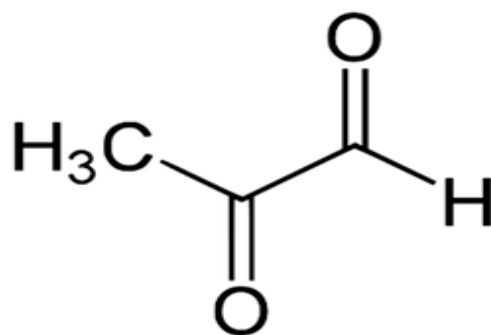

**Figure 1** Chemical structures of the methylglyoxal (MGO) (Alvarez-Suarez *et al.*, 2014).

## 1.5. Tamarind

Tamarind has been used for centuries as a remedy and in cuisines around the world (Gupta *et al.*, 2014). *Tamarindus indica* (known as Tamarind) is a leguminous tree of the family Fabaceae. It is a tropical evergreen tree native to Africa and Southern Asia (Doughari, 2006). The Tamarind tree produces edible, pod-like fruits and Tamarind seeds have been used to treat fevers, diabetes, diarrhea, intestinal infections and also as a laxative (Gupta *et al.*, 2014). The tree leaves contain poly-hydroxylated compounds thus they have a proven hepato-protective activity. Tamarind seeds and the bark have antimicrobial, antifungal and antiseptic effects (Gupta *et al.*, 2014). It is also rich in citric acid, tartaric acid, vitamin c and sugar (Jadhav *et al.*, 2010), and contains alkaloids, tannins, saponins, sesquiterpenes, phlobatamins (Doughari, 2006) and phenolic compounds such as epicatechin, procyanidin B2 and catenin as well as tartaric acid, pectin, mucilage, arabinose, xylose, triterpen, galactose, glucose and uronic acid (Kuru, 2014).

## **1.6. Research objectives**

The overall aim of this study was to find novel and effective honeys and other natural plant products for potential use as alternatives to antibiotics.



**Chapter 2**

**Studies on the Antibacterial Activities  
of a Range of Commercially Available  
Honeys and Tamarind**

## **2.1. Introduction**

Deb Mandal and Mandal (2011) point out that the first written reference to honey was on a Sumerian tablet, dating back to 2100-2000 BC. Honey was also mentioned in the Holy Quran (1400 years ago), the Talmud and in the Old and New Testaments of the Bible (Al-Waili *et al.*, 2012). Recently, honey has been used in medicine against many diseases, notably bacterial infections. Honey has been reported to have an inhibitory effect on many species of bacteria including Gram-positives and Gram-negatives, aerobes and anaerobes (Al-Naama, 2009). The antibacterial properties of honey vary and are associated with a range of different factors such as geographical location of the floral source and the predominant environmental conditions (Irish *et al.*, 2011). Honey possesses a range of components which contribute to its effectiveness against bacteria, some of which are enzymes such as glucose oxidase and catalase which serve as potent antioxidants. Honey works as follows: firstly, the antioxidants present kill bacteria in the wound. Secondly, the antioxidants present reduce reactive oxygen species (ROS) and help in the wound healing process; such effects when combined with antioxidant effects probably contribute to the successful treatment of diabetic wounds (Alam *et al.*, 2014). Manuka honey is used in medicine largely because it promotes acute

and chronic wound healing by the stimulating the host immune system (Liu *et al.*, 2015).

The aim of the work described in this chapter was to explore a broad screening program aimed at finding the most effective antibacterial honeys.

## **2.2 Materials and Methods**

### **2.2.1 Honey samples and Tamarind**

Twelve honey samples were used: Manuka honey 24+ (M24), Manuka honey 15+ (M15), Rata wild honey (R), Beech Forest honey (B), Attiki Firtree Greek honey (A), Greek Pine honey (G), Antibacterial Medical Honey wound gel (W), Thai Sunflower honey (T), Mexican Yucatan honey (Mx), Brazilian Eucalyptus honey (Br), Brezzo Italian Lemon honey (Bz) and New Zealand Rewarewa Ogilvy's Honey (O). Tamarind, molasses and sucralose were also tested. Manuka honey was obtained from Holland and Barrett, Sheffield, UK. The other honeys samples were obtained from local shops, and some honeys were obtained commercially, mainly through Amazon. All honey samples were stored at room temperature until used.

### **2.2.2. Samples preparation**

Different honey samples and Tamarind with concentrations of 100%, 80%, 60%, 50%, 30% and 10% (v/v) were prepared by dissolving samples with sterilized distilled water at 40°C for 30 minutes.

### **2.2.3. Test organisms**

The following test organisms (bacteria) were used: *Escherichia coli*, *Staphylococcus aureus* and methicillin-resistant *Staphylococcus aureus*

(MRSA) strain USA300. The organisms were obtained from the departmental culture collection.

#### **2.2.4. Turbidity standard for inoculum preparation**

The inocula of susceptibility tests were adjusted to  $1.5 \times 10^8$  colony forming units (CFU/ml) which was equivalent to 0.5 McFarland standard. Two isolated colonies of the same morphological type were taken with a sterile loop and inoculated into a tube containing sterilized distilled water then mixed by vortex until homogenized and, turbidity was adjusted using a spectrophotometer at 600 nm. This suspension was used within 30 minutes of preparation (Andrews, 2001).

#### **2.2.5. Agar well diffusion assay**

Concentrations of 100%, 80%, 60%, 50%, 30% and 10% (v/v) were prepared for each type of honey sample and Tamarind; concentrations of 100% of molasses and sucralose were used as a control. The plates were prepared using 20 ml of sterile, Muller-Hinton agar. The surface of the plates was inoculated using a 100  $\mu$ l of 0.5 McFarland standardized inoculum suspension of bacteria and kept for 30 min for absorption to take place. Wells, 8.0 mm in diameter, were cut from the culture media using a sterile, metal cylinder, and then filled with different concentrations of honey and Tamarind. The plates were allowed to stand for 30 min for pre-

diffusion to take place and then incubated at 37°C and observed after 24 hours for clear, circular inhibition zones around the wells; these were then measured.

#### **2.2.6. Minimum inhibitory concentration (MIC)**

Effective antibacterial honeys which were identified in the well diffusion test were selected for use in assessing the minimum inhibitory concentration (MIC) and minimum bactericidal concentration (MBC). MICs were measured by the broth macro-dilution method. A series of 11×100 mm test tubes containing 10 ml of Mueller -Hinton broth medium with honey concentrations which ranged from 3.125% to 100% (v/v) were prepared. 100 µl of bacterial suspension adjusted to 0.5 McFarland standard was then added to each tube. The negative control test tubes received only 10 ml of Mueller-Hinton broth. The tubes were incubated at 37°C with shaking at 250 rpm for 24hrs; the MIC-values were then recorded. MICs were defined as the lowest concentration of honey which showed no visible growth.

#### **2.2.7. Minimum bactericidal concentration (MBC)**

After determining the MICs, 10 µl of bacterial culture was taken from the tubes with no visible growth and plated onto Nutrient Agar. The plates were allowed to stand for 30 min for pre-diffusion to take place and then

incubated overnight at 37°C in order to determine MBC-values. The minimum bactericidal concentration is the lowest concentration which showed no growth on the agar plate.

#### **2.2.8. Autoclaving honey and Tamarind to detect the effectiveness of antimicrobial activity**

Manuka honey 24+ (M24), Manuka honey 15+ (M15), Rata wild honey (R), Beech Forest honey (B), Attiki Firtree Greek honey (A), Greek Pine honey (G), Antibacterial Medical Honey wound gel (W), Thai Sunflower honey (T), Mexican Yucatan honey (Mx), Brazilian Eucalyptus honey (Br), Brezzo Italian Lemon honey (Bz), New Zealand Rewarewa Ogilvy's Honey (O) and Tamarind paste were autoclaved. Plates containing 20 ml of sterile Muller-Hinton agar were prepared. The surface of the plates was inoculated using a 100 µl of 0.5 McFarland standardized inoculum suspension of bacteria. The plates were allowed to stand for 30 min for absorption to take place. Wells, 8.0 mm in diameter, were removed from the culture media using a sterile metal cylinder, then filled with autoclaved honey and Tamarind. The plates were allowed to stand for 30 min for pre-diffusion to take place and then incubated at 37°C and observed after 24 hours for the presence of clear, circular inhibition zones around the wells; these were measured.

### **2.2.9. Determination of pH**

The pH of the honey was determined by dissolving 5ml of honey in 5ml of ultrapure Milli-Q water, stirred until the solution became homogenous. The pH of the final solution was measured with the aid of pH test strips (Oxoid).

### **2.2.10. Peroxide test**

Active honeys were tested for the presence of hydrogen peroxide after they were diluted with sterile distilled water at 50% (v/v). Instructions provided by QUANTOFIX<sup>®</sup> Peroxide 25 were applied. A test strip was dipped for one second in honey solution and read after 15 seconds. The resulting color was compared with the color scale on the container and the result was observed and recorded as (+, ++, +++ or -) depending on the colour reaction. Distilled water was used as a negative control and hydrogen peroxide solution (9% for general, antiseptic purposes) was used as a positive control.

### **2.2.11. Catalase treatment**

Honey samples were tested at a concentration of 50% (v/v) for antibacterial activity against MRSA. Catalase solution was made up by dissolving 2mg of catalase provided by Sigma Aldrich UK in 10 ml of ultrapure, sterile,



distilled water. Different honeys were diluted to 50% (v/v) with sterile, distilled water. Diluted honey (2ml) was mixed with 2ml of bacterial suspension in catalase solution in a sterile tube. 2ml of diluted honey were mixed with a bacterial suspension without catalase as a control. All tubes were incubated at 37°C and shaken for 24hours. The contents of all the tubes were streaked out on Nutrient Agar plate and incubated at 37°C and observed after 24 hours any growth (Chen *et al.*, 2012).

### **2.2.12 Statistical Analysis**

All observations were presented as Mean  $\pm$  SD (Standard Deviation). The data was analysed by IBM crop© 24. One way ANOVA was performed to compare if there was a significant differences of the measured zone of inhibition values of the different honeys against bacteria.  $P \leq 0.05$  was considered as significant. Tukey-Post-Hoc test confirmed the pairwise comparisons.

## 2.3. Results

### 2.3.1. Agar well diffusion assay

Twelve honey samples derived from different regions of the world were tested at different concentrations for their antibacterial activity (Tables 1-3). Seven different types of honey (in 100%) were seen to be remarkably effective against tested bacteria, in the order: New Zealand Rewarewa Ogilvy's Honey, Manuka honey 15+, Manuka honey 24+, Attiki Firtree Greek honey, Brezzo Italian Lemon honey, Antibacterial Medical Honey wound gel and Greek Pine honey were effective against *Staphylococcus aureus* (Table 1). Four types were effective against *E. coli*: Manuka honey 24+, Manuka honey 15+, New Zealand Rewarewa Ogilvy's Honey and Wild Rata honey (Table 2). Manuka honey 24+, New Zealand Rewarewa Ogilvy's Honey, Manuka honey 15+, Attiki Firtree Greek honey and Tamarind were effective on MRSA (Table 3), and there was statistically significant difference between their activities and the activity of other honeys.

In general, as shown in Tables 1, 2 and 3, all tested honeys, except Thai Sunflower honey, Mexican Yucatan honey and Brazilian Eucalyptus honey showed a measurable antibacterial activity against at least one of the tested bacteria with different values. *S. aureus* and MRSA were most sensitive to New Zealand Rewarewa Ogilvy's Honey, Manuka honey 24+ and Manuka

honey 15+ compared to *E. coli*. (Fig. 2- 4). These honeys displayed a potent activity against Gram-positive and moderate activity against Gram-negative bacteria. Manuka honey 15+ showed a potent activity against only *S. aureus* (zone size 20.3mm) (Table 1), and moderate activity against *E. coli* and MRSA (zone size 14mm, 15.3mm, respectively) (Tables 2, 3).

Wild Rata honey showed a moderate activity against *S. aureus* and *E. coli* (Tables 1, 2), but not against MRSA (Table 3); whereas, Antibacterial Medical Honey wound gel displayed a moderate activity against *S. aureus* (Table 1) and MRSA (Table 3), but no activity against *E. coli* (Table 2). Beech Forest honey showed limited inhibition to only *S. aureus* (Table 1) and no inhibition to *E. coli* and MRSA (Tables 2, 3). Attiki Firtree Greek honey, Greek Pine and Brezzo Italian Lemon honeys showed moderate or limited inhibition to the tested bacteria, especially Gram-negative bacteria (Tables 1-3).

Thai Sunflower, Mexican Yucatan and Brazilian Eucalyptus honeys showed no inhibition against the tested bacteria (Tables 1-3). *E. coli* and MRSA showed higher resistance than *S. aureus*, which was resistant to 5 out of 12 (41.6%) of tested honeys (Thai Sunflower, Mexican Yucatan, Brazilian Eucalyptus, Beech Forest and Antibacterial Medical honey wound gel) for *E. coli* and (Thai Sunflower, Mexican Yucatan, Brazilian Eucalyptus, Beech Forest and Wild Rata honey) for MRSA. Whereas *S.*

*aureus* was the less resistance bacterium to 3 out of 12 (25%) of tested honeys (Thai Sunflower, Mexican Yucatan, Brazilian Eucalyptus).

Tamarind was effective against all tested bacteria. There was a statistically significant difference between Tamarind activity and honey activity against *E. coli* ( $P \leq 0.05$ ). Tamarind displayed a potent activity especially against *S. aureus* by 27mm inhibition zone (Fig. 5). Both Molasses and Sucralose were ineffective against all tested bacteria. Artificial sugar products (molasses and sucralose) showed no antimicrobial activities (Tables 1-3). This result confirms that honey activity was not due high sugar content.

Some honey remained active when diluted, while in contrast some totally lost activity when diluted. The results showed that, all honeys lost activity when present at low concentration such as 10% (v/v); some honeys became inactive at more than 10% (v/v) concentration. In contrast, Tamarind was effective at all concentrations, even 10% (v/v).

In some cases, larger inhibition zones were produced by honey following dilution (e.g. Manuka honey 24+, Attiki Firtree Greek, Brezzo Italian Lemon and New Zealand Rewarewa Ogilvy's Honey). The last-named honey exhibited an inhibition zone measuring 17mm in 60% (v/v) compared to a zone of 16.6mm at 100%. Brezzo Italian Lemon showed a zone of 14.3 mm at 50% (v/v) while an 11mm zone was produced at 100% (Table 3). This result could be due to the fact that in undiluted honey, glucose oxidase is inactive and as a result, the hydrogen peroxide effect is

minimized (Zainol *et al.*, 2013).

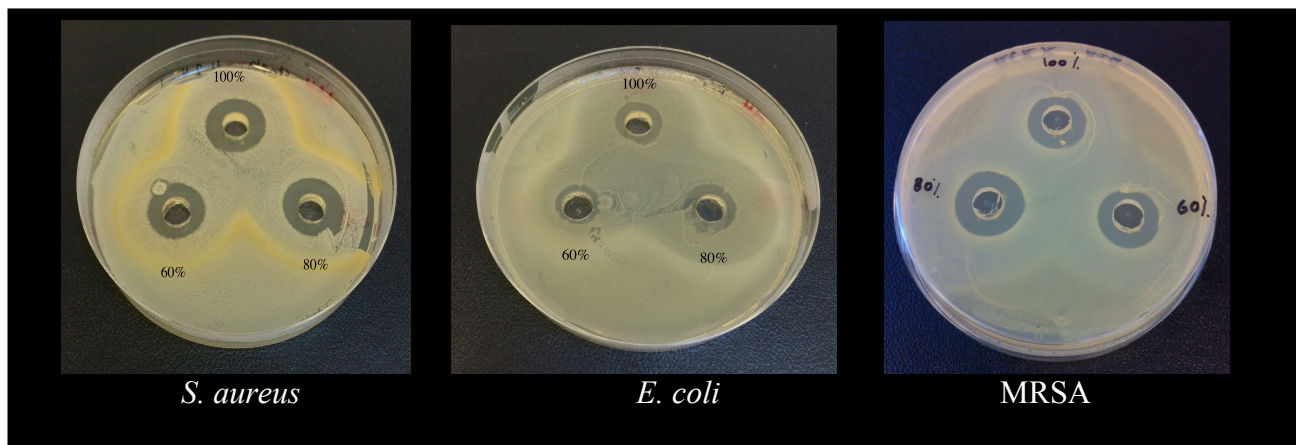

Figure 2. Agar well diffusion assay for Manuka honey 24+ at different concentrations (100%, 80% and 60% v/v); showing zone of inhibition of growth of different bacteria.

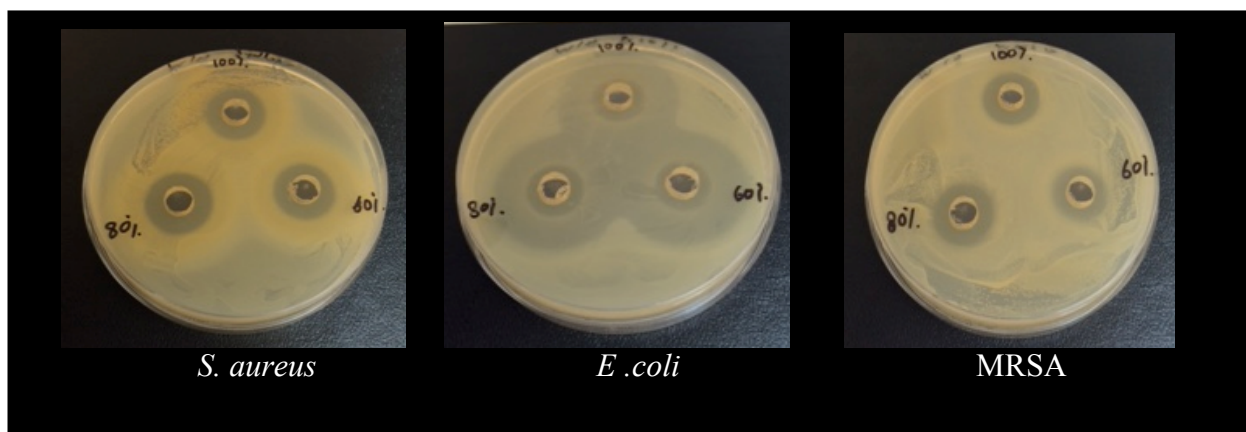

Figure 3. Agar well diffusion assay for Manuka honey 15+ at different concentrations (100%, 80% and 60% v/v); showing zone of inhibition of growth of different bacteria.

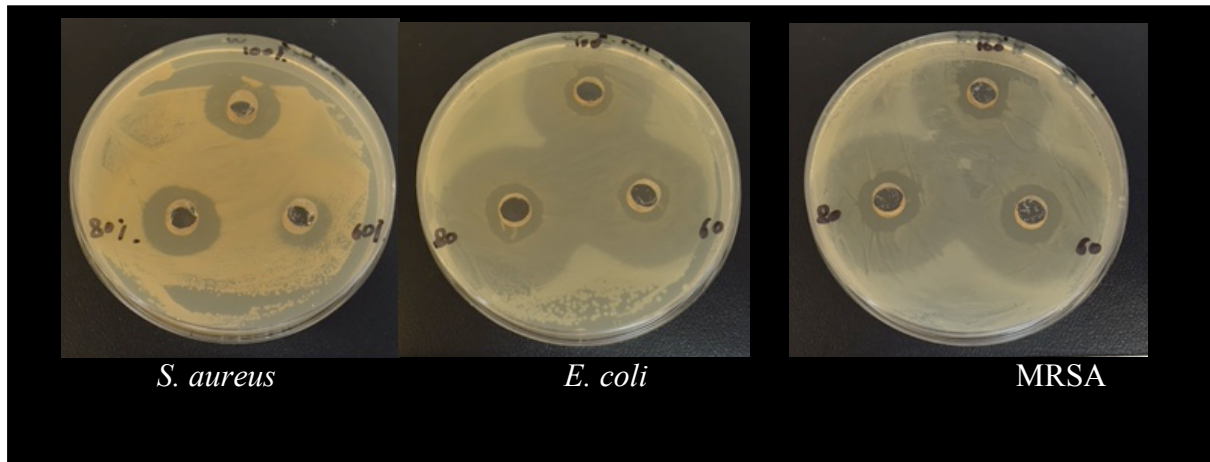

Figure 4. Agar well diffusion assay for New Zealand Rewarewa Ogilvy's Honey at different concentrations (100%, 80% and 60% v/v); showing zone of inhibition of growth of different bacteria.

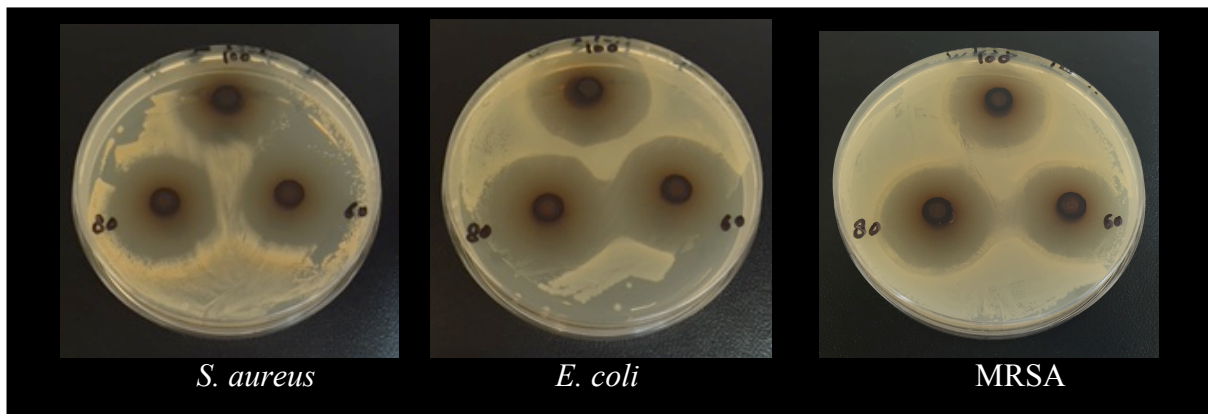

Figure 5. Agar well diffusion assay for Tamarind at different concentrations (100%, 80% and 60% v/v); showing zone of inhibition of growth of different bacteria.

Concentration \ Types of honey	100%	80%	60%	50%	30%	10%
Manuka 24+	19.6 ± 0.57	18.3 ± 0.57	16 ± 1	15.3 ± 0.57	8 ± 0	8 ± 0
Manuka 15+	20.3 ± 0.57	18.6 ± 0.57	18.3 ± 0.57	13.6 ± 0.57	9.3 ± 0.57	8 ± 0
Wild Rata	11 ± 0	9 ± 0	8 ± 0	8 ± 0	8 ± 0	8 ± 0
Beech Forest	10.6 ± 0.57	8 ± 0	8 ± 0	8 ± 0	8 ± 0	8 ± 0
Attiki Firtree Greek	13.6 ± 0.57	14 ± 1	12.3 ± 0.57	8 ± 0	8 ± 0	8 ± 0
Greek Pine	12.3 ± 0.57	11.6 ± 0.57	11.6 ± 0.57	10 ± 1	8 ± 0	8 ± 0
Antibacterial Medical honey wound gel	12.6 ± 0.57	10.6 ± 0.57	10.3 ± 0.57	8 ± 0	8 ± 0	8 ± 0
Thai Sunflower	8 ± 0	8 ± 0	8.3 ± 0.57	8 ± 0	8 ± 0	8 ± 0
Mexican Yucatan	8 ± 0	8 ± 0	8 ± 0	8 ± 0	8 ± 0	8 ± 0
Brazilian Eucalyptus	8 ± 0	8 ± 0	8 ± 0	8 ± 0	8 ± 0	8 ± 0
Brezzo Italian Lemon	13 ± 1	12.3 ± 0.57	8 ± 0	8 ± 0	8 ± 0	8 ± 0
New Zealand Rewarewa Ogilvy **	22.3 ± 0.57	19 ± 1	16.3 ± 0.57	16 ± 1	12.3 ± 0.57	8 ± 0
Tamarind paste*	27 ± 0	27 ± 0	26.6 ± 0.57	26.6 ± 0.57	26.6 ± 0.57	17.3 ± 0.57
Molasses	8 ± 0	8 ± 0	8 ± 0	8 ± 0	8 ± 0	8 ± 0
Sucralose	8 ± 0	8 ± 0	8 ± 0	8 ± 0	8 ± 0	8 ± 0

Table 1. The effect of different concentrations (v/v) of selected honeys from different origins and Tamarind against *S. aureus* determined by the agar well diffusion assay. The values are means of triplicate (including the size of the well (8.0mm)) ± Standard Deviation. The most effective honeys are highlighted in blue.

\* statistically significant difference at  $P \leq 0.05$ . \*\* There was no a statistical significant difference between New Zealand Rewarewa Ogilvy's Honey and Tamarind.

Concentration \ Types of honey	100%	80%	60%	50%	30%	10%
Manuka 24+	14.6 ± 1.15	13.3 ± 0.57	11.3 ± 0.57	9.6 ± 0.57	8 ± 0	8 ± 0
Manuka 15+	14 ± 0	12.6 ± 0.57	12.3 ± 0.57	11.3 ± 0.57	8 ± 0	8 ± 0
Wild Rata	12.3 ± 0.57	8 ± 0	8 ± 0	8 ± 0	8 ± 0	8 ± 0
Beech Forest	8 ± 0	8 ± 0	8 ± 0	8 ± 0	8 ± 0	8 ± 0
Attiki Firtree Greek	9 ± 1	8 ± 0	8 ± 0	8 ± 0	8 ± 0	8 ± 0
Greek Pine	10.6 ± 0.57	8 ± 0	8 ± 0	8 ± 0	8 ± 0	8 ± 0
Antibacterial Medical honey wound gel	8 ± 0	8 ± 0	8 ± 0	8 ± 0	8 ± 0	8 ± 0
Thai Sunflower	8 ± 0	8 ± 0	8 ± 0	8 ± 0	8 ± 0	8 ± 0
Mexican Yucatan	8 ± 0	8 ± 0	8 ± 0	8 ± 0	8 ± 0	8 ± 0
Brazilian Eucalyptus	8 ± 0	8 ± 0	8 ± 0	8 ± 0	8 ± 0	8 ± 0
Brezzo Italian Lemon	11.6 ± 0.57	14.3 ± 0.57	13 ± 1	8 ± 0	8 ± 0	8 ± 0
New Zealand Rewarewa Ogilvy	13.6 ± 0.57	13.6 ± 1	13.6 ± 1.52	13.3 ± 0.57	8 ± 0	8 ± 0
Tamarind *	24 ± 1	24 ± 0	23.6 ± 0.57	23.3 ± 0.57	21 ± 1	8 ± 0
Molasses	8 ± 0	8 ± 0	8 ± 0	8 ± 0	8 ± 0	8 ± 0
Sucralose	8 ± 0	8 ± 0	8 ± 0	8 ± 0	8 ± 0	8 ± 0

Table 2. The effect of different concentrations (v/v) of selected honeys from different origins and Tamarind against *E. coli* determined by the agar well diffusion assay. The values are means of triplicate (including the size of the well (8.0mm)) ± Standard Deviation. The most effective honeys are highlighted in blue.

\* statistically significant difference at  $P \leq 0.05$ .



Concentration \ Types of honey	100%	80%	60%	50%	30%	10%
Manuka 24+ *	17 ± 0	17.3 ± 0.57	15.6 ± 0.57	15 ± 1	8 ± 0	8 ± 0
Manuka 15+ *	15.3 ± 0.57	12 ± 0	12.3 ± 0.57	8.6 ± 0.57	8 ± 0	8 ± 0
Wild Rata	8 ± 0	8 ± 0	8 ± 0	8 ± 0	8 ± 0	8 ± 0
Beech Forest	8 ± 0	8 ± 0	8 ± 0	8 ± 0	8 ± 0	8 ± 0
Attiki Firtree Greek	14.6 ± 0.57	15 ± 1	11.6 ± 0.57	8 ± 0	8 ± 0	8 ± 0
Greek Pine	11 ± 0	11 ± 0	9.3 ± 0.57	8 ± 0	8 ± 0	8 ± 0
Antibacterial Medical honey wound gel	12.3 ± 1.52	11 ± 0	10.6 ± 0.57	8 ± 0	8 ± 0	8 ± 0
Thai Sunflower	8 ± 0	8 ± 0	8 ± 0	8 ± 0	8 ± 0	8 ± 0
Mexican Yucatan	8 ± 0	8 ± 0	8 ± 0	8 ± 0	8 ± 0	8 ± 0
Brazilian Eucalyptus	8 ± 0	8 ± 0	8 ± 0	8 ± 0	8 ± 0	8 ± 0
Brezzo Italian Lemon	11 ± 1	10.6 ± 0.57	8 ± 0	14.3 ± 0.57	8 ± 0	8 ± 0
New Zealand Rewarewa Ogilvy*	16.6 ± 0.57	16.3 ± 0.57	17 ± 0	15 ± 2	14.3 ± 0.57	8 ± 0
Tamarind *	18.6 ± 1.52	17.3 ± 0.57	16.3 ± 0.57	16 ± 0	16 ± 0	8 ± 0
Molasses	8 ± 0	8 ± 0	8 ± 0	8 ± 0	8 ± 0	8 ± 0
Sucralose	8 ± 0	8 ± 0	8 ± 0	8 ± 0	8 ± 0	8 ± 0

Table 3. The effect of different concentrations (v/v) of selected honeys from different origins and Tamarind against MRSA determined by the agar well diffusion assay. The values are means of triplicate (including the size of the well (8.0mm)) ± Standard Deviation. The most effective honeys are highlighted in blue.

\* statistically significant difference at  $P \leq 0.05$ .

### **2.3.2. Minimum inhibitory concentration (MIC) and minimum bactericidal concentration (MBC)**

Nine types of honey: Manuka 24+, Manuka 15+, Wild Rata, Beech Forest, Attiki Firtree Greek, Greek Pine, Antibacterial Medical honey, Brezzo Italian Lemon honey, New Zealand Rewarewa Ogilvy's Honey and Tamarind were chosen for their antibacterial activities to determine their minimum inhibitory concentration (MIC) and minimum bactericidal concentration (MBC) (Fig. 8-10).

Figures 8, 9 and 10 show the lowest minimum inhibitory concentrations (MICs). The MIC for Antibacterial Medical Honey Wound Gel, Manuka 15+ and Tamarind was 6.25% (v/v) against MRSA (Fig. 6 and 10). Also it was 6.25% (v/v) for Tamarind against *E. coli* and for Manuka 15+ against *S. aureus*, whereas the MIC for Manuka 15+ against *E. coli* was 12.5% (v/v). MIC of Manuka 24+ honey against all tested bacteria was 12.5% (v/v) (Fig. 7) and MBC was 60% (v/v). Wild Rata and Beech Forest honeys showed a MIC of 25% (v/v) against all tested bacteria (Fig. 8-10).

The minimum bactericidal concentrations (MBCs) for Manuka 15+ and Tamarind were the lowest values in some tested bacteria such as 12.5% (v/v) for Manuka 15+ against *S. aureus* and *E. coli* (Fig. 8,9); and 6.25% (v/v) for Tamarind against *E. coli* (Fig. 9). The MIC and MBC concentration of Tamarind against *E. coli* was 6.25% (v/v) (Fig. 9). The

lost MBC value against MRSA was for New Zealand Rewarewa Ogilvy's Honey and Tamarind. The following honeys exhibited MBCs of 80% (v/v) or more, which indicated their effectiveness was limited; Greek Pine, Wild Rata, and Beech Forest Honeys (Fig. 8-10).

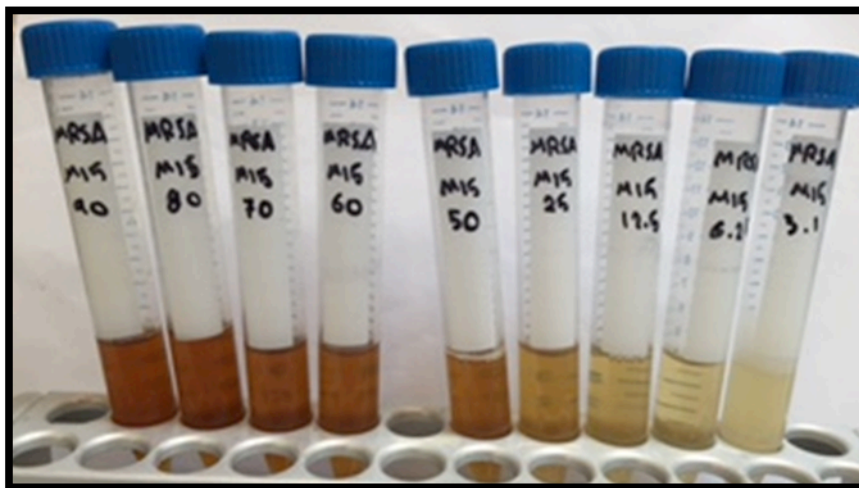

Figure 6. Minimum inhibitory concentration (MIC) of Manuka 15+ honey for MRSA; with no visible growth occurring from 6.25% (v/v).

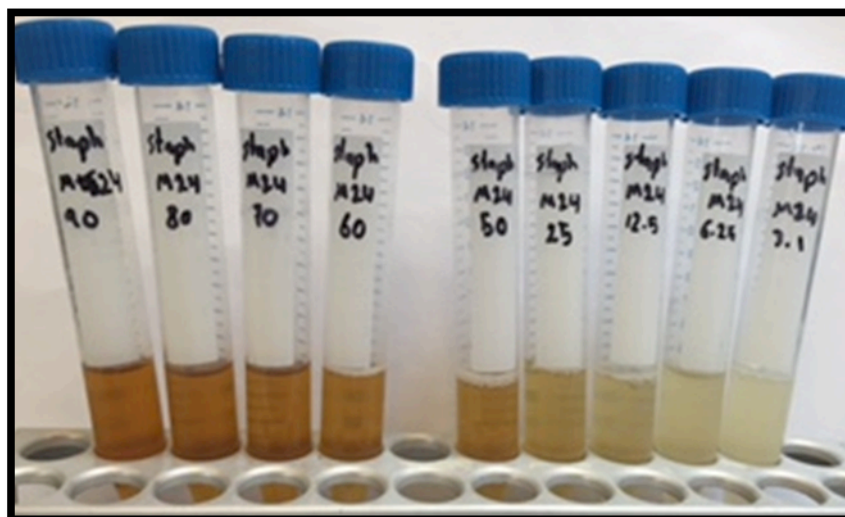

Figure 7. Minimum inhibitory concentration (MIC) of Manuka 24+ honey for *S. aureus*; with no visible growth occurring from 12.5% (v/v).

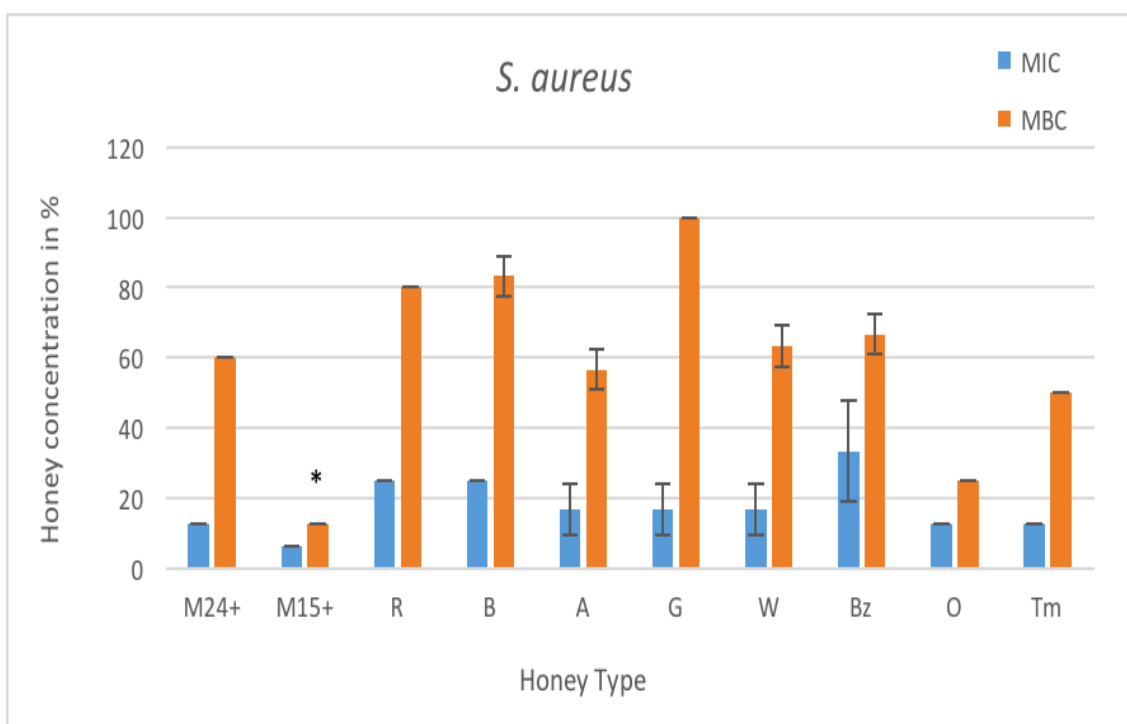

Figure 8. Minimum inhibitory concentration (MIC) (v/v) by the broth macro-dilution method and minimum bactericidal concentration (MBC) of different honeys and Tamarind paste against *Staphylococcus aureus*. The values are represented as means of the triplicate  $\pm$  Standard Deviation.

\* Statistically significant difference at  $P \leq 0.05$ .

(There was no statistically significant difference between M15+ and O in MBC values).

Manuka honey 24+ (M24)

Manuka honey 15+ (M15)

Rata wild (R)

Beech Forest (B)

Attiki Firtree Greek (A)

Antibacterial Medical Honey gel (W)

Greek Pine (G)

Brezzo Italian Lemon (Bz)

New Zealand Rewarewa Ogilvy's (O)

Tamarind paste (Tm)

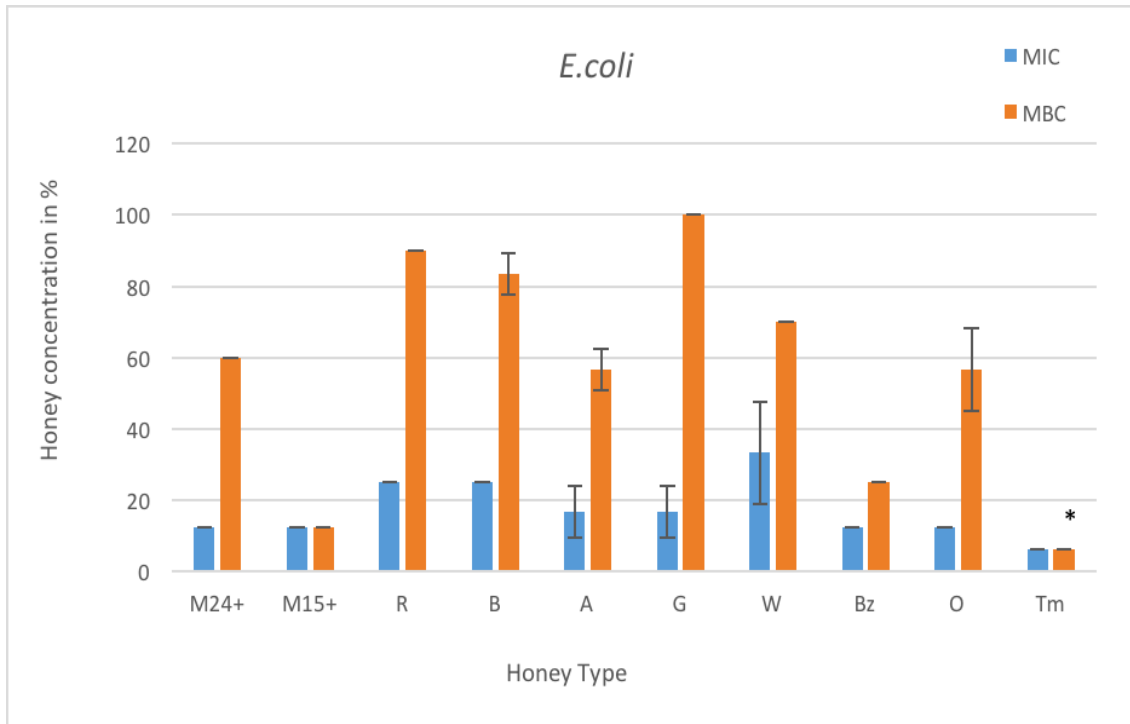

Figure 9. Minimum inhibitory concentration (MIC) (v/v) by the broth macro-dilution method and minimum bactericidal concentration (MBC) of different honeys and Tamarind paste against *Escherichia coli*. The values are represented as means of the triplicate  $\pm$  Standard Deviation.

\* Statistically significant difference at  $P \leq 0.05$ .

(There was no statistically significant difference between Tm and M15+, and Tm and Bz in MBC values).

Manuka honey 24+ (M24)

Manuka honey 15+ (M15)

Rata wild (R)

Beech Forest (B)

Attiki Firtree Greek (A)

Antibacterial Medical Honey gel (W)

Greek Pine (G)

Brezzo Italian Lemon (Bz)

New Zealand Rewarewa Ogilvy's (O)

Tamarind paste (Tm)

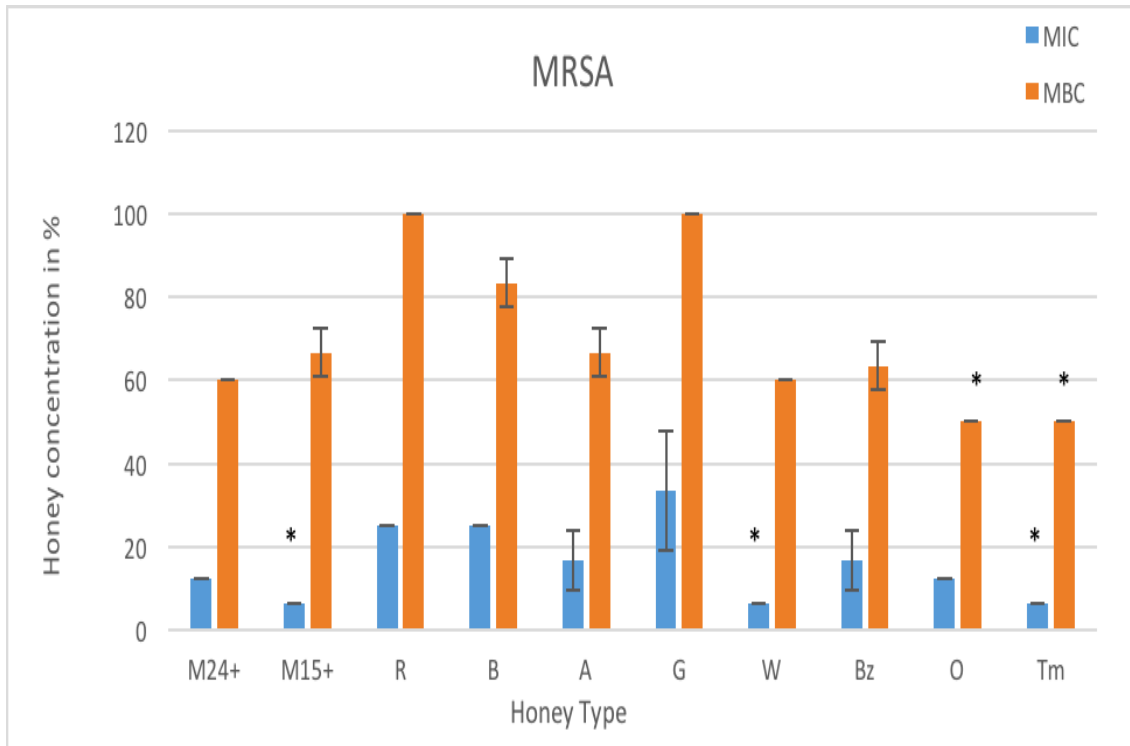

Figure10. Minimum inhibitory concentration (MIC) (v/v) by the broth macro-dilution method and minimum bactericidal concentration (MBC) of different honeys and Tamarind paste against MRSA. The values are represented as means of the triplicate  $\pm$  Standard Deviation.

\* Statistically significant difference at  $P \leq 0.05$ .

(There was no statistically significant difference between Tm, M15+ and W in compare with M24+, A, Bz and O in MIC values; and between Tm and O in compare with M24+, A, W and Bz in MBC values).

Manuka honey 24+ (M24)

Manuka honey 15+ (M15)

Rata wild (R)

Beech Forest (B)

Attiki Firtree Greek (A)

Antibacterial Medical Honey gel (W)

Greek Pine (G)

Brezzo Italian Lemon (Bz)

New Zealand Rewarewa Ogilvy's(O)

Tamarind paste (Tm)

### **2.3.3. The effect of autoclaving of honey and Tamarind to detect the effectiveness of antimicrobial activity**

As shown in Fig. 11, 12 and 13, some types of honey were less effective after autoclaving against all tested bacteria compared with non autoclaved honey. Some honeys such as Rata wild honey (R), Beech Forest honey (B) and Greek Pine honey (G) with MRSA, showed no significant differences. This suggests that antibacterial factors in some honey are denatured by heat, and this is important in relation to use of honey in wound treatment where honeys need to be sterilized before use by gamma radiation (Bansal *et al.*, 2005). In contrast, autoclaved Tamarind was slightly more effective than when non autoclaved, therefore, Tamarind can be sterilized before use by autoclaving.

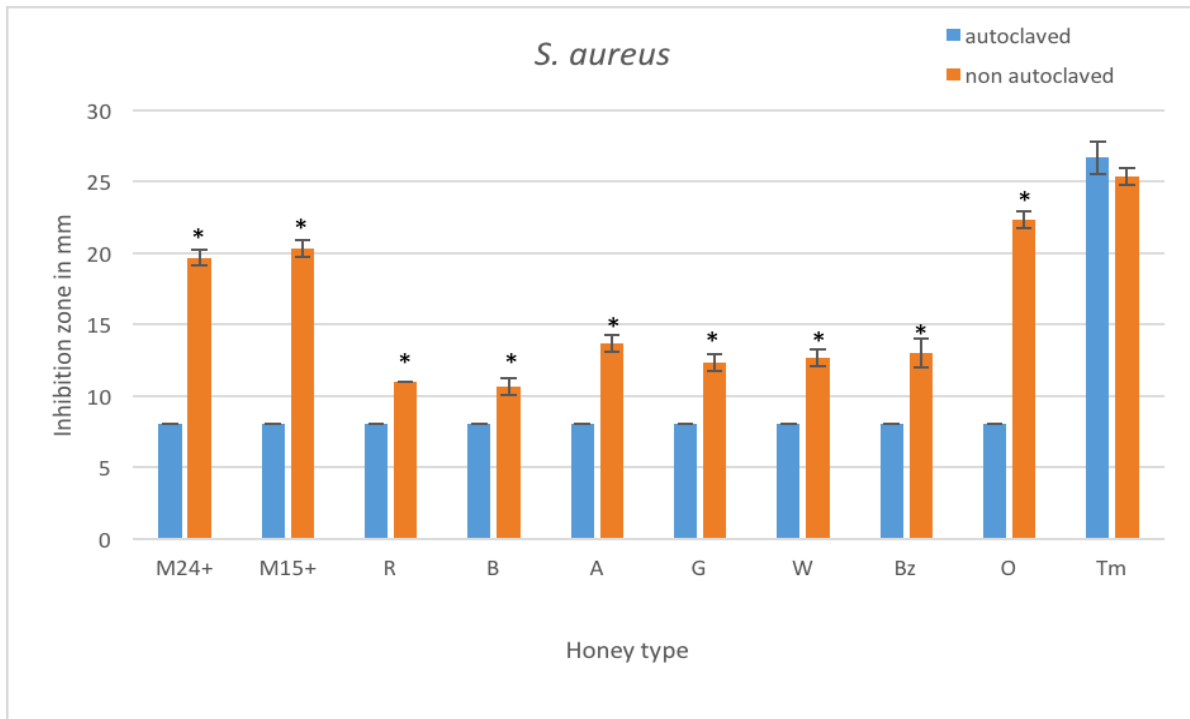

Figure 11. The antibacterial activity of autoclaved and non autoclaved different honeys and Tamarind against *Staphylococcus aureus* determined by the agar well diffusion assay. The values are means of triplicate (including the size of the well (8.0mm))  $\pm$  Standard Deviation.

\* Statistically significant difference at  $P \leq 0.05$  between autoclaved and non autoclaved group except Tm value.

Manuka honey 24+ (M24)

Manuka honey 15+ (M15)

Rata wild (R)

Beech Forest (B)

Attiki Firtree Greek (A)

Antibacterial Medical Honey gel (W)

Greek Pine (G)

Brezzo Italian Lemon (Bz)

New Zealand Rewarewa Ogilvy's(O)

Tamarind paste (Tm)



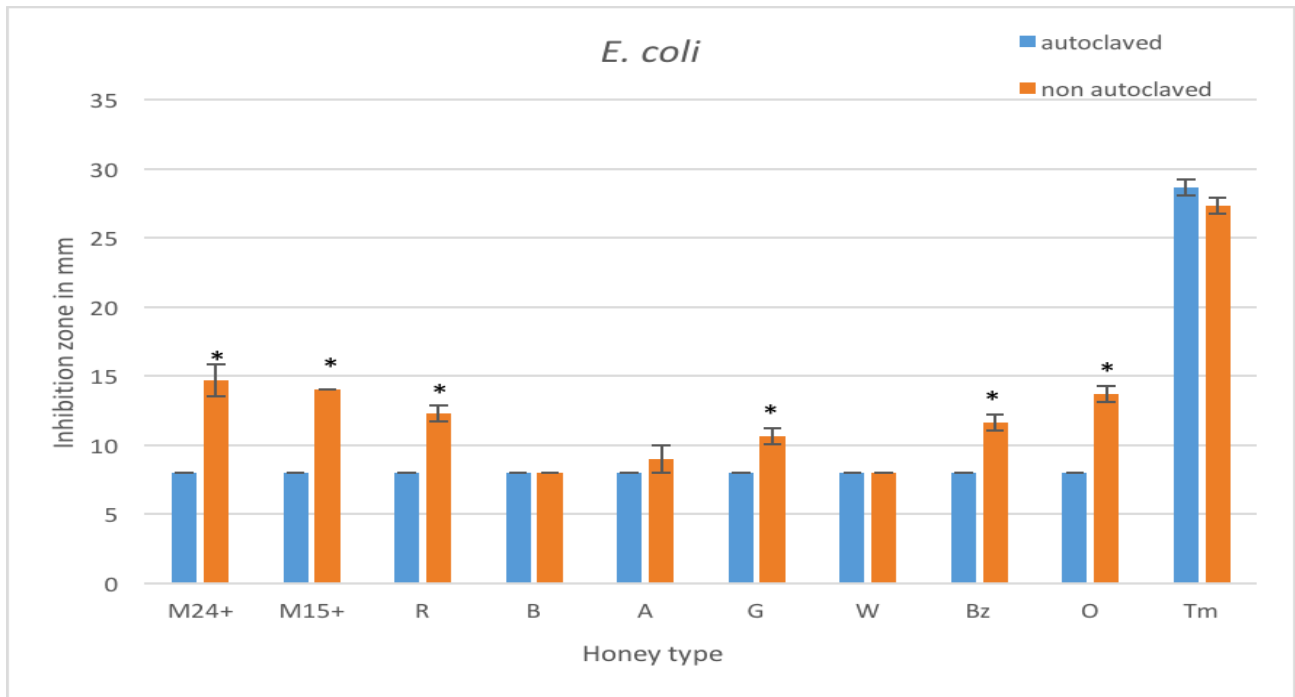

Figure 12. The antibacterial activity of autoclaved and non autoclaved different honeys and Tamarind against *E. coli* determined by the agar well diffusion assay. The values are means of triplicate (including the size of the well (8.0mm))  $\pm$  Standard Deviation.

\* Statistically significant difference at  $P \leq 0.05$  between autoclaved and non autoclaved values.

Manuka honey 24+ (M24)

Manuka honey 15+ (M15)

Rata wild (R)

Beech Forest (B)

Attiki Firtree Greek (A)

Antibacterial Medical Honey gel (W)

Greek Pine (G)

Brezzo Italian Lemon (Bz)

New Zealand Rewarewa Ogilvy's (O)

Tamarind paste (Tm)

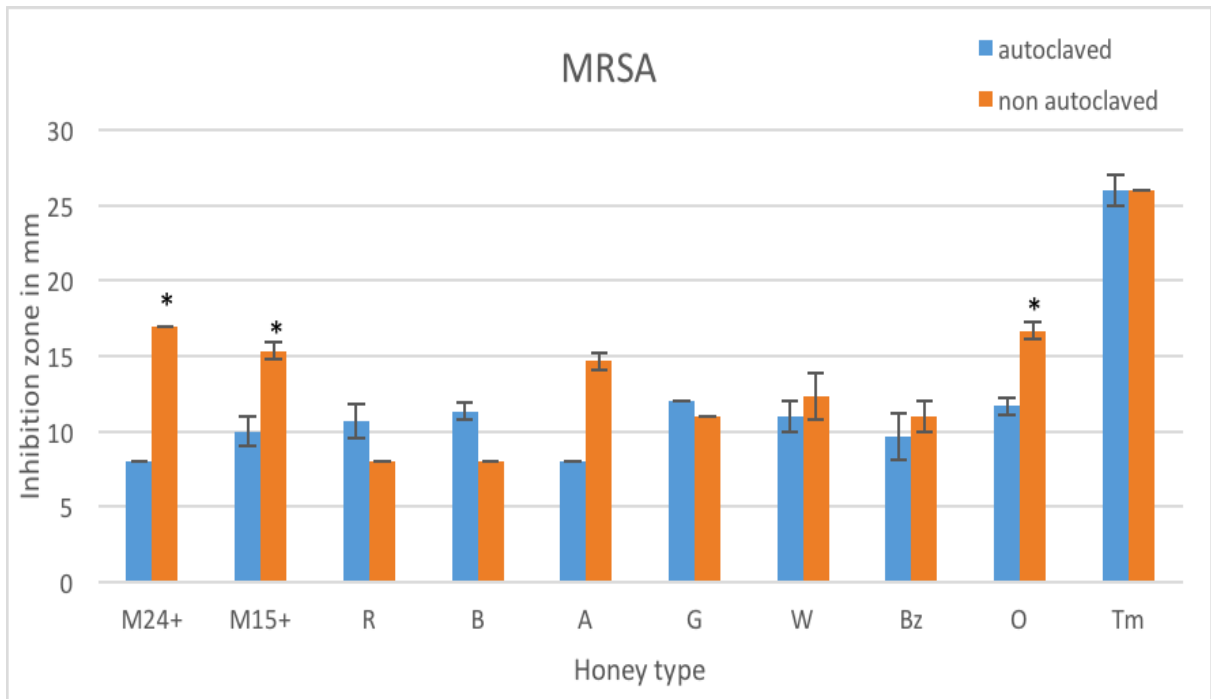

Figure 13. The antibacterial activity of autoclaved and non autoclaved different honeys and Tamarind against MRSA determined by the agar well diffusion assay. The values are means of triplicate (including the size of the well (8.0mm))  $\pm$  Standard Deviation.

\* Statistically significant difference at  $P \leq 0.05$  between autoclaved and non autoclaved values.

Manuka honey 24+ (M24)

Manuka honey 15+ (M15)

Rata wild (R)

Beech Forest (B)

Attiki Firtree Greek (A)

Antibacterial Medical Honey gel (W)

Greek Pine (G)

Brezzo Italian Lemon (Bz)

New Zealand Rewarewa Ogilvy's (O)

Tamarind paste (Tm)

### 2.3.4. Determination of pH

The results of the pH of the tested honeys (Table 4) showed that all honeys have acidic pH ranging between 3.5 and 4.5; the expected pH range for honey is between 3.2 and 4.5 (Alam *et al.*, 2014). The pH of Tamarind was 2.5 which fell within the pH range normally expected for Tamarind, being between 2 and 5 (Nonga, 2014).

Type of Honey	Result
Manuka honey 24+	4.5
Manuka honey 15+	4
Wild Rata	4
Beech Forest	4.5
Attiki Firtree Greek	4
Greek Pine	4
Antibacterial Medical honey wound gel	3.5
Brezzo Italian Lemon	3.5
New Zealand Rewarewa Ogilvy's	4.5
Tamarind	2.5

Table 4. pH of honeys and Tamarind.

### **2.3.5. Determination of the role of hydrogen peroxide in the antibacterial activity of honeys using the peroxidase strip test**

The results (Table 5) show that Manuka honey +24, Manuka honey +15, which are produced from the botanical source *Leptospermum scoparium*, and Antibacterial Medical honey wound gel were non-peroxide honeys. While, Wild Rata honey, Brezzo Italian Lemon honey and New Zealand Rewarewa Ogilvy's honey showed marked peroxide activity when diluted with water, followed by Beech Forest honey, Attiki Firtree Greek honey and Greek Pine honey which showed a low peroxide content. The antibacterial activity of Wild Rata honey, Brezzo Italian Lemon honey and New Zealand Rewarewa Ogilvy's honey is clearly due to their hydrogen peroxide content which is liberated to varying extents from honey after being diluted with water (Zainol *et al.*, 2013). While in complex honeys which do not in the main rely upon hydrogen peroxide for their antimicrobial activity (a perfect example being of course provided by Manuka honey), but are dependent on the presence of more complex antibacterial agents which are derived from plants which are visited by the bee; an obvious example being methylglyoxal.



Figure 14. QUANTOFIX<sup>®</sup> Peroxide 25 test strips.

Type of Honey	Result
Manuka honey 24+	–
Manuka honey 15+	–
Wild Rata honey	++
Beech Forest honey	+
Attiki Firtree Greek honey	+
Greek Pine honey	+
Antibacterial Medical honey wound gel	–
Brezzo Italian Lemon honey	++
New Zealand Rewarewa Ogilvy	++
Negative control	–
Positive control	+++

Table 5. Hydrogen peroxide content of honeys.

### **2.3.6. Catalase treatment**

In attempts to determine if antibacterial activity of tested honey was due to the activity of hydrogen peroxide or due to another factor, eight different origin honeys were evaluated for their antibacterial activity against MRSA. In order to determine non-peroxide activity, tested honeys were diluted in a catalase solution to breakdown (and inactivate) the inherent hydrogen peroxide. The two Manuka honeys (24+ and 15+) showed a negative response to catalase where bacteria could not grow. Whereas, Wild Rata honey, Beech Forest honey, Greek Pine honey, Brezzo Italian Lemon honey, Attiki Firtree Greek honey and Ogilvy's New Zealand honey were deactivated by catalase and bacteria could grow in the presence of the honey Table 6. These results show that the activity of the two Manuka honeys (24+ and 15+) did not depend on the presence of hydrogen peroxide; and they are able to retain antibacterial potency even after removal of the peroxide component from the diluted honey. In this case any antibacterial activity of the honey depends upon non-peroxide components which support its activity, these include phenolic compounds, flavonoids, antibacterial peptides, methylglyoxal.

Honey type	Honey without catalase	Honey with catalase
Manuka honey 24+	–	–
Manuka honey 15+	–	–
Wild Rata	–	++
Beech Forest	–	+
Greek Pine	–	+
Attiki Firtree Greek	–	+
Brezzo Italian Lemon	–	+
New Zealand Rewarewa Ogilvy	–	++

Table 6. The antibacterial activity of 50% (v/v) honey treated with catalase solution compared with non treated 50% (v/v) honey, the assay carried out against MRSA, expressed as:

+ means the antibacterial activity of honey was lost in presence of catalase. (there was bacterial growth).

– means no effect of catalase on antibacterial activity of honey (there was no bacterial growth)

## 2.4. Discussion

Of the twelve types of honey, nine were remarkably effective against tested bacteria. A number of factors may affect the antibacterial activity levels of the various honeys, such as the seasonal and botanical source, the geographical location, climate, harvesting, processing and honey storage conditions (Deb Mandal and Mandal, 2011). In addition, some factors are bee-related, such as bee-age, type of species or colony health (Irish *et al.*, 2011). Some honeys lose part of their antibacterial properties as a result of poor storage conditions, a fact which may explain why the same honey can exhibit varying antibacterial effects.

Gram-negative bacteria were seen to be more resistant to most honey types. This result agrees with the results reported by Zainol *et al.* (2013) who showed that Gram-positive bacteria are more susceptible to the inhibitory action of Malaysian honey than Gram-negative.

The effectiveness of some types of honey is due to hydrogen peroxide such as Wild Rata, New Zealand Rewarewa Ogilvy's Honey, Brezzo Italian Lemon honey, while the effectiveness of other types (which have non-peroxide activity) such as Manuka type is attributed to non-peroxide components which have antibacterial actions. These components include phenolic compounds, antibacterial peptides, flavonoids, methylglyoxal, methyl syringate such as are found in Manuka types (Zainol *et al.*, 2013). Some researchers suggest that methylglyoxal, which is derived from



dihydroxyacetone, is the main component responsible for non-peroxide activity in New Zealand Manuka honey (Irish *et al.*, 2011). Because of the high reactivity of methylglyoxal with nucleic acids and proteins (Thornalley, 1996), DNA and protein synthesis may both be reduced by reacting with guanine residues in DNA and in RNA, respectively (Hayashi *et al.*, 2014).

## **2.5. Conclusion**

Antibiotics are valuable and important agents in the treatment of infectious diseases and are clearly a limited resource which must be conserved. Resistance of bacteria to antibiotics is rapidly increasing and this is causing a worldwide health and financial crisis. Consequently, honey and Tamarind may provide a much needed alternative. The results presented here show how some types of honey have a wide spectrum of antibacterial effectiveness against Gram-positive and Gram-negative bacteria. Of these, New Zealand Rewarewa Ogilvy's Honey exhibited antibacterial activity equal to, or in some cases exceeding, that of Manuka honey, which is the main honey type used in the medical treatment of wounds. This suggests that this type of honey could replace Manuka honey in medicine. Tamarind paste was also an effective antibacterial agent and may prove to be even more effective than honeys in wound treatment.

## **Chapter 3**

### **The Effect of Combining Two honeys**

**Together, Honey Mixed with**

**Tamarind and Combining Honey**

**with Antibiotics**

### 3.1. Introduction

The appearance of methicillin-resistant *Staphylococcus aureus* (MRSA) has become a source of major concern to public health globally (Jenkins and Cooper, 2012a). It is an important nosocomial pathogen and has become the cause of chronic wounds such as diabetic foot ulcers, venous leg ulcers, and pressure ulcers (Liu *et al.*, 2015). MRSA causes serious infections which are associated with high mortality rates, especially in people who suffer from weakened immune systems (Jenkins and Cooper, 2012a). These infections are difficult to treat due to increasing antibiotic resistance to drugs (Müller *et al.*, 2013). With a slow development of antimicrobial agents, alternatives must be found (Jenkins and Cooper, 2012a).

Honey has been used for thousands of years as a traditional remedy for wounds. In modern medicine also, honey is gaining popularity and is used in wound treatment in the form of ointments, gels and wound dressings (Jenkins and Cooper, 2012b). Honey has broad-spectrum antibacterial activity against a wide range of microorganisms. New Zealand Manuka honey is the main honey in clinical use today (Liu *et al.*, 2015). It can eradicate bacteria from colonized wounds. *In vitro* studies showed that Manuka honey can inhibit MRSA by interrupting cell division (Jenkins and Cooper, 2012b). In contrast to antibiotics, bacteria do not develop resistance to Manuka honey, even with usage of sub-inhibitory

concentrations. This may be due to the presence of numerous antibacterial properties in honey that impede bacterial responses. Therefore, honey offers a promising alternative antibacterial agent when used either as a single agent or in combination with antibiotics (Liu *et al.*, 2015).

MRSA is resistant to  $\beta$ -lactam antibiotics; however, there is evidence that some combinations, such as tea extracts and  $\beta$ -lactam antibiotics, can restore methicillin susceptibility. Combination treatment is a strategic method to reduce the emergence of resistance to antimicrobial agents since the use of two or more antimicrobials with different modes of action leads to a decreased probability of bacteria survival (Jenkins and Cooper, 2012b) and thereby improves the efficacy of antibiotics and enhances their value, especially when long-term antibiotic therapy is applied (Liu *et al.*, 2015; Müller *et al.*, 2013).

The advantages of combination treatments are a decrease in treatment costs and a reduction in the antibiotic dose and therefore a reduction in possible drug side effects (Liu *et al.*, 2015; Müller *et al.*, 2013). The last named author stated that "A combination of the antimicrobial properties of clinically approved antibiotics and the antibacterial activity of Manuka honey could lead to a new spectrum of antimicrobials that have the potential to prevent the emergence of resistant bacterial strains, providing broad-spectrum coverage and consequently improving therapeutic efficiency" (Müller *et al.*, 2013). The first synergistic action was reported

in 1998, between an Indian honey and antibiotics against multidrug resistant bacteria (Jenkins and Cooper, 2012a). Synergistic activity between tetracycline, oxacillin, imipenem, rifampicin or mupirocin with Manuka honey against MRSA has been reported (Liu *et al.*, 2015). The result of gentamicin, amikacin and ceftazidime in combination with honey, showed that the combinations act synergistically to inhibit growth of strains of *P. aeruginosa* but not *Klebsiella* strains (Jenkins and Cooper, 2012a). According to Liu *et al.* (2015), any synergistic activity does not simply cause a general weakness for bacteria cells, but is also able to target them more specifically (Liu *et al.*, 2015). A study by Mukherjee *et al.* (2011) showed that the synergistic action between piperacillin, carbenicillin or amikacin with methylglyoxal was confirmed against MDR isolates of *P. aeruginosa* (Mukherjee *et al.*, 2011).

The combination of two drugs can result in an inhibitory effect which is larger or smaller than that of a single drug, a finding which is the result of a response to synergistic or antagonistic interactions between both drugs (Torella *et al.*, 2010). In the synergistic case, the effect of combinations of antimicrobials is significantly greater than the sum of each drug alone (Liu *et al.*, 2015).

In this study, the investigation of honey synergy has been expanded to include different honey types in combination with six antibiotics: tetracycline, vancomycin, erythromycin, ampicillin, chloramphenicol and

gentamycin, against *S. aureus*, MRSA and *E. coli*.

The aim of the work described in this chapter was to investigate whether combinations of different honeys or honey with Tamarind, and the combinations of honey or Tamarind with different antibiotics act positively to increase the susceptibility of the tested bacteria to selected antibiotics.

## **3.2. Materials and Methods**

### **3.2.1 Honey samples and Tamarind**

Nine honey samples were used: Manuka honey 24+ (M24), Manuka honey 15+ (M15), Rata wild honey (R), Beech Forest honey (B), Attiki Firtree Greek honey (A), Greek Pine honey (G), Antibacterial Medical Honey wound gel (W), Brezzo Italian Lemon honey (Bz) and New Zealand Rewarewa Ogilvy's Honey (O). Also Tamarind paste was used.

### **3.2.2. Sample preparation**

A range of honey sample and Tamarind was used at a concentration of 100%.

### **3.2.3. Test organisms**

The following test organisms (bacteria) were used: *Escherichia coli*, *Staphylococcus aureus* and methicillin-resistant *Staphylococcus aureus* (MRSA) strain USA300.

### **3.2.4. Turbidity standard for inoculum preparation**

The inocula was adjusted to  $1.5 \times 10^8$  colony forming units (CFU/ml) which was equivalent to 0.5 McFarland standard. Two isolated colonies of the same morphological type were taken with a sterile loop and transferred into a tube containing sterilized distilled water and then mixed by vortex

until homogenized and, turbidity was adjusted using a spectrophotometer at 600 nm. This suspension was used within 30 minutes of preparation (Andrews, 2001).

### **3.2.5. The effect of combining two honeys together and honey mixed with Tamarind**

The agar well diffusion method was used to assess the effect of combining two honeys together and honey mixed with Tamarind. Known effective honeys from the above tests were used: Manuka honey 24+ (M24), Manuka honey 15+ (M15), Rata wild honey (R), Beech Forest honey (B), Attiki Firtree Greek honey (A), Greek Pine honey (G), Antibacterial Medical Honey wound gel (W), Brezzo Italian Lemon honey (Bz) and New Zealand Rewarewa Ogilvy's honey (O). Equal proportions of the most effective honey (Manuka 24+ and New Zealand Rewarewa Ogilvy's honey) were mixed with other honey types. Tamarind was also mixed with all effective honeys. The bacterial suspension was adjusted to 0.5 McFarland and a 100 µl of inoculum suspension inoculated onto Müller-Hinton agar plate surface kept for 30 min for absorption to take place. Wells, 8.0mm in diameter, were cut from the culture media using a sterile, metal cylinder, and then filled with different mixtures of honeys or honey with Tamarind. The plates were allowed to stand for 30 min for pre-diffusion to take place and then incubated at 37°C and observed after 24 hours for clear, circular inhibition zones around the wells;



these were measured. 50% (v/v) of each individual honey used as a control.

### **3.2.6. The effect of combining honey with antibiotics**

Antibiotic susceptibility was determined using disc diffusion test. Antimicrobial Susceptibility Discs (Tetracycline 10 µg, Chloramphenicol 30µg, Gentamicin 30µg, Ampicillin 10µg, Vancomycin 30µg and Erythromycin 15µg) were purchased from Fisher Scientific (Oxoid™). In order to investigate synergistic interaction between antibiotics and honeys or Tamarind paste against *S. aureus*, MRSA and *E. coli*, the agar diffusion method was used. The bacterial suspension was adjusted to 0.5 McFarland and a 100 µl of inoculum suspension was inoculated onto the Müller-Hinton agar plate surface and kept for 30 min for absorption to take place. Each antibiotic disc was then placed onto the agar surface and 50 µl of 100% honey or Tamarind added to the discs. To compare the combined results with the individual honey and Tamarind results, discs were made using dry, sterile filter papers (with identical thickness and size, 6 mm, as the antibiotic discs) immersed in honey and Tamarind. Antibiotics susceptibility was determined using the disc diffusion test as a control. Culture plates were incubated at 37°C and observed after 24 hours for the presence of clear, circular inhibition zones around the discs; these were measured. All experiments were done with three biological replicates and mean values were presented here.

### **3.2.7 Statistical Analysis**

All observations were presented as Mean  $\pm$  SD (Standard Deviation). The data was analysed by IBM crop© 24. One way ANOVA was performed to compare if there was a significant differences of the measured zone of inhibition values of combinations of antibiotics and honey or Tamarind against bacteria.  $P \leq 0.05$  was considered as significant. Tukey-Post-Hoc test confirmed the pairwise comparisons.

### **3.3. Results**

#### **3.3.1. The effect of combining two honeys together and honey mixed with Tamarind; comparison of the results with those of the effect of individual honey and Tamarind**

The results against *S. aureus* and *E. coli* showed that the inhibition zones were significantly increased after mixing each different honey with Tamarind, especially for honeys with limited inhibition zone when tested individually, such as Wild Rata honey, Beech Forest honey, Attiki Firtree Greek honey, Greek Pine honey, Antibacterial Medical honey wound gel, Brezzo Italian Lemon honey; however, they were still smaller than the inhibition zones of individual Tamarind (Fig. 15 and 16). The result against MRSA shows that the inhibition zones for all combinations of honeys were larger than those for individual honey zone and the individual Tamarind (Fig. 17).

Figures 18, 19 and 20 show that generally the inhibition zones of honeys combined with Manuka 24+ against all tested bacteria were smaller than the zones of Manuka 24+ alone; except in some cases such as the results for *S. aureus* which show that mixing Manuka 15+ with Manuka 24+ gave approximately the same inhibition zone of Manuka 24+ alone, and combination of Antibacterial Medical honey wound gel with Manuka 24+

also gave approximately the same inhibition zone as Manuka 24+ alone (Fig. 18). Other cases such as the results for *E. coli* where the inhibition zones of Manuka 15+, Attiki Firtree Greek honey or Brezzo Italian Lemon honey combined with Manuka 24+ were larger than each of them alone. For MRSA, the inhibition zones of Antibacterial Medical honey combined with Manuka 24+ were larger than each of them alone (Fig. 20).

In the case of combining New Zealand Rewarewa Ogilvy's honey with other honey types (Fig. 21- 23), the zones caused by New Zealand Rewarewa Ogilvy's honey were greater than the combined zones against all tested bacteria except Antibacterial Medical honey wound gel against *S. aureus* (Fig. 21); Manuka 15+ and Antibacterial Medical honey wound gel against MRSA (Fig. 23).

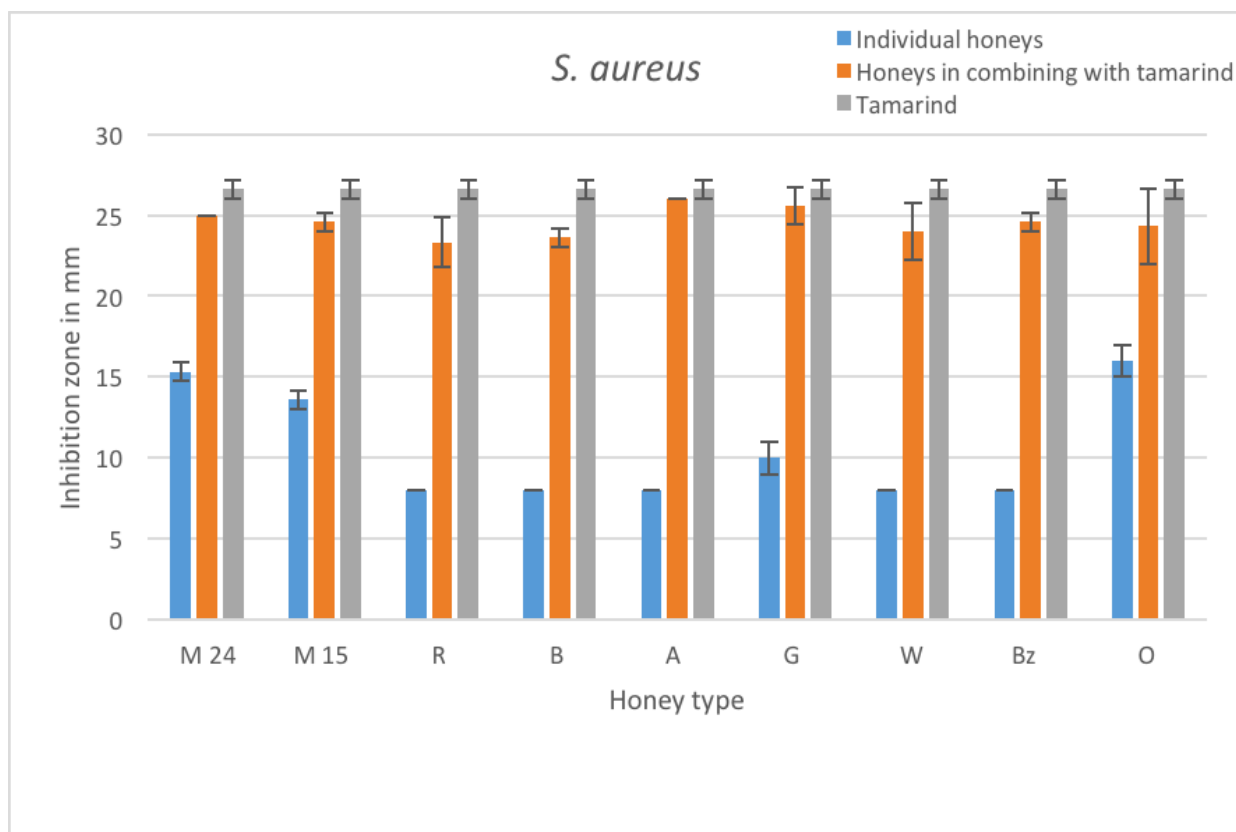

Figure 15. Effect of combining honey and Tamarind against *S. aureus* determined by the agar well diffusion assay. The values are means of triplicates (including the size of the well (8.0mm))  $\pm$  Standard Deviation.

Manuka honey 24+ (M24)

Manuka honey 15+ (M15)

Rata wild (R)

Beech Forest (B)

Attiki Firtree Greek (A)

Antibacterial Medical Honey gel (W)

Greek Pine (G)

Brezzo Italian Lemon (Bz)

New Zealand Rewarewa Ogilvy's (O)

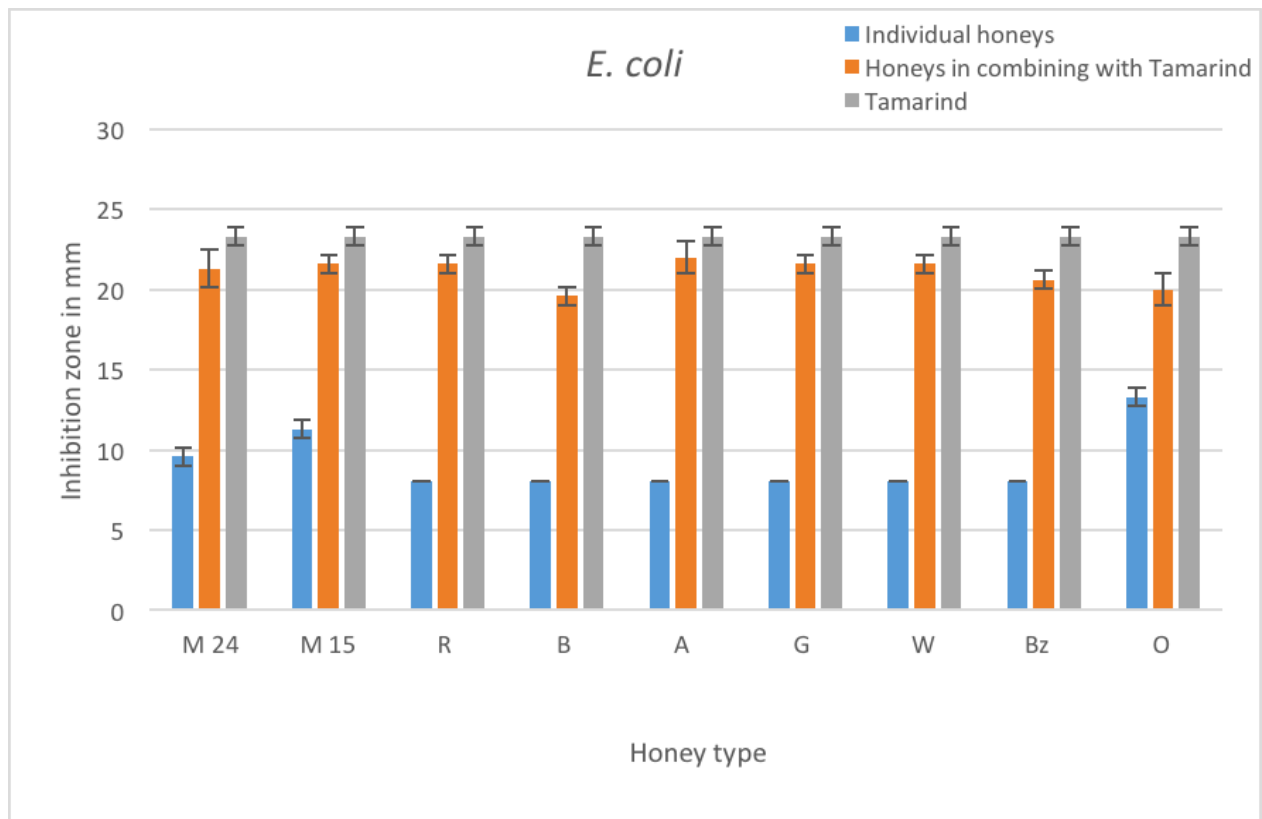

Figure 16. Effect of combining honey and Tamarind against *E. coli* determined by the agar well diffusion assay. The values are means of triplicates (including the size of the well (8.0mm))  $\pm$  Standard Deviation.

Manuka honey 24+ (M24)

Manuka honey 15+ (M15)

Rata wild (R)

Beech Forest (B)

Attiki Firtree Greek (A)

Antibacterial Medical Honey gel (W)

Greek Pine (G)

Brezzo Italian Lemon (Bz)

New Zealand Rewarewa Ogilvy's (O)

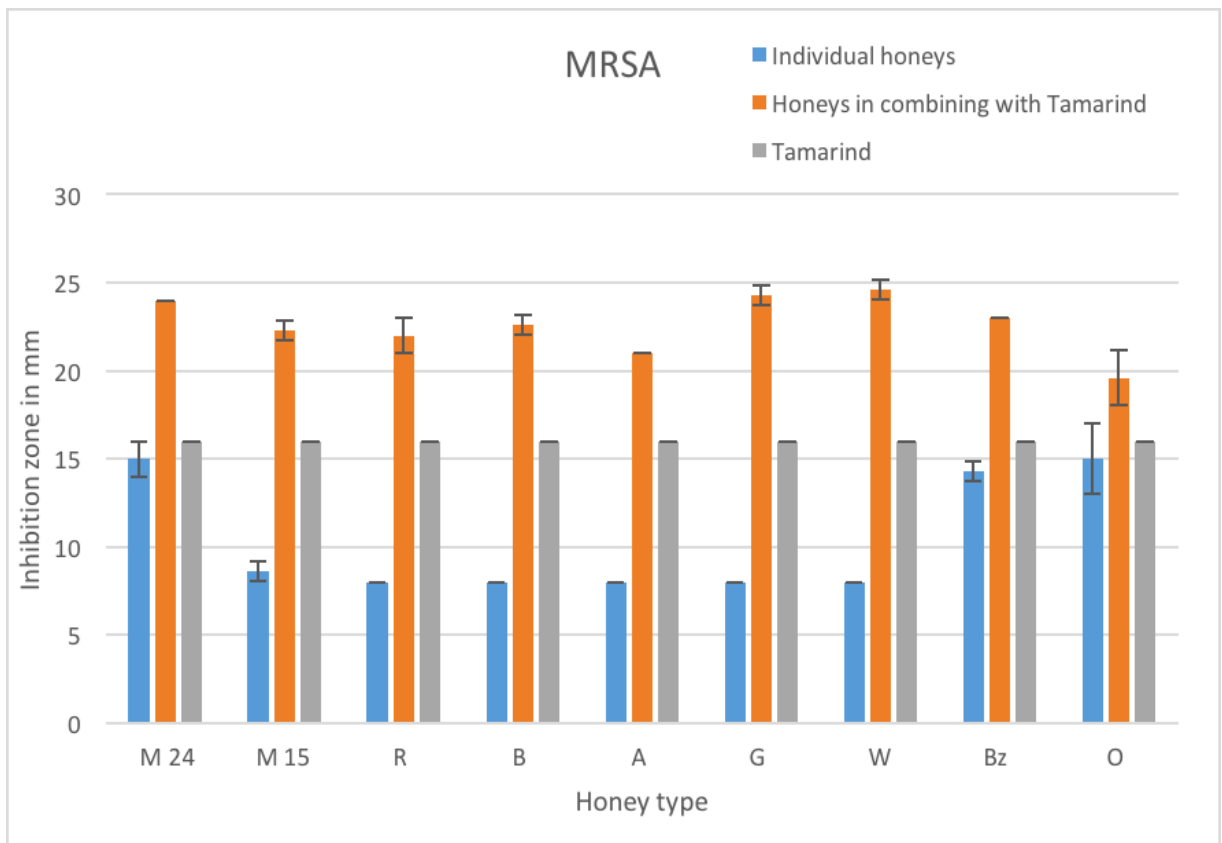

Figure 17. Effect of combining honey and Tamarind against MRSA determined by the agar well diffusion assay. The values are means of triplicates (including the size of the well (8.0mm))  $\pm$  Standard Deviation.

Manuka honey 24+ (M24)

Manuka honey 15+ (M15)

Rata wild (R)

Beech Forest (B)

Attiki Firtree Greek (A)

Antibacterial Medical Honey gel (W)

Greek Pine (G)

Brezzo Italian Lemon (Bz)

New Zealand Rewarewa Ogilvy (O)

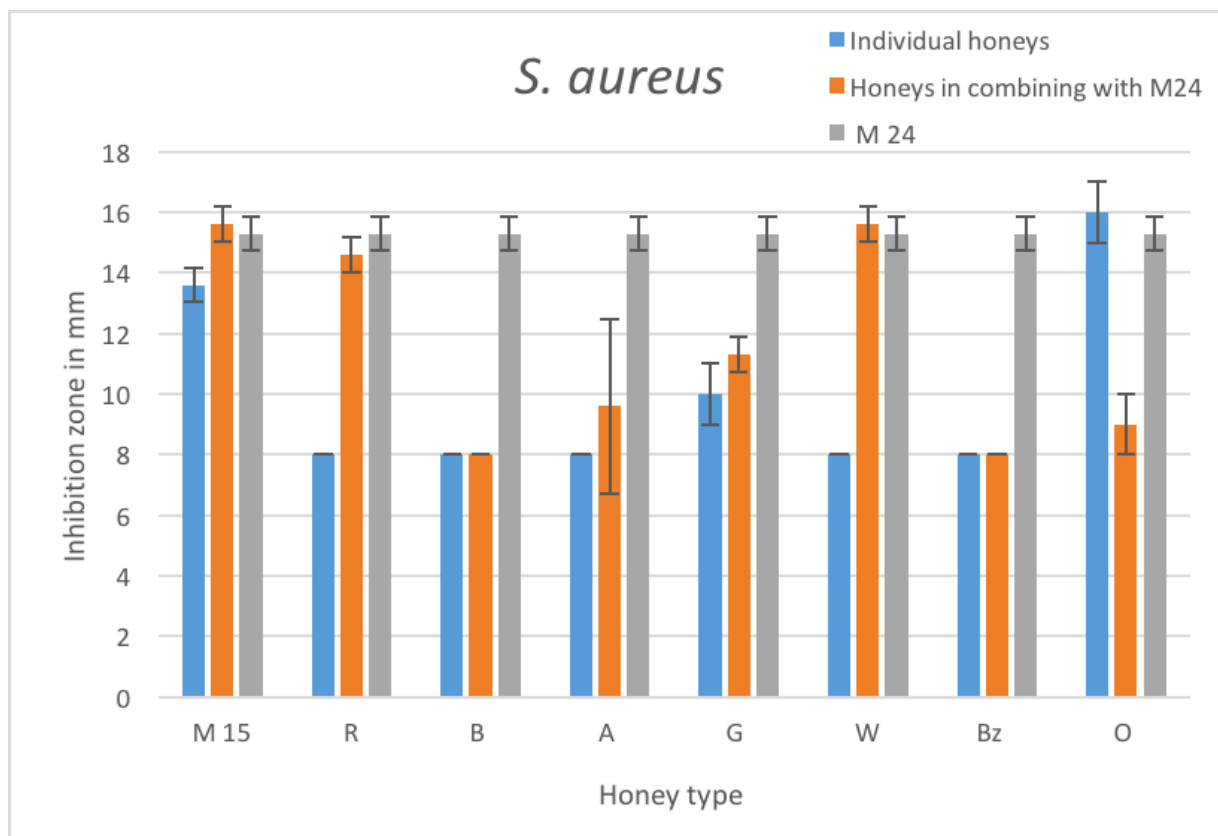

Figure 18. Effect of different honey type in combination with Manuka honey 24+ (M24), against *S. aureus* determined by the agar well diffusion assay. The values are means of triplicates (including the size of the well (8.0 mm))  $\pm$  Standard Deviation.

Manuka honey 15+ (M15)

Rata wild (R)

Beech Forest (B)

Attiki Firtree Greek (A)

Antibacterial Medical Honey gel (W)

Greek Pine (G)

Brezzo Italian Lemon (Bz)

New Zealand Rewarewa Ogilvy (O)



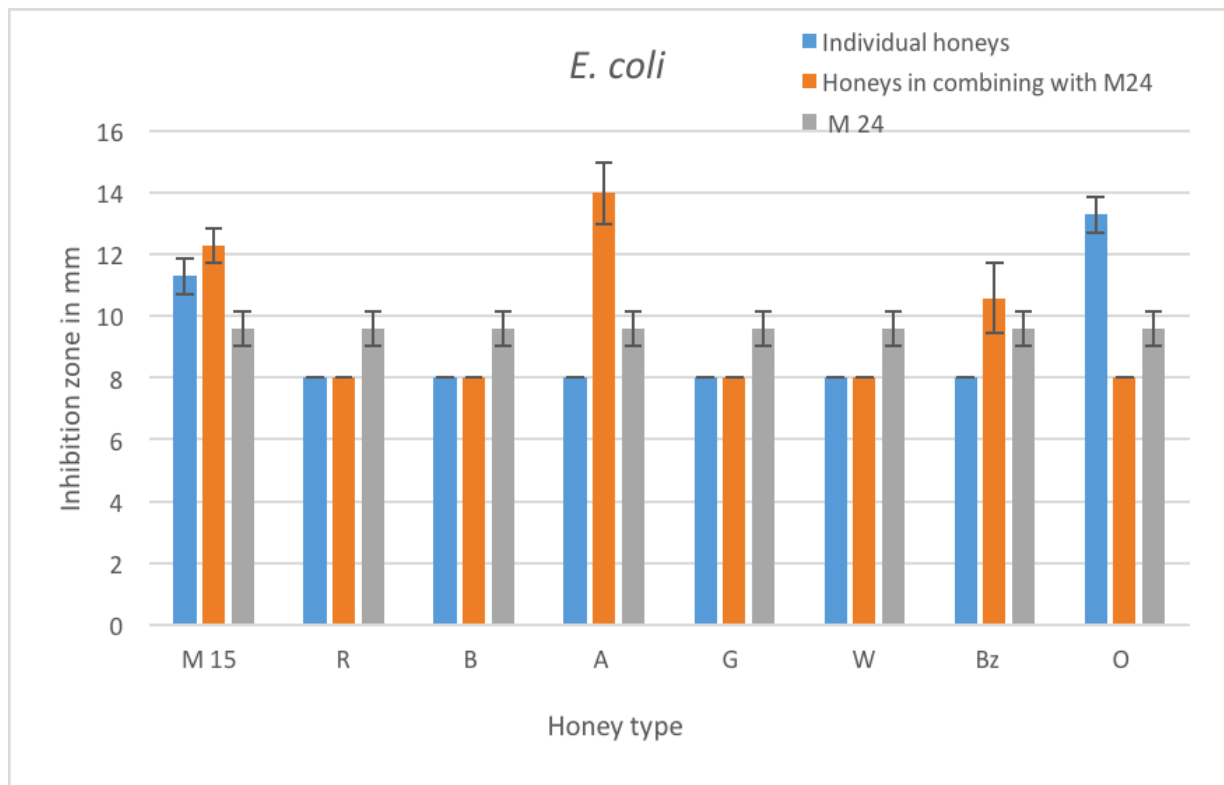

Figure 19. Effect of different honey type in combination with Manuka honey 24+ (M 24+) against *E. coli* determined by the agar well diffusion assay. The values are means of triplicates (including the size of the well (8.0mm))  $\pm$  Standard Deviation.

Manuka honey 15+ (M15)

Rata wild (R)

Beech Forest (B)

Attiki Firtree Greek (A)

Antibacterial Medical Honey gel (W)

Greek Pine (G)

Brezzo Italian Lemon (Bz)

New Zealand Rewarewa Ogilvy (O)

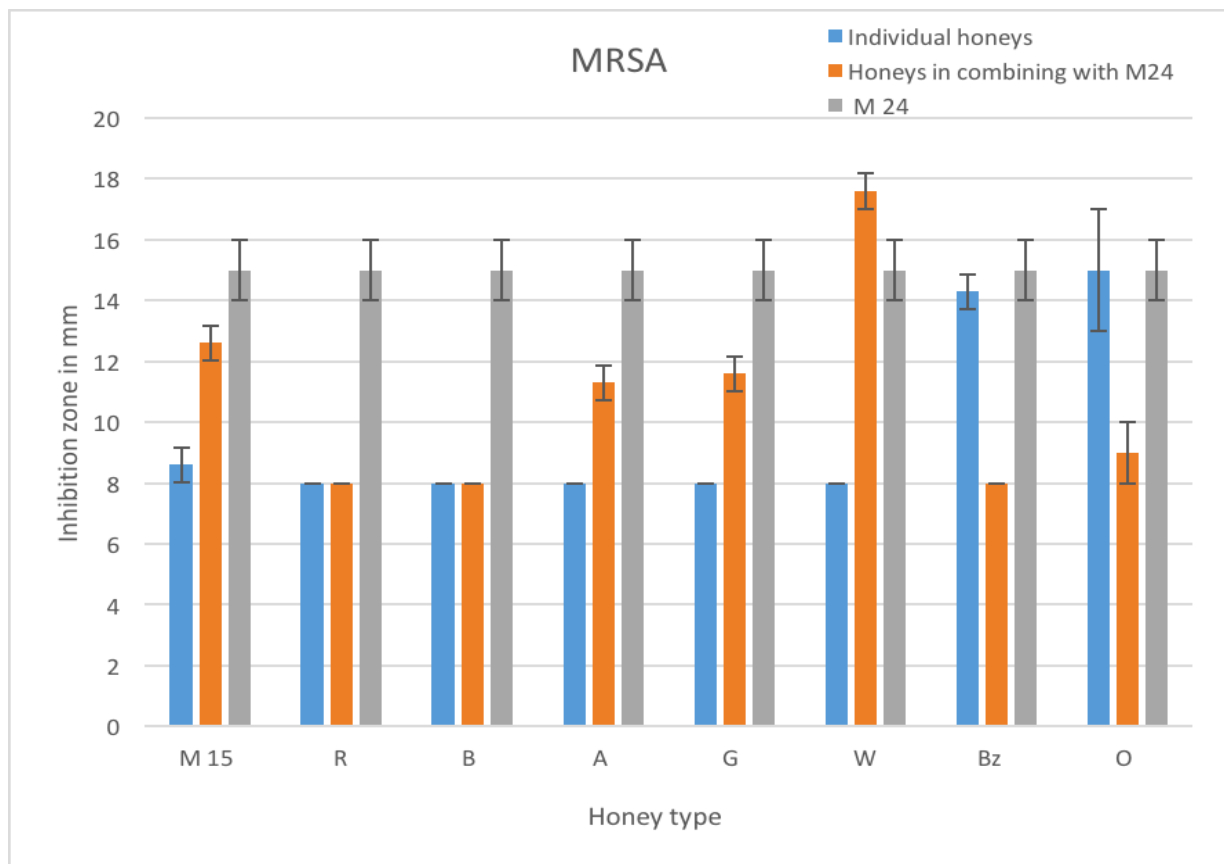

Figure 20. Effect of different honey type in combination with Manuka honey 24+ (M 24+) against MRSA determined by the agar well diffusion assay. The values are means of triplicates (including the size of the well (8.0mm))  $\pm$  Standard Deviation.

Manuka honey 15+ (M15)

Rata wild (R)

Beech Forest (B)

Attiki Firtree Greek (A)

Antibacterial Medical Honey gel (W)

Greek Pine (G)

Brezzo Italian Lemon (Bz)

New Zealand Rewarewa Ogilvy (O)

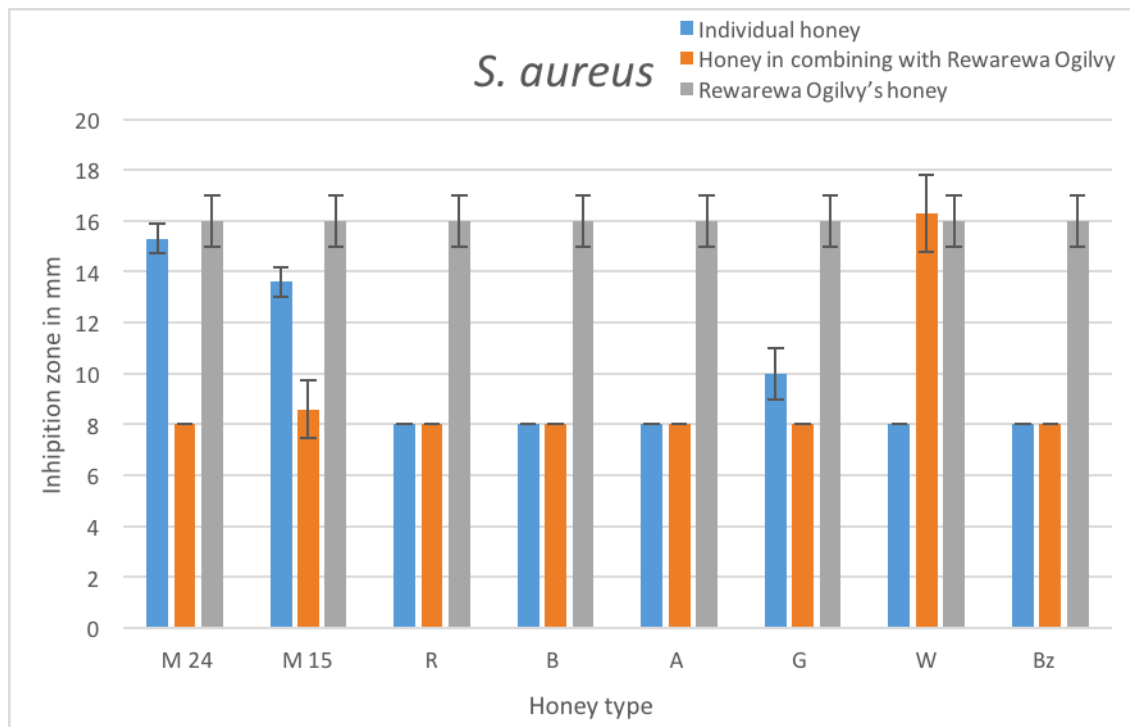

Figure 21. Effect of different honey type in combination with New Zealand Rewarewa Ogilvy's Honey (O) against *S. aureus* determined by the agar well diffusion assay. The values are means of triplicates (including the size of the well (8.0 mm))  $\pm$  Standard Deviation.

- |                        |                                     |
|------------------------|-------------------------------------|
| Manuka honey 24+ (M24) | Attiki Firtree Greek (A)            |
| Manuka honey 15+ (M15) | Greek Pine (G)                      |
| Rata wild (R)          | Antibacterial Medical Honey gel (W) |
| Beech Forest (B)       | Brezzo Italian Lemon (Bz)           |

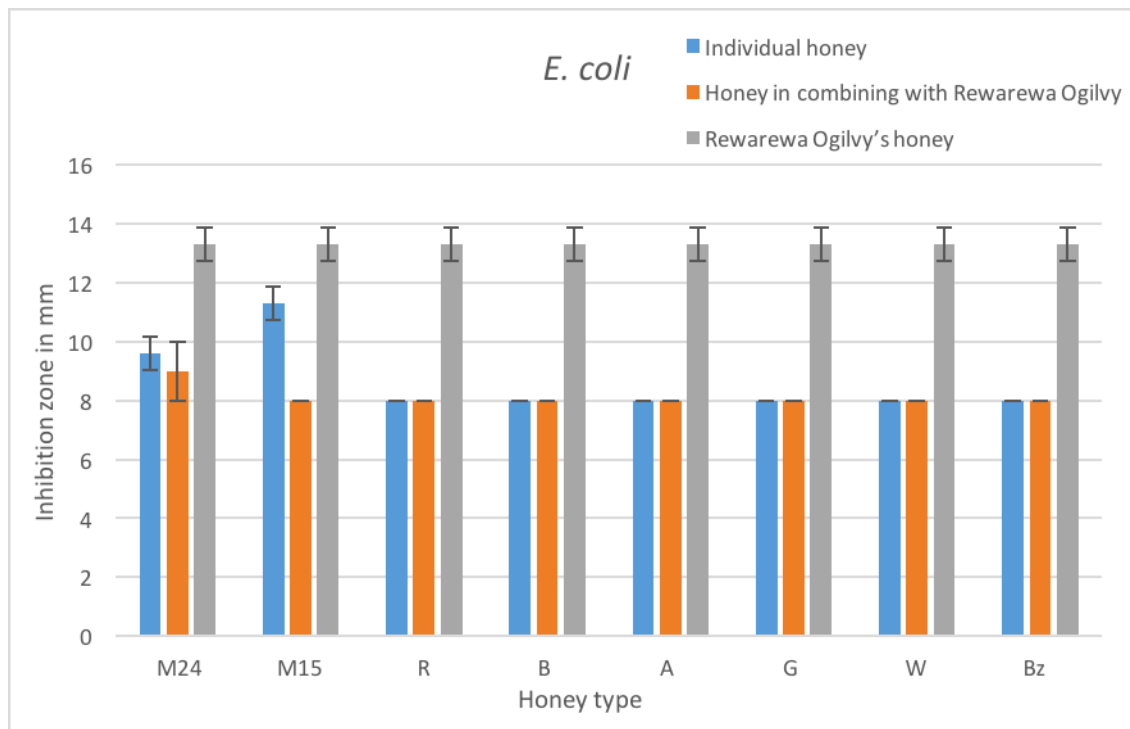

Figure 22. Effect of different honey type in combination with New Zealand Rewarewa Ogilvy's Honey (O) against *E. coli* determined by the agar well diffusion assay. The values are means of triplicates (including the size of the well (8.0mm))  $\pm$  Standard Deviation.

Manuka honey 24+ (M24)

Manuka honey 15+ (M15)

Rata wild (R)

Beech Forest (B)

Attiki Firtree Greek (A)

Greek Pine (G)

Antibacterial Medical Honey gel (W)

Brezzo Italian Lemon (Bz)

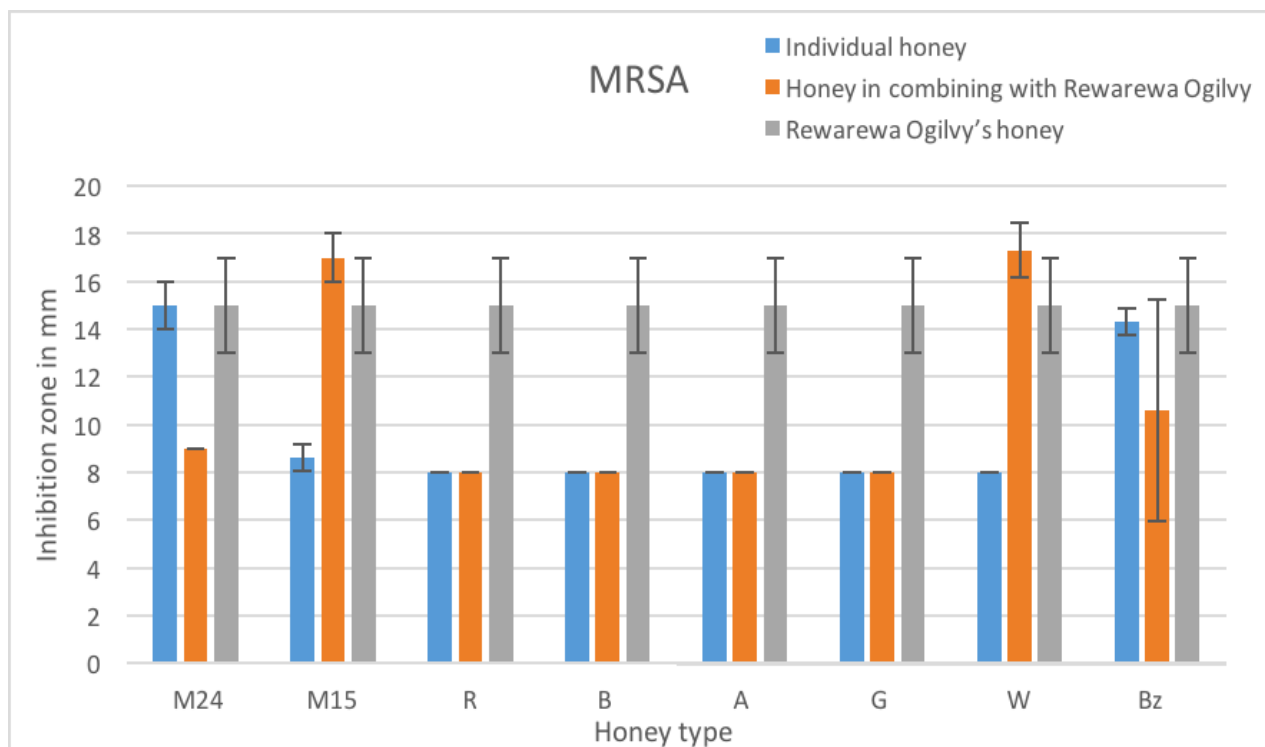

Figure 23. Effect of different honey type in combination with New Zealand Rewarewa Ogilvy's Honey (O) against MRSA determined by the agar well diffusion assay. The values are means of triplicates (including the size of the well (8.0mm))  $\pm$  Standard Deviation.

Manuka honey 24+ (M24)

Manuka honey 15+ (M15)

Rata wild (R)

Beech Forest (B)

Attiki Firtree Greek (A)

Greek Pine (G)

Antibacterial Medical Honey gel (W)

Brezzo Italian Lemon (Bz)

### **3.3.2. Effect of combining honey with antibiotics**

Disc diffusion tests were performed to assess the possible interactions between each honey type and each antibiotic against the tested bacteria. Sensitivity was measured based on the diameter of the zone of growth inhibition for antibiotics alone (Tables 7-9), or in combination with 100% concentration of each honey (Tables 7-9). Resistance of *E. coli* to erythromycin, ampicillin and chloramphenicol was confirmed where zones of inhibition were not seen (Table 8). Any additive effects produce an increase in diameter of the zone of inhibition of both antibiotics and honey when compared to the use of an antibiotic on its own. Generally, many honey-antibiotics combinations interacted positively to inhibit the growth of bacteria (Tables 7-9).

For tetracycline, all tested bacteria were sensitive and showed an additive effect with the addition of honey (Tables 7-9) except in rare case such as New Zealand Rewarewa Ogilvy's honey against *E. coli* (Table 8). The inhibition zones were approximately doubled in some cases, such as when Antibacterial Medical honey and Tamarind were added to tetracycline against MRSA (Table 9). A similar effect was observed for vancomycin, where *E. coli* was sensitive and exhibited an approximate doubling of the inhibition zone following Tamarind addition (Table 8). In contrast, vancomycin produced a little to no additive effects with some honeys

against *E. coli* (Table 8). Erythromycin, ampicillin and chloramphenicol with honeys gave an additive activity for *S. aureus* except in some cases (Table 7) and for MRSA except in some cases (Table 9). This was not the case for *E. coli*, which remained resistant except when added to Tamarind or Manuka 24+ when it became sensitive (Table 8).

For gentamicin, in general tested bacteria were sensitive and showed additive effects with the addition of most honeys except in some combinations (Tables 7-9).

<b>The zones of inhibition</b>						
	<b>Tetracycline</b>	<b>Chloramphenicol</b>	<b>Gentamicin</b>	<b>Ampicillin</b>	<b>Vancomycin</b>	<b>Erythromycin</b>
<b>Manuka 24+</b>	28.3 ± 1.5	22.6 ± 0.5	20.6 ± 0.5	39 ± 1	27.3 ± 3.5	29 ± 1
<b>Manuka 15+</b>	29.6 ± 3.5	6 ± 0	27.6 ± 2.3	6 ± 0	10.3 ± 7.5	6 ± 0
<b>Wild Rata</b>	28.6 ± 2.8	6 ± 0	24.6 ± 1.5	6 ± 0	6 ± 0	6 ± 0
<b>Beech Forest</b>	31.3 ± 3.2	41.6 ± 1.5	27.6 ± 2	43.6 ± 3.2	24.6 ± 1.5	28.3 ± 1.5
<b>Attiki Firtree Greek</b>	31 ± 3.6	27.3 ± 2.5	22.3 ± 0.5	37.3 ± 3	21.3 ± 0.5	26.3 ± 0.5
<b>Greek Pine</b>	30.3 ± 0.5	25 ± 0	31 ± 6.5	41.6 ± 0.5	26.3 ± 1.5	28.6 ± 2.8
<b>Antibacterial Medical gel</b>	33.3 ± 1.5	6 ± 0	6 ± 0	6 ± 0	6 ± 0	6 ± 0
<b>Brezzo Italian Lemon</b>	29.6 ± 1.5	25.3 ± 0.5	31 ± 2.6	44.6 ± 5.1	21.6 ± 0.5	27.6 ± 2
<b>New Zealand Rewarewa Ogilvy</b>	26.3 ± 3.2	6 ± 0	27 ± 4.3	6 ± 0	6 ± 0	6 ± 0
<b>Tamarind</b>	29 ± 1.7	24 ± 0	18.6 ± 0.5	38 ± 0	24.6 ± 0.5	24 ± 2
<b>Antibiotic alone</b>	23.8±0.2	24.5±0.5	20.6±0.5	31.1±0.2 *	15±0	25.1±0.7

Table 7. Effect of combinations of antibiotics and honey or Tamarind on *S. aureus*. The zones of inhibition are represented in mm as mean of triplicates (including the size of the discs (6.0mm)) ± Standard Deviation.

\* Statistically significant difference at  $P \leq 0.05$  between the input group.



<b>The zones of inhibition</b>						
	<b>Tetracycline</b>	<b>Chloramphenicol</b>	<b>Gentamicin</b>	<b>Ampicillin</b>	<b>Vancomycin</b>	<b>Erythromycin</b>
<b>Manuka 24+</b>	22 ± 1.7	6 ± 0	16.6 ± 0.5	14.3 ± 1.5	6 ± 0	10.6 ± 2
<b>Manuka 15+</b>	23 ± 2.6	6 ± 0	20 ± 2.6	6 ± 0	6 ± 0	6 ± 0
<b>Wild Rata</b>	19 ± 2.6	6 ± 0	19.6 ± 3.5	6 ± 0	6 ± 0	6 ± 0
<b>Beech Forest</b>	23.6 ± 0.5	6 ± 0	26 ± 4.3	6 ± 0	6 ± 0	6 ± 0
<b>Attiki Firtree Greek</b>	20.6 ± 1.1	6 ± 0	18.3 ± 1.5	6 ± 0	7.6 ± 0.5	6 ± 0
<b>Greek Pine</b>	22.3 ± 2.5	6 ± 0	20 ± 0	6 ± 0	6 ± 0	6 ± 0
<b>Antibacterial Medical gel</b>	33.3 ± 2.3	6 ± 0	6 ± 0	6 ± 0	6 ± 0	6 ± 0
<b>Brezzo Italian Lemon</b>	22.3 ± 1.5	6 ± 0	19 ± 1.7	6 ± 0	6 ± 0	6 ± 0
<b>New Zealand Rewarewa Ogilvy</b>	15 ± 1	6 ± 0	14 ± 1	6 ± 0	6 ± 0	6 ± 0
<b>Tamarind</b>	27.3 ± 0.5	14.3 ± 1.1	20 ± 0	12 ± 0	19.3 ± 1.1	23.6 ± 3
<b>Antibiotic alone</b>	18±0	6±0	17.6±0.5	6±0	8.3±0.5	6±0

Table 8. Effect of combinations of antibiotics and honey or Tamarind on *E. coli*. The zones of inhibition are represented in mm as mean of triplicates (including the size of the discs (6.0mm)) ± Standard Deviation.

There is no statistical significant difference between the input groups.

<b>The zones of inhibition</b>						
	<b>Tetracycline</b>	<b>Chloramphenicol</b>	<b>Gentamicin</b>	<b>Ampicillin</b>	<b>Vancomycin</b>	<b>Erythromycin</b>
<b>Manuka 24+</b>	33.3 ± 7.6	21.6 ± 0.5	20 ± 1.7	24.6 ± 0.5	20 ± 0	28.3 ± 2
<b>Manuka 15+</b>	33.3 ± 0.5	23.6 ± 1.1	20.3 ± 0.5	25.6 ± 3.7	22 ± 2.6	27.3 ± 0.5
<b>Wild Rata</b>	27.3 ± 2	26 ± 3.6	20.3 ± 0.5	22 ± 2	21 ± 2.6	26.3 ± 1.5
<b>Beech Forest</b>	27 ± 4.3	25 ± 1	30.3 ± 2.5	33.6 ± 6	27 ± 3.4	27.6 ± 0.5
<b>Attiki Firtree Greek</b>	28.3 ± 3.5	26.6 ± 2.8	21.3 ± 1.5	27 ± 1	8.6 ± 1.5	24.3 ± 4.9
<b>Greek Pine</b>	28 ± 1.7	20.6 ± 0.5	19.3 ± 1.1	25.6 ± 0.5	20.3 ± 1.1	27.6 ± 3.7
<b>Antibacterial Medical gel</b>	40.3 ± 4.1	32.6 ± 1.5	23.3 ± 2.8	29.3 ± 1.5	20.3 ± 2.3	26.3 ± 1.1
<b>Brezzo Italian Lemon</b>	26.3 ± 2.3	25.6 ± 2.3	28.6 ± 2.8	25.6 ± 2.5	19.6 ± 0.5	25.3 ± 1.5
<b>New Zealand Rewarewa Ogilvy</b>	25 ± 1.7	23.3 ± 1.1	20.6 ± 0.5	30 ± 1	23.3 ± 2.8	24.6 ± 0.5
<b>Tamarind</b>	45 ± 2.6	23.3 ± 1.1	17 ± 0	25 ± 0	20.6 ± 0.5	24.3 ± 0.5
<b>Antibiotic alone</b>	20.3±0.5 *	22.5±0.8	17±0	22.5±0.5	15±0 *	23.6±0.2

Table 9. Effect of combinations of antibiotics and honey or Tamarind on MRSA. The zones of inhibition are represented in mm as mean of triplicates (including the size of the discs (6.0mm)) ± Standard Deviation.

\* Statistically significant difference at  $P \leq 0.05$  between the input group.

### 3.4. Discussion and conclusion

Chronic wounds are an urgent health problem, especially when infected with multi-drug resistant bacteria. This study evaluated the antimicrobial activity of combinations of honeys with six antibiotics. It is proposed that such combinations could be effective in treating indolent wound infections. It has been shown here that combinations of antibiotics with non-antibiotic substances such as honey or Tamarind can enhance the efficacy of some antibiotics, findings which agree with the work of Jenkins and Cooper (2012b). Honey and Tamarind have also been shown here to have the potential to inhibit antibiotic resistant bacteria. Bacterial sensitivity increased to both antibiotics and Manuka type honeys when used in combination, even when the strains used are resistant to a particular antibiotic; however, the effect depends on the antibiotic and on the bacterial species used. Liu *et al.* (2015) showed that synergy is not a generic weakening process induced by honey, but targets specific processes in bacteria. Müller *et al.* (2013) also suggested that honey could prevent the rifampicin resistance mechanism in *S. aureus* by preventing mutations in the gene encoding its target, or the bacteria cannot survive long enough to develop resistance. Honey has several antibacterial components and has properties which contribute to its antibacterial properties, including naturally low pH, osmotic effect, phenolic acids, flavonoids, lysozyme, as well as the production of hydrogen peroxide and methylglyoxal (Abd-El *et*

*al.*, 2007). The antibiotics used in this study have different modes of action, and thereby inhibit different targets such as 30S ribosome, 50S ribosome and cell wall synthesis. This supports the view that honey is a complex substance with numerous active components which could affect different cellular target sites.

In conclusion, antibiotics are clearly a resource which must be conserved and used correctly since bacterial resistance is rapidly increasing, causing a worldwide health and financial crisis. Consequently, honey may provide a much needed alternative or else be useful in adjunct therapy. The results presented here show that some honeys also increase the effectiveness of some antibiotics. This is particularly true for the non honey product (tamarind). This type of therapy may also reduce the rate of occurrence of antibiotic resistance.

## **Chapter 4**

# **The Effect of Honey or Tamarind on Bacteria after being Exposed to Ultraviolet Light**

#### **4.1. Introduction**

The increase occurrence of antibiotic-resistant pathogens is causing a serious challenge to public health. In response to this problem, inactivation of microorganisms using various light exposures has become a focus of numerous research efforts (Maclean *et al.*, 2009). Ultraviolet radiation is successful in inactivating a wide range of microorganisms (Garrido-Pereira *et al.*, 2013). UV irradiation has been considered as a promising alternative approach to kill antibiotic-resistant pathogens and to treat infectious diseases (Yin *et al.*, 2014, Gupta *et al.*, 2012). It is used in wound infection treatment (Gupta *et al.*, 2012), aquaculture applications to inactivate microorganisms (Sharrer and Summerfelt, 2007) and in the decontamination of food and fruit juice (Yin *et al.*, 2014; Adhikari *et al.*, 2015; Yun *et al.*, 2013).

UV-C inhibits the growth of a range of microorganisms such as bacteria, yeasts, algae, moulds and protozoa (Mansor *et al.*, 2014). Mansor *et al.* (2014) stated that 99.99% of microorganisms in drinking water can be killed by UV-C. Ultraviolet (UV) light is used as a light inactivation treatment (Maclean *et al.*, 2009), and it has different effects on microorganisms depending on the differences in spectral regions which have specific cellular targets (Santos *et al.*, 2013) which cause mutagenic and lethal effects in microorganisms (Gupta *et al.*, 2012). Its negative

effects have been observed on production of enzymes, the growth of bacteria and viability of bacteria (Hortnagl *et al.*, 2010). It can damage DNA or cell membrane proteins, which can lead to death or cause a significant impact on growth and reproduction (Garrido-Pereira *et al.*, 2013, Yin *et al.*, 2014); it may also cause sub-lethal damage in DNA (Maclean *et al.*, 2009).

The wavelength of UVC ranges between 250 nm and 260 nm (Yin *et al.*, 2014), with the wavelength 254 nm having the most marked germicidal effect, due to nucleic acids having the best absorption of photons at this wavelength which results in DNA damage (Mansor *et al.*, 2014; Olsen *et al.*, 2016; Sharrer *et al.*, 2005).

Inactivation of microorganisms by UV occurs because of a combination of photothermal, photochemical and photophysical mechanisms (Montgomery and Banerjee, 2015). The photochemical effects change the chemical structure of DNA by forming a thymine–thymine dimer, which is the principal type of cell damage from UV-C (Liltved and Landfald, 2000), and this change leads to cell death as a result of DNA replication prevention (Montgomery and Banerjee, 2015). Photophysical effects can cause direct damage to the cells causing seepage of cellular materials (Montgomery and Banerjee, 2015). Dimerization of pyrimidine molecules notably thymine (which exclusively occurs in DNA), produces dimers of cyclobutane (CPDs). When thymine–thymine dimers occur, the chemical

structure of DNA chains is changed and it becomes difficult for the DNA to replicate because cyclobutane pyrimidine dimers interrupt the transcription, which eventually leads to cell death (Dai *et al.*, 2012, Shah *et al.*, 2014). UV light can have an effect on the physicochemical and metabolic processes by destroying the outer membrane and protein molecules of microbial cells (Yin *et al.*, 2014). Bacteria produce reactive oxygen species (ROS), which in turn damage cell components when exposed to UV (Hortnagl *et al.*, 2010). The damaging effects of UV on microorganisms differ according to different UV spectral regions (Santos *et al.*, 2013). UVA effects are mostly indirect through reactive oxygen species (ROS) which are formed by photodynamic reactions (Santos *et al.*, 2013), while UVB radiation produces both direct and indirect damage (Santos *et al.*, 2013). UVC radiation is the most harmful to microbial cells because it is directly absorbed by DNA (Santos *et al.*, 2013) which causes damage to the genetic material (Dai *et al.*, 2012), whereas a high dose of UVC or UVB can lead to genetic mutation or cell death (Gupta *et al.*, 2012). Reactive oxygen species react with proteins and lipids which leads to a change in the membrane permeability that can be fatal (Santos *et al.*, 2013). The prolonged use of UV has harmful effects on skin, tissue (Dai *et al.*, 2012) and components of the eye (Maclean *et al.*, 2009). Thus, UV should be applied in a way whereby the side effects are minimized and the development of bacterial resistance of UV is avoided (Gupta *et al.*, 2012).



For many years, UVC radiation has been used in physical therapy for wound healing (Dai *et al.*, 2012) based on the fact that it is highly germicidal (Gupta *et al.*, 2012). The careful use of UV can be useful for wound healing besides its anti-inflammatory and antioxidant effects; the appropriate doses of UVC can selectively inactivate microorganisms while not acting negatively on host cells (Gupta *et al.*, 2012). UV also helps in wound healing by eradicating microorganisms that can hinder the healing process (Dai *et al.*, 2012). Some studies have found that exposing cultured cells to UV irradiation activates cell division and immune response, while exposing skin to low doses of UVB encourages vitamin D production (Gupta *et al.*, 2012). Although long-term exposure to UVC could cause carcinogenic mutation, the treatment of infected wounds only requires limited numbers of repeated UVC irradiation doses (Gupta *et al.*, 2012).

Using UV in wound treatment, especially for burns and other chronic wounds, works faster than antibiotics; UVC can eradicate microorganisms in one hour while antibiotics usually take several days (Gupta *et al.*, 2012).

In addition, exposure of wounds to UV irradiation often stimulates and restores normal melanocyte numbers and might stimulate as well the production of melanin by melanocytes which has a protective effect on the skin. UVC helps wounds in hyperplasia and induces enhanced re-epithelialization (Dai *et al.*, 2012). In general, UV exposure should be

started early in the healing process of infected wounds (Gupta *et al.*, 2012; Dai *et al.*, 2012).

Prolonged exposure to UVB is the main cause of skin cancer, but this can be avoided by the appropriate application of sunscreen. UVB therapy has now been well-researched and has proved an effective therapy with well-recorded, minimal side effects (Dai *et al.*, 2012).

Bacteria differ in the way they respond to UV radiation as they possess efficient repair mechanisms to minimize the damage caused by UV on DNA (Hortnagl *et al.*, 2010; Yin *et al.*, 2014). A study has shown that some inactivation effects caused by UV-C on pathogenic bacteria, such as *Yersinia ruckeri*, *Vibrio anguillarum* and *Aeromonas salmonicida* can be temporary (Liltved and Landfald, 2000).

The exposure of bacterial cells to UV could kill, cause damage or have no effect at all. The bacterial cell has repair mechanisms that enable it to restore its genetic information, giving it the ability to grow and replicate following inactivation. DNA repair mechanisms, which are photo-reactivation and dark repair, can reverse DNA damage (Olsen *et al.*, 2016). Pyrimithedine dimers formation, which is the main damage in the cell, can be repaired by the process of photo-reactivation, whereas the light in the wavelength range of 330 - 480 nm can activate repair enzymes to split the dimers (Liltved and Landfald, 2000).

Dark reactivation is a multistep and light-independent process, unlike photo-reactivation. There are two different dark-activated repair mechanisms, nucleotide excision repair and base excision repair. All repair mechanisms are associated with the *recA* gene pathway, because of its important position in many molecular bacterial regulation processes; the *recA* protein exists widely in a range of microorganisms, including *E. coli* O157:H7 (Yin *et al.*, 2014).

The aim of this experiment was to determine the effects of different time periods of ultraviolet light exposure on bacteria before treatment with honey or Tamarind.

## **4.2. Materials and Methods**

### **4.2.1. Honey samples and Tamarind**

Nine honey samples were used: Manuka honey 24+ (M24), Manuka honey 15+(M15), Rata wild honey (R), Beech Forest honey (B), Attiki Firtree Sreek Honey (A), Greek Pine honey (G), Antibacterial Medical Honey wound gel (W), Brezzo Italian Lemon honey (Bz) and New Zealand Rewarewa Ogilvy's Honey (O). Tamarind was also used. Manuka honey was obtained from Holland and Barrett, Sheffield, UK. The other honey samples were obtained from local shops and some honeys were obtained commercially, mainly through Amazon. All honey samples were stored at room temperature until used.

### **4.2.2. Sample preparation**

Various honey samples and Tamarind paste at a concentration of 100% were used.

### **4.2.3. Test organisms**

The following test organisms (bacteria) were used: *Escherichia coli*, *Staphylococcus aureus* and methicillin-resistant *Staphylococcus aureus* (MRSA). The organisms were obtained from the departmental culture collection.

### **4.2.4. Turbidity standard for inoculum preparation**

The inocula was adjusted to  $1.5 \times 10^8$  colony forming units (CFU/ml) which

was equivalent to 0.5 McFarland standard. Two isolated colonies of the same morphological type were then removed using a sterile loop and transferred into a tube containing sterilized distilled water. Then the mixture was mixed by vortex until the suspension became homogenized and, turbidity was adjusted using a spectrophotometer at 600 nm. This suspension was used within 30 minutes of preparation (Andrews, 2001).

#### **4.2.5. Exposure of bacterial suspensions to ultra-violet radiation**

A suspension of bacteria was pipetted into a Petri dish and exposed to UV-A (365 nm, 8 Watt, White, UVL-18, UVP) and UV-B (302 nm, 8 Watt, White, UVM-18, UVP) light for various time periods (30, 60, 90 and 120 seconds) in a closed box. The distance between the lamps and the surface of the suspension was 6.0 cm. 100µl of the bacterial suspension, immediately after UV exposure, was poured onto Muller Hinton Agar plates. A sterile spreader was used to distribute the suspension. All plates were allowed to dry. Wells, 8.0 mm in diameter, were then cut from the culture media with a sterile, metal cylinder, and finally filled with 200µl of honey or Tamarind. The bacterial suspension before UV exposure with honey or Tamarind was used as a control. The plates were then incubated at 37°C and observed after 24 hours for clear, circular inhibition zones around the wells; these were measured.

#### **4.2.6 Statistical Analysis**

All observations were presented as Mean  $\pm$  SD (Standard Deviation). The data was analysed by IBM crop© 24. One way ANOVA was performed to compare if there was a significant differences of the measured zone of inhibition values of UV-B light treatment in combination with different honey types or Tamarind against bacteria.  $P \leq 0.05$  was considered as significant. Tukey-Post-Hoc test confirmed the pairwise comparisons.

### **4.3. Results and Discussion**

#### **4.3.1. Microbial inactivation as a result of UV light treatment in combination with honey or Tamarind paste**

The inactivation of tested microorganisms as a result of UV light (A, B) treatment in combination with honey was evaluated by using the agar well diffusion assay at four different time points (30, 60, 90, 120 seconds) of exposure. The results of inactivation of bacteria assessed by measuring the inhibition zones around the wells are presented in Figs. 24-26. The bacterial suspension treated with honey or Tamarind paste before UV exposure was used as a control. Exposing bacteria to UV-A showed no increase in inhibition zone to any tested periods (no data shown). The results show that honey exhibits a strong activity against bacteria when weakened by exposure to UVB light for different exposure periods. Generally, the results against *S. aureus* (Fig.24) showed that the inhibition zones were significantly increased after exposing the bacterial suspension to UV-B for all tested periods for each different honey or Tamarind. It was found that the length of the exposure period had a significant influence on killing bacteria. Generally, longer UV-B exposure time resulted in an increase in the inhibition zone diameter except in some rare results such as Attiki Firtree Greek honey, which gave a smaller inhibition zone when *S. aureus* was exposed to UV-B for 90s compared to 60s (Fig.24).

UV-B treatment of *E. coli* for the tested periods increased the diameter of the inhibition zone in general compared with the no treatment control (Fig.25). The longer the exposure time, the greater was the inhibition zone. This was not the case for Wild Rata and Beech Forest honey where no antibacterial effect on *E. coli* was seen, either before or after exposure to UV-B (Fig. 25).

The results of MRSA exposed to UV-B showed that, as with *S. aureus* and *E. coli*, the inhibition zones increased with longer exposure time (Fig. 26). The inhibition zones reached high values at 90s and 120s with 40mm and 45mm, respectively. These values were significant when compared to UV-B untreated controls (Fig. 26). Generally, a longer UV-B exposure time resulted in an increase in inhibition zone diameter and a decrease in intensity of growth, especially with exposure for 90s and 120s (Fig. 24-26). A study has reported a marked antimicrobial activity of UV against bacteria, particularly when used for surface sterilization and the sterilization of drinking water (Maktabi *et al.*, 2011). UV, notably the short wavelength (<280 nm) variety, is not only bactericidal, but also potentially carcinogenic (Nordback *et al.*, 1990). In a study of UV on wound healing, however, it was found that UV has a stimulating effect on wound healing (Nordback *et al.*, 1990). In this study, UV-A and UV-B were used but not UV-C, which is highly carcinogenic. An approach to wound infection control which is worth considering is to combine it with a



physical approach with honey so as to circumvent any problems which are directly associated with antibiotic resistance. It is suggested, for example, that UV light could be applied where wounds do not respond to honey treatment alone.

The killing mechanisms of UV and honey are different. In the study reported in this Thesis, UV appeared to have a bactericidal effect on bacteria, although, UV exposure was too short. The large difference in the inhibition zone clearly shows the killing effect of UV radiation on bacteria, even before being treated with honey. Despite the relatively low impact of some honeys on bacteria, a synergistic antibacterial effect was seen following the use of a combination of UV and honey for most of the honey types used here. Under the experimental conditions used here, it was observed that the synergistic effect was more obvious when applied to Gram-positive rather than Gram-negative bacteria.

In a study of UV Irradiation on live mammalian cells as well as bacteria, it was found that exposure times which caused cell death due to necrosis (i.e. the rupture of cell membranes) are, not surprisingly, much higher than those which are required to inhibit or kill *Escherichia coli*, and can be ten times the dose in the case of fibroblasts (Sosnin *et al.*, 2004). The presence of the threshold dose for cell deactivation makes the effects on specific bacteria different from other bacteria (Sosnin *et al.*, 2004). This may explain the differing results obtained for each individual bacterium. While

MRSA and *E. coli* were shown to be fairly resistant, other species may be more readily eliminated by the use of this method.

In conclusion, the results suggest that the application of UV weakens bacteria, thereby allowing the honeys to show a greater inhibitory effect (i.e. larger inhibition zone). The results suggest that UV should be used in combination with honey to enhance its antibacterial effect during wound treatment.

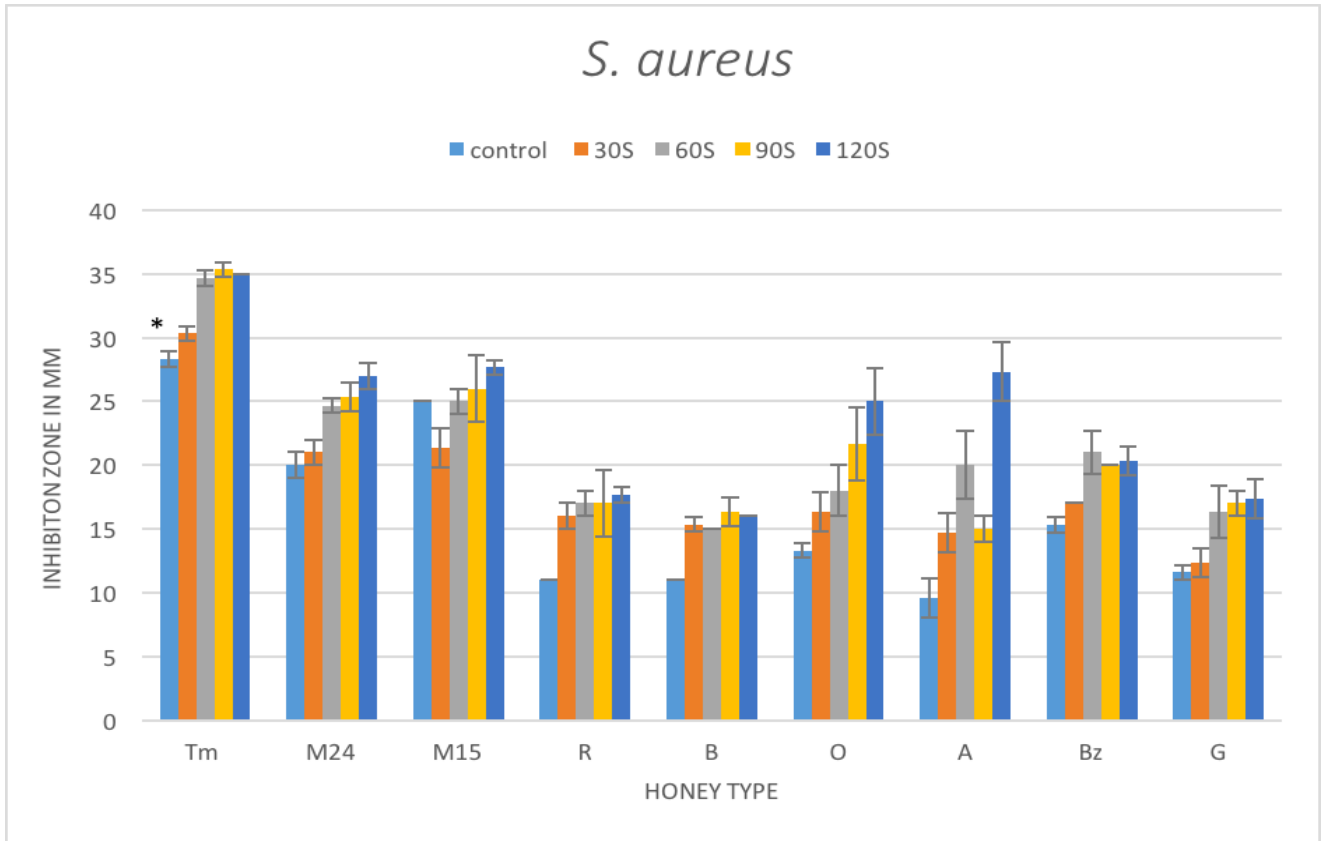

Figure 24. Effect of UV-B light treatment in combination with different honey types and Tamarind paste against *S. aureus*. Inhibition zone in mm. The values are represented as means of the triplicates (including the size of the well (8.0mm))  $\pm$  Standard Deviation.

\* Statistically significant difference at  $P \leq 0.05$  between input group.

Tamarind paste (Tm)

Manuka honey 24+ (M24)

Manuka honey 15+ (M15)

Rata wild (R)

Beech Forest (B)

New Zealand Rewarewa Ogilvy (O)

Attiki Firtree Greek (A)

Brezzo Italian Lemon (Bz)

Greek Pine (G)

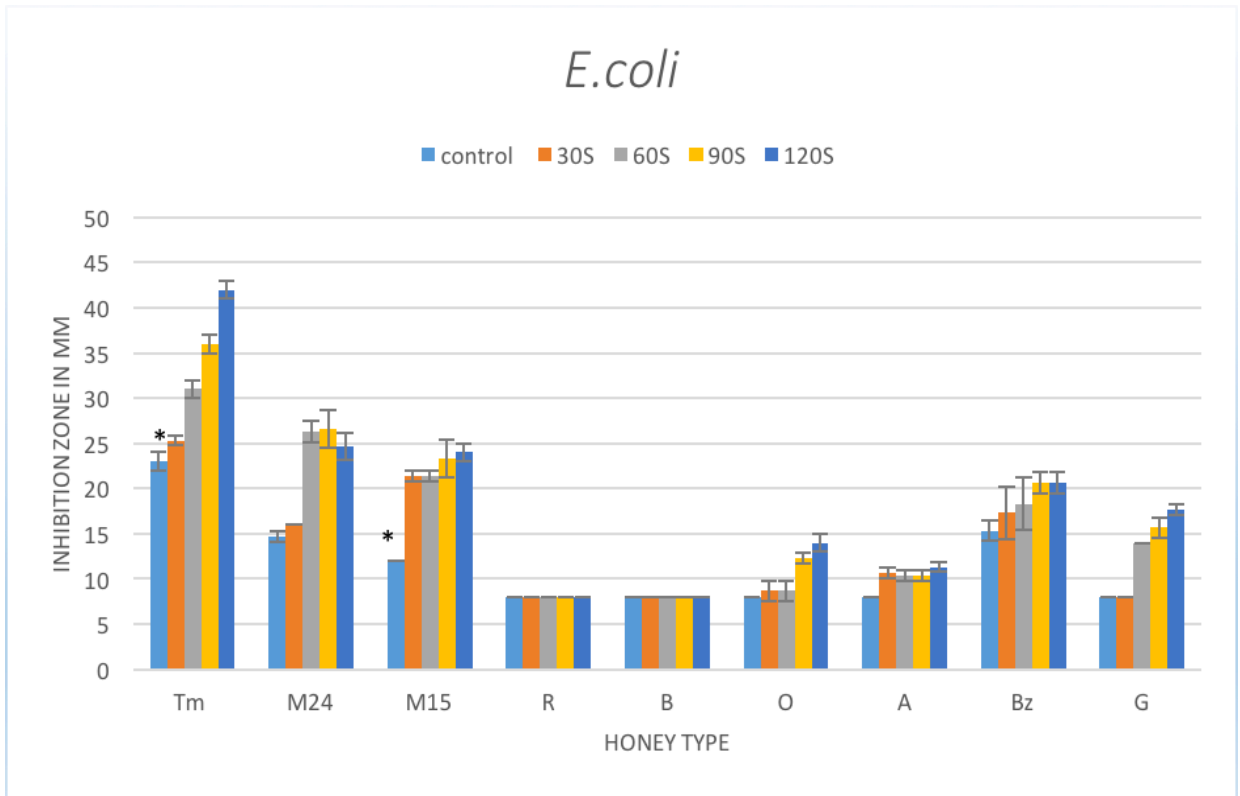

Figure 25. Effect of UV-B light treatment in combination with different honey types and Tamarind paste against *E. coli*. Inhibition zone in mm. The values are represented as means of the triplicates (including the size of the well (8.0mm))  $\pm$  Standard Deviation.

\* Statistically significant difference at  $P \leq 0.05$  between input group.

Tamarind paste (Tm)

Manuka honey 24+ (M24)

Manuka honey 15+ (M15)

Rata wild (R)

Beech Forest (B)

New Zealand Rewarewa Ogilvy (O)

Attiki Firtree Greek (A)

Brezzo Italian Lemon (Bz)

Greek Pine (G)

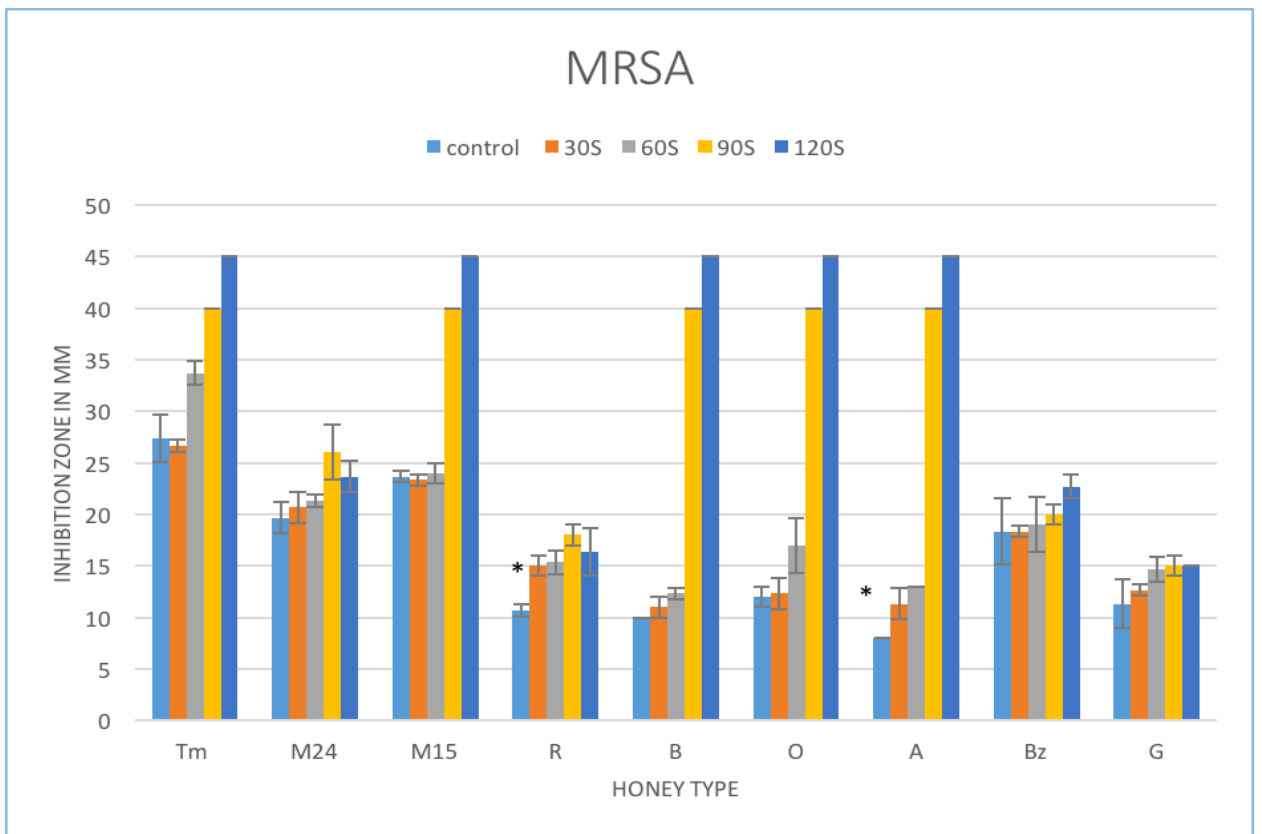

Figure 26. Effect of UV-B light treatment in combination with different honey types and Tamarind paste against MRSA. Inhibition zone in mm. The values are represented as means of the triplicates (including the size of the well (8.0mm))  $\pm$  Standard Deviation.

\* Statistically significant difference at  $P \leq 0.05$  between input group.

Tamarind paste (Tm)

Manuka honey 24+ (M24)

Manuka honey 15+ (M15)

Rata wild (R)

Beech Forest (B)

New Zealand Rewarewa Ogilvy (O)

Attiki Firtree Greek (A)

Brezzo Italian Lemon (Bz)

Greek Pine (G)

## **Chapter 5**

# **Detection of the Liberation of Endotoxin from *E. coli* after being Treated with Honey or Tamarind**

## 5.1. Introduction

Endotoxins are biological toxins which are part of the outer membrane of most Gram-negative bacteria (Abdulraheem *et al.*, 2012). In the 19th century, endotoxin was described as the component of Gram-negative bacteria responsible for the infections which are related to this group of pathogens. Due to recent improvements in analytical techniques and devices, the biological properties and the chemical structures of endotoxins became better understood (Su and Ding, 2015). Endotoxins are high-molecular-weight lipopolysaccharide complexes (Blechova and Pivodova, 2001), consisting of three distinct regions; lipid A, the core oligosaccharide and finally the O-specific polysaccharide chain (Das *et al.*, 2014). Lipid A consists of a hydrophilic part which is a bisphosphorylated diglucosamine backbone and a hydrophobic part, a six or seven acyl chains with amide and ester linkages. Lipid A works as an anchor for LPS in the membrane and it is responsible for the LPS molecules' biological function and specificity. The core oligosaccharide component of LPS can be divided into an inner subdomain and an outer subdomain. The inner subdomain is directly connected to Lipid A and the outer subdomain allows for an attachment site for the O-specific polysaccharide chain. The O-specific polysaccharide chain is open to exposure to the external environment of bacterial cells and enables bacteria to evade the immune system (Su and Ding, 2015). There are more than 1000 different immunochemical of the

O-specific polysaccharide chain in *Salmonella*, whereas in some LPS structures the O-specific polysaccharide chains may be absent (Su and Ding, 2015). Endotoxins are heat stable and can survive the sterilization process (Blechova and Pivodova, 2001).

Although lipopolysaccharide is firmly anchored within the bacterial cell wall, it is released into the environment continuously. Its release can occur as the result of antibiotic use or during cell death and even during growth and division (Das *et al.*, 2014). Since bacteria can grow almost everywhere, endotoxins are ubiquitous and can be found in water, saline, buffers, food, pharmaceuticals and biotechnology products (such as insulin or vaccines) and can create a significant risk to consumers (Das *et al.*, 2014; Chalupniak *et al.*, 2014). In the case of endotoxin in parenteral drug products, its presence may result in fatal pyrogenic reactions (Chalupniak *et al.*, 2014). Water is a major source of endotoxin contamination because of its use as a solvent (Chalupniak *et al.*, 2014). High concentrations of endotoxin can be found where bacteria accumulate or where they are used for bioprocessing (Das *et al.*, 2014). Also, a high content of endotoxin in air can be found where endotoxins are used as bio-aerosols and this can cause respiratory problems (Chalupniak *et al.*, 2014).

High doses of endotoxins cause inflammatory reaction in humans and are responsible for causing fever, headache, flu-like symptoms, cough,



vomiting, diarrhoea, and respiratory distress (Abdulraheem *et al.*, 2012). They also cause septic shock, multi-organ failure, meningococemia, sepsis and severe morbidities, neurologic disability, hearing loss and a limb loss (Das *et al.*, 2014), intravascular coagulation, and even death (Abdulraheem *et al.*, 2012). In fact, Lipid A is the part which is responsible in LPS for these immune responses (Su and Ding, 2015). A study has suggested a possible link between bacterial endotoxins and various chronic diseases such as colorectal adenomas and cancer. The quality of food, particularly dairy products, fish and meat, is also affected by the levels of endotoxins (Chalupniak *et al.*, 2014). It is essential to detect endotoxin for quality control purposes to ensure the safety of biological and serological products following sterilization, as well as medical equipment and therapeutic drug products. It is also essential that such quality control measures be applied to food and to confirm water security (Das *et al.*, 2014).

A laboratory test can be used to determine where endotoxin is present and at what concentration by employing water extracts from blood cells (amoebocytes) of the horseshoe crab (*Limulus polyphemus*). The detection of endotoxin is based on the coagulation of a lysate prepared from the amoebocytes. This assay is the most sensitive test which is currently available for the detection of endotoxin and it simple, rapid, specific and inexpensive when compared with the USP rabbit pyrogenicity test (Abdulraheem *et al.*, 2012). It can be used to detect (in less than 2 hours) as

little as 1 ng of bacterial endotoxins per milliliter. The *Limulus* assay has been used to detect bacterial endotoxins in various fluids, such as blood from patients suspected of having Gram-negative sepsis, in order to detect Gram-negative bacterial meningitis and for screening of urine for bacteriuria (Abdulraheem *et al.*, 2012). LPS is released after Gram-negative bacterial death, and enters the bloodstream through the damaged intestinal mucosa and this could lead to endotoxemia (Su and Ding, 2015). In the 1960s, Levin and Bang described the *Limulus* amoebocyte lysate assay (LAL) for the first time (Abdulraheem *et al.*, 2012). However, in response to increasing demand for the quality of drugs, and a decrease in the use of live animals, a new laboratory method – the *Limulus amoebocyte lysate* (LAL) test was developed. The LAL test is used for the detection of pyrogenic endotoxins and as an alternative to the rabbit pyrogenicity test. Bang (1964) observed that the Gram-negative bacterial infection of *Limulus polyphemus*, the horseshoe crab, results in substantial intravascular clotting and resultant death. Levin and Bang (1964) then demonstrated that the extracellular coagulation of *Limulus* hemolymph (blood) results from a reaction between the endotoxin from GNB and a coagulative protein in amoebocytes. Subsequently, a highly sensitive assay for endotoxin-presence in human plasma was developed using *Limulus amoebocytes* material; then LAL coagulative protein was isolated, purified and described which proved that the reaction between lysate and endotoxin is an enzymatic reaction

(Blechova and Pivodova, 2001).

The aim of the work described in this chapter was to detect liberation of endotoxin from *E. coli* after been treated with honey or Tamarind.

## **5.2. Material and Methods**

### **5.2.1 Honey samples and Tamarind**

Nine honey samples were used: Manuka honey 24+ (M24), Manuka honey 15+ (M15), Rata wild honey (R), Beech Forest honey (B), Attiki Firtree Greek honey (A), Greek Pine honey (G), Antibacterial Medical Honey wound gel (W), Brezzo Italian Lemon honey (Bz) and New Zealand Rewarewa Ogilvy's Honey (O). Tamarind paste was also used; all honey samples and Tamarind were used at concentrations of 100%.

### **5.2.2. Sample preparation**

In order to identify the liberation of endotoxin from Gram-negative bacteria (*E. coli*) under the influence of the addition of honey or Tamarind, endotoxin was detected by using the simplest form of the Limulus Amebocyte Lysate (LAL) assay which is a gel-clot assay. Commercially available assay Gel Clot Endotoxin Assay Kit (ToxinSensor™, GenScript) was used. All materials used for sample preparation and test reagent preparation were endotoxin-free. The aseptic technique was used at all times. LAL-endotoxin reaction is pH dependent; an acceptable pH range of between pH 6.0-8.0 was considered to be ideal for use with the Limulus assay. Honeys and Tamarind have an acidic pH ranging from 3.5 to 4.5, 2 to 5, respectively, thus they were adjusted. Endotoxin-free sodium hydroxide solution 0.1N (Sigma Aldrich) or endotoxin-free hydrochloric

acid solution 0.1N (sigma aldrich) was used to adjust the pH level of honey to between 6.0-8.0.

### **5.2.3. Turbidity standard for inoculum preparation**

The inocula was adjusted to  $1.5 \times 10^8$  colony forming units (CFU/ml), which was equivalent to 0.5 McFarland standard. Two morphologically similar isolated colonies were removed with a sterile loop and transferred into a tube containing sterilized distilled water, then mixed by vortex until the suspension became homogenized and, turbidity was adjusted using a spectrophotometer at 600 nm. This suspension was used within 30 minutes of preparation (Andrews, 2001).

### **5.2.4. Reagent preparation**

All the following steps were according to the manufacturer's instructions (ToxinSensor™, GenScript).

### **5.2.5. Preparation of Limulus amoebocyte lysate (LAL) solution**

Lyophilized lysate was reconstituted by adding 2 ml of endotoxin-free water and was swirled gently for at least 30 seconds until all the solid contents dissolved thoroughly. The lysate solution was stored at -20°C or below for up to one week.

### **5.2.6. *E. coli* endotoxin standard**

*Escherichia coli* Endotoxin Standard 0.5 EU/ml was reconstituted by adding 1 ml of LAL reagent water and was mixed thoroughly for at least 15

minutes using a vortex-mixer so as to obtain the endotoxin stock solution. Reconstituted endotoxin standard was stored at -20°C or below for a period of up to 15 days.

#### **5.2.7. Test procedure**

The inocula of *E. coli* was added to 0.1 ml of honey sample and then incubated for 24h; then this mixture was added to 0.1 ml of Limulus Amoebocyte Lysate solution in disposable endotoxin-free glass test tubes. Then the tubes were capped and shaken thoroughly. All tubes were then placed in an incubation rack and incubated at 37°C for 60 minutes. After incubation, the presence of a gel clot was considered a positive result.

Four types of control were set up; the first as a positive control (*E. coli* endotoxin standard at 0.5 EU/ml only), the second as a negative control (LAL reagent water), the third containing honey or Tamarind samples and the fourth containing equal amounts of endotoxin-samples.

### 5.3. Results and Discussion

Endotoxin was detected in all 9 honey and Tamarind samples (Table. 10). When *Limulus* Amebocyte Lysate (LAL) solution is combined with a sample containing endotoxin, a gel will be formed proportionally. The presence of a solid gel represented a positive reaction for endotoxin, and the absence of a solid clot or the increase of turbidity or viscosity of the sample was considered as a negative result.

Figure 27 (a and b) shows the results of the positive and negative control. A hard gel formation was noted in the positive control which contained *E. coli* endotoxin standard, the negative control vials had not gelled.

Table 10 shows the results of the presence of endotoxin in the samples. All honey or Tamarind samples (HS) showed negative results. Almost all endotoxin-honey samples (EHS) showed hard gel which was considered a positive result. Almost *E coli*-honey samples vials (EHT) showed negative results, that is none gelled after a sixty-minute incubation period at 37°C, indicating that the endotoxin levels in all the tested samples were less than 0.25 EU/ml (Fig. 27). Brezzo Italian Lemon honey was the only honey that showed a positive result, indicating that the endotoxin in the tested sample was more than 0.25 EU/ml (Fig. 27). The formation of hard gel in Brezzo honey could be due to endotoxin release or may be due to the crystallized texture of this honey.

In conclusion, since endotoxin causes a significant problem to the consumers, previous results showed that honey is generally successful in killing bacteria without the release of measurable endotoxin, a finding which could prove beneficial.

<b>Sample</b>	<b>HS</b>	<b>EHS</b>	<b>EHT</b>
<b>Manuka 24+</b>	-	+	-
<b>Manuka 15+</b>	-	+	-
<b>Wild Rata</b>	-	-	-
<b>Beech Forest</b>	-	+	-
<b>Attiki Firtree Greek</b>	-	+	-
<b>Greek Pine</b>	-	+	-
<b>Antibacterial Medical gel</b>	-	+	-
<b>Brezzo Italian Lemon</b>	-	+	+
<b>New Zealand Rewarewa</b>	-	+	-
<b>Ogilvy</b>	-	+	-
<b>Tamarind</b>	-	+	-

Table 10. The presence of endotoxin in honeys and Tamarind.

+: firm gel formed, -: no gel formed,

HS: honey or Tamarind samples.

EHS: endotoxin-honey samples.

EHT: *E. coli*-honey samples test.



Figure 27. The detection of endotoxin in honey samples.



**(a) Negative control:** LAL reagent water, negative result.



**(b) Positive control:** *E. coli* endotoxin standard 0.5 EU/ml only, positive result.

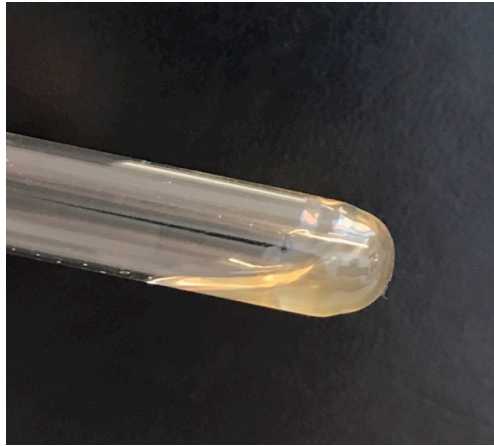

(c) *E. coli*-honey samples (EHT): Manuka 24+ honey, negative result.

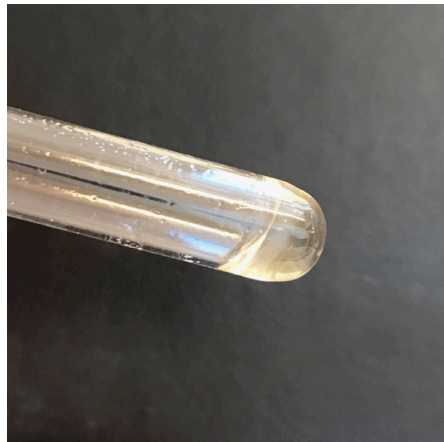

(d) *E. coli*-honey samples (EHT): Brezzo Italian Lemon honey, positive result.

# **Chapter Six**

## **Final Discussion**

## 6.1. Final Discussion

The use of honey in folk medicine has an extremely long history and dates back through all of the classical civilizations (Erejuwa *et al.*, 2012). The medical use of honey has now been re-discovered and has recently been subjected to modern clinical trials (Alam *et al.*, 2014). Honey is of course widely used as a food but can be applied to the treatment of diseases (Chen *et al.*, 2012), to prevent infections (Sufya *et al.*, 2014) as well as a gastrointestinal remedy (Kwakman *et al.*, 2011). The Russians used honey in the World War I in order to heal wounds, while a combination of honey and cod liver oil was used by the Germans in the treatment of a wide variety of medical problems including ulcers and burns (Bansal *et al.*, 2005). Honey is now being widely used with success to treat infected wounds that do not respond to standard antibiotic and antiseptic therapy (Molan, 1992). It is also being used in hospitals and other healthcare settings to treat ulcers and bed sores and for infections which result from burns, wounds and surgical operations. Honey has also been found to be effective against organisms isolated from urinary tract infections, in the treatment of infantile gastroenteritis (Theunissen *et al.*, 2001), and in the management of diabetes mellitus (Erejuwa *et al.*, 2012). In the past decade, a renewed research interest in honey has arisen which has led to an increasing number of clinical trials, and research that has led to attribution

of several medicinal effects to honey, including cardio-protective properties and hepatoprotective, hypoglycemic, antioxidant and antihypertensive effects. Honey also shows antibacterial, anti-viral, anti-fungal, anti-inflammatory and antitumor effects (Erejuwa *et al.*, 2012). A number of studies have shown that honey effectively limits the colonization of wounds by bacteria and helps wound healing compared, for example, with silver sulfadiazine treatment (Sufya *et al.*, 2014). Honey has found a particularly important role in the treatment of venous leg ulcers, chronic leg ulcers, burns, pressure ulcers, and exit sites for central venous catheters (Alam *et al.*, 2014). Honey is also used to treat eye problems like blepharitis, keratitis, conjunctivitis, injuries to the cornea and chemical and thermal burns to eyes (Bansal *et al.*, 2005). Honey has an extremely wide effectiveness against many types of infectious microbes (Sufya *et al.*, 2014), largely because it can stimulate leukocytes to release cytokines which help in wound healing and the repair of tissues. Honey also stimulates immune response to infection through the proliferation of B- and T- lymphocytes as well as phagocyte-action (Yaghoobi *et al.*, 2013). All types of wounds are improved by the application of honey, including abscesses, abrasions, burns, amputation wounds, bed sores, cracked nipples, chill blains, burst abdominal wounds, decubitus ulcers, leprosy ulcers cervical ulcers, traumatic ulcers, diabetic ulcers, fistulas, septic wounds, varicose ulcers, malignant ulcers, sickle cell ulcers, surgical

wound or wounds to abdominal wall and perineum have been found to be responsive to honey therapy (Bansal *et al.*, 2005). Honey is also used with success following the radical surgical removal of breast cancer. It has a number of advantages in all medical applications mainly because it causes few side effects, although some people are allergic to honey, and other bee products such as pollen. Continued use can, however, lead to the dehydration of tissues, a side effect which can fortunately be treated using saline packs (Bansal *et al.*, 2005). The presence of spores of *Clostridium* can also theoretically present problems in relation to botulism, although, since medical honeys are sterilized by gamma irradiation before use, this should not present a major obstacle to their use, where it does not affect its antibacterial activity (Bansal *et al.*, 2005). Raw, unsterilized honey should not be given by mouth to infants, or applied to wounds or lesions (Al-Waili *et al.*, 2012).

In the work presented in this Thesis, the lowest minimum inhibitory concentrations (MICs) was for Antibacterial Medical honey, Manuka 15+ and Tamarind, while Manuka 15+ and Tamarind produced the lowest MBC values. Manuka honey +24, Manuka honey +15 (which are produced from the botanical source *Leptospermum scoparium*) were shown to be non-peroxide honeys. The effectiveness of honey was significantly increased after mixing each different honey with Tamarind. Finally, a number of

honey-antibiotic combinations were seen to interact positively to inhibit the growth of bacteria.

The precise antimicrobial and wound-healing properties of honey are not clearly understood although high sugar content, low water activity, low pH, and hydrogen peroxide release following dilution are thought to be the main factors involved, as is the presence of methylglyoxal (MGO) in Manuka honey (Liu *et al.*, 2015). MGO is a 1,2-dicarbonyl compound and is formed by conversion of dihydroxyacetone (DHA) present in exceptionally large amounts in Manuka tree nectar (*Leptospermum scoparium* (Kwakman *et al.*, 2011). Hydrogen peroxide is by far the most important antimicrobial present in most honeys, being produced by the enzyme glucose oxidase which is produced by the bee (Chen *et al.*, 2012); another enzyme, flower-originated, catalase also plays an important role in the antibacterial properties of honey (Zainol, 2013). As has been demonstrated in the work presented in this Thesis, Manuka honey also exhibits antibacterial activity which is not related to the presence of peroxide, showing that it is a “non-peroxide honey” due to the presence of a number of non-peroxide components including: methylglyoxal (MGO), bee defensin-1, antibacterial peptides, flavonoids, phenols compounds, methyl syringate (Zainol, 2013). Most honeys, in fact, show no non-peroxide activity and their antibacterial properties, are destroyed by the

addition of catalase (Zainol, 2013). Manuka honey used in medicine is labelled with a “Unique Manuka Factor” UMFTM, which indicate its antibacterial strength (Kwakman *et al.*, 2011). The amount of MGO in Manuka honey varies with the Manuka tree variety and the climate (Irish *et al.*, 2011).

Tamarind extract (from the tree, *T. indica*) is an inexpensive, readily available material which is a valuable source of phytochemicals, vitamins and essential amino acids. The root, body, fruit and leaves of this plant are of use and the tamarind fruit is a particularly good source of all essential amino acids with the exception of tryptophan and the seeds are rich in useable protein (Kuru, 2014). Confirmation of the antibacterial effects of Tamarind has been provided in this Thesis.

### **Health related effects of *Tamarindus indica***

Tamarind is recommended for the following complaints:

1. Gastrointestinal system and related disorders
2. Laxative
3. Abdominal pain, diarrhea and dysentery
4. Peptic ulcer
5. Spasmolytic effects



## 6. Cancer

## 7. Antimicrobial, antiparasitic, antifungal, antiviral and antinematodal features (Kuru, 2014).

Tamarind is a potentially effective antimicrobial agent and is effective against *Klebsiella pneumonia*, *Burkholderia pseudomallei*, *Salmonella paratyphi*, *Salmonella typhi*, *Bacillus subtilis*, *Escherichia coli* and *Staphylococcus aureus* (Kuru, 2014). The antibacterial properties of Tamarind are linked to the presence of lupeol, while tannin is also found in *T. indica* and confers its anti-parasitic properties (Kuru, 2014). Fruits of *T. indica* are also an antipyretic, while the leaves provide an effective malaria treatment. Tamarind is also an effective antifungal agent and is effective against *Aspergillus niger* and *Candida albicans*; *T. indica* plant extracts also exhibit antiviral properties (Kuru, 2014).

Tamarind has been used in medicine based on its:

1. Anti-inflammatory effects
2. Antioxidant properties
3. Anti-diabetic effects
4. Effects on cardiovascular system
5. Liver protective effects

6. Weight control effects
7. Effect on fluoride toxicity
8. Wound healing
9. Anti-asthma effects
10. Nerve repair
11. Ability to improve iron bioavailability (Kuru, 2014).

Combination therapy (i.e. the use of different antimicrobials), having differing modes of action in combination, can be used to great effect (even at low doses) to overcome antibiotic resistance (Liu *et al.*, 2015; Jenkins and Cooper, 2012a) and thereby improve treatment-efficacy and allow for the continued use of existing antimicrobials in the absence of new antimicrobial compounds (Liu *et al.*, 2015). Both honey and tamarind are possible candidates for use as synergistic agents in combination with antibiotics. A synergistic action between an Indian honey and antibiotics against MDR bacteria has been demonstrated and mixtures of honey and gentamicin, ceftazidime and amikacin have been shown to synergistically inhibit six strains *P. aeruginosa*, but not eight *Klebsiella* strains (Jenkins and Cooper, 2012a).

In conclusion, the results presented in this Thesis show that a wide range of honeys, most notably Manuka honey are antibacterial against a wide range of potential pathogens and that their activity can be effectively increased by use in combination therapy. While the antibacterial properties of honey have been widely studied and honey is being effectively used to treat wound infections (notably for the treatment of indolent ulcers), Tamarind has been less widely studied and as a result, is not widely used in Western medicine. Tamarind would appear, however, to be potentially as useful as honey for use in wound treatment and the results presented here suggest that more research effort, leading to clinical trials should be devoted to the antibacterial use of this cheap and readily available phyto-product.

## **6.2. Suggestions for future work**

1) The obvious nature of the work presented here is that it refers solely to *in vitro* studies. It is therefore obvious that clinical trials need to be conducted on the honeys used here to determine their true effectiveness as curative agents, particularly in diseases like indolent ulcer of the leg which is particularly common in elderly patients suffering from Type 2 diabetes.

2) While the effectiveness of a wide range of honeys (notably Manuka varieties) against pathogenic bacteria, including MRSA, has been extensively studied, few studies have appeared relating to the effectiveness and use of Tamarind in wound care and treatment. Obviously this situation

needs to be rectified, so that the full potential of Tamarind as an antibacterial agent, for use in medicine, can be realized.

## References

- Abd-El, A.M., El-Hadidy, M.R., El-Mashad, N.B. and El-Sebaie, A.H.** (2007). Antimicrobial effect of bee honey in comparison to antibiotics on organisms isolated from infected burns. *Annals of Burns and Fire Disasters*, 2, 83- 88.
- Abdulraheem, A., Mustafa, S., Al-Saffar, N. and Shahjahan, M.** (2012) Detection of bacterial endotoxin in drinking tap and bottled water in Kuwait. *Environmental Monitoring and Assessment*, 184, 7323– 7328.
- Adhikari, A., Syamaladevi, M., Killinger, K. and Sablani, S.** (2015). Ultraviolet-C light inactivation of *Escherichia coli* O157:H7 and *Listeria monocytogenes* on organic fruit surfaces. *International Journal of Food Microbiology*, 210, 136– 142.
- Alam, F., Islam, Md., Gan, S. and Khalil, Md.** (2014). Review article: Honey: A potential therapeutic agent for managing diabetic wounds. *Evidence-Based Complementary and Alternative Medicine*, 1- 16.
- Allen, H., Trachsel, J., Looft, T. and Casey, T.** (2014). Finding alternatives to antibiotics. *Annals of the New York Academy of Sciences*, 1323, 91– 100.
- Al-Naama, R.** (2009). Evaluation of *in-vitro* inhibitory effect of honey on some microbial isolate. *Journal of Bacteriology Research*, 1, 64- 67.

**Alvarez-Suarez, J., Gasparri, M., Forbes-Hernández, T., Mazzoni, L. and Giampieri, F.** (2014). The composition and biological activity of honey: A focus on Manuka honey. *Foods*, 3, 420- 432.

**Andrews, J.** (2001). BSAC standardized disc susceptibility testing method. *Journal of Antimicrobial Chemotherapy*, 48, 43- 57.

**Al-Waili, N., Salom, K., Al-Ghamdi, A. and Ansari, M.** (2012). Antibiotic, pesticide, and microbial contaminants of honey: Human health hazards. *The Scientific World Journal*, 2012, 1- 9.

**Bansal V., Medhi B. and Pandhi P.** (2005). Honey – a remedy rediscovered and its therapeutic utility. *Kathmandu University Medical Journal*, 3, 305- 309.

**Baquero, F.** (1997). Gram-positive resistance: challenge for the development of new antibiotics. *Journal of Antimicrobial Chemotherapy*, 39, 1- 6.

**Blechova, R. and Pivodova, D.** (2001). Limulus amoebocyte lysate (LAL) test-an alternative method for detection of bacterial endotoxin. *Acta Veterinaria Brunensis*, 70, 291- 296.

**Brudzynski, K. and Lannigan, R.** (2012). Mechanism of honey bacteriostatic action against MRSA and VRE involves hydroxyl radicals

generated from honey's hydrogen peroxide. *Frontiers in Microbiology*, 3, 1- 8.

**Chalupniak, A., Waszczuk, K., Halubek-Głuchowska, G., Piasecki, T. and Rybka, J.** (2014). Application of quartz tuning forks for detection of endotoxins and Gram-negative bacterial cells by monitoring of *limulus* ameocyte lysate coagulation. *Biosensors and Bioelectronics*, 58, 132–137.

**Chen, C., Campbell, L., Blair, S. and Carter, D.** (2012). The effect of standard heat and filtration processing procedures on antimicrobial activity and hydrogen peroxide levels in honey. *Frontiers in Microbiology*, 3, 1- 8.

**Choo, E. and Chambers, H.** (2016). Treatment of methicillin-resistant *Staphylococcus aureus* Bacteremia. *Infection and Chemotherapy*, 48, 267-273.

**Croft, A., D'Antoni, A. and Terzulli, S.** (2007). Update on the antibacterial resistance crisis. *Medical Science Monitor*, 13, 103- 118.

**Croxen, M.** (2013). Recent advances in understanding enteric pathogenic *Escherichia coli*. *Clinical Microbiology Review*, 26, 822– 880.

**Dai, T., Vrahas, M., Murray, C. and Hamblin, M.** (2012). Ultraviolet C irradiation: an alternative antimicrobial approach to localized infections? *National Institutes of Health*, 10, 185–195.

**Das, A., Kumar, P. and Swain, S.** (2014). Recent advances in biosensor based endotoxin detection. *Biosensors and Bioelectronics*, 51, 62– 75.

**Deb Mandal, M. and Mandal, S.** (2011). Honey: its medicinal property and antibacterial activity. *Asian Pacific Journal of Tropical Biomedicine*, 1, 154- 160.

**DeLeo, F., Otto, M., Kreiswirth, B. and Cambers H.** (2010). Community-associated methicillin-resistant *Staphylococcus aureus*. *National Institutes of Health*, 1, 1557- 1568.

**Doughari, J.** (2006). Antimicrobial activity of *Tamarindus indica* Linn. *Tropical Journal of Pharmaceutical Research*, 5, 597- 603.

**Erejuwa, O., Sulaiman, S. and Wahab, M.** (2012). Honey - a novel antidiabetic agent. *International Journal of Biological Sciences*, 8, 913- 934.

**Garrido-Pereira, M., Braga, A., Rocha, A., Sampaio, L. and Abreu, P.** (2013). Effect of ultraviolet (UV) radiation on the abundance and respiration rates of probiotic bacteria. *Aquaculture Research*, 44, 261– 267.

**Gupta, A., Avci, P., Dai, T., Huang, Y. and Hamblin, M.** (2012). Ultraviolet radiation in wound care: sterilization and stimulation. *Wound Healing Society*, 2, 422- 436.



**Gupta, C., Prakash, D. and Gupta, S.** (2014). Studies on the antimicrobial activity of Tamarind (*Tamarindus indica*) and its potential as food bio-preservative. *International Food Research Journal*, 21, 2437-2441.

**Hayashi, K., Fukushima, A., Hayashi-Nishino, M. and Nishino, K.** (2014). Effect of methylglyoxal on multidrug-resistant *Pseudomonas aeruginosa*. *Frontiers in Microbiology*, 5, 1- 6.

**Holden, M., Feil, E., Lindsay, J., Peacock, S., Day, N., Enright, M., Foster, T., Moore, C., Hurst, L., Atkin, R., Barron, A., Bason, N., Bentley, S., Chillingworth, C., Chillingworth, T., Churcher, C., Clark, L., Corton, C., Cronin, A., Doggett, J., Dowd, L., Feltwell, T., Hance, Z., Harris, B., Hauser, H., Holroyd, S., Jagels, K., James, K., Lennard, N., Line, A., Mayes, R., Moule, S., Mungall, K., Ormond, D., Quail, M., Rabinowitsch, E., Rutherford, K., Sanders, M., Sharp, S., Simmonds, M., Stevens, K., Whitehead, S., Barrell, B., Spratt, B. and Parkhill, J.** (2004). Complete genomes of two clinical *Staphylococcus aureus* strains: Evidence for the rapid evolution of virulence and drug resistance. *PNAS*, 101, 9786– 9791.

**Hortnagl, P., Perez, M. and Sommaruga, R.** (2010). Contrasting effects of ultraviolet radiation on the growth efficiency of freshwater bacteria. *Aquatic Ecology*, 45, 125– 136.

**Irish, J., Blair, S. and Carter, D.** (2011). The antibacterial activity of honey derived from Australian flora. *PLoS ONE*, 6, 1- 9.

**Jadhav, D., Sahoo, A., Ghosh, J., Ranveer, R. and Mali, A.** (2010). Phytochemical detection and *in vitro* evaluation of tamarind fruit pulp for potential antimicrobial activity. *International Journal of Tropical Medicine*, 5, 68- 72.

**Jafari, A., Aslani, M. and Bouzari, S.** (2012). Review: *Escherichia coli*: a brief review of diarrheagenic pathotypes and their role in diarrheal diseases in Iran. *Iran Journal of Microbiology*, 4, 102-117.

**Jenkins, R., and Cooper, R.** (2012b). Synergy between oxacillin and manuka honey sensitizes methicillin-resistant *Staphylococcus aureus* to oxacillin. *Journal of Antimicrobial Chemotherapy*, 67, 1405- 1407.

**Jenkins, R. and Cooper, R.** (2012a). Improving antibiotic activity against wound pathogens with Manuka honey *in vitro*. *PLoS One*, 7, 1- 9.

**Kuru, P.** (2014). *Tamarindus indica* and its health related effects. *Asian Pacific Journal of Tropical Biomedicine*, 4, 676- 681.

**Kwakman, P., Velde, A., Boer, L., Vandenbroucke-Grauls, C. and Zaat, S.** (2011). Two major medicinal honeys have different mechanisms of bactericidal activity. *PLoS One*, 6, 1- 7.

**Liltved, H. and Landfald, B.** (2000). Effects of high intensity light on ultraviolet-irradiated and non-irradiated fish pathogenic bacteria. *Water Research* 34, 481- 486.

**Liu, M., Lu, J., Müller, P., Turnbull, L., Burke, C., Schlothauer, R., Carter, D., Whitchurch, C. and Harry. E.** (2015). Antibiotic-specific differences in the response of *Staphylococcus aureus* to treatment with antimicrobials combined with Manuka honey. *Frontiers in Microbiology*, 5, 1- 9.

**Maclean, M., MacGregor, S., Anderson, J. and Woolsey, G.** (2009). Inactivation of bacterial pathogens following exposure to light from a 405-nanometer light-emitting diode array. *Applied and Environmental Microbiology*, 75, 1932– 1937.

**Maktabi, S., Watson, I. and Parton, R.** (2011). Synergistic effect of UV, laser and microwave radiation or conventional heating on *E. coli* and on some spoilage and pathogenic bacteria. *Innovative Food Science and Emerging Technologies*, 12, 129-134.

**Manten, A.** (1981). Side effects of antibiotics. *Veterinary Quarterly*, 3, 179- 182.

**Mansor, A., Shamsudin, R., Adzahan, N. and Hamidon, M.** (2014). Efficacy of ultraviolet radiation as non-thermal treatment for the

inactivation of *Salmonella typhimurium* TISTR 292 in pineapple fruit juice. *Agriculture and Agricultural Science Procedia*, 2, 173– 180.

**Miorin, P., Levy Junior, N., Custodio, A., Bretz, W. and Marcucci, M.** (2003). Antibacterial activity of honey and propolis from *Apis mellifera* and *Tetragonisca angustula* against *Staphylococcus aureus*. *Journal of Applied Microbiology*, 95, 913– 920.

**Molan, P.** (1992). The antibacterial activity of honey 2. Variation in the potency of the antibacterial activity. *Bee World*, 73, 5- 28.

**Montgomery, N. and Banerjee, P.** (2015). Inactivation of *Escherichia coli* O157:H7 and *Listeria monocytogenes* in biofilms by pulsed ultraviolet light. *Bio Med Central Research Notes*, 8, 235.

**Mukherjee, S., Chaki, S., Das, S., Sen, S., Dutta, S., & Dastidar, S.** (2011). Distinct synergistic action of piperacillin and methylglyoxal against *Pseudomonas aeruginosa*. *Indian Journal of Experimental Biology*, 49, 547- 551.

**Müller, P., Alber, D., Turnbull, L., Schlothauer, R., Carter, D., Whitchurch, C. and Harry, E.** (2013). Synergism between medihoney and rifampicin against methicillin-resistant *Staphylococcus aureus* (MRSA). *PLoS One*, 8, 1- 9.

**Mulvey, M. and Simor, A.** (2009). Review: Antimicrobial resistance in hospitals: How concerned should we be? *Canadian Medical Association Journal*, 180, 408- 415.

**Nonga, H., Simforian, E. and Ndabikunze, B.** (2014). Assessment of physicochemical characteristics and hygienic practices along the value chain of raw fruit juice vended in Dar es Salaam City, Tanzania. *Tanzania Journal of Health Research*, 16, 1- 12.

**Nordback, I. Kulmala, R. and Jarvinen, M.** (1990). Effect of ultraviolet therapy on rat skin wound healing. *Journal of Surgical Research*, 48, 68-71.

**Olsen, R., Hoffmann, F., Hess-Erga, O., Larsen, A., Thuestad, G. and Hoell, I.** (2016). Ultraviolet radiation as a ballast water treatment strategy: Inactivation of phytoplankton measured with flow cytometry. *Marine Pollution Bulletin*, 103, 270– 275.

**Pantosti, A.** (2012). Methicillin-resistant *Staphylococcus aureus* associated with animals and its relevance to human health. *Frontiers in Microbiology*, 3, 1- 12.

**Rigby, K. and DeLeo, F.** (2011). Neutrophils in innate host defense against *Staphylococcus aureus* infections. *Seminars in Immunopathology*, 34, 237– 259.

**Santos, A., Moreirinha, C., Lopes, D., Esteves, A., Henriques, I., Almeida, A., Domingues, M., Delgadillo, I., Correia, A. and Cunha, A.** (2013). Effects of UV radiation on the lipids and proteins of bacteria studied by Mid-Infrared spectroscopy. *Environmental Science & Technology*, 47, 6306– 6315.

**Sharrer, M. and Summerfelt, S.** (2007). Ozonation followed by ultraviolet irradiation provides effective bacteria inactivation in a freshwater recirculating system. *Aquacultural Engineering*, 37, 180– 191.

**Sharrer, M., Summerfelt, S., Bullock, G., Gleason, L. and Taeuber, J.** (2005). Inactivation of bacteria using ultraviolet irradiation in a recirculating salmonid culture system. *Aquacultural Engineering*, 33, 135– 149.

**Shah, N., Shamsuddin, R., Abdul Rahman, R. and Adzahan, N.** (2014). Effects of physicochemical characteristics of Pummelo fruit juice towards UV inactivation of *Salmonella typhimurium*. *Agriculture and Agricultural Science Procedia*, 2, 43– 52.

**Sosnin, E., Stoffels, E., Erofeev, M., Kieft, I. and Kunts, S.** (2004). The effects of UV irradiation and gas plasma treatment on living mammalian cells and bacteria: A comparative approach. *IEEE Transaction on Plasma Science*, 32, 1544– 1550.

**Sowash, M. & Uhlemann, A.** (2014). Community-associated methicillin-resistant *Staphylococcus aureus* case studies. *National Institutes of Health*, 1085, 25– 69.

**Su, W. and Ding, X.** (2015). Methods of endotoxin detection. *Journal of Laboratory Automation*, 20, 354– 364.

**Sufya, N., Matar, N., Kaddura, R. and Zorgani, A.** (2014). Evaluation of bactericidal activity of Hannon honey on slowly growing bacteria in the chemostat. *Drug, Healthcare and Patient Safety*, 6, 139– 144.

**Theunissen, F., Grobler, S. and Gedalia, I.** (2001). The antifungal action of three South African honeys on *Candida albicans*. *Apidologie*, 32, 371-379.

**Thornalley, P.** (1996). Pharmacology of methylglyoxal: formation, modification of proteins and nucleic acids, and enzymatic detoxification-A role in pathogenesis and antiproliferative chemotherapy. *General Pharmacology*, 27, 565- 573.

**Tiwari, H. & Sen, M.** (2006). Emergence of vancomycin resistant *Staphylococcus aureus* (VRSA) from a tertiary care hospital from northern part of India. *Bio Med Central. Infectious Diseases*, 6, 156.

**Torella, J., Chait, R. and Kishony, R.** (2010). Optimal drug synergy in

antimicrobial treatments. *PLoS Comput Biol*, 6, e1000796.

**Viuda-Martos, M., Ruiz-Navajas, Y., Fwrnandez-Lopez , J. and Perez-Alvarez, J. A.** (2008). Functional properties of honey, propolis, and royal jelly. *Journal of Food Science*, 73, 117- 24.

**Yaghoobi, R., Kazerouni, A. and kazerouni, O.** (2013). Evidence for clinical use of honey in wound healing as an anti-bacterial, anti-inflammatory anti-oxidant and anti-viral agent: A review. *Jundishapur Journal of Natural Pharmaceutical Products*, 8, 100- 104.

**Yin, F., Zhu, Y., Koutchma, T. and Gong, J.** (2014). Inactivation and potential reactivation of pathogenic *Escherichia coli* O157:H7 in apple juice following ultraviolet light exposure at three monochromatic wavelengths. *Food Microbiology*, 46, 329- 335.

**Yun, J., Yan, R., Fan, X., Gurtler, J. and Phillips, J.** (2013). Fate of *E. coli* O157:H7, *Salmonella* spp. and potential surrogate bacteria on apricot fruit, following exposure to UV-C light. *International Journal of Food Microbiology*, 166, 356– 363.

**Zainol, M., Yusoff, K., and Yusof, M.** (2013). Antibacterial activity of selected Malaysian honey. *Bio Med Central*, 13, 129.

**Zinner, S.** (2007). Antibiotic use: present and future. *New Microbiologica*,



30, 321- 325.

# **APPENDICES**

# Appendix 1

## Peroxide test

### QUANTOFIX® Peroxide 25

en

**Pack content:**

1 aluminium container with 100 test strips

**Hazard warnings:**

This test does not contain hazardous substances that must be labelled.

**General indications:**

Remove only as many test strips as are required. Close the container immediately after removing a strip. Do not touch the test field.

**Additional indications:**

QUANTOFIX® Peroxide 25 is also suitable for the detection of peracetic acid, as well as other organic and free inorganic hydroperoxides. When detecting hydroperoxides in organic solvents, moisten the test field with 1 drop of water after evaporation/drying of the solvent.

**Instructions for use:**

1. Dip the test strip into the test solution for 1 s.
2. Shake off excess liquid.
3. Wait 15 s.
4. Compare with the color scale. If hydrogen peroxide is present, the test field turns blue.

**Interferences:**







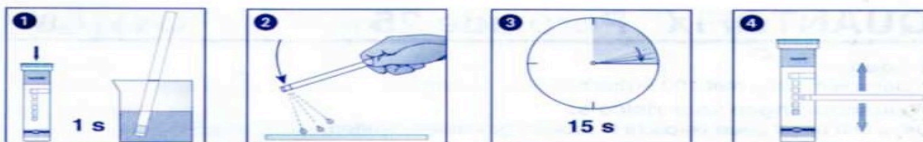

If the sample solution has a pH value of 2–12, the reaction will take place without interferences. Strongly acidic solutions must be buffered with sodium acetate, and alkaline solutions with citric acid to a pH of 5–7. Only the presence of strong oxidants interferes with the determination.

**Storage:**

Avoid exposing the strips to sunlight and moisture. Keep container cool and dry (storage temperature not above +30 °C). If correctly stored, the test strips may be used until the use-by-date printed on the packaging.

MACHEREY-NAGEL GmbH & Co. KG · Neumann-Neander-Str. 6–8 · 52355 Düren · Germany  
Tel.: +49 24 21 969-0 · Fax: +49 24 21 969-199 · info@mn-net.com · [www.mn-net.com](http://www.mn-net.com)



	Haltbarkeitsdatum / Use by / A utiliser jusqu'à / Fecha de vencimiento / Houdbaarheidsdatum / Data di scadenza / Data ważności		Chargenbezeichnung / Lot number / Numéro de lot / Número de lote / Lotnummer / No del lotto / Oznaczenie szarży
	Artikelnummer / Catalog number / Référence / Art. nro. / Referentienumer / Código articulo / Numer artykułu		Packungsinhalt / Package content / Contenu de la boîte / Contenido del envase / Verpakkingsinhoud / Contenuto della confezione / Zawartość opakowania
	Packung geschlossen halten / Keep container closed / Refermer la boîte / Mantenga el envase cerrado / Verpakking gesloten houden / Conservare la confezione chiusa / Przechowywać pojemnik szczelnie zamknięty		Vor Feuchtigkeit schützen / Protect from humidity / Protéger de l'humidité / Protéjase de la humedad / Beschermen tegen vocht / Proteggere dall'umidità / Chronić przed wilgocią
	Lagertemperatur / Storage temperature / Température de stockage / Temperatura de almacenaje / Bewaar temperatuur / Temperatura di magazzino / Temperatura przechowywania		Packungsbeilage lesen / Please read instructions / Lire les instructions, svp / Obsérvense las instrucciones de uso / Lees de bijsluiter / Leggere il foglio informativo / Należy przeczytać ulotkę informacyjną
	Sicherheitshinweise in der Packungsbeilage beachten / Observe the safety precautions in instructions / Respected les précautions de sécurité des instructions / Obsérvense las indicaciones de seguridad / Neem de veiligheidsrichtlijnen in de bijsluiter in acht / Seguire le avvertenze di sicurezza / Należy przestrzegać uwag zawartych w ulotce informacyjnej		

Rev 2011-09 A007802/913 19/09215

# Appendix 2

## Manufacturer information of UV lamps

### EL Series Ultraviolet Hand Lamps User's Guide

---

#### Introduction

The EL Series of Ultraviolet Lamps offer a uniform and intense source of ultraviolet light (radiation). The lamps emit one of three UV wavelengths or white light in four watt, six watt and eight watt configurations for exposure/illumination of materials. All EL Series Lamp models can be used with the universal J138 Lamp Stand. The four watt models can be used with C-10E Cabinet for viewing materials in a darkroom environment. Eight watt lamps can be used with the C-65 Cabinet.

#### Important Safety Information

Caution: Shortwave and midrange UV radiation will cause damage to unprotected eyes and skin. Before operating any unit, be sure all personnel in the area are properly protected. UV Blocking Eyewear should be worn as well. UVP has a complete line of UV Blocking Eyewear: Spectacles, Goggles and Faceshield designed for this purpose.

#### Operation

Plug power cord into a properly grounded electrical outlet. The proper voltage of the lamp is found on the product information label.

A rocker switch is conveniently located on top of the unit to turn the lamp on or off. For models with multiple wavelengths, the rocker switch accommodates for the selection of wavelength or to shut the unit off.

Each lamp comes with two UV tubes or one UV and one white light tubes; the UVLSM-38 is equipped with three tubes. Models with two tubes of the same wavelength operate with both tubes on at same time. Other models operate with only a single tube at one time.

#### Specifications

Physical dimensions for four, six and eight watt lamps:

Four watt lamps:	9.8"L x 2.5"H x 3.8"W (249 x 64 x 97 mm)
Six watt lamps:	11.9"L x 2.5"H x 3.8"W (302 x 64 x 97 mm)
Eight watt lamps:	14.9"L x 2.5"H x 3.8"W (376 x 64 x 97 mm)



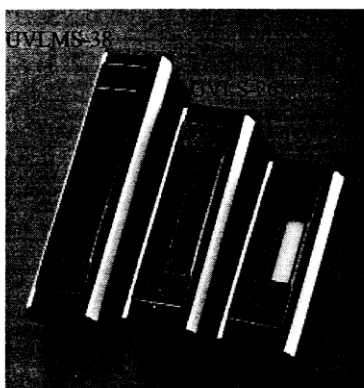

C-10E Cabinet with four watt lamp

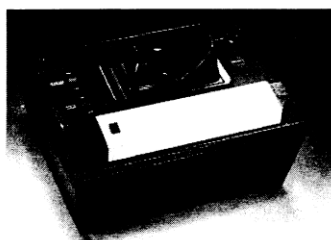

C-65 Cabinet with eight watt lamp

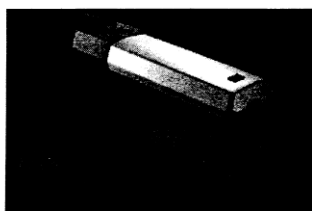

Universal stand for all EL Series Lamps

#### Four Watt Lamp Specifications

Model	Wavelength	Part Number	Nominal Volts/Hz/Amp
UVS-14	254nm/White Light	95-0266-01	115/60/0.16
		95-0266-02	230/50/0.16
		95-0266-03	100/50-60/0.16
UVL-14	365nm/White Light	95-0264-01	115/60/0.16
		95-0264-02	230/50/0.16
		95-0264-03	100/50-60/0.16
UVS-24	254nm	95-0269-01	115/60/0.32
		95-0269-02	230/50/0.32
		95-0269-03	100/50-60/0.32
UVL-24	365nm	95-0267-01	115/60/0.32
		95-0267-02	230/50/0.32
		95-0267-03	100/50-60/0.32
UVLS-24	365nm/254nm	95-0271-01	115/60/0.16
		95-0271-02	230/50/0.16
		95-0271-03	100/50-60/0.16

#### Six Watt Lamp Specifications

Model	Wavelength	Part Number	Nominal Volts/Hz/Amp
UVS-16	254nm/White Light	95-0274-01	115/60/0.16
		95-0274-02	230/50/0.16
		95-0274-03	100/50-60/0.16
UVL-16	365nm/White Light	95-0272-01	115/60/0.16
		95-0272-02	230/50/0.16
		95-0272-03	100/50-60/0.16
UVM-16	302nm/White Light	95-0273-01	115/60/0.16
		95-0273-02	230/50/0.16
		95-0273-03	100/50-60/0.16
UVS-26	254nm	95-0277-01	115/60/0.32
		95-0277-02	230/50/0.32
		95-0277-03	100/50-60/0.32
UVL-26	365nm	95-0275-01	115/60/0.32
		95-0275-02	230/50/0.32
		95-0275-03	100/50-60/0.32
UVM-26	302nm	95-0276-01	115/60/0.32
		95-0276-02	230/50/0.32
		95-0276-03	100/50-60/0.32
UVLS-26	365nm/254nm	95-0279-01	115/60/0.16
		95-0279-02	230/50/0.16
		95-0279-03	100/50-60/0.16
UVLM-26	365nm/302nm	95-0278-01	115/60/0.16
		95-0278-02	230/50/0.16
		95-0278-03	100/50-60/0.16

### Eight Watt Lamp Specifications

Model	Wavelength	Part Number	Nominal Volts/Hz/Amp
UVS-18	254nm/White Light	95-0200-01	115/60/0.16
		95-0200-02	230/50/0.16
		95-0200-03	100/50-60/0.16
UVL-18	365nm/White Light	95-0198-01	115/60/0.16
		95-0198-02	230/50/0.16
		95-0198-03	100/50-60/0.16
UVM-18	302nm/White Light	95-0199-01	115/60/0.16
		95-0199-02	230/50/0.16
		95-0199-03	100/50-60/0.16
UVS-28	254nm	95-0249-01	115/60/0.32
		95-0249-02	230/50/0.32
		95-0249-03	100/50-60/0.32
UVL-28	365nm	95-0248-01	115/60/0.32
		95-0248-02	230/50/0.32
		95-0248-03	100/50-60/0.32
UVM-28	302nm	95-0250-01	115/60/0.32
		95-0250-02	230/50/0.32
		95-0250-03	100/50-60/0.32
UVLS-28	365nm/254nm	95-0201-01	115/60/0.16
		95-0201-02	230/50/0.16
		95-0201-03	100/50-60/0.16
UVLM-28	365nm/302nm	95-0251-01	115/60/0.16
		95-0251-02	230/50/0.16
		95-0251-03	100/50-60/0.16
UVLMS-38	365/302/254nm	95-0252-01	115/60/0.16
		95-0252-02	230/50/0.16
		95-0252-03	100/50-60/0.16

### Replacement Tubes and Switches

Replacement Part	Part Number
Switch, On/Off	53-0134-01
Switch, On/Off/On	53-0135-01
Tube, 4 watt, 365nm	34-0005-01
Tube, 4 watt, 254nm	34-0066-01
Tube, 4 watt, white light	34-0003-01
Tube, 6 watt, 365nm	34-0034-01
Tube, 6 watt, 302nm	34-0044-01
Tube, 6 watt, 254nm	34-0015-01
Tube, 6 watt, white light	34-0063-01
Tube, 8 watt, 365nm	34-0006-01
Tube, 8 watt, 302nm	34-0042-01
Tube, 8 watt, 254nm	34-0007-01
Tube, 8 watt, white light	34-0056-01

### Accessories

Accessories	Part Number
J138 Lamp Stand	18-0063-01
C-65 Cabinet	95-0257-01
C-10E Cabinet	95-0072-08
Spectacles	98-0002-01
Goggles	98-0002-02
Faceshield	98-0002-04

### Changing the Replacement Tubes

Always disconnect the lamp from the electrical power source prior to replacing tubes. Remove the two Phillips Head Screws located in the End Cap. Grasp the extruded housing and slide the chassis and filter out together away from the switch. Disconnect the interior Molex Connector (see Figure 1) and slide chassis and filter out of the housing completely. Once out of the extrusion, the chassis and filter will come apart. Carefully grasp the tube ends and twist one quarter turn until it works free (see Figure 2). Insert the new tube, giving it a twist to lock in place. Reassemble the lamp. Be careful not to pinch wires during assembly.

Figure 1

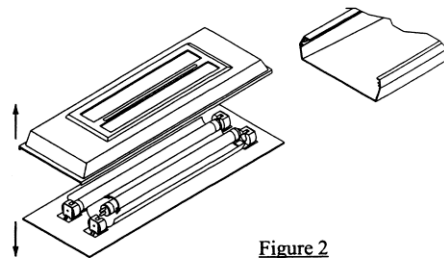
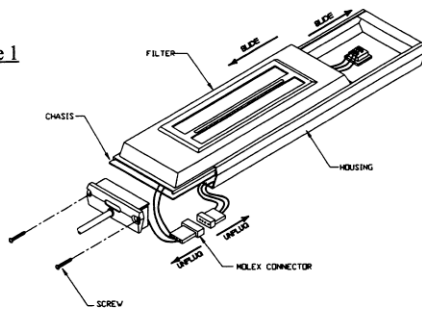

Figure 2

### **Cleaning the EL Series Lamps**

The painted surfaces and filter areas of the lamp should be cleaned with a damp sponge or cloth towel and mild soap. Never use abrasive cleaners, solvent based cleaners or scouring pads.

ALWAYS DISCONNECT THE LAMP FROM THE ELECTRICAL POWER PRIOR TO CLEANING.

### **Maintenance/Repair/Technical Assistance**

UVP offers technical support for all of its products. If you have any questions about the product's use, operation or repair, call or fax UVP Customer Service at the following offices:

In the US: Tel: (909)946-3197 or toll free (800)452-6788; Fax (909)946-3597; E-Mail [uvp@uvp.com](mailto:uvp@uvp.com)  
Europe/UK: Tel: +44(0)1223-420022; Fax: +44(0)1223-420561; E-Mail: [uvp@dial.pipex.com](mailto:uvp@dial.pipex.com)

A **Returned Goods Authorization (RGA)** number must be obtained from UVP Customer Service before returning any products.

### **Warranty**

UVP, Inc. warrants its EL Series Lamps to be free of defects in materials and workmanship for a period of one (1) year from the date of purchase. Tubes and filters are warranted for a period of 90 days. If equipment failure or malfunction occurs during the warranty period, UVP shall examine the inoperative equipment and have the option of repairing or replacing any part(s) which, in the judgement of UVP, were originally defective or became so under conditions of normal usage and service.

No warranty shall apply to this instrument, or part thereof, that has been subject to accident, negligence, alteration, abuse or misuse by the end user. Moreover, UVP makes no warranties whatsoever with respect to parts not supplied by UVP or that have been installed, used and/or serviced other than in strict compliance with the instruments appearing in this manual.

In no event shall UVP be responsible to the end user for any incidental or consequential damages, whether foreseeable or not, including but not limited to property damage, inability to use equipment, lost business, lost profits, or inconvenience arising out of or connected with the use of instruments produced by UVP. Nor is UVP liable or responsible for any personal injuries occurring as a result of the use, installation and/or servicing of equipment.

This warranty does not supersede any statutory rights that may be available in certain countries.



Internet: <http://www.uvp.com>

**Corporate Headquarters: UVP, Inc.**  
2066 W. 11th Street, Upland, CA 91786 USA  
Tel: (909)946-3197 or toll free in US/Canada (800)452-6788  
Fax: (909)946-3597 E-Mail: [uvp@uvp.com](mailto:uvp@uvp.com)

**European Operations: Ultra-Violet Products Limited**  
Unit 1, Trinity hall Farm Estate, Nuffield Road, Cambridge CB4 1TG UK  
Tel: +44(0)1223-420022 Fax: +44(0)1223-420561  
E-mail: [uvpuk@uvp.com](mailto:uvpuk@uvp.com)

81-0117-01 Rev. A

# Appendix 3

## Manufacturer information of Gel Clot Endotoxin Assay



Make Research Easy

### ToxinSensor™ Gel Clot Endotoxin Assay Kit

Cat. No. L00351

Technical Manual No. 0356

Version 02072012

I	Description .....	1
II	Kit Contents .....	1
III	Materials and Equipment Not Provided .....	2
IV	Storage.....	2
V	Endotoxin Detection Protocol.....	2
VI	Ordering Information.....	4

### I DESCRIPTION

GenScript ToxinSensor™ Gel Clot Endotoxin Assay Kit is designed as a simple and sensitive *in vitro* end-product endotoxin test for human and animal parenteral drugs, biological products, and medical devices. The Limulus Amebocyte Lysate (LAL) test is a qualitative test for Gram-negative bacterial endotoxin. Limulus Amebocyte Lysate supplied in the kit needs to be reconstituted with LAL Reagent Water and then mixed in equal parts with the solution being tested. After incubation, and in the presence of endotoxin, gelation occurs; in the absence of endotoxin, gelation does not occur. The kit contains all the necessary reagents and endotoxin-free materials. The sensitivity of LAL in this kit is 0.25 EU/ml. The protocol described herein conforms to those described in the FDA guideline. Similar performance requirements for gel clot assays have been published and are updated regularly in the United States Pharmacopeia.

### II KIT CONTENTS

Components	L00351
Size	40 Assays
Limulus Amebocyte Lysate (LAL), 2 ml/vial	2 vial
LAL Reagent Water, 10 ml/bottle	4 bottles
<i>E. coli</i> Endotoxin Standard, 0.5 EU/vial	2 vials
Endotoxin-free vial	5 × 16
Endotoxin-free Tips, 200 µl	1 box (96 tips)
Endotoxin-free Tips, 1000 µl	2 bags (12 tips)
Incubation Rack	1

### III MATERIALS AND EQUIPMENT NOT PROVIDED

1

---

860 Centennial Ave., Piscataway, NJ 08854, USA

Tel: 1-732-885-9188    Fax: 1-732-210-0262    Email: [order@genscript.com](mailto:order@genscript.com)    Web: [www.genscript.com](http://www.genscript.com)



1. Sodium hydroxide, 0.1 N dissolved in LAL Reagent Water, for pH adjustment.
2. Hydrochloric acid, 0.1 N dissolved in LAL Reagent Water, for pH adjustment.
3. Oven or non-circulating hot water bath ( $37 \pm 1^\circ\text{C}$ )
4. Test tube rack.
5. Vortexer.

#### IV STORAGE

The kit can be stored dry at room temperature for up to one month. For long-term use, the kit can be kept at 2–8°C for up to one year. Do not freeze the kit or any of its components.

#### V ENDOTOXIN DETECTION PROTOCOL

##### 1. Specimen Preparation

All materials or diluents used for specimen collection and test reagent preparation must be endotoxin-free. Use aseptic technique at all times. Samples to be tested must be stored in such a way that all bacteriological activity is stopped or the endotoxin level may increase over time. For example, samples can be stored at 2–8 °C within 24 hours before use, but need to be stored frozen if not used within 24 hours.

Since the LAL-endotoxin reaction is pH dependent, it may be necessary to adjust the pH of the sample to within the range 6.0–8.0 using endotoxin-free sodium hydroxide or hydrochloric acid. Always measure the pH of an aliquot of the bulk sample to avoid contamination by the pH electrode.

Dissolve or dilute test specimen using LAL Reagent Water. It may be necessary to determine the degree of dilution by calculating the MVD value. Maximum Valid Dilution (MVD) is equal to the expected maximum endotoxin concentration in the test sample divided by lambda. Lambda is labeled lysate sensitivity of endotoxin standard. In this kit, lambda is 0.25 EU/ml.

**Note:** The specimen should be certified free of Beta Glucans contaminant which may come from yeast and cellulosic materials, such as blood products.

##### 2. Reagent Preparation

###### Limulus Amebocyte Lysate (LAL)

Reconstitute lyophilized lysate by adding 2 ml LAL Reagent Water to the vial. Swirl gently for at least 30 seconds to thoroughly dissolve the lysate. Do not shake or vortex to avoid foaming. Reconstituted lysate can be stored at -20°C or below for up to one week if frozen immediately after reconstitution. Avoid repeated

freeze and thaw cycles.

### ***E. coli* Endotoxin Standard**

Reconstitute *E. coli* Endotoxin Standard to 0.5 EU/ml by adding 1 ml LAL Reagent Water to the vial. Mix thoroughly for at least 15 minutes with a vortexer to obtain an endotoxin stock solution. Reconstituted endotoxin standard can be stored at -20°C or below for up to 15 days.

### **3. Test Procedure**

Each assay should include both a positive control and a negative control. LAL Reagent Water can be used as a negative control.

- 1) Carefully dispense 0.1 ml of LAL reagent into the endotoxin-free vials. Label them as negative control, positive control and sample, respectively.
- 2) Carefully transfer 0.1 ml of positive control, negative control and the test samples to the LAL reagent in step (1). Cap the vials and mix them thoroughly.
- 3) Place all the vials in the incubation rack and incubate the vials at  $37 \pm 1^\circ\text{C}$  by placing the rack in a non-circulating hot water or oven.
- 4) Remove the rack after  $60 \pm 2$  minutes of incubation, invert each vial and check whether a gel is formed or not.
  - a) A positive reaction is characterized by the formation of a firm gel that remains intact when the vial is inverted.
  - b) A negative reaction is characterized by the absence of a solid clot. The lysate may show an increased turbidity or viscosity. This is considered a negative result.
- 5) Calculation of endotoxin level. In this test, the endotoxin level in the positive sample is equal to or higher than 0.25 EU/ml; while in the negative sample, the endotoxin level is lower than 0.25 EU/ml.

### **4. Application Example**

- 1) Sample: Protein A (1 mg/ml in PBS, pH 7.4) purified from recombinant *E. coli* lysate using Ni-NTA Resin.
- 2) Dilutions using LAL Reagent Water: 1: 200,000, 1: 400,000, 1: 800,000.

The test is performed as the procedure above and the assay result is shown in the table below,

Positive control	Negative control	1: 200,000	1: 400,000	1: 800,000
+	-	+	-	-

- 3) Endotoxin concentration in this sample is, therefore, between 50,000 and 100,000 EU/ml.

**VI ORDERING INFORMATION**

<b>Product Name</b>	<b>Cat. No.</b>
ToxinSensor™ Chromogenic LAL Endotoxin Assay Kit (32 rxns)	L00350
ToxinSensor™ Chromogenic LAL Endotoxin Assay Kit (16 rxns)	L00350C
ToxinSensor™ Gel Clot Endotoxin Assay kit	L00351
ToxinEraser™ Endotoxin Removal kit	L00338

**For *In Vitro* Research Use Only.**

**GenScript USA Inc.**  
860 Centennial Ave.  
Piscataway, NJ 08854  
Tel: 1-877-436-7274  
Fax: 1-732-210-0262  
E-mail: [product@genscript.com](mailto:product@genscript.com)  
Web: [www.genscript.com](http://www.genscript.com)