

**Exploring the role of exercise induced shear
rate upon vascular health throughout the
lifespan**

Gemma Kate Lyall

Submitted in accordance with the requirements for the degree of
Doctor of Philosophy

The University of Leeds
School of Biomedical Sciences
Faculty of Biological Sciences

October 2017

The candidate confirms that the work submitted is his/her own and that appropriate credit has been given where reference has been made to the work of others.

This copy has been supplied on the understanding that it is copyright material and that no quotation from the thesis may be published without proper acknowledgement.

The right of Gemma Kate Lyall to be identified as Author of this work has been asserted by her in accordance with the Copyright, Designs and Patents Act 1988.

© 2017 The University of Leeds and Gemma Kate Lyall

Acknowledgements

Above all I would like to thank my brilliant primary supervisor Professor Karen Birch. Her unending support and guidance throughout this PhD journey has been invaluable, both personally and professionally. Karen's knowledge and enthusiasm has made this PhD an enjoyable experience, the supply of good red wine has also helped immensely. Karen, thank you for making all of this possible. A special thank you also goes to my supervisors Drs Karen Porter and Carrie Ferguson. Their time, knowledge and encouragement (and supply of snacks) have made this thesis possible.

I would also like to thank all those who helped out during the data collection process from fellow postgraduate students to undergraduate students. A huge thank you must also go to all of the participants who volunteered their time and energy making the completion of these studies an absolute pleasure. Without them this research could not have been undertaken.

A big thank you to my colleagues (past and present) who have supported me throughout the highs and lows of this PhD journey. In particular I would like to thank my colleagues and most importantly friends, Jen Airlie, Matt Davies and Nick Renwick who have been vital sources of support, advice and comedy when desperately needed.

Importantly, the love and support of my amazing family (both the Lyalls and the Williams) cannot be underestimated. Mam, Dad and Amy thank you for your support in everything I do, your unconditional love and encouragement have kept me going throughout the toughest parts of this process. I could not have made it this far without you.

A final but most special thank you must go to Huw. The amount he has had to put up with during this entire PhD journey has been incredible and yet he has been hugely

understanding and patient. He has been my rock, offering love and support when I needed it most. He has dragged me out of bed and picked me up from work late into the night on multiple occasions. Huw, I love you and this is for you. Thank you.

Abstract

Introduction: Deterioration in vascular health contributes to cardiovascular disease. Ageing is independently associated with poorer vascular health. Furthermore, the rate of decline in vascular health differs between genders. Exercise-induced shear rate (SR) is hypothesised to be an important stimulus for improvements in vascular health. How interval (IT) and continuous (CON) exercise affect patterns and volumes of SR to modify acute and chronic vascular health across the lifespan and between genders has not been explored. The overall aim of this thesis was to characterise in-exercise SR during IT and CON exercise and assess acute and chronic effect endothelial function and biomarkers of endothelial cell phenotype.

Methods: Ultrasound was used to determine acute and chronic endothelial function following exercise and the association with in-exercise SR. Circulating microRNA-21 expression both acutely and chronically was assessed as a biomarker of SR response. Firstly, 13 young healthy participants underwent 4 separate acute exercise sessions consisting of intensity and duration matched CON and IT exercise. Secondly, 16 younger and 11 older (males and females) participants underwent a 4-week training intervention comprising either CON or IT.

Results: Pattern of in-exercise SR followed the work rate profile of the exercise. Despite differing SR patterns there was no difference in volumes of anterograde and retrograde SR between protocols, with all exercise protocols inducing retrograde SR and brief periods of purely oscillatory SR, in the first study. Acute endothelial function increased and microRNA-21 expression decreased irrespective of exercise protocol. In the second study, IT induced greater volumes of retrograde SR compared to CON and decreased with training. Endothelial function improved acutely and chronically whilst chronic microRNA-21 expression increased following both IT and CON training irrespective of age or gender.

Discussion: In-exercise pattern of SR was driven by heart rate and blood flow. Pattern of SR differed between CON and IT exercise protocols in the second study only. However, all exercise protocols in both studies produced predominantly laminar SR resulting in equivalent improvements in acute and chronic endothelial function, with no influence of age or gender. MicroRNA-21 expression was differentially affected by acute and chronic exercise irrespective of protocol.

Table of Contents

Acknowledgements	iii
Abstract	v
Table of Contents	vii
List of Figures	xiv
List of Tables	xx
List of Abbreviations	xxi
Chapter 1 Introduction	1
Chapter 2 Literature review	4
2.1 Healthy vascular function	4
2.1.1 Arterial structure	4
2.1.2 Role of the endothelium in maintaining healthy vascular function	6
2.1.3 Nitric oxide and vasodilation pathway	7
2.1.3.1 Mechanotransduction	8
2.1.3.2 Synthesis of nitric oxide and VSMC relaxation	9
2.1.4 Determinants of shear stress	11
2.1.5 MicroRNAs in regulation of endothelial cell phenotype	15
2.1.5.1 MicroRNA Biogenesis	16
2.1.5.2 Shear as a regulator of miR	18
2.1.5.3 Detection of MiRs within the circulation	21
2.2 Ageing and Gender influences upon vascular health	23
2.2.1 Ageing negatively impacts cardiovascular health	24
2.2.1.1 Haemodynamics are altered with ageing	24
2.2.1.2 NO production and eNOS expression decrease with ageing	25
2.2.1.3 Vasoconstrictor are upregulated during ageing	28
2.2.1.4 Endothelial cell apoptosis and senescence during ageing	30
2.2.1.5 Oxidative stress and anti-oxidant balance are affected during ageing	32
2.2.1.6 Growth factors and hormonal changes with ageing	35
2.2.1.7 MicroRNA expression in vascular ageing	37
2.2.1.8 Arterial stiffness increases during ageing	38
2.2.2 Gender differences in cardiovascular disease progression	43
2.2.2.1 Influence of gender upon patterns of shear	44

2.2.2.2	Oestrogen contributes to reductions in cardiovascular disease	46
2.2.2.3	Progesterone contributes to vascular health	48
2.2.2.4	Testosterone has a role in maintenance of vascular health ...	49
2.2.2.5	Gender effects upon microRNA	52
2.2.2.6	Effects of gender upon arterial stiffness	53
2.3	Exercise in modification of parameters of vascular health	59
2.3.1	Exercise alters haemodynamics.....	60
2.3.1.1	Acute exercise effects upon haemodynamics and markers of vascular health.....	65
2.3.1.1.1	Exercise intensity affects shear rate and markers of vascular health.....	65
2.3.1.1.2	Type of exercise stimulus alters shear rate patterns	68
2.3.1.2	Chronic exercise training induces changes in vascular health	70
2.3.1.2.1	Exercise intensity during training is an important consideration in the modification of vascular health	70
2.3.1.2.2	Type of exercise is integral for adaptations in vascular health.....	73
2.3.2	Exercise induced shear: consequences for vascular health during ageing and across genders	76
2.3.2.1	Endothelial dysfunction is modified by exercise induced haemodynamics.....	77
2.3.2.2	Arterial stiffness is improved with exercise	80
2.3.2.3	MicroRNA expression changes as a result of exercise.....	82
2.4	Summary.....	85
2.5	Thesis Aims	86
Chapter 3	General Methods	87
3.1	Ethics.....	87
3.2	Participant Recruitment and Health Screening	87
3.3	Experimental Procedures – overview of all studies.....	88
3.4	Anthropometric Measures (BMI).....	88
3.5	Assessment of cardiorespiratory fitness	88
3.5.1	Ramp incremental exercise test (RIT)	88
3.5.2	Determination of VO_{2peak} and LT.....	90
3.6	Assessment of brachial artery endothelial function.....	91

3.6.1	Participant Preparation.....	91
3.6.2	Ultrasound Technology for FMD.....	92
3.6.3	Brachial FMD Procedure	93
3.6.4	Analysis of brachial artery diameter.....	94
3.6.5	Doppler blood flow velocity analysis	96
3.6.6	Reliability and validity of endothelial function assessment.....	97
3.7	In-exercise measures of Doppler blood velocity and diameter	100
3.7.1	Procedure for assessment of in-ex diameter and blood velocity ..	100
3.7.2	Data used to gain anterograde and retrograde and OSI	101
3.8	In-exercise blood pressure assessment	104
3.9	Assessment of chronic carotid artery stiffness.....	105
3.9.1	Reliability and validity of carotid artery stiffness assessment.....	107
3.10	Plasma blood sampling	109
3.11	Assessment of microRNA-21	110
3.11.1	RNA extraction	110
3.11.2	Reverse transcription and real-time quantitative PCR	110
3.11.3	MiR-21 data Analysis	112
3.12	Overview of Statistical Analysis	113
Chapter 4 Novel characterisation of in-exercise vascular shear rate during acute continuous and interval exercise: Mechanisms for changes in endothelial function.....		
4.1	Introduction	114
4.1.1	Type and intensity of exercise affects exercise induced shear rate and resultant endothelial function.....	115
4.1.2	Acute exercise regulates microRNA expression	116
4.1.3	Aims and Hypothesis.....	117
4.2	Methods	119
4.2.1	Participants	119
4.2.2	Experimental procedure	119
4.2.3	Exercise protocols.....	121
4.2.4	Variables assessed during the acute exercise protocols	123
4.2.5	Assessment of endothelial function	125
4.2.6	Assessment of microRNA-21 expression	125
4.2.7	Statistical Analysis	125

4.3	Results.....	128
4.3.1	Participant Characteristics.....	128
4.3.2	VO ₂ patterns during CON and IT exercise protocols.....	128
4.3.3	Heart rate responses during acute CON and IT exercise protocols 131	
4.3.4	In-exercise blood flow and shear rate patterns during acute CON and IT exercise.....	132
4.3.4.1	Anterograde and retrograde shear rate during acute CON and IT exercise	136
4.3.4.2	Oscillatory shear index during acute IT and CON exercise..	139
4.3.5	Brachial artery endothelial function.....	144
4.3.5.1	Allometrically scaled FMD	145
4.3.6	MicroRNA – 21 expression following acute exercise	149
4.3.6.1	MiR-21 expression relative to housekeeper U6.....	149
4.3.6.2	MiR-21 expression relative to cel-miR-39.....	150
4.4	Discussion.....	153
4.4.1	Characterisation of in-exercise SR pattern, VO ₂ and HR during acute CON and IT exercise	153
4.4.1.1	Potential mechanisms which regulated patterns of shear rate during exercise.....	154
4.4.1.2	Oscillatory shear index during exercise and the acute effects upon endothelial function	155
4.4.1.3	The rationale for the inclusion of the Long IT 70 exercise protocol.....	157
4.4.1.4	The haemodynamic response to acute aerobic exercise	158
4.4.2	Acute endothelial function	159
4.4.2.1	CON versus IT exercise does not differentially affect acute endothelial function	159
4.4.2.2	Effect of exercise intensity upon endothelial function	160
4.4.3	Acute MicroRNA-21 expression	161
4.4.3.1	Determination of the appropriate housekeeping gene for relative expression of miR-21.....	162
4.4.3.2	The effect of acute IT and CON SR patterns upon miR-21 expression	162
4.4.4	Limitations.....	163
4.4.5	Future Directions.....	166

4.4.6	Conclusion	166
Chapter 5 Examination of chronic interval and continuous exercise induced shear rate upon vascular health and the role of age and gender.....168		
5.1	Introduction	168
5.1.1	Ageing affects exercise-induced shear rate and endothelial function	168
5.1.2	Gender influences upon in-exercise shear rate and endothelial function	170
5.1.3	Interval exercise effects upon in-exercise shear rate	170
5.1.4	Ageing contributes to arterial stiffening.....	172
5.1.5	Shear rate effects upon chronic miR-21 expression	172
5.1.6	Aims and hypothesis	173
5.2	Methods	174
5.2.1	Participants	174
5.2.2	Experimental procedure	176
5.2.3	Anthropometry and blood pressure	179
5.2.4	Assessment of cardiorespiratory fitness	179
5.2.5	Assessment of endothelial function	179
5.2.6	Assessment of microRNA – 21 expression.....	180
5.2.7	Assessment of carotid artery stiffness	180
5.2.8	In-exercise VO ₂ , HR and shear rate responses	181
5.2.9	Exercise training protocols	181
5.2.10	Home based exercise sessions.....	182
5.2.11	Statistical analysis.....	183
5.3	Results.....	185
5.3.1	Participant characteristics and anthropometric responses to exercise training.....	185
5.3.2	Exercise tolerance measures across the exercise training period	188
5.3.2.1	Exercise training effects upon cardiorespiratory fitness.....	188
5.3.3	In-exercise VO ₂ and heart rate responses to the exercise protocols	193
5.3.3.1	Pattern of exercise influenced VO ₂ recorded during exercise protocols	193
5.3.3.2	The pattern of exercise influenced heart rate recorded during the exercise protocols	198

5.3.3.3	Changes in work rate and energy expenditure from the first to the final exercise training session.....	201
5.3.4	In-exercise shear rate patterns pre and post training.....	201
5.3.4.1	Patterns of antegrade and retrograde SR from the first to the final exercise training session.....	202
5.3.4.2	Oscillatory shear index during exercise in the first and final exercise training sessions	209
5.3.5	Markers of endothelial function following both acute and chronic exercise.....	213
5.3.5.1	Responses to acute exercise	213
5.3.5.2	Responses to chronic exercise training.....	217
5.3.5.3	Scaled responses to acute exercise and chronic exercise training.....	222
5.3.6	Parameters of carotid stiffness with training	224
5.3.7	MicroRNA-21	227
5.4	Discussion.....	229
5.4.1	Participant characteristics across the exercise training intervention 229	
5.4.1.1	Minor changes in blood pressure following exercise training	230
5.4.1.2	Weight was reduced with exercise training.....	231
5.4.2	Cardiorespiratory fitness changes over the course of exercise training	231
5.4.2.1	Exercise mediated reductions in resting HR.....	231
5.4.2.2	Parameters of exercise tolerance improved with exercise training.....	233
5.4.3	VO ₂ and HR recorded during the first and final exercise training sessions	234
5.4.3.1	Exercise induced changes in plasma volume and thermoregulation	236
5.4.4	In-exercise shear rate during the first and final exercise training sessions	237
5.4.4.1	Ageing influences in-exercise shear rate.....	239
5.4.4.2	Gender influences upon in-exercise shear rate	241
5.4.4.3	Oscillatory shear rate during exercise from the first to the final exercise training session is affected by age	241
5.4.5	Acute and chronic endothelial function	242

5.4.5.1	Endothelial function pre and post-acute exercise prior to and following exercise training	243
5.4.5.2	Resting endothelial function across the exercise training intervention	245
5.4.6	Carotid artery stiffness pre and post exercise training	246
5.4.7	Chronic miR-21 expression	249
5.4.7.1	Acute versus chronic expression of miR-21 following exercise	249
5.4.7.2	Association between in-exercise shear rate and miR-21 expression	250
5.4.8	Limitations	251
5.4.9	Future Directions	254
5.4.10	Conclusion	254
Chapter 6 General Discussion		256
6.1	Overview of thesis rationale and purpose	256
6.2	Summary of key findings	258
6.3	Implications for exercise prescription	261
6.4	Limitations and Future Work	264
6.5	Concluding remarks	267
References		268

List of Figures

- Figure 2.1 Arterial structure with the layers of the artery highlighted. The endothelium is a single layer of cells within the tunica intima layer which regulates the relaxation or constriction of the vascular smooth muscle cells within the media layer.....6**
- Figure 2.2 Shear stress stimulating the mechanosensors (black square) on the luminal surface of the endothelial cell which triggers a biochemical pathway to upregulate NO production which diffuses into the vascular smooth muscle cell where hyperpolarisation of the cell induces vasodilation. Adapted from Higashi and Yoshizumi (2004).10**
- Figure 2.3 The actions of the eNOS enzyme in the production of NO within the endothelial cell. Reproduced and modified from ALDERTON et al. (2001).10**
- Figure 2.4 Laminar shear through a straight artery, for example the brachial artery, can be determined via Poiseuille's equation (Equation 1). Adapted from Koskinas et al. (2009).....12**
- Figure 2.5 A computational model of blood flow through the carotid artery bifurcation. The area within the black circle shows an atheroprone area due to the endothelial cells experiencing oscillatory shear. Modified from David Steinman, University of Toronto.....14**
- Figure 2.6 The biogenesis of microRNA from transcription in the nucleus of the cell to its actions upon mRNA in the cytoplasm (Chen et al., 2012). 17**
- Figure 2.7 [A] Laminar shear stress can cause upregulation of miR-21 which inhibits its target gene PTEN. Reduced expression of PTEN removes the inhibition of its antagonist PI3k to allow eNOS to produce NO (Weber et al., 2010). [B] Oscillatory shear stress has been shown to upregulate miR-21 which inhibits PPAR α resulting in increases in vascular adhesion molecules (Zhou et al., 2011).....20**
- Figure 2.8 Low endothelial shear stress disturbs laminar flow altering the endothelial structure and function towards a more atherosclerotic phenotype via the mechanisms shown in the figure (reproduced from Chatzizisis et al. (2007b)).....28**
- Figure 2.9 Coupled eNOS effectively produces NO under normal physiological conditions however in inflammatory states eNOS can become uncoupled leading to production of hydrogen peroxide and peroxynitrite production which can break down NO and results in a cycle of inflammation. Adapted from Katusic (2001).....33**
- Figure 2.10. Factors such as decreased NO, GH and increases in ET-1, O $_2^-$ and endothelial cell apoptosis and senescence contribute to age mediated impairment of endothelial function (black arrows)..37**

Figure 2.11 Sex steroid receptors (oestrogen and androgen) on the surface of the endothelial cell demonstrating the importance of hormones in regulating endothelial function through NO production. Reproduced from Miller and Mulvagh (2007).....	52
Figure 2.12. Endothelial function, as assessed via forearm blood flow responses to increasing doses of acetylcholine, is impaired in older sedentary males compared to younger sedentary males.	78
Figure 3.1 The 4 graphs which enabled the V-slope method to non-invasively determine LT (blue line) and respiratory compensation (red line) through breath by breath gas exchange.	91
Figure 3.2 Assessment of brachial artery FMD.....	94
Figure 3.3 Brachial tools was used for analysis of resting diameter and FMD.	96
Figure 3.4 Ultrasound was used to assess brachial artery diameter and blood flow velocity during cycling exercise on a semi recumbent cycle ergometer. Heart rate and VO₂ was also assessed at the same time via a 12-lead ECG and breath by breath gas exchange system.	101
Figure 3.5 An in-exercise video recording analysed in Brachial Tools to determine brachial artery diameter and anterograde blood flow velocity per frame.	102
Figure 3.6 The Doppler blood flow velocity axis was subsequently inverted on the ultrasound machine before being analysed in Brachial Tools to determine retrograde blood flow velocity and shear rate.	103
Figure 3.7 Carotid analyser used semi-automated wall tracking software to determine carotid diameter, near and far wall IMT, in addition to automatically calculating carotid artery compliance and distensibility.....	106
Figure 3.8 The process of quantification of reverse transcription and real-time PCR to determine miR expression within a sample (reproduced from Chen et al. (2005)).	112
Figure 3.9 The 7500 software was used to determine the Ct of miR-21 and the selected housekeeping gene (either U6 or cel-miR-39). This allowed miR-21 expression relative to the housekeeping gene to be reported.....	113
Figure 4.1 Flow chart of the experimental protocol.....	120
Figure 4.2. The computer model used to determine the work rates required for the Long IT, Short IT and Long IT 70 protocols when the target VO₂ (gained from the RIT) was set at 125% of LT. Model provided courtesy of Dr Al Benson (University of Leeds (Benson et al., 2013)).	122
Figure 4.3 A schematic of the four acute exercise protocols used in the current study.....	123

Figure 4.4. 5 point moving average of the breath by breath VO₂ data recorded for one representative participant during the four exercise protocols demonstrating that the exercise was within the heavy intensity exercise domain intensity (>LT <Critical Power).131

Figure 4.5 Heart rate recorded throughout the four exercise protocols for a representative participant. The same participant was used for the breath by breath VO₂ data.132

Figure 4.6. Group mean second by second anterograde and retrograde SR patterns for all participants' time aligned to the four exercise protocols: (A) CON (B) Long IT (C) Short IT and (D) Long IT 70. The shaded area represents the work rate profile for each exercise protocol.....134

Figure 4.7. Group mean second by second anterograde and retrograde SR (red circles) overlaid with mean second by second forward and backward volumetric blood flow (blue circles) and mean second by second heart rate (black circles) for the CON, Long IT, Short IT and Long IT 70 exercise protocols.....135

Figure 4.8. Mean anterograde and retrograde SR shown in the columns were not significantly different between protocols (mean ± SD).....137

Figure 4.9 Panel A shows mean HR and mean retrograde SR during all of the acute exercise protocols were significantly negatively correlated (r=-0.64, p=0.001). Panel B shows mean HR and mean anterograde SR during all of the exercise protocols were significantly positively correlated (r=0.61, p=0.001).....138

Figure 4.10. Group mean OSI patterns (black circles) for all participants during the four exercise protocols: (A) CON (B) Long IT (C) Short IT and (D) Long IT 70. The shaded area represents the work rate profile for each exercise protocol.140

Figure 4.11 OSI patterns (black circles) for a representative participant during the four exercise protocols: (A) CON (B) Long IT (C) Short IT and (D) Long IT 70. The shaded area represents the work rate profile for each exercise protocol. The red line represents an OSI > 0.5 which indicates purely oscillatory shear.....141

Figure 4.12. Mean, maximum and minimum (mean±SD) OSI were not significantly different between protocols (p>0.05). In all protocols periods of purely oscillatory shear were achieved as indicated by maximum OSI > 0.5.....142

Figure 4.13 Acute FMD (mean ± SD) measured 15 min post exercise.....145

Figure 4.14 Acute allometrically scaled FMD (mean ± SD) measured 15 min post exercise.....146

Figure 4.15 Mean miR-21 expression (%U6) immediately pre-and 6 hours post-acute exercise.149

Figure 4.16 Mean miR-21 expression (%cel-miR-39) immediately pre-and 6 hours post-acute exercise.....	151
Figure 4.17 Panel A shows that mean anterograde SR during the exercise protocols was significantly correlated with log transformed mean miR-21 (%cel-miR-39) expression following the acute exercise protocol ($r=0.33$, $p=0.02$). Panel B shows the change in AUC ₆₀ from pre to post exercise was significantly correlated with log transformed mean miR-21 (%cel-miR-39) expression following the acute exercise protocol ($r=0.33$, $p=0.02$).....	152
Figure 5.1 Consort diagram for the present study	175
Figure 5.2 Flow chart for the experimental procedure of the current study. All visits occurred on separate days.....	178
Figure 5.3 Absolute VO _{2peak} determined from the pre (black bars) and post (grey bars) RIT as divided by age groups (young v. older), gender (male v. females) and exercise training group (CON v. AIT)..	190
Figure 5.4 Lactate threshold determined from pre and post RIT as divided by age groups (young v. older), gender (male v. females) and exercise training group (CON v. AIT).....	191
Figure 5.5 VO ₂ during the first exercise training session (black circles) and the final exercise training session (red circles). Panel A shows a representative participant (young male) in the AIT group. Panel B shows a representative participant (young female) in the CON group. 194	
Figure 5.6 Mean VO ₂ determined from the monitored exercise training session pre (black bars) and post (grey bars) the exercise training intervention as divided by age groups (young v. older), gender (male v. females) and exercise training group (CON v. AIT)..	196
Figure 5.7 Peak VO ₂ determined from the first and final exercise training sessions as divided by age groups (young v. older), gender (male v. females) and exercise training group (CON v. AIT).	197
Figure 5.8 HR during the first exercise training session (black line) and the final exercise training session (red line). Panel A shows a representative participant (young male) in the AIT group. Panel B shows a representative participant (young female) in the CON group. The blue boxes demonstrate the target heart rate zone participant were prescribed based on the exercise group they were randomised to.	199
Figure 5.9 Mean HR determined from the monitored exercise training session pre (black bars) and post (grey bars) the exercise training intervention as divided by age groups (young v. older), gender (male v. females) and exercise training group (CON v. AIT).....	200

Figure 5.10 Group mean in-exercise second by second anterograde (black circles), forward blood flow (gray circles), backward blood flow (blue circles) and retrograde (red circles) SR patterns for younger participants in the first and final exercise training session divided by exercise protocol (CON v AIT). The shaded area represents the work rate profile for each exercise protocol.203

Figure 5.11 Group mean in-exercise second by second anterograde (black circles), forward blood flow (gray circles), backward blood flow (blue circles) and retrograde (red circles) SR patterns for older participants in the first and final exercise training session divided by exercise protocol (CON v AIT). The shaded area represents the work rate profile for each exercise protocol.....204

Figure 5.12 Group mean brachial artery diameter recorded during the first and final exercise training sessions divided by age (younger v older) and gender (female v male).205

Figure 5.13 Group mean anterograde shear rate determined from the monitored exercise training sessions pre (black bars) and post (grey bars) the exercise training intervention as divided by age groups (young v. older) and exercise training group (CON v. AIT).206

Figure 5.14 Group mean retrograde shear rate determined from the monitored exercise training sessions pre (black bars) and post (grey bars) the exercise training intervention as divided by age groups (young v. older) and exercise training group (CON v. AIT).207

Figure 5.15 Mean OSI determined from the monitored exercise training sessions pre (black bars) and post (grey bars) the exercise training intervention as divided by age groups (young v. older) and exercise training group (CON v. AIT). The red line denotes the cut off (OSI>0.5) of which SR becomes purely oscillatory.....210

Figure 5.16 Group mean OSI was significantly correlated with group mean maximum in-exercise heart rate (%HR_{peak}) during the first and final exercise training sessions (r=0.33, p=0.02).....211

Figure 5.17 Group mean time spent at an OSI greater than 0.5 and thus indicating purely oscillatory shear as determined from the monitored exercise training sessions pre (black bars) and post (grey bars) the exercise training intervention as divided by age groups (young v. older) and exercise training group (CON v. AIT).212

Figure 5.18 Schematic of when FMD was recorded in order to assess acute changes in endothelial prior to and following exercise training and to assess chronic endothelial function across the training intervention..213

Figure 5.19 Group mean for absolute FMD as divided by age (younger v older) and exercise protocol (CON v AIT), at the four time points: absolute FMD 1 (pre acute exercise and pre training), absolute FMD 2 (post-acute exercise and pre training), absolute FMD 3 (pre acute exercise and post training) and absolute FMD 4 (post-acute exercise and post training).....215

Figure 5.20 The group mean for time between cuff release and peak diameter during FMD compared across age (younger v older) and exercise protocol (CON v AIT) at the four time points: Time 1 (pre acute exercise and pre training), Time 2 (post-acute exercise and pre training), Time 3 (pre acute exercise and post training) and Time 4 (post-acute exercise and post training).....216

Figure 5.21 Data presented by age (younger v older) and exercise protocol (CON v AIT).....219

Figure 5.22 Allometrically scaled relative FMD data presented by age (younger v older) and exercise protocol (CON v AIT).223

Figure 5.23 Group mean beta stiffness index determined pre (black bars) and post (grey bars) the exercise training intervention as divided by age group (young v. older).225

Figure 5.24 Carotid beta stiffness index pre and post exercise training was significantly correlated with total anterograde shear rate during the first and final exercise training session across all groups ($r=-0.42$, $p=0.002$).227

Figure 5.25. Mean miR-21 expression (%cel-miR-39) pre and post 4 weeks of exercise training. Individual data is also presented for the CON (black squares) and AIT (red circles) groups, pre and post training.228

List of Tables

Table 3.1 Between day reproducibility for indices of FMD and associated shear rate data.	100
Table 3.2 Within day reproducibility for carotid artery stiffness variables measured using ultrasound.	109
Table 4.1: Participant characteristics from visit 1.	128
Table 4.2 Acute VO ₂ and HR responses to each exercise protocol as a percentage of peak values as determined from the initial RIT. Values reported as mean ± standard deviation.....	129
Table 4.3 Mean, maximum, minimum and total values of anterograde and retrograde SR and OSI across the four exercise protocols. Data reported as mean ± SD.	143
Table 4.4 Pre and 15 min post exercise results for FMD variables related to endothelial function. Values presented unscaled, pre and post-acute exercise. Results presented as Mean ± SD. *denotes significant time effect at P<0.05.....	148
Table 5.1 Participant characteristics across the 4 week exercise training intervention as divided by age and gender. Values reported as mean±SD.	187
Table 5.2 Exercise tolerance measures across the 4 week exercise training period. Participants were divided into young and older age groups before being randomised to CON or AIT training groups. Variables were assessed during the initial RIT and again during the post training assessment where the RIT was repeated. Values reported mean±SD. .	192
Table 5.3 Parameters of endothelial function as determined via FMD. Groups were divided into exercise protocol (CON v AIT) and the 4 time points at which FMDs were conducted (1 pre acute exercise and pre training; 2 post-acute exercise and pre training; 3 pre acute exercise and post exercise training; 4 post-acute exercise and post training). Data are presented as mean±SD.....	221
Table 5.4 Parameters of carotid stiffness across the 4 week exercise training intervention (pre v. post) as divided by age (young v. older). Data presented as mean±SD.....	226

List of Abbreviations

AGEs – advanced glycation end products	IMT – intima-media thickness
AIT – Aerobic Interval exercise training	IT – Interval exercise
Akt – protein kinase B	LDL – low density lipoprotein
BMI – body mass index	L-NMMA – NG-monomethyl-L-arginine
BP – blood pressure	LT – lactate threshold
cDNA – complementary DNA	MAP – mean arterial pressure
cGMP – cyclic guanosine monophosphate	MCP-1 – monocyte chemoattractant protein 1
CON – Continuous exercise	miR – microRNA
CP – critical power	MMPs – matrix metalloproteases
CSA – cross-sectional surface area	mRNA – messenger RNA
CSC – cross-sectional compliance	NADPH oxidase - nicotinamide adenine dinucleotide phosphate-oxidase
CSD – cross-sectional distensibility	NO – nitric oxide
Ct – cut threshold	OSI – oscillatory shear index
CVD – cardiovascular disease	PCAM – platelet cell adhesion molecule
DC – diameter compliance	PCR – polymerase chain reaction
DD – diameter distensibility	PFP – platelet free plasma
EC – endothelial cell	PI3k – phosphoinositide 3-kinase
ECG – echocardiogram	PP – pulse pressure
EDRF – endothelium derived relaxation factor	PPAR α - Peroxisome proliferator activated receptor alpha

eNOS – endothelial nitric oxide synthase	PTEN - Phosphatase and tensin homolog
EPC – endothelial progenitor cells	PWV – pulse wave velocity
ER α – oestrogen receptor α	RER – respiratory exchange ratio
ER β – oestrogen receptor β	RIT – ramp incremental test
ET-1 – endothelin-1	RNA – ribonucleic acid
ET _A – endothelin A receptor	ROS – reactive oxygen species
F _{ET} CO ₂ – end tidal carbon dioxide fraction	RPE – rating of perceived exertion
F _{ET} O ₂ – end tidal oxygen fraction	SMC – smooth muscle cell
FMD – flow mediated dilation	SR – shear rate
Fps – frames per second	VCAM-1 – vascular cell adhesion molecule 1
GC – guanylate cyclase	VCO ₂ – carbon dioxide production
GTP – guanosine triphosphate	VEGF – vascular endothelial growth factor
HR – heart rate	VO ₂ – oxygen uptake
HR _{peak} – heart rate peak	VO _{2max} – maximal oxygen uptake
HRT – hormone replacement therapy	VO _{2peak} – peak oxygen uptake
HUVECs – human umbilical vein endothelial cell	VSMC – vascular smooth muscle cell
ICAM – intercellular adhesion molecule	W – Watts
IEM – incremental elastic modulus	WR – work rate
	WR _{peak} – work rate peak

Chapter 1 Introduction

Cardiovascular disease (CVD) remains a leading cause of morbidity and mortality explaining 31% of worldwide deaths (Hajar, 2016). CVD accounts for 28% of deaths in females and 29% of deaths in males in the UK, with the main causes of death attributed to coronary heart disease (46%) and stroke (26%) (Bhatnagar et al., 2015). Mortality from CVD related events has decreased over the last decade, however the cost to the NHS for treatment in 2012/2013 was £6.8 billion, of which 63.4% was spent on secondary care (Bhatnagar et al., 2015).

Ageing is an important factor which increases the incidence of CVD (Seals et al., 2011). However, risk does not increase equally between males and females throughout the lifespan. Males have an increased CVD risk compared to females who appear to display cardiovascular protective effects until the menopause (Celermajer et al., 1992). Following the menopause females display a rapid decline in cardiovascular health which becomes equivalent to that of age matched males (Celermajer et al., 1992). Importantly, whilst females exhibit lower cardiovascular morbidity rates compared to males, females have higher rates of cardiovascular associated mortality (Lloyd-Jones et al., 2010). Additionally, following a cardiac event females have a poorer prognosis compared to males with 43% of females dying within 5 years following the event compared to 33% of males (Lloyd-Jones et al., 2010). The difference in mortality rates following a cardiovascular event between genders is perhaps due to a lack of awareness of CVD symptoms in females (Maas and Appelman, 2010) as symptoms of an event can present differently between genders (Vaccarino et al., 2009). Additionally, research often neglects females as fewer

clinical trials and intervention studies have been conducted on females (Wenger, 2012), therefore gender differences will be explored in some aspects of this thesis.

The Framingham Heart Study identified the major risk factors for CVD: high blood pressure, high cholesterol, obesity, smoking, diabetes and physical inactivity in addition to related risk factors such as age and gender (Hajar, 2016). However, these aforementioned traditional CVD risk factors account for only 60% of CVD risk, the remaining 40% is thought to be related to direct changes within the vascular environment (Green et al., 2008, Joyner and Green, 2009, Mora et al., 2007, Thijssen et al., 2010). In particular, endothelial dysfunction and arterial stiffness are believed to be important components of the remaining parameters of CVD risk.

The underlying pathology for CVD is atherosclerosis which is characterised by lesion formation and inflammation (Ross, 1999). The initial stage of atherosclerosis development comprises of endothelial dysfunction prior to any notable plaque formation forming in the arterial wall (Ross, 1999). Arterial stiffness appears to occur later in the progression of atherosclerosis as a result of thickening of the arterial wall (van Popele et al., 2001). The development of endothelial dysfunction and arterial stiffness is related to ageing and a lack of physical activity (Seals et al., 2008) with gender also having an important role. High levels of oestrogen in females appears to have a cardiovascular protective effect, with risk of CVD higher in males than females until females reach the menopause (Shaw et al., 2006). Following menopause when oestrogen levels are reduced females lose the cardiovascular protective effect afforded by oestrogen, and CVD risk becomes equivalent to age matched males (British Heart Foundation, 2012).

Physical inactivity is an important risk factor for CVD development, as 6-10% of all global deaths from non-communicable diseases have been attributed to physical inactivity (Lee et al., 2012). The UK Government has guidelines for achieving physical

activity which promotes health benefits, these guidelines currently suggest 150 minutes of moderate intensity exercise per week or 75 minutes of vigorous exercise per week. The proportion of the UK adult population who do not currently meet minimum Government targets for physical activity is 39% (BHF, 2017). Gender also appears to be an important factor in whether individuals achieve these guidelines, with 55% of females in the UK meeting physical activity guidelines compared to 67% of males (BHF, 2015). Physical activity declines with age and may further confound increasing CVD risk in older populations (BHF, 2015).

Physical activity and exercise are important in preventing declines in vascular health as increases in heart rate lead to increased endothelial wall shear stress caused by blood flow interacting with the arterial wall. Until now little research has focussed on the characterisation of shear during aerobic continuous type exercise to determine the role of exercise-induced shear upon outcomes of vascular health. Recently interval exercise has become more popular way of exercising and not just for athletes. Sedentary populations in addition to patient populations have all benefited from interval type exercise (Burgomaster et al., 2008, Wisløff et al., 2007). However, how this type of exercise affects shear and whether it is more beneficial than current government guidelines for improvement of vascular health is yet to be delineated. Furthermore, the interaction of gender and ageing upon shear rate in response to different types of exercise has not been explored. Therefore, the purpose of this thesis is to explore the patterns of shear rate during interval and traditional continuous exercise in order to assess their affect upon markers of acute and chronic vascular health in young and older populations and between genders.

Chapter 2 Literature review

Throughout this thesis similar terms will be used which having different meanings.

Therefore, to avoid confusion the following description of terms will be used:

Shear stress is the frictional force of blood flow acting parallel to the endothelial cells when the viscosity of the blood flow is known, for example in cell culture studies.

Shear rate is the frictional force of blood flow acting parallel to endothelial cells when the viscosity of the blood is unknown and is therefore, commonly used when human participants have been studied.

Interval exercise (IT) is a global term used to describe exercise which is characterised by multiple “work” and “recovery” bouts within a single exercise session.

High intensity interval exercise training is a specific type of interval exercise training whereby the “work” bouts are prescribed at high intensity and short durations, thus requiring a more anaerobic metabolism.

Aerobic interval exercise training (AIT) is also a specific type of interval exercise training, however the “work” bouts are of a longer duration and thus require aerobic metabolism to complete this type of exercise.

2.1 Healthy vascular function

2.1.1 Arterial structure

Muscular arteries consist of multiple layers with each layer possessing specific regulatory roles (**Figure 2.1**). These layers are also required to interact with each other to maintain healthy vascular functioning. The innermost layer of an artery is the tunica intima which consists of the endothelium (**Figure 2.1**) on the luminal side and the internal elastic lamina on the other side (Lusis, 2000). Between these layers is the extracellular matrix of connective tissues which is primarily comprised of

proteoglycans and collagen (Lusis, 2000). The media layer is predominantly made up of vascular smooth muscle cells (VSMC), which relax or contract in response to signals received from the endothelium, in addition to elastin and collagen fibres (Lusis, 2000). Finally, the outer most layer is the adventitia which is separated from the media by the external elastic lamina and consists of connective tissues (elastin and collagen) interspersed with fibroblasts and VSMCs (Lusis, 2000). The purpose of the adventitia is to anchor the vessel in position within the surrounding tissues and provide structural support to the artery.

The endothelium of the tunica intima is a single layer of cells which are critical in promoting an anti-atherogenic environment. Endothelial cells maintain arterial wall impermeability, preventing atherosclerotic plaque formation (Rubanyi, 1993), and control vasomotor tone, regulating pressure throughout the vascular system (Bonetti et al., 2003). As endothelial cells are in direct contact with blood and circulating cells they have the ability to sense changes in blood flow as a result of altered frictional forces (shear stress) applied to the endothelial cells from within the lumen. They respond by synthesising and secreting substances to maintain a healthy vasculature. The ability of endothelial cells to sense stimuli within the lumen is due to mechanosensors, the process of mechanotransduction is described in section 2.1.3.1. Mechanosensors can also protrude into the lumen from the surface of the endothelial cells, for example the glycocalyx and isolated G proteins both of which are triggered by changes in shear stress. Furthermore, changes in luminal shear stress can activate endothelial adheren junctions and integrins which alters cytoskeleton structure of the endothelial cell (Quillon et al., 2015) and activates downstream pathways which regulate vasomotor tone (Quillon et al., 2015).

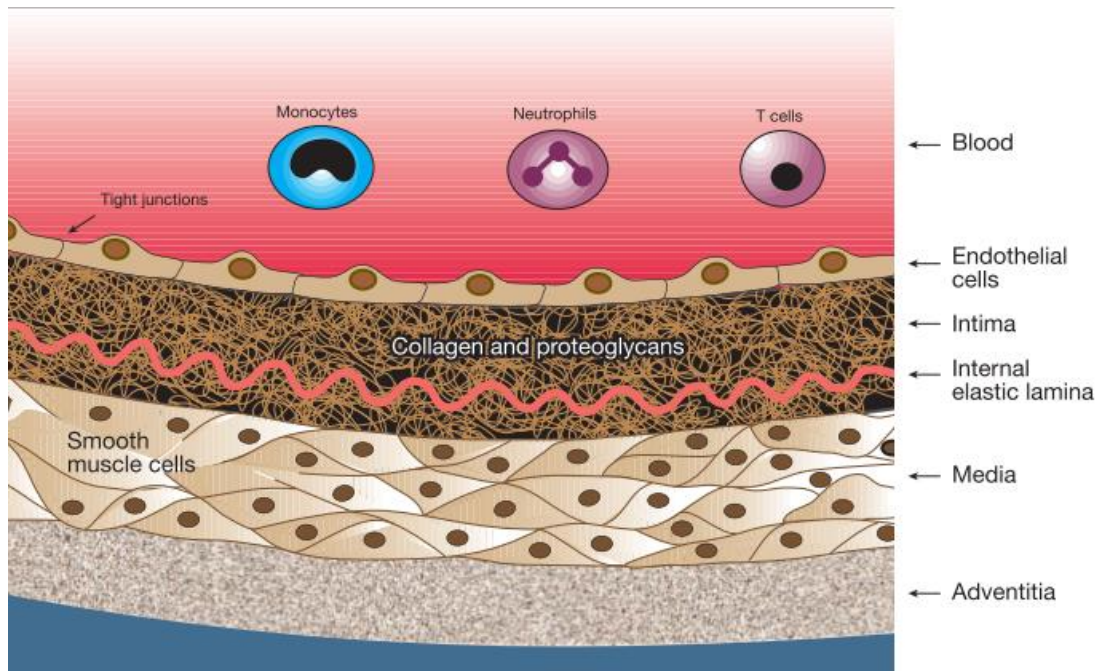

Figure 2.1 Arterial structure with the layers of the artery highlighted. The endothelium is a single layer of cells within the tunica intima layer which regulates the relaxation or constriction of the vascular smooth muscle cells within the media layer. Reproduced from Lusis (2000).

2.1.2 Role of the endothelium in maintaining healthy vascular function

A key role of the endothelium is control of vasomotor tone thus regulating pressure throughout the vascular system (Bonetti et al., 2003). The endothelium senses changes in mechanical stress within the lumen and releases vasodilators or vasoconstrictors as appropriate. Nitric Oxide (NO) is an important vasodilator molecule released from the endothelium in response to chemical (acetylcholine) and mechanical (shear stress) stimuli. Whilst NO is derived in the endothelium it migrates to the VSMC of the tunica media causing vasodilation. Traditional CVD risk factors often do not incorporate assessment of endothelial health; however, the phenotype and function of the endothelium have a critical role in CVD development and progression and could provide important prognostic information on future cardiovascular events.

2.1.3 Nitric oxide and vasodilation pathway

Endothelium derived relaxation factor was previously discovered in the 1980's by Furchgott and Zawadski. At this time the role of the endothelium in regulating vasomotor tone was unknown. Upon application of acetylcholine to rabbit aorta with either an intact endothelium or denuded endothelium, only the aorta with an intact endothelium was shown to vasodilate (Furchgott and Zawadzki, 1980). It was supposed that the endothelium released factors in response to luminal stimuli which governs whether the vessel dilates or constricts. The most widely known endothelium-derived relaxation factor (EDRF) is nitric oxide which is released from the endothelium in response to shear stress stimuli (Berdeaux et al., 1994, Tuttle et al., 2001). Another known EDRF is prostacyclin which has also been shown to contribute to VSMC relaxation through cAMP, however this has not been investigated further in this thesis.

In addition to being a potent vasodilator, NO mediates many other atheroprotective processes through its actions as an anti-inflammatory, anti-thrombotic and anti-hypertrophic molecule (Vanhoutte et al., 2009). In a healthy endothelial cell, the increased bioavailability of NO inhibits leukocyte adhesion and migration displaying its anti-inflammatory properties (Vanhoutte et al., 2009). Furthermore, NO inhibits platelet adhesion and aggregation to the endothelium and prevents VSMC proliferation and migration (Vanhoutte et al., 2009). The resulting effect of upregulation of NO is the promotion of an anti-atherogenic endothelial cell phenotype and reduced CVD risk (Vanhoutte et al., 2009).

Following the discovery of the importance of the endothelium in the control of arterial vasodilation, via production of NO, a stimulus for vasodilation and NO upregulation was sought. It was determined that arterial vasodilation was blood flow dependent and not due to changes in vascular metabolism or pressure sensitive myogenic responses (Koller et al., 1993). A previous study found that increases in "viscous

drag”, now termed shear stress, was the stimulus for acute vasodilation (Rodbard, 1975). Shear stress is the frictional force of blood flow through the artery which contacts the endothelium (Davies, 2009). Prolonged exposure to increases in blood flow and shear stress was suggested to induce vessel wall remodelling (Rodbard, 1975). It has since been shown that shear stress plays an integral role in arterial vasodilation via upregulation of NO within intact endothelial cells (Rubanyi et al., 1986).

2.1.3.1 Mechanotransduction

Shear stress is now known to stimulate vasodilation through interaction of blood flow in the lumen with endothelial cells. The ability of the endothelium to sense changes in mechanical stresses, such as changes in intraluminal pressure, transluminal strain and fluid shear stress, is associated with mechanosensors on the surface of the endothelial cells (EC) (Davies, 2009). Mechanosensors can range from local membrane structures such as ion channels, G proteins and changes to phospholipid metabolism to specialised structures such as primary cilia and the glycocalyx (Davies, 2009). Primary cilia and glycocalyx are present on the surface of the endothelial cells and extend into the lumen, however primary cilia are predominantly only present in regions of low and disturbed blood flow whereas the glycocalyx is present in areas of high flow too (Van der Heiden et al., 2008, Davies, 2009). The mechanical shear stress is converted into a biochemical signal via deformation of the glycocalyx which activates ion channels via direct signalling or via conformational changes to the cytoskeleton (Davies, 1995). Mechanotransduction can also occur via junction signalling where the forces detected on the luminal surface of the EC are transferred to intercellular junction protein complexes via the cytoskeleton (Davies, 1995, Davies, 2009). Another important aspect of mechanotransduction to consider is the effect upon the nucleus, the importance of the nucleus responding to shear stress becomes

apparent later in this thesis when considering microRNAs. Deformation of the cytoskeleton within the cytoplasm of the cell can lead to nuclear deformation which can result in mechanically induced signalling detected in the nuclear membrane (Davies, 2009). It is through this process that alterations in luminal conditions changes gene expression within the EC regulating longer term NO production through mRNA and protein transcription.

2.1.3.2 Synthesis of nitric oxide and VSMC relaxation

Following activation of mechanosensors on the endothelial cell surface downstream biochemical signalling pathways within the cytoplasm of the endothelial cell are activated (**Figure 2.2**)(Davies, 2009). One such pathway is the calcium independent phosphoinositide 3-kinase (PI3K) and protein kinase B (Akt also known as PKB) pathway (Gielen et al., 2010). Deformation of the glycocalyx activates vascular endothelial growth factor receptor-2 (VEGFR2) which activates PI3K (Gielen et al., 2010). PI3K causes phosphorylation of Akt and then induces Akt mediated phosphorylation and activation of the enzyme endothelial nitric oxide synthase (eNOS) at the serine¹¹⁷⁷ site on eNOS (Dimmeler et al., 1999). eNOS is located at the luminal endothelial cell membrane (Gielen et al., 2010) and upon activation electrons are transferred from nicotinamide adenine dinucleotide phosphate-oxidase (NADPH) at the reductase site of eNOS via Flavin adenine dinucleotide (FAD) and then Flavin mononucleotide (FMN) to the oxygenase area (Figure 2.3) (ALDERTON et al., 2001). The electrons then interact with a haem ion and tetrahydrobiopterin (BH₄) to catalyse the conversion of oxygen and L-arginine into NO and L-citrulline (ALDERTON et al., 2001); NO is then free to diffuse into the VSMC (**Figure 2.2**)(Kinlay and Ganz, 1997).

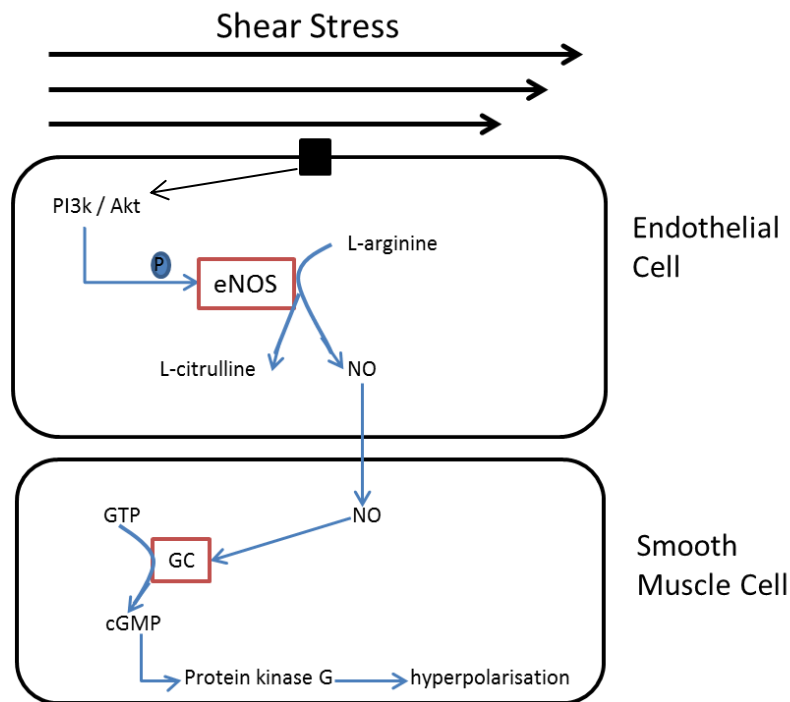

Figure 2.2 Shear stress stimulating the mechanosensors (black square) on the luminal surface of the endothelial cell which triggers a biochemical pathway to upregulate NO production which diffuses into the vascular smooth muscle cell where hyperpolarisation of the cell induces vasodilation. Adapted from Higashi and Yoshizumi (2004).

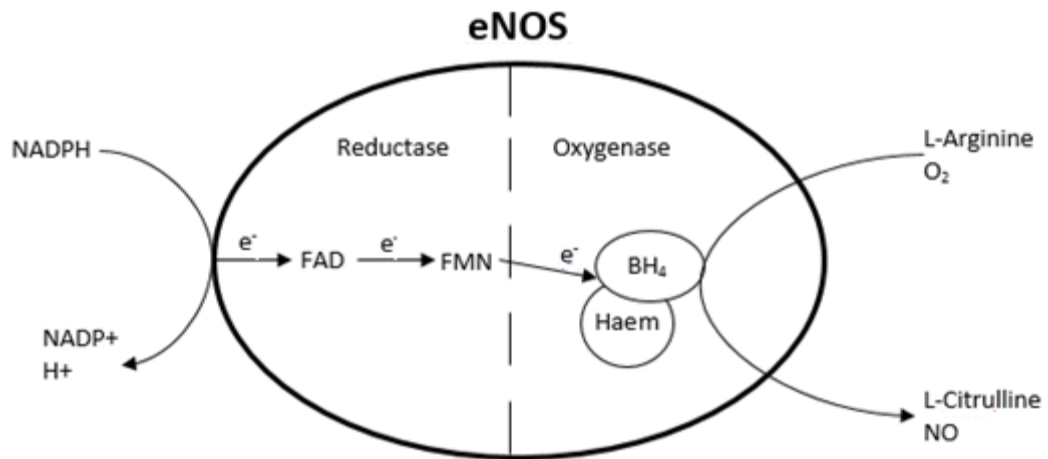

Figure 2.3 The actions of the eNOS enzyme in the production of NO within the endothelial cell. Reproduced and modified from ALDERTON et al. (2001).

NO within the VSMC binds to and stimulates the enzyme guanylate cyclase (GC); GC catalyses the dephosphorylation of guanosine triphosphate into cyclic guanosine monophosphate (cGMP) (**Figure 2.2**)(Cohen and Vanhoutte, 1995). cGMP is a secondary messenger within VSMCs which directly activates protein kinase G (Burgoyne and Eaton, 2010) resulting in phosphorylation of multiple targets capable of regulating both intracellular calcium concentration and contractile protein calcium sensitivity (Burgoyne and Eaton, 2010). An example of these targets is the large conductance calcium activate potassium channel which lies on the VSMC membrane, activation of protein kinase G increases the probability of the potassium channel opening (Burgoyne and Eaton, 2010). Hyperpolarisation of the membrane of the VSMC results from increased exportation of potassium via the aforementioned channel in addition to closing of voltage dependent calcium channels leading to a reduction in total calcium influx into the VSMC (Burgoyne and Eaton, 2010). Reductions in intracellular calcium concentrations within VSMC leads to dephosphorylation of myosin light chains, allowing myofilament cross-bridge cycling resulting in relaxation of the VSMC (Burgoyne and Eaton, 2010). Relaxation of VSMC causes vasodilation of the artery, normalising increases in intraluminal pressure and prevents endothelial dysfunction.

2.1.4 Determinants of shear stress

As stated earlier shear stress is a driving factor in vasodilation through upregulation of NO production in endothelial cells. There are predominantly two types of blood flow through an artery producing either laminar or oscillatory shear. Laminar shear is characterised by steady blood flow travelling in a single direction, parallel to the vessel walls (Nichols and O'Rourke, 1998). This type of shear is highly associated with promoting healthy ECs during cell culture and upregulation of NO (Guo et al., 2007). In-vitro experiments typically assess shear stress in arteries which are predominantly

straight tubes with a constant cross-sectional area, replicating the brachial artery for example. As blood flow is principally unidirectional when assessed in straight tubes like the brachial artery, shear stress can be determined through mathematical modelling via Poiseuille's equation, see Davies (2009). The equation takes into account the radius of the artery, blood viscosity and blood flow velocity whilst a constant pressure is maintained (**Figure 2.4**). Poiseuille's equation where τ is shear stress, R is radius, Q is flow rate, μ is fluid viscosity (Davies, 2009):

$$\tau = \frac{4\mu Q}{R^3}$$

Equation 1

It is apparent from Poiseuille's equation that small changes in the radius of the artery produce large changes in shear stress and importantly changes in shear stress alter the radius of the artery.

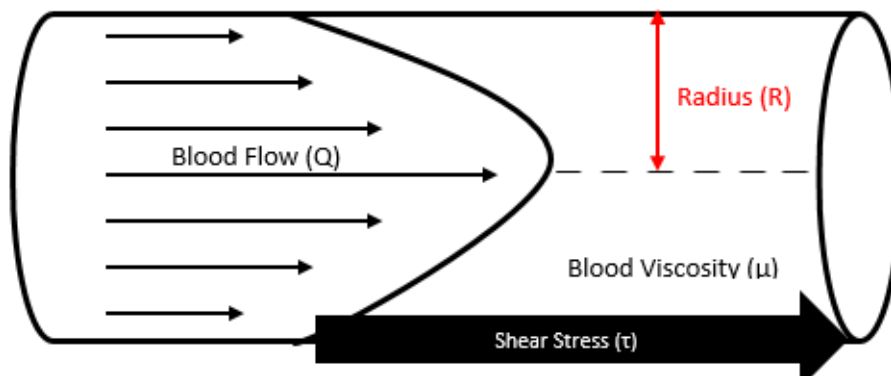

Figure 2.4 Laminar shear through a straight artery, for example the brachial artery, can be determined via Poiseuille's equation (Equation 1). Adapted from Koskinas et al. (2009)

Oscillatory shear typically occurs at anatomical points within the blood vessel, for example branch points, curvatures and bifurcations as can be observed in **Figure 2.5** (Davies, 2009) where there is no net forward blood flow (Hwang et al., 2003). The

aforementioned anatomical points are characterised by low shear caused by low flow velocities, multidirectional force vectors, and steep temporal and spatial gradients (Davies, 2009) ultimately altering endothelial cell phenotype, at branch points, curvatures and bifurcations, becoming atheroprone (Davies, 2009). A general formula to determine whether blood flow could be identified as oscillatory was recommended by Nichols and O'Rourke (1998):

$$Re = 4m\bar{V} / \nu$$

Equation 2

Where $4m$ is the diameter of the vessel, \bar{V} is the mean velocity of flow, ν is the kinematic viscosity. This equation provides Reynolds number (an arbitrary number) which describes the transition of flow from linear to oscillatory. Through animal and in vitro experiments, a Reynolds number of 2000 has been suggested to be the critical point at which laminar flow becomes oscillatory (Nichols and O'Rourke, 1998). This is due to a reduction in blood flow velocity and increasing volumes of blood flow travelling in random cross-sectional movements (Nichols and O'Rourke, 1998). Below 2000 flow is mainly laminar and it is reported to be difficult to induce any oscillatory flow (Nichols and O'Rourke, 1998). The process of laminar shear transitioning into oscillatory shear has been described by Schiller (see Goldstein (1938) and Nichols and O'Rourke (1998)) whereby blood flow appears to exist in three distinct phases. Firstly there is laminar flow which is comprised of completely undisturbed, unidirectional blood flow parallel to the vessel wall (Nichols and O'Rourke, 1998). The second phase occurs at an increased Reynolds number, blood flow during this phase begins to exhibit a wave like motion (Nichols and O'Rourke, 1998). Oscillations in the flow can become larger with small vortices forming (Nichols and O'Rourke, 1998). The final phase comprises of larger and more frequent vortices which combine to

produce large oscillations in flow and results in a higher Reynolds number which would be >2000 when the equation is utilised (Nichols and O'Rourke, 1998).

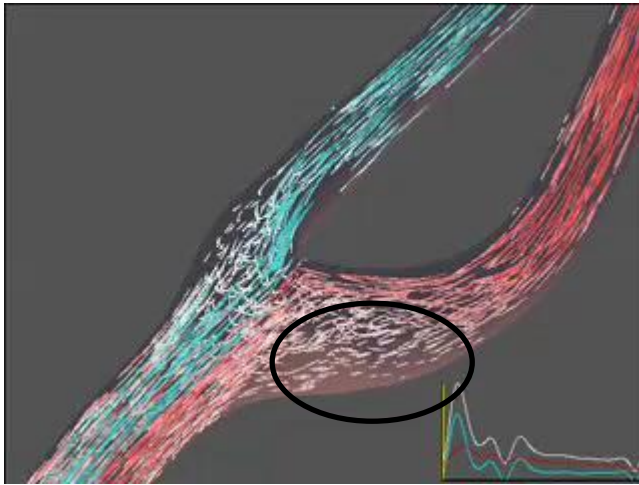

Figure 2.5 A computational model of blood flow through the carotid artery bifurcation. The area within the black circle shows an atheroprone area due to the endothelial cells experiencing oscillatory shear. Modified from David Steinman, University of Toronto.

The best measurement of oscillatory flow is the pressure gradient-flow relationship which provides an indication of the degree of deviation from laminar flow (Nichols and O'Rourke, 1998). During laminar shear the pressure gradient varies in a linear manner with the rate of flow (Nichols and O'Rourke, 1998). In contrast, with oscillatory shear this relationship varies as a greater pressure gradient is necessary to maintain oscillatory flow, i.e. more energy is required to maintain this type of flow due to the increased movement of the flow in multiple directions (Nichols and O'Rourke, 1998). However, determining this pressure flow gradient in vivo is difficult which is especially true during exercise. An alternative method which has been cited in several publications is the oscillatory shear index (OSI) which is relatively easy to determine in vivo when anterograde (from forward blood flow) and retrograde (from decelerative blood flow) shear rate have already been determined (equations detailed in section 3.7.2). OSI provides a measure of the shear at a point of interest where the shear

acting in contrast to the majority of the flow are taken into account and quantified (Davies, 2009). This measure has been used throughout current literature where ultrasound has been used to explore types and ratios of anterograde and retrograde shear rate in vessels, equation in section 3.7.2. An OSI of 0-0.5 is classified as being laminar and an $OSI > 0.5$ is oscillatory (Padilla et al., 2011c).

Pulsatile shear, although categorised as a type of laminar shear due to an overall net forward flow (Hwang et al., 2003), may possess brief periods of oscillatory flow. The pulsatile nature of blood flow may lead to instability of the flow which can result in turbulence and oscillatory shear (Nichols and O'Rourke, 1998). Peak systolic ejection (a point of maximal flow velocity) was shown to briefly disrupt laminar shear before returning to normal during low flow velocity in diastole within rabbit aorta (distal to the renal arteries) causing turbulence (McDonald, 1952). However, the period of oscillatory shear was very brief (50 ms), thus it was concluded that this period of oscillatory shear was too brief to be damaging and was part of normal physiological blood flow during a cardiac cycle (McDonald, 1952, Nichols and O'Rourke, 1998).

2.1.5 MicroRNAs in regulation of endothelial cell phenotype

Mechanisms which can be genetically inherited and are capable of affecting gene expression without changing the base sequence of the DNA are defined as epigenetics (Udali et al., 2013). Simply, epigenetics relates to the modification of DNA that determines whether a gene is transcribed thus influencing cellular phenotype (Udali et al., 2013). As the role of epigenetics has developed, investigations into the relationship between genetics and epigenetics has led to further discoveries of the environmental factors which can impact physiological processes and lead to pathologies such as cancer (Udali et al., 2013). Over the last 20 years small, non-coding RNA, termed microRNA (miRs), have been revealed as novel signalling molecules which have the potential to control mechanisms related to numerous

pathologies (Chen et al., 2012). MiRs are endogenous, single stranded RNAs which are typically between 18-22 nucleotides long and do not code for proteins (Chen et al., 2012). Instead of coding for protein synthesis, miRs regulate genes by binding to the target gene at the 3'-untranslated region (Chen et al., 2012). This results in direct degradation of messenger RNA (mRNA) or repression of translation via perfect/imperfect complementary base pairing (Chen et al., 2012). Currently, 2000 human microRNA have been discovered (Boon et al., 2012) signifying the wide spread regulation of cellular function that miRs exert (Chen et al., 2012).

Furthermore, microRNAs have been discovered within endothelial cells and have been found to be responsive to shear stress. These flow sensitive miRs have been shown to alter endothelial cell phenotype which can create either a pro-atherogenic or anti-atherogenic endothelial cell environment depending upon which miRs are upregulated (Kumar et al., 2014). This has implications upon overall vascular health and CVD risk.

2.1.5.1 MicroRNA Biogenesis

MicroRNAs exist in 3 forms during biogenesis as they develop into functional gene regulators. The biogenesis process is complex and will be briefly described here (**Figure 2.6**).

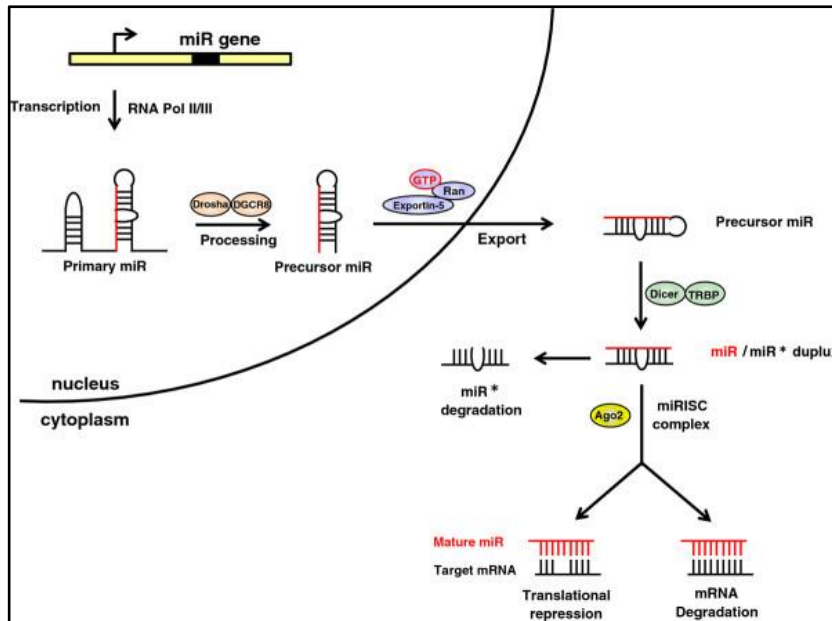

Figure 2.6 The biogenesis of microRNA from transcription in the nucleus of the cell to its actions upon mRNA in the cytoplasm (Chen et al., 2012).

In the first stage, miR genes (located at introns) are transcribed with the mRNA genes in the cell nucleus by RNA polymerase 2/3 (Lee et al., 2004). MiRs can be produced as a single molecule as they contain primary transcripts, whilst other miRs can be clustered together and are therefore expressed together (Chen et al., 2012). At this stage miRs are known as primary miRs.

Following transcription, the primary miRs are cleaved into a hairpin structure consisting of 60-100 nucleotides by a nuclear microprocessor complex (Chen et al., 2012). This microprocessor complex is made up of RNase 3 enzymes DROSHA and DGCR8 and yields precursor miRs (Chen et al., 2012). The precursor miR is then exported from the nucleus to the cytoplasm by exportin-5 with Ran-GTP cofactor (Yi et al., 2003). Once in the cytoplasm the precursor miR undergoes further processing by RNase 3 Dicer, forming the RISC complex (Gregory et al., 2005). This complex cleaves the hairpin section of the precursor miR thus generating a miR complex consisting of 22 nucleotides (Gregory et al., 2005).

The miR duplex consists of two strands: a guide strand made of mature miR and a complementary passenger strand (Chen et al., 2012). The guide strand is preferentially incorporated into the miR RISC, containing proteins such as Dicer, whilst the passenger strand is detached and rapidly degraded (Chen et al., 2012). The guide miR binds to its target mRNA using base pairing, this causes translational repression or degradation of the mRNA (Ghildiyal et al., 2010).

2.1.5.2 Shear as a regulator of miR

As discussed earlier (section 2.1.4), endothelial dysfunction and atherosclerotic plaques are predisposed to forming at points in the vascular tree which are exposed to oscillatory shear. Recently it has been demonstrated that laminar and oscillatory shear stress can differentially alter specific microRNA expression within endothelial cells, these flow sensitive miRs are termed mechano-miRs (Kumar et al., 2014). According to the literature, there are currently 3 classes of mechano-miRs: 1) anti-atherogenic, 2) pro-atherogenic and 3) those that have a dual role. Anti-atherogenic mechano-miRs are either increased by laminar shear stress or decreased by oscillatory shear stress in endothelial cells (Kumar et al., 2014). Conversely, pro-atherogenic mechano-miRs are decreased by laminar shear stress and increased by oscillatory shear stress (Kumar et al., 2014). Mechano-miRs which have a dual role have been implicated in both anti-atherogenic and pro-atherogenic events with an inconsistent sensitivity to different flows (Kumar et al., 2014). The dual role mechano-miRs may also reflect that single miRs can affect multiple target mRNA. It is therefore important to consider the context, cell type and environment when assessing the overall response of the cell (Kumar et al., 2014).

The majority of mechano-miRs have been identified in endothelial cells during in-vitro experiments due to difficulty in extracting endothelial specific RNA in-vivo. However, assessing mechano-miRs in-vitro can also be problematic as mechanosensitive

genes can become lost or dysregulated during the cell culture process (Son et al., 2013). This therefore emphasises the importance of determining mechano-miRs in vivo to compare results with those of in-vitro studies.

In the present thesis, only one mechano-miR was selected from numerous candidates. The miR was required to be affected by shear, play a role in the regulation of endothelial cell phenotype and to be detectable within the circulation. On this basis miR-21 was selected. Artificially induced oscillatory shear stress (0.5 ± 4 dynes/cm²) has been shown to upregulate miR-21 within cultured human umbilical vein endothelial cells (HUVECs) (Zhou et al., 2011). Overexpression of miR-21 was further shown to inhibit translation of its target gene peroxisome proliferator activated receptor (PPAR α) (Zhou et al., 2011). This resulted in increased vascular cell adhesion molecule 1 (VCAM-1) and monocyte chemoattractant protein 1 (MCP-1) expression, proteins associated with adhesion of monocytes to endothelial cells (ECs) (Zhou et al., 2011) (**Figure 2.7**). This study suggests miR-21 aids in promotion of a pro-atherogenic endothelial environment (Zhou et al., 2011).

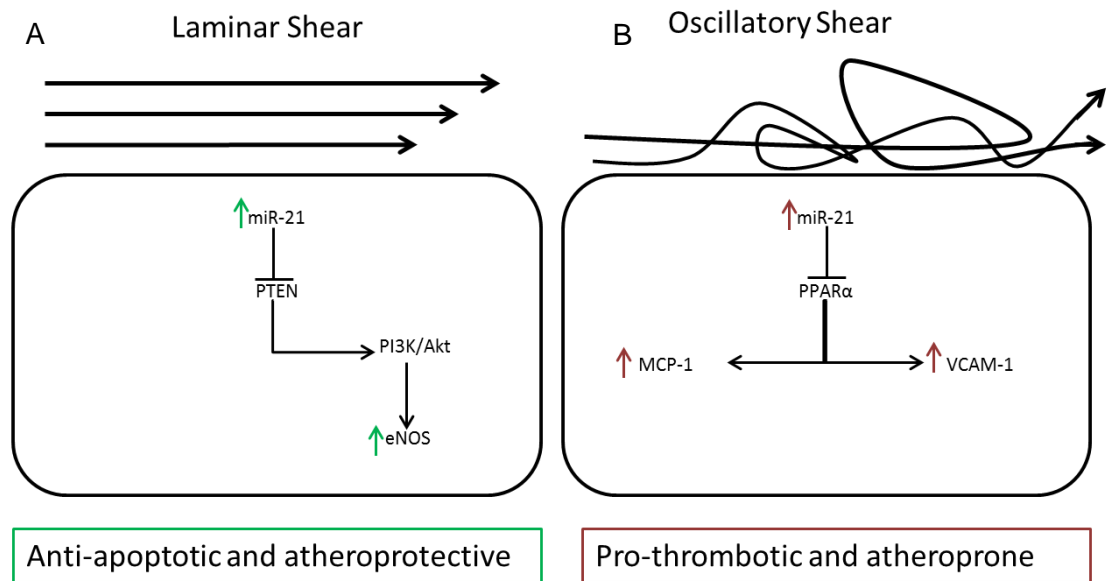

Figure 2.7 [A] Laminar shear stress can cause upregulation of miR-21 which inhibits its target gene PTEN. Reduced expression of PTEN removes the inhibition of its antagonist PI3k to allow eNOS to produce NO (Weber et al., 2010). [B] Oscillatory shear stress has been shown to upregulate miR-21 which inhibits PPAR α resulting in increases in vascular adhesion molecules (Zhou et al., 2011).

HUVECs exposed to laminar shear stress demonstrated a 5.2 fold increase in miR-21 expression compared to control cells (Weber et al., 2010). Furthermore, the phosphatase and tensin homolog (PTEN) gene was shown to decrease in response to exposure to laminar shear stress, it was subsequently confirmed that PTEN appears to be a miR-21 target gene, whereby miR-21 can post-transcriptionally regulate its expression (Weber et al., 2010). The role of PTEN within ECs is to increase apoptosis and inhibit its antagonist PI3k therefore ultimately inhibiting the PI3k/Akt/eNOS pathway (Weber et al., 2010) (**Figure 2.7**). This demonstrates that miR-21 acts in an atheroprotective role by inhibiting PTEN to indirectly promote PI3k to act as an anti-apoptotic (Weber et al., 2010).

The aforementioned studies demonstrate the dual role of miR-21 as a mechano-miR. These in-vitro studies suggest that the mechanosensitivity of miR-21 may be transient

and is an adaptive response when shear stress is imposed (Kumar et al., 2014). Currently it cannot be determined as to whether mir-21 plays a pro- or anti-atherogenic role in endothelial cells (Kumar et al., 2014).

2.1.5.3 Detection of MiRs within the circulation

Circulating miRs can serve as messengers between endothelial cells and VSMCs with alterations in this communication implicated in the formation of atherosclerotic plaques (Kumar et al., 2014). MiRs were discovered within the circulation in 2008 from human serum/plasma samples amongst other human bio fluids (Sapp et al., 2017). The ability to detect miRs within the circulation enables them to be used as potential biomarkers for physiological processes and disease. The advantage of assessing circulating miRs is their ability to be rapidly upregulated therefore reflecting real time physiological responses to a stimuli which may be missed when extracting tissue or culturing cells (Baggish et al., 2014). Additionally, the collection of circulating miRs and their high stability when frozen in plasma/serum demonstrate their potential as useful targets as biomarkers for therapy (Sapp et al., 2017).

Circulating miRs originate from a variety of cells types before being secreted into the circulation where they can travel to target cells in order to regulate physiological functions. It is currently still unclear whether miRs are actively secreted or passively shed into the circulation. Once in the circulation miRs are transported within extracellular vesicles, proteins or HDLs (Sapp et al., 2017). Upon reaching their target cell or tissue miRs are then able to regulate translation of complementary mRNA. It appears that not all miRs are secreted into the circulation and that only a select few undergo this deliberate release in response to specific stimuli for example shear stress induced via exercise (Sapp et al., 2017).

Despite the promising role of miRs as circulating biomarkers of physiological processes and disease there are several key issues which need to be resolved in this

new research area. Firstly, the optimal time for venous sampling to detect circulating miRs shed from cells following a specific stimulus remains unknown. Studies which have used acute exercise as a stimulus to assess miR expression have taken blood samples ranging from immediately after cessation of the exercise to 30min, 1 hr, 3hr, 24 hr, 48hr and 72 hr. There does not appear to be a clear consensus regarding the optimum sampling time and this may partially explain the discrepancy in the literature. Secondly, there is no known consistent housekeeping gene for quantification of circulating miR expression during PCR, thus making comparison of circulating miRs expression between studies difficult. Commonly a synthetic spike-in control not expressed within humans is used during RNA extraction. This is used to normalise samples based on efficiency of extraction and quantify target miRs compared to the expression of the control within samples. However, other studies have normalised expression based on a mean expression of all miRs within an array, or to a chosen circulating miR which has been shown to have low variance within the circulation and between samples. The inconsistency between studies shows the requirement for a universally accepted and gold standard housekeeping gene for normalisation to improve reproducibility and reliability.

2.2 Ageing and Gender influences upon vascular health

Alterations to the normal structure and function of arteries are commonly observed in the early stages of CVD. In particular endothelial dysfunction and arterial stiffening are associated with the initial stages of atherogenesis (Healy, 1990). Atherosclerotic lesions commonly form at weak points in the vasculature for example at bifurcations, branch points and curvatures where the blood flow dynamics lead to activation of exposed endothelial cells (Lusis, 2000). Activation of ECs produces a pro-atherogenic phenotype which changes cell morphology, endothelial permeability and vasodilatory capacity, key features of endothelial dysfunction (Bonetti et al., 2003). Both endothelial dysfunction and arterial stiffening have an increased prevalence with ageing and physical inactivity with differences in development observed between genders.

The Framingham Risk Score was devised to calculate 10-year prediction of cardiovascular events based on traditional CVD risk factors such as blood pressure, cholesterol and diabetes. However, the Framingham risk score fails to predict up to 50% of future CV events (Naghavi et al., 2003), and older age predicted future CVD independently of other traditional risk factors (Mahmood et al., Wilson et al., 1998). Importantly, prevalence of endothelial dysfunction increases with age and can occur in the absence of traditional CVD risk factors (Seals et al., 2011). Endothelial function, assessed in peripheral conduit arteries via flow mediated dilation (FMD), has been shown to progressively decline from age 40 years in males and 50 years in females (Celermajer et al., 1994). Endothelial dysfunction is commonly observed in individuals aged 65 years and above (Celermajer et al., 1994). Decline in endothelial function with age is not specific to conduit arteries and has been observed throughout the vascular system with the aorta most affected in rats (Barton et al., 1997) and reduced

arterial vasodilatory capacity shown in downstream resistance vessels and the microcirculation (Black et al., 2009).

2.2.1 Ageing negatively impacts cardiovascular health

Endothelial function, as assessed via FMD, has also been used to determine hazard ratios in older adults. 2791 adults aged 72-98 years were assessed for FMD and subsequently followed up for 5 years (Yeboah et al., 2007). Participants with FMD above sex specific medians had a better cardiovascular risk factors than those with lower FMD (Yeboah et al., 2007). Over the 5 year follow up 24.1% had an event with 19.1% never previously suffering from a cardiovascular event (Yeboah et al., 2007). FMD was a significant predictor of cardiovascular events over a 5 year period in an older population with a hazard ratio of 0.91 compared with traditional CVD risk factors such as diabetes and hypertension (Yeboah et al., 2007). The predictive value of FMD remained even after adjustment for age, gender and other standard CVD risk factors although the authors argued that FMD added little prognostic accuracy to traditional CVD risk factors in this population (Yeboah et al., 2007).

2.2.1.1 Haemodynamics are altered with ageing

Shear stress is one known regulator of endothelial function (Davies, 2009). As a higher prevalence of endothelial dysfunction has been shown in older populations. It is unclear whether decline in endothelial function with age is due to changes in shear stress. Young et al. (2010) assessed differences in shear rate (SR) patterns between 20 young (24 ± 1 yr.) and 18 older (60 ± 1 yr.) participants in the atheroprone common femoral artery. All participants were free of traditional CVD risk factors. Older participants demonstrated reduced anterograde SR and significantly increased retrograde SR compared to younger participants (Young et al., 2010). This resulted in a lower overall mean shear and 30% higher oscillatory shear in the older compared to the younger group (Young et al., 2010). Additionally, femoral vascular resistance

was higher in the older group and was positively correlated to oscillatory shear in the older group only (Young et al., 2010). Therefore factors contributing to increased vascular resistance in older individuals, such as increased sympathetic nerve activity or increased circulating vasoconstrictors, may contribute to this alteration in shear pattern with age (Young et al., 2010).

Casey et al. (2016) studied brachial and common femoral artery SR in young and older untrained adults. Similar to the above study common femoral and brachial retrograde SR and OSI were greater in 17 older untrained (66 ± 3 yr.) compared to 13 younger adults (24 ± 2 yr.) (Casey et al., 2016). However, there did not appear to be a difference in limb vascular resistance between the young and older groups (Casey et al., 2016). Despite this, the older group only demonstrated a moderate negative correlation between arm vascular resistance and retrograde SR and moderate positive correlations between OSI and arm and leg vascular resistance (Casey et al., 2016). Padilla et al. (2011b) also demonstrated age-related increases in forearm retrograde SR and oscillatory shear at rest in 11 older (61 ± 2 yr.) compared to 11 younger (26 ± 2 yr.) individuals. Furthermore, Credeur et al. (2009) found that age was inversely related to blood flow, vascular conductance and positively related to retrograde flow in the brachial artery. Indeed, there appeared to be an approximately 60% increase in retrograde flow per decade after 60 years (Credeur et al., 2009). Additionally, there was no apparent change in anterograde blood flow with age in this study (Credeur et al., 2009). Although not assessed in the aforementioned study, oscillatory shear index as determined by the ratios of anterograde to retrograde SR would be higher in older adults which is associated with downregulation of NO.

2.2.1.2 NO production and eNOS expression decrease with ageing

An important component of endothelial function is vasomotor balance between vasodilation and vasoconstriction. Alteration in vasomotor balance is due to a number

of mechanisms relating to NO bioavailability and potent endothelial vasoconstrictors such as ET-1 (**Figure 2.10**). With ageing and endothelial dysfunction this balance switches in favour of constriction although the mechanism of this change with ageing remains unclear (Böhm and Pernow, 2007). A possible mechanism includes reduction in the quantity of NO generated within the endothelial cells or reduced release from the ECs and/or an enhanced breakdown of NO once it is produced (Donato et al., 2015). Seals et al. (2011) argues that the vasodilatory response to NO and other dilatory factors are unchanged with age therefore reduced vasodilation must be due to either decreased NO production, increased NO removal or both. Thus, the artery has the ability to dilate but is not suitably instructed to resulting in impaired endothelium dependent dilation in older populations.

With progressing age NO bioavailability is reduced, shown by impaired endothelium dependent vasodilation in response to acetylcholine (known NO mediated vasodilator) (Taddei et al., 1995, Taddei et al., 1996, DeSouza et al., 2000) and during FMD (Celermajer et al., 1994, Eskurza et al., 2005, Donato et al., 2007). This was further supported by a reduction in the inhibition of vasodilation as a consequence of L-NMMA (NO antagonist) infusion with progressing age (Taddei et al., 2001). Taddei et al. (1995) demonstrated decreased NO bioavailability with age in the forearm of older normotensive and hypertensive individuals. In ageing eNOS expression appears to be decreased thus reducing NO bioavailability, through pathways discussed in detail in section 2.1.3, resulting in reduced vasodilation and upregulation of inflammatory molecules in addition to vasoconstrictor ET-1 (Ramzy et al., 2006). Reduced generation of NO suggests a problem with the eNOS pathway. A lack of the substrate L-arginine or any cofactors, e.g. tetrahydrobiopterin (BH₄), leads to uncoupling of eNOS and reduced NO production (Cai and Harrison, 2000). Importantly when L-arginine is given to participants there is an improvement in skin

blood flow suggesting improved response to a dilating stimulus (Holowatz et al., 2006). BH4 has been shown to be reduced with age further supporting disruption in the NO synthesis pathway via eNOS uncoupling (Pierce and LaRocca, 2008). Indeed upon supplementation of BH4 there was a 45% improvement in FMD in 9 older sedentary males (age 62±2 years) although no improvement was shown in younger sedentary males and older aerobically trained males (Eskurza et al., 2005).

Contrasting findings exist within the literature in regards to changes in eNOS expression during ageing. Some studies have reported reduced eNOS expression whereas others have found increased eNOS expression with age. Barton et al. (1997) observed reduced eNOS mRNA expression in older compared to younger rats. However, in a human study Donato et al. (2009) showed that eNOS expression was preserved in older males. This study concluded the alteration in the balance between vasodilation and vasoconstriction with age was due to increased production and reactivity of ET-1 (Donato et al., 2009). Donato et al. (2009) also suggested greater eNOS expression in older individuals was to compensate for lower NO bioavailability due to increased ET-1 or superoxide interactions. This supports the hypothesis that eNOS mediated NO production is maintained during ageing and an additional source interacts to reduce NO bioavailability following synthesis. Alternatively, NO may not be adequately secreted from the ECs to the VSMC to initiate vasodilation (Montero et al., 2015). In a meta-analysis by Montero et al. (2015) there appeared to be a small but significant reduction in SMC function. This may be due to reduced VSMC sensitivity to NO which is integral in the facilitation of vasodilation (Montero et al., 2015).

The importance of shear stress in the upregulation of NO has been discussed earlier in this thesis (section 2.1.3). In regions where low shear stress is experienced NO bioavailability has been shown to be reduced via reductions in eNOS mRNA and

protein expression (Chatzizisis et al., 2007a) (**Figure 2.8**). Qiu and Tarbell (2000) showed that NO production was highest in isolated endothelial cells during steady flow conditions with NO reduced during pulsatile and oscillatory flow across 4 hours. An in-vitro study exposed bovine aortic ECs to highly reversing oscillatory shear stress, typical of the shear experienced by endothelial cells in atheroprone regions, was also studied at 4 and 24 hours (Ziegler et al., 1998). Compared to a unidirectional shear stress, oscillatory shear stress induced a lower expression of eNOS at 24 hours (Ziegler et al., 1998). In the previous section (section 2.2.1.1), older adults were shown to experience higher levels of oscillatory shear compared to younger adults despite a favourable CVD risk profile. The greater levels of oscillatory shear experienced with ageing may offer additional mechanisms for the age associated reduction in NO bioavailability.

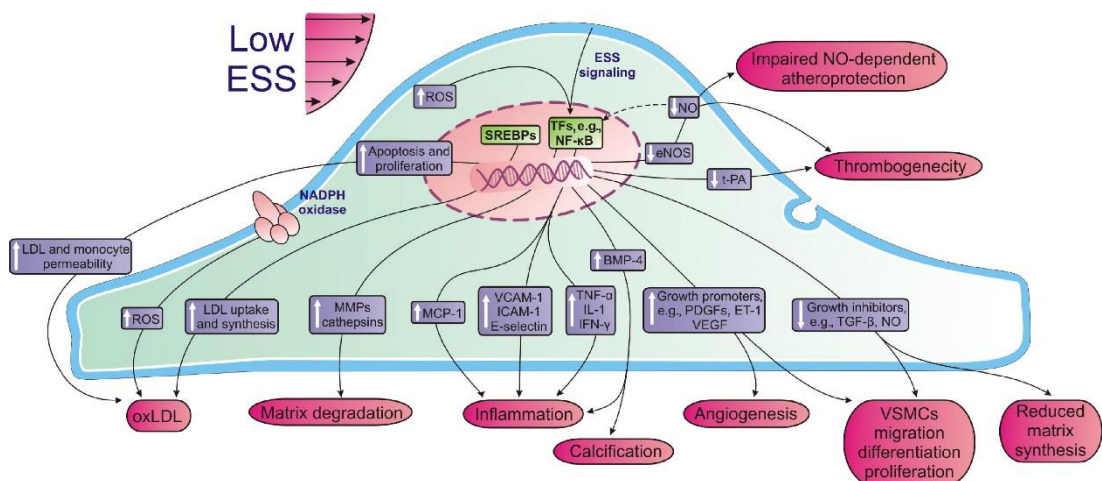

Figure 2.8 Low endothelial shear stress disturbs laminar flow altering the endothelial structure and function towards a more atherosclerotic phenotype via the mechanisms shown in the figure (reproduced from Chatzizisis et al. (2007b)).

2.2.1.3 Vasoconstrictor are upregulated during ageing

In ageing, there is an upregulation of vasoconstrictors altering vasomotor balance to favour vasoconstriction (Donato et al., 2009). In particular the potent vasoconstrictor endothelin-1 appears to be a direct antagonist to NO (**Figure 2.10**) (Ramzy et al.,

2006). ET-1 impairs NO production and downregulates eNOS expression (Ramzy et al., 2006). Under normal physiological conditions ET-1 is produced in small amounts to act as an autocrine/paracrine mediator (Böhm and Pernow, 2007). Donato et al. (2009) demonstrated increased production of ET-1 in 27 older males (61 ± 1 years) in addition to reduced forearm blood flow in response to Ach compared to 27 younger males (22 ± 1 years). Additionally, increased ET-1 with age was significantly inversely ($r=-0.37$) related to endothelial dependent vasodilation (Donato et al., 2009). Furthermore, older males ($n=8$; 67-76 years) have been shown to have greater lower limb vasodilation response to ET receptor blockade compared to younger males ($n=8$; 19-50 years), $29 \pm 9\%$ versus $10 \pm 4\%$ improvement in leg blood flow measured using venous occlusion plethysmography (Thijssen et al., 2007). This suggests ET-1 has a greater role in maintaining vascular tone in older individuals (Thijssen et al., 2007).

The balance between NO and ET-1 is known to be important for endothelial cell health. In the previous section (section 2.2.1.1), a study on bovine aortic ECs showed that oscillatory shear stress induced lower eNOS expression (Ziegler et al., 1998). Additionally, oscillatory shear stress also induced higher expression of ET-1 mRNA at 4 hours compared to cells exposed to unidirectional shear in the same experiment (Ziegler et al., 1998). These results are supported by Qiu and Tarbell (2000) who also demonstrated reductions in NO and increases in ET-1 when endothelial cells were exposed to pulsatile flow. As ageing induces higher volumes of oscillatory shear (section 2.2.1.1), it is reasonable to suggest that alterations in haemodynamics with age plays a role in switching endothelial cell phenotype to produce ET-1 rather than NO.

The increasing role of ET-1 in maintaining vascular tone with age may also be because of increased sensitivity to vasoconstrictors. The upregulation of ET-1 production with age is potentially due to an increased transcription of ET-1 at the

mRNA and protein level or post-translational proteolytic maturation (Rondaij et al., 2006). ET-1 has 2 specific receptors: ETA and ETB (Rubanyi and Polokoff, 1994). The ETA receptor is located on the VSMC; during ageing this receptor may be present at greater densities or may become more sensitive thus contributing to greater vasoconstriction (Thijssen et al., 2016). The ETB receptor is located on both EC and VSMC and is responsible for vasodilation at ECs through release of NO and prostacyclin (de Nucci et al., 1988) and vasoconstriction at VSMC (Böhm and Pernow, 2007). In older monkeys ETB becomes impaired (Asai et al., 2001) which has been suggested to contribute to increased ET-1 bioavailability as ETB typically contributes to clearance of ET-1 (Thijssen et al., 2016).

2.2.1.4 Endothelial cell apoptosis and senescence during ageing

Endothelial cell apoptosis and senescence are examples of two ageing pathways which can contribute to endothelial dysfunction and atherosclerosis development (Campisi, 2003). However, both senescence and apoptosis are important processes which are required in response to intrinsic and extrinsic signals to maintain healthy structure and function (Campisi, 2003).

Cellular senescence is the reduction in cell division by cells which have the ability to continue dividing (Campisi, 2003). In contrast to apoptosis senescence does not eliminate dysfunctional or damaged cells instead it halts their proliferative capabilities (Campisi, 2003). Senescent cells are incapable of renewal and therefore may contribute to ageing phenotypes such as impaired healing, an important factor in the development of endothelial dysfunction as impermeability is affected (Campisi, 2003). Endothelial cells with senescence-associated phenotypes exist in human atherosclerotic lesions (Minamino et al., 2002). It is therefore conceivable that functional changes in senescent endothelial cells in vivo may play an important role in the pathophysiology of age-associated vascular disorders, e.g. atherosclerosis

(Minamino et al., 2002). Endothelial cells from atherosclerotic regions within human coronary arteries were investigated and shown to be senescent in addition to exhibiting a loss of telomere function and this was associated with endothelial dysfunction (Minamino et al., 2002). There also appears to be a relationship between telomere loss within endothelial cells and low haemodynamic stress. It has been suggested that disturbed flow may accelerate telomere loss through increased rate of cell turnover contributing to endothelial dysfunction (Minamino et al., 2002). Additionally, ROS production increases with age and has been implicated in endothelial cell senescence by damaging telomeres and impairing telomerase activity (Erusalimsky, 2009). In patients with atherosclerosis and endothelial dysfunction, increases in circulating endothelial cells and microparticles have been observed (Esposito et al., 2006) which are indicative of cell senescence (Campisi, 2003).

Apoptosis is the rapid, highly conserved process of controlled, programmed cell death (Campisi, 2003). This process is different to necrosis in that the contents of the dying cells are removed by scavenging cells (Campisi, 2003). Thus, the release of degradative enzymes is prevented minimising damage to neighbouring cells and preventing further inflammatory responses (Campisi, 2003). Intrinsic signals govern apoptosis in relation to normal cell differentiation whereas removal of damaged cells from tissues is regulated by extrinsic signals (Campisi, 2003). The exact pathway in which ageing leads to changes in apoptosis control is unknown, however it has been suggested that basic ageing processes may alter regulation of apoptosis within certain cells thus contributing to ageing cell phenotypes and age related diseases (Campisi, 2003).

Senescence and apoptosis of endothelial cells appear to be partially regulated by the type of shear the endothelial cells experience. Laminar shear stress decreases the turnover of endothelial cells by reducing proliferation and apoptosis (Malek et al.,

1999). Furthermore, the action of laminar shear in producing NO within endothelial cells may protect the endothelial monolayer from injury (Dimmeler et al., 2002). In contrast, oscillatory shear results in greater endothelial cell proliferation and turnover in-vitro (Malek et al., 1999). It has also been shown that endothelial cells in areas of disturbed flow show characteristics of cellular ageing and senescence (Bürrig, 1991).

2.2.1.5 Oxidative stress and anti-oxidant balance are affected during ageing

Reactive oxygen species (ROS) are a collection of molecules which in excessive production contribute to oxidant stress (Cai and Harrison, 2000). Types of ROS include superoxide anions, hydrogen peroxide and peroxynitrite with NADH/NADPH oxidase and eNOS potential sources of ROS within vascular cells (Cai and Harrison, 2000). Both of the aforementioned substrates, NADPH and eNOS, have the potential to inactivate NO and contribute to endothelial dysfunction (Cai and Harrison, 2000). Under normal physiological conditions endogenous production of antioxidants act to minimise the interaction between ROS and NO (Cai and Harrison, 2000) thus maintaining endothelial function. However, older adults experience chronic inflammation likely as a result of a reduction (or no compensatory improvement) in anti-oxidant defence with age (Donato et al., 2015). Donato et al. (2007) demonstrated greater markers of oxidative stress in harvested vascular endothelial cells of 44 older males (age 63 ± 1 years) with no change in antioxidant enzyme expression compared to 51 younger males (age 23 ± 1 years). Markers of oxidative stress in both peripheral arterial and venous endothelial cells of older adults were significantly inversely associated with endothelial function, assessed via brachial artery FMD ($r=-0.62$ and $r=-0.44$ respectively) (Donato et al., 2007). The importance of the endothelium in contributing to this inflammatory state is evident when the endothelium was removed from the aorta of rats, resulting in inhibition of NADPH

oxidase and eNOS therefore reducing superoxide anions (Loomis et al., 2005). However, there is much contention over the source of these superoxide anions.

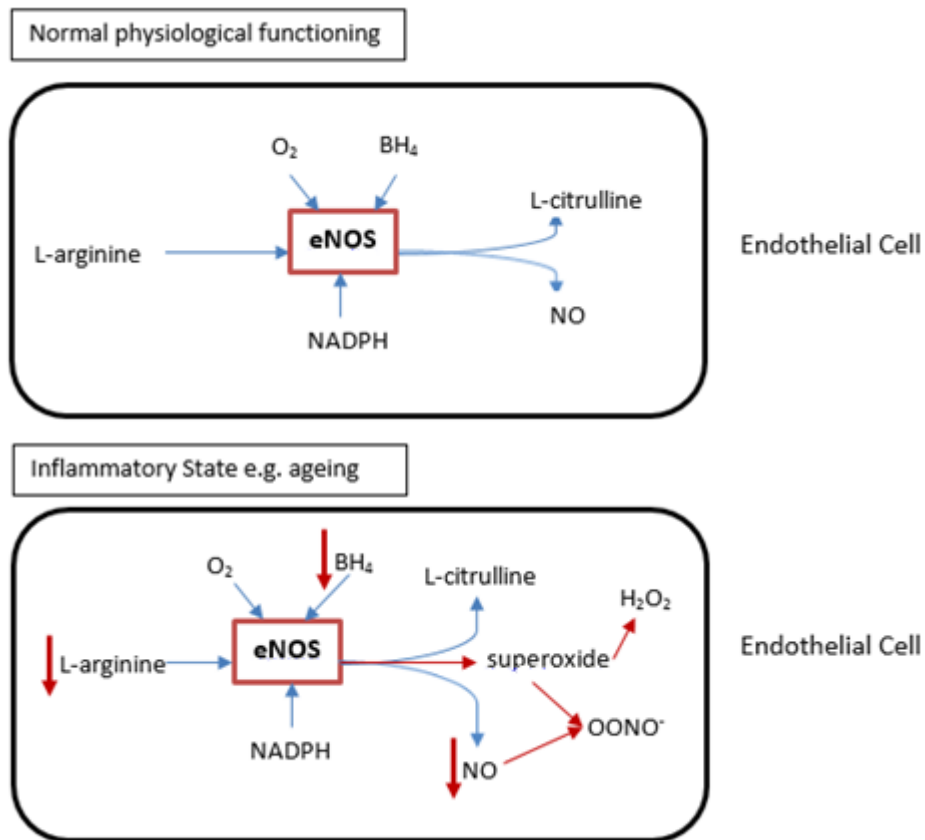

Figure 2.9 Coupled eNOS effectively produces NO under normal physiological conditions however in inflammatory states eNOS can become uncoupled leading to production of hydrogen peroxide and peroxynitrite production which can break down NO and results in a cycle of inflammation. Adapted from Katusic (2001).

eNOS is a likely source of superoxide anion production in endothelial cells. For NO production eNOS requires NADPH to donate electrons and BH₄ for the facilitation of this electron transfer to convert L-arginine to NO and L-citrulline (**Figure 2.9**) (Cai and Harrison, 2000). Lack of L-arginine or BH₄ can cause eNOS to become uncoupled and produce superoxide and hydrogen peroxide (Cai and Harrison, 2000). Uncoupling of eNOS may lead to oxidative stress and endothelial dysfunction through 3 mechanisms: reduced production of NO may allow ROS to interact with alternative

cellular targets; uncoupled eNOS continues to produce ever increasing amounts of superoxide due to continuous NO breakdown; eNOS may become partially uncoupled thus simultaneously producing superoxide and NO (Cai and Harrison, 2000). eNOS is then proposed to become a peroxynitrite generator dramatically exacerbating oxidative stress. As discussed earlier (section 2.2.1.3) older individuals experience upregulation of ET-1. Loomis et al. (2005) used rat aortic rings incubated with ET-1 to show that ET-1 mediates superoxide production through NADPH oxidase and uncoupled eNOS which contribute to ET-1 mediated vasoconstriction. ET-1 oxidises BH4 further exacerbating superoxide production through eNOS uncoupling by reducing the BH4 cofactor (Loomis et al., 2005), further worsening the inflammatory cycle. Another factor is peroxynitrite which is a powerful oxidant of LDLs and is a key stage in the development of atherosclerotic lesions (Lusis, 2000). Oxidised LDLs produce adhesion molecules e.g. intercellular adhesion molecule (ICAM), platelet cell adhesion molecule (PCAM), vascular cell adhesion molecule (VCAM), which are integral in producing macrophages which induce further inflammation (Lusis, 2000). Importantly, low shear stress plays an important role in the promotion of ROS production (**Figure 2.8**). Low shear stress enhances gene expression and post-transcriptional activity of major oxidative enzymes such as NADPH oxidase (Chatzizisis et al., 2007b). Additionally, anti-oxidant enzymes which scavenge ROS appear to downregulated in endothelial cells exposed to low shear stress. HUVECs exposed to disturbed flow showed downregulation of antioxidant enzyme SOD at 24 hours (Brooks et al., 2002). Exposure to disturbed flow also increased inflammatory markers such as adhesion molecules (VCAM-1 and ICAM-1), chemoattractants (MCP-1) and cytokines (TNF α) which may contribute to the chronic inflammation of endothelial cells in atheroprone regions (Brooks et al., 2002). Infiltration of inflammatory cells into the intima may also be facilitated by low shear and disturbed

flow (Chatzizisis et al., 2007b). These types of flow have been shown to stagnate in atheroprone areas, causing widening of endothelial junctions and allowing passage of inflammatory cells into the sub-endothelial layer to oxidise LDLs, thus initiating atherosclerotic plaque formation (Gimbrone, 1999).

The continuous cycle of increased inflammatory molecules and reduced NO production impairs the ability of the endothelium to induce vasodilation when stimulated. The role of inflammatory molecules in the development of endothelial dysfunction is notable when anti-oxidants (e.g. vitamin C) are prescribed. Böhm et al. (2007) assessed forearm blood flow via venous occlusion plethysmography in 12 young males (age 25±1 years) following infusion of ET-1 and vitamin C. Vasodilation was not restored when vitamin C was infused after ET-1 however when vitamin C preceded ET-1 infusion there was no reduction in vasodilation suggesting a protective role of antioxidants (Böhm et al., 2007).

2.2.1.6 Growth factors and hormonal changes with ageing

Ageing is associated with significant reductions in secretion of growth hormone (GH) and serum insulin-like growth factor (IGF-1) (Rosen, 2000). GH deficiency increases CVD risk and increases the risk of mortality from vascular related diseases (Gola et al., 2005). Additionally, individuals deficient in GH, irrespective of age, have increased atherosclerotic plaques within the carotid and femoral arteries (Gola et al., 2005). Replacement of GH reduces CVD risk in younger populations however there are limited changes when prescribed in elderly populations (Rosen, 2000).

In vitro and in vivo studies suggest eNOS can be activated directly through GH acting upon growth hormone receptor or through release of IGF-1 (Duckles and Miller, 2010). Binding of GH to GH receptor causes a conformational change in the receptor triggering downstream signalling ultimately activating the PI3K pathway (Duckles and Miller, 2010). Adult hypo-pituitarism and untreated growth hormone deficiency are

associated with endothelial dysfunction, decreased NO production and increased peripheral resistance thus increasing risk of CV morbidity and mortality (Nyström et al., 2005, Thum et al., 2003). Upon administration of recombinant human growth hormone to GH deficient adults there was an increase in markers of eNOS activation, NO production and decrease in total peripheral resistance (Böger et al., 1996). In cultured human aortic endothelial cells with GH there was no change in eNOS protein content but a time dependent increase in eNOS phosphorylation at serine 1177 (Li et al., 2008). Also in cultured human endothelial cells exposure to GH increased eNOS gene expression within 4 hours of administration and eNOS protein expression also increased (Thum et al., 2003), accompanied by increases in NO production and reduction in intracellular ROS (Thum et al., 2003).

Growth hormone is also able to alter vascular function through its actions on release of insulin-like growth factor (IGF-1) and activation of its receptor (Duckles and Miller, 2010). IGF acts on its own membrane receptor which has intrinsic tyrosine kinase activity and activation of the IGF-1 receptor has been shown to increase eNOS phosphorylation (Duckles and Miller, 2010). When adults with growth hormone deficiency were given human GH there was an observed increase in plasma IGF-1 (Böger et al., 1996). Administration of IGF-1 causes vasodilation in humans and animals which was blocked by eNOS inhibitors suggesting vasodilation occurs through NO mediated pathways (Schini-Kerth, 1998). This was supported by detection of rapid formation of NO in cultured endothelial cells exposed to IGF-1 (Schini-Kerth, 1998).

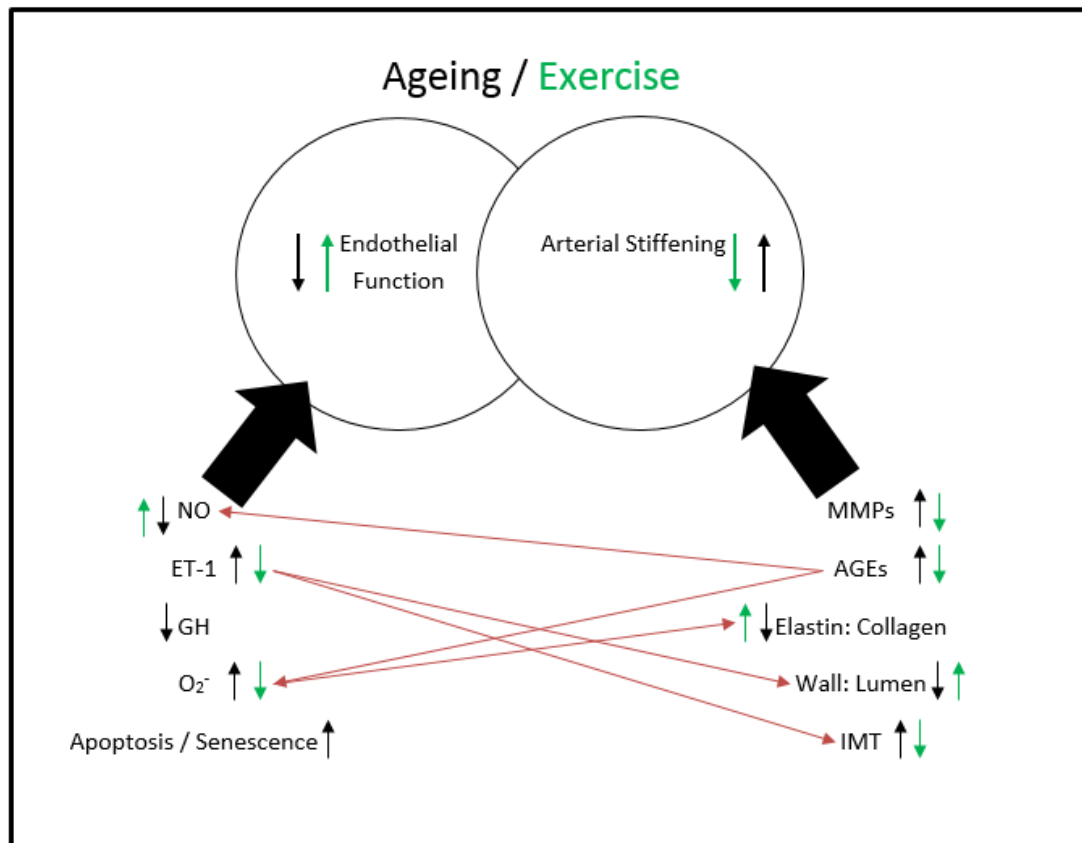

Figure 2.10. Factors such as decreased NO, GH and increases in ET-1, O₂⁻ and endothelial cell apoptosis and senescence contribute to age mediated impairment of endothelial function (black arrows). Increased arterial stiffness with age is a result of increases in MMPs, AGEs, IMT and reductions in the elastin to collagen ratio and the wall to lumen ratio. The red arrows indicate the interrelationships between factors which contribute to endothelial dysfunction and those which contribute to arterial stiffening, therefore emphasising the difficulty in distinguishing whether endothelial dysfunction causes arterial stiffening or vice versa. The effects of exercise training are represented by green arrows. Exercise training can reverse many the factors which contribute to the age mediated endothelial dysfunction and arterial stiffening.

2.2.1.7 MicroRNA expression in vascular ageing

The ability of miRs to modulate protein translation or cause mRNA degradation implicates a role for them in the development of various disease states, for example cancer, type 2-diabetes and CVD (Chen et al., 2012). Additionally, there also appears to be a role for microRNA during ageing which can affect the vasculature and lead to endothelial dysfunction. As discussed previously (section), senescent endothelial

cells increase with ageing and accumulation of these senescent cells has been implicated in contributing to age-related diseases such as cardiovascular disease (Nishiguchi et al., 2014). MiRs expressed in endothelial cells, particularly miR-217, appear to be able to regulate endothelial cell senescence (Menghini et al., 2009). Inhibition of miR-217 delayed senescence in cultured human endothelial cells (Menghini et al., 2009). Furthermore, miR-146a was downregulated in HUVECs during ageing (Vasa-Nicotera et al., 2011). The protein target for miR-146a is NADPH oxidase-4 which is a well-known ROS but also has a role in inducing cell senescence (Nishiguchi et al., 2014).

Ageing associated senescence reduces both the number and function of endothelial progenitor cells (EPC) which are responsible for regeneration of the endothelium following damage (Campisi, 2003). MiR-21 was earlier discussed for its role as a mechano-miR (section), however miR-21 also appears to be a critical regulator of EPC senescence (Zhu et al., 2013). Overexpression of miR-21 in younger mice caused EPC senescence and impaired EPC angiogenesis in vitro and in vivo thus resembling the EPCs from the aged mice (Zhu et al., 2013). In aged mice suppression of miR-21 revived EPCs and reduced senescence (Zhu et al., 2013). In contrast, Rippe et al. (2012) found reduced expression of miR-21 in senescent human aortic endothelial cells (HAECs) was associated with reduced stimulation of proliferation and apoptosis suppression. The decrease of miR-21 in senescent HAECs was also associated with a 50% reduction in eNOS protein phosphorylation (Rippe et al., 2012). Contrasting findings have been observed in the role of miR-21 in ageing cells which may be as a result of the type of in-vitro cell being used, i.e. HUVECs versus HAECs, due to the haemodynamics these cells experience before being collected (Rippe et al., 2012).

2.2.1.8 Arterial stiffness increases during ageing

Arterial stiffness contributes to atherosclerosis and CVD risk (van Popele et al., 2001) and structural stiffening has been proposed as altering endothelial function (Zieman et al., 2005). The layers of the arterial wall are constructed of collagen and elastin fibres which contribute to the structural integrity and elasticity of the artery providing low compliance (Zieman et al., 2005). This structure is regulated by matrix metalloproteases (MMPs) which maintain the balance of fibres through activation or inhibition of gene and protein expression (Zieman et al., 2005). Arterial stiffness is characterised by structural changes to the arterial wall and can occur concomitantly with endothelial dysfunction or independently due to ageing and/or disease, e.g. hypertension, type 2 diabetes, making causality difficult to determine (Zieman et al., 2005).

The process of ageing is strongly associated with endothelial dysfunction and CVD risk (Brandes et al., 2005). Additionally, arterial stiffness has been shown to increase with ageing (Zaydun et al., 2006). Aortic PWV is a marker of central arterial stiffness and was assessed in 2488 participants who were followed over 4.6 years (Sutton-Tyrrell et al., 2005). There were 111 deaths which were as a result of cardiovascular events and 341 recorded events (Sutton-Tyrrell et al., 2005). Aortic PWV was separated into quartiles with the highest aortic PWV associated with total mortality (relative risk 1.7) and cardiovascular mortality (relative risk 2.3) (Sutton-Tyrrell et al., 2005). The Rotterdam Study also supported the association between aortic PWV and CHD (Mattace-Raso et al., 2006). 2835 participants were assessed for aortic PWV and carotid artery distensibility and were followed up over 4.1 years (Mattace-Raso et al., 2006). Higher aortic PWV were associated with an increased risk of developing CHD, with the second and third tertiles exhibiting hazard ratios of 1.72 and 2.45 respectively (Mattace-Raso et al., 2006). In contrast, carotid artery distensibility was not independently associated with CVD risk (Mattace-Raso et al., 2006).

Deterioration in arterial compliance (an indicator of arterial stiffness) with age occurs despite a favourable vascular profile and limited traditional CVD risk factors (Mitchell et al., 2004). Benetos et al. (1993) observed decreased arterial distensibility and arterial compliance throughout the lifespan in the carotid artery. However, this pattern of decreased compliance and distensibility was not observed in the femoral artery suggesting differences in ageing between central and peripheral arteries (Benetos et al., 1993). Van der Heijden-Spek et al. (2000) assessed the differential effects of ageing upon arterial structure and whether site of measurement or participant sex altered the findings. Aortic distensibility as measured by PWV increased gradually with age, whilst no ageing effect upon brachial distensibility was observed (Van der Heijden-Spek et al., 2000). Additionally, there did not appear to be any sex differences in regards to distensibility of the elastic aorta however distensibility of the muscular brachial artery was lower in males than females and displayed a larger diameter and higher compliance (Van der Heijden-Spek et al., 2000). The cause of progressive increase in vascular stiffening with age is currently underdetermined, however several mechanisms have been proposed. During ageing associated arterial stiffness there is widening of the arterial pulse pressure (PP) (Zieman et al., 2005), thickening of the intima-media layer and progressive dilation of the lumen (Sutton-Tyrrell et al., 2001) and wall: lumen ratio reduction (Green et al., 2010b). Often endothelial dysfunction is also observed which may contribute or result from arterial stiffness (Lakatta, 2003). Increased wall thickness of peripheral arteries and decreased wall: lumen ratio with ageing is a characteristic sign of arterial stiffening and a predictor of future CVD risk (Green et al., 2010b). Lack of arterial compliance with age may further promote a decline in eNOS activity as reduced wall stretch may decrease mechanotransduction which is important in eNOS activation (Zieman et al., 2005). Alternatively, endothelial dysfunction may lead to arterial stiffening via changes in endothelial permeability and

the resultant inflammatory cascade described in section 2.2.1.5 producing VSMC proliferation and increased intima media thickness (Lakatta, 2003).

Increased intima-media thickness (IMT) disrupts the ratio of elastin to collagen favouring increased collagen and decreased elastin production within the intima-media layer contributing to arterial stiffness (Zieman et al., 2005). Disruption of elastin: collagen balance is likely a result of inflammation (increased production of cytokines and macrophages, MMPs, intracellular adhesion molecules and growth factors) and increased intraluminal pressure (Lakatta, 2003). Additionally, collagen fibres can become more disorganised with a dysfunctional distribution (Zieman et al., 2005) possibly due to advanced glycation end products (AGEs). AGEs contribute to changes in collagen structure and stiffer fibres through formation of irreversible cross links between collagen proteins (Bailey, 2001). AGEs increase with age and have been directly linked to a reduction in NO production through NO quenching and endothelial dysfunction via ROS generation in addition to arterial stiffness (Rojas et al., 2000). Rojas et al. (2000) demonstrated decreased expression of eNOS activity, protein and transcription levels in cultured bovine aortic endothelial cells following exposure to AGEs. It was concluded that down-regulation of eNOS through AGEs was likely due to increased rate of mRNA degradation (Rojas et al., 2000). This was supported by Yan et al. (1994) where mice and rats were infused with AGEs resulting in oxidative stress in endothelial cells and the sub-endothelial layers which can contribute to endothelial dysfunction.

Arterial diameter increases both centrally (Van den Munckhof et al., 2012, Schmidt-Trucksäss et al., 1999) and peripherally (Van der Heijden-Spek et al., 2000, Sandgren et al., 1998) with age irrespective of the presence of atherosclerosis. Luminal enlargement may be a compensatory mechanism to counteract thickening of the arterial wall that occurs during ageing thus maintaining luminal area and perfusion of

tissue (Thijssen et al., 2016). However, increased luminal diameter has been observed in the absence of plaque formation suggesting that it may not merely be a compensatory mechanism (Thijssen et al., 2016, Eigenbrodt et al., 2006). Alternatively, increases in lumen diameter with age may result from loss of elastic fibres through decreased elastin content, elongation of elastin and loss of elastic recoil during ageing (Van der Heijden-Spek et al., 2000). This occurs at the same time as an increase in collagen fibres and mucopolysaccharides (Lebrun et al., 2002) resulting in greater structural reliance upon collagen thus increasing arterial diameter (Thijssen et al., 2016).

Previously (section 2.2.1.3), ET-1 was shown to contribute to age related endothelial dysfunction (Donato et al., 2009). There also appears to be a role for ET-1 in arterial stiffening. ET-1 binds with ET_A receptors on the surface of smooth muscle cells stimulating production of growth factors which increases fibrosis within the media layer and eventually results in arterial stiffening (Schiffrin, 2001). ET-1 also directly stimulates growth and migration of cells within the smooth muscle layer, this hypertrophy leads to thickening of the intima-media layer thus contributing to arterial stiffening (Schiffrin, 2001).

Reduced arterial compliance and distensibility, in addition to increased IMT, may affect shear rate patterns within stiffened vessels of older individuals (Heffernan et al., 2013). As arteries lose elasticity with age they are less able to accommodate changes in pressure, for example through vasodilation. In 16 young healthy males (23±1 yrs.) a blood pressure cuff on the calf was inflated to sub-diastolic pressure for 5 minutes (to simulate arterial stiffness) to induce upstream retrograde SR in the superficial femoral artery (Heffernan et al., 2013). With progressive increases in cuff pressure there was stepwise increases in retrograde SR in addition to increases in markers of arterial stiffness (negative area, elastic modulus, PWV) (Heffernan et al.,

2013). Arterial stiffness did not appear to be related to increases in retrograde SR in the superficial femoral artery (Heffernan et al., 2013). However, increases in retrograde SR did appear to be associated with wave reflection intensity (Heffernan et al., 2013). Wave reflections create pressure which can determine flow profiles and may contribute to flow reversal and amplitude of shear (O'Rourke and Avolio, 1980). When blood flows through an elastic conduit artery radial expansion and recoil of the vessel occurs, which converts pulsatile into laminar flow (Heffernan et al., 2013). However, with increases in arterial stiffness during ageing the capacity of the artery to buffer pulsatile into laminar flow is lost resulting in increased pulsatile flow and alterations in shear patterns (Nichols et al., 2011).

As discussed earlier in this section, migration of VSMCs contributes to increases in arterial stiffening. Low shear stress acts as a potent stimulus for the migration of VSMC (Ross, 1999). Increased downstream arterial stiffness increases vascular resistance which in turn increases blood pressure and circumferential tensile stress, which has been linked to causing direct endothelial injury altering endothelial permeability (Thubrikar and Robicsek, 1995). A vicious cycle is thus formed between local haemodynamics, arterial stiffness and atherosclerosis development (Chatzizisis et al., 2007b).

2.2.2 Gender differences in cardiovascular disease progression

Gender is an important factor when predicting CVD risk as vascular ageing occurs earlier in males than in females (Celermajer et al., 1994). When CVD risk is compared between males and pre-menopausal females, females have a reduced risk (Celermajer et al., 1994, Miller and Mulvagh, 2007). This pattern in CVD risk is maintained until menopausal age (average age at menopause in UK is 52 years (Shaw et al., 2006)) when the rate of decline is faster in females (Celermajer et al.,

1994). Post-menopausal women have an increased CVD risk compared to pre-menopausal women which is equivalent to age matched males (British Heart Foundation, 2012). Endothelial function, as assessed via FMD, has been shown to be a significant contributor to the model of predicting cardiovascular events in post-menopausal women (Rossi et al., 2008). FMD was assessed in 2264 post-menopausal women who were followed up for 45 ± 13 months, 90 major events were recorded in this time (Rossi et al., 2008). Participants with higher FMDs ($\geq 8.1\%$) had a hazard ratio of 1.0, intermediate FMD (4.6-8%) 1.33 and lower FMD ($\leq 4.5\%$) 4.42 (Rossi et al., 2008) indicating increased CVD risk. The increased risk of cardiovascular disease with menopause may be attenuated with the use of HRT although this is widely debated. Schierbeck et al. (2012) investigated the 10-year CVD risk in 1006 peri- and post- menopausal women who were prescribed either HRT or no treatment. 16 women prescribed HRT had an event compared to 33 women in the control group (hazard ratio of 0.48) and 15 women died compared to 26 in the control group with a hazard ratio of 0.57 (Schierbeck et al., 2012). It was suggested that women who started HRT early after the onset of menopause had a significantly reduced risk of major cardiovascular events and death compared to post-menopausal women who did not take HRT (Schierbeck et al., 2012).

Sex steroid hormones (testosterone and oestrogen) increase production and release of NO in males and females thus enhancing endothelial function (Miller and Mulvagh, 2007). Reduced CVD risk in pre-menopausal women is dependent upon oestrogen which preserves endothelial function, thus changes in hormonal balance at the onset of the menopause may account for elevated CVD risk in post-menopausal females (Mendelsohn and Karas, 2005).

2.2.2.1 Influence of gender upon patterns of shear

Ageing affects shear patterns which influences the development of endothelial dysfunction and arterial stiffness (section 2.2.1.1). It is known that age related CVD risk develops at different rates between genders (Celermajer et al., 1994). However, little research has investigated whether shear patterns also differ between genders during ageing and whether haemodynamics influence the different rates of CVD development. A study by Dammers et al. (2002) showed no differences in brachial artery SR between genders in young (30-47 yrs.) and older (48-65 yrs.) groups when all participants were free of known CVD risk factors. Similarly, Cheng et al. (2003) found no differences in abdominal aorta SR between 6 healthy males (22.3 yrs.) and 5 healthy females (25.2 yrs.) at rest measured using an MRI. It was therefore concluded that differences in abdominal aortic disease development between genders is not related to differences in haemodynamics (Cheng et al., 2003).

Joannides et al. (2002) examined differences in radial arterial vasodilation between 12 males and 12 females (25 ± 1 yr.), in addition to the SR stimulus for this vasodilation. Gender did not appear to affect vasodilation however differences in mean SR were observed between males and females (Joannides et al., 2002). It was hypothesised that the elevated mean SR observed in females was likely as a result of smaller arterial diameter compared to males (Joannides et al., 2002). According to Poiseuille's law (section), smaller arterial diameter increases shear stress as a greater proportion of blood flow is in contact with the arterial wall. Casey et al. (2016) also found differences in SR between genders when assessed in the brachial and femoral arteries. Females had greater anterograde SR in both the brachial and common femoral arteries at rest compared to males, however no differences in retrograde SR was found between genders (Casey et al., 2016). This resulted in a trend for lower oscillatory shear in females compared to males (Casey et al., 2016). Additionally, oscillatory shear showed a moderate positive association with vascular

resistance in males compared to females in both the arm (males $r=0.74$, females $r=0.32$) and leg (males $r=0.64$, females $r=0.28$) (Casey et al., 2016).

2.2.2.2 Oestrogen contributes to reductions in cardiovascular disease

Oestrogen acts to reduce CVD risk and improve endothelial function through two major mechanisms. Firstly, oestrogen binds to oestrogen receptor (ER) α at the membrane which rapidly produces a signal to stimulate the PI3K/Akt pathway (**Figure 2.11**) (Moriarty et al., 2006, McNeill et al., 1999). This results in increased modulation of eNOS activity through rapid phosphorylation of eNOS at serine 1177 producing greater enzyme activity (the same pathway as stimulated through exposure to shear stress) and upregulating NO (Moriarty et al., 2006, Levin, 2009). This is demonstrated by natural fluctuations in circulating oestrogen throughout the menstrual cycle and during pregnancy (Duckles and Miller, 2010). The second mechanism involves oestrogen increasing gene expression through transcription factors or a change in mRNA stability and translation to increase eNOS mRNA and protein, although this has a longer onset and duration of action (McNeill et al., 1999).

Oestrogen binds to two receptors on the endothelium surface: ER α and ER β . ER α is the primary receptor responsible for the atheroprotective effects oestrogen exerts upon the endothelium (Duckles and Miller, 2010). ER α expression was modulated by oestrogen status, with low levels of ER α expression when oestrogen concentrations were lower (Duckles and Miller, 2010). In contrast, ER β is required for normal vasodilation and regulation of blood pressure in both males and females (Zhu et al., 2002). Normal oestrogen receptor function is required in both males and females for normal cardiovascular development and function. Loss of ER β causes greater levels of hypertension in males compared to females (Zhu et al., 2002). Males who lack ER α have an impaired vascular function and demonstrate calcification in the coronary artery (Sudhir and Komesaroff, 1999). Additionally, loss of oestrogen, e.g. at

menopause, removes inhibition of ET-1 production at the mRNA level resulting in upregulation of ET-1 in post-menopausal women (Wingrove and Stevenson, 1997). Improved vasodilation, via NO upregulation, in females receiving oestrogen treatments may also positively influence haemodynamics as vasodilation increases blood flow to the periphery and reduces vascular resistance. According to Poiseuille's Law (section 2.1.4), increases in blood flow results in increases in shear stress which is known to also contribute to upregulation of NO. Additionally, a previous study by Joannides et al. (2002) showed that SR was higher in females due to reduced arterial diameter which also contribute to increases in shear. Therefore, oestrogen not only contributes to improved endothelial function via direct activation of the PI3k/Akt pathway but also by increasing shear stress via vasodilation and increased blood flow further upregulating NO production.

Oestrogen treatment in males and females has been shown to increase plasma NO and decrease ET-1 (McCredie et al., 1998). In young females with low oestrogen, either due to ovarian failure or athletic status, there is an improvement in endothelial function when oestrogen was given as a treatment (Kalantaridou et al., 2006). Van der Schouw et al. (1996) followed up more than 12 000 postmenopausal women over 20 years finding that each year of delay in the onset of menopause in accordance with biological age reduced CV mortality risk by 2%. Older females given oestrogen treatment, often in the form of hormone replacement therapy (HRT), show mixed results in terms of improvements in endothelial function and CVD risk. HRT has been shown in some studies to alleviate menopausal symptoms, reduce CVD and all-cause mortality by 50% in post-menopausal women (Miller et al., 2009). However, when HRT was given to females late into the menopause there does not appear to be a protective effect, indeed CVD risk actually increased leading to premature termination of the clinical trial (Turgeon et al., 2004). The Women's Health Initiative (WHI) study

assessed 16 608 post-menopausal women aged 50-79 years who were randomised to HRT or a placebo group (Rossouw et al., 2007). Women who were <10 years following the menopause had a hazard ratio of 0.76 for development of CHD, women 10-19 years post menopause had a hazard ratio of 1.10 and women 20+ years post menopause had an increased hazard ratio of 1.32. (Rossouw et al., 2007). Prescription of HRT altered the hazard ratios for CHD risk (hazard ratio according to age: 50-59 years 0.7, 60-69 years 1.05, 70-79 years 1.14) with women who initiated HRT closer to menopause at a reduced risk of CHD compared to when HRT was taken later following the menopause (Rossouw et al., 2007). In actuality, the provision of oestrogen late into the menopause, when the incidence of atherosclerosis is greatest may make existing plaques more unstable, thus increasing the risk of a cardiovascular event (Mendelsohn and Karas, 2005). HRT must be prescribed early in the menopause to reduce CVD risk and maintain endothelial function with use later in the menopause avoided for potentially increasing CVD risk. Oestrogen supplementation improves eNOS expression and vascular function in male transsexuals suggesting oestrogen can act effectively in both males and females (Sudhir and Komesaroff, 1999). However, oestrogen treatments in males increase the risk of thrombosis (Miller and Mulvagh, 2007).

In addition to aiding vasodilation, oestrogen has also been shown to increase proliferation of endothelial cells and increase release of EPCs suggesting oestrogen has an important role in vascular wound healing (Miller and Mulvagh, 2007). There also appears to be a reduction in cytokine-induced expression of adhesion molecules related to oestrogen production (Miller and Mulvagh, 2007). Oestrogen suppresses oxidative stress through suppression of superoxide production to improve endothelial vasodilation (Madamanchi et al., 2005).

2.2.2.3 Progesterone contributes to vascular health

Controversy currently surrounds the role of progesterone in the arterial wall. It is unclear, due to contradictory evidence in the literature, whether progesterone exerts either inhibitory or antagonistic effects on 17β -oestradiol and eNOS. There are 2 isoforms of the progesterone receptor (A and B); upon hormone binding the receptors can inhibit each other (Duckles and Miller, 2010) through direct or in-direct mechanisms. Varying levels of each hormone is experienced during the menstrual cycle and during pregnancy suggesting that the competition and inhibitory effects may be to mitigate the fluctuations in NO production (Duckles and Miller, 2010).

Progesterone affects eNOS function through both genomic and non-genomic mechanisms. Non-genomic activation of membrane bound receptors activate PI3K/Akt causing eNOS activation and NO production (Welter et al., 2003, Ellmann et al., 2009). Non-genomic actions of progesterone are mediated through tyrosine kinase, MAPK and PI3K pathways to upregulate NO production (Cutini et al., 2009). These rapid effects may affect the genomic regulation of phosphorylation of co-activators or co-repressors (Cutini et al., 2009).

Difficulty in determining the role of progesterone in endothelial function arises from imprecise categorisation of natural and synthetic progestins (Arnal et al., 2009). These have different binding properties which enable them to bind to either progesterone receptors or other hormone receptors e.g. glucocorticoid receptors which inhibit gene transcription of eNOS and its enzymatic activity (Ellmann et al., 2009). Indeed, progesterone has been shown to lower blood pressure in contrast to synthetic progestin's which can raise BP (Dubey et al., 2002).

2.2.2.4 Testosterone has a role in maintenance of vascular health

In both males and females testosterone has been shown to decline gradually throughout the lifespan (Mendelsohn and Karas, 2005). Males have low concentrations of circulating oestrogen compared to females (Grumbach and Auchus,

1999). Reductions in levels of oestrogen increase testosterone to re-establish optimal levels for normal physiological functioning (Grumbach and Auchus, 1999). Testosterone is metabolised by two enzymes forming either oestrogen or dihydrotestosterone. Testosterone is converted to oestrogen when concentrations of testosterone become too high, via the aromatase enzyme. Testosterone binds to androgen receptors on the surface of the endothelial cells and when converted to oestradiol it can bind to oestrogen receptors (**Figure 2.11**) (Mendelsohn and Karas, 2005). Activation of androgen receptors occurs through binding of dihydrotestosterone (Duckles and Miller, 2010). Aromatase derived oestrogen also appears to have important effects on NO production and endothelial function. 10 healthy males (age 23 ± 1 years) were given aromatase inhibitor for 6 weeks and compared to a control group given a placebo. Males given the aromatase inhibitor showed significantly reduced 17β -oestradiol and reduced brachial FMD compared to baseline ($9.4 \pm 2.2\%$ versus $4.7 \pm 1.3\%$) with no effect in the control group ($7.7 \pm 1.0\%$ versus $7.9 \pm 0.63\%$) (Lew et al., 2003). This study was supported by aromatase knockout mice which showed blunted relaxation in response to Ach (Kimura et al., 2003). It can therefore be difficult to assess testosterone effects due to this conversion to oestrogen. Testosterone affects vascular tone through direct activation of ion channels and thromboxane (Liu et al., 2003).

In contrast to oestrogen, testosterone appears to increase ET-1 and decrease NO suggesting a pro-atherogenic effect (McCredie et al., 1998). Female to male transsexuals given high concentrations of androgen have reduced endothelial function (McCredie et al., 1998). Male pigs during puberty show reduced coronary relaxation compared to age matched females when testosterone is increased (Chatrath et al., 2003). Indeed, 10 males with low levels of testosterone (age 62 ± 8 years) due to treatment for prostate cancer had enhanced brachial FMD compared to

10 healthy controls (age 60 ± 9 years) ($6.2 \pm 3\%$ versus $2.7 \pm 2\%$) suggesting testosterone is detrimental to vasodilatory capacity (Herman et al., 1997). In contrast to HRT, androgen replacement therapy is not generally associated with increased cardiovascular disease (Davis and Burger, 2003) with some studies suggesting a positive cardiovascular effect and improved vasomotion (Liu et al., 2003, Davis and Burger, 2003).

The effect of testosterone upon haemodynamics has not been specifically investigated. However, as testosterone has been linked to increased ET-1 production and reduced NO bioavailability it is likely that shear patterns are adversely affected by testosterone through its actions on increasing endothelial dysfunction and arterial stiffness. Arterial stiffness was earlier linked to increases in wave reflection intensity which can contribute to flow reversal (section 2.2.1.8). However, testosterone is readily converted to oestrogen which is associated with improved vasodilation and reduced arterial stiffness. As discussed previously (section 2.2.2.2), through oestrogens' contribution to vasodilation there are increases in blood flow and increased shear stress which promotes an anti-atherogenic endothelial cell phenotype. Therefore, the role of testosterone in regulating haemodynamics and the resultant effect upon vascular health is undetermined.

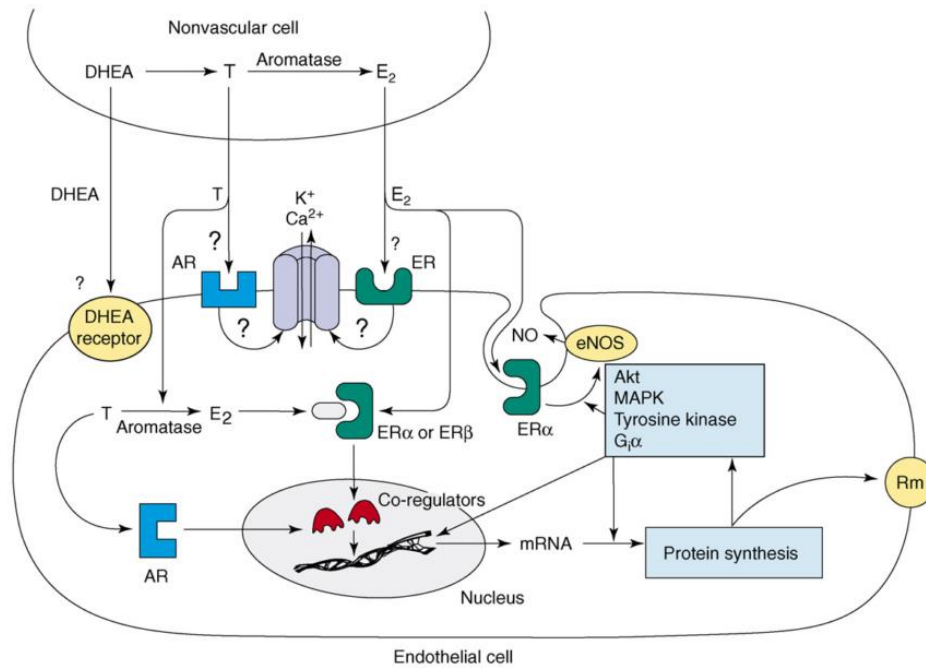

Figure 2.11 Sex steroid receptors (oestrogen and androgen) on the surface of the endothelial cell demonstrating the importance of hormones in regulating endothelial function through NO production. Reproduced from Miller and Mulvagh (2007).

2.2.2.5 Gender effects upon microRNA

Hormonal and genetic differences between males and females can lead to differences in gene expression patterns (Sharma and Eghbali, 2014). Furthermore, differences in gene expression can influence the risk of developing disease and the progression of disease (Sharma and Eghbali, 2014). Sex steroids and X-chromosome linked genes have been shown to influence microRNA regulation although very little research has focussed on the role of miRs in diseases biased to one sex (Sharma and Eghbali, 2014). Importantly, differential expression of miRs have been shown between the genders in invertebrates and mice (Sharma and Eghbali, 2014). Sex steroids bind to nuclear hormone receptors which directly or indirectly alters gene expression thus in turn inducing or repressing miR expression (Sharma and Eghbali, 2014). However, further exploration of sex steroid regulation of miR expression, found that blocking the conversion of testosterone to oestrogen eliminated gender differences in miR expression (Morgan and Bale, 2011). Therefore, it has so far been concluded that

oestrogen is the key sex steroid responsible for the regulation of miR expression (Morgan and Bale, 2011).

The link between certain pathologies, such as cancer, microRNA and sex steroids has become more established recently (Sharma and Eghbali, 2014). However, the relationship between sex steroids, miR expression and cardiovascular disease remains largely unexplored. Whilst not directly assessing the influence of sex steroids upon miRs related to CVD, Murri et al. (2013) assessed differential miR expression between males (29 ± 3 yrs.), control females (29 ± 3 yrs.) and females with polycystic ovary syndrome (PCOS) (27 ± 4 yrs.). Females with PCOS demonstrated higher serum concentrations of androstenedione and lower serum total oestradiol concentrations than control females (Murri et al., 2013). Additionally, there was a positive association between serum free testosterone levels and increased miR-21 expression in females with PCOS (Murri et al., 2013). MiR-21 expression is regulated by shear stress as it is classed as a mechano-miR with a role in regulating endothelial cell phenotype (section 2.1.5.2). Therefore, there does appear to be the potential for gender differences in miR expression to be explored in relation to endothelial cell phenotype, with miR-21 a viable option.

2.2.2.6 Effects of gender upon arterial stiffness

The influence of gender upon arterial structure with age is difficult to discern due to natural ageing effects, CVD risk factors, anthropometric differences and environmental factors which may vary between genders (Rossi et al., 2011). These factors may offer a partial explanation for the disparate results when investigating the influence of gender upon markers of arterial stiffness. Broadly, differences in arterial stiffness development between genders throughout the lifespan is reflective of total CVD development. Some studies have reported no gender differences in regards to stiffening of large arteries during ageing (Van der Heijden-Spek et al., 2000,

Vaitkevicius et al., 1993). However, higher arterial compliance, wall stiffness and pulse pressure have been reported in males until 50-60 years of age, where there appears to be a greater decline in these parameters in females compared to males (Waddell et al., 2001). Zaydun et al. (2006) assessed brachial-ankle PWV (an indicator of peripheral stiffness) in 3149 women aged 21-94 years. The relationship between brachial-ankle PWV and age formed a quadratic curve with the slope of the curve steeper following the menopause (Zaydun et al., 2006). Additionally, women who had experienced the menopause at least 6 years previously had a significant risk of being in the highest tertile for PWV (odds ratio 2.08) indicating stiffer peripheral arteries and suggesting a relationship between arterial stiffness and oestrogen deficiency (Zaydun et al., 2006). Importantly, a strong relationship between arterial wall stiffness and circulating female hormones has been reported by Waddell et al. (1999). This is supported by an observed change in CVD prevalence in post-menopausal females and females with hyperandrogenism (Liu et al., 2001).

The majority of research has focussed upon the effects of oestrogen on arterial wall structure and blood pressure. Both genders produce oestrogen and have oestrogen receptors, however females have higher levels of oestrogen receptors within arteries compared to males (Nakamura et al., 2005). Males consistently present with higher blood pressure compared to females (Rossi et al., 2011), until menopause when post-menopausal women have higher BP compared to pre-menopausal women (Staessen et al., 1989). Oestrogen deficiency, experienced by post-menopausal women, has been associated with increased angiotensin-converting enzyme activity and increased salt sensitivity, both of which contribute to increased blood pressure (Brown et al., 2002).

Direct vascular effects of oestrogen include inhibition of atherosclerotic plaque development and progression (Rossi et al., 2011). In post-menopausal women the

progression of atherosclerosis development is accelerated compared to pre-menopausal women (Rossi et al., 2011). Females prescribed HRT early after menopause onset show deceleration in atherosclerosis development compared to women not taking HRT (Hodis et al., 2003). Oestrogen contributes to arterial structure through regulation of the collagen and elastin fibre ratio and MMP activity (Rossi et al., 2011). Natoli et al. (2005) found that all sex steroids reduced collagen deposition in human aortic SMC cultured for 4 weeks compared to a control. However, female sex steroids (17β -oestradiol and progesterone) in particular, produced an 11 fold increase in the elastin/collagen ratio compared to testosterone (Natoli et al., 2005). Female sex steroids also promoted increases elastin/collagen ratio and decreases systemic vascular resistance demonstrating their importance and accounting for differences between the sexes and with the menopause (Natoli et al., 2005). Systemic arterial compliance was assessed in 26 pre-menopausal women and 52 post-menopausal women of which 26 were already taking hormone replacement therapy (HRT) (mean duration 7 ± 1 years) (Rajkumar et al., 1997). The results showed that post-menopausal women not taking HRT had significantly reduced arterial compliance (0.26 ± 0.02 AU) compared to pre-menopausal (0.57 ± 0.04 AU) women and post-menopausal women taking HRT (0.43 ± 0.02 AU) (Rajkumar et al., 1997). In 11 post-menopausal women HRT was withdrawn for 1 month resulting in decreased arterial compliance (0.33 ± 0.02 AU) although not to the level of post-menopausal women not taking HRT (Rajkumar et al., 1997). Waddell et al. (1999) also demonstrated that withdrawal of HRT for 4 weeks significantly reduced systemic arterial compliance from 0.47 ± 0.06 to 0.40 ± 0.05 AU. Upon resuming HRT for 4 weeks there was an improvement in arterial compliance back to baseline levels (0.47 ± 0.07 A.U.), demonstrating the importance of oestrogen in regulating arterial compliance (Waddell et al., 1999). Other studies have produced conflicting results in regards to the effect of HRT upon vascular stiffness measures. When HRT was

prescribed later following the menopause there appeared to be no protective effect and no reduction in CVD risk (Mosca, 2000). Oestrogen has also been shown to directly impact cell proliferation and arterial remodelling (Natoli et al., 2005, Fischer et al., 1981) by reducing collagen deposition and increasing elastin deposition in humans (Natoli et al., 2005) and animals (Fischer et al., 1981).

Comparatively little research has been conducted on the effects of progesterone upon cardiovascular health with most trials typically using a combination of female sex steroids rather than progesterone only. Progesterone receptors are expressed on both the endothelium and VSMC (Orshal and Khalil, 2004). As a result progesterone has been shown to induce relaxation of the coronary arteries and promote endothelium dependent relaxation through NO mechanisms in pigs (Molinari et al., 2001). Further studies have shown progesterone to be capable of upregulating eNOS to aide vasodilation in sheep (Rupnow et al., 2001). The vasodilatory properties of progesterone may be mediated by modulation of calcium channels (Barbagallo et al., 2001). When assessing endothelium independent relaxation of VSMC the effect of progesterone is smaller than observed following oestrogen infusion (Herkert et al., 2000).

Progesterone decreases collagen deposition producing a 7 fold higher elastin/collagen ratio compared to testosterone and is comparative to the ratio observed upon administration of oestradiol (Natoli et al., 2005). The greatest improvement in the elastin/collagen ratio (11 fold improvement) occurs when oestradiol and progesterone are combined and applied in human aortic SMC tissue culture (Natoli et al., 2005). In contrast to oestradiol which increases elastin deposition, progesterone may reduce elastin deposition (Natoli et al., 2005). Additionally, HRT containing progesterone was shown to counteract the effects of

oestrogen only HRT upon arterial compliance in 109 post-menopausal women at least 2 years post last menses (McGrath et al., 1998).

Testosterone has been difficult to study thus little evidence exists to suggest a role in regulation of vascular structure and CVD risk. Low levels of testosterone have been linked to higher blood pressure in middle aged males (Khaw and Barrett-Connor, 1988). Levels of testosterone are known to decline during normal ageing in males therefore it is difficult to discern whether changes in BP are associated with ageing or testosterone or a combination of both (Ferrini and Barrett-Connor, 1998). Additionally, onset of other traditional CVD risk factors typically begins in middle aged males and further confound the order of effect. When testosterone treatment was prescribed to 24 males (age 64 ± 1 years) with type 2 diabetes there was no significant effect upon BP however overall cardiovascular risk was reduced (Kapoor et al., 2006).

Assessing the direct effect of testosterone upon vascular structure is difficult due to no populations having excess production of testosterone. Testosterone receptors are expressed in both the endothelium and VSMC (Hatakeyama et al., 2002), however the exact mechanisms by which testosterone acts upon the vasculature is unknown. In human males low testosterone is independently associated with increased CVD mortality (Khaw et al., 2007). Furthermore, in conditions where testosterone is suppressed, for example males treated for prostate cancer, there is a greater incidence of acute coronary events (D'amico et al., 2008). This may be due to the role of testosterone in inhibiting plaque development and relaxation of the aorta as demonstrated in 8 castrated male rabbits fed a cholesterol rich diet and treated with testosterone (Alexandersen et al., 1999). High levels of physiological testosterone have been associated with increased endothelial function, reduced peripheral vascular resistance and improved vasomotor function demonstrating similar effects to oestrogen (Jones et al., 2004). As stated in section 2.2.2.4, testosterone is

converted to 17 β -oestradiol when testosterone concentrations are too high which may explain the similarities in vasodilatory capacity compared to oestrogen (Rossi et al., 2011). Conversely, research has shown that high physiological levels of testosterone can be detrimental for endothelial function and increases wall stiffness in rabbits (Hutchison et al., 1997). With regards to arterial structure testosterone was shown to reduce elastin to collagen ratio in aortic VSMC culture during puberty (increasing testosterone levels during development) (Ahimastos et al., 2003). However, a study by Kupari et al. (1994) showed no association between total testosterone and aortic compliance. Contrastingly, males with type 2 diabetes were found to have an inverse relationship between serum testosterone and carotid intima-thickness (Fukui et al., 2003, Fukui et al., 2005) and arterial stiffness (Fukui et al., 2007).

2.3 Exercise in modification of parameters of vascular health

Physical activity is defined as any bodily movement produced by skeletal muscles that results in energy expenditure (Caspersen et al., 1985). Epidemiological evidence suggests that physical activity is associated with a 35% reduction in cardiovascular mortality and a 33% reduction in all-cause mortality (Nocon et al., 2008). Moreover, there is a curvilinear dose–response relationship between physical activity and cardiovascular risk, suggesting higher levels of physical activity are only beneficial up to a point (Williams and Thompson, 2013). Exercise differs from physical activity in that exercise is planned, structured, repetitive with the purpose of improving or maintaining physical fitness (Caspersen et al., 1985). Exercise training is associated with reductions in both primary and secondary vascular events, the magnitude of which cannot be solely accounted for by modification of traditional risk factors as the association with reduced mortality is independent of these risk factors (Green et al., 2004, Dimmeler and Zeiher, 2003). Only 40-60% of CVD risk can be explained by modification of traditional risk factors through exercise, changes to endothelial dysfunction and arterial stiffness likely account for the remainder of this CVD risk (Joyner and Green, 2009). Government recommendations for exercise in the UK suggest that adults should complete at least 30 minutes of moderate intensity exercise on 5 day per week or vigorous intensity exercise of 20 minutes on 3 days per week. Haskell et al. (2007) reported that approximately 6% of the adult population met these guidelines. Reasons for not fulfilling Government recommended criteria included lack of time and lack of enjoyment (Troost et al., 2002a). Therefore, it is vital that a type of exercise which improves adherence and increases participation to yield exercise related health benefits is sought.

An important feature of exercise training is the length of time required for a change to be observed. Studies have reported improved NO dependent vasodilation as early as 2-4 weeks after the onset of exercise training (Birk, 2011, Tinken et al., 2008). Contrastingly, longer exercise interventions, e.g. 8 weeks and longer, have reported little or no change in FMD (Tinken et al., 2010). The rationale for these differences maybe that functional changes to the arteries are only upregulated for a short time period following the onset of a new stimulus before structural adaptations begin to occur (Tinken et al., 2008). Indeed brachial artery dilator capacity, suggested as a surrogate measure of arterial remodelling (Naylor et al., 2005), was gradually increased over 8 weeks of exercise training (Tinken et al., 2008). Short duration exercise interventions are likely enough time for upregulation of eNOS and increased eNOS protein content to improve NO bioavailability (Laughlin et al., 2003). However, there is perhaps a ceiling effect in the production of eNOS and NO. Therefore, longer exercise training durations may induce structural adaptations which are able to accommodate changes in shear stress without the need for NO upregulation hence the return in vasodilator function to pre training levels (Maiorana et al., 2003). Techniques such as FMD not only show functional changes in endothelium dependent NO production but also changes in resting diameter which would support the hypothesis of structural changes induced by longer term exercise training. Similarly, changes in arterial stiffness may require longer training interventions to induce structural changes to the artery.

2.3.1 Exercise alters haemodynamics

Earlier in this literature review (section 2.1.3), the importance of shear stress was discussed for the maintenance of healthy vasculature function and structure. The role of shear stress in development of endothelial dysfunction and arterial stiffness with ageing and differences between genders has also been discussed (sections 2.2.1.1

and 2.2.2.1). It is apparent that modification of shear stress may have an integral role in either prevention or reversal of endothelial dysfunction and arterial stiffness. Exercise is a relatively easy way of modifying shear stress and has a positive effect on outcomes of vascular health such as endothelial function and arterial stiffness. However, there remains many factors relating to exercise induced shear which have not been fully explored. Therefore, optimising exercise for the production of shear stress which induces the greatest improvements in vascular health is yet to be determined.

Exercise increases oxygen demand for working muscles, to meet this demand cardiac output increases through increases in heart rate (Hawley et al., 2014). Blood pressure and blood flow are subsequently increased as a result of increased cardiac output (Hawley et al., 2014). Shear stress increases during exercise due to increased pulse pressure and exercise induced blood flow (Green et al., 2017). Thus, the NO pathway is activated to upregulate NO bioavailability and improve the vessel's vasodilatory capacity (Higashi and Yoshizumi, 2004), described in detail in section 2.1.3.

Exercise not only increases blood flow and shear stress, but also increases the frequency of pulsatile changes in pressure and flow and increases systolic and pulse pressures (Green et al., 2017). The regulation of endothelial cell phenotype by shear stress is dependent upon the time alignment of increases in diameter, blood flow and blood pressure (Green et al., 2017). Pulsatile changes in blood flow, heart rate and blood pressures that have the same time course have been reported in the aorta and are associated with an anti-atherogenic endothelial cell phenotype (Dancu et al., 2004). In contrast, asynchronous changes in blood flow, heart rate and blood pressures cause retrograde flow during diastole, characteristic of coronary arteries (Dancu et al., 2007). Asynchronous haemodynamics also reduce eNOS expression and increase ET-1 expression, promoting a pro-atherogenic endothelial cell

phenotype (Dancu et al., 2007). Coronary arteries are predisposed to developing atherosclerosis compared to the aorta and this may be attributed to the haemodynamics experienced by the endothelial cells in the respective arteries (Green et al., 2017). Exercise appears to be able to reverse pro-atherogenic endothelial cell phenotype in coronary arteries. This is likely through a 4-6-fold exercise induced increase in blood flow to the coronary arteries which increases SR (Laughlin et al., 2008b). The increase in SR is accompanied by a small increase in systolic blood pressure (Laughlin et al., 2008b). These factors result in blood flow during both systole and diastole becoming positive, which is associated with an anti-atherogenic endothelial cell phenotype (Laughlin et al., 2008b).

At the onset of exercise there is an increase in blood flow and SR in active regions which appears to be dependent upon the intensity of the exercise, and is required to meet metabolic demands (Green et al., 2005). Additionally, the type of exercise is also an important factor in determining the effect of exercise upon shear. Handgrip exercise recruits only a small muscle mass and therefore metabolic demand is relatively low. Accordingly, minor increases in cardiac output and blood pressure are observed (Green et al., 2005). However, large increases in blood flow and SR out of proportion to cardiac output and blood pressure are reported (Green et al., 2005). It has therefore been assumed that reductions in downstream peripheral resistance through vasodilation are responsible for the increased blood flow (Green et al., 2005). When larger muscle masses are recruited for exercise, such as lower limb, there are larger increases in blood pressure and cardiac output. This is associated with large increases in blood flow as detected in the femoral artery which results from reductions in downstream peripheral resistance in addition to increases in central driving pressure (Green et al., 2017). Due to technical difficulties, research investigating blood flow to active exercising muscles has not been possible. The closest research

has come to examining blood flow in the active limb is examining brachial artery blood flow during handgrip exercise. However, this type of exercise induces very different haemodynamic response compared to rhythmic aerobic exercise such as cycling. However, assessing femoral artery blood flow during cycling exercise is currently not possible. Therefore, previous studies have attempted to record blood flow responses in the inactive upper limb during lower limb exercise.

When blood flow is assessed in the inactive upper limb during lower limb exercise there is a reduction in blood flow at the onset of exercise which is restored as exercise continues (Bishop et al., 1957). Also at the onset of exercise there are small increases in anterograde blood flow which is accompanied by large increases in retrograde blood flow (Green et al., 2002a, Green et al., 2002b). The disproportionately large increases in retrograde blood flow may be attributed to activation of the sympathetic nervous system and increases downstream peripheral resistance (Casey et al., 2012, Padilla et al., 2010). Alternatively, there may be a role for an increase in microvascular closing pressure (Halliwill and Minson, 2010). This pattern of blood flow is dependent upon the type of exercise prescribed as resistance exercise such as leg kicking is associated with greater increases in systolic blood pressure which is accompanied by pressure driven increases in anterograde flow with little increase in retrograde flow (Green et al., 2017). As exercise continues there is dilation of resistance arteries and skin microcirculation as a thermoregulatory response resulting in decreases in total peripheral resistance and altering upstream blood flow and shear patterns (Green et al., 2017).

An additional factor, which per Poiseuille's Law, is integral in determining shear stress is arterial diameter. A dose dependent dilation in brachial artery diameter following incremental increases in SR was reported by Carter et al. (2013). This occurred when the forearm was heated, increasing blood flow and SR independent of exercise and

associated increases in blood pressure and cardiac output (Carter et al., 2013). This finding was confirmed when bilateral assessment of brachial artery blood flow in response to heating or exercise was examined with one limb cuffed to remove changes in blood flow (Carter et al., 2013). Abolishing the blood flow in the cuffed limb prevented any changes in brachial artery diameter, thus demonstrating the importance of SR in inducing acute vasodilation (Carter et al., 2013).

Many considerations must be made when designing an exercise intervention to improve vascular health for a chosen population. The importance of type of exercise when assessing blood flow responses to exercise and how this may have a knock-on effect on outcomes of vascular health such as endothelial function and arterial stiffness was discussed earlier in this section. For example, hand grip exercise, leg kicking and rhythmic exercise such as walking and cycling induce different patterns of shear due to differences in metabolic demand, blood pressure and cardiac output (Green et al., 2017). In addition to type of exercise, exercise modality is also an important consideration, e.g. resistance versus aerobic training. Whilst this will not be reviewed within this current thesis there is a large body of literature which has compared these exercise modalities upon vascular health. Aerobic exercise appears to be the most consistently effective type of exercise for vascular improvements in the literature and thus will be explored within this thesis.

Exercise intensity also varies between studies assessing vascular health and has important effects upon haemodynamics. Traditional moderate intensity exercise matches current physical activity guidelines to improve general health. However, depending upon how moderate intensity exercise is defined, appears to determine whether markers of endothelial function and arterial stiffness are improved or there is no effect. Recently, similar or greater improvements in markers of endothelial function and arterial stiffness have been observed with interval training (IT), discussed in more

detail in section 2.3.1.2.2. Inter-study differences likely occur due to differences in prescription of exercise intensity which varies widely between studies. Some studies define exercise intensity by metabolic stress (lactate threshold) or a percentage of VO_{2peak} whilst others take a more pragmatic approach using percentage of HR_{peak} . Thus, it is difficult to distinguish the influence of type of exercise and intensity of exercise in driving physiological adaptations to exercise training.

2.3.1.1 Acute exercise effects upon haemodynamics and markers of vascular health

2.3.1.1.1 Exercise intensity affects shear rate and markers of vascular health

Prescription of exercise intensity needs to be considered in relation to desired outcome i.e. improvements in exercise tolerance may require higher intensity exercise whereas for vascular adaptations lower intensity exercise may be more appropriate. Another important consideration is the target population and their ability to safely complete and adhere to the exercise intensity prescribed. Patients with coronary heart disease or peripheral arterial disease may be unable to tolerate high intensity exercise and the risk of a cardiovascular event with this type of exercise may outweigh the physiological benefits. However, in an observational study of over 70 000 post-menopausal females (aged 50-79 yr.) intensity of physical activity was strongly, inversely correlated with risk of cardiovascular events (Manson et al., 2002).

Studies within exercise literature have used varying percentages of VO_{2max} , WR_{peak} , HR_{max} or heart rate reserve (HRR) to define intensity. However, many of these studies have not adequately controlled individual physiological stress i.e. above or below lactate threshold (LT) and critical power (CP) where acid-base balance and pulmonary gas exchange are different. Whipp (1996) has previously defined exercise intensity with respect to metabolic stress using a 4 intensity domain model of aerobic function. Exercise within a single intensity domain (moderate, heavy, very heavy and

severe) has common characteristics of ventilatory gas exchange and acid-base profiles (Whipp, 1996). LT and CP do not occur at the same point in relation to VO_2 in all participants. Therefore, using an intensity of 60% $\text{VO}_{2\text{max}}$ may occur above the lactate threshold in some individuals and below in others, exercise above the lactate threshold places different physiological and metabolic stresses on the body to exercise below the lactate threshold which may contribute to the vast conflict demonstrated within the literature.

As discussed in detail earlier (section 2.1.3), improvements in vascular health are dependent upon shear stress. Whilst few studies have measured shear stress during exercise, it has been assumed that exercise induces large volumes or high magnitudes of laminar shear stress driven by increases in anterograde shear. This is hypothesised due to the relationship between exercise and hyperaemia which is intensity dependent (Green et al., 2017). Acute higher intensity exercise likely induces greater magnitudes of shear stress due to higher heart rates attained during exercise compared to moderate intensity exercise. Therefore, higher intensity exercise associated with greater increases in shear stress may be postulated to induce greater post-exercise endothelial function. Green et al. (2002b) assessed blood flow in the brachial artery during acute lower limb cycling at increasing resistances in 8 healthy males (22 ± 4 years). Magnitude of anterograde flow increased with increasing exercise intensity with the same pattern observed in retrograde flow albeit at a lower total magnitude (Green et al., 2002b). At lower exercise intensities, retrograde flow was observed to have greater impact due to lower anterograde flow resulting in higher oscillatory shear (Green et al., 2002b). However, the resultant effect of these SR patterns upon endothelial function was not assessed.

Contrastingly, high intensity cycling (70-85% HR_{max}) has been shown to induce an immediate reduction in acute endothelial function which was not observed at lower

exercise intensity (50% HR_{max}) (Birk et al., 2012). A recent study by Bailey et al. (2017) investigated how differences in cardiorespiratory fitness affected acute endothelial function in response to either moderate or high intensity exercise in 47 older males (70 ± 5 yr.). Participants were divided into low (24.3 ± 2.9 ml/kg/min) and high fitness (35.4 ± 5.5 ml/kg/min) groups before undertaking acute moderate continuous (MOD CON) (40% PPO) and high intensity IT (70% PPO) (Bailey et al., 2017). At baseline there were no differences in FMD between fitness groups (Bailey et al., 2017). FMD increased after MOD CON in both fitness groups at 10 min post exercise (Low fit: 4.7 ± 1.6 to 5.4 ± 1.9%; high fit: 5.1 ± 1.5 to 6.1 ± 2.5%) and returned to resting levels at 60 min post exercise (Low fit: 4.7 ± 1.6 to 4.8 ± 1.7%; high fit: 5.1 ± 1.5 to 4.9 ± 1.3%) (Bailey et al., 2017). The low fitness group had reduced FMD at 10 min post high intensity IT and at 60 min (resting: 4.8 ± 1.4; 10 min post 4.0 ± 2.2%; 60 min post 4.1 ± 1.3%) whereas the high fitness group had no change in FMD 10 min after but increased at 60 min post exercise (resting: 4.9 ± 1.5; 10 min post 5.0 ± 2.6%; 60 min post 5.7 ± 2.0%) (Bailey et al., 2017). It was concluded that exercise intensity altered acute FMD response which was modulated by cardiorespiratory fitness although the mechanisms for these differences were not investigated (Bailey et al., 2017). It is also interesting that the time course of the FMD response also appears to be affected by exercise intensity. Importantly, larger increases in BP were observed during high intensity IT compared to MOD CON irrespective of fitness (Bailey et al., 2017).

Similarly, Yoo et al. (2017) assessed the acute effect of different exercise intensities and sex differences upon endothelial function. 13 older males (67 ± 1 yr.) and 15 post-menopausal women (65 ± 2 yr.) underwent FMD assessment prior to exercise, 20 min and then 60 min following a single bout of exercise which consisted of high intensity IT (40 min 4x4 90% HR_{peak}), MOD CON (47 min 70% HR_{peak}) and low

intensity CON (47 min 50% HR_{peak}). In older males, acute FMD was reduced 20 min post exercise by 45% following high intensity IT and 37% after MOD CON which was subsequently normalised at 60 min post exercise (Yoo et al., 2017). In females, FMD was not significantly altered at 20 and 60 min following high intensity IT or MOD CON, additionally low intensity exercise had no effect on FMD in both males and females (Yoo et al., 2017). It was concluded that sex and exercise intensity influence acute FMD response with high intensity IT producing a detrimental effect in males shortly after acute exercise (Yoo et al., 2017).

Another important mechanism for exercise intensity related changes to endothelial function may be attributable to changes to the balance between oxidative stress and anti-oxidant defence. Some studies have reported no improvement or reductions in endothelial function following higher intensity exercise compared to moderate intensity exercise which has been assumed to be a result of increased ROS production (Goto et al., 2003). This may be due to an immediate increase in ROS following higher intensity exercise followed by an upregulation of anti-oxidants 60 min post exercise resulting in improved endothelial function (Dawson et al., 2013). Immediate benefits of moderate intensity exercise may be due to an insufficiency in exercise intensity to stimulate ROS production thus enabling an immediate improvement in endothelial function to be detected. In contrast, studies within this lab group have shown no impact of moderate intensity exercise upon endothelial function which may be due to insufficient SR because of small changes in exercise induced heart rate and blood pressure (Rakobowchuk et al., 2012a). This discrepancy observed between studies investigating exercise intensity and endothelial function is likely due to inconsistencies in prescription of exercise intensity.

2.3.1.1.2 Type of exercise stimulus alters shear rate patterns

Type of exercise or stimulus appears to be integral in determining the type of shear stress the endothelium is exposed to, determining the effect upon markers of vascular health. Tinken et al. (2009) assessed the effect of 30 minutes of forearm heating, handgrip exercise or recumbent cycle exercise upon acute endothelial function using FMD in 10 healthy young males (28 ± 7 yr.). A blood pressure cuff was placed on the contralateral limb (abolishing SR changes) and FMD measured simultaneously in both arms to assess the effect of SR from the aforementioned conditions affected (Tinken et al., 2009). Mean and anterograde flow were elevated from baseline across all conditions with retrograde flow elevated in the two exercise conditions only (Tinken et al., 2009). The cuffed limb showed no change in FMD from baseline whereas the non-cuffed limb displayed significant acute increases in acute FMD following forearm heating (3.5%), handgrip exercise (3.5%) and cycle exercise (2.2%) (Tinken et al., 2009). It was concluded that acute FMD change was dependent upon changes in stimulus induced SR (Tinken et al., 2009).

Thijssen et al. (2009a) used ultrasound to image the brachial artery during acute walking, cycling and leg kicking exercise of increasing intensity in healthy males and females (24 ± 3 yr.). Type of exercise affected SR as both walking and cycling were shown to significantly increase retrograde SR compared to leg kicking exercise, with the greatest increase observed during cycling (Thijssen et al., 2009a). Additionally, increasing exercise intensity increased mean and anterograde SR during all protocols although the resulting effect upon endothelial function was not assessed (Thijssen et al., 2009a).

The negative impact of retrograde SR upon endothelial functioning was elegantly demonstrated in a study by Thijssen et al. (2009b). A blood pressure cuff on one arm was inflated to 3 different pressures (25, 50 and 75 mmHg) for 30 minutes on three separate visits. This was to create a dose-response curve of magnitude of retrograde

flow and change in FMD, as inflation of a blood pressure cuff is known to induce retrograde SR (Thijssen et al., 2009b). FMD was measured prior to and following the period of cuff inflation to assess changes in endothelial function (Thijssen et al., 2009b). The study found that the greater cuff pressure caused a greater magnitude of retrograde SR resulting in reduced endothelial function demonstrated by a decrease in FMD, whilst anterograde SR remained unchanged (Thijssen et al., 2009b).

2.3.1.2 Chronic exercise training induces changes in vascular health

2.3.1.2.1 Exercise intensity during training is an important consideration in the modification of vascular health

Exercise training improves endothelial function, with larger improvements observed in populations with cardiometabolic disorders (Green et al., 2017). Improvement in endothelial function with exercise is likely a result of improved NO bioavailability with exercise through regular increases in shear stress and activation of the downstream eNOS pathway (see section 2.1.3) (Higashi and Yoshizumi, 2004). Chronic aerobic exercise increases the magnitude of blood flow velocity thus increasing shear stress and upregulating eNOS gene expression (Sessa et al., 1994). Kingwell et al. (1997) assessed forearm blood flow in response to venous occlusion plethysmography in 13 healthy sedentary males (24 ± 2 yr.) across 4 weeks of cycling exercise (30 min at 65% WR_{max}). This study demonstrated that resting NO was upregulated following exercise training in the untrained limb and therefore the stimulus for this basal improvement in endothelial function must be unrelated to local muscular adaptations and dependent upon elevated SR and systemic adaptations (Kingwell et al., 1997). However, this increased NO production as a result of exercise training may be short lived (Green et al., 2004).

Sessa et al. (1994) demonstrated increased release of nitrite (stable degradation product of NO) and increased eNOS expression in dogs following chronic exercise. Upregulation of these factors are likely due to exercise related increases in SR and alteration in fluid dynamics upregulating eNOS expression (Kojda and Hambrecht, 2005). Additionally, increased eNOS expression upregulates NO production effectively inhibiting ET-1 (Lekontseva et al., 2010) which is associated with superoxide production through uncoupling of eNOS and activation of NADPH oxidase (Loomis et al., 2005). ET-1 production is regulated through oxidative stress, thus greater anti-oxidant release could inhibit ET-1 production (Loomis et al., 2005) thus reversing/preventing endothelial dysfunction and arterial stiffening associated with ET-1. Regular aerobic exercise has been shown to enhance anti-oxidant systems (Higashi and Yoshizumi, 2004) thus counteracting the oxidative effect associated with ET-1.

Chronic exercise training also alters stroke volume through changes in plasma volume and blood viscosity (Joyner and Green, 2009). According to Poiseuille's law, increases in plasma volume and blood viscosity produce greater shear stress and stimulate upregulation of NO, improving endothelial function following exercise training. Additionally, exercise training modifies the relationship between cutaneous vasodilation and core temperature which normally increases linearly until a plateau is reached (Roberts et al., 1977). With exercise training the relationship is shifted left in so much as cutaneous vasodilation occurs at a lower core temperature and reaches a higher plateau where larger volumes of blood reach the skin (Roberts et al., 1977). This appears to be linked to exercise training increases in plasma volume (Ikegawa et al., 2011). This is important when considering reductions in total peripheral resistance which have large effects upon upstream shear patterns.

Intensity of exercise training is an important consideration. Kemi et al. (2005) assessed carotid artery endothelial function in response to acetylcholine in 24 female rats following 10 weeks of moderate or high intensity IT running on a treadmill. In rats, high intensity exercise (85-90% VO_{2max}) correlated with beneficial cardiac adaptations (Kemi et al., 2005). Moderate intensity exercise (65-70% VO_{2max}) displayed comparable improvements in endothelial function to high intensity (Kemi et al., 2005). Similarly, 4 weeks of vigorous cycling exercise training (80% HR_{peak}) improved coronary endothelial function in 10 coronary artery disease patients (60±2 yr.) compared to sedentary controls (Hambrecht et al., 2000). Vasodilation in response to acetylcholine was significantly improved following exercise training indicating reversal of endothelial dysfunction, although vasodilatory capacity was not restored to normal, pre-disease levels (Hambrecht et al., 2000).

In contrast, higher intensity exercise conducted over the course of a chronic exercise training intervention in healthy humans has been shown to induce detrimental effects or is of no greater benefit than lower intensity exercise. This was demonstrated by Bergholm et al. (1999) who showed three months of high intensity running training (70 – 80% VO_{2max}) decreased endothelial dependent vasodilation measured via forearm blood flow in 9 healthy males (26 ± 1 yr.). Goto et al. (2003) showed that cycling exercise for 30 minutes, 5-7 times per week for 12 weeks at high intensity (75% VO_{2max}) did not improve endothelial dependent vasodilation; moderate intensity (50% VO_{2max}) cycling improved endothelial dependent vasodilation in 26 healthy males (25 ± 3 yr.) (Goto et al., 2003). Both of the aforementioned studies indicate a lack of improvement in endothelial function with high intensity aerobic exercise. This may be due to higher exercise intensities causing increases in ROS (Goto et al., 2003) which can degrade NO (explained in detail in section 2.2.1.5) (Cai and Harrison, 2000) or reductions in anti-oxidant defence (Bergholm et al., 1999).

Conversely, acute inflammation induced by higher intensity exercise may upregulate antioxidant defences thus reducing oxidative stress and inflammation within the vasculature, good for healthy endothelial function (Fisher et al., 2011).

In regards to changes in arterial stiffness, Sugawara et al. (2006) examined carotid β -stiffness index in 17 sedentary post-menopausal women following 12 weeks of either moderate (40% HRR) or vigorous cycling (70% HRR). Carotid β -stiffness index, indicative of central vascular stiffness, was reduced following both moderate or vigorous intensity with no differences between (Moderate -4.0 ± 4.8 A.U. vs. Vigorous -4.1 ± 4.9 A.U.) (Sugawara et al., 2006). Similarly, Rakobowchuk et al. (2012b) demonstrated that carotid arterial stiffness improved with 6 weeks of moderate or heavy IT training in 20 males and females (23 ± 3 yr.) but this improvement was not intensity dependent. Joyner (2000) has suggested that increases in pressure with exercise increases the stretch of the arterial wall reducing arterial stiffness.

2.3.1.2.2 Type of exercise is integral for adaptations in vascular health

The importance of shear for chronic improvements in endothelial function has been shown following both handgrip and cycling exercise training. Bilateral handgrip exercise training and cycle exercise training was commenced for 8 weeks with one arm cuffed during exercise (Tinken et al., 2010). The inflation of a blood pressure cuff during exercise removed the influence of shear mediated changes. The arm which underwent cuff inflation showed no changes in endothelial function over the 8-week training intervention (Tinken et al., 2010). In contrast, the arm that was exposed to the increases in blood flow and SR over the course of the training intervention demonstrated improved endothelial function (Tinken et al., 2010). Therefore, irrespective of the type of exercise undertaken during an exercise training intervention, increases in blood flow and SR are vital for changes in vascular function.

Traditionally continuous exercise training has been used to improve markers of exercise tolerance and to improve cardiovascular health. However, current literature now commonly utilises interval (IT) exercise training in various formats as a comparison for traditional CON exercise. The use of IT exercise has stemmed from reported barriers to exercise. Greater volumes of vigorous exercise can be accumulated using an IT exercise approach therefore a shorter duration of exercise may be required compared to CON exercise. This makes interval training more time efficient and therefore more appealing to the public who often cite lack of time for not regularly partaking in exercise (Troost et al., 2002b). Bartlett et al. (2011) also reported increased enjoyment during interval compared to CON exercise training, even when the session durations were of equal length. Interval exercise consists of repeated periods of “work” at a higher resistance interspersed with periods of “active recovery” at a low resistance. Gibala et al. (2012) has suggested that these “work” bouts should consist of repeated bouts of brief, vigorous activity. Indeed, the benefit of IT exercise is that the duration and intensity of these “work” bouts can be adapted to make them suitable for target populations. Additionally, IT exercise enables the attainment of high work rates (WR) at higher volumes than would be sustainable with CON exercise due to the rapid onset of fatigue and is made possible due to the inclusion of recovery periods and may consequently produce greater physiological adaptations (Kessler et al., 2012). The work rate profile created by this pattern of work and recovery has itself been proposed to be of equal or greater benefit in adaptations of the vasculature compared to CON exercise at matched work rate, intensity and volume (Gibala et al., 2012). Peripheral and systemic physiological adaptations have been achieved in healthy (Burgomaster et al., 2008) and patient populations (Wisløff et al., 2007) following IT exercise training. In these studies IT training varied from 4 minutes of “work” with 3 minutes recovery 4 times to 30 seconds work and 30 seconds recovery. Short bursts of intense exercise such as experienced with shorter IT protocols, may

produce mitochondrial adaptations similar to prolonged endurance exercise with a lower volume of work required to attain the same adaptations (Gibala et al., 2012). High intensity interval training induced skeletal muscle remodelling producing larger quantities of oxidative fibres and increased mitochondrial biogenesis contributing to increased VO_{2max} (Gibala et al., 2012, Little et al., 2011).

Rakobowchuk et al. (2008) investigated popliteal and carotid distensibility in addition to popliteal artery endothelial function following 6 weeks of either sprint interval training (SIT: 4-6 Wingates) or CON exercise (40-60 min at 65% VO_{2peak}) in 20 healthy males and females (23 ± 3 yr.). Peripheral popliteal artery distensibility was improved following both types of exercise with no change in carotid artery distensibility. Additionally, both types of exercise produced equivalent improvements in endothelial function (CON 5% to 7% vs. SIT 6% to 7%) despite SIT training requiring a lower time commitment. Importantly, the high intensities attained during SIT did not negatively affect endothelial function (Rakobowchuk et al., 2008). It was concluded that although SIT is a more time efficient way of improving peripheral structure and function compared to CON, changes in measures of central stiffness may require a longer training stimulus or greater initial vessel stiffness (Rakobowchuk et al., 2008). Likewise, Tjønnå et al. (2008) demonstrated that 16 weeks of CON (70% HR_{max}) and aerobic interval training (AIT: 4 min at 90% HR_{max} interspersed with 4 min recovery) improved endothelial function in 32 patients with metabolic syndrome (52 ± 4 yr.). However, IT was superior in producing the greatest change in FMD (IT 9% vs CON 5%).

Wisløff et al. (2007) assessed the effect of 12 weeks of high intensity interval (4 min at 90-95% HR_{peak} interspersed with 3 min at 50-70% HR_{peak} repeated 4 times) or moderate continuous (70-75% HR_{peak}) uphill treadmill walking on cardiac adaptations in 27 heart failure patients (75 ± 11 yr.). Both exercise interventions improved

dependent variables with high intensity IT producing greater improvements in both cardiac adaptations and endothelial function measured via FMD (Wisløff et al., 2007). However, six weeks of either moderate or heavy intensity IT (matched for total work and duration) in 20 untrained males and females reduced carotid β stiffness index in both conditions with no effect on arterial wall thickness (Rakobowchuk et al., 2012b). Guimaraes et al. (2010) demonstrated that 16 weeks of treadmill IT exercise training (2 min at 50% HRR and 1 min 80%HRR) reduced carotid-femoral pulse wave velocity (PWV), a measure of central arterial stiffness. No effect on carotid-femoral PWV was observed following continuous exercise (40min at 60% HRR) in 65 sedentary hypertensive participants (Guimaraes et al., 2010). Mechanisms related to improvements in cardiovascular risk with IT exercise are likely to be dependent upon higher power outputs and intensities achieved in an easier format compared to CON. Therefore, intensity of the interval training needs to be clearly defined so that the metabolic stress between participants is controlled which allows disambiguation of factors driving physiological adaptations induced by exercise training.

2.3.2 Exercise induced shear: consequences for vascular health during ageing and across genders

As discussed in the above sections prevalence of endothelial dysfunction and arterial stiffness increase with age contributing to elevated CVD risk. Exercise has been shown to prevent age related declines in endothelial function and to reverse endothelial dysfunction (DeSouza et al., 2000). Sedentary younger adults have also demonstrated improved endothelial function following exercise training interventions (Goto et al., 2003, Rakobowchuk et al., 2008). However, not all exercise interventions appear to be effective in improving endothelial function in younger populations (Franke et al., 1998, Green et al., 1994). This may be due to preserved endothelial function and/or a ceiling effect. Alternatively, a greater exercise stimulus maybe

required in younger populations to illicit improvements which may range from intensity or volume of exercise to whether a large or small muscle mass is recruited.

2.3.2.1 Endothelial dysfunction is modified by exercise induced haemodynamics

The role of exercise in the prevention and reversal of endothelial dysfunction has been demonstrated in young, older and patient populations. DeSouza et al. (2000) used strain gauge phlethysmography to examine forearm blood flow and forearm vascular conductance in response to acetylcholine in 68 males throughout the lifespan. Older sedentary males (58 ± 2 yr.) showed a 25% reduction in forearm blood flow and vascular conductance compared to sedentary younger males (27 ± 1 yr.) (DeSouza et al., 2000) **Figure 2.12**. However, endurance trained older males (63 ± 2 yr.) showed comparable endothelium dependent vasodilation and forearm blood flow to sedentary younger males (DeSouza et al., 2000). Middle aged and older males who regularly undertook aerobic exercise had greater acetylcholine mediated vasodilation compared to age matched sedentary counterparts (DeSouza et al., 2000). It appears regular aerobic exercise training prevents age related loss of endothelium dependent dilation in sedentary and older males (DeSouza et al., 2000). The changes in vasodilatory capacity were independent of changes in body composition and VO_{2max} suggesting a primary effect of exercise upon endothelial function (DeSouza et al., 2000). The prevention in age related decline in endothelial function was also demonstrated by Grace et al. (2015) where lifelong sedentary males ($n=22$, 62.7 ± 5.2 yr.) were compared to lifelong male exercisers ($n=17$, 61.1 ± 5.4 yr.). FMD was lower in sedentary males compared to age matched lifelong exercisers ($3.4 \pm 1.5\%$ v $5.4 \pm 1.4\%$).

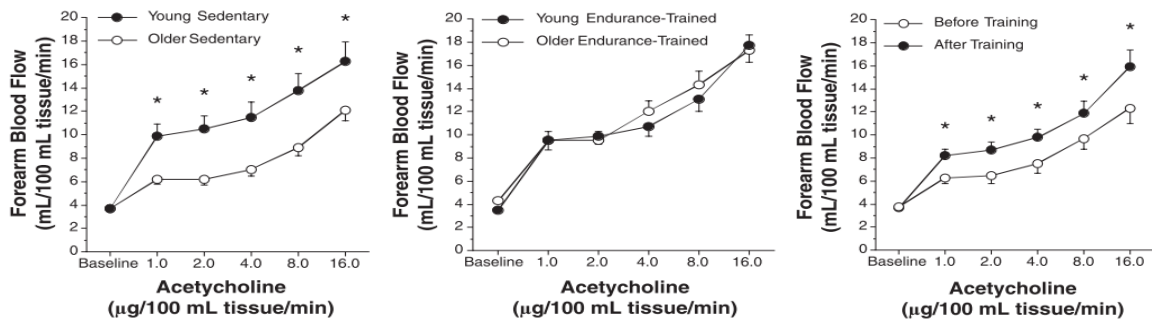

Figure 2.12. Endothelial function, as assessed via forearm blood flow responses to increasing doses of acetylcholine, is impaired in older sedentary males compared to younger sedentary males. However, older endurance trained males have comparable endothelial function to young endurance trained males suggesting exercise prevents age related declines in endothelial function. Exercise training improves endothelial function in older sedentary males with previously impaired endothelial function. (DeSouza et al., 2000)

As discussed earlier patterns of shear change with age at rest (section). However, older trained adults showed no differences in SR patterns within the brachial artery compared to younger sedentary adults (Casey et al., 2016). Furthermore, common femoral artery retrograde SR and OSI were reduced in older trained compared to older untrained adults and were similar to younger participants (Casey et al., 2016). It appears that lifelong exercise training prevents age related increases in retrograde SR and OSI which likely contributes to the preservation of endothelial function in this population. Padilla et al. (2011b) demonstrated age-related increases in resting retrograde and oscillatory SR in older compared to a younger population. However, this difference was abolished at the onset of steady-state exercise in that there were no longer differences in retrograde and oscillatory SR between the younger and older groups (Padilla et al., 2011b).

Grace et al. (2015) demonstrated the role of exercise in reversing endothelial dysfunction when the sedentary older males underwent 6 weeks of aerobic exercise training at 55-65% HRR which improved FMD to $4.9 \pm 1.1\%$. Previously, DeSouza et al. (2000) also showed this effect in 13 older sedentary males (56 ± 2 yr.) who completed 3 months of aerobic exercise training ($72\% HR_{max}$) resulting in a 30% increase in acetylcholine mediated vasodilation from baseline and was comparable

to young adults and endurance trained older males. The reversal of endothelial dysfunction with exercise has also been shown in females. 11 post-menopausal women (59 ± 5 yr.) underwent 8 weeks of exercise training on 3 days per week at 60% -75% HR_{max} (Akazawa et al., 2012). Brachial FMD increased significantly in the exercise group but there was no difference in the age matched controls ($n=10$, 64 ± 6 yr.) (Akazawa et al., 2012). Important sex differences have been observed in the literature in regards to changes in endothelial function with exercise training. Whilst male lifelong exercisers have been shown to have preserved endothelial function (DeSouza et al., 2000), Santos-Parker et al. (2017) showed that lifelong exercise in females was not protective against age/menopausal associated decline in vascular function. 12 premenopausal sedentary (24 ± 1 yr.), 25 sedentary post-menopausal women (62 ± 1 yr.) and 16 active post-menopausal women (59 ± 1 yr.) were assessed for forearm blood flow to indicate microvascular function and FMD to indicate macrovascular function (Santos-Parker et al., 2017). Forearm blood flow was lower in post-menopausal than younger females irrespective of activity status and brachial FMD was 34% and 45% lower in sedentary and active post-menopausal women respectively than younger females (Santos-Parker et al., 2017). Interestingly active post-menopausal women had lower circulating levels of c-reactive protein and oxidised LDLs suggesting a favourable CVD risk profile however these factors were not correlated with forearm blood flow or FMD (Santos-Parker et al., 2017).

As discussed in detail previously, (sections 2.2.1.2 and 2.2.1.3) ageing disrupts the balance between vasodilators and vasoconstrictors to favour vasoconstriction and thus endothelial dysfunction. In older sedentary males (66 ± 2 yr., $n=8$) ET-1 plasma concentrations were higher than young sedentary males (23 ± 1 yr., $n=8$) and older endurance trained males (62 ± 2 yr., $n=8$) (Nyberg et al., 2013). Indeed, plasma ET-1 levels in endurance trained older males (1.93 ± 0.27 pg/ml) were comparable with

young sedentary males (1.86 ± 0.32 pg/ml), demonstrating the role of lifelong exercise in preventing age-related decline in endothelial function (Nyberg et al., 2013). Furthermore, hypertensive individuals (47 ± 1 yr., $n=10$) demonstrated elevated plasma ET-1 levels (2.67 ± 0.37 pg/ml) compared to normotensive individuals (46 ± 1 yr., $n=11$) (1.59 ± 0.21 pg/ml) which was reduced following 8 weeks of walking exercise to levels similar to normotensive individuals (1.54 ± 0.21 pg/ml) (Nyberg et al., 2013). Moreover, Maeda et al. (2003) demonstrated significantly reduced blood pressure and plasma ET-1 concentrations (2.9 reduced to 2.2 pg/ml) in older, post-menopausal women following 3 months of cycling training (30 min at 80% ventilatory threshold). Reductions in ET-1 following exercise training have been associated with significant improvements in arterial compliance accompanied by significant reductions in systolic BP and PP (Maeda et al., 2009).

2.3.2.2 Arterial stiffness is improved with exercise

Animal studies have provided evidence that aerobic exercise training is capable of modifying markers of arterial stiffness. Matsuda et al. (1993) exercised 16 young male rats for 16 weeks to assess the effect of exercise upon aortic stiffness and structure. Following exercise training there was an increase in elastin content and a decrease in calcium content within elastin fibres of the aortic wall which was associated with increased aortic distensibility (Matsuda et al., 1993). Additionally, aortic incremental elastic modulus decreased significantly which was positively related to elastin calcium content in the aortic wall (Matsuda et al., 1993). It was therefore concluded that physical exercise from an early age decreased calcium deposition in aortic wall elastin producing a distensible aorta thus reducing stiffness (Matsuda et al., 1993). The mechanism for exercise induced changes in arterial structure may be due to a reduction in AGEs which have been shown to be responsible for cross linking of collagen fibres (Bailey, 2001). This was demonstrated by Boor et al. (2009) who

separated obese rats into a running (n=8) or a sedentary (n=8) group for 10 weeks of exercise training. Following the exercise training intervention there was a significant reduction in AGEs within the plasma of the exercise trained rats (Boor et al., 2009).

The effect of ageing and lifelong exercise training upon arterial stiffness in humans was investigated by Tanaka et al. (2000) where central arterial compliance of the common carotid artery was measured via ultrasound and applanation tonometry in young (18-37 yr.), middle (38-57 yr.) and older (58-77 yr.) males. Central arterial compliance was lower in the middle and older aged males compared to the younger males. There were no differences in arterial compliance between sedentary and recreationally active males in any of the age groups, however arterial compliance in endurance trained middle and older age males was 20% and 35% higher than in the less active groups. It therefore appears that age related differences in central arterial compliance are smaller in endurance trained males compared to sedentary and recreationally active males. 20 older sedentary males (53 ± 2 yr.) were subsequently recruited to a 3-month aerobic exercise intervention. Following the exercise intervention there was an increase in central arterial compliance of 25% which was equivalent to central arterial compliance in older endurance trained males; this was accompanied by a 20% reduction in β -Stiffness index in the exercise trained males (Tanaka et al., 2000). Green et al. (2010b) assessed wall thickness and remodelling in the popliteal and brachial arteries of 15 young and 16 older sedentary human male and females participants. Wall thickness was higher in the popliteal compared to the brachial artery of both groups although there was no difference in wall thickness between the age groups (Green et al., 2010b). The only observed ageing effect was apparent in increasing luminal diameter in older participants resulting in a reduced wall: lumen ratio (Green et al., 2010b). The older group then underwent 24 weeks of exercise training (30 min cycling or walking at 30% HRR) resulting in reduced wall

thickness in popliteal and brachial arteries and wall: lumen ratio with no gender effects (Green et al., 2010b). The increased vessel calibre is likely due to changes in ratio of collagen to elastin fibres in favour of greater production of elastin (Shimada et al., 2011). The vessel is therefore better able to accommodate changes in pulsatile pressure and shear stress without requiring high productions of NO to induce vasodilation (Prior et al., 2003).

2.3.2.3 MicroRNA expression changes as a result of exercise

Research regarding the effect of exercise upon miR expression is still in its early stages. A recent review showed only 30 studies have currently been published in regards to acute and chronic effects of both aerobic and resistance exercise upon circulating miRs (Sapp et al., 2017). However, designing exercise interventions to combat these pathologies at the epigenetic level (particularly miRs) is complex. Whilst some miRs may have individual genes which they target, these targets are often members of multiple pathways (Boon et al., 2012). Therefore, the regulation of the individual target gene may show only minor changes whilst the overall change on that particular pathway may in fact be profound (Boon et al., 2012). However, interest within this area is starting to garner further interest.

Bye et al. (2013) investigated the relationship between aerobic fitness and circulating levels of microRNA. After screening 720 miRs from serum samples of healthy males and females aged 40-45 years, 50 miRs were successfully assessed in 80% of the samples, with 7 miRs showing significant differences between those with a high VO_{2max} and those with a low VO_{2max} (Bye et al., 2013). Participants with a low VO_{2max} (reported as 104.2 ml/kg^{0.75}/min) showed higher serum levels of miR-210 and miR-125a and lower levels of miR-652 compared to participants with a high VO_{2max} (151.2 ml/kg^{0.75}/min) (Bye et al., 2013). MiR-222 was also shown to be 20% higher in participants with a low VO_{2max} (Bye et al., 2013). Of the seven circulating miRs, three

were concluded to be promising biomarkers of cardiovascular health related to fitness (miRs-210,-21,-222). These microRNA all have regulatory roles within endothelial cells including angiogenesis and vascular smooth muscle cell proliferation (Bye et al., 2013). Of these three miRs only miR-21, involved in inflammation and apoptosis in the endothelium, has been reported to be affected by shear stress (Zhou et al., 2011, Weber et al., 2010) and can be detected in the circulation (Baggish et al., 2011).

Typically, research investigating the effect of shear stress upon miR-21 regulation have been conducted in vitro. However, exercise studies have conducted in vivo research into the effect of exercise upon microRNA and have found miR-21 to be highly expressed within the circulation (Baggish et al., 2011). The ability to detect miR-21 in plasma allowed Baggish et al. (2011) to assess the effect of acute versus chronic exercise upon circulating miR-21. Blood samples were taken pre and immediately post an acute bout of maximal cycling exercise which was repeated following 90 days of chronic rowing training in healthy males (Baggish et al., 2011). Prior to exercise training miR-21 was shown to be upregulated 1.89 fold following acute maximal exercise (Baggish et al., 2011). After the exercise training period the resting miR-21 level was elevated 2.63 fold compared with the pre training levels with no further acute effect of maximal exercise following the training period (Baggish et al., 2011), possibly due to a threshold of expression being reached. The study concluded that miR-21 was responsive to acute exercise before but not after exercise training (Baggish et al., 2011).

Kilian et al. (2016) further examined the effect of acute exercise upon miR-21 expression within the circulation of healthy young male cyclists (14 ± 1 yr.) Participants completed a 4 by 4 min IT session and low intensity high volume session on separate days. Circulating miR-21 expression was significantly higher 30-minute post exercise following high volume exercise compared to IT (Kilian et al., 2016).

Compared to pre-exercise, miR-21 expression was significantly reduced 30 minutes following IT exercise (Kilian et al., 2016). Xu et al. (2016) also explored miR-21 expression following acute exercise. Congestive heart failure patients (n=28, age 59±2 yr.) underwent a maximal cycle exercise test with blood sampled before and immediately after exercise. In contrast to other studies, circulating miR-21 was significantly upregulated immediately following acute maximal exercise (Xu et al., 2016).

In contrast, circulating miR-21 was shown to be unaffected immediately and 24 hours after acute exercise where a single marathon was used as the exercise stimulus (Mooren et al., 2014). Furthermore, Nielsen et al. (2014) examined plasma miRs in response to acute aerobic exercise and endurance training. Healthy males (28 ± 8 yr.) completed 60-minute acute cycling at 65% peak power, participants carried on with this exercise 5 times per week for 12 weeks. Blood samples were collected immediately prior to the acute exercise bout then immediately, 1 hour and 3 hours' post exercise, with a final sample collected following the 12 weeks of training (Nielsen et al., 2014). Following global miR screening, miR-21 expression did not appear to be affected by acute exercise at any time point following the exercise (Nielsen et al., 2014). However, following 12 weeks of cycle training, miR-21 expression was significantly downregulated (Nielsen et al., 2014).

Currently, large amounts of conflicting research surround the role of miR-21 within the endothelium and how exercise, and exercise-induced shear in particular, can alter its expression. The lack of consensus in the studies described in this section is likely due to the dual role of miR-21 as described earlier (section 2.1.5.2). Therefore, the exercise used to assess miR-21 expression may induce either greater volumes of oscillatory or laminar shear, which was not measured in the aforementioned studies, which may differentially regulate miR-21 expression. Furthermore, the exercise

literature has not studied how type and intensity of exercise may differentially affect miR-21 thus providing an explanation for the disparate findings cited here. However, the ability to detect miR-21 in the circulation in vivo may allow the effects of differing exercise protocols, IT vs. CON (assessing intensity and pattern of the exercise) upon miR-21 and therefore the effect upon the endothelium to be delineated.

2.4 Summary

In summary, CVD remains a leading cause of morbidity and mortality. Traditional CVD risk factors do not fully account for CVD risk, endothelial function and arterial stiffness thought to account for the remainder of this risk. This is likely due to the role of endothelial dysfunction as an initial step in atherosclerosis development. Ageing increases CVD risk and has been shown to increase endothelial dysfunction and arterial stiffness prevalence. There may also be an important role for ageing in altering epigenetic factors, such as microRNA which regulate endothelial cell phenotype. Females have a reduced CVD risk prior to the menopause, compared to age matched males, due to the role of oestrogen in contributing to anti-atherogenic effects. Following the menopause, the decline in CVD health in females is accelerated with post-menopausal females at an equal CVD risk to age matched males.

Haemodynamics, i.e. shear stress are important regulators of endothelial function, arterial stiffness and microRNAs within endothelial cells. Shear stress can be divided into laminar or oscillatory shear, which are responsible for inducing either an anti-atherogenic or pro-atherogenic endothelial cell phenotype respectively. Exercise improves endothelial function, arterial stiffness and appears to alter circulating microRNA-21 expression. These improvements are likely as a result of increased blood flow and therefore increased shear stress with exercise onset. However, the

type and intensity of exercise have integral roles in endothelial adaptations which may be attributed to the type of shear stress the exercise induces.

Interval exercise has been suggested to be more or at least equally effective in improving endothelial function compared to traditional continuous exercise. However, the pattern of shear stress during continuous and interval exercise has not been characterised. The repeated work and recovery bouts which are characteristic of interval exercise have the potential alter pattern of blood flow and perhaps induce a more oscillatory shear stress pattern compared to continuous exercise. Therefore, the differential effect of interval versus continuous exercise and the resultant effect upon markers of vascular health both acutely and chronically has not been delineated. This is important to allow determination of exercise-induced mechanisms responsible for changes in vascular health in order to determine the most effective exercise interventions for prevention or reversal of CVD.

2.5 Thesis Aims

The aims of this thesis are:

- I. To characterise in-exercise shear rate during intensity and duration matched interval and continuous exercise and assess the acute effect upon endothelial function and biomarkers of endothelial cell phenotype in a young healthy population.
- II. To determine the effect of 4 weeks of either interval versus continuous upon in-exercise shear rate profiles upon acute and chronic vascular health in samples of differing age and gender.

Chapter 3 General Methods

3.1 Ethics

Ethical approval was sought for all studies within this thesis from the University Of Leeds Faculty Of Biological Sciences Ethical Committee in accordance with the Declaration of Helsinki. Upon response to recruitment materials participants were provided with participant information sheets. Participants were given a minimum of 48 hours to decide whether to participate and were encouraged to ask questions.

3.2 Participant Recruitment and Health Screening

Participants for all studies were recruited via poster advertisements distributed throughout the local vicinity in addition to University wide email advertisements and an advertisement in a local community magazine. Upon response to recruitment materials, participants were screened in accordance with standard laboratory procedures. Exclusion criteria included pregnancy, current or historical cardiovascular, pulmonary and metabolic diseases, smoking, musculoskeletal impairment or injuries which may affect their ability to complete the prescribed exercise and any other contraindications to exercise. Additionally, participants were free of prescribed medications, e.g. hormonal contraceptive pills. Further specific criteria pertaining to individual studies are outlined in the relevant chapters.

Participants then visited the laboratory for health screening where they provided written informed consent and completed a physical activity health questionnaire. A resting 12-lead ECG and three supine blood pressures in addition to height and weight were also recorded at this visit. Information from this health screening session was then checked by a cardiologist before participants were cleared to continue with the exercise studies. Participants who presented with ECG abnormalities or blood

pressure that consistently exceeded 140/90 mmHg were provided with a letter containing the information recorded at the health screening and were strongly advised to follow up with their GP. Until written permission was received from the GP stating that they were eligible to take part, participants were excluded.

3.3 Experimental Procedures – overview of all studies

Specific experimental procedures for individual studies are detailed within the relevant chapter. Briefly, all visits took place in temperature and light controlled exercise physiology laboratories at the University of Leeds. Prior to all testing sessions, participants were required to abstain from exercise and alcohol in the 24 hours before testing. Before all vascular assessments participants were required to abstain from food and caffeine for >6 hours. Before assessment of cardio-respiratory fitness, participants abstained from food and caffeine for >2 hours.

3.4 Anthropometric Measures (BMI)

At the initial health screening visit all participants were assessed for height and weight to determine BMI. Height was measured to the nearest 0.5 cm using a stadiometer. Body mass was measured to the nearest 0.1 kg using automatic calibrated scales. BMI was subsequently calculated using the following equation:

$$BMI (kg/m^2) = \frac{Body\ mass\ (kg)}{Height^2\ (m)}$$

Equation 3

3.5 Assessment of cardiorespiratory fitness

3.5.1 Ramp incremental exercise test (RIT)

All participants completed ramp incremental exercise tests to non-invasively determine peak oxygen uptake ($\dot{V}O_{2\text{peak}}$), heart rate peak (HR_{peak}) and lactate threshold (LT). Determination of these parameters enabled exercise-mediated changes in cardiorespiratory fitness following the exercise intervention in Chapter 5 whilst also providing the work rates required during the exercise sessions in Chapters 4 and 5.

Tests were completed on an electronically braked, semi-recumbent cycle ergometer (LODE Angio, Lode BV, Groningen, Netherlands). The ergometer was adjusted prior to testing to ensure both optimal knee extension and participant comfort. The breath by breath system (MedGraphics D-Series, Medical Graphics Corporation, St Paul, MN, USA) was calibrated for flow across a known volume (3 L) and known oxygen and carbon dioxide concentrations (21% O₂: 0% CO₂ and 12% O₂: 5% CO₂). Participants were familiarised with the procedure, the equipment and the researchers before a 12-lead ECG was attached. Participants' feet were strapped into the ergometer pedals. A mouthpiece and nose-clip were subsequently fitted to allow breath by breath data collection.

Testing began with a period of rest (≥ 2 min) on the cycle ergometer before continuing into a warm up at 10 W (equivalent of unloaded pedalling) for ≥ 3 min at a cadence of 50-60 rpm. The exercise ECG was monitored continuously throughout the RIT to check for abnormalities which may require premature test termination. The RIT portion of the test began when RER reached a steady state of 0.7-0.9 and $\dot{V}O_2$ was stable. The rate of the increment varied depending on the population with the intention that the incremental phase of the test lasted 8-12 min thus allowing accurate determination of LT. Participants were required to maintain a cadence ≥ 50 rpm throughout the test until volitional fatigue. Volitional fatigue was determined when a cadence > 50 rpm could no longer be maintained despite strong verbal

encouragement. Participants then entered an active recovery period conducted at 10 W for ≥ 4 min until gas exchange and heart rate returned towards baseline.

3.5.2 Determination of $\dot{V}O_{2peak}$ and LT

Breath by breath and heart rate data were exported to Origin Lab software (OriginPro V. 7.5) for analysis. HR_{peak} was determined as the highest heart rate achieved during the RIT from the 12-lead ECG. Work rate peak from the end of the RIT was calculated as follows:

$$WR_{peak} (W) = \frac{RIT \text{ duration } (s)}{60} \times \text{ramp rate} + 10$$

Equation 4

where 10 is the resistance (in Watts) at warm up.

For determination of $\dot{V}O_{2peak}$ raw breath by breath data were checked for erroneous breaths which were removed if they were outside of 99% confidence limits (i.e. 4 standard deviations away from the mean). Eight-point rolling averages of 12 breaths from the end of the RIT were used to determine $\dot{V}O_{2peak}$. The highest $\dot{V}O_2$ value was selected and defined as absolute $\dot{V}O_{2peak}$ ($L \cdot \text{min}^{-1}$). Relative $\dot{V}O_{2peak}$ ($\text{ml}/\text{kg}/\text{min}$) was calculated by dividing absolute $\dot{V}O_{2peak}$ by body mass (kg).

LT was estimated non-invasively using the V-slope method whereby $\dot{V}CO_2$ production increased at a greater rate than $\dot{V}O_2$ utilisation (Wasserman, 1999). This was reflected on a graph of $\dot{V}O_2$ versus $\dot{V}CO_2$ where a point of inflection on the curve represents the LT, as can be seen in **Figure 3.1** (Wasserman, 1999). To ensure greater reliability, LT was also confirmed using graphs of $\dot{V}O_2$ versus $P_{ET}O_2$ and $\dot{V}O_2$ versus $\dot{V}_E/\dot{V}O_2$ respectively. This procedure was conducted by at least 2 researchers

to ensure estimations of LT were within normal breath by breath variability (200 ml), the average of these values was then defined as LT.

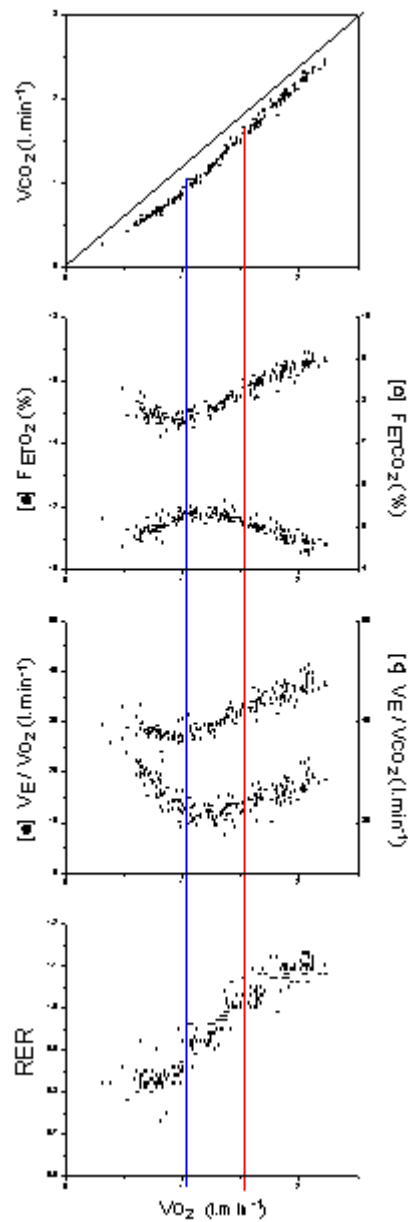

Figure 3.1 The 4 graphs which enabled the V-slope method to non-invasively determine LT (blue line) and respiratory compensation (red line) through breath by breath gas exchange.

3.6 Assessment of brachial artery endothelial function

3.6.1 Participant Preparation

To ensure the accuracy of flow mediated dilatation (FMD) and to be certain that changes in arterial diameter are dependent upon improvements in NO bioavailability only, participant preparation is an important consideration. Smoking is known to attenuate FMD as well as being a risk factor for CVD; participants who were current smokers were excluded from all studies as a result of this increased CVD risk. Participants were also required to abstain from food and caffeine for >6 hours prior to FMD assessment, in addition to refraining from strenuous exercise in the preceding 24 hours. The inclusion of females in the studies described in this thesis was important; however, the menstrual cycle has been shown to increase eNOS activity and antioxidant capacity. Therefore, for all premenopausal women all FMD measures were endeavoured to be tested within the same phase of the menstrual cycle. Ideally, previous literature has reported that the optimum time for measurement of FMD is days 1-7 of the menstrual cycle to minimise the impact of hormonal changes (Thijssen et al., 2011), however practically this was not always possible within the current studies in this thesis.

3.6.2 Ultrasound Technology for FMD

Accurate measurement of FMD is dependent upon specialised ultrasound equipment which is capable of detecting small changes in arterial diameter. A 10 MHz linear probe (9L) was used to obtain a high-resolution B-mode image at a depth of 3-4 cm (dependent upon individual participants). Additionally, Doppler blood velocity was acquired through Duplex mode on a Vivid E9 (GE Healthcare, Milwaukee, WI, USA). The optimum angle to intersect the vessel during B-mode imaging is at 90° however in Doppler mode this would yield a blood velocity of virtually zero. Therefore, an angle of insonation of ≤60° is widely accepted as the greatest compromise to achieve an acceptable vessel image and a reduced level of error when measuring blood velocity. During all FMD procedures in this thesis the angle of insonation was constantly set

at 60° and the angle steer of the ultrasound beam altered in order to obtain the most accurate data with the lowest associated error.

3.6.3 Brachial FMD Procedure

Participants entered the laboratory following the preparation detailed in 3.6.1. Participants then completed >10 min semi-recumbent rest prior to any measures being recorded. The right arm of the participant was extended away from the body and supported under the shoulder and wrist. The ultrasound probe was used to image the brachial artery in the lower third of the upper arm (proximal to the antecubital fossa), with the probe subsequently clamped securely into place thus allowing micro manual adjustments to optimise the B-mode image. The dynamic range and 2D gain were also adjusted to ensure optimal image quality. The ultrasound was then switched into Duplex mode to assess Doppler blood velocity. The angle steer was adjusted so the angle of insonation could remain at 60° (described in 3.6.2) and the sample volume altered to encompass all blood flow through the artery including the lower velocity flow at the arterial wall. The scale of the blood velocity trace was also adjusted to ensure that the increase in blood velocity as a result of reactive hyperaemia was measured. A baseline recording was then taken at 15 frames per second (fps) for 20 seconds on the Vivid ultrasound which was live streamed through Vascular Imager software (Vascular Imager; Medical Imaging Applications, Coralville, IA, USA) and recorded.

A blood pressure cuff was then placed on the forearm (distal to the probe) and rapidly inflated to supra-systolic pressure (>200 mmHg) for a period of 5 minutes, the ultrasound probe remained in its original position throughout this time. The blood pressure cuff occluded blood flow to the forearm causing a period of downstream ischemia. At 4 min 30 s into the occlusion period, recording started and lasted for 180

s consecutively at 15 fps using Vascular Imager. At 5 min of occlusion the blood pressure cuff was rapidly deflated inducing a reactive hyperaemia. Once recording was completed the placement of the ultrasound probe was measured relative the medial epicondyle using a standard tape measure. As further ultrasound measurements were recorded within the same sessions, a permanent pen was used to mark the probe position on the upper arm. The set up used for assessment of brachial artery FMD can be seen in **Figure 3.2**.



Figure 3.2 Assessment of brachial artery FMD.

3.6.4 Analysis of brachial artery diameter

Analysis of arterial diameter was conducted offline using automated edge-detection software, as shown in **Figure 3.3** (Brachial Tools V5; Medical Imaging Applications,

Coralville, IA, USA). In both the resting and FMD recordings a region of interest was selected where both the media of near and far vessel walls were clearly distinguished. Frames were removed from the analysis if a confidence interval of 70% was not met. Resting diameter was calculated as an average from all frames during the 20 s recording period using Microsoft Excel. Peak diameter was determined as the greatest diameter from a 3-frame rolling average of diameters recorded post cuff release. Absolute and relative FMD were subsequently calculated as follows:

$$\text{Absolute FMD (mm)} = \text{Peak diameter} - \text{Resting diameter}$$

Equation 5

$$\text{Relative FMD (\%)} = \frac{\text{Peak diameter} - \text{Resting diameter}}{\text{Resting diameter}} \times 100$$

Equation 6

Time to reach peak diameter was determined as the time (seconds) from cuff deflation to the time where the greatest diameter occurred.

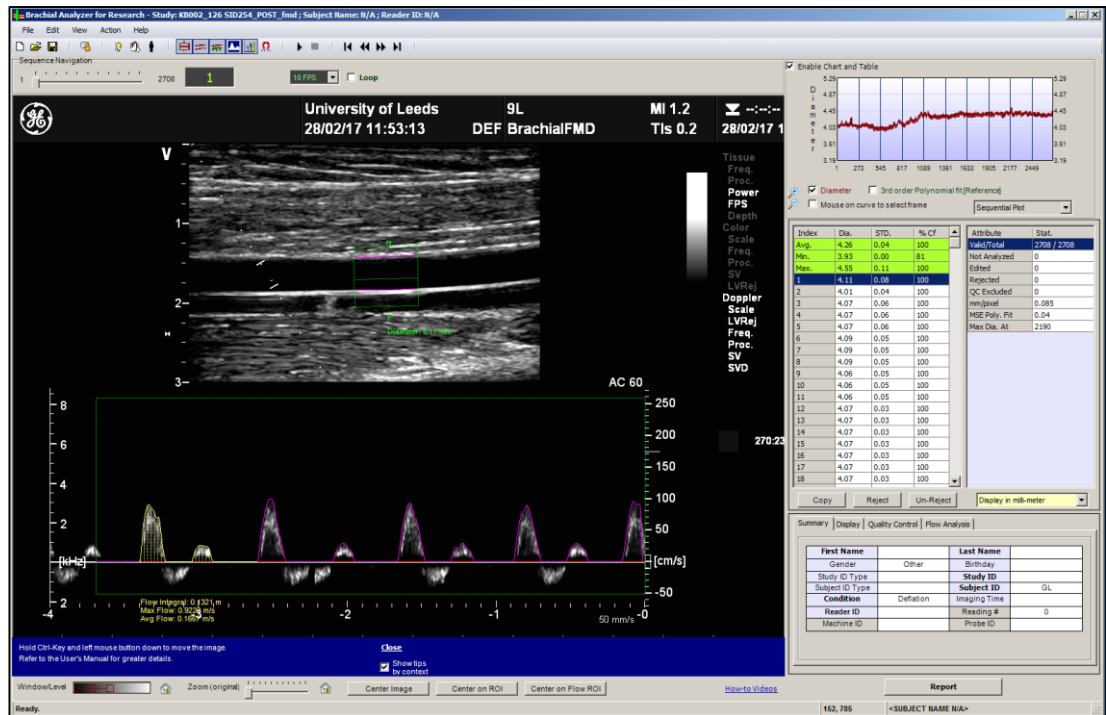

Figure 3.3 Brachial tools was used for analysis of resting diameter and FMD. A region of interest (green box) was selected and the software used semi-automated edge detection to assess the distance between the near and far walls (pink lines) to determine brachial artery diameter t rest and following cuff deflation. A region of interest was also drawn over the Doppler blood flow velocity trace and the forward flow waveforms detected.

3.6.5 Doppler blood flow velocity analysis

Blood velocity following cuff occlusion was measured directly using Brachial Tools. The horizontal (time) and vertical (velocity) axes of the Doppler graph were calibrated prior to analysis with a region of interest used to select the blood flow profile to be measured. The Doppler trace was then automatically analysed across all cardiac cycles in conjunction with vessel diameter to provide mean blood flow velocity using the Doppler shift equation as follows:

$$\text{mean blood flow velocity (m/s)} = \frac{\text{doppler frequency} \times 1540}{(2 \times 5000) \times \cos \theta}$$

Equation 7

Where 1540 m/s is the average velocity of sound in a tissue, 5000 is the transmitted frequency and θ is the angle of insonation.

Peak hyperaemia was determined as the highest mean blood flow velocity in the initial 10 s period following cuff deflation. Mean blood flow velocity was used to calculate peak shear rate using the equation:

$$\text{Peak Shear Rate (s}^{-1}\text{)} = \frac{8 \times \text{mean blood velocity (m/s)}}{\text{Baseline diameter (mm)}}$$

Equation 8

A factor of 8 was used in the above equation as the sample volume incorporated all of the blood flow through the vessel as described in 1.6.3. In addition to mean blood flow velocity, Brachial Tools also calculated the velocity time integral (VTI) automatically using the trapezium rule:

$$\text{VTI (cm)} = \frac{V1 + V2}{2} \times t$$

Equation 9

Where V1 and V2 are net velocities and t is the difference in time between the two velocities.

3.6.6 Reliability and validity of endothelial function assessment

FMD is a widely-used procedure to assess NO dependent endothelial function most commonly within the brachial artery, however whilst it is frequently utilised within research it is still not used as a clinical tool to identify and stratify CVD risk. This is despite the strong relationship between the endothelium and atherosclerotic lesion development in addition to the association between endothelial dysfunction and cardiovascular events (Lerman and Zeiher, 2005). Indeed, there is current literature which suggests that endothelial function as measured by FMD provides important prognostic information of CVD risk that traditional risk factors cannot solely account for (Lerman and Zeiher, 2005). This is perhaps due to brachial artery FMD showing a strong positive correlation with coronary artery function (Takase et al., 1998).

Additionally, Green et al. (2011) reported that a 1% improvement in FMD was associated with a 13% reduction in risk from the occurrence of a cardiovascular event.

Although NO is not directly measured during FMD, previous literature has shown that the vasodilatation induced by the reactive hyperaemia during the FMD procedure is predominantly NO dependent. This has been confirmed in studies where vasoactive agents which upregulate NO production through activation of eNOS, such as acetylcholine (Ach), have been administered in addition to an intra-arterial infusion of N^G – monomethyl-L-arginine (L-NMMA), a known NO inhibitor (Higashi and Yoshizumi, 2003). Ach increased forearm blood flow, measured using strain gauge plethysmography, and produced vasodilation which was then attenuated following infusion of L-NMMA (Higashi and Yoshizumi, 2003).

To maximise the validity and reliability of FMD measures standardised procedures have been published to ensure FMD is NO-mediated and the variation between measurements is minimised. This is demonstrated by the importance of the positioning of the blood pressure cuff when performing an FMD. Guidelines recommend placing the cuff distal to the ultrasound probe (principally on the forearm during brachial artery FMD). However, some studies have placed the cuff proximal to the probe (Wisløff et al., 2007, Shechter et al., 2014) which may affect the volume of endothelial vasodilation observed. Doshi et al. (2001) examined the effect upon FMD when the cuff was placed in either proximal or distal to the ultrasound probe. When the cuff was distal to the probe there was attenuation in FMD upon infusion of L-NMMA however, when the cuff was proximal to the probe there was only partial attenuation of FMD when L-NMMA was infused. Another important methodological issue is the duration of blood pressure cuff inflation to induce ischemia. It is recommended that 5 min is the optimal duration for cuff inflation as vasodilation via

FMD is completely abolished when L-NMMA is infused. However, when the cuff was inflated for 15 min, there was no effect upon FMD when L-NMMA was infused suggesting that the mechanism for the observed vasodilatation was no longer NO-dependent (Mullen et al., 2001).

The section of the brachial artery where the ultrasound probe is placed to measure diameter can produce unreliable results when compared across multiple sessions. This is due to brachial artery diameter narrowing towards the periphery; therefore, it is important that the same section of artery is located and imaged when determining FMD. Within this thesis, the section of skin where the ultrasound probe was placed was marked using a permanent pen to maintain consistency within the same session. To ensure the same site was imaged across different days a tape measure was used to measure the distance from anatomical landmarks, in this case the medial epicondyle, and the images recorded at previous sessions were also observed during image optimisation. Edge detection software was utilised for the analysis of brachial artery diameter during both FMD and in-exercise (In-Ex) sessions due to previous recommendations stating that this software provides a valid measurement of arterial diameter whilst minimising experimenter bias. Using the standardised procedures described in this chapter which are consistent with recommendations from previous literature, it is reasonable to assume that the FMD procedures utilised within this thesis are producing NO dependent vasodilation.

An important factor which may affect the assessment of vasodilatation is experimenter error due to the skill required in obtaining reproducible measurements of arterial diameter. It is therefore imperative to assess intra-rater reliability across different days to ensure reproducible FMD results are presented in this thesis. The between – day reproducibility for 10 participants assessed by the same sonographer on two separate days are reported in **Table 3.1**.

Table 3.1 Between day reproducibility for indices of FMD and associated shear rate data.

	Absolute Difference	Coefficient of Variation (%)	Raw Values Time Point 1	Raw Values Time Point 2
Baseline Diameter (mm)	0.09	2.1	4.13	4.15
Absolute FMD (mm)	0.01	9.2	0.28	0.27
Relative FMD (%)	0.37	9.0	6.79	6.41
Peak reactive hyperaemia (cm/s)	10.9	11.7	81.5	92.4
Peak shear rate (s ⁻¹)	216.6	15.9	1646.0	1862.6
Shear Rate AUC ₆₀	2030.0	17.9	40764.5	42794.5
Shear Rate AUC ₉₀	4355.8	18.9	55787.9	60143.7

3.7 In-exercise measures of Doppler blood velocity and diameter

3.7.1 Procedure for assessment of in-ex diameter and blood velocity

Participants reclined on the semi-recumbent cycle ergometer with their right arm extended and supported as described in the FMD procedures (section 3.6), see **Figure 3.4**. The same site of the upper arm was imaged with the 9L linear probe as in the FMD recording to ensure the same section of the brachial artery was recorded. The ultrasound was set up in Duplex mode with both the B-mode image and Doppler blood flow velocity optimised as described previously (section 3.6.3). Recording started during the 10 W warm up phase of the exercise session, 30 s prior to the work

bout beginning. The Duplex images were recorded directly onto the Vivid ultrasound at 9.1 fps. Ultrasound recording continued throughout the duration of the exercise session in 4 min video loops with 30 s separating each loop. This was necessary due to equipment limitation whereby the maximum length of time available for video recording was dictated by the equipment and the length of time required for saving the images. Recordings were ended following ≥ 1 min of recovery at 10 W.



Figure 3.4 Ultrasound was used to assess brachial artery diameter and blood flow velocity during cycling exercise on a semi recumbent cycle ergometer. Heart rate and VO_2 was also assessed at the same time via a 12-lead ECG and breath by breath gas exchange system.

3.7.2 Data used to gain anterograde and retrograde and OSI

All in-exercise video loops were exported into EchoPac (GE Healthcare, Milwaukee, WI, USA) where the videos were saved as Dicom files before being exported into Brachial Tools for analysis of diameter and anterograde blood flow velocity (**Figure**

3.5). Using the EchoPac software the Doppler velocity axis (y axis) for each video loop was inverted and the file re-exported in Dicom format to allow determination of retrograde blood flow velocity in Brachial Tools (Figure 3.6). A confidence limit of 70% around the near and far walls of the artery was applied to all frames, with frames falling outside of this cut off excluded. Brachial diameter and blood flow velocity were produced in a frame by frame format by Brachial Tools, which was converted into second by second data (division of frame number by frame rate (fps)) for the purposes of further analysis. The data was subsequently analysed in real time in order to correspond to heart rate and VO_2 also collected during exercise.

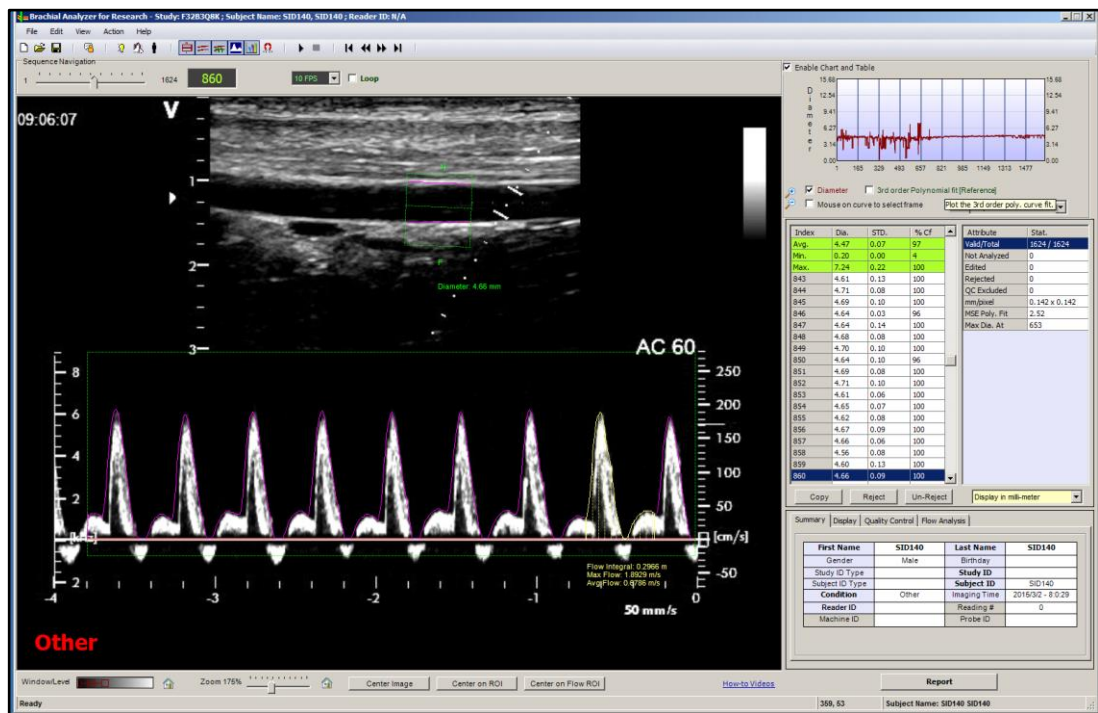

Figure 3.5 An in-exercise video recording analysed in Brachial Tools to determine brachial artery diameter and anterograde blood flow velocity per frame.

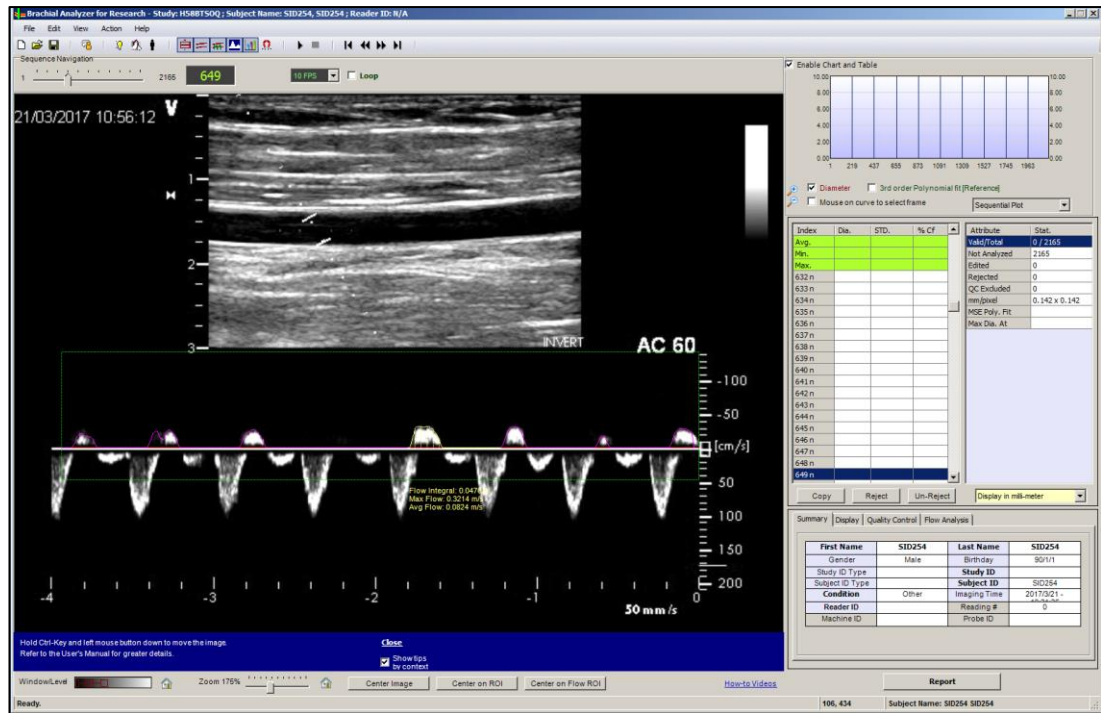

Figure 3.6 The Doppler blood flow velocity axis was subsequently inverted on the ultrasound machine before being analysed in Brachial Tools to determine retrograde blood flow velocity and shear rate.

Mean diameter of the brachial artery was calculated as a mean of one 4 min video recorded throughout the exercise. Prior to this, diameter throughout the exercise protocol was graphed second by second for each individual and visualised to ensure that diameter did not increase/decrease as the exercise session progressed. It was evident that brachial diameter did not demonstrate a trend for dilation/constriction during exercise and that fluctuations in diameter were purely due to noise during the recording process. Mean brachial artery diameter enabled determination of mean cross sectional surface area (CSA calculated using πr^2) which was required for determination of volumetric flow:

$$\text{Volumetric flow (ml/min)} = (\text{CSA} \times \text{mean blood flow}) \times 60$$

Equation 10

Anterograde and retrograde shear rate (SR) at each second were also calculated from mean anterograde and retrograde blood flow velocities and mean brachial diameter using the following equation:

$$\text{Shear Rate (s}^{-1}\text{)} = \frac{\text{mean blood flow velocity}}{\text{brachial diameter}} \times 8$$

Equation 11

Oscillatory shear index (OSI) was subsequently calculated from anterograde and retrograde SR using the following equation:

$$\text{OSI (a.u.)} = \frac{\text{Retrograde shear}}{(\text{retrograde} + \text{anterograde shear})}$$

Equation 12

OSI is a useful measure to identify whether blood flow within in the artery is primarily laminar (0-0.5) or oscillatory (>0.5) (Padilla et al., 2010).

3.8 In-exercise blood pressure assessment

Attempts to measure blood pressure during exercise protocols was made. An automated blood pressure cuff was attached to the opposite arm to which in-exercise ultrasound scanning was conducted. However, due to excessive movement during cycling the automated blood pressure cuff was unable to detect blood pressure. An automated wrist blood pressure cuff was subsequently attempted. The cuff was placed on the wrist of the opposite arm to which in-exercise ultrasound scanning was conducted. However, once again the cuff was unable to detect blood pressure following multiple attempts. A fingertip finometer was borrowed to assess its ability at recording in-exercise blood pressure. A blood pressure cuff was attached to the middle finger of the hand on the opposite side to the arm which in-exercise ultrasound scanning was conducted. Whilst accurate blood pressure readings were obtained at

rest, when compared with the automated blood pressure cuff on the upper arm, in-exercise blood pressure readings were inaccurate and unreliable.

3.9 Assessment of chronic carotid artery stiffness

Participants were asked to abstain from exercise and alcohol in the 24 hours prior to the lab visit plus food and caffeine in the 2 hours prior to the visit. Upon entering the lab participants were required to rest in a supine position for ≥ 10 min before brachial artery blood pressure was recorded. A 9L linear ultrasound probe was used to obtain a 2D image of the right common carotid artery, proximal to the carotid bulb and bifurcation. The 2D image was optimised to obtain clear images of the tunica media and tunica intima of the near and far walls. Upon optimisation of the 2D image, three 20 s videos were recorded at 15 fps using Vascular Imager (Medical Imaging Applications, Coralville, IA, USA).

Video recordings of the carotid artery were analysed using automated edge detection software which tracked the walls of the artery throughout the recordings (Carotid Analyser; Medical Imaging Applications, Coralville, IA, USA) **Figure 3.7**. A region of interest was drawn around the vessel incorporating both walls where the IMT borders were most visible. The distance of the region of interest to the carotid bulb was measured to ensure the same section of the artery was assessed across all recordings and across the training intervention. The software automatically determined carotid artery diameter in addition to intima-media thickness (IMT) of near and far walls. Some frames required manual detection of both intima and media borders for near and far walls.

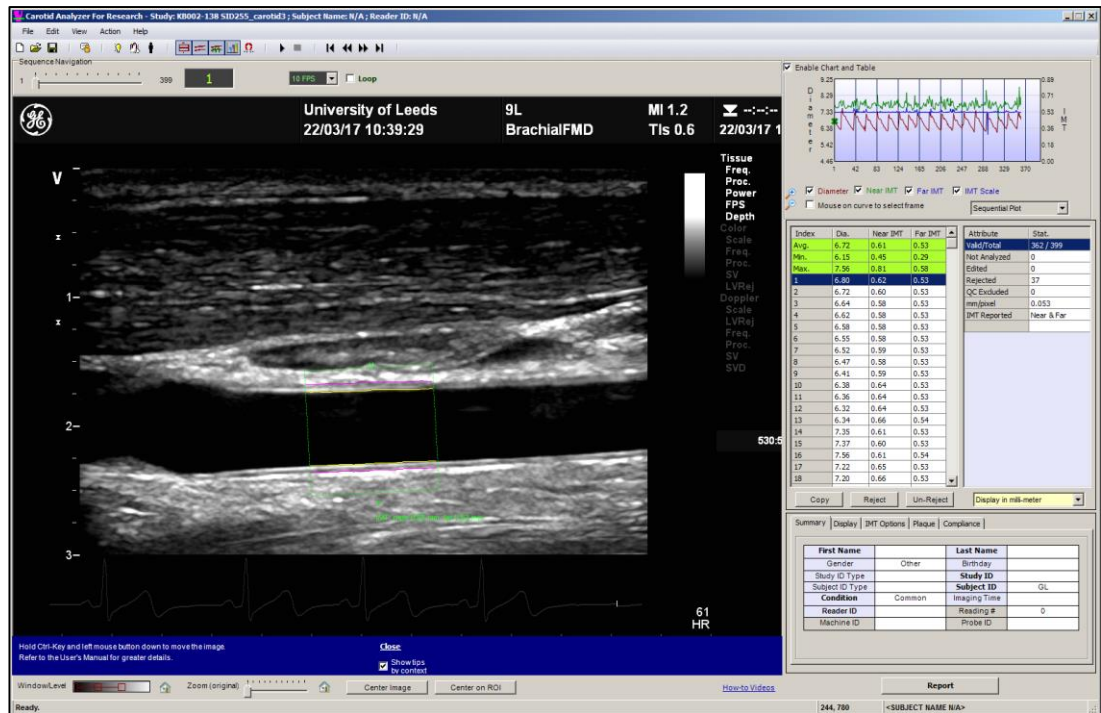

Figure 3.7 Carotid analyser used semi-automated wall tracking software to determine carotid diameter, near and far wall IMT, in addition to automatically calculating carotid artery compliance and distensibility.

Measures of carotid artery distensibility and compliance were calculated within the carotid analyser software from the diameters and brachial blood pressure, recorded immediately prior to the carotid recordings. The equations used within the software are shown below (Tounian et al., 2001):

$$\text{Diameter Distensibility (DD, \%)} = \frac{(D_{max} - D_{min})}{D_{min}} \times 100\%$$

Equation 13

$$\text{Cross - sectional distensibility (CSD, \%)} = \frac{\pi \left(\frac{D_{max}}{2}\right)^2 - \pi \left(\frac{D_{min}}{2}\right)^2}{\pi \left(\frac{D_{min}}{2}\right)^2} \times 100\%$$

Equation 14

$$\text{Diameter Compliance (DC, mm/mmHg)} = \frac{(D_{max} - D_{min})}{\Delta P}$$

Equation 15

$$\text{Cross – sectional compliance 1 (CSC 1, mm}^2\text{/mmHg)} = \frac{\pi(\frac{D_{max}}{2})^2 - \pi(\frac{D_{min}}{2})^2}{\Delta P}$$

Equation 16

$$\text{Cross – sectional compliance 2 (CSC2, 1/mmHg)} = \frac{\pi(\frac{D_{max}}{2})^2 - \pi(\frac{D_{min}}{2})^2}{\pi(\frac{D_{min}}{2})^2 \times \Delta P}$$

Equation 17

Incremental elastic modulus (IEM, mmHg)

$$= \frac{3(1 + (\pi(\frac{D_{min}}{2})^2)/(\pi(\frac{D_{min}}{2})^2))}{CSC2}$$

Equation 18

Where D_{max} is maximum carotid diameter, D_{min} is minimum carotid diameter and P is pulse pressure. Beta stiffness index was calculated outside of the software using the following equation (Selzer et al., 2001):

$$\text{Beta Stiffness Index (a. u.)} = \ln\left(\frac{SBP}{DBP}\right) / \left(\frac{D_{max} - D_{min}}{D_{min}}\right)$$

Equation 19

3.9.1 Reliability and validity of carotid artery stiffness assessment

Increased carotid artery intima media thickness (IMT) and reduced carotid artery distensibility have previously been significantly associated with increased CVD risk (Simons et al., 1999). Non-invasive assessment of carotid artery stiffness using ultrasound and automated edge detection software has been shown to be a reliable method for predicting CVD risk (Selzer et al., 2001). Ultrasound measurement of carotid IMT has been used to identify asymptomatic individuals at an increased CVD

risk as it appears to be an early precursor to atherosclerosis development prior to any plaque in the artery wall being identifiable. Carotid IMT was also better able to distinguish between high and low risk individuals who already had vascular diseases or CVD risk factors (Simons et al., 1999). Additionally, reduced carotid artery distensibility was linearly associated with increasing risk scores for CVD (Simons et al., 1999). Following adjustment for CVD risk factors and carotid IMT a significant association between the hazard ratios of arterial distensibility (1.19), stiffness indices (1.14) and elastic moduli (1.13) and stroke (Yang et al., 2012) have been reported. However, arterial compliance (1.02) did not appear to demonstrate this relationship (Yang et al., 2012).

Validity of ultrasound for non-invasive assessment of carotid artery stiffness to determine atherosclerotic development can be assessed when compared to invasive measures such as coronary angiography. Alan et al. (2003) used coronary angiography to divide participants into known CAD and a control group. Participants with CAD were shown to have significant increases in IMT (0.82 ± 0.1 , 0.57 ± 0.1 , $p < 0.05$) and stiffness index (0.25 ± 0.9 , 0.37 ± 0.1 , $p < 0.05$), in addition to a significant reduction in arterial distensibility (13 ± 4 , 8 ± 3 , $p < 0.05$) compared to the control group (Alan et al., 2003). The study concluded that IMT, distensibility and stiffness indices could be used as a cheaper and non-invasive alternative for the early detection of CAD (Alan et al., 2003).

For this thesis the within day reproducibility for parameters collected during assessment of carotid artery stiffness via B-mode ultrasound in 10 participants are presented in **Table 3.2**. Coefficient of variation for IMT has been reported to vary between 10-40% in previous studies (Bots et al., 2002), whilst between day reproducibility for cross-sectional compliance and distensibility have been reported as 11-14% and 13-17 % respectively (Gamble et al., 1994). With advances in

technology, coefficient of variation for these techniques assessing carotid artery stiffness have improved. Additionally, as reproducibility was assessed within day by the same sonographer for this thesis the values reported are low as would be expected.

Table 3.2 Within day reproducibility for carotid artery stiffness variables measured using ultrasound.

	Absolute Difference	Coefficient of Variation (%)	Raw Values Time Point 1	Raw Values Time Point 2
Near wall IMT (mm)	0.02	18.6	0.61	0.58
Far wall IMT (mm)	0.01	26.7	0.54	0.52
Vessel Diameter (mm)	0.04	0.7	7.12	7.08
β stiffness index (a.u.)	0.07	3.1	6.55	6.61
Diameter Distensibility (DD) (%)	0.10	3.5	8.02	7.91
Diameter Compliance (DC) (mm/mmHg)	0.0003	3.6	0.014	0.013
Cross-sectional compliance (CSC) (mm ² /mmHg)	0.003	3.6	0.150	0.146
Incremental elastic modulus (IEM) (mmHg)	12.9	4.7	1586.8	1599.7

3.10 Plasma blood sampling

Venous blood samples were collected at the antecubital fossa into one 10 ml EDTA treated vacutainer. The vacutainers were inverted 8-10 times as per the manufacturers' instructions and stored in a fridge for further processing. Samples were processed within two hours of blood draw. The vacutainer was centrifuged using a swing bucket centrifuge for 10 min at 3000 rpm (1900 x g) at 4°C to obtain plasma. The plasma was then transferred into four 2 ml eppendorfs. Two eppendorfs containing plasma were respun for 10 min at 16000 x g at 4°C in a fixed angle

centrifuge to yield platelet free plasma (PFP), as recommended by the manufacturers of the RNA extraction kit (Qiagen, Maryland, USA). The supernatant was then aliquoted, removing the platelets, into new eppendorfs. All samples (both plasma and PFP) were stored at -80°C until required for further analysis.

3.11 Assessment of microRNA-21

3.11.1 RNA extraction

Total RNA extraction was performed using a miRNeasy serum/plasma kit (Qiagen, Maryland, USA). PFP samples were thawed on ice before 200 µl was removed and lysed (1 ml Qiazol Lysis Reagent, Qiagen), 3.5 µl cel-miR-39 spike-in control was also added. The addition of 200 µl chloroform plus centrifugation at 12,000g for 15 min at 4°C resulted in the separation of the solution into aqueous and organic phases. The upper aqueous phase contained the extracted RNA which was then bound to the membrane of mini spin columns. Contaminants were removed through repeated washing with ethanol, buffer RWT and buffer RPE. Final centrifugation produced a pellet of high quality RNA which was solubilised using RNase free water. The extracted RNA samples were stored at -80°C for later analysis.

3.11.2 Reverse transcription and real-time quantitative PCR

The next stage required extracted total RNA to be converted into cDNA via reverse transcription **Figure 3.8**. 2 µl of either miR-21 (000397) or control snRNA-U6 (001973) specific, stem-loop RT primer (TaqMan Small RNA assays transcription kit, Applied Biosciences, Foster City, USA) was added to 1.3 µl of extracted RNA sample and 6.67 µl master mix (containing nucleotides to create the complementary strand, a buffer for pH maintenance, RNase inhibitor to protect RNA breakdown and the multiscribe RT which initiates the reverse transcription process). This facilitates the extension of the primer on the sample RNA and the synthesis of the first cDNA strand

during repeated heating cycles (30 min at 16°C, 30 min at 42°C, 5 min at 85°C) to anneal the nucleotides (**Figure 3.8**).

Amplification of the cDNA was achieved through the use of fluorescently labelled Taqman primers and probes (**Figure 3.8**). A second Taqman master mix was added to the fluorescent primers for miR-21 or snRNA-U6; 18 µl of this mixture was added to a PCR specific plate with 2 µl of the cDNA samples from the reverse transcription step. All samples were tested in triplicate to assess reliability. The plate was then transferred to the Applied Biosystems 7500 Real-Time PCR System whereupon it underwent thermal cycling (2 min at 50°C, 10 min at 95°C to activate the enzymes, 50 cycles of 15 s at 95°C and 60 s at 60°C to denature then anneal and extend the cDNA). The PCR process consists of multiple cycles of heating to anneal the probes in order to extend the primers on the cDNA before synthesising a second cDNA strand (**Figure 3.8**). This process continues through polymerisation and strand displacement. The complementary pairing between the probe and the cDNA results in an increase in the fluorescence signal and is then further amplified during PCR.

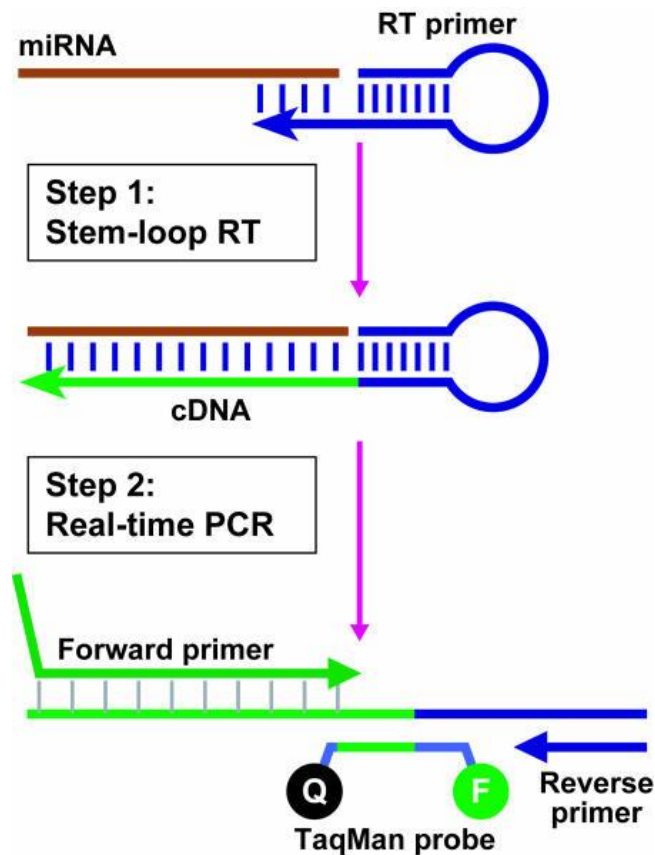

Figure 3.8 The process of quantification of reverse transcription and real-time PCR to determine miR expression within a sample (reproduced from Chen et al. (2005)).

3.11.3 MiR-21 data Analysis

The output file from the plate reader was loaded into 7500 software (Life Technologies V 2.0.1). This programme allowed for cycle threshold (Ct) values to be manually adjusted for both miR-21 and U6. The Ct value was selected from determination of the linear part of the curves for miR-21 and U6 respectively, with the same Ct value selected for both miR-21 and U6, see **Figure 3.9**. The Ct values for miR-21 and U6 were exported into Excel whereupon the difference between the Ct for miR-21 and U6 for each sample was calculated (Δ Ct). As samples were tested in triplicate any outliers due to inaccurate pipetting were removed from further analysis at this stage. Results for miR-21 were then reported as a percentage of the control (U6 in this case).

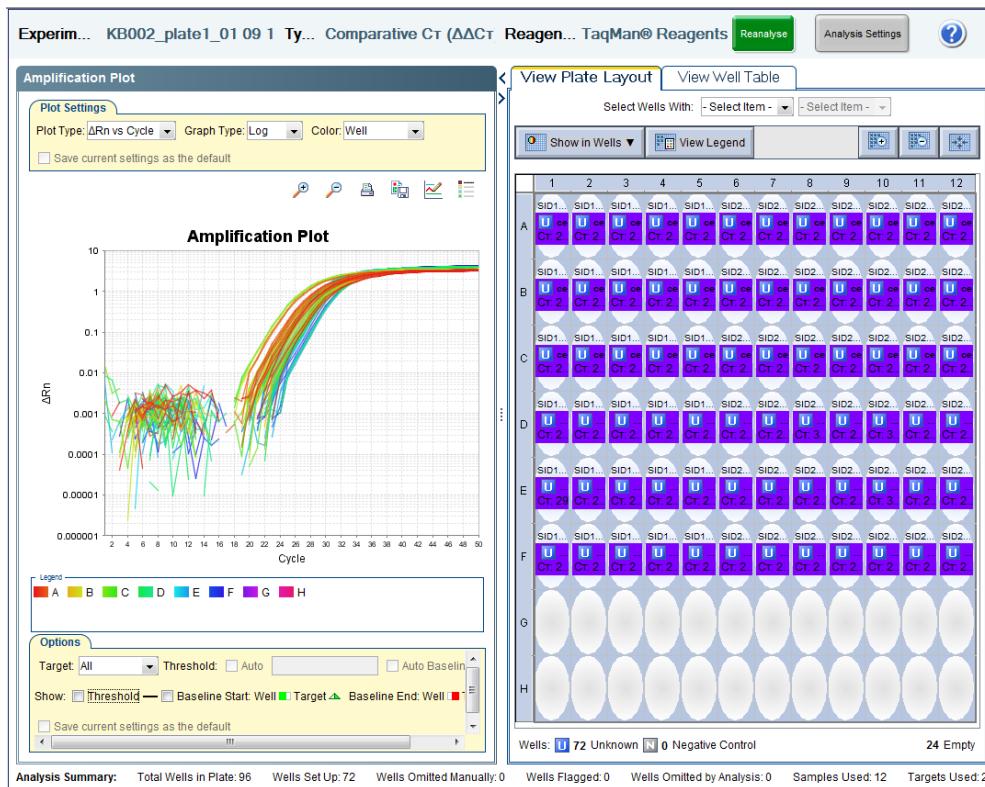

Figure 3.9 The 7500 software was used to determine the Ct of miR-21 and the selected housekeeping gene (either U6 or cel-miR-39). This allowed miR-21 expression relative to the housekeeping gene to be reported.

3.12 Overview of Statistical Analysis

All analysis within this thesis was carried out using a standard statistical software package (SPSS Statistics V.21, IBM Corporation, Somers, NY, USA). Data were tested for normality using the Shapiro-Wilk test. If data were skewed, variables were log transformed allowing standard parametric tests to be undertaken. If log transformation did not alter the skew of the variable non-parametric tests were conducted. Data are reported throughout the thesis as Mean \pm Standard deviation (SD) and alpha accepted as $p < 0.05$. The statistics utilised in each study are detailed in the relevant chapters.

Chapter 4 Novel characterisation of in-exercise vascular shear rate during acute continuous and interval exercise: Mechanisms for changes in endothelial function

Aspects from this Chapter were presented at the following conferences:

- University of Leeds Postgraduate Symposium 2015 – Poster Presentation (Awarded runner – up Prize)
- University of Leeds Postgraduate Symposium 2016 – Poster Presentation
- Northern Vascular Biology Forum December 2015 – Poster Presentation
- American College of Sports Medicine Annual Meeting June 2016 – Poster Presentation (Awarded the International Student Scholarship Prize)
- University of Leeds and LABioMed international research collaboration Symposium October 2016 – Oral Presentation

4.1 Introduction

Endothelial cell phenotype and thus endothelial function is regulated by endothelial wall shear stress (Davies, 2009). Laminar shear promotes an anti-atherogenic EC phenotype through increased production of NO, the mechanisms of which are detailed in section 2.1.3 (Davies, 2009). However, ECs exposed to oscillatory shear demonstrate upregulation of inflammatory factors, oxidative enzymes and vasoconstrictors, associated with endothelial dysfunction and a pro-atherogenic endothelial cell phenotype (Chatzizisis et al., 2007b). It is therefore apparent, that interventions which alter shear stress profiles will result in changes to NO bioavailability, endothelial function and vasomotor function.

Exercise induced shear stress improves endothelial function (Green et al., 2004). Effects of exercise interventions upon endothelial function have been widely investigated whilst the effects of exercise upon shear stress, the stimulus for changes in endothelial function, require further exploration. Previous studies have found an association between lower limb exercise and increases in SR in upstream conduit arteries, such as the brachial artery (Simmons et al., 2011, Green et al., 2002a, Green et al., 2002b, Green et al., 2005, Thijssen et al., 2009a, Tanaka et al., 2006). Padilla

et al. (2011a) suggested that SR induced by lower limb exercise may stimulate endothelial adaptations in non-exercising conduit arteries and thus provide a systemic effect.

4.1.1 Type and intensity of exercise affects exercise induced shear rate and resultant endothelial function

Acute and chronic continuous (CON) type exercise has been seen to improve endothelial function in both healthy and patient populations (Currie et al., 2012, Goto et al., 2003, Hambrecht et al., 2000, Kemi et al., 2005, Rakobowchuk et al., 2008, Swift et al., 2012). Interval (IT) exercise is now becoming a popular alternative to CON exercise although conflicting results of its effect upon endothelial function have been reported. Compared to CON, acute (Currie et al., 2012) and chronic (Rakobowchuk et al., 2008, Tjønnå et al., 2008) IT produces equivalent or superior improvements in endothelial function in some studies. However, the differential impact of IT and CON exercise upon SR patterns during acute exercise is largely unknown. Shear rate patterns during exercise have only been examined for brief periods during acute CON type exercise (Green et al., 2002b, Thijssen et al., 2009a, Green et al., 2002a, Tinken et al., 2009). Comparatively little research has been conducted on SR patterns during acute bouts of aerobic IT exercise. It is assumed acute SR increases during CON exercise in accordance with heart rate and blood pressure, thus promoting NO production (Laughlin et al., 2008a). However, as IT exercise consists of multiple transients throughout a single session, the pattern of SR may oscillate in a manner consistent with endothelial activation and a pro-atherogenic phenotype. Additionally, the duration of 'work' and 'active recovery' bouts during IT exercise can be adapted to be short (60s work: 60s recovery) or long (4 min work: 4 min recovery) depending upon the target population. How changing the duration of the work and recovery periods affects pattern of SR and resultant endothelial function is not known.

Recumbent cycle exercise increases antegrade SR in conduit arteries (Tinken et al., 2009), which is further augmented by increasing exercise intensity (Thijssen et al., 2009a). Cycling also significantly increases retrograde SR in conduit arteries (Thijssen et al., 2009a, Green et al., 2002b) and Green et al. (2002b) indicated a dose dependent relationship between volumes of retrograde flow and exercise intensity. Additionally, Thijssen et al. (2009c) reported a dose-response curve for magnitude of retrograde SR and change in FMD. Despite cycling exercise inducing higher volumes of retrograde SR there was no impairment in endothelial function assessed via FMD. Furthermore, when higher intensity IT training has been used there appears to be an impairment in endothelial function. Bergholm et al. (1999) and Goto et al. (2003) have shown that exercise intensity is an important consideration when using exercise to target improvements in endothelial function as higher intensity exercise impairs endothelial function likely as a result of an imbalance between ROS production and anti-oxidant defence (detailed in section 2.3.1.1.1). It has been proposed that interval exercise enables the benefits of high intensity exercise to be achieved without the negative effects due to shorter durations at higher exercise intensities and the inclusion of the recovery periods. However, the pattern of SR during interval type exercise has not been explored to ascertain whether predominantly laminar or oscillatory shear is produced.

4.1.2 Acute exercise regulates microRNA expression

Recently, mechano-microRNAs within endothelial cells have been found to be responsive to both laminar and oscillatory shear (section 2.1.5.2). In particular, miR-21 expression has been shown to be regulated by shear stress. We have therefore proposed that miR-21 may be a biomarker of exercise-induced shear in this study which may alter endothelial cell phenotype depending upon whether predominantly laminar or oscillatory shear is induced. In vitro work in cultured human umbilical vein endothelial cells (HUVECs) showed artificially induced oscillatory shear stress

upregulated miR-21 expression resulting in promotion of a pro-atherogenic endothelial environment (Zhou et al., 2011). Contrastingly, laminar shear stress has also been shown to upregulate miR-21 expression which was associated with decreased apoptosis and increased NO bioavailability, suggesting an atheroprotective role for miR-21 (Weber et al., 2010). Importantly, unlike most miRs which can only be detected within cells, miR-21 has been shown to be present within the circulation and is thus detectable in plasma (Baggish et al., 2011). However, investigation of miR-21 expression in response to acute and chronic exercise has produced inconsistent results (Baggish et al., 2011, Mooren et al., 2014, Nielsen et al., 2014). Furthermore, the relationship between exercise-induced shear, miR-21 expression and outcomes upon vascular function has yet to be delineated. The effect of exercise upon microRNA is a novel area of research and therefore the type and intensity of exercise required for shear stress to differentially affect miR-21 expression is yet to be delineated.

4.1.3 Aims and Hypothesis

The research question of this present study was to investigate the shear rate patterns in response to CON and differing types of IT exercise and assess the acute effects of this exercise upon FMD.

Therefore, this study aimed to:

- I. characterise the acute in-exercise brachial artery SR responses of intensity and duration matched IT and CON exercise, and
- II. investigate the effect of acute IT and CON in-exercise SR patterns upon acute post-exercise endothelial function and miR-21 expression.

It was hypothesised that acute IT exercise within the heavy intensity exercise domain may induce a more oscillatory shear rate pattern compared to CON exercise. Furthermore, as the short interval protocol will include the greatest number of oscillations with the shortest time between work and recovery bouts it may induce the

greatest volume of oscillatory shear rate and subsequently impair post-exercise endothelial function. Additionally, shear related miR-21 expression may be upregulated following acute IT exercise compared to CON as a result of oscillations in shear rate patterns.

4.2 Methods

4.2.1 Participants

Participants were recruited as described in section 3.2. Thirteen healthy participants (9 male: 4 female, mean age 22.1 ± 2.9 years, BMI 23.6 ± 2.1 kg/m²) volunteered for this study. The University of Leeds ethics committee approved the study protocols which were in accordance with the declaration of Helsinki (BIOSCI 14-005).

4.2.2 Experimental procedure

Informed consent was received in writing from all participants prior to data collection. Participants were then invited to attend the laboratory on 5 separate occasions separated by at least >24 hours. The initial visit comprised a pre-exercise health screening consisting of a questionnaire and resting ECG to confirm the absence of abnormalities which would preclude participants from taking further part in the study. This was followed by a standard ramp incremental exercise test (RIT) for determination of VO_{2peak} and LT on a semi-recumbent cycle ergometer (see section 3.5), and anthropometric measures of height and weight. Following this visit participants reported for testing following >8 hours overnight fasting and abstinence of caffeine, alcohol and strenuous exercise for 24 hours as described in section 3.6.1. Protocols were completed in standardised testing conditions in a quiet, darkened, temperature controlled laboratory. Participants completed four separate exercise protocols in a random order on separate days: CON, Long IT, Short IT and Long IT 70 (detailed later). At each of the four visits participants had a venous blood sample (10 ml) taken from the antecubital fossa on the arm not intended for subsequent FMD measurement. Participants then completed >10 min semi-recumbent rest prior to ultrasound recordings of resting brachial artery diameter and the subsequent pre-exercise FMD. Following the pre-exercise assessments participants completed the prescribed exercise protocol consisting of >3 min warm up and 24 min cycling in the heavy intensity domain (calculated from RIT) and >2 min cool down on a semi-

recumbent cycle ergometer. During each exercise protocol heart rate, breath by breath gas exchange and Duplex ultrasound of the brachial artery were recorded. Following cessation of the exercise, participants were required to complete a further 15 min semi-recumbent rest before post-exercise resting brachial diameter and FMD were repeated. Venous blood sampling (10 ml) was once again completed 6 hours post cessation of the exercise protocol. A schematic of the experimental protocols can be viewed in **Figure 4.1**.

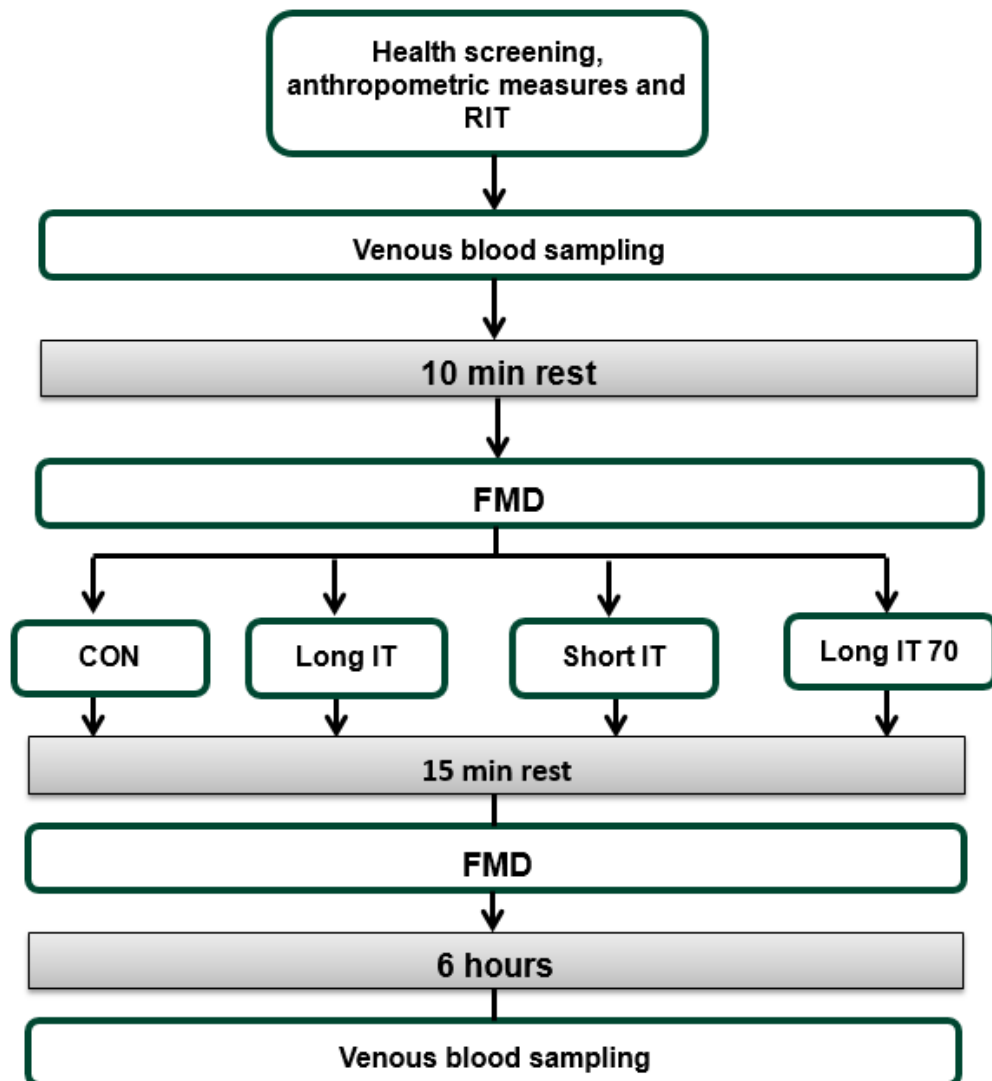

Figure 4.1 Flow chart of the experimental protocol.

4.2.3 Exercise protocols

A separate exercise protocol was completed in a randomised order on separate days. The exercise protocols were designed to be in the heavy intensity exercise domain, i.e. between LT and critical power (CP) at 125% LT, and of the same duration. Therefore total work and energy expenditure differed between protocols. The work rates for the exercise protocols were determined from the RIT completed in visit 1. For the CON protocol the time at which VO_2 reached 125% LT during the RIT was determined and the subsequent work rate selected. For the IT protocols a computer model designed at the University of Leeds by Dr A. Benson was utilised. This model allowed for the determination of WR for each IT protocol (**Figure 4.2**) (Benson et al., 2013). Therefore, the four exercise protocols were of intentionally different work rates to ensure that all protocols were within the heavy intensity exercise domain. The model integrates pulmonary, circulatory and muscular responses to exercise in order to predict the VO_2 kinetic response and determine work rates for interval exercise in healthy individuals (Benson et al., 2013). Standard values for healthy young individuals were used to provide inputs for the model: baseline VO_2 at 10 W = 0.5 Lmin^{-1} , time constant of change in VO_2 (TVO_2) = 30 s and functional gain = 10 $\text{ml}^{-1}\text{min}^{-1}\text{W}$.

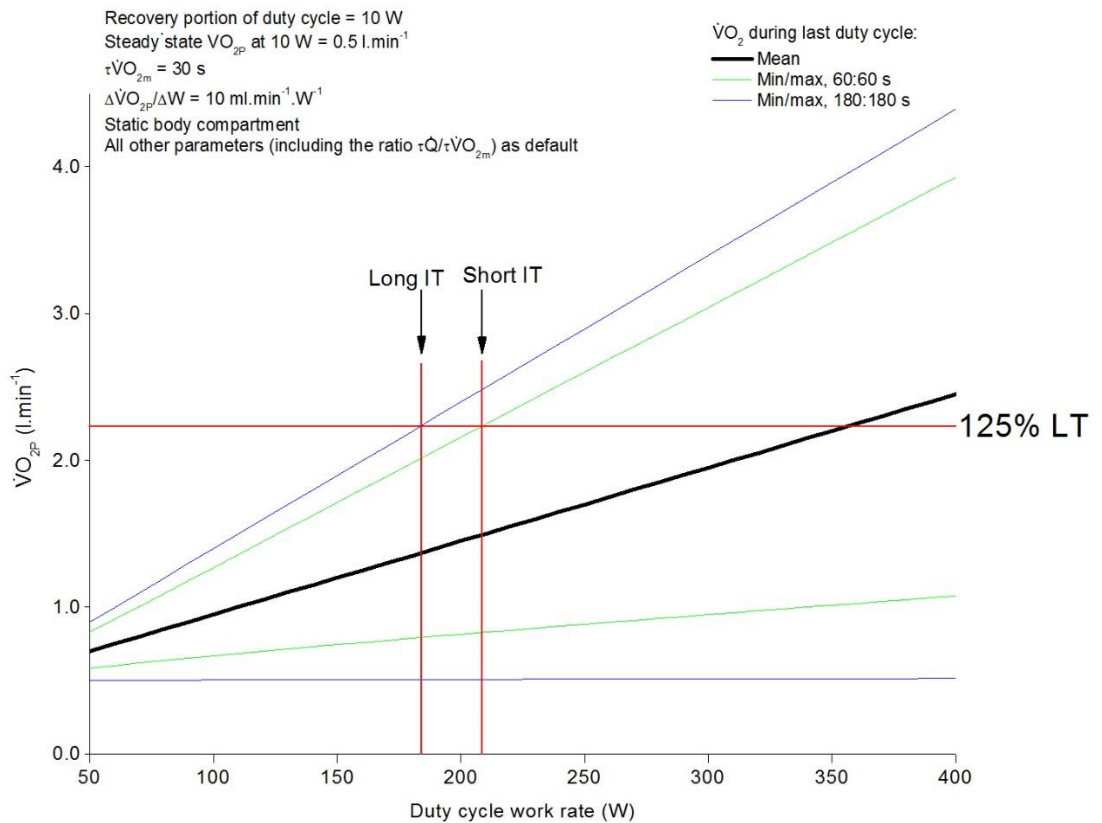

Figure 4.2. The computer model used to determine the work rates required for the Long IT, Short IT and Long IT 70 protocols when the target $\dot{V}O_2$ (gained from the RIT) was set at 125% of LT. Model provided courtesy of Dr Al Benson (University of Leeds (Benson et al., 2013)).

The CON exercise protocol consisted of cycling continuously for 24 min at 125% LT, see **Figure 4.3**. All of the IT protocols were conducted at a 1:1 work: recovery ratio. Long IT consisted of 3 min of “work” at a work rate which would produce a $\dot{V}O_2$ equivalent to 125% LT, interspersed with 3 min “active recovery” at 10 W, repeated 4 times to produce 24 min of exercise (**Figure 4.3**). Short IT consisted of 1 min “work” and 1 min active recovery at 10 W repeated 12 times (**Figure 4.3**). The Long IT 70 protocol repeated the duty cycles of the Long IT protocol (i.e. 3 min work, 3 min active recovery) however, during the recovery bouts the work rate was increased from 10 W to a work rate equivalent of 70% LT (**Figure 4.3**). The mean $\dot{V}O_2$ of the Long IT

protocol was below LT due to the long periods of active recovery where VO_2 during recovery periods returned to unloaded cycling levels. The aim of the Long IT 70 protocol was to increase mean VO_2 during the exercise so that the mean intensity of the protocol was comparable to the Short IT and CON protocols.

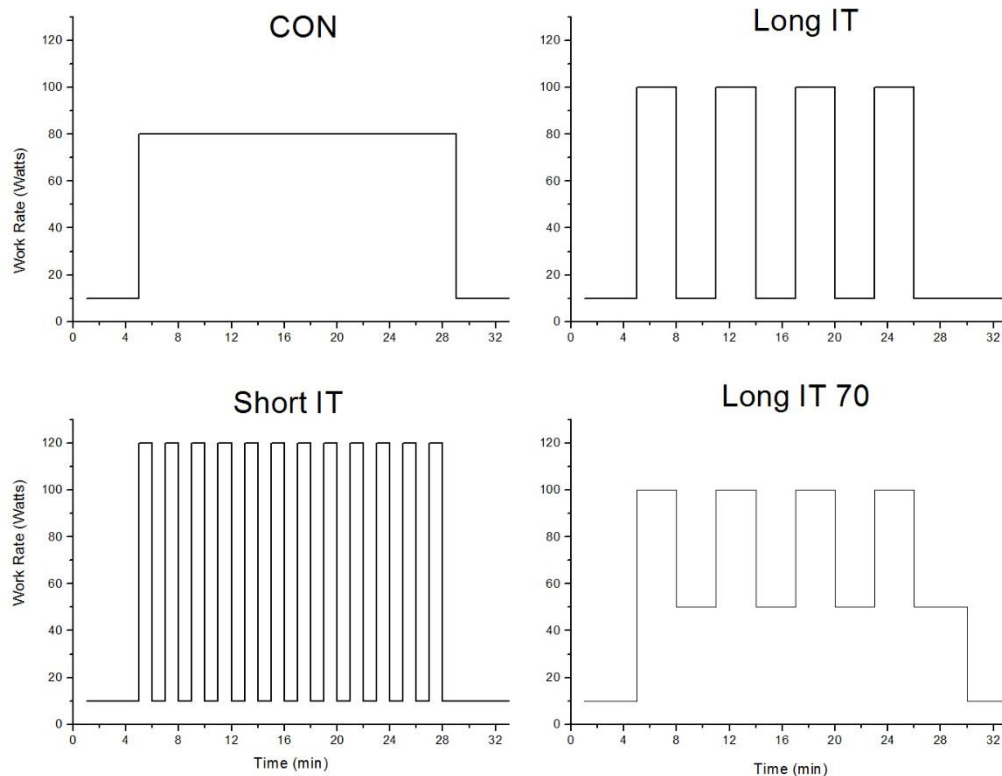

Figure 4.3 A schematic of the four acute exercise protocols used in the current study.

4.2.4 Variables assessed during the acute exercise protocols

During the four exercise protocols, HR and gas exchange were recorded via a 12-lead ECG and breath by breath system (MedGraphics D-Series, Medical Graphics Corporation, St Paul, MN, USA) respectively to confirm the exercise protocols were at the prescribed intensity (between LT and CP). Recording of HR and VO_2 began during the initial rest period and ended during recovery. The 12 lead ECG was also observed during the exercise protocols to ensure no abnormalities occurred and to

maintain participant safety. Additionally, ultrasound (in duplex mode; VIVID E9, GE Healthcare, Milwaukee, WI, USA) of the brachial artery was used during each protocol to assess in-exercise blood flow and vessel diameter in accordance with the procedures described in section 3.7. The same section of the upper right arm at the same site as used in the FMD assessment was imaged for all in-exercise recordings, this was ensured through the use of a permanent marker pen and a tape measure to mark the site. Following optimisation of the B-mode image and the Doppler signal, recording started during the final 30 s of warm up and ended 1 min into cool down. Images were recorded directly onto the Vivid E9 in consecutive loops and saved for subsequent offline analysis. Videos were recorded consecutively for 4 min before a 30 s pause until recording began again. The timings of the start and end of each 4 min recording loop was noted to allow accurate matching of the blood flow, HR and VO_2 data during analysis.

The duplex recordings of in-exercise brachial diameter and blood flow velocity were analysed in Brachial Tools (Medical Imaging Applications, Coralville, IA, USA). This software allowed for automated wall tracking and blood flow to discern diameter and blood flow velocity. The Doppler blood flow signal was inverted during analysis to determine retrograde blood flow velocity in the same way as anterograde blood flow velocity. A confidence limit of 70% around the near and far walls of the artery was applied to all frames with frames falling outside of this cut off excluded. Anterograde and retrograde SR in addition to OSI (the equations for which are detailed in section 3.7.2) and brachial artery diameter were obtained for each participant during all protocols (described fully in section 3.7.2). Mean, maximum, minimum and total values for the aforementioned parameter of blood flow during exercise were calculated for each participant across each exercise protocol.

4.2.5 Assessment of endothelial function

FMD procedures were conducted in accordance with previous guidelines (Thijssen et al., 2011) and as described in section 3.6. Images of brachial artery diameter and blood flow velocity were obtained at the distal third of the upper arm using high-resolution ultrasound. The same site of the brachial artery was imaged across all protocols for each individual participant.

Analysis of diameter and blood flow velocity were conducted using automated, commercially available, edge detection software (Brachial Tools V5; Medical Imaging Applications, Coralville, IA, USA) (described in sections 3.6.4 and 3.6.5). The outcome measures provided by this software were resting and peak diameter which provided absolute and relative FMD in addition to peak hyperaemia, peak SR, area under the curve (AUC) for 60 and 90 s following cuff deflation and time to these peak values.

4.2.6 Assessment of microRNA-21 expression

Venous blood samples were processed as described in section 3.10 to yield platelet free plasma which were immediately frozen at -80°C for subsequent analysis. Total RNA was extracted from thawed platelet free plasma and cel-miR-39 spike-in control was added using miRNeasy serum/plasma kit (Qiagen, Maryland, USA), described in section 3.11.1. Standard reverse transcription quantitative real time polymerase chain reaction (RT-qPCR) was conducted on extracted RNA using TaqMan probes and primers specific to miR-21 and ribosomal RNA U6. The 7500 Real-Time PCR system assessed relative quantification of miR-21 to RNA U6, detailed in section 3.11.2. Subsequently, cel-miR-39 was assessed as an additional housekeeping gene for assessment of circulating miR-21 within plasma samples.

4.2.7 Statistical Analysis

The sample size required for this current study was primarily based on previous literature looking at acute exercise effects upon endothelial function where studies

have typically used between 10 – 20 participants. The logistics and access to resources limited subject numbers resulting in only 13 participants completing the study. A formal power calculation was undertaken using http://hedwig.mgh.harvard.edu/sample_size/js/js_crossover_quant.html with FMD as the primary outcome variable. A total of 18 patients would provide a probability of 80% for the study to detect a treatment difference at a two-sided 0.05 significance level, if the true difference between treatments is 2.00 units. This is based on the assumption that the standard deviation of the response variable is 2. Following the study the power calculation was retrospectively completed to detect power with 13 participants. 13 participants would provide a 64% probability of detection of a treatment difference at a two-sided 0.05 significance level if the true difference between treatments is 3.00 units and the standard deviation of the response variable is 3.

All statistical analysis was carried out using SPSS (IBM SPSS Statistics 21). Variables were assessed for normality using Shapiro-Wilks test, significant variables were deemed skewed and log transformed where possible. If log transformation was not possible non-parametric tests were used on these data. Differences in pre-exercise values between protocols were assessed via one way ANOVAs. One way ANOVAs were also conducted on mean data collected across the exercise protocols (i.e. anterograde and retrograde SR, OSI, HR and VO_2) to assess whether the exercise protocol had a differential effect upon the aforementioned variables. A repeated measures ANOVA was used to assess time (pre v post) by exercise protocol (CON v Long IT v Short IT v Long IT 70) interactions for FMD and miR-21 expression. ANCOVAs were used to remove the influence of baseline resting brachial artery diameter and shear rate AUC_{60} upon absolute and relative FMD. An ANCOVA was also used for assessment of miR-21 expression with baseline miR-21 expression

used as a covariate due to the high variation in pre-exercise miR-21 expression. Bonferroni post – hoc analysis was performed when significant effects were found.

Post – hoc power analysis of main outcome variables (FMD, OSI, anterograde and retrograde SR) were calculated following determination of beta probability in SPSS.

Power was calculated using:

1-beta probability

Equation 20

Additionally, for the aforementioned variables, partial eta squared (η^2) and the 95% confidence intervals (CI) were reported. The thresholds for effect size when using partial η^2 were small effect = 0.0099, medium effect = 0.0588, large effect = 0.1379 as per Cohen (1977).

Absolute and relative FMD pre-and post-exercise underwent allometric scaling as per Atkinson (2014). Pearson correlations were used to identify relationships between normally distributed variables.

4.3 Results

4.3.1 Participant Characteristics

Table 4.1 displays the participants' (n=13) demographics and exercise tolerance results from the initial RIT (mean \pm SD). Participants were active as determined by a mean relative VO_{2peak} of 46.4 ± 5.5 ml/kg/min. All 13 participants completed the initial RIT and all CON, Long IT and Short IT protocols with 10 participants completing a further modified Long IT 70 exercise session.

Table 4.1: Participant characteristics from visit 1.

	Mean \pm SD
Participants, N (male:female)	13 (9:4)
Age (years)	23 ± 3
Height (m)	1.73 ± 0.09
Weight (kg)	70.3 ± 11.6
BMI (kg/m ²)	23.4 ± 2.0
Absolute VO_{2peak} (L.min ⁻¹)	3.3 ± 0.6
Relative VO_{2peak} (ml/kg/min)	46.4 ± 5.5
Heart Rate peak (bpm)	183 ± 9
Lactate Threshold (L.min ⁻¹)	1.39 ± 0.19

4.3.2 VO_2 patterns during CON and IT exercise protocols

Table 4.2 displays the within exercise session characteristics for the 4 exercise protocols. Mean, peak (work bout during IT protocols) and nadir (recovery bouts during IT protocols) data for each protocol are presented. As stated previously (section 4.2.3), protocols were matched for intensity domain and duration which resulted in differing mean energy expenditure for the 4 exercise protocols ($p < 0.05$). The CON protocol produced the greatest mean energy expenditure which was significantly greater than Long ($p = 0.001$) and Short IT ($p = 0.01$). However, there was

no difference in energy expenditure between CON and Long IT 70 ($p=1.00$). Additionally, the Long IT protocol produced a lower energy expenditure compared to Long IT 70 ($p=0.003$; **Table 4.2**).

Table 4.2 Acute VO_2 and HR responses to each exercise protocol as a percentage of peak values as determined from the initial RIT. Values reported as mean \pm standard deviation.

	CON	Long IT	Short IT	Long IT 70
N	13	13	13	10
Mean WR, W (%WR_{peak})	134 \pm 26 (49 \pm 6)	183 \pm 31 (72 \pm 9)	197 \pm 40 (77 \pm 10)	Work: 183 \pm 31 (72 \pm 9) Rec: 76 \pm 13 (30 \pm 10)
Mean VO_2, L/min (%VO_{2peak})	2.31 \pm 0.36 (72 \pm 8)	1.84 \pm 0.29* (58 \pm 11)*	2.00 \pm 0.32* (62 \pm 8)*	2.26 \pm 0.52† (72 \pm 9)†‡
Peak VO_2, L/min (%VO_{2peak})	2.71 \pm 0.47 (84 \pm 11)	2.92 \pm 0.52 (91 \pm 14)	2.83 \pm 0.51 (87 \pm 10)	3.05 \pm 0.63 (97 \pm 10)*‡
Nadir VO_2, L/min (%VO_{2peak})	1.90 \pm 0.27 (60 \pm 8)	0.60 \pm 0.14* (19 \pm 6)*‡	1.15 \pm 0.19*† (36 \pm 6)*†	1.32 \pm 0.41*† (42 \pm 10)*†‡
Mean HR, bpm (%HR_{peak})	149 \pm 11 (79 \pm 7)	142 \pm 17 (74 \pm 10)	143 \pm 21 (76 \pm 10)	153 \pm 14 (83 \pm 7)
Peak HR, bpm (%HR_{peak})	161 \pm 6 (89 \pm 4)	169 \pm 16 (92 \pm 6)	164 \pm 20 (89 \pm 7)	173 \pm 12 (95 \pm 6)*‡
Nadir HR, bpm (%HR_{peak})	86 \pm 33 (48 \pm 16)	105 \pm 17 (57 \pm 8)	120 \pm 21* (63 \pm 11)*	128 \pm 16*† (70 \pm 8)*†
Energy Expenditure (KJ)	193.6 \pm 37.5	135.2 \pm 23.2*	152.3 \pm 26.1*	185.1 \pm 36.9†‡

*denotes significance difference from CON protocol at $P<0.05$

† denotes significance difference from Long IT protocol at $P<0.05$

‡ denotes significance difference from Short IT protocol at $P<0.05$

Figure 4.4 displays a representative participant during the four exercise protocols and demonstrates that the 4 protocols were within the heavy intensity domain (VO_2 stabilised above LT but does not approach VO_{2peak}). This was also evident for all participants in the study as shown in **Table 4.2** where mean VO_2 for the session was above LT but below VO_{2peak} . However, mean VO_2 across the 24 min exercise sessions differed between protocols ($p=0.01$). Mean VO_2 for CON exercise remained within the heavy intensity exercise domain throughout the session, however mean VO_2 during Long IT occurred at LT ($107\pm 14\%$ LT). There was a significant difference in mean VO_2 ($\%VO_{2peak}$) between the CON and the Long IT protocols ($p=0.001$) and the CON and Short IT protocols ($p=0.01$) respectively (**Table 4.2**). This was due to the peaks and nadirs experienced during the IT protocols, which are characteristic of interval exercise. Peak VO_2 achieved did not significantly differ between protocols ($p=0.47$, **Table 4.2**). As a result of the purposive design, the nadir in VO_2 can be seen to differ between all protocols ($p=0.001$) with the lowest VO_2 observed to decrease below LT in all of the IT protocols and in the case of the Long IT protocol being equivalent to VO_2 during warm up (**Table 4.2**). Both VO_2 (**Figure 4.4**) and HR (**Figure 4.5**) were observed to stabilise during each exercise protocol across all participants as was expected with exercise in the heavy intensity exercise domain.

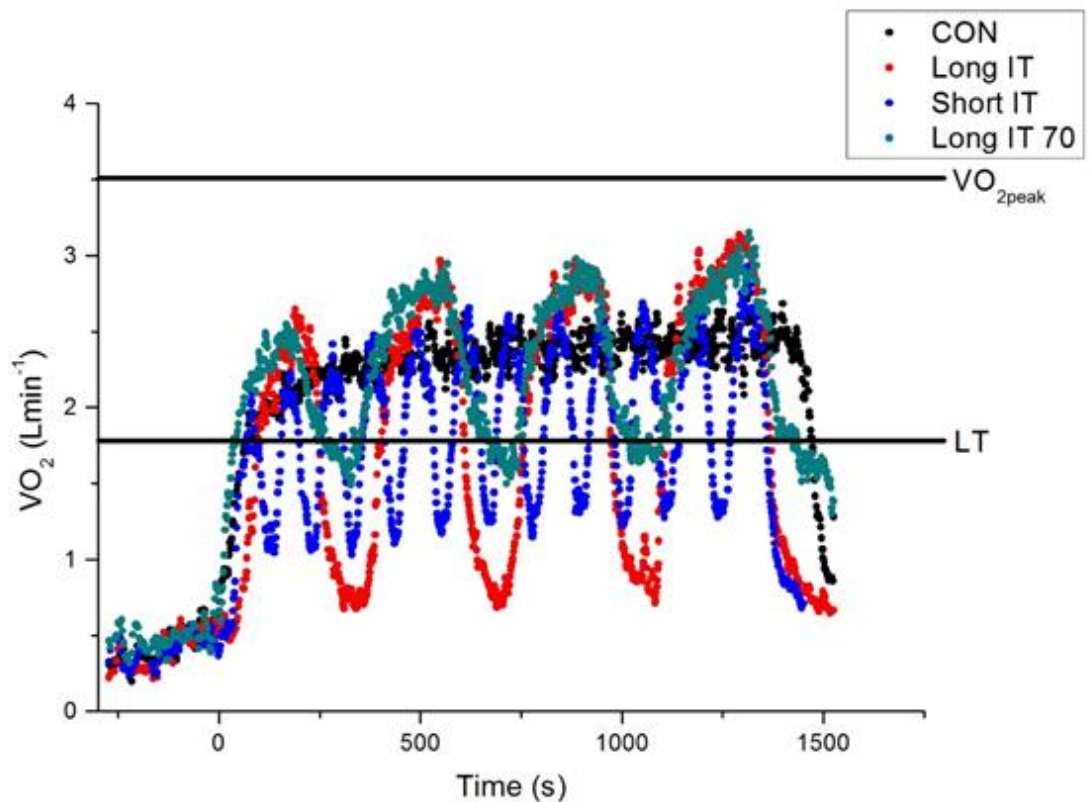

Figure 4.4. 5 point moving average of the breath by breath VO_2 data recorded for one representative participant during the four exercise protocols demonstrating that the exercise was within the heavy intensity exercise domain intensity ($>\text{LT}$ $<\text{Critical Power}$).

4.3.3 Heart rate responses during acute CON and IT exercise protocols

Peak HR during each exercise protocol and mean HR ($\% \text{HR}_{\text{peak}}$) across the 24 min of exercise were not significantly different between exercise protocols ($p=0.28$, **Table 4.2**). The lowest HR attained during the exercise sessions was significantly different between protocols ($p=0.001$), specifically between: CON and Short IT ($p=0.01$) and between CON and Long IT 70 ($p=0.001$, **Table 4.2**).

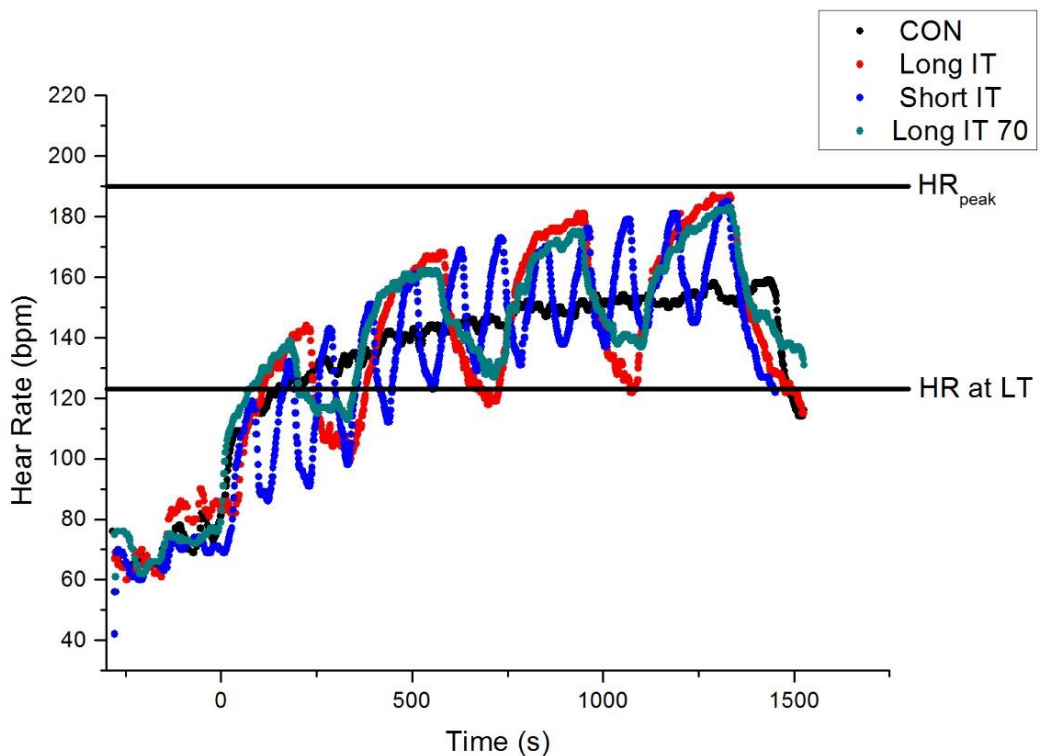

Figure 4.5 Heart rate recorded throughout the four exercise protocols for a representative participant. The same participant was used for the breath by breath VO_2 data.

4.3.4 In-exercise blood flow and shear rate patterns during acute CON and IT exercise

Brachial artery diameter measured during exercise did not significantly differ between the four exercise protocols ($p=0.98$). Additionally, brachial artery diameter measured second by second throughout each exercise protocol was not observed to change during exercise.

Patterns of anterograde and retrograde SR mirrored the exercise profile undertaken and was consistent with patterns of forward and decelerative blood flow, work rate, VO_2 and HR during all protocols (**Figure 4.6** and **Figure 4.7**). However, in contrast to VO_2 and HR both of which stabilised in accordance with exercising in the heavy intensity domain, anterograde SR continued to increase throughout each exercise

protocol. Retrograde SR exhibited the opposite pattern to anterograde SR with a continuous decline throughout each protocol observed.

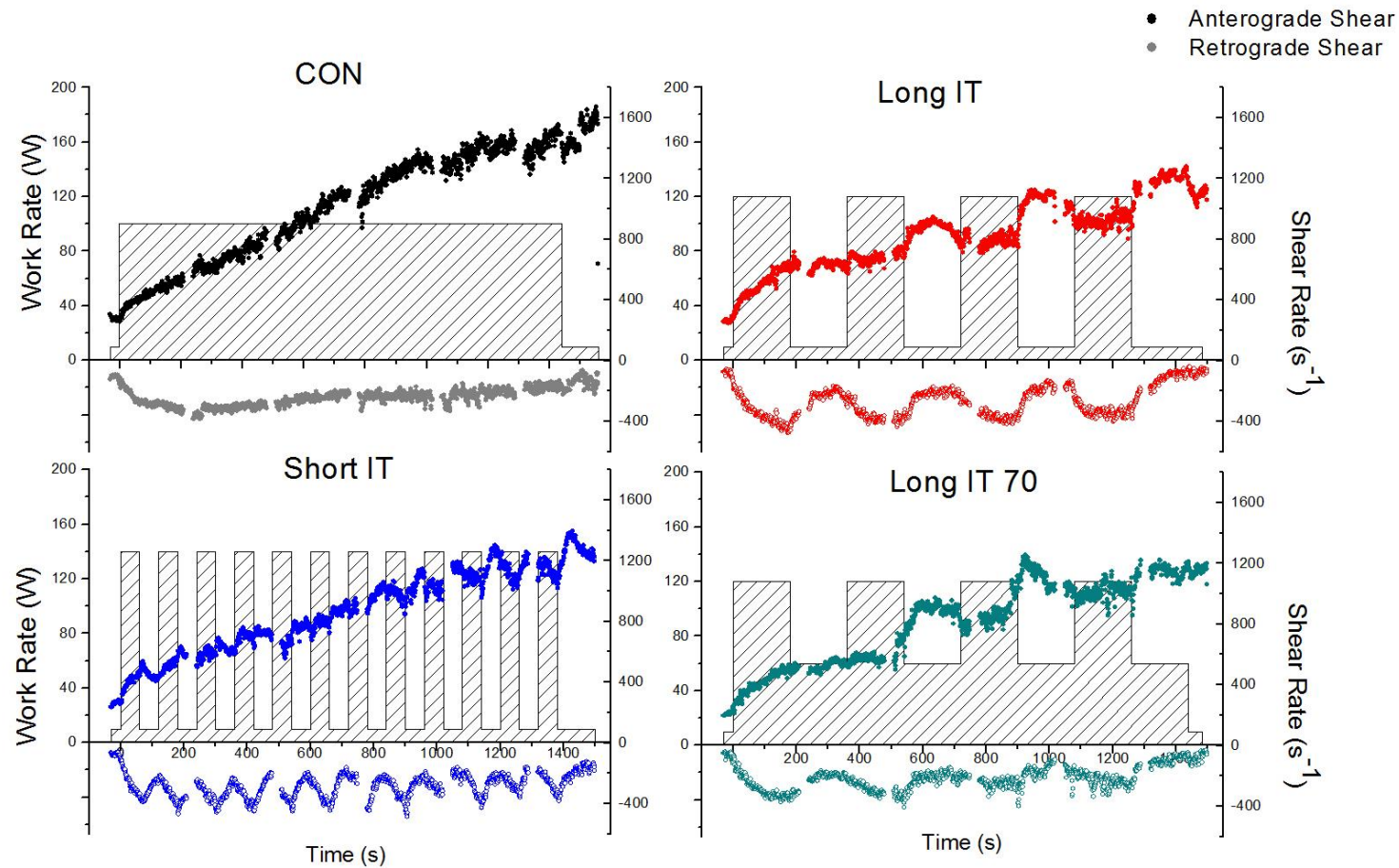

Figure 4.6. Group mean second by second anterograde and retrograde SR patterns for all participants' time aligned to the four exercise protocols: (A) CON (B) Long IT (C) Short IT and (D) Long IT 70. The shaded area represents the work rate profile for each exercise protocol.

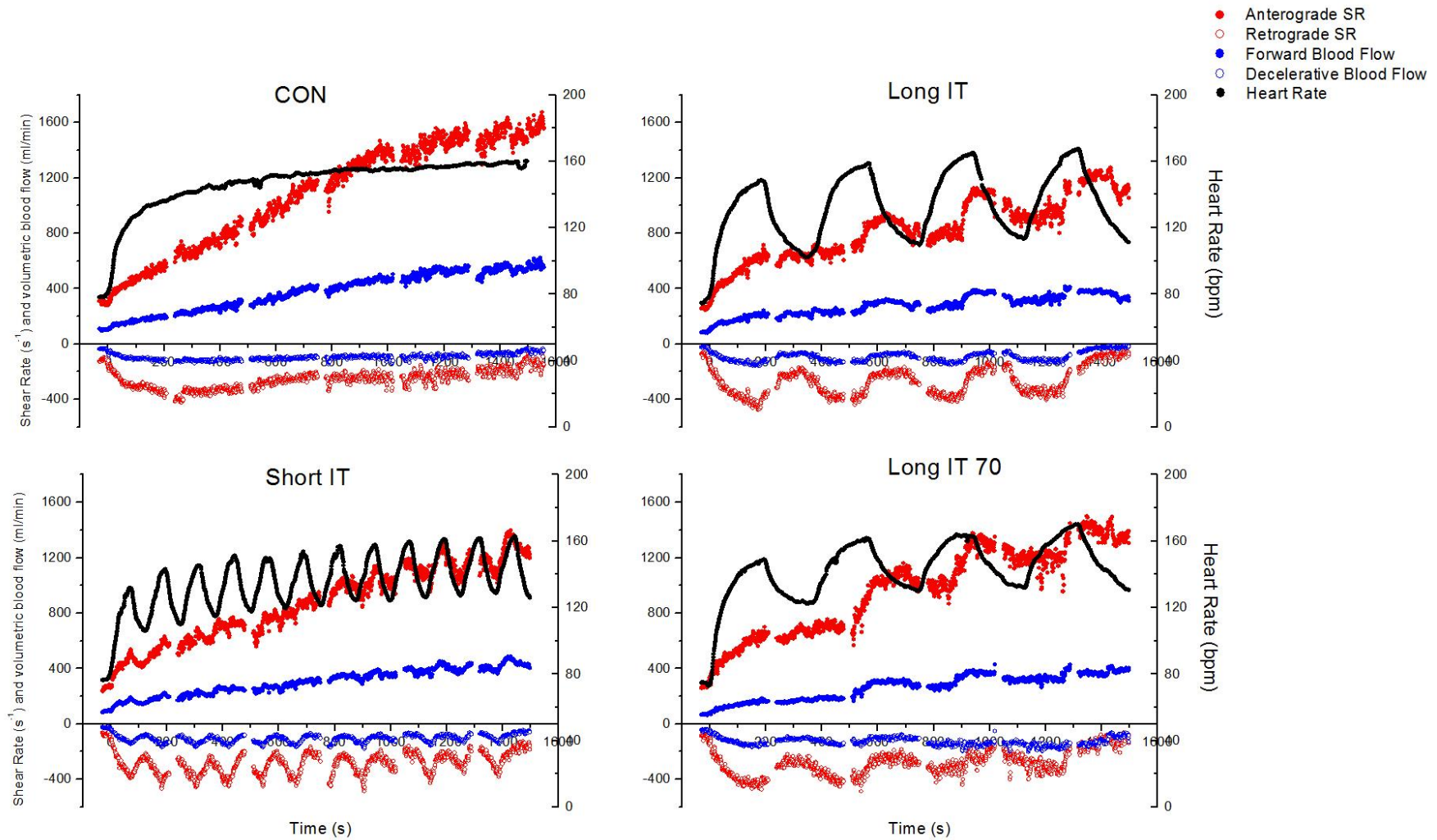

Figure 4.7. Group mean second by second anterograde and retrograde SR (red circles) overlaid with mean second by second forward and backward volumetric blood flow (blue circles) and mean second by second heart rate (black circles) for the CON, Long IT, Short IT and Long IT 70 exercise protocols.

4.3.4.1 Anterograde and retrograde shear rate during acute CON and IT exercise

Peaks and nadirs, as observed in VO_2 and HR, were also observed in both anterograde and retrograde SR in the IT protocols and can be found under maximum and minimum values in **Table 4.3**. Despite different anterograde and retrograde SR patterns between exercise protocols, total volumes of anterograde (time effect $p=0.15$, 95% CI 1127927 – 1355419 s^{-1} , power=0.55, partial $\eta^2=0.11$) and retrograde ($p=0.72$, 95% CI -318728 – -407544 s^{-1} , power=0.89, partial $\eta^2=0.02$) shear did not differ between protocols (**Table 4.3**). Similarly, both mean and minimum anterograde (time effect mean: $p=0.11$, 95% CI 841.3 – 993.5 s^{-1} , power=0.49, partial $\eta^2=0.13$; time effect min: $p=0.65$) and retrograde SR (time effect mean: $p=0.74$, 95% CI -244.3 – -306.5 s^{-1} , power=0.90, partial $\eta^2=0.02$; min: $p=0.91$) did not differ between protocols (**Figure 4.8**). Maximum retrograde SR did not differ between protocols ($p=0.42$), however, maximum anterograde SR was significantly greater in CON than in Long IT only ($p=0.03$, **Figure 4.8**).

Mean anterograde and retrograde SR were significantly correlated with mean heart rate during the exercise session for all exercise protocols ($r=0.61$, $p=0.001$ and $r=0.64$, $p=0.001$ respectively, **Figure 4.9**). The Long IT 70 exercise protocol demonstrated the strongest correlation between retrograde SR and mean HR during the exercise session ($r=-0.67$, $p=0.03$). CON, Long IT and Long IT 70 all showed similar strength relationships between anterograde SR and mean HR during the exercise session, however short IT 70 showed a weaker relationship ($r=0.56$, $p=0.05$). Mean HR was also significantly correlated with total anterograde ($r=0.57$, $p=0.001$) and retrograde SR ($r=0.68$, $p=0.001$). Additionally, peak HR was significantly correlated with maximum anterograde and retrograde SR ($r=0.32$, $p=0.05$ and $r=0.45$,

p=0.004 respectively). Parameters of VO₂ recorded during the exercise sessions did not show a significant association with in-exercise anterograde and retrograde SR.

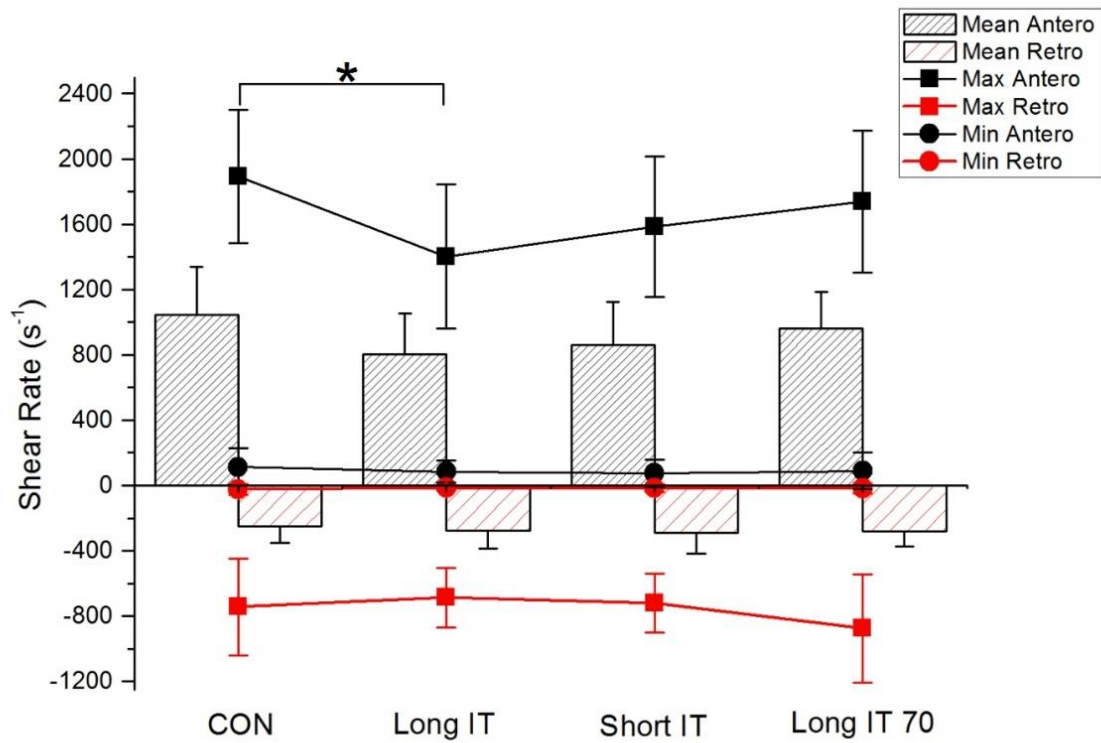

Figure 4.8. Mean anterograde and retrograde SR shown in the columns were not significantly different between protocols (mean \pm SD). Minimum anterograde and retrograde SR did not significantly differ between protocols. Maximum retrograde SR did not significantly differ between protocols however, maximum anterograde SR was significantly different between the CON and Long IT protocols only (* denotes significance where $P < 0.05$).

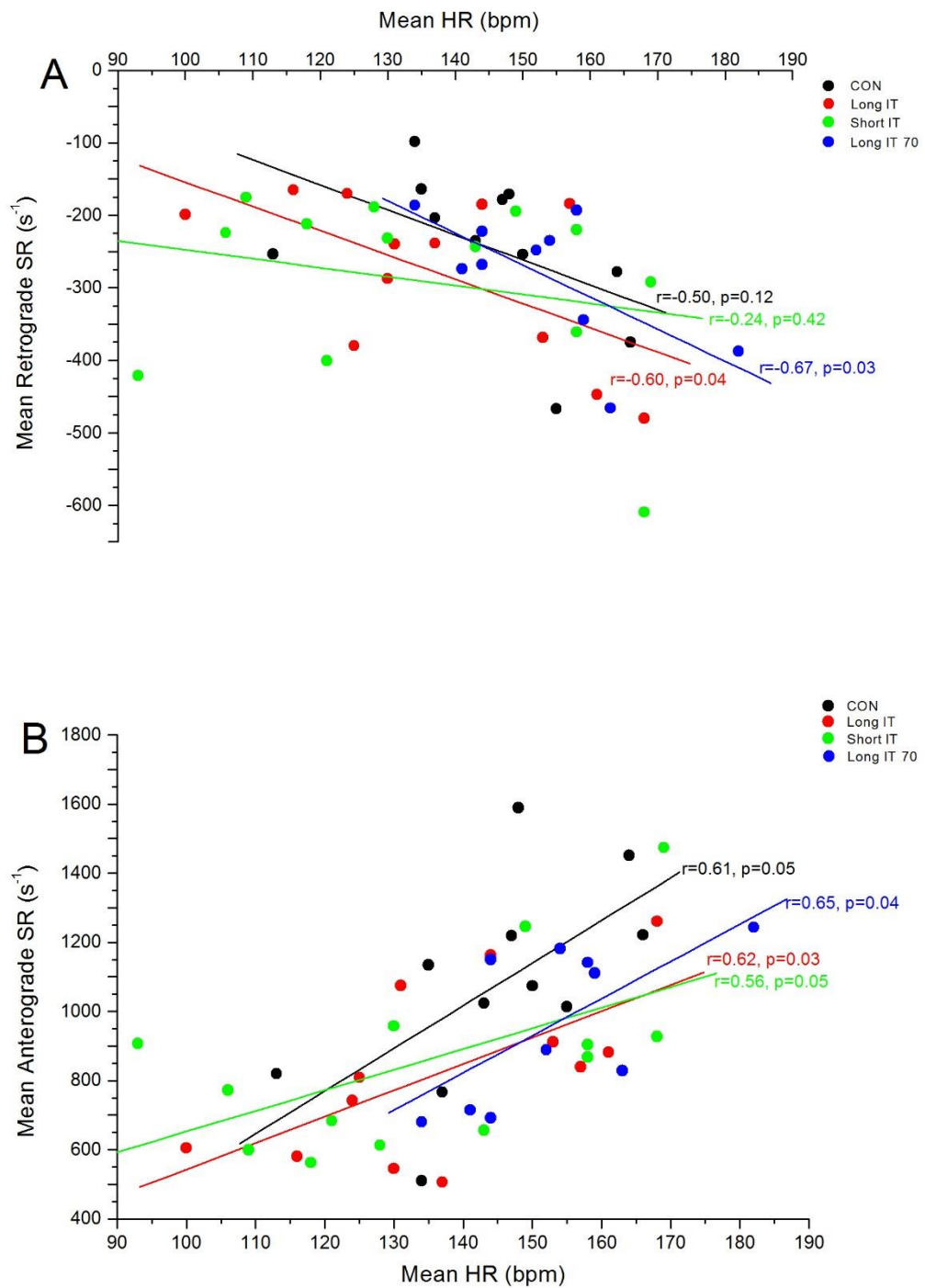

Figure 4.9. Panel A shows mean HR and mean retrograde SR during all of the acute exercise protocols were significantly negatively correlated ($r=-0.64$, $p=0.001$). Panel B shows mean HR and mean anterograde SR during all of the exercise protocols were significantly positively correlated ($r=0.61$, $p=0.001$).

4.3.4.2 Oscillatory shear index during acute IT and CON exercise

Mean ($p=0.18$, 95% CI 0.23 – 0.27 a.u., partial $\eta^2 = 0.10$, power = 0.58), maximum ($p=0.11$) and minimum OSI ($p=0.98$) were not significantly different between the four exercise protocols (**Figure 4.11**). Importantly, during all exercise protocols an OSI greater than 0.5 (indicating periods of purely oscillatory shear) occurred for a period of time. **Figure 4.9** and **Figure 4.10** show that purely oscillatory shear typically occurs within the first half of the exercise session and at the end of a work bout in the IT protocols. The time spent at an OSI greater than 0.5 was not significantly different between protocols (CON 13.3 ± 15.6 s; Long IT 31.2 ± 38.0 s; Short IT 29.0 ± 29.9 s; Long IT 70 35.8 ± 41.4 s; $p=0.35$). OSI was not significantly correlated with VO_2 or HR recorded during the exercise protocols.

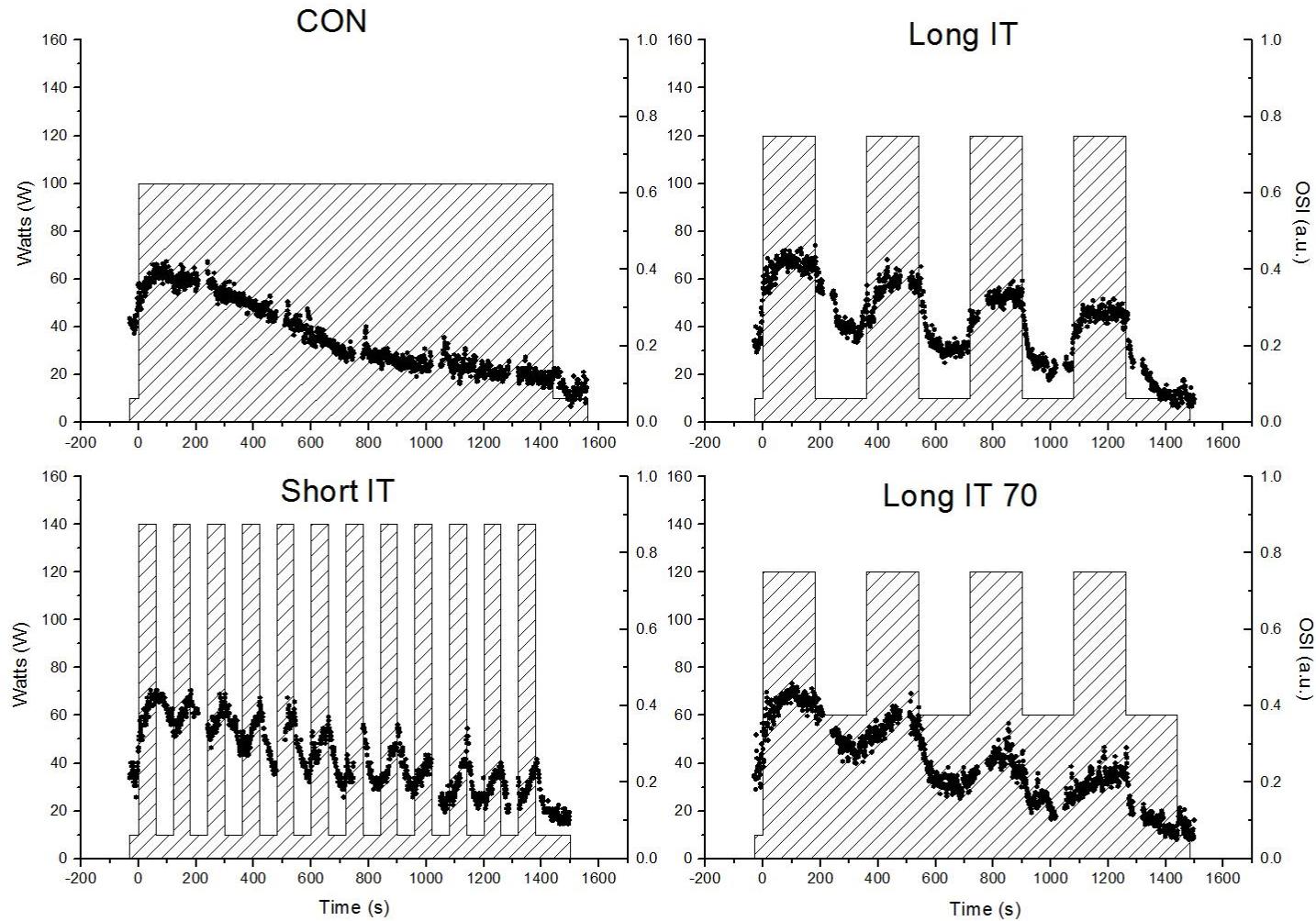

Figure 4.9. Group mean OSI patterns (black circles) for all participants during the four exercise protocols: (A) CON (B) Long IT (C) Short IT and (D) Long IT 70. The shaded area represents the work rate profile for each exercise protocol.

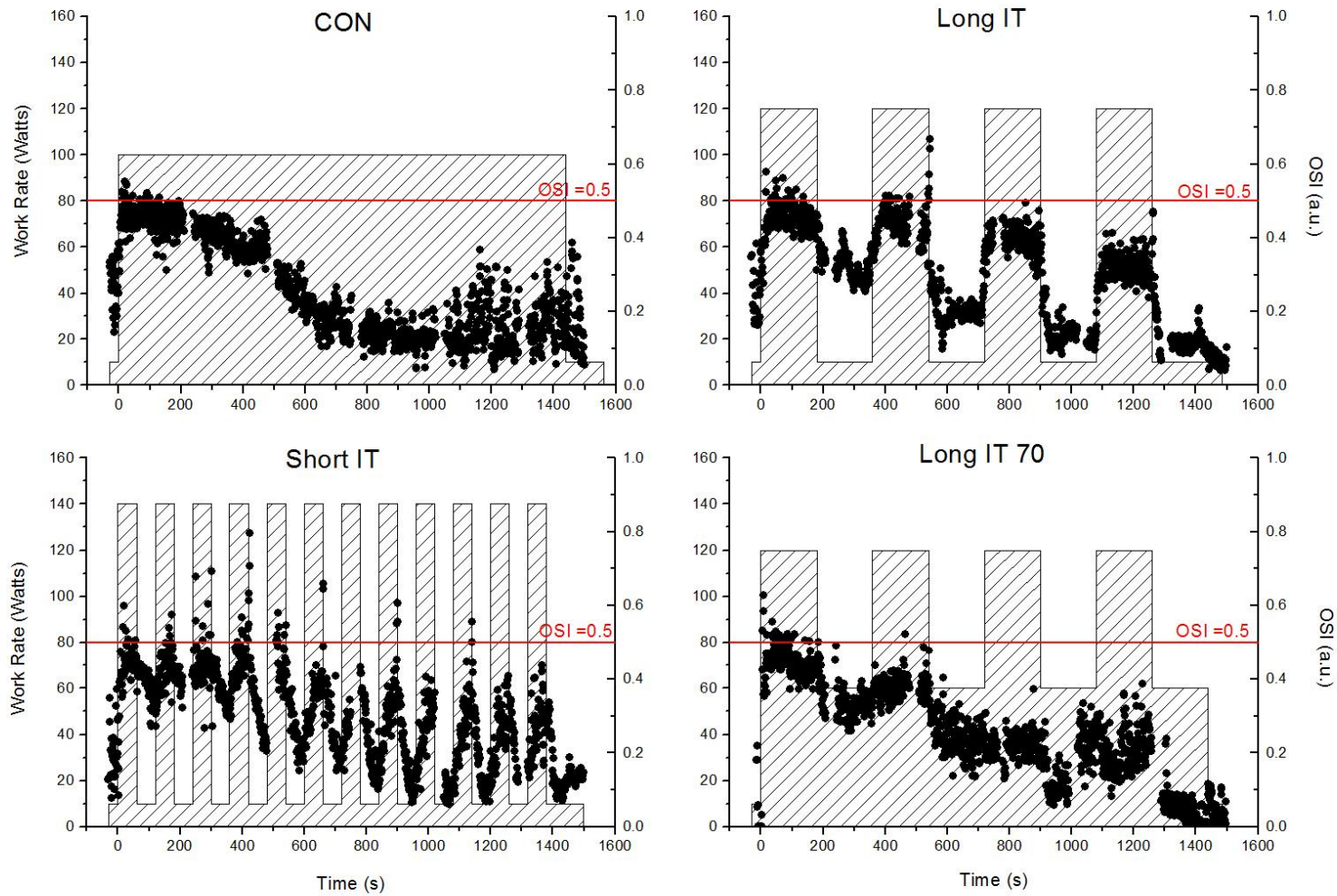

Figure 4.10 OSI patterns (black circles) for a representative participant during the four exercise protocols: (A) CON (B) Long IT (C) Short IT and (D) Long IT 70. The shaded area represents the work rate profile for each exercise protocol. The red line represents an OSI > 0.5 which indicates purely oscillatory shear.

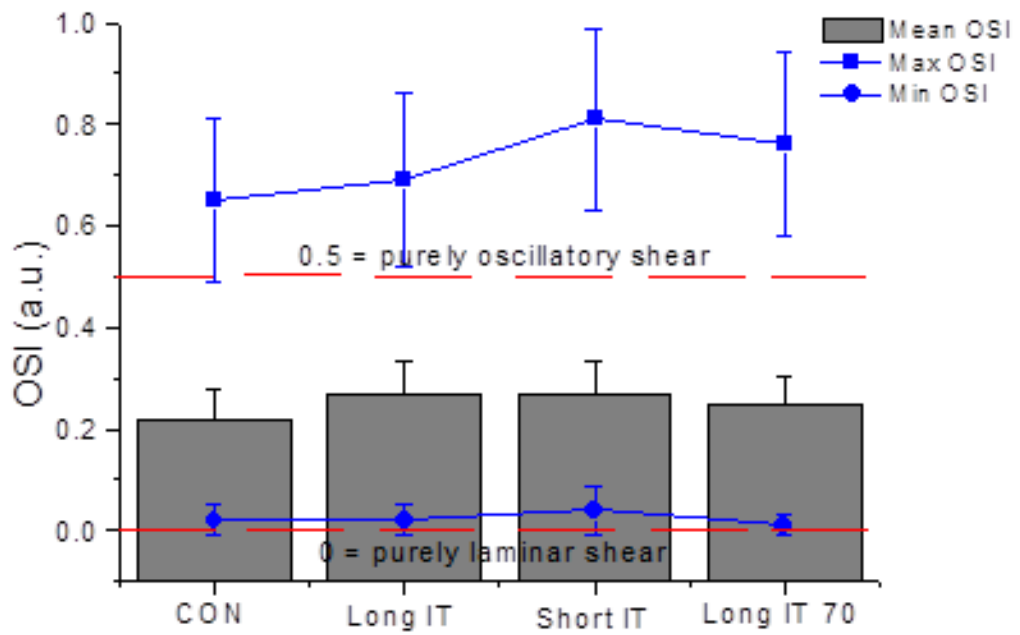

Figure 4.11. Mean, maximum and minimum (mean \pm SD) OSI were not significantly different between protocols ($p>0.05$). In all protocols periods of purely oscillatory shear were achieved as indicated by maximum OSI > 0.5.

Table 4.3 Mean, maximum, minimum and total values of anterograde and retrograde SR and OSI across the four exercise protocols. Data reported as mean \pm SD.

	Anterograde SR (s ⁻¹)				Retrograde SR (s ⁻¹)				OSI (a.u.)		
	Total	Mean	Max	Min	Total	Mean	Max	Min	Mean	Max	Min
CON	142881 \pm 483671	1044 \pm 297	1892 \pm 408	112 \pm 114	-336449 \pm 146269	-252 \pm 98	-744 \pm 295	-24 \pm 34	0.22 \pm 0.06	0.65 \pm 0.16	0.02 \pm 0.03
Long IT	1077392 \pm 358488	803 \pm 251	1403 \pm 441 *	85 \pm 67	-355436 \pm 148766	-277 \pm 108	-686 \pm 183	-14 \pm 19	0.27 \pm 0.07	0.69 \pm 0.17	0.02 \pm 0.03
Short IT	1184756 \pm 363661	859 \pm 265	1584 \pm 430	75 \pm 82	-395255 \pm 177355	-290 \pm 126	-720 \pm 179	-16 \pm 25	0.27 \pm 0.07	0.81 \pm 0.18	0.04 \pm 0.05
Long IT 70	1275664 \pm 334353	963 \pm 224	1738 \pm 435	90 \pm 112	-365407 \pm 132676	-282 \pm 90	-875 \pm 332	-17 \pm 32	0.25 \pm 0.06	0.76 \pm 0.18	0.01 \pm 0.02

*denotes significantly different from CON exercise protocol at the p<0.05 level.

4.3.5 Brachial artery endothelial function

There were no significant differences between protocols in pre-exercise resting brachial artery diameter ($p=0.98$), peak diameter ($p=0.98$), absolute FMD ($p=0.73$), relative FMD ($p=0.75$), time to peak diameter ($p=0.54$), peak hyperaemia ($p=0.76$), peak shear ($p=0.85$), AUC_{60} ($p=0.81$), AUC_{90} ($p=0.95$) and time to peak hyperaemia ($p=0.77$). Additionally, prior to exercise absolute and relative FMD were not significantly correlated with stimuli of vasodilation i.e. peak shear following cuff deflation and AUC ($p>0.05$). Resting brachial artery diameter did not significantly differ pre to post-exercise ($p=0.86$) and no difference in pre or post-exercise resting brachial diameter was observed between exercise protocols ($p=0.99$).

It has been suggested that resting diameter should be used as a covariate when assessing changes in absolute and relative FMD. Therefore, resting diameter was used in ANCOVAs for assessment of time and exercise protocol interaction. All measures of endothelial function were significantly increased following acute exercise, however there was no significant difference between exercise protocols (**Table 4.4**). Specifically, all protocol absolute and relative FMD were both significantly increased by 0.14 ± 0.01 mm (95% CI 0.31 – 0.39 mm; time effect $p=0.03$, power=0.41, partial $\eta^2=0.10$; time x protocol $p=0.79$, power=0.89, partial $\eta^2=0.02$; time x resting diameter $p=0.20$) and 3.46 ± 0.48 % (95% CI 7.95 – 9.97%; time effect $p=0.001$, power=0.15, partial $\eta^2=0.18$; time x protocol $p=0.83$, power=0.86, partial $\eta^2=0.03$; time x resting diameter $p=0.02$) respectively post – exercise, irrespective of exercise protocol (**Figure 4.12**).

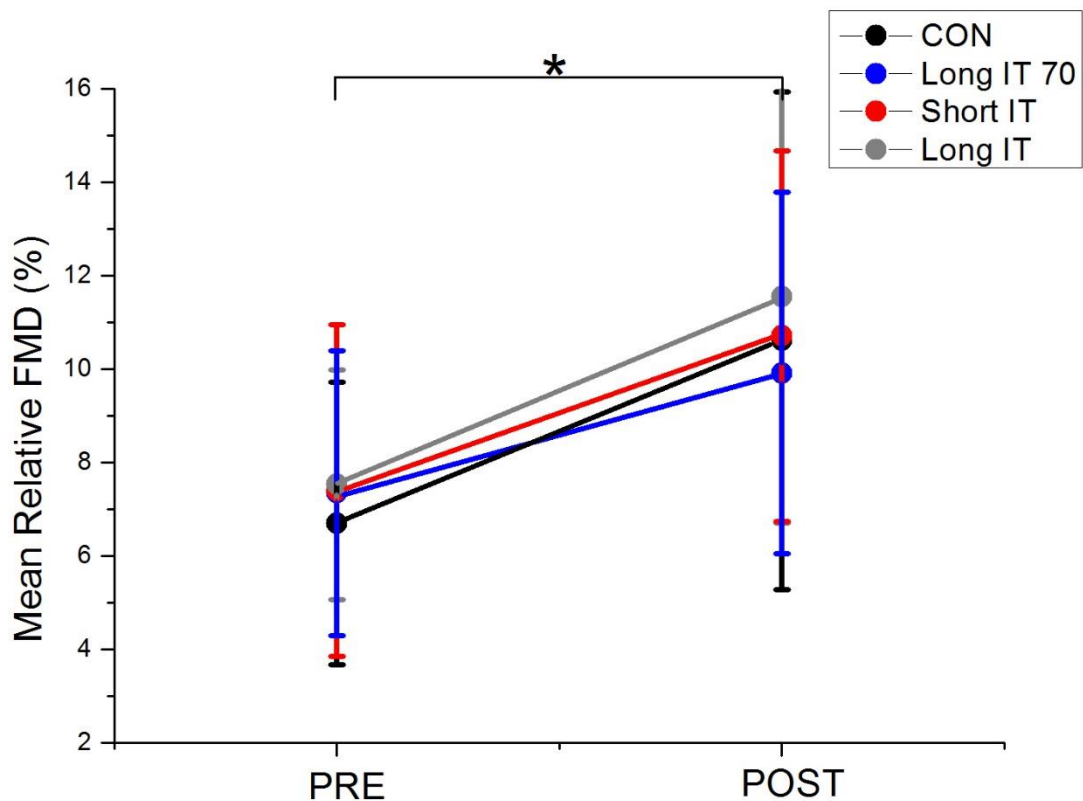

Figure 4.12 Acute FMD (mean \pm SD) measured 15 min post exercise (Post: CON 10.61 ± 5.33 %; Long IT 11.54 ± 4.84 %; Short IT 10.70 ± 3.97 %; Long IT 70 9.91 ± 3.87 %) was significantly higher than pre FMD (Pre: CON 6.69 ± 3.02 %; Long IT 7.52 ± 2.47 %; Short IT 7.40 ± 3.55 %; Long IT 70 7.34 ± 3.66 %) with no differential effect of protocol (*denotes significance $P < 0.05$).

4.3.5.1 Allometrically scaled FMD

Recently, statisticians have argued that as FMD is a ratio of resting and peak diameter allometric scaling should be undertaken to provide an accurate scaling index to mitigate the influence of resting diameter upon FMD (Atkinson, 2014). The slope of the relationship between naturally log transformed resting and peak diameter should have a value of 1, allometric scaling is appropriate when this relationship produces a value < 1 (Atkinson, 2014). When this process was undertaken in the current study the scaling factor was 0.98 prior to exercise and 0.89 following exercise. Analysis of

absolute and relative FMD from the scaled data demonstrated a significant time effect (absolute FMD $p=0.001$; relative FMD $p=0.001$) although no time by protocol interaction was observed (absolute FMD $p=0.58$; relative FMD $p=0.71$,

Figure 4.13).

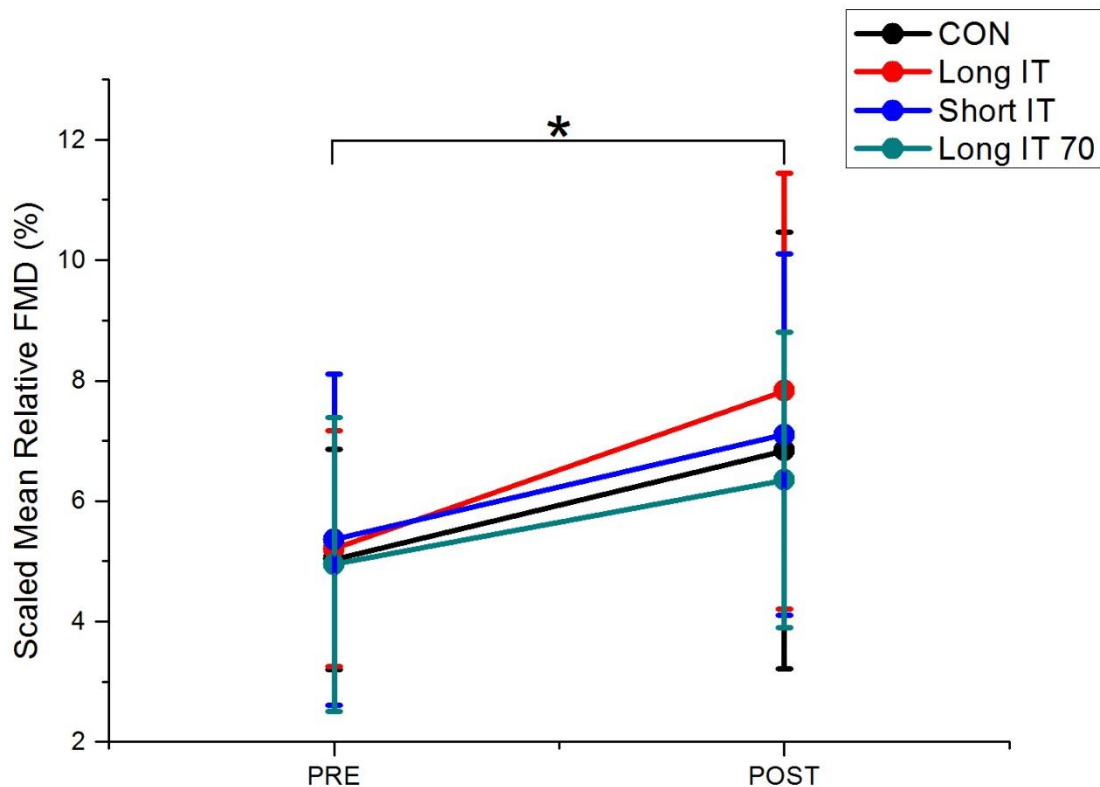

Figure 4.13 Acute allometrically scaled FMD (mean ± SD) measured 15 min post exercise (Post: CON 6.84 ± 3.62 %; Long IT 7.83 ± 3.62 %; Short IT 7.10 ± 3.00 %; Long IT 70 6.35 ± 2.45 %) was significantly higher than pre FMD (Pre: CON 5.03 ± 1.83 %; Long IT 5.21 ± 1.96 %; Short IT 5.36 ± 2.75 %; Long IT 70 4.95 ± 2.44 %) with no differential effect of protocol (*denotes significance $p < 0.05$).

Peak hyperaemia (time effect $p=0.01$; time x protocol $p=0.77$), peak SR (time effect $p=0.02$; time x protocol $p=0.90$), AUC_{60} (time effect $p=0.02$; time x protocol $p=0.44$) and AUC_{90} (time effect $p=0.001$; time x protocol $p=0.95$), the stimuli for vasodilatation, were also significantly increased post – exercise (**Table 4.4**). As the shear stimulus

was increased following acute exercise, AUC_{60} was used as a covariate during re-analysis of absolute and relative FMD. Absolute FMD showed no significant effect of exercise when AUC_{60} was used as a covariate (time effect $p=0.89$, time x protocol $p=0.96$, time x AUC_{60} $p=0.20$), this was also replicated in relative FMD (time effect $p=0.94$, time x protocol $p=0.75$, time x AUC_{60} $p=0.12$). This suggests that the acute exercise effect upon FMD was dependent upon an increase in the shear stimulus.

Post-exercise relative FMD was significantly correlated with peak SR during the FMD ($r=0.31$, $p=0.03$), AUC_{60} ($r=0.36$, $p=0.01$) and AUC_{90} ($r=0.40$, $p=0.01$). Following acute exercise over all protocols, peak SR during FMD was correlated with mean in-exercise anterograde SR ($r=0.62$, $p=0.001$), mean OSI ($r=-0.41$, $p=0.003$), max anterograde SR ($r=0.59$, $p=0.001$) and total anterograde SR ($r=0.60$, $p=0.001$). Similarly, AUC_{90} was also correlated with mean anterograde SR ($r=0.33$, $p=0.02$), mean OSI ($r=-0.35$, $p=0.01$), max anterograde SR ($r=0.36$, $p=0.01$) and total anterograde SR ($r=0.33$, $p=0.02$). However, no correlations with in-exercise retrograde SR was observed ($p>0.05$).

Table 4.4 Pre and 15 min post exercise results for FMD variables related to endothelial function. Values presented unscaled, pre and post-acute exercise. Results presented as Mean \pm SD. *denotes significant time effect at P<0.05.

	CON		Long IT		Short IT		Long IT 70	
	Pre	Post	Pre	Post	Pre	Post	Pre	Post
Baseline diameter, mm	3.98 \pm 0.53	3.97 \pm 0.54*	3.98 \pm 0.57	3.97 \pm 0.54*	3.96 \pm 0.54	3.97 \pm 0.51*	3.92 \pm 0.50	3.90 \pm 0.54*
Peak diameter, mm	4.25 \pm 0.55	4.38 \pm 0.56*	4.27 \pm 0.62	4.41 \pm 0.53*	4.25 \pm 0.57	4.39 \pm 0.57*	4.20 \pm 0.51	4.28 \pm 0.58*
Time to Peak Diameter, s	45 \pm 22	74 \pm 33*	55 \pm 27	68 \pm 40*	53 \pm 24	68 \pm 31*	48 \pm 14	69 \pm 31*
Absolute FMD, mm	0.26 \pm 0.12	0.41 \pm 0.21*	0.30 \pm 0.11	0.44 \pm 0.16*	0.29 \pm 0.14	0.42 \pm 0.17*	0.28 \pm 0.15	0.38 \pm 0.16*
Peak Hyperaemia, cm/s	93.1 \pm 28.8	104.2 \pm 14.7*	88.5 \pm 16.5	96.4 \pm 19.8*	89.2 \pm 17.7	100.1 \pm 21.3*	97.7 \pm 24.9	100.5 \pm 17.7*
Peak Shear Rate, s⁻¹	1910 \pm 700	2124 \pm 489*	1842 \pm 397	1982 \pm 560*	1864 \pm 446	2049 \pm 388*	2030 \pm 551	2109 \pm 482*
AUC₆₀, a.u.	41206 \pm 11671	41353 \pm 10824*	42130 \pm 8439	36899 \pm 10367*	44371 \pm 8760	38431 \pm 8016*	40376 \pm 13173	36687 \pm 8566*
AUC₉₀, a.u.	58894 \pm 20133	61263 \pm 17507*	61937 \pm 15001	53889 \pm 15771*	62840 \pm 13783	56530 \pm 12061*	60820 \pm 23066	57041 \pm 12833*
Reactive Hyperaemia, cm/s	4719 \pm 1692	6534 \pm 1518*	4928 \pm 1476	5860 \pm 1733*	4838 \pm 1563	5961 \pm 1675*	4815 \pm 1824	6137 \pm 1290*

*denotes a significant main time effect at the P<0.05 level.

4.3.6 MicroRNA – 21 expression following acute exercise

4.3.6.1 MiR-21 expression relative to housekeeper U6

No significant pre-exercise differences in levels of miR-21 (%U6) were observed between exercise protocols ($p=0.57$). However, there was a large standard deviation between pre-exercise miR-21 (%U6) expression thus pre-exercise values were subsequently used as a covariate. There was no apparent effect of acute exercise upon miR-21 (%U6) expression (time effect $p=1.04$, **Figure 4.14**) and no effect of the specific exercise protocols (time x protocol interaction $p=0.63$) when pre-exercise values were used as a covariate. Post-exercise miR-21 (%U6) expression was significantly correlated with post-exercise AUC_{60} ($r=0.33$, $p=0.03$) during FMD. Additionally, miR-21 (%U6) expression following acute exercise was correlated with the maximum OSI ($r=-0.30$, $p=0.03$) during the exercise only.

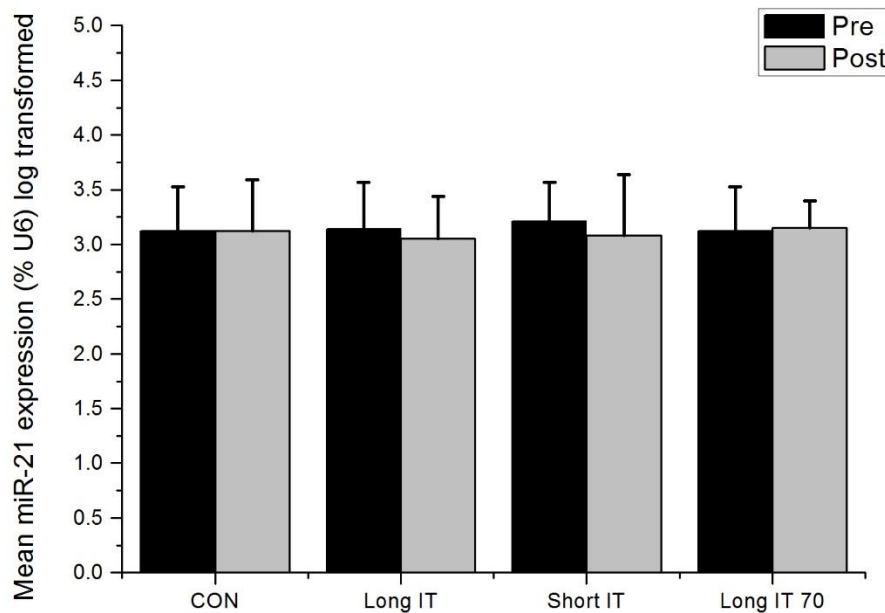

Figure 4.14 Mean miR-21 expression (%U6) immediately pre-and 6 hours post-acute exercise There was no significant effect of time and no interaction with exercise protocol ($p>0.05$). Data are presented with pre-exercise values used as a covariate. Data were not normally distributed therefore log transformed data are presented. Data are presented as mean \pm SD.

4.3.6.2 MiR-21 expression relative to cel-miR-39

When circulating miR-21 expression was reported as a percentage of cel-miR-39 expression (used as an exogenous spike-in control) there was no significant pre-exercise differences in miR-21 expression between exercise protocols ($p=0.65$). Again, there was a large standard deviation between pre-exercise miR-21 (%cel-miR-39) expression thus pre-exercise values were used as a covariate. Acute exercise resulted in an overall reduction in miR-21 expression (%cel-miR-39) (time effect $p=0.02$, **Figure 4.15**) but demonstrated no significant time by protocol interaction ($p=0.68$). Post-exercise miR-21 expression (%cel-miR-39) following acute exercise was significantly correlated with post-exercise AUC_{60} ($r=0.38$, $p=0.01$, **Figure 4.16**) during FMD analysis. Furthermore, miR-21 expression (%cel-miR-39) following acute exercise was also significantly correlated with mean anterograde SR ($r=-0.33$, $p=0.02$, **Figure 4.16**) and total anterograde SR ($r=-0.31$, $p=0.03$) but not retrograde SR during exercise.

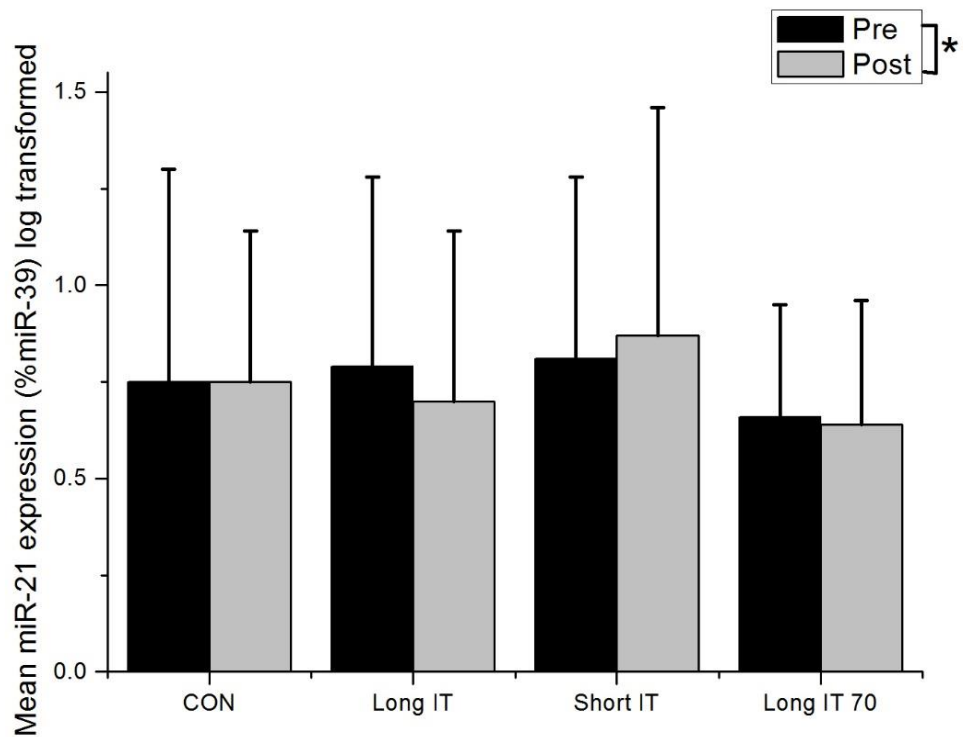

Figure 4.15 Mean miR-21 expression (%cel-miR-39) immediately pre-and 6 hours post-acute exercise. There was a significant effect of time ($p=0.02$) but no interaction with exercise protocol ($p=0.68$) when pre-exercise values were used as a covariate ($p=0.004$). Data are presented with pre-exercise values used as a covariate. Data were not normally distributed therefore log transformed data are presented. Data are presented as mean \pm SD. * denotes significance at the $p<0.05$ level.

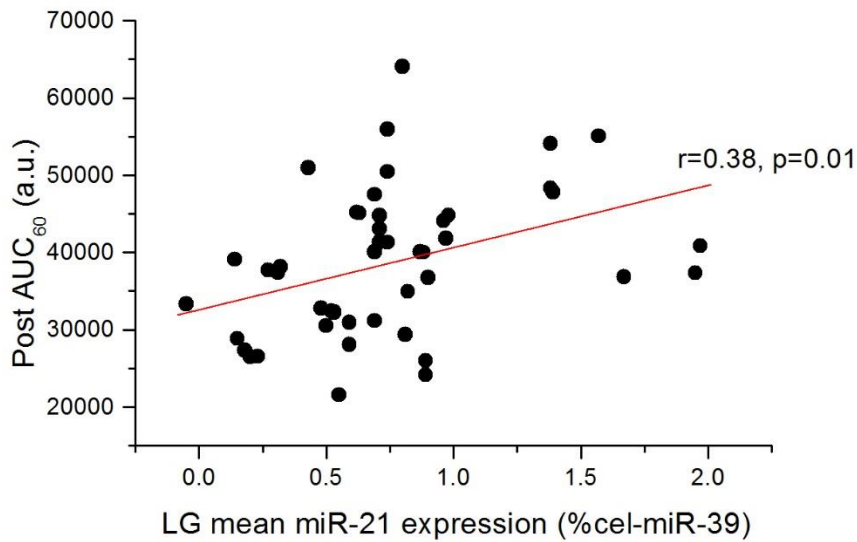
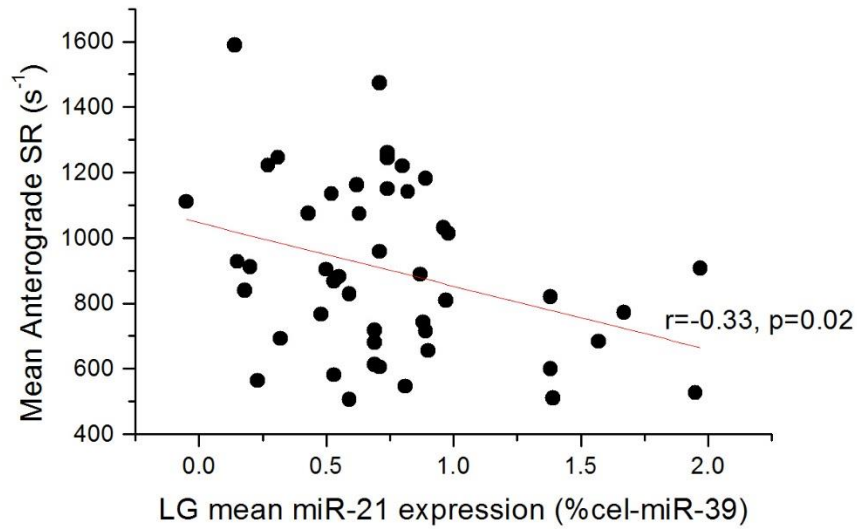

Figure 4.16 Panel A shows that mean anterograde SR during the exercise protocols was significantly correlated with log transformed mean miR-21 (%cel-miR-39) expression following the acute exercise protocol ($r=-0.33$, $p=0.02$). **Panel B** shows the change in AUC_{60} from pre to post exercise was significantly correlated with log transformed mean miR-21 (%cel-miR-39) expression following the acute exercise protocol ($r=0.33$, $p=0.02$).

4.4 Discussion

The present study was the first to continually assess patterns of anterograde and retrograde SR during intensity and duration matched acute CON and different IT exercise protocols in a young, healthy population. The study also determined whether exercise-induced SR pattern differentially affected acute endothelial function and miR-21 expression. In contrast to the hypothesis, acute brachial artery endothelial function improved following all types of exercise with no differential effect of SR pattern. The exercise protocols produced different and distinct anterograde and retrograde SR patterns, however, volumes of SR were not different between protocols. Mean OSI for all acute exercise protocols was predominantly laminar. However, all protocols produced brief periods of purely oscillatory SR but it is likely that these periods of purely oscillatory SR were too brief to induce detrimental effects upon the endothelium. Additionally, acute expression of miR-21 was reduced following exercise irrespective of exercise – induced SR pattern.

4.4.1 Characterisation of in-exercise SR pattern, VO₂ and HR during acute CON and IT exercise

The novel aspect of this study was the characterisation and comparison of anterograde and retrograde SR patterns throughout the duration of four different acute exercise protocols. The exercise protocols utilised in this study were matched for intensity and duration to delineate the effect of WR profile upon SR pattern and outcome of this pattern upon endothelial function. Both anterograde and retrograde SR followed the work rate profile of the exercise protocols in agreement with VO₂ and HR responses. Indeed, anterograde and retrograde SR showed strong associations with in-exercise heart rate responses to the exercise. In contrast to the VO₂ and HR profiles which stabilised, as is expected with exercise in the heavy intensity domain (Whipp, 1996), anterograde SR continued to increase throughout the duration of all

exercise protocols. Retrograde SR was immediately elevated at the onset of exercise and then steadily decreased throughout the four exercise protocols. The continuing increase in anterograde SR observed as exercise progressed may be due to thermoregulatory effects of exercise inducing downstream peripheral and cutaneous vasodilation (Simmons et al., 2011). This current study is consistent with previous research which found that lower limb exercise was capable of modifying conduit artery endothelial function in the non-exercising limb (Padilla et al., 2011c).

4.4.1.1 Potential mechanisms which regulated patterns of shear rate during exercise

All exercise protocols induced retrograde SR in the non-exercising brachial artery consistent with other studies which have utilised cycling exercise. Green et al. (2005) suggested that high volumes of retrograde SR occurs at the onset of exercise as a result of increased vascular tone in downstream resistance vessels. Retrograde SR decreases as exercise progresses through reductions in downstream peripheral resistance which occurs as a result of thermoregulation (Simmons et al., 2011). Brief alterations in the pressure gradient between upstream and downstream points within the brachial artery have previously been used to explain the occurrence of retrograde SR during cardiac cycles at rest (Padilla et al., 2010, McDonald, 1955). Changes in the pressure gradient may be further exacerbated with exercise and increased frequency of cardiac cycles thus offering a suggestion for greater retrograde SR during exercise. Indeed, the SR pattern induced by the exercise protocols in this study may be a product of changes in blood pressure altering the pressure gradient within the artery (Padilla et al., 2010). Padilla et al. (2010) suggested that blood pressure changes may influence the sympathetic nervous system. Exercise increases mean arterial pressure and sympathetic outflow in inactive muscle beds which has previously been correlated with increased brachial artery retrograde and

oscillatory SR following sympathoexcitatory manoeuvres (Padilla et al., 2010). The contracting muscle causes a delayed elevation in muscle sympathetic nerve activity which is related to the intensity of the exercise (Saltin et al., 1998). Exercise induced increases in sympathetic nerve activity are required in order to redistribute blood flow to the active muscles and away from non-active muscles (Saltin et al., 1998). The contraction of the skeletal muscles themselves during exercise may also affect blood flow patterns. Indeed, blood flow varies during the contraction and relaxation phases of muscles during exercise and is primarily determined by power output (Rådegran and Saltin, 1998). The muscle pump has been suggested to promote muscle blood flow during contractions by squeezing blood from veins inducing a low venous pressure and determining arterial inflow (Rådegran and Saltin, 1998). During muscular relaxation, the muscle pump has been suggested to open the veins as a result of negative venous pressure (Rådegran and Saltin, 1998). It is therefore clear that the impact of the muscle pump depends upon the force, frequency and duration of muscular contractions (Rådegran and Saltin, 1998). The four protocols utilised in the present study were within the same exercise intensity domain but were of differing work rates. Therefore, the force exerted by the muscles also differed between exercise protocols which may account for the differing SR patterns.

4.4.1.2 Oscillatory shear index during exercise and the acute effects upon endothelial function

This current study matched exercise intensity between the four exercise protocols and therefore did not assess the effect of exercise intensity upon patterns and volumes of SR during exercise. However, previous studies have shown exercise intensity, as defined by increased work rate, is integral in determination of volumes of anterograde and retrograde SR during cycling exercise (section 2.3.1.1.1) (Thijssen et al., 2009a). All four exercise protocols in the current study produced

equivalent volumes of both anterograde and retrograde SR, likely due to matched duration and intensity between acute exercise protocols. Volumes of retrograde SR increase with exercise intensity and impair endothelial function measured via FMD (Green et al., 2002b, Thijssen et al., 2009b). However, in the current study volumes of exercise-induced retrograde SR did not negatively impact acute post-exercise endothelial function. It is possible that the large volumes of exercise-induced anterograde SR overcame the retrograde SR resulting in predominantly laminar shear. Mean OSI for each exercise protocol was mainly laminar using the parameters defined by Padilla et al. (2010), thus supporting this theory. Maximum OSI indicates periods of purely oscillatory SR were experienced for brief periods during all exercise protocols. The greatest incidence of purely oscillatory SR occurred during the first half of the exercise session, when retrograde SR was also highest, and during the work bouts of IT protocols. This supports Padilla et al. (2011c), where greatest retrograde SR and OSI occurred within the first 5-10 minutes of a 60 minute continuous cycling exercise protocol. It has been suggested that retrograde SR and OSI is highest at the onset of exercise due to constriction of resistance vasculature in the forearm via the sympathetic nervous system or other circulating vasoconstrictors (Padilla et al., 2011c). The short time periods of purely oscillatory SR did not adversely affect acute endothelial function, however chronic exposure to episodes of purely oscillatory SR may be associated long term with endothelial dysfunction.

It was originally hypothesised that the short IT exercise protocol may induce the greatest amount of oscillatory SR due to the numerous oscillations between work and recovery bouts, compared to the other IT protocols used in this study. However, this was not the case and the numerous recovery periods may have acted to normalise OSI which had the potential to be higher in this protocol due to the high work rates

required. Furthermore, the short IT exercise protocol had the shortest recovery time between work bouts. These characteristics of the short IT protocol produced a very different pattern of SR, with more rapidly occurring transients of anterograde and retrograde SR matching work to recovery bouts, compared to the other exercise protocols. Despite the different patterns of anterograde and retrograde SR, volumes of both and OSI were not different between exercise protocols. Observation of **Figure 4.7** shows that forward blood flow between the four exercise protocols demonstrated gradual increases as each exercise session progressed with the greatest increase occurring in the CON exercise protocol. Decelerative blood flow returns to baseline as exercise progresses at a similar rate across all exercise protocols. It appears that blood flow begins to stabilise towards the end of each exercise protocol which is in accordance with the heart rate responses to each exercise protocol. Whilst heart rate and blood flow demonstrate similar responses during exercise, the patterns of anterograde and retrograde SR show different responses. The work rate profile is more evident in anterograde and retrograde SR compared to forward and decelerative blood flow. Anterograde SR also demonstrates the continual increase as exercise progresses in each protocol. Retrograde SR appears to respond similarly to decelerative blood flow as a decrease towards baseline is observed in all protocols as the exercise progresses. However, the immediate increase in retrograde SR at the onset of exercise is apparent whereas a corresponding increase in decelerative blood flow is not evident.

4.4.1.3 The rationale for the inclusion of the Long IT 70 exercise protocol

Following completion of the first three participants through the exercise study it was apparent that the 4 min recovery periods at unloaded cycling in the Long IT exercise protocol resulted in a lower energy expenditure, mean VO_2 and mean HR across the

exercise session. This resulted in a lower exercise intensity when compared to the CON and Short IT exercise protocols. It was therefore decided to include a fourth exercise protocol which consisted of the same work and recovery durations but with a higher resistance used during the recovery periods. The aim of this exercise protocol was to prevent HR, VO_2 and therefore SR dropping back to warm-up levels to reduce the intensity of the exercise session which would result in the exercise protocols no longer being matched for intensity. This aim was fulfilled with the inclusion of the Long IT 70 exercise protocol. Energy expenditure, mean VO_2 and mean HR were higher in Long IT 70 than Long IT exercise protocol. Whilst not statistically different from one another, Long IT 70 produced higher total, mean and maximum anterograde SR compared to Long IT 70 although volumes of retrograde SR showed little difference between the two protocols.

4.4.1.4 The haemodynamic response to acute aerobic exercise

As discussed in section 2.3.1, exercise which utilises a large muscle mass, i.e. lower limb exercise such as cycling, induces high metabolic demand. To meet this metabolic demand there is an increase in cardiac output facilitated by increases in heart rate. In turn, increases in HR increase blood flow through the artery to meet metabolic demand for O_2 resulting in an increase in SR (**Figure 4.7**). At the onset of exercise it has been reported that blood flow to the non-exercising limb (i.e. brachial artery of the arm) is reduced before starting to increase as exercise continues (Green et al., 2017). This was not evident in the current study as both blood flow and SR were increased from warm up at exercise onset. However, whether there was a reduction in initial blood flow during warm up from resting was not assessed in the current study. As exercise continues there are reportedly small increases in anterograde SR which is accompanied by large increases in retrograde SR in the inactive limb. This is supported by the results of all 4 exercise protocols included in

this current study where OSI (i.e. the ratio of anterograde to retrograde SR) can be seen to be highest during the first portion of the exercise, indicating a more oscillatory type of shear initially, and reduced as exercise progresses. Large initial increases in retrograde SR at the onset of exercise may be as a result of downstream vasoconstriction which is reduced as exercise progresses (Green et al., 2017).

Continuation of exercise induces a thermoregulatory response whereby the microcirculation dilates leading to a reduction in downstream total peripheral resistance affecting upstream blood flow and shear rate patterns (Green et al., 2017). This thermoregulatory response leads to a reduction in retrograde SR and further increases anterograde SR as exercise progresses, when OSI is determined a more laminar type of shear is evident as exercise progresses. This type of shear can be overserved in all exercise protocols within this study irrespective of whether the exercise was continuous or interval.

4.4.2 Acute endothelial function

Pre-exercise measures of endothelial function were not different between conditions suggesting any changes in post-exercise endothelial function would be as a result of the exercise-induced SR stimulus. FMD significantly increased 15 min post cessation of acute exercise irrespective of exercise protocol and therefore SR pattern. The lack of difference in endothelial function between exercise protocols is likely due to the matching of duration and intensity, which produced similar volumes of anterograde and retrograde SR.

4.4.2.1 CON versus IT exercise does not differentially affect acute endothelial function

Previous research has been unable to determine whether CON or IT exercise produces the greatest improvement in endothelial function. As suggested previously this may have been due to inadequate control of exercise intensity, duration or both.

Therefore, when intensity and duration were suitably controlled in this present study there was no apparent difference between IT and CON exercise protocols in terms of acute endothelial function. Allometric scaling of relative and absolute FMD was undertaken to assess the influence of resting diameter upon change in diameter following the hyperaemic stimulus, as per Atkinson (2014). The acute improvement in endothelial function remained when the influence of resting diameter was accounted for. However, when the hyperaemic stimulus for endothelium-dependent vasodilation, i.e. shear caused by the cuff deflation, was used as a covariate during analysis the acute improvement in FMD following all exercise protocols was abolished. Therefore, this suggests that the acute exercise protocols increased the SR stimulus during the FMD procedure following exercise and this caused the greater degree of vasodilation observed post-exercise.

4.4.2.2 Effect of exercise intensity upon endothelial function

Previous studies have shown chronic high intensity exercise training (70-80 % VO_{2max}) to have no effect (Goto et al., 2003) or to impair endothelial function (Bergholm et al., 1999), which has also been shown following acute high intensity exercise (Bailey et al., 2017). This impairment in endothelial function with high intensity exercise has been attributed to an increase in ROS production which can interact and breakdown NO (section 2.3.1.1.1). Specifically, NOX a NADPH oxidase subunit, has been suggested as a candidate for reducing NO bioavailability (Cocks et al., 2013). However, Cocks et al. (2013) did not find an increase in NOX2 content in skeletal muscle microvasculature following an acute bout of endurance or sprint interval exercise. The participants included in the study were young and healthy, therefore participants may have had an enhanced anti-oxidative defence. Indeed, trained individuals appear to exhibit a smaller reduction in FMD following an acute exercise bout (Dawson et al., 2013). It is therefore interesting that heavy intensity

exercise prescribed in this study produced an improvement in acute endothelial function 15 min post-exercise. Mean VO_2 of the four exercise protocols in this study was between 58-72% VO_{2peak} which was within the heavy intensity exercise domain based on individual characteristics. However, intensity was not prescribed in the same manner between this current study and the aforementioned studies and therefore may not have been of sufficient intensity to induce ROS production to impair NO dependent vasodilation. Furthermore, the participants included in the present study were young, healthy and moderately trained therefore it is likely they had enhanced anti-oxidative status which would minimise any post-exercise impairment in FMD. Alternatively, acute exercise may promote different FMD responses to chronic exercise potentially due to the accumulation of greater volumes of oscillatory SR over multiple training sessions which may be detrimental to endothelial function. This highlights the importance of assessing the findings from this acute study in a chronic setting where the effects of repeated exercise protocols upon endothelial function can be evaluated

4.4.3 Acute MicroRNA-21 expression

MiR-21 has also been implicated in regulation of EC phenotype through responses to changes in SR. We proposed miR-21 to be a potential circulating biomarker of exercise induced SR which may ultimately aid in regulation of endothelial function through changes in endothelial cell phenotype. Typically, miR-21 expression is assessed in-vitro in HUVECs. However, in the current study circulating miR-21 was assessed from plasma samples. Previous literature has shown miR-21 to be a flow sensitive miR, with overexpression of miR-21 reported following exposure to both laminar and oscillatory shear. It has therefore been determined that miR-21 may have a dual role in the endothelium which can vary depending upon the type of shear the endothelial cells are exposed to.

4.4.3.1 Determination of the appropriate housekeeping gene for relative expression of miR-21

In the current study, miR-21 expression relative to sRNA-U6 showed no change following acute exercise and no effect of exercise protocol and therefore SR pattern. U6 is the standard housekeeping gene used as a comparison for determination of relative miR expression in cell culture studies. Currently, there is no gold standard housekeeping gene for relative comparison when assessing circulating miR expression within the literature. In the current study, it was evident upon assessment of circulating miR-21 expression that U6 was not suitable as a housekeeping gene. It appears that there is low expression of circulating U6 in plasma samples hence circulating miR-21 appears to be highly expressed in comparison. The manufacturers of the RNA extraction kit suggest an exogenous spike-in control (cel-miR-39) may be a more robust housekeeping gene and has been utilised in some studies when assessing circulating miRs. Therefore, samples were reanalysed to assess cel-miR-39 expression. MiR-21 expression relative to cel-miR-39 showed a significant reduction post-acute exercise that was not influenced by the exercise protocol and therefore SR pattern. When miR-21 expression was reported relative to U6 there appeared to be high variance between individuals for baseline samples. When using cel-miR-39 for relative quantification of miR-21 there remained variance between individuals at baseline, however the magnitude of this variance appeared to be reduced.

4.4.3.2 The effect of acute IT and CON SR patterns upon miR-21 expression

Acute exercise does appear to have an effect in regulating miR-21 expression irrespective of type of exercise. Whether circulating miR-21 expression was reported relative to U6 or cel-miR-39, the 4 exercise protocols and therefore the differential SR patterns utilised in this study did not affect acute miR-21 expression. MiR-21

expression following acute exercise showed a weak to moderate association with anterograde SR during the exercise protocols irrespective of type of exercise, suggesting exercise-induced SR has the potential for regulation of miR-21 expression.

The lack of difference in miR-21 expression between exercise protocols may be more reliant upon volume rather than pattern of SR, similar to endothelial function. Whilst pattern of SR differed, mean OSI was equivalent between protocols and suggested ECs were exposed to predominantly laminar SR. In-vitro research has suggested laminar shear stress results in changes in increased miR-21 expression and promotion of an anti-atherogenic EC phenotype via NO production (section 2.1.5.2). However, miR-21 expression reduced following acute exercise in this study which is in contrast to Baggish et al. (2011) who found a 1.89 fold upregulation in miR-21 following acute maximal exercise. The results of the current are more in line with Kilian et al. (2016) who found a reduction in miR-21 expression 30 minutes post-acute exercise. On the other hand, Nielsen et al. (2014) found no effect of acute exercise (60 min duration) upon miR-21 expression immediately, 1 hour and 3 hours post exercise. The lack of consensus in the studies is likely due to the dual role of miR-21 in regulating of endothelial cell phenotype and the adaptive change in mechanosensitivity depending upon the stimulus (Kumar et al., 2014). In the current study, predominantly laminar shear was produced by all types of exercise and endothelial function was acutely improved. It may be reasonable to hypothesise that reduced miR-21 expression aided in the regulation of an anti-atherogenic endothelial cell phenotype. Alternately, decreased circulating levels of miR-21 may reflect a reduction in endothelial cells shedding miR-21 into the circulation and instead higher levels remain within the cell.

4.4.4 Limitations

SR is affected not only by vessel diameter and blood flow velocity but also by blood pressure which alters the stretch of the artery. BP was not measured in the current study, although in future studies in-exercise BP may yield further understanding of the mechanisms driving and regulating SR patterns. The current study assessed SR in the brachial artery during semi-recumbent lower limb cycling exercise as peripheral conduit arteries have been shown to be sensitive to changes in blood flow induced by lower limb cycling exercise (Green et al., 2005). However, when determining how changes in SR affect susceptibility to atherosclerotic lesion formation the brachial artery is known to be less atheroprone than the femoral artery for example. Blood flow patterns in the femoral artery may be different compared to the brachial artery as a result of changes in hydrostatic pressure and vessel calibre. Doppler ultrasound of the femoral artery during lower limb cycling exercise would provide greater insight into how patterns and volume of SR in the exercising limb affects EC phenotype/function in a more atheroprone vessel. However, in-exercise femoral artery Doppler ultrasound during cycling exercise is difficult to obtain reliably. Previous studies have obtained femoral SR during resistance type exercise, predominantly leg kicking, which is difficult to compare with aerobic, rhythmic cycling exercise. Despite this limitation, endothelial function in the brachial artery is well correlated with endothelial function in the coronary arteries (Takase et al., 1998) suggesting that exercise-induced SR in the brachial artery may be representative of systemic SR.

Thousands of miRs have been identified, however only miR-21 was presently assessed which may over simplify the complex regulation of EC phenotype and NO production, especially as miR-21 may have a transient response to different SR patterns. Acute assessment of miR-21 expression was made at only one time point, 6 hours post exercise. Currently, no studies have conducted time course experiments

to examine to optimum time to collect samples for assessment of circulating miRs following an acute stimulus. It is therefore possible that the time point used in this study was too early or too late to determine the effect of the exercise protocols and therefore, SR pattern upon miR-21 expression.

Furthermore, the small sample used in this study yielded a 64% chance of detecting differences between repeated protocols, suggesting the study was underpowered to detect changes in outcome measures of endothelial function and miR-21 expression. Retrospective power was calculated for the main outcome variables in the present study to determine the likelihood of making a type 2 error, i.e. a false negative result whereby it is assumed there is no change in a variable, however there is simply not enough power to detect this change. It can be observed that the chance of making a type 2 error for retrograde SR was 90%, 49% for anterograde SR and 58% for OSI. In contrast, the power to detect a type 2 error for assessing relative FMD pre and post exercise was 15% although this rose to 86% when assessing the effect of exercise protocol. This suggests that the power of the study was insufficient for detecting the effect of exercise protocol upon FMD and detecting a difference between exercise protocols upon in-exercise SR. However, determination of effect size for the aforementioned variables shows that retrograde SR demonstrated a small-medium effect, anterograde SR a medium-large effect and OSI a medium-large effect. Relative FMD pre to post exercise demonstrated a large effect whilst the effect of the exercise protocol only demonstrated a small-medium effect. Overall, it appears that the current study had better power to detect differences between exercise protocols for anterograde SR and OSI but not for retrograde SR, which was also supported by the effect sizes. Additionally, the effect of exercise upon acute FMD was appropriately powered, however there appeared to be insufficient power to determine the effect of different exercise protocols upon acute FMD.

This study also used young, healthy participants who were free of known CVD risk factors and had normal endothelial function. Therefore, translation of these findings into an at-risk population cannot be made reliably.

4.4.5 Future Directions

The following chapter employs similar exercise protocols in a training intervention in populations with a more inherent risk of CVD to determine whether the periods of purely oscillatory SR observed acutely become detrimental to endothelial function across time and multiple sessions. More widely, further work on reducing the standard deviation in miR-21 expression and to determine the time-course of detecting circulating miR at the point of greatest expression is required before it can become a more viable option for use as a biomarker of exercise induced SR and endothelial function. In future, additional miRs which are known regulators of EC phenotype should be assessed as potential biomarkers of shear with an influence upon endothelial cell phenotype and function.

4.4.6 Conclusion

In regards to the research question for this present study, the SR patterns were different between the CON and IT exercise protocols although the total volumes of SR were not different between protocols. This resulted in equivalent increases in acute FMD following all exercise protocols.

Acute IT and CON exercise protocols, matched for intensity and duration, produced SR patterns which corresponded with the work rate profile and HR and VO₂ responses. Despite differing SR patterns there was no difference in volumes of anterograde and retrograde SR between the exercise protocols. All exercise protocols induced retrograde SR and brief periods of purely oscillatory SR. Regardless CON and IT demonstrated equivalent improvements in acute post-exercise endothelial function. Whilst, the exercise protocols and SR patterns did not

appear to differentially affect circulating acute miR-21 expression, exercise does appear to reduce acute miR-21 expression. However, it remains unknown as to how a reduction in miR-21 expression following acute exercise affected endothelial cell phenotype.

Chapter 5 Examination of chronic interval and continuous exercise induced shear rate upon vascular health and the role of age and gender

Aspects from this Chapter were presented at the following conferences:

- University of Leeds Multidisciplinary Cardiovascular Research Centre (MCRC) March 2017 – Oral Presentation
- University of Leeds Postgraduate Symposium May 2017 - Oral Presentation
- European College of Sports Science Annual Meeting July 2017 - Oral Presentation

5.1 Introduction

Endothelial dysfunction is a precursor to atherosclerosis development (2.1.2) (Ross, 1999). The prevalence of endothelial dysfunction increases with age (Seals et al., 2011), however, the exact mechanism of age-related declines in endothelial function with age is unknown. Importantly, it appears unlikely that the decline in endothelial function is due to accumulation of traditional CVD risk factors alone. As stated earlier 40% of CVD cannot be explained by traditional CVD risk factors resulting in the hypothesis that changes in vascular structure and function contributes to the remainder of this risk (Green et al., 2008, Joyner and Green, 2009, Mora et al., 2007, Thijssen et al., 2010).

5.1.1 Ageing affects exercise-induced shear rate and endothelial function

Shear stress is one known regulator of endothelial function (Davies, 2009). However, it is unclear whether this decline in endothelial function with age is due to changes in shear stress as few studies have investigated the effects of age upon shear. Young et al. (2010) assessed differences in SR patterns between young and older

participants in the more atheroprone common femoral artery. Older participants demonstrated reduced anterograde SR and significantly increased retrograde SR compared to younger participants (Young et al., 2010). This resulted in a lower overall mean shear and higher volumes of oscillatory shear in the older group compared to the younger group (Young et al., 2010). Additionally, femoral vascular resistance was higher in the older group and was positively correlated to oscillatory shear in the older group only (Young et al., 2010).

Older males who participated in lifelong endurance exercise had comparable endothelial function and traditional CVD risk factors to younger endurance trained males (DeSouza et al., 2000). This suggests that exercise preserved endothelial function and exercise-induced SR contributed to the prevention of the age-related decline (DeSouza et al., 2000). Similarly, when older sedentary males were given an exercise intervention there was an improvement in endothelial function across the 4-week training period (DeSouza et al., 2000). However, whilst endothelial function was shown to improve in this study with no change in traditional CVD risk factors, the shear response was not studied. Casey et al. (2016) studied brachial and common femoral artery shear rates in young, older untrained and older endurance exercise-trained adults. Similar to the above study older trained adults, showed no differences in SR within the brachial artery compared to the younger group (Casey et al., 2016). However, brachial retrograde SR and OSI were greater in older untrained compared to younger adults (Casey et al., 2016). Common femoral artery retrograde SR and OSI were reduced in older trained compared to older untrained adults however were similar to younger participants (Casey et al., 2016). It appears that lifelong exercise training prevents age related increases in retrograde SR and OSI which likely contributes to the preservation of endothelial function in this population. Padilla et al. (2011b) demonstrated age-related increases in resting retrograde and oscillatory SR

in older compared to a younger population. However, this difference was abolished at the onset of steady-state exercise in that there were no longer differences in retrograde and oscillatory SR between the younger and older groups (Padilla et al., 2011b).

5.1.2 Gender influences upon in-exercise shear rate and endothelial function

Importantly, sex differences may also affect shear patterns as endothelial function differs between males and females throughout the lifespan (Celermajer et al., 1994). Females have a lower CVD risk prior to menopause compared to males, endothelial function decreases and CVD risk increases rapidly following the menopause (Celermajer et al., 1994). This results in comparable CVD risk in older males and post-menopausal women (Celermajer et al., 1994, British Heart Foundation, 2012). This has been attributed to the reduction of oestrogen production following the menopause in addition to the rebalancing of testosterone and oestrogen in older males which favours higher oestrogen production, therefore conveying greater cardiovascular protection (Mendelsohn and Karas, 2005). This also occurs in conjunction with lower physical activity levels in females compared to males throughout the lifespan and further reductions in physical activity in females with age (BHF, 2015). Oestrogen and physical activity play a vital role in maintaining healthy endothelial function. Therefore, it may be hypothesised that mean shear also decreases through increases in retrograde SR and OSI in older females which contributes to impairment of endothelial function.

5.1.3 Interval exercise effects upon in-exercise shear rate

The current popularity of interval type exercise has resulted in assessment of the effect of this type of exercise upon endothelial function. Some studies have shown greater (Wisløff et al., 2007, Sawyer et al., 2016) or equivalent (Rakobowchuk et al.,

2008) improvements in endothelial function following IT exercise training. The mechanisms behind these changes, i.e. effect of SR pattern or intensity of the interval exercise, was explored in regards to acute exercise in the previous chapter. Recently, the introduction of aerobic interval training (AIT) has been shown to be an effective intervention in improving endothelial function as assessed by FMD in chronic heart failure patients (Wisløff et al., 2007). This type of exercise training utilises longer work and recovery periods thus reducing the number of oscillations during the protocol and uses a lower peak heart rate to enable the 4 minute work bout to be sustainable.

The ability of exercise to induce SR related improvements in acute endothelial function was shown in a young healthy population in the first study of this thesis. This first study originally hypothesised that IT exercise may induce oscillatory shear which may have a detrimental impact upon markers of vascular health compared to traditional CON exercise. However, whilst anterograde and retrograde shear rate patterns were very different between CON and IT protocols as per the design of the study, total volumes of SR were not different between exercise protocols. Mean OSI did not differ between CON and IT exercise although all protocols did induce periods of purely oscillatory SR. The incidence of purely oscillatory SR was greatest during the short IT protocol which may be as a result of the multiple transients between work and recovery throughout the exercise session and the high work rates. These periods of purely oscillatory SR were not detrimental to acute endothelial function following CON and IT exercise. However, accumulating this purely oscillatory SR across a training period consisting of multiple training sessions may affect chronic vascular health. Additionally, this acute study was conducted on a young healthy population who were free of known CVD risk factors. Therefore, the effect of the periods of purely oscillatory SR upon vascular health may be more relevant in a population with increased CVD risk such as an older population.

5.1.4 Ageing contributes to arterial stiffening

Arterial stiffness increases with age and further contributes to increased CVD risk (Zaydun et al., 2006). Multiple mechanisms may contribute to age-associated increases in arterial stiffness and are described in detail in section 2.2.1.8. Important components of arterial stiffness are reduced compliance and distensibility in addition to increased IMT, all of which are demonstrated in older populations (Simons et al., 1999). These factors may affect shear patterns within the stiffened vessel of older individuals (Heffernan et al., 2013). As the arteries become less elastic with age they are less able to accommodate changes in pressure, for example through vasodilation. It does not appear that arterial stiffness is related to increases in retrograde SR in the superficial femoral artery (Heffernan et al., 2013). However, increases in retrograde SR does appear to be associated with wave reflection intensity (Heffernan et al., 2013). Wave reflections create pressure which can determine flow profiles and may contribute to flow reversal and amplitude of shear (O'Rourke and Avolio, 1980).

5.1.5 Shear rate effects upon chronic miR-21 expression

Shear stress not only affects endothelial function and arterial stiffness but can also regulate microRNA expression in endothelial cells. In-vitro studies have shown that specifically miR-21 can be regulated by shear stress experienced by endothelial cells (Zhou et al., 2011, Weber et al., 2010). Artificially induced oscillatory shear stress has been shown to upregulate miR-21 within cultured human umbilical vein endothelial cells (HUVECs) (Zhou et al., 2011). Contrastingly, Weber et al. (2010) has shown that miR-21 stimulated by laminar shear stress can promote anti-atherogenic factors within the endothelium. In the previous study of this thesis, miR-21 was proposed as a potential biomarker of shear response. Different patterns of SR promoted by the different exercise protocols used in the first study did not appear to differentially affect acute miR-21 expression. However, all exercise protocols induced mainly laminar SR

which may account for the lack of differences observed in acute miR-21 expression. Similarly, miR-21 expression may be regulated by volume of SR rather than pattern and these were matched closely between the four exercise protocols in the first study. It is unclear in the literature whether circulating miR-21 expression could also be a potential biomarker of chronic SR as promoted by an exercise intervention or whether miR-21 is only responsive to acute changes (Baggish et al., 2011). There are also few studies which have studied the effects of ageing upon miR-21 expression and therefore whether miR-21 expression will be differentially affected between younger and older populations following the exercise training intervention.

5.1.6 Aims and hypothesis

The research question of this present study was to investigate whether four weeks of exercise training altered shear rate patterns in younger and older participants and how these shear rate patterns affected acute and chronic FMD.

Therefore, the aims of this study were to:

- I. evaluate exercise-induced shear rate patterns during aerobic interval exercise (AIT) and traditional moderate continuous (CON) exercise pre and post 4 weeks of exercise training,
- II. assess the effect of acute and chronic exercise-induced shear rate patterns on markers of vascular health, and
- III. determine the interaction between acute and chronic changes in SR patterns, age and gender.

It was hypothesised that shear rate patterns would differ between AIT and CON exercise protocols, genders, age groups and from pre to post 4 weeks of exercise training. Additionally, AIT would produce the greatest improvements in acute and chronic markers of vascular health with the most beneficial improvement observed in the older population and little differences between the genders.

5.2 Methods

5.2.1 Participants

Participants were recruited as described in section 3.2. Twenty-seven sedentary but healthy participants (12 male: 15 female, aged 20-35 years or 45-60 years) volunteered for this study. All participants were free of current or previous risk factors associated with cardiovascular and respiratory diseases and metabolic disorders, further details of exclusion criteria are provided in section 3.2. An initial health screening, comprising a health questionnaire, a resting 12 lead ECG, three supine blood pressures, height and weight, was used to ensure all participants were safe to participate in the study. The resting ECG and blood pressures were checked by a cardiologist for abnormalities which would preclude participants from taking further part in the study. Participants with ECG abnormalities or multiple resting BPs of $\geq 140/90$ were provided with a Doctor's note and were excluded from the study until further investigation had been undertaken (**Figure 5.1**). A GP note stating participants were fit and well to continue the study was required before participation could be resumed. The University of Leeds ethics committee approved the study protocols which were in accordance with the declaration of Helsinki (BIOSCI 15-008).

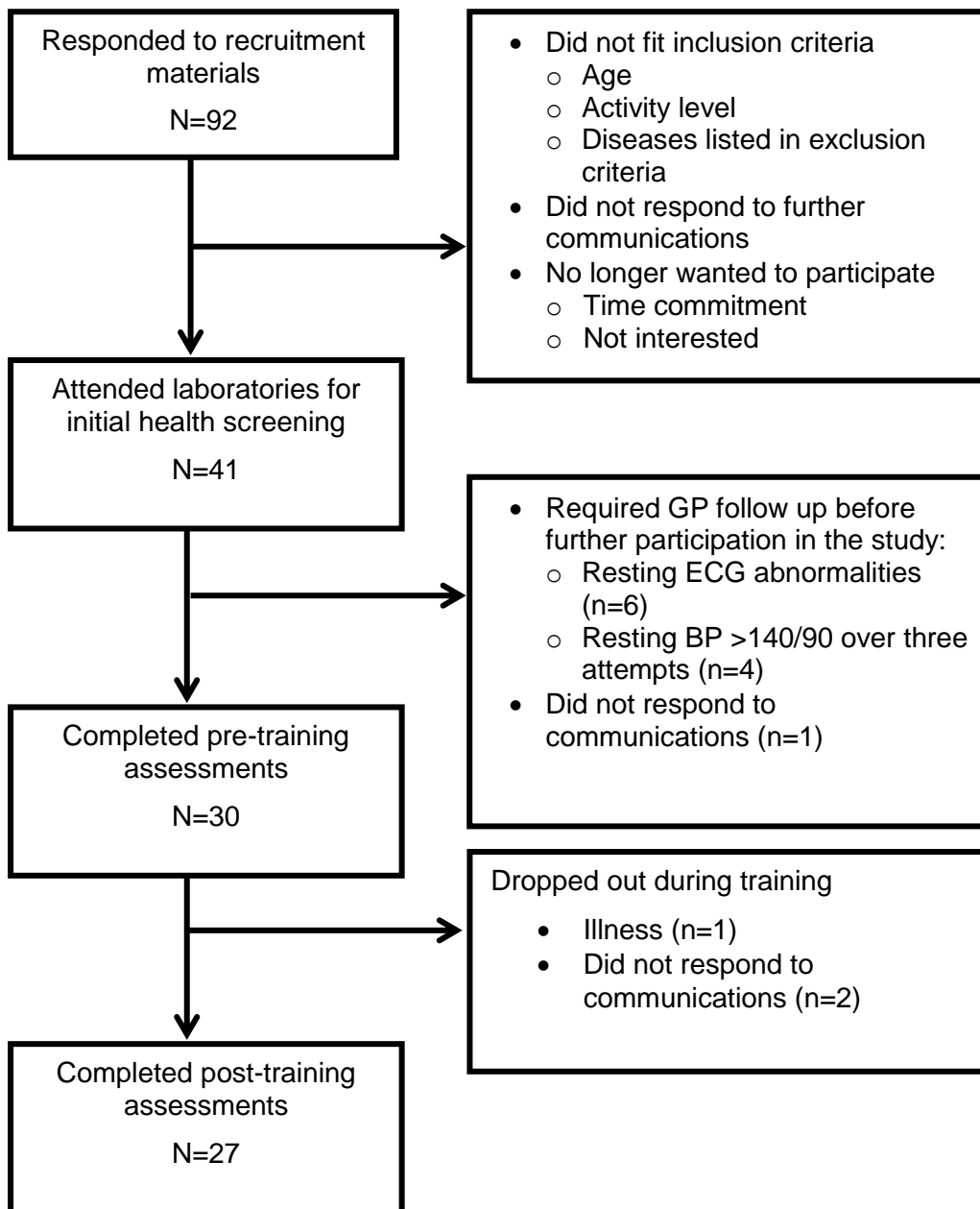

Figure 5.1 Consort diagram for the present study

5.2.2 Experimental procedure

Informed consent was received in writing from all participants prior to data collection. Participants were invited to attend the laboratory for an initial health screening and to ensure participants met the inclusion criteria. Participants who met the inclusion criteria and passed the health screening returned on a separate day for the second visit. Visit 2 included ultrasound assessment of the carotid artery to determine arterial stiffness and a standard ramp incremental exercise test (RIT) on a semi-recumbent cycle ergometer for determination of VO_{2peak} and HR_{peak} (see section 3.5). Participants were asked to abstain from exercise and alcohol in the 24 hours prior to the lab visit plus food and caffeine in the 2 hours prior to this visit. Following the second visit participants were matched on age, gender, BMI and VO_{2peak} before being randomly assigned to either the moderate continuous (CON) or aerobic interval (AIT) training groups.

For the third visit participants reported for testing following >8 hours overnight fasting and abstinence of caffeine, alcohol and strenuous exercise for 24 hours as described in section 3.6.1. Protocols were completed in standardised testing conditions in a quiet, darkened, temperature controlled laboratory. A venous blood sample (10 ml) was taken at the antecubital fossa on the arm not intended for subsequent FMD measurement. Participants completed >10 min semi-recumbent rest prior to ultrasound recordings of resting brachial artery diameter and pre-exercise FMD. Participants then began the prescribed exercise protocol consisting of >3 min warm up and 32 min of either CON or AIT followed by >2 min cool down on a semi-recumbent cycle ergometer. During each exercise protocol heart rate, breath by breath gas exchange and Duplex ultrasound of the brachial artery were recorded. Following cessation of the exercise, participants completed a further 15 min semi-recumbent rest before post-exercise resting diameter and FMD were recorded for

assessment of acute endothelial function. Visits 4 – 9 consisted of laboratory based exercise training twice per week for 4 weeks on an upright cycle ergometer. During training sessions participants wore heart rate monitors and perceived rate of exertion (RPE) was recorded at the end of each training session. Participants were also asked to undertake an additional home based exercise session each week which produced similar levels of perceived exertion.

Visit 10 was a repeat of visit 3 consisting of a venous blood sample prior to a 10 min rest period which preceded brachial artery ultrasound recordings for pre-exercise resting diameter and FMD. This was followed by the monitored exercise session where heart rate, breath by breath gas exchange and Duplex ultrasound of the brachial artery were recorded. 15 min post exercise the FMD was repeated. The same site of the brachial artery was imaged pre and post-acute exercise and training for each individual participant. The 11th (final) visit comprised of an assessment of body weight, followed by a 10 min period of supine rest before 3 blood pressures were recorded. This was followed by a carotid artery ultrasound scan and maximal RIT. A schematic of the experimental protocols can be viewed in **Figure 5.2**.

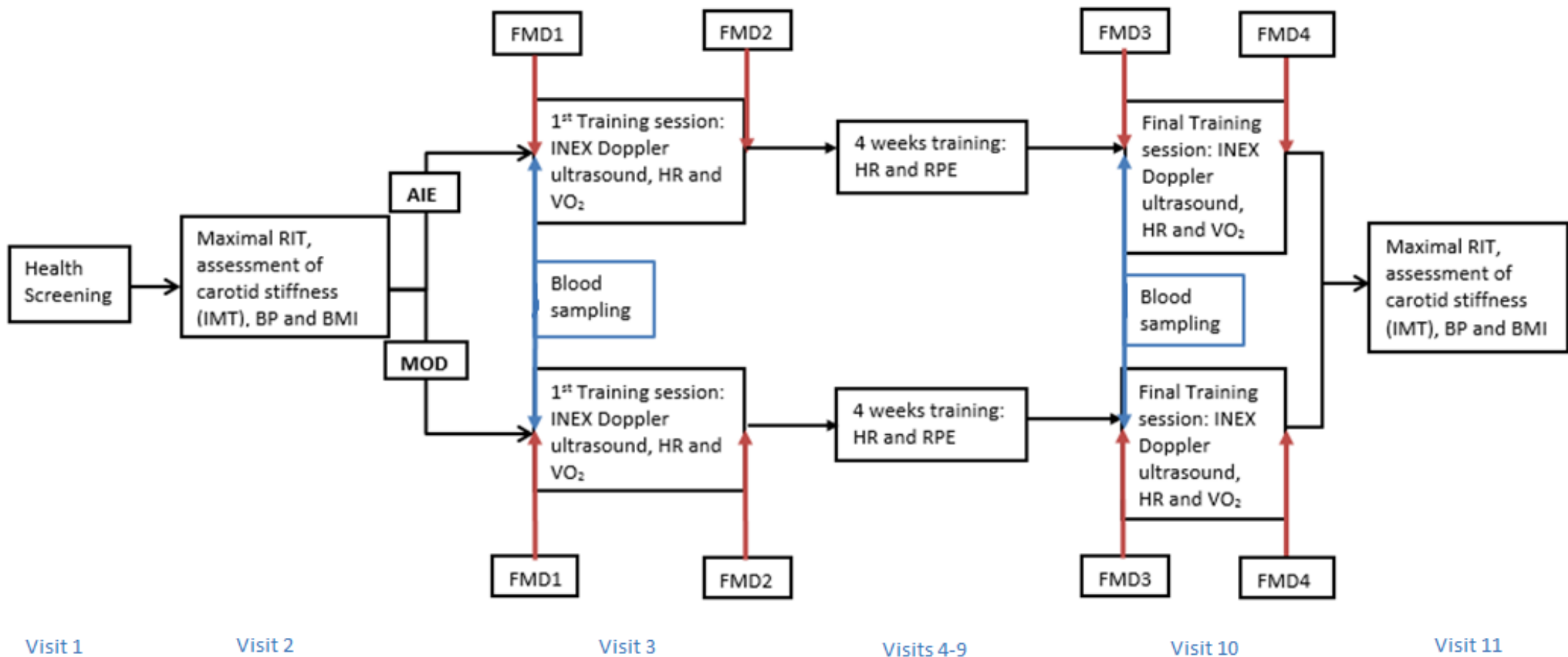

Figure 5.2 Flow chart for the experimental procedure of the current study. All visits occurred on separate days.

5.2.3 Anthropometry and blood pressure

Anthropometric measures were performed pre-and post-exercise training, described in detail in section 3.4. Anthropometric measures included height and weight to assess changes in body mass and BMI that may result from the prescribed exercise. Additionally, three supine resting blood pressures were recorded pre-and post-training.

5.2.4 Assessment of cardiorespiratory fitness

All participants completed a standard RIT pre-and post-training on a semi-recumbent cycle ergometer, as described in section 3.5. The ramp rate varied between 12 W/min to 20 W/min and was selected based on an estimation of individual participant's fitness level. The RIT allowed determination of absolute and relative VO_{2peak} , lactate threshold and HR_{peak} . Relative VO_{2peak} prior to training was used in matching participants before randomisation into training groups. HR_{peak} at the end of the test allowed work rates for the training sessions to be prescribed on an individual basis. These variables, in addition to LT, were important for comparisons post training to evaluate the effectiveness of the respective training interventions upon markers of cardiorespiratory fitness.

5.2.5 Assessment of endothelial function

Endothelial function was assessed via brachial artery FMD, conducted in accordance with previous guidelines (Thijssen et al., 2011) and as described in section 3.6. Participants rested in the semi-recumbent position for 10 minutes prior to recording of resting brachial diameter. A blood pressure cuff was then immediately inflated to >200 mmHg around the forearm for 5 min. Diameter and blood flow velocity were recorded continuously 30 s prior to cuff deflation and continued for 2 min 30 s post cuff deflation.

Diameter and blood flow velocity at rest and during FMD at all four time points were conducted using automated, commercially available, edge detection software (Brachial Tools V5; Medical Imaging Applications, Coralville, IA, USA) (described in sections 3.6.4 and 3.6.5). The outcome measures provided by this software were resting and peak diameter which provided absolute and relative FMD in addition to peak hyperaemia, peak SR, area under the curve (AUC) for 60 and 90 s following cuff deflation and time to peak diameter.

5.2.6 Assessment of microRNA – 21 expression

Blood samples were processed into plasma or platelet free plasma (described in section 3.10), before being frozen at -80°C for subsequent analysis. RNA was extracted from the thawed platelet free plasma following the procedures detailed in section 3.11.1. Quantification of miR-21 pre-and post-exercise training was then determined via real time PCR, as described in section 3.11.2, and expression reported relative to spike-in control cel-miR-39.

5.2.7 Assessment of carotid artery stiffness

Participants were required to rest in a supine position for ≥ 10 min before brachial artery blood pressure was recorded. An ultrasound probe was used to obtain a 2D image of the right carotid artery, proximal to the carotid bulb and bifurcation. Upon optimisation of the tunica media and tunica intima of the near and far walls, three 20 s videos were recorded at 15 fps using Vascular Imager (Medical Imaging Applications, Coralville, IA, USA).

Video recordings of the carotid artery were analysed using automated edge detection software which tracked the walls of the artery throughout the recordings (Carotid Analyser; Medical Imaging Applications, Coralville, IA, USA). The software automatically determined carotid artery diameter in addition to intima-media thickness

(IMT) of near and far walls, arterial distensibility and compliance, as described in section 3.9.

5.2.8 In-exercise VO_2 , HR and shear rate responses

The first (visit 3) and final (visit 10) training sessions were monitored for HR and gas exchange via a 12-lead ECG and breath by breath system respectively. Duplex ultrasound was used to assess anterograde and retrograde shear rates in the brachial artery during the first and final exercise training sessions, using procedures described in section 3.7. Following optimisation of the B-mode image and the Doppler signal, recording started 30 s before the end of the unloaded warm up period. Recordings lasted 4 minutes before a 30 s pause, required for storage of the recording, then the next 4 minute recording began and continued in this manner until the final recording which ended 1 min into the cool down.

In-exercise brachial diameter and blood flow velocity were analysed in Brachial Tools (Medical Imaging Applications, Coralville, IA, USA) as described in section 3.7.2. The Doppler blood flow signal was inverted during analysis to determine retrograde blood flow velocity in the same way as anterograde blood flow velocity. A confidence limit of 70% around the near and far walls of the artery was applied to all frames with frames falling outside of this cut off excluded. Brachial artery diameter, anterograde and retrograde SR and OSI (equations in section 3.7.2) were obtained for each participant. Mean, maximum, minimum and total values for shear rate parameters were calculated for each participant during in the first and final training sessions.

5.2.9 Exercise training protocols

Participants were divided into four groups dependent upon age (young 20-35 yrs., older 45-60 yrs.) and gender before being randomly assigned to either CON or AIT groups following matching of BMI and VO_{2peak} . Both exercise protocols were 32 min in duration with the CON protocol prescribed at a work rate equivalent to 65-70%

HR_{peak} . The AIT protocol consisted of 4 repeated 4 min “work” bouts at a work rate equivalent to 85-90% HR_{peak} interspersed with 4 repeated 4 min “recovery” bouts at a work rate equivalent to 60-65% HR_{peak} . HR_{peak} was determined as the highest heart rate achieved at the end of the maximal RIT. The first and last exercise training sessions were conducted on a semi-recumbent cycle ergometer to allow in-exercise Duplex ultrasound of the brachial artery. Visits 4-9 consisted of laboratory based exercise training sessions performed on an upright cycle ergometer (LODE Corival; Lode BV, Groningen, Netherlands) twice per week for the duration of the training intervention. These sessions consisted of a 3 min warm up period at 10 W before beginning the CON or AIT protocols, followed by a >2 min cool down at 10 W. During training sessions (visits 4-9) participants wore a standard heart rate monitor with chest strap (Polar V800; Polar Electro, Warwick, UK) to confirm they met the target HR zones. The work rate of the training sessions were adjusted to ensure participants were within their target HR zones. At the end of each exercise session participants provided RPE.

5.2.10 Home based exercise sessions

Participants were asked to complete an additional home based exercise session each week, in addition to the two lab based exercise sessions. Participants were asked to perform the home based exercise session in the same manner as the exercise based sessions, i.e. continuous or interval. Participants in the CON group were asked to perform 30 minutes of steady exercise, whereas participants in the AIT exercise group were asked to perform 4 minutes of harder exercise interspersed with 4 minutes of recovery, repeated 4 times. The perceived rate of exertion experienced during the lab based exercise sessions was replicated during the home based exercise sessions to roughly match the exercise intensity and heart rates attained. Adherence to the home

based exercise sessions was monitored through verbal self-reporting by the participants to the experimenter.

5.2.11 Statistical analysis

A formal power calculation was performed using http://hedwig.mgh.harvard.edu/sample_size/js/js_parallel_quant.html. FMD was used as the primary outcome measure. Using previous FMD data from our laboratory 52 participants would provide an 80 percent probability of detecting a treatment difference at a two-sided 0.05 significance level, if the true difference between treatments is 2.00 units. This is based on the assumption that the standard deviation of the response variable is 2. The calculation assesses age differences with gender to be assessed post hoc. To account for drop outs a sample size of 60 was sought during recruitment.

Data were analysed using SPSS (IBM SPSS Statistics 21). Firstly, data were assessed for normality using Shapiro-Wilks, these variables were analysed further using parametric tests. Log transformation was conducted on variables which were not normally distributed. If log transformation was not possible then non-parametric tests were subsequently conducted. A one-way ANOVA was used to assess group differences (age: younger vs. older, gender: male vs. female, exercise protocol: AIT vs. CON) pre exercise training. A general linear model was utilised to assess time (pre vs. post training or first vs. final exercise training session) by group (age: younger vs. older, gender: male vs. female, exercise protocol: AIT vs. CON) interactions on dependent variables. A separate general linear model was used to assess endothelial function and variables associated with FMD at 4 time points: pre and post-acute exercise prior to training (FMD 1 v FMD 2), pre and post-acute exercise following exercise training (FMD 3 v FMD 4) and the chronic response to exercise training (FMD1 v FMD3). Post – hoc analysis was carried out where appropriate. Pearson

correlations were used to identify relationships between normally distributed variables.

Post – hoc power analysis of main outcome variables (FMD, OSI, anterograde and retrograde SR) were calculated following determination of beta probability in SPSS.

Power was calculated using:

1-beta probability

Equation 21

Additionally, for the aforementioned variables, partial eta squared (η^2) and the 95% confidence intervals (CI) were reported. The thresholds for effect size when using partial η^2 were small effect = 0.0099, medium effect = 0.0588, large effect = 0.1379 as per Cohen (1977).

5.3 Results

5.3.1 Participant characteristics and anthropometric responses to exercise training

In this section variables assessed prior to and following training are referred to with the terms “pre” and “post”. Prior to beginning the exercise training, participants (n=27) were divided into groups based upon age and gender. The characteristics of these groups are displayed in Table 5.1. Prior to exercise training, weight was lower in females versus males (gender effect $p=0.03$). Additionally, SBP was 7% lower in the younger compared to the older group at this point (ageing effect $p=0.05$) with a trend for lower SBP in females compared to males (gender effect $p=0.08$). Pulse pressure (PP) was 8.5 mmHg lower in females compared to males (gender effect $p=0.004$). An ageing effect for 14% higher DBP ($p=0.001$) and 11% higher mean arterial pressure (MAP) ($p=0.002$) in the older group prior to exercise training was also observed. Therefore, pre-training weight, SBP, DBP, MAP and PP were used as covariates in subsequent analysis of training effect.

Following the 4-week exercise training intervention weight decreased by 0.5 kg (time effect $p=0.001$) irrespective of age ($p=0.28$), gender ($p=0.41$) or exercise protocol ($p=0.35$). BMI did not change across the training period (time effect $p=0.10$). Systolic BP showed a trend for an increase of 0.63 mmHg (time effect $p=0.06$). Diastolic BP decreased by 0.4 mmHg (time effect $p=0.02$) and MAP decreased by 0.1 mmHg (time effect $p=0.05$) with training irrespective of age, gender or exercise protocol ($p>0.05$). Pulse pressure increased by 1.07 mmHg with training (time effect $p=0.001$). Additionally, there was a trend for a significant time by age by gender effect ($p=0.06$) suggesting younger females showed a decrease in PP with training whilst increases were observed in young males and older males and females. Furthermore, there was an interaction between time, gender and exercise protocol ($p=0.01$) which indicated

that females who underwent CON training showed an increase in PP (3.73 mmHg), whilst females completing AIT training showed a decrease (5.02 mmHg). Both training conditions appeared to increase PP in males (CON 1.09 mmHg), with more of an increase following AIT (5.27 mmHg).

Table 5.1 Participant characteristics across the 4 week exercise training intervention as divided by age and gender. Values reported as mean±SD.

	Young				Older			
	Males		Females		Males		Females	
N	8		8		4		7	
Age (yr)	23.5 ± 5.9		26.6 ± 5.0		51.5 ± 6.5		54.0 ± 5.7	
Height (m)	1.8 ± 0.1		1.7 ± 0.1		1.8 ± 0.1		1.6 ± 0.1	
	Pre	Post	Pre	Post	Pre	Post	Pre	Post
Weight (kg) *†‡	78.1 ± 14.6	77.6 ± 14.7	66.1 ± 15.3	65.8 ± 15.1	94.8 ± 8.6	93.8 ± 11.1	69.9 ± 24.0	70.1 ± 23.6
BMI (kg/m²)	24.7 ± 4.3	24.5 ± 3.7	24.4 ± 6.3	24.2 ± 5.5	30.3 ± 1.8	30.0 ± 2.6	27.0 ± 6.8	27.0 ± 6.8
SBP (mmHg) §	118 ± 7	118 ± 9	106 ± 12	107 ± 10	124 ± 12	121 ± 8	119 ± 9	122 ± 13
DBP (mmHg) §	73 ± 7	71 ± 8	71 ± 7	72 ± 6	81 ± 11	79 ± 10	83 ± 6	83 ± 6
MAP (mmHg) §	87.8 ± 6.7	86.6 ± 7.6	82.8 ± 8.3	83.7 ± 6.9	94.9 ± 10.9	92.8 ± 9.7	95.2 ± 4.6	96.4 ± 7.2
PP (mmHg) †	45.0 ± 6.2	46.8 ± 5.2	34.6 ± 6.5	34.3 ± 6.8	42.8 ± 3.8	41.8 ± 2.8	35.6 ± 11.7	38.7 ± 11.3

* indicates significant time effect (pre v post) at the $p < 0.05$ level

† indicates significant gender effect (male v female) prior to training at the $p < 0.05$ level

§ indicates significant ageing effect (young v older) prior to training at the $p < 0.05$ level

‡ indicates significant time (pre v post) x gender (male v female) interaction at the $p < 0.05$ level

5.3.2 Exercise tolerance measures across the exercise training period

Exercise tolerance data pre-and post-4 weeks of exercise training are displayed in Table 5.2. Prior to the exercise training intervention absolute VO_{2peak} demonstrated a significant effect of gender (Female 1.90 ± 0.45 v Male 3.22 ± 0.58 Lmin⁻¹; $p=0.001$), whilst relative VO_{2peak} was 8.4 ml/kg/min higher in younger than older participants ($p=0.01$) and 9.2 ml/kg/min higher in males than females ($p=0.002$). Similarly, prior to exercise training lactate threshold and work rate peak were 0.77 Lmin⁻¹ and 102 W higher respectively in males compared to females ($p=0.001$). Heart rate peak attained at the end of the RIT was 13% higher in younger compared to older participants prior to the exercise intervention ($p=0.002$). Therefore, pre-training absolute and relative VO_{2peak} , LT, WR_{peak} and HR_{peak} were used as covariates in subsequent analysis of training effect.

Resting heart rate demonstrated a 7 bpm reduction (time effect $p=0.01$) across the 4-week training period irrespective of age ($p=0.12$), gender ($p=0.73$) or exercise protocol ($p=0.81$). Additionally, there was a trend for a significant time by gender by exercise protocol effect ($p=0.06$). The greatest reduction in resting HR over the training period occurred in females who completed CON exercise (12 bpm) and males completing AIT exercise (11 bpm) compared to females in the AIT (4 bpm) and males in the CON exercise groups (1 bpm). Unloaded VO_2 at the beginning of the RIT should not vary between tests and is determined from the legs moving against gravity only. Indeed, unloaded VO_2 did not change over time (time effect $p=0.19$).

5.3.2.1 Exercise training effects upon cardiorespiratory fitness

Absolute VO_{2peak} showed a significant increase of 6% (time effect $p=0.05$) with training and a greater increase in males (8%) compared to females (3%) (time by gender interaction $p=0.02$, **Figure 5.3**). There was also a significant time by age by gender

by exercise protocol interaction ($p=0.02$, **Figure 5.3**). This interaction indicated that absolute VO_{2peak} increased in all groups other than older females who undertook CON exercise training, with the greatest improvement occurring in older males in the CON exercise training group (Young: Female CON +0.17, Female AIT +0.15, Male CON +0.24, Male AIT +0.27 $L\text{min}^{-1}$; Older: Female CON -0.25, Female AIT +0.18, Male CON +0.44, Male AIT +0.14 $L\text{min}^{-1}$). Older females appeared to benefit more with AIT exercise training, older males with CON exercise training, whilst younger males and females showed that CON and AIT appeared to be equally effective in improving absolute VO_{2peak} .

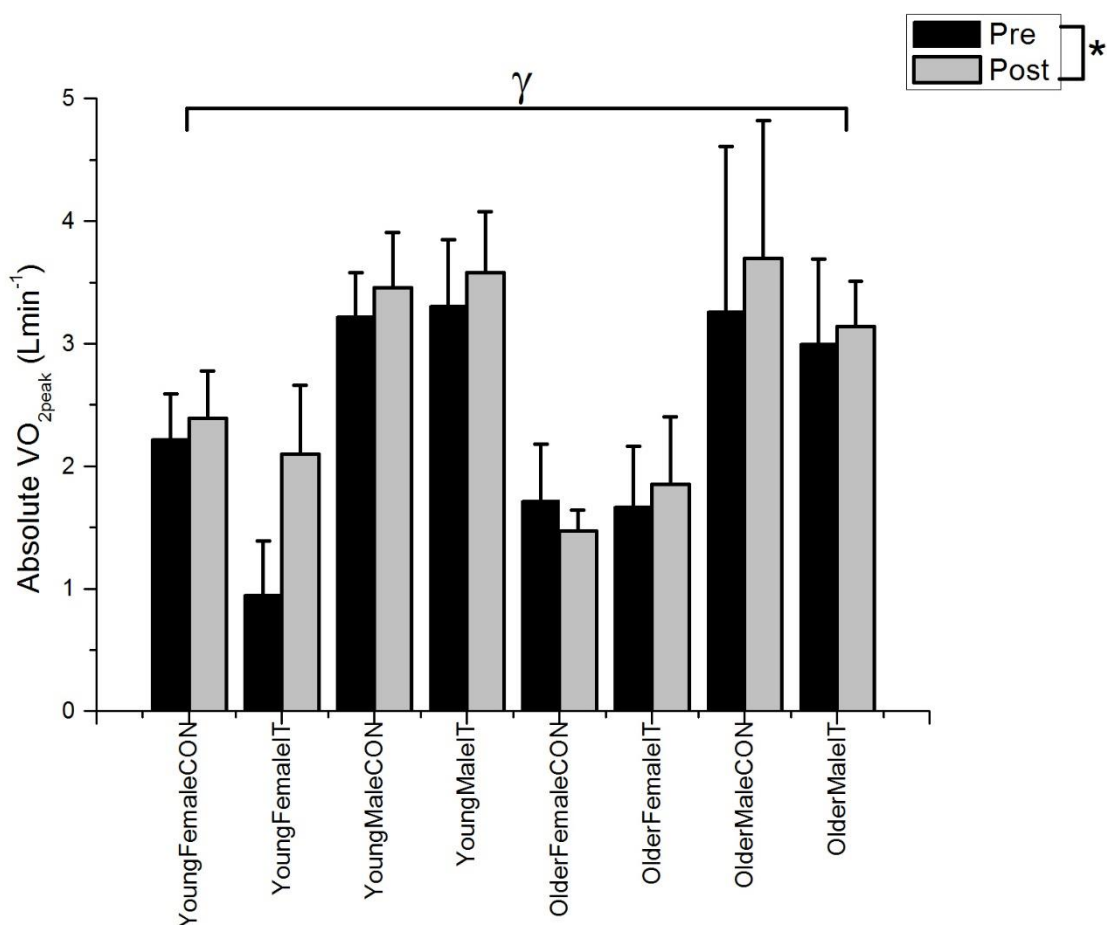

Figure 5.3 Absolute VO_{2peak} determined from the pre (black bars) and post (grey bars) RIT as divided by age groups (young v. older), gender (male v. females) and exercise training group (CON v. AIT). Data presented as mean \pm SD. * indicates significant time effect (pre v post), γ indicates significant time x age x gender x exercise protocol interaction at the $p<0.05$ level.

Relative VO_{2peak} did not change with training (time effect $p=0.16$, **Table 5.2**) although there was a trend for a greater increase in relative VO_{2peak} in males (9%) than females (4%) (time x gender interaction $p=0.06$). Lactate threshold demonstrated a significant increase (time effect $p=0.01$) and a significant time by age by gender by exercise protocol effect ($p=0.003$, **Figure 5.4**). It appears that AIT exercise training provides the greatest improvement in the young male group whilst CON exercise training produced the greatest improvement in older males. Older females demonstrated the

greatest improvement following AIT exercise training whilst younger females benefitted from both exercise training conditions.

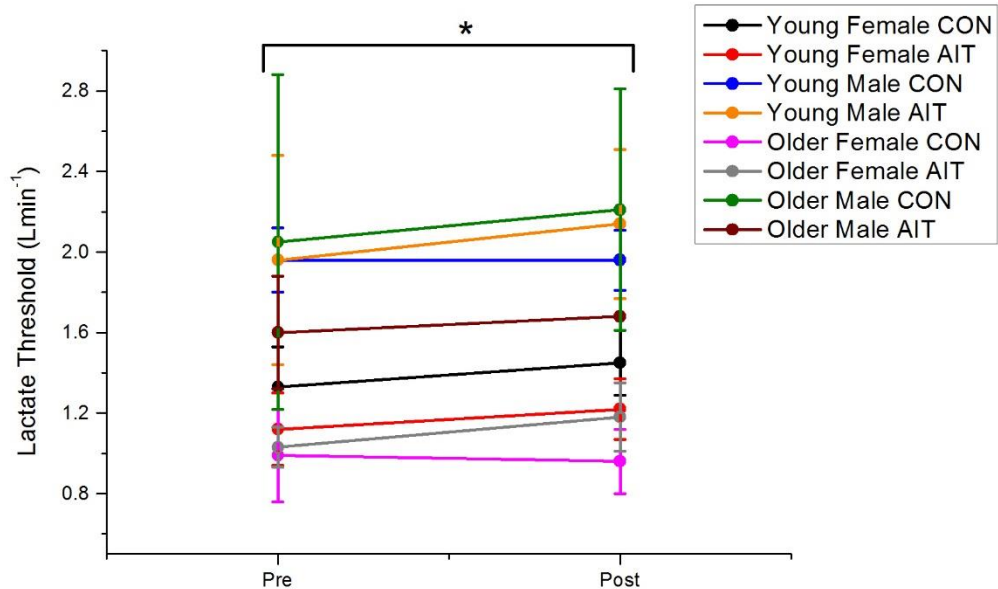

Figure 5.4 Lactate threshold determined from pre and post RIT as divided by age groups (young v. older), gender (male v. females) and exercise training group (CON v. AIT). Data presented as mean±SD. * indicates significant time effect (pre v post) at the p<0.05 level.

Work rate peak did not change across the 4-week training period (time effect p=0.11, **Table 5.2**). HR_{peak} did not change with training (time effect p=0.86, **Table 5.2**).

Therefore, it appears that AIT exercise training provides the greatest improvement in exercise tolerance measures the young male group whilst CON exercise training produced the greatest improvement in older males. Older females demonstrated the greatest improvement following AIT exercise training whilst younger females benefitted from both exercise training conditions.

Table 5.2 Exercise tolerance measures across the 4 week exercise training period. Participants were divided into young and older age groups before being randomised to CON or AIT training groups. Variables were assessed during the initial RIT and again during the post training assessment where the RIT was repeated. Values reported mean±SD.

	Younger				Older			
	CON		AIT		CON		AIT	
	Pre	Post	Pre	Post	Pre	Post	Pre	Post
Resting Heart Rate (bpm)* §	79 ± 17	70 ± 6	77 ± 13	65 ± 11	78 ± 14	73 ± 9	65 ± 9	62 ± 10
Unloaded VO₂ (L/min) ‡	0.55 ± 0.13	0.59 ± 0.06	0.53 ± 0.12	0.51 ± 0.10	0.54 ± 0.10	0.52 ± 0.11	0.48 ± 0.08	0.55 ± 0.12
Relative VO_{2peak} (ml/kg/min)	35.4 ± 8.4	38.3 ± 9.3	39.6 ± 9.2	43.1 ± 10.5	28.4 ± 10.2	28.3 ± 11.4	27.8 ± 6.4	30.2 ± 5.3
Heart Rate Peak (bpm) †§	175 ± 22	174 ± 23	173 ± 13	175 ± 12	157 ± 9	149 ± 15	144 ± 18	151 ± 16
Work Rate Peak (W)#	202 ± 48	211 ± 49	209 ± 67	222 ± 74	175 ± 79	177 ± 89	169 ± 62	184 ± 57

* denotes significant time effect (P<0.05)

† denotes significant time x exercise interaction (P<0.05)

§ denotes significant time x gender x exercise interaction (P<0.05)

‡ denotes significant time x age by exercise interaction (P<0.05)

denotes significant time x age x gender x exercise interaction (P<0.05)

5.3.3 In-exercise VO₂ and heart rate responses to the exercise protocols

In-exercise VO₂ and HR responses to the first exercise training session were assessed for differences between age groups, gender and exercise protocols. No effects of ageing were observed ($p > 0.05$), however females demonstrated significantly lower mean VO₂ ($p = 0.001$), peak VO₂ ($p = 0.001$), work rate ($p = 0.05$) and energy expenditure ($p = 0.002$) compared to males. Furthermore, AIT exercise resulted in higher peak VO₂ ($p = 0.05$), mean HR (%HR_{peak}) ($p = 0.002$), mean VO₂ (%VO_{2peak}) ($p = 0.01$) and maximum HR ($p = 0.001$) compared to CON exercise. Therefore, the aforementioned variables were used as covariates during subsequent analysis of training effects.

5.3.3.1 Pattern of exercise influenced VO₂ recorded during exercise protocols

The pattern of VO₂ during the first and final exercise training sessions was driven by the work rate profile resulting in very different VO₂ patterns between CON and AIT protocols (**Figure 5.5**). Unlike the first study in this thesis, VO₂ was not matched between exercise protocols. This resulted in differences in the intensity of the exercise as both mean and peak VO₂ were anticipated to be different between protocols.

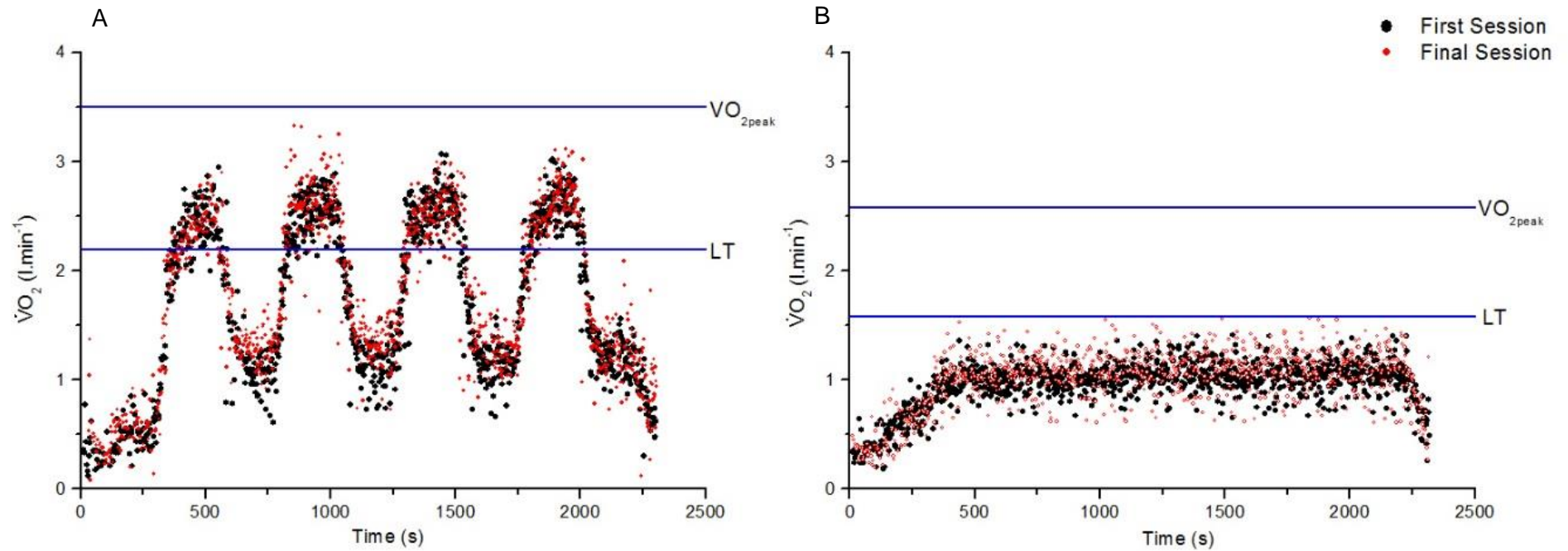

Figure 5.5 $\dot{V}O_2$ during the first exercise training session (black circles) and the final exercise training session (red circles). Panel A shows a representative participant (young male) in the AIT group. Panel B shows a representative participant (young female) in the CON group.

Mean VO_2 during the final exercise training session was 3.5% higher than mean VO_2 in the first exercise training session (time effect $p=0.001$, **Figure 5.6**). Additionally, there was a time by exercise protocol interaction ($p=0.02$) with mean VO_2 during the exercise sessions increasing more in CON (11%) than AIT (-3%) from the first to the final training session. No effect of age ($p=0.16$) or gender ($p=0.68$) was observed (**Figure 5.6**). There was also a significant interaction of time by age by gender by exercise protocol during the training sessions (Young: Female CON +0.14, Female AIT +0.09 $L\text{min}^{-1}$; Male CON +0.17, Male AIT -0.05 $L\text{min}^{-1}$; Older: Female CON -0.01, Female AIT +0.07 $L\text{min}^{-1}$; Male CON +0.30, Male AIT -0.30 $L\text{min}^{-1}$; $p=0.02$, **Figure 5.6**). This showed that mean VO_2 increased most in participants who were assigned to CON exercise training with the exception being the older females. When mean VO_2 during the training sessions was reported as a percentage of $VO_{2\text{peak}}$ from the RIT there was a significant decrease from 55% to 54% with training (time effect $p=0.001$).

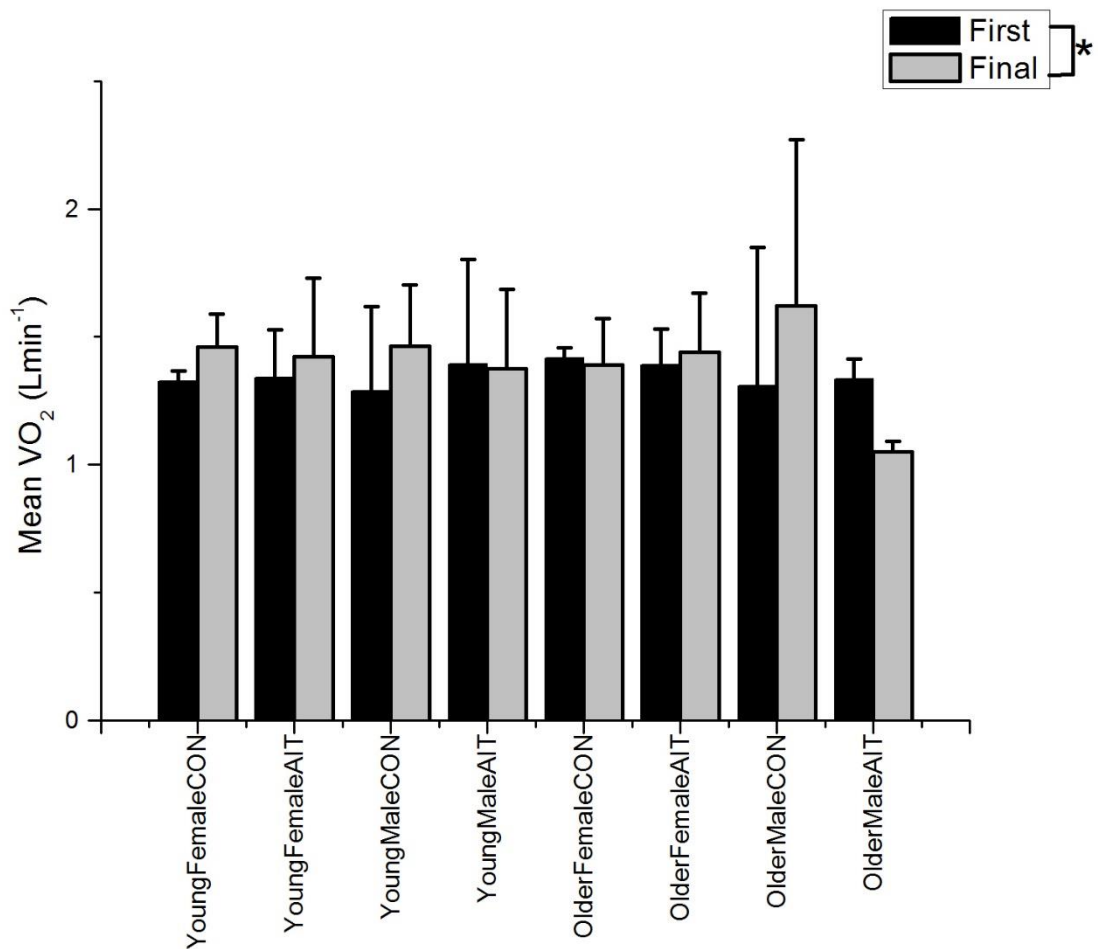

Figure 5.6 Mean VO₂ determined from the monitored exercise training session pre (black bars) and post (grey bars) the exercise training intervention as divided by age groups (young v. older), gender (male v. females) and exercise training group (CON v. AIT). Data presented as mean±SD. * denotes a significant time effect and a significant time by age by gender x exercise protocol interaction at the p<0.05 level.

Peak VO₂ attained during the monitored exercise training sessions demonstrated a significant increase from the first to final session (time effect: First 2.08 ± 0.76 L/min, Final 2.17 ± 0.77 L/min; p=0.004). A trend for a larger increase was observed in participants who were in the CON training group compared to the AIT training group (First: CON 1.79 ± 0.58 L/min, AIT 2.35 ± 0.83 L/min; Final: CON 1.95 ± 0.68 L/min,

AIT 2.38 ± 0.81 L/min; time by protocol $p=0.06$). Additionally, there was a significant interaction between time, age, gender and exercise protocol ($p=0.04$) as can be seen in **Figure 5.7**. When peak VO_2 during the exercise sessions was reported as a percentage of VO_{2peak} from the RIT there was no significant effect of time ($p=0.35$), or interactions with age ($p=0.41$), gender ($p=0.50$) or exercise protocol ($p=0.13$). However, as expected AIT produced a significantly higher peak VO_2 ($\%VO_{2peak}$) compared to CON (CON 71.9 ± 11.7 %, AIT 95.5 ± 9 %; $p=0.001$).

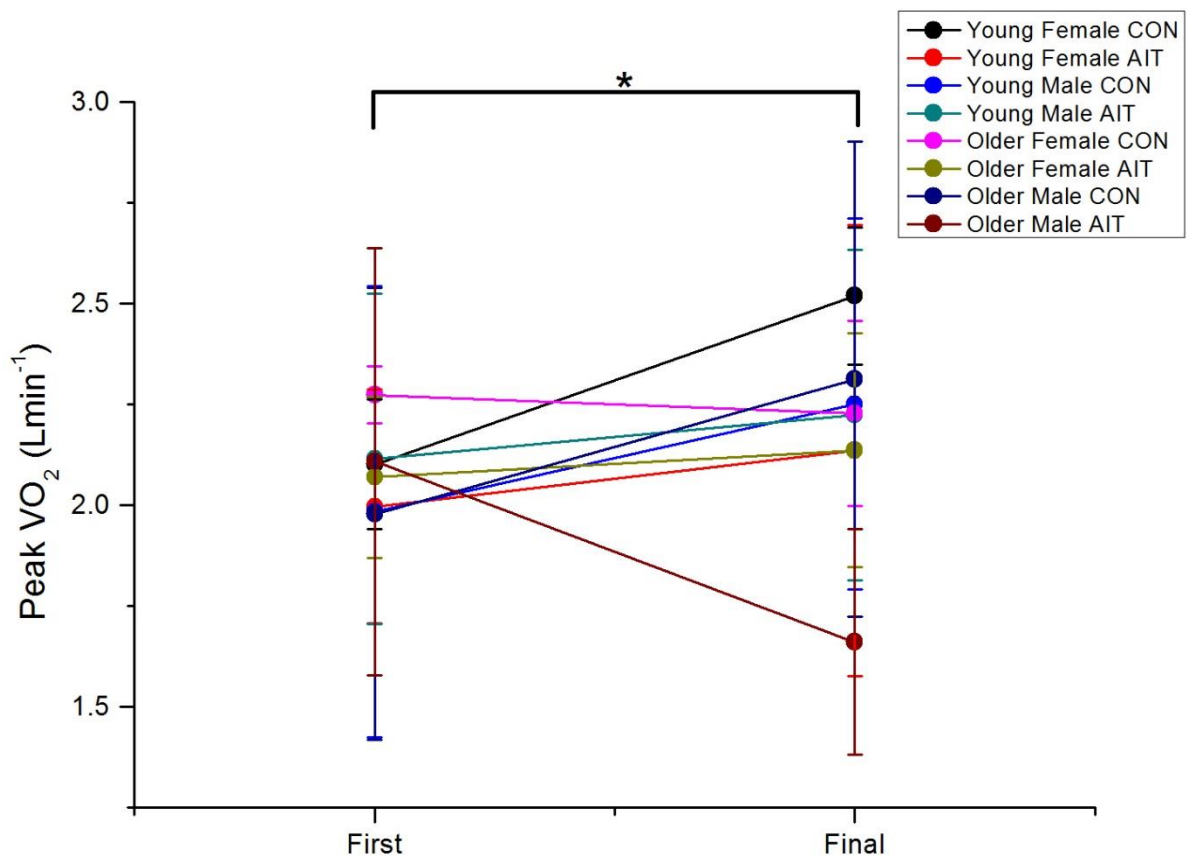

Figure 5.7 Peak VO_2 determined from the first and final exercise training sessions as divided by age groups (young v. older), gender (male v. females) and exercise training group (CON v. AIT). Data presented as mean \pm SD. * indicates significant time effect (pre v post) and time by age by gender by exercise protocol interaction at the $p<0.05$ level.

The lowest VO_2 attained during the exercise sessions showed a significant effect of time (First 0.40 ± 0.22 L/min, Final 0.41 ± 0.11 L/min; time effect $p=0.001$) but no significant interaction with age ($p=0.63$), gender ($p=0.84$) or exercise protocol ($p=0.44$). The lowest VO_2 during the exercise sessions reported as a percentage of $\text{VO}_{2\text{peak}}$ from the initial RIT showed no significant effect of time ($p=0.93$), or interaction with age ($p=0.64$), gender ($p=0.78$) or exercise protocol ($p=0.22$). However, overall the lowest VO_2 attained was higher in females than males (gender effect Females 19.8 ± 7.4 %, Males 14.3 ± 7.1 %; $p=0.02$).

5.3.3.2 The pattern of exercise influenced heart rate recorded during the exercise protocols

Heart rate was recorded during the first and final exercise training sessions and demonstrated different patterns as per the intention of the study. By design, the heart rate attained during the AIT and CON exercise protocols were different. AIT was used to drive heart rate higher than the CON protocol and is evident in **Figure 5.8**. Due to the nature of the exercise protocols used, the pattern of heart rate was driven by the work rate profile.

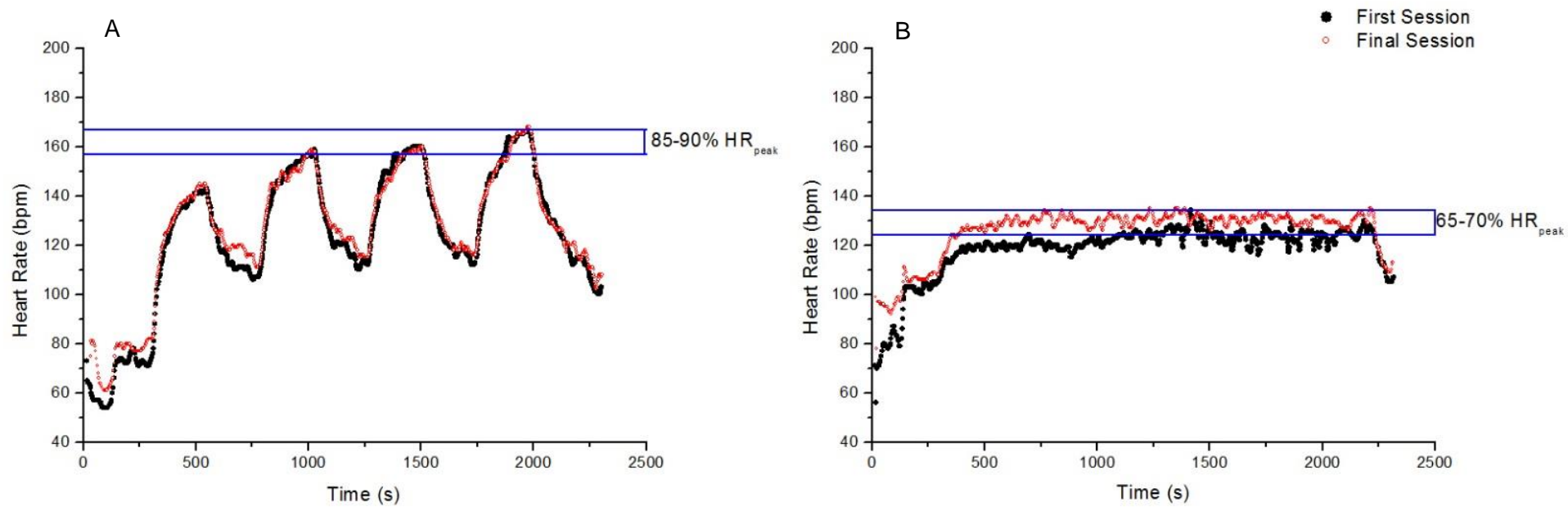

Figure 5.8 HR during the first exercise training session (black line) and the final exercise training session (red line). Panel A shows a representative participant (young male) in the AIT group. Panel B shows a representative participant (young female) in the CON group. The blue boxes demonstrate the target heart rate zone participant were prescribed based on the exercise group they were randomised to.

Mean HR recorded during the exercise sessions showed no significant time effect ($p=0.40$, **Figure 5.9**). Mean HR during the exercise sessions as a percentage of HR peak attained during the RIT decreased by 1% from the first to the final training session (time effect $p=0.02$) irrespective of age ($p=0.63$), gender ($p=0.41$) or exercise protocol ($p=0.50$).

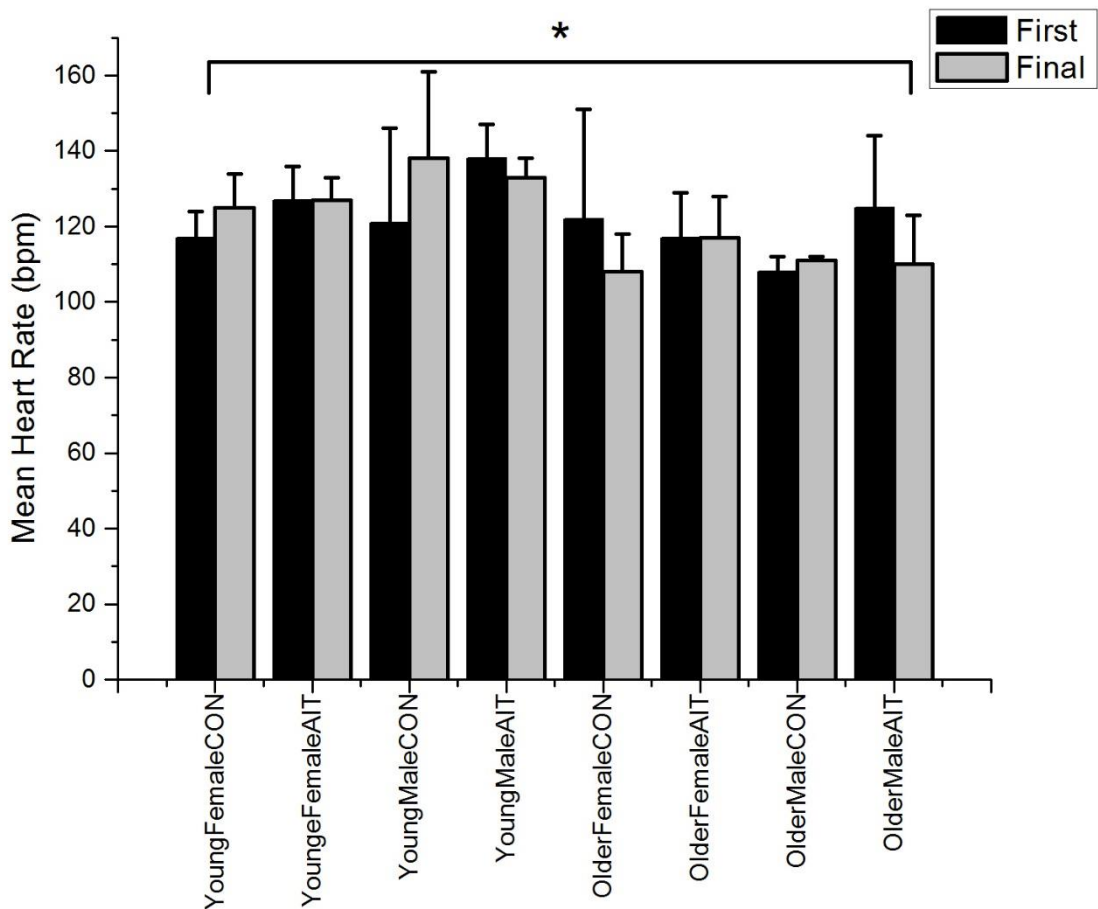

Figure 5.9 Mean HR determined from the monitored exercise training session pre (black bars) and post (grey bars) the exercise training intervention as divided by age groups (young v. older), gender (male v. females) and exercise training group (CON v. AIT). Data presented as mean \pm SD. * denotes a significant time by age interaction ($p<0.05$).

Maximum HR attained during the exercise sessions decreased from 142 to 139 bpm from the first to final exercise session ($p=0.02$), with no interaction with gender ($p=0.67$) or exercise protocol ($p=0.27$). However, younger participants attained a significantly higher maximum HR compared to older participants (time by age interaction First: Younger 146 ± 22 bpm, Older 138 ± 22 bpm; Final: Younger 148 ± 19 bpm, Older 130 ± 16 bpm; $p=0.01$). Maximum HR during exercise reported as a percentage of HR_{peak} attained during the initial RIT was significantly higher at the first compared to the final training session (First: 87 ± 14 % Final: 85 ± 11 %; time effect $p=0.001$) irrespective of age ($p=0.65$), gender ($p=0.86$) or exercise protocol ($p=0.50$).

The minimum HR attained during the exercise sessions did not significantly change from the first to final exercise training session (time effect $p=0.53$), nor demonstrate any significant interactions with groups ($p>0.05$). Minimum heart rate was lower in males than females (gender effect Females: 87 ± 12 bpm, Males 76 ± 12 bpm; $p=0.01$).

5.3.3.3 Changes in work rate and energy expenditure from the first to the final exercise training session

The mean work rate used in the training sessions showed a significant increase from the first to the final exercise training session (First: 88 ± 46 W, Final: 98 ± 47 W; time effect $p=0.001$) irrespective of age ($p=0.79$), gender ($p=0.40$) or exercise protocol ($p=0.22$). Mean work rate was higher in males than females (gender effect Females 76 ± 38 W, Males 117 ± 49 W; $p=0.04$). Mean energy expenditure showed a significant increase from the first to the final exercise training session (First: 129.1 ± 60 KJ, Final: 148 ± 62 KJ; $p=0.002$) irrespective of the exercise protocol undertaken ($p=0.21$). Females had a lower mean energy expenditure compare to males (Females 108 ± 43 KJ, Males 182 ± 58 W; $p=0.003$).

5.3.4 In-exercise shear rate patterns pre and post training

In-exercise SR responses to the first exercise training session were assessed for differences between age groups, gender and exercise protocols. Ageing had a significant effect on time spent at an OSI>0.5 ($p=0.01$) with younger participants spending less time at purely oscillatory SR (11.9 s) compared to older participants (64.9 s). In-exercise brachial artery diameter was significantly lower in females (3.31 mm) compared to males (4.15 mm) ($p=0.001$). Furthermore, AIT exercise induced higher mean ($p=0.01$) and total ($p=0.02$) retrograde SR compared to CON exercise. Therefore, the aforementioned variables were used as covariates during subsequent analysis of training effects.

5.3.4.1 Patterns of anterograde and retrograde SR from the first to the final exercise training session

Patterns of volumetric blood flow and anterograde and retrograde SR mirrored the exercise profile set (either CON or AIT) across both age groups and genders, shown in **Figure 5.10** and **Figure 5.11**. These SR patterns were consistent with work rate, VO_2 and HR during all protocols. As in the first study of this thesis anterograde SR continued to increase throughout each exercise protocol in both exercise groups. Retrograde SR exhibited the opposite pattern to anterograde SR with a gradual reduction throughout each protocol observed.

In the final exercise training session, patterns of anterograde and retrograde SR once again followed the exercise profile. There appeared to be little difference in anterograde and retrograde SR between in the first and final training sessions between the young CON and AIT groups. However, compared to the first exercise training session there appeared to be a reduction in retrograde SR in the older CON and AIT groups.

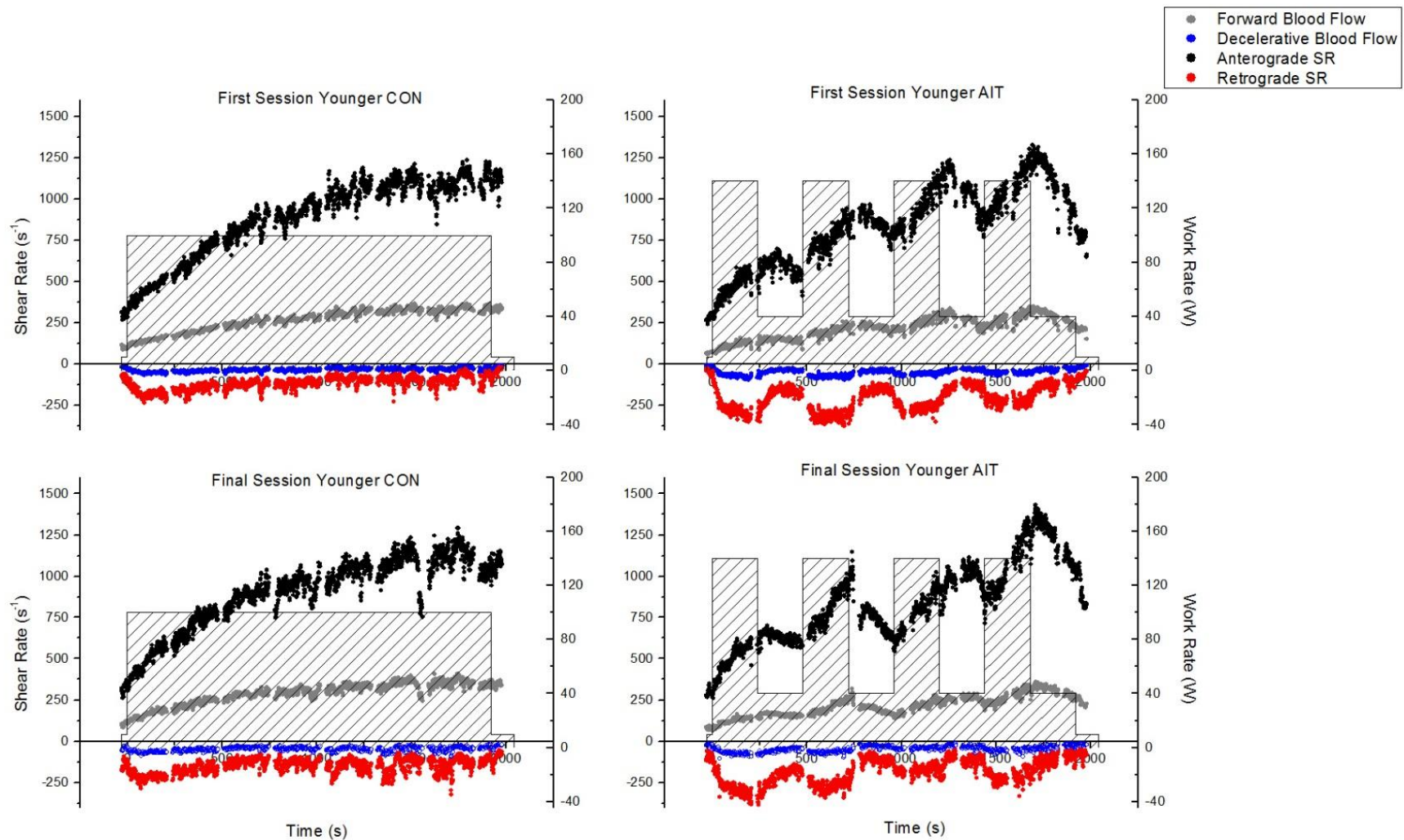

Figure 5.10 Group mean in-exercise second by second anterograde (black circles), forward blood flow (gray circles), backward blood flow (blue circles) and retrograde (red circles) SR patterns for younger participants in the first and final exercise training session divided by exercise protocol (CON v AIT). The shaded area represents the work rate profile for each exercise protocol.

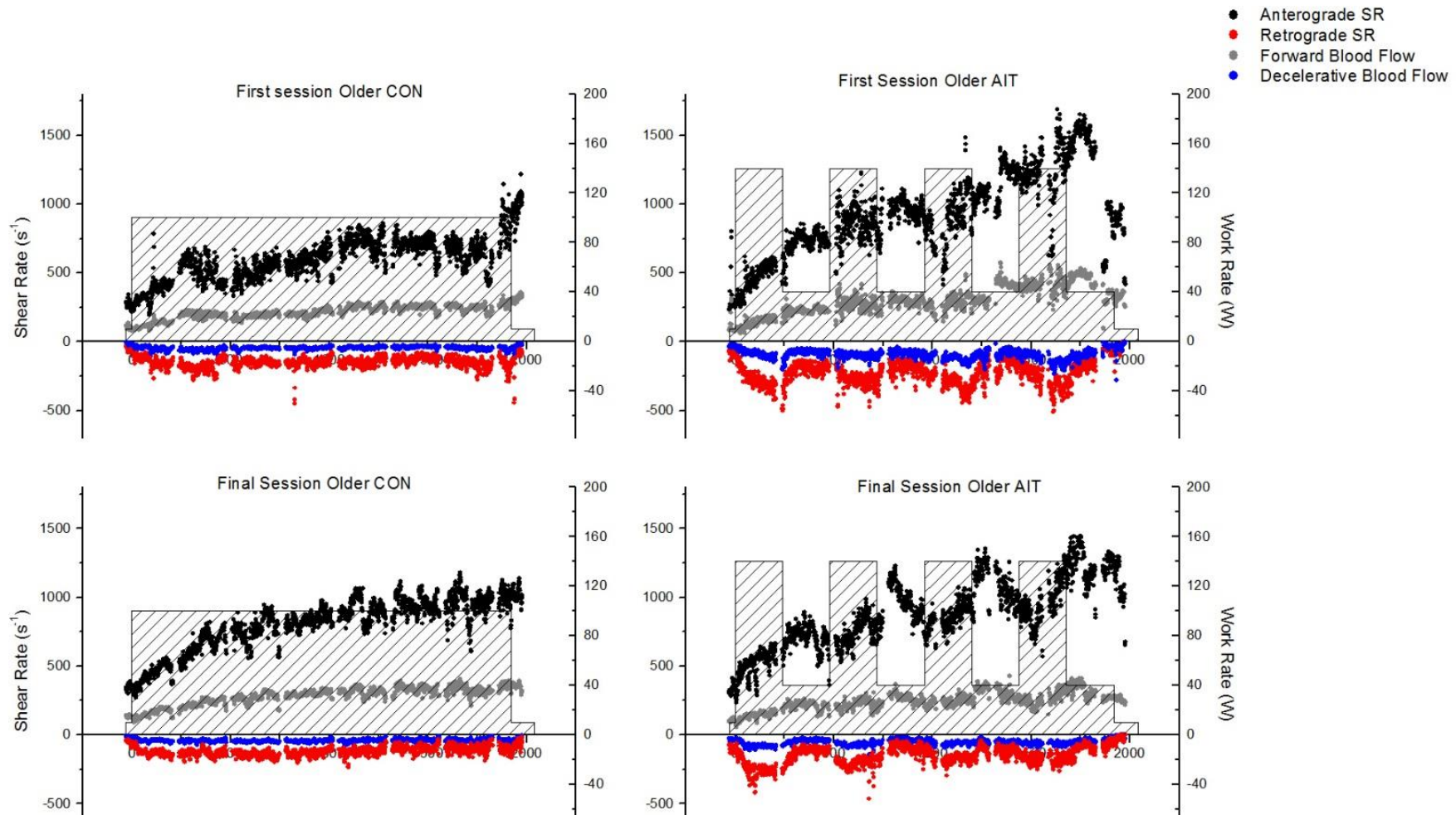

Figure 5.11 Group mean in-exercise second by second anterograde (black circles), forward blood flow (gray circles), backward blood flow (blue circles) and retrograde (red circles) SR patterns for older participants in the first and final exercise training session divided by exercise protocol (CON v AIT). The shaded area represents the work rate profile for each exercise protocol.

Brachial artery diameter during exercise demonstrated a small increase in younger participants with a small decrease in older participants from the first to the final exercise training session (time and age interaction First: Younger 3.68 ± 0.59 mm, Older 3.68 ± 0.69 mm; Final Younger 3.72 ± 0.59 mm, Older 3.65 ± 0.64 mm; $p=0.003$). Additionally, there was a significant interaction between time, age and gender (Younger Female $+0.03$, Male $+0.04$ mm; Older Females $+0.02$, Male -0.09 mm; $p=0.03$, **Figure 5.12**). This indicated that brachial artery diameter recorded throughout exercise increased from the first to the final exercise training session in younger males and females and older females, however a reduction was observed in older males.

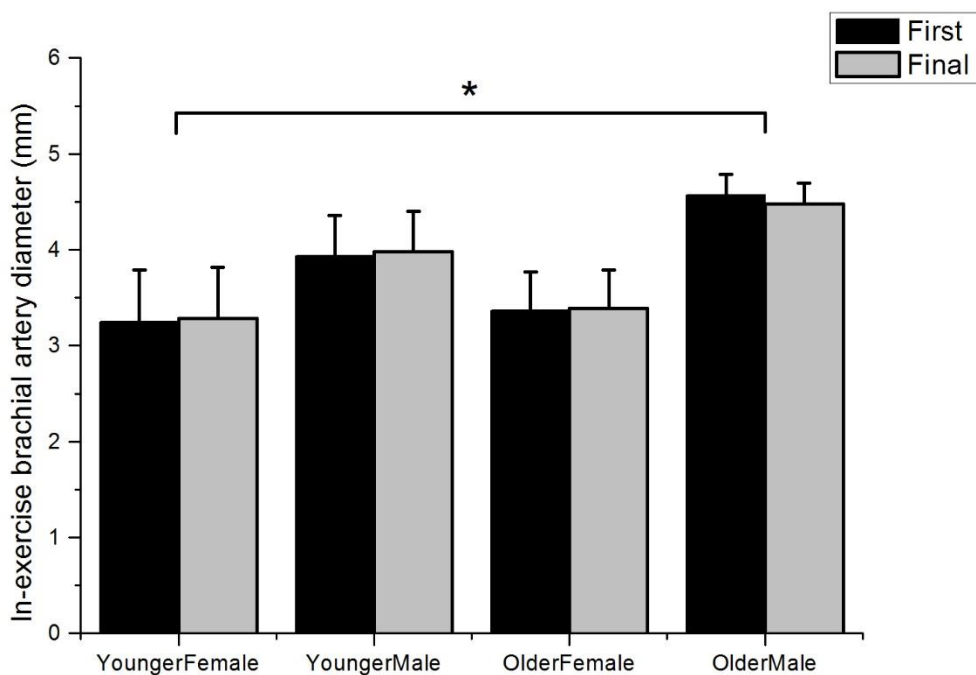

Figure 5.12 Group mean brachial artery diameter recorded during the first and final exercise training sessions divided by age (younger v older) and gender (female v male). There was no change in diameter across the exercise training intervention however there was a significant time by age by gender interaction (* denotes significance at the $p<0.05$ level).

Mean anterograde SR did not change over the 4-week exercise training intervention (95% CI 752.1 – 940.2 s⁻¹, time effect p=0.40, partial η^2 = 0.05, power = 0.82; **Figure 5.13**). Additionally, there was no interaction of age (p=0.88, partial η^2 = 0.004, power = 0.94), gender (p=0.65) or exercise protocol (p=0.17, partial η^2 = 0.10, power = 0.67). Mean anterograde SR and mean HR throughout the recorded sessions were significantly correlated (r=0.46, p=0.001).

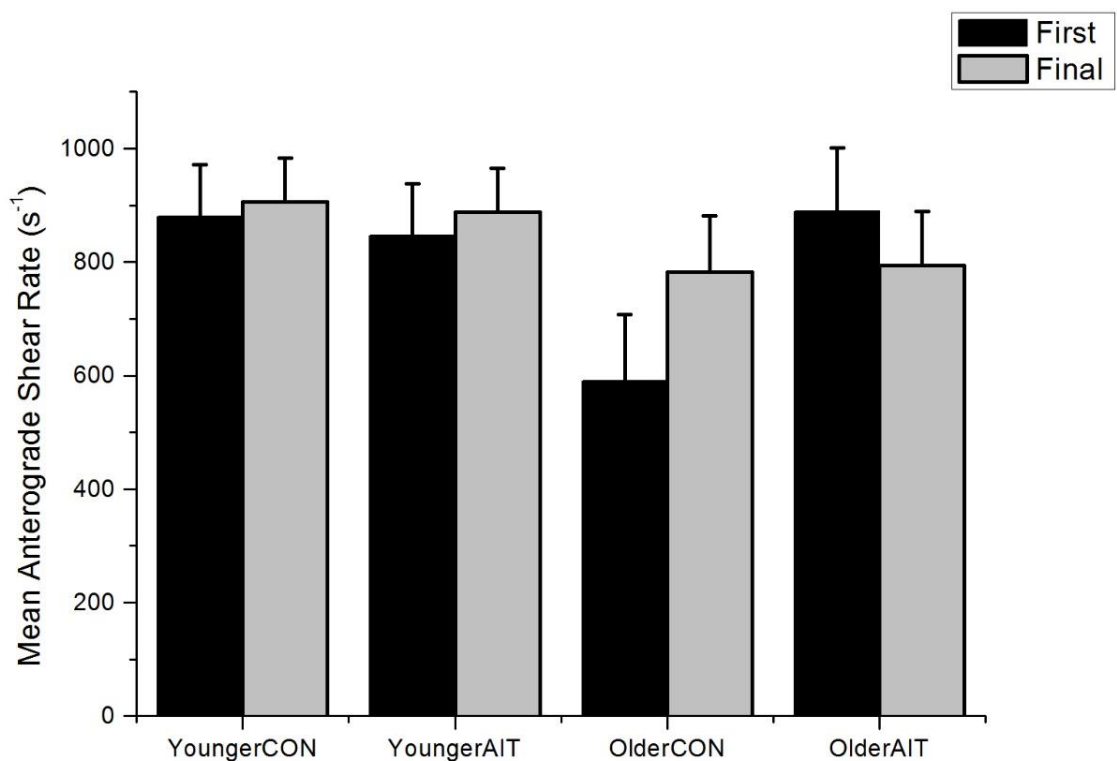

Figure 5.13 Group mean anterograde shear rate determined from the monitored exercise training sessions pre (black bars) and post (grey bars) the exercise training intervention as divided by age groups (young v. older) and exercise training group (CON v. AIT). Data presented as mean±SD. There was no significant change in mean anterograde SR over the exercise training intervention (p>0.05).

Mean retrograde SR decreased with exercise training (95% CI -197.6 – -142.3 s⁻¹, time effect p=0.01, partial η^2 = 0.07, power = 0.75; **Figure 5.14**) although this was not affected by age (p=0.12, partial η^2 = 0.14, power = 0.55), gender (p=0.62) or exercise protocol (p=0.62, partial η^2 = 0.08, power = 0.73). Overall CON exercise induced

lower mean retrograde SR ($-134.58 \pm 78.97 \text{ s}^{-1}$) compared to AIT ($-205.05 \pm 56.96 \text{ s}^{-1}$) exercise (exercise protocol effect $p=0.02$). Mean retrograde SR recorded throughout the exercise sessions was significantly correlated with mean VO_2 ($\% \text{VO}_{2\text{peak}}$; $r = -0.47$, $p=0.001$), mean HR ($r = -0.35$, $p=0.01$) and mean HR ($\% \text{HR}_{\text{peak}}$; $r = -0.32$, $p=0.02$).

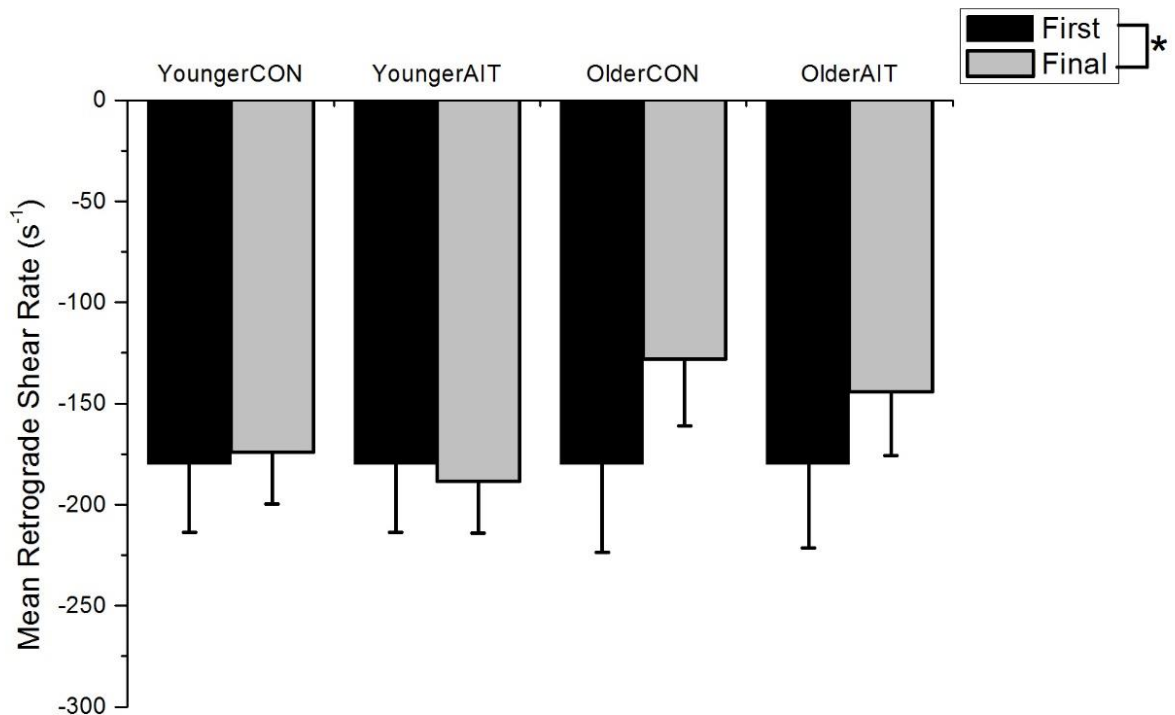

Figure 5.14 Group mean retrograde shear rate determined from the monitored exercise training sessions pre (black bars) and post (grey bars) the exercise training intervention as divided by age groups (young v. older) and exercise training group (CON v. AIT). Data presented as mean \pm SD. * denotes significant time effect at the $p<0.05$ level.

Total anterograde SR was not significantly different across 4 weeks of exercise training (time effect $p=0.22$, 95% CI $1278417 - 1599378 \text{ s}^{-1}$, partial $\eta^2 = 0.07$, power = 0.77). However, total retrograde SR significantly reduced by 11% with training (time effect $p=0.01$, 95% CI $-333983 - -241742 \text{ s}^{-1}$, partial $\eta^2 = 0.06$, power = 0.79). Furthermore, there was no significant interaction of total anterograde and retrograde SR with age (Anterograde SR: $p=0.70$, partial $\eta^2 = 0.01$, power = 0.93; Retrograde SR: $p=0.06$, partial $\eta^2 = 0.14$, power = 0.53), gender ($p>0.05$) or exercise protocol

(Anterograde SR: $p=0.16$, partial $\eta^2 = 0.08$, power = 0.72; Retrograde SR: $p=0.22$, partial $\eta^2 = 0.07$, power = 0.77). Greater volumes of retrograde SR were experienced in the AIT group (CON $-229724 \pm 125808 \text{ s}^{-1}$, AIT $-345684 \pm 131823 \text{ s}^{-1}$; exercise protocol $p=0.03$). Total anterograde SR recorded throughout the exercise sessions was significantly correlated with mean HR ($r=0.46$, $p=0.001$) and maximum HR ($r=0.38$, $p=0.01$). Similarly, total retrograde SR was significantly correlated with mean HR ($r=-0.35$, $p=0.01$) and maximum HR ($r=-0.50$, $p=0.001$).

There was a significant reduction in maximum anterograde SR from the first to the final exercise training session (First $1624 \pm 671 \text{ s}^{-1}$, Final $1589 \pm 420 \text{ s}^{-1}$; time effect $p=0.001$). There was also a significant interaction between time and age and gender (First: Younger Female $1454 \pm 323 \text{ s}^{-1}$, Younger Male $1551 \pm 395 \text{ s}^{-1}$, Older Female $2094 \pm 992 \text{ s}^{-1}$, Older Male $1289 \pm 758 \text{ s}^{-1}$; Final: Younger Female $1520 \pm 429 \text{ s}^{-1}$, Younger Male $1653 \pm 378 \text{ s}^{-1}$, Older Female $1799 \pm 364 \text{ s}^{-1}$, Older Male $1229 \pm 446 \text{ s}^{-1}$; $p=0.04$). This suggested that maximum anterograde SR decreased with training in the older participants only and more so in older females compared to males.

In contrast, maximum retrograde SR did not significantly change across the exercise intervention (time effect $p=0.56$) or demonstrate an interaction with age ($p=0.21$), gender ($p=0.29$) or exercise protocol ($p=0.27$). AIT produced higher maximum retrograde SR than CON (CON $-563 \pm 375 \text{ s}^{-1}$, AIT $-815 \pm 351 \text{ s}^{-1}$; $p=0.02$). Maximum anterograde SR recorded throughout the exercise sessions was significantly correlated with peak VO_2 ($\% \text{VO}_{2\text{peak}}$; $r=0.40$, $p=0.002$) and maximum HR ($r=0.49$, $p=0.001$). Furthermore, maximum retrograde SR recorded throughout the exercise sessions was significantly correlated with peak VO_2 ($\% \text{VO}_{2\text{peak}}$; $r=0.45$, $p=0.01$) and maximum HR ($r=0.41$, $p=0.002$).

Minimum anterograde SR showed a significant interaction between time and gender and exercise protocol (First: Female CON $85 \pm 108 \text{ s}^{-1}$, Female AIT $91 \pm 104 \text{ s}^{-1}$, Male

CON $134 \pm 116 \text{ s}^{-1}$, Male AIT $13 \pm 11 \text{ s}^{-1}$; Final: Female CON $115 \pm 98 \text{ s}^{-1}$, Female AIT $94 \pm 120 \text{ s}^{-1}$, Male CON $140 \pm 117 \text{ s}^{-1}$, Male AIT $57 \pm 70 \text{ s}^{-1}$; $p=0.05$). This showed the greatest increase in minimum anterograde SR from the first to the final exercise training sessions occurred in females in the CON training group and males in the AIT training group. Minimum retrograde SR did not significantly change with training (time effect $p>0.05$) or show an interaction between age ($p>0.05$), gender ($p>0.05$) or exercise protocol ($p>0.05$).

5.3.4.2 Oscillatory shear index during exercise in the first and final exercise training sessions

Mean OSI showed a 10% reduction from the first to the final exercise training session (time effect $p=0.02$, 95% CI 0.17 – 0.22 a.u., partial $\eta^2 = 0.24$, power = 0.36; **Figure 5.15**). There was no change in mean OSI in the younger participants, but a 21% reduction in older participants (time and age interaction $p=0.02$, partial $\eta^2 = 0.24$, power = 0.35). However, there were no significant interactions with gender ($p=0.89$) or exercise protocol ($p=0.76$, partial $\eta^2 = 0.01$, power = 0.94; **Figure 5.15**). Mean OSI recorded throughout the exercise sessions was significantly correlated with maximum HR ($\%HR_{\text{peak}}$; $r=0.33$, $p=0.02$, **Figure 5.16**).

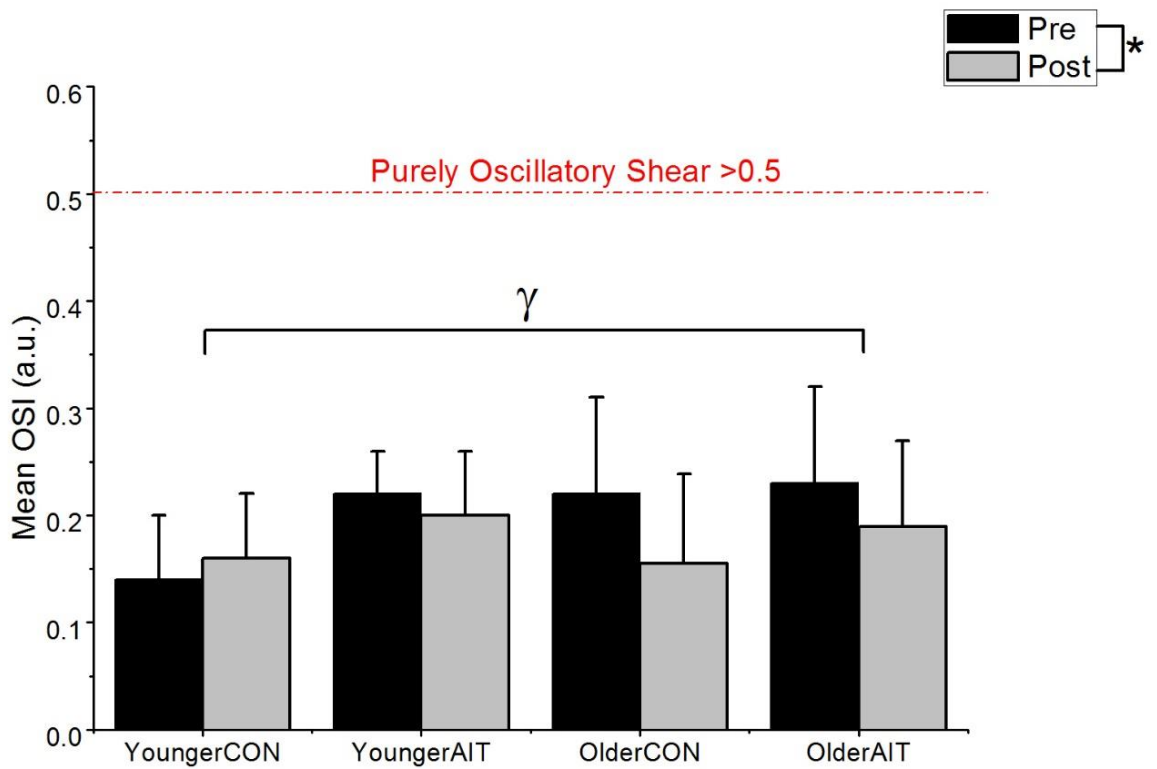

Figure 5.15 Mean OSI determined from the monitored exercise training sessions pre (black bars) and post (grey bars) the exercise training intervention as divided by age groups (young v. older) and exercise training group (CON v. AIT). The red line denotes the cut off (OSI>0.5) of which SR becomes purely oscillatory. Data presented as mean \pm SD. * denotes a significant time effect and γ denotes a significant time by age interaction at the $p<0.05$ level.

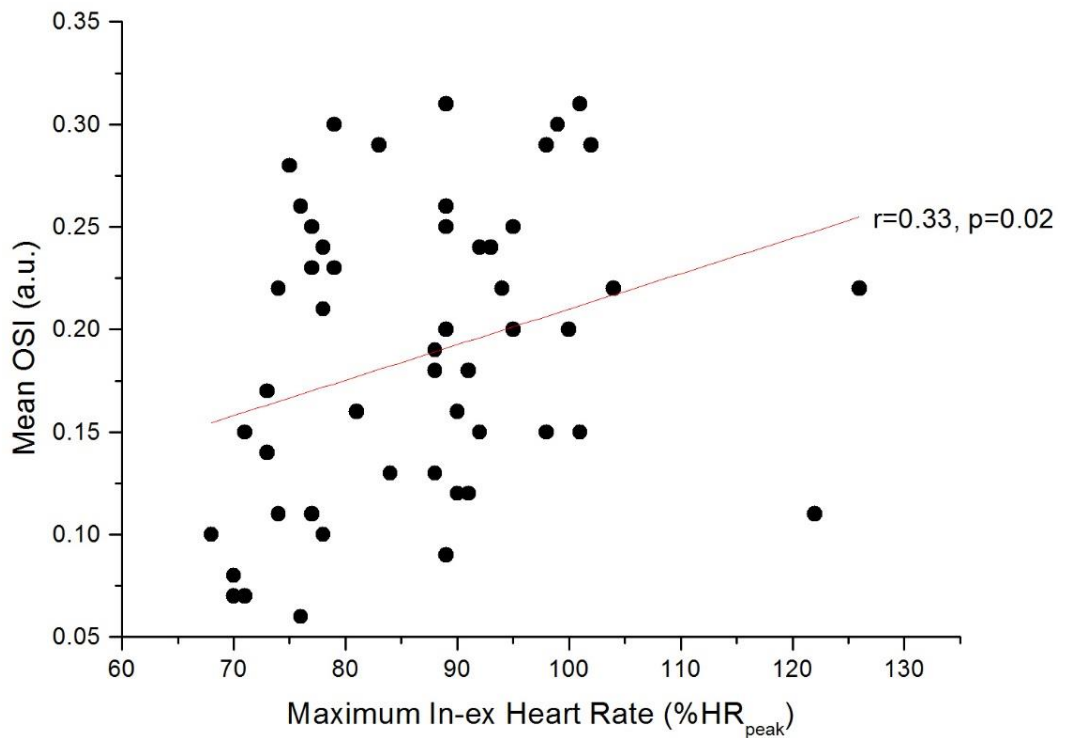

Figure 5.16 Group mean OSI was significantly correlated with group mean maximum in-exercise heart rate (%HR_{peak}) during the first and final exercise training sessions (r=0.33, p=0.02).

Minimum OSI did not significantly change with training (time effect p=0.66) or show an interaction between age (p=0.40), gender (p=0.65) or exercise protocol (p=0.20). Maximum OSI did not significantly change with training (time effect p>0.05). There was a trend for a significant reduction in time spent at OSI>0.5 with training (time

effect $p=0.08$, **Figure 5.17**) with no interaction with age ($p=0.55$), gender ($p=0.11$) or exercise protocol ($p=0.45$).

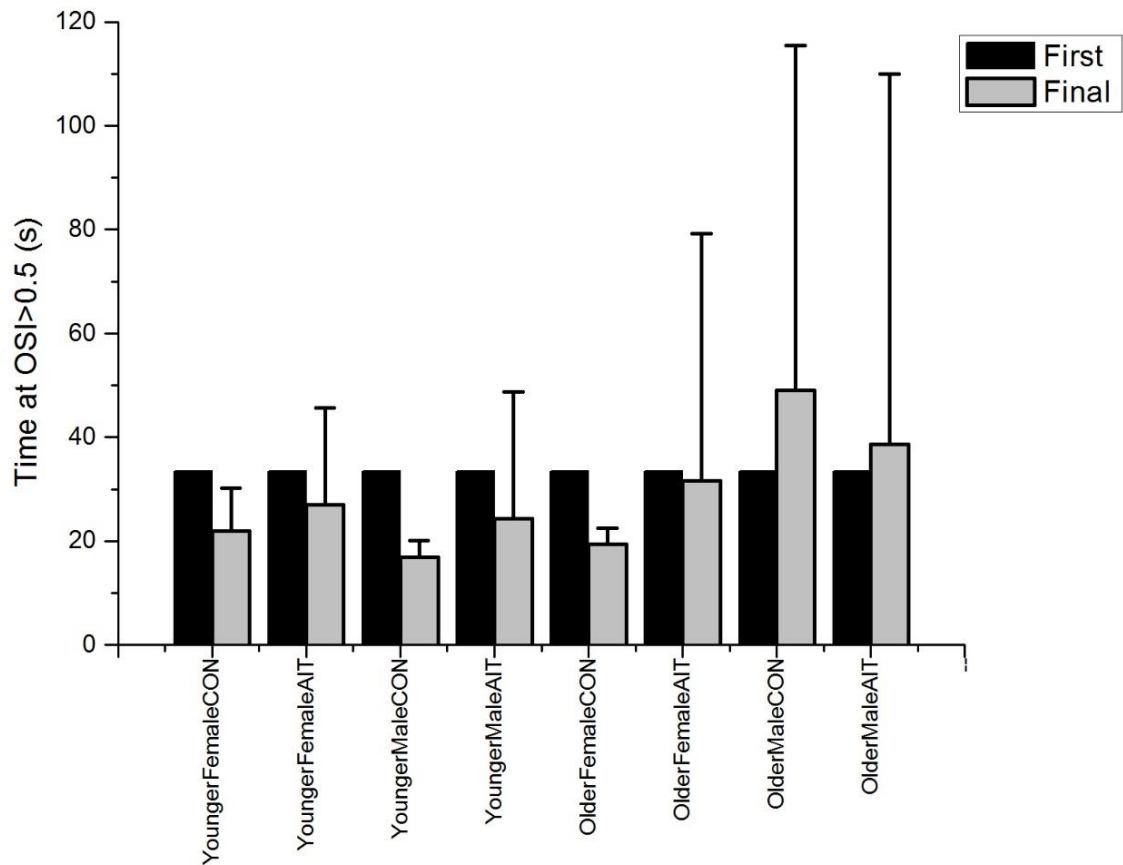

Figure 5.17 Group mean time spent at an OSI greater than 0.5 and thus indicating purely oscillatory shear as determined from the monitored exercise training sessions pre (black bars) and post (grey bars) the exercise training intervention as divided by age groups (young v. older) and exercise training group (CON v. AIT). Data presented as mean \pm SD. There was a trend for a significant reduction with training ($p=0.08$).

5.3.5 Markers of endothelial function following both acute and chronic exercise

Endothelial function was assessed acutely prior to training (FMD 1 v FMD 2). The acute response in endothelial function following exercise training was also assessed (FMD 3 v FMD 4). The chronic endothelial function response to exercise training was assessed by comparing FMD1 with FMD3, see **Figure 5.18**.



Figure 5.18 Schematic of when FMD was recorded in order to assess acute changes in endothelial prior to and following exercise training and to assess chronic endothelial function across the training intervention.

Prior to the training intervention FMD variables were assessed for differences between age groups, gender and exercise protocols. No effects of ageing or exercise protocol were observed ($p > 0.05$). However, females demonstrated significantly lower resting (Females 3.33 ± 0.52 mm, Males 4.13 ± 0.50 mm; $p = 0.001$) and peak (Females 3.56 ± 0.48 mm, Males 4.34 ± 0.49 mm; $p = 0.001$) brachial artery diameter compared to males. Therefore, the aforementioned variables were used as covariates during subsequent analysis of training effects.

5.3.5.1 Responses to acute exercise

This section reviews acute endothelial function pre training (FMD 1 v FMD 2) and acute endothelial function post training (FMD 3 v FMD 4).

Resting brachial artery diameter did not significantly change following acute exercise pre ($p=1.00$) or post training ($p=0.86$, **Table 5.3**). There was also no significant interaction with age ($p=0.22$), gender ($p=0.70$) or exercise protocol ($p=0.55$). Pre training values showed no significant correlations. However, post training, resting brachial artery diameter was significantly correlated with in-exercise parameters of mean anterograde SR ($r=-0.53$, $p=0.004$), maximum anterograde SR ($r= -0.44$, $p=0.02$) and total anterograde SR ($r= -0.54$, $p=0.003$) throughout the final exercise training session.

Peak brachial artery diameter significantly increased following acute exercise pre training ($p=0.001$) but only showed a trend for a significant increase post training ($p=0.07$, **Table 5.3**). There was also no interaction with age ($p=0.70$), gender ($p=0.75$) or exercise protocol ($p=0.75$). Pre training values showed no significant correlations. Post training, peak brachial artery diameter was significantly correlated with mean anterograde SR ($r= -0.53$, $p=0.01$), maximum anterograde SR ($r= -0.44$, $p=0.02$) and total anterograde SR ($r= -0.54$, $p=0.004$) throughout the final exercise training session.

Absolute FMD demonstrated a significant increase following acute exercise pre ($p=0.001$) and post training ($p=0.001$) when resting diameter was used as a covariate (**Figure 5.19**). There was no interaction with age ($p=0.53$), gender ($p=0.81$) or exercise protocol ($p=0.76$). Relative FMD showed a significant increase following acute exercise pre training ($p=0.001$, 95% CI 7.55 – 9.45 %, partial $\eta^2 = 0.13$, power = 0.64), however there was no significant change following acute exercise post training ($p=0.96$, 95% CI 8.32 – 10.79 %, partial $\eta^2 = 0.03$, power = 0.90) when resting diameter was used as a covariate. There was no impact of age ($p=0.70$, partial $\eta^2 =$

0.13, power = 0.88), gender ($p=0.88$) or exercise protocol ($p=0.61$, partial $\eta^2 = 0.16$, power = 0.86) (**Figure 5.21**).

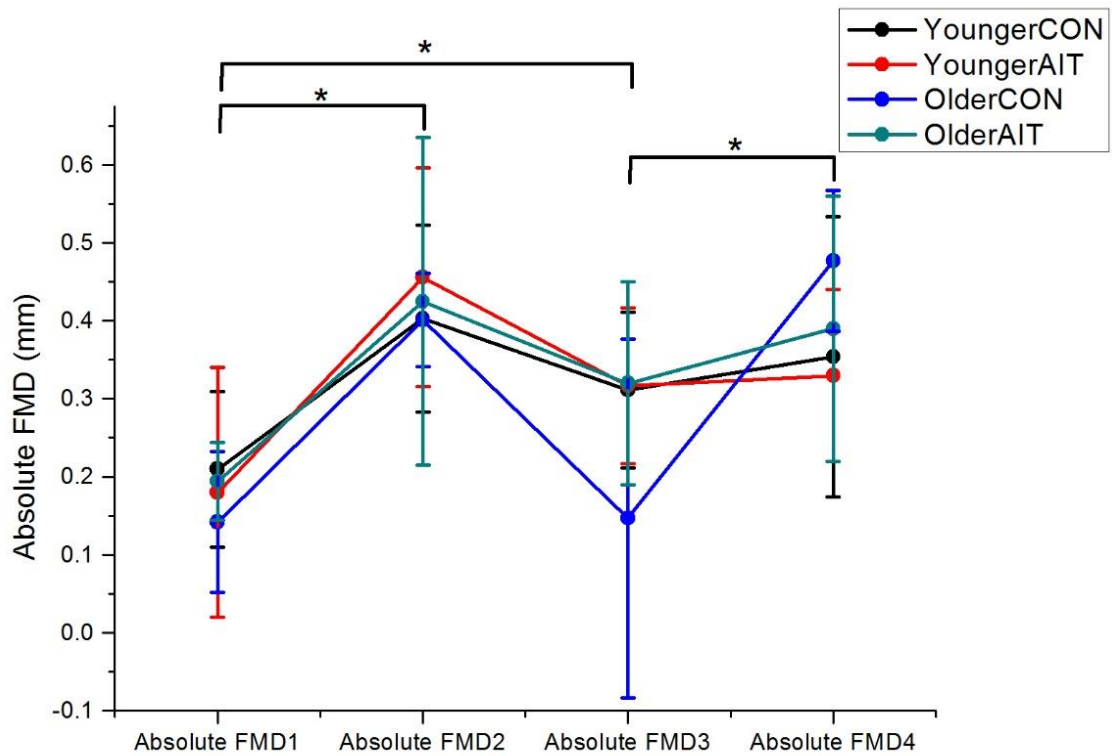

Figure 5.19 Group mean for absolute FMD as divided by age (younger v older) and exercise protocol (CON v AIT), at the four time points: absolute FMD 1 (pre acute exercise and pre training), absolute FMD 2 (post-acute exercise and pre training), absolute FMD 3 (pre acute exercise and post training) and absolute FMD 4 (post-acute exercise and post training). Data presented as mean \pm SD. * indicates significance at the $p<0.05$ level.

The time taken from cuff release to peak diameter during the FMD procedure increased following acute exercise pre training ($p=0.001$), but did not significantly change following acute exercise post training ($p=0.20$, **Figure 5.20**). Additionally, there was a significant time by age interaction ($p=0.03$). Acute exercise pre training produced similar time to peak between young and older participants. Following

training, acute exercise reduced the time to peak diameter in younger participants but extended it in older participants. There was also a significant time by age by exercise protocol interaction for time taken to peak diameter ($p=0.02$) which can be observed in **Figure 5.20**.

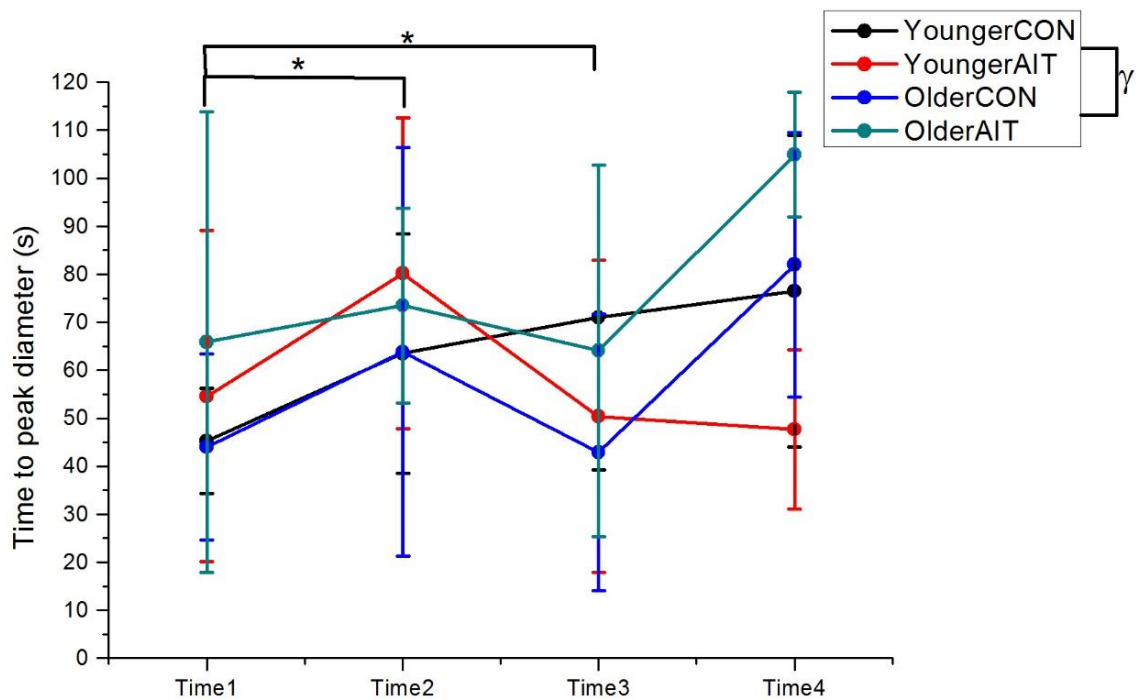

Figure 5.20 The group mean for time between cuff release and peak diameter during FMD compared across age (younger v older) and exercise protocol (CON v AIT) at the four time points: Time 1 (pre acute exercise and pre training), Time 2 (post-acute exercise and pre training), Time 3 (pre acute exercise and post training) and Time 4 (post-acute exercise and post training). * denotes a significant effect of time and Y denotes a significant time by age by exercise protocol interaction at the $p<0.05$ level.

Peak hyperaemia did not change following acute exercise pre ($p=0.40$) or post training ($p=0.18$). Additionally there was no effect of age ($p=0.46$), gender ($p=0.24$) or exercise protocol ($p=0.28$, **Table 5.3**). Peak hyperaemia pre training was significantly correlated with in-exercise mean OSI throughout the first exercise training session ($r=-0.41$, $p=0.04$). Peak hyperaemia post training was significantly correlated with in-

exercise mean anterograde SR ($r=0.40$, $p=0.04$) and total anterograde SR ($r=0.39$, $p=0.04$) during the final exercise training session.

Peak SR did not change following acute exercise pre ($p=0.43$) or post training ($p=0.26$, **Table 5.3**) and there was no effect of age ($p=0.34$), gender ($p=0.40$) or exercise protocol ($p=0.27$). Females had a significantly higher peak SR than males (females $2645 \pm 1072 \text{ s}^{-1}$, males $1872 \pm 575 \text{ s}^{-1}$; $p=0.04$). Pre training values showed no significant correlations. Peak SR post training was significantly correlated with in-exercise mean anterograde SR ($r=0.57$, $p=0.002$) and total anterograde SR ($r=0.56$, $p=0.002$) during the final exercise training session.

Shear rate AUC_{60} did not change following acute exercise pre ($p=1.00$) or post training ($p=1.00$) or demonstrate an interaction with age ($p=0.19$), gender ($p=0.19$) or exercise protocol ($p=0.67$). Females had significantly higher SR AUC_{60} than males (females $47231 \pm 18450 \text{ a.u.}$, males $34471 \pm 9956 \text{ a.u.}$; $p=0.05$). SR AUC_{60} pre training was significantly correlated with in-exercise maximum OSI ($r= -0.41$, $p=0.04$) during the first exercise training session; whilst SR AUC_{60} post training was significantly correlated with in-exercise mean anterograde SR ($r=0.59$, $p=0.001$) and total anterograde SR ($r=0.59$, $p=0.001$) during the final exercise training session.

Additionally, there was no significant change in SR AUC_{90} following acute exercise pre ($p=1.00$) or post training ($p=1.00$, **Table 5.3**) and no interaction with gender ($p=0.39$) or exercise protocol ($p=0.70$). SR AUC_{90} pre training was significantly correlated with in-exercise maximum OSI ($r= -0.50$, $p=0.01$) during the first exercise training session; whilst SR AUC_{60} post training was significantly correlated with mean anterograde SR ($r=0.63$, $p=0.001$) and total anterograde SR ($r=0.63$, $p=0.001$) during the final exercise training session.

5.3.5.2 Responses to chronic exercise training

This section compares endothelial function pre training (FMD 1) and endothelial function post training (FMD 3).

Resting brachial artery diameter ($p=1.00$) and peak brachial artery diameter ($p=1.00$) did not significantly change following chronic exercise training (**Table 5.3**). There was also no significant interaction with age ($p>0.05$), gender ($p>0.05$) or exercise protocol ($p>0.05$).

Absolute FMD significantly increased with exercise training ($p=0.001$) when resting diameter was used as a covariate (**Figure 5.19**). There was no interaction with age ($p=0.53$), gender ($p=0.81$) or exercise protocol ($p=0.76$). Relative FMD showed a significant increase with chronic exercise training ($p=0.001$, 95% CI 5.52 – 8.30 %, partial $\eta^2 = 0.44$, power = 0.13) when resting diameter was used as a covariate. **Figure 5.21** shows the increase in relative FMD following both acute and chronic exercise irrespective of age ($p=0.70$, partial $\eta^2 = 0.13$, power = 0.88), gender ($p=0.88$) or exercise protocol ($p=0.61$, partial $\eta^2 = 0.16$, power = 0.86).

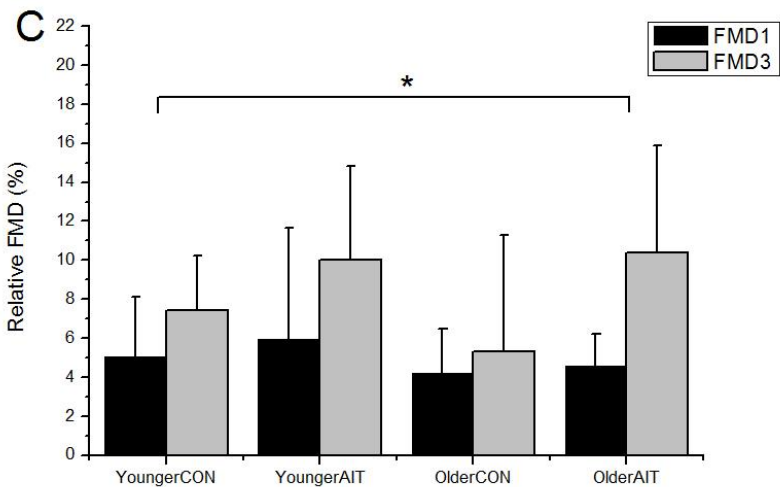
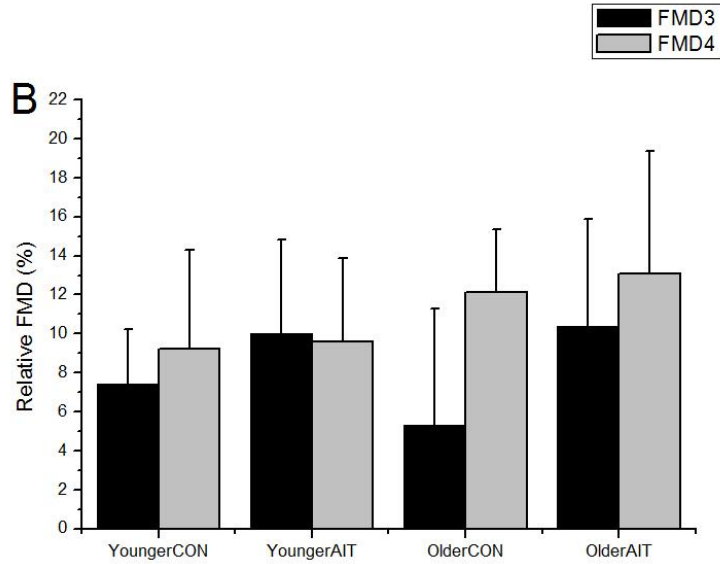
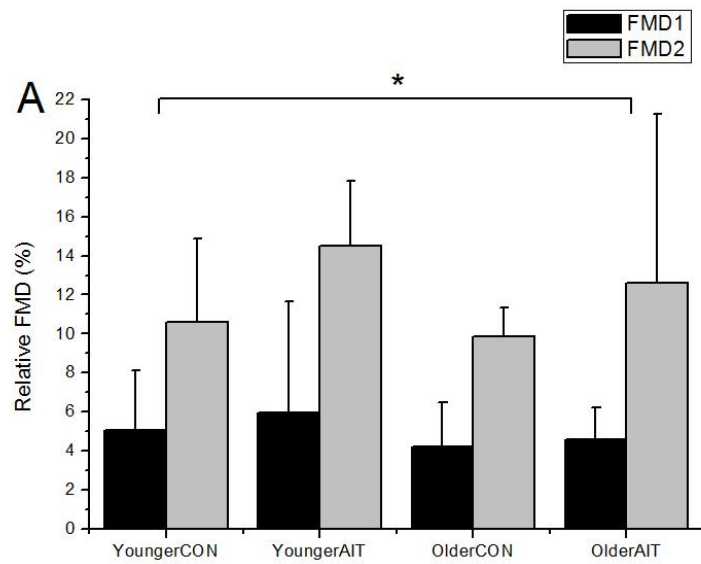

Figure 5.21 Data presented by age (younger v older) and exercise protocol (CON v AIT).

Panel A: the acute relative FMD response prior to the exercise training. Comparing the pre (FMD1; black bars) and post (FMD2; grey bars) showed a significant acute increase in endothelial function.

Panel B: Acute relative FMD response following the 4 week exercise training intervention. Pre (FMD3; black bars) and post (FMD4; grey bars) showed the acute improvement in endothelial function was abolished.

Panel C: The chronic relative FMD response across the 4 week exercise training intervention. Comparing pre (FMD1; black bars) and post (FMD3; grey bars) showed a significant chronic improvement in endothelial function.

(*denotes significant time effect at the $p < 0.05$ level).

The time taken from cuff release to peak diameter during the FMD procedure showed a significant increase with exercise training ($p=0.001$, **Figure 5.20**). Additionally, there was a significant time by age interaction (Delta chronic response: younger 10.8 s; older 8.6 s; $p=0.03$). Time to peak increased with exercise training in both young and older participants, with the greatest increase observed in younger participants with training. There was also a significant time by age by exercise protocol interaction for time taken to peak diameter ($p=0.02$) which can be observed in **Figure 5.20**.

Peak hyperaemia ($p=1.00$) and peak SR ($p=1.00$) did not change with training with no effect of age ($p>0.05$), gender ($p>0.05$) or exercise protocol ($p>0.05$, **Table 5.3**). Shear rate AUC_{60} ($p=1.00$) and SR AUC_{90} ($p=1.00$) did not change following exercise training (**Table 5.3**) or demonstrate an interaction with age ($p>0.05$), gender ($p>0.05$) or exercise protocol ($p>0.05$).

Table 5.3 Parameters of endothelial function as determined via FMD. Groups were divided into exercise protocol (CON v AIT) and the 4 time points at which FMDs were conducted (1 pre acute exercise and pre training; 2 post-acute exercise and pre training; 3 pre acute exercise and post exercise training; 4 post-acute exercise and post training). Data are presented as mean±SD.

	CON				AIT			
	1	2	3	4	1	2	3	4
Resting Diameter (mm)	3.87 ± 0.57	3.88 ± 0.55	3.85 ± 0.57	3.88 ± 0.55	3.47 ± 0.67	3.48 ± 0.69	3.44 ± 0.66	3.52 ± 0.71
Peak Diameter (mm)*	4.05 ± 0.58	4.28 ± 0.53	4.10 ± 0.52	4.27 ± 0.53	3.73 ± 0.64	3.94 ± 0.70	3.76 ± 0.59	3.88 ± 0.68
Peak Hyperaemia (cm/s)	94.5 ± 26.1	103.1 ± 24.5	94.0 ± 22.8	103.4 ± 45.5	93.2 ± 42.4	110.6 ± 35.1	100.5 ± 33.9	115.2 ± 37.4
Peak Shear Rate (s ⁻¹)	2038 ± 790	2172 ± 687	2005 ± 609	2192 ± 1022	2250 ± 1148	2716 ± 1245	2455 ± 1164	2705 ± 1036
AUC ₆₀ (a.u.)	36223 ± 11268	37917 ± 9542	37107 ± 11172	40420 ± 16781	44197 ± 23020	45657 ± 20472	48075 ± 20495	47584 ± 16352
AUC ₉₀ (a.u.)	56172 ± 17147	58528 ± 13612	57512 ± 17492	63466 ± 27603	65591 ± 36155	70271 ± 35659	69518 ± 31156	74768 ± 30685

*denotes a significant acute effect pre training (p<0.05).

5.3.5.3 Scaled responses to acute exercise and chronic exercise training

To remove the influence of resting diameter upon FMD it has been suggested that allometric scaling should be undertaken (Atkinson, 2014). When this process was undertaken in the current study the scaling factor for FMD1 was 0.88, FMD2 was 0.86, FMD3 was 0.81 and FMD4 was 0.88. A four time point ANOVA was used for analysis of changes in both acute and chronic absolute and relative FMD from scaled data.

Absolute FMD showed no change following acute exercise pre training ($p=0.14$), however there was a significant increase following acute exercise post training ($p=0.001$). Relative FMD was significantly increased following acute exercise pre training ($p=0.02$), however post training there was no change following acute exercise in relative FMD ($p=0.09$).

Chronic absolute FMD decreased with training ($p=0.003$). Chronic relative FMD did not change with exercise training ($p=1.00$; **Figure 5.22**). Additionally, no significant effect of age (absolute FMD $p=0.62$; relative FMD $p=0.49$), gender (absolute FMD $p=0.70$; relative FMD $p=0.61$) or exercise protocol (absolute FMD $p=0.73$; relative FMD $p=0.62$) were observed.

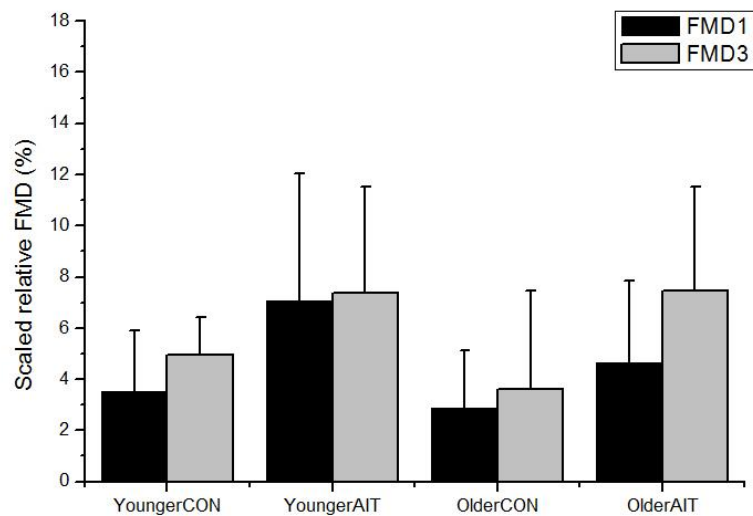
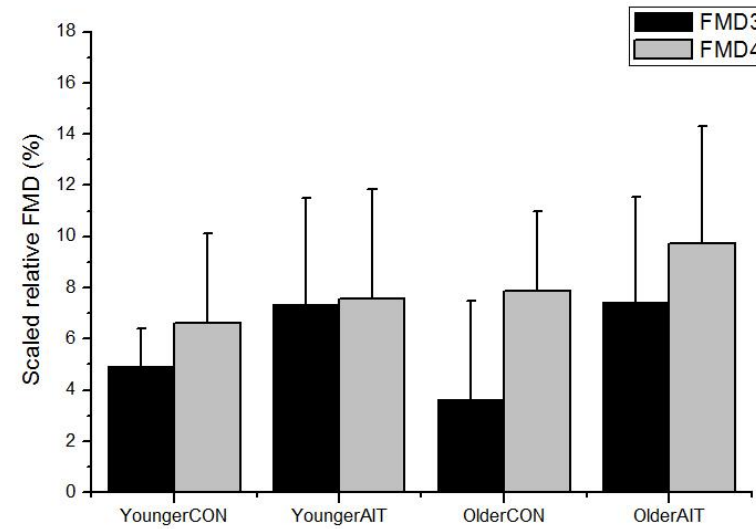
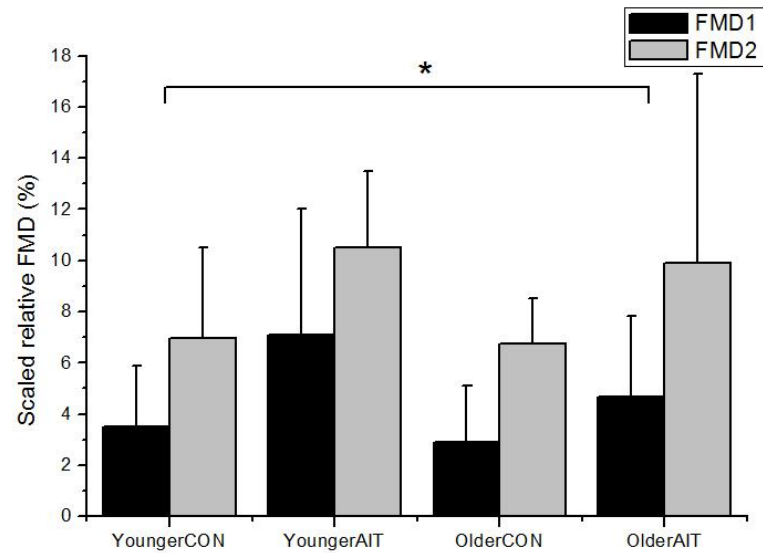

Figure 5.22 Allometrically scaled relative FMD data presented by age (younger v older) and exercise protocol (CON v AIT).

Panel A: the acute scaled relative FMD response prior to the exercise training. Comparing the pre (FMD1; black bars) and post (FMD2; grey bars) showed a significant acute increase in FMD.

Panel B: Acute scaled relative FMD response following the 4 week exercise training intervention. Pre (FMD3; black bars) and post (FMD4; grey bars) showed the acute improvement in endothelial function was abolished.

Panel C: The chronic scaled relative FMD response across the 4 week exercise training intervention. Comparing pre (FMD1; black bars) and post (FMD3; grey bars) showed no significant chronic improvement in endothelial function.

(*denotes significant time effect at the $p < 0.05$ level).

Systolic BP prior to exercise training was significantly correlated with resting ($r=0.62$, $p=0.001$) and peak ($r=0.59$, $p=0.002$) brachial artery diameter 1, absolute FMD 1 ($r=-0.51$, $p=0.01$), relative FMD 1 ($r=-0.56$, $p=0.01$) and AUC_{60} 1 ($r=-0.39$, $p=0.05$). Pre systolic BP was also correlated with resting ($r=0.56$, $p=0.003$) and peak ($r=0.57$, $p=0.002$) brachial artery diameter 2, peak SR 2 ($r=-0.40$, $p=0.05$), AUC_{60} 2 ($r=-0.43$, $p=0.03$) and AUC_{90} 2 ($r=-0.39$, $p=0.05$). Additionally, post training systolic BP was significantly correlated with AUC_{60} 3 ($r=-0.43$, $p=0.03$) and AUC_{90} 3 ($r=-0.40$, $p=0.05$).

5.3.6 Parameters of carotid stiffness with training

In this section variables assessed prior to and following training are referred to with the terms “pre” and “post”. Parameters of carotid artery stiffness were assessed for differences between age groups, gender and exercise protocols prior to training. No effects of gender or exercise protocol were observed ($p>0.05$). However, a significant ageing effect was observed. Near wall IMT ($p=0.001$), far wall IMT ($p=0.01$), beta-stiffness index ($p=0.001$, **Figure 5.23**) and carotid artery diameter ($p=0.002$) were higher in older compared to younger participants. Diameter distensibility (DD; $p=0.001$), cross-sectional distensibility (CSD; $p=0.001$), diameter compliance (DC; $p=0.04$), cross-sectional compliance (CSC; $p=0.002$), and incremental elastic modulus (IEM; $p=0.001$) were lower in older compared to younger participants. Therefore, the aforementioned variables were used as covariates during subsequent analysis of training effects.

Beta stiffness index, near wall IMT, DD, CSD and CSC did not change following the chronic exercise intervention (time effect $p>0.05$, **Table 5.4**). Additionally, these parameters showed no interactions with age, gender or exercise protocol ($p>0.05$). However, far wall IMT, carotid artery diameter, DC and IEM all demonstrated a time effect ($p<0.05$, **Table 5.4**) irrespective of gender ($p>0.05$) or exercise protocol ($p>0.05$). Far wall IMT decreased by 3% in young and increased by 15% in older

participants (time by age interaction $p=0.02$). DC increased by 14% in young and decreased by 36% in older participants (time by age interaction $p=0.01$). Vessel diameter and IEM increased with training ($p<0.05$) but did not show an effect of ageing ($p>0.05$).

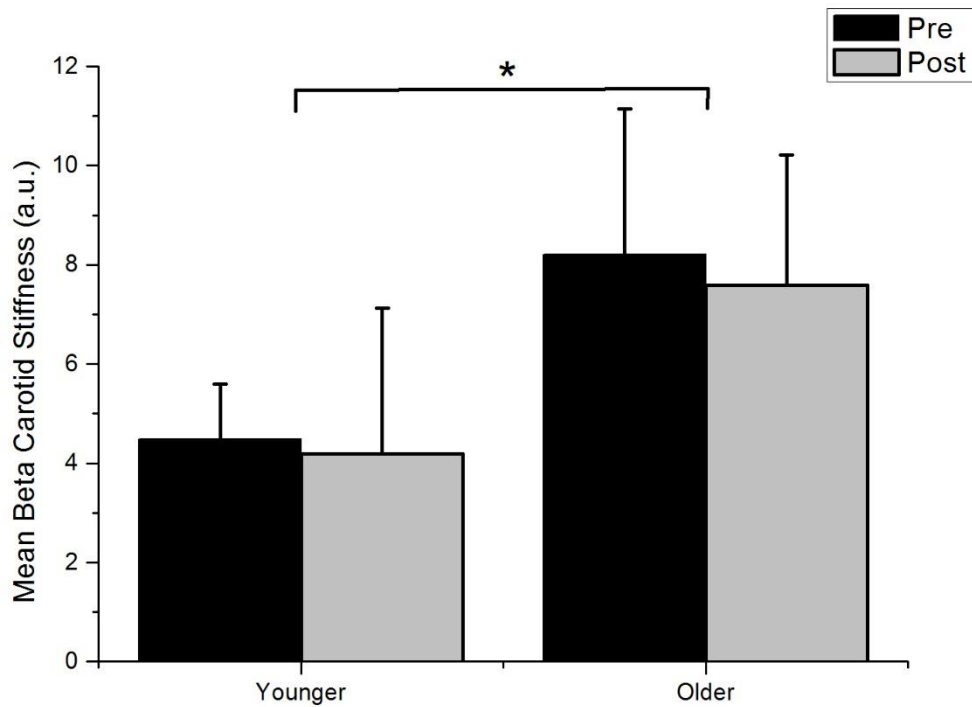

Figure 5.23 Group mean beta stiffness index determined pre (black bars) and post (grey bars) the exercise training intervention as divided by age group (young v. older). Data presented as mean \pm SD.

Table 5.4 Parameters of carotid stiffness across the 4 week exercise training intervention (pre v. post) as divided by age (young v. older). Data presented as mean±SD.

	Younger		Older	
	Pre	Post	Pre	Post
Near Wall IMT (mm)	0.53 ± 0.12	0.57 ± 0.09	0.78 ± 0.12	0.74 ± 0.14
Far Wall IMT (mm) *†	0.43 ± 0.17	0.46 ± 0.12	0.64 ± 0.17	0.64 ± 0.14
Carotid Diameter (mm) *	6.53±0.41	6.55 ± 0.49	7.50 ± 0.99	7.50 ± 0.91
DD (%)	10.77 ± 2.87	11.68 ± 3.96	5.38 ± 1.59	5.68 ± 2.20
CSD (%)	22.79 ± 6.35	25.10 ± 9.31	11.08 ± 3.35	11.89 ± 4.44
DC (mm/mmHg) *†	0.02 ± 0.01	0.02 ± 0.01	0.01 ± 0.004	0.01 ± 0.004
CSC (mm²/mmHg)	0.17 ± 0.04	0.18 ± 0.05	0.13 ± 0.09	0.13 ± 0.05
IEM (mmHg) *	1022 ± 266	967 ± 253	2090 ± 823	2051 ± 908

* denotes significant time effect at the p<0.05 level

† denotes significant time by age interaction at the p<0.05 level

Diameter compliance (DC) recorded throughout the exercise sessions was significantly correlated with mean anterograde SR ($r=0.36$, $p=0.01$) and total anterograde SR ($r=0.35$, $p=0.01$). Pre and post IEM was significantly correlated with mean anterograde ($r=-0.40$, $p=0.004$) and total anterograde SR ($r=-0.40$, $p=0.003$) recorded throughout the exercise sessions. Beta stiffness index recorded throughout the exercise sessions was significantly correlated with mean anterograde SR ($r=-0.42$, $p=0.002$) and total anterograde SR ($r=-0.42$, $p=0.002$, **Figure 5.24**).

Additionally, DC prior to the exercise training intervention was significantly correlated with absolute ($r=0.48$, $p=0.01$) and relative FMD 1 ($r=0.42$, $p=0.04$) only. Cross-sectional compliance (CSC) following the exercise training intervention was significantly correlated with absolute FMD4 ($r=-0.40$, $p=0.04$); post training IEM was also correlated with absolute FMD4 ($r=0.39$, $p=0.05$) only.

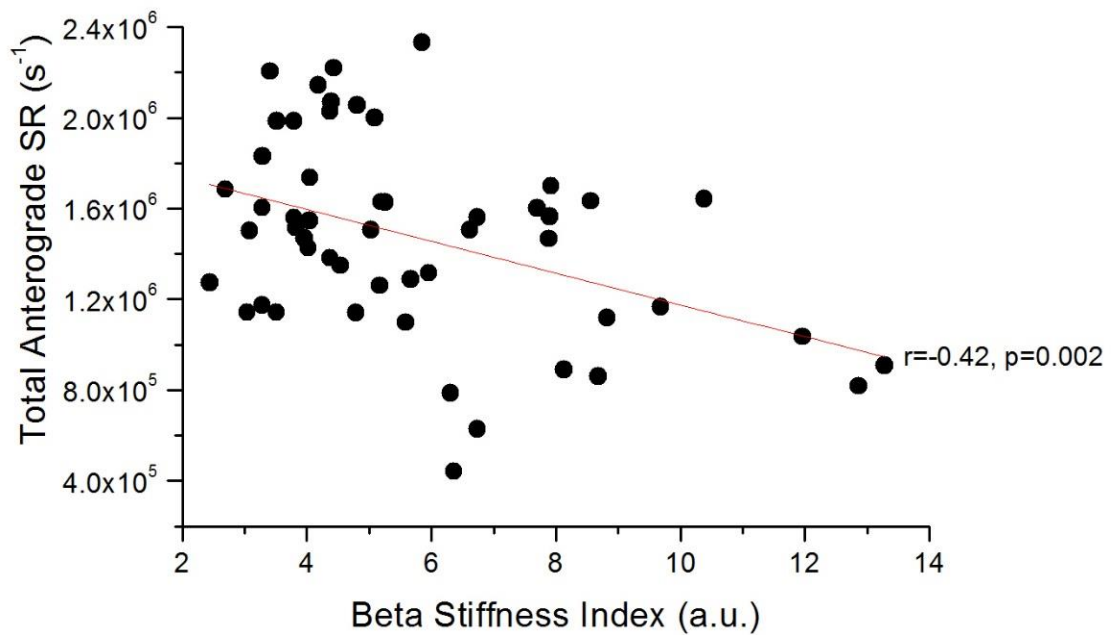

Figure 5.24 Carotid beta stiffness index pre and post exercise training was significantly correlated with total anterograde shear rate during the first and final exercise training session across all groups ($r=-0.42$, $p=0.002$).

5.3.7 MicroRNA-21

In this section variables assessed prior to and following training are referred to with the terms “pre” and “post”. No significant pre-exercise training differences in levels of miR-21 (%cel-miR-39) were observed between exercise protocols ($p=0.18$), age groups ($p=0.70$) or genders ($p=0.31$). However, there was a large standard deviation between pre-training miR-21 (%cel-miR-39) expression thus pre-training values were subsequently used as a covariate. Following the exercise training intervention circulating miR-21 (%cel-miR-39) showed a significant increase pre to post training (time effect $p=0.01$, **Figure 5.25**). However, there was no significant interaction with age ($p=0.97$), gender ($p=0.85$) or exercise protocol ($p=0.24$). There were no correlations between miR-21 (%cel-miR-39) pre and post training with markers of vascular health or in-exercise SR parameters measured in the current study ($p>0.05$).

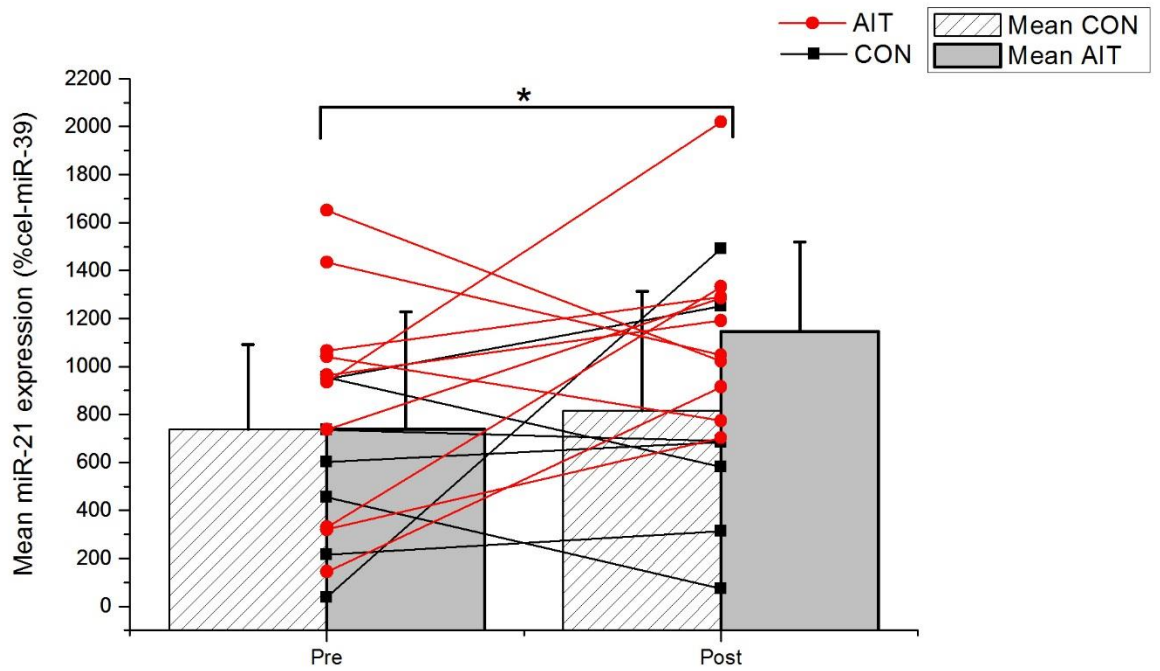

Figure 5.25. Mean miR-21 expression (%cel-miR-39) pre and post 4 weeks of exercise training. Individual data is also presented for the CON (black squares) and AIT (red circles) groups, pre and post training. There was a significant effect of time ($p=0.01$) but no interaction with exercise protocol ($p=0.24$). Data are presented as mean \pm SD. * denotes significant time effect at the $p<0.05$ level.

5.4 Discussion

The novel aspect of this study was the comparison of CON and AIT in-exercise SR patterns across a chronic exercise training intervention and the interaction of ageing and gender upon these SR patterns. The study also aimed to determine whether AIT and CON exercise-induced SR patterns differentially affected acute and chronic measures of vascular health across age and genders. It was hypothesised that SR patterns would differ between AIT and CON exercise protocols, genders, age groups and from pre-to post exercise training. Different anterograde and retrograde SR patterns were observed between exercise groups with AIT inducing higher volumes of retrograde SR compared to CON. Mean and total retrograde SR decreased from the first to the final exercise training session with no change in anterograde SR and no apparent influence of gender or age upon these patterns. Prior to training endothelial function increased immediately after exercise irrespective of the exercise protocol undertaken. Both 4 week exercise training protocols also improved resting endothelial function. However, acute endothelial function following training appeared to be blunted compared to pre-training acute endothelial function. Carotid artery stiffness was higher in older participants irrespective of gender and was unchanged with exercise training. MiR-21 expression increased with training, again no effect of SR pattern, age or gender was evident.

5.4.1 Participant characteristics across the exercise training intervention

Participants recruited into this current study were free of known CVD. Prior to training, older participants had higher systolic blood pressure (BP), pulse pressure (PP) and mean arterial pressure (MAP) than younger participants. Ageing effects upon elevations in blood pressure are well known and have been described previously (Franklin et al., 1997). Increased systolic BP with age is often accompanied by no

change or a reduction in diastolic BP resulting in increased PP (Franklin et al., 1997). Age related changes in systolic BP have been attributed to increases in vascular resistance and increased central arterial stiffness, whilst reductions in diastolic BP are a product of aortic stiffening and a reduction of the elastic reservoir capacity (Franklin et al., 1997). This results in less blood in the aorta at the beginning of diastole resulting in lower diastolic BP (Franklin et al., 1997). In the current study, older participants were shown to have significantly higher carotid artery stiffness compared to younger participants which may account for higher systolic BP in older participants. Females were also shown to have lower systolic and diastolic BP compared to males prior to training in the present study. This was not unexpected as males regularly present with higher blood pressure compared to females (Rossi et al., 2011). Females have higher levels of oestrogen receptors within arteries compared to males and oestrogen is known to have potent vasodilatory properties (Nakamura et al., 2005) which likely contributes to consistently lower blood pressures in females.

5.4.1.1 Minor changes in blood pressure following exercise training

Minor changes were observed in blood pressure measures (SBP, DBP, PP, MAP) over the 4-week exercise intervention, however day to day variability likely accounts for the small changes observed which were within the standard deviations of measurement. However, even minor changes in BP can be clinically relevant as longer term reductions of 5 mmHg in systolic BP have been associated with a 7% reduction in all-cause mortality (Stamler et al., 1989). It is possible that 4 weeks of exercise training was not a sufficient duration in which to make clinically relevant changes in blood pressure. More likely, blood pressure for both younger and older participants was within a clinically healthy range and therefore it is unlikely that exercise would significantly improve already healthy blood pressure values.

5.4.1.2 Weight was reduced with exercise training

Prior to training, weight was lower in females than males as was expected, likely due to the smaller stature of females. Weight decreased across the 4-week exercise training intervention irrespective of exercise group. Despite a statistically significant reduction in weight, observation of the data shows a 0.5 kg reduction from pre-to post exercise training which may be accounted for by simple day to day variability. Previous studies have also shown no effect of exercise training upon weight (Little et al., 2011). This may have been due to the short training period and relatively low energy expenditure in the current study which may not have produced a large enough energy deficit to induce weight loss.

5.4.2 Cardiorespiratory fitness changes over the course of exercise training

Prior to the training intervention gender effects upon exercise tolerance measures were observed. Females displayed lower absolute and relative VO_{2peak} and lactate threshold values compared to males. Females are typically smaller in stature and have a lower proportion of muscle mass and higher fat mass compared to males, therefore contributing to lower VO_{2peak} values. Prior to training HR_{peak} and relative VO_{2peak} were lower in older compared to younger participants. This is unsurprising as maximal HR is known to reduce with age probably as a result of reductions in intrinsic heart rate and β -adrenergic responsiveness (Christou and Seals, 2008). Additionally, VO_{2max} has been shown to decline with age by 9% per decade in males and 7.5% in females, this has been attributed to decreases in muscle mass with age (Fleg and Lakatta, 1988).

5.4.2.1 Exercise mediated reductions in resting HR

Resting heart rate was reduced across the 4-week exercise training period, with the greatest decrease observed in females following CON and males following AIT

training. Thus, exercise protocol appears to exert differing effects upon resting HR depending upon gender. Variations in heart rate between genders have been reported previously, with females typically showing lower resting HR to males (Carter et al., 2003). This is due to females having higher levels of parasympathetic activity compared to males, who demonstrate higher levels of sympathetic activity until 60 years of age (Carter et al., 2003). After this age it has been reported that gender differences are abolished, likely due to females going through the menopause (Carter et al., 2003). It has therefore been suggested that sex steroids may also have a role in controlling resting HR (Carter et al., 2003).

In the current study, reductions in resting HR were also accompanied by increases in absolute and relative VO_2 and LT following the exercise intervention. As exercise tolerance improves, resting HR reduces and is therefore suggested to be an indicator of improved physical fitness and reduced mortality risk (Greenland et al., 1999). Reductions in resting HR with endurance exercise training have been shown in previous studies and are apparent in both genders and across young and older participants (Carter et al., 2003), although no ageing effects were demonstrated in the current study. Reductions in resting HR with exercise training are a result of increases in parasympathetic activity and potentially changes in intrinsic HR, in addition to improvements in stroke volume (Carter et al., 2003). Although, few studies have compared differential effects of interval versus continuous type exercise training upon resting heart rate. Therefore, the reason for greater improvements in females following CON and in males following AIT remains unclear. Effects upon resting HR with training are in direct contrast to changes in VO_{2peak} and LT with training. Older females showed greater improvements following AIT versus males where the greatest improvements were shown following CON training.

5.4.2.2 Parameters of exercise tolerance improved with exercise training

Exercise tolerance measures (resting HR, LT and VO_{2peak}) improve quickly following the introduction of a new exercise stimulus (Gibala and McGee, 2008). Furthermore, for a 1 ml/kg/min improvement in relative VO_{2peak} there is a 15% reduction in all cause and CVD specific mortality (Keteyian et al., 2008). In the current study, relative VO_{2peak} was not statistically improved with training, however there was a 2.4 ml/kg/min improvement across all groups suggesting a reduction in all-cause mortality. Previous studies have demonstrated a differential effect of IT and CON type exercise upon markers of exercise tolerance (Tjønnå et al., 2008, Wisløff et al., 2007). In the current study, AIT and CON training were equally effective in improving absolute VO_{2peak} in younger males and females. In contrast, absolute VO_{2peak} improved more in older females following AIT training and following CON training in older males. This suggests that different types of exercise may be more suited to certain populations, based upon age and gender when considering improvements in exercise tolerance. Indeed, differential effects of AIT and CON exercise have previously been reported (Helgerud et al., 2007, Kemi et al., 2005, Tjønnå et al., 2008) although differences between genders have not been explored. AIT appears to improve VO_{2peak} and corresponds with improvements in stroke volume not seen with CON type exercise training (Helgerud et al., 2007, Tjønnå et al., 2008). This may suggest systemic changes following AIT training.

It has also been reported that improvements in VO_{2peak} are dependent upon fitness level, individuals of lower fitness prior to the start of training demonstrate greater improvements compared to those of higher fitness (Helgerud et al., 2007). In the present study, pre training VO_{2peak} was used as a covariate during analysis to account for initial fitness levels. Additionally, in the present study AIT was of a higher exercise

intensity to CON exercise training. Exercise intensity is an important determinant for improvements in VO_{2peak} , cardiomyocyte dimensions and contractile capacity, potentially due to the higher heart rates attained (Kemi et al., 2005). In the present study, it may be hypothesised that cardiorespiratory fitness improved more in older females following AIT training as a result of greater central adaptations due to working at a higher exercise intensity and higher HR. In contrast, CON training may have induced greater improvements in cardiorespiratory fitness in older males due to comparably higher work rates used than older females which may have induced greater peripheral muscular adaptations. This is an important consideration when prescribing exercise for specific populations.

5.4.3 VO_2 and HR recorded during the first and final exercise training sessions

Potential group differences between in-exercise VO_2 and HR were assessed at the first exercise training session. Ageing did not affect any in-exercise variables however gender effects were shown. Females displayed lower mean VO_2 , peak VO_2 , mean WR and mean energy expenditure in the first exercise session compared to males. As discussed in the previous section (5.4.2), gender differences in VO_2 are potentially due to differences in proportions of muscle and fat mass between genders (Sparling, 1980). Additionally, work rate during the exercise sessions was lower in females as a consequence of their smaller size and lower VO_{2peak} . During the first exercise session, an effect of exercise protocol was evident in mean VO_2 , peak VO_2 , mean HR, and maximum HR. In the present study, a more pragmatic approach was taken to exercise prescription whereby exercise was prescribed at 85-90% HR_{peak} for AIT and 65-70% HR_{peak} for CON, as determined from the pre-training RIT. Therefore, the aforementioned variables were significantly higher in the AIT protocol compared to CON.

Intensity and patterns of CON and AIT exercise protocols used in this current study were intentionally different. The different work rate profiles of CON and AIT exercise protocols were reflected in the patterns of the VO_2 and HR responses. This design was used to attempt to induce different volumes and patterns of anterograde and retrograde SR. Opting for a pragmatic approach to exercise prescription of intensity allowed monitoring during exercise training sessions, therefore work rate could be adjusted as exercise tolerance improved. Indeed, mean WR of the exercise training sessions progressed equivalently in both exercise protocols over the exercise training period. Furthermore, mean and peak VO_2 throughout the exercise sessions increased over 4 weeks of training and increased more so following CON exercise training. Interestingly, whilst mean WR progressed with training there was no differential effect of exercise training protocol. The increase in mean and peak VO_2 may be attributed to improvements in VO_{2peak} , LT and resting HR with training. AIT and CON training were equally effective in improving absolute VO_{2peak} and lactate threshold in younger males and females. However, older females benefitted more from AIT training and older males from CON training. The greater increases in mean and peak VO_2 observed following CON training may be attributed to superior improvements in cardiorespiratory fitness in older males which, although not significant, was demonstrated through an increase in mean WR of 12.1% in CON and a 9.6% increase in AIT training.

Mean HR throughout the exercise sessions demonstrated small increases in younger participants with small decreases shown in older participants from the first to the final exercise session. However, the changes in mean HR in both young and older groups were minor and are probably accounted for by day to day variability. Alternatively, increases in stroke volume may precede exercise training induced reductions in heart rate. The lack of difference in mean HR between protocols is likely due to the inclusion

of 4-minute active recovery periods in the AIT protocol, thus lowering the mean HR despite higher peak HR compared to CON. In regards to exercise intensity, it is unclear whether peak VO_2 and HR attained during the exercise session or the mean across the entire session are the most important stimulus for driving physiological adaptations. In the current study, there was no differential impact of CON v AIT upon measures of endothelial function which may suggest mean exercise intensity is more important than the peaks attained for this variable only. In particular, this study relied upon exercise as a stimulus for inducing SR, therefore it is important to understand how exercise intensity may affect blood flow and SR. Maximum HR was higher in AIT compared to CON due to the prescription of the exercise training as discussed earlier. From the first to the final exercise session maximum HR attained varied slightly, however upon observation of standard deviations of the measurement it is likely this can be accounted for by day to day variability.

5.4.3.1 Exercise induced changes in plasma volume and thermoregulation

With exercise training thermoregulation becomes more efficient, in so much as the onset of sweating occurs earlier, and is directly related to the fitness of the individuals (Convertino, 1991). Therefore, as individuals undergo exercise training and increase their cardiorespiratory fitness, as was shown to occur in the current study, thermoregulatory response during an exercise session is likely to be altered. The small changes in in-exercise heart rate from the first to the final exercise training session may be attributed to changes in plasma volume and thermoregulation (Convertino, 1991), although these were not measured in the current study. Exercise training may also alter plasma volume. In exercise training studies hypervolemia reached a plateau after 1 week of exercise training, with this initial blood volume expansion explained by increased plasma volume and no change in red blood cell

mass (Convertino, 1991). This effect does not appear to be gender specific but ageing may have an impact upon the time course of the exercise induced changes (Convertino, 1991). Indeed in the current study, older and younger participants showed different responses to exercise training with regards to mean HR during the exercise sessions.

Hypervolemia and thermoregulation may be associated, as reduced blood volume has been shown to produce a higher core temperature during exercise (Convertino, 1991). Indeed, increased heat dissipation during exercise with hypervolemia demonstrates the contribution of volume to increased sweating and skin blood flow (Convertino, 1991). Importantly, hypervolemia caused by endurance exercise training is associated with reduced heart rate and an elevated stroke volume during exercise (Convertino, 1983). Hypervolemia is associated with elevated central venous pressure at rest and during exercise which is associated with the increase in stroke volume (Convertino et al., 1991). The elevation of stroke volume during exercise may result from greater venous return and right atrial filling pressure (Convertino et al., 1991). It has been suggested that a 1% increase in plasma volume is associated with a 1% reduction in heart rate during exercise (Convertino, 1991).

In the first exercise session females demonstrated lower mean energy expenditure throughout both AIT and CON exercise compared to males. This was probably due the lower work rates required for females completing the exercise sessions. It did appear that energy expenditure increased in both exercise groups over the course of the 4-week exercise training intervention. This was concomitant with an increase in work rate over the exercise training intervention and likely the reason for increases in energy expenditure.

5.4.4 In-exercise shear rate during the first and final exercise training sessions

As in the first study of this thesis, both anterograde and retrograde SR patterns followed the WR profile, HR and VO_2 throughout CON and AIT exercise. Indeed, anterograde SR was positively correlated with mean HR during the exercise session, whilst retrograde SR was negatively correlated with mean HR. This suggests that the patterns of both anterograde and retrograde SR during the exercise protocols were related HR, which was dependent upon the work rate profile of the exercise session. Prior to training higher mean and total retrograde SR were also attained during AIT compared to CON. Mean and peak HR were higher throughout AIT prior to training, which according to the negative correlation would result in higher volumes of retrograde SR. Females were shown to have lower brachial artery diameter compared to males during exercise. This gender difference has also been shown in previous studies (Joannides et al., 2002). It is probably as a result of differences in stature between males and females which affects vessel calibre in order to effectively control blood pressure.

Patterns of both anterograde and retrograde SR were not observed to change with training which is unsurprising as the work rate profile and the HR patterns were also unchanged with training. Mean and total anterograde SR were not different between AIT and CON exercise protocols throughout the first exercise session and were unchanged with 4-weeks of exercise training, with no influence of age or gender. In contrast, mean and total in-exercise retrograde SR reduced with training irrespective of exercise protocol, age or gender. Reductions in retrograde SR with training may be due to improved NO bioavailability which reduces total peripheral resistance (Green et al., 2017). Therefore, at the onset of exercise upstream retrograde SR is reduced. AIT exercise produced higher maximum retrograde SR compared to CON with no apparent influence of age, gender or exercise training. This was probably as a result of the greater requirements of HR, VO_2 and work rate.

Conversely, maximum anterograde SR decreased with exercise training in both exercise protocols. Importantly, no change in maximum anterograde SR was shown in younger participants with training, whereas older participants did demonstrate a reduction which was greatest in older females. As there were no changes in arterial diameter, reductions in maximum anterograde SR may have been due to decreases in peripheral resistance in older participants as a result of changes in autonomic control with training (Green et al., 2017). Ageing increases sympathetic nervous activity (Matsukawa et al., 1998) and may be reduced following exercise training (Joyner and Green, 2009). Additionally, younger females show less sympathetic nervous activity to younger males which becomes equivalent between genders with age (Matsukawa et al., 1998). Therefore, with exercise training reductions in sympathetic activity in females may lead to reductions in vascular resistance producing greater reductions in SR with training.

5.4.4.1 Ageing influences in-exercise shear rate

Previous studies have shown ageing effects upon SR patterns which were not demonstrated in the present study. Young et al. (2010) reported reductions in anterograde and retrograde SR at rest in older compared to younger adults. The changes in SR pattern were attributed to increased downstream peripheral resistance in older individuals, possibly due to increased sympathetic nerve activity or circulating vasoconstrictors (Young et al., 2010). Casey et al. (2016) also showed retrograde SR and OSI were higher in older compared to younger populations although no differences in vascular resistance were reported between age groups. In contrast to these previous studies, there was no apparent ageing effects upon in-exercise anterograde or retrograde SR observed in the current study. This is consistent with Padilla et al. (2011b) who reported age related increases in retrograde SR and OSI were abolished at the onset of exercise. Resting volumes and patterns of SR between

younger and older participants were not evaluated in the current study. It is therefore possible, that the lack of age-related difference in retrograde SR and OSI observed during exercise in the current study was due to the measurement of these variables during exercise and not at rest.

Padilla et al. (2011b) suggested age related increases in retrograde SR and OSI at rest may be as a result of reductions in NO bioavailability in resistance vessels, thus increasing downstream peripheral resistance. This theory was supported when eNOS was inhibited in the forearm circulation of younger participants, resulting in elevated retrograde and oscillatory SR in the brachial artery the levels of which were comparable to older adults (Padilla et al., 2011b). However, no impairment in NO dependent endothelial function was found suggesting mechanisms other than impairment of the NO pathway were responsible for increased peripheral resistance and changes in upstream SR patterns (Padilla et al., 2011b). Similarly, in the current study there was no difference in endothelial function between young and older groups suggesting NO vasodilatory pathways were functioning normally. It may therefore be hypothesised that, at the onset of exercise the abolishment of age related differences in SR patterns is due to reduced peripheral resistance through NO mediated vasodilation and mechanisms associated with exercise induced thermoregulation (Simmons et al., 2011).

Further mechanisms have been proposed for age related differences in SR patterns such as VSMC impairment (Montero et al., 2015), increased arterial stiffness (Heffernan et al., 2013) or increased sympathetic nerve activity (Matsukawa et al., 1998). Whilst sympathetic nerve activity and functionality of the VSMCs were not explored in the current thesis, carotid artery stiffness was higher in the older compared to the younger population in the present study. Arterial stiffness may be related to increases in wave reflection intensity (Heffernan et al., 2013) which can

contribute to flow reversal and retrograde SR (O'Rourke and Avolio, 1980). However, despite greater arterial stiffness in the older population of this study no differences in volumes of in-exercise retrograde SR were shown between young and older participants.

5.4.4.2 Gender influences upon in-exercise shear rate

Gender differences in SR at rest or during exercise have not been comprehensively explored within the literature. Studies which have investigated the influence of gender upon SR patterns have not reported any differences between males and females (Dammers et al., Cheng et al., 2003). In contrast, Joannides et al. (2002) did report a difference in mean shear rates between genders when assessing the stimulus for FMD. Females appeared to have higher mean SR compared to males which was attributed to smaller vessel diameter (Joannides et al., 2002), as determined by Poiseuille's Law. Whilst in-exercise brachial artery diameter was smaller than males in the current study, this did not appear to affect the volumes of anterograde and retrograde SR during exercise.

5.4.4.3 Oscillatory shear rate during exercise from the first to the final exercise training session is affected by age

Using parameters of OSI as defined by Padilla et al. (2010), mean OSI in the first and final exercise sessions suggests predominantly laminar SR was experienced across both AIT and CON protocols and across age groups. Younger participants did not demonstrate a change in mean OSI with training whilst older participants showed a decrease. OSI is comprised of ratios of anterograde to retrograde SR, whilst mean retrograde SR was reduced with training there was no apparent effect of ageing. However, upon observation of **Figure 5.14** it does appear that there was a greater reduction in mean retrograde SR in older participants. Over the course of the 4-week exercise training intervention there was no change in mean OSI in the younger

population whilst there was a 21% reduction observed in the older population irrespective of the exercise protocol. This reduction in mean OSI reflects the reduction in retrograde SR observed with training. This suggests greater volumes of purely laminar SR were experienced throughout exercise as training progressed. Mean OSI showed a weak to moderate positive correlation with maximum HR attained throughout exercise, therefore if exercise intensity increased causing an increase in maximum HR, mean OSI may become more oscillatory. However, further research is required.

Group differences were assessed at the first exercise training session and showed that time spent at an $OSI > 0.5$ was higher in the older population compared to the younger population and did not appear to be affected by the type of exercise prescribed in the intervention. Furthermore, training did not change time spent at an $OSI > 0.5$ in any group. Previous studies have reported higher volumes of oscillatory SR in older adults, potentially as a result of increased vascular resistance, through increases in vasoconstrictors or sympathetic nerve activity (Young et al., 2010). Whilst volumes of OSI did not differ between age groups in the current study, the aforementioned factors may have contributed to the greater amount of time spent at an $OSI > 0.5$ in older adults.

5.4.5 Acute and chronic endothelial function

Prior to acute and chronic exercise, variables associated with measurement of FMD were assessed for differences between groups (age, gender and exercise protocol). In contrast to previous studies, no difference in any FMD variables were affected by age. Older individuals did not demonstrate impaired endothelial function in the current study, despite age-related declines in endothelial function reported in the literature (Celermajer et al., 1994, Eskurza et al., 2005, Donato et al., 2007). Older adults in the current study were free of known CVD risk factors, which may explain preserved

endothelial function. However, declines in endothelial function with age are independent of accumulation of traditional CVD risk factors (Seals et al., 2011). Previous studies have suggested that ageing impairs FMD through alterations in vasomotor balance resulting in decreased NO, reviewed in detail in section 2.2.1.2.

There were no differences in variables associated with FMD between participants, randomised to AIT and CON exercise groups prior to acute and chronic exercise. Resting and peak brachial artery diameter were smaller in females compared to males which has been observed in previous literature (Joannides et al., 2002). A smaller arterial diameter is likely as a result of the smaller stature of females. Smaller vessel diameters can produce greater vasodilation which is a reason allometric scaling may be necessary to remove the influence of resting diameter (Atkinson, 2014). Smaller diameter may also be responsible for inducing higher shear rates due to Poiseuille's Law which demonstrates the powerful effect of arterial diameter in determining shear stress (see section 2.1.4). However, SR during FMD was not influenced by gender in the current study.

5.4.5.1 Endothelial function pre and post-acute exercise prior to and following exercise training

Acute endothelial function was assessed prior to and following the exercise intervention to determine how changes in acute endothelial function were affected by chronic exercise – induced SR. Resting brachial artery diameter was not affected by acute exercise prior to or following exercise training suggesting changes in vasodilation were not influenced by structural changes in resting diameter. Acute endothelial function prior to training increased in all groups irrespective of age, gender or exercise protocol. Therefore, as in the first study of this thesis, SR pattern did not appear to influence acute endothelial function. This is despite AIT exercise inducing greater mean and total volumes of retrograde SR compared to CON exercise.

Retrograde SR has previously been associated with impaired endothelial function measured via FMD (Thijssen et al., 2009b). However, this was not reflected in acute FMD. Additionally, mean OSI during the first exercise session indicated that both exercise protocols induced predominantly laminar SR which is associated with an anti-atherogenic endothelial cell phenotype and healthy endothelial function.

It has recently been argued that FMD should be allometrically scaled to account for the significant influence of resting diameter upon absolute and relative FMD. When FMD was scaled in the current thesis, the increase in acute FMD prior to training remained. The stimulus for vasodilation, as measured via FMD, is reactive hyperaemia whereby rapid increases in blood flow and SR induce upregulation of NO to stimulate vasodilation. Acute changes in peak hyperaemia and shear rate were not observed prior to training suggesting that improvement in acute FMD was not dependent upon increases in the stimulus.

Acute endothelial function following exercise training appeared to be blunted when compared with acute endothelial function prior to training. This effect was irrespective of age, gender or exercise protocol. Whilst there still appeared to be an acute increase in both scaled and unscaled FMD following training this was no longer statistically significant. Anterograde SR did not change from the first to the last exercise training session however, retrograde SR was reduced. To attain an acute improvement in endothelial function following the exercise training intervention, the intensity of the final session i.e. mean VO_2 and HR could be increased. It was earlier shown that mean HR in particular was associated with in-exercise SR which is hypothesised to be the stimulus for acute increases in FMD. However, increasing exercise intensity to further increase NO bioavailability requires caution as previous research has shown high intensity exercise to impair acute FMD (Bailey et al., 2017, Yoo et al., 2017) likely as a result of increases in ROS production which degrades NO (section 2.3.1.1.1).

Additionally, blunting of acute FMD following exercise training may be due to the chronic improvement in endothelial function with exercise training. Chronic exercise training may result in eNOS functioning at capacity to produce NO, therefore an acute exercise bout is unable to immediately increase eNOS transcription within the endothelial cell nucleus to further increase NO production.

5.4.5.2 Resting endothelial function across the exercise training intervention

Chronic endothelial function was assessed pre exercise prior to and following the exercise training intervention. This allowed the chronic effect of exercise-induced SR upon endothelial function to be assessed. Resting brachial artery diameter did not change with training suggesting no structural adaptations occurred. FMD increased with chronic exercise training irrespective of age, gender or exercise protocol. Previous studies that have shown improvements in chronic endothelial function over a short training intervention such as the four weeks used in the present study (Tinken et al., 2008). Chronic improvements in endothelial function with exercise training are likely as a result of regular increases in exercise-induced shear stress (Higashi and Yoshizumi, 2004), upregulating eNOS gene expression thus increasing basal NO bioavailability (Sessa et al., 1994, Kingwell et al., 1997). In particular, AIT training has been shown to be more effective than traditional CON exercise for improvement in endothelial function over 12 weeks, when prescribed at the same intensities used in the current study (Wisløff et al., 2007). However, the population this was assessed in was a patient population with known cardiovascular disease. It has been argued that improvements in endothelial function with exercise are easier to achieve in populations with impaired endothelial function to start with (Green et al., 2017). Therefore, in the current study AIT exercise training does not appear to be superior in improving chronic endothelial function but importantly produces equivalent

improvements to traditional CON training offering an effective alternative way of exercising. Importantly, a 1% improvement in has been associated with a 13% risk reduction for a cardiovascular event occurring (Green et al., 2011).

5.4.6 Carotid artery stiffness pre and post exercise training

Previous studies have reported increases in carotid artery stiffness parameters accompanied by reductions in distensibility and compliance in older compared to younger populations (Zaydun et al., 2006). Older participants in the current study had significantly stiffer arteries and reduced compliance and distensibility compared to younger participants prior to training, despite being free known CVD risk factors. Mitchell et al. (2004) also observed a deterioration in arterial compliance with age despite a favourable vascular profile and limited traditional CVD risk factors. Increased carotid artery diameter with age is also an important factor in assessment of arterial stiffness and was observed in the present study. It suggests potential loss of elastic fibres (Van der Heijden-Spek et al., 2000) at the same time as an increase in collagen fibres (Lebrun et al., 2002) resulting in greater structural reliance upon collagen producing a stiffer vessel (Thijssen et al., 2016). Furthermore, IMT was significantly higher in older versus younger participants. Previous literature has suggested that an IMT of >0.95 mm places individuals at high risk of developing coronary heart disease (Bard et al., 2004). In the present study, older participants presented with mean IMT between 0.64-0.78 mm suggesting the older population had an intermediate risk (0.60-0.95 mm) of developing coronary heart disease according to previous criteria (Bard et al., 2004). Unlike CVD risk which shows a clear effect of gender there did not appear to be an effect of gender upon carotid artery stiffness, distensibility or compliance in the current study.

Previous studies have shown that carotid artery stiffness, distensibility and compliance are modifiable through use of exercise interventions (Matsuda et al.,

1993, Tanaka et al., 2000, Green et al., 2010b). Exercise protocols used within this study were selected to induce different patterns of SR with the aim of differentially modifying markers of vascular health. However, the 4-week exercise training intervention used in the current study only affected far wall IMT, carotid artery diameter, diameter compliance and incremental elastic modulus with no effect of exercise protocol and therefore SR pattern. The small changes in compliance over the short training intervention may be attributed to functional changes in improved vasodilatory capacity and less related to structural adaptations (Sugawara et al., 2007). Indeed, endothelial function was improved with exercise training in the current study suggesting an increased NO upregulation. This resulted in improved vasomotor tone which has been associated with reductions in arterial stiffness (Zieman et al., 2005).

The time course for improvements in vascular health with exercise have shown that changes in endothelial function via increased NO production are required before structural adaptations (Green et al., 2017). Therefore, it is likely that the duration of the exercise intervention in the current study was not sufficient to induce structural adaptations which would result in modification of carotid artery beta stiffness index, IMT and distensibility. Whilst endothelial function can improve over a few short weeks, changes in arterial stiffness have been shown following 10-24 weeks of exercise training (Sugawara et al., 2006, Tanaka et al., 2000, Green et al., 2010b). Therefore, if the current exercise intervention was extended in duration, perhaps to 12 weeks, changes in markers of carotid artery stiffness are more likely to be observed.

Whilst SR patterns and volumes have been suggested to play an important role in preventing and reversing endothelial dysfunction there has not been a clear role for SR in modifying arterial structure. It has been suggested that structural adaptations may be more reliant upon changes in pressure within the vessel which alter the

stretch of the artery and can change lumen diameter and wall thickness (Joyner, 2000). As blood pressure was not measured during the exercise training interventions it is unclear how the exercise protocols used in this study may have altered the stretch of the vessel. Exercise increases systolic BP during exercise with little change in diastolic BP, thus increasing pulsatile pressure on the arterial wall. This has been suggested to increase elastin synthesis (Matsuda et al., 1993) or reduce cross linking (Joyner, 2000) to reduce arterial stiffness. Resting systolic BP, PP and MAP prior to exercise training were higher in older compared to younger participants in the present study. This may be attributed to increased arterial stiffness with age (Franklin et al., 1997). Following exercise training in the present study, systolic BP showed a trend for a minor increase whilst diastolic BP decreased slightly, resulting in increased pulse pressure with training across all groups. This may suggest exercise training resulted in increased stretch of the artery and reduced arterial stiffness. However, whether pattern of exercise i.e. IT exercise produces greater changes in pulsatile pressure throughout an exercise session compared to CON is yet to be determined.

Previous studies assessing the effect of chronic exercise interventions upon carotid artery stiffness have found no differential effect of IT versus CON exercise (Rakobowchuk et al., 2008, Rakobowchuk et al., 2012b). Therefore, if the duration of the exercise intervention was extended in this study there may be no benefit of one type of exercise over the other. Additionally, improvements in carotid artery stiffness with exercise may only be observed in the older population as they demonstrate signs of progressive arterial stiffness which may be reversible. In contrast, the younger population did not exhibit signs of stiffness therefore they have no requirement for improvement in carotid artery stiffness and would be unlikely to show changes over 12 weeks of exercise training.

Overall, non-invasive ultrasound assessment of carotid artery stiffness may serve as an important clinical tool to identify those at greater risk of developing chronic and acute CVD. Artery stiffness is known to be an early step in the development of atherosclerotic plaque formation and may provide an early marker which may allow early interventions to slow or reverse progression to full plaque development. Plaque development is known to occur near to the bulb and bifurcation in the carotid artery and therefore the assessment of this artery is likely to highly relevant to CVD prognosis.

5.4.7 Chronic miR-21 expression

Circulating miR-21 expression was assessed in the plasma pre-and post the exercise training intervention. In the previous study of this thesis (Chapter 4), it was proposed that miR-21 may be a potential biomarker of exercise-induced SR which may alter endothelial cell phenotype. Furthermore, miR-21 has been suggested to be a flow-sensitive miR with overexpression of miR-21 appearing to have a dual role (Kumar et al., 2014) as it responds to both laminar (Weber et al., 2010) and oscillatory shear stress (Zhou et al., 2011).

In the present study, pre-training miR-21 did not show any ageing, gender or exercise protocol effects. However, high variability between participants was demonstrated and therefore pre-training values were used as a covariate during subsequent analysis. So far, the effects of ageing and gender upon miR-21 expression have not been explored in the literature. Circulating miR-21 expression was increased by the exercise training intervention. However, there was no differential effect of the exercise protocols suggesting the difference in retrograde SR volumes between AIT and CON did not influence expression.

5.4.7.1 Acute versus chronic expression of miR-21 following exercise

In the previous study of this thesis (Chapter 4), acute miR-21 expression was reduced 6 hours post exercise irrespective of type of exercise (CON or IT). This was in contrast to a previous study by Baggish et al. (2011) who showed an upregulation following acute maximal exercise. Baggish et al. (2011) also explored the effect of 90 days of exercise training upon chronic miR-21 expression. There was an elevation in circulating miR-21 expression following the exercise training period (Baggish et al., 2011), thus supporting the increase in miR-21 expression found following the training intervention in the current study. Increases in miR-21 expression with chronic exercise is likely due to either transcriptional or post-transcriptional processing of intra-cellular microRNA (Baggish et al., 2011). Another potential mechanism for increased circulating miR-21 expression over time is through changes in plasma volume (Baggish et al., 2011). Exercise training typically increases plasma volume resulting in haemodilution which may affect levels of microRNA detected within the circulation (Baggish et al., 2011). Plasma volume was not measured in the present study therefore its influence over detection of circulating miR-21 cannot be ascertained.

5.4.7.2 Association between in-exercise shear rate and miR-21 expression

Whilst miR-21 expression was not correlated with in-exercise anterograde or anterograde SR, in vitro studies have shown shear stress to be important regulators of miR-21 expression (Weber et al., 2010, Zhou et al., 2011). Analysis of in-exercise shear rates in the present study demonstrated that mean and total retrograde SR were highest throughout AIT exercise, with training there was a reduction in retrograde SR with no influence of exercise protocol. Higher retrograde SR suggests a more oscillatory SR pattern in the AIT exercise training group. However, no difference in mean OSI was observed between the CON and AIT protocols and both

appeared to produce predominantly laminar SR throughout the exercise session and across training. Overexpression of miR-21 following exposure to oscillatory SR has been shown to be associated with promotion of a pro-atherogenic endothelial cell phenotype (Zhou et al., 2011). Endothelial function was improved following 4 weeks of exercise training with no difference between CON and AIT training. This suggests endothelial cell phenotype expresses an anti-atherogenic phenotype following training in both groups, thus increased miR-21 expression maybe a positive adaptation to exercise training. However, without further investigation into the pathways which miR-21 overexpression regulates, it cannot be certain as to how endothelial cell phenotype was affected.

5.4.8 Limitations

An obvious limitation to the current study is the sample size, with only four older males successfully completing the study. Therefore, it was difficult to determine age by gender by exercise protocol effects over the course of the exercise training intervention due to low statistical power. This makes exercise prescription specific to older males difficult as the sample is not adequately powered or representative.

When retrospective power was calculated for the main outcome variables in the present study, it can be observed that the chance of making a type 2 error across the exercise training intervention was 75% for retrograde SR, 82% for anterograde SR and 36% for OSI. In contrast, the power to detect a type 2 error when assessing acute relative FMD prior to exercise training was 64% and 90% when assessing acute relative FMD following exercise training. The power to detect a type 2 error when assessing chronic relative FMD pre and post exercise training was 13%. When the effect of exercise protocol upon the aforementioned variables was investigated the type 2 error for anterograde SR was 67%, 73% for retrograde SR and 94% for OSI. The effect of exercise protocol upon relative FMD produced a power of 86%. When

the effect of age upon the aforementioned variables was investigated the type 2 error for anterograde SR was 94%, 55% for retrograde SR and 35% for OSI. The effect of exercise protocol upon relative FMD produced a power of 88%. This suggests that the power of the current study for detecting an effect of exercise training, age and exercise protocol without making a type 2 error was low except when assessing chronic FMD and OSI across the exercise training intervention, and OSI across age groups.

Determination of effect size for the aforementioned variables shows that across the exercise training intervention, retrograde SR demonstrated a medium-large effect, anterograde SR a small-medium effect and OSI a large effect. Acute relative FMD prior to exercise training demonstrated a large effect, whilst acute relative FMD following exercise training demonstrated a small-medium effect. Chronic relative FMD pre and post exercise training demonstrated a large effect.

Determination of effect size between age groups showed retrograde SR demonstrated a large effect, anterograde SR a small effect and OSI a large effect. The effect of age upon acute relative FMD demonstrated a large effect, whilst chronic relative FMD also demonstrated a large effect. Determination of effect size between exercise protocol groups showed retrograde SR demonstrated a medium-large effect, anterograde SR a medium-large effect and OSI a small-medium effect. The effect of exercise protocol upon acute relative FMD demonstrated a large effect, whilst chronic relative FMD also demonstrated a large effect.

Overall, in-exercise anterograde and retrograde SR had insufficient power to successfully assess the effect of exercise training, age and exercise protocol. However, OSI appeared to demonstrate greater power which was supported by the large effect sizes shown. It appeared that the current study was able to successfully assess the effect of the exercise training intervention upon chronic FMD, which was

supported by the determination of a large effect size. Although, acute FMD showed lower power and smaller effect sizes which was consistent when the effect of age and exercise protocol was also assessed.

It was also evident during screening that a large proportion of the older participants had some level of cardiovascular risk factors and were therefore excluded from participating in the study. This was necessary to isolate the effect of ageing upon vascular health without the influence of cardiovascular risk factors. However, the sample of participants used in the current study may not be an accurate representation of the population who the exercise prescription would be aimed at.

The importance of ageing in alteration of the balance between NO and ET-1 and the resultant effect upon vascular function and structure has been emphasised throughout this study. Furthermore, exercise has been shown in previous studies to modify the relationship between NO and ET-1 to favour increased NO production (Seals et al., 2008). However, in the current study ET-1 was not measured pre-or post the exercise training intervention. It is therefore impossible to determine whether the older population had elevated ET-1 concentrations compared to the younger population and whether the exercise training protocols were capable of modifying ET-1 expression.

The balance between increasing exercise intensity to stimulate further upregulation of NO bioavailability and inducing ROS production has also been discussed. However, in the current study no measures of ROS were made pre-or post-training. Ageing has been associated with increased in ROS production (Donato et al., 2007). Comparisons between younger and older groups prior to and following training may have provided greater insight as to which exercise training intervention may be more appropriate for specific populations. Indeed, prescribing AIT exercise in older

participants with elevated levels of ROS may exacerbate inflammation resulting in impaired vascular function.

5.4.9 Future Directions

Future studies would extend the duration of the exercise training intervention to assess changes in arterial stiffness, endothelial function and circulating miR-21 expression. It has been discussed that changes in arterial structure require a longer exercise training intervention to assess the differential effects of the prescribed exercise protocols and the resultant role of exercise induced SR in modifying arterial stiffness. Furthermore, both pre-and post-menopausal females were included in the present study. However, important differences in vascular health and CVD risk have been reported between pre-and post-menopausal females (British Heart Foundation, 2012). Therefore, if additional older females were recruited to the present study the interaction of menopause and vascular health following the exercise training intervention could be explored.

5.4.10 Conclusion

In relation to the main research question for the present study, four weeks of exercise training altered SR pattern in both younger and older participants, furthermore acute and chronic increases in FMD were also demonstrated.

Prior to training AIT exercise induced higher volumes of retrograde SR compared to duration matched CON, at differing exercise intensity. Retrograde SR decreased from the first to the final exercise training session with no change in anterograde SR and no interaction with gender or age. Despite AIT inducing larger volumes of retrograde SR to CON, both exercise protocols induced predominantly laminar SR during the first and final exercise training sessions. Therefore, endothelial function showed improvements acutely prior to training and chronically across the 4-week training intervention in both AIT and CON exercise groups. Acute endothelial function

following training was blunted compared to acute endothelial function prior to training. Additionally, carotid artery stiffness was higher in older participants and was unaffected by exercise training. Finally, chronic miR-21 expression demonstrated an increase with training irrespective of exercise protocol, age or gender was evident.

Chapter 6 General Discussion

6.1 Overview of thesis rationale and purpose

Cardiovascular disease (CVD) remains a leading cause of morbidity and mortality. However, traditional CVD risk factors such as hypertension and diabetes account for only 60% of CVD risk, the remaining 40% is thought to be related to vascular changes (Green et al., 2008, Joyner and Green, 2009, Mora et al., 2007, Thijssen et al., 2010). Endothelial cell phenotype, endothelial function and arterial stiffness are important components of vascular health, due to their role in atherosclerosis development, which may account for the remaining CVD risk.

An important regulator of vascular health is haemodynamics, for example shear stress. Laminar shear stress aids the maintenance of endothelial function, prevents arterial stiffness and upregulates expression of specific flow sensitive microRNAs which promote an anti-atherogenic endothelial cell phenotype. Ageing increases CVD risk and the prevalence of endothelial dysfunction (Seals et al., 2011), however the exact mechanism of age-related declines in vascular health with age is unknown. Importantly it does appear that there are alterations in haemodynamics with age. Older adults appear to have reduced anterograde SR and increased retrograde SR compared to younger adults (Young et al., 2010). This creates a lower overall mean SR thus inducing higher volumes of oscillatory SR which may be as a result of increases downstream peripheral resistance (Young et al., 2010). This thesis attempted to explore in-exercise SR in younger and older populations during an exercise training intervention.

Gender differences in CVD development are not commonly studied, however gender plays an important role in the development and progression of CVD. Prior to

menopause females have a reduced CVD risk compared to age matched males (Celermajer et al., 1994), likely through the role of oestrogen in conveying vascular health benefits. However, after the menopause women have a steeper decline in cardiovascular health compared to age matched males resulting in equivalent CVD risk between the genders (Celermajer et al., 1994). However, following a cardiovascular event females have greater incidence of morbidity and mortality compared to males (Shaw et al., 2006). Therefore, this thesis explored the role of gender when attempting to modify CVD risk with ageing as comparatively little research focusses on females to males.

Exercise is known to improve CVD risk, the improvement is reflected in improvements in endothelial function, reductions in arterial stiffness and promotion of an anti-atherogenic endothelial cell phenotype. It has been purported that exercise-induced changes in haemodynamics, in particular shear stress, may be the stimulus for exercise related improvements in vascular health (Green et al., 2017). However, whilst shear stress may be an important stimulus for improvements in vascular health, in-exercise shear stress has not been characterised during different types of exercise. Shear stress during exercise is dependent upon changes in cardiac output, blood pressure, vascular resistance and blood flow (Hawley et al., 2014). It has become evident that type and intensity of exercise are integral aspects in determining exercise induced shear stress.

Typically traditional moderate continuous exercise has been used when using exercise to modify CVD risk, which matched current Government guidelines. However, recently interval exercise has become a more popular way of exercising. Interval exercise utilises repeated periods of higher intensity exercise interspersed with periods of recovery to make the exercise session sustainable (Gibala et al., 2012). It has also been shown that IT exercise is a more enjoyable way of exercising

compared to traditional continuous exercise (Bartlett et al., 2011). However, although interval exercise has been shown to improve endothelial function, the intensity of the interval exercise is important as acute and chronic high intensity exercise have been shown to impair endothelial function due to production of inflammatory markers (Bailey et al., 2017, Yoo et al., 2017, Goto et al., 2003, Bergholm et al., 1999). A further consideration when prescribing interval exercise for improvements in vascular health is the oscillatory nature of interval exercise which is a result of the repeated work and recovery periods. Research within this thesis attempted to characterise in-exercise SR during multiple transitions between work and recovery. Additionally, this thesis compared in-exercise SR during differing types of IT versus CON exercise to determine whether there were differential effects upon acute and chronic vascular health.

6.2 Summary of key findings

In chapter 4 it was hypothesised that IT exercise may induce an oscillatory SR pattern which may adversely affect markers of vascular health compared to continuous exercise in a group of young healthy males and females. The four differing acute exercise protocols utilised in this first study were matched for exercise intensity and duration and thus produced equivalent volumes of anterograde and retrograde SR between protocols. Despite similar volumes of SR the patterns in which SR was accumulated throughout the exercise sessions were very different. Pattern of anterograde and retrograde SR in each exercise protocol were dependent upon the work rate profile which in turn affected pattern of heart rate and blood flow. All four exercise protocols induced similar volumes of OSI, despite brief periods of purely oscillatory SR being achieved in all exercise protocols, mean OSI throughout all exercise protocols suggested predominantly laminar shear was experienced. This

was supported by acute improvement in endothelial function following all exercise protocols. The improvement in endothelial function was equivalent between all exercise protocols which suggests that the volume of SR rather than the differing patterns of SR was a more important stimulus for changes in endothelial function. MicroRNA-21 was selected as a potential circulating biomarker of endothelial cell phenotype as regulated by shear stress. Following acute exercise miR-21 expression was reduced. Previous studies had shown miR-21 expression to be upregulated in vitro following exposure to both laminar (Weber et al., 2010) and oscillatory shear stress (Zhou et al., 2011). It is therefore difficult to determine how a reduction in miR-21 expression affects endothelial cell phenotype without follow up of the pathways which miR-21 regulates. Additionally, decreased circulating levels of acute miR-21 expression may reflect a reduction in endothelial cells shedding miR-21 into the circulation with intracellular expression remaining high. As exercise induced predominantly laminar shear and endothelial function was acutely improved it is likely that endothelial cell phenotype was positively affected.

Chapter 4 assessed shear rate volumes and patterns during acute exercise and in a younger population who had low CVD risk. However, the exercise used did induce periods of purely oscillatory SR which is known to be damaging to vascular health. Therefore, it was deemed pertinent to explore how accumulating the shear rate volumes and patterns, in particular purely oscillatory SR over repeated exercise session as per a chronic exercise training intervention would affect markers of vascular health. It was also important to select a population with a greater CVD risk to assess potential differences in SR patterns and resultant markers of vascular health with exercise. Therefore, older males and females were recruited alongside younger males and females to the study in Chapter 5. Selecting both genders also

allowed potential differences in SR patterns and volumes to be discerned over the course of the exercise training intervention.

In Chapter 5, AIT and CON exercise protocols were matched for duration but were of differing exercise intensities based on percentage of HR_{peak} as determined from the pre training ramp incremental test. These exercise protocols were chosen to determine whether AIT and CON exercise-induced SR patterns differentially affected acute and chronic measures of vascular health across age and genders.

Both anterograde and retrograde SR patterns followed the WR profile, HR and VO_2 throughout CON and AIT exercise, as in Chapter 4. Anterograde SR was not affected by age, gender or exercise protocol. However, AIT exercise induced higher volumes of retrograde SR compared to CON exercise; volumes of retrograde SR decreased with exercise training. This supports the hypothesis for the study which stated that AIT and CON exercise would differentially affect SR patterns, however in contrast to the hypothesis there was no influence of age or gender upon these SR patterns. Both exercise protocols did induce brief periods of purely oscillatory SR as in chapter 4, however mean OSI indicated that predominantly laminar SR was produced throughout both exercise protocols. Older individuals spent greater periods of time at purely oscillatory SR compared to younger participants irrespective of the type of exercise. With exercise training mean OSI was reduced in both exercise training groups regardless of age or gender, however time spent as purely oscillatory SR during exercise was not changed with training.

In contrast to previous literature, there no was no impairment in acute or chronic endothelial function with age, indeed ageing and gender did not influence measures of endothelial function. Despite differing SR patterns between exercise protocols, equivalent improvements in acute endothelial function prior to training were observed. However, following training this acute increase in endothelial function was blunted in

both groups. This may have been due to a chronic increase in endothelial function following exercise training in both AIT and CON groups irrespective of age and gender. In agreement with previous literature, measures of carotid artery stiffness prior to exercise training were higher in older participants with lower distensibility and compliance also observed in the older compared to younger populations. No effect of gender was observed. The 4 weeks of exercise training used in the current study did not change carotid artery stiffness, distensibility or compliance with exercise training in either AIT or CON groups. Circulating miR-21 expression was not influenced by age or gender. Following exercise training in both conditions circulating miR-21 expression was increased irrespective of SR pattern and with no apparent influence of age or gender. Due to miR-21 overexpression being regulated by both laminar and oscillatory SR it is difficult to discern whether exercise training resulted in a pro or anti-atherogenic endothelial cell phenotype. However, as endothelial function was observed to improve with exercise training it may be assumed that overexpression of miR-21 was associated with an anti atherogenic endothelial cell phenotype.

6.3 Implications for exercise prescription

Exercise reduces all cause morbidity and mortality and is a cost-effective alternative to medications, thus reducing NHS burden and expenditure. However, the number of individuals currently meeting the Government recommendations for exercise remains low, with even lower rates of participation reported in females (BHF, 2015). Investigations into perceived barriers to exercise have reported that individuals cite a lack of time and enjoyment as the primary reasons for not participating in exercise (Trost et al., 2002b). Additionally, some barriers to exercise may depend upon the age and gender of the populations surveyed. This demonstrates that types of exercise

may be better suited to certain populations in order to target desired outcomes and improve chance of adherence based upon barriers to participation.

As discussed in detail previously (section 2.3.1), exercise mediated improvements in vascular health are in part facilitated by exercise-induced SR. To maximise the benefits upon vascular health from exercise-induced SR a number of alterations could be made to the prescribed exercise protocols. In the current thesis, it appeared that the mean intensity of the exercise session was the important factor in determining volumes of anterograde and retrograde SR. Therefore, increasing the mean intensity of the exercise session may induce greater volumes of SR leading to larger improvements in vascular health. This could be achieved by using higher work rates during the exercise protocols used in the current thesis. This would result in greater peak anterograde and retrograde SR in addition to increasing the mean and total volumes of SR. Indeed, sprint interval training (SIT) has been used in previous studies to successfully induce improvements in peripheral vascular structure and function (Rakobowchuk et al., 2008). The maximal efforts required for SIT likely resulted in the attainment of near maximal HR, producing high volumes of blood flow and increasing SR. A consideration for the prescription of SIT and increasing exercise intensity is the balance between anti-oxidants and ROS production, as higher exercise intensities may induce greater ROS production which would negatively affect vascular health. The benefit of using IT exercise to attain higher exercise intensities is the inclusion of recovery periods reduce overall exercise intensity thus reducing the likelihood of excessive ROS production.

Additionally, the inclusion of long recovery periods can be detrimental when aiming to increase the mean intensity of the exercise session in order to increase volumes of SR. In the first study of this thesis, the inclusion of 3 minutes of recovery at the equivalent of unloaded cycling resulted in SR returning to levels associated with the

warm up period. This reduced the mean and total volume of SR during the exercise session. Therefore, the recovery periods must consist of an increased work rate, greater than unloaded but low enough to provide a recovery, or the recovery periods must be kept short. This was evident during the Short IT exercise protocol in the first study where the brief recovery periods (30 s) did not allow SR to decrease substantially before the next work bout. It would therefore be recommended that for IT exercise a duty cycle of 1:1, whereby equal lengths of work and recovery are employed, or the recovery period could be half the duration of the work bout.

Exercise is known to be an effective method of increasing SR in order to improve vascular health, however exercise independent methods of increasing SR have also been explored which may benefit individuals who have conditions which limit their ability to exercise, e.g. chronic obstructive pulmonary disease patients. Heating has been shown to be an effective method of increasing SR to improve endothelial function in previous studies (Naylor et al., 2011, Tinken et al., 2009). Typically, the forearm is heated whilst upstream SR patterns and endothelial function are measured. Tinken et al. (2009) immersed both forearms in a 40°C water bath continuously for 30 min. Forearm heating did not induce retrograde SR as seen with cycling exercise, however heating produces equivalent volumes of anterograde SR to cycling. This resulted in equivalent improvements in acute endothelial function between heating and cycling exercise (Tinken et al., 2009). This is likely due to a reduction in peripheral vascular resistance through heating of the microvasculature and cutaneous vascular which has been suggested to be the cause of increased retrograde SR at the onset of aerobic exercise until thermoregulation causes a reduction in downstream peripheral resistance (Green et al., 2010a).

It has been demonstrated that other methodologies are effective in inducing SR-mediated improvements in endothelial function in addition to exercise. However,

forearm heating may only induce localised adaptations in endothelial function whereas exercise can induce systemic effects. Therefore, a method of increasing core temperature maybe more beneficial to induce systemic adaptations rather than localised heating. Carter et al. (2014) used hot water immersion of the legs for 30 min to assess SR and endothelial function in the upper limb over an 8-week intervention. Heating of the legs induced elevations in core temperature which increased blood flow and SR in the upper arm (Carter et al., 2014). Endothelial function was improved at 4 weeks into the intervention before returning to baseline at 8 weeks (Carter et al., 2014). An interval approach, as has been explored in the current thesis, may be applied to heating. Repeated bouts of heating and cooling may create higher peak SR, increasing mean SR throughout a session thus inducing a greater stimulus for improvements in endothelial function compared to continuous heating approach.

6.4 Limitations and Future Work

A key limitation in both studies within this thesis was the inability to accurately and reliably determine blood pressure during exercise. Despite repeated efforts using a variety of different instruments blood pressure during exercise was not collected. Determination of blood pressure during exercise would enable further mechanisms governing the role of shear stress to be determined. Future studies should make further attempts to accurately determine in-exercise blood pressures through use of a manual blood pressure cuff or a fingertip finometer if movement of the arm during exercise is restricted, for example use of restraints.

The role of haemodynamics in regulating vascular health was a primary outcome of this thesis. Whilst mechanisms which link haemodynamic stimuli to markers of vascular health were nor directly studied it was assumed that upregulation of NO and anti-oxidants as a result of exercise-induced SR were key mediators of improved

endothelial function. Similarly, the literature review in this thesis explored many of the determinants of endothelial dysfunction and arterial stiffness with age and across genders such as ET-1, cellular senescence and apoptosis and sex steroids. However, none of these variables were assessed in the current thesis and have important role in the age-related decline in vascular health. Assessment of these variables within the circulation may provide greater insight into the mechanism of changes in chronic vascular health with exercise training and potential differences depending on the type of exercise undertaken and the patterns and volumes of SR induced. Furthermore, changes in NO bioavailability were inferred through the use of FMD which assesses endothelium dependent NO mediated vasodilation. Whilst NO is a key mediator of this process, as shown by NO antagonist L-NMMA (Taddei et al., 2001), there may be other metabolites such as prostacyclin which may also contribute to the measured vasodilation. Therefore, whilst direct measurement of NO concentration is difficult due to its rapid half-life, measurement of a stable marker such as nitrate may provide further insight into how exercise and SR affect vascular health through NO pathways.

In the current thesis shear rate was measured in the non-exercising upper limb during lower limb cycling exercise. The use of the arm in this thesis is comparable to other studies within this area of research due to technical difficulties in the assessment of SR in the lower limb, during lower limb aerobic exercise. Previously, haemodynamics have been measured in the lower limb during leg kicking exercise due to the ability to immobilise the upper part of the leg (Thijssen et al., 2009a). However, leg kicking exercise is a resistance type exercise which has a differential impact on blood pressure and cardiac output which may affect SR patterns differently to aerobic type exercise (Green et al., 2017). How SR patterns differ when measured in the exercising limb is currently unknown however the properties of the femoral artery may influence SR patterns. The femoral artery is known to be more atheroprone compared

to the brachial artery, therefore there may be higher volumes of retrograde SR contributing to higher oscillatory SR at rest. The effect of exercise upon these shear rate patterns is yet to be explored.

MiR-21 expression following acute and chronic exercise was explored throughout this thesis with inconclusive results upon the influence of exercise-induced SR patterns. The possible factors which contribute to these inconclusive results have been discussed in detail within the experimental chapters. Future studies may examine the time course of peak circulating miR expression following acute exercise. This thesis only examined one circulating microRNA, however previous studies have used a panel to detect changes in expression of any circulating miRs. Therefore, future studies should run a panel to detect any circulating miRs which regulate endothelial cell phenotype which may be affected by the exercise-induced shear stimulus. Whilst the current thesis inferred the effect of miR-21 upon endothelial cell phenotype and its relation to endothelial function there did not appear to be an association between miR-21 expression and endothelial function either chronically or acutely. Future studies should attempt to determine the pathway which changes in miR-21 expression affects. In-vivo assessment of miR-21 expression, as in this thesis, only detects the spill over of miR-21 from the endothelial cells into the circulation. Therefore, in-vitro assessment of miR-21 either from harvesting human endothelial cells following exercise or culturing human endothelial cells and exposing them to SR equivalent to the exercise protocols within this thesis would provide information upon miR-21 pathways.

Intensity of exercise, both acutely and chronically, affects SR pattern and can either improve or impair endothelial function depending upon the effect upon inflammatory markers. Volumes of retrograde SR increase with increasing exercise intensity (Green et al., 2002b), this would result in higher OSI which may lead to impairment

of endothelial function (Thijssen et al., 2009b). Future studies may expand upon Chapter 4 and assess the impact of very heavy or moderate intensity CON and IT exercise upon haemodynamics and the resultant effect upon endothelial function and miR-21 expression. It would also be pertinent to measure markers of ROS to assess the tipping point at which exercise intensity becomes detrimental to NO production and endothelial function.

6.5 Concluding remarks

The studies presented within this thesis have demonstrated the role of exercise-induced shear rate patterns in regulating markers of vascular health. This has been explored acutely in young healthy participants using a variety of interval exercise protocols versus traditional CON type exercise to induce different patterns of SR and to evaluate the differential effect upon vascular health. The results from the first study helped to inform a chronic exercise intervention in a young and an older population to examine whether interval or CON shear rate patterns were more beneficial in improving vascular health across age and genders. It is hoped that these studies will add to previous research and inform future exercise prescription as to the most beneficial type of exercise for specific populations.

References

- AHIMASTOS, A. A., FORMOSA, M., DART, A. M. & KINGWELL, B. A. 2003. Gender Differences in Large Artery Stiffness Pre- and Post Puberty. *The Journal of Clinical Endocrinology & Metabolism*, 88, 5375-5380.
- AKAZAWA, N., CHOI, Y., MIYAKI, A., TANABE, Y., SUGAWARA, J., AJISAKA, R. & MAEDA, S. 2012. Curcumin ingestion and exercise training improve vascular endothelial function in postmenopausal women. *Nutrition Research*, 32, 795-799.
- ALAN, S., ULGEN, M. S., OZTURK, O., ALAN, B., OZDEMIR, L. & TOPRAK, N. 2003. Relation Between Coronary Artery Disease, Risk Factors and Intima-Media Thickness of Carotid Artery, Arterial Distensibility, and Stiffness Index. *Angiology*, 54, 261-267.
- ALDERTON, W. K., COOPER, C. E. & KNOWLES, R. G. 2001. Nitric oxide synthases: structure, function and inhibition. *Biochemical Journal*, 357, 593-615.
- ALEXANDERSEN, P., HAARBO, J., BYRJALSEN, I., LAWAETZ, H. & CHRISTIANSEN, C. 1999. Natural androgens inhibit male atherosclerosis. *Circulation Research*, 84, 813-819.
- ARNAL, J. F., GOURDY, P. & SIMONCINI, T. 2009. Interference of Progestins With Endothelial Actions of Estrogens. *A Matter of Glucocorticoid Action or Deprivation?*, 29, 441-443.
- ASAI, K., KUDEJ, R. K., TAKAGI, G., KUDEJ, A. B., NATIVIDAD, F., SHEN, Y.-T., VATNER, D. E. & VATNER, S. F. 2001. Paradoxically enhanced endothelin-B receptor-mediated vasoconstriction in conscious old monkeys. *Circulation*, 103, 2382-2386.
- ATKINSON, G. 2014. Shear rate normalization is not essential for removing the dependency of flow-mediated dilation on baseline artery diameter: past research revisited. *Physiological Measurement*, 35, 1825.
- BAGGISH, A. L., HALE, A., WEINER, R. B., LEWIS, G. D., SYSTROM, D., WANG, F., WANG, T. J. & CHAN, S. Y. 2011. Dynamic regulation of circulating microRNA during acute exhaustive exercise and sustained aerobic exercise training. *The Journal of physiology*, 589, 3983-3994.
- BAGGISH, A. L., PARK, J., MIN, P.-K., ISAACS, S., PARKER, B. A., THOMPSON, P. D., TROYANOS, C., D'HEMECOURT, P., DYER, S., THIEL, M., HALE, A. & CHAN, S. Y. 2014. Rapid upregulation and clearance of distinct circulating microRNAs after prolonged aerobic exercise. *Journal of Applied Physiology*, 116, 522-531.
- BAILEY, A. J. 2001. Molecular mechanisms of ageing in connective tissues. *Mechanisms of Ageing and Development*, 122, 735-755.
- BAILEY, T. G., PERISSIOU, M., WINDSOR, M., RUSSELL, F., GOLLEDGE, J., GREEN, D. J. & ASKEW, C. D. 2017. Cardiorespiratory fitness modulates the acute flow-mediated dilation response following high-intensity but not moderate-intensity exercise in elderly men. *Journal of Applied Physiology*, 122, 1238-1248.

- BARBAGALLO, M., DOMINGUEZ, L. J., LICATA, G., SHAN, J., BING, L., KARPINSKI, E., PANG, P. K. T. & RESNICK, L. M. 2001. Vascular Effects of Progesterone. *Role of Cellular Calcium Regulation*, 37, 142-147.
- BARD, R. L., KALSI, H., RUBENFIRE, M., WAKEFIELD, T., FEX, B., RAJAGOPALAN, S. & BROOK, R. D. 2004. Effect of carotid atherosclerosis screening on risk stratification during primary cardiovascular disease prevention. *The American Journal of Cardiology*, 93, 1030-1032.
- BARTLETT, J. D., CLOSE, G. L., MACLAREN, D. P. M., GREGSON, W., DRUST, B. & MORTON, J. P. 2011. High-intensity interval running is perceived to be more enjoyable than moderate-intensity continuous exercise: Implications for exercise adherence. *Journal of Sports Sciences*, 29, 547-553.
- BARTON, M., COSENTINO, F., BRANDES, R. P., MOREAU, P., SHAW, S. & LÜSCHER, T. F. 1997. Anatomic Heterogeneity of Vascular Aging. *Role of Nitric Oxide and Endothelin*, 30, 817-824.
- BENETOS, A., LAURENT, S., HOEKS, A. P., BOUTOUYRIE, P. H. & SAFAR, M. E. 1993. Arterial alterations with aging and high blood pressure. A noninvasive study of carotid and femoral arteries. *Arteriosclerosis, Thrombosis, and Vascular Biology*, 13, 90-97.
- BENSON, A. P., GRASSI, B. & ROSSITER, H. B. 2013. A validated model of oxygen uptake and circulatory dynamic interactions at exercise onset in humans. *Journal of Applied Physiology*, 115, 743-755.
- BERDEAUX, A., GHALEH, B., DUBOIS-RANDÉ, J. L., VIGUÉ, B., DRIEU LA ROCHELLE, C., HITTINGER, L. & GIUDICELLI, J. F. 1994. Role of vascular endothelium in exercise-induced dilation of large epicardial coronary arteries in conscious dogs. *Circulation*, 89, 2799-2808.
- BERGHOLM, R., MÄKIMATTILA, S., VALKONEN, M., LIU, M.-L., LAHDENPERÄ, S., TASKINEN, M.-R., SOVIJÄRVI, A., MALMBERG, P. & YKI-JÄRVINEN, H. 1999. Intense physical training decreases circulating antioxidants and endothelium-dependent vasodilatation in vivo. *Atherosclerosis*, 145, 341-349.
- BHATNAGAR, P., WICKRAMASINGHE, K., WILLIAMS, J., RAYNER, M. & TOWNSEND, N. 2015. The epidemiology of cardiovascular disease in the UK 2014. *Heart*, 101, 1182-1189.
- BHF 2015. *Physical Activity Statistics*
- BHF 2017. *Physical Inactivity and Sedentary Behaviour Report*.
- BIRK, G. K. 2011. *Impact of inactivity and exercise on the vasculature in humans: the role of blood flow and shear stress on arterial adaptations in healthy males*. Liverpool John Moores University.
- BIRK, G. K., DAWSON, E. A., ATKINSON, C., HAYNES, A., CABLE, N. T., THIJSSSEN, D. H. J. & GREEN, D. J. 2012. *Brachial artery adaptation to lower limb exercise training: role of shear stress*.
- BISHOP, J., DONALD, K., TAYLOR, S. & WORMALD, P. 1957. The blood flow in the human arm during supine leg exercise. *The Journal of Physiology*, 137, 294-308.
- BLACK, M. A., CABLE, N. T., THIJSSSEN, D. H. J. & GREEN, D. J. 2009. Impact of age, sex, and exercise on brachial artery flow-mediated dilatation. *American Journal of Physiology - Heart and Circulatory Physiology*, 297, H1109-H1116.
- BÖGER, R. H., SKAMIRA, C., BODE-BÖGER, S. M., BRABANT, G., VON ZUR MUHLEN, A. & FROLICH, J. C. 1996. Nitric oxide may mediate the hemodynamic effects of recombinant growth hormone in patients with

- acquired growth hormone deficiency. A double-blind, placebo-controlled study. *Journal of Clinical Investigation*, 98, 2706-2713.
- BÖHM, F. & PERNOW, J. 2007. The importance of endothelin-1 for vascular dysfunction in cardiovascular disease. *Cardiovascular Research*, 76, 8-18.
- BÖHM, F., SETTERGREN, M. & PERNOW, J. 2007. Vitamin C blocks vascular dysfunction and release of interleukin-6 induced by endothelin-1 in humans in vivo. *Atherosclerosis*, 190, 408-415.
- BONETTI, P. O., LERMAN, L. O. & LERMAN, A. 2003. Endothelial Dysfunction: A Marker of Atherosclerotic Risk. *Arteriosclerosis, Thrombosis, and Vascular Biology*, 23, 168-175.
- BOON, R. A., HERGENREIDER, E. & DIMMELER, S. 2012. Atheroprotective mechanisms of shear stress-regulated microRNAs. *Thrombosis and haemostasis*, 108, 616-620.
- BOOR, P., CELEC, P., BEHULIAK, M., GRANČIČ, P., KEBIS, A., KUKAN, M., PRONAYOVÁ, N., LIPTAJ, T., OSTENDORF, T. & ŠEBEKOVÁ, K. 2009. Regular moderate exercise reduces advanced glycation and ameliorates early diabetic nephropathy in obese Zucker rats. *Metabolism*, 58, 1669-1677.
- BOTS, M. L., DIJK, J. M., OREN, A. & GROBBEE, D. E. 2002. Carotid intima-media thickness, arterial stiffness and risk of cardiovascular disease: current evidence. *Journal of Hypertension*, 20, 2317-2325.
- BRANDES, R. P., FLEMING, I. & BUSSE, R. 2005. Endothelial aging. *Cardiovascular Research*, 66, 286-294.
- BRITISH HEART FOUNDATION 2012. Coronary heart disease statistics: A compendium of health statistics *Department of Public Health*.
- BROOKS, A. R., LELKES, P. I. & RUBANYI, G. M. 2002. Gene expression profiling of human aortic endothelial cells exposed to disturbed flow and steady laminar flow. *Physiological genomics*, 9, 27-41.
- BROWN, N. J., ABBAS, A., BYRNE, D., SCHOENHARD, J. A. & VAUGHAN, D. E. 2002. Comparative Effects of Estrogen and Angiotensin-Converting Enzyme Inhibition on Plasminogen Activator Inhibitor-1 in Healthy Postmenopausal Women. *Circulation*, 105, 304-309.
- BURGOMASTER, K. A., HOWARTH, K. R., PHILLIPS, S. M., RAKOBOWCHUK, M., MACDONALD, M. J., MCGEE, S. L. & GIBALA, M. J. 2008. Similar metabolic adaptations during exercise after low volume sprint interval and traditional endurance training in humans. *The Journal of Physiology*, 586, 151-160.
- BURGOYNE, J. R. & EATON, P. 2010. Oxidant Sensing by Protein Kinases A and G Enables Integration of Cell Redox State with Phosphoregulation. *Sensors*, 10, 2731.
- BÜRRIG, K. F. 1991. The endothelium of advanced arteriosclerotic plaques in humans. *Arteriosclerosis, Thrombosis, and Vascular Biology*, 11, 1678-1689.
- BYE, A., RØSJØ, H., ASPENES, S. T., CONDORELLI, G., OMLAND, T. & WISLØFF, U. 2013. Circulating microRNAs and aerobic fitness—the HUNT-Study. *PLoS one*, 8, e57496.
- CAI, H. & HARRISON, D. G. 2000. Endothelial Dysfunction in Cardiovascular Diseases: The Role of Oxidant Stress. *Circulation Research*, 87, 840-844.
- CAMPISI, J. 2003. Cellular senescence and apoptosis: how cellular responses might influence aging phenotypes. *Experimental Gerontology*, 38, 5-11.
- CARTER, H. H., DAWSON, E. A., BIRK, G. K., SPENCE, A. L., NAYLOR, L. H., CABLE, N. T., THIJSSSEN, D. H. & GREEN, D. J. 2013. Effect of SR

- Manipulation on Conduit Artery Dilation in Humans Novelty and Significance. *Hypertension*, 61, 143-150.
- CARTER, H. H., SPENCE, A. L., ATKINSON, C. L., PUGH, C. J., NAYLOR, L. H. & GREEN, D. J. 2014. Repeated core temperature elevation induces conduit artery adaptation in humans. *European journal of applied physiology*, 114, 859-865.
- CARTER, J. B., BANISTER, E. W. & BLABER, A. P. 2003. Effect of Endurance Exercise on Autonomic Control of Heart Rate. *Sports Medicine*, 33, 33-46.
- CASEY, D. P., PADILLA, J. & JOYNER, M. J. 2012. α -Adrenergic Vasoconstriction Contributes to the Age-Related Increase in Conduit Artery Retrograde and Oscillatory Shear. *Hypertension*, 60, 1016-1022.
- CASEY, D. P., SCHNEIDER, A. C. & UEDA, K. 2016. Influence of chronic endurance exercise training on conduit artery retrograde and oscillatory shear in older adults. *European Journal of Applied Physiology*, 116, 1931-1940.
- CASPERSEN, C. J., POWELL, K. E. & CHRISTENSON, G. M. 1985. Physical activity, exercise, and physical fitness: definitions and distinctions for health-related research. *Public health reports*, 100, 126.
- CELERMAJER, D. S., SORENSEN, K. E., GOOCH, V. M., MILLER, SULLIVAN, I. D., LLOYD, J. K., DEANFIELD, J. E. & SPIEGELHALTER, D. J. 1992. Non-invasive detection of endothelial dysfunction in children and adults at risk of atherosclerosis. *The Lancet*, 340, 1111-1115.
- CELERMAJER, D. S., SORENSEN, K. E., SPIEGELHALTER, D. J., GEORGAKOPOULOS, D., ROBINSON, J. & DEANFIELD, J. E. 1994. Aging is associated with endothelial dysfunction in healthy men years before the age-related decline in women. *Journal of the American College of Cardiology*, 24, 471-476.
- CHATRATH, R., RONNINGEN, K. L., SEVERSON, S. R., LABRECHE, P., JAYACHANDRAN, M., BRACAMONTE, M. P. & MILLER, V. M. 2003. Endothelium-dependent responses in coronary arteries are changed with puberty in male pigs. *American Journal of Physiology - Heart and Circulatory Physiology*, 285, H1168-H1176.
- CHATZIZISIS, Y. S., COSKUN, A. U., JONAS, M., EDELMAN, E. R., FELDMAN, C. L. & STONE, P. H. 2007a. Role of Endothelial Shear Stress in the Natural History of Coronary Atherosclerosis and Vascular Remodeling. *Journal of the American College of Cardiology*, 49, 2379-2393.
- CHATZIZISIS, Y. S., COSKUN, A. U., JONAS, M., EDELMAN, E. R., FELDMAN, C. L. & STONE, P. H. 2007b. Role of Endothelial Shear Stress in the Natural History of Coronary Atherosclerosis and Vascular Remodeling: Molecular, Cellular, and Vascular Behavior. *Journal of the American College of Cardiology*, 49, 2379-2393.
- CHEN, C., RIDZON, D. A., BROOMER, A. J., ZHOU, Z., LEE, D. H., NGUYEN, J. T., BARBISIN, M., XU, N. L., MAHUVAKAR, V. R., ANDERSEN, M. R., LAO, K. Q., LIVAK, K. J. & GUEGLER, K. J. 2005. Real-time quantification of microRNAs by stem-loop RT-PCR. *Nucleic Acids Research*, 33, e179-e179.
- CHEN, L.-J., LIM, S., YEH, Y.-T., LIEN, S.-C. & CHIU, J.-J. 2012. Roles of microRNAs in atherosclerosis and restenosis. *Journal of Biomedical Science*, 19, 1-13.
- CHENG, C. P., HERFKENS, R. J. & TAYLOR, C. A. 2003. Comparison of abdominal aortic hemodynamics between men and women at rest and during lower limb exercise. *Journal of Vascular Surgery*, 37, 118-123.

- CHRISTOU, D. D. & SEALS, D. R. 2008. Decreased maximal heart rate with aging is related to reduced β -adrenergic responsiveness but is largely explained by a reduction in intrinsic heart rate. *Journal of Applied Physiology*, 105, 24-29.
- COCKS, M., SHAW, C. S., SHEPHERD, S. O., FISHER, J. P., RANASINGHE, A. M., BARKER, T. A., TIPTON, K. D. & WAGENMAKERS, A. J. 2013. Sprint interval and endurance training are equally effective in increasing muscle microvascular density and eNOS content in sedentary males. *The Journal of physiology*, 591, 641-656.
- COHEN, J. 1977. Statistical power analysis for the behavioural sciences (Revised edition). *New York*, 7.
- COHEN, R. A. & VANHOUTTE, P. M. 1995. Endothelium-Dependent Hyperpolarization. *Beyond Nitric Oxide and Cyclic GMP*, 92, 3337-3349.
- CONVERTINO, V. A. 1983. Heart rate and sweat rate responses associated with exercise-induced hypervolemia. *Medicine and science in sports and exercise*, 15, 77-82.
- CONVERTINO, V. A. 1991. Blood volume: its adaptation to endurance training. *Medicine and science in sports and exercise*, 23, 1338-1348.
- CONVERTINO, V. A., MACK, G. W. & NADEL, E. R. 1991. Elevated central venous pressure: a consequence of exercise training-induced hypervolemia? *American Journal of Physiology-Regulatory, Integrative and Comparative Physiology*, 260, R273-R277.
- CREDEUR, D. P., DOBROSIELSKI, D. A., ARCE-ESQUIVEL, A. A., WELSCH, M. A. & LOUISIANA HEALTHY AGING, S. 2009. Brachial artery retrograde flow increases with age: relationship to physical function. *European journal of applied physiology*, 107, 219-225.
- CURRIE, K. D., MCKELVIE, R. S. & MACDONALD, M. J. 2012. Flow-Mediated Dilatation Is Acutely Improved after High-Intensity Interval Exercise. *Medicine & Science in Sports & Exercise*, 44, 2057-2064
10.1249/MSS.0b013e318260ff92.
- CUTINI, P., SELLÉS, J. & MASSHEIMER, V. 2009. Cross-talk between rapid and long term effects of progesterone on vascular tissue. *The Journal of Steroid Biochemistry and Molecular Biology*, 115, 36-43.
- D'AMICO, A. V., CHEN, M. H., RENSHAW, A. A., LOFFREDO, M. & KANTOFF, P. W. 2008. Causes of death in men undergoing androgen suppression therapy for newly diagnosed localized or recurrent prostate cancer. *Cancer*, 113, 3290-3297.
- DAMMERS, R., TORDOIR, J. H. M., HAMELEERS, J. M. M., KITSLAAR, P. J. E. H. M. & HOEKS, A. P. G. Brachial artery shear stress is independent of gender or age and does not modify vessel wall mechanical properties. *Ultrasound in Medicine and Biology*, 28, 1015-1022.
- DANCU, M. B., BERARDI, D. E., HEUVEL, J. P. V. & TARBELL, J. M. 2004. Asynchronous shear stress and circumferential strain reduces endothelial NO synthase and cyclooxygenase-2 but induces endothelin-1 gene expression in endothelial cells. *Arteriosclerosis, thrombosis, and vascular biology*, 24, 2088-2094.
- DANCU, M. B., BERARDI, D. E., HEUVEL, J. P. V. & TARBELL, J. M. 2007. Atherogenic endothelial cell eNOS and ET-1 responses to asynchronous hemodynamics are mitigated by conjugated linoleic acid. *Annals of biomedical engineering*, 35, 1111-1119.

- DAVIES, P. F. 1995. Flow-mediated endothelial mechanotransduction. *Physiological Reviews*, 75, 519-560.
- DAVIES, P. F. 2009. Hemodynamic shear stress and the endothelium in cardiovascular pathophysiology. *Nat Clin Pract Cardiovasc Med*, 6, 16-26.
- DAVIS, S. R. & BURGER, H. G. 2003. The role of androgen therapy. *Best Practice & Research Clinical Endocrinology & Metabolism*, 17, 165-175.
- DAWSON, E. A., GREEN, D. J., TIMOTHY CABLE, N. & THIJSEN, D. H. J. 2013. Effects of acute exercise on flow-mediated dilatation in healthy humans. *Journal of Applied Physiology*, 115, 1589-1598.
- DE NUCCI, G., THOMAS, R., D'ORLEANS-JUSTE, P., ANTUNES, E., WALDER, C., WARNER, T. D. & VANE, J. R. 1988. Pressor effects of circulating endothelin are limited by its removal in the pulmonary circulation and by the release of prostacyclin and endothelium-derived relaxing factor. *Proceedings of the National Academy of Sciences of the United States of America*, 85, 9797-9800.
- DESOUZA, C. A., SHAPIRO, L. F., CLEVINGER, C. M., DINENNO, F. A., MONAHAN, K. D., TANAKA, H. & SEALS, D. R. 2000. Regular Aerobic Exercise Prevents and Restores Age-Related Declines in Endothelium-Dependent Vasodilation in Healthy Men. *Circulation*, 102, 1351-1357.
- DIMMELER, S., FLEMING, I., FISSLHALER, B., HERMANN, C., BUSSE, R. & ZEIHNER, A. M. 1999. Activation of nitric oxide synthase in endothelial cells by Akt-dependent phosphorylation. *Nature*, 399, 601-605.
- DIMMELER, S., HAENDELER, J. & ZEIHNER, A. M. 2002. Regulation of endothelial cell apoptosis in atherothrombosis. *Current Opinion in Lipidology*, 13, 531-536.
- DIMMELER, S. & ZEIHNER, A. M. 2003. Exercise and cardiovascular health. *Am Heart Assoc.*
- DONATO, A. J., ESKURZA, I., SILVER, A. E., LEVY, A. S., PIERCE, G. L., GATES, P. E. & SEALS, D. R. 2007. Direct Evidence of Endothelial Oxidative Stress With Aging in Humans: Relation to Impaired Endothelium-Dependent Dilatation and Upregulation of Nuclear Factor- κ B. *Circulation Research*, 100, 1659-1666.
- DONATO, A. J., GANO, L. B., ESKURZA, I., SILVER, A. E., GATES, P. E., JABLONSKI, K. & SEALS, D. R. 2009. Vascular endothelial dysfunction with aging: endothelin-1 and endothelial nitric oxide synthase. *American Journal of Physiology - Heart and Circulatory Physiology*, 297, H425-H432.
- DONATO, A. J., MORGAN, R. G., WALKER, A. E. & LESNIEWSKI, L. A. 2015. Cellular and Molecular Biology of Aging Endothelial Cells. *Journal of molecular and cellular cardiology*, 89, 122-135.
- DOSHI, S. N., NAKA, K. K., PAYNE, N., JONES, C. J., ASHTON, M., LEWIS, M. J. & GOODFELLOW 2001. Flow-mediated dilatation following wrist and upper arm occlusion in humans: the contribution of nitric oxide. *Clin. Sci.*, 101, 629-635.
- DUBEY, R. K., OPARIL, S., IMTHURN, B. & JACKSON, E. K. 2002. Sex hormones and hypertension. *Cardiovascular Research*, 53, 688-708.
- DUCKLES, S. P. & MILLER, V. M. 2010. Hormonal modulation of endothelial NO production. *Pflugers Archiv : European journal of physiology*, 459, 841-851.
- EIGENBRODT, M. L., BURSAC, Z., ROSE, K. M., COUPER, D. J., TRACY, R. E., EVANS, G. W., BRANCATI, F. L. & MEHTA, J. L. 2006. Common carotid arterial interadventitial distance (diameter) as an indicator of the damaging

- effects of age and atherosclerosis, a cross-sectional study of the Atherosclerosis Risk in Community Cohort Limited Access Data (ARICLAD), 1987–89. *Cardiovascular ultrasound*, 4, 1.
- ELLMANN, S., STICHT, H., THIEL, F., BECKMANN, M. W., STRICK, R. & STRISSEL, P. L. 2009. Estrogen and progesterone receptors: from molecular structures to clinical targets. *Cellular and Molecular Life Sciences*, 66, 2405-2426.
- ERUSALIMSKY, J. D. 2009. Vascular endothelial senescence: from mechanisms to pathophysiology. *Journal of Applied Physiology*, 106, 326-332.
- ESKURZA, I., MYERBURGH, L. A., KAHN, Z. D. & SEALS, D. R. 2005. Tetrahydrobiopterin augments endothelium-dependent dilatation in sedentary but not in habitually exercising older adults. *The Journal of physiology*, 568, 1057-1065.
- ESPOSITO, K., CIOTOLA, M., SCHISANO, B., GUALDIERO, R., SARDELLI, L., MISSO, L., GIANNETTI, G. & GIUGLIANO, D. 2006. Endothelial Microparticles Correlate with Endothelial Dysfunction in Obese Women. *The Journal of Clinical Endocrinology & Metabolism*, 91, 3676-3679.
- FERRINI, R. L. & BARRETT-CONNOR, E. 1998. Sex hormones and age: a cross-sectional study of testosterone and estradiol and their bioavailable fractions in community-dwelling men. *American journal of epidemiology*, 147, 750-754.
- FISCHER, G. M., CHERIAN, K. & SWAIN, M. L. 1981. Increased synthesis of aortic collagen and elastin in experimental atherosclerosis. *Atherosclerosis*, 39, 463-467.
- FISHER, G., SCHWARTZ, D. D., QUINDRY, J., BARBERIO, M. D., FOSTER, E. B., JONES, K. W. & PASCOE, D. D. 2011. Lymphocyte enzymatic antioxidant responses to oxidative stress following high-intensity interval exercise. *Journal of Applied Physiology*, 110, 730-737.
- FLEG, J. L. & LAKATTA, E. G. 1988. Role of muscle loss in the age-associated reduction in VO₂ max. *Journal of Applied Physiology*, 65, 1147-1151.
- FRANKE, W., STEPHENS, G. & SCHMID 3RD, P. 1998. Effects of intense exercise training on endothelium-dependent exercise-induced vasodilatation. *Clinical physiology (Oxford, England)*, 18, 521-528.
- FRANKLIN, S. S., GUSTIN, W., WONG, N. D., LARSON, M. G., WEBER, M. A., KANNEL, W. B. & LEVY, D. 1997. Hemodynamic Patterns of Age-Related Changes in Blood Pressure. *The Framingham Heart Study*, 96, 308-315.
- FUKUI, M., KITAGAWA, Y., NAKAMURA, N., KADONO, M., MOGAMI, S., HIRATA, C., ICHIO, N., WADA, K., HASEGAWA, G. & YOSHIKAWA, T. 2003. Association between serum testosterone concentration and carotid atherosclerosis in men with type 2 diabetes. *Diabetes care*, 26, 1869-1873.
- FUKUI, M., KITAGAWA, Y., NAKAMURA, N., KADONO, M., YOSHIDA, M., HIRATA, C., WADA, K., HASEGAWA, G. & YOSHIKAWA, T. 2005. Serum dehydroepiandrosterone sulfate concentration and carotid atherosclerosis in men with type 2 diabetes. *Atherosclerosis*, 181, 339-344.
- FUKUI, M., OSE, H., KITAGAWA, Y., YAMAZAKI, M., HASEGAWA, G., YOSHIKAWA, T. & NAKAMURA, N. 2007. Relationship between low serum endogenous androgen concentrations and arterial stiffness in men with type 2 diabetes mellitus. *Metabolism*, 56, 1167-1173.
- FURCHGOTT, R. F. & ZAWADZKI, J. V. 1980. The obligatory role of endothelial cells in the relaxation of arterial smooth muscle by acetylcholine. *Nature*, 288, 373-376.

- GAMBLE, G., ZORN, J., SANDERS, G., MACMAHON, S. & SHARPE, N. 1994. Estimation of arterial stiffness, compliance, and distensibility from M-mode ultrasound measurements of the common carotid artery. *Stroke*, 25, 11-16.
- GHILDIYAL, M., XU, J., SEITZ, H., WENG, Z. & ZAMORE, P. D. 2010. Sorting of Drosophila small silencing RNAs partitions microRNA* strands into the RNA interference pathway. *RNA*, 16, 43-56.
- GIBALA, M. J., LITTLE, J. P., MACDONALD, M. J. & HAWLEY, J. A. 2012. Physiological adaptations to low-volume, high-intensity interval training in health and disease. *The Journal of Physiology*, 590, 1077-1084.
- GIBALA, M. J. & MCGEE, S. L. 2008. Metabolic Adaptations to Short-term High-Intensity Interval Training: A Little Pain for a Lot of Gain? *Exercise and Sport Sciences Reviews*, 36, 58-63 10.1097/JES.0b013e318168ec1f.
- GIELEN, S., SCHULER, G. & ADAMS, V. 2010. Cardiovascular Effects of Exercise Training. *Molecular Mechanisms*, 122, 1221-1238.
- GIMBRONE, J., MICHAEL A. 1999. Vascular Endothelium, Hemodynamic Forces, and Atherogenesis. *American Journal of Pathology*, 155, 1-5.
- GOLA, M., BONADONNA, S., DOGA, M. & GIUSTINA, A. 2005. Growth Hormone and Cardiovascular Risk Factors. *The Journal of Clinical Endocrinology & Metabolism*, 90, 1864-1870.
- GOLDSTEIN, S. 1938. *Modern developments in fluid dynamics: an account of theory and experiment relating to boundary layers, turbulent motion and wakes*, Clarendon Press.
- GOTO, C., HIGASHI, Y., KIMURA, M., NOMA, K., HARA, K., NAKAGAWA, K., KAWAMURA, M., CHAYAMA, K., YOSHIZUMI, M. & NARA, I. 2003. Effect of Different Intensities of Exercise on Endothelium-Dependent Vasodilation in Humans: Role of Endothelium-Dependent Nitric Oxide and Oxidative Stress. *Circulation*, 108, 530-535.
- GRACE, F. M., HERBERT, P., RATCLIFFE, J. W., NEW, K. J., BAKER, J. S. & SCULTHORPE, N. F. 2015. Age related vascular endothelial function following lifelong sedentariness: positive impact of cardiovascular conditioning without further improvement following low frequency high intensity interval training. *Physiological Reports*, 3.
- GREEN, D., CHEETHAM, C., MAVADDAT, L., WATTS, K., BEST, M., TAYLOR, R. & O'DRISCOLL, G. 2002a. *Effect of lower limb exercise on forearm vascular function: contribution of nitric oxide*.
- GREEN, D., CHEETHAM, C., REED, C., DEMBO, L. & O'DRISCOLL, G. 2002b. *Assessment of brachial artery blood flow across the cardiac cycle: retrograde flows during cycle ergometry*.
- GREEN, D. J., BILSBOROUGH, W., NAYLOR, L. H., REED, C., WRIGHT, J., O'DRISCOLL, G. & WALSH, J. H. 2005. Comparison of forearm blood flow responses to incremental handgrip and cycle ergometer exercise: relative contribution of nitric oxide. *The Journal of Physiology*, 562, 617-628.
- GREEN, D. J., CABLE, N. T., FOX, C., RANKIN, J. M. & TAYLOR, R. R. 1994. Modification of forearm resistance vessels by exercise training in young men. *Journal of Applied Physiology*, 77, 1829-1833.
- GREEN, D. J., CARTER, H. H., FITZSIMONS, M. G., CABLE, N. T., THIJSSSEN, D. H. & NAYLOR, L. H. 2010a. Obligatory role of hyperaemia and shear stress in microvascular adaptation to repeated heating in humans. *The Journal of physiology*, 588, 1571-1577.

- GREEN, D. J., HOPMAN, M. T. E., PADILLA, J., LAUGHLIN, M. H. & THIJSSSEN, D. H. J. 2017. Vascular Adaptation to Exercise in Humans: Role of Hemodynamic Stimuli. *Physiological Reviews*, 97, 495-528.
- GREEN, D. J., JONES, H., THIJSSSEN, D., CABLE, N. T. & ATKINSON, G. 2011. Flow-Mediated Dilation and Cardiovascular Event Prediction: Does Nitric Oxide Matter? *Hypertension*, 57, 363-369.
- GREEN, D. J., MAIORANA, A., O'DRISCOLL, G. & TAYLOR, R. 2004. Effect of exercise training on endothelium-derived nitric oxide function in humans. *The Journal of Physiology*, 561, 1-25.
- GREEN, D. J., O'DRISCOLL, G., JOYNER, M. J. & CABLE, N. T. 2008. Exercise and cardiovascular risk reduction: time to update the rationale for exercise? *Journal of Applied Physiology*, 105, 766-768.
- GREEN, D. J., SWART, A., EXTERKATE, A., NAYLOR, L. H., BLACK, M. A., CABLE, N. T. & THIJSSSEN, D. H. J. 2010b. Impact of age, sex and exercise on brachial and popliteal artery remodelling in humans. *Atherosclerosis*, 210, 525-530.
- GREENLAND, P., DAVIGLUS, M. L., DYER, A. R., LIU, K., HUANG, C.-F., GOLDBERGER, J. J. & STAMLER, J. 1999. Resting Heart Rate is a Risk Factor for Cardiovascular and Noncardiovascular Mortality: The Chicago Heart Association Detection Project In Industry. *American Journal of Epidemiology*, 149, 853-862.
- GREGORY, R. I., CHENDRIMADA, T. P., COOCH, N. & SHIEKHATTAR, R. 2005. Human RISC Couples MicroRNA Biogenesis and Posttranscriptional Gene Silencing. *Cell*, 123, 631-640.
- GRUMBACH, M. M. & AUCHUS, R. J. 1999. Estrogen: Consequences and Implications of Human Mutations in Synthesis and Action¹. *The Journal of Clinical Endocrinology & Metabolism*, 84, 4677-4694.
- GUIMARAES, G. V., CIOLAC, E. G., CARVALHO, V. O., D'AVILA, V. M., BORTOLOTTI, L. A. & BOCCHI, E. A. 2010. Effects of continuous vs. interval exercise training on blood pressure and arterial stiffness in treated hypertension. *Hypertens Res*, 33, 627-632.
- GUO, D., CHIEN, S. & SHYY, J. Y.-J. 2007. Regulation of Endothelial Cell Cycle by Laminar Versus Oscillatory Flow: Distinct Modes of Interactions of AMP-Activated Protein Kinase and Akt Pathways. *Circulation Research*, 100, 564-571.
- HAJAR, R. 2016. Framingham Contribution to Cardiovascular Disease. *Heart Views : The Official Journal of the Gulf Heart Association*, 17, 78-81.
- HALLIWILL, J. R. & MINSON, C. T. 2010. *Retrograde shear: backwards into the future?*
- HAMBRECHT, R., WOLF, A., GIELEN, S., LINKE, A., HOFER, J., ERBS, S., SCHOENE, N. & SCHULER, G. 2000. Effect of Exercise on Coronary Endothelial Function in Patients with Coronary Artery Disease. *New England Journal of Medicine*, 342, 454-460.
- HASKELL, W. L., LEE, I.-M., PATE, R. R., POWELL, K. E., BLAIR, S. N., FRANKLIN, B. A., MACERA, C. A., HEATH, G. W., THOMPSON, P. D. & BAUMAN, A. 2007. Physical activity and public health. Updated recommendation for adults from the American College of Sports Medicine and the American Heart Association. *Circulation*.
- HATAKEYAMA, H., NISHIZAWA, M., NAKAGAWA, A., NAKANO, S., KIGOSHI, T. & UCHIDA, K. 2002. Testosterone inhibits tumor necrosis factor- α -induced

- vascular cell adhesion molecule-1 expression in human aortic endothelial cells. *FEBS letters*, 530, 129-132.
- HAWLEY, JOHN A., HARGREAVES, M., JOYNER, MICHAEL J. & ZIERATH, JULEEN R. 2014. Integrative Biology of Exercise. *Cell*, 159, 738-749.
- HEALY, B. 1990. Endothelial cell dysfunction: an emerging endocrinopathy linked to coronary disease. *J Am Coll Cardiol*, 16, 357-358.
- HEFFERNAN, K. S., LEFFERTS, W. K., KASPROWICZ, A. G., TARZIA, B. J., THIJSSSEN, D. H. & BRUTSAERT, T. D. 2013. Manipulation of arterial stiffness, wave reflections, and retrograde shear rate in the femoral artery using lower limb external compression. *Physiological Reports*, 1.
- HELGERUD, J., HØYDAL, K., WANG, E., KARLSEN, T., BERG, P., BJERKAAS, M., SIMONSEN, T., HELGESEN, C., HJORTH, N. & BACH, R. 2007. Aerobic high-intensity intervals improve V O₂max more than moderate training. *Medicine & Science in Sports & Exercise*, 39, 665-671.
- HERKERT, O., KUHL, H., BUSSE, R. & SCHINI-KERTH, V. B. 2000. The progestin levonorgestrel induces endothelium-independent relaxation of rabbit jugular vein via inhibition of calcium entry and protein kinase C: role of cyclic AMP. *British Journal of Pharmacology*, 130, 1911-1918.
- HERMAN, S. M., ROBINSON, J. T. C., MCCREDIE, R. J., ADAMS, M. R., BOYER, M. J. & CELERMAJER, D. S. 1997. Androgen Deprivation Is Associated With Enhanced Endothelium-Dependent Dilatation in Adult Men. *Arteriosclerosis, Thrombosis, and Vascular Biology*, 17, 2004-2009.
- HIGASHI, Y. & YOSHIZUMI, M. 2003. New Methods to Evaluate Endothelial Function: Method for Assessing Endothelial Function in Humans Using a Strain-Gauge Plethysmography: Nitric Oxide-Dependent and -Independent Vasodilation. *Journal of Pharmacological Sciences*, 93, 399-404.
- HIGASHI, Y. & YOSHIZUMI, M. 2004. Exercise and endothelial function: Role of endothelium-derived nitric oxide and oxidative stress in healthy subjects and hypertensive patients. *Pharmacology & Therapeutics*, 102, 87-96.
- HODIS, H. N., MACK, W. J., AZEN, S. P., LOBO, R. A., SHOUBE, D., MAHRER, P. R., FAXON, D. P., CASHIN-HEMPHILL, L., SANMARCO, M. E., FRENCH, W. J., SHOOK, T. L., GAARDER, T. D., MEHRA, A. O., RABBANI, R., SEVANIAN, A., SHIL, A. B., TORRES, M., VOGELBACH, K. H. & SELZER, R. H. 2003. Hormone Therapy and the Progression of Coronary-Artery Atherosclerosis in Postmenopausal Women. *New England Journal of Medicine*, 349, 535-545.
- HOLOWATZ, L. A., THOMPSON, C. S. & KENNEY, W. L. 2006. L-Arginine supplementation or arginase inhibition augments reflex cutaneous vasodilatation in aged human skin. *The Journal of Physiology*, 574, 573-581.
- HUTCHISON, S. J., SUDHIR, K., CHOU, T. M., SIEVERS, R. E., ZHU, B.-Q., SUN, Y.-P., DEEDWANIA, P. C., GLANTZ, S. A., PARMLEY, W. W. & CHATTERJEE, K. 1997. Testosterone Worsens Endothelial Dysfunction Associated With Hypercholesterolemia and Environmental Tobacco Smoke Exposure in Male Rabbit Aorta 1. *Journal of the American College of Cardiology*, 29, 800-807.
- HWANG, J., ING, M. H., SALAZAR, A., LASSÈGUE, B., GRIENGLING, K., NAVAB, M., SEVANIAN, A. & HSIAI, T. K. 2003. Pulsatile Versus Oscillatory Shear Stress Regulates NADPH Oxidase Subunit Expression: Implication for Native LDL Oxidation. *Circulation Research*, 93, 1225-1232.

- IKEGAWA, S., KAMIJO, Y.-I., OKAZAKI, K., MASUKI, S., OKADA, Y. & NOSE, H. 2011. Effects of hypohydration on thermoregulation during exercise before and after 5-day aerobic training in a warm environment in young men. *Journal of Applied Physiology*, 110, 972-980.
- JOANNIDES, R., COSTENTIN, A., IACOB, M., COMPAGNON, P., LAHARY, A. & THUILLEZ, C. 2002. Influence of vascular dimension on gender difference in flow-dependent dilatation of peripheral conduit arteries. *American Journal of Physiology - Heart and Circulatory Physiology*, 282, H1262-H1269.
- JONES, R. D., JONES, T. H. & CHANNER, K. S. 2004. The influence of testosterone upon vascular reactivity. *European journal of endocrinology*, 151, 29-37.
- JOYNER, M. J. 2000. Effect of Exercise on Arterial Compliance. *Circulation*, 102, 1214-1215.
- JOYNER, M. J. & GREEN, D. J. 2009. Exercise protects the cardiovascular system: effects beyond traditional risk factors. *The Journal of Physiology*, 587, 5551-5558.
- KALANTARIDOU, S. N., NAKA, K. K., BECHLIOULIS, A., MAKRIGIANNAKIS, A., MICHALIS, L. & CHROUSOS, G. P. 2006. Premature ovarian failure, endothelial dysfunction and estrogen-progestogen replacement. *Trends in Endocrinology & Metabolism*, 17, 101-109.
- KAPOOR, D., GOODWIN, E., CHANNER, K. & JONES, T. 2006. Testosterone replacement therapy improves insulin resistance, glycaemic control, visceral adiposity and hypercholesterolaemia in hypogonadal men with type 2 diabetes. *European Journal of Endocrinology*, 154, 899-906.
- KATUSIC, Z. S. 2001. Vascular endothelial dysfunction: does tetrahydrobiopterin play a role? *American Journal of Physiology - Heart and Circulatory Physiology*, 281, H981-H986.
- KEMI, O. J., HARAM, P. M., LOENNECHEN, J. P., OSNES, J.-B., SKOMEDAL, T., WISLØFF, U. & ELLINGSEN, Ø. 2005. Moderate vs. high exercise intensity: Differential effects on aerobic fitness, cardiomyocyte contractility, and endothelial function. *Cardiovascular Research*, 67, 161-172.
- KESSLER, H., SISSON, S. & SHORT, K. 2012. The Potential for High-Intensity Interval Training to Reduce Cardiometabolic Disease Risk. *Sports medicine*, 42, 489-509.
- KETEYIAN, S. J., BRAWNER, C. A., SAVAGE, P. D., EHRMAN, J. K., SCHAIRER, J., DIVINE, G., ALDRED, H., OPHAUG, K. & ADES, P. A. 2008. Peak aerobic capacity predicts prognosis in patients with coronary heart disease. *American heart journal*, 156, 292-300.
- KHAW, K.-T. & BARRETT-CONNOR, E. 1988. Blood pressure and endogenous testosterone in men: an inverse relationship. *Journal of hypertension*, 6, 328-332.
- KHAW, K.-T., DOWSETT, M., FOLKERT, E., BINGHAM, S., WAREHAM, N., LUBEN, R., WELCH, A. & DAY, N. 2007. Endogenous testosterone and mortality due to all causes, cardiovascular disease, and cancer in men. *Circulation*, 116, 2694-2701.
- KILIAN, Y., WEHMEIER, U. F., WAHL, P., MESTER, J., HILBERG, T. & SPERLICH, B. 2016. Acute response of circulating vascular regulating microRNAs during and after high-intensity and high-volume cycling in children. *Frontiers in physiology*, 7.
- KIMURA, M., SUDHIR, K., JONES, M., SIMPSON, E., JEFFERIS, A.-M. & CHINDUSTING, J. P. F. 2003. Impaired Acetylcholine-Induced Release of Nitric

- Oxide in the Aorta of Male Aromatase-Knockout Mice. *Regulation of Nitric Oxide Production by Endogenous Sex Hormones in Males*, 93, 1267-1271.
- KINGWELL, B. A., SHERRARD, B., JENNINGS, G. L. & DART, A. M. 1997. Four weeks of cycle training increases basal production of nitric oxide from the forearm. *American Journal of Physiology - Heart and Circulatory Physiology*, 272, H1070-H1077.
- KINLAY, S. & GANZ, P. 1997. Role of Endothelial Dysfunction in Coronary Artery Disease and Implications for Therapy. *The American Journal of Cardiology*, 80, 111-161.
- KOJDA, G. & HAMBRECHT, R. 2005. Molecular mechanisms of vascular adaptations to exercise. Physical activity as an effective antioxidant therapy? *Cardiovascular Research*, 67, 187-197.
- KOLLER, A., SUN, D. & KALEY, G. 1993. Role of shear stress and endothelial prostaglandins in flow- and viscosity-induced dilation of arterioles in vitro. *Circulation Research*, 72, 1276-1284.
- KOSKINAS, K. C., CHATZIZISIS, Y. S., BAKER, A. B., EDELMAN, E. R., STONE, P. H. & FELDMAN, C. L. 2009. The role of low endothelial shear stress in the conversion of atherosclerotic lesions from stable to unstable plaque. *Current opinion in cardiology*, 24, 580-590.
- KUMAR, S., KIM, C. W., SIMMONS, R. D. & JO, H. 2014. Role of Flow-Sensitive microRNAs in Endothelial Dysfunction and Atherosclerosis Mechanosensitive Athero-miRs. *Arteriosclerosis, thrombosis, and vascular biology*, 34, 2206-2216.
- KUPARI, M., HEKALI, P., KETO, P., POUTANEN, V. P., TIKKANEN, M. J. & STANDERSTKJÖLD-NORDENSTAM, C. G. 1994. Relation of aortic stiffness to factors modifying the risk of atherosclerosis in healthy people. *Arteriosclerosis, Thrombosis, and Vascular Biology*, 14, 386-394.
- LAKATTA, E. G. 2003. Arterial and Cardiac Aging: Major Shareholders in Cardiovascular Disease Enterprises: Part III: Cellular and Molecular Clues to Heart and Arterial Aging. *Circulation*, 107, 490-497.
- LAUGHLIN, M. H., NEWCOMER, S. C. & BENDER, S. B. 2008a. *Importance of hemodynamic forces as signals for exercise-induced changes in endothelial cell phenotype.*
- LAUGHLIN, M. H., NEWCOMER, S. C. & BENDER, S. B. 2008b. Importance of hemodynamic forces as signals for exercise-induced changes in endothelial cell phenotype. *Journal of Applied Physiology*, 104, 588-600.
- LAUGHLIN, M. H., RUBIN, L. J., RUSH, J. W. E., PRICE, E. M., SCHRAGE, W. G. & WOODMAN, C. R. 2003. Short-term training enhances endothelium-dependent dilation of coronary arteries, not arterioles. *Journal of Applied Physiology*, 94, 234-244.
- LEBRUN, C. E., VAN DER SCHOUW, Y. T., BAK, A. A., DE JONG, F. H., POLS, H. A., GROBBEE, D. E., LAMBERTS, S. W. & BOTS, M. L. 2002. Arterial stiffness in postmenopausal women: determinants of pulse wave velocity. *Journal of Hypertension*, 20, 2165-2172.
- LEE, I. M., SHIROMA, E. J., LOBELO, F., PUSKA, P., BLAIR, S. N. & KATZMARZYK, P. T. 2012. Effect of physical inactivity on major non-communicable diseases worldwide: an analysis of burden of disease and life expectancy. *The Lancet*, 380, 219-229.
- LEE, Y., KIM, M., HAN, J., YEOM, K. H., LEE, S., BAEK, S. H. & KIM, V. N. 2004. *MicroRNA genes are transcribed by RNA polymerase II.*

- LEKONTSEVA, O., CHAKRABARTI, S. & DAVIDGE, S. T. 2010. Endothelin in the female vasculature: a role in aging? *American Journal of Physiology - Regulatory, Integrative and Comparative Physiology*, 298, R509-R516.
- LERMAN, A. & ZEIHNER, A. M. 2005. Endothelial Function. *Cardiac Events*, 111, 363-368.
- LEVIN, E. R. 2009. Plasma Membrane Estrogen Receptors. *Trends in endocrinology and metabolism: TEM*, 20, 477-482.
- LEW, R., KOMESAROFF, P., WILLIAMS, M., DAWOOD, T. & SUDHIR, K. 2003. Endogenous Estrogens Influence Endothelial Function in Young Men. *Circulation Research*, 93, 1127-1133.
- LI, G., DEL RINCON, J.-P., JAHN, L. A., WU, Y., GAYLINN, B., THORNER, M. O. & LIU, Z. 2008. Growth Hormone Exerts Acute Vascular Effects Independent of Systemic or Muscle Insulin-like Growth Factor I. *The Journal of Clinical Endocrinology and Metabolism*, 93, 1379-1385.
- LITTLE, J. P., GILLEN, J. B., PERCIVAL, M. E., SAFDAR, A., TARNOPOLSKY, M. A., PUNTHAKEE, Z., JUNG, M. E. & GIBALA, M. J. 2011. Low-volume high-intensity interval training reduces hyperglycemia and increases muscle mitochondrial capacity in patients with type 2 diabetes. *Journal of Applied Physiology*, 111, 1554-1560.
- LIU, P. Y., DEATH, A. K. & HANDELSMAN, D. J. 2003. Androgens and Cardiovascular Disease. *Endocrine Reviews*, 24, 313-340.
- LIU, Y., DING, J., BUSH, T. L., LONGENECKER, J. C., NIETO, F. J., GOLDEN, S. H. & SZKLO, M. 2001. Relative androgen excess and increased cardiovascular risk after menopause: a hypothesized relation. *American journal of epidemiology*, 154, 489-494.
- LLOYD-JONES, D., ADAMS, R. J., BROWN, T. M., CARNETHON, M., DAI, S., DE SIMONE, G., FERGUSON, T. B., FORD, E., FURIE, K. & GILLESPIE, C. 2010. Heart disease and stroke statistics—2010 update. *Circulation*, 121, e46-e215.
- LOOMIS, E. D., SULLIVAN, J. C., OSMOND, D. A., POLLOCK, D. M. & POLLOCK, J. S. 2005. Endothelin Mediates Superoxide Production and Vasoconstriction through Activation of NADPH Oxidase and Uncoupled Nitric-Oxide Synthase in the Rat Aorta. *Journal of Pharmacology and Experimental Therapeutics*, 315, 1058-1064.
- LUSIS, A. J. 2000. Atherosclerosis. *Nature*, 407, 233-241.
- MAAS, A. H. E. M. & APPELMAN, Y. E. A. 2010. Gender differences in coronary heart disease. *Netherlands Heart Journal*, 18, 598-603.
- MADAMANCHI, N. R., VENDROV, A. & RUNGE, M. S. 2005. Oxidative Stress and Vascular Disease. *Arteriosclerosis, Thrombosis, and Vascular Biology*, 25, 29-38.
- MAEDA, S., SUGAWARA, J., YOSHIZAWA, M., OTSUKI, T., SHIMOJO, N., JESMIN, S., AJISAKA, R., MIYAUCHI, T. & TANAKA, H. 2009. Involvement of endothelin-1 in habitual exercise-induced increase in arterial compliance. *Acta Physiologica*, 196, 223-229.
- MAEDA, S., TANABE, T., MIYAUCHI, T., OTSUKI, T., SUGAWARA, J., IEMITSU, M., KUNO, S., AJISAKA, R., YAMAGUCHI, I. & MATSUDA, M. 2003. Aerobic exercise training reduces plasma endothelin-1 concentration in older women. *Journal of Applied Physiology*, 95, 336-341.

- MAHMOOD, S. S., LEVY, D., VASAN, R. S. & WANG, T. J. 2014. The Framingham Heart Study and the epidemiology of cardiovascular disease: a historical perspective. *The Lancet*, 383, 999-1008.
- MAIORANA, A., O'DRISCOLL, G., TAYLOR, R. & GREEN, D. 2003. Exercise and the nitric oxide vasodilator system. *Sports Medicine*, 33, 1013-1035.
- MALEK, A. M., ALPER, S. L. & IZUMO, S. 1999. Hemodynamic shear stress and its role in atherosclerosis. *JAMA*, 282, 2035-2042.
- MANSON, J. E., GREENLAND, P., LACROIX, A. Z., STEFANICK, M. L., MOUTON, C. P., OBERMAN, A., PERRI, M. G., SHEPS, D. S., PETTINGER, M. B. & SISCOVICK, D. S. 2002. Walking Compared with Vigorous Exercise for the Prevention of Cardiovascular Events in Women. *New England Journal of Medicine*, 347, 716-725.
- MATSUDA, M., NOSAKA, T., SATO, M. & OHSHIMA, N. 1993. Effects of physical exercise on the elasticity and elastic components of the rat aorta. *European journal of applied physiology and occupational physiology*, 66, 122-126.
- MATSUKAWA, T., SUGIYAMA, Y., WATANABE, T., KOBAYASHI, F. & MANO, T. 1998. Gender difference in age-related changes in muscle sympathetic nerve activity in healthy subjects. *American Journal of Physiology-Regulatory, Integrative and Comparative Physiology*, 275, R1600-R1604.
- MATTACE-RASO, F. U. S., VAN DER CAMMEN, T. J. M., HOFMAN, A., VAN POPELE, N. M., BOS, M. L., SCHALEKAMP, M. A. D. H., ASMAR, R., RENEMAN, R. S., HOEKS, A. P. G., BRETELER, M. M. B. & WITTEMAN, J. C. M. 2006. Arterial Stiffness and Risk of Coronary Heart Disease and Stroke. *The Rotterdam Study*, 113, 657-663.
- MCCREDIE, R. J., MCCROHON, J. A., TURNER, L., GRIFFITHS, K. A., HANDELSMAN, D. J. & CELERMAJER, D. S. 1998. Vascular reactivity is impaired in genetic females taking high-dose androgens. *Journal of the American College of Cardiology*, 32, 1331-1335.
- MCDONALD, D. A. 1952. The velocity of blood flow in the rabbit aorta studied with high-speed cinematography. *The Journal of Physiology*, 118, 328-339.
- MCDONALD, D. A. 1955. The relation of pulsatile pressure to flow in arteries. *The Journal of Physiology*, 127, 533-552.
- MCGRATH, B. P., LIANG, Y.-L., TEEDE, H., SHIEL, L. M., CAMERON, J. D. & DART, A. 1998. Age-Related Deterioration in Arterial Structure and Function in Postmenopausal Women. *Impact of Hormone Replacement Therapy*, 18, 1149-1156.
- MCNEILL, A. M., KIM, N., DUCKLES, S. P. & KRAUSE, D. N. 1999. Chronic Estrogen Treatment Increases Levels of Endothelial Nitric Oxide Synthase Protein in Rat Cerebral Microvessels. *Stroke*, 30, 2186-2190.
- MENDELSON, M. E. & KARAS, R. H. 2005. Molecular and Cellular Basis of Cardiovascular Gender Differences. *Science*, 308, 1583-1587.
- MENGHINI, R., CASAGRANDE, V., CARDELLINI, M., MARTELLI, E., TERRINONI, A., AMATI, F., VASA-NICOTERA, M., IPPOLITI, A., NOVELLI, G. & MELINO, G. 2009. MicroRNA 217 modulates endothelial cell senescence via silent information regulator 1. *Circulation*, 120, 1524-1532.
- MILLER, V. M., BLACK, D. M., BRINTON, E. A., BUDOFF, M. J., CEDARS, M. I., HODIS, H. N., LOBO, R. A., MANSON, J. E., MERRIAM, G. R., NAFTOLIN, F., SANTORO, N., TAYLOR, H. S. & HARMAN, S. M. 2009. Using Basic Science to Design a Clinical Trial: Baseline Characteristics of Women Enrolled

- in the Kronos Early Estrogen Prevention Study (KEEPS). *Journal of Cardiovascular Translational Research*, 2, 228-239.
- MILLER, V. M. & MULVAGH, S. L. 2007. Sex steroids and endothelial function: translating basic science to clinical practice. *Trends in Pharmacological Sciences*, 28, 263-270.
- MINAMINO, T., MIYAUCHI, H., YOSHIDA, T., ISHIDA, Y., YOSHIDA, H. & KOMURO, I. 2002. Endothelial Cell Senescence in Human Atherosclerosis. *Role of Telomere in Endothelial Dysfunction*, 105, 1541-1544.
- MITCHELL, G. F., PARISE, H., BENJAMIN, E. J., LARSON, M. G., KEYES, M. J., VITA, J. A., VASAN, R. S. & LEVY, D. 2004. Changes in Arterial Stiffness and Wave Reflection With Advancing Age in Healthy Men and Women: The Framingham Heart Study. *Hypertension*, 43, 1239-1245.
- MOLINARI, C., BATTAGLIA, A., GROSSINI, E., MARY, D., STOKER, J., SURICO, N. & VACCA, G. 2001. The effect of progesterone on coronary blood flow in anaesthetized pigs. *Experimental physiology*, 86, 101-108.
- MONTERO, D., PIERCE, G. L., STEHOUSER, C. D. A., PADILLA, J. & THIJSEN, D. H. J. 2015. THE IMPACT OF AGE ON VASCULAR SMOOTH MUSCLE FUNCTION IN HUMANS. *Journal of hypertension*, 33, 445-453.
- MOOREN, F. C., VIREECK, J., KRÜGER, K. & THUM, T. 2014. Circulating micrnas as potential biomarkers of aerobic exercise capacity. *American Journal of Physiology - Heart and Circulatory Physiology*, 306, H557-H563.
- MORA, S., COOK, N., BURING, J. E., RIDKER, P. M. & LEE, I.-M. 2007. Physical activity and reduced risk of cardiovascular events. *Circulation*, 116, 2110-2118.
- MORGAN, C. P. & BALE, T. L. 2011. Early prenatal stress epigenetically programs dysmasculinization in second-generation offspring via the paternal lineage. *Journal of Neuroscience*, 31, 11748-11755.
- MORIARTY, K., KIM, K. H. & BENDER, J. R. 2006. Estrogen Receptor-Mediated Rapid Signaling. *Endocrinology*, 147, 5557-5563.
- MOSCA, L. 2000. The role of hormone replacement therapy in the prevention of postmenopausal heart disease. *Archives of Internal Medicine*, 160, 2263-2272.
- MULLEN, M. J., KHARBANDA, R. K., CROSS, J., DONALD, A. E., TAYLOR, M., VALLANCE, P., DEANFIELD, J. E. & MACALLISTER, R. J. 2001. Heterogenous Nature of Flow-Mediated Dilatation in Human Conduit Arteries In Vivo. *Relevance to Endothelial Dysfunction in Hypercholesterolemia*, 88, 145-151.
- MURRI, M., INSENER, M., FERNÁNDEZ-DURÁN, E., SAN-MILLÁN, J. L. & ESCOBAR-MORREALE, H. F. 2013. Effects of Polycystic Ovary Syndrome (PCOS), Sex Hormones, and Obesity on Circulating miRNA-21, miRNA-27b, miRNA-103, and miRNA-155 Expression. *The Journal of Clinical Endocrinology & Metabolism*, 98, E1835-E1844.
- NAGHAVI, M., LIBBY, P., FALK, E., CASSCELLS, S. W., LITOVSKY, S., RUMBERGER, J., BADIMON, J. J., STEFANADIS, C., MORENO, P., PASTERKAMP, G., FAYAD, Z., STONE, P. H., WAXMAN, S., RAGGI, P., MADJID, M., ZARRABI, A., BURKE, A., YUAN, C., FITZGERALD, P. J., SISCOVICK, D. S., DE KORTE, C. L., AIKAWA, M., AIRAKSINEN, K. E. J., ASSMANN, G., BECKER, C. R., CHESEBRO, J. H., FARB, A., GALIS, Z. S., JACKSON, C., JANG, I.-K., KOENIG, W., LODDER, R. A., MARCH, K., DEMIROVIC, J., NAVAB, M., PRIORI, S. G., REKHTER, M. D., BAHR, R.,

- GRUNDY, S. M., MEHRAN, R., COLOMBO, A., BOERWINKLE, E., BALLANTYNE, C., INSULL, W., SCHWARTZ, R. S., VOGEL, R., SERRUYS, P. W., HANSSON, G. K., FAXON, D. P., KAUL, S., DREXLER, H., GREENLAND, P., MULLER, J. E., VIRMANI, R., RIDKER, P. M., ZIPES, D. P., SHAH, P. K. & WILLERSON, J. T. 2003. From Vulnerable Plaque to Vulnerable Patient. *A Call for New Definitions and Risk Assessment Strategies: Part II*, 108, 1772-1778.
- NAKAMURA, Y., SUZUKI, T. & SASANO, H. 2005. Estrogen actions and in situ synthesis in human vascular smooth muscle cells and their correlation with atherosclerosis. *The Journal of Steroid Biochemistry and Molecular Biology*, 93, 263-268.
- NATOLI, A. K., MEDLEY, T. L., AHIMASTOS, A. A., DREW, B. G., THEARLE, D. J., DILLEY, R. J. & KINGWELL, B. A. 2005. Sex Steroids Modulate Human Aortic Smooth Muscle Cell Matrix Protein Deposition and Matrix Metalloproteinase Expression. *Hypertension*, 46, 1129-1134.
- NAYLOR, L. H., CARTER, H., FITZSIMONS, M. G., CABLE, N. T., THIJSSSEN, D. H. J. & GREEN, D. J. 2011. Repeated increases in blood flow, independent of exercise, enhance conduit artery vasodilator function in humans. *American Journal of Physiology - Heart and Circulatory Physiology*, 300, H664-H669.
- NAYLOR, L. H., WEISBROD, C. J., O'DRISCOLL, G. & GREEN, D. J. 2005. Measuring peripheral resistance and conduit arterial structure in humans using Doppler ultrasound. *Journal of Applied Physiology*, 98, 2311-2315.
- NICHOLS, W., O'ROURKE, M. & VLACHOPOULOS, C. 2011. *McDonald's blood flow in arteries: theoretical, experimental and clinical principles*, CRC press.
- NICHOLS, W. W. & O'ROURKE, M. F. 1998. *McDonald's Blood Flow in Arteries: Theoretical, experimental and clinical principles*, London, Arnold.
- NIELSEN, S., ÅKERSTRÖM, T., RINNOV, A., YFANTI, C., SCHEELE, C., PEDERSEN, B. K. & LAYE, M. J. 2014. The miRNA Plasma Signature in Response to Acute Aerobic Exercise and Endurance Training. *PLoS ONE*, 9, e87308.
- NISHIGUCHI, T., IMANISHI, T. & AKASAKA, T. 2014. MicroRNAs and Cardiovascular Diseases. *BioMed Research International*.
- NOCON, M., HIEMANN, T., MÜLLER-RIEMENSCHNEIDER, F., THALAU, F., ROLL, S. & WILLICH, S. N. 2008. Association of physical activity with all-cause and cardiovascular mortality: a systematic review and meta-analysis. *European Journal of Cardiovascular Prevention & Rehabilitation*, 15, 239-246.
- NYBERG, M., MORTENSEN, S. P. & HELLSTEN, Y. 2013. Physical activity opposes the age-related increase in skeletal muscle and plasma endothelin-1 levels and normalizes plasma endothelin-1 levels in individuals with essential hypertension. *Acta Physiologica*, 207, 524-535.
- NYSTRÖM, H. C., KLINTLAND, N., CAIDAHL, K., BERGSTRÖM, G. & WICKMAN, A. 2005. Short-term administration of growth hormone (GH) lowers blood pressure by activating eNOS/nitric oxide (NO)-pathway in male hypophysectomized (Hx) rats. *BMC Physiology*, 5, 17-17.
- O'ROURKE, M. F. & AVOLIO, A. P. 1980. Pulsatile flow and pressure in human systemic arteries. Studies in man and in a multibranch model of the human systemic arterial tree. *Circulation Research*, 46, 363-372.
- ORSHAL, J. M. & KHALIL, R. A. 2004. Gender, sex hormones, and vascular tone. *American Journal of Physiology - Regulatory, Integrative and Comparative Physiology*, 286, R233-R249.

- PADILLA, J., SIMMONS, G. H., BENDER, S. B., ARCE-ESQUIVEL, A. A., WHYTE, J. J. & LAUGHLIN, M. H. 2011a. Vascular Effects of Exercise: Endothelial Adaptations Beyond Active Muscle Beds. *Physiology*, 26, 132-145.
- PADILLA, J., SIMMONS, G. H., FADEL, P. J., LAUGHLIN, M. H., JOYNER, M. J. & CASEY, D. P. 2011b. Impact of Aging on Conduit Artery Retrograde and Oscillatory Shear at Rest and During Exercise. *Role of Nitric Oxide*, 57, 484-489.
- PADILLA, J., SIMMONS, G. H., VIANNA, L. C., DAVIS, M. J., LAUGHLIN, M. H. & FADEL, P. J. 2011c. Brachial artery vasodilatation during prolonged lower limb exercise: role of shear rate. *Experimental Physiology*, 96, 1019-1027.
- PADILLA, J., YOUNG, C. N., SIMMONS, G. H., DEO, S. H., NEWCOMER, S. C., SULLIVAN, J. P., LAUGHLIN, M. H. & FADEL, P. J. 2010. *Increased muscle sympathetic nerve activity acutely alters conduit artery shear rate patterns.*
- PIERCE, G. L. & LARROCCA, T. J. 2008. Reduced vascular tetrahydrobiopterin (BH4) and endothelial function with ageing: is it time for a chronic BH4 supplementation trial in middle-aged and older adults? *The Journal of Physiology*, 586, 2673-2674.
- PRIOR, B. M., LLOYD, P. G., YANG, H. T. & TERJUNG, R. L. 2003. Exercise-Induced Vascular Remodeling. *Exercise and Sport Sciences Reviews*, 31, 26-33.
- QIU, Y. & TARBELL, J. M. 2000. Interaction between Wall Shear Stress and Circumferential Strain Affects Endothelial Cell Biochemical Production. *Journal of Vascular Research*, 37, 147-157.
- QUILLON, A., FROMY, B. & DEBRET, R. 2015. Endothelium microenvironment sensing leading to nitric oxide mediated vasodilation: A review of nervous and biomechanical signals. *Nitric Oxide*, 45, 20-26.
- RÅDEGRAN, G. & SALTIN, B. 1998. Muscle blood flow at onset of dynamic exercise in humans. *American Journal of Physiology - Heart and Circulatory Physiology*, 274, H314-H322.
- RAJKUMAR, C., KINGWELL, B. A., CAMERON, J. D., WADDELL, T., MEHRA, R., CHRISTOPHIDIS, N., KOMESAROFF, P. A., MCGRATH, B., JENNINGS, G. L., SUDHIR, K. & DART, A. M. 1997. Hormonal Therapy Increases Arterial Compliance in Postmenopausal Women. *Journal of the American College of Cardiology*, 30, 350-356.
- RAKOBOWCHUK, M., HARRIS, E., TAYLOR, A., BALIGA, V., CUBBON, R. M., ROSSITER, H. B. & BIRCH, K. M. 2012a. Heavy and moderate interval exercise training alters low-flow-mediated constriction but does not increase circulating progenitor cells in healthy humans. *Experimental physiology*, 97, 375-385.
- RAKOBOWCHUK, M., HARRIS, E., TAYLOR, A., CUBBON, R. & BIRCH, K. 2012b. Moderate and heavy metabolic stress interval training improve arterial stiffness and heart rate dynamics in humans. *European Journal of Applied Physiology*, 1-11.
- RAKOBOWCHUK, M., TANGUAY, S., BURGOMASTER, K. A., HOWARTH, K. R., GIBALA, M. J. & MACDONALD, M. J. 2008. Sprint interval and traditional endurance training induce similar improvements in peripheral arterial stiffness and flow-mediated dilation in healthy humans. *American Journal of Physiology - Regulatory, Integrative and Comparative Physiology*, 295, R236-R242.
- RAMZY, D., RAO, V., TUMIATI, L. C., XU, N., SHESHGIRI, R., MIRIUKA, S., DELGADO, D. H. & ROSS, H. J. 2006. Elevated Endothelin-1 Levels Impair

- Nitric Oxide Homeostasis Through a PKC-Dependent Pathway. *Circulation*, 114, I-319-I-326.
- RIPPE, C., BLIMLINE, M., MAGERKO, K. A., LAWSON, B. R., LAROCCA, T., DONATO, A. J. & SEALS, D. R. 2012. MicroRNA Changes in Human Arterial Endothelial Cells with Senescence: Relation to Apoptosis, eNOS and Inflammation. *Experimental gerontology*, 47, 45-51.
- ROBERTS, M. F., WENGER, C. B., STOLWIJK, J. & NADEL, E. R. 1977. Skin blood flow and sweating changes following exercise training and heat acclimation. *Journal of Applied Physiology*, 43, 133-137.
- RODBARD, S. 1975. Vascular caliber. *Cardiology*, 60, 4-49.
- ROJAS, A., ROMAY, S., GONZÁLEZ, D., HERRERA, B., DELGADO, R. & OTERO, K. 2000. Regulation of Endothelial Nitric Oxide Synthase Expression by Albumin-Derived Advanced Glycosylation End Products. *Circulation Research*, 86, e50-e54.
- RONDAIJ, M. G., BIERINGS, R., KRAGT, A., VAN MOURIK, J. A. & VOORBERG, J. 2006. Dynamics and Plasticity of Weibel-Palade Bodies in Endothelial Cells. *Arteriosclerosis, Thrombosis, and Vascular Biology*, 26, 1002-1007.
- ROSEN, C. J. 2000. Growth hormone and aging. *Endocrine*, 12, 197-201.
- ROSS, R. 1999. Atherosclerosis — An Inflammatory Disease. *New England Journal of Medicine*, 340, 115-126.
- ROSSI, P., FRANCÈS, Y., KINGWELL, B. A. & AHIMASTOS, A. A. 2011. Gender differences in artery wall biomechanical properties throughout life. *Journal of Hypertension*, 29, 1023-1033.
- ROSSI, R., NUZZO, A., ORIGLIANI, G. & MODENA, M. G. 2008. Prognostic Role of Flow-Mediated Dilation and Cardiac Risk Factors in Post-Menopausal Women. *Journal of the American College of Cardiology*, 51, 997-1002.
- ROSSOUW, J. E., PRENTICE, R. L., MANSON, J. E. & ET AL. 2007. Postmenopausal hormone therapy and risk of cardiovascular disease by age and years since menopause. *JAMA*, 297, 1465-1477.
- RUBANYI, G. M. 1993. The role of endothelium in cardiovascular homeostasis and diseases. *Journal of cardiovascular pharmacology*, 22 Suppl 4, S1-14.
- RUBANYI, G. M. & POLOKOFF, M. A. 1994. Endothelins: molecular biology, biochemistry, pharmacology, physiology, and pathophysiology. *Pharmacological Reviews*, 46, 325-415.
- RUBANYI, G. M., ROMERO, J. C. & VANHOUTTE, P. M. 1986. Flow-induced release of endothelium-derived relaxing factor. *American Journal of Physiology-Heart and Circulatory Physiology*, 250, H1145-H1149.
- RUPNOW, H. L., PHERNETTON, T. M., SHAW, C. E., MODRICK, M. L., BIRD, I. M. & MAGNESS, R. R. 2001. Endothelial vasodilator production by uterine and systemic arteries. VII. Estrogen and progesterone effects on eNOS. *American Journal of Physiology - Heart and Circulatory Physiology*, 280, H1699-H1705.
- SALTIN, B., RÅDEGRAN, G., KOSKOLOU, M. D. & ROACH, R. C. 1998. Skeletal muscle blood flow in humans and its regulation during exercise. *Acta Physiologica Scandinavica*, 162, 421-436.
- SANDGREN, T., SONESSON, B., AHLGREN, Å. R. & LÄNNE, T. 1998. Factors predicting the diameter of the popliteal artery in healthy humans. *Journal of vascular surgery*, 28, 284-289.
- SANTOS-PARKER, J. R., STRAHLER, T. R., VORWALD, V. M., PIERCE, G. L. & SEALS, D. R. 2017. Habitual aerobic exercise does not protect against micro-

- or macrovascular endothelial dysfunction in healthy estrogen-deficient postmenopausal women. *Journal of Applied Physiology*, 122, 11-19.
- SAPP, R. M., SHILL, D. D., ROTH, S. M. & HAGBERG, J. M. 2017. Circulating microRNAs in acute and chronic exercise: more than mere biomarkers. *Journal of Applied Physiology*, 122, 702-717.
- SAWYER, B. J., TUCKER, W. J., BHAMMAR, D. M., RYDER, J. R., SWEAZEA, K. L. & GAESSER, G. A. 2016. Effects of high-intensity interval training and moderate-intensity continuous training on endothelial function and cardiometabolic risk markers in obese adults. *Journal of Applied Physiology*, 121, 279-288.
- SCHIERBECK, L. L., REJNMARK, L., TOFTENG, C. L., STILGREN, L., EIKEN, P., MOSEKILDE, L., KØBER, L. & JENSEN, J.-E. B. 2012. Effect of hormone replacement therapy on cardiovascular events in recently postmenopausal women: randomised trial. *BMJ : British Medical Journal*, 345.
- SCHIFFRIN, E. L. 2001. Role of endothelin-1 in hypertension and vascular disease. *American Journal of Hypertension*, 14, S83-S89.
- SCHINI-KERTH, V. 1998. Dual effects of insulin-like growth factor-I on the constitutive and inducible nitric oxide (NO) synthase-dependent formation of NO in vascular cells. *Journal of endocrinological investigation*, 22, 82-88.
- SCHMIDT-TRUCKSÄSS, A., GRATHWOHL, D., SCHMID, A., BORAGK, R., UPMEIER, C., KEUL, J. & HUONKER, M. 1999. Structural, functional, and hemodynamic changes of the common carotid artery with age in male subjects. *Arteriosclerosis, thrombosis, and vascular biology*, 19, 1091-1097.
- SEALS, D. R., DESOUZA, C. A., DONATO, A. J. & TANAKA, H. 2008. Habitual exercise and arterial aging. *Journal of Applied Physiology*, 105, 1323-1332.
- SEALS, D. R., JABLONSKI, K. L. & DONATO, A. J. 2011. Aging and vascular endothelial function in humans. *Clinical Science*, 120, 357-375.
- SELZER, R. H., MACK, W. J., LEE, P. L., KWONG-FU, H. & HODIS, H. N. 2001. Improved common carotid elasticity and intima-media thickness measurements from computer analysis of sequential ultrasound frames. *Atherosclerosis*, 154, 185-193.
- SESSA, W. C., PRITCHARD, K., SEYEDI, N., WANG, J. & HINTZE, T. H. 1994. Chronic exercise in dogs increases coronary vascular nitric oxide production and endothelial cell nitric oxide synthase gene expression. *Circulation Research*, 74, 349-53.
- SHARMA, S. & EGHBALI, M. 2014. Influence of sex differences on microRNA gene regulation in disease. *Biology of Sex Differences*, 5, 3.
- SHAW, L. J., BAIREY MERZ, C. N., PEPINE, C. J., REIS, S. E., BITTNER, V., KELSEY, S. F., OLSON, M., JOHNSON, B. D., MANKAD, S., SHARAF, B. L., ROGERS, W. J., WESSEL, T. R., ARANT, C. B., POHOST, G. M., LERMAN, A., QUYYUMI, A. A. & SOPKO, G. 2006. Insights From the NHLBI-Sponsored Women's Ischemia Syndrome Evaluation (WISE) Study Part I: Gender Differences in Traditional and Novel Risk Factors, Symptom Evaluation, and Gender-Optimized Diagnostic Strategies. *Journal of the American College of Cardiology*, 47, S4-S20.
- SHECHTER, M., SHECHTER, A., KOREN-MORAG, N., FEINBERG, M. S. & HIERSCH, L. 2014. Usefulness of Brachial Artery Flow-Mediated Dilatation to Predict Long-Term Cardiovascular Events in Subjects Without Heart Disease. *The American Journal of Cardiology*, 113, 162-167.

- SHIMADA, K., MIKAMI, Y., MURAYAMA, T., YOKODE, M., FUJITA, M., KITA, T. & KISHIMOTO, C. 2011. Atherosclerotic plaques induced by marble-burying behavior are stabilized by exercise training in experimental atherosclerosis. *International journal of cardiology*, 151, 284-289.
- SIMMONS, G. H., PADILLA, J., YOUNG, C. N., WONG, B. J., LANG, J. A., DAVIS, M. J., LAUGHLIN, M. H. & FADEL, P. J. 2011. *Increased brachial artery retrograde shear rate at exercise onset is abolished during prolonged cycling: role of thermoregulatory vasodilation.*
- SIMONS, P. C. G., ALGRA, A., BOTS, M. L., GROBBEE, D. E. & VAN DER GRAAF, Y. 1999. Common Carotid Intima-Media Thickness and Arterial Stiffness. *Indicators of Cardiovascular Risk in High-Risk Patients The SMART Study (Second Manifestations of ARterial disease)*, 100, 951-957.
- SON, D. J., KUMAR, S., TAKABE, W., KIM, C. W., NI, C.-W., ALBERTS-GRILL, N., JANG, I.-H., KIM, S., KIM, W. & KANG, S. W. 2013. The atypical mechanosensitive microRNA-712 derived from pre-ribosomal RNA induces endothelial inflammation and atherosclerosis. *Nature communications*, 4, 3000.
- SPARLING, P. B. 1980. A meta-analysis of studies comparing maximal oxygen uptake in men and women. *Research quarterly for exercise and sport*, 51, 542-552.
- STAESSEN, J. A., BULPITT, C. J., FAGARD, R., LIJNEN, P. & AMERY, A. 1989. The influence of menopause on blood pressure. *Hypertension in postmenopausal women*. Springer.
- STAMLER, J., NEATON, J. D. & WENTWORTH, D. N. 1989. Blood pressure (systolic and diastolic) and risk of fatal coronary heart disease. *Hypertension*, 13, 12.
- SUDHIR, K. & KOMESAROFF, P. A. 1999. Cardiovascular Actions of Estrogens in Men. *The Journal of Clinical Endocrinology & Metabolism*, 84, 3411-3415.
- SUGAWARA, J., KOMINE, H., HAYASHI, K., YOSHIZAWA, M., YOKOI, T., OTSUKI, T., SHIMOJO, N., MIYAUCHI, T., MAEDA, S. & TANAKA, H. 2007. Effect of systemic nitric oxide synthase inhibition on arterial stiffness in humans. *Hypertension Research*, 30, 411-415.
- SUGAWARA, J., OTSUKI, T., TANABE, T., HAYASHI, K., MAEDA, S. & MATSUDA, M. 2006. Physical Activity Duration, Intensity, and Arterial Stiffening in Postmenopausal Women*. *American Journal of Hypertension*, 19, 1032-1036.
- SUTTON-TYRRELL, K., NAJJAR, S. S., BOUDREAU, R. M., VENKITACHALAM, L., KUPELIAN, V., SIMONSICK, E. M., HAVLIK, R., LAKATTA, E. G., SPURGEON, H., KRITCHEVSKY, S., PAHOR, M., BAUER, D. & NEWMAN, A. 2005. Elevated Aortic Pulse Wave Velocity, a Marker of Arterial Stiffness, Predicts Cardiovascular Events in Well-Functioning Older Adults. *Circulation*, 111, 3384-3390.
- SUTTON-TYRRELL, K., NEWMAN, A., SIMONSICK, E. M., HAVLIK, R., PAHOR, M., LAKATTA, E., SPURGEON, H., VAITKEVICIUS, P. & INVESTIGATORS, F. T. H. A. 2001. Aortic Stiffness Is Associated With Visceral Adiposity in Older Adults Enrolled in the Study of Health, Aging, and Body Composition. *Hypertension*, 38, 429-433.
- SWIFT, D. L., EARNEST, C. P., BLAIR, S. N. & CHURCH, T. S. 2012. The effect of different doses of aerobic exercise training on endothelial function in postmenopausal women with elevated blood pressure: results from the DREW study. *British Journal of Sports Medicine*, 46, 753-758.

- TADDEI, S., VIRDIS, A., GHIADONI, L., MATTEI, P., SUDANO, I., BERNINI, G., PINTO, S. & SALVETTI, A. 1996. Menopause Is Associated With Endothelial Dysfunction in Women. *Hypertension*, 28, 576-582.
- TADDEI, S., VIRDIS, A., GHIADONI, L., SALVETTI, G., BERNINI, G., MAGAGNA, A. & SALVETTI, A. 2001. Age-Related Reduction of NO Availability and Oxidative Stress in Humans. *Hypertension*, 38, 274-279.
- TADDEI, S., VIRDIS, A., MATTEI, P., GHIADONI, L., GENNARI, A., FASOLO, C. B., SUDANO, I. & SALVETTI, A. 1995. Aging and Endothelial Function in Normotensive Subjects and Patients With Essential Hypertension. *Circulation*, 91, 1981-1987.
- TAKASE, B., UEHATA, A., AKIMA, T., NAGAI, T., NISHIOKA, T., HAMABE, A., SATOMURA, K., OHSUZU, F. & KURITA, A. 1998. Endothelium-dependent flow-mediated vasodilation in coronary and brachial arteries in suspected coronary artery disease. *American Journal of Cardiology*, 82, 1535-1539.
- TANAKA, H., DINENNO, F. A., MONAHAN, K. D., CLEVENGER, C. M., DESOUZA, C. A. & SEALS, D. R. 2000. Aging, Habitual Exercise, and Dynamic Arterial Compliance. *Circulation*, 102, 1270-1275.
- TANAKA, H., SHIMIZU, S., OHMORI, F., MURAOKA, Y., KUMAGAI, M., YOSHIZAWA, M. & KAGAYA, A. 2006. Increases in blood flow and shear stress to nonworking limbs during incremental exercise. *Medicine and science in sports and exercise*, 38, 81-85.
- THIJSSSEN, D., DAWSON, E. A., BLACK, M. A., HOPMAN, M., CABLE, N. T. & GREEN, D. J. 2009a. Brachial artery blood flow responses to different modalities of lower limb exercise. *Med Sci Sports Exerc*, 41, 1072-9.
- THIJSSSEN, D. H., DAWSON, E. A., TINKEN, T. M., CABLE, N. T. & GREEN, D. J. 2009b. Retrograde flow and shear rate acutely impair endothelial function in humans. *Hypertension*, 53, 986-992.
- THIJSSSEN, D. H., MAIORANA, A. J., O'DRISCOLL, G., CABLE, N. T., HOPMAN, M. T. & GREEN, D. J. 2010. Impact of inactivity and exercise on the vasculature in humans. *European journal of applied physiology*, 108, 845-875.
- THIJSSSEN, D. H., RONGEN, G. A., VAN DIJK, A., SMITS, P. & HOPMAN, M. T. 2007. Enhanced endothelin-1-mediated leg vascular tone in healthy older subjects. *Journal of applied physiology*, 103, 852-857.
- THIJSSSEN, D. H. J., BLACK, M. A., PYKE, K. E., PADILLA, J., ATKINSON, G., HARRIS, R. A., PARKER, B., WIDLANSKY, M. E., TSCHAKOVSKY, M. E. & GREEN, D. J. 2011. Assessment of flow-mediated dilation in humans: a methodological and physiological guideline. *American Journal of Physiology - Heart and Circulatory Physiology*, 300, H2-H12.
- THIJSSSEN, D. H. J., CARTER, S. E. & GREEN, D. J. 2016. Arterial structure and function in vascular ageing: are you as old as your arteries? *The Journal of Physiology*, 594, 2275-2284.
- THIJSSSEN, D. H. J., DAWSON, E. A., TINKEN, T. M., CABLE, N. T. & GREEN, D. J. 2009c. Retrograde Flow and Shear Rate Acutely Impair Endothelial Function in Humans. *Hypertension*, 53, 986-992.
- THUBRIKAR, M. J. & ROBICSEK, F. 1995. Pressure-induced arterial wall stress and atherosclerosis. *The Annals of Thoracic Surgery*, 59, 1594-1603.
- THUM, T., TSIKAS, D., FRÖLICH, J. C. & BORLAK, J. 2003. Growth hormone induces eNOS expression and nitric oxide release in a cultured human endothelial cell line. *FEBS Letters*, 555, 567-571.

- TINKEN, T. M., THIJSSSEN, D. H. J., BLACK, M. A., CABLE, N. T. & GREEN, D. J. 2008. Time course of change in vasodilator function and capacity in response to exercise training in humans. *The Journal of Physiology*, 586, 5003-5012.
- TINKEN, T. M., THIJSSSEN, D. H. J., HOPKINS, N., BLACK, M. A., DAWSON, E. A., MINSON, C. T., NEWCOMER, S. C., LAUGHLIN, M. H., CABLE, N. T. & GREEN, D. J. 2009. Impact of Shear Rate Modulation on Vascular Function in Humans. *Hypertension*, 54, 278-285.
- TINKEN, T. M., THIJSSSEN, D. H. J., HOPKINS, N., DAWSON, E. A., CABLE, N. T. & GREEN, D. J. 2010. Shear Stress Mediates Endothelial Adaptations to Exercise Training in Humans. *Hypertension*, 55, 312-318.
- TJØNNA, A. E., LEE, S. J., ROGNMO, Ø., STØLEN, T. O., BYE, A., HARAM, P. M., LOENNECHEN, J. P., AL-SHARE, Q. Y., SKOGVOLL, E., SLØRDAHL, S. A., KEMI, O. J., NAJJAR, S. M. & WISLØFF, U. 2008. Aerobic Interval Training Versus Continuous Moderate Exercise as a Treatment for the Metabolic Syndrome. *Circulation*, 118, 346-354.
- TOUNIAN, P., AGGOUN, Y., DUBERN, B., VARILLE, V., GUY-GRAND, B., SIDI, D., GIRARDET, J.-P. & BONNET, D. 2001. Presence of increased stiffness of the common carotid artery and endothelial dysfunction in severely obese children: a prospective study. *The Lancet*, 358, 1400-1404.
- TROST, S. G., OWEN, N., BAUMAN, A. E., SALLIS, J. F. & BROWN, W. 2002a. Correlates of adults' participation in physical activity: review and update. *Medicine and science in sports and exercise*, 34, 1996-2001.
- TROST, S. G., OWEN, N., BAUMAN, A. E., SALLIS, J. F. & BROWN, W. 2002b. Correlates of adults' participation in physical activity: review and update. *Medicine & Science in Sports & Exercise*, 34, 1996 - 2001.
- TURGEON, J. L., MCDONNELL, D. P., MARTIN, K. A. & WISE, P. M. 2004. Hormone Therapy: Physiological Complexity Belies Therapeutic Simplicity. *Science*, 304, 1269-1273.
- TUTTLE, J. L., NACHREINER, R. D., BHULLER, A. S., CONDUCT, K. W., CONNORS, B. A., HERRING, B. P., DALRING, M. C. & UNTHANK, J. L. 2001. Shear level influences resistance artery remodeling: wall dimensions, cell density, and eNOS expression. *American Journal of Physiology-Heart and Circulatory Physiology*, 281, H1380-H1389.
- UDALI, S., GUARINI, P., MORUZZI, S., CHOI, S.-W. & FRISO, S. 2013. Cardiovascular epigenetics: From DNA methylation to microRNAs. *Molecular Aspects of Medicine*, 34, 883-901.
- VACCARINO, V., PARSONS, L., PETERSON, E. D., ROGERS, W. J., KIEFE, C. I. & CANTO, J. 2009. Sex differences in mortality after acute myocardial infarction: Changes from 1994 to 2006. *Archives of Internal Medicine*, 169, 1767-1774.
- VAITKEVICIUS, P., FLEG, J., ENGEL, J., O'CONNOR, F., WRIGHT, J., LAKATTA, L., YIN, F. & LAKATTA, E. 1993. Effects of age and aerobic capacity on arterial stiffness in healthy adults. *Circulation*, 88, 1456-1462.
- VAN DEN MUNCKHOF, I., SCHOLTEN, R., CABLE, N., HOPMAN, M., GREEN, D. & THIJSSSEN, D. 2012. Impact of age and sex on carotid and peripheral arterial wall thickness in humans. *Acta physiologica*, 206, 220-228.
- VAN DER HEIDEN, K., HIERCK, B. P., KRAMS, R., DE CROM, R., CHENG, C., BAIKER, M., POURQUIE, M. J., ALKEMADE, F. E., DERUITER, M. C. & GITTENBERGER-DE GROOT, A. C. 2008. Endothelial primary cilia in areas

- of disturbed flow are at the base of atherosclerosis. *Atherosclerosis*, 196, 542-550.
- VAN DER HEIJDEN-SPEK, J. J., STAESSEN, J. A., FAGARD, R. H., HOEKS, A. P., BOUDIER, H. A. S. & VAN BORTEL, L. M. 2000. Effect of age on brachial artery wall properties differs from the aorta and is gender dependent. *Hypertension*, 35, 637-642.
- VAN DER SCHOUW, Y. T., VAN DER GRAAF, Y., STEYERBERG, E. W., EIJKEMANS, M. J. & BANGA, J. D. 1996. Age at menopause as a risk factor for cardiovascular mortality. *The lancet*, 347, 714-718.
- VAN POPELE, N. M., GROBBEE, D. E., BOTS, M. L., ASMAR, R., TOPOUCHIAN, J., RENEMAN, R. S., HOEKS, A. P. G., VAN DER KUIP, D. A. M., HOFMAN, A. & WITTEMAN, J. C. M. 2001. Association Between Arterial Stiffness and Atherosclerosis : The Rotterdam Study. *Stroke*, 32, 454-460.
- VANHOUTTE, P. M., SHIMOKAWA, H., TANG, E. H. C. & FELETOU, M. 2009. Endothelial dysfunction and vascular disease. *Acta Physiologica*, 196, 193-222.
- VASA-NICOTERA, M., CHEN, H., TUCCI, P., YANG, A. L., SAINTIGNY, G., MENGHINI, R., MAHÉ, C., AGOSTINI, M., KNIGHT, R. A. & MELINO, G. 2011. miR-146a is modulated in human endothelial cell with aging. *Atherosclerosis*, 217, 326-330.
- WADDELL, T. K., DART, A. M., GATZKA, C. D., CAMERON, J. D. & KINGWELL, B. A. 2001. Women exhibit a greater age-related increase in proximal aortic stiffness than men. *Journal of hypertension*, 19, 2205-2212.
- WADDELL, T. K., RAJKUMAR, C., CAMERON, J. D., JENNINGS, G. L., DART, A. M. & KINGWELL, B. A. 1999. Withdrawal of hormonal therapy for 4 weeks decreases arterial compliance in postmenopausal women. *Journal of hypertension*, 17, 413-418.
- WEBER, M., BAKER, M. B., MOORE, J. P. & SEARLES, C. D. 2010. MiR-21 is induced in endothelial cells by shear stress and modulates apoptosis and eNOS activity. *Biochemical and Biophysical Research Communications*, 393, 643-648.
- WELTER, B. H., HANSEN, E. L., SANER, K. J., WEI, Y. & PRICE, T. M. 2003. Membrane-bound Progesterone Receptor Expression in Human Aortic Endothelial Cells. *Journal of Histochemistry & Cytochemistry*, 51, 1049-1055.
- WENGER, N. K. 2012. Women and Coronary Heart Disease: A Century After Herrick. *Circulation*, 126, 604-611.
- WHIPP, B. 1996. Domains of Aerobic Function and Their Limiting Parameters. In: STEINACKER, J. & WARD, S. (eds.) *The Physiology and Pathophysiology of Exercise Tolerance*. Springer US.
- WILLIAMS, P. T. & THOMPSON, P. D. 2013. Walking Versus Running for Hypertension, Cholesterol, and Diabetes Mellitus Risk ReductionSignificance. *Arteriosclerosis, Thrombosis, and Vascular Biology*, 33, 1085-1091.
- WILSON, P. W. F., D'AGOSTINO, R. B., LEVY, D., BELANGER, A. M., SILBERSCHATZ, H. & KANNEL, W. B. 1998. Prediction of Coronary Heart Disease Using Risk Factor Categories. *Circulation*, 97, 1837-1847.
- WINGROVE, C. & STEVENSON, J. 1997. 17 beta-Oestradiol inhibits stimulated endothelin release in human vascular endothelial cells. *European Journal of Endocrinology*, 137, 205-208.

- WISLØFF, U., STØYLEN, A., LOENNECHEN, J. P., BRUVOLD, M., ROGNMO, Ø., HARAM, P. M., TJØNNA, A. E., HELGERUD, J., SLØRDAHL, S. A., LEE, S. J., VIDEM, V., BYE, A., SMITH, G. L., NAJJAR, S. M., ELLINGSEN, Ø. & SKJÆRPE, T. 2007. Superior Cardiovascular Effect of Aerobic Interval Training Versus Moderate Continuous Training in Heart Failure Patients. *Circulation*, 115, 3086-3094.
- XU, T., ZHOU, Q., CHE, L., DAS, S., WANG, L., JIANG, J., LI, G., XU, J., YAO, J. & WANG, H. 2016. Circulating miR-21, miR-378, and miR-940 increase in response to an acute exhaustive exercise in chronic heart failure patients. *Oncotarget*, 7, 12414-12425.
- YAN, S. D., SCHMIDT, A. M., ANDERSON, G. M., ZHANG, J., BRETT, J., ZOU, Y. S., PINSKY, D. & STERN, D. 1994. Enhanced cellular oxidant stress by the interaction of advanced glycation end products with their receptors/binding proteins. *Journal of Biological Chemistry*, 269, 9889-97.
- YANG, E. Y., CHAMBLESS, L., SHARRETT, A. R., VIRANI, S. S., LIU, X., TANG, Z., BOERWINKLE, E., BALLANTYNE, C. M. & NAMBI, V. 2012. Carotid Arterial Wall Characteristics Are Associated With Incident Ischemic Stroke But Not Coronary Heart Disease in the Atherosclerosis Risk in Communities (ARIC) Study. *Stroke*, 43, 103-108.
- YEBOAH, J., CROUSE, J. R., HSU, F.-C., BURKE, G. L. & HERRINGTON, D. M. 2007. Brachial Flow-Mediated Dilation Predicts Incident Cardiovascular Events in Older Adults. *The Cardiovascular Health Study*, 115, 2390-2397.
- YI, R., QIN, Y., MACARA, I. G. & CULLEN, B. R. 2003. Exportin-5 mediates the nuclear export of pre-microRNAs and short hairpin RNAs. *Genes & Development*, 17, 3011-3016.
- YOO, J.-K., PINTO, M. M., KIM, H.-K., HWANG, C.-L., LIM, J., HANDBERG, E. M. & CHRISTOU, D. D. 2017. Sex impacts the flow-mediated dilation response to acute aerobic exercise in older adults. *Experimental Gerontology*, 91, 57-63.
- YOUNG, C. N., DEO, S. H., PADILLA, J., LAUGHLIN, M. H. & FADEL, P. J. 2010. Pro-atherogenic shear rate patterns in the femoral artery of healthy older adults. *Atherosclerosis*, 211, 390-392.
- ZAYDUN, G., TOMIYAMA, H., HASHIMOTO, H., ARAI, T., KOJI, Y., YAMBE, M., MOTOBE, K., HORI, S. & YAMASHINA, A. 2006. Menopause is an independent factor augmenting the age-related increase in arterial stiffness in the early postmenopausal phase. *Atherosclerosis*, 184, 137-142.
- ZHOU, J., WANG, K.-C., WU, W., SUBRAMANIAM, S., SHYY, J. Y.-J., CHIU, J.-J., LI, J. Y.-S. & CHIEN, S. 2011. MicroRNA-21 targets peroxisome proliferators-activated receptor- α in an autoregulatory loop to modulate flow-induced endothelial inflammation. *Proceedings of the National Academy of Sciences*, 108, 10355-10360.
- ZHU, S., DENG, S., MA, Q., ZHANG, T., JIA, C., ZHUO, D., YANG, F., WEI, J., WANG, L., DYKXHOORN, D. M., HARE, J. M., GOLDSCHMIDT-CLERMONT, P. J. & DONG, C. 2013. MicroRNA-10A* and MicroRNA-21 Modulate Endothelial Progenitor Cell Senescence Via Suppressing High-Mobility Group A2. *Circulation Research*, 112, 152-164.
- ZHU, Y., BIAN, Z., LU, P., KARAS, R. H., BAO, L., COX, D., HODGIN, J., SHAUL, P. W., THORÉN, P., SMITHIES, O., GUSTAFSSON, J.-Å. & MENDELSON, M. E. 2002. Abnormal Vascular Function and Hypertension in Mice Deficient in Estrogen Receptor β . *Science*, 295, 505-508.

- ZIEGLER, T., BOUZOURÈNE, K., HARRISON, V. J., BRUNNER, H. R. & HAYOZ, D. 1998. Influence of Oscillatory and Unidirectional Flow Environments on the Expression of Endothelin and Nitric Oxide Synthase in Cultured Endothelial Cells. *Arteriosclerosis, Thrombosis, and Vascular Biology*, 18, 686-692.
- ZIEMAN, S. J., MELENOVSKY, V. & KASS, D. A. 2005. Mechanisms, Pathophysiology, and Therapy of Arterial Stiffness. *Arteriosclerosis, Thrombosis, and Vascular Biology*, 25, 932-943.