

The Syntax of Left Periphery in Arabic  
A Minimalist Analysis

Swailem Alatawi

PhD

University of York  
Language & Linguistic Science

September 2016

## **Dedication**

*I would like to dedicate this work to the memory of my father*

.....

*May Allah rest his soul in Paradise  
who passed away just before finishing  
my Ph.D.*

*Swulam*

## Abstract

This thesis investigates the syntax of the left periphery in two varieties of Arabic, Modern Standard Arabic and Tabuki Arabic. The thesis adopts the Split-CP hypothesis proposed by Rizzi (1997) and the minimalist theoretical framework proposed by Chomsky (2000; 2001; 2008; 2013). The thesis looks at the possible constituent orders in the two varieties of Arabic, and how they differ, and accounts for that variation order within a minimalist analysis. Within the core clause, an account is proposed for the agreement patterns and the case assignment between the subject and the verb in the two main orders VS and SV. Then Rizzi's (1997) proposals for the CP-left periphery are examined here with data from Modern Standard Arabic and Tabuki Arabic, with regard to the positioning of two kinds of topic and focus.

In embedded clauses, there are different lexical complementizers in the left peripheries of the two varieties of Arabic, and an account is given for their properties of assigning case or mood. Based on the feature valuations of the complementizers in Arabic, they interact with other left peripheral elements differently. Finally, the phenomenon of Complementizer Agreement in Modern Standard Arabic and Tabuki Arabic is analysed, as a kind of clitic agreement of Complementizer Agreement following the establishment of an Agree relation between the complementizers and the relevant following elements of clausal structure.



## Table Contents

Dedication .....	ii
Abstract .....	iii
Table Contents .....	v
List of Tables .....	ix
List of Phonetic Symbols .....	x
Acknowledgment .....	xi
Author's Declaration.....	xiii
<b>Chapter 1 Introduction</b> .....	<b>15</b>
1.1 The purpose of the present study .....	15
1.2 The significance of the present study.....	16
1.3 Outline of the thesis.....	17
<b>Chapter 2 Clause structure and word order in Modern Standard Arabic and Tabuki Arabic</b> .....	<b>19</b>
2.1 Introduction .....	19
2.2 The main grammatical and morphological features in MSA .....	20
2.2.1 Overview.....	20
2.2.2 Case marking in MSA.....	20
2.2.3 Tense and mood in MSA .....	24
2.2.4 Constituent order in MSA.....	26
2.2.5 Basic constituent order in MSA.....	29
2.2.6 Sentence and clause types in MSA .....	30
2.2.7 Summary.....	32
2.3 Functional layers and projections.....	32
2.4 Agreement asymmetry in MSA.....	34
2.4.1 Agreement facts in MSA .....	34

2.4.2	Pre-minimalist accounts of the Agreement asymmetry in MSA .....	40
2.5	The derivation of VSO order in MSA .....	46
2.5.1	Overview .....	46
2.5.2	Verb movement .....	46
2.5.3	Can V move to C? .....	56
2.5.4	Summary .....	59
2.6	The derivation of SVO order in MSA .....	59
2.6.1	The problem of the Preverbal DP subject in SVO order in MSA .....	60
2.6.2	Previous analysis of the preverbal DP subject .....	62
2.6.3	An alternative analysis of the preverbal DP subject .....	65
2.6.4	Summary .....	70
2.7	The analyses of VSO and SVO orders in MSA .....	70
2.7.1	Overview .....	70
2.7.2	Background .....	71
2.7.3	The analysis of VSO order in MSA .....	73
2.7.4	The analysis of SVO order in MSA .....	85
2.8	Tabuki Arabic and its main grammatical features .....	88
2.8.1	Overview .....	88
2.8.2	TA dialect and its speakers .....	89
2.8.3	Agreement and morphology in TA .....	89
2.8.4	The lack of definiteness and adjacency condition .....	91
2.8.5	Constituent orders in TA .....	92
2.8.6	Basic constituent order .....	93
2.9	The derivations of SVO and VSO clauses .....	95
2.10	The preverbal DP subject in TA .....	98
2.11	Conclusion .....	101
<b>Chapter 3</b>	<b>The background of the left periphery .....</b>	<b>103</b>
3.1	Introduction .....	103
3.2	Topic .....	103
3.2.1	Definition of topic .....	103
3.2.2	Types of Topic .....	104
3.2.3	The syntax of Topic .....	111
3.3	Focus .....	115
3.3.1	Definition .....	115
3.3.2	Focus-Presupposition Articulation .....	116

3.3.3	Ground-Focus articulation .....	118
3.3.4	Focus types.....	119
3.3.5	The syntax of wh-question.....	120
3.4	The Split CP hypothesis (Rizzi, 1997).....	125
3.5	Conclusion.....	132
<b>Chapter 4</b>	<b>The syntax of the left periphery in MSA and TA .....</b>	<b>134</b>
4.1	Introduction .....	134
4.2	The description of topic and focus in MSA .....	134
4.2.1	Topic types.....	134
4.2.2	The distribution between OTop and STop phrases.....	142
4.2.3	Topic types and CLD classification.....	145
4.2.4	Focus in MSA .....	146
4.2.5	Focus construction .....	146
4.2.6	The nature of the fronted focus element .....	149
4.2.7	Wh-phrase focus .....	154
4.2.8	The interaction between topic and focus phrases in MSA.....	157
4.3	The cartographic approach to the left periphery of the clause in MSA .....	160
4.3.1	Overview.....	160
4.3.2	Shlonsky (2000).....	160
4.3.3	An alternative analysis .....	165
4.4	The description of Topic and Focus elements in TA .....	171
4.5	The cartographic approach to the left periphery of the clause in TA.....	174
4.5.1	Introduction.....	174
4.5.2	Previous studies on Arabic.....	174
4.5.3	TA topic and focus positions .....	179
4.5.4	The DP subject in TA .....	184
4.6	Conclusion.....	187
<b>Chapter 5</b>	<b>The syntax of complementizer particles .....</b>	<b>189</b>
5.1	Introduction .....	189
5.2	The Complementizer particles in MSA.....	190
5.2.1	Over view.....	190
5.2.2	The Comp <i>ʔinna/ʔanna</i> and topic phrases .....	190
5.2.3	The Comp <i>ʔinna/ʔanna</i> and focus phrases.....	197
5.2.4	The Comp <i>ʔan</i> .....	201
5.2.5	Summary.....	204

5.3	The analysis of the complementizer.....	204
5.3.3	Previous analyses for MSA Comp particles .....	204
5.3.4	Alternative analysis.....	208
5.4	The derivation of the Complementizers .....	213
5.5	The Comp particles in Tabuki Arabic .....	220
5.6	The analysis of the TA embedded clause.....	224
5.7	Conclusion.....	230
<b>Chapter 6</b>	<b>Complementizer agreement .....</b>	<b>232</b>
6.1	Introduction .....	232
6.2	The interactions of CA in MSA clausal structure .....	235
6.2.1	The interaction of CA with the inflectional domain .....	235
6.2.2	The interaction of CA with the left peripheral elements in MSA.....	241
6.2.3	The interaction of CA with coordination phrases in MSA .....	245
6.3	Generative discussions of CA .....	249
6.4	Empirical evidence from MSA against C-T phi-connections .....	252
6.5	Alternative analyses for MSA .....	255
6.6	The derivation of complementizer agreement in MSA.....	260
6.7	The Tabuki Arabic complementizer particles .....	266
6.8	The analysis of complementizer agreement in TA.....	272
6.9	Conclusion.....	274
<b>Chapter 7</b>	<b>Conclusions of the thesis.....</b>	<b>277</b>
7.1	Summarizing the main analyses .....	277
7.2	The implication of the thesis .....	279
	List of Abbreviations .....	282
	Bibliography .....	284



## List of Tables

Table 2.1 Case marking in MSA nouns .....	21
Table 2.2 Strong pronouns in MSA .....	22
Table 2.3 Weak pronouns in MSA .....	23
Table 2.4 Tense in MSA verbs .....	25
Table 2.5 Agreement patterns distributions in MSA .....	40
Table 3.1 Topic-comment and focus-background structure .....	118
Table 3.2 Vallduví's Information packaging .....	118
Table 4.1 Topic types properties.....	142
Table 4.2 Focus phrases features in MSA .....	154
Table 6.1 Phi-features of CA in MSA .....	234
Table 6.2 CA in null verbal clauses MSA .....	240
Table 6.3 CA withn left peripheral clauses MSA .....	245
Table 6.4 Phi-features of CA in coordinate structure in MSA .....	249

### List of Phonetic Symbols

Arabic script	Symbols used here
أ	ʔ
ب	b
ت	t
ث	θ
ج	dʒ
ح	ħ
خ	kh
د	d
ذ	ð
ر	r
ز	z
س	s
ش	ʃ
ص	S
ض	dh
ط	T
ظ	D
ع	ʕ
غ	G
ف	f
ق	q
ك	k
ل	l
م	m
ن	n
ه	h
و	w
ي	y
ا	aa
و	uu
ي	ii
َ	a
ُ	u
ِ	i

## **Acknowledgment**

First and foremost, I would like to express my deep gratitude to my supervisor, Prof. Peter Sells. It has been a great honour to be his student. He taught me many things in life besides his most valuable and illuminating guidance during the four years of my study. I am also very thankful to him for his patience with me and the materials which I did not know when to read them and with which one I should start.

I would also like to thank my advisor, Dr. Bernadette Plunkett for her rich comments. I believe I was so lucky to have her as a TAP member.

Thanks to the University of York for giving me the chance to do this work and to be one of its students, and thanks to York for making these years so lovely and nice.

My postgraduate studies were funded by Tabuk University via the Saudi Cultural Bureau. I gratefully acknowledge their support which is highly appreciated. A great acknowledgement is also made to all the Arabic Department staff for their endless support and friendly encouragement. Warm thanks must be shown to Prof. Mohammad Atya from Arabic Department at Tabuk University for his suggestions and discussions of some part of the data.

I would also like to thank my friends in York, Sameh Danina and Ali Zafar for their consistent support and continuous encouragement.

A special word of thanks goes to my friends in York who are members of Saudi Students Association during my PhD journey to whom I wholeheartedly offer my sincere regards and profound appreciations for being around and making my life here enjoyable and memorable:

Anwar Al-jadani, Sultan Al-Amri, Ali Al-Ghamdi, Magbool Al-Elyani, Khalid Al-Asmari, Abdullah Al-Garni, Jassas Al-Otaibi, Mansoor Bensarhan, Yasir Almkhaizeem and Abdulrahman Al-Quait.

Last but not least, my deepest thankfulness goes to my family, starting from my father and mother for their *du`ā*, and my dear wife, Samar Alatawi. My dear children Sadeem, Anas, and little Farh, you are the candles of my life.

Thanks to everyone and please accept my apologies if I forgot to mention you.

## **Author's Declaration**

I hereby certify that this thesis is a presentation of my own original research work and effort. It has never been previously accepted in candidature for any academic degree anywhere and wherever other sources of information and contributions were involved, they are clearly indicated and acknowledged. The thesis was done under the supervision of Prof. Peter Sells.

An early version of clause structure and word order in Tabuki Arabic has been published under the title:

Al-Alataiy, S. 2014. Clause Structure and Word Order in Tabuki Arabic. Language at the University of Essex (LangUE) 2014 Proceedings, pp.2-14.

The Syntax of the Left Periphery in Modern Standard Arabic and Tabuki Arabic was presented as a poster at the 8th Saudi Students Conference-UK at Imperial College London2014.

I hereby give permission for my thesis, if accepted, to be available for photocopying and for interlibrary loan, and for the title and summary to be made available to outside organisations.



## **Chapter 1 Introduction**

### **1.1 The purpose of the present study**

This thesis investigates the syntax of the left periphery in two varieties of Arabic which are Modern Standard Arabic (MSA) and Tabuki Arabic (TA). The thesis adopts the Split-CP hypothesis proposed by Rizzi (1997) and the minimalist theoretical framework proposed by Chomsky (1993; 1995; 2000; 2001; 2008) in order to provide answers for the basic questions of the thesis as follows:

- What are the possible constituent orders in MSA and TA and what minimalist assumptions are needed to account for the variations of constituent order? – Specifically, for the agreement patterns and the case assignment between the subject and verb in the two main orders: verb-subject (VS) and subject-verb (SV).
- What is the relative order between the topic and focus phrases in the two varieties of Arabic, and how can they be articulated in Rizzi's (1997) analysis of the CP-left periphery, with contrasting orders in the two varieties?
- What are the properties of the lexical complementizers (Comp) in left domain of the two varieties of Arabic, and what are their case or mood values? How do they interact with other left peripheral elements such as topic and focus?
- How do MSA and TA show the phenomenon of Complementizer Agreement (CA)? What are the sources of agreement on the different complementizers?

## 1.2 The significance of the present study

Why study the left clausal domain of Arabic? The left periphery is important for understanding the syntax of Arabic. A number of elements occur in the left peripheral domain. Topic-like preverbal DPs and focus-like wh-phrases are generally assumed to be left peripheral phrases in Arabic (Fassi Fehri, 1993; Ouhalla 1994b). They have a fixed relative order in MSA and more flexible order in Arabic dialects (Bakir 1980; Aoun et al. 2010). In addition, Arabic complementizers, which head embedded clauses, are left peripheral elements which appear preceding the two main orders SV and VS. There are different complementizers in Arabic which are variable in their positions and also appear in different types of clausal structure. In MSA, for instance, the Comp *?inna/?anna* selects only certain DPs while the Comp *?an* only selects verbs but not DPs. In TA, however, two different Comp *?inn* and *?in* select DPs only. These distributions and the interactions with the left peripheral elements are an interesting syntactic topic to investigate.

How is the Arabic left periphery important in the syntax of minimalism? Syntactic operations such as Agree, case or mood assignment, Merge position and then movement have been taken as keys to understanding grammar in a generative approach. These key concepts are involved in the syntax of the left peripheral structure in Arabic. DPs appear with different cases in the left clausal domain and they can have either a base-generated or a movement analysis, which partly determines their distribution and their feature values. Moreover, complementizers can have case or mood values in Arabic and then always require specific syntactic elements such as DP or V to follow them. Arabic complementizers also can carry clitic agreement reflecting the phi-features of a DP in the clause. Therefore, left periphery in Arabic is a syntactically rich domain which deserves to be analysed.

Why study the two varieties of MSA and TA? The study of syntax concerning MSA and certain dialects is proposed by many Arabic scholars involving different varieties of Arabic. This includes Fassi Fehri (1993) who studies MSA and Moroccan, Mohammad (2000) with Palestinian and Mahfoudhi (2002) with Tunisian, and Aoun et al. (2010) with Lebanese. The advantage of such studies is that MSA compared to other varieties of Arabic shows some



similarities and some differences according to the grammatical features which we can infer from the facts of their clausal structure. These comparative points will have impact on syntactic analysis, as the case of MSA and TA shows.

In the literature on MSA, to the best of my knowledge, the syntax of the left periphery has only a few studies. The most comprehensive one is the study of Shlonsky (2000) who adopts the split CP hypothesis (Rizzi 1997) for the order of the left projections in MSA. Other studies mainly concentrate on topic and focus, such Ouhalla (1994b), Aoun and Benmamoun (1998) and Aoun et al. (2010). The variety of TA, however, has not been syntactically investigated before.

### 1.3 Outline of the thesis

The thesis is divided into seven chapters. Chapter one is the introduction of the thesis. Chapter two investigates the syntax of the TP domain in both varieties which the later analyses of left periphery rely on. For MSA, the chapter has the following parts (i) a short description of the grammatical and morphological features besides the sentences types, (ii) the variations of constituent order and the underlying and basic 'unmarked' constituent order, (iii) the possibility of V-to-T head movement in MSA as in early minimalist assumptions (Chomsky, 1993; 1995) and the impossibility of T-to-C head movement, (iv) the interpretations of a preverbal DP subject as a real subject or as a topic, (v) accounting for the agreement between the subject and the verb in VS and SV orders and case assignment under different minimalist accounts (Chomsky 2000; 2001). For TA, the chapter has fewer parts: (i) the difference of grammatical and morphological features compared to MSA and how that affects the constituent order, (ii) the derivation and analyses of SV and VS order, (iii) the possible interpretations of a preverbal DP subject.

Chapter three introduces the theoretical framework employed in the thesis. This chapter shows some analyses of topic and focus in the literature, and it also presents the split CP hypothesis (Rizzi 1997).

Chapter four gives syntactic descriptions of the left periphery in MSA and TA, in particular, the relative order between topic and focus phrases and the interaction between them. It examines the positions of topic and focus in MSA and TA within the proposals of Shlonsky (2000) which is based on the split CP hypothesis. The chapter has a comparative study between TA and Lebanese Arabic (Aoun and Benmamoun 1998; Aoun et al. 2010) to develop a base-generated analysis for topic and a movement analysis for focus.

Chapter five shows the types of the complementizer in MSA and TA and their distributions relative to other left peripheral elements, including different types of topic phrase, focus phrases, and the verb. It also accounts for the case and the mood assignments of the complementizer particles applying Agree theory. The chapter shows some derivations for the complementizer structure in both varieties.

Chapter six looks at complementizer agreement in MSA and TA and explains the interaction of Complementizer Agreement (CA) with the following embedded elements such as (i) post verbal and *pro* subjects, (ii) other left peripheral elements, (iii) conjoined DPs. It proposes some generative discussions of the CA constructions and provides evidence from MSA and TA data against the previous analyses of CA. The chapter also suggests an alternative analysis of CA in Arabic to identify the source of clitic agreement on the complementizers and presents some derivations of different CA constructions in MSA and TA.

Chapter seven concludes the thesis and summarizes the main points of the analyses of the left periphery in MSA and TA and it also offers the implications of the thesis.

## **Chapter 2 Clause structure and word order in Modern Standard Arabic and Tabuki Arabic**

### **2.1 Introduction**

This chapter identifies the basic clause structures in two Arabic varieties, namely Modern Standard Arabic (MSA, henceforth) and Tabuki Arabic (TA, henceforth). It accounts for agreement patterns between the subject and the verb and subject case assignment within different versions of minimalist accounts (Chomsky 2000; 2001) for the two varieties. The chapter is organized in ten sections other than the introduction. The second section presents the main grammatical features of MSA clause structures. The third section looks at the main functional categories in MSA and their hierarchical structure. The fourth section shows the agreement facts in MSA and expresses some pre-minimalist accounts of the agreement patterns between the subject and the verb. The fifth section examines the verb movement in MSA in VSO order. The sixth section explains the derivation of the SVO order in MSA and proposed interpretations of the preverbal DP. The seventh section offers a minimalist analysis for word order in MSA. The eighth section presents the main grammatical features in TA and how different are they from those used in MSA. The ninth section outlines the derivation of SVO and VSO order in TA. The tenth section discusses the interpretation and positions of the subject in TA. The eleventh section concludes the chapter.

## 2.2 The main grammatical and morphological features in MSA

### 2.2.1 Overview

In this section, I will give a short description of the main grammatical and morphological features of MSA clausal structures. The section will be divided into eight parts. Part two is the case marking of DPs and pronouns in MSA. Part three is the morphology of the verb in terms of tense and mood marking. Part four is the possible constituent orders in MSA. Part five shows the unmarked order in MSA and then part six defines sentence and clause types in MSA. Part seven is a summary of the grammatical and morphological features in MSA clausal structure.

### 2.2.2 Case marking in MSA

Case is crucial in the syntax because it shows the grammatical functions of the words regardless of their positions. Nouns in MSA are marked for case which typically is realised by overt short vowel suffixes on the end of nouns. There are three types of case in MSA: nominative (nom), accusative (acc) and genitive (gen) (Ryding 2005). Typically, nominative case is marked on nouns by default. Accusative is marked on objects of transitive verbs. Genitive case is marked on construct state nominals or on the objects of a preposition.

Holes (1995) mentions that nouns with regard to case marking in MSA can be divided into either triptotic or diptotic. Triptotic nouns such as singular and broken plural are realized for case by adding the case marker *u* for nominative, *a* for accusative and *i* for genitive. However, diptotic nouns such as dual, feminine and masculine sound plurals are realized for case with different system of marking (Versteegh 1997).<sup>1</sup> This variation is as a result of the

---

<sup>1</sup> The Arabic number system has singular, dual, and plural. Plurals are traditionally distinguished into two categories: the regular (so-called sound) plurals, and the irregular (so-called broken) plurals. Sound Plurals are formed by appropriate suffixation (like English: hand → hands). The sound masculine plural is formed by adding the suffix *uuna* in the nominative case and the suffix *iina* in the accusative & genitive cases. The sound feminine plural is formed by attaching the suffix *aat* to the singular. Irregular or broken plurals apply mostly to triliteral roots and are formed by altering the singular (as in English: tooth → teeth).

على النص الذي ترغب في أن يظهر هنا.Heading 2 خطأ! استخدم علامة التبويب "الصفحة الرئيسية" لتطبيق  
على النص الذي ترغب في أن يظهر هنا.Heading 2 خطأ! استخدم علامة التبويب "الصفحة الرئيسية" لتطبيق

nouns representing number through different morphological forms. For the dual nouns, the case is realized by adding the suffix *aani* for nominative case and *ayni* for accusative and genitive case. The case realization of the masculine sound plural is different as the suffix *uuna* represents the nominative case while the suffix *iina* represents the accusative and genitive cases. The feminine sound plural is similar to the singular and broken plural nouns but the marker *i* is used for accusative as well as for the genitive while the case marker *a* does not exist.

Fassi Fehri (1993) suggests another instance of diptotic noun which is *al-asmaaʕu l-mamnuuʕatu min S-Sarfi* 'the forbidden of nunation'. The term *tanwiin* 'Nunation' is used in Arabic to refer to the process of attaching a final sound *-n* after the case marker (*u/a/i*) to indefinite nouns and some proper names (Ryding 2005). For example, *qalam* 'pen' is marked nominative case as *qalam-u* and because it is a nunated noun it can also appear as *qalam-un* if not attached to the definite article or not a member of a construct state nominal. In contrast, *Zaynab* can be marked nominative case as *Zaynaba-u*, but it cannot be suffixed with the nunation marker (*Zaynaba-un*). These unnunated nouns are diptotic, since the nominative case is marked by the addition of the case marker *u* while both accusative and genitive case are marked by the addition of the case marker *a*, so the case marker *i* does not exist with unnunated nouns.

Triptotic and diptotic nouns with their case markers are shown in the following table:

Table 2.1 Case marking in MSA nouns

Cases	Triptotic	Diptotic			
	Singular and broken plural	Dual	Masculine sound plural	Feminine sound plural	Forbidden nunation
Nominative	<i>u</i>	<i>aani</i>	<i>uuna</i>	<i>u</i>	<i>u</i>
Accusative	<i>a</i>	<i>ayni</i>	<i>iina</i>	<i>i</i>	<i>a</i>
Genitive	<i>i</i>				

--	--	--	--	--	--

Personal pronouns are formed with specific forms for case. They occupy different syntactic positions in the clause structure depending on their case types. Personal pronouns fall into one of two groups: strong pronouns (independent words that can stand alone with no need for suffixation or prefixation to the preceding or following words) and weak pronouns (dependent words that cannot stand alone). The strong pronouns are assigned nominative case only, so they occupy the subject position, while weak pronouns are only assigned accusative case or genitive case, and thus occupy object or genitive positions.

The full strong and weak pronouns are shown in the following two tables.

Table 2.2 Strong pronouns in MSA

Strong pronoun	Gender	Singular	dual	Plural
1st	Masculine	<i>ʔanaa</i> 'I'	<i>naħnu</i> 'we'	
	Feminine			
2nd	Masculine	<i>ʔanta</i> 'you'	<i>ʔantumaa</i> 'you two'	<i>ʔantum</i> 'you'
	Feminine	<i>ʔanti</i> 'you'		<i>ʔantunna</i> 'you'
3rd	Masculine	<i>huwa</i> 'he'	<i>humaa</i> 'they'	<i>hum</i> 'they'
	Feminine	<i>hiya</i> 'she'		<i>hunna</i> 'they'

على النص الذي ترغب في أن يظهر هنا. 2.Heading خطأ! استخدم علامة التبويب "الصفحة الرئيسية" لتطبيق  
على النص الذي ترغب في أن يظهر هنا. 2.Heading خطأ! استخدم علامة التبويب "الصفحة الرئيسية" لتطبيق

Table 2.3 Weak pronouns in MSA

Weak pronoun	Gender	Singular	dual	Plural
1st	Masculine	<i>-nii/-ii</i>		<i>naa</i> 'us/our'
	Feminine	'me/my'		
2nd	Masculine	<i>-ka</i> 'you/your'	<i>-kumaa</i> 'you/your'	<i>-kum</i> 'you/your'
	Feminine	<i>-ki</i> 'you/your'		<i>-kunna</i> 'you/your'
3rd	Masculine	<i>-hu</i> 'him/his'	<i>-humaa</i> 'them/their'	<i>-hum</i> 'them/their'
	Feminine	<i>-haa</i> 'her/hers'		<i>-hunna</i> 'them/their'

Consider the case in the following examples:

- (1) a. *huwa yu-qaabilu ʔaSdiqaaʔ-a-hu fii l-madrasat-i*  
 he 3m-meet.s friends-acc-his in the-school-gen  
 'He meets his friends in the school'
- b. *al-malikat-u yu- hibbu-haa ʔaGlab-u n-naas-i*  
 the-queen-nom 3m-like.s-her most-nom the-people-gen  
 'The queen, most people like her'

In (1a), 'he' is a nominative strong pronoun in a subject position, the DP 'friends' is an object of the verb 'meet', then it is marked with the accusative case and shows the accusative marker *-a*. The weak pronoun *hu* 'his' is genitive as it is the possessor of the possessive DP *ʔaSdiqaaʔ-a-hu* 'friends-his' while the DP 'the school' is genitive by the prepition *fii* 'in'. In (1b), the DP *al-malikat-u* 'the queen' is nominative showing the marker *-u* on the end, the weak pronoun *haa* 'her' is accusative in the object position of the verb 'likes', the DP

*ʔaGlab-u* ‘most’ is nominative subject while the *n-naas-i* ‘people’ is a genitive construct noun having the marker *-u* and *-i* respectively.

More examples of the two groups of the personal pronouns will be represented through the discussion of thesis

Having shown how case is marked in MSA, let us now introduce how tense and mood are represented in this MSA variety.

### 2.2.3 Tense and mood in MSA

Tense and mood in MSA are two features of the verb (Benmamoun 2000). In detail, the verb can be marked with either past tense or present tense also referred to in the literature as perfective (perf) or imperfective (imperf), respectively (see, Fassi Fehri 1993; 2012). The past/perfective verb is formed by adding suffixes to the root of the verb e.g. *qaraʔu* ‘read.perf.3mp’. The present/imperfective verb, however, is formed by adding prefixes to the root of the verb e.g. *ya-qaraʔu* ‘3m-read.imperf.s’. These suffixes and prefixes represent the verb’ features e.g. person, gender and number. The following table shows the forms of tense of verbs in MSA:



على النص الذي ترغب في أن يظهر هنا. 2.Heading خطأ! استخدم علامة التبويب "الصفحة الرئيسية" لتطبيق

على النص الذي ترغب في أن يظهر هنا. 2.Heading خطأ! استخدم علامة التبويب "الصفحة الرئيسية" لتطبيق

Table 2.4 Tense in MSA verbs

	Gender	Singular		dual		Plural	
		Perfect	Imperfect	Perfect	Imperfect	Perfect	Imperfect
1st	Masculine	<i>-tu</i>	<i>ʔa-</i>	-		<i>-naa</i>	<i>na-</i>
	Feminine						
2nd	Masculine	<i>-ta</i>	<i>ta-</i>	<i>-tumaa</i>	<i>ta-</i>	<i>-tum</i>	<i>ta-</i>
	Feminine	<i>-ti</i>				<i>-tunna</i>	
3rd	Masculine	<i>-a</i>	<i>ya-</i>	<i>-aa</i>	<i>ya-</i>	<i>-uu</i>	<i>ya-</i>
	Feminine	<i>-at</i>	<i>ta-</i>	<i>-taa</i>	<i>ta-</i>	<i>-na</i>	

Mood, parallel to case, is also usually realised by overt vowel suffixes on the end of the verb. The realisation of mood is exclusive for the present tense verb (imperfective) only (Ryding 2005). This is because the present verb form in MSA is *muʔrab* 'inflectable' that can inflect different morphological features including moods while the past verb form is *mabni* 'noninflectable' that is restricted form being morphologically inflected and is not specified for moods.

According to Ryding (2005), the present verb is marked with one of four moods: indicative, subjunctive, jussive and imperative. Different patterns play a role in expressing the required moods on the verb. The indicative mood is the default mood for a present verb and the realization of indicative is by the appearance of the suffix *u* on the end of the present verb e.g., *ta-lʕab-u* '3f-plays.s-Indic' for present verb. The past verb form does not show moods, the suffix *u* cannot appear as *\*laʕib-u* 'played.3ms-indic'. However, subjunctive and jussive mood are triggered by certain particles which precede the verb. The subjunctive mood, for instance, is triggered by the subjunctive particles, e.g., the Comp *ʔan* and the negative *lan*, the

realization of subjunctive mood is by the suffix *a* e.g., *ʔan ya-ʔkul-a* ‘that 3m-eat.s-subjun’. The jussive mood is triggered by jussive particles, e.g., the negative *lam* or *laa*, the realization of jussive mood is by *sukuun* which is actually ‘silence’ e.g. *lam ya-ʔkul-0* ‘Neg 3m-eat.s-juss’. In other words, there is no vowel suffix for jussive. Imperative, as jussive, has no mood realization and there are no particles required e.g. *kul-* ‘eat.2ms-0’.

However, mood in dual, masculine plural and feminine plural verbs is diptotic, since a dual verb realizes indicative by the marker *ni* e.g. *ya-ʔkulaa-ni* ‘3m-eat.d-indic’ and realizes subjunctive, jussive and imperative by deleting *ni* e.g. *ʔan ya-ʔkulaa-* ‘that 3m-eat.d-subjun’ *lam ya-ʔkulaa-* ‘Neg 3m-eat.d-juss’ and *kulaa-* ‘eat.2mp-0’ respectively. Similarly, a masculine plural verb realizes indicative by the marker *na* e.g. *ya-ʔkuluu-na* ‘3m-eat.d-indic’ and realizes subjunctive, jussive and imperative by deleting the marker *na* e.g. *ʔan ya-ʔkuluu-* ‘that 3m-eat.p-subjun’, *lam ya-ʔkuluu-* ‘Neg 3m-eat.p-juss’ and *kuluu-* ‘eat.2mp-0’ respectively.

#### 2.2.4 Constituent order in MSA

The simple sentence in MSA consists of three main constituents: verb, subject and object. These three constituents can form four possible orders in MSA grammars, that is VSO, VOS, SVO, and OVS as shown in (2a-d). However, the main constituents cannot form SOV and OSV order, as shown in (2f).

- (2) a. *ʃariba*                      mohammed-un                      l-maaʔ-a                      (VSO)  
       drank.perf.3ms              Mohammed-nom              the-water-acc  
       ‘Mohammed drank water.’
- b. *ʃariba*                      l-maaʔ-a                      mohammed-un                      (VOS)  
       drank.perf.3ms              the-water-acc              Mohammed-nom  
       ‘Mohammed drank the water.’

c.	mohammed-un	ʃariba	l-maaʔ-a	(SVO)
	Mohammed-nom	drank-perf.3ms	the-water-acc	
	'Mohammed drinks the water.'			
d.	al-maaʔ-a	ʃariba	mohammed-un	(OVS)
	the-water-acc	drank.perf.3ms	Mohammed-nom	
	'It was the water that Mohammed drank.'			
e.	*mohammed-un	l-maaʔ-a	ʃariba	*(SOV)
	Mohammed-nom	the-water-acc	drank.perf.3sm	
	'Mohammed, it was the water that he drank.'			
f.	*al-maaʔ-a	mohammed-un	ʃariba	*(OSV)
	the-water-acc	Mohammed-nom	drank.perf.3ms	
	'It was the water that Mohammed drank.'			

The variation of constituent orders in (2a-d) is due to richness of the inflectional morphology in MSA (Holmberg & Roberts 2013). However, the ungrammaticality of (2e-f) is due to the fact that these orders do not exist in any corpora unless a resumptive pronoun is also present. Additionally, Mohammad (2000) assumes that there is no grammatically accepted use of V-final structures (i.e., SOV and OSV) as possible orders in MSA. I will analyse the derivations of the possible and impossible constituent orders in detail in different chapters in the thesis.

Note that the constituents (verb, subject and object) need to be recognised in order to form any constituent orders from (1a-d). The verb always is recognized in MSA by the virtue of bearing agreement features with the subject. Subject and object are typically identified by their case marking *u/un* 'nominative' and *a/an* 'accusative', respectively. Therefore, the freedom of subject-object and object-subject is possible as long as they are recognizable i.e. with overt case. In contrast, when there is ambiguity between subject and object the freedom of order is restricted. For instance, when the case marking of subject and object are covert there will be an ambiguity in distinguishing them. Therefore, they occur only in subject-object order as the following examples (Mohammed 2000: 3):

(3) a. qaabala          muusaa          ʕiysaa  
          met.perf.3ms   Musa          Isa  
          ‘Musa met Isa.’

b. qaabala          ʕiysaa          muusaa  
          met.perf.3ms   Isa          Musa  
          \*‘Musa met Isa.’

Both ‘Musa’ and ‘Isa’ have covert case markings in (3a-b) since they are ended by a vowel *aa* that cannot carry any case marking (i.e. *u*, *a* and *i*). Therefore, subject and object are undistinguishable by overt case, then, they are restricted in SO order as in (3a) where ‘Musa’ is the subject while ‘Isa’ is an object. OS order with covert case marking renders (3b) ungrammatical with the reading that the subject is Musa.

On the other hand, the covert case marking does not always prevent subject and object to have free constituent orders. Two cases will be expressed where overt/covert case marking has no impact of constituent orders as long as subject and object can be recognised by. First, consider (4) where the object can precede the subject though both lack overt morphological case marking, as they are distinguishable by reasoning:

(4) al-kummaθraa          ʔʕtarat          munaa  
          the-pear.f                bought.perf.3fs          Muna.f-nom  
          ‘It was the pear that Muna bought.’

In (4), logically, the only subject of the sentence is ‘Muna’ while the object is ‘pear’ since ‘pear’ cannot buy ‘Muna’. Therefore, OVS order is acceptable.

Second, covert case marking constituents such as subject and object can be distinguished by agreement system which will be discussed in detail in 2.4 below. With the agreement asymmetry in MSA that subject but not object has an agreement relation with the verb, at



b. ?inna	Tabiib-an	faħaSa	kull-a	Tifl-in
that	a doctor-acc	examined.perf.3ms	every-acc	child-gen
'Indeed, a doctor examined every child.'				(Ayed 2003: 22, ex. 25)

In (6a), VSO order is embedded under the Complementizer (Comp) *?an* while in (6b) the SVO order is embedded under the Comp *?inna*. Therefore, equally VSO and SVO order are required in embedded clauses as well as main clauses in MSA.

It is, however, widely accepted that VSO is the basic constituent order in MSA, and SVO order is a derived order (Bakir 1980; Ayoub 1981; Fassi Fehri 1982; Mohammed 1990; 2000). The assumption that VSO is the unmarked order in MSA is based on many observations. Mohammed (2000) states that there are two reasons to account VSO order as the unmarked. First, there is discontinuity between verb and object when the case marking is absent as shown in (3-5). Since undistinguished subject and object occur in VSO constituent order only. Second, the VSO order does not involve the problematic agreement between subject and verb, which will be explained in 2.4. Bakir (1980) asserts that VSO order is the only order that can be used in discourse-initial sentences and for answering general state questions such as 'what happened?' Such questions are called out of the blue questions which presuppose no discourse; hence the resulting word order in the answer is possibly the unmarked as far as discourse neutrality is concerned (see Rizzi 2004). Fassi Fehri (1993) postulates that VSO order is a common order in Arabic since it occurs in a simple sentence that has few syntactic operations (verb movement only as it will be shown in 2.5).

### 2.2.6 Sentence and clause types in MSA

The Arabic sentence is divided into two main types, namely, nominal and verbal sentences. This division, however, has two different interpretations proposed by two different groups of traditional grammarians. The first interpretation, which is usually assumed, is held by a group of grammarians called Al-BaSriyyuuna. According to this group, the nominal sentence is a

sentence that begins with DP which is interpreted as “topic” following by different types of categories as (7a-b) while verbal sentence is the only one that begins with a verb as in (6c):

- (7) a. aT-Taalib-u            ya-qra?-u                            l-kitaab-a  
           the-student-nom    3m-read.imperf.s-indic    the-book-acc  
           ‘The student reads the book.’
- b. aT-Taalib-u            fii            l-maktabat-i  
           the-student-nom    in            the-library-gen  
           ‘The student is in the library.’
- c. ya-qra?-u                            T-Taalib-u                            l-kitaab-a  
           3m-read.imperf.s-indic    the-student-nom            the-book-acc  
           ‘The student reads the book.’

The second interpretation of the division is held by a group of grammarians called Al-Kuufiyyuuna who assume that the nominal sentences is the one that does not have a verb in any syntactic position while a verbal clause is the sentence that does have a verb. According to their interpretation, (7a-c) are verbal sentences since they contain the verb ‘read’, while the (6b) is a nominal sentence since it is verbless.<sup>2</sup> Al-Kuufiyyuuna interpretation of the nominal and verbal sentences are more cross-linguistically consistent with modern studies of syntax in generative grammar. However, some Arab grammarians (e.g., Hassan 1961) and modern researchers (e.g., Fassi Fehri 1993 and Plunkett 1993) follow Al-BaSriyyuuna interpretation of the nominal and verbal sentences.

Another division of MSA sentences is with regard to the number of clauses, either a single clause sentence as (7a-d) shows or a sentence which has main and embedded clauses as (6a-b) shows. Embedded clauses must be introduced by Comp particles such as *?inna/?anna* (6a) or *?an* clause as (6b) show. I will discuss the embedded clause in MSA in detail in Chapter 5.

<sup>2</sup> Al-BaSriyyuuna and Al-Kuufiyyuuna are the two schools of traditional Arabic syntax during the eighth century. Al-BaSriyyuuna are from Al-BaSra and Al-Kuufiyyuuna are from Kufa, they are located in Iraq where both schools are established.

### 2.2.7 Summary

In this section, we have presented some grammatical features for clausal structures in MSA. We showed that noun and adjective are specified for case (nominative, accusative and genitive) while verbs are specified for mood and aspect. Four different types of mood appear on the verb (indicative, subjunctive, jussive and imperative) and two types of aspect (past/perfect and present/imperfective). MSA has variation of constituent orders. The VSO order is the unmarked order in MSA and subject-object order is the default order if they cannot be distinguished from each other. MSA sentences have been traditionally divided into nominal and verbal by two types of division. One considers the initial constituent of a clause, if it is a verb the sentence then is verbal and if it is noun then the sentence is nominal. The other division considers the existence of the verb; if the clause has a verb regardless of its position the clause then is verbal, while the absence of a verb makes the sentence nominal. MSA sentences have been also divided into main and embedded clauses.

### 2.3 Functional layers and projections

Before investigating the clausal structure in MSA, it is important to determine the main components of the clause structure in MSA. Current assumptions about a clause structure suggest that each clause is comprised of three main layers: lexical, functional, and operator (Ouhalla and Shlonsky 2002). The functional layer, which occupies the A-domain positions between the complementizers and the lexical predicates, includes several categories, including tense (TP), negation (NegP), aspect (AspP) and agreement (AgrP). In fact, there is no universal hierarchal structure for these functional categories; they vary from one language to another (Pollock 1989 and). This chapter assumes that MSA functional categories appear in the following order: MSA verbs reflect tense, aspect and mood (Mood); AspP appears above a 'little verb' phrase ( $\nu$ P), which carries the morphological features of the verb tense, either perfect or imperfect. TP and NegP are separate Hornstein et al 2005 syntactic heads, and TP dominates NegP (Ouhalla 1991; Shlonsky 1997; Benmamoun 1992; 2000). The combination of TP and NegP will determine the Mood, which appears lower than TP and



على النص الذي ترغب في أن يظهر هنا. 2.Heading خطأ! استخدم علامة التبويب "الصفحة الرئيسية" لتطبيق  
 على النص الذي ترغب في أن يظهر هنا. 2.Heading خطأ! استخدم علامة التبويب "الصفحة الرئيسية" لتطبيق

NegP since they play a role in selecting it (Plunkett, 1993). However, the Mood can be also determined by the combination of complementizer *ʔan* 'that' and TP. Modality (ModP) is projected just above TP (Fassi Fehri 1993). Focus and topic phrases are projected under CP, various functional projections, labelled generally as FP (Ouhalla 1994b). The MSA verbal clause structure, including both obligatory and optional functional categories, has at least the following hierarchy:

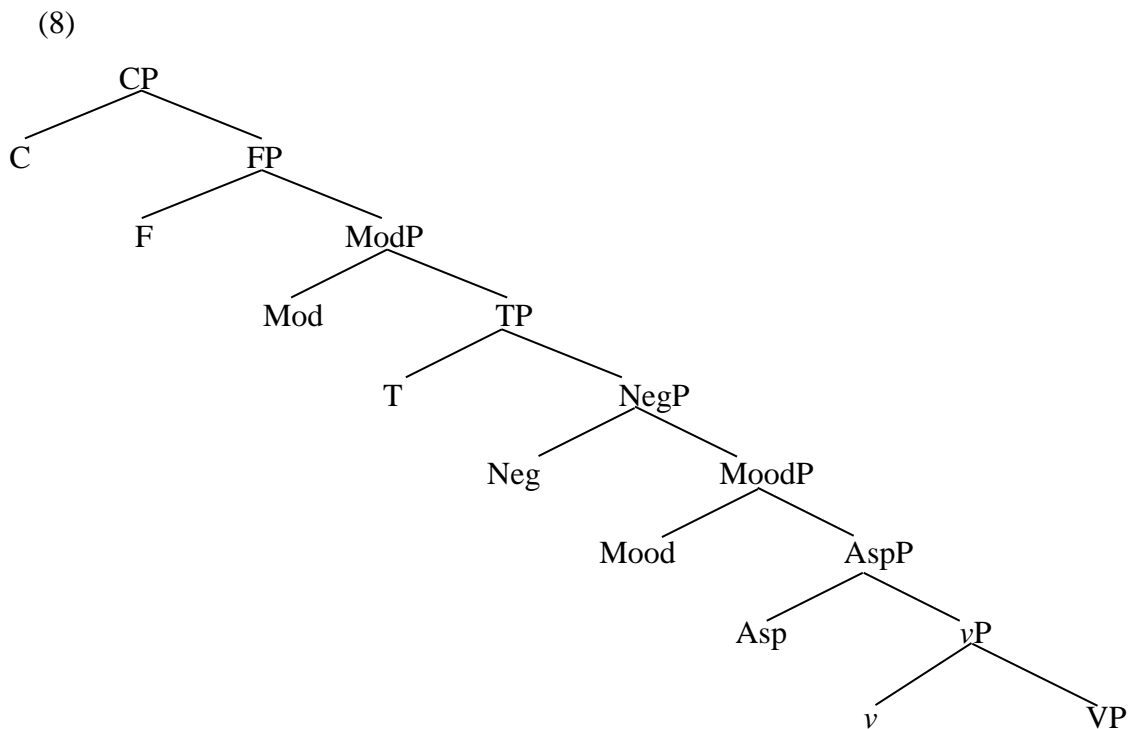

For the structure (8), the functional categories will not all appear in the syntactic structures. Only those functional categories needed for the derivation will be included in the trees. In the discussion of MSA clause structure, we identify the verb, subject and topic positions with regard to other functional categories as appearing in the structure (8).

## 2.4 Agreement asymmetry in MSA

### 2.4.1 Agreement facts in MSA

The agreement in MSA clausal structure is crucial since it plays a role in word order variations. The agreement asymmetry in MSA occurs between the subject and verb while the object lacks agreement with the verb. Two main patterns of agreement features appear between the verb and the subject in MSA: full agreement and partial agreement. The verb shows the reflection of the agreement with the subject by three features; Person (Pers), Gender (Gen) and Number (Num). It is argued that verb usually expresses Person by prefixes and expresses Number by the suffixes while it expresses Gender by either prefixes or suffixes (Halle 1990; Noyer 1992; Fassi Fehri 1993; Tourabi 2002).

The full agreement pattern includes [Pers, Gen, Num] while the partial agreement pattern includes [Pers, Gen] and lacks [Num]. In this section, I will investigate the two agreement patterns (full and partial) in three different clausal structures in MSA. They are a single DP clause, a conjunction of DPs clause and the multiple (mixed) clause which has finite and auxiliary verbs.

It is widely accepted that agreement patterns (full and partial) in MSA are determined by the relative order between verb and subject (Fassi Fehri, 1993 Aoun et al. 1994; Bolotin 1995; Shlonsky 1997; Benmamoun 2000a; Mohammed 2000). The two agreement patterns work as follows: in SVO, the verb always has full agreement in [Pers, Gen, Num] with subject, while in VSO order the verb must have partial agreement in [Pers, Gen] only with subject, as long as the latter is not a pronoun. Assuming the VSO as unmarked order in MSA, the subject position relative to the verb is then what determines agreement asymmetry in MSA. The position of the object in the clause does not affect the agreement pattern, whether it is preceding or following the verb. Consider the following examples:

على النص الذي ترغب في أن يظهر هنا. 2.Heading خطأ! استخدم علامة التبويب "الصفحة الرئيسية" لتطبيق  
على النص الذي ترغب في أن يظهر هنا. 2.Heading خطأ! استخدم علامة التبويب "الصفحة الرئيسية" لتطبيق

- (9) a.  $qaraʔa/*uu$                       T-Tullaab-u                      l-kitaab-a  
       read.perf.3ms/\*3mp            the-students.m-nom            the-book-acc  
       ‘The students read the book.’
- b. aT-Tullaab-u                       $qaraʔuu/*a$                       l-kitaab-a  
       the-students.m-nom            read.perf.3mp/\*3ms            the-book-acc  
       ‘The students read the book.’
- c.  $kitaab-an$      $qaraʔa/*uu$                       T-Tullaab-u  
       book-acc    read.perf.3ms/\*3mp            the-students.m-nom  
       ‘It was a book, the students read.’
- d. aT-Tullaab-u                      l-kitab-a                       $qaraʔuu/*a$   
       the-students.m-nom            the-book-acc            read.perf.3mp/\*3ms  
       ‘The students read the book.’

In (9a), the order is VSO, and agreement between the verb ‘read’ and the postverbal plural subject ‘the students.m’ must be partial in [Pers and Gen] only. Thus, the verb  $qaraʔ$  ‘read.perf’ obligatorily shows  $a$  ‘3ms’ features while [p Num]  $uu$  is impossible. In (9b), however, the order is SVO and the agreement between the preverbal subject ‘the students.m’ and verb ‘read.perf’ must be full in [Pers, Gen and Num]. Thus, the verb obligatorily shows  $uu$  ‘3mp’ features while [s Num]  $a$  is impossible<sup>3</sup>. In (9c) the object is topicalized to the initial position while in (9d) the object intervenes between the subject ‘the students.m’ and the verb ‘read.perf.3mp’. However, the object movement in (9c-d) has no impact on agreement as shown in (9a-b).

In a conjunction clause, similar to a simple DP clause, the two different patterns of agreement features (full and partial) occur with two different orders between the verb and the conjunct subjects. Typically, the verb picks its features up from the subject, in a conjoined DP; however, there are two DPs and the question is with which one of them the verb takes for the

<sup>3</sup> Note that verb (Num) agreement is only visible in dual or plural, not in singular verb.

features? Three logical options: the verb could agree either with first conjunct DP, the second conjunct DP or with the full conjunct DP. Let us examine these possibilities in detail.

In verb-subject order, the verb always agrees partially in [Gen and Num] only with first conjunct of the DP subject, the agreement pattern which is known as First Conjunct Agreement (FCA) (Aoun et al 1993). Agreement with the second DP or the entire conjoined DP, however, is restricted. Consider the following conjunction examples:

- (10) a. *qaraʔa/\*at/\*aa*      T-Taalib-u      wa      T-Taalibaat-u      l-kitaab-a  
       read.perf.3ms/3fs/3d the-student.m-nom and the-student.f-nom the-book-acc  
       ‘The student (male) and the student (female) read the book.’
- b. *qaraʔat/\*a/\*aa*      T-Taalibaat-u      wa      T-Taalib-u      l-kitaab-a  
       read.perf.3fs/3ms/3d the-student.f-nom and the-student.m-nom the-book.acc  
       ‘The student (female) and the student (male) read the book.’

In (10a), since the verb ‘read’ precedes the conjoined subjects ‘the student.m and the student.f’ The verb then ‘read’ can only show partial agreement in [Pers, Gen] with first conjunct subject ‘the student.m’. The verb *qaraʔ* ‘read.perf’ has to show *a* ‘3ms’. The verb ‘read’, however, cannot agree with second conjunct DP subject ‘the student.f’ or with the full conjoined DP, and then it is restricted to show neither *at* ‘3fs’ nor *aa* ‘3d’. In (10b), ‘the student.f’ occurs in the first DP position, and the verb ‘read.perf’ must agree with it. The verb ‘read’ has to show *at* ‘3fs’ and it cannot agree with second conjunct DP subject ‘the student.m’ or with the full conjoined DPs, and then the verb ‘read.perf’ cannot show either *at* ‘3fs’ or *aa* ‘3d’ as agreement morpheme. Note that *-a* ‘3ms’ is possible in (10b) as a default masculine agreement with a group of mixed genders.

The subject-verb order in conjoined examples has a different agreement system. The verb always agrees fully in [Pers, Gen and Num], crucially, with the full preverbal DP subject. The verb in this order cannot agree only with the first or the second DP. This pattern of agreement is exemplified below:

على النص الذي ترغب في أن يظهر هنا. 2.Heading خطأ! استخدم علامة التبويب "الصفحة الرئيسية" لتطبيق  
على النص الذي ترغب في أن يظهر هنا. 2.Heading خطأ! استخدم علامة التبويب "الصفحة الرئيسية" لتطبيق

- (11) aT-Taalib-u            wa    T-Taalibaat-u            qaraʔaa/\*a/\*at            l-kitaab-a  
the-student.m-nom    and    the-student.f-nom    read.perf.3d/3ms/3fs    the-book-acc  
‘The student (male) and the student (female) read the book.’

In (11), the verb and subject has contrary order to (11a-b), since the conjoined subjects ‘the student.m’ and ‘the student-f’ precede the verb ‘read’. In this order, the verb has to agree fully with the full preverbal subject. Agreement with first conjunct DP subject ‘the student.m’ as well as with the second conjunct DP subject ‘the student-f’ are not possible. As a result, the verb *qaraʔa* ‘read.perf’ must show *aa* ‘3d’ only while *a* ‘3fs’ and *at* ‘3ms’ are not possible.

In the more complex agreement asymmetry, the finite verb and an auxiliary verb show a specific pattern of agreement with the subject. This called Mixed or Multiple Agreement (see McCloskey 1986; Munn 1999; Ouali 2014). A number of distributional facts should be considered in such clauses. For instance, the auxiliary verb always precedes the finite verb. The subject however, has the optionality to occur in two different positions: (i) following the auxiliary verb and preceding the finite verb as in (12a), the auxiliary verb then must agree partially with the subject while the finite verb must agree fully with subject. Or (ii) preceding the both verbs as in (12b), and then they must appear with full features of agreement. The subject, however, cannot follow both auxiliary verb and finite verb as the ungrammaticality of (12c) shows:

- (12) a. kaana/\*uu            T-Tullaab-u            ya-qraʔuuna/\*u            l-kitaab-a  
was.perf.3ms/3mp    the-students.m-nom    3m-read.imperf.p/s    the-book-acc  
kull-a            yawm-in  
every-acc    day-gen  
‘The students were reading the book every day.’

b. aT-Tullaab-u            kaanuu/\*a                            ya-qraʔuuna/\*a            l-kitaab-a  
 the-students.m-nom   were.perf.3mp/was.3ms   3m-read.imperf.p/\*s   the-book-acc  
 kull-a            yawm-in  
 every-acc   day-gen

‘The students were reading the book every day.’

c. \*kaana/uu                            ya-qraʔu/uuna            T-Tullaab-u            l-kitaab-a  
 was.perf.3ms/were.3mp   3m-read.imperf.s/p   the-students.m-nom   the-book-acc  
 kull-a            yawm-in  
 every-acc   day-gen

‘The students were reading the book every day.’

Example (12a) is crucial, since it triggers two types of agreement pattern. The subject ‘the students’ with the preceding auxiliary verb *kaana* ‘was.perf.3ms’ has VS order displaying partial agreement. Meanwhile, the subject ‘the students.m’ with the following finite verb *ya-qraʔuuna* ‘3m-read.imperf.p’ has SV order displaying full agreement. In (12b), the subject ‘the students.m’ precedes the auxiliary verb ‘were.3mp’ and the finite verb ‘read’. Accordingly, both verbs must show full agreement features with the preverbal DP subject ‘the students’. In (12c), in contrast to (12b) the auxiliary verb ‘were.3mp’ and the finite verb ‘read’ precede the subject ‘the student.m’. Either with full or partial agreement pattern the sentence is ill-formed.

The same possibilities of agreement patterns within complex agreement clauses as in (12a-c) also extend into a conjoined DP structure as in the following examples:

(13) a. kaana/\*uu                            T-Tullaab-u                            wa            T-Taalibaat-u  
 was.perf.3ms/were.3mp   the-students.m-nom   and   the-students.f-nom  
 ya-qraʔuuna/\*a            l-kitab-a            kull-a            yawm-in  
 3m-read.imperf.p/s   the-book-acc   every-acc   day-gen

The students (male) and the students (female) were reading the book every day.’

على النص الذي ترغب في أن يظهر هنا. 2.Heading خطأ! استخدم علامة التبويب "الصفحة الرئيسية" لتطبيق  
على النص الذي ترغب في أن يظهر هنا. 2.Heading خطأ! استخدم علامة التبويب "الصفحة الرئيسية" لتطبيق

- b. aT-Tullaab-u                      wa    T-Taalibaat-u                      kaanuu/\*a  
the-students.m-nom    and    the-students.f-nom    were.perf.3mp/was.3ms  
ya-qraʔuuna/\*u    l-kitaab-a                      kull-a                      yawm-in  
3m-read.imperf.p/s    the-book-acc    every-acc    day-gen  
‘The students (male) and the students (female) were reading the book every day.’
- c. \*kaana/uu                                      ya-qraʔu/uuna                      T-Tullaab-u                      wa  
was.perf.3ms/were.3mp    3m-read.imperf.s/p                      the-students.m-nom    and  
T-Taalibaat-u                      l-kitaab-a                      kull-a                      yawm-in  
the-students.f-nom    the-book-acc    every-acc    day-gen  
‘The students (male) and the students (female) were reading the book every day.’

In (13a), the clause has mixed agreement, with First Conjunct Agreement with the auxiliary verb *kaana* ‘was.perf.3ms’ and full agreement for the finite verb *ya-qraʔuun* ‘3m-read.imperf.p’ occur in one clause. In (13b), the clause has only one type of agreement pattern for both verbs which is full agreement. In (13c), occurrence of the subject following the auxiliary and the main verb rules the clause out.

The following table summarizes the two patterns of agreement feature (full and partial) in three different structures:

Table 2.5 Agreement patterns distributions in MSA

Word orders	Agreement patterns	
	Partial	Full
V S	Yes	No
S V	No	Yes
V S Conj S	Yes, with FCA	No
S Conj S V	No	Yes, with full DPs
Aux S V	Yes, with Aux	Yes, with finite V
S Aux V	No	Yes (Aux + V)
V Aux S	No	No
Aux S Conj S V	Yes (Aux)	Yes (V)
S Conj S Aux V	No	Yes (Aux + V)
V Aux S Conj S	No	No

#### 2.4.2 Pre-minimalist accounts of the Agreement asymmetry in MSA

This section presents different accounts for the agreement asymmetry in MSA within earlier versions of generative grammar. Within Government and Binding theory, Chomsky (1986) postulates the Spec-Head configuration to explain subject-verb agreement and the subject case assignment. The configuration accounts for agreement relation between the subject in [Spec, IP] and the verb in I for SVO. It also accounts for the government of verb movement to I with the following subject in VP, for VSO order. MSA has a considerable amount of theoretical contributions regarding the agreement between the verb and the subject within Spec-Head configuration. One early theoretical development in MSA with Spec-Head agreement is the Expletive Hypothesis (Mohammed, 1990). Under this hypothesis, the post-verbal order (VSO) has two kinds of subjects: a thematic subject which is generated in Spec-VP and a null expletive subject which is generated in Spec-TP. In VSO order, the achievement of the partial agreement and subject case assignment takes place in two steps. (i) The *pro* expletive subject which is assumed to be default third masculine/feminine singular (3ms/3fs) enters into agreement with T head via Spec-Head agreement, to show partial agreement. (ii) The *pro* subject, therefore, receives the nominative case by T and then



على النص الذي ترغب في أن يظهر هنا. 2.Heading خطأ! استخدم علامة التبويب "الصفحة الرئيسية" لتطبيق  
 على النص الذي ترغب في أن يظهر هنا. 2.Heading خطأ! استخدم علامة التبويب "الصفحة الرئيسية" لتطبيق

transmits it to the post-verbal subject in Spec-VP via a co-indexing relation. In SVO order, however, the achievement of full agreement is in one step which is Spec-Head agreement between the verb in T and the overt the DP subject in Spec-TP where the nominative case is assigned. Consider the full agreement relation in SVO order in (14a) and partial agreement relation in VSO in (14b) as a null Expletive hypothesis suggests:

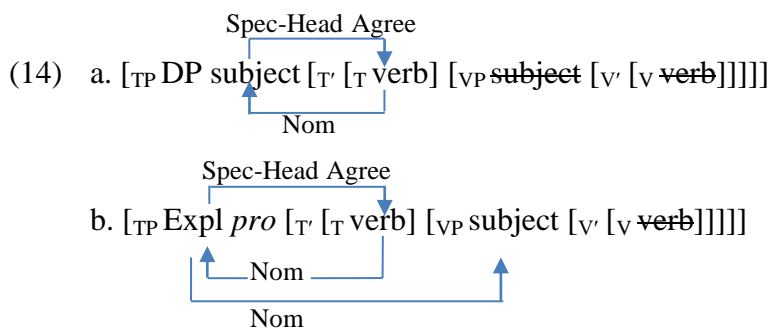

Two empirical arguments are given by Mohammed for the existence of expletive *pro* subject in MSA clausal structures. First, the expletive *pro* subject is expected with verb that has no argument subject e.g. *ya-bduu* '3m-seem.imperf.s' as in (15a) or in an impersonal passive structure as in (15b). Consider the following examples from Mohammed (1990: 123):

- (15) a. *pro*    *ya-bduu*                    ?anna    T-Tullaab-a                    waSaluu.  
 '3ms'    3m-seems.imperf.s    that    the-students-acc    arrive.perf.3mp  
 'It seems that the students have arrived.'
- b. *pro*    *niima*                            tahta    ʃ-fadʒar-i  
 '3ms'    sleep(passive).3ms    under the    tree-gen  
 'It has been slept under the tree.'

In (15a-b), the *pro* expletive subject originates in Spec-TP and partially agrees with the verb 'seems' in T which displays third masculine singular '3ms'.

The second piece of evidence for the null expletive *pro* can be adduced from the fact that the *pro* expletive must be lexicalized in embedded clauses, for example, when the *pro* expletive

is assigned by non-nominative case by a Comp which introduces embedded clauses as in following examples:

- (16) a.  $\text{ʔiddaʕaa}$        $\text{r-radʒul-u}$        $\text{ʔanna-hu}$        $\text{ya-bduu}$   
 claimed.3ms    the-man-nom    that-3ms      3m-seems.imperf.s  
 $\text{ʔanna}$      $\text{l-awlaad-a}$      $\text{saafaruu}$   
 that    the-boys      departed.3mp  
 ‘The man claimed that it seems that the boys departed.’
- b. \* $\text{ʔiddaʕaa}$        $\text{r-radʒul-u}$        $\text{ʔanna-}$        $\text{ya-bduu}$   
 claimed.3ms    the-man-nom    that-      3m-seems.imperf.s  
 $\text{ʔanna}$      $\text{l-awlaad-a}$      $\text{saafaruu}$   
 that    the-boys      departed.3mp  
 ‘The man claimed that it seems that the boys departed.’

The *pro* expletive in (16a) occurs in embedded clause under the Comp *ʔanna* ‘that. Pro must be lexicalized as an accusative pronominal clitic *hu* ‘3ms’. Without presenting the *pro* expletive as an overt clitic, the sentence will be ruled out as in (16b).

Benmamoun (1992) following Mohammed (1990) suggests that the expletive *pro* subject in his analysis. According to the former, the partial agreement in VSO order occurs by a government configuration when the verb in T governs the subject in Spec-VP while case is assigned to the subject in two different configurations. First, the case licensing takes place by the Spec-Head configuration between the expletive *pro* in Spec-TP and the verb in T. Second, the case is assigned to the Spec-VP under a government configuration from T. Full agreement in SVO and subject case assignment, however, take place in a Spec-Head configuration between the subject in TP with the verb in T head. The configuration of (17a) represents the partial agreement while (17b) represents the full agreement configuration.

على النص الذي ترغب في أن يظهر هنا. 2.Heading خطأ! استخدم علامة التبويب "الصفحة الرئيسية" لتطبيق  
 على النص الذي ترغب في أن يظهر هنا. 2.Heading خطأ! استخدم علامة التبويب "الصفحة الرئيسية" لتطبيق

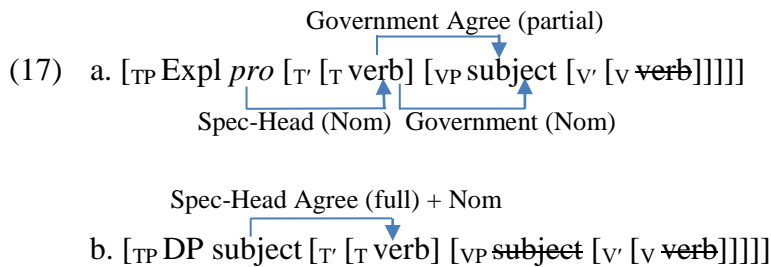

Aoun et al.'s proposal (1994) develops the Spec-Head relation with the proposal which is known as the Agreement Loss approach. Regarding to this proposal, the SVO and VSO orders are derived in Spec-Head relation configurations. The full agreement in SVO order takes place between the subject in Spec-IP and the verb on the head T as (18a). The partial agreement in VSO also takes place between the subject in Spec-TP and the verb on T head. The hypothesis, however, requires some of the verb's agreement feature then get lost by raising the verb into a higher functional projection (FP) as (18b), so that the verb becomes outside of the Spec-Head configuration where the agreement takes place. The number feature then gets lost and becomes singular by default.

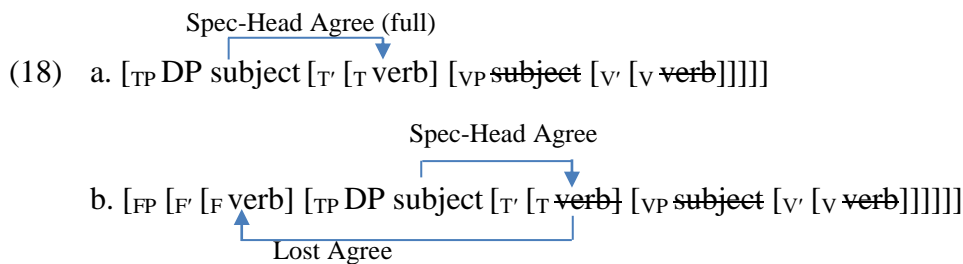

The Spec-Head agreement module is extended to functional categories (Pollock, 1989; Chomsky, 1991; Ouhalla 1994). Pollock (1989), for instance, suggests the Split-IP hypothesis where tense and agreement are split into different functional categories. They are the AgrP projection which hosts agreement morphemes and the TP projection which hosts tense, and AgrP is higher than TP. Fassi Fehri (1993) in this regard suggests a principle the AGR Criterion to regulate full agreement in MSA:

- (19) AGR Criterion: Rich AGR is licensed by an argumental NP in its Spec, and an argumental NP in Spec AGR is licensed by rich AGR. (Fassi Fehri 1993: 27)

According to this view, partial agreement is licensed in VSO order by moving the verb to the T position while full agreement is licensed by moving the subject to Spec-TP or higher to Spec-AgrP, if TP is split. Consider the following schema:

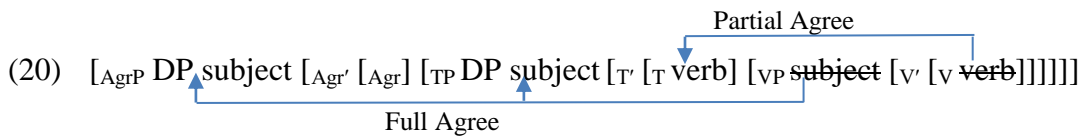

Ouhalla (1994) develops the Split-Infl Hypothesis of Pollock (1989) which holds that the IP has to be split. Ouhalla argues that in VSO languages, as in MSA, the relative order between AgrP and TP should be different from Pollock's order which is compatible with SVO, the order by Ouhalla is assuming AgrP as lower than TP. Here, in both orders the verb moves to Agr to license partial agreement features and the verb with Agr moves to T for tense features. The VSO order is derived by leaving the subject in Spec-VP where it is assigned case by default. The SVO order, is derived by moving DP to Spec-TP and assigning case by default. The DP subject in Spec-TP agrees fully with verb in the Agr head has a co-indexing relation with the *pro* which is first merged in Spec-VP and moves to be licensed in Spec-Agr. Consider the following schemas:

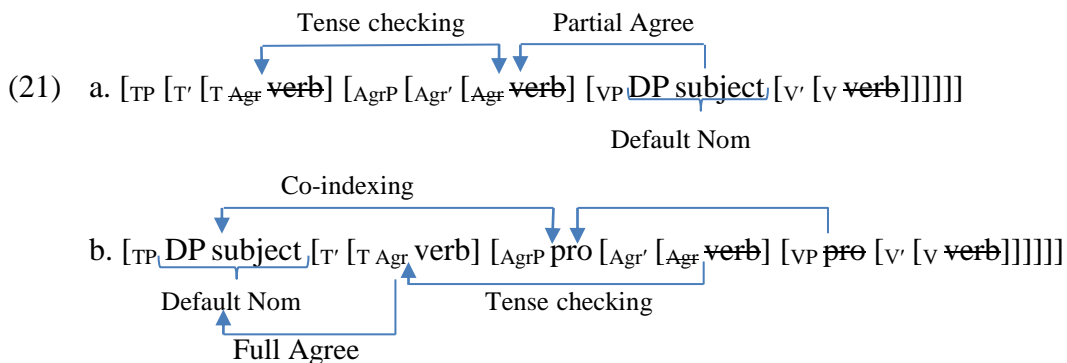

The purpose of the section is to provide the basis for the analyses that will be adopted in the thesis. None of these hypotheses will be adopted on its own, and some points should be raised about the analyses above. The null Expletive Hypotheses, theoretically and empirically is problematic. From a theoretical point of view, Benmamoun argues that in VSO order, the subject has the ability to check its agreement features in Spec-VP via government from T. In the Spec-Head configuration, however, it has been hypothesized that the subject can agree with T when it occupies the Spec-TP position while Spec-VP is a position for case assignment. If the subject can check a feature in the lower position, then why does it need to move to Spec-TP for SVO order? From an empirical point of view, Mohammed (2000) suggest that in VSO order the postverbal subject is assigned case by transmission operation from Spec-TP where the case is assigned and the expletive *pro* is licensed. The motivation of expletive *pro*, according to him, is the obligatory appearance of this *pro* under the Comp *?anna* 'that'. However, the example in (22) is problematic if we follow Mohammed's assumption:

- (22) ?iddaʕaa      r-radʒul-u      ?anna-hu      ya-bduu  
claimed.3ms    the-man-nom    that-him.acc    3m-seems.imperf.s  
T-Taʕaam-u    laḏiiḏ-an  
the-food-nom    delicious.acc  
'The man claimed that the food looks delicious.'

In (22), if the postverbal subject is assigned the nominative case by transmission operation from the overt expletive *pro* the DP subject 'the food' should be accusative and not nominative. This is because the expletive *pro* is assigned accusative case by the case assigner Comp *?anna* 'that' and overtly appears as an accusative pronoun *hu*. This seems to be problematic for transmission case operation between the expletive *pro* and postverbal subject which Mohammed advocates.

Soltan (2007) criticises the implication of the null Expletive Hypotheses as well as the Spec-Head configuration. His criticism is based on two points. First, the presence of the null

expletive is not well motivated in the grammar, since “[a] null expletive is LF-inert and PF-empty; hence it has no interface value; it simply lives and dies in the syntax” (p4). Second, empirically, the Spec-Head configuration fails to explain the VS agreement with a conjoined DP subject. The verb in T can agree only with first conjunct and neither the second nor the full DP subjects as explained in 2.4.1. In such a structure, it is not clear how the Spec-Head configuration can account for the verb-subject agreement with part of the full DP subjects.

A crucial problem for the analyses above I would raise here is the analysis of the structure with the full agreement pattern, specifically, the position of the preverbal DP subject in SVO. As shown in these analyses, the subject raises to Spec-TP from a lower position, and with verb in T head, and the full agreement is licensed in MSA. However, for the preverbal subject it is a controversial issue whether it moves to Spec-TP or is a base generated as a topic higher up in the CP domain. This point will be discussed in depth in 2.6.

In the following section, I will show the derivation of VSO order within a minimalist perspective.

## **2.5 The derivation of VSO order in MSA**

### **2.5.1 Overview**

In this section, I follow the assumption that VSO in MSA is formed by V-to-T head movement. I divide this section into three parts. First, I will show how VSO order can be accounted with some of the theoretical framework of minimalism. Second, I will examine T-to-C movement in MSA. Third, I will summarize the section.

### **2.5.2 Verb movement**

In MSA, VSO is the basic constituent order, as explained in section 2.2.5. One of the most well-known theoretical claims in Arabic is that VSO in MSA is derived by raising the verb to T while the subject and object are in lower positions occupying Spec-VP and the complement

على النص الذي ترغب في أن يظهر هنا. 2.Heading خطأ! استخدم علامة التبويب "الصفحة الرئيسية" لتطبيق  
على النص الذي ترغب في أن يظهر هنا. 2.Heading خطأ! استخدم علامة التبويب "الصفحة الرئيسية" لتطبيق

of V, respectively (Bakir 1980; Benmamoun 1992; 2000; Fassi Fehri 1993; Mohammed 1990; 2000; Soltan 2007). In MSA, the V-movement operation plays a crucial role in forming VSO and SVO orders, since it is assumed that both orders involve head movement V-to-T. Consider the V-to-T movement in VSO order as the example (23a) and the structure in (23b) show:

- (23) a. qaraʔa                    T-Tullaab-u                    l-kitaab-a  
 read.perf.3ms            the-students-nom            the-book-acc  
 ‘The students read the book.’

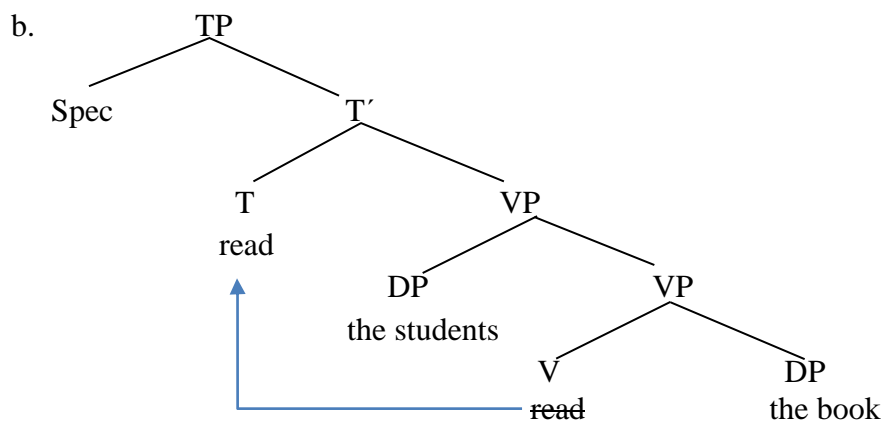

In (23b), the verb ‘read’ moves from V to T position while the subject ‘the students’ remains in merge position Spec-VP. The VSO order in MSA then formed by V-to-T head movement.

In early minimalist approach, the verb movement operation is discussed with the concept of overt and covert movement. This concept has been accounted with different assumptions of the minimalist literature. Chomsky (1993), for instance, assumes that the derivation at some point (Spell out) branches into Logical Form (LF) and Phonological Form (PF) as the following diagram:

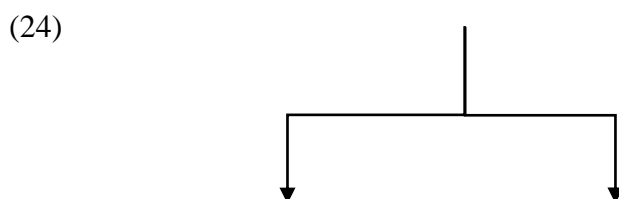

## Spell out

Phonological Form (PF)      Logical Form (LF)

According to (24), overt movement is assumed to be taken on PF branch of the derivation while covert movement on LF branch of derivation. In this regard, the studies of functional categories play a vital role in defining the syntactic properties of sentences (overt and covert movement). Functional categories such as TP and NegP led to the observation that there are some differences between English and French in the distribution of the VP head. It, particularly, shows whether V-to-T movement lives in narrow syntax (PF) or at LF. The analyses assume that since both adverbs and Neg in French follow the verb, the French verb then moves overtly to T at PF, while the English verb moves covertly at LF. This can be assumed with a different parameter setting (Pollock 1989; 1997):

- |      |          |           |          |                           |
|------|----------|-----------|----------|---------------------------|
| (25) | a. *John | likes     | not      | Mary.                     |
|      | b. Jean  | (n') aime | pas      | Marie.                    |
| (26) | a. *John | kisses    | often    | Mary.                     |
|      | b. Jean  | embrasse  | souvent  | Marie.                    |
|      | c. John  | often     | kisses   | Mary.                     |
|      | d. *Jean | souvent   | embrasse | Marie (Pollock 1989: 367) |

The verb never appears preceding either Neg or adverb in English; this accounts for the ungrammaticality of (25a) and (26a), where the verbs precede the Neg *not* and the adverb *often*, respectively. Differently, French verbs precede either the Neg as in (25b), or the adverb as in (26b), and do not follow them. That explains the ungrammaticality in (26d), where the adverb *souvent* precedes the verb *embrasse*. The contrast of the relative order between French and English verbs with regard to the adverb and the Neg is based on the fact that the adverb and the Neg are located higher than the verb's merge position in the structure, and the verb moves higher to tense in French but not in English in overt syntax. As a result, the verb always follows an adverbs or Neg in English but not in French. The structures (27a) and



على النص الذي ترغب في أن يظهر هنا. 2.Heading خطأ! استخدم علامة التبويب "الصفحة الرئيسية" لتطبيق  
 على النص الذي ترغب في أن يظهر هنا. 2.Heading خطأ! استخدم علامة التبويب "الصفحة الرئيسية" لتطبيق

(27b) below represent two different interactions between the verb and the adverb which are in (26b) and (26c), respectively:

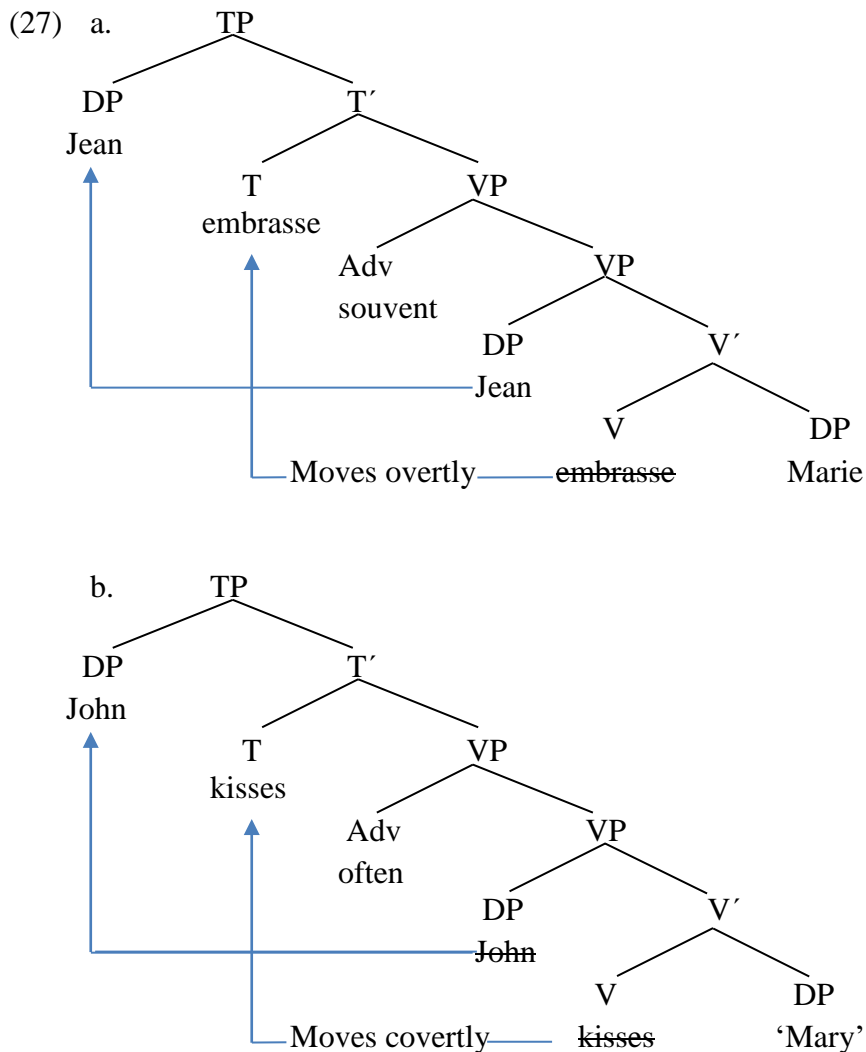

How does the verb interact with an adverb and Neg in MSA? Does it behave similarly to the English or to the French case?

Let us examine at the interaction between the verb and the adverb in MSA. According to Fassi Fehri (1993), MSA adverbs are classified as adjuncts and each kind of adverb typically adjoins to certain projections and not to others. The adverbs that adjoin to VP are needed here to identify the syntactic verb position, such adverbs are like *daa?iman* 'always'. Consider the

following example to show the relative order between the verb and the VP-adverb *daaʔiman* 'always':

- (28) a. *yu-saafiru*                    *ʔaħmad-u*                    *daaʔiman*                    *ʔilaa*                    *landan*  
           3m-travels.imperf.s    Ahmad-nom                    always                    to                    London  
           'Ahmad always travels to London.'
- b. \**yu-saafiru*                    *daaʔiman*                    *ʔaħmad-u*                    *ʔilaa*                    *landan*  
           3m-travels.imperf.s    always                    Ahmad-nom                    to                    London  
           'Ahmad always travels to London.'

The examples in (28a) show that the verb 'travels' appears preceding the adverb *daaʔiman* 'always' because the verb moves to the T position crossing the adverb which is adjoined to VP. Otherwise the sentence is ruled out as in (28b), since the verb 'travels' does not move to T and stays in its merged position, following the adverb *daaʔiman* 'always'. This indicates that V must move overtly to the T position and appear to the left of the adverb as shown in (29) below.

على النص الذي ترغب في أن يظهر هنا. 2.Heading خطأ! استخدم علامة التبويب "الصفحة الرئيسية" لتطبيق  
 على النص الذي ترغب في أن يظهر هنا. 2.Heading خطأ! استخدم علامة التبويب "الصفحة الرئيسية" لتطبيق

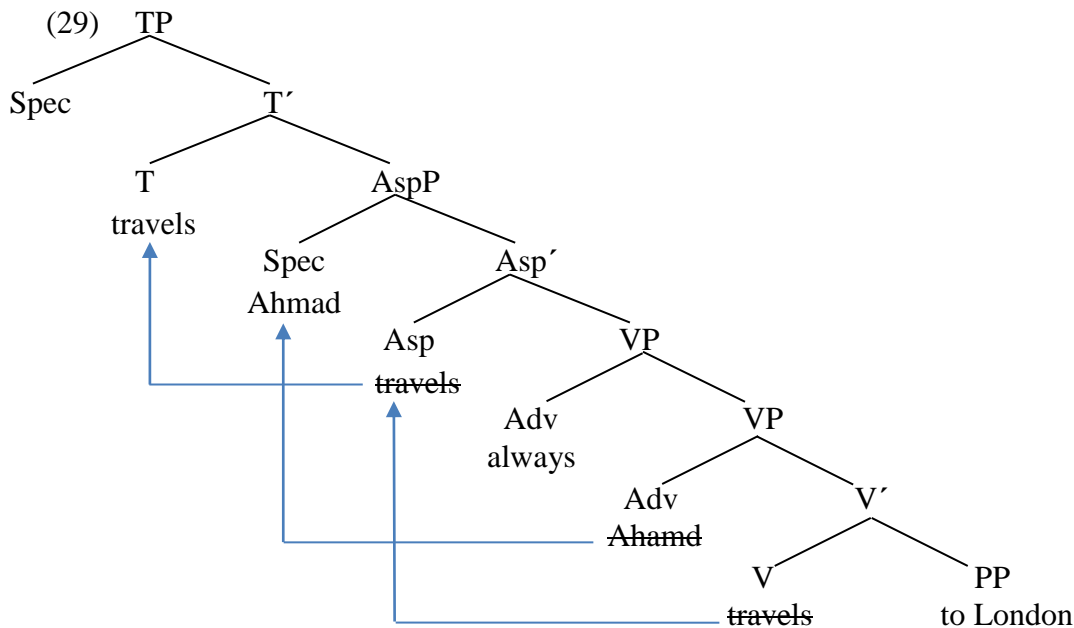

Assuming the tree in (29), the DP subject 'Ahmad' is merged initially in Spec-VP. Since the subject is spelled-out preceding the adverb 'always', the subject needs to be higher than the adverb. The subject as a result will move to Spec-AspP crossing the adverb. The verb moves overtly through Asp to T position. Therefore, the relative order between the verb and adverb in MSA is similar to the French case, since the verb moves overtly (at PF level) preceding VP-adverbs such *daa?iman* 'always'.

Another concept of minimalist approach that could explain the overt movement is Copy Theory of Movement. Chomsky (1993; 1995), proposes the Copy Theory of Movement in which a movement element leaves a covert copy behind it to form a chain movement. The movement chain of the element could be as  $\langle \text{copy } i, \text{copy} \rangle$  and pronouncing the higher copy is assumed to be overt movement while the pronouncing the lower copy is assume to be covert movement (see Nissenbaum 2000). Under this approach, verb movement in MSA can be explained by two operations: (i) verb gets copied (ii) the lower copy of verb gets deleted while the higher copy is pronounced. By contrast, languages that do not shows (finite) verb movement such English will have the lower copy pronounced while the higher copy is deleted. Consider the example (30a) which has the movement chain as the schema in (30b):



على النص الذي ترغب في أن يظهر هنا. 2.Heading خطأ! استخدم علامة التبويب "الصفحة الرئيسية" لتطبيق  
على النص الذي ترغب في أن يظهر هنا. 2.Heading خطأ! استخدم علامة التبويب "الصفحة الرئيسية" لتطبيق

negative particle heading its own syntactic projection (Ouhalla 1991; Benmamoun 1992; 2000; Shlonsky 1997). Consider the example in (31a) in its negative versions in the three negative examples in (31b-d):

- (31) a. ya-drus-u                                      T-Tullaab-u                                      l-kitaab-a  
3m-study.imperf.s-indic      the-students-nom                                      the-book-acc  
'The students study/are studying the book.'
- b. lan                                      ya-drus-a                                      T-Tullaab-u                                      l-kitaab-a  
Neg.future      3m-study.imperf.s-subjun      the-students-nom      the-book-acc  
'The students will not study the book.'
- c. lam                                      ya-drus-                                      T-Tullaab-u                                      l-kitaab-a<sup>5</sup>  
Neg.past      3m-study.imperf.s-juss      the-students.nom      the-book-acc  
'The students did not study the book.'
- d. laa                                      ya-drus-u                                      T-Tullaab-u                                      l-kitaab-a  
Neg.present      3m-study.imperf.s-indic                                      the-students-nom                                      the-book-acc  
'The students do not study the book.'

The negatives (*lan*, *lam*, *laa*) in (31b-c-d) appear left adjacent to the finite verb and inflect the tense; future, past and present respectively. No lexical items may intervene between the negative and the verb. Otherwise, the negative clause is ruled out as in (32).<sup>6</sup>

- (32) \*lam                                      T-Tullaab-u                                      ya-drus-                                      l-kitaab-a  
Neg.past                                      the-students.nom                                      3m-study.imperf.s-juss                                      the-book-acc  
'The students did not study the book.'

Assuming the strong tense feature on T can be satisfied by verb movement predicts the ungrammaticality below:

<sup>6</sup> The negatives *laa*, *lam*, *lan* show distinctions of tense-present, past and future, respectively and occur only with imperfect forms of the verb.

- (33) \**ya-drus-*                      *lam*              T-Tullaab-u              l-kitaab-a  
 3m-study.imperf.s-juss    Neg.past    the-students-nom      the-book-acc  
 'The students did not study the book.'

In order to fix ungrammaticality in (33) the assumption that V-to-T movement check the tense in Neg clauses has to be modified. The standard assumption is that Neg *lam* must appear to the left of the verb 'study', in the meanwhile, the T head position has to be filled by a lexical head to check the strong tense feature there. Assuming that the Neg heads inflect the tense as (31b-c-d) shows the suggestion is that the Neg head *lam* in (33) which inflects the past tense moves to T head to checks the tense while the verb can move up to Mood head to check the mood feature. Consider the following tree as the structure for (31c).

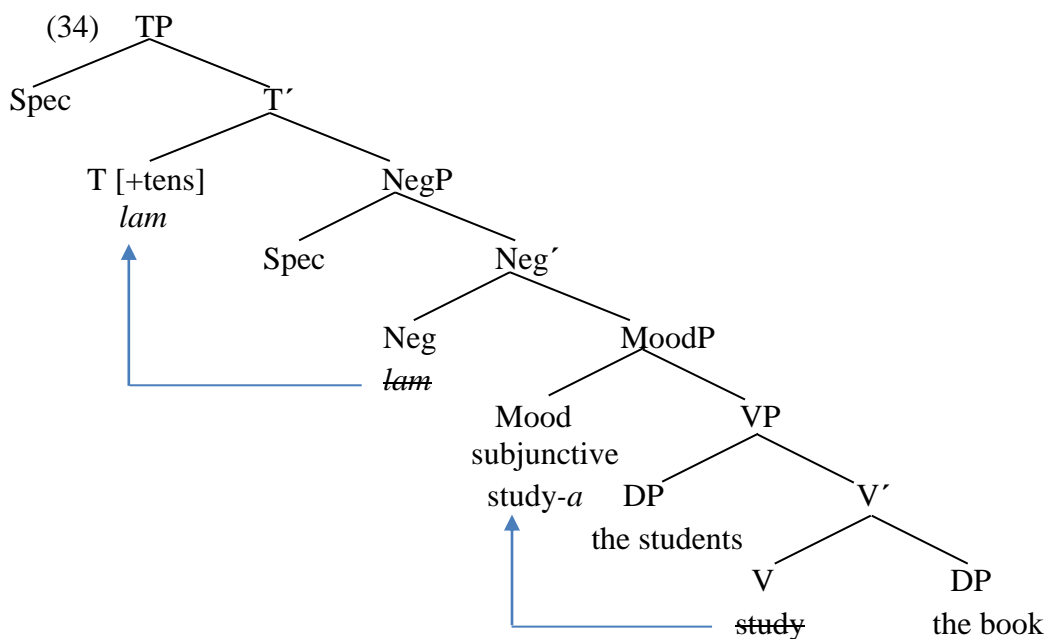

From the structure (34), T in negative clauses continues to bear a strong tense feature and Neg-to-T movement satisfies this strong tense feature.

Benmamoun (2000: 100-103) suggests that T has two separate strong features which are verb and tense features. In a clause where the tense is inflected by the Neg head e.g. *lam* in (31c)

على النص الذي ترغب في أن يظهر هنا. 2.Heading خطأ! استخدم علامة التبويب "الصفحة الرئيسية" لتطبيق  
على النص الذي ترغب في أن يظهر هنا. 2.Heading خطأ! استخدم علامة التبويب "الصفحة الرئيسية" لتطبيق

both verb 'study' and Neg *lam* has to move to T head to check verb and tense feature respectively. The derivation, with regard to Benmamoun will work in two movement operations: (i) the verb 'study' first raises to the Neg head *lan* through Mood and (ii) the Neg *lan* jointly with the verb 'study' raises to T. Therefore, both tense and verb movement are checked. An overall structure of verb movement in a negative clause will have the following tree:

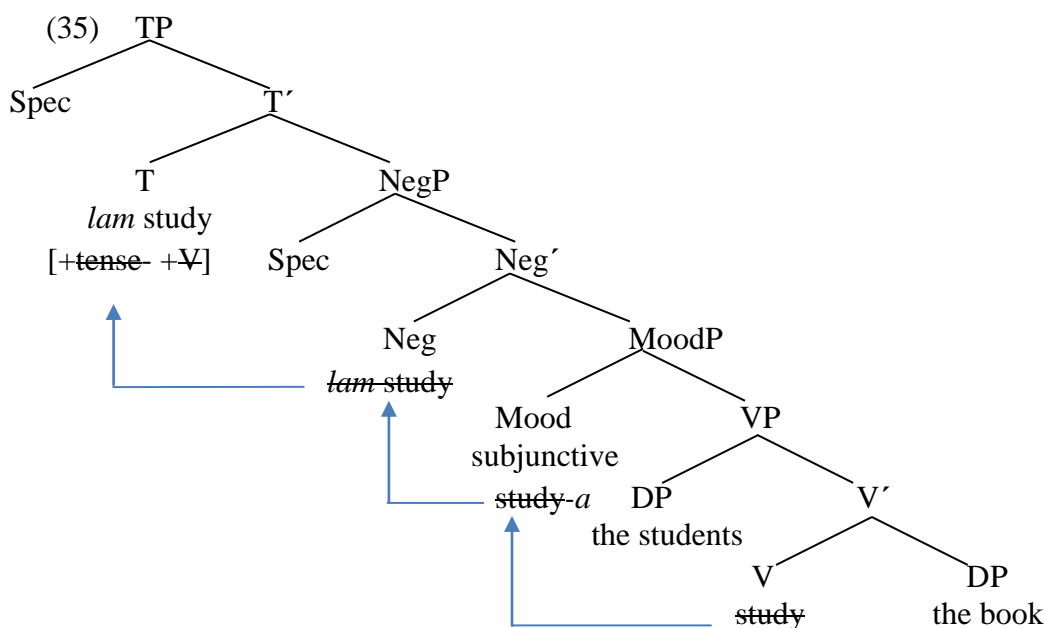

From the structure (35), the T head in negative clauses has a strong tense feature which is checked by the Neg *lam* and also has a strong verb feature that is checked by the verb 'study'. Hence, both types of features (tense and verb) need to be checked by head movement to T.

Therefore, I conclude that the T head in MSA seems to have has a strong feature that must be satisfied by hosting the syntactic head which inflects the tense such as finite verbs, auxiliary verbs or Neg heads.

More analysis of verb movement with more recent minimalist framework will be presented in 2.7.3

### 2.5.3 Can V move to C?

The importance of this question for my thesis here is to identify the possibility of the MSA verb moving higher up in the traditional clausal structure (CP), and then compare this result to the more recent clausal structure (Split CP hypothesis) later on in the thesis.

As we explained, MSA has VSO order which can be derived by raising the verb over the subject to the inflectional position of T to satisfy the tense feature. One question that has been raised in VSO languages is whether the verb moves to the C position. There are two proposed answers to this question. The first proposal, that the verb never appears higher than the T position and V-to-C movement is not possible, is assumed in many analyses (Sadler 1988; Guilfoyle 1990; McCloskey 1990; 1991; 1996; Duffield 1995; Rouveret 1991; Pyatt 1992; Fassi Fehri 1993; Chomsky 1993; Carnie 1995). The second proposal, with some analyses within Government and Binding framework, assumes that the verb, after V-to-T movement, exhibits T-to-C movement in matrix declarative clauses (Sproat 1985; Deprez and Hale 1986; Stowell 1989).

The suggestion that the verb can move to C originates from the syntax of verb second (V2) languages. In German and Dutch, for instance, the verb can appear in two positions: the first position is in TP and the second position is in the C head position. One requirement is that the complementizer position must be filled, i.e. the verb must raise to C position; another requirement motivates other elements such as the subject to precede the verb and fill Spec-CP (den Besten 1981; Koopman 1984; Holmberg and Platzack 1988; McCloskey 1992, among others). In contrast, in embedded clauses when the complementizer is overt, the verb cannot raise to the second position in C, but only appears in TP. The construction in (37) shows the verb positions in V2 languages:

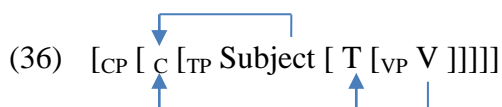

The following German examples illustrate the possible verb positions in the V2 structure (Santorini 1994: 88):





1s-want.imperf.s-Ind 3m-leave-imperf.s.indic that the-students-nom  
 'I want the students to leave.'

In (38a), the verb 'leave' must follow the Comp *ʔan* 'that' which is in C head position. However, the verb 'leave' is restricted from crossing the Comp *ʔan* 'that' and this accounts for the ungrammaticality in (38b).

The impossibility of the verb moving to C position in embedded clauses in MSA raises the following question: Can V-to-C movement apply in matrix clauses? In fact, there is no independent evidence that V moves higher than T in embedded or matrix clauses either.

Aoun et al. (1994) propose that there is an exceptional occurrence of the verb in the C position. According to them, an interrogative can sometimes have a question particle cliticized to the verb. Consider the following example:

(39) ʔa-qaraʔta l-kitaab-a  
 Q-read.perf.2ms the-book-acc  
 'Did you read the book?' (Aoun et al. 1994:  
 204)

The example in (39), however, does not keep us from assuming that the question particle is in C while the verb is in T position, and only shows that C and T must be adjacent.

In order to examine the possibility of the verb to move higher to the C position we need to look at the distribution of the verb with elements that occur between the T and C heads. Consider the functional category hierarchy in (8) which is adopted in this chapter. ModP occupies the position between TP and CP (Fassi Fehri 1993). The observation shows that verb cannot cross Mod particles in MSA as ungrammaticality shown below:

على النص الذي ترغب في أن يظهر هنا. 2.Heading خطأ! استخدم علامة التبويب "الصفحة الرئيسية" لتطبيق  
على النص الذي ترغب في أن يظهر هنا. 2.Heading خطأ! استخدم علامة التبويب "الصفحة الرئيسية" لتطبيق

- (40) \*ya-ʔkulu                      qad      ʕaliyy-un      t-tuffaaḥat-i  
3m-eat.imperf.s-indic      may      Ali-nom      the-apples.acc  
'Ali may eat the apples.'

The ungrammaticality of (40) is attributed to the Mod particle 'may' appearing preceding the verb 'eat'. The verb 'eat' must not appear crossing the Mod 'may'; the impossible position for the verb is shown in (42). Therefore, V-to-C again is not possible in modality sentences.

- (41) [CP [C' [C \*eat] [ModP [Mod [Mod may] [TP [T' [T +tense eat] VP [V' [V eat] [DP the apples]]]]]]]]

#### 2.5.4 Summary

To summarize the discussion on V-movement, I support that V in MSA moves overtly from its base position to T due to the fact that the T head in MSA has a strong tense feature that must be satisfied by hosting the syntactic head such as finite verbs, auxiliary verbs or Neg. The relative order between verb and adverb shows that the verb always crosses the adverb which adjoins to VP. I propose that the interaction between V and NegP suggests that the Neg always precedes the verb on T to check the tense feature while the verb moves up to Asp head. VSO order in MSA is consistent with deriving head movement as V-to-T but V-to-C movement is not possible. This comes from two observations: (i) the verb cannot be in C as C is filled by the Comp *ʔan*; and (ii) the verb always follows the Mod particle which occupies the Mod head below the C head.

## 2.6 The derivation of SVO order in MSA

This section concerns the derivation of SVO order. It begins first with discussion of the problem of the preverbal DP in MSA. Second, it presents the previous analyses of the preverbal DP in MSA. Third, it suggests an alternative analysis for the preverbal DP in SVO. Fourth, it summarises the section.

### 2.6.1 The problem of the Preverbal DP subject in SVO order in MSA

The position of the preverbal DP is a controversial syntactic issue in MSA. There is no consensus in the interpretation of the preverbal DP in SVO order, it can be considered one of the most controversial syntactic issues of Arabic syntax in traditional literature as well as modern linguistic studies (42). The preverbal DP subject in SVO order is exemplified below (Here, the preverbal DP is in bold line):

- (42) **aT-Tullaab-u**      qaraʔuu/\*a      l-kitaab-a  
 the-students-nom      read.perf.3mp/ \*3ms      the-book-acc  
 ‘The students read the book.’

Bakir (1980) was the first grammarian who shed the light into the problematic structure. He points out that the occurrence the preverbal subject in clause-initial position in SVO as in (42) will result an ambiguous structure. The ambiguity of pre-verbal subject structure is based on the possibility of subject to be either a neutral moved subject in Spec-TP or a base generated topic in Spec-CP. In other words, the preverbal DP subject in SVO order can be seen in two different derivations, as a subject-verb clause or a Topic-Comment construction. According to Bakir, the SVO sentence in (42) would have two possible derivations which are shown in (43a) and (43b).

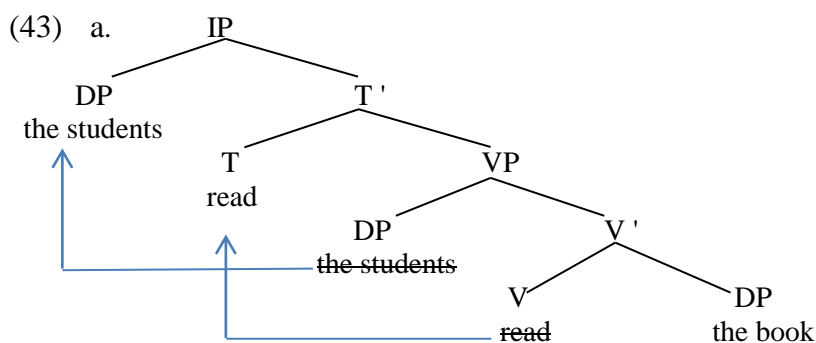

على النص الذي ترغب في أن يظهر هنا. 2.Heading خطأ! استخدم علامة التبويب "الصفحة الرئيسية" لتطبيق  
 على النص الذي ترغب في أن يظهر هنا. 2.Heading خطأ! استخدم علامة التبويب "الصفحة الرئيسية" لتطبيق

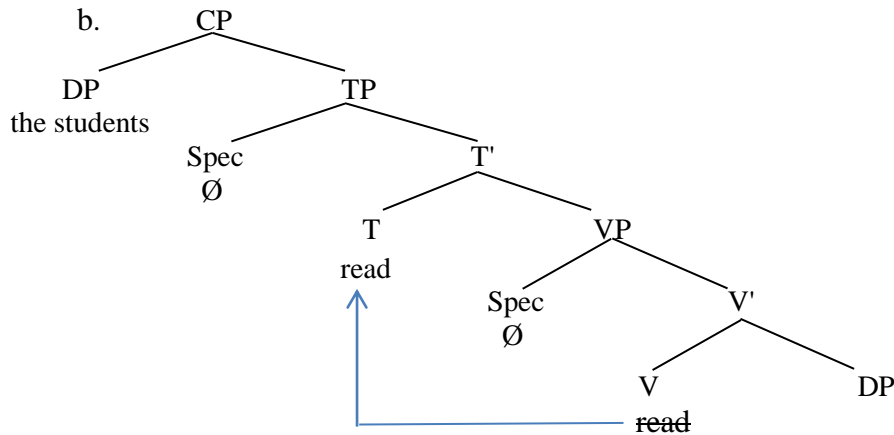

In the structure (43a), within minimalism, the preverbal DP internally is merged and raises higher to Spec-TP while in the structure in (43b) the preverbal DP is externally merged in Spec-CP (the connection of that DP to the clause is not specified). However, the main point is that there are two different derivations for the preverbal DP subject.

There is a need of studying the structure of preverbal DP subject in SVO order. The importance of such a structure is not only to solve the ambiguity shown in (43a-b) but also is based in two more important points of syntax. The first important point is the fact that the verb always shows full agreement with a preverbal DP subject. The second important point of the preverbal DP subject in SVO order is to understand the mechanism of case assignment for the preverbal DP subject and how different positions of the preverbal DP in (43a-b) could affect the mechanism(s) of case assignment. In order to account for full agreement pattern and case assignment to preverbal DP subject in SVO the structures in (43-a-b) need to be well-addressed in MSA.

In this section, I will attempt to solve this controversial issue by answering the following central question: Which function and position can the preverbal DP have in SVO order?

### 2.6.2 Previous analysis of the preverbal DP subject

According to the previous studies which investigate the SVO order, there are three competing views which have been put forward to account for the preverbal DP subject in SVO order. The first view considers the preverbal DP as a real subject which is initially generated within the VP projection and can remain there to produce VSO order or it moves over the verb to the higher position of Spec-TP to produce SVO (Mohammed 1989; 2000; Benmamoun 1992; 2000b; Aoun et al. 1994; Bolotin 1995). The sentence in (44a) has the structure in (44b) which represents the first proposal of the preverbal DP subject in SVO:

- (44) a. **T-Tullaab-u**      qara?uu      l-kitaab-a  
           the-students-nom    read.perf.3mp    the-book-acc  
           ‘The students read the book.’

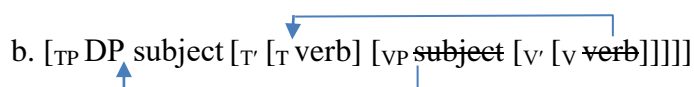

The view that considers the preverbal DP subject as a neutral subject as (44a-b) is theoretically well-motivated in the generative literature. Within the Principles and Parameters framework, the preverbal DP is motivated by the standard assumption that there are two potential positions of the real subject in a given clause. The first one is within the verbal predicate, found within VP as the case for Irish, while the second is in Spec-TP, which c-commands VP as is the case for English and French (Koopman and Sportiche 1991; Mckloskey 1996; 1997). Within minimalist assumptions (Chomsky 1995), the preverbal DP subject in SVO also is also motivated. In a language such as English the preverbal DP subject is also derived by raising the subject to Spec-TP. In more recent work, Chomsky (2000) suggested that subject in Spec-TP is motivated by an Extended Projection Principle feature (an ‘EPP’ feature)<sup>7</sup> on T. The preverbal position of DP and *pro* subjects in Spec-TP is exemplified in (45a) by English data which has the simplified representation in (45b):

<sup>7</sup> The term EPP was first introduced by Chomsky (1981): the structural requirement that certain configurations ‘must have subjects’ (p.27). A more recent analysis assumed that the EPP condition specifies that an

على النص الذي ترغب في أن يظهر هنا. 2.Heading خطأ! استخدم علامة التبويب "الصفحة الرئيسية" لتطبيق  
 على النص الذي ترغب في أن يظهر هنا. 2.Heading خطأ! استخدم علامة التبويب "الصفحة الرئيسية" لتطبيق

(45) a. He does want to scare them.

b. [CP [C  $\emptyset$ ] [TP *He* [T does] [VP *He* [V want] [CP [C  $\emptyset$ ] [TP *pro* [T to] [VP ~~*pro*~~ [V scare] them]]]]]]]] (Radford 2009: 224)

The second view assumes a different analysis of the preverbal DP subject. The assumption is that the subject can only be generated within VP and does not raise to over T position, and in such a construction, where the DP precedes the verb, the DP is a base generated topic rather than a real subject, and it occupies the left periphery domain (Bakir 1980; Ouhalla 1991; 1994a; Plunkett 1993).

A study by Plunkett (1993) indicated that subjects in MSA are always in their canonical position. She adopts the Lexical Clause Hypothesis LCH (Fukui and Speas 1986) in which the subject originates within a lexical projection, namely VP. Plunkett (1993), in her analysis, depends on two observations to show that the preverbal DP subject in MSA has a topic reading. The first observation is linked with the interpretation of the nominal sentence in MSA classic literature. That is, assuming the preverbal DP as a topic property is compatible with the common traditional division of the sentences that consider every clause that begins with DP is a nominal clause and that DP is a topic phrase while the rest of sentence is a comment for the DP topic. The comment part, however, can be a predicate (non-sentential) or a sentential clause, which can also be divided into verbal clause contain a verb or verbless (see 2.2.6 for sentence division details). As result, interpreting the preverbal DP as a topic will include all sentence types in MSA. The second observation comes from the fact that MSA is a pro-drop language where subject can be overt or null. Consider the following example (Plunkett 1993: 241):

(46) a. **aT-Tullaab-u** *pro* ya-drusuuna

uninterpretable EPP feature on a probe is deleted by movement of the closest active goal of the relevant type to become the specifier of the probe.

the-students-nom they 3m-study.imperf.p

‘The students, (they) are studying.’

b. **aT-Tullaab-u**                      ʔu-ħibbu-**hum**

the-students-nom                      1s-like.imperf.s-them

‘The students, I like them.’

According to Plunkett, the preverbal DP ‘the students’ in (46a) and (46b) are both instances of a topic phrase which typically appears with nominative case. While the former is associated with a null pronoun in subject position, in the latter the DP is coreferential with a resumptive clitic ‘them’ in the object position.

Fassi Fehri (1993:29) presents the third proposal which assumes that considering all preverbal DP as neutral subjects or as left dislocated topics is not possible, since either a neutral subject or a topic reading can be given to the pre-verbal DP subject. He distinguishes between topic and subject DPs with respect to referential properties. His assumption works as following: topics in SA must be definite and “strongly referential” as (47a) in which the topic has an agreement in definiteness with definite resumptive clitic. The pre-verbal neutral subject on the other hand, can be definite as in (47a), similar to topic, and it can also be indefinite while being only ‘weakly referential’. The indefinite neutral subject, however, must be specific in (47b) or quantificational as (47c). However, a pure indefinite is not allowed to be preverbal as (47d):

(47) a. **al-ʔawlaad-u**                      dʒaaʔuu

the-children-nom                      came.perf.3mp

‘The boys came.’

(Fassi Fehri 1993: 27)

b. **walad-un**                      Tawiil-un                      dʒaaʔa

boy-nom                      tall-nom                      came.perf.3ms

‘A tall boy came.’

(Mohammed                      2000:

ex.22)



على النص الذي ترغب في أن يظهر هنا. 2.Heading خطأ! استخدم علامة التبويب "الصفحة الرئيسية" لتطبيق  
على النص الذي ترغب في أن يظهر هنا. 2.Heading خطأ! استخدم علامة التبويب "الصفحة الرئيسية" لتطبيق

c. Kull-u      **radgul-in**      ya-ħtarim-u      haaḏaa  
every-nom    man-gen      3m-respect.imperf.s-indic    this  
‘Every man respects this.’      (Fassi Fehri 1993: 28)

d. \***walad-un**    kasara      l-baab-a  
boy-nom      broke.perf.3ms    the-door-acc  
‘A boy broke the door.’      (Soltan 2007: 51)

According to Fassi Fehri, the pre-verbal DP ‘the children’ in (47a) can be interpreted as a topic phrase as well as a genuine subject. He asserts that if the preverbal DP ‘the children’ is assumed to be topic then it is then generated in the CP domain while if it is assumed to be a subject then it is in Spec-TP, moved from VP. In (47b-c), the specific indefinite DP ‘a boy’ and the quantificational subject ‘every man’ are available to be preverbal but only with a subject reading. (47d) is ungrammatical since the indefinite ‘boy’ occupies the initial position and is not even weakly referential.

### 2.6.3 An alternative analysis of the preverbal DP subject

From the discussion above, I, following Bakir (1980), Ouhalla (1991; 1994) and Plunkett (1993), agree with the second view which treats the preverbal DP subject as a base generated topic in the left peripheral domain similar to the topic which is associated to a resumptive clitic. To advocate this view, I will revise the hypothesis of Fassi Fehri (1993) of characterizing the preverbal DP subject. I will, in addition, show two pieces of observation to support the assumption that the preverbal DP in SVO clauses is a topic not a subject. The first observation comes the contrast between the preverbal subject and postverbal subject with respect to their possible interpretation. The second observation relies on the adjacency facts in focus clauses (Bakir 1980; Shlonsky 2000). Finally, I assume that a *pro* subject, and not a DP subject, always moves to the preverbal position in Spec-TP to license the full agreement pattern in SVO order.

Let us revise the proposal of Fassi Fehri (1993). According to him, the specific preverbal DP ‘a tall boy’ and the quantificational subject ‘every man’ in (47b-c) can only be subject DPs, since they are not strongly referential by being definite. However, these DPs can be left dislocated and associated with a resumptive clitic as in (48a-b) while a pure indefinite still cannot be grammatical be associated with a clitic as in (48c):

(48) a. **walad-un** Tawiil-un qaabaltu-**hu**  
 boy-nom tall-nom meet.perf.1s-him  
 ‘A tall boy, I meet him.’

b. **kull-u** sayyaarat-in yu-riiduuna ?an ya-Gsiluu-**haa**  
 every-nom car.f-gen 3m-want.imperf.p that 3m-wash.imperf.p-it  
 ‘Every car, they want to wash it.’ (Aoun et al. 2010:

195)

c. \***risaalat-un** kataba-**ha** walad-un  
 letter.nom wrote.perf.3ms-it boy-nom  
 ‘A letter, the boy wrote it.’ (Shlonsky 2002:

329)

In (48a), the specific indefinite preverbal DP ‘a boy’ appears in nominative case and is coreferential with resumptive clitic *hu* ‘him’. In (48b), the quantificational DP subject ‘every car’ is appears nominative and is co-referential to the resumptive clitic *haa* ‘it’. Thus, the preverbal DPs in (48a-b) are certainly topic and more importantly have at least weak referential properties. In (48c) the preverbal subject ‘a letter’ cannot be left dislocated.

From the observation of (47a-d), comparing to those in (48a-c), we could assume that (48a-b) should be analogues to (47a-c). The only difference is that the topics in (48a-b) are co-referential to a resumptive clitic while the topics in (47a-c) have a topic that is coreferential to a *pro* subject. The ungrammaticality in (47d) and (48c) shows that indefinite preverbal DP

على النص الذي ترغب في أن يظهر هنا. Heading 2 خطأ! استخدم علامة التبويب "الصفحة الرئيسية" لتطبيق  
 على النص الذي ترغب في أن يظهر هنا. Heading 2 خطأ! استخدم علامة التبويب "الصفحة الرئيسية" لتطبيق

---

can never be a topic whether it is co-referential to a null *pro* as (47d) shows or to a resumptive pronoun as (48c) shows.

I then conclude that the data provided by Fassi Fehri (1993) show the preverbal DP to be a topic not a subject.

The nature of the preverbal position in MSA supports the interpretation of the preverbal DP as a topic. Consider an unacceptable pure indefinite in preverbal position in (47d), repeated in (49a) with the fully acceptable pure indefinite in postverbal position in (49b):

- (49) a. \***walad-un** kasara l-baab-a  
 boy-nom broke.perf.3ms the-door-acc  
 'A boy broke the door.'
- b. kasara walad-un l-baab-a  
 broke.perf.3ms boy-nom the-door-acc  
 'A boy broke the door.'

In (49a), the preverbal DP 'a boy' is not possible since it is a pure indefinite and lacks of definiteness and specificity in the context. In (49b), by contrast, the same indefinite DP subject but in postverbal position is grammatically possible. Thus, the assumption that the preverbal subject DP is a moved subject from low position is questionable and must be modified. Bearing in mind that topic must be subjected to definiteness or specificity condition while a pure indefinite DP cannot be topic at all, then, the topic reading for the preverbal DP subject is compatible with the nature of the preverbal position and is not explained if the DP is a pure subject.

The contrast in (49a-b) also indicates that MSA, unlike English, does not allow existential interpretations of subject. Alexiadou and Anagnostopoulou (1998) have a minimalist study with pro-drop languages in which they postulate that all preverbal DPs are assumed to be

topic in null subject language such as Greek and Spanish. Their assumptions are based on the lack of existential interpretations in these languages which the case in MSA.

To show more support for the assumption that the subject cannot be preverbal, let us now look at the position of the preverbal DP subject in focus clauses. Bakir (1980: 128) and Fassi Fehri (1982) assume that the initial subject cannot intervene between the focus phrase (e.g. wh-phrase) and the verb. Consider the following examples:

- (50) a. mataa      ḍahaba                      **T-Tullaab-u**              ḥilaa      l-ḥiraaq-i?  
           when      go.perf.3ms                      the-students-nom      to            the-Iraq-gen  
           ‘When did the students go to Iraq?’
- b. \*mataa      **T-Tullaab-u**                      ḍahabuu                      ḥilaa      l-ḥiraaq-i?  
           when      the-students-nom      go.perf.3mp                      to            the-Iraq-gen  
           ‘When did the students go to Iraq?’

The example (50a) indicates that the subject ‘the students’ appears following the verb ‘go’ immediately (VS) to derive the adjacency fact which requires the verb ‘go’ to be adjacent to the focus phrase ‘when’. In (50b), the occurrence of the subject in a preverbal position (SV) is blocked and causes ungrammaticality as the adjacency fact is not derived here. Therefore, the preverbal subject is blocked in focused clauses and can only appear postverbally following the verb.

To conclude the discussion, I argue that although overt subjects as explained above are more restricted in a preverbal position, null subjects have different analyses. The position of *pro* subjects varies among languages and can occur preverbally (Burzio 1986; Rizzi 1987) or post-verbally (Bonet 1990; Contreras 1991). MSA is considered a pro-drop or a null subject language where full agreement is triggered by null subjects (preverbally). Consider the following example:

على النص الذي ترغب في أن يظهر هنا. 2.Heading خطأ! استخدم علامة التبويب "الصفحة الرئيسية" لتطبيق  
على النص الذي ترغب في أن يظهر هنا. 2.Heading خطأ! استخدم علامة التبويب "الصفحة الرئيسية" لتطبيق

- (51) a. ya-qraʔuuna/ \*u      l-kitaab-a  
3m.read.imperf.p/ s    the-book-acc  
‘They are reading the book.’

Recall the fact that full agreement is found when the subject appears to the left of the verb. In (51), the verb ‘read’ shows rich agreement with the preverbal null subject *pro* in TP. The subject cannot be in Spec-VP since an overt subject cannot be there with full agreement. Therefore, for the example in (50), the order is in (52a) rather than in (52b):

- (52) a. pro.3mp      ya-qraʔuuna[full Agree]      l-kitab-a  
they              3m-read.imperf.p              the-book
- b. ya-qraʔuuna[full Agree]      pro.3mp      l-kitaab-a  
3m-read.imperf.p              they              the-book

Examples (52a-b) show that as the verb with a null subject shows full agreement, the null subject *pro* is licensed only in spec-TP, which moves there from spec-VP.

Evidence for the *pro* subject in null subject clauses is shown in complementizer agreement clauses as the following example:

- (53) ʔinna-**hum**      ya-qraʔuuna      l-kitab-a  
that-them.3mp      3m-read.imperf.p      the-book  
‘That they read the book.’

In (53), the *pro* subject which shows full agreement with verb ‘3m-read.imperf.p’ is lexicalised since it precedes by the complementizer particle *ʔinna* ‘that’. The complementizer agreement structure will be discussed in chapter 6. I assume that the obligatory licensing of *pro* subject in MSA following the proposal of the Pro Identification Requirement (Rizzi 1982; 1986 and McCloskey 1986). Rizzi (1986), for instance, assumes that in null subject

languages like Italian the argumental *pro* has to be licensed and identified. The identification of *pro* is realized by full agreement on the licensing head.

In MSA, when a preverbal DP appears as well as the *pro* subject it has a co-indexing relation with it as in (54):

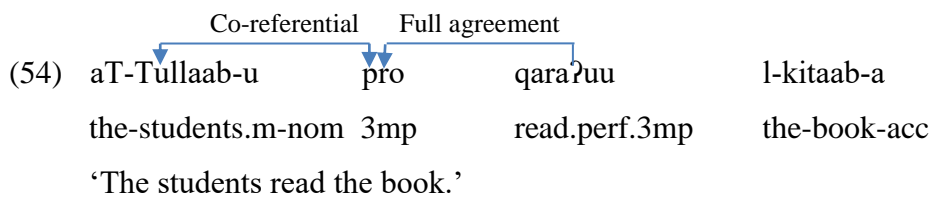

The coreferential relation between the preverbal DP subject and the *pro* subject is understood by the compulsory of identical features in full agreement patterns between them.

#### 2.6.4 Summary

To sum up, there are different views on the function and the position of the preverbal DP, to derive the SVO order in MSA. A topic phrase is in the left peripheral domain and associated with a null pronoun inside the clause. A genuine subject moves from lower than T to Spec-TP. The view adopted in the thesis is the topic view since the observations show that the topic associated with a resumptive clitic inside the clause can be associated with a null subject and will show a full agreement pattern. The considerations of the nature of the preverbal position in MSA and the distribution of the subject with focus phrase show that the preverbal DP subject is an instance of a clitic left dislocation construction. Finally, I propose that the full agreement is triggered by the by the preverbal null subject while the preverbal DP subject co-referential with the *pro* subject.

## 2.7 The analyses of VSO and SVO orders in MSA

### 2.7.1 Overview

The main goal of this section is to examine the applicability of the minimalist principles to account for the agreement in MSA in both constituent orders. There is a challenge for the Agree-based theory to account for partial agreement in VS order in MSA. In this section, I will provide analyses for both VSO and SVO orders from the minimalist perspective, using Agree theory (Chomsky 2000; 2001). The analyses account for verb agreement and subject case assignment in VSO and SVO orders. The section is divided into three parts. The first part represents the theoretical background of the analyses. The second part has the analysis of the VSO order while the third part has the analysis of SVO order.

### 2.7.2 Background

I will analyse the VSO and SVO order accounting for the agreement patterns (full and partial) and subject position in different types of clausal structures using the Agree theory account which has the following principles (Chomsky 2001: 122):

- (55) Probe  $\alpha$  agrees with Goal  $\beta$  condition as follows:
- a. P  $\alpha$  has unvalued features (e.g.  $u$  phi-features).
  - b. G  $\beta$  has matching valued features of P  $\alpha$  (e.g. phi-features).
  - c. G  $\beta$  is active if it has unvalued features (e.g.  $u$  case feature).
  - d. P  $\alpha$  c-commands G  $\beta$ .
  - e. P  $\alpha$  cannot agree with G  $\beta$  if there is  $\gamma$  c-commanding  $\beta$  and c-commanded by  $\alpha$  which has valued features.

As (55) states, the operation Agree is activated by the existence of an uninterpretable feature in the syntax in both the probe as (55a) and the goal (55c). However, Chomsky (2000) assumes that the uninterpretable feature must be deleted by copying a value of the valued feature onto the unvalued feature where the features are matched.

The standard assumption of Agree theory is that the operation of Agree including case and phi-features is achieved via this Probe-Goal-Agree system which has a number of requirements as shown in (55). For example, a probe such as T,  $\nu$  carries uninterpretable unvalued phi-features while the goal such as DP subject, DP object carries interpretable valued phi-features and unvalued case features. The uninterpretable unvalued phi-features of the probe are valued by copying the interpretable valued phi-features of the goal, while the probe then values and assigns the relevant case to the nominal goal. The operation of phi-Agree could also involve the probe head encoding an EPP feature which requires the goal to move to its specifier. This extra step is optional, depending on the language or construction type.

An important observation for the standard assumption of Agree theory is that case and phi features are not valued from independent probes. Chomsky (2001: 6) confirms this by asserting that “[s]tructural Case is not a feature of the probes (T,  $\nu$ ), but it is assigned a value under agreement”. A probe (T or  $\nu$ ) with uninterpretable phi-features has to enter into an Agree operation to value two types of unvalued features, which are uninterpretable unvalued phi-features of the probe and unvalued case of the nominal goal. By contrast, a probe head (T,  $\nu$ ) cannot value unvalued case feature of the nominal goal if it is not active through carrying uninterpretable features i.e. phi-features. Under this assumption, the case assignment is a result of the Agree relation involving phi-features.

The operation of Agree resulting in case assignment and subject movement to Spec-TP is exemplified with English as in (56a), which has the simplified representation in (56b):

(56) a. He does love Mary.

b. [CP [C  $\emptyset$ ] [TP *He* [T does] [VP *he* [V love] [Mary]]]]

In (56b), T *does* is an active probe looking for an active goal to value the uninterpretable phi-features [Pers, Num], and *he* is the closest goal since it has interpreted valued phi-features



على النص الذي ترغب في أن يظهر هنا. 2.Heading خطأ! استخدم علامة التبويب "الصفحة الرئيسية" لتطبيق  
على النص الذي ترغب في أن يظهر هنا. 2.Heading خطأ! استخدم علامة التبويب "الصفحة الرئيسية" لتطبيق

and an unvalued case feature. Therefore, the operation Agree is activated, and the probe and goal match in features. The goal *he* values the unvalued uninterpretable phi-features [Pers, Num] on the probe *does*. The subject *he* has its case valued as nominative by the probe T. The EPP feature forces T *does* to attract the pronoun *he* to be its subject by moving to spec-TP. The uninterpretable phi-feature [Pers, Num], as a result of these operations, are then deleted as well as the EPP feature.

### 2.7.3 The analysis of VSO order in MSA

Above we showed that the verb moves to T to satisfy the requirements of the tense head. Within the Split-VP hypotheses, the verb has to raise to the *v* head before moving to the T head while subject remains lower than T and this derives the VSO order in MSA, which therefore has the following structure:

$$(57) \quad [TP [T' [T+v \text{ verb}] [_{VP} \text{ subject} [_{v'} [_v \text{ verb}] VP [_{v'} [V \text{ verb}]]]]]]$$

As shown in (57), the MSA verb in VSO order moves to two positions which are the *v* and T heads, moving from V. First, the light verb *v* attracts the lexical verb to adjoin it since it is affixal in nature. Second, the tense feature in T derives *v*-to-T movement, and so we account for the role of tense feature of *v*-to-T movement within Agree theory. Adger (2003) argues that *v* has an uninterpretable tense feature [*u* tense: ] which needs to be in an Agree relation, to value its uninterpretable feature. The T head has [tense: present/past] and can do the valuation operation. We could then take it that MSA has strong tense valuation which requires T to be filled by a lexical head, as assumed in 2.5.2. So, the *v*-to-T is derived in MSA as in the structure in (58a) and according to (58b):

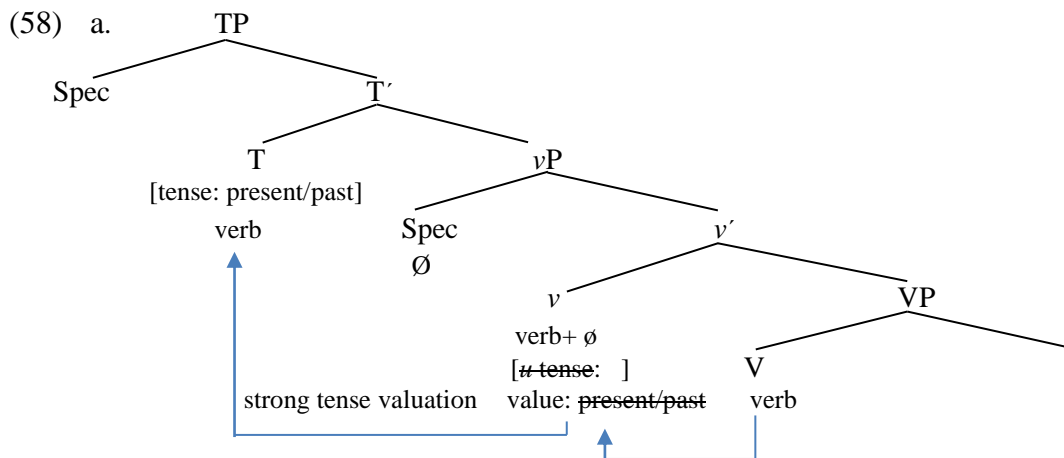

- b. Tense Feature Valuation: The [*u* tense] feature on *v* is valued as present or past as it appears on T and the lexical verb moves to T to satisfy the strong valuation of the tense feature.

It should be noticed that the valuation of tense feature in (58) shows that the goal T c-commands probe *v*. This contrasts to the requirements of Agree theory as in (55d) that a probe  $\alpha$  c-commands a goal  $\beta$ . Within minimalist approaches, there are two views of the direction of valuation in *u* feature agreement. First, in early assumptions of minimalism, the probe must c-command the goal which is now referred to as Upward Valuation (Lasnik & Saito 199; Den Dikken, 1995; Chomsky 2000; 2001; Polinsky & Potsdam 2001); see (59). Second, recent minimalist assumptions allow Downward Valuation where the goal c-commands the probe (Adger 2003; Koopman 2006; Merchant 2011; Zeijlstra 2012; Preminger & Polinsky 2015).

Preminger & Polinsky (2015) explain the direction of valuation in *u* feature agreement as Upward Valuation in (59a) and the Downward Valuation in (59b):

على النص الذي ترغب في أن يظهر هنا. 2.Heading خطأ! استخدم علامة التبويب "الصفحة الرئيسية" لتطبيق  
 على النص الذي ترغب في أن يظهر هنا. 2.Heading خطأ! استخدم علامة التبويب "الصفحة الرئيسية" لتطبيق

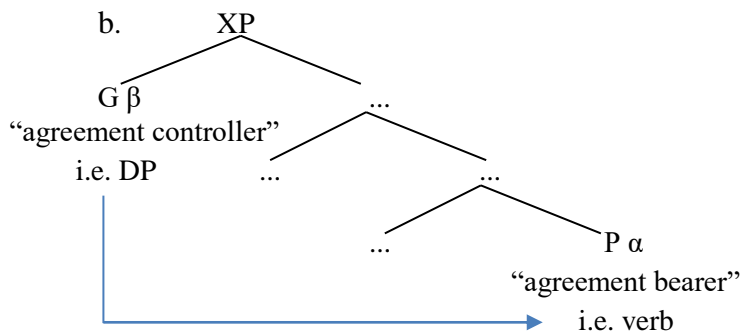
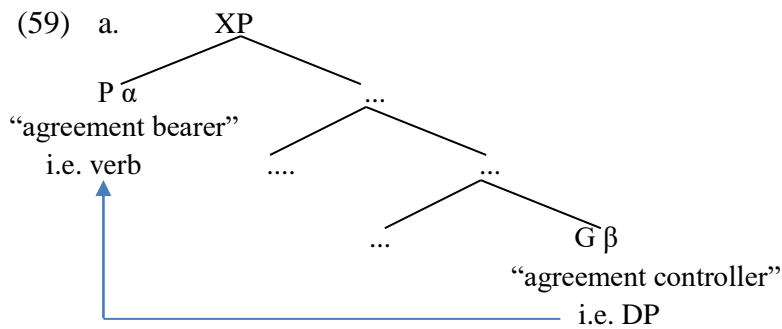

The tense feature is valued in MSA in (58) under Downward Valuation as in (59b). The P  $\nu$  is lower than the goal T that c-commands the probe  $\nu$  and the [tense: present/past] value is ‘transmitted’ downward from T to  $\nu$ .

Two more Agree relations can be found in MSA VSO order involving the functional heads T. The first Agree relation is for phi-features [Pers, Gen]. The T head have uninterpretable phi-features while DP subject is assumed to have interpretable phi-features. Therefore, the operation Agree take place between the functional head T which serve as an active probe with the following DP subject which serve as a goal. The matching interpretable phi-features are copied into a given functional head T.

Radford (2009: 260) assumes that a transitive verb in  $\nu$  agrees with its assignee object in phi-features, this sort of agreement, however, is visible in some languages such as Swahili which has over verb-object morphology and not visible in some languages such as English “in the sense that it has no overt phonetic manifestation”. I will not follow Radford assuming that

MSA has covert verb-object agreement/morphology as in English since there is no evidence shows verb could invisibly have agreement with the object in MSA.

The second Agree relation in MSA VSO order is with respect to case. Within minimalism, it has been claimed that case, is unvalued and has to be valued during the derivation via the Agree relation with a given functional head. Chomsky (2000; 2001), for example, assumes that the heads  $v$  and T are two functional heads assigning two different cases. While the head  $v$  is responsible for accusative case assignment to the DP object, the head T is responsible for the nominative case assignment to the DP subject.

However, the standard assumption of the Agree theory that the case is checked under agreement, mentioned above, does not hold for MSA. This condition states that an unvalued case feature can only be valued if there is phi-agreement with the case assigner which is not always the case in MSA. Two motivations in MSA support this decision. The first motivation comes from the observation of case valuation between the probe  $v$  head and the DP goal object, since case assignment is realized without phi-Agree between the verb and the assignee nominal object i.e., phi-agreement. The second motivation is with regard to subject case valuation in conjoined DP clauses with VSO order, since the probe head T has to assign the nominative case to the whole conjunct DP. The probe T, however, agrees in phi-features only with the first DP in the conjunction (FCA) as shown in 2.4.1 while the second conjunct DP is assigned nominative case without phi-agreement with the probe T. Consider the following schema that shows the absence of agreement between the probe T and the second conjunct DP and between the probe  $v$  and the DP object:



In order to maintain the activation condition between the probe and its goal as in (60), I will, instead, follow Chomsky (1981) and Adger (2003) who propose that the case assigner (i.e., T,  $v$ ), carries an uninterpretable unvalued feature encoding the relevant case of the assigner

while the DP goal carries an unvalued case feature that is valued via Agree. Consequently, I assume that each case feature and set of phi-agreement features is an independent probe on T. In other word, the case assignment is dissociated from phi-agreement.

Let us explain the Agree-based analysis of VSO clauses in MSA in more detail. For the phi-features valuation, the T is an active probe since it carries [*u* phi- Pers, Gen]. The DP subject is suitable goal for the probe T by virtue of carrying [phi Pers, Gen]. Since the verb probe and the goal subject have matching uninterpretable features, the operation of Agree is established. The [*u* phi Pers, Gen] of the probe verb are valued as a copy of their counterpart on the goal subject. The [phi Num] of the verb is not an active probe and takes [singular] value by default. For the case valuation, the *v* has an unvalued accusative case feature [*u* Acc] while the DP object has an unvalued case feature [*u* Case]. The probe T has an unvalued nominative case feature [*u* Nom] while the DP subject has an unvalued case feature [*u* Case]. Since the probes T and *v* and the goals (the subject and the object) have matching features, the Agree relation takes place. As a result, [*u* Acc] and [*u* Nom] features are valued and deleted, while the [*u* Case] feature on the subject and object DPs get valued as [Nom] and [Acc] respectively.

The phi-agreement and case assignment in MSA VSO clauses have the following valuations:

- (61) a. Phi-feature Valuation: The [*u* phi Pers, Gen] features on the probe T will be valued by a copy of their counterpart of the goal DP subject in Spec-*v*P while the *u* [phi Num] feature on the probe T will be valued [s] by default.
- b. Case Feature Valuation: The [*u* Nom] feature on the probe T values [*u* Case] of the goal (i.e. subject) as nominative while the [*u* Acc] features on the probe *v* values [*u* Case] of the goal (i.e. object) as accusative.

After the uninterpretable features are valued and deleted, they become inaccessible in the syntax and cannot be available for further feature valuation operations.

The following tree shows the operation of Agree in MSA VSO order:

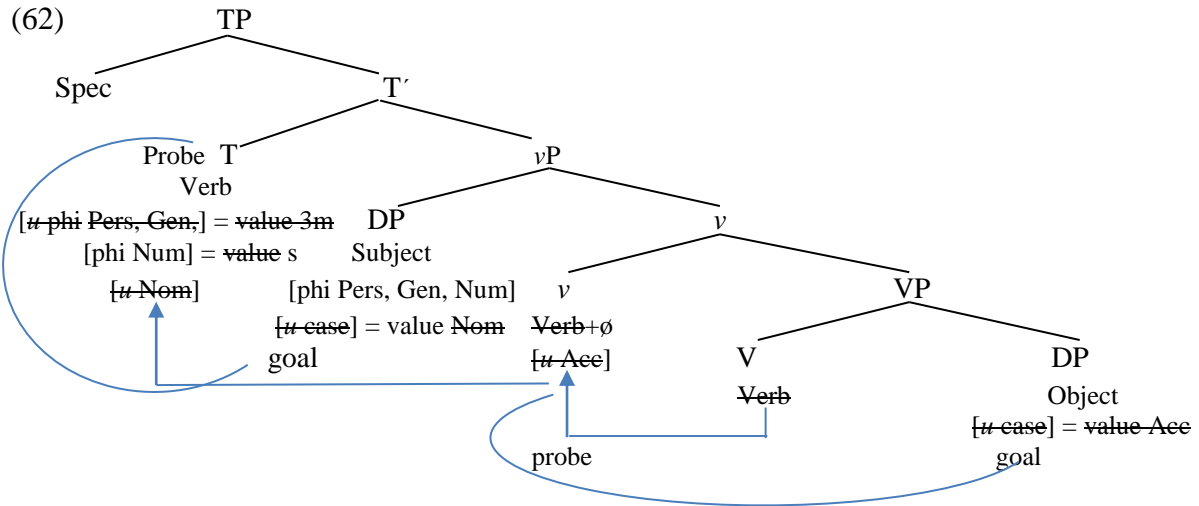

In the tree (61), the probe T does not carry the EPP feature in VSO order. VS order exhibits ‘partial agreement’ which does not include agreement of [Num], which must have the value [s] by default as we showed in 1.4.1. A consequence of the only partial phi-agreement is allowed between the probe on T and the goal in Spec-vP with respect to number, at least in VSO order, the subject is blocked from movement to Spec-TP. Therefore, T in VSO clauses in MSA does not carry an EPP feature. In fact, when T has the EPP feature it also has full agreement in MSA so a preverbal DP subject with only partial agreement from T will crash as in the following structure:

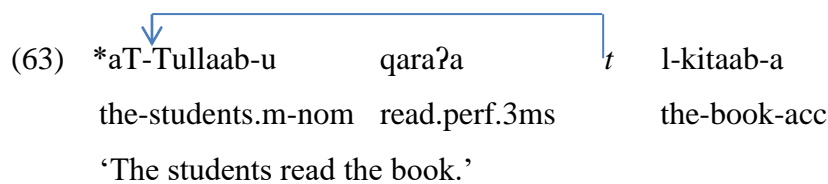

Since the verb ‘read’ spells out with ‘3ms’ features and not with ‘3mp’. Thus, (63) is ruled out since the subject ‘the students’ must remain below the verb to be consistent with the partial agreement pattern (VSO order), as T lacks the EPP feature.

Therefore, with the minimalist principles discussed above, there is something to be accounted for to block the preverbal DP with partial agreement on the verb in MSA. An explanation for

على النص الذي ترغب في أن يظهر هنا. 2.Heading خطأ! استخدم علامة التبويب "الصفحة الرئيسية" لتطبيق  
على النص الذي ترغب في أن يظهر هنا. 2.Heading خطأ! استخدم علامة التبويب "الصفحة الرئيسية" لتطبيق

---

this ungrammaticality is assumed by Chomsky (2001) who argued that the EPP feature can attract the subject to the specifier position only if it has a complete set [ $u$  phi-features Pers, Gen and Num] on T. However, VSO order occurs with incomplete [ $u$  phi-features] on T, without the [ $u$  phi Num], and so cannot attract the subject to be in its specifier as in the following:

- (64) The MSA partial agreement pattern has a T head which lacks an EPP feature due to incomplete  $u$  phi-features (no Number) and the subject then cannot move to Spec-TP.

Another alternative explanation for restricting the subject from movement to Spec-TP in VSO is by the implementation of the null expletive hypothesis which suggested by Mohammed (2000). The Spec-TP position in VSO order, according to him, is always filled by a default null *pro*, which must be overt in embedded clauses, as discussed in 2.4.2. This null *pro*, however, blocks the DP subject from being in Spec-TP. Therefore, the EPP feature does exist in VSO order in MSA, but it is satisfied by an expletive *pro*.

To put the analysis of the VSO clauses on a concrete footing, look at the example (65a) which has the simplified structure in (65b):

- (65) a. qaraʔa                      T-Tullaab-u                      l-kitaab-a  
           read.perf.3ms            the students-nom            the-book-acc  
           ‘The students read the book.’

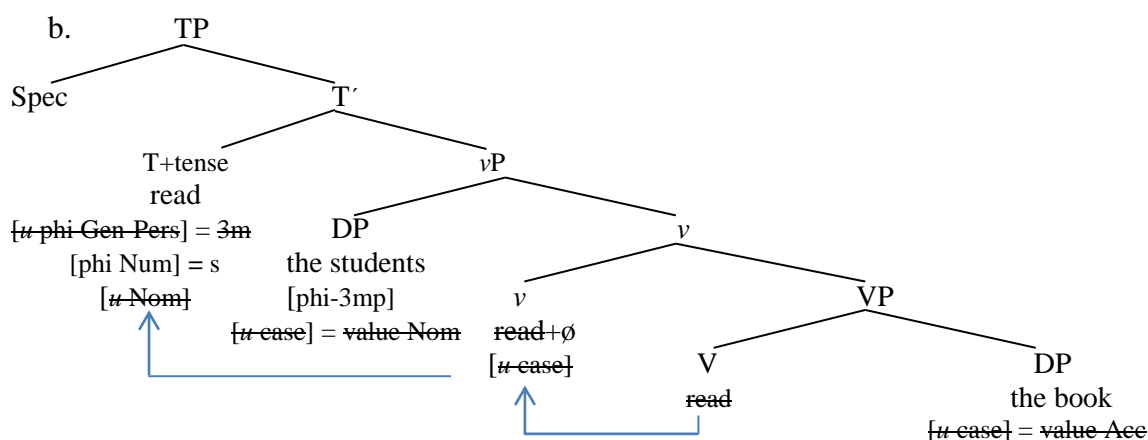

In (65b), the verb ‘read’ on T serves as probe searching for a local goal to value its [*u phi Pers, Gen*] features. The subject ‘the students’ is a suitable goal for the probe T ‘read’ since it carries [*phi 3mp*]. The verb ‘read’ in T c-commands the DP subject ‘the students’ and their features are matching. Thus, the Agree operation is established between the probe T ‘read’ and goal ‘the students’. By the Phi-features valuation rule in (61a), the [*Pers, Gen*] features on the probe ‘read’ in T get valued [*Per= 3, Gen= m*] with the values of the goal ‘the students’ and then delete. The verb ‘read’ on T and *v* heads are two probes carrying [*u Nom*] and [*u Acc*] features respectively while the DP subject ‘the student’ and DP object ‘the book’ are two goals by virtue of their [*u case*] features. By the Case Valuation in (61b), the [*u Acc*] feature on *v* is valued and deleted while [*u case*] on the object ‘the book’ valued as [*Acc*]. The [*u Nom*] feature on T is valued and deleted while [*u case*] on the subject ‘the students’ valued as [*Nom*]. The result of these operations of Agree is to produce a TP forming the VSO order ‘read.3ms students-Nom the book-Acc’ as (64a-b). The DP subject ‘the students’ is restricted to move to Spec-TP since T lacks a *u* [*Num*] feature, and so then it does not encode the EPP feature.

Recall that the conjoined DP structure triggers FCA pattern in VS order where the verb can only agree (partially) with the first conjunct subject while both the second and the full conjoined DP are blocked for agreement with the verb. I assume the operation of Agree into a conjoined DP in VS order with the following relation:



على النص الذي ترغب في أن يظهر هنا. 2.Heading خطأ! استخدم علامة التبويب "الصفحة الرئيسية" لتطبيق  
 على النص الذي ترغب في أن يظهر هنا. 2.Heading خطأ! استخدم علامة التبويب "الصفحة الرئيسية" لتطبيق

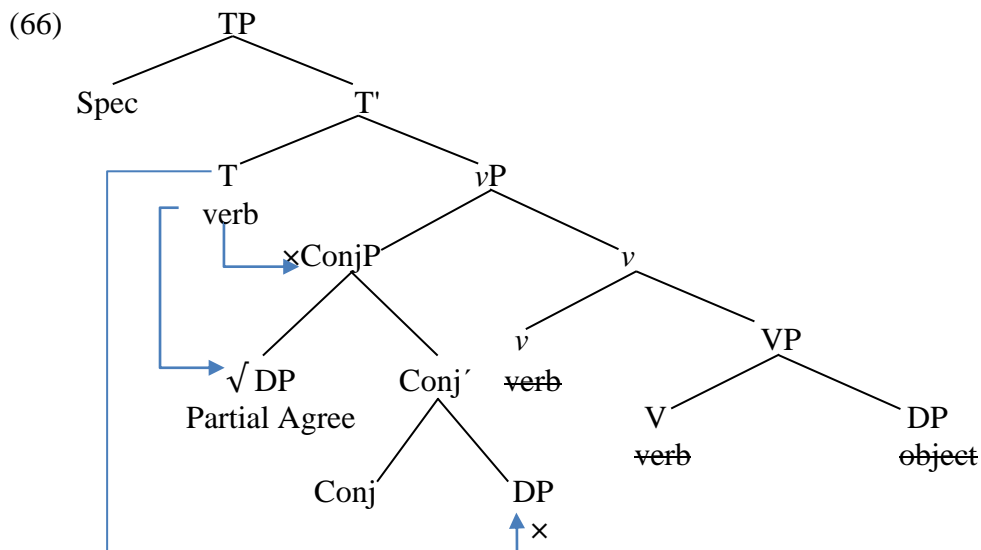

In the tree above, the head T is a probe for the entire conjoined DP which will get the [Nom] value, they are the first and the second conjunct DPs. The probe T, also, is active since it has [*u* phi Pers, Gen] features and is looking for an appropriate goal to value its *u* phi-features. In the domain of the probe T there are three potential goals and each one has a set of phi-features. The probe T can only have one potential goal which is the first conjunct DP which is located in the Spec-ConjP position. Neither the full conjunction nor the second coordinated DP can be a potential goal for the probe T. In such structure, the locality rules should be stated to explain the possible operation of Agree between one probe and multiple potential goals. Consider the Intervention Condition of Chomsky (2008) which is formulated below:

(67) Intervention Condition

Probe P cannot target goal G if there is some other visible goal of the same kind as G is intervening between the two and if the intervening goal is inactive for P.

(Radford 2009: 354)

The condition in (67) prevents the probe T from having the second conjunct DP as its goal as shown in the tree (66), since the second conjunct DP is asymmetrically c-commanded by the first conjunct DP (Munn 1993; Kayne 1994; Zoerner 1995). However, the Intervention Condition does not prohibit the Agree relation between the probe T and the goal full ConjP or

the first coordinated DP. That is because the full conjunction does not c-command the first conjoined DP and the converse is true, then they are equally at the same distance for the Agree relation to the probe T with respect the condition (67). However, there is a contrast between the first conjunct and the full conjunct ConjP as shown in tree (66) since only the first DP can be a goal for the probe T while full conjunction is barred from this relation. Therefore, the Intervention Condition in (67) cannot fully account for FCA in VSO order in MSA.

Soltan (2007) accounts for the unacceptability of the probe head T to take the full conjunction DPs or the second conjunct DP as its goal by the Late Merge hypothesis. His analysis builds on the assumption that adjuncts can post-cyclically merge as suggested by many (Lebeaux 1988; Chomsky 1993; Uriagereka 2002). According to him, the post-cyclical Merge could explain the agreement of verb either with the first conjunct DP subject or with full conjunction DPs. Whereas the agreement with first DP conjunct is a result of the second coordinated DP being late merged after the operation of Agree as in (68a), the agreement with full conjunction DP, however, results from the second conjunct DP being early merged before the operation of Agree as (68b):

- (68) a.  $[_{TP} [_{T'} [_{T} \text{Probe}] [_{VP} [_{ConjP} \text{DP Goal}] [_{Conj'} \dots \text{Late Merge} \Rightarrow [_{Conj'} [_{Conj} \text{DP}] [_{V'} [_{V}]]]]]]]$
- b.  $[_{TP} [_{T'} [_{T} \text{Probe}] [_{VP} [_{ConjP} \text{DP Goal}] [_{Conj'} [_{Conj} \text{DP Goal}] [_{V'} [_{V}]]]]]] \text{ Early Merged}$

As a result, the FCA in MSA with VS order can be accounted with the Late Merge analysis as represented as in (68a). The probe T and can only get the first conjunct DP as a goal while the second conjunct DP merges after Agree takes place, so then it is not possible for it to be a goal for the probe T. However, MSA is not consistent with the Early Merge analysis as in (68b) with VS order, since the probe is prohibited from agreeing with the full conjoined DP, even though that whole DP is valued with Nominative case.

A theoretical problem can be raised with Late Merge analysis is that late merged elements cannot include a position where the subject assigned the case i.e. Spec-*v*P (see Stanton 2016 for more details). Therefore, I will not adopt the Late Merge analysis here to explain the FCA construction in MSA.

In fact, the FCA construction under our analyses of phi-agreement in VSO order should not be so problematic. Before we explain this, it is important to remember one syntactic fact and one analysis. The fact is that in conjunction clause with a group of mixed genders the verb can agree with first conjunct DP or else it shows a default masculine agreement as in (10b). The analysis is that T in VSO order is valued for number as [s] only regardless of the number of the first or full conjunction DP. However, the gender and person of the probe T are unvalued and they must value these features. To derive the analysis of MSA FCA via the Intervention Condition which allows T to agree only with first DP or full DP, I assume that the probe T [*u* phi Gen, Pers] can be valued only by the matching features on the goal. The first conjunct DP is a suitable goal since it carries matched interpretable feature [Per, Gen] while the full conjunction DP is not always specified for Gender and Person, but Number only, particularly, when the first and second conjunct DPs are mismatched in gender. Consider the following example, where the conjoined subject appears postverbally with mismatched gender as shown in (69):

- (69) a. qaraʔat/\*a/\*uu            T-Taalibaat-u            wa T-Tullaab-u            l-kitaab-a  
           read.perf.3fs/3ms/3mp    the-students.f-nom and the-students.m-nom    the-book-acc  
           ‘The students (female) and the students (male) read the book.’

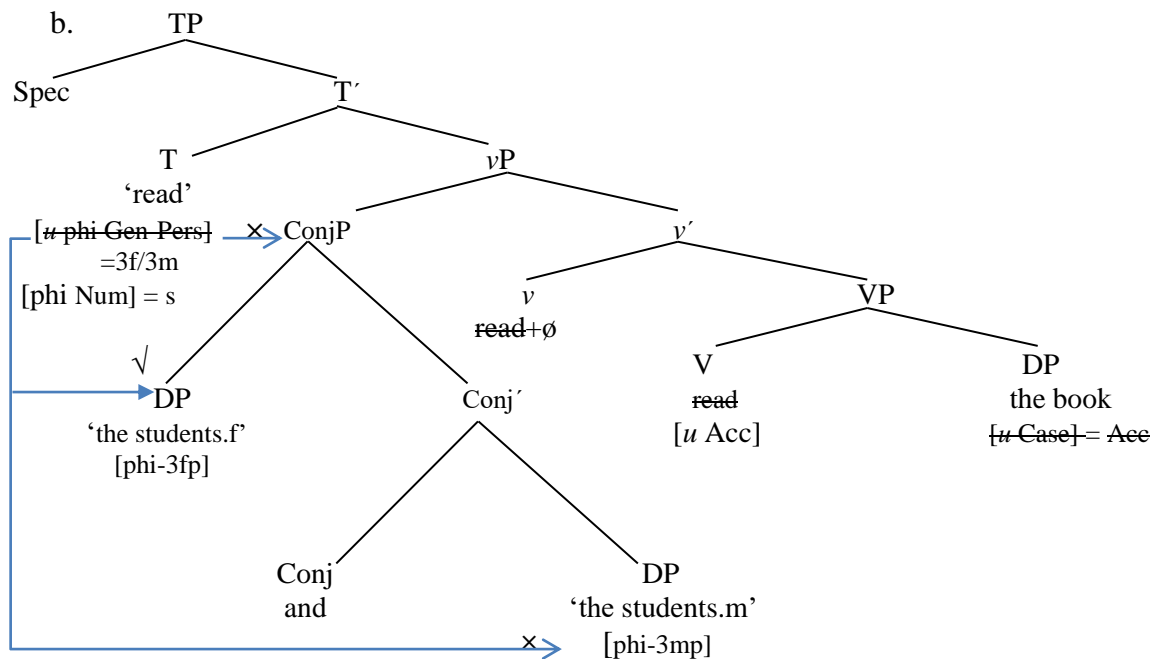

In (69b), the probe T 'read' serves as active probe by virtue of having  $[u \text{ phi Per, Gen}]$  and looks for a goal which can value its uninterpretable features. According to the Intervention Condition in (67), the probe T 'read' can agree with the first conjunct DP or the full conjunct DPs while the second conjunct DP is not available. Therefore, the probe T 'read' can agree with first conjunct DP 'the students.f' and shows '3fp'. The probe T 'read', however, cannot agree with the full ConjP since it is not specified for gender by having mismatched genders (masculine for the first DP and feminine for the second DP). Hence, the ConjP lacks matched features for the probe T 'read'. In addition to the FCA, the probe T can also show default features '3ms' when there is a group of mixed genders.

Now we look at verb-subject agreement in the mixed agreement pattern. Having a subject agreeing with two verbs shows the multiple agreement construction where one verb precedes the subject with partial agreement features and other verb follows the subject with full agreement features. Look at the example in (70a) which has the structure in (70b):

على النص الذي ترغب في أن يظهر هنا. 2.Heading خطأ! استخدم علامة التبويب "الصفحة الرئيسية" لتطبيق  
 على النص الذي ترغب في أن يظهر هنا. 2.Heading خطأ! استخدم علامة التبويب "الصفحة الرئيسية" لتطبيق

- (70) a. kaana/\*uu                    T-Tullaab-u                    ya-qraʔuuna/u\*                    l-kitab-a  
           was.perf.3ms/3mp    the-students.m-nom    3m-read.imperf.p/\*s    the-book-acc  
           ‘The students were reading the book.’

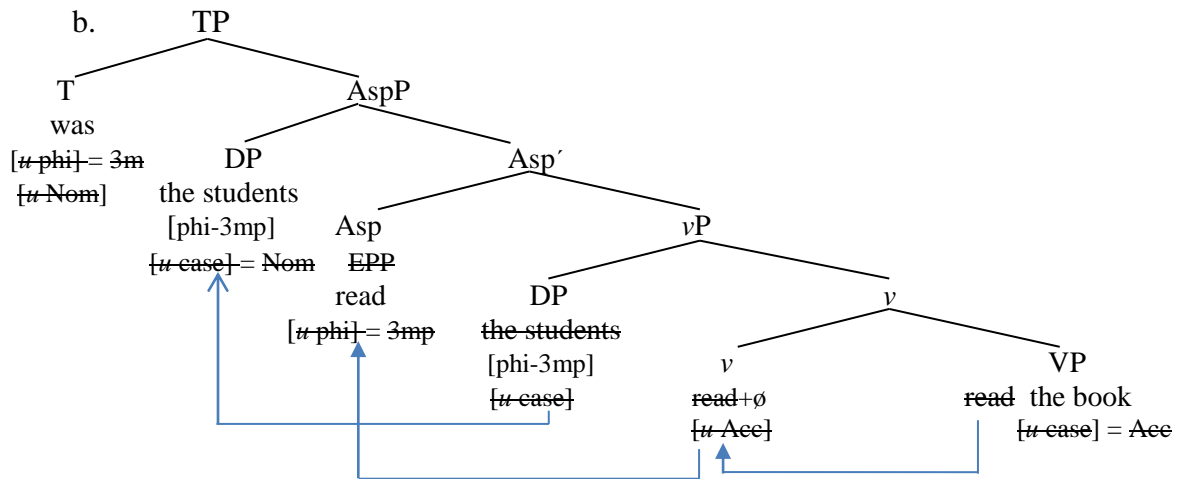

Both T and Asp enter the derivations carrying [u phi]. The Asp has an EPP feature since it has a complete set of phi features [Per, Gen and Num]. Therefore, the DP subject ‘the students’ moves to Spec-AspP to satisfy the EPP feature and displays the full agreement pattern with the finite verb ‘read.3mp’ in the Asp head. The DP subject ‘the students’ there values its [u Case] feature from the [u Nom] feature on the probe T. The T head, however, lacks an EPP feature since it has an incomplete set of phi-features [Pers and Gen] but not [Num]. The subject DP, therefore, cannot move to Spec-TP and can only show partial agreement with the auxiliary verb ‘was.3ms’ (see Ouali 2014 for more details).

Now consider the example (71a) with Aux > ConjP subject > finite verb > object order which has the structure in (71b):

- (71) a. kanna/\*aa                    T-Taalib-u                    wa                    T-Taalibat-u  
           was.perf.3ms/\*3d    the-student.m-nom    and                    the-student-f-nom  
           ya-qraʔaa/ \*a                    l-kitaab-a                    kull-a                    yawm-in  
           3m-read.imperf.d/ \*s    the-book-acc                    every-acc                    day-gen  
           ‘The student (male) and the student (female) were reading the book every day.’

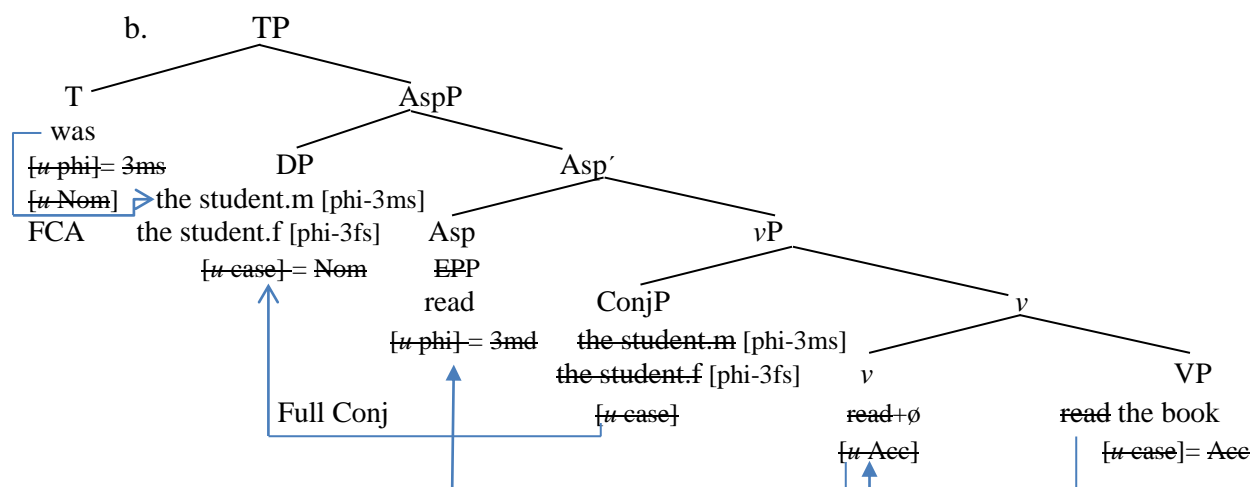

In (71b), since Asp has an EPP feature and the verb ‘read’ has full phi-features the conjoined DP is required to move to Spec-AspP. The Agree relation must be established between the probe Asp ‘read’ and the full ConjP as a possible goal. The T ‘was.3ms’, however, has partial FCA with the first DP ‘the student.m’. The second DP ‘the student.f’ is not an appropriate goal for the probe ‘was’ as it is c-commanded by the first DP ‘the student.m’. The full conjunct DP also is not an appropriate goal for the probe T since as it lacks matched interpretable features [Gen, Pers]. The goal ‘the student.m’ cannot be attracted by the T ‘was’ since it does not have full phi-features and movement of the first conjunct DP only would violate the Coordinate Structure Constraint.

#### 2.7.4 The analysis of SVO order in MSA

As I explained 2.6.3, an overt subject cannot be in preverbal position since it is restricted against moving to Spec-TP for a number of reasons, while a *pro* subject is licensed only in Spec-TP in SVO or null clauses. The initial DP, however, is a topic rather than a subject, and occupies a left periphery position (in Spec-CP or Spec of some other functional projection). In addition, I showed that the initial DP topic is co-referential with a *pro* subject in Spec-TP, which is responsible for the full agreement features with the verb.

The difference of SVO from VSO order is that T carries EPP, so the T has a complete set of [*u phi* Per, Gen and Num], and the *pro* subject then moves to Spec-TP to display full agreement pattern with the following verb in SVO order in null subject clauses.

- (72) a. aT-Tullaab-u      qaraʔuu      l-kitaab-a  
 the-students-nom    read.perf.3mp    the-book-acc  
 ‘The students read the book.’

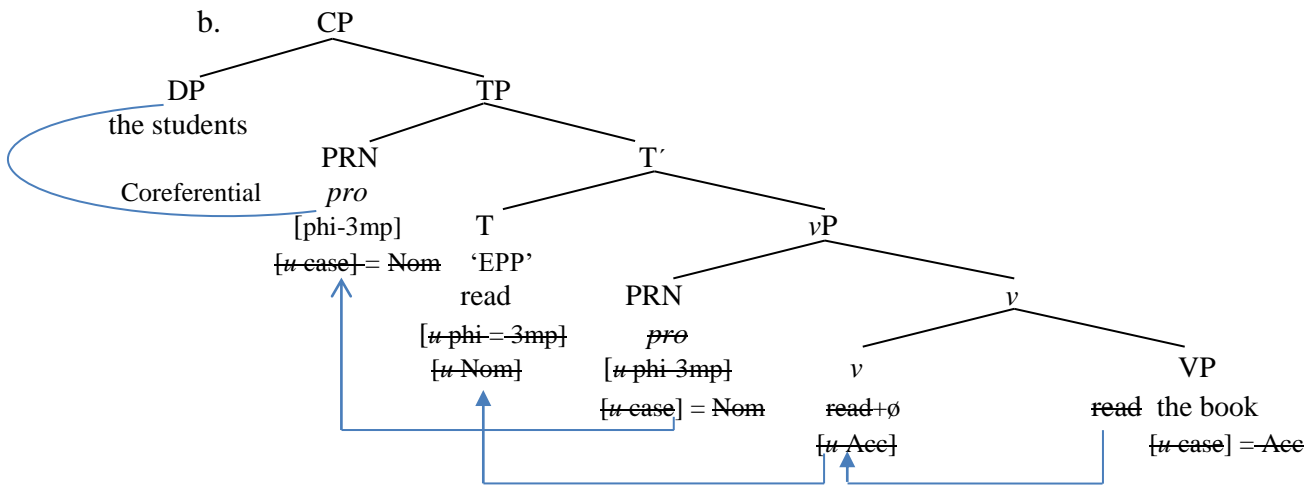

In (72b), the verb ‘read’ moves to the T position, and the initial DP ‘the students’ is a base generated topic in Spec-CP. The T ‘read’ is an active probe looking for a goal to value the [*u phi* Pers, Gen, and Num]. The *pro* subject is a suitable goal as it has [*phi* 3mp]. Since the probe ‘read’ and the goal *pro* match in features, a copy of the phi of goal *pro* is move to the probe ‘read’ with respect to Phi-feature Valuation in (61a). The *pro* subject assigned nominative case by the Case Valuation rule in (61b). The EPP feature enables T ‘read’ to attract the *pro* to be its subject and move to Spec-TP since it has a complete set of phi-features including number. As a result, the *pro* subject with the verb ‘read’ forms (invisible) SV order and displays full agreement features. Through co-indexing the topic ‘the students’ with *pro* in spec-TP, the topic will have a co-referential relation with *pro* since the topic has its own set of features and *pro* has identical agreement features. I will delay the discussion of case assignment to the preverbal DP e.g. ‘the students’ in SVO to Chapter 4.

In summary, for SVO, the T head has an EPP feature and full phi agreement features, and a pro subject moves up to Spec-TP after Agree has taken place. The overt subject is a base-generated topic higher in the structure.

For the conjoined DP subject in SVO order, consider (11) repeated below in (73a) which has the structure in (73b):

- (73) a. aT-Taalib-u            wa    T-Taalibat-u            qaraʔaa/\*a/\*at            l-kitaab-a  
           the-student.m-nom    and    the-student.f-nom    read.perf.3d/3ms/3fs    the-book-acc  
           ‘The student (male) and the student (female) read the book.’

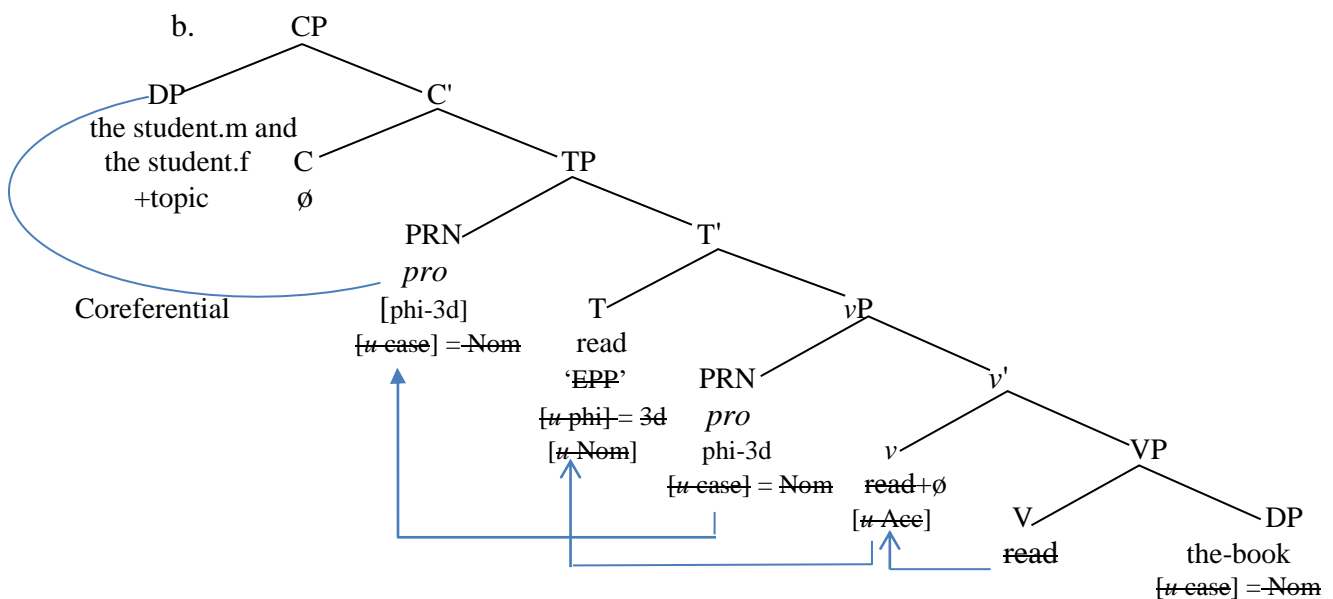

With an auxiliary in SVO order as in (13b) repeated in (74a), it has the structure in (74b):

- (74) a. aT-Tullaab-u            wa    T-Taalibaat-u            kaanuu/\*a            ya-qraʔuuna/\*u  
           the-students.m-nom    and    the-students.f-nom    were.perf.3mp/3ms    3m-read.imperf.p/s  
           l-kitaab-a            kull-a            yawm-in  
           the-book-acc    every-acc    day-gen  
           ‘The students (male) and the students (female) were reading the book every day.’



على النص الذي ترغب في أن يظهر هنا. 2.Heading خطأ! استخدم علامة التبويب "الصفحة الرئيسية" لتطبيق  
على النص الذي ترغب في أن يظهر هنا. 2.Heading خطأ! استخدم علامة التبويب "الصفحة الرئيسية" لتطبيق

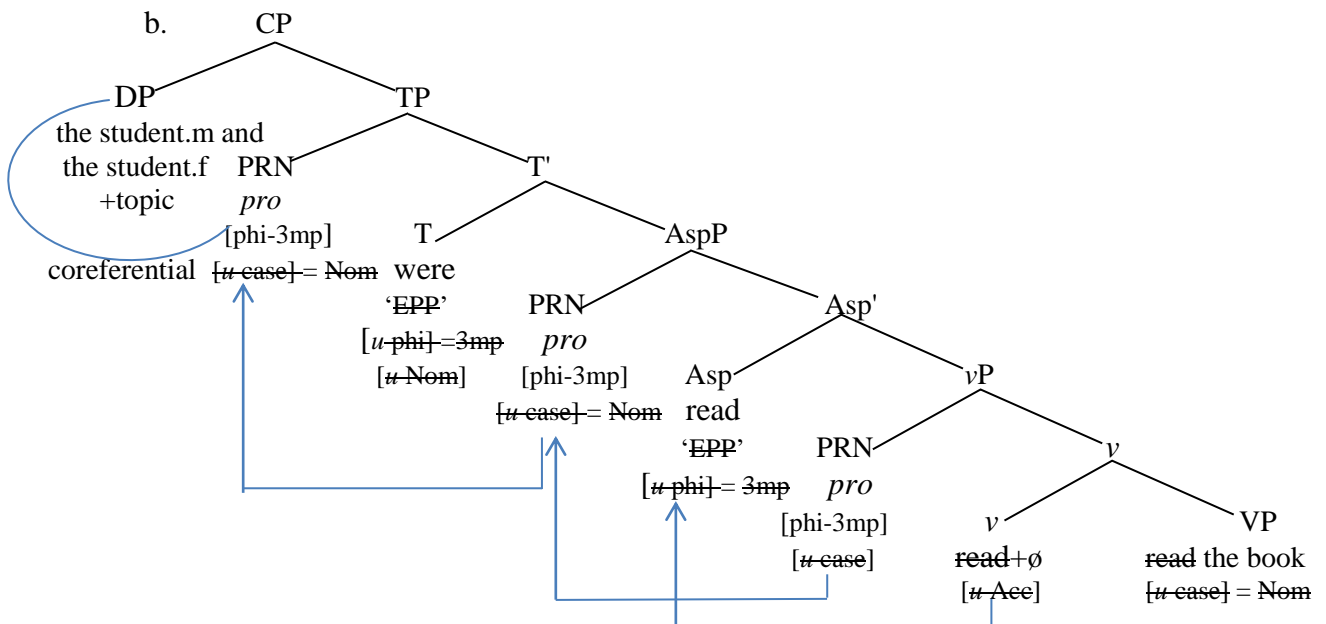

Here the same properties that I have shown for T hold for Asp. Both Asp and T have full agreement features and an EPP feature, and a strong V feature, so when the verb moves there it shows full agreement. Additionally, the *pro* subject moves to Spec-AspP as well as to Spec-TP to check the EPP feature on Asp and T heads.

## 2.8 Tabuki Arabic and its main grammatical features

### 2.8.1 Overview

The clause structure in Tabuki Arabic (TA), as well as most modern Arabic dialects, has different properties from those in MSA. In this section, I will show the main grammatical features of TA in six subsections. In the second section, I introduce the TA dialect and its speakers. In the third section, I explain the morphology in TA including the agreement features. In the fourth section, I show that TA is lacking to the definiteness condition and the adjacency-condition between focus and the verb. In the fifth section, the constituent orders will be outlined, and in the sixth section, the basic constituent order will be identified.

### 2.8.2 TA dialect and its speakers

Tabuki is a dialect spoken primarily by people in the northwest region of the Arabian Peninsula. According to the 2010 population census, in Tabuk City alone, approximately 900,000 people speak the dialect; other surrounding towns have between 250,000 and 300,000 speakers. Since MSA is used as a form of communication and education in these areas, and no previous descriptive work has been done on this dialect, it is considered an undocumented dialect. The data used in this thesis were not derived from any particular written source. The author is a native speaker of the dialect who was born, raised and educated in Tabuk; he and his family, along with other speakers of the dialect, served as the main sources of the data. This section provides an introduction to Tabuki clause structure and identifies the key new data and the analysis which is novel to this work.

### 2.8.3 Agreement and morphology in TA

Arabic varieties have simpler morphological features in the system than MSA, and this includes TA as well. Some of the morphological features in MSA are lost in TA. The DPs, for instance, do not have overt case marking and the verb does not appear with overt mood marking. TA, however, still shows some features of morphology. For example, the verb in TA, similar to MSA, can be perfect/past carrying suffixes on the root of the verb or imperfect/present carrying prefixes on the root of the verb. These suffixes and prefixes are determined with respect to person, gender, and number features. Additionally, both types of personal pronouns exist in TA: independent (strong) and dependent (weak) in TA.

The agreement inflections in TA, as well as most modern Arabic dialects, have a different system from MSA. Remember that the verb has to show full agreement features in [Pers, Gen and Num] with the subject in SVO order, while it has to show partial agreement features in [Pers and Gen] with the subject only in VSO order, in MSA. TA, however, does not have this agreement asymmetry. The verb always shows full agreement in [Pers, Gen and Num] irrespective of the subject's position while partial agreement is not possible. The lack of

على النص الذي ترغب في أن يظهر هنا. Heading 2 خطأ! استخدم علامة التبويب "الصفحة الرئيسية" لتطبيق  
 على النص الذي ترغب في أن يظهر هنا. Heading 2 خطأ! استخدم علامة التبويب "الصفحة الرئيسية" لتطبيق

agreement asymmetry is assumed by many Arabic scholars for different varieties of Arabic including Fassi Fehri (1993) for Moroccan; Aoun et al. (1994) for Lebanese; Mohammed (2000) for Palestinian and Mahfoudhi (2002) for Tunisian.

Consider the agreement in TA as in the following examples (Agreement features are bold):

- (75) a. af-fabaab    **jauu**                      l-l-bayt                      (SV)  
           the-guys    came.perf.3mp            to-the house  
           ‘The guys came to the house.’
- b. **jauu**                      f-fabaab                      l-l-bayt                      (VS)  
           came.perf.3mp    the-guys                      to-the house  
           ‘The guys came to the house.’
- c. \*af-fabaab    **jaa**                      l-l-bayt                      (VS)  
           the-guys            came.perf.3ms            to-the house  
           ‘The guys came to the house.’
- d. \***jaa**                      f-fabaab                      l-l-bayt                      (SV)  
           came.perf.3ms    the-guys                      to-the house  
           ‘The guys came to the house.’

In (75a-b), the verb *jauu* ‘came.3mp’ agrees fully with the subject ‘the guys.m’ in SV order or in VS orders respectively. Therefore, (75a-b) are grammatical. In (75c-d), in contrast, the verb appears agreeing only partially with the subject as *jaa* ‘came.3ms’. Therefore, (75c-d) are ungrammatical.

The auxiliary verb also has only full the agreement pattern. The auxiliary verb always precedes the finite verb while the subject either can precede the verb auxiliary as in (76a), or it occurs between the auxiliary and main verb as in (76b):

- (76) a. kaanuu                ʃ-fabaab    ya-lʕabuu                kuura                                (SVO)  
          were.perf.3mp    the-guys    3m-play.imperf.p    football  
          ‘The guys were playing football.’
- b. aʃ-fabaab    kaanuu                ya-lʕabuu                kuura                                (SVO)  
          the-guys        were.perf.3mp    3m-play.imperf.p    football  
          ‘The guys were playing football.’

As result, TA has only one pattern of agreement regarding verb-subject agreement, which is full agreement.

#### 2.8.4 The lack of definiteness and adjacency condition

Like MSA, TA allows the initial position to be occupied by either definite DP as in (77a) or a specific indefinite DP as in (77b). TA, though, in contrast to MSA, also allows the initial position to be occupied by pure indefinite DP as (77c):

- (77) a. ar-riɖɖʒaal        waSal  
          the-man                arrived.perf.3ms  
          ‘The man has arrived.’
- b. riɖɖʒaal        Gariib                waSal  
          man                strange                arrived.perf.3ms  
          ‘A stranger man has arrived.’
- c. riɖɖʒaal        waSal  
          man                arrived.perf3ms  
          ‘A man has arrived.’

In (77a), the definite DP ‘the man’ occupies the initial position; in (77b), the specific indefinite DP ‘a strange man’ occupies the initial position. In (77c), the indefinite DP ‘a man’ in (77c) occupies the initial position.



d. kuura      ya-lʕabuu      ʃ-ʃabaab      (OVS)  
 football      3m-play.imperf.p      the-guys  
 ‘It is football that the guys play.’

e. aʃ-ʃabaab      kuura      ya-lʕabuu      (SOV)  
 the-guys      football      3m-play.imperf.p  
 ‘The guys play football.’

f. ya-lʕabuu      kuura      ʃ-ʃabaab  
 (VOS)  
 3m-play.imperf.p      football      the-guys  
 ‘The guys play football.’

Examples (79a-f) raise several questions. How are these clauses derived? What are the positions of the verb and subject in each of those clauses? The following sections answer these questions by examining each constituent order shown above.

### 2.8.6 Basic constituent order

It is widely assumed that SVO is the unmarked word order across Arabic varieties while VSO order is the alternative order, in contrast to MSA. This includes Lebanese (Aoun et al. 1994) Palestinian (Shlonsky 1997; Mohammed 2000), Egyptian (Benmamoun 2000b), Tunisian (Mahfoudhi 2002) and Moroccan (Fassi Fehri 1993). In TA, although the sentences in (79a-f) show constituent order variation, I will argue that SVO order is the basic order while VSO order is derived as most other Arabic varieties show. My assumption depends on the distributional observations of SVO order in TA clauses. For example, both Comp particles in TA *ʔinn* or *ʔin* require SVO order while VSO order is prohibited, since the verb cannot immediately be preceded by the Comp particles. A DP has to follow the complementizer and then possibly be followed by the verb. Consider the following examples:

على النص الذي ترغب في أن يظهر هنا. Heading 2 خطأ! استخدم علامة التبويب "الصفحة الرئيسية" لتطبيق  
 على النص الذي ترغب في أن يظهر هنا. Heading 2 خطأ! استخدم علامة التبويب "الصفحة الرئيسية" لتطبيق

- (80) a. saalem y-quul                   ʔinn/ʔin   ʃ-ʃabaab   ya-lʃabuu           l-kuura  
 Salem   3m-say.imperf.s   that           the-guys   3m-play.imperf.p   the-football  
 ‘Salem says that the guys are playing football.’
- b. \*ʕaliyy y-quul                   ʔinn/ʔin   ya-lʃabuu           ʃ-ʃabaab           l-kuura  
 Ali       3m-say.imperf.s   that           3m-play.imperf.p   the-guys       the-football  
 ‘Ali says that the guys are playing football.’

The example in (80a) is acceptable since the Comp *ʔinn/ʔin* ‘that’ is followed by the subject DP ‘the guys’ while the verb ‘play’ occurs following the DP subject ‘guys’. In (80b), however, the verb ‘play’ immediately follows the Comp *ʔinn/ʔin* ‘that’ forming VSO order, and the example is ungrammatical. To further support the fact that VSO order is not a possible order in embedded clauses, the Comp *ʔan* ‘that’, which is exclusively used to introduce verbal clauses in MSA and some modern Arabic dialects, does not exist in TA.

The following schemas show the possible constituent orders in TA embedded clauses:

- (81) a. ... [Comp + DP Subject + V]  
 b. ... \*[Comp + V + DP Subject]

The SV is the neutral order in TA not only in declarative clauses, but also in questioned clauses. In *wh*-constructions, both VS and SV order are equally possible. However, a yes-no question clause in TA is typically formed on a declarative SV order with a rising pitch and no question particle. This fashion of yes-no question is found in some languages, such as spoken French (Cheng and Rooryck 2000). Consider the following as a TA yes-no question example:

- (82) aʃ-ʃabaab  (rising pitch)   ya-lʃabuu           l-kuura   l-yuum           (SVO)  
 the-guys                                   3m-play.imperf.p   the-football   to-day  
 ‘Are the guys playing football today?’

In (82), the yes-no question in TA is constructed in SVO order with the DP subject having rising pitch in the clause-initial position.

## 2.9 The derivations of SVO and VSO clauses

In this section, the derivation of SVO and VSO clauses is discussed with respect to Agree-based theory. As discussed in MSA, verbs must overtly move to T, since they always appear to the left of adverbs and overt subjects cannot move to Spec-TP, but only *pro*. An initial DP is best considered to be a topic rather than a real subject. However, these analyses cannot be extended to TA; both VSO and SVO order, I assume, are derived with different derivational structures from MSA.

For SVO order which is the basic constituent order in TA, we could assume that the verb, on the one hand, needs to move out of VP to the T position to check the strong tense feature. The subject, on the other hand, merges in Spec-VP and then moves to Spec-TP motivated by the EPP feature. Consider the following TA clausal structure in SVO order:

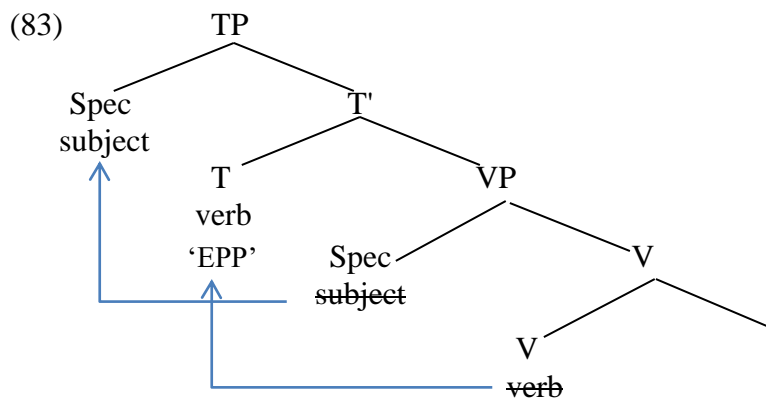

As it can be seen in (83) that the SVO order is the underlying structure for TA as is the case in MSA. Whereas verb only moves to T to produce the unmarked VSO order in MSA, both verb and subject move to TP to produce the unmarked SVO order in TA.



على النص الذي ترغب في أن يظهر هنا. 2.Heading خطأ! استخدم علامة التبويب "الصفحة الرئيسية" لتطبيق  
 على النص الذي ترغب في أن يظهر هنا. 2.Heading خطأ! استخدم علامة التبويب "الصفحة الرئيسية" لتطبيق

The verb and subject positions in SVO order in TA need to be defined whether verb and subject undergo movement to T and Spec-TP positions respectively or may remain in their base positions, since both possibilities still form SVO order. With regard to the VP-adverb e.g., *bhmaas* ‘excitingly’ in TA, both subject and verb occur to the left of the adverb as the following examples:

- (84) *af-fabaab ya-lfabuu bhmaas kuura* (SVO)  
 the-guys 3m-play.imperf.p excitingly football  
 ‘The guys play excitingly football.’

The subject ‘the guys’ and the verb ‘play’ appears preceding the VP-adverb *bhmaas* ‘excitingly’. The verb and the subject, therefore, are outside VP. The verb ‘play’ moves to T via Asp to check the tense feature. The subject ‘the guys’ moves to Spec-TP via Spec-AspP to check the EPP feature on T as in the following tree:

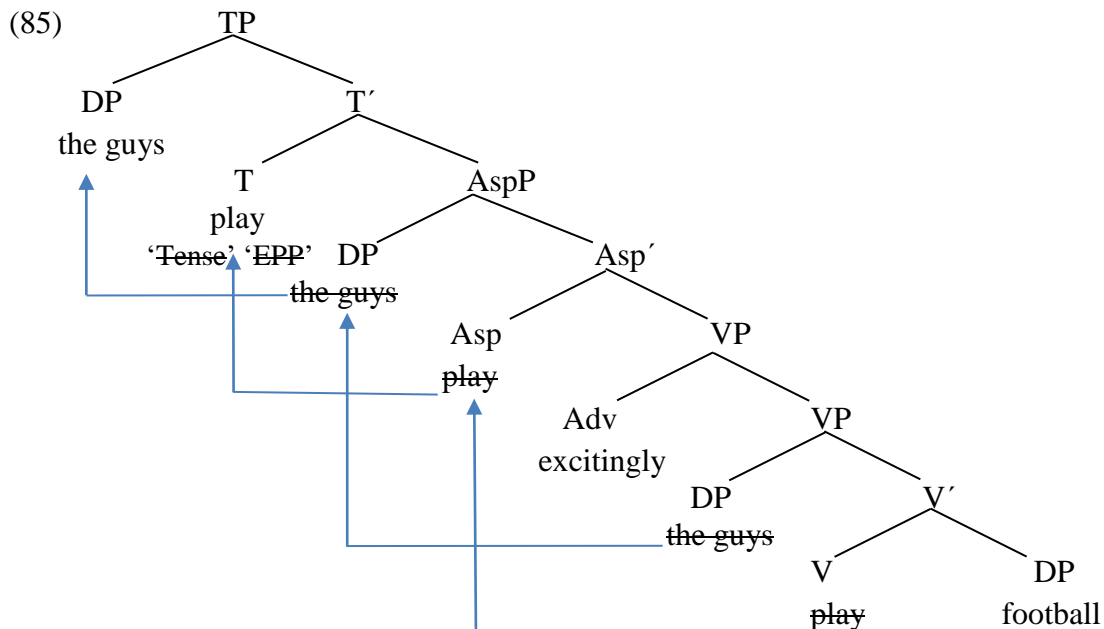

Adopting this analysis requires the subject to move to Spec-TP, which is a crucial difference from MSA where it can be shown that only a topic interpretation is available to the preverbal DP. The assumption that the overt subject in TA undergoes movement to Spec-TP

is built on several observations about the syntactic behaviour of subject DP in TA. In fact, most of the restrictions that prevent the subject DP from being preverbal in Spec-TP in MSA do not apply in TA. One of the obstacles constraining the subject from being preverbal in MSA is the agreement asymmetry, since the subject cannot be preverbal when the verb shows partial agreement. However, TA lacks this agreement asymmetry as shown in (75), since full agreement must be applied in all verbal clauses in either SV or VS orders. Thus, the subject position is not significant for agreement licensing as it is in MSA TA. Furthermore, the definiteness condition is not operative in the initial position of TA clausal structure as in (77a-c). As a result, no subject is prohibited from being preverbal including a pure indefinite subject DP. The adjacency requirement also is optional in focused clauses in TA, and SV is possible in focused clauses as in (78b). Thus, I assume that T attracts the subject to be in its specifier as shown in (83-85). Consequently, the T is always having complete phi-features [Pers, Gen and Num]. I will continue the discussion of the interpretation to preverbal DP subject in TA in the following section.

The VSO order, however, is derived by raising the verb again higher than the subject into a position above TP. For MSA, the FP projection has been suggested to occupy the position between TP and CP for different syntactic purposes. Aoun et al. (1994) assume FP for the verb to give T-to-F movement to derive VSO in the partial agreement pattern in MSA that involves the Agreement Loss approach as discussed in 2.4.2. Ouhalla (1994b), however, assumes FP in MSA where the F head feature can be identified by a focus fronted phrase or wh-phrase in focus clauses. Ouhalla assumes that the F head feature can also be identified by merging a head carrying [+f] on F head. This can be shown when the verb has to be adjacent the focus phrase. In TA, I propose that the verb initial order is by raising the verb from T over the subject to the F head of FP to identify [+V] feature and produce VSO order as the following tree shows:

على النص الذي ترغب في أن يظهر هنا. 2.Heading خطأ! استخدم علامة التبويب "الصفحة الرئيسية" لتطبيق  
على النص الذي ترغب في أن يظهر هنا. 2.Heading خطأ! استخدم علامة التبويب "الصفحة الرئيسية" لتطبيق

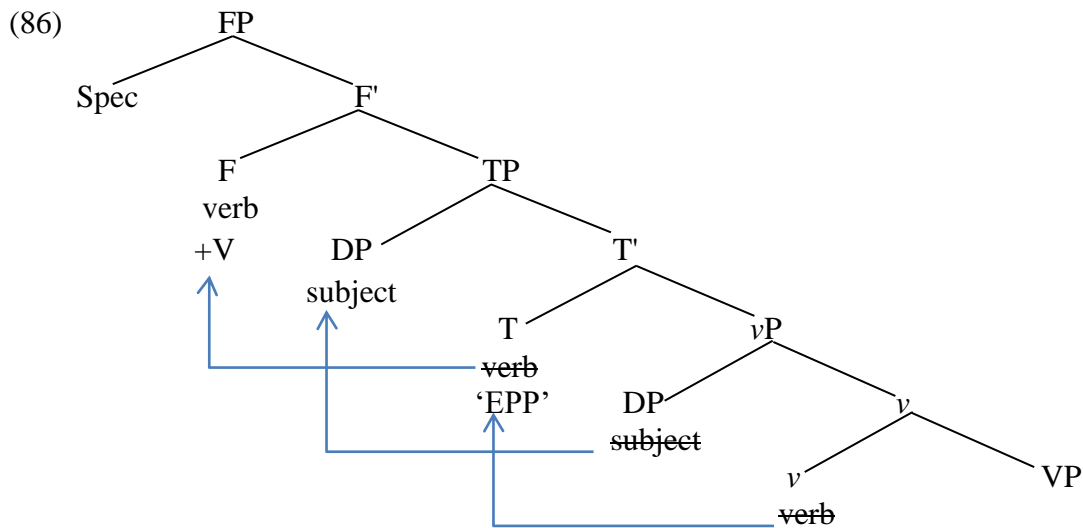

The verb can be blocked from moving over the subject producing VSO order in two cases. First, in embedded clauses, since Comp in TA is required to be followed by DP. Following MSA, the Comp particles in TA are based in the C head, and the Comp system of TA will be investigated in details in Chapter 5. Second, when F can be filled by an auxiliary verb and the finite verb then does not move higher than T. Later in the thesis, I will propose that FP is FinP (Rizzi 1997).

## 2.10 The preverbal DP subject in TA

In SVO order, the clause-initial position in TA can be occupied by a variety of DPs with different characteristics, such as a definite DP subject, a specific indefinite DP subject and a pure indefinite DP subject. To account for these elements in terms of their functions and position I argue for the following proposal. The DP phrase that is related to a resumptive can only be interpreted as a left dislocated property whether it is definite or specific indefinite as in (87a-b):

- (87) a. **as-sayyaarah** Saalih    ?ʃtaraa-h  
the-car                    Salih            bought.3ms-it  
‘The car, Saleh bought it.’

- b. **sayyaarah** jidiidah Saaliḥ ʔʃtaraa-**haa**  
 a car new Salih bought.3ms  
 ‘A new car, Saleh bought it.’

The definite DP ‘the car’ in (87a) and the specific undefined DP ‘a new car’ in (87b) are coreferential to the resumptive clitic *haa* ‘it’. Therefore, they are topic phases. (87a) is represented in the following structure:

- (88) [CP the car [C' [C] [TP Saleh [T' [T bought] [<sub>VP</sub> Salih [<sub>V'</sub> [<sub>V</sub> 'bought'] VP [V' [V bought]]]]]]]]]

The pure indefinite DP subject can only be interpreted as a genuine subject which occupies the Spec-TP position as (89a). It cannot be, however, behave as topic and be coreferential to a resumptive clitic inside the clause as ungrammaticality shown in (89b):

- (89) a. **fabaab** jauu l-l-bayt  
 guys came.perf.3mp to-the house  
 ‘Guys came to the house.’
- b. \***fabaab** liqiyt-hum ba-l-bait  
 guys met.perf.1s-them in-the house  
 ‘Guys, I met them in the house.’

In (89a), the indefinite DP subject ‘guys’ occurs preverbally. The preverbal indefinite DP subject, therefore, must be a real subject followed by the verb in SVO order. TA, like English, allows simple existential interpretations of a DP subject. In (89b), the indefinite DP ‘guys’ serves as left dislocated topic and associated with a resumptive clitic *hum* ‘them’. Thus, (89b) is ungrammatical. Consider the structure below for (89a):

- (90) [TP Guys [T' [T came] [<sub>VP</sub> Guys [<sub>V'</sub> [<sub>V</sub> came] VP [V' [V came] [to the house]]]]]]]



b. [<sub>CP</sub> the guys [<sub>c'</sub> [<sub>c</sub>] [<sub>FP</sub> football [<sub>F'</sub> [<sub>F</sub>] [<sub>TP</sub> [<sub>T'</sub> [<sub>T</sub> play] [<sub>vP</sub> [<sub>v'</sub> [<sub>v</sub> play] VP [<sub>V'</sub> [<sub>V</sub> play] [~~football~~]]]]]]]]]]]

In (92a), the initial DP ‘the guys’ can only have topic reading occupying a Spec-CP position. The initial DP ‘the guys’ is followed by the focus phrase ‘football’ which is Spec-FP. The appearance of DP subject e.g. ‘the guys’ in (92b) preceding the focus phrase ‘football’ restricts the interpretation of the DP subject to topic reading while subject reading is no longer available.

The subject interpretation, on the other hand, must apply to the preverbal DP subjects appear following an initial verb in the F head position. Consider the following example:

(93) *ya-ɫabuu                    ʃ-ʃabaab      kuura* (VSO)  
 3m-play.imperf.p   the-guys      football  
 ‘The guys play football.’

In (93), since the subject ‘the guys’ appears following the verb ‘play’ in the F head. As a result, the DP subject has only a subject interpretation, in Spec-TP, since the verb-initial position is lower than the topic position (Spec-CP).

It can be concluded that the definite and specific definite subject DPs in the initial position of the clause can have two different interpretations with two different positions: they can have subject and topic reading unless they precede focus phrases, when only topic is possible, or following the verb in verb-initial order, and then they are subjects only.

The constituent orders OVS, OSV and VOS will be examined later in Chapter 4.

**2.11 Conclusion**

Although both MSA and TA varieties have one underlying structure with SVO in vP, through initial merge, they derive different unmarked surface constituent orders. Whereas the VSO

على النص الذي ترغب في أن يظهر هنا. 2.Heading خطأ! استخدم علامة التبويب "الصفحة الرئيسية" لتطبيق  
 على النص الذي ترغب في أن يظهر هنا. 2.Heading خطأ! استخدم علامة التبويب "الصفحة الرئيسية" لتطبيق

---

order is the unmarked order in MSA by raising the verb to T, it is the SVO order that is the unmarked one in TA by raising both the verb and then the subject to TP. The alternative order for both varieties, therefore, is derived differently.

In MSA, the SVO order is derived by raising a *pro* subject to Spec-TP to license the full agreement with the verb and being coreferential with a preverbal DP which is generated in Spec-FP. In TA, however, the alternative order (VSO) is derived by T-to-F head movement. In MSA, the overt subject occupies Spec-*v*P but can never be preverbal in Spec-TP, as shown by the existence of the agreement asymmetry, the definiteness condition, and the adjacency fact. The preverbal subject DP in MSA has only a topic reading whether it has strong or weak referential properties while a pure subject reading is prohibited. In TA, the overt subject is preverbal in Spec-TP as shown by the lack of agreement asymmetry and the definiteness condition as well as the optionality of the adjacency facts. Both interpretations of topic and subject are available to a definite preverbal subject DP while a pure indefinite has only a subject interpretation.

The existence of partial agreement in MSA in VSO order requires the T to not have an EPP feature. In TA, however, the absence of partial agreement shows that the T head always carries the EPP feature. Therefore, TA shows more uniform instances of the minimalist principles of Agree more than MSA.

## **Chapter 3 The background of the left periphery**

### **3.1 Introduction**

The aim of this chapter is to introduce the theoretical framework employed in the analyses in this thesis. This chapter is composed of three main sections rather than the introduction. The first section expresses in detail the study of topic including the definition of topic, the different types of topic and the main analyses of topics in generative grammar. The second section concerns the idea of focus comprising the definition of focus, focus in information structure, types of focus and the syntax of focus. The third section outlines the split CP hypothesis (Rizzi 1997). Then the conclusion will be drawn.

### **3.2 Topic**

#### **3.2.1 Definition of topic**

The term “topic” has been used broadly in syntactic theory. Reinhart (1981: 53) states that “[d]espite the intensive attention that linguists of various schools have paid to the notion topic, there is no accepted definition of it”. López (2009) argues that a wide definition of topic or topicalization does not provide specific enough syntactic, semantic or phonological properties. Hockett (1958: 201) assumed that “the most general characteristic of predicative constructions is suggested by the terms “Topic” and “comment” for their immediate constituents: the speaker announces a topic and then says something about it”.



Many definitions of the topic have essentially identified it with old or given information. Brustad (2000), for instance, postulates that topics must be definite and provide old information which is recognized from the previous discourse or usually known by both participants; hence, topics appear in initial positions. Rizzi (1997: 264) defined Topic as “a preposed element characteristically set off from the rest of the clause by ‘comma intonation’ and normally expressing old information, somehow available and salient in previous discourse” (see Danes, 1970; Haviland & Clark 1974; Chafe 1974 for more definitions of topic as old information). Some linguists define the topic as a “link” (Vallduvì 1992; Vallduvì & Engdahl 1996) while other refers to the topic as “psychological subject” and to the comment as “psychological predicate” (von der Gabelentz 1969).

According to classical articulations of the information structure, a sentence is divided into two main parts: a topic and a comment (Hockett 1958; Li & Thompson 1976; Reinhart 1981; Gundel 1988), a theme and a rheme (Firbas 1969; 1975; Halliday 1967), or a focus and a presupposition (Chomsky 1971; Jackendoff 1972; Rochemont 1986).

### 3.2.2 Types of Topic

Ross (1967) introduced the term left dislocation, which refers to two different constructions: topicalized and left-dislocated (LD) topic. Consider the following examples where topic types and their conferential properties are bold-faced:

- (1) a. **This book**, I recommend **it**.  
b. **This book**, I have read \_\_\_\_\_ twice.

The DP ‘this book’ in (1a) is an instance of a LD topic and it co-refers to the resumptive pronoun ‘it’ inside the clause, while the DP ‘this book’ in (1b) is an instance of a topicalized topic that is associated with a gap inside the clause.

The term (LD), however, has been further classified into three different types: clitic left dislocation (CLLD), hanging topic left dislocation (HTLD) and contrastive left dislocation

(CLD). HTLD and CLLD are proposed by Cinque (1977) while CLD is by Van Haften et al., (1983/1997). The following part investigates the differences between the three LD topic types.

### 3.2.2.1 Topic between LD and topicalized topics

There are a number of differences that can be observed between topicalisation and LD constructions. The first point that can be raised to differentiate between them is the relationship that links topicalized and LD topics to the following clause. The most obvious relation is that LD constructions, on one hand, do not have gaps and involve a resumptive pronoun in the sentence (Cinque, 1977). That is, LD constructions are complete predications and the DP does not play a direct role in the predicate-argument structure of the clause. Topicalized constructions, on the other hand, involve gaps where the topicalized elements should originate inside the clause as exemplified in (1b).

The second difference is with regard to the observations of Ross (1967) who differentiated between topicalized and LD topics through the sensitivity to certain types of syntactic constraints. He argued that a topicalized element obeys island constraints such as the Complex NP Constraint (CNPC), or the Coordinate Structure Constraint (CSC), while an LD topic does not obey island constraints. Consider the following examples:

- (2) a. \***This hat**, I know [the boy who was wearing \_\_\_ ].  
 b. \***This hat**, [the gloves and \_\_\_ ] were on the table. (Ross 1967: 214-15)
- (3) a. **My father**, [the man **he** works with in Boston] is going to tell the police that ...  
 b. **My father**, I hardly ever see [**him** and my mother] when they're not glaring at each other. (Ross 1967: 233-235)

The contrasts between (2a-b) and (3a-b) examples are with regard to the CNPC and CSC constraints, since the topicalized topic phrases 'this hat' obeys CNPC in (2a) and CSC in

على النص الذي ترغب في أن يظهر هنا. 2.Heading خطأ! استخدم علامة التبويب "الصفحة الرئيسية" لتطبيق  
على النص الذي ترغب في أن يظهر هنا. 2.Heading خطأ! استخدم علامة التبويب "الصفحة الرئيسية" لتطبيق

---

(2b), and hence ruled out. By contrast, the LD topic phrase 'my father' does not obey these constraints in (3a-b) and the sentences are well-formed.

The third difference is to do with the position of topicalized and LD topics, the fact that an LD topic is in a higher position than a topicalized one. Thus, topicalized topics must follow LD topics and the reverse order leads to ungrammaticality as the following examples show (Grohmann 2003: 139):

- (4) a. **John, Mary, he** likes t. (LD > Top)  
b. \***Mary, John, he** likes t. (Top > LD)

### 3.2.2.2 HTLD vs. CLLD

Cinque (1977: 405-410) classified HTLD and CLLD constructions as types of LD constructions. He assumes that four contrasts can be observed between HTLD and CLLD topics. The first contrast is that despite the fact that both HTLD and CLLD topics are separated from the following part of the clauses by an intonational break, the gradation of this intonation varies from one to another, since HTLD topics have a longer intonational pause duration than CLLD topics.

The second contrast is about the relation that links topics with their resumptive pronouns. CLLD topics are distinctively required to be corresponding to clitics or null pronouns *pro* inside their clauses in Italian, HTLD topics, by contrast, can occur coreferential to real resumptive elements. Consider the following Italian examples (Cinque 1977: 406):

- (5) a. **Giorgio**, sapevo che **pro** voleva andare a stare in campagna.  
'Giorgio, I used to know that (he) wanted to go and live in the country.'  
b. **Giorgio**, sapevo che **lui** voleva andare a stare in campagna.  
'Giorgio, I knew that (he) wanted to go and live in the country.'

In (5a), Italian CLLD topic *Giorgio* corresponds to a null *pro* subject 'he' in the embedded clause. But the HTLD topic in (5b) has a coreferential relation to a resumptive pronoun which is a strong pronoun.

The third contrast between HTLD and CLLD constructions is that CLLD topics can apply in embedded clauses whereas HTLD topics cannot, consider the following (Cinque 1977: 410):

- (6) a. Ho paura che a **Giorgio**, Macro **gli** abbia già scritto.  
 'I fear that to Giorgio, Macro has already written-to-him<sub>i</sub> (clitic).'
- b. \*Sono sicuro che **Mario**, **lui** vuole andare al mare.  
 'I am sure that Mario, he (nonclitic) wants go to the sea.'

In (6a), the CLLD topic 'to Giorgio' is in an embedded clause but (6b), however, is ungrammatical since the HTLD topic 'Mario' occurs in an embedded clause.

The fourth contrast is with regard to syntactic constraints, since CLLD topics in Romance are sensitive to island constraints while HTLD topics are not. The CNPC island, for example, prevents a CLLD topic from corresponding to a resumptive pronoun as in (7a). A HTLD topic, however, can correspond to a resumptive without sensitivity to island constraints as in (7b). Consider the following examples from Cinque (1977: 408):

- (7) a. \*A **Giorgio**, ieri ho conosciuto [la ragazza che **gli** ha scritto quelle insolenze].  
 'To Giorgio, yesterday I met the girl who wrote those insolent words to him.'
- b. **Giorgio**, ieri ho conosciuto [la ragazza che **gli** ha scritto quelle insolenze].  
 'Giorgio, yesterday I met the girl who wrote those insolent words to him.'

Further to those contrasts which Cinque (1977) assumed, Alexiadou (2006) additionally provided two more contrasts. First, multiple CLLD topics are available in a sentence, in Italian for example, each sentence can involve multiple CLLD topics. HTLD, however, is restricted to one topic per sentence in Italian as well as in English (Alexiadou 2006: 672):

على النص الذي ترغب في أن يظهر هنا. Heading 2 خطأ! استخدم علامة التبويب "الصفحة الرئيسية" لتطبيق  
 على النص الذي ترغب في أن يظهر هنا. Heading 2 خطأ! استخدم علامة التبويب "الصفحة الرئيسية" لتطبيق

(8) a. [Di vestiti][a me] Gianni in quel negozio non mi ce ne ha mai  
 comprati

clothes to me Gianni in that shop not to me there of them has ever bought  
 'As for clothes, for me, Gianni has never bought them in that shop.'

b. \*Mary John she likes him.

The clause in (8a) has two CLLD topics 'as clothes' and 'as for me'; in comparison to (8b) the multiple HTLDs 'Mary' and 'John' lead to the sentence to be ruled out.

Second, in contrast to HTLD topics it is essential for CLLD topics to have connectivity with their resumptive pronoun inside the clause. This connectivity can be observed with regard to the binding and the case agreement, as in the following Greek examples Alexiadou (2006: 673):

(9) a. I Maria tin emathe kala tosa hronia.

the Mary-nom her learnt well so many years.  
 'As for Mary, I know her after so many years.'

b. Ipe oti ti Maria /\*i Maria tin emathe kala tosa hronia.

said that the Mary-acc/\*nom her learnt well so many years  
 'He said that as for Mary, he knows her well after so many years.'

In (9a), the topic 'Mary' shows nominative case while its resumptive pronoun 'her' is accusative, it is hence an HTLD topic since there is no case connectivity. The CLLD topic 'the Mary' in (9b) by contrast, must have connectivity with resumptive 'her' and show accusative case which the resumptive pronoun has.

### 3.2.2.3 CLD vs. CLLD

Grohmann (2000: 196) distinguished between CLLD topics and CLD topics with regard to five points, based on Greek and German cases. First, despite the fact that both types of structure must have connectivity between the topics and their resumptive pronouns, CLD

topics are linked to a stressed *d*(emonstrative)-pronoun as in (10a) while CLLD topics are linked to an unstressed clitic as in (10b) as the following examples (Grohmann 2000: 147):

- (10) a. **Diesen Mann, den** kenne ich nicht  
 this-acc man that-one-acc know I not  
 ‘This man, I don’t know [him]’ (German)
- b. **Afton ton andra,** dhen **ton** ksero.  
 this-acc the-acc man-acc not ’m-acc know-1Sg  
 ‘This man, I don’t know [’em].’ (Greek)

Second, the relative order between the topics and their resumptive pronouns are distinctive, since CLD topics must be followed by the *d*-pronoun whereas in CLLD topics the clitics can appear in clause-internal positions.

- (11) \***Diesen Mann,** kenne **den** ich nicht.  
 this-acc man know that-one-acc I not  
 ‘This man, I don’t know [him]’

In (11), the CLD topic ‘this man’ and *d*-pronoun ‘that-one’ are separated by the verb ‘know’. Hence, the sentence is ruled out.

Third, CLLD topics can appear in embedded clauses as in (12a). However, CLD topics cannot appear in embedded clauses as in (12b). Consider the following examples (Grohmann 2000: 196):

- (12) a. ...oti **ton Janni** dhen **ton** ksero.  
 that the-acc John not CL-acc know-1sg.  
 ‘...that John, I don’t know.’ (Greek)

على النص الذي ترغب في أن يظهر هنا. 2.Heading خطأ! استخدم علامة التبويب "الصفحة الرئيسية" لتطبيق  
 على النص الذي ترغب في أن يظهر هنا. 2.Heading خطأ! استخدم علامة التبويب "الصفحة الرئيسية" لتطبيق

- b. \*...daß **den Martin den** ich nicht kenne.  
 that the-acc Martin RP-acc I not know.  
 ‘...that Martin, I don’t know.’ (German)

Fourth, while multiple CLLD topics are possible in one clause, it is impossible for a CLD structure to have multiple topics, as in the following examples (Grohmann 2000: 196):

- (13) a. **Tis Marias to vivlio tis to** edosa  
 the-dat Maria the-acc book CL-dat CL-Acc gave-1Sg  
 ??‘Mary, the book, I gave to.’ (Greek)
- b. **Der Maria, das Buch, der das** gab ich.  
 the-dat Maria the-acc book RP-dat RP-acc gave I  
 ?? ‘Mary, the book, I gave to.’ (German)

Fifth, with contrast to CLLD topics in Greek which are not sensitive to wh-islands, CLD topics in German are sensitive to this island. Consider the following examples (Grohmann 2000: 196):

- (14) a. **To forema** dhen ksero pu na **to** valo.  
 the-acc dress not know-1s where to CL-acc put  
 ‘The dress, I do not know where to put.’ (Greek)
- b. \***Den Rock** weiß ich nicht **den** wohin ich legen soll.  
 the-acc dress know I not RP-acc where I put shall  
 ‘The dress, I do not know where I should put’. (German)

### 3.2.2.4CLD vs. HTLD

Sturgeon (2008) showed comparative analyses between CLD and HTLD construction based on Czech. She assumes that both constructions have an intonational break between a topic which is at the left edge and the following part of the clause. Moreover, a resumptive pronoun

which is coreferential with the topic appears to the left edge of a clause. Both a LD topic and a resumptive correspond to a clause internal position. However, these constructions show differences in respective ways. The first difference is that in CLD constructions, the left-dislocated element matches the case of the resumptive (the expected case of the clause internal gap). Consider the following examples (Sturgeon 2008: 1-2):

- (15) **Anička**      **té**                      se      nic                      nestalo  
 Anička.nom    that.dat                      refl-cl    nothing                      neg-happened  
 “Anička? Nothing happened to her.”

- (16) Ale **tu** **dívku** ...      **tu**                      znám                      určitě.  
 but that girl.acc      that.acc                      know.1sg                      for-sure  
 ‘But that girl ... I know her for sure ...’

In (15) HTLD involves the LD topic and there is no case match with its resumptive element: since LD topic *Anička* must have the nominative case while its resumptive element has dative case. In (16) CLD involves the LD topic with matching case with its resumptive element since LD topic *tu dívku* and its resumptive element *tu* are accusative.

The second difference is with regard to discourse analysis, in contrast with HTLD constructions CLD constructions can be used to answer wh-questions (Sturgeon, 2008: 84).

### 3.2.3 The syntax of Topic

#### 3.2.3.1 Topic and movement theory

Since Ross (1967) introduced the term LD much attention has been paid to left-dislocated topics and topicalized elements whether they derived by movement or are given a base-generated account. Ross first assumes that both left-dislocated topics and topicalisation constructions are basically derived by undergoing movement, from base positions to clause-



على النص الذي ترغب في أن يظهر هنا. 2.Heading خطأ! استخدم علامة التبويب "الصفحة الرئيسية" لتطبيق  
على النص الذي ترغب في أن يظهر هنا. 2.Heading خطأ! استخدم علامة التبويب "الصفحة الرئيسية" لتطبيق

initial positions. LD and topicalisation, however, are derived in different ways, he specifically points out that the LD topics do not obey movement constraints while the topicalized elements do. Moreover, LD topics get moved and leave resumptive pronouns where they move from (17a), and that derivation of LD topic is called a copying operation as in (17a). Whereas topicalized topics get moved and there are no resumptive pronouns left behind as in (18a), and that derivation of topicalized topics is called a “chopping” operation as in (18)<sup>8</sup>.

(17) a. **Mary**, John admires **her**.

b. [S [DP *Mary*] [S [DP John] [VP [V admires][*him*]]]]

(18) a. **Mary**, John admires \_\_\_.

b. [S [DP *Mary*] [S [DP John] [VP [V admires] [ ]]]]

According to Ross (1973), movement accounting for LD topics is expected at least in some LD constructions to show connectedness. In German, for instance, there is a case matching between LD topics and their resumptive which clearly involves the relation between LD topics and their positions inside the clause.

Ross's assumptions have been questioned by some researchers, Gundel (1975), for instance, proposed problems for the LD movement analysis in English. Her constraint is with regard to connectedness, since LD topics and their resumptive pronouns do not have any kind of connectivity. LD personal pronouns, for instance, are LDed and must appear in accusative case whether their resumptive pronoun is assigned a similar or different case:

(19) a. **Me**, I never drink beer.

b. \***I**, I never drink beer.

c. **Him**, he never does anything right.

d. \***He**, he never does anything right.

(Gundel 1975:

75)

<sup>8</sup> In (17), Ross (1967) traditionally refers to nominal expressions as NPs, now is taken to be DPs instead.

- (20) As for **myself**, **I** never would have said that to Bill.  
 b. Harry told Linda that as for **himself**, **he** did not like bagels.  
 c. Mary believes that as for **herself**, **she** will not be invited to the party.

(Gundel 1975:

100)

In (19a-d), the LD personal pronouns indicate that case agreement cannot be an instance of connectivity between the left-dislocated topic and their resumptive elements in English. Moreover, (20a-c) indicate that LD pronouns can occur in a reflexive form and also show no connectivity between the LD topics and their resumptive elements.

Another disagreement with Ross's analyses is proposed by Chomsky (1977) who postulated that LD topics are base-generated while topicalized topics are moved, as in the following examples:

- (21) a. \***This book**, to whom should we give *t*?  
 b. \***John**, who do you think saw *t*?

- (22) a. (As for) **this book**, to whom should we give **it**?  
 b. (As for) **John**, who do you think saw **him**?

(Chomsky, 1977)

According to Chomsky, the examples in (21a-b) are topicalized topics; that is, they are derived by movement which leads to a doubly filled COMP in (21a) and to a violation of the wh-island in (21b) and as a result both are ruled out. The examples in (22a-b) are base-generated LD topics and correspond to resumptive pronouns, thus the ungrammaticalities in (22a-b) do not appear here.

Chomsky postulated that left-dislocated and topicalized structures are derived by two different rules:

- (23) a. R1: S'' → Top S'

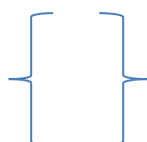

$$\begin{array}{c}
 S'' \\
 \text{b. R2: } S' \rightarrow \text{Comp} \\
 S
 \end{array}$$

Both left dislocation and topicalisation show different analyses according to the rules in (23a-b). Topicalisation involves the two rules R1 and R2; base-generating the topicalized topic in the clause-initial position as in R1 and undergoes wh-operator to the head of Comp as in R2. Consider (24a) as a topicalized topic and it has the derivation as in (24b).

(24) a. **Mary**, John admires.

$$\text{b. } [S'' [_{\text{Top}} \mathbf{Mary}] S' [_{\text{Comp}} \text{what } [S [_{\text{DP}} \text{John}] [_{\text{VP}} [V \text{admires}] \iota]]]]$$

Chomsky (1977) argues that a wh-phrase such as ‘what’ in (25b) is deleted. It is never spelled out overtly in this construction. Moreover, the wh-phrase has two roles for the topicalisation structures: i) it creates an open sentence out of the proposition shown by the S’/S part of the sentence, and ii) it demonstrates the fact that topicalized element cannot occur with wh-phrase, as shown in (24a-b).

Left dislocation, however, involves a base-generated operation with R1 only. Consider (25a) as a left-dislocated topic and it has the derivation as in (25b).

(25) a. **Mary**, John admires **her**.

$$\text{b. } [S'' [_{\text{Top}} \mathbf{Mary}] S' [S [_{\text{DP}} \text{John}] [_{\text{VP}} [V \text{admires}] \mathbf{her}]]]$$

Chomsky (1977) assumes that through the relation between left-dislocated topic and the resumptive clitic the “aboutness” relation is imposed on the topic phrase. The resumptive pronoun ‘her’ establishes an open sentence while the corresponding topic ‘Mary’ fulfils this open sentence. No wh-operator movement is applied in the left-dislocated constructions. Thus, it can occur with left-dislocated topic and does not violate the wh-island constraint as shown in (25a-b).

Sturgeon (2008) assumed the connectivity effect through a movement or a base-generated account of left-dislocated topics. According to her, LD topics which show any kind of connectivity such as case matching with their resumptive are considered to have a movement account while those do not show any connectivity are considered to have a base-generated account. Both types of LD topics exist in Czech since HTLD topics show no case match connectivity with their resumptive as in (15) and a base-generated account, therefore, is applied. In contrast, CLD topics show a close syntactic connection with their clause-internal gaps as shown in (16) and a movement account, therefore, is applied.

From the discussions above, we can assume that both movement and base-generated analyses are involved for LD constructions and they are seen by the availability of connectivity between LD topics and their resumptive pronouns such as matching of case. LD topics are moved elements if they obtain any kind of connectivity with their resumptive pronouns, and such structures can be found in some languages like German, Greek and Czech. LD topics are base-generated elements if they are not in a connectivity relation as in the analyses of English by Gundel (1975) and Chomsky (1977).

### 3.3 Focus

#### 3.3.1 Definition

Focus has been widely defined as “providing new information” (a.o. Halliday 1967; Jackendoff 1972; The Prague School: Sgall et al. 1986). Focus was always an essential part to describe information structure with different kinds of articulations: presupposition and focus articulation (Chomsky 1971; Jackendoff 1972), theme and rheme articulation (Firbas 1972), topic and comment articulation (Gundel 1974; 1978), open proposition and focus articulation (Ward 1985; Prince 1986) and ground and focus articulation (Vallduví 1990). Here, I will consider presupposition and focus articulation and ground and focus articulation.

### 3.3.2 Focus-Presupposition Articulation

In early works, Chomsky (1965) hypothesized the ‘Standard Theory’ in which the semantic representation of a sentence is determined by its deep structure, since the deep structure has the rationale which comprises the inherent semantic of content to lexical items as well as the grammatical relations that exist between them. Within this framework, focus was defined as “the predicate of the dominant proposition of the deep structure”.

Chomsky (1971) discusses the semantic representations of focus in generative grammar. He speaks about the information structure in terms of the distinguishing between deep and surface structure of the sentence. Chomsky proposes the view that includes the surface structure in the semantic interpretation of a sentence. He assumes that the semantics of a sentence cannot be only determined by its deep structure but also requires surface structure. The argument involves focus-presupposition structure in English. Within this view focus was defined as “a phrase containing the intonation center” while the presupposition as “an expression derived by replacing the focus by a variable” (Chomsky 1971: 200). Given the focus-presupposition dichotomy, example (27) is an appropriate response to (26a) which has the presupposition that John writes poetry somewhere:

- (26) a. Does John write poetry in **his study**?  
 b. Is it in **his study** that John writes poetry?  
 c. John does not write poetry in **his study**.  
 d. It is not in **his study** that John writes poetry

(27) No, John writes poetry in **the garden**.

The deep structure for (27) is as in (28), where the embedded sentence is the presupposition while the focus is *in the garden* which is a part of the matrix predicate.

(28) [the place where John writes poetry] is [in the garden]

presupposition: John writes poetry at a place

focus: garden

Jackendoff (1972: 230) built his analyses of focus based on Chomsky's (1971) focus-presupposition. The sentence, according to him, has two parts; one is the focus which is "the information in the sentence that assumed to be heard by the speaker not to be shared by him and the hearer". The other part is the presupposition which refers to "the information in the sentence that assumed to be heard by the speaker to be shared by him and the hearer". Look the following question-answer pairs:

- (29) a. Is it **John** who writes poetry?  
 b. No, it is **Bill** who writes poetry.  
 c. No, it is **John** who writes short stories. (Jackendoff, 1972: 229)

According to Jackendoff, the focus 'John' in (29a/c) and 'Bill' in (29b) are known to the speaker but not the hearer while the rest of presupposition 'who writes poetry' is known by the speaker as well as the hearer.

Jackendoff (1972), in his proposal, adds the syntactic contribution of focus by assuming 'F-marking' where syntactic nodes can have notated with the feature F(ocus). According to him, F-marking interacts with semantics to assign the interpretation of focus-presupposition and with phonology to put emphatic stress. The explanation of the F-feature and its rule of assignment is in the following rule (p: 247):

- (30) Focus assignment: In a sentence S, with otherwise determined semantic representation SR, the semantic material associated with surface structure nodes dominated by F is the Focus of S. Substitute an appropriate semantic variable  $x$  for Focus in SR to form the function Presupps( $x$ ).

على النص الذي ترغب في أن يظهر هنا. 2.Heading خطأ! استخدم علامة التبويب "الصفحة الرئيسية" لتطبيق  
على النص الذي ترغب في أن يظهر هنا. 2.Heading خطأ! استخدم علامة التبويب "الصفحة الرئيسية" لتطبيق

### 3.3.3 Ground-Focus articulation

Vallduví (1990) develops the idea of “information packaging” by connecting focus-background and topic-comment to develop the notion of information structure. In (32b) ‘John’ is a topic and ‘a novel’ focuses on the object that John reads.

- (31) a. What does John read?  
b. John reads **a novel**.

The predicate ‘read’ takes part in both comment and background as shown in the table below:

Table 3.1 Topic-comment and focus-background structure

Topic	Comment	
John	reads	a novel
Background		Focus

Vallduví (1990: 55) further suggested the Ground-Focus articulation in which the sentence has two main parts: (i) a “non-informative” part which is the ground (background) or the known elements, and (ii) an “informative” part which is the Focus or new/unknown elements. The ground part, however, is divided again into two units; *link* and *tail* representing the topic, and then the rest of the ground. Consider the information packaging as in following table:

Table 3.2 Vallduví’s Information packaging

Ground		Focus
link	tail	focus
John	reads	a novel

Therefore, the information packing will have the following simplified structure:

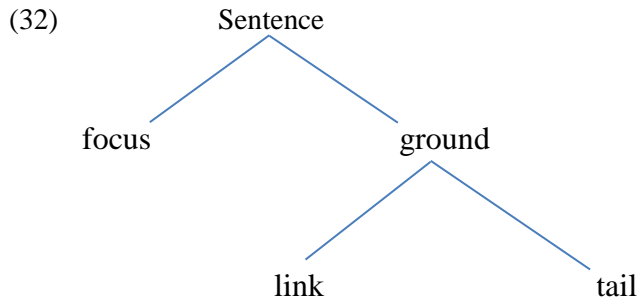

### 3.3.4 Focus types

Lambrecht (1994) classified focus into three types which are predicate focus, broad focus and narrow focus. The broad focus can be either predicate and sentence focus. The predicate focus cross-linguistically is the unmarked type that traditionally has been referred in the ‘topic-comment’ structures of sentences information. In the predicate focus, the subject serves as the topic part the while the focal predicate serves as the comment part. Consider the following examples where focus elements appear in boldface (Lambrecht 1994: 223):

(33) Q: How’s your car?

- |   |          |
|---|----------|
| A: a. My car/it broke down.             | English  |
| b. <b>La mia macchina</b> si è rotta.   | Italian  |
| c. <b>Ma voiture</b> elle est en panne. | French   |
| d. <b>Kuruma wa</b> kosyoo sita.        | Japanese |

The sentence focus, however, is a marked focus type where the focus domain takes both subject and predicate to include the whole sentence. Consider the following sentence focus constructions in (34a-d) where stressed words are in boldface (Lambrecht: 1994: 223):

(34) Q: What happened?

- |                                       |         |
|---------------------------------------|---------|
| A: a. My <b>car</b> broke down.       | English |
| b. Mi Si é rotta la <b>macchina</b> . | Italian |



على النص الذي ترغب في أن يظهر هنا. 2.Heading خطأ! استخدم علامة التبويب "الصفحة الرئيسية" لتطبيق  
على النص الذي ترغب في أن يظهر هنا. 2.Heading خطأ! استخدم علامة التبويب "الصفحة الرئيسية" لتطبيق

- |   |          |
|---|----------|
| c. J'ai ma <b>voiture</b> qui est en <b>panne</b> . | French   |
| d. <b>Kuruma</b> ga <b>koosyoo</b> sita.            | Japanese |

But narrow focus takes only a single focused phrase as (36-d) shows:

- (35) Q: I heard your motorcycle broke down.  
A: a. My **car** broke down.  
b. E la mia **macchina** che si e rotta. Italian  
c. C'est ma **voiture** qui est en panne. French  
d. **Kuruma** ga kosyoo sita Japanese

### 3.3.5 The syntax of wh-question

This section concentrates on wh-question structure as it relates to the syntax of focus. A wh-question clause is defined as one where an interrogative phrase (what, where, when, why ...) is in the Spec-CP position. The wh-phrase, however, moves from its canonical position, typically in the argument domain (e.g. A-position) to the non-argument domain (i.e. A-bar position) as shown in the following example (Rizzi 1996; Radford 2009):

- (36) a. What did you read?  
b. [<sub>CP</sub> [<sub>DP</sub> What] [<sub>C'</sub> [<sub>C</sub> did] [<sub>TP</sub> [<sub>DP</sub> you] [<sub>T'</sub> [<sub>T</sub> did] [<sub>VP</sub> [<sub>V</sub> read] [<sub>DP</sub> what]]]]]]]

In (36b), the wh-phrase 'what', which is the object of the verb 'read', moved from base position, i.e. the complement position in VP to the Spec-CP position.

Radford (2009) supports the analysis of wh-phrase movement by the observation of the Belfast English variety that has wh-phrase that directly precedes the Comp as in the following example:

- (37) I wonder [<sub>CP</sub> *which dish* [<sub>C</sub> that]] they picked]? (Henry 1995: 107)

Belfast English grammatically shows the specifier and the head of CP are filled by the wh-phrase 'which dish' and 'that' respectively. This is reasonable evidence to say that the wh-phrase 'which dish' is in Spec-CP.

Chomsky (2001) assumes that the derivation of an interrogative clause involves two types of syntactic operations. First, the external merge operation which contains two elements which are independent. Second, the internal merge operation which requires movement of some of the elements that were introduced by external merge. Given that the wh-phrase 'what' in (36b) is externally merged as a complement of the verb 'read' it is then merged internally into Spec-CP.

With regard to the Copy Theory of Movement (Chomsky, 1995), a movement element leaves an overt copy behind to form chain movement. Thus, the example (36a) represents the movement chain as  $\langle \text{what}_i, \text{what}_i \rangle$  where the higher copy of the movement chain spells out overtly while the lower copy of the movement chain is null. Therefore, wh-constructions involve two operations: (i) the wh-phrase gets copied while in (ii) the lower copy of wh-phrase is not pronounced (so it gets deleted) as the following schema shows:

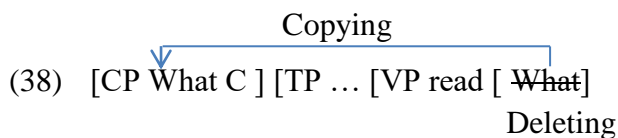

Radford (2009: 157) provides evidence for the movement chain of the wh-phrase by the prepositional copy of wh-structure in Shakespearean English as in the following example:

(39) [PP *in what enormity*] is Marcius poor [PP *in what enormity*]?

(Prologue to Act II, Romeo and Juliet)

In (39), the wh-prepositional phrase 'in what enormity' has movement to the initial position of the clause. However, the lower copy of the wh-preposition is partially deleted since the

copy of the preposition *in* is still pronounced in the original position. This copy of the wh-prepositional phrase in (39) confirms the assumption that the fronted wh-phrase leaves a copy in the original position where wh-phrase moves from and that copy is null in modern English. In the early minimalist account (Chomsky 1995: 199), wh-movement is analysed within a feature checking mechanism where strong/weak features trigger the wh-movement or not. In English, for instance, the wh-phrase undergoes movement to Spec-CP motivated by a strong wh-feature on the C head. According to Chomsky, “the natural assumption is that C may have an operator feature and that feature is a morphological property of such operators as wh. For an appropriate C, the operators raise for feature checking to the checking domain of C: [Spec, CP]”.

Chomsky (2000: 44) assumes the theory of Agree, in this regard: he argues that “the wh-phrase has an uninterpretable feature [wh-] and an interpretable feature [Q], which matches the uninterpretable probe [Q] of a complementizer”. Therefore, the wh-movement operation applies as follows: the interrogative C which has an uninterpretable [*u* Q] feature serves as a probe while the wh-phrase which has an interpretable [Q] and uninterpretable [*u* wh-] serves as a goal. Since the probe C and the goal ‘wh-phrase’ have similar features, the wh-phrase which has a [Q] feature which gets moved by the probe C to its specifier. As a result, the [*u* Q] of the probe C, in addition, to the uninterpretable [*u* wh] feature that is carried by the wh-phrase being valued and deleted. As a result, the [*u* Q] is working as an operator feature that motivates the matching wh-phrase to raise to the Spec-CP. The example in (36a) would have the following tree:

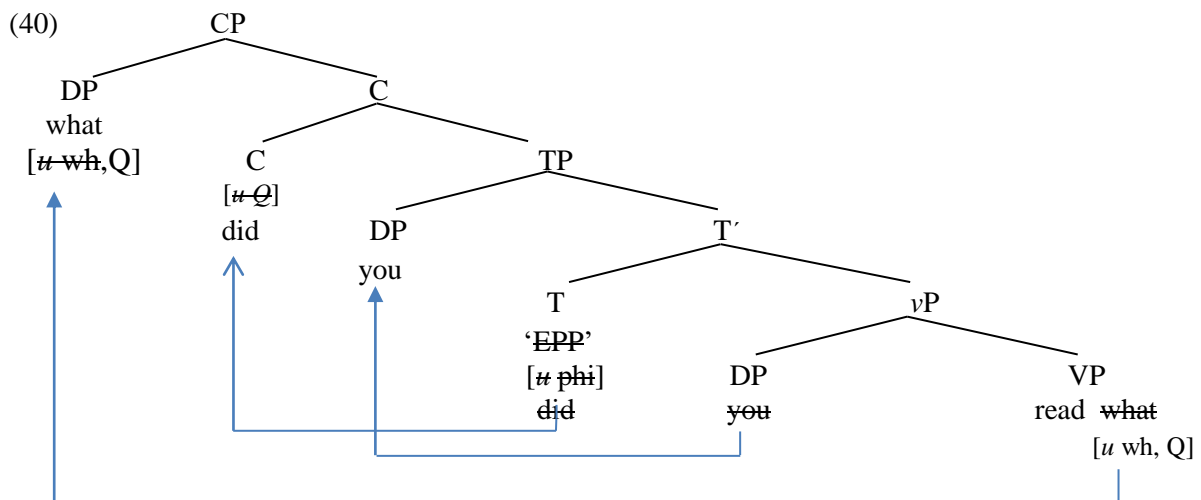

Chomsky (2001) postulates that sentences are built up in two phases, they are CP and  $vP$ . Each phase has a phase head e.g. C and  $v$ , a complement and a specifier that is the ‘edge’. Once the derivation of phases is completed the domain of the phase head undergoes spell out (i.e. is sent to PF and LF components) and it becomes impenetrable to any further syntactic operations as in the following condition:

- (41) Phase Impenetrability Condition: In Phase  $a$  with head  $H$ , the domain of  $H$  is not accessible to operations outside  $a$ , only  $H$  and its edge are accessible to such operations.

(Chomsky 2000: 108)

Chomsky (2008) proposes that phase heads e.g. C and  $v$  are specified with the Edge feature (EF), however, he asserts that “For an LI to be able to enter into a computation, merging with some SO [syntactic object], it must have some property permitting this operation. A property of an LI is called a feature, so an LI has a feature that permits it to be merged. Call this the edge-feature (EF) of the LI.” (p: 139). The edge feature in the head C, for example, serves as a probe without requiring feature matching as explained for the features [wh] or [Q] within the approach of Agree (Chomsky, 2000) which require agreement. The edge feature works in parallel fashion to the EPP feature on the T head which requires its specifier to be filled i.e. subject. In a similar way, the EF on the C head can attract an element to fill its specifier (its

edge). The key difference between the EPP feature on the T head and the EF feature which is on the C head is that the former needs agreement while the EF feature does not. Therefore, a wh-word, for instance, can be attracted by EF feature and undergoes movement to the Spec-CP. Hence, the edge feature can be described as “indiscriminate” since it can attract any element. However, only wh-phrases raise for the correct interpretation. The wh-question in (36a) will have the following structure:

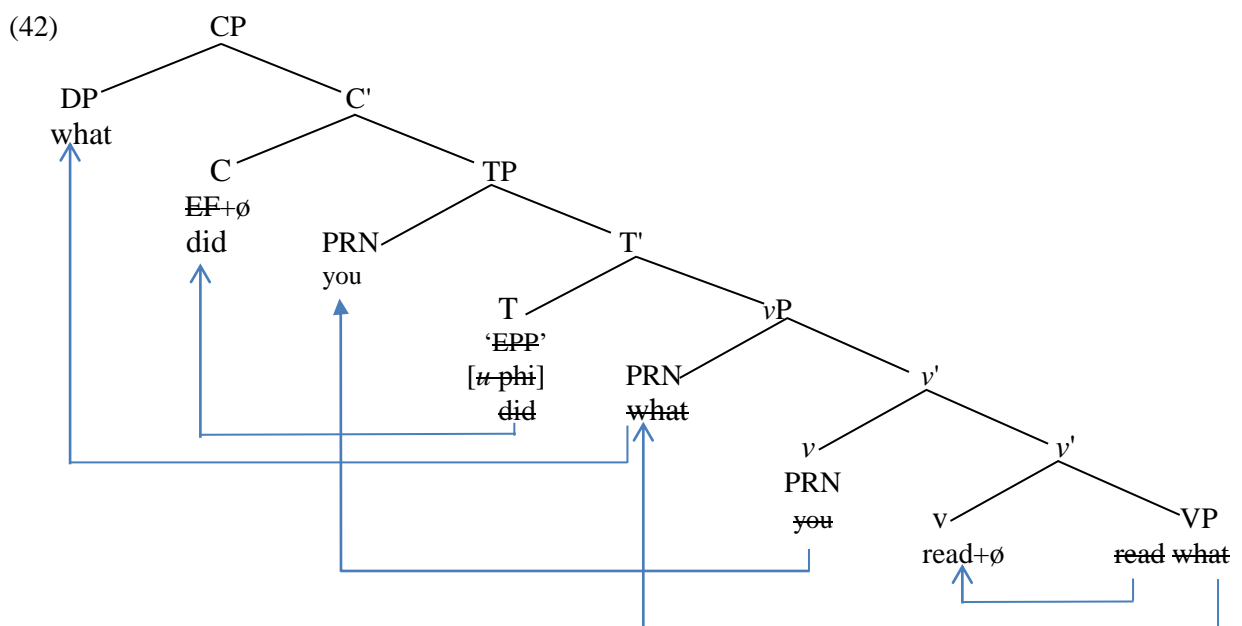

From the tree above, the wh-phase ‘what’ moves to the edge of the phase vP motivated by the EF on the phase head v, to be accessible for further operations as the condition (41) suggests. Therefore, the wh-phase ‘what’ can be probed by the C and is attracted by the EF on the phase head C to move to its specifier. Hence, the EF is satisfied and deleted in v and C. Note that the movement of the wh-phase ‘what’ to Spec-CP via Spec-TP is restricted by the following constraint which is suggested by Chomsky (2008), and formulated below by Radford (2009: 335):

(43) **Mixed Chains Constraint (MCC)**

Movement cannot give rise to a mixed chain containing one copy of a constituent which has moved to the edge of a phase, and another which has moved to the edge of non-phase projection.

The constraint in (43) applies that the result chain cannot contain two copies of extracted constituents from different projections. Therefore, in the structure (42), the constituent 'what' is restricted to move to the Spec-TP which is not a phase edge, then to Spec-CP which is a phase edge since it will result in a mixed chain.

**3.4 The Split CP hypothesis (Rizzi, 1997)**

Within the cartographic approach to the clausal left periphery, Rizzi (1997) proposes the split CP hypothesis, which assumes that CP should be split for more than one type of projection, located between CP and TP. He investigates Italian data to define the left periphery clause structure through the following examples (Rizzi 1997: 288):

	C	Topic						
(44) a.	Credo	<b>che</b>	<b>loro</b>	apprezzerebbero	molto	il	tuo	libro
	believe.1s	that	they	appreciated.3pl	much	the	your	book

'I believe that they would appreciate your book very much.'

		Topic		C				
b. *	Credo	<b>il tuo libro,</b>	<b>che</b>	loro lo	apprezzerebbero	molto		
	believe.1s	the your book	that	they it	appreciated.3pl	a lot		

'I believe that your book, they would appreciate it a lot.'

		Topic		C				
c.	Credo,	<b>il tuo libro,</b>	<b>di</b>	apprezzarlo	molto			
	believe.1s	the your book	that	appreciate.3pl	a lot			

'I believe your book, "of" they would appreciate it a lot.'

على النص الذي ترغب في أن يظهر هنا. 2.Heading خطأ! استخدم علامة التبويب "الصفحة الرئيسية" لتطبيق  
 على النص الذي ترغب في أن يظهر هنا. 2.Heading خطأ! استخدم علامة التبويب "الصفحة الرئيسية" لتطبيق

C Topic

d. \*Credo **di il tuo libro**, apprezzarlo molto  
 believe.1s that the your book appreciate.3pl a lot  
 'I believe "of" your book they would appreciate it a lot.'

C Top Foc Top IP

e. Credo **che a Gianni, QUESTO, domani**, gli dovremmo dire  
 believe.1s that to Gianni THIS tomorrow the we should say  
 'I believe that to Gianni, THIS, tomorrow we should say.'

The examples in (44a-e) contain two kinds of complementizers; *che* and *di*. The complementizer *che* is applied with finite sentences, and the topic phrase *loro* must follow that complementizer as (44a) and never precede it as the ungrammaticality of (44b) shows. By contrast, the complementizer *di* is applied with non-finite sentences, and the topic phrase *il tuo libro* must precede *di* as in (44c) and never follow it as the ungrammaticality of (44d) shows. In (44-e), the complementizers *che* appear and is followed by two topic phrases *Gianni* and *domani* respectively while the focus phrase *QUESTO* is sandwiched between these topics.

Rizzi additionally observes that the relative order between topics and operators in Italian depends on the type of operator involved. A relative operator, for instance, must precede the topic elements as (45a), and this accounts for the ungrammaticality in (45b). However, a question operator must follow the topic element as in (46a), and this accounts for the ungrammaticality in (46b). This contrast leads Rizzi to assume that there are two topic positions which can precede or follow the focused phrase, as shown in the following examples (Rizzi 1997: 289):

Foc Top

(45) a. un uomo **a cui**, **il premio Nobel**, lo daranno senz'altro  
 a man to whom the prize Nobel it give.3p undoubtedly  
 'A man to whom, the Nobel Prize, they give it undoubtedly.'

Top Foc  
 b. \*un uomo, **il premio** Nobel **a cui** l daranno senz'altro  
 a man the prize Nobel to whom it give.3p undoubtedly  
 'A man, the Nobel Prize, to whom they give it undoubtedly.'

Top Foc  
 (46) a. **il premio** Nobel, **a chi** lo daranno?  
 the prize Nobel to whom it give.3p  
 'The Nobel Prize, to whom, will they give it?'

Foc Topc  
 b. \***a chi**, **il premio** Nobel, lo daranno?  
 to whom the prize Nobel it give.3p  
 'To whom, the Nobel Prize, they give it.'

According to the distributions of the examples (44a-e), (45a-b) and (46a-b), Rizzi concludes that in order for the left periphery to contain more than one element, CP must be split into several independent projections as in (47a) and the tree of Rizzi's proposal is represented in (47b):

(47) a. Force > (TopP) > FocP > (TopP) > FinP > IP



على النص الذي ترغب في أن يظهر هنا. 2.Heading خطأ! استخدم علامة التبويب "الصفحة الرئيسية" لتطبيق  
على النص الذي ترغب في أن يظهر هنا. 2.Heading خطأ! استخدم علامة التبويب "الصفحة الرئيسية" لتطبيق

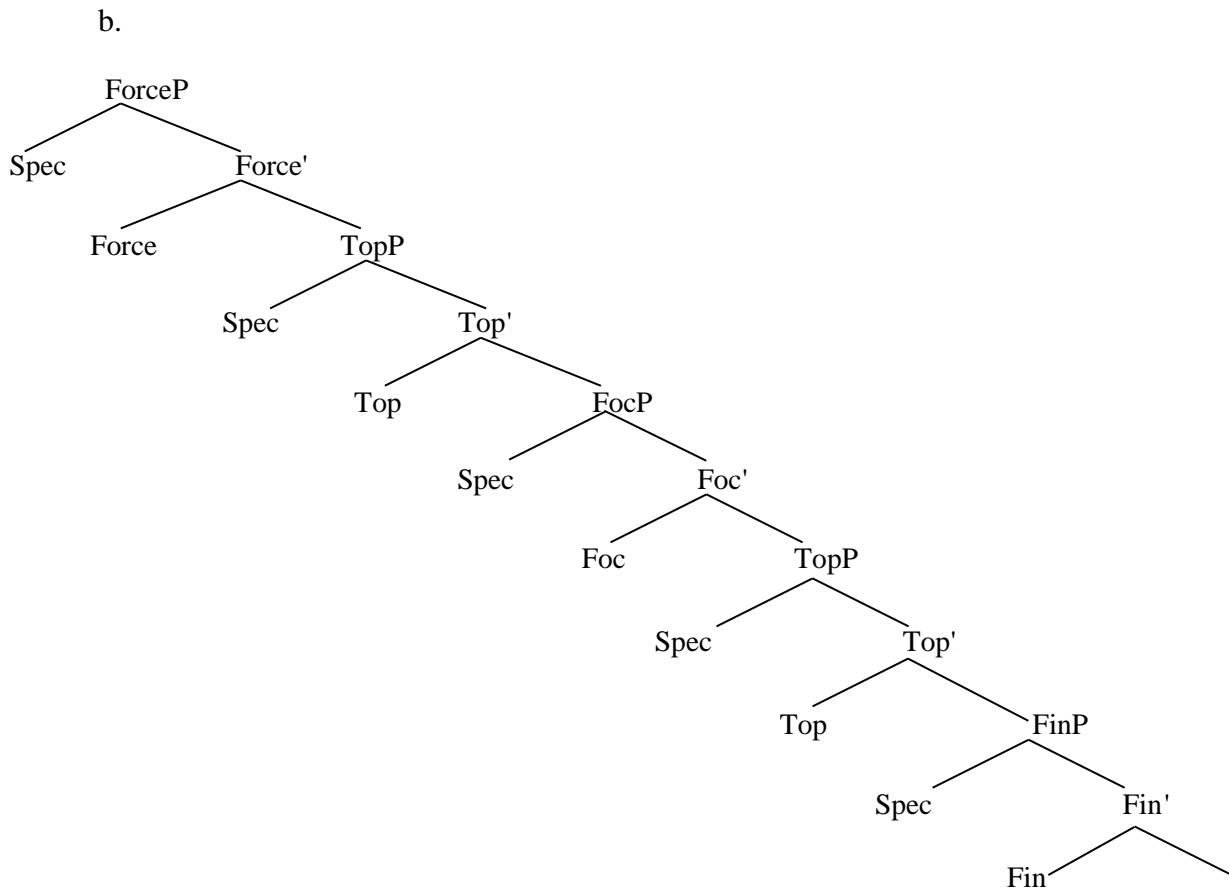

In this hierarchical structure, the highest projection is the Force Phrase (ForceP), while the lowest projection is the Finiteness Phrase (FinP). The former determines the illocutionary force or clause mood, e.g. indicative, interrogative whereas the latter selects TP. Between the ForceP and the FinP there is one FocP to host the focus phrase and there are two TopP projections that can contain topic phrases. One TopP precedes the FinP allowing the Focus phrase to precede it. Other TopP follows ForceP, and is higher than Focus phrase. All left periphery phrases are positioned in the specifiers to the left of the heads in their projections. These projections, however, project only when needed to host focus or topic phrases as necessary.

Rizzi (1997: 282), however, states that “all kinds of movement to the left periphery must be motivated by the satisfaction of some criteria”. The motivation for base generated Topic is by a Topic feature [+topic] while the motivation of Focus phrase movement has often been

claimed to be a Focus feature [+focus] on the focused phrase (e.g. Brody 1990; 1995; É. Kiss 2002) as in the following rules:

- (48) a. At S-structure and LF the Spec of Focus must contain a [+Focus] phrase.  
b. At LF all [+Focus] phrases must be in a FocP.

Rizzi (1997) distinguishes between Italian focus and topic phrases in a number of respects. First, a topic phrase is associated with a resumptive clitic if it is a direct object as in (49a) while if it is associated with a gap it will make an ill-formed example as in (49b) (Cinque 1990: 63).

Topic:

- (49) a. **Il tuo libro, lo** ho comprato. (Topic)  
the your book, I have bought  
'Your book, I bought it.'
- b. **Il tuo libro, t** ho comprato .  
the your book, t have bought  
\* 'Your book, I bought.'

This contrasts with a focus phrase that is associated with a gap as (50b) and can never be associated with resumptive clitic as the ungrammaticality of (50a) shows:

Focus:

- (50) a. \***Il tuo libro lo** ho comprato (non il suo).  
the your book I have bought (not his)  
'Your book I bought it (not his).'
- b. **Il tuo libro t** ho comprato (non il suo).  
the your book t have bought (not his)  
'Your book I bought (not his).'

على النص الذي ترغب في أن يظهر هنا. Heading 2 خطأ! استخدم علامة التبويب "الصفحة الرئيسية" لتطبيق  
 على النص الذي ترغب في أن يظهر هنا. Heading 2 خطأ! استخدم علامة التبويب "الصفحة الرئيسية" لتطبيق

Second, topic phrase never gives rise to any kind of Weak Crossover effect (WCO) as in (51a) while these effects obviously appear with the focus phrase as in (51b). The phenomenon of WCO is described by Lasnik & Stowell (1991: 14) "In a configuration where a pronoun P and a trace T are both bound by a quantifier Q, T must c-command P". The WCE raises only when the antecedent is quantificational element binding a variable (Rizzi 1997: 290):

- (51) a. **Gianni**, sua madre **lo** ha sempre apprezzato.  
 Gianni his mother him has always appreciated  
 'Gianni, his mother always appreciated him.'
- b. ??**GIANNI** sua madre ha sempre apprezzato *t* (non Piero).  
 Gianni his mother has always appreciated *t* not Piero  
 'GIANNI his mother always appreciated, not Piero.'

Third, it is not possible for a topic phrase to be a bare quantificational element such as *no one*, *all* etc. as in (52a), while focus phrase is possible as (52b) shows (Rizzi 1997: 290):

- (52) a. \***Ognuno** **I** ho visto.  
 everyone him have-1sg. seen  
 Lit: 'Everyone, I saw him.'
- b. **Ognuno** **t** ho visto.  
 everyone t have-1sg. seen  
 'Everyone I saw.'

Fourth, there can be more than one topic phrase per clause as in (53a), while only one focus phrase is available per clause (Cinque 1990; Culicover 1992; Boskovic 1997; Rizzi 1997) as in the grammaticality of (53b) shows (Benincà: 144):

- Top 1      Top 2      Top3
- (53) a. **Il libro, a Gianni, domani,** glielo daro' senz'altro  
 the book to Gianni tomorrow him-it will give-1sg. for sure  
 'The book, to Gianni, tomorrow, I'll give it to him for sure.'
- Foc 1              Foc 2
- b. \***A Gianni il libro** daro' (non a Piero, l'articolo).  
 to Gianni the book will give-1sg. not to Piero the article  
 'To John the book, I'll give, not to Piero, the article.'

The focus phrase, therefore, can be preceded and followed by topic phrases in one clause as the following example, because multiple topics are possible.

- (54) **A Gianni, QUESTO domain,** gli doverte dire (Top > Foc > Top)  
 'To Gianni, THIS, tomorrow, you should tell him.'

Fifth, a topic phrase is compatible with wh-element in the fixed order as in (55a), while a focus phrase is not compatible with it as in (55b):

- (55) a. **A Gianni,** che cosa gli hai detto? (Top > wh)  
 'To Gianni, what did you tell?'
- b. \***A GIANNI** che cosa hai detto (, non a Piero)? (Foc > wh)  
 'to GIANNI what did you tell (, non a Piero)?'

The topic and focus, however, must to be in Top > Foc order only as in (55a), otherwise, it induces ungrammaticality as shown below:

- (56) \***Che cosa, a Gianni,** gli hai detto? (wh > Top)  
 'What, to Gianni, did you tell him?'

Rizzi (1997: 297) justifies the impossibility of multiple focus phrases per clause to fact that the focus head complement represents presupposed of information that cannot contain any focused element representing new information. Thus, a focused phrase never shows up as a complement to additional focused phrase.

### 3.5 Conclusion

The chapter gives some backgrounds of left periphery, namely topic and focus. The term left dislocation refers to two different constructions: topicalized and left-dislocated topic. The left-dislocated topic has been divided into three different types: CLLD, HTLD and CLD that show some similarities and differences in their clausal structures. Although there is an agreement on the movement analysis of topicalized topic, there is a debate of movement analyses for left-dislocated topics. However, it has been showed that both topicalized and left-dislocated topic can have movement and base-generated analyses and they are seen by the availability of connectivity between LD topics and their resumptive pronouns such as matching of case. LD topics are moved elements if they obtain any kind of connectivity with their resumptive pronouns, and such structures can be found in some languages like German, Greek and Czech. LD topics are base-generated elements if they are not in a connectivity relation as in the analyses of English by Gundel (1975) and Chomsky (1977).

Focus is discussed within information structure in different kinds of articulations: presupposition and focus articulation, theme and rheme articulation, topic and comment articulation, open proposition and focus articulation and ground and focus articulation. Focus has two types which are broad and narrow focus. The broad focus can be either predicate and sentence focus. The wh-question is instance of focus and can be analysed within different minimalist assumptions.

Rizzi (1997) proposes the split CP hypothesis, which assumes that CP should be split for more than one type of projection, located between CP and TP. Within Italian data, there are

two topic positions and one focus position between the two topic positions while complementizers can precede or follow topics.

## **Chapter 4 The syntax of the left periphery in MSA and TA**

### **4.1 Introduction**

The aim of this chapter is to introduce syntactic description and analysis of the left periphery in MSA and TA. This chapter is composed of six main sections. Section two describes topic and focus constructions in MSA. This section investigates the different types of topic and focus phrases exhibited in the left periphery, demonstrating the interaction between them. Section three presents the cartography approach with special attention paid to the interaction between topic and focus phrases in MSA. Section four extends the argument topic and focus in TA, whereas section five advances a cartographic account of the TA left periphery. Conclusions are drawn in section six.

### **4.2 The description of topic and focus in MSA**

#### **4.2.1 Topic types**

In MSA, as explained in chapter 2, topics can appear in two different patterns: a topic that is associated with a resumptive clitic in an object position and a topic that is associated with *pro* in a subject position. To illustrate these topics, consider how the basic clause (VSO) in (1a) can relate to two different topic structures as in (1b-c) (topic types and their co-referential pronouns are in bold):

- (1) a. ʔakala            r-radʒul-u            t-tuffaaħat-a            (VSO)  
          ate.perf.3ms    the-man-nom        the-apples-acc  
          ‘The man ate the apples.’
- b. **ar-radʒul-u**            *pro*    ʔakala            t-tuffaaħat-a            (Topic-pro-V-O)  
          the-man-nom                            ate.perf.3ms    the-apples-acc  
          ‘The man ate the apples.’
- c. **at-tuffaaħat-u**    ʔakala-**haa**            r-radʒul-u            (Topic-V-clitic-S)  
          the-apples-nom    ate.perf.3ms-it        the-man-nom  
          ‘The apples, the man ate it’

Comparing the structures of the examples (1a-c), it is observed that the example (1b) is an SVO clause where the preverbal DP ‘the man’ is in the left peripheral domain and is coreferential with ‘he’ (*pro*) in the subject position (Spec-TP) as I explained in 2.6.3. In (1c), the DP ‘the apples’, similarly to (1b), is a left dislocated element but it corresponds to the overt resumptive clitic *haa* ‘it’ in the object position of the verb ‘eat’. To differentiate between the two instances of topic phrases in (1b-c), I suggest the following: since the DP topic ‘the man’ in (1b) is the subject of the clause, I refer to it as Subject Topic (STop henceforth) and since the DP topic ‘the apples’ in (1c) is the direct object of finite verb ‘eat’, I name it as Object Topic (OTop, henceforth).

OTop and STop structures are different kinds of topics and are quite distinguishable in their clause structures. To complete the picture of the two types of topic I outline some similar and contrasting properties between OTop and STop phrases. Beginning with the similarities, one of the most obvious similar properties is that both OTop and STop phrases are obligatory to be have either definiteness and specificity conditions. OTop and STop phrases must be a definite element or a specific indefinite element while a pure indefinite element is not allowed (see 2.6.3 for more details).<sup>9</sup> The definiteness of OTop and STop phrases can be

<sup>9</sup> Ayoub (1981:2) denies the definiteness and specificity condition for the STop phrase where the constructions reporting extraordinary actions as the following example shows:



على النص الذي ترغب في أن يظهر هنا. 2.Heading خطأ! استخدم علامة التبويب "الصفحة الرئيسية" لتطبيق  
على النص الذي ترغب في أن يظهر هنا. 2.Heading خطأ! استخدم علامة التبويب "الصفحة الرئيسية" لتطبيق

shown as a noun phrase which is marked with the definite article *al* 'the' as in (1a-b), names as (2a-b), strong pronouns as in (2c-d) or demonstrative pronouns as in (2e-f):

- (2) a. **ʕaliyy-un** *pro* qaraʔa l-kitaab-a  
Ali-nom read.perf.3ms the-book-acc  
'Ali read the book.'
- b. **ʕaliyy-un** qaabalat-**hu** hind-un  
Ali-nom met.perf.3fs-him Hind.nom  
'Ali, Hind met him.'
- c. **hiya** *pro* ta-ʔkulu t-tuffaaḥ-a bikaṮrat-in  
she 3f-eat.imperf.s the-apple-acc abundantly-gen  
'She eats the apple abundantly.'
- d. **huwa** raʔaytu-**hu** fi-l-madiinat-i  
she saw.perf.1s-him in-the-city-gen  
'Him, I saw him in the city.' (Aoun et al. 2010: 195)
- e. **haḏaa** l-muʕallim-u *pro* ya-ʕrifu kull-a T-Tullaab-i  
this the-teacher-nom 3m-know.imperf.s all-acc the-students.gen  
'This teacher knows all the students.'
- f. **haḏaa** l-muʕallim-u ya-ʕrifu-**hu** kull-u T-Tullaab-i  
this the-teacher-nom 3m-know.imperf.s-him all-nom the-students.gen  
'This teacher, all the students know him.'

The motivation of OTop and STop to respect definiteness or specificity condition is related to the pragmatic/semantic purposes. For the pragmatic purposes, the nature of topic element is

- (i) baqarat-un ta-kallamat  
cow-nom 3f-spoke-s  
'A cow spoke.'

Mohammed (2000) comments that such a structure as in (i) can be justified because of "newsworthiness".

always “given information” and imposes an aboutness property (see Reinhart 1981 for the notion of ‘aboutness topic’). For semantic purposes, indefinite DPs cannot establish co-referential relations with resumptive pronouns.

The second shared property is about the category type of OTop and STop phrases. Cinque (1977; 1990) postulates that any phrase can be left dislocated. The fact is that both topic types in MSA are restricted to arguments. This is due to the fact that the topic must bind either a resumptive pronoun or a pro subject, and these are elements which only occupy argument positions (Aoun et al. 2010: 193). As such, it is expected that only DPs can function as OTop or STop phrases. Consider the ungrammaticality of the following examples:

- (3) a. \*?ila hind-in      ?aʕTaa-haa      l-muʕallim-u      jaaʕizat-an  
to Hind-gen      gave.perf.1ms-her      the-teacher-nom      prize.acc  
‘To Hind, the teacher gave her a prize.’
- b. \*nafs-u-hu      *pro*      raʕat      ?aħmad-a  
self.f-nom-his      saw.perf.3fs      Ahmad-acc  
‘Himself saw Ahmad.’
- (Mohammad 2000: 149)

In, (3a) the PP ‘to Hind’ cannot be dislocated and coreferential to the resumptive clitic *haa* ‘her’ inside the clause. In (3b), the reflexive ‘himself’ grammatically cannot be associated with the pro subject inside the clause.

The third shared property concerns case. The two topic types typically receive nominative case as in the previous examples demonstrate, since nominative is the default case for DPs topic (Fassi Fehri 1993: 45; Ouhalla 1994b; Mohammad 2000: 86; Aoun et al. 2010: 38). Topic phrases as in (4a-b) are not allowed to have other cases e.g. accusative or genitive case:

على النص الذي ترغب في أن يظهر هنا. Heading 2 خطأ! استخدم علامة التبويب "الصفحة الرئيسية" لتطبيق  
على النص الذي ترغب في أن يظهر هنا. Heading 2 خطأ! استخدم علامة التبويب "الصفحة الرئيسية" لتطبيق

- (4) a. \***al-maal-a/i**                    ʔaʕTaa-**hu**                    ʕaliyy-un                    li-hind-in  
the-money-acc/gen                    gave.perf.3ms-it                    Ali-nom                    to-hind-gen  
‘The money, Ali gave it to Hind.’
- b. ʔ**aliyy-\*an/ \*in**                    *pro*                    ʔaʕtaa                    l-maal-a                    li-hind-in  
Ali-acc/ gen                    gave.perf.3ms                    the-money-acc                    to-Hind-gen  
‘Ali gave the money to Hind.’

Fassi Fehri (1993: 45) points out that “subjects in SVO sentences receive default nominative only in the absence of external governors, otherwise, they receive specific structural cases from the latter.” A DP in Arabic, for instance, can receive accusative case when it is positioned embedded and preceded by the Comp *ʔinna* or *ʔanna* which will be discussed in detail in Chapter 5.

Despite for all these similarities between OTop and STop phrases, some differences can be attested between both topic types. The first contrasting property is connectedness. Although OTop and STop are associated with the clause-internal positions, they have different strategies of connectedness. The OTop phrase must correspond to an overt resumptive pronoun inside the rest of the clause in different positions such an object position as in (5a), a construct state position as in (5b), and a prepositional phrase as in (5c):

- (5) a. **al-kitaab-u**                    qaraʔa-**hu**                    ʕaliyy-un  
the-book-nom                    read.perf.1ms.it                    Ali-nom  
‘The book, Ali read it.’
- b. **faatimat-u**                    ʔʕtarat                    zaynab-un                    bayt-a-**haa**  
Fatimat-nom                    bought.perf.3fs                    Zaynab-nom                    house-acc-her  
‘Fatimat, Zaynab bought her house.’

(Bakir 1980:





- b. \***aT-Tullaab-u**      *pro*      qaraʔa      l-kutub-a  
the students.m-nom      played.perf.3ms      the-books-acc  
‘The students read the books’
- c. **al-kutub-u**      qaraʔa-**haa**      T-Taalib-u  
the books-nom      read.perf.3ms-them      the-student-nom  
‘The books, the student has read them.’

In (9a), the *pro* subject ‘they’ displays full agreement with the verb ‘read’. In addition, the preverbal S<sub>Top</sub> phrase ‘the students’ has identical full agreement features. Otherwise, the clause is ill-formed as (9b) shows. Thus, it is reasonable to postulate that the preverbal S<sub>Top</sub> phrase ‘the students’ is co-indexed with the *pro* subject ‘they’. By contrast, the example in (9) indicates that there is no such co-indexing between the O<sub>Top</sub> ‘the books’ and the verb ‘read’ which has partial agreement with the postverbal subject ‘the student’.

The third contrasting property between O<sub>Top</sub> and S<sub>Top</sub> phrases is the availability of multiple phrases. O<sub>Top</sub> elements can be multiple per clause as in (10a), while the S<sub>Top</sub> cannot be multiple as the ungrammatical example in (10b):

- (10) a. **zayd-un<sub>i</sub>**      **zaynab-u<sub>j</sub>**      ʔaʕTaytu-**hu<sub>i</sub>**      kitaab-a-**haa<sub>j</sub>**  
Zayd-nom      Zaynab-nom      gave.perf.1s-him      book-acc-her  
‘Zayd, Zaynab, I gave him her book.’      (Aoun et al. 210: 206)
- b. \***ʔahmad**      **hind-un**      *pro*      qaraʔaa      l-kitaab-a  
Ahmad-nom      Hind-nom      read.perf.2md      the-book-a  
‘Ahmad and Hind read the book.’

In (10a), the DPs ‘Zayd-un’ and ‘Zaynab’ are multiple O<sub>Top</sub> phrases corresponding to the resumptive clitics ‘him’ and ‘her’ respectively. In (10b), ‘Ahmad’ and ‘Hind’ are multiple S<sub>Top</sub>s causing an ill-formed sentence.

على النص الذي ترغب في أن يظهر هنا. 2.Heading خطأ! استخدم علامة التبويب "الصفحة الرئيسية" لتطبيق  
على النص الذي ترغب في أن يظهر هنا. 2.Heading خطأ! استخدم علامة التبويب "الصفحة الرئيسية" لتطبيق

The fourth contrast between the both topics is the fact that the OTop element always receives pitch higher than other elements in the sentence. Moreover, it is always set off from the following part of the sentence by an intonational pause. This observation of OTop phrase in MSA is stated by a number of researchers with different types of topic phrase. Rizzi (1997) defines the topic phrase as set off from the clause by 'comma intonation', and Cinque (1977: 405-410) asserts that both CLD and CLLD are separated from their following clauses by intonational breaks with different degrees of gradation. The STop element, in contrast, has no higher pitch, and there is no intonational pause following it.

To sum up, the following table summarises the main similarities and differences of OTop and STop phrases:

Topic's Properties	OTop	STop
Definiteness/Specificity condition	Obligatory	Obligatory
Conferential relation	Obligatory with resumptive clitic	Obligatory with a null <i>pro</i>
Possible category	Only DPs	Only DPs
Case	Nominative	Nominative
Multiple topics	Possible	Not possible
Higher pitch & intonational pause	Yes	No

Table 4.1 Topic types properties

#### 4.2.2 The distribution between OTop and STop phrases

Now my discussion turns to the interaction between OTop and STop. A sentence that contains any OTop phrase in MSA has been traditionally divided into two parts: the topic which comes usually initial and the comment which can have different patterns, such as a verbal clause as in (11a), or a nominal clause as (11b):

- (11) a. **al-kitaab-u**      qaraʔa-**hu**      ʕaliyy-un  
           the-book-nom      read.perf.3ms-it      Ali-nom  
           ‘The book, Ali read it.’
- b. **al-kitaab-u**      lawna-**hu**      dʒamiil-un  
           the-book-nom      colour-its      beautiful.nom  
           ‘The book, its colour is beautiful.’

The STop phrase can appear with a verbal comment clause as in (12a) or an adjective phrase (12b) or a prepositional phrase as in (12c).

- (12) a. **ʕaliyy-un**      *pro* qaraʔa      l-kitaab-a  
           Ali-nom                      read.perf.3ms      the-book-acc  
           ‘Ali read the book.’
- b. **al-kitaab-u**      mufiid-un  
           the-book-nom      useful.nom  
           ‘The book is useful.’
- c. **ʕaliyy-un**      fii      l-bayt-i  
           Ali-nom      in      the-house-gen  
           ‘Ali is in the house.’

The OTop and STop phrases are not in complementary distribution, and they can occur in one clause. The question that presents itself is what is the relative order between OTop and STop



على النص الذي ترغب في أن يظهر هنا. 2.Heading خطأ! استخدم علامة التبويب "الصفحة الرئيسية" لتطبيق  
على النص الذي ترغب في أن يظهر هنا. 2.Heading خطأ! استخدم علامة التبويب "الصفحة الرئيسية" لتطبيق

phrases? It has been given some attention in the literature on the Arabic grammar to answer the question. Bakir (1980), for instance, assumes that two DPs in a clause-initial position can appear in either order as long as the subject is distinguishable:

- |         |                         |                |                  |                    |             |
|---------|-------------------------|----------------|------------------|--------------------|-------------|
|         | STop                    |                | OTop             |                    |             |
| (13) a. | <b>hind-un</b>          | <i>pro</i>     | <b>saalim-un</b> | <b>dharabat-hu</b> | STop > OTop |
|         | Hind.f-nom              |                | Salem.m-nom      | hits.perf.3fs-him  |             |
|         | 'Salim, Hind hits him.' |                |                  |                    |             |
|         |                         |                |                  |                    |             |
|         | OTop                    |                | STop             |                    |             |
| b.      | <b>saalim-un</b>        | <b>hind-un</b> | <i>pro</i>       | <b>dharabat-hu</b> | OTop > STop |
|         | Salem.m-nom             | Hind.f-nom     |                  | hits.perf.3fs-him  |             |
|         | 'Salim, Hind hits him.' |                |                  |                    |             |

However, Bakir (1980: 162-163) supports the OTop > STop order where two initial DPs in one clause are of the same number and gender as the following example:

- |      |                          |                |            |                  |  |
|------|--------------------------|----------------|------------|------------------|--|
| (14) | <b>faatimat-u</b>        | <b>hind-un</b> | <i>pro</i> | <b>raʔat-haa</b> |  |
|      | Fatimat.f-nom            | Hind.f-nom     |            | see.perf.3fs-her |  |
|      | 'Fatimat, Hind saw her.' |                |            |                  |  |
|      | *Hind, Fatimat saw her.' |                |            |                  |  |
- (Bakir 1980: 163)

In (14), the DP 'Fatimat' occurs initially and is followed by the DP 'Hind'. The verb 'see' shows agreement features '3fs' which could match either of the initial DPs 'Fatimat' and 'Hind'. Grossly speaking, either initial DP can be interpreted as STop or OTop phrase. However, this interpretation leads to an ambiguous structure, and Bakir (1980) proposes that in such clauses as (14), they should be constructed with the second DP as the subject of the verb. Accordingly, the initial DP 'Fatimat' must be interpreted as the OTop phrase, while the second DP 'Hind' must be interpreted as the STop phrase.

The interaction between OTop and STop also takes place in a multiple topic clause that has three topic phrases. Recall that OTop can iterate while STop is a unique in MSA clause structure. One way to form a multiple topic construction is by having one or two OTop phrase with one STop phrase in a particular order as in the following examples:

- (15) a. OTop            OTop            STop  
 a. **zayd-un<sub>j</sub>**    **zaynab-u<sub>i</sub>**    **hind-un<sub>k</sub>**    *pro<sub>k</sub>*    ?aʕTat-**haa<sub>i</sub>**    kitaab-a-  
**hu<sub>j</sub>**  
 Zayd.m-nom    Zaynab.f-nom    Hind.f-nom                    gave.perf.3fs-her    book-acc-his  
 ‘Zayd, Zaynab, Hind gave her his book.’
- b. STop            OTop            OTop  
 b. **hind-un<sub>j</sub>**    **zayd-un<sub>i</sub>**    **zaynab-u<sub>k</sub>**    *pro<sub>j</sub>*    ?aʕTat-**hu<sub>i</sub>**    kitaab-a-  
**haa<sub>k</sub>**  
 Hind.f-nom    Zayd.m-nom    Zaynab.m-nom            gave.perf.3fs-him    book-acc-her  
 ‘Zayd, Zaynab, Hind gave him her book.’

In (15a-b), there are multiple topics construction with three initial DPs. In (15a), the DPs ‘Zayd’ and ‘Zaynab’ are OTop phrases corresponding to the resumptive pronouns inside the clause ‘him’ and ‘her’ respectively while the DP ‘Hind’ is the STop phrase corresponding to the *pro* subject ‘she’. Therefore, the multiple topic construction in (15a) shows the OTop phrases preceding the STop phrase. By contrast, (15b) shows the reverse order between the OTop phrases and the STop phrase, since the STop phrase ‘Hind’ appears preceding both OTop phrases ‘Zayd’ and ‘Zaynab’ and the sentence is still well-formed.

### 4.2.3 Topic types and CLD classification

Consider the properties of OTop and STop phrases in MSA in table 4.1 with respect to the classification of topic as CLD, CLLD or HTLD as shown 3.2.2. Which type of topic does the MSA topic phrases belong to? The literature on the LD topic is very rich within the generative analysis. We have substantially relied in our classification of MSA topic phrases

on Cinque (1990). Given MSA topic's classifications, it should be noted that the MSA topics share two properties with HTLD in Italian which are (i) there is no obligatory connectivity and (ii) violating island conditions. Moreover, MSA topic shares two properties of CLLD in Italian and the same properties with German and Greek, which are corresponding to a resumptive pronoun and the availability of multiple topics. MSA topics, however, do not share any property with CLD in German and Greek. This observation leads us to assume that MSA topic are not CLD and are more to be like CLLD or HTLD. So far, it is not clear whether MSA topics are CLLD or HTLD and the further clarification is difficult to capture. Support for this comes from the assumption of Ouhalla (1994b: 4) who writes that "Cinque (1990) has shown that sentences which involve a left-dislocated phrase and a resumptive pronoun, the phenomenon which came to be known as CLLD show signs of movement too at least in some languages. The tests he uses for detecting movement in such sentences are hard to apply to Standard Arabic". However, Ouhalla (1994b) and Aoun et al. (2010) are in agreement that the MSA topics are an instance of CLLD more than other topic classes.

Looking again at the MSA topic with respect to its shared properties, we realize that it has two types of shared properties with topic's classifications. It shares with CLLD in distribution, since it occurs embedded multiple and corresponds to resumptive pronouns, while it shares HTLD in terms of the absence of connectedness and lack of island sensitivity. I assume, following Ouhalla (1994b) and Aoun et al. (2010), that topic in MSA is CLLD rather than HTLD. The reason to support this analysis of MSA topic, I assume, is that the properties of HTLD are not consistent cross-linguistically, the connectivity property, for instance, varies. Some languages like English have a base-generated analysis for topic (Chomsky 1977) because they show no connectivity, while other languages have a movement analysis for topic as Italian (Cinque 1990) for the opposite reasons. The insensitivity to islands property is a result of connectedness and the base-generated analysis and is not an independent one.



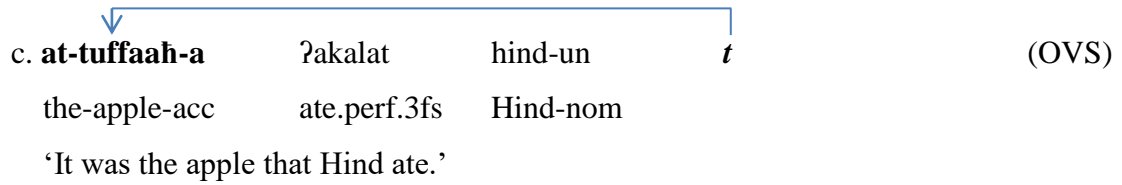

The answers (17a-c) of the question (16) contribute new information through the DP object ‘the apple’ which occupies various positions. In (17a), the DP object ‘the apple’ occupies an in-situ position to produce the VSO. In (17b), the object DP ‘the apple’ optionally undergoes movement from its base position to the clause-internal position leaving a trace behind it. The focus phrase ‘the apple’ then lands between the verb ‘eat’ and the subject ‘Hind’ forming VOS. In (17c), the object DP ‘the apple’ is fronted from its base position to the clause-initial position preceding the VS clause ‘eat Hind’ and forming OVS order and this is known as fronted focus.

The three types of narrow focus in (17a-c) have significant differences in their syntactic and semantic respects. Syntactically, the focused phrase ‘the apple’ in (17a) occupies an object position and does not require any syntactic movement operation. In (17b-c), however, the object DP ‘the apple’ leaves its base position and so involves syntactic movement operations. In (17b) the object DP ‘the apple’ undergoes movement to an A position below the verb, while it undergoes movement to A-bar position higher than the verb in (17c).

In addition to the difference of syntactic positions, Moutaouakil (1989) postulates that the in-situ focus as (17a) and the fronted focus as (17c) are semantically different in discourse. An in-situ focus phrase can only give new information while a fronted focus phrase could also be functioning as a contrastive reading that perhaps corrects the existing information. According to Moutaouakil (1989), the answer of the question (16) can be (17a) with the focus phrase being in an in-situ position while the fronted focus can be constructed as a contrastive focus. Ouhalla (1994b) suggested one way to construct the fronted contrastive focus by using a negative continuation. Consider the contrastive fronted focus in (18) as the contrastive focus interpretation of (17c):

- (18) **al-mawz-a**      ʔakalat      hind-un      *t*      laa      t-tuffaah-a  
 the-bananas-acc   ate.perf.3fs   Hind-nom      not      the-apple-acc  
 'It was bananas that Hind ate, not the apple.'

Ryding (2005) offers a pragmatic motivation for narrow focus which is found in VOS order. According to her, this order for focus especially is specified when the object is noticeably shorter than the subject in the sentence. Hence, the information flows more easily in the discourse as in (19):<sup>10</sup>

- (19) ʔʔtaraa      **t-tuffaah-a**      madʒmuuʕat-un      min      l-muzaariʕ-iina      *t*  
 bought.perf.3fs   the-apple-acc   group-nom      of      farmers-gen  
 'It was the apple that a group of farmers bought.'

The second focus type in MSA is the sentence focus. In this type, the sentence rather than single object is focused. The sentence focus can either be in an in-situ position as in (20b) or fronted and focused as in (20-c) which are the answers of the question in (20a):

- (20) a. maaḏaa      faʕalat      hind.un  
 what      did.perf.3fs      Hind.nom  
 'What did Hind do?'
- b. hind-un      ʔakalat      **t-tuffaah-a**  
 Hind-nom   ate.peref.3fs   the-apple-acc  
 'Hind ate the apple.'
- c. **at-tuffaah-a**      ʔakalat      hind-un      *t*  
 the-apple-acc      ate.perf.3fs      Hind-nom  
 'It was the apple that Hind ate.'

<sup>10</sup> Chomsky (2001: 35) assumes that the head *v* may bear an EPP feature. This is only allowed if the existence of this feature plays semantic role in the structure. The focus phrase which occurs in an internal position forming VOS order can be accounted by assuming an EPP feature on the head *v*. The focus phrase then is attracted to the outer edge of *v*P to add the focus interpretation to the structure.

على النص الذي ترغب في أن يظهر هنا. 2.Heading خطأ! استخدم علامة التبويب "الصفحة الرئيسية" لتطبيق  
على النص الذي ترغب في أن يظهر هنا. 2.Heading خطأ! استخدم علامة التبويب "الصفحة الرئيسية" لتطبيق

Since the fronted focus is the only type of focus that occurs in the left peripheral domain the rest of the chapter excludes other types of focus from the discussion. For simplicity, the fronted focus is referred to as ‘focus’.

#### 4.2.6 The nature of the fronted focus element

There are a number of observations relating to the focus phrase. First, a focus phrase, in contrast to a topic phrase, is not restricted by the definiteness or specificity condition. Bakir (1980) argues that a focus DP phrase is typically an indefinite property as (21):

- (21) **kitaab-an** wadzada muhammad *t*  
 book.acc found.perf.3ms Mohamad.nom  
 ‘It was a book that Mohammed found. (Bakir 1980: 57)

The focus phrase in contrast to the topic phrase always displays “new” or “relevant” information in the discourse. Following this path of analysis, the aboutness is not required for the focus phrase.

Second, a focus phrase must be associated with a gap as in the clause as (22a) shows. A focus phrase, however, cannot be associated with a resumptive pronoun as in (22b):

- (22) a. **at-tuffaah-a** ?akalat hind-un *t*  
 the-apple-acc ate.perf.3fs Hind-nom  
 ‘It was the apple that Hind ate.’  
 b. \***at-tuffaah-a** ?akalat-hu hind-un *t*  
 the-apple-acc ate.perf.3fs-it Hind-nom  
 ‘It was the apple that Hind ate.’

In (22a), in order for the DP ‘the apple’ to function as a focus phrase it must be associated with a gap inside the clause e.g. an object position. In (22b), at the first glance, it seems that

the DP 'the apple' is an OTop phrase or a focus phrase, but in fact it is neither. It is not an OTop phrase because 'the apple' appears as accusative, not nominative. It is not a focus phrase because 'the apple' is associated with a resumptive pronoun *ha* 'it', and not a gap. Thus, (22b) does not have any right interpretation and then it is ungrammatical. The contrasting examples in (22a-b) show that the gap in MSA goes with the focus interpretation while a DP corresponding to a resumptive or null pronoun has the topic property.

The distribution of the focus phrase with its coreferential gap is similar to the OTop phrase with its coreferential resumptive clitic. Both the focus and its gap can occur in a main clause as in the previous focus examples. Furthermore, the focus phrase can occur in the main clause which is associated with a gap in an embedded clause as exemplified below:

- (23) **ʕaliyy-an** zaʕama                      saalim-un    ʔinna    faatimat-a    tazawwadʒat    *t*  
 Ali-acc      claimed.perf.3ms    Salem.nom    that    Fatimat-acc    married.3fs  
 'Salim claimed that it was Ali that Fatimat married.'                      (Bakir 1980: 114)

In (23), the focus phrase 'Ali' is fronted from its base position in the embedded clause over the Comp *ʔinna* to the initial position of the main clause and leaves a gap behind.

Third, since the resumptive pronoun is absent in the focus structure, it does not restrict its corresponding phrase only to DP. It is expected, as a result, that a variety of phrasal categories can be focused in MSA. In addition to DPs, AdvP can be focused as in (24a), AP as in (24b), PP as in (24c) and wh-phrase as in (24d):

- (24) a. **bikaθrat-in**                      ʔakalat                      hind-un                      t-tuffaaḥ-a                      *t*  
 abundantly-gen                      ate.perf.3fs                      Hind-nom                      the-apple-acc  
 'It was abundantly that Hind ate the apple.'
- b. **miftaah-a**                      **l-bayt-i**                      faqadtu                      *t*  
 key-acc                      the-house-gen                      lost.perf.1s.  
 'It was the key house that I have lost.'



على النص الذي ترغب في أن يظهر هنا. Heading 2 خطأ! استخدم علامة التبويب "الصفحة الرئيسية" لتطبيق  
 على النص الذي ترغب في أن يظهر هنا. Heading 2 خطأ! استخدم علامة التبويب "الصفحة الرئيسية" لتطبيق

c. **bi-l-malfaqat-i**    ʔakalat    hind-un    l-wadʒbat-a    *t*  
 by-the-spoon-gen    ate.perf.3fs    Hind-nom    the-meal-gen

‘It was by spoon that Hind ate the meal.’

d. **maaḏaa**    qaraʔa    muhammad.un    *t*  
 what    read.perf.3ms    Mohaamad.nom

‘What did Mohammed read?’

Fourth, the fronting of the DP object focus phrase always retains the accusative case which is assigned by the verb in the lower position. The motivation of retaining the case is the fact that there is a chain formed between the focus phrase and the gap. Since the gap is in an object position where the focus phrase is assigned its case and moves, then, only accusative case is possible. Other cases assigned to the focus leads to ungrammaticality as in (25):

(25) \***at-tuffah-u/ i**    ʔakalat\_    hind-un  
 the-apple-nom/ gen    ate.perf.3fs    Hind-nom

‘It was the apple that Hind ate.’

Fifth, the fronted focus phrase cannot be multiple and only one focus phrase can be fronted per clause. Ouhalla (1994b: 69) states that “while more than one topic can be found in a given sentence, only one focus phrase can occur in the sentence-initial position.” Consider the possibilities of fronted focus phrases from their base position in the following examples:

(26) a. ʔakalat    hind-un    **t-tuffaah-a**    **bikaθrat-in**  
 ate.perf.3fs    Hind-nom    the-apple-acc    abundantly.gen

‘Hind ate the apple abundantly.’

b. **at-tuffaah-a**    ʔakalat\_    hind-un    *t*    **bikaθrat-in**  
 the-apple-acc    ate.perf.3fs    Hind-nom    abundantly.gen

‘It was the apple that Hind ate abundantly.’

- c. **bikaθrat-in**      ʔakalat\_      hind-un      **t-tuffaah-a**      *t*  
 abundantly.gen      ate.perf.3fs      Hind-nom      the-apple-acc  
 ‘It was abundantly that Hind ate the apple.’
- d. \***at-tuffaah-a**      **bikaθrat-in**      ʔakalat\_      hind-un      *t*      *t*  
 the-apple-acc      abundantly.gen      ate.perf.3fs      Hind-nom  
 ‘It was the apple that Hind ate abundantly.’

In (26a), there are two potential focus phrases which are ‘the apple’ and ‘abundantly’. Only one focus phrase is allowed to be fronted in clause-initial position as in (26b, c). The two focalized phrases being fronted results in an ungrammatical sentence as in (26d) shows.

Sixth, the distribution of the focus phrase is unique since only VS order is allowed in verbal focus clause in order to derive the adjacency fact (Bakir 1980) which strictly requires the verb to be adjacent to the focus phrase. Consider the following examples:

- (27) a. **at-tuffaah-a**      ʔakalat      hid-un      *t*      V > S  
 the-apple-acc      ate.perf.3fs      Hind-nom  
 ‘It was the apple that Hind ate’
- b. \* **at-tuffaah-a**      hind-un      ʔakalat      *t*      S > V  
 the-apple-acc      Hind-nom      ate.perf.3fs  
 ‘It was the apple that Hind ate’

In (27a), the focus phrase ‘the apple’ can stand in VS order ‘ate Hind’ as the adjacency condition is respected. In (27b), the focus phrase cannot stand in SV order ‘Hind ate’ since the adjacency condition is violated.

Seventh, according to traditional Arabic grammar, fronting the focus phrase cross the subject position is always associated with a higher degree of relevance in discourse or pragmatic importance (Erteschik-shir 1997: 11). Moreover, Moutaouakil (1989) and Ouhalla (1994b)

على النص الذي ترغب في أن يظهر هنا. 2.Heading خطأ! استخدم علامة التبويب "الصفحة الرئيسية" لتطبيق  
 على النص الذي ترغب في أن يظهر هنا. 2.Heading خطأ! استخدم علامة التبويب "الصفحة الرئيسية" لتطبيق

point out that focus phrases are marked by a primary stress which is usually termed “focal stress”.

The following table summarizes the properties of focus phrases features in MSA:

Table 4.2 Focus phrases features in MSA

Definiteness/specificity	Not obligatory
Coreferential	To a gap only
Focus phrase category	All categories are possible
Case for focus DP	Accusative only
Multiple focus	Not possible
Adjacency condition	Obligatory
Focal stress	Yes

#### 4.2.7 Wh-phrase focus

An interrogative clause in MSA is an instance of a focus clause (Ouhalla, 1994b; Shlonsky, 2000), since interrogative phrases have similar distributions to fronted focus phrases. The observation is that a wh-phrase must be as the front of a clause followed by the verb, representing the adjacency fact. The MSA wh-phrases are divided into two main categories: nominal and adverbial wh-phrases. Nominal wh-phrases are such as *man* ‘who’, *ma/maaḏaa* ‘what’, *ʔayy* ‘which’ and *kam* ‘how many/how much’. These nominal wh-phrases can be subjects or objects or adjuncts. Most wh-phrases are uninflected and they do not show any varying morphological features e.g. the case, gender and number like DPs do. However, the wh-phrase *ʔayy* ‘which’ is inflected and can show morphological features (i.e. case, gender and number). Since the wh-phrase *ʔayy* functions as focus associated with a gap it is restricted to accusative case *a* only as (28c) when it corresponds to an object. Consider the nominal wh-phrases as illustrated in (28a-d):

- (28) a. **man** qaraʔa r-risaalat-a?  
 who read.perf.3ms the-message.acc  
 'Who read the message?'
- b. **maaḏaa** ya-ʕmalu ʔaḥmad-u?  
 what 3m-work.imperf.s Ahmad-nom  
 'What did Ahmed do?'
- c. **ʔayy-a** lawn-in tuḥibbu?  
 which.ms-acc colour-gen like.2ms  
 'Which colour do you like?'
- d. **kam** kitaab-in ʔʔtaraa muhammad-un?  
 how many book-gen bought.perf.2ms Mohammad-nom  
 'How many books did Muhammad buy?'

Adverbial phrases such as *ʔayna* 'where', *mataa* 'when', *kayfa* 'how' and *limaaḏaa* 'why' are illustrated in (29a-d):

- (29) a. **ʔayna** raʔyata ʕaliyy-an?  
 where saw.perf.2ms Ali-acc  
 'Where did you see Ali?'
- b. **mataa** tuqliʕu T-Taʔirat-u?  
 when take-off.perf.3fs the-airplane-nom  
 'When does the airplane take off?'
- d. **kayfa** saafart hind-un  
 how travels.perf.3fs Hind-nom  
 'How does Hind travel?'
- d. **limaaḏaa** yu-hibbu l-aTfaal-u ʕ-ʕukulaatat-a?  
 why 3m-love.imperf.s the-children-nom the-chocolate-acc  
 'Why do children love chocolate?'

In the case of indirect questions, the wh-phrase still needs to occupy the clause-initial position followed by verb as the following examples (30a-d):

- (30) a. nasiitu            **?ayna**            qabal            ?ahmad-u            ?aliyy-an?  
forgot.perf.1s    where            met.3ms    Ahmad-nom    Ali-acc  
'I forgot where did Ahmad meet Ali.'
- b. \*nasiitu            ?ahmad-u            qabal            ?aliyy-an?            **?ayna**  
forgot.perf.1s    Ahmd-nom    met.3ms    Ali-acc            where  
'I forgot where did Ahmad meet Ali.'
- c. \*nasiitu            **?ayna**            ?ahmad-u            qabal            ?aliyy-an?  
forgot.perf.1s    where            Ahmd-nom    met.3ms    Ali-acc  
'I forgot where did Ahmad meet Ali.'
- d. \*nasiitu            ?ahmad-u            qabal            ?aliyy-an            **?ayna?**  
forgot.perf.1s    Ahmd-nom    met.3ms    Ali-acc            where  
'I forgot where did Ahmad meet Ali.'

MSA allows a multiple wh-phrase construction where two wh-phrases appear in one clause. Such a construction must have the following features: (i) only the nominal wh-phrases *man* 'who' and *maaḏaa* 'what' can form multiple wh-clauses as in (31a) while adverbial wh-phrases cannot be as in the ungrammaticality shown in (31b). (ii) Only one wh-phrase can be fronted followed by the verb, otherwise it is ill-formed clause as (31c-d) shows. (iii) The wh-subject must appear in a sentence-initial position while wh-object is in its in-situ position as in (31a), this is supported by 'Superiority Effects' (Mohammad, 2000) which entails that only the nearest wh-phrase can raise to the front position. The appearance of the wh-subject following the wh-object as in (31e) is not allowed.

- (31) a. **man**            ?akhaḏa            maaḏaa?  
who            took.perf.3ms    what  
'Who took what?'

- b. \*man      dʒaaʔa      mitaa  
 who      came.perf.3ms      when  
 'When did who come?' (Moutaouakil 1989: 48)
- c. \*man      man      zaara?  
 who      what      visted.perf.3ms  
 'Who visited whom?' (Aoun et al. 2010: 206)
- d. \*man      maaḏaa      ʔakhaḏa?  
 who      what      took.perf.3ms  
 'Who took what?'
- e. \*maaḏaa      ʔakhaḏa      man?  
 what      took.perf.3ms      who  
 'Who took what?'

Briefly, wh-phrases can be nominal or adverbial and one must be fronted and adjacent with the verb. Although a wh-phrase clause is an instance of a focus clause there is a main difference between them in relation to their position, since one wh-phrase is always fronted and cannot be in an internal position or in an in-situ position, unlike a focus phrase, unless it is in a multiple wh-constructions and then the object wh-phrase is allowed to be in situ.

#### 4.2.8 The interaction between topic and focus phrases in MSA

In this section, after showing the main properties of topic and focus, the discussion turns to the investigation of the interaction between topic and focus phrases. Let us begin with the interaction between the OTop and focus phrases. Only one order is possible between the OTop and focus phrases in MSA which is OTop > Focus (Bakir 1980; Fassi Fehri 1993; Mohammad 2000 and Aoun et al. 2010). The impossibility of having OTop phrase following the focus phrase is due to the adjacency requirement which forces the verb to be adjacent to the focus phrase. Consider the following schemas:

على النص الذي ترغب في أن يظهر هنا. 2.Heading خطأ! استخدم علامة التبويب "الصفحة الرئيسية" لتطبيق  
على النص الذي ترغب في أن يظهر هنا. 2.Heading خطأ! استخدم علامة التبويب "الصفحة الرئيسية" لتطبيق

- (32) a. OTop > Foc > V  $\longrightarrow$  adjacency is satisfied  
b. \*Foc > OTop > V  $\longrightarrow$  adjacency is not satisfied

Thus, MSA OTop and fronted focus phrases must have the order (32a) not (32b). An MSA OTop phrase, as a result, cannot appear following the focus phrase as it violates the adjacency condition and so it can only occupy the initial position of the sentence. Consider the following MSA examples from Bakir (1980: 29):

- (33) a. **faatimat-u**            **l-wardat-a**            **?aʕtaa-haa**            saalim-un    *t*  
Fatimat.nom            the-flower-acc            gave.perf.3ms-her    Salim-nom  
'It was the flower that Fatimat, Salim gave.'
- b. \***al-wardat-a**            **faatimat-u**            **?aʕtaa-haa**            saalim-un    *t*  
the-flower-acc            Fatimat.nom            gave.perf.3ms-her    Salim-nom  
'It was the flower that Fatimat, Salim gave.'

In (33a), the OTop 'Fatimat' which is associated with the resumptive clitic *haa* 'her' preceding the focus phrase 'the flower' that appears before the verb 'gave'. The reverse order between OTop and focus is not possible as the ungrammaticality in (33b) shows, since it violates the adjacency condition.

Evidence for relative order between the OTop phrase and the focus phrase comes from the distributions between OTop phrase and wh-phrase which as we have seen is an instance of focus phrase in MSA. The fact is that OTop and wh-phrase focus can stand together in one clause since they land in different positions and the wh-phrase always follows the OTop (Bakir 1980; Fassi Fehri 1993; Aoun et al. 2010). Consider the following examples:

- (34) a. **al-kitaab-u**            **mataa**            **ya-qraʔu-hu**            T-Tullaab-u            *t*  
the-book-nom            when            3m-read.perf.s-it            the students-nom  
'The book, when do the students read it?'

- b. \*mataa    l-kitaab-u    ya-qraʔu-hu    T-Tullaab-u    t  
 when    the-book-nom    3m-read.perf.s.it    the students-nom  
 ‘The book, when do the students read it?’

In (34a), the OTop ‘the book’ associates with the resumptive pronoun ‘it’ while the wh-phrase ‘when’ is focused in the following position and is associated with a gap. In (34b), putting the OTop phrase ‘the book’ between the focus phrase ‘when’ and the verb ‘read’ rules out the example. To correct this, the interrogative phrase must follow the OTop phrase ‘the book’ and the verb ‘read’ are adjacent to the wh-phrase ‘when’.

The relative order between OTop and focus phrases is extended to multiple OTop constructions. As we showed above, MSA allows multiple OTop phrases per clause when more than one OTop occurs. Consider the interactions of the multiple OTop phrases with the focused wh-phrase in the following distribution:

- (35) a. zayd-un<sub>i</sub>    zaynab-u<sub>j</sub>    limaaḏaa    ʔaʕTayta-hu<sub>i</sub>    kitaab-a-haa<sub>j</sub>  
 Zayd-nom    Zaynab-nom    why    gave.perf.2s-him    book-acc-her  
 ‘Zayd, Zaynab, why did you give him her book?’
- b. \*zayd-un<sub>i</sub>    limaaḏaa    zaynab-u<sub>j</sub>    ʔaʕTayta-hu<sub>i</sub>    kitaab-a-haa<sub>j</sub>  
 Zayd-nom    why    Zaynab-nom    gave.perf.2ms-him    book-acc-her  
 ‘Zayd, Zaynab, why did you give him her book?’
- c. \*limaaḏaa    zayd-un<sub>i</sub>    zaynab-u<sub>j</sub>    ʔaʕTayta-hu<sub>i</sub>    kitaab-a-haa<sub>j</sub>  
 why    Zayd-nom    Zaynab-nom    gave.perf.2ms-him    book-acc-her  
 ‘Zayd, Zaynab, why did you give him her book?’

The example in (35a) is grammatical since the two OTop phrases ‘Zayd’ and ‘Zaynab’ appear to the left of the wh-phrase ‘why’. The orders in (35b-c) are ungrammatical since both OTop phrases do not appear preceding the focus ‘why’ resulting in the adjacency condition being violated.



على النص الذي ترغب في أن يظهر هنا. 2.Heading خطأ! استخدم علامة التبويب "الصفحة الرئيسية" لتطبيق  
على النص الذي ترغب في أن يظهر هنا. 2.Heading خطأ! استخدم علامة التبويب "الصفحة الرئيسية" لتطبيق

---

For the interaction between the S<sub>Top</sub> and focus phrases, recall that S<sub>Top</sub> cannot be in a preverbal position when the focus phrase such wh-phrase appear as this order (S<sub>Top</sub> > focus > verb) does not exist in MSA (See 2.2.4).

To summarize the section, the interaction between topic and focus phrases in MSA shown that the O<sub>Top</sub> phrases must occupy the sentence-initial position preceding all other elements including the focus phrase while S<sub>Top</sub> phrases cannot stand with fronted focus phrases.

### 4.3 The cartographic approach to the left periphery of the clause in MSA

#### 4.3.1 Overview

In this section, I adopt the split CP hypothesis for the MSA data to identify the syntactic positions of the interactions between topic and focus in the left peripheral domain and the main differences with Italian. The section is divided into three parts. The second part outlines the study of Shlonsky (2000). Part three provides an alternative proposal of the MSA left peripheral domain.

#### 4.3.2 Shlonsky (2000)

Rizzi (1997) argues that there are two topic projections and one focus projection available in the clausal left periphery. The higher TopP precedes the FocP and lower TopP follows the FocP as illustrated in 3.4. Shlonsky (2000) follows the proposal of Rizzi (1997) and claims that the CP projections in Arabic generally would be seen as in (36):

$$(36) \text{ ForceP} > \text{ TopP} > \text{ FocP} > \text{ TopP} > \text{ FinP}$$

Shlonsky, however, assumes that MSA left clausal projections are ordered differently from (36) which is more compatible with other modern varieties of Arabic, more particularly in

accordance with possibility of having TopP below the FocP in MSA clause structure. His analysis is based on the observation of the relative order fact between OTop phrase and focus phrase. Note that Shlonsky discusses OTop phrase only and excludes STop from his analysis. He, following Brody (1990), assumes that the focus phrase, on the one hand, enters the derivation bearing the [+focus] feature and then must move to Spec-FocP. The focus phrase movement is motivated by the need to satisfy the Focus Criterion as stated below:

(37) Focus Criterion:

a. At S-structure and LF the Spec of an FP must contain a +f-phrase

b. at LF all +f-phrases must be in an FP (Brody 1990:

208)

The OTop, on other hand, has two potential positions with respect to Rizzi' analysis, in the higher Spec-Top or in the lower Spec-TopP. Assuming the OTop phrase in the lower TopP allows the focus phrase to be higher than the OTop phrase. By contrast, assuming the OTop phrase in the higher TopP prevents the focus phrase from being higher than the OTop phrase. According to Shlonsky, the possibility of the Topic phrase to occupy the higher or the lower positions is based just on whether the focus phrase can dominate the OTop phrase or not. In MSA, the answer is not possible because MSA holds the adjacency requirement and the verb must be adjacent to the focus phrase. Consider the relative order between OTop and focus phrases in (33a) repeated below in (38a) which has the structure in (38b):

- (38) a. (faatimat-u) l-wardat-a (\*faatimat-u) ʔaʕtaa-haa saalim-un  
 (Fatimat.nom) the-flower-acc (Fatimat.nom) gave.perf.3ms-her Salim-nom  
 'It is the flower that Fatimat, Salim gave.'

على النص الذي ترغب في أن يظهر هنا. 2.Heading خطأ! استخدم علامة التبويب "الصفحة الرئيسية" لتطبيق  
 على النص الذي ترغب في أن يظهر هنا. 2.Heading خطأ! استخدم علامة التبويب "الصفحة الرئيسية" لتطبيق

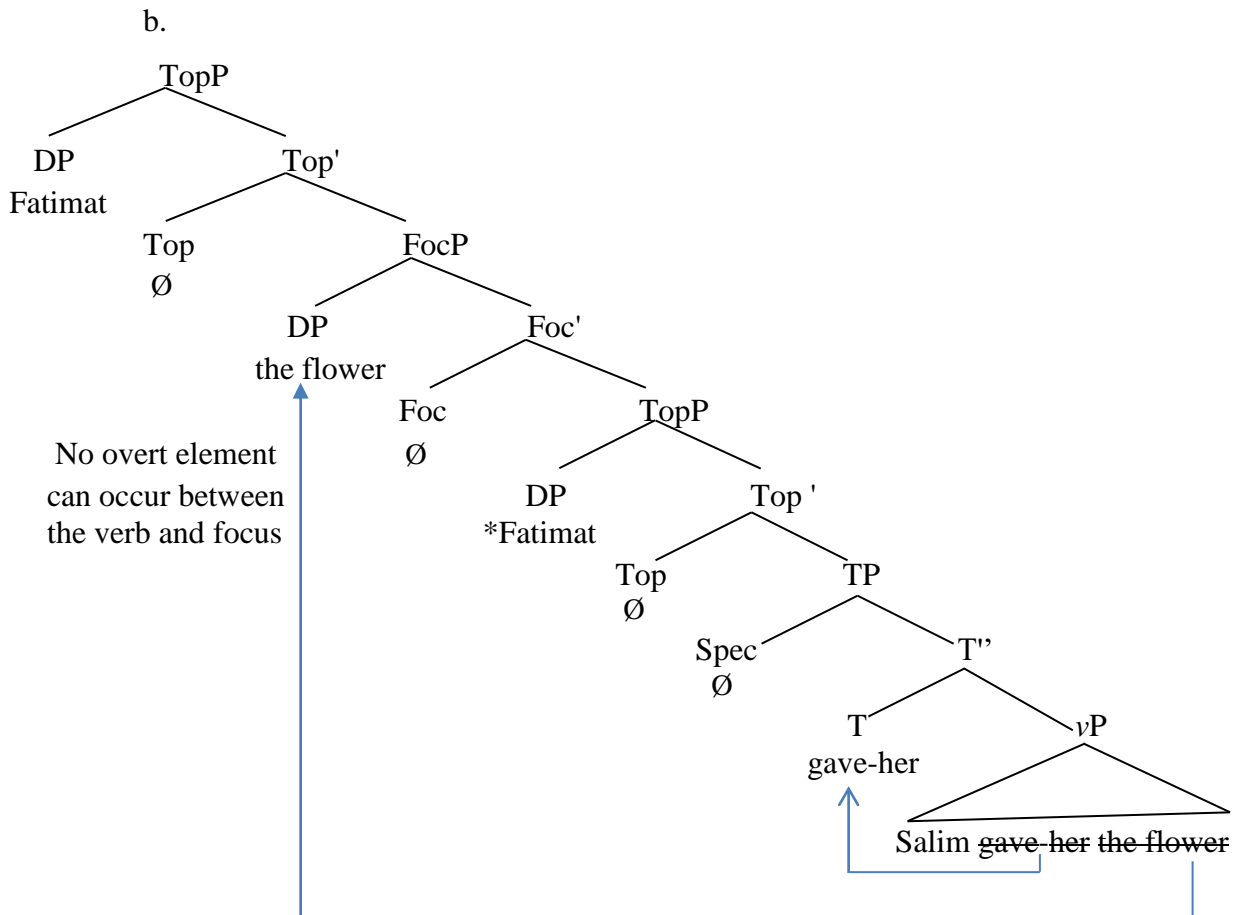

In (38b), the OTop 'Fatimat' is a base-generated in the higher Spec-TopP which is motivated by the [+topic] feature and is coreferential to the resumptive *haa* 'her'. The DP 'the flower' is focused in Spec-FocP motivated by the [+focus] feature and is associated with a gap. The focus phrase, however, appears immediately to the left of the verb 'gave' in T to satisfy the adjacency condition. The DP 'Salem' is a post-verbal subject in Spec-vP. Under structure (38b), the relative order between OTop and focus phrase in MSA is that OTop phrase must appear preceding the Focus phrase. That is to say that OTop phrase occupies the higher Spec-TopP and cannot be instantiated in the lower Spec-TopP. That order is motivated by the observation of adjacency requirements.

According to the structure (38b), Shlonsky furthermore argues that since the verb must be adjacent to the focus phrase, which is in Spec-FocP, it is plausible for the verb could move to the head position of the focus projection. This kind of movement construction is found in

Hungarian languages as in Brody (1990). The focus phrase and the verb come to be in one projection namely FocP as the following simplified schema shows:

- (39) [<sub>TopP</sub> DP Fatimat [<sub>Top</sub>] [<sub>FocP</sub> DP the flower [<sub>Foc</sub> gave-her] [<sub>TopP</sub> [<sub>Top</sub>] [<sub>TP</sub> [<sub>T</sub> gave-her] [<sub>vP</sub> DP Salem [<sub>v</sub> gave-her] [<sub>DP</sub> the flower]]]]]]]]

Regarding (39), one might suggest that since the verb movement to Foc head just following the focus phrase satisfies the adjacency condition the OTop phrase may have no obstacle to fill the lower TopP forming focus > verb > OTop order. This is not a possible assumption either, Shlonsky (2000) clearly demonstrates that in addition to the impossibility of the OTop to appear between the focus phrase and the verb in order to avoid violating the adjacency condition, the appearance of the OTop lower than the verb is not licensed in MSA. Consider the ungrammaticality of the following sentence:

- (40) a. \***al-wardat-a**      **ʔaʕtaa-haa**      **faatimat-u**      saalim-un      *t*  
the-flower-acc      gave.perf.3ms-her      Fatimat.nom      Salim-nom  
‘It is the flower that Fatimat, Salim gave.’
- b. \***mataa**      ya-qraʔu-**hu**      **l-kitaab-u**      T-Tullaab-u      *t*  
when      3m-read.imperf.s.it      the-book-nom      the students-nom  
‘The book, when do the students read it?’

The examples in (40a-b) respect the adjacency requirement, given that the verbs ‘gave’ and ‘read’ immediately follow the focus phrases ‘the flower’ and ‘when’ respectively. However, the sentence is ill-formed since the verb with the resumptive pronoun ‘gave-her’ and ‘read.it’ appear preceding the OTop ‘Fatimat’ and ‘the book’ respectively.

Shlonsky did not give an account for such restricted order between the verb and the OTop phrase as in (40a-b). However, it should be noticed that the problematic order is due to the fact that the resumptive clitic appears cliticized to the verb head in Foc and placing the OTop



intervene between them. The second reason is the impossibility of producing Foc < verb-clitic < OTop if the verb is located in Foc head position, as it blocks the coreferential relation between the OTop phrase and its preceding resumptive clitic.

### 4.3.3 An alternative analysis

From the observations of Shlonsky's (2000) analysis, I follow his analysis for MSA but modify it slightly to fit with the structure in (43) as the best order of projections for the left clausal structure in MSA. I particularly include the lower TopP which can only host the STop phrase which has not been considered for Shlonsky's analysis:

$$(43) \text{ ForceP} > \text{ TopP} > \text{ FocP} > \text{ TopP} > \text{ FinP}$$

According to (43), I confirm two following points: first, following Shlonsky (2000), I assume that the MSA OTop, regardless of consideration of the verb position, must only be realized higher than FocP in the higher Spec-TopP. This due to the general assumption that OTop is the only element that must occur in clause-initial position preceding the focus and other elements of the clause (see more in Fassi Fehri 1993; Aoun et al. 2010). The MSA OTop then is a base-generated element in the higher Spec-TopP motivated by [+topic] and associated with a resumptive pronoun which must be in the following part of the clause. Second, I generalize the standard assumption that focus phrase including wh-phrase is limited to one phrase that targets the Spec-FocP motivated by [+focus] hence, it immediately follows the OTop phrase.

Starting from this basic idea, three further points need to be investigated within the left projection order which is suggested for the left clausal structure MSA as (43) shows. First, the position of STop phrase which is dismissed in Shlonsky's discussion. Second, the possibility of the verb to appear in the left peripheral domain when focus phrase is realized and how that would interact with the position of the STop phrase. Third, the interaction of left peripheral elements in one clause and how multiple topic phrases are accommodated in the left domain in MSA.

على النص الذي ترغب في أن يظهر هنا. 2.Heading خطأ! استخدم علامة التبويب "الصفحة الرئيسية" لتطبيق  
 على النص الذي ترغب في أن يظهر هنا. 2.Heading خطأ! استخدم علامة التبويب "الصفحة الرئيسية" لتطبيق

First, let us look at the derivations of the MSA data in (44) that has a simple SVO order:

- (44) **aT-Tullaab-u**      *pro*      ya-qraʔuuna      l-kitaab-a  
 the-students-nom                  3m-read.p      the-book.acc  
 ‘As for the students, they read the book.’

In (44), the DP ‘the students’ is an instance of S<sub>Top</sub> and is generated to the left of the verb position in the left peripheral domain. Since the S<sub>Top</sub> phrase always appears to the left of the verb in SVO order it is plausible to assume that the S<sub>Top</sub> phrase is in the lower Spec-TopP position checking [+topic]. The DP ‘the students’ is co-referential with the *pro* subject ‘they’ in Spec-TP while the verb ‘read’ is in the T position showing full agreement features with the preverbal *pro* subject and it takes ‘the book’ as an object. Consider the structure below for the derivation of (44).

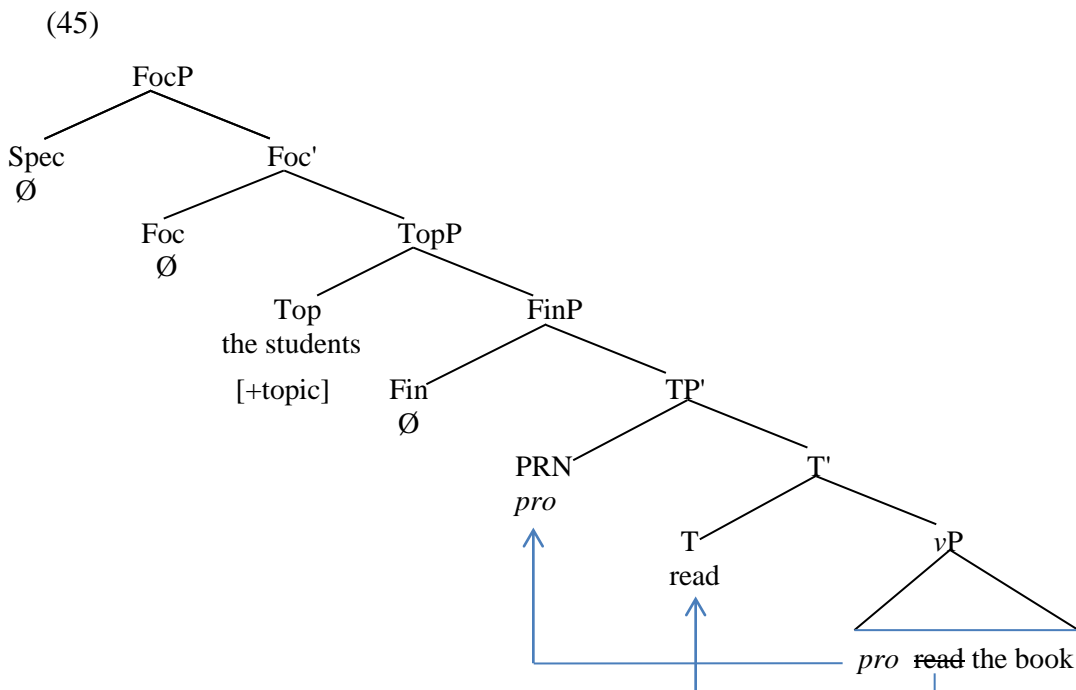

However, in more complex sentences, the lower Top position is not available. Consider the derivation where S<sub>Top</sub> interacts with a wh-phrase in (46a-b):

- (46) a. \***aT-Tullaab-u**    **mataa**    *pro*    ya-qraʔuuna    l-kitaab-a    *t* ?  
the-students-nom    when                    3m-read.imperf.p    the-book.acc  
‘As for the students, when they read the book.’
- b. \***mataa**    **T-Tullaab-u**    *pro*    ya-qraʔuuna    l-kitaab-a    *t* ?  
when            the-students-nom            3m-read.imperf.p    the-book.acc  
‘The students, when did they read the book?’

The example (46a) is ungrammatical because it does not exist in MSA as explained 2.2.4. The (46b) is also ungrammatical because the appearance of the focus ‘when’ in Spec-FocP blocks the STop ‘the students’ to be in the lower Spec-TopP by the adjacency condition which requires the verb ‘read’ in T to be adjacent to the focus phrase ‘when’. One could suggest that the grammaticality in (46b) can be fixed when the verb e.g. ‘read’, following Shlonsky (2000), moves to Foc over the preverbal STop phrase ‘the students’ to satisfy the adjacency condition. As a result, the STop phrase ‘the students’ then has the right to be licenced in the lower TopP and be coreferential to *pro* subject in Spec-TP. In fact, such analysis is not possible as it produces the following ungrammaticality:

- (47) **mataa**    (\*ya-qraʔuuna)    **T-Tullaab-u**    *pro* (ya-qaraʔuuna)    l-kitaab-a    *t* ?  
when    3m-read.imperf.p    the-students-nom            3m-read.imperf.p    the book.acc  
‘The students, when did they read the book?’

In (47), although the adjacency condition is respected between the focus phrase ‘when’ and the verb ‘read’ but the agreement asymmetry is clearly violated between the verb ‘read.3mp’ and the STop phrase ‘the students’. Since the verb has full agreement in SV order and then cannot appear preceding the STop phrase ‘the students’ forming VS order which must show partial agreement. Consequently, T-to-Foc is blocked and adjacency condition cannot be satisfied for the wh-phrase ‘when’. Consequently, the DP ‘the students’, in focused verbal clauses, can only occupy postverbally in partial garment pattern in Foc > verb > subject.



على النص الذي ترغب في أن يظهر هنا. 2.Heading خطأ! استخدم علامة التبويب "الصفحة الرئيسية" لتطبيق  
على النص الذي ترغب في أن يظهر هنا. 2.Heading خطأ! استخدم علامة التبويب "الصفحة الرئيسية" لتطبيق

The impossibility of the S<sub>Top</sub> phrase being in the lower TopP in focused clauses is still maintained for the position of an S<sub>Top</sub> phrase in an example which has both an auxiliary and a finite verb. The subject can only occur postverbally following both auxiliary and finite verbs as in (48a). The appearance of the S<sub>Top</sub> phrase following the wh-phrase ‘when’ violates the adjacency condition as in (48b) while moving the auxiliary verb to Foc to satisfy the adjacency condition is restricted by full agreement requirement as in (48c). The tree in (48d) represents (48a):

- (48) a. **mataa**      kaan                      **T-Tullaab-u**      ya-qraʔuuna      l-kitaab-a      *t*  
when                      were.perf.3ms      the-students-nom      3m-read.imperf.p      the-book-acc  
‘The students, when did they were reading the book?’
- b. \***mataa**      **T-Tullaab-u**                      kaanuu                      ya-qraʔuuna      l-kitaab-a      *t*  
when      the-students-nom                      were.perf.3ms      3m-read.imperf.p      the-book-acc  
‘The students, when did they were reading the book?’
- c. **mataa**      \*kaanuu                      **T-Tullaab-u**                      ya-qraʔuuna      l-kitaab-a      *t*  
when      were.perf.3ms                      the-students-nom                      3m-read.imperf.p      the-book-acc  
‘The students, when did they were reading the book?’

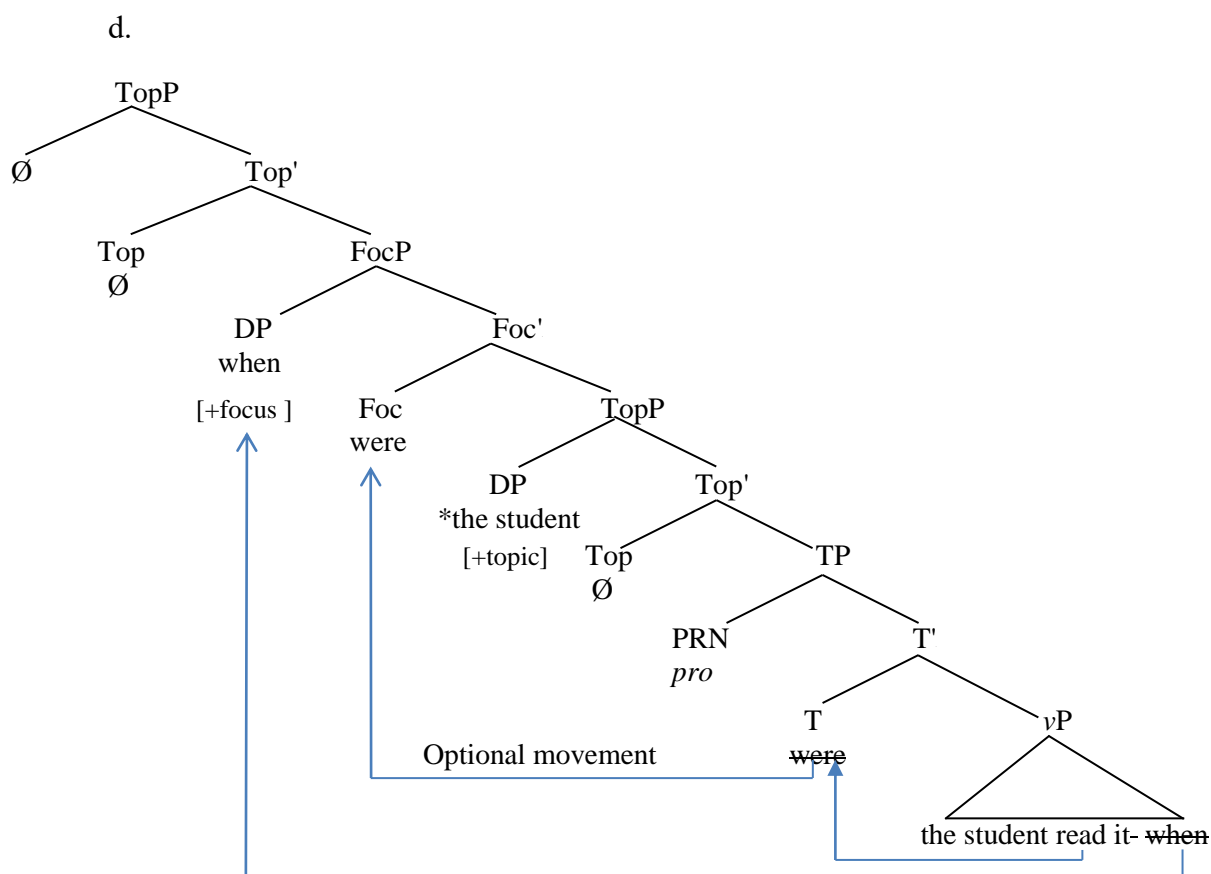

From (46-48), we can see that it is clearly required that a Focus XP must be immediately followed by a tensed verb or auxiliary. This is the case even though the Focus XP and the following verb are in different projections. I leave this as an open issue, as there is no obvious mechanism with Minimalist syntax to derive it.

Now consider the derivation of the multiple topic construction consisting of one **OTop** phrase and one **S<sub>Top</sub>** phrase:

- (49) a. al-kitaab-u            T-Tullaab-u            ya-qraʔuuna-hu  
           the-book-nom        the-students-nom        3m-read.imperf.p-it  
           ‘The book, the students read it.’

على النص الذي ترغب في أن يظهر هنا. 2.Heading خطأ! استخدم علامة التبويب "الصفحة الرئيسية" لتطبيق  
 على النص الذي ترغب في أن يظهر هنا. 2.Heading خطأ! استخدم علامة التبويب "الصفحة الرئيسية" لتطبيق

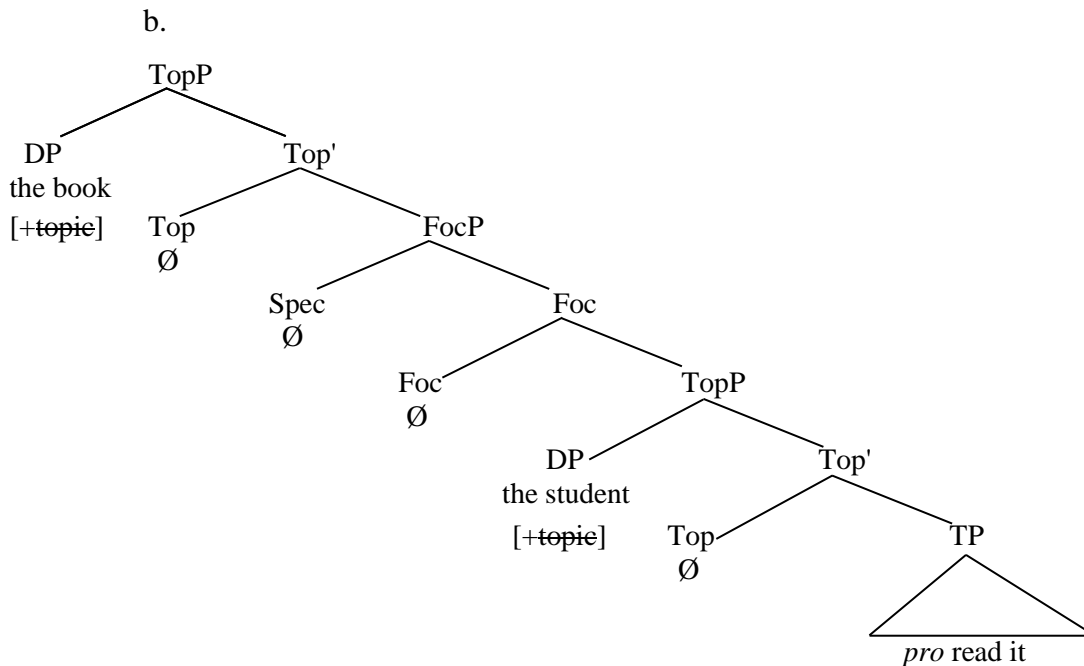

In (49b), the OTop phrase 'the book' is positioned in the higher Spec-TopP while the STop phrase is positioned in the lower Spec-TopP.

If the focus phrase is involved in the multiple topic construction as in the examples in (50a) they have the simplified structures in (50cb) respectively:

- (50) a. **al-kitaab-u T-Tullaab-u mataa ya-qra?u-hu l-mu?allim-in la-hum**  
 the-book-nom the-students.m-nom when 3m-read.imperf.s-it l-teacher-gen to-them  
 'The book, the students, when the teacher read it for them.'

c. [<sub>TopP</sub> DP the book [<sub>TopP</sub> DP the students [<sub>Top</sub>] [<sub>FocP</sub> DP when [<sub>Foc</sub>] [<sub>TopP</sub> DP [<sub>Top</sub>] [<sub>TP</sub> [<sub>T</sub> read-it] [<sub>vP</sub> DP the teacher] [<sub>v</sub> read-it] [<sub>vP</sub> [<sub>v</sub> read-it] [<sub>pp</sub> for them]]]]]]]]]]

As (50a-b), show that the higher TopP is occupied by two OTop phrases which are 'the book' and the 'the students', since they are (i) associated to resumptive clitics inside the clause, 'it' and 'them' respectively and (ii) preceding the focus phrase 'when'.

To summarize this section, the left peripheral projections in MSA can be as in the order of (43) which is repeated below:

(51) ForceP > TopP > FocP > TopP > FinP

The motivation for (51) is that there are two topic positions, higher and lower. The higher Top, on one hand, can be occupied by OTop. This is supported by the obligatoriness to have OTop phrase preceding the focus phrase which is in Spec-Foc. The lower Top, on the other hand, can be occupied by the STop phrase in SVO order, but however, when a focus phrase appears the STop then must be in postverbal position as Foc-VS order. The Focus phrase is unique and occupies the Spec-FocP. Multiple topic phrases are accommodated in the left periphery by either STop occupying the lower position and OTop occupying the higher position or by the two OTop phrases that occupy the higher positions. The higher TopP in MSA is recursive while the lower one is not.

#### 4.4 The description of Topic and Focus elements in TA

The nature of the OTop phrase in TA has similar features with MSA. One similarity can be observed with respect to the obligatory of definiteness and specificity condition, the restriction of the OTop phrase to DP only corresponding to a resumptive clitic inside the clause. With this in mind, the OTop DP can be either a definite as in (52a) or a specific indefinite as in (52b) and correspond to a resumptive pronoun inside the clause. However, the OTop DP can be neither a pure indefinite nor lack a resumptive pronoun as the ungrammaticality of (52c-d) show.

(52) a. **al-haraami**    ʃ-ʃurTi            ʃaaf-ah  
           the-thief            the-police man        saw.3ms-him  
           ‘The thief, the police man saw him.’

على النص الذي ترغب في أن يظهر هنا. 2.Heading خطأ! استخدم علامة التبويب "الصفحة الرئيسية" لتطبيق  
 على النص الذي ترغب في أن يظهر هنا. 2.Heading خطأ! استخدم علامة التبويب "الصفحة الرئيسية" لتطبيق

b. **haraami** khaTiir ʃ-ʃurTi ʃaaf-ah  
 thief dangerous the police man saw.3ms-him  
 'A dangerous thief, the police man saw him.'

c. \***haraami** ʃ-ʃurTi ʃaaf-ah  
 thief the police man saw.3ms-him  
 'A thief, the police man saw him.'

d. \***al-harami** ʃ-ʃurTi ʃaaf  
 the-thief the police man saw.3ms  
 'The thief, the police man saw.'

The preverbal DP subject of the clause in TA, as Chapter 2 explained, can be interpreted as a neutral subject as well as an instance of a S<sub>Top</sub> phrase. However, the nature of the DP is different in both interpretations. A definite preverbal DP or a specific indefinite preverbal DP can be interpreted as S<sub>Top</sub> or a neutral subject as (53a) shows, and also a nonspecific indefinite preverbal DP can only be interpreted as a neutral subject as in (53b):

(53) a. **al-banaat** Tabakhuu l-ʃaʃaa (S<sub>Top</sub>/SVO)  
 the-girls cooked.3mp the-dinner  
 'The girls, they cooked the dinner.'  
 'The girls cooked the dinner.'

b. **banaat** Tabakhuu l-ʃaʃaa (\*S<sub>Top</sub>/SVO)  
 girls cooked.3mp the- dinner  
 'Girls cooked the dinner'  
 \*'Girls, they cooked the dinner.'

The fronted focus in TA involves a new piece of information or something emphasized in the discourse. A simple focus clause is derived when the object focus phrase 'the letter' in (54a) is focused in (54b) and leaves a gap behind:

- (54) a. *munaa* Talabat **ʔidʒaazah** min l-mudiir *t*  
 Muna asked.3ms **holiday** from the-manager  
 ‘Muna asked for a holiday from the manager.’
- b. **ʔijaazah** *munaa* Talabat min l-mudiir *t*  
**holiday** Muna asked.3ms from the-manager  
 ‘It was a holiday that Muna asked for from the manager.’

Since a focus phrase provides new information in the discourse, it should be no surprise that a non-specific indefinite phrase can be focused in TA as in (55):

- (55) **fluus** ʕaliyy yi-ħtaadʒ *t*  
 money Ali 3m-needs.s  
 ‘It is money that Ali needs.’

In (55), the DP ‘money’ is a non-specific definite and associated with a gap inside the clause and that also well-formed focus clause.

Like MSA, a variety of phrases can be focused in TA, which includes DPs as in (56), prepositional phrases as in (56a) and an adverb as in (56b):

- (56) a. **fii l-biit** ʃ-ʃabaab yi-tqaabluu **ʕallaTuul** *t*  
 in the-house the-boys 3m-met.p always  
 ‘It is in the house that the guys meet always.’
- b. **ʕallaTuul** ʃ-ʃabaab yi-tqabluu **fii l-biit** *t*  
 always the-guys 3m-met.p in the-house  
 ‘It is always that the boys meet in the house.’

The possibility of a multiple focus construction in TA has similarity to MSA, because only one focus phrase is possible per clause as in the following example:

على النص الذي ترغب في أن يظهر هنا. 2.Heading خطأ! استخدم علامة التبويب "الصفحة الرئيسية" لتطبيق  
على النص الذي ترغب في أن يظهر هنا. 2.Heading خطأ! استخدم علامة التبويب "الصفحة الرئيسية" لتطبيق

- (57) \*al-mubaaraah<sub>i</sub>    l-khbaar    tafarradzat    nuuf    t<sub>i</sub>    t<sub>j</sub>  
the-match                    the-news            watched.3fs    Nouf  
'It was the match and the news that Nouf watched.'

Following this line of analysis, it should be plausible to assume that a focused phrase cannot occur with a wh-phrase as in the ungrammatical example (58):

- (58) \*mitaa<sub>i</sub>    l-mubaaraah<sub>j</sub>    tafarradzat    nuuf    t<sub>i</sub>    t<sub>j</sub>  
when    the-match            watched.3fs    Nouf  
'The match, when did Nouf watched?'

## 4.5 The cartographic approach to the left periphery of the clause in TA

### 4.5.1 Introduction

In this section, I adopt the split CP hypothesis (Rizzi, 1997) for the TA data and identify the main differences with MSA and Italian. The subsection is divided into three parts. Part two expresses some of the previous studies of the left periphery for Arabic. Part three identifies the relative order between topic and focus phrases in TA showing the possible topic positions regarding to focus. Part four, then, explains the distributions of the DP subject in TA clause structure.

### 4.5.2 Previous studies on Arabic

The syntax of left peripheral domain in modern Arabic varieties has received a considerable attention of studies from Arabic scholars in different Arabic varieties. Aoun and Benmamoun (1998) and Aoun et al. (2010) investigate the interaction of the left periphery elements in Lebanese Arabic (LA henceforth), particularly, the relative order between topic and focus phrases in their clause structures regarding to Minimality (Rizzi 1990; Chomsky 1995).

According to them, a simple clause structure in LA typically has no fixed order between topic and focus as the following examples show (Aoun et al. 2010: 205-206):

- (59) a. **ziyna<sub>i</sub>**      **ʕal kariim<sub>j</sub>**      ʕarrafnii-**haa<sub>i</sub>**      **t<sub>j</sub>**  
 Zeina.f      to Karim.m      introduced.1p-her  
 ‘Zeina, it is to Karim that we introduced her.’
- b. **ʕal kariim<sub>j</sub>**      **ziyna<sub>i</sub>**      ʕarrafnii-**haa<sub>i</sub>**      **t<sub>j</sub>**  
 to Karim.m      Zeina.f      introduced.1p-her  
 ‘Zeina, it is to Karim that we introduced her.’

The OTop phrase ‘Zeina’ is free to precede the focus phrase ‘to Karim’ as in (59a) or follow it as in (59b) given the analysis that the OTop phrase ‘Zeina’ can be instantiated in either the higher or the lower Spec-TopP position. The verb ‘introduce-her’ appears below the Topic and Focus phrases in either order which indicates that the verb does not move to the Foc head but stays lower than topic and focus position. Shlonsky (2000) states that this flexibility of topic-focus order like (59a-b) can be observed in some varieties of Arabic. This is due the fact that in contrast to MSA, the adjacency condition is not obligatory on focus in the Arabic dialects and so the verb does not have to be immediately to the right of the focus phrase. Accordingly, the OTop phrase in non-MSA clauses including LA can occupy the higher Spec-TopP as (59a) or the lower Spec-TopP intervening between the fronted focus phrase and the verb as (59b) shows.

Although the topic-focus order is flexible in a simple LA clause as (59a-b), but this is not always the case in complex clauses involving syntactic islands (Ross 1967). Once topic (OTop phrase) and focus phrases occur in island contexts, where the OTop phrase is separated from its resumptive clitic by an island boundary the interaction with a focus phrase has a restricted left projection order which is TopP > FocP only. The topic phrase can appear preceding a focused phrase such as a wh-phrase as in (60a). Moreover, the topic phrase can be related to a resumptive element within an island boundary as in (60b) (Aoun et al. 2010: 219):



على النص الذي ترغب في أن يظهر هنا. 2.Heading خطأ! استخدم علامة التبويب "الصفحة الرئيسية" لتطبيق  
على النص الذي ترغب في أن يظهر هنا. 2.Heading خطأ! استخدم علامة التبويب "الصفحة الرئيسية" لتطبيق

- (60) a. **naadiya<sub>i</sub>** saʔaluu      ʔayya-rajil<sub>j</sub>      khabbartu-(u)<sub>j</sub>      ʕann-a<sub>i</sub><sup>11</sup>      t<sub>j</sub>  
Nadia      asked.3mp      which-man      told.2p-(him)      about-her  
‘Nadia, they asked which man you told (him) about her.’
- b. **naadiya<sub>i</sub>** saʔaluu      ʔayya-rajil<sub>j</sub>      ziʕil      laʔannu      khabbartu-(u)<sub>j</sub>      ʕann-a<sub>i</sub>      t<sub>j</sub>  
Nadia      asked.3p      which-man      upset.3ms      because      told.2p-(him)      about-her  
‘Nadia, they asked which man was upset because you told (him) about her.’

In (60a), the topic phrase ‘Nadia’, which is co-referential to the clitic *a* ‘her’, appears preceding the wh-phrase *ʔayya rajil* ‘which man’ which is optionally co-referential to the clitic *u* ‘him’. This being so, the topic phrase ‘Nadia’ is instantiated in the higher TopP preceding the focus phrase ‘which man’. This can be also true when this topic phrase ‘Nadia’ is separated from its resumptive clitic ‘her’ by the adjunct clause Island *laʔannu* ‘because’ as (60b) shows. Therefore, topic-focus order is always available in LA. The schemata in (61a-b) represent the examples in (60a-b):

- (61) a. Topic<sub>i</sub> ... Focus<sub>j</sub> ... V + clitic<sub>j</sub> ... clitic<sub>i</sub>  
b. Topic<sub>i</sub> ... Focus<sub>j</sub> ... [Island ... clitic<sub>j</sub> ... ] ... clitic<sub>i</sub>

By contrast, topic phrase is not allowed to follow focus phrase once this topic phrase is separated from its co-referential clitic by an island boundary. Consider the following examples from Aoun and Benmamoun (1998: 575):

- (62) a. **nikti<sub>i</sub>** (smiʕti      ʔinnu)      **naadiya<sub>j</sub>** (smiʕti      ʔinnu)      khabbaru-u-a<sub>j</sub>      t<sub>i</sub>  
joke      (heard.2fs that)      Nadia      (heard.2fs that)      told.3p-her  
‘A joke, (you heard that) Nadia, (you heard that) they told her.’

<sup>11</sup> The focus phrase in MSA always corresponds to a gap while in some dialects of Arabic including LA allow the focus phrase to correspond to a clitic as well a gap (see Aoun et al, 2010 for more information on LA).

- b. \***nikti<sub>j</sub>** (smiʕti ʔinnu) **naadiya<sub>i</sub>** khabbaru ʃ-ʃabi ʔalli byaʕrif-a<sub>i</sub> t<sub>j</sub>  
 joke (heard.2fs that) Nadia told.3p the-boy that know.3ms-her  
 ‘A joke, (you heard that) Nadia, they told the boy that knows her.’

In (62a), the topic ‘Nadia’, which is co-referential to the resumptive clitic *a* ‘her’, grammatically appears following the focus phrase *nikti* ‘a joke’ which is co-referential to a gap. Thus, the focus phrase ‘a joke’ occupies Spec-Foc while the topic ‘Nadia’ occupies the lower Spec-TopP. In (62b), however, the topic phrase ‘Nadia’ is separated from the resumptive clitic *a* ‘her’ by a complex DP Island *ʃ-ʃabi ʔalli* ‘the boy that ...’. Then, it is ungrammatical for the topic phrase ‘Nadia’ to appear following the focus phrase ‘a joke’ in islands boundary. One conclusion is thus that focus-topic order is not always available in LA as (62b) shows.

The schemata in (63a-b) represent the examples in (62a-b):

- (63) a. Focus<sub>i</sub> ...Topic<sub>j</sub> ...V + clitic<sub>j</sub> ... t<sub>i</sub>  
 b. \*Focus<sub>i</sub> ...Topic<sub>j</sub>... [Island... clitic<sub>j</sub>... t<sub>i</sub>]

According to the observation in (60-61) and (62-63) Aoun and Benmamoun have an account with Minimality (Rizzi, 1990; Chomsky, 1995), which requires shortest derivations, to explain why the LA topic can sometimes precede or follow the focus phrase but in certain structures cannot. Specifically, they state that the variation of focus phrase behaviour regarding to the topic phrase can be attributed to “the derivational history” of the left peripheral elements. They propose that focus phrases are always derived by movement while topic phrases can be either base-generated in their surface position or they can be derived by PF-movement (topicalisation). Ross (1976) first assumes the movement analysis of topic in English by observation some connectivity between topic and its coreferential resumptive pronoun. The same observation is suggested by Cinque (1977) for topic in Romance languages (see 3.2.4 for more details). Aoun and Benmamoun (1998: 579) apply the

على النص الذي ترغب في أن يظهر هنا. 2.Heading خطأ! استخدم علامة التبويب "الصفحة الرئيسية" لتطبيق  
على النص الذي ترغب في أن يظهر هنا. 2.Heading خطأ! استخدم علامة التبويب "الصفحة الرئيسية" لتطبيق

---

movement analysis to the LA topic and observe a kind of connectivity as in the following representations:

- (64) a. Topic-DP<sub>i</sub> ... *pro*<sub>i</sub>-X clitic  
b. Topic-DP<sub>i</sub> ... t<sub>i</sub>-X clitic

In the representation of (64a), the clitic is coindexed with the *pro* that is related to the topic phrase. In this representation, a base-generated analysis is given to the topic phrase which must precede the focus after focus movement and is not sensitive to island constraints as (60a-b) and 61a-b) show, hence, the minimality rules do not apply. In the representation of (64b), however, the clitic is coindexed with the topic phrase that is base-generated in a certain position and then moves higher in the clausal structure and leaves a trace behind. The topic phrase, in this level of representation, is given a movement analysis and must follow the focus phrases and be sensitive to island constraints as (62a-b and (63a-b) show, hence the minimality rules apply. Ultimately, the discussion of topic and focus positions within islands contexts is concluded by the following structures (Aoun and Benmamoun 1998: 583-584; Aoun et al. 2010: 222):

- (65) a. (\*Focus) ... (Base-generated Topic<sub>i</sub>) Focus [<sub>Island</sub> ... *pro*<sub>i</sub> V + clitic<sub>i</sub> ...] (Higher topic)  
b. \*(Moved Topic<sub>i</sub>) ... Focus... (Moved Topic<sub>i</sub>) ... [<sub>Island</sub> ... t<sub>i</sub> V + clitic<sub>i</sub> ...] (Lower topic)

According to (65a-b), LA has two topic positions, the higher topic which can only host a base-generated topic phrase as in (65a) and lower topic which can only host a preposed topic phrase as in (65b).

Note that this type of analysis is not applicable to MSA, for two reasons. First, there is no independent evidence for the connectedness between the topic phrase and their coreferential resumptive in MSA. For instance, there is matching case between the topic phrase and the resumptive clitic inside the clause. The former is typically nominative while the former is

always accusative. Second, the relative order between the two types and focus phrase in MSA is fixed whether they involve island contexts or not. Since the two types of topic phrases are not allowed to follow the focus phrase, including wh-phrase, this is correctly predicted by the base-generated analysis for MSA topic phrases while a moved topicalized topic should not exist in MSA.

### 4.5.3 TA topic and focus positions

In this section, I shed light on the interaction between topic and focus phrases in TA clausal structure along with the minimality account that was suggested for LA in the previous subsection. The relative order between topics and focus is crucial to outline the order of the left projections. The observation shows that there are two ways to determine the interaction between topic and focus phrases in their clausal structures. To put the structures on a concrete footing, let us look at the following simple examples that show possible orders between topic and focus in TA:

- (66) a. **huda<sub>i</sub>**    **ktaab<sub>j</sub>**    ʔaʕTa-haa<sub>i</sub>    ʕaliyy    *t<sub>j</sub>*  
          Huda    book    gave.3ms-her    Ali  
          ‘Huda, it was a book that Ali gave her’
- b. **ktaab<sub>j</sub>**    **huda<sub>i</sub>**    ʔaʕTa-haa<sub>i</sub>    ʕaliyy    *t<sub>j</sub>*  
          book    Huda    gave.3ms-her    Ali  
          ‘Huda, it was a book that Ali gave her’

In (66a), the DP object ‘a book’ is focused in Spec-FocP between the topic phrase ‘Huda’ and the rest of the clause ‘give her Ali’. That is to say the topic ‘Huda’ occupies the higher Spec-TopP. Another way for the focus phrase to appear with a topic phrase is shown in (66b). The focus phrase ‘a book’ appears immediately preceding the topic phrase ‘Huda’. As a result, the topic phrase ‘Huda’ should occupy the lower Spec-TopP. The following structure shows the possible positions of topic-focus interaction in TA representing the examples (66a-b):

على النص الذي ترغب في أن يظهر هنا. 2.Heading خطأ! استخدم علامة التبويب "الصفحة الرئيسية" لتطبيق  
 على النص الذي ترغب في أن يظهر هنا. 2.Heading خطأ! استخدم علامة التبويب "الصفحة الرئيسية" لتطبيق

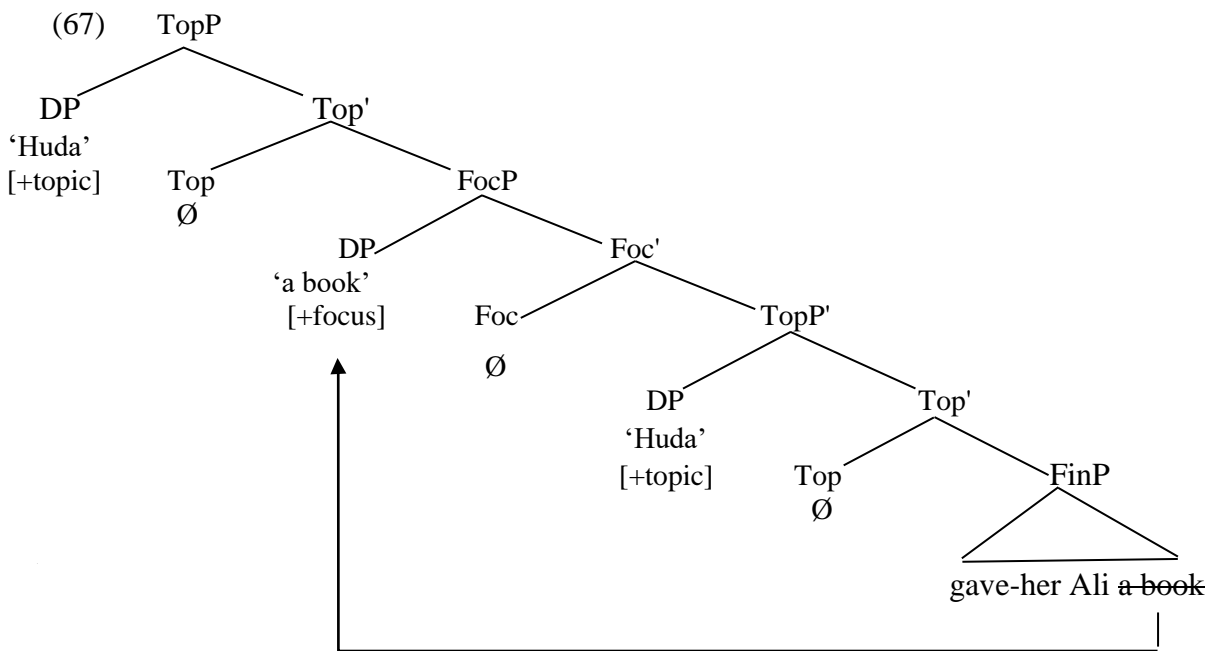

The structure in (67) shows the topic phrase ‘Huda’ can be instantiated in higher TopP or in lower TopP positions allowing focus phrase to appear preceding or following the topic phrase ‘Huda’. TA left clausal structure has two topic positions, higher and lower, which leads to the fact that TA does not impose a fixed topic-focus order in a simple clause as in LA as the following schemes show:

- (68) a. Top<sub>i</sub> ... Foc<sub>j</sub> ... V + clitic<sub>i</sub> ... t<sub>j</sub>
- b. Focus<sub>j</sub> ... Top<sub>i</sub> ... V + clitic<sub>i</sub> ... t<sub>j</sub>

There are two independent pieces of evidence which can support the analyses of TA in (67) and (68a-b). First is the fact that TA can have a multiple topic construction where the focus phrase can appear between the topic phrases. Consider the following examples:

- (69) **af-fabaab<sub>i</sub>** mitaa<sub>j</sub> **l-qiSSah<sub>t</sub>** qara-**haa<sub>t</sub>** l-mdrriiss la-**hum<sub>i</sub>** t<sub>j</sub>  
 the-guys when the-story read.3ms-it the-teacher to-them  
 ‘The guys, the story, when did the teacher read it to them.’

In (69), the DP ‘the guys’, which corresponds to the clitic *ham* ‘them’, is a higher topic that precedes the focus phrase ‘when’ while the DP ‘the story’, which corresponds to the clitic *haa* ‘it’, is a lower topic following the focus phrase ‘when’. As such, TA has two topic positions and one focus position intervening between them. Consider (70) as the structure below:

- (70) [<sub>TopP</sub> DP the guys [<sub>Top</sub>] [<sub>FocP</sub> DP when [<sub>Foc</sub>] [<sub>TopP</sub> DP the story [<sub>Top</sub>] [<sub>FP</sub> [F read-it] [<sub>TP</sub> DP the teacher [<sub>T</sub> read] [<sub>PP</sub> to-them]]]]]]]

The second piece of evidence to support the two topic positions in TA comes from the fact that TA does not impose the adjacency condition. Look at the following examples where (71a) does not hold to the adjacency condition while (71b) does:

- (71) a. **rsaalah<sub>i</sub>**    hudaa    ʔaʕTat    ʕaliyy    ʔams    *t<sub>i</sub>*  
 letter        Huda    gave.3fs    Ali        yesterday  
 ‘It was a letter that Huda gave to Ali yesterday’
- b. **rsaalah<sub>i</sub>**    ʔaʕTat    hudaa    ʕaliyy    ʔams    *t<sub>i</sub>*  
 letter        gave.3fs    Huda    Ali        yesterday  
 ‘It was a letter that Huda gave to Ali yesterday’

In (71a), the DP object ‘a letter’ is focused in clause-initial position motivated by the [+focus]. The subject ‘Huda’ is either a base generated topic or a moved subject to Spec-TP while the verb ‘read’ stays in T forming the basic SVO order ‘Huda gave Ali’. In (71b), the focus phrase ‘a letter’ is followed by VSO order ‘gave Huda Ali’ where the verb ‘read’ moves over the subject ‘the boys’ to F head position. This is possible, as the adjacency requirement does not always need to be satisfied in TA as well as in LA. Therefore, topic phrase is not prevented from occupying the lower TopP by the adjacency condition as in MSA. Consider the following structure for (71b):

- (72) [<sub>FocP</sub> DP the letter [<sub>Foc</sub>] [<sub>FP</sub> [F gave] [<sub>TP</sub> DP Huda [<sub>T</sub> gave] [<sub>DP</sub> Ali] [<sub>DP</sub> yesterday]]]]]

على النص الذي ترغب في أن يظهر هنا. Heading 2 خطأ! استخدم علامة التبويب "الصفحة الرئيسية" لتطبيق  
 على النص الذي ترغب في أن يظهر هنا. Heading 2 خطأ! استخدم علامة التبويب "الصفحة الرئيسية" لتطبيق

Let us look into complex sentences to investigating the interaction between TA topic and focus phrases within an islands context. Suppose that the topic phrase which is always co-referential to a resumptive clitic binds into an island as in (73a) while the focus phrase which always binds a gap must obey the island condition as in (73b):

- (73) a. **al-rrsaalah<sub>i</sub>** hudaa ʃaافت l-walad ʔilli ʔakhað-**haa<sub>i</sub>**  
 the-letter Huda saw.3fs the-boy who took.3ms-it  
 ‘The letter, Huda saw the boy who took it.’
- b. \***al-rrsaalah<sub>i</sub>** hudaa ʃaافت l-walad ʔilli ʔakhað **t<sub>i</sub>**  
 the-letter Huda saw.3fs the-boy who took.3ms  
 ‘It was the letter that Huda saw the boy who took.’

We have already seen that the TA topic phrase, in contrast to LA, can precede or follow the focus phrase even when the topic phrase is separated from its resumptive clitic by an island. Consider the following examples:

- (74) a. **hudaa<sub>i</sub> mita<sub>j</sub>** ʃ-ʃabaab ʃaafuu r-rijil ʔilli khaTab-**haa<sub>i</sub>** **t<sub>j</sub>**  
 Huda when the guys saw.3mp the-man who engages.3ms-her  
 ‘Huda, when did the guys see the man who engages her.’
- b. **mita<sub>j</sub> hudaa<sub>i</sub>** ʃ-ʃabaab ʃaafuu r-rijil ʔilli khaTab-**haa<sub>i</sub>** **t<sub>j</sub>**  
 when Huda the guys saw.3mp the-man who engages.3ms-her  
 ‘Huda, when did the guys see the man who engages her.’

In (74a) the topic phrase ‘Huda’ appears preceding the focus phrase ‘when’ and is separated from its resumptive clitic ‘her’ by the complex DP island *r-rijil ʔilli khatāb* ‘the man who engages’. In (74b), however, the topic phrase ‘Huda’ appears following the focus phrase ‘when’ and still corresponds to the resumptive pronoun *haa* ‘her’ despite being inside an island environment. Hence, the minimality does not have any influence in (74a-b).

In TA, not only DPs can be focused but also verbal phrase can be focused. Consider the constituent order in (79f) in 2.8.5, which is repeated in (75), and have the structure in (76):

- (75) (ya-lfabuu kuura)<sub>j</sub>      ʃ-ʃabaab      t<sub>j</sub>      Foc (VO) S  
 3m-play.p      football      the-guys  
 'It is playing football, the guys.'

The VOS order is derived by considering the DP 'the guys' a base generated topic in lower TopP as the following tree:

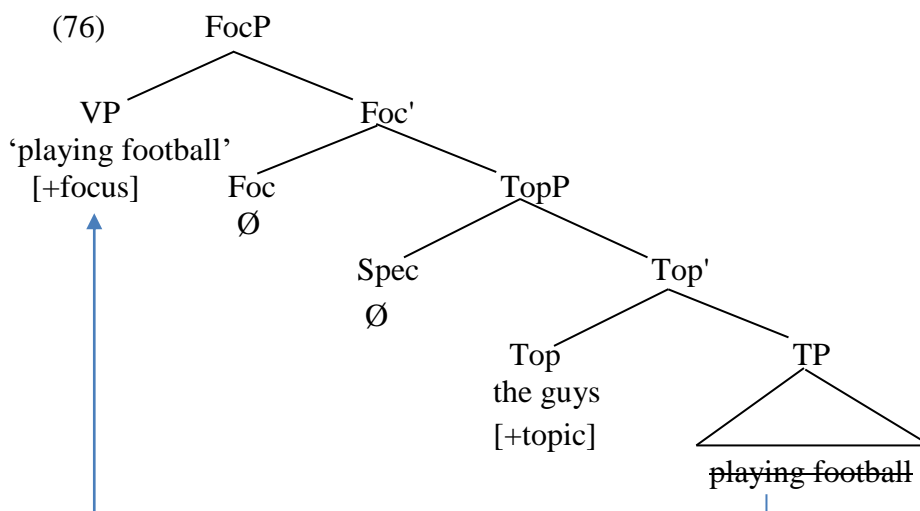

In view of this, I conclude that TA has two real topic positions, higher and lower which are occupied by base-generated DPs which are not sensitive to any island constraints. I also argue that there is only one level of representation that can host the topic phrases in TA, in relation to the focus position. Look at the following rules:

- (77) a. Base-generated topic<sub>i</sub> ... [Foc]<sub>j</sub> ... [Island ... V + clitic<sub>i</sub> ...] ... j  
 b. Foc<sub>j</sub> ... Base-generated topic<sub>i</sub> ... [Island ... V + clitic<sub>i</sub> ...] ... j

According to the structures in (77), all topic phrases are base-generated in TA.



#### 4.5.4 The DP subject in TA

The DP subject in TA has a wide distribution in the clause. There are at least three possible positions of the DP subject which have different interpretations accordingly. The first position of the DP subject is in pre-verbal position (SVO order). Recall that the basic TA order is derived by moving the subject to Spec-TP to form SVO order to check EPP feature on T. In this, the DP subject can be definite or indefinite, and the definite DP subject as in (78a) can have two interpretations with two different syntactic functions (i) a real subject in spec-TP (ii) a topic phrase in the left domain. The indefinite DP subject, however, can only have one interpretation as subject as in (78b).

- (78) a. **af-fabaab**    ʔaʕTuu    fluus<sub>j</sub>    l-ʕaliyy    (Top/S)VOO  
          the guys    gave.3mp    money    to-Ali  
          ‘The guys gave money to Ali.’
- b. **fabaab**    ʔaʕTuu    fluus    l-ʕaliyy    SVOO  
          guys    gave.3fp    money    to-Ali  
          ‘Guys gave money to Ali.’

In (78a), the definite DP subject ‘the guys’ appears initially in SV order and can have one of the two functions with different positions. It can be understood as a neutral subject in Spec-TP and the verb in T or as a topic phrase in the lower Spec-TopP while the verb is either in Fin or T heads. In (78b), since the DP subject ‘guys’ appears indefinite in a preverbal position it can only have a subject function occupying the Spec-TP while the verb is in T since topic never be indefinite. Consider the following tree for (78a):

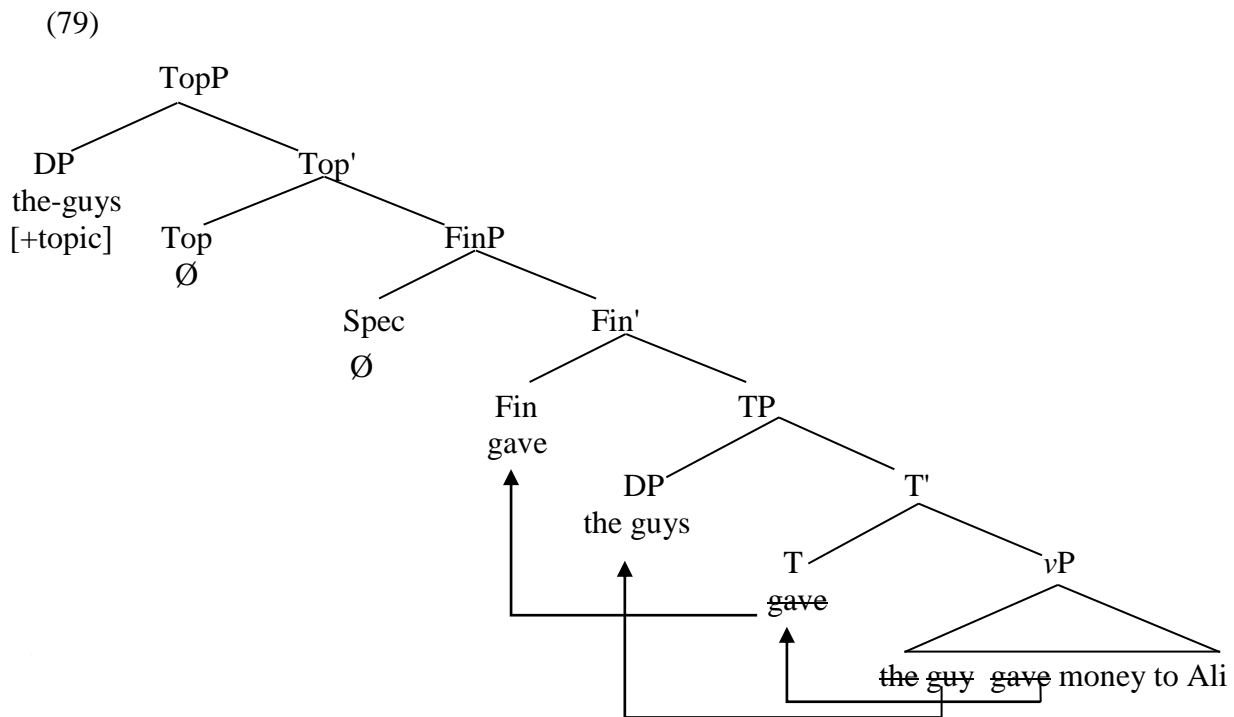

The second position of DP subject is in a position preceding the focus, where it can only be a definite with a topic interpretation as in (80a). Otherwise, the example is ill-formed as (80b).

- (80) a. **af-fabaab** **fluus<sub>j</sub>** ?aʕTuu l-ʕaliyy  $t_j$  Top Foc VO  
 the-guys money gave.3mp to-Ali  
 ‘The guys, it was money they gave to Ali’
- b. \***f-fabaab** **fluus<sub>j</sub>** ?aʕTuu l-ʕaliyy  $t_j$  Top Foc VO  
 guys money gave.3mp to-ali  
 ‘Guys, it was money they gave to Ali’

In (80a) the definite DP subject ‘the guys’ appears preceding the focus phrase ‘money’ and can only be understood as a topic phrase in the higher Spec-TopP while the verb can be in either F or T. In the example (80b), however, the indefinite DP ‘guys’ appears preceding the focus ‘money’, thus, is ruled out since the indefinite subject cannot be high than Spec-TP and topic phrase must always have a definite property. Consider the following tree for (80a):

على النص الذي ترغب في أن يظهر هنا. 2.Heading خطأ! استخدم علامة التبويب "الصفحة الرئيسية" لتطبيق  
 على النص الذي ترغب في أن يظهر هنا. 2.Heading خطأ! استخدم علامة التبويب "الصفحة الرئيسية" لتطبيق

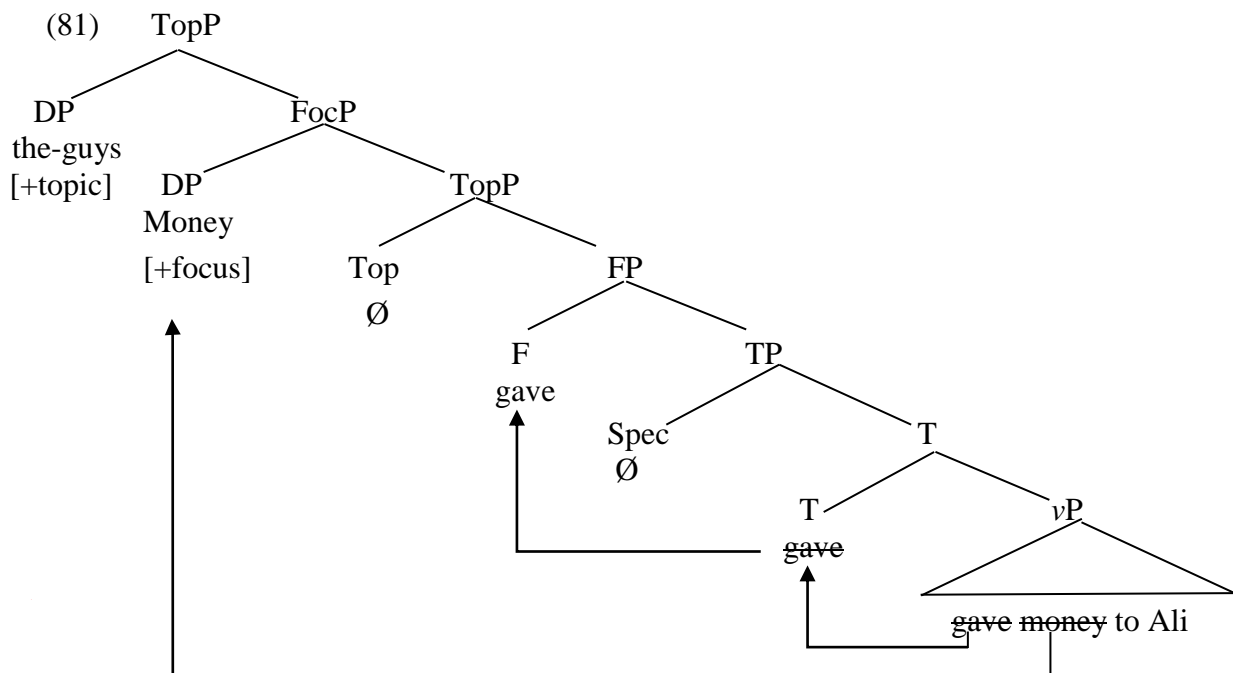

After I explore the interaction between topic and focus in the left domain and explain the DP subject positions, I turn the discussion to the verb position and the possibility of moving it higher than F. Recall that the finite verb in TA in SVO order remains in the lower position while in VSO order it raises to T position but must move further over the subject to the Fin position. The auxiliary verb initially is based in T forming S-Aux-V-O order and can move to F to form Aux-S-V-O order. The question arising here is whether the finite or auxiliary verb in TA can be focused in Foc head position similar to MSA as shown in 4.3. The observation shows that finite verb cannot move to Foc while the lower TopP is occupied by the OTop phrase as the following example:

- (82) mitaa<sub>j</sub> \*ʃazam-hum<sub>i</sub> ʃ-ʃabaab<sub>i</sub> ʃazam-hum l-muʃallim<sub>i</sub> l-l-ʃashaa t<sub>j</sub>  
 when invite.3ms-them the-guys the-teacher to-the-dinner  
 ‘The guys, when did the teacher invite them to dinner?’

In (82), moving the finite verb ‘invite-them’ to Foc head between the focus ‘when’ and the topic ‘the boys’ which is in lower Spec-TopP causes ungrammaticality.

However, the auxiliary verb in TA such as *can* be in the focus head position preceding the lower topic position. Consider the following examples:

- (83) mitaa<sub>j</sub> kaanu      ʃ-ʃabaab<sub>i</sub> yi-khtabir-hum<sub>i</sub> l-mʃallim    fii l-madrasah    t<sub>j</sub>  
 when    were.3mp    the-guys    examine.3ms-them    the-teacher    in    the-school  
 ‘The guys, when was the teacher examining them in the school?’

In (83), the auxiliary verb ‘were’ is situated higher than the topic phrase ‘the guys’ which is in lower Spec-TopP, so it is focused.

The contrast between the finite verb (82) and auxiliary verb (83) in TA left domain can be attributed to the fact that the finite verb in TA carries a clitic which is analysed as anaphoric that has to follow its antecedent such as a topic phrase while the auxiliary verb never carries a clitic. Consequently, the finite verb ‘invite’ (82) shows the resumptive anaphoric *hum* ‘them’ which cannot precede its antecedent the topic ‘the guys’ and the verb, then, is blocked to move to Foc position. By contrast, the auxiliary verb ‘were’ in (83), however, is free to precede the lower topic ‘the guys’ since it is not selecting any clitic as it is an intransitive verb.

#### 4.6 Conclusion

To summarize the chapter, the left periphery domain in MSA shows a number of interesting features. Topic is a nominative DP which can be either OTop phrase coreferential to a resumptive clitic inside the clause or STop phrase coreferential to a *pro* subject in Spec-TP. Focus is an accusative phrase and always corresponds to a gap and can appear with different categories. In a given clause, both types of topic phrases must appear preceding the focus phrase. Concerning Rizzi’s left periphery order, the OTop phrase occupies the higher TopP followed by the Focus phrase in Spec-FocP and that order is motivated by the obligatory adjacency condition between focus and the verb. The STop phrase can occupy the lower TopP only in non-focus clauses but it must occupy the postverbal subject position when a

على النص الذي ترغب في أن يظهر هنا. 2.Heading خطأ! استخدم علامة التبويب "الصفحة الرئيسية" لتطبيق  
 على النص الذي ترغب في أن يظهر هنا. 2.Heading خطأ! استخدم علامة التبويب "الصفحة الرئيسية" لتطبيق

---

focus phrase appears. The verb can optionally move to Foc when a focused element fills the Spec-FocP position.

For the TA left periphery, topic and focus phrases do not have a fixed order even within island contexts, since the adjacency condition is not obligatory and both higher and lower topics are base-generated which does not cause minimality rules to apply. When the lower Top is occupied the finite verb cannot move to Foc while an auxiliary verb can because the former hosts a clitic while the latter does not.

With this being the case, comparing the analysis of MSA and TA left periphery structure with Rizzi's analysis for Italian, we observe that there is a similarity with TA in which two topic positions are filled and the focus phrase is sandwiched between them in one clause. The MSA left periphery structure can fill the two topic positions but when the focus appears the lower topic position must not be occupied.

## **Chapter 5 The syntax of complementizer particles**

### **5.1 Introduction**

In the left peripheral domain of MSA within Rizzi's (1997) structure, a number of complementizer (Comp) elements are instantiated in the heads of different projections. These are essential elements in the syntax of the left clausal structure. This is because the Comp elements interact with other left domain elements e.g. OTop, STop and focus phrases in two aspects of syntax which are Agree and case assignment.

In this chapter, the discussion will be divided into seven sections. Section two shows the types of the Comp in MSA clausal structures and their distributions relative to other left peripheral elements, including: OTop, STop and focus phrases and the verb. It also explains the case and the mood assignments of the Comp particles in Arabic. Section three contains the analyses of the Comp particles in the left clausal structure in MSA within the generative approach. Section four delves into several derivations proposed for the Comp structure. Section five shows the types of the Comp in TA clausal structures and their distributions with other left peripheral elements. Section six suggests an account for TA Comp particles. Section seven concludes the chapter.

## 5.2 The Complementizer particles in MSA

### 5.2.1 Over view

There are two main types of complementizer in MSA. The first type is known as *Huruuf t-tawkiid* 'confirmation particles'<sup>12</sup>. The second type of complementizer is known as *ʔan n-naaSibah* 'the subjunctive *ʔan*'. In the following subsections these two different types of Comp are discussed and their functions are spelled out.

### 5.2.2 The Comp *ʔinna/ʔanna* and topic phrases

The complementizers *ʔinna* and *ʔanna* have a number of properties. (i) They can only select a finite clause to introduce verbal and nominal clauses. (ii) They are case assigners and the following DP must be assigned accusative case. (iii) They are prohibited to be directly followed by any verb types. (iiii) They can be morphologically inflected showing agreement features (Shlonsky, 2002).

Although both Comp particles *ʔinna* and *ʔanna* have similar properties they, however, do not occur in the same positions. The Comp *ʔinna*, on the one hand, occupies many positions: (i) the main clause-initial position preceding all left peripheral elements within the meaning of 'indeed', (ii) between OTop and STop phrases and (iii) following the verb 'say' introducing an embedded clause. The complements of the verb 'say' have root-like clause properties. The C *ʔanna*, on the other hand, (i) can only head an embedded clause and (ii) is preceded by a communicative verb such as *think*, *hope*, *guess*, and *claim*. The distributions of the Comp particles *ʔinna* and *ʔanna* are explained below.

The well-known fact is that the particles *ʔinna* and *ʔanna* can have at least three main distributions with DP topic phrases (OTop and STop) in MSA clausal structure. The first

<sup>12</sup> In MSA, there are certain complementizers which have been popularly known as *ʔinna wa akhawaatuhaa* 'ʔinna and its sisters'. Sisters includes *liʔanna* 'because', *lakinna* 'but', *kaʔanna* 'as if and *laʔalla* 'perhaps'. Since all have similar distributions and identical syntactic functions we will use the Comp *ʔinna/ʔanna* as a representative of this class of particles.

distribution for *ʔinna* and *ʔanna* is to select verbal clauses as their complements which begin with either OTop or STop phrases as in (1a-b).

- (1) a. *ħasibtu ʔanna l-kitaab-a ya-qraʔu-hu T-Tullaab-u*  
 thought.perf.1m that the-book-acc 3m-read.imperf.s-it the-students-nom  
 ‘I thought that the book, the students read it.’
- b. *ʔinna T-Tullaab-a pro ya-qraʔuuna l-kitaab-a*  
 indeed the-students-acc 3m-read.imperf.p the-book-acc  
 ‘Indeed the students read the book.’

In (1a) the Comp *ʔanna* ‘that’ occurs in the embedded verbal clause selecting the OTop phrase ‘the book’ while in (1b), the Comp *ʔinna* occurs in the main verbal clause selecting the STop phrase ‘the students’. The Comp *ʔanna* and *ʔinna* are accusative case assigners, thus, OTop phrase ‘the book’ and the STop phrase ‘the students’ are assigned accusative case as the accusative case maker *-a*. Therefore, Comp > OTop/Stop > verb > is a possible verbal clause order in MSA structure.

The second distribution of the Comp *ʔinna* and *ʔanna* can be attested in nominal clauses where Comp is followed by OTop phrase as in (2a) or STop phrase as in (2b):

- (2) a. *ħasib-tu ʔanna l-kitaab-a lawna-hu dʒamiil-un*  
 thought.perf.1m that the-book-acc colour-his useful-nom  
 ‘I thought that the book, his colour is beautiful.’
- b. *qaalat faatimat-u ʔinna l-kitaab-a mufiid-un*  
 said.perf.3fs Fatimat-nom that the-book-acc useful-nom  
 ‘Fatimat said that the book is useful.’

In (2a-b), the Comp *ʔanna* and *ʔinna* introduce the nominal clauses embedding the topic phrase ‘the book’ and the DP subject ‘the book’ respectively, and then, the accusative case is assigned to them.



The third interesting distribution is uniquely for the Comp *ʔinna*, since it is the only Comp can show up in main clauses. Consider the Comp *ʔinna* is followed by OTop in verbal clauses in (3a) and, further, the OTop is selected by another *ʔinna* as in (3b):

- (3) a. **al-ʔummahaat-u/\*a** ʔinna l-ʔaTfaal-a ya-ħtarimuuna-**hunna**  
 the-mothers.f-nom/ \*acc that the-children-acc 3m-respect.imperf.p-them.f  
 ‘The mothers, indeed the kids respect them.’
- b. ʔinna **l-ʔummahaat-a/\*u** ʔinna l-ʔaTfaal-a ya-ħtarimuuna-**hunna**  
 that the-mothers-acc/ \*nom that the-children-acc 3m-respect.imperf.p-  
 them.f  
 ‘That the mothers, indeed the children respect them.’

In (3a) the OTop phrase ‘the mothers’ appears preceding the Comp *ʔinna* which, in turn, is followed by the STop ‘the kids’ assigned with an accusative case. In (3b), however, the OTop phrase ‘the mothers’ appears sandwiched between two particles of Comp *ʔinna*, one occupies the clause-initial position preceding the OTop phrase ‘the mothers’, assigning the accusative case to it while the other follows it. The example (3a) indicates that the Comp *ʔinna* cannot assign accusative case to the preceding OTop ‘the mother’ that can appear only nominative while (3b) indicates that a multiple Comp particle structure is available per clause in MSA with the Comp *ʔinna*. Ouhalla (1994b), in this respect, assumes that the Comp particle *ʔinna* can be interpreted as a focus particle. As a result, it would be possible in main MSA clauses to have the Comp *ʔinna* > OTop > Comp *ʔinna* > STop order.

For the case assignment rule, we need to investigate the case relation between the assigner Comp and following elements of its syntactic domain. Recall that topic phrases (OTop and STop) in MSA are assigned nominative case by default when there is no external governor appearing as shown in Chapter 4. However, the appearance of external governors such as the accusative *ʔanna/ʔinna* requires the following topic phrase to be accusative as shown in previous examples. Therefore, DPs in the left peripheral domain can appear in one of the two

cases namely nominative or accusative, and each case is assigned in a particular construction and only one case is available for each DP topic phrase depending on the availability of the external governor or not. Consider the following examples:

- (4) a. \***aT-Tullaab-a**      ya-qraʔuuna      l-kitaab-a  
          the-students-acc    3m-read.imperf.p    the-book-acc  
          ‘The students read the book.’
- b. ʔinna      \***T-Tullaab-u**      ya-qraʔuuna      l-kitaab-a  
          that      the-students-nom    3m-read.imperf.p    the-book-acc  
          ‘Indeed the students read the book.’

The ungrammatical example in (4a) demonstrates that the Comp *ʔanna* and *ʔinna* must be overt to assign the accusative case to DP. The ungrammatical example in (4b) demonstrates that *ʔanna/ʔinna* are strictly case assigners requiring the following topic phrase to be accusative.

There are four distinctive features must be taken into considerations between the assigners *ʔinna* and *ʔanna* and its assignee in the following position of the clause. The first feature is the number of topic phrases that the assigner *ʔinna* and *ʔanna* can assign per clause. Recall that MSA clause structure allows multiple topic phrases. Therefore, the Comps *ʔinna* and *ʔanna* can possibly head a clause where more than one topic phrase is present in following position. In such a structure, which DP will be assigned the accusative case? The observation shows that the head assigner *ʔinna/ʔanna* assigns accusative once and that only the closest DP will be assigned the accusative case, while other topic phrases will receive nominative case by default. Consider the following examples:

- (5) a. **al-maal-u**      ʔaliyy-un    ʔaʕTaa-hu      li-hind-in  
          the-money-nom    Ali-nom    gave.perf.3ms-it    to-Hind-gen  
          ‘The money, Ali gives to Hind.’

على النص الذي ترغب في أن يظهر هنا. 2.Heading خطأ! استخدم علامة التبويب "الصفحة الرئيسية" لتطبيق  
 على النص الذي ترغب في أن يظهر هنا. 2.Heading خطأ! استخدم علامة التبويب "الصفحة الرئيسية" لتطبيق

b. *ħasibtu ʔanna l-maal-a/ \*u ʕaliyy-un/\*a ʔaʕTaa-hu li-hind-in*  
 thought.1s that the-money-acc/\*nom Ali-nom/\*acc gave.perf.3ms-it to-Hind-  
 gen  
 ‘I thought that the money, Ali give it to Hind.’

In (5a), there is no external assigner; consequently, the nominative case will be assigned by default to the two topic phrases ‘the money’ and ‘Ali’. Once the case assigner head *ʔanna* is embedded as in (5b), it assigns the accusative case to the closest DP ‘the money’ while the nominative case will be assigned by default to the second topic phrase ‘Ali’. Locality rules, which will be presented later in this chapter, require the first DP ‘the money’ but not the second DP ‘Ali’ to be the assignee of the Comp *ʔanna*.

The second feature concerns the identity of assignee of *ʔanna/ʔinna*. Only an XP that accepts the accusative case can function as the assignee DP for assigner *ʔinna/ʔanna*. Therefore, it is not surprising that the Comp *ʔinna/ʔanna* cannot have a strong pronominal subject as its assignee, which must be nominative, as the ungrammatical (6) shows:

(6) \**hind-un ħasib-tu ʔanna hiya ta-qraʔu l-kitaab-a*  
 Hind-nom thought.1sm that she 3f-read.imperf.s the-book-acc  
 ‘Hind, I thought that she read the book.’

Since the Comp *ʔinna/ʔanna* is an accusative case assigner head and if there is any case-marked XP surfaces in the following position it has to be accusative. Therefore, the subject pronoun e.g. ‘she’ in (6) is not possible to be selected by the accusative assigner *ʔinna/ʔanna* for a clashing case effect. Note that an accusative resumptive pronoun e.g. *ħaa* ‘her’ can be attached to the C *ʔinna/ʔanna* and this combination of the Comp with the accusative resumptive pronoun is called the ‘complementizer agreement’ phenomenon which will be left aside here and will be discussed in detail in Chapter 6.

The third feature between the assigner  $\text{?inna}/\text{?anna}$  and its assignee is that the adjacency condition between them is not always required. In the other word, certain elements are allowed to intervene between the  $\text{?inna}/\text{?anna}$  and its DP assignee as shown shortly. However, the verb as in (7) is not permitted to separate between the Comp  $\text{?anna}/\text{?inna}$  and its complement DP.

- (7) \* $\text{?asibtu}$   $\text{?anna}$   **$\text{ya-qra?u}$**  T-Tullaab-u/a l-kitaab-a  
 thought.1s that 3mread.imperf.s the-students-nom/acc the-book-acc  
 ‘I thought that the students read the book.’

In (7), the verb ‘read’ interferes between the Comp  $\text{?anna}$  and the accusative DP ‘the book’. Because of the fact that the verb ‘read’ in (7) is a case assigner head (a nominative) with a par with the Comp head (accusative) and not a case receiver XP like DP.

Concerning the locality rules, the DP ‘the students’ is c-commanded by two head assigners, the nominative head assigner ‘read’ and the accusative case assigner  $\text{?anna}$ . The DP topic ‘the students’ is assigned the nominative case only by the closest head which is the verb ‘read’. Hence, the case of the Comp  $\text{?anna}$  is blocked by the head ‘read’ to deliver the accusative case to the DP ‘the students’. Thus, (7) is ungrammatical due to an intervening case effect of the Comp  $\text{?anna}$ . Furthermore, (7) leads us to the analysis that while there is “pure pro-drop” in main clauses in MSA it is not possible in embedded clauses under the Comp  $\text{?anna}/\text{?inna}$ . Since an inflected verb can appear in main clauses without any preverbal DP, this is clearly restricted in embedded clauses within the Comp  $\text{?anna}/\text{?inna}$ .

By contrast, the interference of PP between the Comp  $\text{?anna}$  and the accusative DP is permitted as in (8):

- (8)  $\text{qaala}$   $\text{?aħmad-u}$   $\text{?inna}$   **$\text{fi d-daar-i}$**   $\text{radʒul-an/ *un}$   
 said.perf.3ms Ahmad-nom that in the house-gen a man-acc/ nom  
 ‘Ahmad said that it is in the house that a man is.’ (Mohammad 2000: 22)

Interestingly, in (8), the PP 'in the house' grammatically appears in the position between the Comp  $\varphi_{inna}$  and the accusative DP 'a man'. The question which should be raised here is why there is a contrast between the intervening of PP in (8) and the verb in (7) within the case assignment of the Comp  $\varphi_{inna}/\varphi_{anna}$  to the following DP? In (8), the grammaticality is understood once we notice the fact that the PP 'in the house' is neither case marked e.g. unlike some strong pronouns as (6) nor a case assigner head e.g. a verb as in (7) but it is not related to case at all. Therefore, the Comp  $\varphi_{inna}/\varphi_{anna}$  can assign the accusative case over an uncased PP and the intervening case effect is not invoked. The example (8), further, implies two things, first the adjacency condition between the Comp  $\varphi_{inna}$  and  $\varphi_{anna}$  and their accusative complements DPs is not compulsory. Second, the PP 'in the house' cannot satisfy the case assigner  $\varphi_{anna}/\varphi_{inna}$  and the closest DP must be assigned the accusative case even though they are not adjacent.

Let us summarise the distributions of the Comp  $\varphi_{inna}/\varphi_{anna}$  with topic phrases in the left peripheral domain as the following schemes:

- (9) a. Comp  $\varphi_{inna}/\varphi_{anna}$  > DP<sub>ACC</sub>  
 b. Comp  $\varphi_{inna}/\varphi_{anna}$  > PP > DP<sub>ACC</sub>  
 c. \*Comp  $\varphi_{inna}/\varphi_{anna}$  > DP<sub>NOM</sub>/DP<sub>ACC</sub>  
 d. \*Comp  $\varphi_{inna}/\varphi_{anna}$  > V > DP<sub>ACC</sub>  
 e. \*Comp  $\varphi_{inna}/\varphi_{anna}$  > strong pronoun

The contrasts in (9) between the following elements of the Comp have something to do with the nature of the following position of the assigner Comp  $\varphi_{inna}/\varphi_{anna}$ . The various distributions of the Comp  $\varphi_{inna}/\varphi_{anna}$  with topic phrases in the following position and the case rules are given below:

- (10) a. The head assigner Comp  $\varphi_{inna}/\varphi_{anna}$  must assign accusative case to a DP in following position. Otherwise, the clause is ruled out as (4b).

- b. Only the closest DP can be assigned by Comp *?inna/?anna* as supported by the locality rules as in (5b).
- c. A non-accusative case-marked XP e.g. strong nominative pronoun is not allowed to be the assignee of Comp *?inna/?anna* as (6) shows.
- d. No assigner head e.g. a verb can separate the case assigner Comp *?inna/?anna* and its assignee DP as the ill-formed example in (7).
- e. Non-case-marked XPs e.g. PPs can separate the case assigner the Comp *?inna/?anna* and its assignee DP, so (8) is well-formed

### 5.2.3 The Comp *?inna/?anna* and focus phrases

Shlonsky (2000) and Mohammad (2000) do not accept fronted focus DPs to be embedded directly under the Comp *?inna* and *?anna* as (11a-b) shows:

(11) a. \*qaala      ?ahmad-u      ?inna    **t-tuffaahat-i**      ?akala      ?aliyy-un    *t*  
 said.perf.3m Ahmed-nom    that    the-apples-acc    ate.perf.3ms Ali-nom  
 ‘Ahmad said that it is the apples that Ali ate.’      (Mohammad 2000:

20)

b. \*za?amtu      ?anna      **r-risaalat-a**      kataba      l-walad-u      *t*  
 claimed.perf.1s    that    the-letter-acc    wrote.perf.3ms    the-boy-nom  
 ‘I claimed that the it is letter that the boy wrote.’      (Shlonsky      2000:

336)

The ungrammaticality of (11a-b) is due to the occurrence of the DP focus ‘the apples’ and ‘the letter’ just after the Comp *?inna*.

It is important to notice that focus, unlike topic, can appear with different types of phrases. A focus DP typically appears with an accusative case marker, while a focus PP appears with no case. In contrast to focus DPs, the Comp *?anna* and *?inna* can be followed by focus PPs is the

given order once the closest DP is (otherwise) assigned accusative case as the example in (8) shows.

For that reason, the structure which is shown in (12) below is considered to be marginal, e.g. Ayoub (1981), since the Comp *?anna* selects focus PP but the case assigner has not been satisfied by an accusative DP in a following position:

- (12) ??*a-dhunnu ?anna fi baGdaad-a ħaSala l-?ittifaaq-u t*<sup>13</sup>  
 1-think.perf.s that in Baghdad-gen happened.perf.3ms the-agreement-nom  
 'I think that in Baghdad, the agreement took place.' (Aoun et al. 2010:

203)

The observations above lead us assume that the syntactic behaviour of the focus phrase interacting with the Comp *?anna/?inna* indicates that the problem concerns when focus DPs are considered directly following the Comp *?anna/?inna* as shown in (13a-c) while a PP focus phrase is fully accepted to be selected by the Comp *?anna/?inna* as long as it is followed by an accusative DP as shown in (8). These behaviours of the focus in the domain of the Comp *?inna/?anna* are schematized as follows:

- (13) a. Comp *?anna/?inna* > PP focus > DP<sub>ACC</sub>  
 b. \*Comp *?anna/?inna* > DP focus > verb  
 c. ??Comp *?anna/?inna* > PP focus > (without DP<sub>ACC</sub>).

Our explanation for the ungrammaticality of (13b-c) is connected with the case assignment effect. Specifically, I assume that the DP focus is not sufficient to satisfy the case of the assigner Comp since it is already assigned accusative case by the verbal head from its low position before being focused. Meanwhile, the head assigner *?anna/?inna* must assign the same case to the following DP. Consequently, there are two assigner heads for one DP and

<sup>13</sup> The genitive DP *baGdaad-a* 'Baghdad' is instance of *al-mamnuu9tu min aŠ-Šarfī* 'the forbidden of nunation'. Therefore, the genitive marker appears *-a* rather *-i* (see 2.2.2 for more details)

this is a clear violation of the Case Uniqueness Principle in (14) below which restricts two cases from being assigned to one DP:

(14) Case Uniqueness Principle: A lexical DP may receive only one Case.

(Polinsky and Preminger 2014: 5)

Moreover, the locality principles apply for the Comp  $\varnothing_{anna}/\varnothing_{inna} > DP$  focus  $>$  verb order, such that the closest head that c-commands the DP focus and assigns accusative case to it is the verbal head. As a result, the accusative case of the Comp  $\varnothing_{anna}/\varnothing_{inna}$  is blocked to be delivered to the DP focus, so it cannot then be embedded just to the right of the Comp  $\varnothing_{anna}/\varnothing_{inna}$ .

If our explanation is correct, focus DPs should not be banned to occur embedded when separated from the Comps  $\varnothing_{inna}$  and  $\varnothing_{anna}$  which select and assign accusative case to some other DP as in (15a). Moreover, the DP focus phrase can occur in a main clause where it is fronted from low position of the embedded clause over the Comp  $\varnothing_{anna}$  which then assigns accusative case to a following DP as in (15b):

(15) a. qaala                    ḡahmad-u   ḡinna   ḡaliyy-an   **t-tuffaahat-i**   ḡakala   *t*  
 said.perf.3ms   Ahmed-nom   that   Ali-acc   the-apples-acc   ate.perf.3ms  
 ‘Ahmed said that it is the apples that Ali ate.’                    (Mohammad 2000: 21)

b. **ḡaliyy-an<sub>i</sub>**   zaḡama                    saalim-un   ḡanna   faatimat-a   tazawwadḡat   *t*  
 Ali-acc   claimed.perf.3ms   Salim-nom   that   Fatimat-acc   married.perf.3fs  
 ‘Salim claimed that it was Ali that Fatimat married.’                    (Bakir 1980:

114)

In (15a), the DP focus ‘the apples’ is embedded but not adjacent to the Comp  $\varnothing_{inna}$  that assigns the accusative case to the DP ‘Ali’. In (15b), the DP focus ‘Ali’ has been fronted from the embedded clause preceding the Comp  $\varnothing_{anna}$  to the initial position of the main clause while the Comp  $\varnothing_{anna}$  assigns case to following DP ‘Fatimat-acc’. The Case



Uniqueness Principle in (14) and the locality condition do not rule out (15a) since the following DPs of the Comp  $\text{?inna}/\text{?anna}$  ‘Ali’ and ‘the apples’ are assigned accusative case only once each by different assigners. The verbal head ‘ate’ takes the focus DP ‘the apples’ as its complement while the Comp  $\text{?inna}$  takes the closest DP phrase ‘Ali’ as its accusative assignee. This claim, in the same manner, would be right for (15b). Thus, the focus DP has the freedom to occur at the left of the domain once the accusative case is assigned elsewhere by the Comp  $\text{?anna}$  or  $\text{?inna}$ . Therefore, an embedded focus DP in verbal clauses can possibly have of the two orders in (16a-b) which represent (15a-b):

- (16) a. Comp  $\text{?anna}/\text{?inna}$  > DP (OTop/STop)<sub>ACC</sub> > Focus DP  
 b. Focus DP ... > Comp  $\text{?anna}/\text{?inna}$  > DP (OTop/STop)<sub>ACC</sub>

We cannot test the assignment possibility of the Comp  $\text{?inna}/\text{?anna}$  to deliver accusative case over the fronted focus DP to the next following DP. This is due to the fact that the adjacency condition (Focus and the verb) must be respected in focus clauses as the ungrammaticality in (17) shows:

- (17) \*qaala            ?aħmad-u        ?inna    **t-tuffaahat-i**    ?aliyy-an    ?akala        *t*  
 said.perf.3ms    Ahmed-nom    that    the-apples-acc    Ali-acc    ate.perf.3ms  
 ‘Ahmed said that, it is the apples that Ali ate.’

The Case Uniqueness Principle in (15) and the locality condition do not rule out (17). The two assigner heads the Comp  $\text{?inna}$  and the verb ‘ate’ take two different assignee DPs which are the ‘Ali’ and ‘the apples’ respectively. However, the example is ungrammatical and the reason is because the adjacency condition is violated, since the DP ‘Ali’ separates between

the focus DP 'the apples' and the verb head 'ate'. Thus, the Comp  $\text{?anna/?inna} > \text{Focus DP} > \text{DP (OTop/STop)}_{\text{ACC}}$  order is not possible<sup>14</sup>.

Therefore, since the Comp  $\text{?anna}$  or  $\text{?inna}$  is an accusative case assigner and has to assign its case to the closest DP. The focus DPs is prohibited from being its assignee as it has already been assigned accusative case by the verbal head in the low position. However, since a focus PP does not have/need case it is acceptable for PP to separate the Comp  $\text{?inna/?anna}$  and the accusative assignee DP in the following position.

#### 5.2.4 The Comp $\text{?an}$

The Comp  $\text{?an}$  is called 'the subjunctive particle' since it assigns the subjunctive mood to the flowing imperfective verb as explained in 2.3. The Comp  $\text{?an}$  has some characteristic features in MSA clausal structure. First, the Comp  $\text{?an}$  typically is selected by verbs that indicate wish, desire and doubt. Second, the Comp  $\text{?an}$  also can only select finite clauses either in VS order or null subject clauses<sup>15</sup>. Third, there is a relation between the Comp  $\text{?an}$  with respect tense since it must directly be followed by verbs. However, the Comp  $\text{?an}$  can only assign a subjunctive mood to the present (imperfect) verbs but not past (perfect) once (Ryding 2005:

<sup>14</sup> Although the Comp  $\text{?inna/?anna} > \text{(OTop/STop)}_{\text{ACC}}$  is a fully accepted order while Comp  $\text{?inna/?anna} > \text{DP}_{\text{NOM}}/\text{verb}/\text{pro}$  is a fully rejected order, it becomes, however, a different degree of acceptability when the Comp  $\text{?inna}/\text{?anna}$  selects fronting focus DPs. Ouhalla (1994b), for instance, accepts the fronting focus DPs to be selected by Comp  $\text{?inna} / \text{?anna}$  as shown below:

- (1) dhanantu ?anna kitaab-an qara?at zaynab-u  
 believe.1s that book-acc read.3fs Zaynab-nom  
 'I believe that, a book, Zaynab read.' (Ouhalla 1994b: 70)

According to Ouhalla, every DP can be embedded directly under the Comp  $\text{?inna/?anna}$  including the focus DP such as 'book' in (1). However, Mohammad (2000) and Shlonsky (2000) have different views as they reject focus DPs to target the immediate position after the Comp  $\text{?anna/?inna}$ , as explained in the main text. If any examples like (1) are found to be acceptable to speakers, the theoretical analysis could be changed as follows: accusative case from the complementizer  $\text{?anna} / \text{?inna}$  is usually assigned to the closest DP. The accusative case then could be blocked in the situation in (1), but the example would be considered very marginal.

<sup>15</sup> Aoun et al. (2010) name the Comp  $\text{?in}$  as a non-finite particle in the sense that it introduces only a non-finite clause that does not have a finite context, neither does an independent interpretation. Since MSA does not allow non-finite clauses to exist as argued by many. Receive

على النص الذي ترغب في أن يظهر هنا. 2.Heading خطأ! استخدم علامة التبويب "الصفحة الرئيسية" لتطبيق  
على النص الذي ترغب في أن يظهر هنا. 2.Heading خطأ! استخدم علامة التبويب "الصفحة الرئيسية" لتطبيق

444). Fourth, the Comp *ʔan* is impossible to be inflected showing some agreement features. Consider the following examples:

- (18) a. tamannaytu ʔan **ya-qrafa** T-Tullaab-u l-kitaab-a  
hoped.perf.1s that 3m-read.s-Subjun the-students-nom the-book-acc  
'I hoped that the students read the book.'
- b. tamannaytu ʔan **qaraʔa** T-Tullaab-u l-kitaab-a  
hoped.1s that read.perf.3ms the-students-nom the-book-acc  
'I hoped that the students have read the book.'

In (18a), the Comp *ʔan* selects the imperfect verb 'read' and assigns the subjunctive mood to it. In (18b) the Comp *ʔan* can select the perfect verb 'read' but does not deliver an overt subjunctive mood. From (18a-b), it could be assumed that the following position of the Comp *ʔan* is mood and must contain a verb to satisfy the Comp *ʔan*.

The contrast between imperfect and perfect verbs under the Comp *ʔan* comes from the fact that moods can be realized on imperfect verbs while they cannot be morphologically realized on perfect verbs. This can be supported by the observation that once the assigner *ʔan* is absent an imperfect verb spells out with an indicative mood by default as in (19a) while a perfect verb still shows no mood as in (19b):

- (19) a. **ya-qraʔ-u** T-Tullaab-u l-kitaab-a  
3m-read.imperf.s-ind the-students-nom the-book-acc  
'The students read the book.'
- b. **qaraʔa** T-Tullaab-u l-kitaab-a  
read.perf.3ms the-students-nom the-book-acc  
'The students have read the book.'

In contrast to the Comp *ʔinna/ʔanna*, no overt element is allowed to intervene between the Comp *ʔan* and its assignee verb. This includes DPs e.g. OTop as in (20a), STop as in (20b)

and PP as in (20c). However, a covert element such as a null subject *pro* in (20d) is allowed to intervene between the Comp *ʔan* and the verb:

- (20) a. \*tamannaytu **ʔan** l-kitaab-u **ya-qraʔ-a-hu** T-Tullaab-u  
 hoped.[erf.1s that the-book-nom 3m-read.imperf.s-subjun-it the-students-  
 nom  
 ‘I hoped that the book, the students read it.’
- b. \*tamannaytu **ʔan** T-Tullaab-u **ya-qraʔ-a** l-kitaab-a  
 hoped.perf.1s that the-students-nom 3m-read.perf.s-subjun the-book-acc  
 ‘I hoped that the students read the book.’
- c. \*tamannaytu **ʔan** fii l-faʔʔi-i **ya-qraʔ-a** T-Tullaab-u  
 hoped.perf.1s that in the-house.gen 3m-read.imperf.s-Subjun the-students-  
 nom  
 l-kitaab-a  
 the-book-acc  
 ‘I hoped that it is in the house, the students have read the book.’
- d. aT-Tullaab-u tamannuu **ʔan** pro **ya-qraʔuu-** l-kitaab-acc  
 the-students-nom hoped.perf.3mp that 3m-read.imperf.p-Subjun the-book-  
 acc  
 ‘I hoped that the students have read the book.’

One might assume that the occurrence of the DPs and PPs in a fronted position between the Comp *ʔan* and its assignee verb should not be banned, since these elements neither receive mood nor assign mood and the mood assignment of the Comp *ʔan* should not be blocked for being delivered to the assignee verb. That is a reasonable assumption, and the only explanation that can be suggested for the ungrammaticalities showed (20a-c) is that the Comp *ʔan* occupies a position lower than topic and focus phrases. In (20d), the null subject ‘they’ can grammatically occur in the intervening position between the Comp *ʔan* and its assignee verb ‘read’. This shows that only *pro* can appear following the Comp *ʔan*.

على النص الذي ترغب في أن يظهر هنا. 2.Heading خطأ! استخدم علامة التبويب "الصفحة الرئيسية" لتطبيق  
 على النص الذي ترغب في أن يظهر هنا. 2.Heading خطأ! استخدم علامة التبويب "الصفحة الرئيسية" لتطبيق

---

The distribution of the Comp  $\lambda an$  is summarised as in following schema:

$$(21) \text{ Comp } \lambda an > *DP/ *PP/ \text{ null}_{\text{subject}} > V_{\text{Subjun}}$$

The order in (21) shows that the Comp  $\lambda an$  can only select VSO order or null subject verbal clauses. It, therefore, shows that topic and focus phrases are not expected to follow the Comp  $\lambda an$ .

### 5.2.5 Summary

To summarise the discussion, as can be seen that the interactions of the Comp  $\lambda inna/\lambda anna$  in the MSA left peripheral domain, there is some syntactic evidence on the complementizers. The assigner Comp  $\lambda anna/\lambda inna$  is an accusative-assigning head that can only select either an accusative DP or, over a non-case marked XP such as PP, then followed by an accusative DP or resumptive pronoun e.g. *hu* 'him'. The case assigner e.g. a verb is prohibited to occur between the assigner Comp  $\lambda inna/\lambda anna$  and its accusative DP. A non-accusative marked XP such as a strong nominative pronoun cannot be the assignee for Comp  $\lambda inna/\lambda anna$ . The DP focus, also, is prohibited to be selected by the Comp  $\lambda anna/\lambda inna$  due to the case assignment while it is not restricted for a PP focus to be in the same position once there is an active DP that the  $\lambda anna/\lambda inna$  can assign the case to.

The Comp  $\lambda an$  is a mood assigner which can select verbs or *pro* subjects only and assigns the subjunctive mood overtly to the imperfect verbs only. Although left peripheral DPs are not mood receivers they are banned from following the Comp  $\lambda an$  because they occur in a position higher than the mood assigner  $\lambda an$ .

In the following section, I will provide theoretical accounts for the different instances of the Comp in MSA.

### 5.3 The analysis of the complementizer

#### 5.3.3 Previous analyses for MSA Comp particles

In the literature on MSA, there is a number of studies investigating the structures of the Comp particle types. Fassi Fehri (2005), for instance, suggests a model of multiple case valuations to account for assignment of the Comp particles in MSA. Fassi Fehri also debates the Phase Theory and assumes that the clause is built up from two phases only, CP and  $\nu$ P where C-to-T has the feature-inheritance system. He specifically argues that the Comp type on the C head phase defines the clause properties including case assignments. The MSA Comp *ʔinna/ʔanna* selects only the SVO order while the Comp *ʔin* selects only the VSO order. According to Fassi Fehri, it could be possible for each Comp particle to assign two types of case with the following properties: (i) accusative case and (ii) a temporal case (which he applies for mood). For the Comp *ʔinna/ʔanna*, it assigns the accusative case to the following DP and assigns the nominative case for the *pro* or overt DP subject as in (22a). For the Comp *ʔin* however, it assigns the nominative case to the postverbal *pro* or the postverbal DP subject and assigns the temporal subjunctive case (mood) to the verb as (22b) shows (from Fassi Fehri (2005: 2):

- (22) a. *ħasibtu ʔanna n-nisaħ-a pro dakhalna makaatib-a-hunna*  
 thought.perf.1s that the-women-acc ntered.perf.3fp offices-acc-their.f  
 ‘I thought that the women entered their offices.’
- b. *ʔaraada ʔan ya-ħtiy-a r-radʒul-u*  
 wanted that 3m-come.imperf.s-subjun the-man-nom  
 ‘He wanted the man to come.’

In (22a), the Comp *ʔanna* assigns the accusative case to the preverbal DP subject ‘the women’ and the assign the nominative case the *pro* subject of the verb ‘entered’. In (22b), the comp *ʔan* assigns the nominative case to the postverbal DP subject ‘the man’ and the subjunctive mood to the verb ‘come’.

على النص الذي ترغب في أن يظهر هنا. 2.Heading خطأ! استخدم علامة التبويب "الصفحة الرئيسية" لتطبيق  
على النص الذي ترغب في أن يظهر هنا. 2.Heading خطأ! استخدم علامة التبويب "الصفحة الرئيسية" لتطبيق

Notice that the multiple model for case valuations proposes that the nominative case of postverbal subject is valued by the Comp particles. This is different from the assumption which is adopted here that the postverbal subject is assigned case by the closest assigner head which is T head and this is supported by the locality principles.

Fassi Fehri supports his analysis of multiple case valuations with the following data:

- (23) *ʔinna* l-fataat-a ʃumm-u-haa Gaadhibat-un  
that the-girl-acc mother-nom-her angry-nom  
'Indeed, the girl, her mother is angry.'  
(Fassi Fehri 2005: 11)

According to Fassi Fehri, the Comp *ʔinna* assigns accusative case to the first DP 'the girls' and nominative case to the second DP 'mother'. Therefore, the Comp *ʔinna/ʔanna* is an accusative and a nominative assigner. In this analysis, however, is not clear how the Comp *ʔinna* can value multiple cases to more than DPs. We showed here that the Comp *ʔinna/ʔanna* has the ability to assign the accusative case only to the closest DP while the other DPs of the given clause are assigned to nominative case by default. Consider the example in (24) without the assigner *ʔinna/ʔanna* as in the following example:

- (24) l-fataat-u ʃumm-u-haa Gaadhibat-un  
the-girl-nom mother-nom-her angry-nom  
'The girl, her mother is angry.'

In (24), the Comp *ʔinna/ʔanna* is absent and the first DP 'the girl' then appears nominative. However, the second DP 'mother' still appears nominative just as within the clauses headed by the Comp *ʔinna/ʔanna* in (23). Therefore, *ʔinna/ʔanna* has no role for case valuation beyond than the closest DP. I, therefore, exclude the multiple agree/value model from accounting for the Comp particles with their domains.

Another analysis of case and mood features in MSA is proposed by Leung (2011: 135) who hypothesises that structural case is assigned by the mood feature on the head T. According to him, cross-linguistically, some languages can have main and embedded clauses connected with different types of relations with regard to tense, aspect and modality and the C head mediates these relations between the two clauses. In MSA, for instance, the agreement relation is observed between main and embedded clauses. Particularly, there is “[a] concord relation between the use of complementizer and the embedded mood” (p: 135)<sup>16</sup>. This observation is based on the fact that when a communicative verb appears in the main clause the embedded clause should have the Comp *?inna/?anna* with an accusative DP followed by an indicative verb. However, when verbs indicating intention, feeling, possibility, need or desire appear in the main clause then the embedded clause should have the Comp *?an* with a subjunctive verb. As a result, there is an agreement relation of the Comp particles with the tense in the main clause and the mood type of the embedded clause as in the following rules:

- (25) a. communicative verbs + *?inna/?anna* + DP + an indicative mood verb  
 b. wish and feeling verbs + *?an* + a subjunctive mood verb

In this context, from Government and Binding theory, it was assumed that a C can carry a [ $\pm$ wh] feature and that this indicates the Comp types such as declarative, interrogative, etc. Leung applies this analysis to the agreement relation between the Comp and the embedded verb's mood and assumes that the C head embeds a mood feature, i.e. [mood] which is the responsible for establishing an agreement relation within the domain it governs. In addition, the Comp particles in C head can be analysed as connectors between the main and embedded clauses which allow features e.g. a mood (Indicative and subjunctive) to be transferred from one clause to another. Ultimately, the following schema summarizes the discussion:

<sup>16</sup> Note that MSA, unlike English, does not show a clear case of infinitives, since the main clause always subcategorizes for a finite clause as its complement.



- (26) a. Communicative verbs <sub>[+indicative]</sub> ... [CP C *ʔinna/ʔanna* <sub>[+indicative]</sub> [TP DP<sub>ACC</sub> [T <sub>[+indicative]</sub> ...]]]  
 b. Wish/request/suggest verbs <sub>[+subjunctive]</sub> ... [CP C *ʔan* <sub>[+subjunctive]</sub> ... [TP T <sub>[+subjunctive]</sub> ...]]

In (26a), once the agreement relation between the Comp *ʔinna/ʔanna* and T of the embedded clause is established both should carry the <sub>[±indicative]</sub> mood feature. Meanwhile, both mood features originate on Comp and being subcategorized by the main predicate; the <sub>[±indicative]</sub> mood feature is subcategorized by communicative verbs. The main verb probes the Comp as the goal, which in turn agrees with its following T, transferring the indicative features from the main clause domain to the embedded. The schema (26a) also has an additional agreement between C and T that is observed when the Comp *ʔinna/ʔanna* appears with an accusative case DP. The indicative mood feature is inherited from C *ʔanna* to T within the line of the feature-inheritance system (Chomsky 2008). The indicative mood feature on T is responsible for the accusative case being assigned to the following DP of the Comp *ʔinna/ʔanna*. In (26b) once the agreement relation between the Comp *ʔan* and T of the embedded clause is established both should carry <sub>[±subjunctive]</sub> mood as the <sub>[±subjunctive]</sub> mood feature is subcategorized by wish, feelings and desire verbs. The main verb probes the Comp particle as its Goal, which in turn agrees with its following T, transferring the subjunctive features from the main clause domain to the embedded.

However, Leung's (2011) analysis does not address all the distributions of Comp types since the Comp *ʔinna* and the Comp *ʔin* in MSA do not occur only in embedded clauses but also in main clauses as explained early in (1b) and (3a-b). It is not clear how the indicative mood feature inherited to T and can assign the accusative case to DPs that could occupy the topic position higher than T head which clearly is not in its c-command domain.

#### 5.3.4 Alternative analysis

With regard to the structure of Rizzi (1997), I start the discussion by showing the Comp structures within the left periphery domain in different languages followed by the MSA Comp structures. In the Romance and Germanic languages, the Comp particles are expressed

in the Force head which occurs in finite clauses and in the Fin head which occurs in non-finite clauses as the case in Italian in Rizzi (2004) as shown below:

		Force	Top	Foc	Top	Fin	IP
(27)	a. Credo	<b>che</b>	ieri	QUESTO	a Gianni		avreste dovuto dirgli
		'I believe that	yesterday	THIS	to Gianni		you should have said
		Force	Top	Fin	IP		
	b. Penso		a Gianni,	<b>di</b>	dovergli parlare		
		'I think,	to Gianni,		to have to talk to him'		

In (27a), the Comp *che* is in Force followed by two topic phrases *ieri* and *a Gianni* which are separated by one focus phrase *QUESTO*. In (27b), the Comp *di* is in Fin preceded by the topic phrase *a Gianni*.

In Celtic languages, the Comp can be expressed in Fin in finite clauses as well as non-finite clauses. Irish, for instance, shows the Comp on Fin in finite clauses as in (28a) while Welsh can show the Comp in both Force and Fin in finite clauses as in (28b) (Roberts 2004):

				Fin
(28)	a. Is doíche	[faoi chean ncúpla lá		[ <b>go</b> bhféadfaí imeacht]]
	is probable	at-the-end-of couple day		that could leave
		Force		Fin
	b. Dywedais i	[ <b>mai</b> 'r dynion fel arfer	<b>a</b>	[werthith y ci ]]
	said	I	the men as usual	will-sell the dog

In (28a), the Irish Comp *go* occupies the Fin head and appears preceded by another left-peripheral element, namely the preposed adverbial *faoi chean ncúpla lá*. In (28b), the Welsh Comps *mai* and *a* occupy the Force and Fin heads respectively. The left peripheral elements 'the men as usual' occur between these two Comp particles.

For the MSA complementizer system with regard to the observations I showed earlier, I assume the Comp particles in MSA can have different positions. The accusative Comp *?inna/?anna* in finite clauses are expressed in Force. This assumption is motivated by certain distributional observations. The Comp *?inna/?anna* can precede all other left peripheral elements of either main or embedded clauses such as OTop, STop as in (1-2) and focus phrases as in (16a). The Comp *?inna* can follow the OTop phrase and select the STop phrase as in (3b). Thus, it can be expressed on Foc. Therefore, *?inna/?anna* are positioned either just above the OTop position presumably in Force head position or between the OTop and STop positions in Foc head position. The Comp *?in*, however, cannot select any left peripheral elements e.g. OTop, STop and focus phrases as in (20a-c), but it can select either basic VSO clauses as in (18a-b) or null subject clauses as (20d) shows. Thus, the Comp *?in* occupies a position just higher than *pro* subject position in Spec-TP and lower than all left peripheral elements. I will assume the Comp *?in* is in the Fin head. The schemas below show the structures for MSA Comp particles:

- (29) [ForceP [<sub>Force</sub> *?inna/?anna*] [TopP [Top] [FocP [<sub>Foc</sub> *?inna*] [TopP [Top] [FinP [<sub>Fin</sub> *?an*]  
 [TP [T]]]]]]]

To provide an account of the two Comp types in MSA and their interactions within the clausal structure in (29), I assume that the Comp system should be analysed with a specific set of formal features along with the assumptions of the Minimalist program. There are three types of features can be associated with Comp particles. The first feature is with regard to the subdivisions of Rizzi which postulates that ForceP, on the one hand, was meant to convey information relates clause type or illocutionary force such as declarative, interrogative, etc. In MSA, the Force head can only be occupied by the Comp *?inna/?anna* which always select declarative clauses. The Force head, therefore, encodes the declarative Force feature [+decl] which is lexically satisfied by the Comp *?inna/?anna*. The FinP, on the other hand, is meant to express finiteness of the clause which can be occupied by the Comp *?in*. So, the Fin head encodes the [+fin] feature which is lexically satisfied by the Comp *?in*.

The second type of feature is connected with the requirements of the following position of the Comp. As we showed that it is obligatory for the Comp *?inna/?anna* to be followed by DP phrase which can only be interpreted as a topic phrase while the Comp *?in*, however, needs to be followed by a verb. Therefore, the Agree relations are established between the Comp particles and their following domains with regard to the identity of a phrase in the complement of Comp particles. Chomsky (2000) proposes that, in the syntax, Agree is activated by the existence of an uninterpretable feature. I will use the operation Agree (Chomsky, 2000; 2001) to account for the compulsory appearance of the DP topic in the following complement of the Comp *?inna/?anna* and for the compulsory appearance of the verb in the following position of the Comp *?in*. Specifically, the *?inna/?anna* carries uninterpretable topic feature while the following DP carries interpretable topic feature. The uninterpretable topic feature on Comp gets valued derivationally by Agree. The Comp *?in*, however, enters the derivation with an uninterpretable V feature that can be valued via Agree with the [+V] on the following verb. The features will be shown as in the trees which follow.

The third feature relates the case or mood features. In the generative approach, case always has been an important key for syntactic analysis. The idea that Comp is specified for case has been claimed by many researchers (Carstens 2003; Chomsky 2008; Tanaka 2005, among others). The case valuing between the functional head C and its assignee DP can be captured by many analyses. Three stages of generative analysis discussion include the core of case, in particular, assignment between the assigner head and its DP assignee. Within the Government and Binding theory, Borer (1984) postulates that case assigners lexically enter the derivation carrying a case feature which is transferred or delivered to their complement DP via the local relation of government. Within Minimalist Program, Chomsky (1995) proposes that there are lexically specified case features for both case assigners and their complement DPs. In order for complement DPs to license case features, they have to move to a higher specifier for checking relation with the case assigner heads. Since both case features are matched and, then, the case feature on the case assigner will be deleted while the appropriate case will be assigned to the DP complement. In the later stages of the Minimalist Program, Chomsky

(2000; 2001) and Adger (2003), it is proposed the Probe-Goal-Agree framework for case assignment between the head assigner and its assignee but with different techniques. Whereas Chomsky assumes the case assigner head assigns and values the uninterpretable case feature on its assignee (e.g. T assigns nominative for subject and *v* assigns accusative for object) Adger takes both case assigner and its assignee to have uninterpretable features that are valued via Agree. Chomsky (2008) postulates a different analysis that can explain the case assignment between the case assigner and its assignee which is called the feature-inheritance system. In this analysis, features are merged in Comp including the case or mood feature and are inherited to T which, in turn, agrees and assigns the case to assignee DP subject. This analysis, however, cannot work in MSA for two reasons: (i) the assignee DP in MSA is a topic rather than a subject in the A domain, so T cannot assign case to the DP topic since it does not c-command it, (ii) such analyses requires the assignee DP to have one case value in both embedded and main clauses which is not always the case in MSA. The feature-inheritance system (Chomsky) will be addressed in Chapter 6 within the Complementizer Agreement structures.

To account for the case and mood valuations between the functional head Force and Fin and their assignee DP and verb respectively I follow the Probe-Goal-Agree analysis with Adger's (2003) techniques. I argue that the Force head is a locus of the case feature while the Fin head is a locus of the mood feature in MSA. As the Comp head *?inna/?anna* is assumed to be an accusative assigner and must give accusative case to the following topic phrase, we analyse the Comp head *?anna/?anna* as a probe which has an uninterpretable unvalued Acc [*u* Acc] feature while the following DP is analysed as a goal which has an uninterpretable case [*u* Case] feature which needs a value. Via agreement, the uninterpretable features are matched; then the [*u* Acc] feature on the Comp *?anna* will be valued and deleted while the [*u* Case] feature on the closest assignee DP will be valued as Acc. Similar to the case valuation on Comp *?inna/?anna*, the mood valuation between the Comp *?in* and its adjacent assignee verb can be captured by the probe-goal-agree framework. Since the Comp *?in* is a mood assigner head which must select the following verb within subjunctive mood, then, the Comp *?in* has an uninterpretable Subjunctive [*u* Subjun] feature while the following verb has an

uninterpretable mood [*u* Mood] feature which needs a value. Via agreement, the uninterpretable features are matched, then, the [*u* Subjun] feature on the Comp *?in* will be valued and deleted while the [*u* Mood] feature on the assignee verb will be valued as Subjun.

Ultimately, the case assigner Comp *?inna/?anna* and its assignee DP can have the structure in (30a) while the mood assigner Comp *?in* and its assignee verb can have the structure in (30b)<sup>17</sup>:

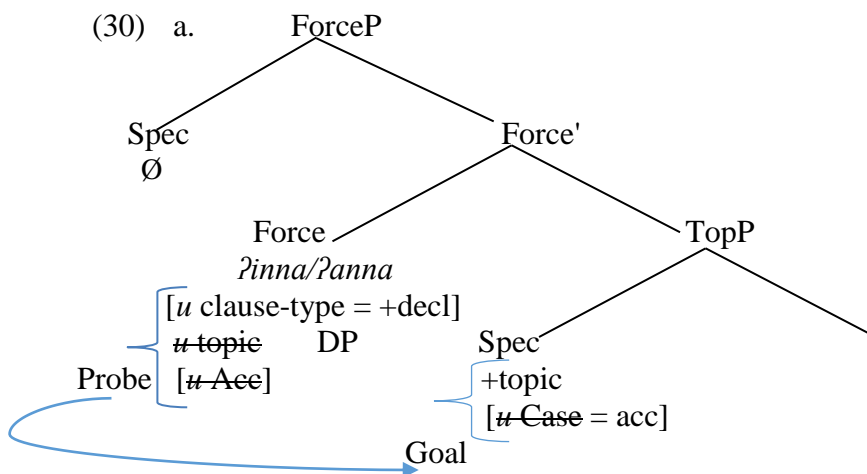

17 The abbreviations that Adger (2003) adopted are different from those in (30a-b). He, for instance, notes uninterpretable unvalued case feature as [case] rather than [*u*Case] and checked valued feature as [~~nom~~] rather than [~~u~~case: nom]. For consistency, I will adopt the abbreviations as in (30a-b).

على النص الذي ترغب في أن يظهر هنا. 2.Heading خطأ! استخدم علامة التبويب "الصفحة الرئيسية" لتطبيق  
 على النص الذي ترغب في أن يظهر هنا. 2.Heading خطأ! استخدم علامة التبويب "الصفحة الرئيسية" لتطبيق

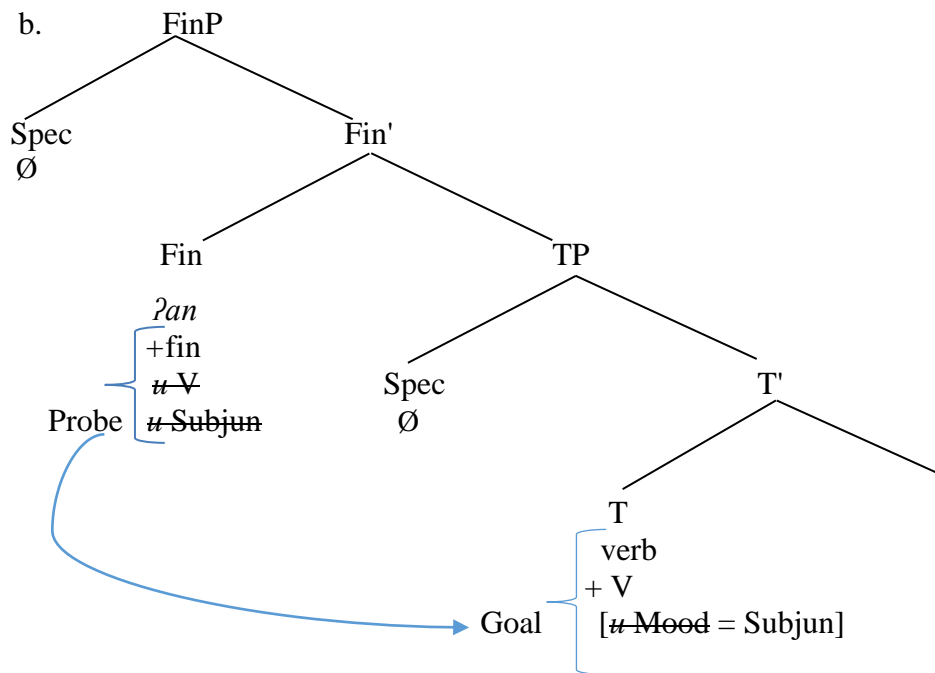

Assuming the case and mood features valuations for the probe Comp and their relevant goals in (30a-b) leads us to the observation that the Agree relations are not limited just to the phi-features between C and the subject or T.

#### 5.4 The derivation of the Complementizers

Let us draw the derivations of the two kinds of Comp within MSA structures:

- (31) a. *ħasibtu*                    **?anna** **l-kitaab-a**                    *ya-qra?u-hu*                    T-Tullaab-u  
 thought.perf..1m                    that                    the-book-acc                    3m-read.imperf.s-it                    the-students-nom  
 ‘I thought that the book, the students read it.’

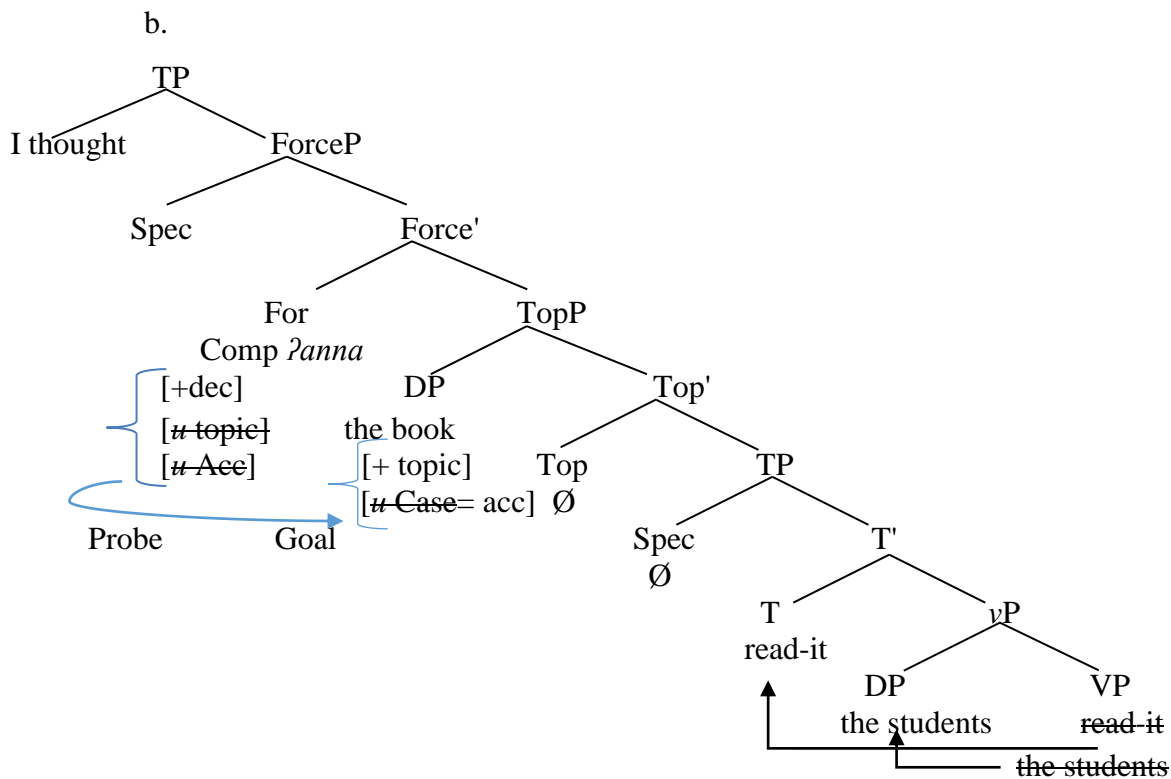

In (31b), the main TP clause 'I thought' selects the embedded clause which is introduced by Comp  $\lambda_{anna}$  that occupies the Force head to satisfy the [+declarative] feature. Following the Comp  $\lambda_{anna}$  the OTop phrase 'the book' instantiates the higher Spec-TopP to satisfy the [+topic] feature. The Force head ' $\lambda_{anna}$ ', however, carries a  $[u \text{ topic}]$  feature which is valued by the [+topic] features on the OTop 'the book'. The Comp head  $\lambda_{anna}$ , also, carries  $[u \text{ Acc}]$  while the following DP 'the book' has a  $[u \text{ Case}]$  feature. Via the probe-goal-agree framework, the case assigner  $\lambda_{anna}$  is an active probe by virtue of being a case-bearing head carrying the  $[u \text{ Acc}]$  feature. The active probe  $\lambda_{anna}$  is looking for an active goal which it commands to value its uninterpretable features. The DP 'the book' is an active goal since it carries  $[u \text{ Case}]$  feature. The agreement between the probe  $\lambda_{anna}$  and the goal 'the book' takes place since features are matched, hence, the  $[u \text{ Acc}]$  feature on the Comp  $\lambda_{anna}$  will be valued and deleted while the  $[u \text{ Case}]$  feature on the DP 'the book' will be valued as Acc.



على النص الذي ترغب في أن يظهر هنا. Heading 2 خطأ! استخدم علامة التبويب "الصفحة الرئيسية" لتطبيق

على النص الذي ترغب في أن يظهر هنا. Heading 2 خطأ! استخدم علامة التبويب "الصفحة الرئيسية" لتطبيق

- (32) *ħasibtu*      *ʔanna l-maal-a/\*u*      *ʕaliyy-un/\*a ʔaʕTa-hu*      *li-hind-in*  
 thought.perf.1s that the-money-acc/nom Ali-nom/acc gave.perf.3ms-it to-Hind-gen  
 'I thought that the money, Ali give it to Hind.'

In (32), the probe *ʔanna* is active since it has [*u* Acc] feature that has to be valued and deleted. However, more than one active goals is available for the probe *ʔanna*; they are 'the money' and the 'Ali' which have [*u* Case] feature. The Comp *ʔanna* cannot probe other than the closest goal, this is restricted by the Locality Condition (Chomsky 2000: 122) as stated below:

- (33) Locality Condition

Suppose P is a probe and G is a goal. Then Agree holds between P and G just in case G is the closest set of features in the domain D(P) of P that match those of P. The domain D(P) of P is the sister of D, and G is closest to P if there is no G' matching P such that G is in D(G').

According to (33), the Comp *ʔanna* must only probe the closest appropriate goal which is 'the money'. Therefore, the [*u* Case] feature on 'the money' will be valued as accusative while the [*u* Case] feature on 'Ali' will be valued as a nominative case by default.

Consider the derivation of the following grammatical example in (34) where PP intervenes between the C *ʔanna* and its assignee DP:

- (34) *ħalimtu*      *ʔanna maʕa-ka*      *radʒul-an/un\**      *l-ʔlmaniyy t*  
 knew.perf.1s that with-you.2ms man-acc/nom German  
 'I knew that it was with you, a German man.'

In (34), the Force head *ʔanna* carries an uninterpretable topic feature, and the PP focus cannot value these features since it lacks an interpretable topic feature. However, lower in the structure, the DP phrase 'a man' can do the valuation job since it carries interpretable [+topic] feature. Furthermore, the *ʔanna* is an active probe since it has [*u* Case] feature looking lower

in its domain for an active goal to value its unvalued feature. So, there are two possible goals, the closest goal is the PP ‘with you’ while the following goal is the DP ‘a man’. The former, however, lacks a [*u* Case] feature since PP does not receive case while the latter carries [*u* Case] feature since it is cased phrase. As a result, the DP ‘a man’ is an active goal which can be probed by the Comp *?anna* while PP cannot be. The [*u* Acc] feature of the probe is deleted while accusative case is assigned on the goal DP ‘a man’ at spellout.

By contrast, the intervention between the Comp *?inna/?anna* and its assignee by an assigner head such as a verb will crash the derivation as the following example:

- (35) a. \**hasibtu*            *?anna*    *ya-qra?-a*                            T-Tullaab-a            I-kitaab-a  
           thought.perf.1s    that            3m-read.imperf.s-subjun    the-students-acc    the-book-acc  
           ‘I thought that the students read the book.’

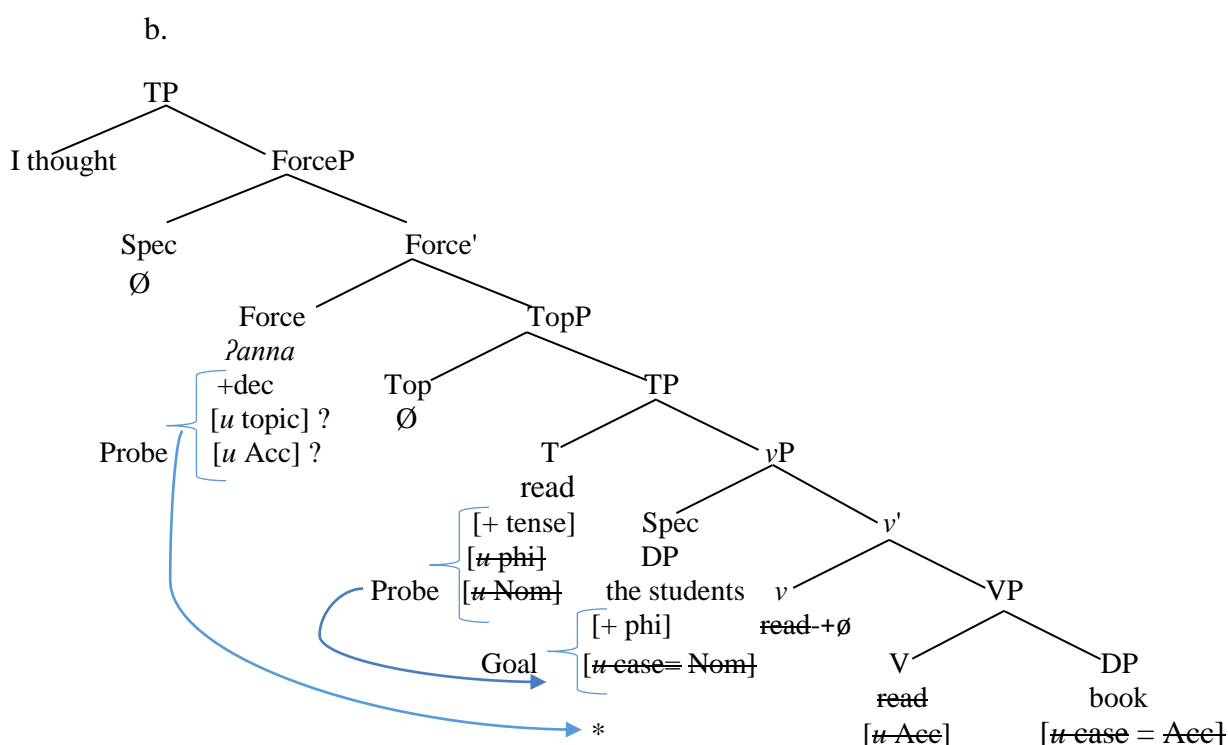

The structure (35b) has three active case assigner probes. The higher active probe is the assigner Force *?anna* since it has [*u* Topic] and [*u* Acc] features. The intermediate active probe is the assigner T ‘read’ since it has a set of [*u* phi] features (person and gender), and the

[*u* Nom] feature. The lowest active probe is the assigner *v* 'read' since it has a [*u* Acc] feature. However, there are only two goals in the domains of the three probes in the structure which are the DP 'the students' and the DP 'the book'. The former has phi-features (3 Per, m Gen and p Num) and [*u* Case] features and the latter has a [*u* Case] feature and similar phi features but singular. Based on the locality and the features of each probe and goal it can be assumed that the assigner *v* head 'read' probes the object 'the book' as its goal since they have matching features, then, the agree relation values and deletes the [*u* Acc] features while the accusative case will be assigned on the goal 'the book'.

The assigner T 'read' probes the DP 'the students' which has similar features, via agreement between the probe T 'read' and the goal 'the students' the set of [*u* phi] features on the probe 'read' are valued as [Per= 3 and Gen= m] while [Num= s] spells out by default. Moreover, the [*u* Case] feature on the DP 'the students' will be valued as Nom while [*u* Nom] is valued and deleted. T cannot attract the subject to be in Spec-TP since the T 'read' lacks the EPP feature and subject 'the students' then stays in lower position.

The probe Force *λanna* must probe the closest DP in its complement which is the 'the students' and assigns the accusative case to it. However, the goal 'the students' cannot be probed by the assigner *λanna* due to the restriction of locality which requires that a DP e.g. 'the student' can only be a goal to the closest assigner head that c-commands it, which is the probe T 'read'. Another restriction, which is connected with the case valuation, is that once the [*u* Acc] feature is valued and deleted, it becomes inaccessible in the syntax and cannot be available for further feature valuation operations. This is called the Inactivation Condition in Chomsky (2000) who assumes that an element has to carry [*u* F] to be active for an Agree relation, and while an interpretable element is not active and then cannot participate in the operation of Agree.

According to the Inactivation Condition, once the unvalued case feature on the DP e.g. 'the students' has been valued as Nom by the probe T 'read' it cannot be valued again by another probe e.g. *λanna* as accusative and then receive Accusative case as well. Therefore, the



على النص الذي ترغب في أن يظهر هنا. 2.Heading خطأ! استخدم علامة التبويب "الصفحة الرئيسية" لتطبيق  
 على النص الذي ترغب في أن يظهر هنا. 2.Heading خطأ! استخدم علامة التبويب "الصفحة الرئيسية" لتطبيق

- (38) a. tamannaytu      **ʔan**    ya-qraʕ-a                      T-Tullaab-u      l-kitaab-a  
 hoped.perf.1m    that    3m-read.imperf.s-subjun    the-students-nom    the-book-acc  
 ‘I hoped that the students read the book.’

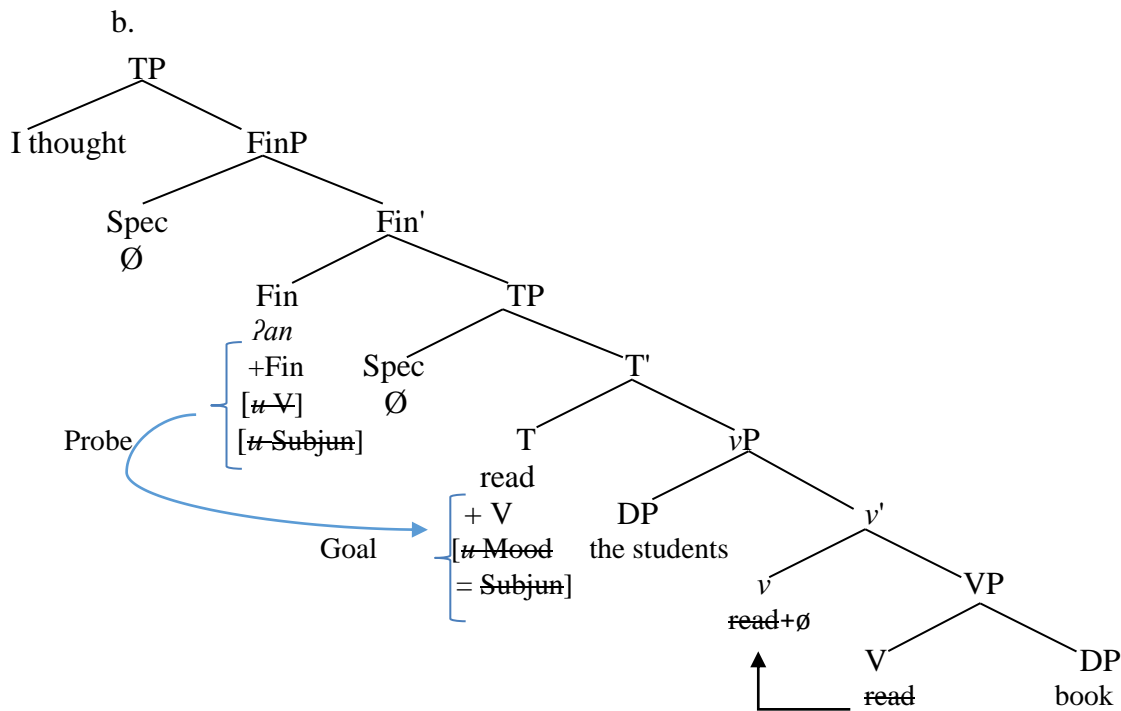

In (38a-b), the Comp *ʔan* occupies the Fin head and satisfies [+Fin] feature while the imperfect verb ‘read’ moves the T position to satisfy the tense feature. The subjunctive *ʔan*, however, is carrying a [*u* V] feature which will be get valued by the [+V] feature on the verb ‘read’. The subjunctive *ʔan* also has a [*u* Subjun] feature, then, it is an active probe looking for an active goal which it c-commands to value its uninterpretable feature. The verb ‘read’ is an active goal since it has a similar feature which is a [*u* Mood] feature. The agreement between the probe *ʔan* and the goal ‘read’ is established once the features are matched, hence, the [*u* Subjun] and [*u* V] features on the Comp *ʔan* will be valued and deleted while the [*u* Mood] feature on the T ‘read’ will be valued as Subjun.

How can we account for the grammaticality of (39) below?

- (39) a. aT-Tullaab-u      tamannauu    **ʔan**    *pro*    **ya-qraʕuu-**                      l-kitaab-a  
 the-students-nom    hoped.3mp    that    they    3m-read.imperf.s-Subjun    the-book-acc  
 'I hoped that the students read the book.'

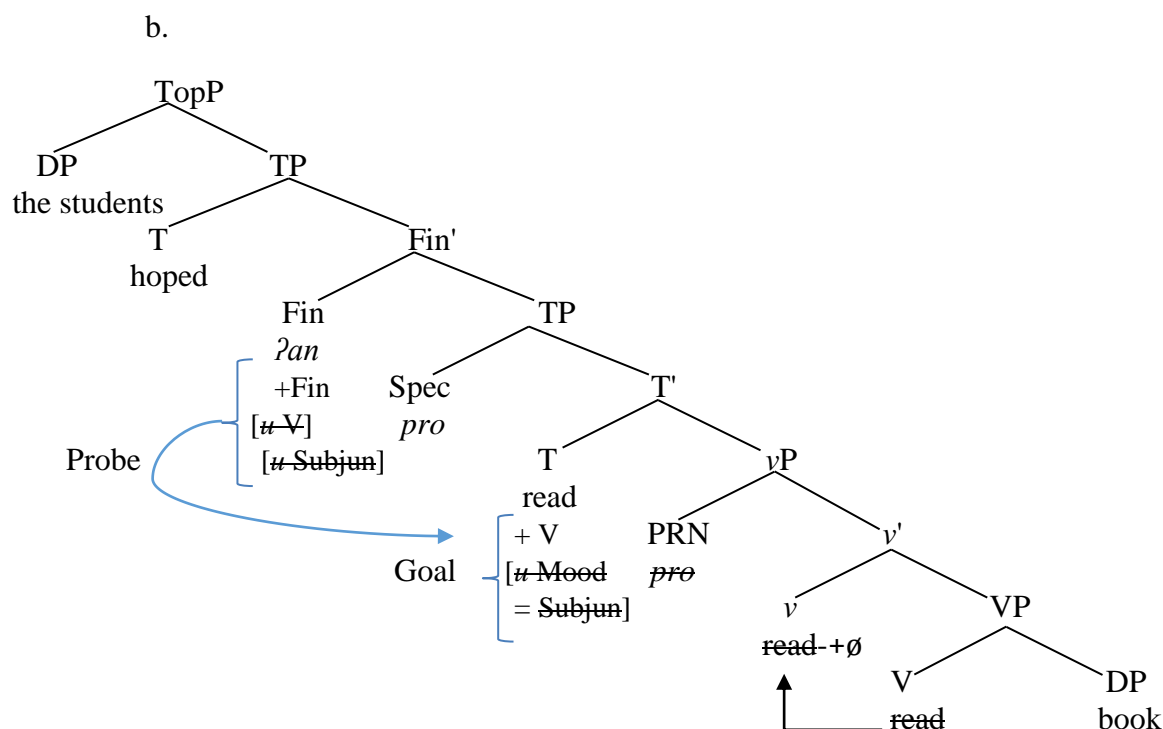

In (39b), the Comp *ʔan* occupies the Fin head position and assigns the subjunctive mood to the verb 'read' in T position. The *pro* subject 'they' which is in Spec-TP intervenes between the assigner *ʔan* and its assignee 'read' and the structure survives. To account for such possible intervention, we could reasonably assume that the occurrence of the *pro* subject 'they' should have no intervention effect to block the subjunctive mood to be discharged to the following verb 'read', since the subject 'they' is neither a mood assigner nor a mood receiver.

## 5.5 The Comp particles in Tabuki Arabic

There are two types of Comp in TA, namely *ʔinn* and *ʔin* which occur only in embedded clauses. The data show that the both *ʔinn* and *ʔin* have different distributions with other left

على النص الذي ترغب في أن يظهر هنا. 2.Heading خطأ! استخدم علامة التبويب "الصفحة الرئيسية" لتطبيق  
 على النص الذي ترغب في أن يظهر هنا. 2.Heading خطأ! استخدم علامة التبويب "الصفحة الرئيسية" لتطبيق

peripheral elements. The Comp *?inn*, for instance, can select an OTop phrase as in (40a) or an STop phrase as in (40b) but cannot select a pronominal subject as in (40c) or directly select a focus DP phrase as (40d):

- (40) a. *?aliy ye-ʕtigid ?inn s-sayyaarah<sub>i</sub> saalim ?ʕtaraa-haa<sub>i</sub>*  
 Ali 3m-believes.s that the-car Salem bought.3ms.it  
 ‘Ali believes that the car, Salem bought it.’
- b. *?aliy ye-ʕtigid ?inn saalim ?ʕtaraa s-sayyaarah*  
 Ali 3m-believes.s that Salem bought.3ms the-car  
 ‘Ali believes that Salem bought the car.’
- c. \**?aliy ye-ʕtigid ?inn huu ?ʕtaraa s-sayyaarah*  
 Ali 3m-believes.s that he bought.3ms the-car  
 ‘Ali believes that he bought the car.’
- d. \**?aliy ye-ʕtigid ?inn sayyaraah saalim ?ʕtaraa t*  
 Ali 3m-believes.s that car Salem bought.3ms.3ms  
 ‘Ali believes that it was a car Salem bought.’

The Comp *?in*, however, can select the DP subject as in (41a) as well as the pronominal subject as in (41b), but cannot select a topic or focus phrase as in the ungrammaticality shown in (41c) and (41d) respectively:

- (41) a. *?aliy ye-ʕtigid ?in saalim ?ʕtaraa s-sayyaarah*  
 Ali 3m-believes.s that Salem bought.3ms the-car  
 ‘Ali believes that Salem bought the car.’
- b. *?aliy ye-ʕtigid ?in huu ?ʕtaraa s-sayyaarah*  
 Ali 3m-believes.s that he bought.3ms the-car  
 ‘Ali believes that he bought the car.’

- c. \*ʔaliy ye-ʕtigid ʔin **s-sayyaarah** saalim ʔʕtaraa-**ha**  
 Ali 3m-believes.s that the-car Salem bought.3ms.it  
 ‘Ali believes that the car, Salem bought it.’
- d. \*ʔaliy ye-ʕtigid ʔin **sayyaraah** saalim ʔʕtaraa **t**  
 Ali 3m-believes.s that car Salem bought.3ms.3ms  
 ‘Ali believes that it was a car Salem bought.’

From the data above, it could be generalized that the two Comp particles *ʔinn* and *ʔin* require DP phrases in the following position. Therefore, they are prohibited to select a *pro* subject as the follow example:

- (42) \*ʔaliy ye-ʕtigid **ʔinn/ʔin** *pro* ʔʕtaraa s-sayyaarah  
 Ali 3m-believes.s that bought.3mp the-car  
 ‘Ali believes that they read the letter.’

In (42), the Comp *ʔin* selects the *pro* subject ‘they’ which leads to ungrammaticality. The well-known fact in this Arabic variety is that the TA pronominal subject in main clauses is free to be an overt subject as in (43a) or a null as in (43b):

- (43) a. saalem/ **huu** ʔʕtaraa s-sayyaarah  
 Salem/ he bought.3ms the-car  
 ‘Salem/He bought the car.’
- b. **pro** ʔʕtaraa s-sayyaarah  
 bought.3ms the-car  
 ‘He bought the car.’

However, when the *pro* subject is preceded by the Comp *ʔinn* or *ʔin*, it is obligatory for the *pro* subject to be overt. Otherwise the example is ungrammatical as (42) shows.



على النص الذي ترغب في أن يظهر هنا. 2.Heading خطأ! استخدم علامة التبويب "الصفحة الرئيسية" لتطبيق  
على النص الذي ترغب في أن يظهر هنا. 2.Heading خطأ! استخدم علامة التبويب "الصفحة الرئيسية" لتطبيق

Additionally, the two Comp particles *?inn* and *?in* are not allowed to select a verb as in the ungrammaticality shown below:

- (44) \*?aliy yi-tawaqqaʕ **?inn/?in** waʕluu ʃ-ʃabaab l-dʒamʕah  
Ali 3m-guesses.s that arrived.3mp the-guys the-university  
'Ali guesses that the guys have arrived at the university.'

Finally, embedded clauses in TA can be headed by a covert complementizer, consider the following examples:

- (45) a. huda y-quul **s-sayyaarah** saalem ʔʃtaraa-**ha**  
Huda 3m-say.s the-car Salem bought.3ms.it  
'Huda believes that the car, Salem bought it'
- b. huda y-quul **saalem** ʔʃtaraa s-sayyaraah  
Huda 3m-say.s Salem bought.3ms the-car  
'Huda believes that Salem bought the car'
- c. huda y-quul **huuw** ʔʃtaraa s-sayyaarah  
Huda 3m-say.s he bought.3ms the-car  
'Huda believes that he bought the car'

The examples in (45a-c) are grammatical although they are constructed from main and embedded clauses without an overt Comp element. This shows that null complementizer constructions exist in TA.

To summarise, this section shows the possible orders between the left peripheral elements with respect to the Comp *?inn* and *?in* in TA. It is obvious that each complementizer particle in TA requires specific kinds of syntactic elements in the following position. The Comp *?inn*, on the one hand, is to be followed by either a topic phrase binding a resumptive pronoun or an overt DP subject but not a pronominal subject. The Comp *?in*, on the other hand, requires to be followed by an overt subject including a pronominal one and prohibits a topic phrase.

Both the Comps  $\varrho_{inn}$  and  $\varrho_{in}$ , however, share similar properties since they must select SVO order only, while a following verb or pro subject are not allowed. In addition, the focus phrase cannot be selected by Comp  $\varrho_{inn}$  and  $\varrho_{in}$  while the Comp  $\varrho_{inn}$  only can precede the focus phrase but must be separated by the topic phrase. Finally, null complementizer constructions exist in TA.

In the following section, I will provide the theoretical account for the Comps in TA.

### 5.6 The analysis of the TA embedded clause

For the TA Comp structure with regard to the observations I showed in the last section, I would assume that the Force and Fin in finite clauses are expressed by  $\varrho_{inn}$  and  $\varrho_{in}$  respectively. This assumption comes from the following observations: The Comp  $\varrho_{inn}$  always precedes all other left peripheral elements of the embedded clauses such as topic or focus phrases. Therefore,  $\varrho_{inn}$  is positioned just above the topic position, presumably in the Force head position. The Comp  $\varrho_{in}$ , however, cannot select either topic or focus phrases, but it can only select the basic SVO clause. Thus, Comp  $\varrho_{in}$  is not in the Force head but in a position just higher than TP below the lower TopP, presumably in the Fin head position. Independent evidence for the position of the Comp  $\varrho_{in}$  comes from the distribution of  $\varrho_{in}$  with the verb-initial order. The observation shows that the verb and the Comp  $\varrho_{in}$  are in a complementary distribution and cannot occupy the same position. Recall that the verb is moved to Fin to produce the VSO constituent order in TA, but the verb is blocked to do so when the Comp  $\varrho_{in}$  appears as the following examples:

- (46) a.  $\varrho_{in}$ tarat      saalim    sayyaarah  
           bought.3fs    Salem    car  
           ‘Salem bought the car.’

على النص الذي ترغب في أن يظهر هنا. 2.Heading خطأ! استخدم علامة التبويب "الصفحة الرئيسية" لتطبيق

على النص الذي ترغب في أن يظهر هنا. 2.Heading خطأ! استخدم علامة التبويب "الصفحة الرئيسية" لتطبيق

- b. \*saarah tʃik            ʔin    ʔʃtaraa        saalim        sayyaarah  
 Sarah    3m-doubt.s    that    bought.3ms    Salem        car  
 ‘Sarah doubts that Salem bought the car.’

In (46a), the VSO clause ‘Salem bought the car’ is grammatical where the verb is fronted in Fin head position. This VSO clause, however, appears embedded in (46b) and causes ungrammaticality due to the Fin head position being targeted by two different elements, the Comp *ʔin* and the verb ‘bought’. The unavoidable conclusion suggests that the Comp *ʔin* and the fronted verb are in a complementary distribution suggesting that the Comp *ʔin* is in Fin and can only select SVO clauses where the verb remains in lower position in the T head.

The Comp particles in TA can have the following structure:

- (47) [ForceP [<sub>Force</sub> *ʔinn*] [TopP [Top] [FocP [Foc] [TopP [Top] [FinP [<sub>Fin</sub> *ʔan*] [TP [T]]]]]]]

According to the structure (47), the Comp particles can have the following formal features: since both particles *ʔinn* and *ʔin* are required to be followed by DP phrases only, it is reasonable to assume that both Comp particles carry uninterpretable nominal feature. The Comp *ʔinn* Force head and selects topic or subject phrases, then it carries [*u* D] that must be satisfied by an interpretable [D] feature in the following DP topic or subject phrase. The Comp *ʔin* occupies the Fin head and selects DP subject phrases and not a pro subject, then it also carries [*u* D] that must be satisfied by an interpretable [D] feature on the following DP subject. Regarding the case feature, the Comp *ʔinn* is specified for the Acc feature while the Comp *ʔin* is not. The contrast of bearing case features between the Comps *ʔinn* and *ʔin* comes from the distribution of the Comp particles with pronouns in TA. Note that TA as other Arabic dialects somehow lost the case markings and the marker of the accusative case *-a* is not present or does not spell out. One might ask that what the evidence is for the case to be assigned to the closest DP if the marker of accusative case *-a* does not appear. The answer is supported by the observation that *ʔinn* is an assigner Comp in TA since it can, in addition to DP phrases, select an accusative weak pronoun such as *ah* ‘him’, meanwhile it cannot select

an overt nominative pronoun such as *huu* 'he' as shown (40c). However, an accusative weak pronoun is accepted under the Comp *?inn* as the following example:

- (48)  $\zeta$ a-twaqqa? *?inn-ah* *?ftaraa* s-sayyaarah  
 1.guess.s that-him bought.3ms the-car  
 'I guess that he bought the car.'

In (48), the Comp *?inn* selects the accusative pronoun *ah* 'him', and the combination of the Comp *?inn* and the accusative pronoun is called 'Complementizer agreement' and will be discussed in Chapter 6. The Comp *?inn*, however, cannot select a nominative pronominal subject *huu* 'he'. This observation leads us to assume that the Comp *?inn* is an accusative case assigner and can only select accusative phrases to host the accusative case assignment. Thus, the Comp *?inn* carries an unvalued accusative case feature [*u* Acc] which can be valued by either an accusative pronoun or by the unvalued case feature [*u* Case] on the selected DP which will be assigned accusative case but be covert at spell out.

The Comp *?in*, however, is not followed by any topic phrases or accusative weak pronouns like the Comp *?inn* can do. The Comp *?in* can only select DP or nominative strong pronominal subject. This is shown in (41a-b) and in the following example:

- (49)  $\zeta$ a-twaqqa? *?in* \*ah/ badr/ **huu** *?ftaraa* s-sayyaarah  
 1.guess.s that \*him/ Badr/ he bought.3ms the-car  
 'I guess that Badr/he bought the car.'

In (49), the Comp *?in* selects the accusative weak pronoun *ah* 'him' and this causes ungrammaticality, but it is perfectly possible with the nominative strong pronominal subject *huu* 'he' or DP subject which is Spec-TP. The conclusion then is that the Comp *?in* is not an accusative assigner and neither selects an accusative weak pronoun nor covertly assigns accusative case to the closest DP. Consequently, the Comp *?in* does not carry the [*u* Acc]

على النص الذي ترغب في أن يظهر هنا. 2.Heading خطأ! استخدم علامة التبويب "الصفحة الرئيسية" لتطبيق  
 على النص الذي ترغب في أن يظهر هنا. 2.Heading خطأ! استخدم علامة التبويب "الصفحة الرئيسية" لتطبيق

feature like *?inn* does and the nominative case will be assigned to the following DP by the T head as explained in 2.9.

Let us draw the derivations of the TA Comp clauses starting with the Comp *?inn*:

- (50) a.  $\zeta$ -tawaqqa? **?inn** s-sayyaarah salim  $\zeta$ [taraa-ha  
 1.guess.s that the-car Salem bought.3ms.it  
 'I guess that the car, Salem bought it.'

b.

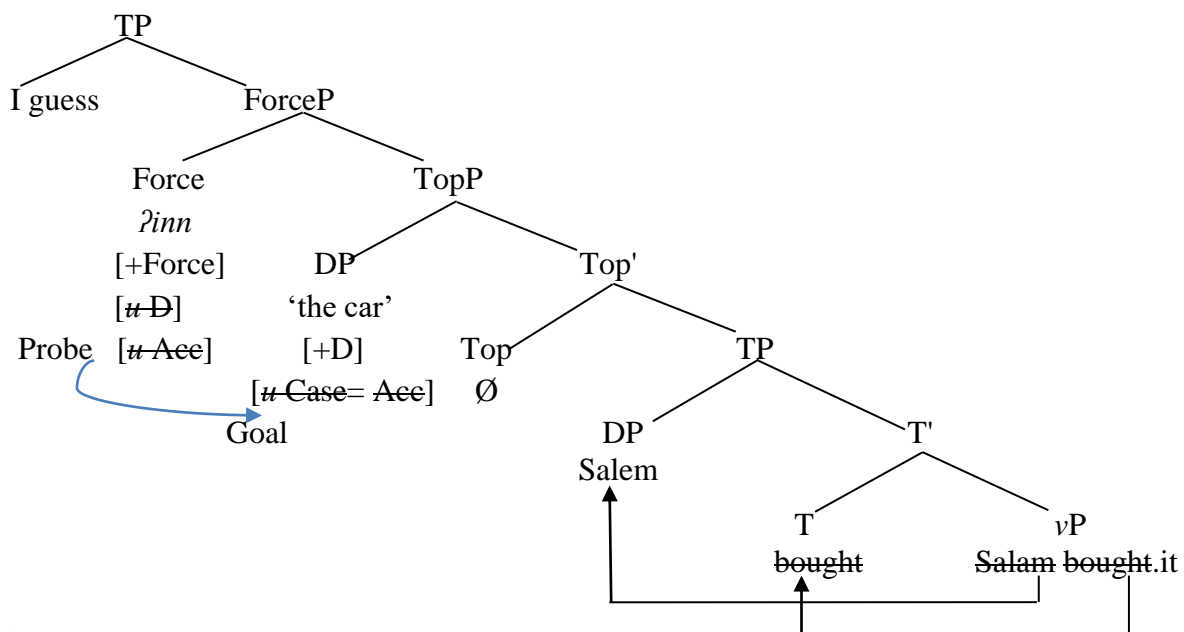

In the tree above, the Comp *?inn* heads the embedded clause and originates in the Force head, hence, the Force feature is being checked. The DP 'the car' is base-generated in the Spec-TopP to check the [+topic] feature. The DP 'the car', however, enters the derivation carrying [*u* Acc] and [*u* D], and then they are active probes looking for an active goal to value their unvalued features. The topic phrase 'the car' is an active goal since it has [D] and [*u* Case] features. Since the features of the two probes and the goal are matched, their unvalued features will be valued, and deleted while the accusative case covertly is assigned to the DP 'the car'. The DP subject 'Salem' is base-generated in Spec-*v*P and, then, moves to Spec-TP

to check the EPP feature while the verb moves from its merge position to the T head to check tense.

In the following example, I will consider the derivation of the Comp *?inn* interacting with the DP subject:

- (51) *twaqqaʔ ?inn saalim ʔftaraa s-sayyaarah*  
 guess.1s that Salem bought.3ms the-car  
 ‘I guess that Salem bought the car.’

In (51), the Comp *?inn* occupies the Force head and checks the Force feature while the DP subject ‘Salem’ moves to Spec-TP to check the EPP feature. Since *?inn* is a case assigner it has [*u* Case] and [*u* D] features which will be checked and valued by the counterpart features on the subject or topic phrase. Hence, the closest DP ‘Salem’ is assigned accusative case by the Comp *?inn*.

Recall that as I showed in 4.5.4 the subject in TA, in general, is not restricted to Spec-TP position. It can have a wide range of interpretations in the clause, namely as a real subject in SpecTP or as a topic phrase in Spec-TopP. However, the distribution of the focus phrase with DP subject shows that the DP subject such as ‘Salem’ must be in the higher Spec-TopP once the Force head is filled by the Comp *?inn*, since the appearance of the DP subject in the following position of the focus phrase leads to an ungrammatical example. Consider the following:

- (52) a. *?-twaqqaʔ ?inn ʃ-ʃabaab fluusj ʔaʃTuu l-ʔaliy t*  
 1.guess.s that the-guys money gave.3mp to-Ali  
 ‘I guessed that the guys, it was money they gave to Ali.’
- b. \**?-twaqqaʔ ?inn fluusj ʃ-ʃabaab ʔaʃTuu l-ʔaliy t*  
 guess.1s that money the-guys gave.3mp to-Ali  
 ‘I guessed that the guys, it was money they gave to Ali.’

In (52a), since the DP subject ‘the guys’ appears preceding the focus phrase ‘money’, therefore, it must only be interpreted as a topic phrase occupying higher Spec-Top and checking the strong [+topic] feature get into an Agree relation with the Comp *?inn* for further case valuation. In (52b), since the DP subject appears following the focus phrase ‘money’ it can be interpreted either as a topic phrase in the lower Spec-TopP or as a real subject occupying Spec-TP. However, the occurrence of the focus phrase ‘money’ adjacent to the Comp *?inn* the [*u* Acc] and [*u* Topic] features for not being checked leads to the derivation being crashed.

In the following example, I will draw the derivation of the Comp *?in* interacting with the DP subject:

- (53) a. twaqqaʃt **?in** saalim ʔ[ʃara s-sayyaarah  
 guess.1s that Salem bought.3ms the-car  
 ‘I guess that Salem bought the car.’

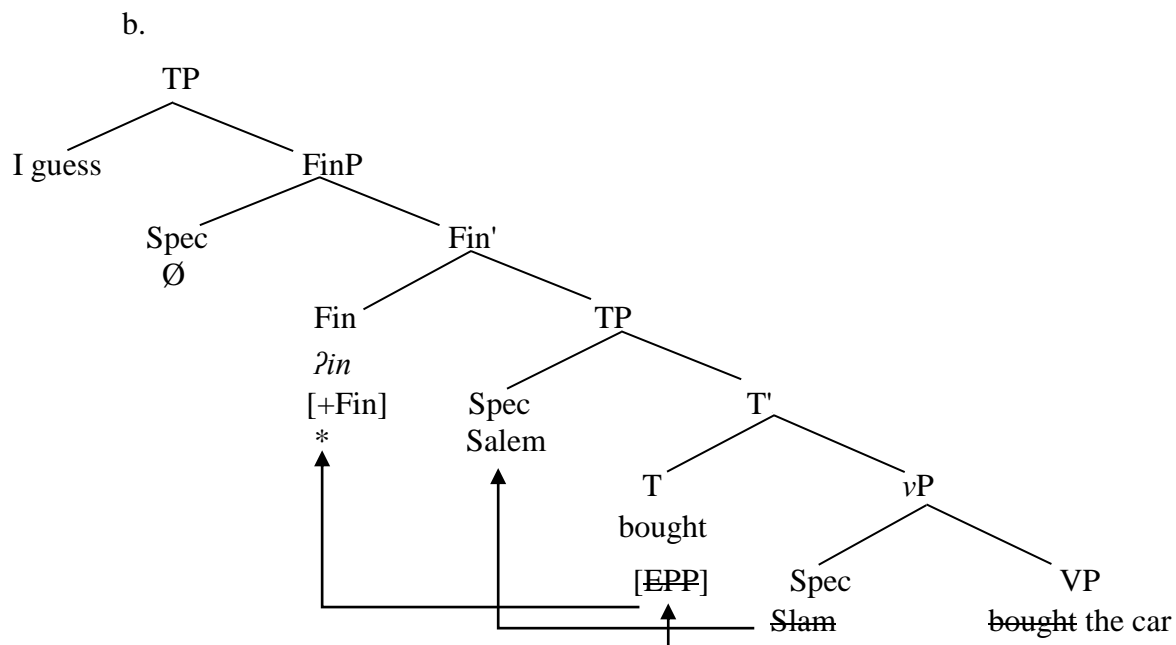

In (53a-b), the Comp *?in* originates in the head of the FinP and satisfies the Finiteness feature. The Comp *?in*, however, selects the SVO clause ‘Salem bought the car’ where the

subject moves to Spec-TP. The Comp  $\lambda_{in}$  is not an accusative assigner and will not assign case to the closest DP 'Salem' but it requires to be followed by DP to value its [ $u$  D] feature. Now the subject 'Salem' is blocked by the Comp  $\lambda_{in}$  to move higher than the Spec-TP position and so the subject cannot appear in the left periphery domain. Moving the verb 'bought' to the left peripheral domain over the subject to Fin head is restricted as Comp  $\lambda_{in}$  fills this position.

Consider also the following ungrammatical example:

- (54) \*twaqqʕuu  $\lambda_{inn}$             ʔʕtaraa        s-sayyaarah  
 guess.3ms    that    *pro*    bought.1s    the-car  
 'They guess that he bought the car.'

In (54), the example is not well-formed since  $\lambda_{inn}$  is an assigner head and enters the derivation with a [ $u$  Acc] feature that must assign the accusative case to the closest DP or a pronoun. However, there is no local DP for the Comp  $\lambda_{inn}$  to assign the accusative case to and the *pro* does not overtly appear as accusative. As a result, the [ $u$  Acc] feature can not be valued and deleted and then the structure of (54) crashes.

## 5.7 Conclusion

To conclude the chapter, MSA has two different Complementizers which are the accusative-assigning  $\lambda_{inna}/\lambda_{anna}$  and the subjunctive  $\lambda_{an}$ . The accusative head Comp  $\lambda_{anna}/\lambda_{inna}$  must be followed OTop or STop phases and assign accusative case to them. Therefore, it occupies the Force head while the following DP is a topic phrase. The subjunctive  $\lambda_{an}$  selects verbs and assigns subjunctive mood to the verbs. The case and mood valuations for the two Comp are accounted for by Agree theory. The case assigner  $\lambda_{anna}/\lambda_{inna}$  occupies the Force head and carries [ $u$  Acc] which probes the following DP topic as its goal since it has [ $u$  Case]. The uninterpretable feature is valued while the DP is valued as Acc. The mood assigner occupies the Fin head carrying [ $u$  Subjun] which probes the following verb as its goal since it has [ $u$  Mood]. The uninterpretable feature is valued while the following verb is valued as Subjun.



على النص الذي ترغب في أن يظهر هنا. 2.Heading خطأ! استخدم علامة التبويب "الصفحة الرئيسية" لتطبيق  
 على النص الذي ترغب في أن يظهر هنا. 2.Heading خطأ! استخدم علامة التبويب "الصفحة الرئيسية" لتطبيق

---

In TA, there are two Comps which are  $\lambda_{inn}$  and  $\lambda_{in}$ . The former is specified for accusative case while the latter is not specified for case or mood. Therefore, only SVO order is possible in the following domain of the both Comp  $\lambda_{inn}$  and  $\lambda_{in}$ , since the Comp  $\lambda_{inn}$  is an accusative head it requires to be followed by either a topic phrase or overt DP subject but not a pronominal nominative subject. The Comp  $\lambda_{inn}$ , then, targets the Force head. The Comp  $\lambda_{in}$  requires to be followed by an overt subject including a pronominal one to value its [ $u$  D]. The Comp  $\lambda_{in}$  cannot select a topic phrase since it occupies the Fin head while topic phrase occurs in a higher position.



It is important to point out that although CA in West-Germanic dialects, in addition to the subject agreement, has some identical phi-features (agreement) with the finite verb there are two different types of CA. First, one CA construction shows similar agreement features (phi-features) with the finite verb with identical morphological morphemes as Brabantish Dutch in (2a). Second, the other CA construction that Zwart (1997) calls “double agreement” where CA shows similar phi-features agreement with the finite verb but with different morphological realisation as Lower Bavarian in (2b):

- (2) a. *des doow morge kums*  
       that.2p you.2P tomorrow come.2p
- b. ...*dasma mir noch Minga fahrn/ \*ma*  
       that.1p we to Munich go.1p

In (2a), the Comp *des* agrees with the finite verb ‘come’ in one form which is *s* ‘2p’ features. In (2b), however, although the agreement features are identical between Comp *dasma* and the finite verb ‘go’ in ‘1p’ features, but these phi-features appear with different morphological suffixes on both positions, since the CA ends up with the morpheme *ma* while the finite verb ends up with the morpheme *n*.

MSA, like other varieties of Arabic, allows the Comp *?inna/?anna* to show some phi-agreement. The CA in MSA is basically formed by attaching an agreement clitic to the Comp *?inna/?anna* expressing a set of phi-features of agreement. However, the nature of the clitic, which represents phi-features of CA, has two distinctive properties: first, it can only be equivalent to an accusative weak pronoun e.g. *?inna-hu* ‘that-him’ while strong subject (nominative) pronouns e.g., *huwa* ‘he’ do not appear as CA. Second, the accusative weak pronoun can have one of the two agreement patterns of phi-features: (i) full phi-features with the following element inside the clause or (ii) default phi-features ‘3ms/3fs’ somewhat irrespective of the subject in the embedded clause. The following table shows all the CA phi-feature combinations in MSA:

Table 6.1 Phi-features of CA in MSA

Features	Comp+ Morphological Agreement	Features	Comp + Morphological Agreement
1ms-1fs	Comp-nii	3ms	Comp-hu
1md-1fd-1mp-1fp	Comp-naa	3fs	Comp-haa
2ms	Comp-ka	3md-3fd	Comp-humaa
2fs	Comp-ki	3mp	Comp-hum
2md-2fd	Comp-kumaa	3fp	Comp-hunna
2mp	Comp-kum		
2fp	Comp-kunna		

The phenomenon of CA has not received much discussion in Arabic studies, given that the main emphasis has been placed on the word order of the negative clauses (Aoun et al. 2010). In this research, we will shed the light on the facts of the CA constructions in MSA and TA, supplying a syntactic account for them.

The chapter is divided into several sections. In the second section, I show the interaction of the CA with the different types of MSA elements in three subsections: (i) postverbal DP subject and *pro* subject (ii) left peripheral elements, (iii) conjunct DPs. In the third section, generative discussions of CA construction are presented. In the fourth section, I provide evidence from MSA against the traditional analyses of CA. In the fifth section, an alternative analysis of CA in MSA is presented. In the sixth section, I elaborate on the derivations of different CA constructions in MSA. In the seventh section, I bring the CA in TA to the fore. In the eighth section, an analysis of TA CA is suggested. In the ninth section, I draw the conclusion of the chapter.

## 6.2 The interactions of CA in MSA clausal structure

### 6.2.1 The interaction of CA with the inflectional domain

This section describes the CA in basic verbal clauses. The CA constructions are triggered by two different types of subjects in MSA verbal clauses. The first type of subject that triggers CA construction is the postverbal subject. The CA must take place in CA > V > S clauses and can only appear with a default agreement features '3ms/3fs'. According to Mohammad (2000: 137); also van Gelderen (1996: 760), for CA constructions, the default phi-features '3ms' can occur with either masculine or feminine postverbal subjects as (3a-b) while the default phi-features '3fs' can only occur with feminine postverbal subjects as in (3b) (the agreement of Comp and the subject gender are in bold):

- (3) a. *ʔinna-hu/ \*haa*      ya-*n*ʔudu      l-mutadhaahiruuna      l-*ḥ*urriyat-a  
 that-him.3ms/ her.3fs 3m-*seek*.imperf.s the-demonstrators.**m**-nom the-freedom-acc  
 'Indeed, the demonstrators (male) seek freedom.'
- b. *ʔinna-hu/ haa*      ta-*n*ʔudu      l-mutadhaahiraat-u      l-*ḥ*urriyat-a  
 that-him.3ms/ her.3fs 3f-*seek*.imperf.s the-demonstrators.**f**-nom the-freedom-acc  
 'Indeed, the demonstrators (female) seek freedom.'
- c. \**ʔinna-*      ya-*n*ʔudu      l-mutadhaahiruuna      l-*ḥ*urriyat-a  
 that-      3m-*seek*.imperf.s the-demonstrators.**m**-nom the-freedom-acc  
 'That the demonstrators (male) seek freedom.'

In (3a), since the postverbal DP subject 'the demonstrators' is masculine the CA can only show '3ms' features. In (3b), since the postverbal DP subject 'the demonstrators' is female, the CA can be inflected with either '3ms' or '3fs'. (3c) is ungrammatical since Comp *ʔinna* is followed by the verb 'seek' lacking any default phi-features. Recall that Comp *ʔinna/ʔanna* can only select particular elements such as DPs or PPs. However, if these elements are absent and the verb instead appears in the following position the existence of bare Comp *ʔinna/ʔanna* is impossible and CA on Comp must surface displaying default phi-features.

The same possibilities are found in embedded coordinated subject clauses when CA can only have default phi-features with respect to the first conjoined DP's gender. Consider the following examples:

- (4) a. ?inna-**hu**/ **\*haa**            ya-nʃudu            l-mutadhaahiruuna            wa  
           that-him.3ms/ \*her.3fs    3m-seeK.imperf.s    the-demonstrators.**m**-nom    and  
           l-mutadhaahiraat-u            l-ħurriyat-a  
           the-demonstrators.**f**-nom        the-freedom-acc  
           ‘Indeed, the demonstrators (male and female) seek freedom.’
- b. ?inna-**hu**/ **haa**            ta-nʃudu            l-mutadhaahiraat-u            wa  
           that-him.3ms/ her.3fs)    3f-seeK.imperf.s    the-demonstrators.**f**-nom    and  
           l-mutadhaahiruuna            l-ħurriyat-a  
           the-demonstrators.**m**-nom    the-freedom-acc  
           ‘Indeed, the demonstrators (female and male) seek freedom.’

In (4a), only the CA.3ms is possible because the first conjoined DP ‘the demonstrators’ is masculine. In (4b) CA.3ms/3fs are equally possible since the first conjoined DP ‘the demonstrators’ is female. With this being the case, in the case of coordinated postverbal subjects, the CA only displays default phi-features according to the gender of the first conjoined DP, regardless of the phi-features of the second conjunct of the postverbal subject.

It is not possible, however, for the CA to show full phi-features in postverbal subject clauses. Consider the following examples from Fassi Fehri (1993: 39):

- (5) a. **\*?inna-hunna**            zurna-nii            ʔalaaʔ-u            ʃaaʃiraat-in  
           that-them.3fp        visited.perf.3fp-me    three.**f**-nom        poets.f-gen  
           ‘It visited me three poets.’

على النص الذي ترغب في أن يظهر هنا. 2.Heading خطأ! استخدم علامة التبويب "الصفحة الرئيسية" لتطبيق  
 على النص الذي ترغب في أن يظهر هنا. 2.Heading خطأ! استخدم علامة التبويب "الصفحة الرئيسية" لتطبيق

b. *ʔinna-haa zaarat-nii ʔalaaʔ-u ʃaaʃiraat-in*  
 that-her.3fs visited.perf.3fs-me three.f-nom poets.f-gen  
 'It visited me three poets.'

In (5a) the CA has full phi-features similar to the postverbal DP subject 'three' which causes ungrammaticality. In contrast, using the default phi-features instead of full phi-features '3fs' in (5b) is totally acceptable. Hence, the CA can only appear with default phi-features (3ms/3fs) and never appear with full phi-features in the postverbal subject structure.

The CA is still available when an adverb e.g. 'always' appears along with the VS order as the following example:

(6) *ʔinna-hu daaʔiman ya-nʃudu l-mutadhaahiruuna l-ħurriyat-a*  
 that-him.3ms always 3m-see.perf.s the-demonstrators.m-nom the-freedom-acc  
 'Indeed, it is always that the demonstrators seek freedom.'

In (6), the CA *ʔinna-hu* 'that.him' shows default phi-feature '3ms' with postverbal subject DP 'the demonstrators.m' while the adverb 'always' occurs between the CA and the VS order.

The constituent order in CA clauses with postverbal subject is represented below:

(7) CA (Default Agree '3ms/3fs') > adverb > verb > subject

The second type of subject that triggers the CA construction is null subject clauses. Recall that null subject clauses always trigger full agreement features. The same analysis can be extended to the CA with null subject structure. In CA > *pro* > V clauses, the CA must exist this time showing full phi-features (gender, person and number). Consider the CA with full agreement phi-features in the following null subject clauses:

- (8) a. qaalat      ʃ-ʃurTat-u      ʔinna-**hum**      pro ya-nʃuduuna      l-ħurriyat-a  
           said.perf.3fs    the police-nom    that-them.3mp      **3m**-seekimperf.**p**    the-freedom-  
 acc  
           ‘The police said that they seek freedom.’
- b. qaalat      ʃ-ʃurTat-u      ʔinna-**hunna**      pro ya-nʃudna      l-ħurriyat-a  
           said.perf.3fs    the police-nom    that-them.3fp      **3f**-seeking.**p**    the-freedom-acc  
           ‘The police said that they seek freedom.’
- c. \*qaalat      ʃ-ʃurTat-u      ʔinna      pro ya-nʃuduuna      l-ħurriyat-a  
           said.perf.3fs    the police-nom    that                    **3m** seek.perf.**p**    the-freedom-acc  
           ‘The police said that they seek freedom.’

In (8a), the Comp *ʔinna* selects the accusative weak pronoun *hum* ‘them.3mp’ which has identical phi-features to the embedded *pro* subject ‘they.3mp’. In (8b), the Comp *ʔinna* selects an accusative weak pronoun *hunna* ‘them.3fp’ that matches the phi-features of the *pro* subject ‘they.3fp’. In (8c), however, the Comp *ʔinna* selects the *pro* subject ‘they’ without showing phi-features, and as a result the sentence is ill-formed, since CA is compulsory when it selects a *pro* subject. Although the preverbal subjects of (8a-b) are null and no phi-features surface, the evidence of the *pro* subject’s phi-features comes from the full agreement fact in MSA, since a *pro* subject structure obligatorily triggers full agreement features with the verb. The verb has to reflect its full agreement phi-features to the *pro* subject which will be similarly realised on the CA. The verb ‘seek’ in (8a) shows ‘3mp’ features, and so the *pro* subject must have similar phi-features *hum* ‘they.3mp’ which in turn agrees with the phi-features of the CA ‘that-them.3mp’. In (8b), the verb ‘seek’ has ‘3fp’ features which reflect ‘3fp’ features on the *pro* subject *hunna* ‘they.3fp’ that are similar to the CA ‘that-them.3fp’.

The CA cannot accept other than with full phi-features in *pro* subject clauses. For instance, the CA cannot appear with default phi-features *hu* ‘him.3ms’ or *haa* ‘her.3fs’. Consider (9a-b) below which have plural *pro* subject and verbs but CA appears with default phi-features:





- (11) a. qaalat      ʃ-furTat-u      ʔinna-**hum**      l-ḥurriyat-u  
 said.perf.3fs    the police-nom    that-them.3mp    the-freedom-nom  
 pro      ya-nʃuduuna-haa  
 they.m    **3m**-seek.imperf.p-it  
 ‘The police said that freedom, they (male) seek it.’
- b. qaalat      ʃ-furTat-u      ʔinna-**hunna**    ḥurriyat-a    *pro*    ya-nshudna  
 said.perf.3fs    the-police-nom    that-them.3fp    freedom-acc    they.f    3f-seeking.imperf.p  
 ‘The police said that it is freedom they (female) seek.’

In (11a), the appearance of the OTop phrase ‘the freedom’ does not restrict the surface realisation of CA *ʔinna-hum* ‘that-them.3mp’ with features that are identical to the *pro* subject ‘they.m. In (11b), despite the intervention of the focus phrase ‘the freedom’ between the CA *ʔinna-hunna* ‘that-them.3fp’ and the rest of clause, it is a grammatical CA construction. The example (11a-b) indicates that CA is not required to be obligatorily adjacent to the agreeing *pro* subject and left peripheral elements can occur between them.

The constituent order in CA clauses with a *pro* subject is represented as the following schema:

- (12) CA (Full phi) > OTop/focus > *pro* subject > verb
- Identical phi features
- 

The following table summarizes the CA distributions in postverbal and *pro* subject clauses:

Table 6.2 CA in null verbal clauses MSA

Subject structure type	CA appearance	phi-features types	Intervening XPs
Postverbal subject	Obligatory	Default (3ms/3fs)	Accepted
Null subject	Obligatory	Full	Accepted

In the following section, I will show how CA interacts with left peripheral elements.

### 6.2.2 The interaction of CA with the left peripheral elements in MSA

This section explains how CA is constructed when it agrees with a left peripheral element such as OTop, STop or a Focus phrase. I will discuss the possibility of the agreement relation between Comp with each left peripheral element in the CA construction.

For an OTop phrase, the CA can optionally agree with it in full phi-features as (13a-b) shows:

- (13) a. *ʔinna-hunna* l-ʔummahaat-u ya-ħtarimu-**hunna** l-abnaaʔ-u  
 that-**them.f** the-mothers-nom 3m-respect.s-**them.f** the-children-nom  
 ‘Indeed, the mothers, the kids respect them.’
- b. *ʔinna* l-ʔummahaat-a ya-ħtarimu-**hunna** l-abnaaʔ-u  
 that the-mothers-acc 3m-respect.s-**them.f** the-children-nom  
 ‘Indeed, the mothers, the kids respect them.’

In (13a-b), either CA *ʔinna-hunna* ‘that-them.3fp’ or Comp *ʔinna* ‘that’ heads the embedded clause that begins with OTop DP phrase ‘the mothers’. However, the CA is followed by the nominative DP while Comp is followed by an accusative pronoun. There are two possible structures to explain the CA in (13a). The first structure, perhaps more apparent one, is that the CA ‘that-them.3fp’ agrees fully with the DP ‘the mothers’ which functions as OTop phrase since it is associated with a clitic *hunna* ‘them.f’ inside the clause as shown below:

- (14) [<sub>ForceP</sub> [<sub>Force'</sub> [<sub>Force</sub> *ʔinna-hunna* ‘that-them’] [<sub>TopP</sub> [<sub>DP</sub> the mothers] <sub>Top'</sub> [<sub>Top</sub>] [<sub>TP</sub> [<sub>T'</sub> [<sub>T</sub> respect-them] [<sub>VP</sub> [<sub>DP</sub> the children] <sub>v'</sub> [<sub>v</sub> respect-them]]]]]]]]

From (14), it can be noticed that the CA shows the phi-features *hunna* ‘them.3fp’ agreeing with OTop ‘the mothers’. Meanwhile the OTop ‘the mothers’ is coreferential with the clitic *hunna* ‘them.3fp’. Notice that the phi-features of CA and the clitic pronoun which is cliticized to the verb are identical.

The second structure of (13a) is based on that the clause is built up from two clauses, a nominal clause as in (15a) and a verbal clause as (15b):

- (15) a. [<sub>ForceP</sub> [<sub>Force'</sub> [<sub>Force</sub> *ʔinna-hunna*] [<sub>TP</sub> PRN *pro* T' [<sub>T</sub> (covert copula were.3fp)]] [<sub>DP</sub> the mothers]]]]]]  
 b. [<sub>TP</sub> [<sub>T</sub> [<sub>T</sub> respect-them] [<sub>vP</sub> [<sub>DP</sub> the children] v' [<sub>v</sub> respect-them]]]]]]

The structure in (15), accordingly, leads us to assume that the CA 'that-3fp' in (13a) could agree fully with *pro* subject 'they.3fp' of the nominal clause rather than with DP 'the mothers'.

Two pieces of evidence support the second possible structure in (15) for the sentence in (13a): first, the optionality of having a relative marker between the two clauses as the following example:

- (16) *ʔinna-hunna* l-ʔummahaat-u **ʕallaati** ya-ħtarimuuna-**hunna** l-abnaaʔ-u  
 that-them.f the-mothers-nom **who** 3f-respect.imerf.s-**them.p** the-children-nom  
 'Indeed, they are the mothers who the children respect them.'

The second piece of evidence which can support the assumption that 'the mothers' is a predicate of the *pro* subject 'them.3fp' of the nominal clause comes from the fact that the meaning is grammatically complete by just the first clause alone as the following example shows:

- (17) *ʔinna-hunna* l-ʔummahaat-u  
 that-them.f the-mothers-nom  
 'Indeed, they are the mothers.'

على النص الذي ترغب في أن يظهر هنا. Heading 2 خطأ! استخدم علامة التبويب "الصفحة الرئيسية" لتطبيق  
 على النص الذي ترغب في أن يظهر هنا. Heading 2 خطأ! استخدم علامة التبويب "الصفحة الرئيسية" لتطبيق

If 'the mothers' in (17) is a topic phrase this should be ruled out as a clause, since the topic phrase must have a comment clause in the following position to complete it. 'the mothers' in (17) is hence the predicate of a null subject which agrees with the Comp forming CA *?inna-hunna* 'that-them.3fp'.

Regardless of the possible interpretations of the DP which agrees with CA in (13), the CA has to be adjacent to the agreeing DP. Although the OTop/predicate phrase occupies the immediate position after Comp in embedded clause, a given embedded clause is allowed to have multiple OTop phrases. In this case, the agreeing OTop must be the adjacent phrase to the CA. Consider the following example:

- (18) a. *?inna-hu* *l-htiraamu* *l-?ummahaat-u* *yu-dhhiru-hu*  
 that-him the respect.nom.m the-mothers-nom 3m-show.imperf.s-it  
*l-abnaaf-u* *la-hunna*  
 the-children-nom to-them.f  
 'Indeed, the respect, the mothers, the kids show it to them.'

- ┌──────── blocked Agree ─────────┐  
 └──────────────────────────────────┘
- b. \**?inna-hu* *l-?ummahaat-u* *l-htiraamu* *yu-dhhiru-hu*  
 that-him. the-mothers-nom. the respect.nom.m 3m-show.imperf.s  
*al-abnaaf-u* *la-hunna*  
 the-children-nom to-them.3fp  
 'Indeed, the mothers, the respect, the kids show it to them.'

The embedded clause in (18a) has two OTop DPs, they are 'the mothers' and 'the respect' which are associated to the resumptive clitics *hunna* 'them' and *hu* 'it' respectively inside clause. The CA *?inna-hu*, however, agrees with the closest OTop 'the respect' showing its phi-features '3ms'. Thus, (18a) is well-formed. In (18b), the CA *?inna-hu* agrees with non-closest OTop 'the respect' crossing the closest OTop phrase 'the mothers'. This causes the clause in (18b) to be ill-formed. As a result, CA can only hold an agree relation with the phi-feature of the closest DP.

For a DP S<sub>Top</sub> phrase, it works in a similar way as O<sub>Top</sub>; the CA agrees optionally with S<sub>Top</sub> DP as in (19a) and obligatory with pronominal S<sub>Top</sub> as in (19b):

- (19) a. *ʔinna-hum*    *l-abnaaʔ-u*    *ya-ħtarimuuna-hunna*    *l-ʔummahaat-i*  
           that-you.mp    the-kids-nom    3m-respect.imperf.p    the-mothers-acc  
           ‘Indeed, the children respect the mothers.’
- b. *ʔinn-hum*    *hum*    *ya-ħtarimuuna*    *l-ʔummahaat-i*  
           that-them.m    they    3m-respect.imperf.p    the-mothers-acc  
           ‘Indeed, they respect the mothers’.

In (19a-b), two structures can be offered for CA that shows phi-features followed by the DP ‘the kids’ and the overt pronominal subject ‘they.2mp’ respectively. The first structure is that the CA *ʔinna-kum* ‘they.3mp’ agrees fully with the S<sub>Top</sub> ‘the kids’ in (19a) and the pronominal subject ‘they.3mp’ in (19b). The other structure is that the CA *ʔinna-hum* ‘that.3mp’ agrees fully with null subject ‘they.2mp’, followed by the predicate ‘the kids’ in (19a) and ‘you.2mp’ in (19b).

The adjacency condition must be satisfied between the CA and S<sub>Top</sub>, and no element is allowed to come between CA and the agreeing S<sub>Top</sub> phrase. The O<sub>Top</sub> can block the Comp to agree with S<sub>Top</sub> as shown below:

- (20) *ʔinna-\*hum*    *l-ʔummahaat-u*    *l-abnaaʔ-u*    *ya-ħtarimuuna-hunna*  
           that-them.m    the-mothers-nom    the-children-nom    3m-respect.imperf.p-them.f  
           ‘Indeed, the mothers, the children respect them.’

The ungrammaticality of (20) is due to the violation of the adjacency condition by the occurrence of the O<sub>Top</sub> ‘the mothers’ between the CA *ʔinna-\*hum* and the agreeing S<sub>Top</sub>

على النص الذي ترغب في أن يظهر هنا. 2.Heading خطأ! استخدم علامة التبويب "الصفحة الرئيسية" لتطبيق  
على النص الذي ترغب في أن يظهر هنا. 2.Heading خطأ! استخدم علامة التبويب "الصفحة الرئيسية" لتطبيق

'the children'. Thus, the adjacency is required between CA and STop phrases; otherwise, the agreement is blocked.

Although a focus phrase can follow the CA in a postverbal or *pro* subject structure it cannot agree with it as the ungrammaticality of (21) shows.

- (21) ?inna-**\*hunna** l-?ummahaat-i ya-ħtarimu l-abnaa?-u  
that-them.f the-mothers-acc 3m-respect.imperf.s the-kids-nom  
'Indeed, it is the mothers, the children respect.'

In (21), the full phi-features '3fp' are not possible for the CA since it is followed by the focus phrase 'the mother'. This indicates that Comp is still not possible to have phi-agreement with a focus phrase (as well as it cannot assign case to it). Because CA can surface agreeing with some left peripheral elements such as OTop and STop, this suggests that the CA phenomenon in MSA is not restricted to *pro* or postverbal subjects. The distribution of the CA with left peripheral elements is summarized in the following table:

Table 6.3 CA withn left peripheral clauses MSA

Left peripheral elements	CA appearance	phi-features types	Adjacency affect
OTop DP	Optional	Full	Required
STop DP	Optional	Full	Required
Focus	Blocked	–	–

In following section, I will look at coordinated phrases under the CA construction.

### 6.2.3 The interaction of CA with coordination phrases in MSA

In this section, the interaction of CA with embedded coordinated subjects will be investigated in two different distributions. The first distribution is when CA selects a coordinate structure that consists of two coordinated DPs as subject. In this case, the CA

shows two types of agree relations of phi-features and is blocked to have one type of agree relation.

One possible type of agreement for CA is with the first conjoined DP as the following examples show:

- (22) a. *ʔinna l-ʔab-a wa l-ʔumm-a ya-ħdhuraani l-dʒtmaaʕ-a*  
 that the-father-nom and the-mother-acc 3m-attend.imperf.d the-meeting.acc  
 ‘Indeed, the father and the mother attend the meeting.’
- b. *ʔinna-hu l-ʔab-u wa l-ʔumm-u ya-ħdhuraani l-dʒtmaaʕ-a*  
 that-him the-father-nom and the-mother-nom 3m-attend.imperf.d the-meeting.acc  
 ‘Indeed, the father and the mother are attending the meeting.’
- c. *ʔinna-haa l-ʔumm-u wa l-ʔab-u ya-ħdhuraani l-dʒtmaaʕ-a*  
 that-her the-mother-nom and the-father-nom 3m-attend.imperf.d the-meeting.acc  
 ‘Indeed, the mother and the father are attending the meeting.’

In (22a) the Comp *ʔinna* is followed by the coordinated DPs ‘the father and the mother’ without showing agreement features. In (22b), however, the CA *ʔinna-hu* ‘that.him.3ms’ is followed by the coordinated DPs and agrees with first conjoined DP ‘the father’ sharing its phi-features ‘3ms’. In (22c), CA *ʔinna-haa* ‘that.her.3fp’ also agrees with the first conjoined DP ‘the mother’ sharing the same phi-features ‘3fp’. The verb ‘attended’, noticeably, in (22a-c) has one value of phi-features which is ‘3md’ since the verb must show full agreement with the full preverbal coordinated DP. As a result, CA, under the first conjoined DP agreement, carries different phi-features from the verb, given that there is no agree relation between Comp and the verb.

The second possible type of phi-agreement for CA with two DPs as subject is the agreement with the full coordinate phrase as shown below:



- (23) *ʔinna-huma l-ʔab-u wa l-ʔumm-u ya-ħdhuraani l-dʒtimaaf-a*  
 that-3d the-father-nom and the-mother-nom 3m-attend.imperf.d the-meeting.acc  
 ‘Indeed, the father and the mother are attending the meeting.’

In (23), the CA *ʔinna-huma* ‘that.them.3d’ agrees fully with phi-features of conjoined DP ‘the father’ and ‘the mother’. Both CA *ʔinna-huma* and the verb ‘attended’ agree with the full coordinated DP, they then share identical phi-features which are ‘3d’.

One blocked type of agree relation for CA in coordinate structures is the agreement with the phi-features of the second conjoined DP as in the ungrammaticality of the examples below:

- (24) a. \**ʔinna-haa l-ʔab-u wa l-ʔumm-u ya-ħdhuraani l-dʒtimaaf-a*  
 that-her the-father-nom and the-mother-nom 3m-attend.imperf.d the-meeting.acc  
 ‘Indeed, the father and the mother are attending the meeting.’
- b. \**ʔinna-hu l-ʔumm-u wa l-ʔab-u ya-ħdhuraani l-dʒtimaaf-a*  
 that-him the-mother-nom and the-father-nom 3m-attend.imperf.d the-meeting.acc  
 ‘Indeed, the mother and the father are attending the meeting.’

In (24a), the CA carries the weak pronoun *haa* ‘her’ which agrees with the second coordinated DP subject ‘the mother’ in ‘3fs’. In (24b), the CA carries the weak pronoun *hu* ‘him’ which also agrees with the second coordinated DP subject ‘the father’ in ‘3ms’. Thus, (24a-b) are ungrammatical and indicate that the agree relation between CA and the second conjoined DP is blocked.

The second distribution of CA is when it selects the coordinate structure that comprises a *pro* subject and DP subject. In this case, only one type of agree relation is possible whereby the agreement is necessarily with first conjoined subject that has to be *pro*. Consider the following examples:

- (25) a.  $\zeta$ alimtu       $\zeta$ anna      hind-an      wa       $\zeta$ aliyy-an      tazawwad $\zeta$ aa  
 knew.perf.1s      that      Hind.f-acc      and      Ali.m-acc      married.3md  
 'I knew that Hind and Ali got married.'
- b.  $\zeta$ alimtu       $\zeta$ anna-haa      pro      wa       $\zeta$ aliyy-an      tazawwad $\zeta$ aa  
 knew.perf.1s      that-her      she      and      Ali.m-acc      married.perf.3md  
 'I knew that she and Ali got married.'
- c. \* $\zeta$ alimtu       $\zeta$ anna-haa      hind-un      wa      pro      tazawwad $\zeta$ aa  
 knew.perf.1s      that-her      Hind.f-nom      and      he      married.perf.3md  
 'I knew that Hind and he got married.'
- d. \* $\zeta$ alimtu       $\zeta$ anna-huma      pro      wa       $\zeta$ aliyy-un      tazawwad $\zeta$ aa  
 knew.1s      that-3d      she      and      Ali.m-acc      married.3md  
 'I knew that she and Ali got married.'

In (25a), the Comp  $\zeta$ anna is followed by the conjunct DPs 'Hind.f and Ali.m'. In (25b), the occurrence of the first conjunct subject as *pro* 'she' is allowed and CA  $\zeta$ anna-haa must show agreement with it. In (25c), although the CA  $\zeta$ anna-haa can agree with the first coordinated DP subject 'Hind.f', the occurrence of the second coordinated subject as *pro* 'she' is not allowed and the clause is ruled out. In (25d), the CA  $\zeta$ anna-huma shows agreement with the full coordinate phrase of the *pro* subject and the DP 'Ali', but this is also not possible. The contrast in (25c) is understood assuming two things: (i) the only way to identify the phi-features of *pro* subject is to have agreement with the head Comp, and (ii) to do so the *pro* subject has to occupy the first conjoined position in order to have agreement relation with CA. Therefore, it comes as no surprise that the second conjoined subject cannot be *pro* as Comp does not agree with it as with the second conjoined DP. The ungrammaticality of (25d) is understood by assuming that Comp can have agreement with full coordinated subjects only when phi-features of each coordinated subject is overt showing phi-features as DPs. Thus, the full coordinate structure that has *pro* subject cannot agree with CA, but only the *pro* as a first coordinated can agree with CA to show its phi-features.

The following table summarises the phi-features of CA with coordinated phrases:

Table 6.4 Phi-features of CA in coordinate structure in MSA

CA + coordinated subjects	Agree with the first DP subject	Agree with the second DP subject	Agree with the full DP subject
CA > DP > DP	√	*	√
CA > pro > DP	√	*	*
CA > DP > pro	*	*	*

In the following section, I will show and discuss some previous analyses of CA in generative syntax.

### 6.3 Generative discussions of CA

The analyses of CA constructions have produced two main views in generative grammar. In early discussions, CA is based on the head movement of features from the lower head e.g. INFL or AGR to the C head position (Hoekstra & Marácz 1989; Zwart 1993 and Watanabe 2000). More recent discussions postulate that the CA features merge in C (Carstens 2003: 394; Van Koppen 2005: 33; Chomsky 2008; 2013), as originally proposed in Bennis & Haegeman (1984: 39). In this section, I will expand the discussion of the early view of CA regarding Zwart (1993, 1997) and Watanabe (2000) followed by the more recent views of Carstens (2003) and Chomsky (2008; 2013).

Zwart (1993; 1997) assumes that the CA phenomenon is based on  $T^0$ -to- $C^0$  movement, particularly, he argues that the verb stays in the lower position in embedded clause while the formal features of the finite verb move to AgrO, and from there they move via T to AgrS and then eventually land on C. The phi-features of AgrS will be realized on the C head and meanwhile the finite verb will have a copy/trace of its formal features to satisfy the verb agreement as the following tree shows:

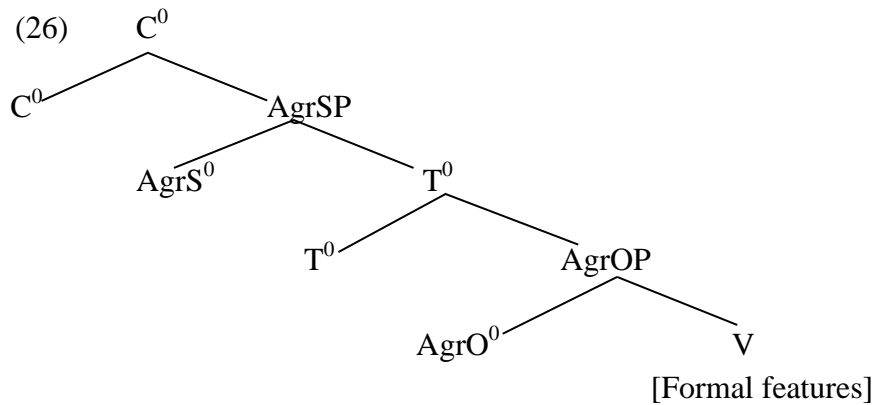

Watanabe (2000), however, criticises Zwart's analysis in the manner of checking theory (Chomsky 1995). He mentions two weak points. The first point relates to Agr heads. Chomsky proposes phi-features based on T for the subject agreement as the following structure:

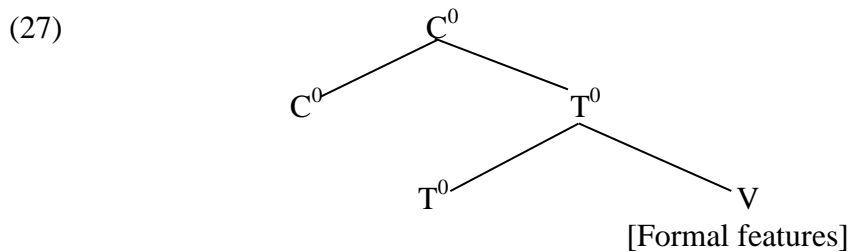

The second weakness is related to the feature checking mechanism that is based on the interpretability of features when the analysis involves subject movement. Since Chomsky (1995) argues that uninterpretable features must be checked and deleted at spell out, and then they are no longer being available for further computation as the following rule by Inactivation Condition. Suppose that the subject moves to Spec-TP for agreement purposes and any phi-features on T such as a case feature is deleted and becomes inaccessible. Therefore, it cannot be responsible for the movement of features for T<sup>0</sup>-to-C<sup>0</sup> which expresses CA. Watanabe (2000) makes a modification of Zwart's analysis to solve this problem, and he particularly assumes that CA phenomenon can be accounted for by the phi-features on the subject which are interpretable at LF and visible for further computation such as being moved to C. His proposal is based on the idea of using a complex functional head that moves

على النص الذي ترغب في أن يظهر هنا. 2.Heading خطأ! استخدم علامة التبويب "الصفحة الرئيسية" لتطبيق  
 على النص الذي ترغب في أن يظهر هنا. 2.Heading خطأ! استخدم علامة التبويب "الصفحة الرئيسية" لتطبيق

carrying phi-features as in Chomsky's (1998) account of phi-feature checking which assumes that uninterpretable features do not delete after being checked, but instead "stick around" and are accessible for further computation. Watanabe's (2000: 166) analysis is expressed in the following rules:

- (28) a. [TP [T<sub>0</sub> [T<sub>0</sub>  $\Phi$ -( $\mathbb{F}^0$ )] +  $\Phi$  (subj)] [VP Subj ... ]  
 b. [TP subj [T<sub>0</sub> [T<sub>0</sub>  $\Phi$ -( $\mathbb{F}^0$ )] +  $\Phi$  (subj)] [VP subj ... ]  
 c. [TP Exp [T<sub>0</sub> [T<sub>0</sub>  $\Phi$ -( $\mathbb{F}^0$ )] +  $\Phi$  (subj)] [VP Subj ... ]

Watanabe, then, claims that the phi-features of the subject will have to be copied onto the head of the inflectional layer and then will be transported by head movement to the CP layer as agreement morphology to produce a complex C<sup>0</sup> as the following structure:

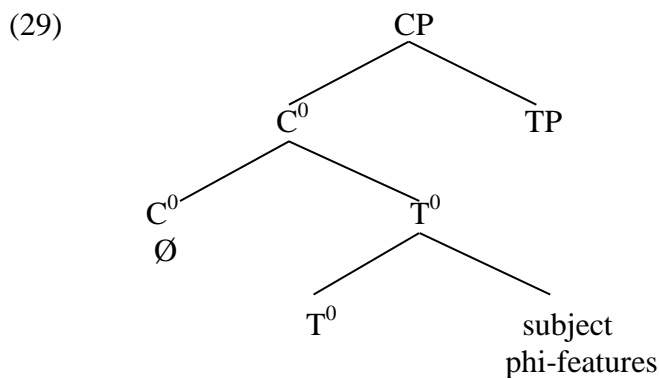

According to the structure of (29), the phi-features of Comp will agree with those of the embedded subject, and meanwhile the verb agrees with the subject showing the same phi-features.

Therefore, both Zwart and Watanabe agree in the assumption that the phi-features on C are coming from a lower position but for the former they are from the INFL/Agr head while for the latter they are from the subject which has a copy of the phi-features on the verbal head.

The other view on the CA phenomenon is proposed by Carstens (2003: 394); Van Koppen (2005: 33); Chomsky (2008; 2013). According to these analyses, the phi-features of  $T^{\circ}$  are basically inherited from C while T does not encode phi-features but acquires them from C, where they are merged. Chomsky (2008) argues that T and V cannot assign the relevant case and phi-agreement unless they inherit them from the phase heads C and  $v$  respectively. Thus, C is the locus of case and agreement features. This hypothesis which he calls “feature inheritance” can be supported by the fact that “sometimes the phi-features of C are morphologically expressed, as in the famous West Flemish examples” (Chomsky 2008). Such observation, therefore, leads us to maintain the idea that  $C^{\circ}$  express phi-features. Empirical evidence for C-to-T feature inheritance system comes from the constructions of ECM (Chomsky 2008) as following example:

- (30) Bill wants (\*that) her to win. (Ouali 2010: 124)

The C ‘that’ is prohibited to head the non-finite embedded clause as the ungrammaticality shown in (30) since it is associated with finiteness.

Noticeably, this recent view is similar to early ones that there is somehow a connection between the CA and verb. Whereas the earlier analyses demonstrate CA’s phi-features via T-to-C head movement the latter once assume the CA’s phi-features are inherited to the T head.

In the following section, I will examine the MSA clause structure with the background of these previous analyses.

#### 6.4 Empirical evidence from MSA against C-T phi-connections

This section shows data calling into question some of the previous analyses which basically hold a reflection of phi-features between CA and the verb or subject. Given MSA clausal structures, there is no guarantee of copying the CA’s phi-features from the verb in the T

على النص الذي ترغب في أن يظهر هنا. 2.Heading خطأ! استخدم علامة التبويب "الصفحة الرئيسية" لتطبيق  
على النص الذي ترغب في أن يظهر هنا. 2.Heading خطأ! استخدم علامة التبويب "الصفحة الرئيسية" لتطبيق

position or the subject in all instances of CA. For the postverbal subject clauses as explained in section 6.2.1, the CA can have one type of phi-features which is default phi-features ('3ms' with masculine subject and '3ms/3fs' with female subject). The verb and subject, however, may reveal similar or different phi-features to CA as the following structure:

- (31) a. [<sub>ForceP</sub> [<sub>Force'</sub> [<sub>Force</sub> *ʔinna*-phi '3ms'] [<sub>TP</sub> [<sub>T'</sub> [<sub>T</sub> V '3ms'] [<sub>VP</sub> [<sub>DP</sub> subject '3ms/3mp']]]]]]]  
 b. [<sub>ForceP</sub> [<sub>Force'</sub> [<sub>Force</sub> *ʔinna*-phi '3ms/3fs'] [<sub>TP</sub> [<sub>T'</sub> [<sub>T</sub> V '3fs'] [<sub>VP</sub> [<sub>DP</sub> subject '3fs/3fp']]]]]]]]]

In (31a), both CA and the verb on T have an identical copy of phi-features. In (31b) the CA can have similar or different copies of phi-features with respect to the gender of the CA. Moreover, the subject has a default phi-feature of number. Thus, postverbal subject structures do not consistently maintain a copy of phi-features of CA from the verb or the subject. Therefore, the CA in the postverbal subject clauses cannot be analysed by the traditional analyses which based on the reflection of phi-features between C and T.

For the *pro* subject clauses as in section 6.2.2, the CA can be one type of phi-features which is the full phi-features. The verb and subject(s), with regard CA, have similar full phi-features in non-coordinate structures as in (32a) and different full phi-features in coordinate structures as (32b):

- (32) a. [<sub>ForceP</sub> [<sub>Force'</sub> [<sub>Force</sub> *ʔinna*-full phi] [<sub>TP</sub> *pro* subj [<sub>T'</sub> [<sub>T</sub> V phi]]]]]]  
 b. [<sub>ForceP</sub> [<sub>Force'</sub> [<sub>Force</sub> *ʔinna*-full phi] [<sub>ConjP</sub> *pro* subj [<sub>Conj'</sub> [<sub>Conj</sub> [<sub>Conj</sub> [<sub>DP</sub> subj] [<sub>TP</sub> [<sub>T'</sub> [<sub>T</sub> V phi]]]]]]]]]]]]

Both traditional analyses of CA can explain the Agree relation between the CA and *pro* subject in embedded simple clauses as in (32a), since CA's phi-features are copied into both the verb and the subject. However, they cannot explain this agree relation of CA in coordinated phrases in (32b) since CA's phi-features have to agree with first conjoined *pro*





shows the adjacency affect when an adverb intervenes between the CA and the agreeing subject (Ackema & Neeleman 2003).

In the following section, we will suggest an alternative analysis for CA structures in MSA.

### 6.5 Alternative analyses for MSA

This section will provide some syntactic analyses to account for the CA instances in MSA. As we see that CA in MSA cannot be captured by the early analyses of Zwart, (1993; 1997) and Watanabe, (2000) or by recent analysis of Chomsky (2008; 2013). They rely on the connection of phi-features between the finite verb on T or the subject with C, which, however, does not exist in CA instances in MSA. I will, alternatively, suggest two views of analyses under minimalist assumptions to analyse the different types of CA constructions in MSA.

The first analysis has two steps: (i) the case-Agree analysis followed by (ii) pronoun cliticization/incorporation. This analysis explains CA with *pro* and postverbal DP subjects. In the postverbal subject structure, the verb shows partial agreement features with the following DP subject, while there is default *pro* (3ms/3fs) in Spec-TP which is always covert unless it occurs under the Comp *?inna/?anna*, following the Expletive Hypothesis of Mohammad (2000). In *pro* subject clauses, the verb shows full agreement features, while the *pro* subject occurs preverbally in Spec-TP.

Now involving the Comp *?inna/?anna* to head *pro* and postverbal subject clauses, the Comp *?inna/?anna* is case assigner and must discharge accusative case. In normal clauses, the case is assigned to the closest DP. However, if there is no DP available in the following position the assigner *?inna/?anna*, alternatively, could assign the accusative case to the *pro* subject in Spec-TP. Recall that the Comp *?inna/?anna* must deliver the case to an assignee that can show the case, e.g. DP but not PP. The *pro* subject, therefore, must phonologically be overt to

receive the accusative case and it will spell out as an accusative weak pronoun. It is well-known that accusative weak pronouns occur in complementary distribution with accusative DPs. Moreover, they occupy different syntactic positions, as a DP in the left periphery fills the specifier position while an accusative weak pronoun always joins to a head. One of the most distinctive properties of the weak pronouns is that they cannot stand alone without being attached to a head. Thus, they must move to cliticize/incorporate, and if they move to ForceP, they can join to the assigner head Comp *?inna/?anna*. The tree in (34) represents this incorporation analysis of CA.

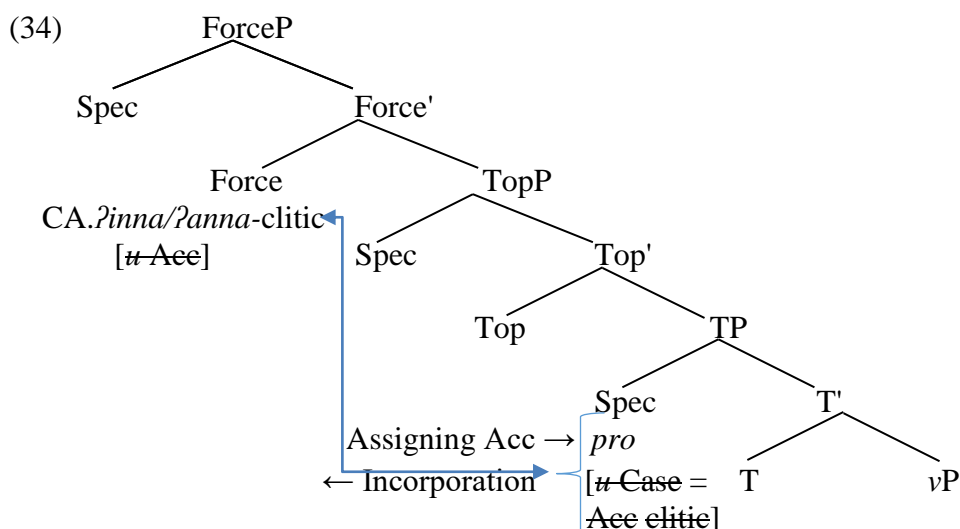

The tree in (34) has two main operations: First, the case valuation operation, once the *pro* subject is probed by the head assigner Comp *?inna/?anna*, the [*u Acc*] features on Force are valued and deleted while the [*u Case*] feature on *pro* subject are valued as an accusative weak pronoun. Second, there is the incorporation operation, since the weak pronoun raises from Spec-TP to the head of ForceP to spell out the case agreement with the head Comp. Therefore, CA is formally not a case assigner since the weak pronoun satisfies the [*u Acc*] feature of Comp and it should not be a surprise to observe that no element is restricted to occur following the CA. This includes focus phrases as well as nominative pronouns which are strictly not allowed to follow Comp *?inna/?anna* without showing an agreement clitic for the reasons of case assignment.

There is some evidence for the cliticization analysis for CA clauses as (35) shows. The first evidence is the accessibility of CA to select left peripheral elements. The cliticization of the pronominal clitic and the Comp *?inna/?anna* is observed by allowing the intervention of focus adverb between the CA and the rest of the clause as in the following example:

- (35) *?inna-kum*      *daaʕiman*      *kum*      *ta-nʕuduuna*      *l-ħurriyat-a*  
 that-you.2mp      always      2m-seeking.imperf.p      the-freedom-acc  
 ‘Indeed, you always seek freedom.’

In (35), the Comp *?inna* appears followed by the focus adverb ‘always’ in Spec-FocP. The Comp *?inna* cannot assign the case to the focus phrase ‘always’, the Comp *?inna* then case-Agrees with the embedded *pro* subject which therefore must appear as an accusative weak pronoun like *kum* ‘you.2mp’. It is finally cliticized/ incorporated from Spec-TP into the head Force Comp *?inna* preceding the focus phrase ‘always’ and respect the focus phrase ‘always’ and the verb ‘seek’.

The obligatory cliticization between the accusative pronominal clitic and the Comp *?inna/?anna* explains the ungrammaticality of the intervention of the PP between the Comp *?inna/?anna* and the pronominal clitic as in the following example:

- (36) \**?inna-*      *fii s-saaħaaht-i*      ***kum***      *ta-nʕuduuna*      *l-ħurriyat-a*  
 that-      in the-arena-gen      you.mp      2m-seeking.p      the-freedom-acc  
 ‘Indeed, it is in the arena, you seek freedom.’

In (36), the PP ‘in the arena’ follows the assigner *?inna* and the PP does not receive case. The Comp *?inna*, as a result, assigns the case to the following *pro* which then appears accusative as *kum* ‘you.3mp’. However, the absence of the cliticization/incorporation operation between the pronoun ‘you.2mp’ to Comp *?inna* rules (36) out. Therefore, the cliticization analysis guarantees the phi-features to surface on Comp.



pronominal clitic and the head Force *?inna/?anna* works in the same way for the cliticization between the pronominal clitic object and the head *v*.

The second proposed analysis for CA constructions is the phi-Agree analysis. This analysis is available for the structure where the Comp *?inna/?anna* is followed by DP. The Comp *?inna/?anna* is a case assigner which must be satisfied by discharging accusative case to the following DP. An option to satisfy the case assigner is by entering into an agreement relation of phi-features with a following DP. To support the phi-agree analysis between the CA and the following DP phrase recall the fact that no element is allowed to intervene between the CA and the left peripheral elements when they enter into an agree relation as (18a-b) as will be shown in the derivation shortly.

Carstens (2003), and Haegeman & van Koppen (2012) account for CA in West Germanic dialects by a feature checking analysis in the probe-agree-goal framework. These analyses account for subjects or auxiliary verbs to act as goals for the probe Comp particles. In MSA, however, I will develop an account of the phi-agreement between the CA and the following DP. Specifically, the Comp *?inna/?anna* optionally encodes [*u* phi] which agrees with the interpretable phi-features of a following DP e.g. O<sub>Top</sub> or S<sub>Top</sub>. Agreement is then spelled out by attaching the pronominal clitic to the Comp *?inna/?anna* as a marker of the agreement of phi-features. As a result, the [*u* Acc] is lexically checked by the accusative pronominal clitic while the [*u* Case] feature on the following DP spells out nominative by default. The following tree represents the phi-Agree analysis for CA clauses:

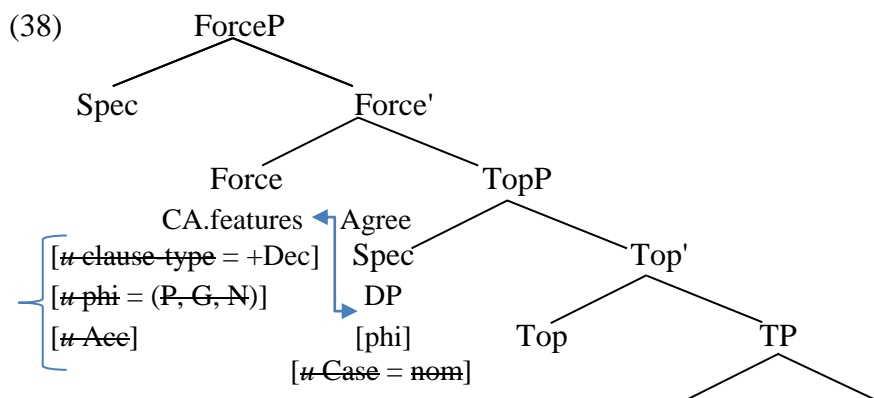

By default

Spec

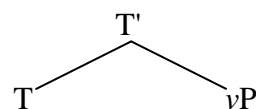

In (38), the phi-Agree relation between the Comp  $\varnothing$ inna/ $\varnothing$ anna on Force head and the following DP is motivated by the need of valuation of the [ $u$  Acc] feature on the case assigner  $\varnothing$ inna/ $\varnothing$ anna. The phi-agreement that appears attached to the  $\varnothing$ inna/ $\varnothing$ anna is the accusative agreement marker which indicates case valuation of the assigner Comp.

From the two analyses of CA, case-Agree with pronoun cliticization and phi-agree, we could, accordingly, confirm that the Comp  $\varnothing$ inna/ $\varnothing$ anna has a [ $u$  Acc] feature which can be checked by one of two different Agree operations: (i) Agree of Case where the probe Comp  $\varnothing$ inna/ $\varnothing$ anna takes the closest DP or *pro* as its goal since they have similar unvalued case features, the [ $u$  Acc] feature of the Comp  $\varnothing$ inna/ $\varnothing$ anna being checked by assigning an accusative case to either DP as in (39a) or pronominal clitic as in (39b). Or, (ii) Agree of phi-features the probe Comp  $\varnothing$ inna/ $\varnothing$ anna to find a goal under the phi-agree operation with a following DP as in (39c), then the [ $u$  Acc] features of the Comp  $\varnothing$ inna/ $\varnothing$ anna are checked by generating an accusative agreement marker. However, the two Agree operations (case and phi) cannot be present together in one clause since CA can only be followed by a nominative DP as in (39d). Consider the following:

- (39) a.  $C > DP_{Acc} > V \rightarrow$  Agree of case with DP.
- b.  $CA > clitic_{Acc} > V \rightarrow$  Agree of case with pronominal incorporation.
- c.  $CA > DP_{Nom} > V \rightarrow$  Agree of phi-relation.
- d.  $*CA > DP_{ACC} > V \rightarrow$  Agree of case with DP and Agree of phi-features.

In the following section, we will show the derivations of the different analyses of CA in MSA.

### 6.6 The derivation of complementizer agreement in MSA

Let us draw the derivations of some instances of CA in MSA. Consider, first, where the CA agrees with a *pro* subject in (40a) which has the structure in (40b):

- (40) a. qaalat    ʃ-ʃurTat-u    ʔinna-**hum**    ya-nʃuduuna    l-ħurriyat-a  
 said.3fs    the police-nom    that-them.m    3m-seeking.perf.p    the-freedom-acc  
 ‘The police said that they seek freedom.’

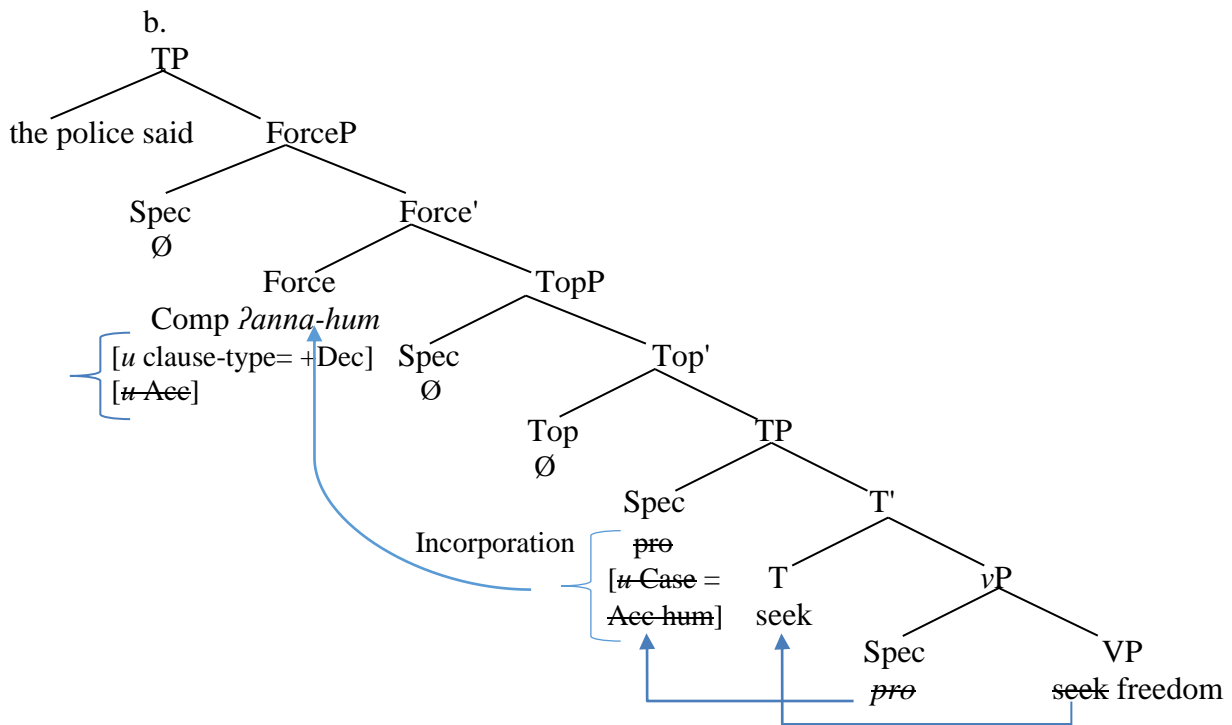

In (40b), the Comp *ʔinna* occupies the Force head and becomes an active probe by virtue of being a case assigner carrying [u Acc] features. The Comp *ʔinna* takes the *pro* subject as an active goal since it has an [u Case] feature. The agree relation is established between the probe Comp *ʔinna* and the goal *pro* subject ‘they’ and the [u Acc] features are checked and deleted while [u Case] feature valued as an accusative pronominal clitic *hum* ‘them.m’. Then, the accusative pronominal clitic *hum* ‘they.3mp’ cliticizes onto the case assigner *ʔinna* in the Force head.

Now consider the following example where an OTop phrase shows no intervention for the pronoun cliticization analysis of CA:

- (41) a. qaalat      ʃ-furTat-u      ʔinna-**hum**      hurriyat-u      ya-nʃuduuna-haa  
 said.perf.3fs the-police-nom that-them.m freedom-nom **3m**-seeking.imperf.p.her  
 ‘The police said that freedom, they seek it’

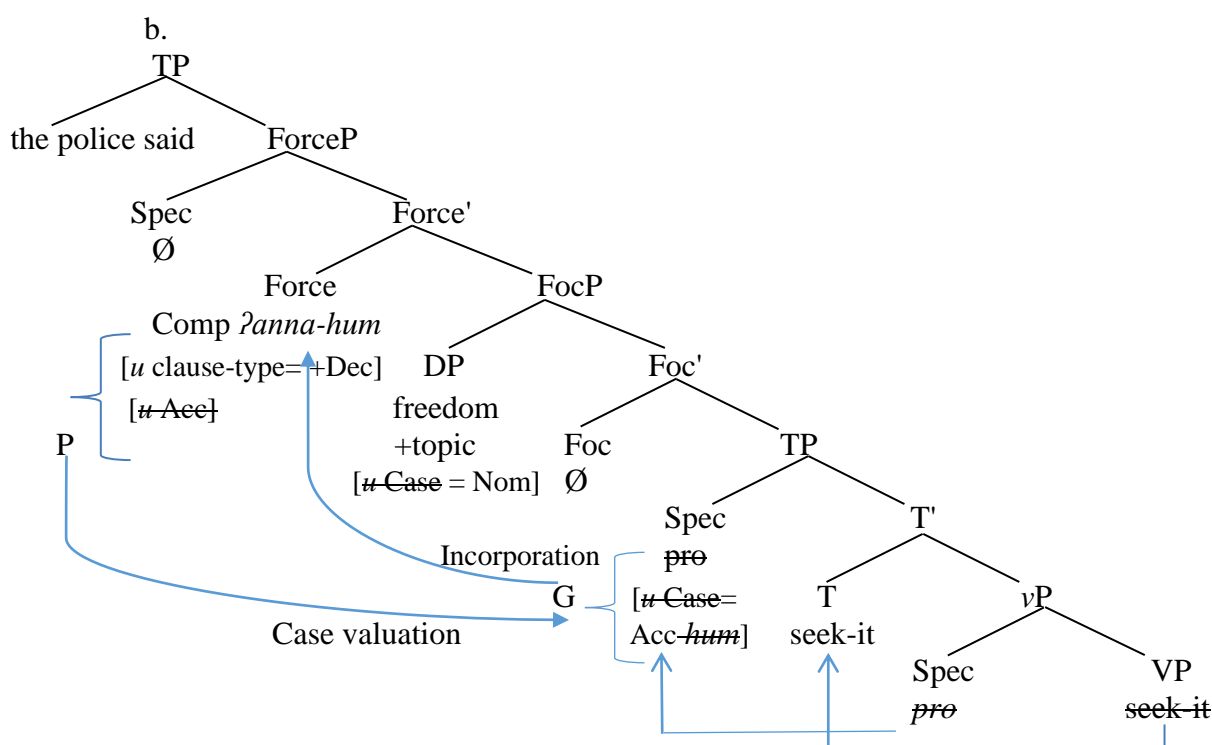

From the derivation (41b), it should be noticed that although the OTop phrase ‘freedom’ is case-marked and could be the assignee goal for the probe Comp ʔanna, it does count as an intervener to block the clitic pronominal to be a goal for the probe Comp ʔanna. Thus, the [u Acc] of Comp ʔanna is valued by an Agree relation with non-closest goal. To explain this, it can be postulated that the case agreement of CA with *pro* subject clauses is not really restricted by the locality rules if the assignee has the ability to be adjacent to the assigner e.g. the clitic pronominal after cliticization.



على النص الذي ترغب في أن يظهر هنا.Heading خطأ! استخدم علامة التبويب "الصفحة الرئيسية" لتطبيق  
 على النص الذي ترغب في أن يظهر هنا.Heading خطأ! استخدم علامة التبويب "الصفحة الرئيسية" لتطبيق

The CA can optionally show agree with the following DP as in (13), repeated here as (42):

- (42) *ʔinna-hunna* l-ʔummahaat-u ya-ħtarimu-hunna l-abnaaʔ-u  
 that-them.f the-mothers-nom 3m-respect.imperf.s-them.f the-children-nom  
 ‘Indeed, the mothers, the kids respect them.’

Two derivations are available for (42), one derivation shows the CA *ʔinna-hunna* is formed by case-agree within the pronoun in a covert copular clause where the pronominal clitic *hunna* moves higher into the head assigner *ʔinna* as in (43a). The other derivation shows the CA *ʔinna* probes the OTop ‘the mothers’ by phi-Agree to produce the agreement marker *hunna* as in tree (43b):

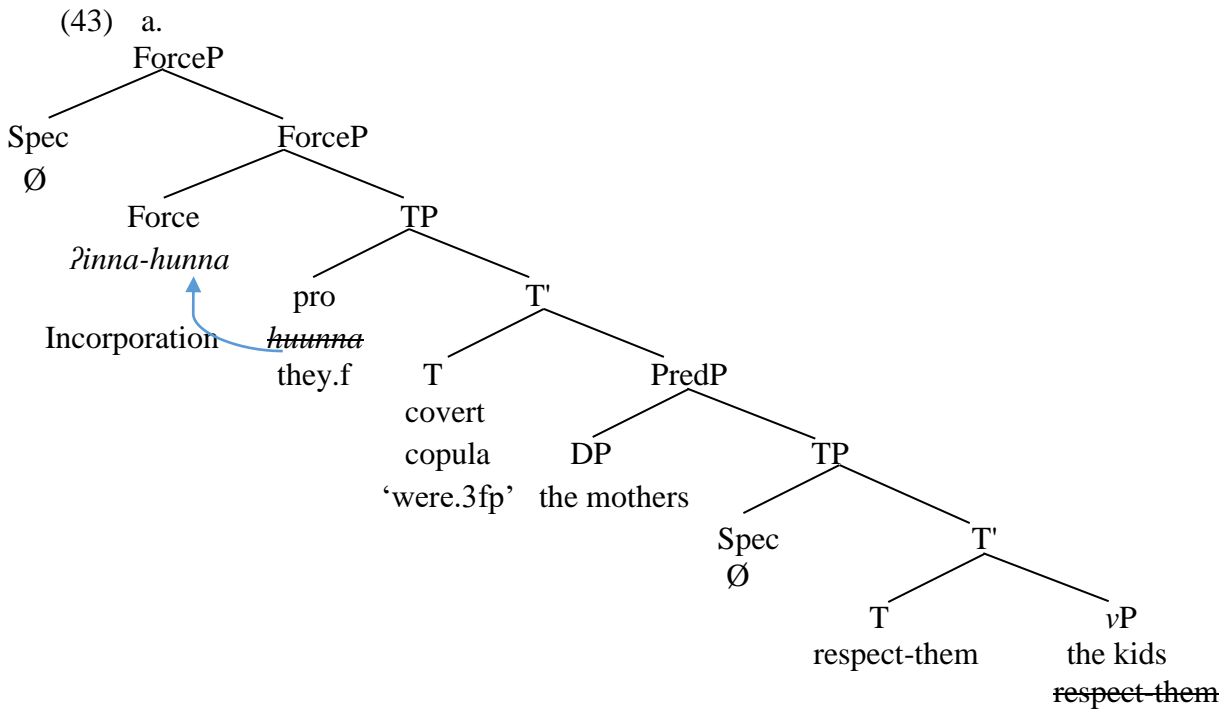

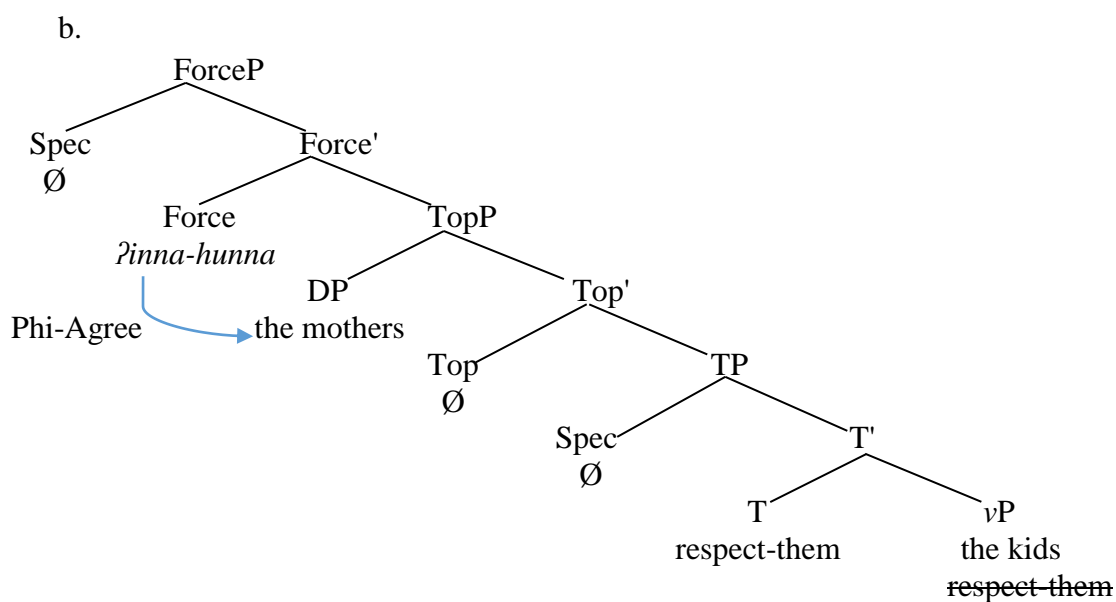

The structures in (43a-b), however, show that the finite verb in T ‘respect’ and the subject ‘the kids’ carry different phi-feature from the CA’s features. Then, (43a-b) confirms that Comp and T are different sources of features.

In multiple topic clauses, only the closest topic can be probed by the CA as in the following example:

- (44)  $\overbrace{\text{?inna-hunna/*hu}}^{\text{Agree}} \text{ I-?ummahaat-u} \quad \text{I-?tiraamu} \quad \text{yu-dhhiru-hu}$   
 that-them.f/\*him the-mothers.f-nom the-respect.m-nom 3m-show.imperf.s-it  
 I-abnaa?-u la-hunna  
 the-children-nom to-them.f  
 ‘Indeed, the mothers, the respect, the kids show it to them.’

The CA agrees with the DP topic ‘the mothers’ and not ‘the respect’, which is to say that the locality must be respected in the phi-agree relation between the CA and the agreeing DP.

Now look at the derivation of CA with first conjunct DP agreement in (45a-b) and the structure in (45c) of (45a-b):

- (45) a. *?inna-hu/humaa l-walad-u wa l-bint-u ya-ktubaani l-qiSSat-a*  
 that-him/them.d the-boy-nom and the-girl-nom 3m.write.imperf.d the-  
 story.acc

‘Indeed, the boy and the girl write the story.’

- b. \**?inna-haa l-walad-u wa l-bint-u ya-ktubaani l-qiSSat-a*  
 that-her the-boy-nom and the-girl-nom 3m.write.imperf.d the-story.acc

‘Indeed, the boy and the girl write the story.’

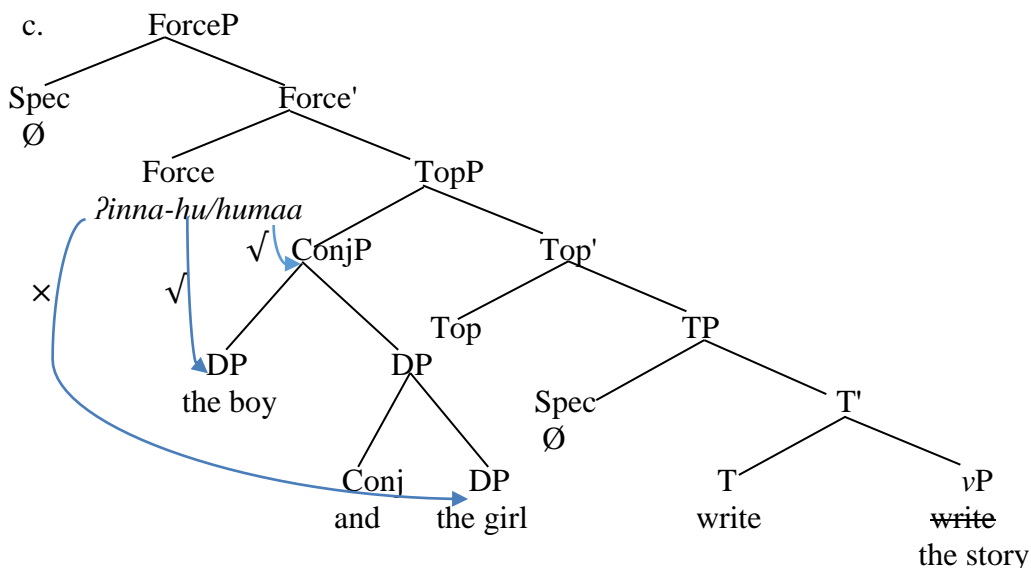

As shown in (45c), the first conjunct ‘the boy’ and the full coordination ‘the boy and the girl’ are equally possible to be goals for Agree in phi-features with the probe Comp *?inna*. However, the second conjunct alone ‘the girl’ is blocked from phi-Agree with the probe Comp *?inna*. This is due to the fact that the second DP ‘the girl’ is c-commanded by the first conjunct DP ‘the boy’ while the first conjunct DP ‘the boy’ and the full conjunct DPs ‘the boy and the girl’ are equally of the same distance for the Agree relation from the probe Force, and none of them is c-commanded by the other. The Force head can then probe the first conjunct or full conjunct DP subject as structure (45c) shows.

The CA with first conjunct *pro* subject is shown in (25b), which is repeated below as (46a) and has the tree in (46b):

- (46) a. *ʔalimtu ʔanna-haa pro wa ʔaliyy-an tazawwadʒaa*  
 knew.1s that.her she and Ali-acc married.perf.3d  
 'I knew that she and Ali got married.'

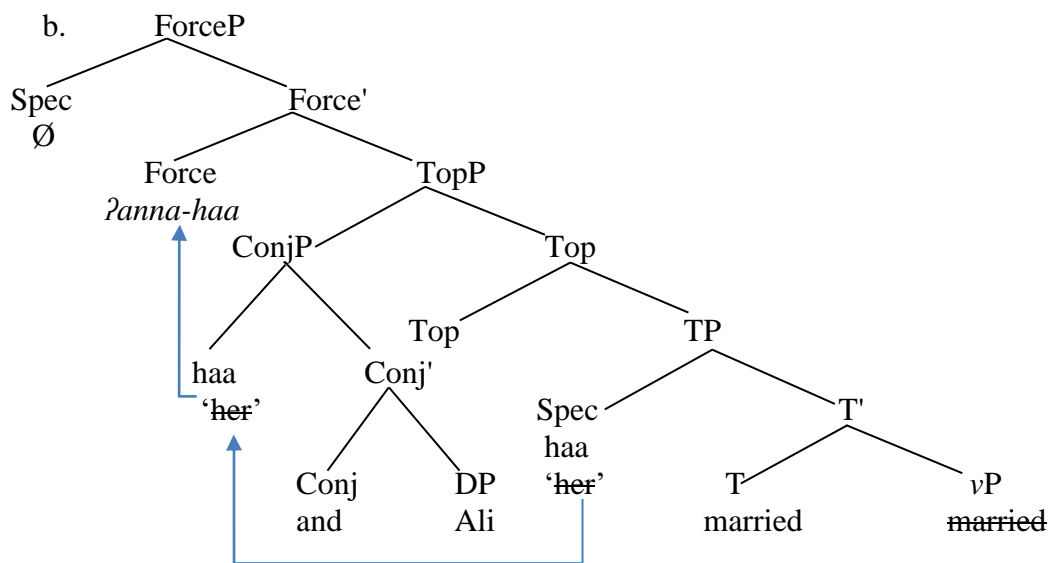

In (46b), the whole conjoined DP is in Spec-TopP and the CA enters into agree with the left conjunct, which is the pronoun. There is no phi-agree relation as such. There is case-Agree instead where pronominal clitic *haa* 'her' is probed by *ʔanna* and then raises from Spec-TP to Spec-ConjP. Then via incorporation operation, it is cliticized to the head *ʔanna* of ForceP forming CA *ʔanna-haa*.

### 6.7 The Tabuki Arabic complementizer particles

A variety of Arabic dialects display the phenomenon of CA; look at the constructions of CA in (47a) for Lebanese Arabic and (47b) for Najdi Arabic (NA):

- (47) a. *fakkar ʔinn-i (ʔana) ruħt.*  
 thought.3ms that-1ms (I) left.1s  
 'He thought that I left.'

Aoun et al. (1994:

على النص الذي ترغب في أن يظهر هنا. 2.Heading خطأ! استخدم علامة التبويب "الصفحة الرئيسية" لتطبيق  
على النص الذي ترغب في أن يظهر هنا. 2.Heading خطأ! استخدم علامة التبويب "الصفحة الرئيسية" لتطبيق

b. ʔaʕtiqid ʔinn-haa ʃaafat ʕahmed rima  
think.1s that-her. see.3fs Ahmed Rima.fs  
‘I think that Rima saw Ahmad.’

Lewis Jr. (2013: 67)

In (47a), the Comp *ʔinn* agrees with preverbal pronominal subject *ʔinn* ‘I’ forming the morphological form *i* ‘1.ms’ while the Comp *ʔinn* in (47b) agrees with the postverbal subject ‘Rima’ forming the morphological form *haa* ‘3fs’. As we have seen, CA in Arabic is expressed by appearing as an agreement morpheme which is a pronoun on the end of Comp expressing some phi-features of the subject or following DP.

The CA phenomenon also exists in TA when the Comp *ʔinn* agrees with a *pro* subject showing a pronoun attached to the end of *ʔinn* to express some phi-features. Recall that the Comp *ʔinn* in TA must select overt DPs. There is an apparent exception, however, where the Comp *ʔinn* is able to select the *pro* subject. This can only be allowed when Comp shows morphological agreement. The agreement relation between Comp *ʔinn* and the *pro* subject fall into one of the three distributions: with finite verbs, auxiliary verbs or predicates. Consider the following examples:

- (48) a. ʔa-twaqqaʕ ʔinn-ah ʔʕtaraa s-sayyaarah  
1-guess.s that-him **pro** bought.3ms the-car  
‘I guess that he bought the car.’
- b. ʔa-twaqqaʕ ʔinn-hin kaanin ya-qran l-ktaab  
1-guess.s that-them.f were.3fp 3-read.fp the-book  
I guess that they (female) were reading the book.’
- c. ʔa-twaqqaʕ ʔinn-haa faatmah  
1-guess.s that-her Fatmah  
‘I guess that she is Fatmah.’
- d. \*ʔa-twaqqaʕ ʔinn- ʔʕtaraa s-sayyaarah  
1-guess.s that- **pro** bought.3ms the-car  
‘I guess that he bought the car.’

- e. \*ʔa-twaqqaʕ ʔinn- kaant ta-qra l-ktaab  
 1-guess.s that- pro was.3fs 3f.read.s the-book  
 'I guess that she was reading the book.'
- f. \*ʔa-twaqqaʕ ʔinn- faatmah  
 1-guess.s that- Fatmah  
 'I guess that she is Fatmah.'

In (48a), the Comp *ʔinn* heads the embedded clause and shows phi-identical features to the embedded *pro* subject and expresses *ah* in 3mp features following by the finite verb 'bought' while in (48b) the *ʔinn* agrees with the *pro* subject 'they.f' followed by the auxiliary verb 'were'. In (48c), the CA *ʔinn-ha* selects and agrees with subject of a small clause formed by the null subject 'she' and the predicate 'Fatmah'. In (48d-f), the Comp *ʔinn* select a *pro* subject without shown any agreement morphemes, hence the structures are ill-formed as the use of the CA is compulsory with *pro* subject.

Additionally, these agreement features of the Comp *ʔinn* in (49a-c) must be identical not only with the selected *pro* subjects but also with a preverbal DP subject at the left edge of the clause as in (49a). The non-agreement or disagreement of the features will cause the sentence to be ruled out as shown in (49b-c).

- (49) a. **saalim** ʔa-twaqqaʕ ʔinn-ah ʔʃtaraa sayyaarah  
 Salem.ms 1.guess.s that-him *pro* bought.3ms car  
 'Salem, I guess that he bought the car.'
- b. \***saalim** ʔa-twaqqaʕ ʔinn-hum ʔʃtaraa sayyaarah  
 Salem.ms 1.guess.s that-them *pro* bought.3ms car  
 'Salem, I guess that he bought the car.'
- c. \***saalim** ʔa-twaqqaʕ ʔinn ʔʃtaraa ssayyaarah  
 Salem.ms 1.guess.s that *pro* bought.3ms car  
 'Salem, I guess that he bought the car.'

In (49a), the DP subject 'Salem' appears in the main clause and corresponds to the *pro* subject 'he' in the embedded clause. The Comp *?inn* will select this *pro huu* 'he', therefore, the CA phenomenon is warranted and the pronoun *-ah* '3ms', must be attached to the Comp. Therefore, the preverbal DP 'Salem' and the *pro* subject 'he' have a co-indexing agreement relation which in turn is identical to the Comp features. In (49b), the pronoun *-hum* '3mp' causes ungrammaticality since it disagrees with the *pro* subject 'he'. In (49c) is ungrammatical since the Comp *?inn* lacks of any agreement features. To correct the sentences in (49b-c) the agreement marker *-ah* '3ms' must be used, then the sentences are well-formed, as the case in (49a).

This analysis can be extended to interrogative clauses where subject wh-phrase is extracted to the main clause. Since CA must be used as in (50a) when the subject wh-phrase is fronted to the main and the CA must have indicial features to the fronted subject wh-phrase. Otherwise, the sentence is ill-formed as (50b-c) show.

- (50) a. **?ayy-ridzil** ta-twaqqaʕ ʔinn-**ah** ʔʕtaraa s-sayyaarah  
 which-man.ms 2.guess.ms that-him bought.3ms the-car  
 'Which man, do you guess he bought the car?'
- b. **\*?ayy-ridzil** ta-twaqqaʕ ʔinn-**ah** ʔʕtaraa s-sayyarah  
 which-man 2.guess.ms that-him bought.3ms the-car  
 'Which man, do you guess he bought the car?'
- c. **\*?ayy-ridzil** ta-twaqqaʕ ʔinn- ʔʕtaraa s-sayyaarah  
 which-man. 2-guess.ms that pro bought.3ms the-car  
 'Which man, do you guess he bought the car?'

However, the CA does not agree with DP subject as in (51a) including the pronominal subject as in (51b), topic phrase as in (51c), and focus phrase as in (51d). Since they will lead to ungrammaticalities:

- (51) a. \*ʔa-twaqqaʕ ʔinn-ah salman ʔʕtaraa s-sayyaarah  
 guess.1s that-him Salman bought.3ms the-the car  
 'I guess that Salman bought the car.'
- b. \*ʔt-waqqaʕ ʔinn-ah huu ʔʕtaraa s-sayyaarah  
 guess.1s that-him he bought.3ms the-car  
 'I guess that he bought the car.'
- c. \*ʔa-twaqqaʕ ʔinn-haa s-sayyaarah salman ʔʕtaraa-ha  
 guess.1s that-3fs the-the car Salman bought.3ms-it  
 'I guess that the car Salman bought it.'
- d. \*ʔa-twaqqaʕ ʔinn-haa s-sayyaarah salman ʔʕtaraa  
 guess.1s that-3fs the-the car Salman bought.3ms  
 'I guess that it was the car Salman bought.'

The CA is prohibited to agree with overt DPs as (51a-d) show and the default Comp is the only optional to select DPs except focus and wh-phrase as I showed in Chapter 4.

Although CA is not available with the left peripheral elements such as topic and focus, none of these elements are prohibited to appear between the CA and the *pro* subject. Consider the following examples:

- (52) a. ʔa-twaqqaʕ ʔinn-ah s-sayyaarah ʔʕtaraa-ha  
 1-guess.s that-3ms the-car.f *pro* bought.3ms.it  
 'I guess that the car, he bought it.'
- b. ʔa-twaqqaʕ ʔinn-ah sayyaarah ʔʕtaraa  
 1-guess.s that-3ms car *pro* bought.3ms  
 'I guess that it was a car, he bought.'
- c. ti-twaqqaʕ ʔinn-ah wish ʔʕtaraa  
 2.guess.ms that-3ms what *pro* bought.3ms  
 'Do you guess which he bought?'



The topic 'the car' in (52a), the focus phrase 'the car' in (52b), and the wh-phrase *wish* 'which' in (52c) intervene between CA *?inn-ah* and the *pro* subject 'he'. These intervenors, however, do not block the agreement relation between the CA *?inn-ah* with the *pro* subject *huu* 'he' and the agreement marker *-ah* '3ms' surfaces on the end of Comp *?inn*. This to say that the CA does not have to be adjacent to the *pro* subject that agrees with it.

The Comp *?in*, by contrast, never show agreement clitic either with a *pro* subject or an overt DP subject as in (53a). Additionally, the Comp *?in* never agree with topic and focus as (53b-c) respectively:

- (53) a. \*?a-twaqqaʃ **?in-haa**            hudaa    ta-qra    l-ktaab  
 1-guess.s    that-3fs    *pro* Huda    3f-read.s    the-book  
 'I guess that she/Huda read the book.'
- b. \*?a-twaqqaʃ **?in-ah**    l-ktaab    hudaa    ta-qra-ah  
 1-guess.s    that-3ms    the-book    Huda    3f-read.s-it  
 'I guess that the book that Huda read it.'
- c. \*?a-twaqqaʃ **?in-ah**    l-ktaab    hudaa    ta-qraa  
 1.guess. s    that-3ms    the-book    Huda    3f-read.s  
 'I guess that it was the book that Huda read.'

To summarize, it can be assumed the Comp *?inn* must show agreement features with the *pro* subject. The CA is allowed to be appear with finite verbs, auxiliary verbs, and predicates. The CA, however, does not agree with a DP subject, or focus or topic phrases. The adjacency condition is not required between the CA and the *pro* subject and other elements can occupy the position between them. In contrast the Comp *?inn*, the Comp *?in* cannot inflect any agreement.

## 6.8 The analysis of complementizer agreement in TA

Given TA complementizer agreement, under the traditional analyses in 6.3, it is important to recall the fact the subject in TA has full agreement phi-features with the verb in both SV and VS orders. In single subject clauses, these phi-features of the agreement can be identical between the Comp and the verb but with unlike morphological expressions. Therefore, there is a guaranteed result for subject's phi-features to be copied into both T and Force heads. Consider the following example:

- (54) ?a-twaqqaʕ      ?inn-hum                      ?ʕtaruu              s-sayyaarah  
 1-guess.s              that-3mp              *pro*              bought.3mp              the-car  
 'I guess that they bought the car.'

In (54) the Comp ?inn fully agrees with pro subject 'they' in '3fp' features and the finite verb/T 'bought' agrees fully with the pro subject 'they' in '3fp' features. This will lead to the result that the phi-features of the Comp '3mp' are transported from the subject's phi-features and are identical to the phi-features of finite verb 'bought'. However, the CA and the finite verb have different morphological forms, since the former ends with *-hum* morpheme while the latter ends with *uu*.

However, this is not always the case, since the verb in some constructions shows a different form due to different features with regard to CA as the following example shows:

- (55) ?a-twaqqaʕ      ?inn-ah                      wa              ʕaliyy              ?ʕtaruu              s-sayyaarah  
 1-guess.s              that-3ms              *pro*              and              Ali              bought.3mp              the-car  
 'I guess that he and Ali bought the car.'

In (55), the verb shows plural agreement with the full conjoined subject which is the pro subject 'he' in '3ms' and the overt subject 'Ali' in '3ms'. However, the Comp ?inn agrees only with the first conjunct the pro subject 'he'. Consequently, the phi-features of the Force cannot be inherited to the finite verb 'bought'. This observation shows that CA and subject-verb agreement do not result from the same feature checking relation.

على النص الذي ترغب في أن يظهر هنا. 2.Heading خطأ! استخدم علامة التبويب "الصفحة الرئيسية" لتطبيق  
 على النص الذي ترغب في أن يظهر هنا. 2.Heading خطأ! استخدم علامة التبويب "الصفحة الرئيسية" لتطبيق

Thus, CA in TA, similar to MSA, cannot be captured by the analysis of Zwart (1993; 1997), Watanabe (2000) and Chomsky (2005; 2013), since they fail to account for the connection between phi-features relation of the finite verb or the subject with C°. The alternative analysis is based on the behaviour of CA in the left peripheral domain, specifically, the acceptability of TA CA to agree with pro as (48) and unacceptability to agree with the following DP as (51a-d). Thus, it plausible to assume that it is only the case-Agree with pronoun cliticization/incorporation analysis which is available for the TA data presented here.

Consider the derivation of the following example:

- (56) ?a-twaqqaʕ      ?inn-ah              ?ʃtaruu              sayyaarah  
 1.guess.s              that-him              pro              bought.3ms              car  
 'I guess that Salem, he bought a car.'

In (56), ?inn heads the embedded clause in Force and has inflectional morphological features -ah '3ms'. It serves as a probe to value its [*u* Acc] while the pro subject huu 'he' will serve as a goal as it has [*u* Case]. Force c-commands the pro 'he' and the features are matched. The pro subject is assigned accusative case by the Comp ?inn as -ah while [*u* Acc] in the Force head is valued and deleted. This accusative weak pronoun -ah cannot stand without being cliticized to a head, and then it is attached to the Force head as ?inn-h. The following tree represents the example (56):

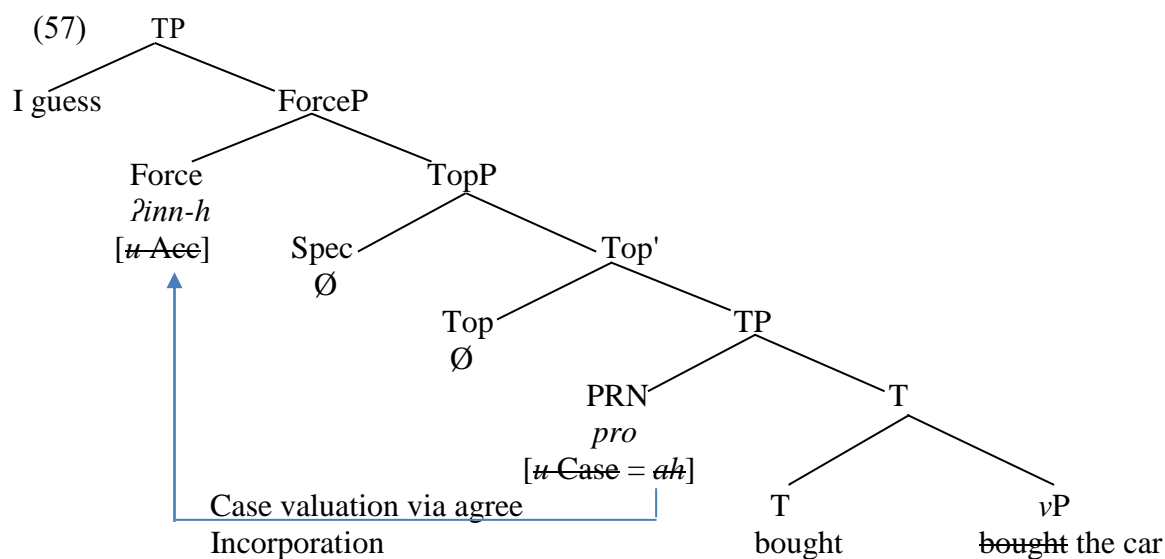

The auxiliary verb can enter the derivation with an agreeing complementizer as below shows:

- (58) a. *ʔa-twaqqaʃ ʔinn-ha kaant ti-ʃtirii s-ayyaarah*  
 1.guess.s that-3fs was.3fs 3f-bought.s the-car  
 'I guess that she bought the car.'

In (58) the CA *ʔinn-ha* is a result of case-Agree and cliticization between the Comp *ʔinn* and the *pro* subject to satisfy the [*u Acc*] of the Force head. The auxiliary verb *kaant* moves from T to the Fin head position. The main verb 'bought' is merged in *v* and may move higher.

## 6.9 Conclusion

The chapter discussed CA in MSA and TA. The CA in MSA agrees with a postverbal DP subject and *pro* subject, left peripheral elements and conjunct DPs. The TA CA, however, can only agree with *pro* subject. With respect to the traditional analyses, both varieties show empirical evidence against the assumption that CA is accounted for as the head movement of features from the lower head or the C-to-T inheritance system.

على النص الذي ترغب في أن يظهر هنا. 2.Heading خطأ! استخدم علامة التبويب "الصفحة الرئيسية" لتطبيق  
على النص الذي ترغب في أن يظهر هنا. 2.Heading خطأ! استخدم علامة التبويب "الصفحة الرئيسية" لتطبيق

---

The CA in MSA shows has a wider distribution than TA since the former can be followed by null subject clauses or by DPs while the latter can only select null subject clauses. This difference has been reflected to the analyses in the different varieties. MSA CA can be analysed by the case-Agree analysis followed by cliticizing the accusative pronoun in the cases of a postverbal DP subject or a *pro* subject, or by phi-Agree with other following DPs. TA CA, however, can only have the analysis of case-Agree with *pro* including the pronoun cliticization since TA does not allow the CA to be agreed with following DPs.



## Chapter 7 Conclusions of the thesis

### 7.1 Summarizing the main analyses

In this thesis, the syntax of the left periphery in MSA and TA has been investigated using the Split-CP hypothesis (Rizzi, 1997) and the minimalist assumption of Chomsky (2000; 2001; 2008; 2013) to provide answers for the basic questions listed in the introduction.

The main analysis of the thesis is with regard to the cartographic approach of the left peripheral domain. MSA and TA, according to this hypothesis, shows the projections in the order in (1):

(1) ForceP > TopP > FocP > TopP > FinP

For MSA, in (1), the OTop DP phrase can only be instantiated in the higher Spec-TopP motivated by a [+topic] feature and being co-referential with a resumptive clitic inside the clause. A focus phrase is instantiated in Spec-FocP motivated by a [+focus] feature. An adjacency condition has to be respected between the focus phrase and the verb in MSA, with nothing allowed between the Focus and the verb. In SVO within full agreement pattern, the STop always appears to the left of verb in full agreement pattern, and in fact the subject instantiates the lower TopP of (1). However, once the focus clause is constructed the STop cannot be instantiated in the lower Top position due to the necessity of the adjacency fact.

If there is a focus, the lower TopP cannot be filled by the OTop DP phrase since the resumptive clitic on the verb, which is on the Foc head, cannot be co-referential with a

following OTop DP phrase. The OTop DP phrase in MSA can be iterated but these are only allowed in the higher TopP preceding the focus.

MSA has two complementizers, the case assigner *ʔinna/ʔanna* on Force which checks [+decl] while the subjunctive *ʔin* is in Fin to check [+finite]. According to Chomsky (2000; 2001), the heads *v* and T are two functional heads assigning two different cases. The head *v* is specified for accusative case assignment to the DP object, and the head T is specified for nominative case assignment to the DP subject. On a par with T and *v* the heads Force and Fin are two functional heads assigning case and mood respectively. Assuming the mechanism of Adger (2003) for case and mood valuations, the Force head *ʔinna/ʔanna*, on one hand, is specified for a [*u* Acc] feature which will be valued when the following DP has a [*u* Case] feature, being valued as accusative. On the other hand, the head Fin is specified for [*u* Subjun] which will be valued when the following verb has [*u* Mood], being valued as subjunctive.

For TA, with regard to the projection order in (1), there are two topic positions and one focus position articulated in the left domain, and one topic position precedes the focus and other follows it. The focus phrase does not have the obligatory adjacency condition and so a topic phrase (OTop or STop) can precede focus, e.g. as a wh-phrase, or follow it, intervening between the focus and the verb which is in Fin or in T. TA has two complementizers which are *ʔinn* and *ʔin*. The former is a case assigner head in Force while the latter is in Fin but is not a case assigner head. Although case is overtly lost in TA the [*u* Acc] feature of *ʔinn* is shown by the possibility of selecting only accusative clitic pronouns and the impossibility to selecting strong pronouns. The Comp *ʔin* is not specified for a case value and has a different distribution.

Despite the fact that both Comps *ʔinna/ʔanna* in MSA and *ʔinn* in TA have the ability to appear carrying clitic agreement the source in each case is different. In MSA, the clitic agreement of Comp *ʔinna/ʔanna* can be from two sources based on their distribution with following elements. (i) The first source is the incorporation of the following *pro* subject which has to spell out as an accusative weak pronoun once it is valued [*u* Acc] by Comp



*ʔinna/ʔanna*. (ii) The second source of the clitic agreement of Comp *ʔinna/ʔanna* in MSA is after phi-agreement with a following DP. The agreement marker then is an accusative weak pronoun expressing the phi-features after the valuing of [*u* Acc] by Comp *ʔinna/ʔanna*. In case of CA in TA, only one source of clitic agreement is available for the Comp *ʔinn* which is the cliticization analysis. This is because the CA in TA is prohibited with a following DP which would trigger CA under phi-features. As far as the data of the two varieties go, the CA constructions in Arabic cannot be analysed with previous analyses which accounted for CA as head movement of features from the lower head or which used the C-to-T inheritance system, since Force and T in Arabic can be shown to have separate feature checking relations. A good example of this is with conjoined DPs where the Comp in MSA and TA agrees with first conjunct only while the following verb agrees with the full conjoined DP.

## 7.2 The implication of the thesis

The thesis shows a number of aspects of syntactic theory. For Agreement, for instance, MSA presents a challenge for the Agree-based theory, since the partial agreement pattern in VSO clauses requires the T head not to carry an EPP feature and so the DP subject does not move to Spec-TP. However, SVO clauses in MSA and TA show more support for the Agree-based theory as the pro subject in MSA and the overt DP subject in TA always move to Spec-TP, satisfying the EPP feature of T, which then must show full agreement features. Specifically, the full set of phi-features (Pers, Gen and Num) on T are active for Agree in full agreement clauses while (Num) is not present, and so not active, for Agree in partial agreement clauses, and the inflection spells out as singular by default.

For case valuation, there is no evidence that DPs require phi-agreement with their case assigners (i.e. T, *v*) to value their cases, since case assigner and case assignee simply carry unvalued case features which are active for the case-Agree operation. This is shown clearly in the accusative case valuation between the case assigner P *v* and the G DP object. This also appears to go against the standard assumption of Agree theory that takes the case valuation as a reflex of phi-agreement, which assumed to be a necessary condition on Agree.

In addition, the data shows that whereas the Force head with an overt Comp, in the manner of a *v* head, is an accusative case assigner and always takes the closest DP as its assignee.

The thesis has taken the base generated topic analysis for the preverbal DP in MSA and does not adopt a moved subject analysis. This goes well with the requirement of the Agree theory with respect to the Activation Condition on goals (Chomsky 2000) which restricts the DP subject to move to Spec-TP and be valued Nom by T, yet then again be active to receive Acc value from the overt Force Comp. As a result, the overt true subject can only appear postverbally. Although both post- and preverbal DP subjects appear in nominative case, case is assigned with different mechanisms in each circumstance. The postverbal subject is assigned structural nominative case by the head T, under Agree, while the preverbal ‘subject’, actually a Topic, can be assigned default nominative case by the absence of structural case assigner.

The syntax of CA in MSA reduces the empirical evidence for a Feature Inheritance approach (T-to-C movement). The data of MSA and TA show that C and T have independent feature checking relations. This contrast to previous analyses of CA which require a connection between the T and C heads (Zwart 1993; Watanabe 2000; Carstens 2003: 394; Van Koppen 2005: 33; Chomsky 2008; 2013). Instead, the CA phenomenon induces incorporation and phi-agreement analyses as sources of the clitic agreement attached to the Comp *?anna* and *?inna*.

The thesis also shows differences between MSA and other Arabic varieties such as TA in a number of syntactic aspects, including the agreement asymmetry and the complementizer system. More significantly, the adjacency condition which has a clear effect on word order variation and constraints, but only in MSA. In MSA, for instance, a DP topic is prevented to follow a Focus phase in the left peripheral domain as Focus > Topic order is necessary to respect the adjacency facts, while the reverse order is acceptable in TA since the adjacency condition does not apply in that variety.

---

For the further research, the adjacency facts, the default case for the topics and the default number [Num= s] of verb in MSA VSO order need to be addressed with developed minimalist perspective.

## List of Abbreviations

1	First Person
2	Second Person
3	Third Person
acc	Accusative Case
Adv	Adverb
Agr	Agreement Phrase
AP	Adjective Phrase
AspP	Aspect Phrase
CA	Complementizer Agreement
Comp	Complementizer (Lexical item)
CP	Complementizer Phrase
dat	Dative Case
DP	Determiner Phrase
d	Dual
EF	Edge Feature
EPP	Extended Projection Principle
f	Feminine
FinP	Finiteness Phrase
FocP	Focus Phrase
FP	Focus Phrase
gen	Genitive Case
imperf	Imperfective
indic	Indicative
juss	Jussive
LA	Lebanese Arabic

---

LF	Logical Form
m	Masculine
ModP	Modality Phrase
MoodP	Mood Phrase
MP	Minimalist Program
MSA	Modern Standard Arabic
NegP	Negative Phrase
nom	Nominative Case
O	Object
p	Plural
PA	Palestinian Arabic
past	Past Tense
perf	Perfective
PF	Phonetic Form
Phi	person, gender and number
PP	Prepositional Phrase
RP	Resumptive Pronoun
s	Singular
S	Subject
subjun	Subjunctive
TopP	Topic Phrase
TP	Tense Phrase
V	Verb
VP	Verb Phrase
vP	Light Verb Phrase

## Bibliography

- Ackema, P. and A. Neeleman 2004. *Beyond Morphology: Interface Conditions on Word Formation*. Oxford: Oxford University Press
- Adger, D. 2003. *Core syntax: A minimalist approach* (Vol. 33). Oxford: Oxford University Press.
- Aoun, J. and Benmamoun, E. 1998. 'Minimality, reconstruction, and P movement'. *Linguistic Inquiry*, 29: 569-597.
- Aoun, J., Benmamoun, E. and Sportiche, D. 1994. 'Agreement, word order, and conjunction in some varieties of Arabic'. *Linguistic Inquiry* 24: 195-220.
- Aoun, J., Benmamoun, E., and Choueiri, L. 2010. *The Syntax of Arabic*. Cambridge University Press.
- Ayed, B. 2003. *Mood and Functional Projections*. Unpublished PhD dissertation. McGill University.
- Ayoub, G. 1981. *Structure de la Phrase en Arabe Standard*. Unpublished PhD dissertation, University de Paris VII, France.
- Bakir, M. 1980. *Aspects of Clause Structure in Arabic*. Unpublished PhD dissertation, MIT, Cambridge, MA.
- Barbiers, S. 2005. Generative linguistics and sociolinguistics. *Syntax and variation: Reconciling the biological and the social* 265, p.233.
- Benmamoun, E. 1992. Structural Conditions on Agreement. *Proceedings of the North Eastern Linguistic Society* 22. University of Massachusetts at Amherst. 17-32.

- 
- Benmamoun, E. 2000a. *The feature structure of functional categories: A comparative study of Arabic dialects*. New York: Oxford University Press.
- Benmamoun, E. 2000b. *The feature structure of functional categories: a comparative study of Arabic dialects*. New York, Oxford: Oxford University Press.
- Bennis, H. J. and Haegeman, L. 1984. 'On the status of agreement and relative clauses in West-Flemish'. In W. de Geest & Y. Putseys (eds) *Sentential complementation*. Dordrecht: Foris.
- Bolotin, N. 1995. Arabic and parametric VSO agreement. In M. Eid, (ed). *Perspectives on Arabic Linguistics VII*: 7-27. Amsterdam, Philadelphia: John Benjamin's Publishing Company.
- Bonet, E. 1990. 'Subjects in Catalan'. MIT Working Papers in Linguistics (*Papers on Wh movement*) 13: 1-26.
- Bošković, Ž. 1997. *The syntax of nonfinite complementation: An economy approach*. Monograph No. 32. MIT Press.
- Brody, Michael 1990 "Some remarks on the Focus Field in Hungarian" *UCL Working Papers in Linguistics*.
- Brustad, K. 2000. *The syntax of spoken Arabic: A comparative study of Moroccan, Egyptian, Syrian, and Kuwaiti dialects*. Georgetown University Press.
- Burzio, L. 1986. *Italian Syntax*. Dordrecht: Reidel.
- Carnie, A. and Pilar, B. 1995. Is Right Adjunction Right?. Paper presented at the Linguistic Society of America Meeting. New Orleans.
- Carstens, V. 2003. 'Rethinking complementizer agreement: Agree with a Case-checked goal'. *Linguistic Inquiry* 34: 393-412.
- Cheng, L. L.-S. and Rooryck, J. 2000. 'Licensing wh-in-situ'. *Syntax* 3: 1-19.
- Chomsky, N. 1965. *Aspects of the theory of syntax*. Cambridge: MIT Press.
- Chomsky, N. 1981. *Lectures on Government and Binding*. Dordrecht: Foris.

- Chomsky, N. 1991. Some notes on the economy of derivation and representation. In Freidin, R. (ed.) *Principles and Parameters in Comparative Grammar*. Cambridge: MIT Press. 417-54.
- Chomsky, N. 1993. A Minimalist Program for Linguistic Theory. In K. Hale and S. J. Keyser, (eds). *The View From Building 20*, Cambridge: MIT Press.
- Chomsky, N. 1995. *The Minimalist Program*. Cambridge. Mass: The MIT Press.
- Chomsky, N. 2000. 'Minimalist Inquiries: the Framework'. In R. Martin, D. Michaels and J. Uriagereka (eds). *Step by Step: Essays on Minimalist Syntax in Honor of Howard Lasnik*. Cambridge. Mass: The MIT Press.
- Chomsky, N. 2001. 'Derivation by Phase'. In: M. Kenstowicz, ed., *Ken Hale. A Life in Language*. MIT Press, Cambridge, Massachusetts, 1-52.
- Chomsky, N. 2008. 'On phases'. *Current Studies in Linguistics Series 45*.
- Chomsky, N. 2013. 'Some notes on economy of derivation and representation'. *Anuario del Seminario de Filología Vasca "Julio de Urquijo"*. 53-82.
- Contreras, H. 1991. 'On the Position of Subjects'. *Perspectives on Phrase Structure: Heads and Licensing*. Syntax and Semantics 25, ed. by S. Rothstein, 63-79. San Diego: Academic Press.
- Culicover, P.W. 1992. 'English tag questions in universal grammar'. *Lingua* 88: 193-226.
- den Besten, H. 1981. A case filter for passives. In A. Belletti, L. Brandi & L. Rizzi (eds.). *Theory of markedness in generative grammar*. 65-122. Pisa: Proceedings of the 1979 GLOW Conference.
- Déprez, V and Hale, K. 1986 'Resumptive Pronouns in Irish'. *Proceedings of the Harvard Celtic Colloquium* 5: 38-48.
- Den Dikken, M. 1995. *Particles: On the syntax of verb-particle, triadic, and causative constructions*. Oxford University Press on Demand.
- Duffield, N. 1995. *Particles and Projections in Irish Syntax*. Dordrecht: Kluwer Academic Publishers.
- Emonds, J. 1980. 'Word Order in Generative Grammar'. *Journal of Linguistic Research* 1: 33-54.



- 
- Fassi Fehri, A. 1982. *Linguistique Arabe: Forme et Interpretation*. Rabat: Publications Stanford: CSLI.
- Fassi Fehri, A. 1993. *Issues in the Structure of Arabic Clauses and Words*. Dordrecht: Kluwer.
- Fassi Fehri, A. 2005. The Arabic case for a CP phase. *Ms. Mohammad V University. Rabat*.
- Fassi Fehri, A. 2012. *Key features and parameters in Arabic grammar* (Vol. 182). John Benjamins Publishing. Fehri, A.F., 2012. *Key features and parameters in Arabic grammar* (Vol. 182). John Benjamins Publishing.
- Fukui, N and Speas, M. 1986. Specifiers and Projection. In N. Fukui, T. Rapoport and E. Sagey, (eds). *Papers in Theoretical Linguistics: MIT Working Papers in Linguistics* 8, 128-172.
- Guilfoyle, E. 1990. *Functional Categories and Phrase Structure Parameters*. Unpublished PhD Dissertation, McGill University.
- Haegeman, L. and Van Koppen, M. 2012. 'Complementizer agreement and the relation between  $C^0$  and  $T^0$ '. *Linguistic inquiry*, 43: 441-454.
- Haegeman, L.M. 1992. *Theory and description in generative syntax: A case study in West Flemish*. Cambridge University Press.
- Halle, M. 1990. An approach to morphology. In *Proceedings of NELS* 20. 150-184.
- Hassan, A. 1961. *an-nahwal-wafi*. Cairo: dar al-ma'araef.
- Henry, A., 1995. *Belfast English and Standard English: Dialect variation and parameter setting*. Oxford University Press on Demand.
- Hoang, H., Koehn, P. and Lopez, A. 2009. 'A unified framework for phrase-based, hierarchical, and syntax-based statistical machine translation'. In *IWSLT* (pp. 152-159).
- Hoekstra, J. and Marácz, L. 1989. 'On the position of inflection in West Germanic'. *Working Papers in Scandinavian Syntax* 44 75-88.
- Holes, C. (1995). *Modern Arabic: structures, functions, and varieties*. London, New York: Longman.
- Holmberg, A. and Roberts, I. 2013. 'The syntax–morphology relation'. *Lingua* 130, 111-131.

- Hornstein, N., Nunes, J. and Grohmann, K.K., 2005. *Understanding minimalism*. Cambridge University Press.
- Jackendoff, R.S. 1972. *Semantic Interpretation in Generative Grammar*. Cambridge, MA: The MIT Press.
- Kayne, R.S. 1994. *The antisymmetry of syntax* (Monograph No. 25). Mit Press.
- Koopman, H. 1984. *The syntax of verbs*. Holland: Dordrecht.
- Koopman, H., and Sportiche, D. 1991. 'The Position of Subjects'. *Lingua* 85, 211-285.
- Koopman, H. 2006. Agreement configurations. *Agreement systems*, 92, p.159.
- Koppen, M.V. 2005. *One probe-two goals: Aspects of agreement in Dutch dialects*. LOT: Netherlands Graduate School of Linguistics.
- Lasnik, H. and Saito, M. 1991. On the subject of infinitives. *In 27th regional meeting of the Chicago Linguistic Society (Vol. 27, pp. 324-343)*.
- Law, S.P. 1991. *The syntax and phonology of Cantonese sentence-final particles*. University Microfilms.
- Li, C.N. and Thompson, S.A. 1976. 'Development of the causative in Mandarin Chinese: Interaction of diachronic processes in syntax'. *Syntax and semantics* 6: 477-492.
- Mahfoudhi, A. 2002. 'Agreement lost, agreement regained: A minimalist account of word order and agreement variation in Arabic'. *California Linguistic Notes*, 27(2),.1-28.
- McCloskey, J. 1986. 'Inflection and Conjunction in Modern Irish'. *Natural Language and Linguistic Theory* 4: 245-81.
- McCloskey, J. 1990. 'Resumptive Pronouns, A-Bar binding and Levels of Representation in Irish'. *Syntax and Semantics* 23, 199-248.
- McCloskey, J. 1991. 'Clause Structure, Ellipsis and Proper Government in Irish'. *In The syntax of Verb Initial Languages. Lingua* 85, 259-302.
- McCloskey, J. 1992. On the scope of verb movement in Modern Irish. Technical Report LRC-92-10. Linguistics Research Center, Cowell College University of California at Santa Cruz.
- McCloskey, J. 1996. 'Subjects and Subject Positions'. *In R. Borsely and I. Roberts, (eds). The Syntax of Celtic Languages*, 241-283. Cambridge University Press.

- 
- McCloskey, J. 1997. 'Subjecthood and Subject Positions'. In Liliane Haegeman, (ed). *Elements of Grammar: Handbook in Generative Syntax*, 197-235.
- McCloskey, J. 1991. 'There, it, and agreement'. *Linguistic Inquiry* 22(3), 563-567.
- Merchant, J. 2011. Aleut case matters. *Pragmatics and autolexical grammar: In honor of Jerry Sadock, 176*, p.193.
- Mohammad, M. 1990. The Problem of Subject-Verb Agreement in Arabic: Towards a Solution. In M. Eid (ed). *Perspectives on Arabic Linguistics I*, Amsterdam: John Benjamins.
- Mohammad, M. 2000. *Word Order, Agreement and Pronominalization in Standard and Palestinian Arabic*. Amsterdam: John Benjamins.
- Moutaouakil, A. 1989. *Pragmatic functions in a functional grammar of Arabic*. Walter de Gruyter.
- Noyer, R. R. 1992. *Features, positions and affixes in autonomous morphological structure*. Unpublished PhD dissertation, Massachusetts Institute of Technology.
- Ouali, H. 2014. Multiple agreement in Arabic. In Khamis-Dakwar, R. and Froud, K., editors, *Perspectives on Arabic Linguistics XXVI*, pages 121–134, New York. John Benjamins.
- Ouhalla J. 1994a. 'Verb Movement and Word Order in Arabic'. In D. Lightfoot and N. Hornstein (eds). *Verb Movement*, 241-72. Cambridge University Press.
- Ouhalla, J. 1991. *Functional Categories and Parametric Variation*. London: Routledge.
- Ouhalla, J. and Shlonsky, U. 2002. Introduction, in J. Ouhalla and U. Shlonsky (eds). *Themes in Arabic and Hebrew Syntax* Dordrecht 1-43.
- Plunkett, B. 1993. 'The position of subjects in Modern Standard Arabic'. In M. Eid and C. Holes (eds.) *Perspectives on Arabic Linguistics V*, 231-259. Amsterdam: John Benjamins.
- Polinsky, M. and Potsdam, E. 2001. Long-distance agreement and topic in Tsez. *Natural Language & Linguistic Theory*, 19(3), pp.583-646.
- Polinsky, M. and Preminger, O. 2014. 'Case and grammatical relations'. *The Routledge Handbook of Syntax*. 150-166.

- Pollock, J. 1989. Verb Movement, UG and the Structure of IP. *Linguistic Inquiry* 20: 365-424.
- Preminger, O. and Polinsky, M. 2015. Agreement and semantic concord: a spurious unification. *Manuscript: University of Maryland*.
- Pyatt, E. 1992. 'Incomplete subject raising and Welsh word order'. *Proceedings of the Harvard Celtic Colloquium* 12, 135-165.
- Radford, A. 2009. *Analysing English Sentences: A Minimalist Approach*. Cambridge: Cambridge University Press.
- Reinhart, T. 1981. 'Pragmatics and Linguistics: An Analysis of Sentence Topics in Pragmatics and Philosophy' *Philosophica anc Studia Philosophica Gandensia Gent*, 27: 53-94.
- Rizzi, L. 1982. *Issues in Italian syntax*. Dordrecht: Foris.
- Rizzi, L. 1986. 'Null objects in Italian and the theory of pro'. *Linguistic Inquiry* 17: 501-57.
- Rizzi, L. 1990. *Relativized minimality*. The MIT Press.
- Rizzi, L. 1997. 'The Fine Structure of The Left Periphery'. In L. Haegeman (ed.) *Elements of Grammar*. Dordrecht: Kluwer.
- Rizzi, L. ed., 2004. *The structure of CP and IP: The cartography of syntactic structures* (Vol. 2). Oxford University Press.
- Roberts, J.E., Rosenfeld, R.M. and Zeisel, S.A. 2004. 'Otitis media and speech and language: a meta-analysis of prospective studies'. *Pediatrics* 113: 238-248.
- Rouveret, A. 1991. 'Functional Categories and Agreement'. *The Linguistic Review* 8: 353-387.
- Sadler, L 1988. *Welsh Syntax, A Government Binding Approach*. Croom Helm, New York.
- Santorini, B. 1994. 'Some similarities and differences between Icelandic and Yiddish'. In D. Lightfoot and N. Hornstein (eds). *Verb Movement*. Cambridge University Press. 87-104
- Shlonsky, Ur 1997. *Clause Structure and Word Order in Hebrew and Arabic: An Essay in Comparative Semitic Syntax*. Oxford University Press.

- 
- Shlonsky, Ur 2000. 'Remarks on the Complementizer Layer of Standard Arabic'. In J. Lecarme, J. Lowenstamm and Ur Shlonsky (eds.) *Research in Afroasiatic Grammar. Papers from the Third conference on Afroasiatic Languages*. Philadelphia: John Benjamins.
- Soltan, U. 2007. *On Formal Feature Licensing in Minimalism: Aspects of Standard Arabic Morphosyntax*. Unpublished PhD Dissertation, University of Maryland.
- Sproat, R. (1985). 'Welsh Syntax and VSO Structure'. *Natural Language and Linguistic Theory*. 3: 173-216.
- Stanton, J. 2016. 'Wholesale Late Merger in  $\bar{A}$ -movement: Evidence from Preposition Stranding'. *Linguistic Inquiry* 47: 89-126.
- Stowell, T. 1989. 'Subjects, specifiers, and X-bar theory'. In M. Baltin and A. Kroch (eds). *Alternative conceptions of phrase structure*. University of Chicago Press, Chicago. 232-262.
- Torrego, E. and Uriagereka, J. 2002. *Derivations: Exploring the dynamics of syntax*, Routledge.
- van Gelderen, Elly. 1996 'Parametrising Agreement Features in Arabic, Bantu Languages Varieties of Arabic'. *Linguistic Inquiry* 25:195-220.
- Versteegh, K. 1997. *The Arabic language*. New York: Columbia University.
- Von der Gabelentz, G. 1969. *Die Sprachwissenschaft* (Vol. 1). Рипол Классик.
- Watanabe, A. 2000. 'Feature Copying and Binding: Evidence from Complementizer Agreement and Switch Reference'. *Syntax* 3: 159-181.
- Zeijlstra, H. 2012. There is only one way to agree.
- Zwart, C. J.-W. 1993. *Dutch syntax: A minimalist approach*.
- Zwart, C. J.-W., 1997. *Morphosyntax of Verb Movement: A Minimalist Approach to the Syntax of Dutch* (Vol. 39). Springer Science & Business Media.

