

CHAPTER 6

INTERACTIONS AND POWER RELATIONS

ABOUT THE DEPRECIATION STANDARD (SSAP12)

6.0 INTRODUCTION

The Depreciation standard, as it is shown in Figure 6.0, is a dynamic and complex standard in the sense that it has changed over time since the issuing of the first exposure draft (ED15) in January 1975 to the issuing of the latest standard (SSAP12 "Revised") in January 1987. Also, different forms of documents were presented through its history (i.e ED, SSAP, Discussion Paper, and SoI).

Considering this dynamic and complex nature of this standard, and based on the analysis of the wider context of interactions and power relations about the process of setting accounting standards discussed in the previous chapter, this chapter has two connected purposes.

Firstly, to argue and demonstrate -based on the material available in the financial press and the ASC documents-, that the issuing of the first exposure draft on depreciation (ED15) in January 1975 and the changes that followed to 1987, as visible events during this period, were preceded and surrounded with invisible interactions and power relations between the ASC and

finance directors (and other directors) of the companies. These interactions and power relations were accompanied and supported by interactions and power relations between the ASC and other interested groups.

This will, and in contrast to the previous studies discussed in Chapter 4, both illustrate and lend support to the following points: (1) the role of UK companies finance directors (and other directors) in setting the depreciation standard is not just a reactive role in terms of written comments to the ASC, but also, and maybe more importantly, it is an interactive role in which different forms of interactions are involved; (2) this role of UK companies' finance directors (and other directors) in the process of setting depreciation standard, can be fully understood within the wider context of interactions and power relations concerning the standard-setting process at the more general level.

Secondly, and building on the above first purpose and the analysis of section 5.5, to demonstrate that power exercised about the Depreciation standard has, in contrast to the previous studies, disciplinary, relational, and positive aspects.

The design and content of this chapter is summarised in Figure 6.0. Section 6.1 to 6.5 (each section is concerned with one or two of the events depicted) address the first purpose. Section 6.6 is devoted to addressing the second purpose.

6.1 ISSUING ED15 IN JANUARY 1975

The first British exposure draft on depreciation (ED15) was issued in January 1975. This suggested that all fixed assets, having a finite useful life, should be depreciated.

This exposure draft, as a visible event at that time, it will be argued and demonstrated in this Section, was preceded and surrounded by invisible interactions and power relations between the ASC and organisations and persons concerned with financial reporting.

These interactions and power relations manifested themselves in a variety of ways which are depicted in diagrammatic form in Figure 6.1 and described below.

In 1969, Mr W.Parker (1.69) wrote: 'Sir, Your brief report of a speech by Lord Shawcross (Business News, Nov.21) refers to criticisms of the accountancy profession because of differences in the treatment of such important matters as stocks and work in progress, depreciation, and research and development expenditure. Your leading article in the same issue seems to imply that the main cause of these differences is a failure of the profession to reach agreement on its accounting principles.... Rules or no rules, it will always be to some extent, and often to a great extent, a matter of opinion.'

In 1970, the ASC in its second meeting on 21 January,

considered the proposed five year programme. The depreciation topic was placed in the fifth priority of this programme.

In 1971, the ASC, in its April meeting noted a letter received from Sir Henry Benson requesting the Committee to issue an accounting standard on depreciation of fixed assets and noted that a sub-committee of the Technical Committee had been set up to prepare a draft statement.

In August, Leeds, Bradford & District Society Regional Technical Advisory Committee (TAC) -and other TAC committees- prepared and submitted a paper on 'Fundamental Principles of Depreciation of Fixed Assets'

In 1972, the ASC, in the June meeting, considered the draft paper on Accounting for Depreciation (Presenter Mr S.Duncan) In this draft paper it was stated: 'Special considerations arise in the case of freehold properties which are acquired not for use in the business carried on by the acquirer, but as investments by concerns such as insurance companies, property investment companies and pension funds, whose primary activity, or a main aspect thereof, is the making of investments....In these circumstances freehold land and the buildings thereon are properly regarded as a single investment and provision for depreciation will not be required so long as current market value exceeds balance sheet value.'

In the July meeting, the ASC agreed that the draft paper

should be resubmitted to the Technical Committee with a request for more detailed guidance to be given on the depreciation of land and buildings, and considerations being given to the paper being confined to this subject.

In 1973, Mr Goodwin (73.1), a member of the Monopolies Commission accountancy staff, in an article entitled 'fixed assets in a period of inflation' explained accounting for depreciation of assets whose values are changing.

G. Holmes (73.2), in an article, discussed the accounting problems faced by property companies. He argued that 'depreciation of freehold buildings and leaseholds is normal in United States and Canada -should the time ever come when statute law, or accounting standards, insist upon it over here, earnings of property companies will be sharply reduced.'

Professor W. Baxter (73.3) commenting on Mr Goodwin's article (73.1), said: 'Mr Goodwin explored an important and topical problem -whether, when accounts allow for price change, we should adjust not merely the depreciation change of this year, but also the cumulative provision brought forward from past years. As a member of the Monopolies Commission accounting staff, presumably he has in mind possible rulings by the commission; but the issues plainly have a much wider implication. I suspect that they are more complex, and the answers more debatable, than his examples suggest.'

At an English ICA course on property company auditing (73.4), W.Stern of Stern Holdings called for annual valuations in property companies and the reform of current accounting practice. He said that 'property portfolios should be revalued every year -whether they appeared as current or fixed assets in the balance sheet.' 'All property assets are equally saleable, whether called current or fixed', he said. Stern complained of the lack of conformity in property company accounts and auditing practice. At the course, partners from leading accountancy firms called for urgent publication of an accounting standard dealing with property companies. P.Hipps of Stoy Hayward claimed it would be extremely difficult to influence clients' away from traditional practices with ASC backing. D.Tillet, of Binder Hamlyn, emphasised, also, the urgent need for an accounting standard to clarify the confused and complex situation surrounding property companies' accounts. Commenting on this course, a press comment (73.5) said that 'Last weeks English ICA course on property company audits showed just how great was the need for guidance on a host of accounting aspects.' It argued that 'In the meantime, there are a number of major issues to be resolved -with or without the backing of the Accounting Standards Steering Committee. Firstly, should it be possible to distribute unrealised capital profits to shareholders? The property tycoons would favour such a step, but the accountants are very cautious. ...Another extremely difficult area for auditors concerns valuations.'

In 1974, R.Ashton and Professor G.Murphy (74.1) discussed some problems peculiar to the accounts of property companies,

suggesting that there was an urgent need for the publication of an accounting standard dealing with property companies. This would clarify the confused and complex situation surrounding property companies' accounts.

K. Sherwood (74.2) argued that 'In recent months, there apparently unrelated publications have referred to methods of accounting for fixed asset valuations. First to be published was the companies Bill in 1973, which proposed the introduction of a distinction between realized and unrealized capital profits. Two months later, in February 1974, the Companies Bill lapsed with the dissolution of Parliament, but a joint statement from the English Institute and the Royal Institution of Chartered Surveyors on 'Valuation of Company Property Assets' referred to the need to develop accounting standards in this area. Then, in April 1974, the issue of SSAP6 'Extraordinary Items and Prior Year Adjustments' included a reference to surpluses arising on fixed assets valuations.' He concluded that 'with the present impetus to more fixed asset valuations, an accounting standard on when and how to account for them becomes urgently necessary.'

In the September meeting, the ASC noted that a revised paper on Depreciation would be submitted at the next meeting.

The ASC, in its October meeting, received a secretarial memorandum on accounting for depreciation together with a revised proposed exposure draft. It was agreed that a revised draft should be prepared for further consideration and that this paper should,

in particular, make clear that it dealt with accounting for depreciation in the context of the historical cost system.

In the December meeting, after discussion of the detailed contents of Part 3 in the draft paper about depreciation, the ASC agreed to delete the Appendix and the definition of 'Fixed Assets'.

The conclusion from this section is that there was a discourse (in the period from 1969 to 1974), as illustrated in this Section, about the differences in the treatment of depreciation and the urgent need for the publication of accounting standard dealing with such matter. This discourse, as shown in Figure 6.1, manifested itself in the form of letters to the financial press [see (69.1) and (69.2)], published articles [see (73.1), (73.2), (73.3), (74.1) and (74.2)], and a course about property company auditing. Involved in this discourse were accountants, auditors, academics and profession.

This discourse about the need for a standard for depreciation, it can be argued, was accompanied, at the same time, with discussions concerning the accounting standard programme more generally -discussed at the more general level in the previous chapter. For example involved in the discourse at the general level there was also an argument for the need for an accounting standard for depreciation [see (69.11) and (69.20) in Section 5.1].

Both discourses (at the specific and general level), during the period from 1969 to 1974, rendered the first exposure draft on

depreciation (ED15) visible in January 1975.

It should be noted that the lack of much more interactions during this period, in comparison with the following periods, about the depreciation standard can be linked to the reluctancy of the standard setters at that time to be open about their work. This was reflected in the lack of much more interactions at the general level [see elements 1969 and 1970 in Figure 5.1 and elements 1971, 1972, 1973, and 1974 in Figure 5.2]. This is because, as indicated in the previous chapter, the standard setters at that time saw the standards primarily as technical pronouncements which should be set by technical experts.

6.2 ISSUING SSAP12 IN DECEMBER 1977

SSAP 12 'Accounting for Depreciation' was issued in December 1977 which followed closely the proposals contained in ED15 (issued in January 1975). However, it contained an exemption for investment properties for periods starting before 1 January 1979. This exemption was subsequently extended for a second year.

In this section, it is argued that the issuing of SSAP12 with the temporary exemption of property companies from its requirements (as a visible event at that time) was preceded and surrounded by invisible interactions and power relations -during the period from January 1975 to December 1977- between the ASC and companies' finance directors (and other directors). These

interactions and power relations were accompanied and facilitated, intentionally or otherwise, by the interactions and power relations with the other interested groups (i.e. auditors, academics, other regulators and other representative bodies).

These interactions and power relations manifested themselves in a number of different forms which are presented diagrammatically in Figure 6.2 and described as follows.

In 1975, The ASC, in its January meeting, noted that ED15 'Accounting for Depreciation, were published on 10 January.

P. Sober and D. Harris of Stoy Hayward (75.1) argued that ED15 on accounting for depreciation had very serious implications for property investment companies. They said: 'If the Exposure Draft is adopted in its present form, it will mean that property companies' accounts will show a substantial reduction in distributable profits for current accounting periods and in retained profits for past years.'

A press comment (75.2) said that ED15 -Accounting for Depreciation- raised implications likely to be found unwelcome, and was thus potentially controversial though for different reasons. ...It had been accepted over several generations of accounting practice, for instance, that the management of a business had a duty to allocate depreciation as fairly as possible to the periods expected to benefit from the use of the asset..., and, while accountants generally accept that it was not appropriate to omit

changing depreciation of a mixed asset on the grounds that its market value was greater than its net book value..., the assertion of this simplification, without argument, might fail to convince those whose opinions differ.

Mr. Naoakely (75.3), Commenting on the Sober's article said: 'I should like to add a further factor to the excellent criticisms by P. Sober and D. Harris of ED15..... Consider the case of a close property investment company which must pay sufficient dividends to avoid the consequences of schedule 16 Finance Act 1972. If depreciation (not allowable for tax purposes) is changed in the profit and loss account it is more than possible that there would not be sufficient profits left to meet the distribution requirements. It follows from this that tax law may well require dividends to be paid which company law forbids..... I should welcome suggestions -other than taking steps to remove the close company status- from any readers on how to overcome these difficulties, assuming ED15 is adopted in its present form.'

J. Hopkins (75.4) wrote: ' ED15 far from being an accounting standard for depreciation, is an apologia for obscurantist accounting. Following the proposal statement shareholders' funds and net fixed assets would both be overstated until the assets in question became life-expired. Would any practising member certify such accounts? The correct treatment is that the whole of the under provision should be written off in the year in which it is identified. It may be argued that the shareholders' funds might be insufficient or bear the full adjustment on one year. This is all

the more reason for showing the full adjustment. I urge that ED15 be withdrawn.'

A press report (75.5) said that professional property valuers and the accountancy profession's standard makers had clashed over ED15 which recommended that freehold land and building should be separated for depreciation purposes. The report revealed the written submission (75.6) of the Royal Institute of Chartered Surveyors in which they said that a freehold building cannot be isolated from the land it stands on. They said that valuation must be based on an assessment of location, property values, age of building and several other factors. N.Bowie (75.7), Chairman of the Asset Valuation Standards Committee of the RICS, said that despite liaison arrangements between the accountancy bodies and the valuers, no consultation took place before the exposure draft was issued in January. Describing the separation of land and buildings as 'logically sound but unrealistic', N.Harker (75.8) -partner in a firm of estate agents- said: 'shareholders were only interested in the market of assessing buildings' 'This is the only really valid method of assessing buildings', he said. Professor R. Parker (75.9) pointed out that at least two European countries treat land and buildings separately in accounts. Buildings were depreciated in France and Germany but this was for tax purposes. He denied that ED15 would be unworkable if consistently opposed by property companies. 'Accounting standards are not just a statement of existing practice', he said. The English ICA spokesman (75.10) said that not all evidence to ASC had been received. It would take some time for comments to be studied and discussed.

P. Rutteman (75.11) argued that the ED15 covered a number of problems that warrant further thought. Perhaps the Knottiest problem was that of depreciating freehold buildings - the subject of controversy for many years. He said: 'The proposed standard resolves one problem and gives rise to others. Is there any solution which meets all these problems? Perhaps a more fundamental approach should be considered. One such approach is to reassess the whole question of recognition of market values in accounts.... Alternatively, another answer might be to reflect all changes in market values in the profit and loss account but unrealised gains are excepted where freehold buildings are concerned and particularly in the case of property companies this often tends to uneven recognition of property gains because realised profits on sales of assets are so material that profits are distorted.'

K. Sherwood (75.12) said: 'the ASSC will shortly be considering the comments received on ED15. It is to be hoped that they will decide to remove from the standard the references to the depreciation of revalued assets -recognizing that the whole question of accounting for revalued assets and surpluses arising on revaluation requires separate consideration, preferably in the form of a separate SSAP. He built his argument in this letter on his previous article (74.2) in which he considered some of the difficulties, of accounting for fixed asset valuations.

Sir Eugene Melville (75.13), the British Property Federation's (BPF) director-general, claimed, in its submission to the ASC on ED15, that the effects of ED15's proposals would be felt by banks,

insurance companies, pension funds and the entire gamut of private investment, as well as by the Government itself.....' Commenting on this, Sir Eugene Melville (75.14) said that the reduction in earnings for distribution to property shareholders would be dramatic and unjustifiable. ...' He called for a working party to review the entire subject of property company accounting. 'Representatives should come from the various institutes, the RICS, the Property industry and the BPF', he said. The English ICA spokesman (75.15) said that the ASC would not comment on Sir Eugene's letter until it had received evidence from other sources.

In addition to the interactions and power relations mentioned above, the ASC received, during March and April 1975, 107 written comments on ED15 from the interested parties, 24 came from property companies. Objections were made both to the principle of providing depreciation on building, generally and to the special problem of investment properties. These objections came mainly from the property companies and their representative bodies. The concerns of this property group were, it can be argued, supported, intentionally or otherwise, by the comments of the other interested groups. The following extracts from comments on ED15 support this.

Accounting Firms:

'The key issue in the exposure draft is the depreciation of freehold buildings. In countries where valuations are not written into the accounts the depreciation of buildings can be shown to be consistent with the depreciation of other assets having a limited useful life. In the UK, however, where frequent property

revaluations are not only accepted but actively encouraged under recommendations S.20 of the ICAEW it is questionable whether it is logical to write up (or down) the property assets of say a property company each year through reserve adjustments and then to depreciate the same property each year through the profit and loss account. This must be extremely confusing to the reader of such accounts'

(Arthur Young McClelland Moores&Co.)

'The proposal to require all companies to provide depreciation on freehold buildings and the related valuations, brings with it numerous practical difficulties and anomalies. It is not the practice in this country on the purchase of a freehold building to attribute separate values to land and buildings, nor on the revaluations of such property is it present practice to attribute values to them. Therefore, the requirement in Para.12 to estimate the component parts could, in practice, and without appropriate guidelines from the Royal Institution of Chartered Surveyors, result in widely differing bases being adopted..... Finally, we would draw your attention to the special position of property companies. In our view, there are good reasons for separate considerations to be given to such companies...'

(Stoy, Hayward & Co.)

(NB: underlining in this quotes and the ones that follow are added by the researcher to emphasise the points made)

'....We suggest also that the consequences of the application to property investment companies of the requirement to depreciate buildings needs to be considered and dealt with in the accounting standard...We ourselves are, at the moment, not convinced that it would be correct to impose this requirement on such companies.'

(Spicer and Pegler)

'The concept of the division between land and buildings is theoretically sound but unrealistic....'

(Stokes Kennedy Crowley & Co.)

'We believe that without professional advice it is going to be exceedingly difficult to distinguish between land and buildings.... We believe that problems are likely to arise in respect of Property Investment Companies who, through fairly frequent revaluations of their properties, deal with the appreciation or depreciation of their property portfolio in their accounts every few years. We consider that some mention should be made in the Statement of these companies and the applicability of the Statement to their property portfolios.'

(Turquand & Barton Mayhew & Co.)

Representative Bodies of Accountants:

'..the committee considered that in many instances there would be severe difficulties in implementing the principle involved in depreciation freehold buildings....'

(The Institute of Chartered Accountants in Ireland)

'The Committee accepts the general approach to depreciation accounting of the Accounting Standards Steering Committee, but disagrees with the proposals relating to the depreciation of all buildings...'

(The Institute of Chartered Accountants of Scotland)

Other Representative Bodies:

'The Stock Exchange are concerned that Exposure Draft (ED15) dated 10th January 1975, which refers to the separation of buildings from freehold land, does not provide adequate guidance for property investment companies....The stock Exchange consider that further guidance might be given in the case of property investment companies perhaps after consultation with the Royal Institute of Chartered Surveyors.'

'The committee considers that the paper (ED15) adds nothing to that which can be found in a good accounting text book and is of the opinion fails to deal with the contentious aspects of depreciation there is no value in its being published. The Committee were of the opinion that publication of the paper in its present form could detract from the importance of other SSAPs'

(Bradford & District Society)

Individuals:

'...It seems that freehold land and buildings are invariably lumped together in the balance sheet and it is not possible to find out whether the depreciation charge relates to the land, to the buildings or to both...'

(Roger Chung-Wee)

In 1976, the ASC, in the January meeting, noted the analysis of comments received on the Exposure Draft (copies circulated on 6 January 1976). It was stated that these were currently being considered by a panel under the Chairmanship of Mr S. Wilkins in conjunction with the UK comments received on ED4 (Accounting for Depreciation) of IASC on which ASC would also be expected to comment.

In the February meeting, the ASC noted two papers received from the Panel set up by ASC to consider a response to the IASC Exposure draft and the comments received on ED15.

(a) The draft comments on IASC E4 for submission to IASC were approved subject to the inclusion of reference to the fact that strong opinions have been expressed on ED15 and that it was not possible therefore to be certain of the final form of the UK and Irish paper.

(b) It was agreed that a further report should be made by the Panel in connection with ED15 when it had finished its consideration of the comments received and had met with representatives of the Royal Institution of Chartered Surveyors (RICS) and of the British Property Federation (BPF). The views of the Panel, as it was expressed in its meeting held on 12 February 1976, were as follows,

'The Panel has not yet completed its review of the comments received on this Exposure Draft. In particular the Panel has not met with representatives of the RICS or the BPF whom we have agreed to meet and hear their comments.'

The ASC Panel on Depreciation held a meeting, on 19 March 1976, with the Royal Institution of Chartered Surveyors. The purpose of the meeting was to discuss the RICS's views on the relevant provisions on ED15 concerning the depreciation of buildings and, in particular, the separation of land and building costs/values.

One of the RICS representatives mentioned that, as a result of discussions which have taken place, RICS have better understanding of the aims of ED15 than they had when their original comments were submitted.

After discussion, it was felt that the problems of attributing to buildings amounts which would represent sums of money to be the subject of depreciation were not inseparable and that guidelines could be developed.

Further discussion centred on Property Investment Companies' desire to treat land and buildings as long-term investments rather than depreciable assets. There was a consensus of opinion that annual valuations of such properties might provide a solution. Such valuations would reflect both wear and tear as well as market variations.

One of the RICS representatives suggested that when ED15 was published as a standard, RICS should issue, simultaneously, guidance notes for its members on methods of valuation. It was agreed that close liaison between ASC and RICS should be maintained towards this end.

On 30 March, a meeting was held between the ASC Panel on Depreciation and representatives of BPF. The purpose of the meeting was to discuss the relevant provisions of ED15.

One of the BPF representatives indicated that BPF should be regarded as a major body for consultation on matters affecting companies with property interests and sought assurance that there would be opportunities for joint discussions for future problems.

The Chairman of the ASC Panel indicated the practical problems of wide prior consultation and discussions. He mentioned the recent meeting with RICS and emphasised that ED15 was based on the historical cost concept and, although it included the treatment of revalued assets, it did not deal with accounting for inflation. RICS had said that they believed it would be practicable to separate the values of land and buildings.

In the discussion, the BPF representatives re-iterated the points made in their submission in April 1975, stressing that they felt there should be a special rule for property investment companies. They would accept annual revaluation for property investment companies to be reflected in the accounts but not in the Profit and Loss account, there was already a movement towards annual valuation. The ASC representatives undertook to ensure that BPF was informed of ASC's decisions before publication.

The BPF (76.1), in evidence to the Inflation Accounting Steering Group, agreed to an annual valuation provided it was practical and cheap. But the Federation pointed out that 'since directors have sole responsibility for company accounts, it is inconsistent to compel them to delegate valuation to outsiders. Instead, the Federation proposes a procedure in which the valuation is carried out internally but is reviewed by a firm of independent valuers, along predetermined lines.' P. Sober (76.2),

financial adviser to the BPF said: 'This is a practical way of getting over the problem.'

This shows how the companies interacted with the ASC about the inflation accounting standard, but, in an indirect way, addressed the depreciation standard.

In the July meeting, the ASC received a report from the Panel on Depreciation. The Panel, in this report, concluded that the principles embodied in the ED15 were correct in the context of the historic cost basis of accounting and should be retained in the proposed standard. The Panel was of the opinion that a standard based on ED15 would not be in conflict with IAS4 which had been approved for publication in October 1976.

The ASC, in its meeting held on 2 October, considered the main principles of the accounting treatment accorded to fixed assets and depreciation in ED18 (Presenter Mr. J. Pearcy who is a member of the ASC Panel on Depreciation). This shows the interaction between the inflation standard and the depreciation one.

In a memorandum, dated 9th November 1976, to the Secretary of the ASC, Nigel Davey (of the Inflation Accounting Steering Group's "IASG" fixed assets working party) wrote: 'Following your memo dated 29th October to Chris Westwick, I am setting out some initial comments in the way in which ED15 conflicts with the proposals of ED18. While I realise that ED15 relates to the historical accounting convention, I have still spelt out all the matters in which ED18 differs from the ED15 proposals.'

The ASC, in its November meeting, considered the report of the Panel on Depreciation which was presented in the July meeting. It was agreed that a draft standard should be prepared for the next meeting which would take into account the areas in which ED18 differed from ED15. Also, it noted secretarial memoranda concerning the differences between ED15 (which was applied to all fixed assets including mines) and the recommendations in IAG4 (which was applied to all fixed assets except mines). This shows the interaction between the two different national standards, and the interaction between national and international standard dealing with the the same topic.

In 1977, the ASC, in the January meeting, noted a revised draft accounting standard. It was agreed that a meeting of the panel should be called to consider the draft which would be discussed again at the next meeting.

In the February meeting, the ASC approved the text of the accounting standard on depreciation. The chairman was authorised to approve the text in the light of comments made by members. The objections of the BPF were noted and it was agreed that a meeting should be held before the publication of the standard between members of ASC and BPF. It was agreed that the implementation date for this standard should be 1 January 1978. It was agreed that the text of SSAP12 should be circulated.

P. Kirkman and C. Nobes (77.1) discussed the effects of ED18 (Current Cost Accounting) on depreciation charges, arguing that

'the definition of depreciation by ED15 is still compatible with a system of depreciation which allocates historic cost over an asset's life.' In practice, they pointed out, some companies departed from this overwhelmingly popular view of depreciation. The Sandilands Report suggested that the failure of ED15 to move away from allocating historic cost was an important omission. Recommendations were made about the way in which the value of business assets (on which depreciation was based) should be calculated,. It was suggested that replacement costs of an identical or similar asset, ... These recommendation were accepted by the Morpeth committee and incorporated into ED18 on current cost accounting issued on 30 November 1976. They concluded that it seemed probable, therefore, that in future years depreciation calculations in major UK companies would be based on current replacement costs, although historical cost calculations would be retained for a short interim period.

Sir Eugene Melville, Director General BPF, wrote a letter to the ASC -dated 29 March- about Depreciation Charge Under Exposure Draft 18 Proposals. He pointed out that 'at the meeting of the Commercial Property Committee on 8 March the view was expressed in strong terms that should the similar proposals of ED 18 in relation to CCA become an accounting standard, the major companies would have no alternative but to continue their existing practices and accept qualifications of their accounts.'

In the April meeting, Mr.S.P. Wilkins gave an oral report on the meeting of members of ASC and a delegation from the BPF held on

25 April 1977 (to discuss its application to property investment companies). The ASC, also, noted that the results of the ballot held to decide upon the publication of SSAP12 was 22 votes in favour of publication, nil against. The Chairman was authorised to approve the final version of the text for submission to the Councils of the governing bodies. It was agreed that the Councils of the governing bodies should be made aware of the opposition on the part of the BPF to providing depreciation on buildings held by property investment companies.

P. Sober (77.2), partner in Stoy Hayward & Co. and the financial adviser to the British Property Federation, examined the implication of ED18 for property investment companies. He argued that ED18 did not appreciate the basic characteristics of this type of company. He pointed out that the most important subject in ED18 that affects property companies is that of depreciation. He concluded that 'The prime aim must be to improve the credibility and usefulness of accounts to the user. I hope that during the discussion period of the exposure draft and the RICS draft guidance notes, further efforts will be made to reach a solution to the various anomalies referred to above -in particular, the depreciation proposals which I believe negate any benefits of ED18 so far as property investment companies are concerned. This shows again how the companies have tried to exercise power about depreciation standard through another standard (Inflation Accounting).

A press report (77.3) revealed that 'SSAP 12 is at an

advanced stage. Having been approved unanimously by members of the ASC, it not only requires to be passed by the Councils of the six member bodies of the ASC. Usually, approval by the Councils of the members bodies of the ASC is pretty much a matter of course, but the members of BPF are seeking to change all that: they do not believe that depreciation should be charged in the accounts of property investment companies; and although the decision to approve SSAP12 was made in the light of this opposition from the BPF, their attitude could well encourage second thoughts. Property companies may be different, but it would be a pity if the accounting bodies were to be faint-hearted.'

In the September meeting, the ASC considered the following matters: (a) a note from Auditing Practices Committee on the need for guidance on SSAP12, (b) a request from the Scottish Institute in the need to publish reasons for the need for property investment companies to depreciate property, and (c) a request from Brixton Estate Ltd on points of interpretation in SSAP12. It was agreed that a paper should be prepared for consideration at the next meeting setting down the Committee's views on the need for property investment companies to depreciate properties.

The ASC, in the October meeting, discussed a secretarial memorandum on the decision of the Council of the English Institute to refer back this standard to ASC for consideration of the position of the property investment companies. It was agreed that an amendment should be made to the stating date of the standard so that for investment properties (i.e. not merely property investment

companies) the starting date would be 1 January 1979. It was agreed that the standard with the revised starting date should be sent to Councils for approval. It was further agreed that a working party should be set up to review the application of the standard to investment properties.

In a press comment (77.4) under the title 'Should the Property companies climb down over SSAP12 , it was pointed out that more than 100 comments were received on ED15, almost 25% of them from property owning/investment interests. Despite these submissions, the stance taken by the BPF and evidence given by a number of its leading members, SSAP12 takes a hard line, insisting on depreciation of all fixed assets with a finite useful life, including those of property investment companies. The comment said that 'Two major property companies have already announced that if SSAP12 goes ahead in its present form they will continue with their present accounting policies at the risk of qualification; and it seems probable that many other members of the Federation would be willing to follow their lead.'

Asked by Accountancy to summarize the Federation's view, Sir Eugene Melville (77.5), Director General, argued that the underlying concept of depreciation (that fixed assets have a finite useful life) was not applicable to a property investment company. Also, he argued, it was impossible to calculate depreciation of an investment property as it was difficult to estimate the useful life of such property.

Press reports (77.6), (77.7) and (77.8) revealed that the draft standard on depreciation was referred back by the English Institute's Council, at its October meeting, to the ASC. The Council's unusual step followed strong and continued opposition from the BPF on the issue of attempting to depreciate buildings separately from their sites. Such a course, BPF had consistently maintained, would be impracticable and misleading, and a number of leading companies had indicated that they were prepared to accept auditors' qualifications to their accounts rather than attempt to comply with the standard. A re-think of SSAP12, the English Council decided, was preferable to such a head-on clash between auditors and their property clients- even at the cost of delaying the general adoption of a uniform standard on depreciation.

A press comment (77.9) argued that 'the ASC listened to the the views of BPF, considered them carefully, and rejected them ... The ASC has so far resisted pressure to provide separate standards for individual special interest group. But this call to rethink SSAP 12 could be the thin end of a potentially dangerous wedge: it could invite pressure from other industries which feel that they too are different, that they too merit special treatment or even different standards. The comment concluded that 'Many people are bound to say: surely it would have been better for the accounting bodies to have set down a clear standard (which the draft SSAP12 was) on the fundamental principle of depreciation, rather than to worry about specific, relatively narrow, problem areas; better that the UK should be seen to comply with international standards, in which it has played a pioneering role, even if this means

qualifying some people's accounts, than that it would be seen to dally.'

N. Westbrook (77.10), Chairman and chief executive of Trafford Park Estates Ltd, said that 'The annual valuation of properties proposed in ED18 would cause an 'unwarranted and unnecessary expense from the shareholders 'point of view', he said. He considered that it was pointless to depreciate buildings out of profits, and at the same time show a surplus in revaluation of the same properties.

The conclusion of this section is that issuing SSAP12 with exemption to the property companies (as a visible event at that time) was preceded and surrounded with invisible interactions and power relations between the ASC and finance directors (and directors) of UK companies (particularly the property companies). These interactions and power relations were accompanied and facilitated by the wider context of interactions between the ASC and other interested groups.

6.3 ISSUING ED26 IN SEPTEMBER 1980 AND SSAP19 IN NOVEMBER 1981

ED26 'Accounting for Investment Properties' was issued in September 1980. This suggested the following,

1. Investment properties should not be depreciated but should be revalued annually on an open market basis and the valuation incorporated in the accounts.

2. The valuation need not be made by qualified or independent valuers but the names of the persons making the valuation should be disclosed together with the bases of valuation used by them.
3. Any revaluation surplus should be credited to an investment revaluation account.

In November 1981, the ASC issued SSAP19 'Accounting for Investment Properties' on the basis of the proposals contained in ED26.

The issuing of ED26 in September 1980 and SSAP19 in November 1981 (as visible events at that time), it is argued and demonstrated in this section, were preceded and surrounded by invisible interactions and power relations between the ASC and the companies' finance directors (and other directors). These interactions and power relations accompanied and connected, intentionally or otherwise, by the interactions and power relations with other interested groups.

These interactions and power relations manifested themselves in a variety of ways which are depicted in a diagrammatic form in Figure 6.3 and described below.

In 1978, the ASC Consultative Group, in its meeting held on 12 January, discussed -as indicated in Chapter 5- SSAP 12 Accounting for Depreciation. Mr J.Pearcy outlined the main points of SSAP12 which was published on 29 December 1977, pointing out that SSAP 12

provided an exemption for investment properties for one year and during this time ASC would make a special study of all the problems of accounting for investment properties. All members of the Consultative Group were invited to make their views known on this difficult problem. A report about this meeting was noted in the February meeting of the ASC.

The RICS issued Guidance Note J1 'Accounting for Depreciation, in January 197² to help surveyors and accountants in applying SSAP12.

It was reported (78.1) that SSAP12 was issued which retained the potentially controversial provision for the separate treatment of freehold land - not normally requiring to be depreciated - and buildings, .. The ASC gave its unanimous approval to SSAP12 after careful consideration for the accounting practices of property investment companies, and had concluded : '..that it would not be appropriate to reconsider the question of depreciation in relation to property investment companies without bringing into consideration all aspect of the application of accounting standards and generally - accepted accounting practices to such companies. Further, the review cannot be limited to properties held by property investment companies, since many of the companies hold properties purely as investments as distinct from employing them in their own manufacturing or commercial businesses ...the Royal Institution of Chartered Surveyors, it appears, has accepted the practicability of attributing depreciable amounts anticipated where the expected life exceeds 50 years.'

Another press report (78.2) announced the issuing of SSAP12, reproducing the ASC's statement on SSAP12.

C. Smith (78.3), finance director of Grand Metropolitan, said that his company decided to ignore the new international accounting standard on depreciation. He said that he wanted to wait until the new UK domestic standard came into force before making a move. 'What we are doing is allocating properties between site values and building values and probably we will carry out a total review of values. In any case we are not convinced of the need to depreciate freehold property -the element of appropriation I think probably offsets the need for depreciation' he said.

A meeting (as indicated in Chapter 5) was held on 2 February between the ASC, the Parliamentary & Law Committee and the British Insurance Association (BIA) -at the request of BIA- to discuss problems arising from the application to accounting standards to the financial standards prepared by insurance companies. In this meeting, the BIA representatives argued that SSAP12 Depreciation, assumed a distinction between fixed and current assets which was not appropriate in the insurance industry. They said that buildings were incorporated into the financial statements of insurance companies on a valuation basis and depreciation under SSAP 12 appeared to them to be unnecessary. The purchase of an office block was very often an investment decision even if the insurance company used all or part of the block for its own purposes. In reply to them, the ASC representatives reported that ASC had set up a panel of members to consider all the problems of accounting for

investment properties and the BIA had been invited to submit their views on this matter.

Mr T.Salter (78.4) commenting on a press comment (77.6) made the following points. '(1) As a simple man, it seems to me, that there is a basic confusion in your argument.. Buildings owned by property companies are trading assests, ..., so why should a property company depreciate its trading assests ?. (2) If the ASC used a little more common sense in the first place, instead of living in an ivory tower glazed with distorting mirrors, they wouldn't have to back down to anybody. (3) .. It would, I feel, become the accountancy bodies well to show a little originality in their thoughts, as professional people, and to tell the detractors outside, to go hang themselves on the branches of their own folly. I should add that I have no connection with property companies.'

A press report (78.5) stated that 'the application of SSAP12 can give rise to a number of practical problems, particularly in the apportionment of costs or values as between land and buildings. We reproduce the guidelines issued by the RICS to its members as we feel they will be helpful to accountants by providing them with an understanding of the bases which surveyors are likely to use in providing information to clients for the purposes of SSAP12.'

M. Joseph (78.6), in his statement as a chairman of the Norfolk Capital hotles group, described the requirements of the depreciation standard as 'inappropriate.' He commented: 'The accountancy bodies have postponed application to investment

properties of their depreciation requirement, and it is hoped that further thought will be given to other special cases such as hotels.' J.Clemes (78.7), finance director of Allied Breweries, said he did not believe there was any material depreciation which was not provided by way of maintenance on the company's pubs, which were not presently depreciated. He said it is 'extremely unlikely that any material amount will be provided in subsequent years.'

The ASC held a meeting, on 13 March, with RICS to discuss problems which had arisen when companies had sought advice from surveyors on the apportionment of amounts to land and buildings in situations where a revaluation had been made. In this meeting, the ASC representatives explained that representations had been made to the ASC by directors of department stores that the amounts attributed to buildings on revaluations by surveyors were proving to be a substantial proportion of the total value attributed to land and buildings so that the depreciation charge became unacceptably high. The RICS representative said that the RICS Guidance Note J1 'Accounting for Depreciation' had only been issued in January 1978 and that surveyors might not always have fully appreciated the significance of all sections of the note. It was agreed that steps should be taken to provide some explanatory material on the interpretation of the RICS guidance notes so that they might be more fully understood by accountants and surveyors. The RICS representatives agreed that they would prepare a paper which could be published in the 'Estates Gazette' and the accountancy journals. Consideration would also be given to including explanatory material in the Members Handbooks of

accountancy bodies at a later date. At the end of the meeting, it was agreed that meetings would be arranged in the future to discuss the question of applying SSAP12 to investment properties.

A report of this meeting was noted in the March meeting of the ASC. Also, the ASC, in this meeting, received a progress report on the work of the panel on depreciation. In this report it was pointed out that the panel was continuing its work of reviewing the appropriate treatment of investment properties and investment property company accounts and invitations had been sent to representative bodies to submit their views on these matters and if necessary a meeting with members of the panel.

At a press conference to discuss the latest accounts of Trust Houses Forte Ltd, the hotel and catering group, H. Broad director of finance (78.8) said that 'until the accountancy profession sorts out the position on depreciation of property, the group will continue to adhere to the principles it has always applied. No depreciation is provided on freehold properties, properties held on leases with 50 years and over to run at the balance sheet date.' Mr Broad said: 'There is a conflict between depreciating properties, on the one hand, and writing up their values through revaluations, on the other. Trust Houses Forte intends each year to value one seventh of its properties; this fraction will include a reasonable cross-section of properties both in the UK and overseas.' Sir Charles Forte (78.9), the deputy chairman and chief executive, said that this plan had been approved by the group's auditors. Broad continued; 'When accountants prepare general rules for everybody,

they are not always properly applicable to every company. I believe a more sensible way of dealing with properties for groups such as THF will evolve. Our job is to produce accounts which are sensible and meaningful to shareholders; our prime interest is not to be theoretical accountants'

H.Quitman (78.10), chairman and managing director of Aquis Securities Ltd, the property company, criticised both the Institute, for recommending that building held as an investment should be depreciated, and the Royal Institute of Chartered surveyors, for being concerned in the division of the value of a property between the building itself and the land. He argued that 'The ability of these professional bodies to set standards which are in the main unrealistic in terms of their practical application to property investment company is truly amazing!' And he added that 'the company intends to ignore SSAP12, 'accepting the fact that our accounts may be qualified in relation to this accounting standard.' Arthur Young McClelland Moores in their auditor's report (78.11) commented: ' No amortisation has been provided for the year and 31 December 1977 in respect of short leasehold properties valued during the year. They show the effect on profits and earnings if such amortisation had been provided.'

The ICAS in a letter, dated 12 June 1978, to the ASC pointed out that 'they feel that in relation to the application of SSAP12 to investment properties there is a grave danger of the situation arising that the accounts of all companies having such properties will have to be qualified and consider this must be avoided. They

said that 'at present the ASC should maintain its stand that SSAP12 should also be applicable to investment properties and that the property companies have not so far provided satisfactory justification for not doing so.' And they added 'if, as seems likely, no agreement can be reached within the allotted time, the requirement to apply SSAP12 to investment properties should not be allowed to come into force by default. The accountancy bodies should therefore act positively by putting back the deadline for the application of the standard to investment properties to a further specified date: the matter should not be allowed to drift by the extending the exemption for an unspecified period.'

A meeting was held between the ASC and British Insurance Association to discuss 'SSAP12 and Insurance Companies.' In the discussion the BIA representatives made the following points: (1) insurance companies found it difficult to accept that it was meaningful for them to depreciate properties held as investments, (2) properties were regularly revalued and the results of the valuations were incorporated into financial statements. Depreciation would be recognised in the valuation, (3) If an insurance company did not revalue its properties it would be appropriate for depreciation to be charged, (4) the case for special standards for insurance companies should be examined, (5) A memorandum prepared by the BIA was provided at the meeting in which they set out how they consider SSAP12 and IAS4 should be applied in relation to investment properties owned by insurance companies. The ASC representative said that ASC would consider the points made at the meeting by the British Insurance Association,

and let them know their views in due course.

The ASC, in its June meeting, received an oral report on the results of a meeting held on 27 June with the BIA and the Brewers' Society to discuss the problem of depreciating investment properties. Also, the committee noted that the BPF has sent to the committee a paper entitled 'Consultative Paper on Accounts of Public Property Investment Companies.' (copy circulated 19 June 1978) and that would be discussed in the forthcoming meeting between members of ASC and a delegation from the BPF. In addition, the committee noted a letter from the Scottish Institute dated 12 June 1978 concerning SSAP12.

In editorial article (78.12) in Estates Gazette under the title 'Framework for property company accounts', it was argued that, commenting on BPF consultative paper, 'the BPF is manifestly correct in drawing attention to the anomalies that could arise from over-enthusiastic attempts to force accounting systems of property investment companies into a mould which would ostensibly provide for comparability. Equally, however, the federation acknowledges that some degree of standardisation in presentation is essential to eliminate those grey areas which have blurred the reliability of property company accounts for so long. The result -and this is the constructive aspect of the consultative paper- is a series of detailed guidelines which, if they are followed, could produce the hoped-for consistency. And this is the key to the future. If the BPF can provide a logical framework and ensure that its members work within it, the problem of non-standardisation will

have been largely solved on the federation's terms. The alternative, a continuing eccentricity, will only strengthen the ASC's case for reform.'

The ASC held a meeting, on 7 July 1978, with BPF (represented by companies and auditors) to discuss their consultative paper on the accounts of public property investment companies. The BPF representative said that the BPF's paper had been prepared by a sub-committee consisting of the managing directors and chief accountants drawn from the major property companies. The paper had been approved by the Commercial Property Committee of the BPF and by the Chairmen and managing directors of five major property investment companies. Mr Axton (Brixton Estate) drew the attention of the meeting to a leading article on the Estates Gazette of 1 January 1978 (copy was attached for the July meeting of the ASC) which he thought gave the views of the industry on accounting for property investment companies. An ASC representative asked whether the BPF were essentially concerned that any company with a large portfolio of properties could be considered to be a property investment company. Mr Sober (Stoy Hayward) said that the BPF were essentially concerned with companies which held properties to earn rental incomes which were negotiated at arm's length. Their paper did not advocate that other companies should be able to adopt the same accounting principles. In conclusion Mr Axton stressed that the BPF paper was not produced simply to avoid depreciation but all aspects of accounting by property investment companies had been taken into account in formulating their recommendations.

In the statement by Basil Samuel (78.13), Chairman of Great Portland Estates, in which he devoted almost half of it to an assessment and critique of the ASC work, he said: 'It is the directors' present intention that the company will not comply with SSAP12 although this will inevitably lead to a qualification in the report of the company's auditors'. Applying SSAP 12, says Samuel, 'leads to an absurd situation whereby, if the company's properties appreciate in value, there would be less revenue from which dividends could be paid.'

In the ASC consultative Group meeting held on 26 July 1978 discussed. The Building Society Association (BSA) representatives said that there was disquiet within the Building Societies Association about the implications of SSAP12, The ASC Chairman said that the ASC had set up a panel of members to discuss all the problems concerned with SSAP12 and that the Chairman of the Panel would be willing to arrange a meeting with members of the Building Societies Association to discuss their points. The Association of Investment Trust Companies representatives said that SSAP12 might cause problems for charitable trusts which were required to draw up their financial statements in accordance with the terms laid down in the Trust Deed. In some instances the Trust Deed may not allow depreciation to be provided and therefore a qualification would have to be made in the audit report. The ASC Chairman said that '.... The Explanatory Foreword to accounting standards explained the application of accounting standards and it would be advisable for those responsible for charitable trusts to discuss with their auditors whether in fact accounting standards necessarily apply to

their trust.'

In the July meeting, the ASC noted reports of meetings held with the Brewers' Society, the BIA and the BPF. Also, in this meeting it was agreed that the application date for SSAP12 in respect of investment properties should be delayed for a further year until accounting periods starting on or after 1 January, 1980.

A press report (78.14) said; 'The ASC is to delay the implementation of its depreciation standard on property investment companies for another year. The controversial standard which requires all buildings to be depreciated came into force on 1 January this year but the property investment companies forced a year's delay, claiming they were a special case, so that the standard (SSAP12) applies to them a year later than other companies.' According to the ASC Secretary, Jim Carty (15.78): 'There will be no quick decision on the problems. We have had meetings with the interested parties and the ASC will in due course be making representations. There may well be a further year's delay for the property investment companies.'

Another press report (78.16) said: 'Strong representation' from the BPF have already led the ASC to postpone the application of SSAP12 to the holding of properties for investment. BPF has now published its own discussion paper which has been sent to the ASC, and which includes a series of guidelines on the presentation of property investment company accounts designed to provide shareholders and investment analysts with full information on which

to judge the position of individual companies and to make comparisons between companies.' Ron Striger of BPF (78.17) pointed out that 'we have made our case and are sticking to it.' 'When the original exposure draft came out we commented on it in strong terms. Then it was resuscitated in SSAP12 and we did a lot of lobbying again', he said.

The ASC held a meeting, on 6 September 1978, with the RICS Assets Valuation Standards Committee to discuss the problems arising from SSAP12. It was agreed that in assessing depreciable amounts on respect of buildings it was not thought appropriate to reduce the value of the land in its existing use for depreciation purposes where the buildings on that land suffer to a high degree from age, obsolescence, poor layout or are used for processes which have a limited life. It was agreed, also, that where premises could be used for alternative purposes with only limited alterations, as in the case of a betting shop, a valuation on an alternative use basis should be made for depreciation purposes to eliminate the effects of the licence. In addition, it was agreed that the problem of hotels' valuation would be considered by the ASC and discussed again at a later meeting. Furthermore, the RICS considered it necessary to require all properties held by a property investment company to be valued every year. To be consistent this should include all development properties. This meeting was reported to the ASC in its September meeting.

A meeting between the ASC and the Building Society Association was held on 2 October, to discuss the problems of applying SSAP12

to properties held by building societies. The BSA representative said that there were practical problems in establishing the depreciable amount of buildings and in general building societies did not see the value of introducing depreciation charges into their financial statements. The Chairman of the ASC Panel on Depreciation explained that SSAP12 required depreciation to be provided on assets with a finite life, and clearly buildings were subject to depreciation and provision for this wearing out or consumption should be provided in financial statements. He drew the attention of the BSA to the guidance notes prepared by the RICS on apportioning the value of properties between the building element and the land element. BSA representatives asked what action auditors would take if building societies did not provide for depreciation. They were concerned that many building societies would not follow the standard and that their audit reports would therefore be qualified. The ASC representatives explained that the ASC could not interfere in the relationship between a building society and its auditors. The BSA representative explained that the BSA wanted to give guidance to its members on the interpretation of SSAP12 and asked if the Chairman of the ASC Panel on Depreciation would comment upon the proposed guidance note. The Chairman of the ASC Panel on Depreciation explained that the ASC could not give official approval to any guidance note on an accounting standard but he would be happy to discuss with the Chairman of the ASC the draft of a statement to be issued to the building societies by the BSA and to give his personal view on any matters included therein.

A report of this meeting was noted in the ASC's October meeting. It was agreed that the proposed circular letter from the British Society Association giving advice to its members on SSAP12 should be commented upon on behalf of the committee by the Chairman of Working Party on Depreciation.

It was reported (78.18) that the 'Property standard has its dead line extended. The 31 December deadline, after which property investment companies are expected to comply with SSAP12 and depreciate their freehold properties, is likely to be extended until the new year. This is because the ASC will have been unable to come up with formula to resolve the fears of the property companies by that date. Deloitte partner S.Wilkins has been talking to the various pressure groups and will report to the ASC on these meetings at its November meeting.'

A press report (78.19) pointed out that several leading accountig firms feared a revolt in industry against the new accounting standard on depreciation, because of the savage effect it would have on corporate profits.....This in turn would lead to many companies ignoring the standard and risking the resultant audit qualificationNaturally the auditors were worried about this development, partly because many secretly sympathized with the company boards, and partly because they felt it would do the credibility of accounting standards no good at all if another rule was largely ignored. Already several finance directors of leading companies had preliminary discussion with their auditors. No one at that time had decided to defy the standard, but many attempts were

made which were likely to increase.

A press comment (78.20) said: 'In a few weeks time finance directors are going to have to start explaining to their boards that a new accounting standard has been promulgated which will make a nasty hole right where it hurts, in the bottom line. The Standard is SSAP12 accounting for Depreciation. The trouble is that most companies do not depreciate freehold property, and they never have done. When challenged they say that the value of the freeholds is going up year by year, and it therefore seems to fly in the face of reality to try to write them down. So the stage is set for a confrontation between elegant theory and hard nosed business reality.... So it should be an interesting few months. Will industry bite the bullet and fall into line? Or will it, spurred by its success in overturning deferred tax, indulge in a mass opposition to this standard too? And if it does, what will the ASC do then?'

In the November meeting, the ASC noted the amendment to SSAP12 to delay the implementation date of the standard in respect of investment properties for one year until 1 January 1980.

R.Paterson of Arthur Young McClelland Moores (78.21), under the title 'Some problems areas with SSAP12, argued that 'the lion's share of the attention to problems which may arise under SSAP12 has so far been accorded to the minority groups who seek recognition of their particular difficulties, notably property companies, but also those in the insurance and brewing industries.

This has served to direct attention from some of the more general issues which will have a significant impact on most companies and which do not appear to be adequately addressed by SSAP12. The purpose of this article is to redress the balance by highlighting these grey areas, and exploring the alternative accounting treatments which appear to be available in each case.'

P. Sober and P. Darnell (78.22), partners in Stoy Hayward and were representatives of BPF in its meeting with the ASC in July 1978, took a detailed look at the recent BPF submission to the ASC. They argued that annual valuations, clarity of presentation and comparability of property investment company accounts would do much to improve their credibility in the eyes of readers for whom this area of investment had proved difficult in the past. The BPF paper had already received provisional approval by a large majority of the quoted member companies of the BPF. They said: 'we look forward to its eventual adoption by the ASC, and hope that it will prove to be a useful contribution to improved financial reporting.'

A press report (78.23) revealed that 'Property companies will not have to comply with the Accounting Standard on Depreciation (SSAP12) for yet another year. And it seems likely that the final version of the standard which should emerge in the first half of next year will be very different, providing an annual valuation of properties. The original standard required depreciation on buildings, and a new book published this week by the English ICA proposes a method of calculating such depreciation, based on a study of the problems of property companies.'

In the December meeting, the ASC noted that the amendment to SSAP12 to delay the implementation date of the standard in respect of investment properties for one year until 1 January 1980, was approved by the six Councils and promulgated with effect from 7 December 1978.

N.G. Westbrook (78.24) (Chairman of Trafford Park Estates Ltd), in the accounts for the year ended 30 June 1978, took up half his yearly review to explain why he would not like his company to provide depreciation on its investment properties. The depreciated value of properties, he wrote, 'would not show a true picture as in times of inflation values increase and also values vary with every change in interest rates'

A survey (78.25) of the accounts of five property companies, revealed how property companies reacted to SSAP12. These companies were: Alliance Property Holdings Ltd (auditors Price Waterhouse & Co), Fairview Estates Ltd (auditors Spicer and Pegler), Estates Property Investment Company Ltd (auditors Brebner Allen & Trapp), Imry Property Holdings Ltd (auditors Thomson McLintock & Co), and the Schroder Property Fund for Pension Funds and Charities (auditors Coopers & Lybrand).

It was reported (78.26), (78.27) that 'Implementation of the accounting standard on depreciation (SSAP12) in respect of investment properties has been deferred for a further year. This, according to ASC, is to enable discussions to continue with interested parties on the appropriate accounting treatment of

Investment properties.'

In 1979, H.Axton of Brixton Estate (79.1), commenting on a press report (78.21), said that '... owing I imagine to space limitations, my comments to your reporter on depreciation problems of property investment companies were compressed to such an extent that the last para. was difficult to follow. The arguement regarding depreciation in connection with property investment companies is well set out in the BPF.'

A press report (79.2) said that MFI the furniture retailing group, might have found a way to avoid depreciating its properties in spite of the new accccounting standard SSAP12 The group had created a separate company, MFI Properties...and as this subsidiary was a property investment company, it might not have to apply the depreciation rules. B.C.Fine (79.3), the MFI auditors, claimed that the depreciation policy had not yet been finalised. 'We are still waiting for the company to explain what it wants to do, said partner Julian Synett. But he agreed that the properties might not be depreciated. This view was shared by a partner (79.4) in one of the leading firms with several property clients. 'Provided it is an investment company, the properties are revalued annually, they are let at fair market rents and they are freehold or long leasehold, then they may well avoid depreciation,' he said. But Secretary of the ASC (79.5) disagreed. His view was that the properties would have to be let to third parties before they would gain exemption. And even if the companies avoided depreciation at the subsidiary level, he thought there should be a compensating

adjustment on consolidation. MFI's finance director E.Lee (79.6) insisted that they had not thought of the depreciation angle when planning the reconstruction. 'It all sounds a bit complicated to me', he said. 'We haven't finally thrashed out our depreciation policy. But I think it is universally accepted that it is ludicrous to depreciate freeholds.'

A press report (79.7) said: 'The brewers' resistance to the depreciation standard SSAP12 appears to be crumbling.' Apart from property companies, which have received special deferment of the implementation date twice since the standard was introduced, the hotel and brewing industry has been most vehement in its opposition. The latest accounts of Grand Metropolitan, the hotel, brewing and entertainments group were published this week. They did not have to comply with SSAP12, which was mandatory for years beginning after 1 January 1978. But the directors' report (79.8) revealed that it was intended to change depreciation policy to comply with the standard. G.Smith (79.9), Grand Metropolitan finance director, pointed out that property depreciation was closely linked with inflation accounting, especially where a company holds good properties in prime sites.

The ASC, in its March meeting, considered a report from the Panel on depreciation on investment properties, property investment companies and the problems arising from the application of the standard.

A press report (79.10) said that 'the depreciation standard

SSAP12 is coming under increasing fire from all sides of the profession. A committee under Deloitte's S.Kitchen is still deliberating on how to apply the standard to property companies which have already been twice exempted...' E.Silvester (79.11), group accountant of BOC International, pointed out that 'profession is saddled with an out of date standard' because SSAP 12 was developed 'in historical cost times'. The standard was delayed during the inflation accounting debate, and, Silvester claimed, eventually issued without taking any account whatsoever of the change in approach. Silvester was particularly concerned because BOC have been engaged in a continuing revaluation exercise on all assets since 1974. 'we are blazing a trail', he said, 'by carrying most of our assets in the books at replacement cost.'

In its April meeting, the ASC noted a report from the Panel on Depreciation on investment properties, property investment companies and the problems arising from the application of the standard. The report provided: (1) recommendations on the treatment of investment properties, (2) recommendations on the accounting practices adopted by property investment properties (in which it was recommended that the BPF consultative paper on the accounts of public property investment companies as amended by the BPF letter dated 8 August 1978, should be used as a basis for recommendations on the accounting practices for property investment companies), (3) recommendations on the main problem areas in SSAP12, (4) responses to interested parties with whom meetings had been held (BPF, Property Unit Trusts, BSA, Licensed Premises, Department Stores, Housing Associations, and Insurance companies).

The Committee agreed that papers should be revised in the light of comments made by members at the meeting and discussed again in the future.

A press report (79.12) said that T.Kenny, Chairman of Dorada, the motor and engineering group, had this year rebelled against the accounting standard on depreciation. And the accounts had been duly qualified by auditors, Deloitte Haskins and Sells. T.Kenny (79.13) said: 'It strikes me as being next door to lunacy'. In his chairman's statement(79.14) he said: 'The accountancy profession seems to be envious of the spate of government regulations. They have joined the party and issue statements of standard accounting practice. One of the latest is for trading companies to depreciate their freehold properties, We have not followed this recommendation although it results in a reservation in the auditors' report. 'We intend to revalue our properties every five years', he continued. 'The next revaluation is in 1979. I am more attracted to a professional valuer's opinion than that of a committee of accountants.' 'What do accountants know about valuations?' he said. 'What's the point of having a standard which forces you to write down the values of property only to have to write them up again later.'

The directors of Henly Ltd (79.15) asserted that no depreciation was provided on freehold or long leasehold properties because they considered that, if sold, these properties would realise at least their book values.' The auditors (Coopers & Lybrand) (79.16) stated that '...no depreciation is provided on

freehold or long leasehold properties With this exception, in our opinion, the accounts give a true and fair view.'

In a press report (79.17) it was revealed that 'the ASC is to look again at the controversial standard on depreciation which has run into strong criticism about the difficulties surrounding its practical application.' Chairman of the ASC Tom Watts (79.18) said: 'We are reconsidering it and a panel has been appointed to look at it' But he said: 'there is no expectation that it will be a major revision'. He said that the principle of depreciation itself was not in question. Secretary to the ASC J.Carty (79.19) said that the panel under S.Wilkins, who was also chairing a committee considering the specific problems of the standard for the property companies, had meetings with a number of interested parties. Wilkins confirmed that they had discussed the application of the standard and he said 'most people have managed to find a sensible way of dealing with it'. P.Martin of House of Fraser (79.20) as an opponent of depreciation even before SSAP12 was released, said that it was not so much depreciation that they objected to but the difficulties which surrounded its application.

A press report (79.21) said the depreciation standard might soon be changed following the report by an ASC Sub-Committee set up to look at the exemption for property companies and at practical difficulties into the application of the standard. Chairman of the Sub-Committee, according the report, proposed that investment property should be completely exempt for the provisions of the depreciation standard. S.Wilkins (79.22) said: 'we have been

sympathetic to the case made by the investment companies and the views expressed by the bodies'. Wilkins' solution was that 'investment properties should be exempt from depreciation provided that properties are accounted for in the books on a valuation basis and not a cost basis. And he admitted that this was a bit of 'a half way house between historical cost and current cost.'

A meeting between members of the Panel on SSAP12 and members of the Assets Valuation Standards Committee of the RICS was held on 18 June 1979. The purpose of the meeting was to consider the problems associated with the valuation of hotels within the framework of the Guidance Notes and to consider those valuations in relation to depreciation under SSAP12. The main problem seen by the RICS was that hotels are valued on a going concern basis using adjusted trading results as the means of establishing a value. Hotel valuations therefore contained an element of goodwill. Members of the ASC Panel on SSAP12 considered this approach acceptable. ASC was asked to confirm this decision.

It should be noted that the RICS held a meeting, before they met with the members of the Panel on SSAP12, with a number of experts concerned with buying, selling and valuing hotels in order to try and resolve the problem as to how they can be valued within the framework of the Guidance Note.

B.Lyons (79.23), Chairman of UDS group, said: 'It would be inappropriate and could be misleading to introduce a charge for depreciation of properties. 'UDS auditor V.Merrets (79.24), in his

audit report, said: 'This departure from Statement of accounting Practice No.12 does not materially affect the profit for the year.'

The Chairman of Marshall's Universal (79.25), motor distributor and wholesalers, said: 'It would be unrealistic to provide depreciation on these assets when there is every indication that they are appreciating in value.' Marshall's Universal auditors Allfields (79.26) considered the omission worth a qualification. J.Oliver, Managing director of Marshall's universal (79.27) explained his company's point of view. He said 'We are a bit suspicious about dealing with depreciation when it is separated from inflation accounting.' But it was also intrinsically unsatisfactory and represented a 'quite nonsensical' solution to the Accounting Standards Committee's inability to find a suitable form of inflation accounting, he said. At present 'it mixes historical accounting with current cost accounting. It must be one thing or another' he added. M.Verey (79.28), Chairman of the Company, said: 'While the costs are not inconsiderable, your board feels that it provides shareholders with an accurate indication of the Company's asset base in these times of fluctuating property values.'

A press report (79.29) revealed that 'the long promised review of the depreciation standard SSAP 12 is nearing completion'. It said that the working party -chaired by Deloitte's S.Wilkins- had produced a preliminary report which had been discussed in broad outline. Wilkins (79.30) confirmed that the way was clear since

the ASC had given the go ahead to the sub-committee to prepare a draft for further discussion. He said that the new draft concentrated on the case for complete exemption for the property companies.

In a memorandum to the DTI, the BPF (79.31) asked for special exceptions to be made to the general rules governing company accounting bodies or in legislation .. In the BPF memo there was a warning against the Fourth Directive which asked that 'depreciation of buildings be set against profit in the profit/loss accounts of all public companies.'

It was reported (79.32) that SSAP12's application to property companies was still in the melting pot.....The BPF would like property companies to be treated like investment trusts, ... But, according to the report, even if the ASC accepted the view that depreciation was unnecessary and unsuitable for the property industry, EEC regulations might force the issue. Under the Fourth Directive on the harmonisation for European Company law which had to be implemented by July 1982, all companies barring investment trusts, must provide for depreciation for assets with a finite life, including buildings. The BPF hoped that, if it could convince the ASC, a joint front of property men and accountants could persuade the UK Government to argue for exemption.

Adnams & Co Ltd (79.33), the Southwold brewer of traditional ales, had decided in the year ended 31 December 1978 to depreciate brewery freehold buildings for the first time, but not the public

houses which it owns. A note under accounting policies explained: 'The nature of the licensed trade requires the maintenance of property to a high standard in order to protect that trade. Maintenance expenditure is charged against profits as incurred and is such that when applying the requirements of SSAP12, the aggregate of residual values of freehold licensed properties is, in the opinion of the directors, at least equal to book amounts. Accordingly, licensed and other freehold properties are not depreciated.'

The ASC, in its July meeting, noted the report on the meeting with the RICS Assets Valuation Standards Committee concerning Hotel Valuations.

Tesco retailing giant (79.34), ignoring the accounting standard on depreciation, argued that since 'the estimated total residual value of freehold and long leasehold properties is at least equal to current book value there is no need for additional depreciation.' But it had sympathy from Price Waterhouse Technical partner G. Stacey (79.35). He said that 'businessmen who do not comply because they see no reason to write down an appreciating asset are on rational ground.' 'The concentration on value is a basic mistake in the standard,' he said. Martin Gibbs (79.36) -a member of the ASC- said: 'I would be surprised if non-compliance of companies leads to a major row'. 'And if the provisions of the EEC fourth directive on depreciation are eventually embodied in UK company law, that will be the end of the debate', he suggested.

C. Black (79.37), Chairman of MF North, commenting on a press article (Accountancy Age, 15 June 1979) in which there was a comment on the accounts of the hotel group, MF North, said: 'I think the following facts, which would have been readily available if you had referred to me should be brought to the notice of your readers. 'Whether or not hotel company should provide depreciation on its buildings which, incidentally, involves a valuation based on an artificial division of the value of the land from the value of the building, is certainly a matter on which opposite views can well exist. I can only make the point that, for more than half a century past, this company, in common with many hotel operating companies, has not provided depreciation of buildings, and I can recollect no occasion until this year when the auditors have suggested that such provision should be made.'

In a press article (79.38), under the title 'Depreciation rules need further interpretation', it was argued that SAPP12 was difficult for companies to implement because estimating the value of property was not easy where the value of other factors had to be separated out. And there were additional objections on a purely practical level from companies which were reluctant to carry out costly annual valuations. Price Waterhouse's technical partner G. Stacy (79.39) said: 'The standard does not take account of business realities.'

G. Suckling (79.40), chairman of Abwood Machine Tools, said that the depreciation rules made a nonsense of property valuation. The company's accounts had been qualified by auditors Shipley

Blackburn for non-compliance with the SSAP12. 'There may be a case for diminishing the power of the companies who try to mislead the public by putting in an artificially high figure in the accounts. But to make a rule for everyone makes a nonsense of it', he added. M.Lambert (79.41), Chairman of investment property company Lynton Holdings said: 'Further pressure is now coming from within the EEC to oblige property companies to provide depreciation.'

Award winning aerospace and mining group Dowty (79.42) had revised its policy on depreciation and so gained a qualification for its latest annual report from auditors Tansley Witt. Bracher (79.43), finance director of the company, said that 'Depreciation rates and lives have been revised because the company came to the conclusion that we were depreciating too fast.' 'The company has not complied with SSAP12 because such treatment would result in overstatement of profits for future years. It's much easier to do this way', Bracher said. Tansley Witt partner Allan Wyborn (79.44) said: 'What we did in the auditors' report was point out that they have departed from the letter of the standard.'

It was reported (79.45) that the major furniture group MFI joined the growing band of companies which, as a matter of policy, choose not to comply with the depreciation standard. It paid the price because the auditors have qualified the accounts. A.Southon (79.46) Group Chairman, said: 'the standard was not particularly practical or material' But auditors B.Cohen Fine (79.47) did not agree, stating, in the audit report, that 'we are unable to quantify the effect on stated profit of this depreciation from the

standard.' The Chairman of the company (79.48) disagreed, saying that Any valuation would be 'impractical in view of the very slight difference it would make'. The auditors, he added, had no basis on which to decide if profits would be materially affected or not. Chairman Southon was also critical of the difficulties posed by 'valuing the land and content' which was needed to comply with the standard. 'Its just not worth it,' he suggested.

Martin Haslam (79.49) said that SSAP12 on accounting for depreciation was the 'most stupid of the lot' (accounting standards). He added: 'We feel very strongly about it. We don't think anybody should be forced to depreciate freehold property. This will lead to commercial nonsense: buildings will have to be depreciated while the land of which those buildings are constructed will appreciate freehold property. If somebody wants to depreciate freehold property we have no objection, but there should be no compulsion.'

Pannell Fitzpatrick & Co (79.50) qualified the accounts of Young and Co. Brewers Ltd; 'As noted in the accounting practices, the company has provided for depreciation of industrial buildings and offices, but has not fully complied with the Standard Accounting Practice No.12 that the group's freehold Public houses, off-licences and private houses have not been depreciated . We are unable to quantify the effect of of this omission. With this exception, the accounts give under the accounting convention stated above, and so far as concern members of the company, a true and fair view of the state of affairs..'

In the October meeting, the ASC discussed the proposal (prepared by the Panel on Depreciation) to add a section to SSAP12 dealing with the accounting and disclosure requirements relating to investment properties. The main points in the additional section were: (a) an investment property need not be depreciated if it is carried in the financial statements at a current valuation; (b) an annual valuation is required; (c) changes in valuations should be treated as movements on reserves. The report, also, suggested that consideration should be given to forming an industry Sub-Committee to prepare a guidance note on the accountancy practices of property investment companies based on the BPF's submission 'Consultative Paper on Accounts of Public Property Investment Companies.' It was agreed that the proposed additional section should be amended in the light of comments made by members at the meeting and sent round for a formal ballot. It was also agreed that a technical release should be prepared for publication with the additional section to SSAP12 explaining the background to the proposals.

The ASC, in its meeting held on 14 November 1979, noted that the Australian Accounting Research Foundation had issued an exposure draft entitled 'Accounting for the Revaluation of Tangible Fixed Assets and Investment in the Context of Historical Cost Accounting'. It, also, noted a secretariat memorandum on the problems of accounting for depreciation which had been provided in the past on revalued assets. It was agreed that it would not be appropriate in the UK and Ireland but it was agreed that the matter should be dealt with when SSAP12 as a whole was revised in the light of the EEC Fourth Company Law Directive.

In the ASC meeting, held on 28 November, it was reported that the proposal to add an additional section to SSAP12 dealing with investment properties had been approved by members of the Committee by 20 votes in favour to 2 against. The Chairman reported that the Accounting Standards Review Committee of the Scottish Institute had reservations about recommending acceptance of the change. Discussions were in progress on an appropriate course of action.

C.Noke discussed, in two articles (79.51) and (79.52), the depreciation of property under the historical cost convention, with particular reference to property investment companies. He suggested that the accounting problems of property values had been exaggerated. 'There is, in fact, little doubt that the property companies' concern over SSAP12 and the Fourth Directive stems largely from fear of the effect of a depreciation change on reported profits and dividends. Certainly some companies have claimed that the prior year adjustment required on initial introduction of a depreciation policy could more than extinguish revenue reserves. However, if a depreciation policy is adopted that reflects the economic reality of long-lived assets, the effect need not be disastrous for either profit or reserves. The method outlined here may be applied by any company owning buildings to which streams of future cash flow may be attributed.'

It was reported (79.53) that 'a new tighter exemption -for investment property- from the depreciation standard is foundering on objections from the Scottish ICA. And it will not become

effective from 1 January next year as planned...the Scots are arguing that the revised accounting practice will produce inconsistencies. The terms of the new exemption are that 'an investment property which is accounted for on a current value basis of accounting, should not be subject to periodic charges for depreciation. But it will have to be revalued annually at its open market value'. Professor D.Tweedie (79.54), technical director of the Institute, said: 'there appear to be two distinct policies there'. 'On one hand it recommends cost and depreciation and on the other revaluation' 'We find that rather inconsistent -that is the major difficulty', he added. Tweedie said: 'We have not reached our final position and discussions are still going on.' But 'the general feeling here is that a little more thinking is needed', he added. Chairman of the ASC, Tom Watts (79.55) said: 'We can take it for granted that there will continue to be exemption for investment property. 'The only real arguments whether the standard should continue to be applied as it is -or whether the tightened up exemption should be brought in.'

In 1980, a meeting (attended by the ASC Chairman) of the Accounting Standards Review Panel of the Institute of Chartered Accountants of Scotland was held on 23 January 1980. In this meeting the proposed amendment to SSAP12 concerning investment properties was discussed. The Panel was not in favour of the proposed amendment to SSAP12 on both practical and theoretical grounds. The Panel said that 'it would be inappropriate to produce temporary proposals which could be overturned by the implementation of the Fourth Directive in 1982. The ASC, in its January meeting,

received an oral report on this meeting. It was agreed that the proposed amendment to SSAP12 concerning investment properties should be discussed at a future meeting of the Committee.

The ICAS, in a letter to the ASC, dated January 24, said: '...the logic of the proposed addition to SSAP12 was unsatisfactory. The aim of Accounting Standards should be to narrow areas of accounting treatment whereas the addition would cause a divergence.' The letter suggested two alternatives: (1) the extension of the current exemption for investment properties, (2) applying the concept of an investment to investment properties. Also, The ICAI opposed, in a letter to the ASC, the draft on the grounds that allowing investment properties to be accounted for either at cost less depreciation or at a revalued amount would cause a divergence in accounting treatment rather than narrow the areas of difference.

The proposed amendment to SSAP12 had been circulated to the Property Unit Trust Association (PUTA), the RICS, the BPF, and the Life Offices Association (LOF). The PUTA accepted the proposal but did not accept that for investment trust companies a net deficit on property valuations should be changed in the profit and loss accounts. The Association also suggested that a valuation of a property need only be made if in the opinion of the directors its value had changed by more than five per cent. The RICS and the BPF agreed with the proposal but suggested that the historical cost of short leaseholds should be depreciated to prevent an abuse being made of valuation surpluses. The LOA considered that long term life

funds should be exempted from the proposed treatment.

A meeting was held, on 15 February 1980, between representatives of the ASC and representatives of the RICS to discuss the valuation of properties with trading potential.

The RICS's draft Background Paper, which complement their Guidance Notes, was presented to the meeting and discussed. The paper concerns properties which are normally sold as fully operational business units including hotels, public houses, cinemas, theatres, bingo halls, gaming clubs, petrol filling stations, etc. The ASC representatives stated that, in their opinion, the proposed Background Paper would be acceptable to ASC.

A report on this meeting with the RICS was presented in the February meeting of the ASC. It was agreed that the proposals on the RICS's background paper were acceptable from an accounting point of view.

It was reported (80.1) that 'the Scottish ICA's decision to stand firm against the proposed amendment to depreciation standard has forced a rethink.' The report revealed news about the meeting of The Accounting Standard Review Panel of the ICAS, mentioned above, saying that 'the ASC is having to draw up a new wording to get over the proposed revised accounting treatment ...'

A press report (80.2) revealed that 'A revised draft has now been drawn up which takes account of the Scots objections and goes before the ASC on March 26 for approval.'

In the March meeting of the ASC preliminary consideration was given to revised proposals for dealing with the proposed amendment concerning investment properties in SSAP12 in the light of reactions from the Irish and Scottish Institutes. It was agreed that the matter should be considered again at the next meeting.

A press comment (80.3) said that 'in its attempts to formulate a policy, the ASC is having to develop SSAP12 bearing in mind the fact that the requirements of the EEC 4th Directive, which includes the depreciation of all fixed assets, must be enacted in the UK by 1982. It is therefore unlikely that an exemption from depreciation could continue unless it could be proved that to depreciate would not show a true and fair view as far as investment properties were concerned.' The comment concluded that 'the fundamental question is -what is the economic reality of the holding of investment properties?.. What this all comes down to in the end is a search for a means of measuring and portraying economic reality. It could be argued that current accounting and reporting conventions take only partial account of the performance of certain enterprises...'

In the April meeting, the ASC noted a letter from the Professional Standards Committee (PSC) dated 5 March 1980 concerning the treatment of surplus on the revaluation of fixed assets. In this letter, the PSC pointed out that there was no positive requirement about this treatment in any published standard or guidance note, asking the ASC to act speedily to remedy this apparent loophole. It was agreed that it would be premature to

take action on this point in isolation. It was agreed that a panel should be established to review all the problems which had arisen on SSAP12.

In a press report (80.4), it was said: 'Shot down by the Scots on its first appearance, the amendment to the depreciation standard is set to make a return revamped as an exposure draft if members of ASC agree to it in a vote this week.' In the revised version, the report said, investment property was to be '...an interest in land and buildings on which construction work has been completed. Leases of 50 years or less do not count. And neither does owner occupied property. To clear up the difficulties over revaluation the ASC has proposed that investment property should be revalued annually at open market value.' The initial reaction from the Scots was that the new version '...has gone some way towards solving the problem.'

It was reported (80.5) that '... The 12 months temporary exemption given to such property when the standard was introduced has run out but the ASC has been unable to persuade all the accountancy bodies that the exclusion should be made permanent. Compounding the gloom for property companies is the fact that they are unlikely to get special treatment when negotiations on the implementation of the EEC's fourth directive aimed at harmonising European company law come to a head at the end of the year.' A spokesman at the DTI (80.6) said that 'it would normally argue for the UK position -based on Britain's accounting standards and what is accepted as best practice.' 'Nothing has yet been decided and

the British Property Federation has made a very good case for special treatment,' he said, 'but we would need a great deal of persuading before we would negotiate for property to be made a special case.' Jim Carty (80.7), Secretary to the ASC, claimed that 'Scots objections, to the ASC's exemption, stem from the fact that they do not understand the concept of a property investment company. ASC's next meeting on May 28 will consider what should be done now.' Chairman Tom Watts (80.8) said that whatever the decision, an exposure draft containing exemption proposals will be released. 'Manifestly there are different views and the best thing to do would be air them,' he said.

In the May meeting, the ASC noted a secretariat memorandum on the position of the proposed amendment to SSAP12 concerning investment properties. It was agreed that a paper should be circulated to the committee for further considerations.

A meeting was held, on 29 May, between representatives of ASC and representatives of 'the Life Offices' Association -at the request of the later- to discuss ASC's proposed amendment to SSAP12 dealing with the accounting treatment of investment properties. The LOA representatives explained that the LOA considered that properties held in a life fund were fundamentally different in nature from properties held by commercial and manufacturing companies. In a life fund there was no split between fixed assets and current assets also assets were held for investment purposes for the benefit of the fund. They explained that the LOA did not consider it appropriate to depreciate head

office buildings which were used for administrative purposes. The ASC Chairman explained that the ASC set standards for general application. The standards dealt with general principles and detailed application was left to particular companies. In setting out general principles it was difficult for members of the ASC to see why a head office of an assurance company which was used for administrative purposes was any different from the head office of a major industrial or commercial company. The LOA representatives said that assurance companies could always sell their head office if it seemed to the company that alternative forms of investment would provide a better return. The head office was essentially held as an investment. The ASC Chairman explained that 'ASC's proposed amendment would accept that there is no need to depreciate properties held within a life fund which were let to external users, the only point of difference was offices held in a life fund which were used for administration purposes.' The LOA representatives said it would be difficult to treat a mutual fund differently from a fund within a company which carried on other business. The ASC Chairman said that the ASC appreciate the point of view of the LOA and further consideration would be given to this matter by ASC before any decision was made to proceed with the exposure draft.

Professor W.T. Baxter (80.9) discussed the problem of depreciating the building of property companies. He concluded that 'We should not think in terms of two conflicting viewpoints that must some how or other be crammed into a single standard. Nor should exemptions be doled out to particular industries. Rather,

there is one general rule: assets whose values decline during the ownership period must be depreciated; if assets can be shown not to decline in real value during that period, they need not be depreciated. There is here an obvious risk that a well meant but doctrinaire standard will invite evasion and ridicule. The property companies have a case. But the onus is on them to prove that the value change in their portfolio is indeed adding to the 'well-offness' of their shareholders. The latter's long-run loss could be severe if the figures lack caution and fail to allow for inflation.'

In its meeting on 30 June, the ASC considered the draft of ED26, the proposed addition to SSAP12 concerning the accounting treatment of investment properties. It was agreed that the paper should be revised in the light of comments made by the Department of Trade on the relationship with the EEC 4th Directive and circulated as a pre-ballot draft. It was noted that the meeting with the DTI had been arranged for Tuesday, 1 July 1980. Also, in this meeting, the Committee noted a report of a meeting with The Life Offices' Association held on 29 May 1980.

A press report (80.10) revealed that 'An exposure draft on the treatment of depreciation in the accounts of property companies is expected to be released next month.' The draft has been developed from the original amendment to SSAP12, the accounting standard on depreciation which gave 12 months' temporary exemption to property companies. The exposure draft is likely to be 'fairly short', according to Professor D. Tweedie (80.11), technical

director of the Scottish ICA. 'Similarly, the period of exposure will be short, probably no more than three months in order that there should be no clash with the date for official implementation of the EEC fourth directive', he said.

A meeting was held between the ASC Chairman Tom Watts and the DTI to discuss the final form for the investment property exemption from the depreciation standard, to be included in the fourth directive legislation. Commenting on this meeting, a press report (80.12) said that it was a crucial move by the standard setter as the EEC's fourth directive would affect most British companies' accounts. Another press report (80.13) said that 'Attempts by the ASC to sidestep the EEC's fourth directive on depreciation for investment property appears to have had some success. After the meeting with the DTI, the ASC Chairman Tom Watts (80.14) said: 'The response was enormously encouraging. I think we will get something before long.'

It was reported (80.15) that 'the ASC has drawn up a new exposure draft which will be released shortly -but it has so far done nothing to clarify the position on inflation accounting. David Ross (80.16), Secretary to the new inflation accounting steering group, said that 'there would have been too many difficulties in trying to come up with an answer for investment property companies as well.' He pointed to certain idiosyncracies in the structure of the companies to explain where the difficulties were. But Harry Axton (80.17) of Brixton Estate, suggesting a new way of dealing with this problem, said: 'We assumed that if you have annual

valuations then you have achieved the greater part of current cost accounting anyway. It is not so important to show the adjustments to the profit and loss account.' Developing the point he indicated 'What most shareholders are interested in is the capital position ...We feel that it is important for shareholders to understand what inflation does and the approach we have adopted goes some way towards doing that'. Ross, however, commenting on this proposal said: 'That sort of statement appears to be one way of doing the deed -but I do not know how practicable it is on a broader scale, and it is doubtful whether it could successfully be applied to insurance companies for example.'

A press report (80.18) revealed that 'agreement has been reached on the technical problems of investment properties (ED26). All is now set for the publication of ED26. It only rests with the chairman of the ASC, Tom Watts to put the presses into motion.'

It was reported (80.19), (80.20) that 'A permanent exemption for investment property from the depreciation standard is now one step nearer with the release of ED26 Accounting for investment property. The ASC has beaten the deadline imposed by the imminent implementation of the EEC's fourth directive - which would have made any exemption at all very doubtful.' Announcing the new exposure draft the ASC Chairman Tom Watts denied (80.21) that the Committee was merely bowing to pressure from property interests. 'They made a good case and we listened,' he said. Watts admitted that this is not the end of the saga -SSAP12 will have to be further reviewed when the fourth directive makes its mark on UK

company law.

Commenting on the publication of ED26, a press report (80.22) said that the exposure draft will not satisfy everybody. Some say that outside valuers should be brought in every year. Others like Mr Sydney Mason, Chairman of Hammerson Property and Investment Trust, hold the view that properties should be revalued only when rents are renegotiated. The Stock Conversion and Investment Trust, run by Mr R.Clark, had a policy of directors revaluing investment properties at intervals of not more than five years.

J.Carty, ASC Secretary, met representatives of the CCAB Insurance Companies Sub-Committee on 13 October 1980 to discuss the application of ED26 to insurance companies.

The ASC, in its October meeting, noted that a number of companies had indicated that although they wished to comply with the proposals in ED26, it would not be possible for them to complete valuations of properties for 1980 financial statements. It was therefore agreed that the Councils of the CCAB bodies should be asked to extend the exemption for investment properties within SSAP12 for a further year.

Keith Crawford (80.23), a property analyst of Greenwells, said that 'although the exposure draft has rightly recommended annual revaluation of investment properties, ... they should be carried out by external firms of professional valuers, and not -as the exposure draft still permits- by the company itself or its board.'

Crawford criticised the ASC for failing to consider the disclosure of other information forming part of the valuation figures. The standard he said: 'should give guidance on statements detailing the anticipated rental flows expected from rent reviews and reversions.'

Keith Grawford (80.24) made the following comments on ED26: '(1) The ASC has rightly recommended that investment properties be revalued annually from now on, and the new figures incorporated in each balance sheet. However, these valuations should be carried out by external firms of professional valuers and not (as the exposure draft still permits) by the company itself or its board, (2) the ASC has not referred in this exposure draft to other information provided by some -but not all- quoted companies which amplifies, and indeed forms, a basis for the valuation figures...Investors are entitled to more detail on valuation than the ASC recommends. .., (3) The ASC has excluded the accounting treatment of development and other unlet properties from this exposure draft. Guidance on their treatment is required, and (4) the exclusion of investment property from depreciation charges fails to resolve this particular controversy once and for all. Property companies still need to provide against the anticipated cash outflow arising on eventual renovation of older buildings, no matter how long term that commitment may be.'

According to R.Miquel (80.25), Chairman of Bells, the company had not shown any depreciation on property in its accounts for the

second year running. And the auditors 'agree with the treatment', despite their qualification of the accounts. A brief note in the accounts (80.26) stated: 'No depreciation has been provided on the part of freehold heritable properties relative to buildings as the board considers that such buildings currently have a value not less than that shown in the accounts.' Bell's finance directors, Geoff Cooper (80.27) stressed that it was only the freehold heritable property which is not being depreciated. 'We have revalued the buildings from time to time and have always found that the existing values were ahead of book value. There seems little point in depreciating', he said.

Professor W.T. Baxter (80.28) traced the steps leading to the recent publication of ED26 Accounting for Investment Properties, explained the proposals made by the draft and its supporting statements, and added his own comments. He argued that 'ED26 has on the whole been well received by the large property companies, who regard the cost of yearly revaluation as an acceptable price for victory elsewhere. Some of the small fry are less happy about the cost; and other companies are worried by the exclusion of short-term leases. From the standpoint of accountants, ED26 must seem an odd mixture of merit and demerit. Its switch to current value is bold and may lead to welcome reform in other areas. But its indifference to inflation is deplorable. Unless it is amended on this point, accountants will be open to justified attack for slap-dash thought and feckless finance.'

The Royal Institution of Chartered Surveyors (80.29) held a

conference on 3 December. Entitled 'Valuations for Current Cost Accounting', the conference was concerned with the requirements of SSAP16, on current cost accounting, SSAP12 on depreciation, and ED 26 on investment property.

It was announced (80.30) that the exemption of investment property from SSAP12 was to be extended for another year. An ASC spokesman (80.31) said 'this is only a stop-gap measure to free investment property from the standards until a new permanent exemption can be introduced through ED26.'

A press report (80.32) said that 'the ASC has once more bowed to the investment property lobby and pronounced that application of the standard on depreciation, insofar as it affects that sector, will be deferred for another year...'

In another press report (80.33) it was revealed that 'The CCAB Councils have accepted an ASC recommendations that the existing exemption for investment properties in SSAP12 should be extended for a further year and that, the longer-term solution contained in ED26 if approved, should become effective in financial statements for accounting periods beginning on or after January 1st.1981.'

During the period from December 1980 to February 1981, the written comments on ED26 from companies and others concerned with the exposure draft. These written submissions could lend support to the following points.

Firstly, the acceptance of ED26 by the property companies and their representatives bodies was supported, intentionally or otherwise, by the comments of the other interested groups. For example the following interested groups, in their comments on ED 26, said: 'It (Stoy Hayward & Co.) supports the principle of annual revaluations of investment properties in place of depreciation in the published accounts of public investment property companies. It believes, however, that it is inappropriate to insist on the application of the same principle to other companies which own 'investment properties'

(Stoy Hayward & Co.)

'We welcome the proposals in principles as they recognise the current value approach to accounting which has, in fact, been adopted by many property companies for a number of years.'

(Price Waterhouse & Co.)

'We agree with the principles of the proposals in ED26. In the case of an investment property, both the current value of the property and changes in the current value are more important to most users of financial statements than is the calculation of an annual depreciation charge.'

(Deloitte Haskins + Sells)

'We write on behalf of various property and investment companies whose affairs we manage..to give our support to the proposals whereby property investment companies should not be forced to show depreciation of investment properties in their Profit and Loss

accounts.'

(David Lewis & Partners)

'The Stock Exchange accepts the logic of the argument contained in the ASC's Statement accompanying ED26, and accordingly welcomes the general approach adopted in the Exposure Draft.'

(The Stock Exchange)

Secondly, the acceptance of ED26 by other interested groups, in some cases, was built on the assured acceptability of this exposure draft by investment property companies. For example the following accounting firms, in their comments on ED26, said:

'..While we support the general principles of ED26, we do so only on the implicit assumption that these principles prove acceptable to the companies that will be affected by them.'

(Josolyne Layton - Bennett & Co.)

'In principle, we consider that the proposed exemption from the depreciation requirements in SSAP12 is undesirable.. However, we recognise that there is support within the ASC and in the business community for investment properties to be accounted for in the manner described in ED 26; provided that on balance those commenting on the exposure draft accept its main provisions, we would also accept it.'

(Coopers & Lybrand)

Thirdly, the acceptance of ED26 by some other interested groups was accompanied by a defence for considering the exemption in the context of other types of companies. For example the following accounting firms and their representative bodies said:

'Whilst, in general, we would support its proposals if applied to portfolio companies, we have reservations as to their applicability to properties held by trading companies and other enterprises.....We consider that a similar exemption should apply to life assurance companies and other insurance companies holding investment properties as investments of their general insurance funds, if SSAP12 is revised in line with ED26.'

(Ernst & Whinney)

'The definitions of investment properties contained in the proposed standard appear not to include the types of properties commonly owned by housing associations. Thus, the proposed standard requires these properties to be depreciated, which is contrary to the Recommended Form of Accounts for housing associations, issued by the Housing Corporation.'

(Thornton Baker)

'In general we are in agreement with the substance of the exposure draft subject to the following matters which we consider to warrant either amendment or further explanation....one further point of specific relevance to insurance companies dealing with both long term and general business. The long term business is maintained in

a legally separate fund in which the interest of shareholders in surpluses is usually insignificant in relation to those of policy holders. Thus, properties which are classified as investments of the life fund but which are occupied by the general side of the business (or vice versa) should still, in our view, be regarded as investment properties.'

(Peat, Marwick & Co.)

'The general principles of the proposals are acceptable provided that organisations can be protected from the excessive costs that may arise from the requirement to have investment properties revalued annually.'

(The Association of Certified Accountants)

Fourthly, the acceptance of ED26 by some other interested groups was conditioned by reviewing the whole subject of depreciation (SSAP12). For example the following interested groups said:

'We agree with its (ED26) suggestions that investment properties should not be depreciated but instead should be revalued annually at open market value and that that valuation should be incorporated in the balance sheet....we believe that the ASC should concentrate on completely revising SSAP12. On this subject, we shall be forwarding to the ASC some of our criticisms of the practical application of the standard, but in the context of issuing ED26 we would make the following points:

1. We query the value of amending SSAP12 to allow exemption for investment properties if, in view of the imminent implementation of the Fourth Directive in the UK, the entire standard will have to be revised and re-issued within a possible six months of ED 26 being issued.

2. We believe that SSAP12 was drafted far too loosely....Companies such as brewery companies, store groups, and hotel companies have argued that because their buildings are being maintained to such a standard that they do not lose any value during use no depreciation is necessary. We, therefore, would prefer an addition to SSAP12 to cover all those cases (which include property companies) where assets are not held for consumption in the business operations.'

(Thomson McLintock &Co.)

'The Accounting Standards Review Panel of the ICAS is prepared to accept the thrust of ED26 as an interim measure to deal with the problem of investment properties. The Panel however, wishes to stress that it considers that the need to review SSAP12 in its entirety is vital and that action should be taken as soon as possible ..'

(ICAS)

'In conclusion ICAI supported the approach of ED 26. It was, however, felt that ED26 only dealt with one aspect of a wider problem, that of accounting for investments generally. ICAI recommended that ASC should give urgent consideration to this general area.'

(ICAI)

Fifthly, the companies utilised more than one form of interactions with the ASC. For example, the CCAB Insurance Companies Sub-Committee said:

'.. The sub-committee has considered this matter further with a view to submitting formal representations to the ASC, to confirm the representations made orally at the meeting on 13 October.'

Also, The Life Offices' Association said:

'When the first draft of the additional note to SSAP12 was published the Life Associations expressed their concern that the life revenue account of an insurance company came within the scope of the proposed standard. We wrote to you on 23 May and there was a meeting with Mr Watts and yourself on 29 May at which our case for exclusion of life revenue account was put in detail.'

Sixthly, the disciplinary power exercised by companies, in some cases, was carrying some non-diciplinary power (such as threat of non complying with the standard). For example the following companies said:

'We therefore urge the ASC to reconsider its decision. If at the end of the day no exemption is granted in respect of properties held as assets of insurance companies' long-term business funds, there must be a real possibility that the great majority of our members will feel unable to comply with the standard. Clearly this is a situation which should be avoided.'

(The Life Offices' Association)

'It would be disastrous for the Institute to come out with a standard that was not accepted generally by the Property Industry which could debase the value of Accounting Standards generally and could, in this particular example, result in large scale reluctance if not refusal to implement the standards.'

(London & Provincial Shop Centres "Holdings" Ltd)

'It would be absurd if we were forced to show depreciation of our investments in our profit and loss accounts and it is obvious that investment properties must be exempt from depreciation when the standards are finalised, other wise investment companies will simply not comply and the accounts will be qualified.

(Lingwood Estates Ltd)

Seventhly, the disciplinary techniques of power exercised by companies on the ASC were applied, firstly on themselves. For example, the following extracts support this.

'The Technical Advisory Committee (TAC) in preparing this memorandum has taken account of the comments submitted by District TACs, copies of which have been forwarded to the ASC. The views contained in the memorandum were agreed at a meeting of TAC held on 18 December 1980, at which 32 committee members were present, attend by Mr K. Robinson (Under-Secretary) as an observer on behalf of ASC.'

'The British Property Federation have made detailed comment on this

Standard and the views expressed by the British Property Federation are endorsed by ourselves. This company is represented on the BPF Accounting Standards Working Party and contributed to the proposals the Federation had put to yourselves.'

(London & Provincial Shop Centres "Holdings" Ltd)

The British Property Federation of which this Society is a member has asked for comments on ED26.. It should be emphasised that these comments related largely to the valuation aspects of property. There are other accounting aspects about which the Society had made representations through the Life Offices' Association.'

(Clerical Medical & General Life Assurance Society)

Finally, some companies consulted certain auditors before making written submissions to the ASC. for example the Committee of Property Unit Trusts said:

'The management committee has considered your recent addition to SSAP12 and having taken advice from Thomson McLintock & Co., Price Waterhouse, Ernst & Whinney and Coopers & Lybrand, would like to take this opportunity to comment as follows...'

In 1981, the ASC Consultative Group, in its meeting on 25 February 1981, as we indicated in Chapter 5, discussed ED26 Accounting for Investment Properties. The ASC Chairman gave a brief summary of the main provisions of ED26 and explained the reasons why it had been prepared. He then invited comments on the exposure draft from members of the group.

The Building Societies Association representative explained that under the Building Societies Act 1962 it was illegal for a society to purchase a property for the express purpose of letting. He said that under the definitions given in the exposure draft it would be quite possible for a building owned quite properly by a building society to be classified as an investment property in apparent contravention of the Act. The difficulty would be eased if properties could be viewed as a whole rather than individually for the purposes of classification.

The Stock Exchange representative welcomed the proposals in the exposure draft. But he pointed out that there was no requirement for properties to be valued professionally or independently. The Stock Exchange considered that shareholders would benefit from a requirement that valuers should be suitably qualified and that there should be periodic independent valuations. The exposure draft proposed that investment properties need not be depreciated unless they are held on a lease of less than 20 years. The Stock Exchange recommended that the period should be increased to 50 years so that the distinction was in accord with the generally accepted definitions of long and short leases.

The Association of Investment Trust Companies (AIRC) representative said that he was pleased to see that many of the

comments made by the AITC in the past had been taken in the exposure draft.

The Institute of Chartered Secretaries and Administrators representative supported the principle that if a property was held primarily for its investment potential then it should be accounted for as an investment. The present definitions in the exposure draft might be drawn too narrowly to achieve this objective.

The Royal Institution of Chartered Surveyors representative, considered that buildings did not cease to be an investment property simply because it was occupied by the owning company for its own purposes.

The National Association of Pension Funds representative considered that ED 26 should not apply to pension funds, arguing that property investment probably represented only about 20% of the total of pension fund investments. There was no requirement to use current value accounting for gilts and equities and it was therefore deemed to be illogical to require its use for investments. Annual valuations of properties as required by ED26 would be of no practical value to the managers or the members of pension funds and the cost would be as great as the present cost of the whole investment operation.

A Department of Trade representative argued that the proposals in ED 26 relied on the necessity of giving a true and fair view as a justification for taking a valuation approach to investment properties rather than the cost and depreciation solution. For this to be successful it must be made a mandatory rule and not an option. The wider the definition of an investment property the more difficult it would be to consider the treatment an acceptable

departure from the EEC 4th Directive. ED26 required that the names of the persons making the valuation should be disclosed or, alternatively, particulars of their qualifications. The Companies Bill required both to be disclosed.

The British Insurance Association representative explained that BIA views had not yet submitted its comments but should be doing so shortly. One problem was that the Companies Bill had now been published and this exempted insurance companies from compulsorily depreciating fixed assets. SSAP12 which required compulsory depreciation was in conflict with the exemption in the Companies Bill and the ASC had always accepted that accounting standards could not override the legislation. The BIA would be considering the legal position but this should not be taken to imply that the BIA would not support amendments to SSAP12 to cover the position of investment properties. He said that insurance companies tended to hold most of their investment properties as assets of the life fund rather than as assets for the general business, therefore depreciation might well be an immaterial item although it might be material for some companies.

In the April meeting, the ASC considered, as we indicated in the previous Chapter, a request from the BPF for membership of the Consultative Group. Also, in this meeting, the Committee noted a report of a meeting between members of the ASC and the Technical Advisory Committee of the English Institute.

The ASC, in its May meeting, considered a report from the panel on ED26. It was agreed that: (a) the Document should be

issued as a separate standard and not as an appendix to SSAP12, (b) Leases with an unexpired term of less than 20 years should be depreciated, (d) Charities should be exempt from the standard and from SSAP12, (e) Insurance companies should not be required to maintain a separate investment property reserve account. It was further agreed that the proposed standard should be amended in the light of comments made at the meeting and be sent to members of the ASC as a ballot draft together with consequential amendments which would need to be made to SSAP12.

In a press report (81.1) it was revealed that 'The ASC was asked earlier this week to approve the revised version of exposure draft 26 which sets out the new rules and to put it to a ballot of members. The ASC was pushed into action with a degree of urgency because the existing accounting rules for investment property, which exempts it from depreciation, will be removed by the EEC's fourth directive and is due to run out soon any way. The ASC's new accounting treatment gets around the restrictions imposed by the directive as implemented through the companies number two bill.' D.Morpeth of the ASC (81.2) confirmed that the committee would be asked to approve release of the revised proposals as a separate standard SSAP19 and not as recommended in ED26, as an addition to SSAP12 accounting for depreciation. The ASC Secretary Jim Carty (81.3) said, 'There is no change of substance between the revised text and the original exposure draft despite the mixed reception which greeted ED26 during its exposure period.' Professor D.Tweedie (81.4), technical director at the Scottish ICA, commenting on ED26, said that it holds on to its view that 'a lot of the problems

remain'. 'All the ASC is doing is plugging a gap,' he added.

The ASC, in its July meeting, noted that a ballot of ASC members had resulted in the approval of the proposed accounting standards on investment properties for submission to CCAB Councils.

A press report (81.5) revealed that the way had been cleared for early release of new accounting rules for investment property in the UK's first standard to be published in 1981. The ASC had given a combined nod of approval to the exposure draft 26 proposals which effectively maintain the exemption of property companies from the depreciation standard. The report said that the new rules, scheduled to be issued as SSAP19 by October, only needed the final go ahead from the CCAB. This allowed the property companies to beat the EEC fourth directive deadline which would have forced them to depreciate along the SSAP12 line. But, according to the report, the early rebels (the Scots and Irish ICAs) have only reluctantly agreed to fall into line. The Scots in particular were adamant that the standard would only be an interim measure to get round the fourth directive's requirement for property companies to be treated like all others. Their agreement had been gained on the back of a promise of an early all-round review of the depreciation standard.'

Henry Lunt (81.6) examined the positions of depreciation of investment properties following comments on ED26.

The ASC Chairman, in the October meeting of the ASC, reported that the Technical Advisory Committee of the ICAEW had

expressed concern that, in practice, SSAP19 'Accounting for Investment Properties' would require small property companies to incur burdensome valuation costs, although their representatives accepted that the standard itself was silent on the issue of the quality of valuations. To alleviate this concern, a modification to the wording of Paragraph 6 of the Explanatory Note to the standard had been proposed. The Committee considered and approved the revised wording. It was agreed that the Chairman would consult with the Chairman of the Technical Advisory Committee to ensure that the Committee could now support the Standard.

A press report (81.7) argued that The fierce dispute over investment property which opened up a rift between the accountancy bodies and threatened the new government an EEC- backed reporting framework, was finally settled this week with the release of a new accounting standard. SSAP19 Accounting for investment property, was the standard setters' last word on the subject and gave formal exemption from the depreciation rules. It beared a striking resemblance to ED26 and the principles were unchanged..... the threat of 'Argyll- style' legal actions by the Department of Trade against companies with investment property who fail to depreciate in accordance with the Companies Act, also receded this week.' A spokesman for the DTI (81.8) said that after talks with the ASC and the BPF, 'there are no problems as far we are concerned'. ASC chairman Tom Watts (81.9) said the new standard only marked the beginning of a programme for developing an accounting treatment for 'value companies' as a whole.

In another press report (81.10), it was pointed out that the new standard (SSAP19) accounting for investment properties defined an investment property as an interest in land or buildings which was held for its investment potential, but not as one owned and occupied by a company for its own purposes. ...Without the standard, investment properties would have to be depreciated annually under the terms of the 1981 Companies Act.

A. Adams (81.11) (the finance director at the Peachey Property corporation with £60 Million invested in property), commenting on SSAP19, said: 'We are in line with it now .' 'Peachey has revalued its property portfolio in each of the last four years. It doesn't work out expensive if you do it on a regular basis,' said Adams, confirming his company's practice to show a revalued balance sheet each year. Also in line with the new standard, Adams said, 'the Peachey profit and loss account only includes net rental income, trading profits and realised surpluses on property sales.' But, said Adams, 'the whole question of CCA with investment property companies, and in general 'value based' companies, is difficult.'

P. Sober (81.12) (partner at Stoy Hayward and Chairman of the BPF's own accounting standards committee), commenting on SSAP19, said: 'A full CCA approach would run into gearing problems but we have taken a step in that direction.' 'The new standard prescribes a form of accounts that give an overriding true and fair view', said Sober. 'It's now established that the true and fair view overrides any requirement to depreciate assets', he said.

I.C.Adam (81.13) discussed the practical implications of SSAP19, concluding that the underlying concept of SSAP19 was that current value accounting was the appropriate method of reporting investment properties in financial statements. The standard was the culmination of extensive discussions between the property industry and the accounting profession and it should result in a greater degree of consistency and comparability between financial statements.

The conclusion of this section is that ED26 was issued in September 1980, followed by SSAP19 in November 1981. Both gave the property companies permanent exemption from depreciation requirements of SSAP12. This permanent exemption as a visible event at that time, was connected, in one way or another, with the invisible interactions and power relations between the ASC and Companies about such exemption during the period from 1978 to 1981.

These interactions and power relations have their effect upon the visible event (the permanent exemption by ED26 and SSAP19) as a result of the following.

Firstly, these interactions and power relations manifested themselves in a number of different ways such as published articles, formal and informal meetings with the ASC, talks to the press by officials, press reports and comments, published annual reports and audit reports, campaigns against the standard by some companies, meetings between the finance directors and auditors, and conferences held by other institutions.

Secondly, more than one way of interaction was utilised by Particular persons or groups (interactors) such as, (1) written comment followed by a meeting, (2) a meeting followed by a memorandum, and (3) a letter, followed by a meeting ,then by an article.

Thirdly, these interactions and power relations between the ASC and companies, were accompanied by interactions with other interested groups. These groups supported, intentionally or otherwise, the companies claim for the exemption from the requirements of SSAP12 (e.g some auditors [see (78.21), (78.22), (79.4), (79.35), (79.39),and (79.49)], the press [see (79.38)], and other bodies [see the ICAS's letters to the ASC dated June 1978 and 23 January 1980]).

Fourthly, these interactions about this permanent exemption, was, also, facilitated by the ASC's move towards greater openness about its work at that period (1978-1981). This openness, as indicated in the previous Chapter, came in 1979 through, for instance, the issue of the Watts report. This report recommended: (a) involving the Consultative Group of the ASC more closely in the debates on specific standards, (b) issuing technical release with each ED and SSAP, and (c) much more openness with the press. Such openness, at the more general level, was reflected in the depreciation standard at the specific level. As an example of case (a) the Consultative Group, in its meeting held on 11 February 1981, discussed ED26 in greater detail. As an example of case (b) technical releases accompanied the issuing of ED 26 and SSAP19. And

an example of case (c) is that the openness with the press was translated into intensive interactions and power relations, at the general level, during this period (1979 - 1981) [see elements 1979, 1980, 1981 in Figure 5.3]. This in turn, was reflected in a form of intensive interaction at the specific level (the Depreciation Standard) during this period [see and compare Figure 6.3 with the 1979, 1980, 1981 elements in Figure 5.3].

6.4 ISSUING THE DISCUSSION PAPER 'A REVIEW OF SSAP12' IN DECEMBER 1982 AND SOI IN SEPTEMBER 1984.

In December 1982, the ASC published the Discussion paper 'A Review of SSAP12- Accounting for Depreciation'. This paper addressed the main areas of difficulty arising in the application of SSAP12 and SSAP16 (Current Cost Accounting) in relation to depreciation provisions. It put forward ten conclusions on which comments were specifically invited in addition to any others on SSAP12 generally.

In September 1984 the ASC issued a Statement of Intent (SoI) on the revision of SSAP12. It proposed that modified historical cost accounting should be allowed, and encouraged, and that the accounting treatment of balance sheet and profit and loss account items should be consistent. Also, it banned the charging of supplementary depreciation without a corresponding revaluation of the assets concerned.

The Discussion Paper and SoI as visible events at that time,

it is argued in this section, were preceded and surrounded by the following interactions and power relations (which are presented diagrammatically in Figure 6.4).

In 1982, the CCAB (82.1) issued, in March, guidance to housing associations and their auditors on accounting for depreciation and housing association grant in respect of housing properties. The guidance became necessary following the ASC's statement, accompanying SSAP19, that such properties were unlikely to fall within the definition of investment properties, consequently, SSAP12 must be applied .

The ASC, in its June meeting, considered a draft discussion paper which deals with the various problem areas of SSAP12 'Accounting for Depreciation'. During a wide-ranging discussion of the issues behind the paper, the Committee asked the working party to consider making some detailed amendments after which the paper would be submitted to the Technical Committee of the CCAB for a pre-publication review.

A press report (82.2) revealed that the ASC was carrying out a major review of SSAP12 on depreciation, after wide spread refusal of companies to comply with the provisions relating to depreciation of buildings. The ASC stressed that the review was a general one which was also looking at the impact of the Companies Act 1981, current cost accounting and the effects of revaluation on historic cost accounts, but said it was aware of the resistance to SSAP12 in many companies.

The directors' report of Valor PLC (82.3), who had repeatedly had their accounts qualified by auditors Arthur Young McClelland Moore of Birmingham for refusing to provide for depreciation on building, said: 'This requirement is unnecessarily onerous, meaningless and even misleading,....' After initial conflict with Arthur Young, the matter was reported to be no longer a subject for discussion between Valor and its auditors, although it might come under review in the future. A spokesman for the ASC (82.4) said that refusal to comply with SSAP12 was most common in the brewing industry, where public houses were undergoing constant refurbishment, and in other companies involving the use of public buildings.

In the October meeting of the ASC, it was reported that the committee had approved, by ballot, the publication of the discussion paper 'A review of SSAP12-Accounting for Depreciation' subject to some comments on detail.

A press report (82.5) indicated that practical problems encountered in the application of SSAP12 'Accounting for Depreciation' were to be reviewed in a new discussion paper. Problems relating to the use of depreciation as a back-door way of accounting for inflation, and difficulties in calculating profit and loss on the sale of an asset, were two examples. According to this report, the working party, under the chairmanship of J. Bowman, senior partner at Price Waterhouse, suggested that at least two practices should be expressly prohibited. They were the practice of charging supplementary depreciation in historic cost

accounts without incorporating them into the accounts, and the practice of writing back to the profit and loss account depreciation charged in respect of an asset when that asset was revalued.

It was reported (82.6) that I. Davison, Chairman of the ASC, and J. Bowman, the Chairman of the working party to review the depreciation standard, had clashed over the importance of a review of the depreciation standard SSAP12. Bowman (82.7) argued that (SSAP12) was still relevant 'There are enough difficulties and problems in the present standard for a rethink to be both necessary and important,' he said. But Davison (82.8) argued that much of the importance of SSAP12 had been swallowed up inside the current cost accounting issue. He said that the review was unlikely to alter the list of priorities facing the ASC, which had placed a rewrite of the depreciation standard a long way down its list. 'Of course, I could be wrong', Davison said. 'There might be a storm of interested comment, which would make us totally re-evaluate the importance of SSAP12. But somehow I don't think this will be the case.' But Bowman argued that depreciation was among the most important issues facing UK industry. 'In a recession such as we have at the moment, the biggest problem accountants face is that there is a great deal of spare capacity in UK industry. Because of this people are unwilling to change the full replacement cost depreciation since that would knock too big a hole in their profits. We urgently need some ruling in this area', he said. The review recommends that the principle behind depreciation should remain the same in all accounts. Bowman pointed out that, far from

being undercut by the CCA standard, SSAP12 dealt with both historical cost and CCA depreciation.

The Discussion Paper was published on 15 December 1982 and the comment period was to expire on 30 June 1983.

In 1983, a press report (83.1) said that the ASC discussion paper on depreciation set out some known problem areas which have arisen when applying SSAP12 in practice and, where appropriate, expressed the working party's opinions thereon. It invited commentators to express their views on the matters raised and asked two further questions: '(1) are there any other matters causing concern regarding depreciation that you wish to bring to ASC's attention?, (2) Do you consider that SSAP12 should be revised?'

Another press report (83.2) said that a discussion paper on depreciation had been issued by the ASC. It addressed some of the anomalies currently arising in the application of SSAP12 and SSAP16 (CCA) in relation to depreciation provisions.

K. Sherwood (83.3), a national technical partner with Chalmers, Impey & Co, and a London member of the Institute's Council, discussed the various problems arising from the introduction of the Companies Act 1981 concerning depreciation, and the impact which they are likely to have on the development of accounting practice. He concluded that, (1) estimated residual values taken into account for the purposes of calculating rates of depreciation

should be updated regularly, (2) while there was a specific requirement in law to write back provisions for diminution on value and exceptional depreciation if they were no longer required, there was no such requirement to write back systematic depreciation, (3) asset valuation should be incorporated into accounts by substituting value for cost.

P. Stilling (83.4), a national director of accounting and auditing with Touche Ross, discussed the treatment of surpluses and deficits arising on the revaluation of fixed assets in the light of the Companies Act 1981, and SSAP19, and the fourth EEC directive.

A press comment (83.5) discussed the issues of the discussion paper 'A review of SSAP12, Accounting for Depreciation', saying that perhaps one of the most dangerous sections of the document was that on special types of asset. 'Certain assets do not depreciate; such assets clearly do not need to be the subject of a depreciation charge in the accounts.'

The ICAEW (83.6) published a new Accountants Digest which considered the provision to be made in the accounts for depreciation. The digest's authors, I. Campbell and C. Swinson of Binder Hamlyn, considered the professional requirements in the light of SSAPs 12, 16 and 20, and the provisions of the 1981 Companies Act.

T. Cooke (83.7) discussed some of the major issues raised in

discussion paper on depreciation issued by the ASC, arguing that it was curious that the review committee did not seem to have addressed itself to the depreciation of freehold property, since this was the area which was most frequently resisted in practice. There was also no discussion in the review document on the treatment of investment properties, an area where some clarification would have been helpful. Concluding his argument, he said that 'depreciation is an issue which is important to industry. The review committee has raised some interesting points, which needed clarification. However, the suggestions made in the document are not radical enough to warrant a change in the list of priorities facing the ASC.'

In the November meeting, the ASC approved for publication two statements (press releases) setting out the Committee's policy with regard to the reviews of SSAP6 'Extraordinary Items and Prior Y.A.' and SSAP12 'Accounting for Depreciation', subject to a minor amendment in each case. The press release on SSAP12 said: 'The Discussion Paper on SSAP12 aroused less comments but, nonetheless, sufficient points were raised to warrant the development of a revised standard. However, as depreciation is so closely linked to inflation accounting, the Planning Sub-Committee recommends that the work is deferred until the exposure draft on reporting the effects of changing prices is published.'

H. Sopher (83.8), a member of Spicer and Pegler's insurance audit group, argued that while SSAP12 addressed itself to the fundamental problem of depreciation by focusing on the

calculations, it did not explicitly consider the definition and identification of fixed assets and the components of cost.' He concluded that 'the issues emerging from the ASC review indicate the need to get back to basic concepts... Once underlying principles are set out, practical application becomes simple. To this end, further research into financial reporting objectives is to be welcomed.'

In addition to the interactions and power relations mentioned above, the ASC received, during the period from February to July 1983, the written submissions from 70 organisations and individuals. In general, commentators supported the proposal in the discussion paper "A Review of SSAP12". Most commentators, it should be noted, emphasised the interaction between SSAP12 and SSAP16. The following extracts from the written submissions of different groups lend support to this point.

Companies and their representatives bodies

'..Our preference would be for a standard which dealt comprehensively with the principles involved, in a context wider than that of depreciation alone. It would appear that it would not be possible to do this until the issues concerning SSAP16 have been resolved, and we therefore believe it would be preferable to defer taking action on SSAP12 for the time being. If the ASC however regards some action of SSAP12 as urgent, we would recommend the issue of some form of temporary guidance note, followed in due course by a more thorough-going amendment of the standard itself.'

(The POC Group)

'Until the way in which inflation should be reflected in accounts has been resolved, which cannot be before the review of SSAP 16 is completed, it is premature to advocate "current cost principles" as the preferred basis for asset revaluations, as proposed in point 1.3 of the foreword...'

(Imperial Chemical Industries PLC)

'There are no other matters to which we would draw your attention, but a revision of SSAP12 might clarify some of the points covered above. Perhaps such a revision should be coupled with a revision of SSAP12?'

(Cookson Group PLC)

'A revision of SSAP12 is seen as useful rather than desirable, but it would be inappropriate to do so before resolution of the discussion on SSAP16'

(Midlands Industry Group of Finance directors)

Accounting Firms

'.. When considering revisions to SSAP12 the ASC will no doubt take into account the review of SSAP16 and likely future requirements on the effects of changing prices.'

(Peat, Marwick, Mitchell & Co.)

'In our opinion, any revision of SSAP12 should be deferred until full consideration has been given to the review of SSAP16'

(Edward Moore & Sons)

Other representatives bodies

'..We would suggest that consideration of responses to the views you have put forward are linked with on-going consideration of SSAP16 generally.'

(The Institute of Cost and Management Accountants)

'..We suggest the ASC postpones the revision of SSAP12 until the position of current cost accounting has been dealt with'

(The Association of Certified Accountants)

'We do not think that the revision of SSAP12 can be considered in a sufficiently wide context until it has been decided what kind of accounting is to be provided in the aftermath of SSAP16....Any revision of SSAP12 should be deferred until the ASC agree on a revised system for inflation accounting to replace SSAP16.'

(The Stock Exchange)

Also, these written submissions, in some cases, were built on and sometimes accompanied by the detailed contents of "published articles" or the ICAEW's "Survey of Published Accounts". The following extracts support this.

'... The undersigned wrote an article for 'Accountancy' which was published in September 1980. Although this article could not be said to represent official ASC policy at the time, it was agreed before publication by a number of ASC specialists in the subject. A copy of the article is enclosed for it may help to expand on some of the argument set below.'

(May & Baker Ltd)

'I enclose my comments on "A Review of SSAP12" These comprise:

1. A summary of my conclusions.
2. An article that provides the reasoning and argument underlying the conclusions.'

(Professor J. Grinyer)

'..Appendix B contains a more detailed submission on matters causing concern, including a copy of a draft article which "Accountancy" has accepted for publication during 1983.'

(Chalmers, Impey & Co.)

' Greater analysis of the ICAEW 'Survey of Published Accounts, reveals (i) that the practice of revaluing fixed assets is not increasing, (ii) that non-property revaluations are almost invariably of a minor nature, and (iii) a substantial number of property revaluations can be accounted for by the fact that overseas subsidiaries are often required to revalue fixed assets annually as a statutory requirement....' (ICAS)

Furthermore, these written submissions -in some cases- were built on discussions at the local level between auditors, companies and academics. The following extracts support this point.

'The Association appointed a Working Party, predominantly composed of members in commerce, to consider the the ASC Discussion Paper reviewing SSAP12. The Working Party was chaired be Professor C. Nobes.'

(The Association of Certified Accountants)

'The Technical Advisory Committee (TAC) in preparing this memorandum have taken account of comments submitted by 19 District TACs, copies of which have been forwarded to the ASC. The views contained in this memorandum were agreed at a meeting of TAC held on 12 May 1983 at which 33 committee members were present, attended by Mr J. Bowman (Chairman ASC Working Party) and K. Robinson (Secretary of the ASC).'

(TAC of the ICAEW)

'As requested by you during the TAC discussions, I give below my comments on question 8 of the discussion paper'

(Letter, dated 9th March, 1983 from Mr G. Hall of Pilkington to Mr G. Rider of the Liverpool Society of Chartered Accountants)

In 1984, press reports (84.1), (84.2) on the ASC's Discussion Paper reviewing SSAP12 on depreciation, said that while there was general agreement that a revision of the standard was appropriate, many commentators drew attention to inflation cost accounting. It had therefore been decided that work on the exposure draft to revise SSAP12 should await the outcome of the review of SSAP16.

P. Stilling (84.3), a national director of accounting and auditing with Touche Ross, argued that it seemed appropriate to discuss some of the problems of SSAP12 as the ASC had brought the matter under the spotlight again by issuing a discussion paper. He argued that there were at least three distinct areas which created a lack of consistency in the treatment of depreciation.

These were: (1) the treatment of a decision to change the estimate of an asset's useful economic life, (2) the position of fully depreciated assets, and (3) the practice amongst some companies to adopt different asset lives in the current-cost accounts to those used in the historical cost accounts.

Professor H.Edey (83.4), commenting on P.Stilling's article, said: '..I query the statement that no asset should be fully depreciated before the end of its economic life. I think this depends upon the meaning we attach to 'economic life'. An asset can be giving useful service after its capital value is zero or negligible. This can arise when the operating cost of the asset is equal to the sum of the operating cost and capital service (depreciation plus return on investment cost) of a replacement that will give the same service, or when the old asset will not be replaced but its operating cost is just covered by its revenue contribution. In such cases there is no economic depreciation cost on the old asset (unless it has a salvage value which is deteriorating).. Further depreciation may also be inappropriate where the asset has positive value but this has ceased to fall, because the value derives from its ultimate sale as junk.'

It was reported (84.5) that 'A new plan to boost company earnings and inflate balance sheet figures is to be reviewed by the Accounting Standards Committee. The plan, devised by Deloitte Haskins and Sells, takes the revaluation element of a depreciation charge straight to a company's reserves.' Matthew Patient (84.6), Deloitte's technical expert, defended the scheme as falling within

the companies act and SSAP12 rules on accounting for depreciation. Patient said: 'We are saying there is a third accounting convention. It has great attractions in terms of simplicity.' The Stock Exchange and the ASC had, Patient said, been told of this accounting practice which would enable companies to revalue properties on their balance sheet but restrict the depreciation charge in the profit and loss account to that on the previous historic cost of the asset. SSAP12, as currently worded, did not state where depreciation should be debited. Patient said: 'We are not advocating it; we are allowing it.' He argued that where revaluations were spasmodic the amount and trend of earnings per share were artificially affected.

J. Bowman (84.7), Chairman of the working party on Depreciation, said that he was 'a bit unhappy' about the treatment devised by Woolworth auditors Deloitte Haskins and Sells. Bowman's main objection concerned inconsistency between the stores groups' balance sheet and its profit and loss account. Under Deloitte's treatment the balance sheet had been beefed up by a revaluation of property interests while the profit and loss account remains on an entirely historical cost basis. Matthew Patient, defended the treatment as 'allowable' under SSAP12. The standard did not state where depreciation should be debited, he argued.

R. Glendinning (84.8) discussed the problems that arose in connection with depreciation, concluding that 'what should be stressed is that depreciation should not be regarded to be the result of conformity with some simple law (like straight line). In

principle, the value of each individual asset should be considered annually for accounting purposes in the light of the changes in its operating cost and in extent of utilisation, but this would be a considerable task that could hardly be contemplated. As a practical matter, however, accountants should endeavour to avoid the mere observance of conventional approaches lest that leads them to overlook the possibility of asset over-valuation.'

A press report (84.9) revealed that Coopers & Lybrand had given British Telecom the go-ahead to make two major changes in its accounting policies and to depart from SSAP12, Accounting for Depreciation. The changes were to prepare the corporation for its likely flotation at the end 1984. Chairman Sir G. Jefferson (84.10) said that the ending of BT's nationalised industry monopoly would bring about a 'fundamental change in the nature of the business' and justified the departure from normal accounting practice. 'He would never make a treatment like that unless he had our full support', said P. Benson of Coopers (84.11).

M. Patient (84.12), partner of Deloitte Haskins & Sells, pointed out that Deloitte Haskins & Sells had indicated to clients that it might be appropriate in certain instances to charge depreciation on revalued fixed assets partly to reserves. In such instances the profit and loss account could be presented in pure historical cost terms, while only the balance sheet was affected by the revaluation. He indicated 'This new basis was at present unconventional, but nonetheless acceptable. It would allow the

depreciation on fixed assets to split, with the part on historical cost being charged to the profit and loss account, and the part on the revaluation excess being charged directly to revaluation reserve..... Such treatment would remove some concern about SSAP12 among companies which neither saw the need to depress earnings by depreciating property when it was rising in value nor saw the sense in artificially separating buildings from land. It would also have the benefit of closing the earnings gap which was arbitrarily created by the different treatment of some property assets under SSAP12 and others under SSAP19 (Accounting for Investment Properties).'

Matthew Patient's article (84.12) provoked the following comments. K.Sherwood (84.13), said: 'Matthew Patient's argument that it is permissible to revalue fixed assets within the balance sheet, but not to charge depreciation on the revaluation surplus against profits, is, at the very least, questionable....In addition, I find it difficult to reconcile M. Patient's approach with the 'consistency' concept set out in SSAP2.' He provided some suggestions. K.Wild (84.14), of Touche Ross, said: 'I remain unconvinced by the arguments put forward by Matthew Patient. In my view the treatment he advocates does not solve any of the problems caused by mixing historical costs and current costs; it merely side steps some of them. It can be nothing but confusing for a reader of the accounts to be told that fixed assets are valued in different ways for balance sheet and profit and loss account purposes.' C.Ellenor (84.15), PE II student with Goodman Jones, said: 'Surely both SSAP12 'Accounting for Depreciation', and the

ASC's discussion paper, 'A Review of SSAP12 ', prohibit the treatment described by Matthew Patient.' Professor H.Edey (84.16) said that it '... has been suggested that where fixed assets are revalued upward, there are advantages in splitting the depreciation charge, so that only the historical cost part is debited to the profit and loss... Does the treatment suggested accord well with the view that the profit and loss account should do its best to indicate business performance?.. Nor is it only a matter of performance measurement. Historical cost depreciation is not appropriate for such exercises as setting prices in government contracts...'

The ASC, in its September meeting, approved a Statement of Intent on Depreciation.

It was reported (84.17) that the Stock Exchange Quotations Department review of the year ended 31 March 1984 revealed that the accounting standards with which companies most frequently fail to comply continued to be SSAP12, 'Accounting for Depreciation', and SSAP16, 'Current cost Accounting'. The Quotations Department noted 44 qualifications in auditors' reports for failure to depreciate freehold buildings (previous year 62). The most common reason given for not providing depreciation was that the market value of the property was at least equal to its book value. The Quotations Department, following accepted practice, discussed such non-compliance with the companies concerned through their brokers, and in some cases referred to the accountancy bodies . Written assurances as to future compliance were sought from companies.

It was reported (84.18) that 'Approval has been given, at the September meeting of CCAB/ASC, to the issue of Statement of Intent (SoI) on the revision of SSAP 12 'Accounting for Depreciation'. The SoI outlined the Working Party's proposals to be contained in a future Exposure Draft.

A press article (84.19), commenting on the SoI on the review of SSAP12, argued that the statement was on the whole favourable. It not only sought to address the amalgam of SSAP12 and the 1981 Companies Act but said that the proposed standard 'will also deal with matters not specifically covered by the legal requirements'. The main points of the statement were presented in the article.

A press report (84.20) revealed that 'Deloitte Haskins and Sells were on course for a clash with the ASC over the Statement of Intent on Depreciation which was released after the first meeting on the new look ASC. Ironically the statement was the brainchild of Jeffery Bowman, UK senior partner of the firm with which Deloitte's aim to merge, Price Waterhouse. The statement was the latest landmark in a study by a working party, headed by Bowman, into a review of SSAP12. Although it is generally a tidying-up exercise, aimed at establishing a consistent approach to SSAP12, Deloitte's were certain to contest the ASC's bid to stamp out, among others, the novel approach to depreciation the firm introduced in Woolworth's accounts earlier this year....The Statement of Intent proposed that this approach should not be used.' Bowman (84.21) said: 'The review should end these practices.'

It was reported (84.22) that Woolworth Holdings 1983/1984 accounts continued to arouse controversy. Though interest had been expressed by some companies in following the company's unusual treatment of depreciation, the method seemed to be finding little favour. R.Brandt (84.23), Thornton Baker's audit partner, said that 'Woolworth's treatment is out of line with the view taken by the profession, but it's difficult to say whether it's contrary to the Companies Acts. It's not a practice to be encouraged though, because it goes against the accounting approach which says that all current matters should be dealt with in the P&L account. This is going back to reserve accounting.' Ken Wild (84.24), of Touche Ross argued that 'it is confusing to any non-specialist reader to be told an asset has one value for P&L account and a different one for the balance sheet.' Another technical partner (84.25) commented that 'we don't like what they're doing -it may not contravene the law but it's against the spirit of it.' Ray Hinton (84.26) of Arthur Andersen considered that 'even if Deloitte's are broadly within the law they are not playing the game as it is intended.' But G.Mulcahy (84.27), who, was originally with British Sugar, but now managing director of the Woolworth stores part of the group, had firm opinions on the group's depreciation policy. He stated, from the commercial point of view, that '...a vital part of the company's strategy to show the performance of the retailing side of the business, unenhanced by any property benefits arising from unrealistic rents or asset sales. ...Under the former system, said Mr Mulcahy, 'the retailing side thought they were doing better than they were because they were not paying a market rate on their properties, while the board thought it could get the profits up

every so often by selling a few extra properties.' But, according to Mr Mulcahy, the usual method of depreciating the revalued amount would have produced a 'ridiculous situation' as far as the P&L account was concerned.

M. Patient (84.28), replying to these comments, said that 'Ken Wild, from Touche Ross, quite rightly highlighted the difficulty in interpreting para 32, Sch 8, Companies Act 1948, and went on to advance the argument that that paragraph prohibits such a method. I respect his views, but have received those of leading counsel, who has advised us that the paragraphs concerned do permit such a method. Another argument advanced was by Chistine Ellenor, who rightly drew attention to the discussion paper, 'A Review of SSAP12'. However, that is only a discussion paper, the arguments in which may or may not be accepted. I cannot find any specific prohibition against the proposed method in SSAP12 itself. Both Ken Sherwood, and Professor H. Edey rightly pointed out the anomalies that such a method could cause, but failed to point out similar anomalies in the existing methods. Surely, it is better to get down to the bedrock, ie pure historical cost. If then we wish to show the impact of revaluing assets on the profits we can do it by reporting profits adjusted for inflation in a form such as CCA. That requires the numbers to be updated annually, and will give rise to some consistency where there is none at the moment. This will achieve the performance measurement quite rightly needed by H. Edey, and avoid the nonsenses correctly pointed out by Ken Sherwood.'

It was reported (84.29) that 'The new Chairman of the ASC Peter Godfrey appealed to accountants to send in responses to the ASC documents after the Committee received only 70 comments from 7000 copies of the draft SoI on accounting for depreciation, which had been sent out to interested parties. The standard of replies in general, the Chairman (84.30) said, was a 'poor response'. In addition, he suggested '...our work would be made better if we could get a higher standard of input from those who are interested in the subject'. One area, according the report, on which the 70 commentators did disagree was the treatment of profits or losses on the sale of an asset which has been revalued. But an ASC decision on this contentious point had been shelved until 'the committee gets round to issuing a document on extraordinary items'.

A press article (84.31) discussed the problems of the depreciation standard with respect to non-depreciation of buildings, revalued assets, and revaluation reserve, providing some extracts from the accounting policies of Allied-Lyons, British Telecom, Davy Corporation, and Woolworth Holdings. It concluded that 'It will be interesting to see what the ASC will say on this matter when they get round to producing an Exposure Draft of a revised SSAP12.'

It was reported (84.32), '....in a recently issued Statement of Intent (SoI), the ASC had set out its proposals for the revision of SSAP12... The SoI took account of comments received on a discussion paper on the subject, issued in December 1982. Recognising the interaction between depreciation and current cost

accounting, further work on the revision of SSAP12 was delayed, pending the outcome of the revised SSAP16.' The report provided a summary of the main points of the SOI.

In the December meeting, the ASC considered a research report entitled 'The Reporting of Profits, and the Concept of Realisation' by Professor B.V. Carberg and Mr C. Noke. The Committee welcomed the report, discussed the issues it raised and noted its recommendations. It was agreed that the report would be a useful starting point for the working party which is to be set up shortly to review all accounting standards in the light of the Companies Acts 1980 and 1981.

Professor C. Nobes (84.33) was asked by Deloitte's technical partner Matthew Patient to produce a report on the problems of depreciation in the context of historical cost accounting. This was because 'he knew what my views already were,' Nobes said. His monograph (Depreciation Problems in the Context of Historic Cost Accounting) came down in favour of split depreciation. He argued that 'there is no legal or technical reason why split depreciation cannot be allowed as long as 'ad hoc balance sheet revaluation of fixed assets is allowed.' He stated that this 'remarkably dis-organised' approach to revaluation threw up a number of illogicalities.

The conclusion from this section is that the issuing of the Discussion Paper on Depreciation in December 1982, as a visible event at that time, was preceded by interactions and power

relations about the perceived problems in SSAP12. Involved in such network of interactions and power relations, the issuing of SSAP16 in April 1980 (which introduced CCA); which led, in turn, to a reconsideration by companies of their depreciation policies (including their estimate of asset lives), as did the issuing of the Companies Act 1981 (which introduced various rules relating to the depreciation standard).

This Discussion Paper itself reflected the open policy adopted by the ASC at that time, as we indicated in the previous chapter, about the process of setting accounting standards. This openness is expressed clearly in the following two questions at the end of the Discussion Paper:

'(1) are there any other matters causing concern regarding depreciation that you wish to bring to ASC's attention?, (2) Do you consider that SSAP12 should be revised?'

The interactions and power relations about this paper preceded the issuing of the SoI on Depreciation in September 1984. These interactions and power relations manifested themselves in a number of different ways such as published articles, press reports and comments, publications of news about non-compliance with SSAP12 by the Stock Exchange Department, and clash between auditors and companies. In addition, the written comments on the Discussion Paper received during the the period from February to July 1983. In these written comments, most commentators supported the proposal in the discussion paper and emphasised the interaction between SSAP12

and SSAP16. This led the ASC to delay the revision of SSAP12 until the issuing of ED35 on a revised SSAP16.

These interactions and power relations during the period from 1981 to September 1984, rendered the issuing of the SoI on Depreciation visible in September 1984.

6.5 ISSUING ED37 IN APRIL 1985 AND SSAP12 (REVISED) IN JANUARY 1987.

In April 1985 the ASC issued ED37 incorporating the proposals contained in the SoI. The exposure draft contained the following major changes to SSAP12.

1. The depreciation charge in the profit and loss account must be based on the 'carrying amount' of the corresponding asset in the Balance Sheet, thus prohibiting the charging of that element of depreciation relating to any revaluation surplus, direct to the revaluation reserve.
2. The writing back to the profit and loss account of depreciation already charged, prior to the revaluation of the asset, is prohibited, except to the extent that it relates to a reversal of the provision for permanent diminution in value.
3. An enterprise is likely to have a few fully depreciated assets still in use. Where the omission of depreciation on such assets would result in a failure to give a true and fair view these assets should be reinstated and this amount credited directly to reserves.

4. The definition of residual value is included to make it clear that the effects of inflation should not be taken into account unless the asset is revalued.
5. It is recognised that in very restricted circumstances it may not be appropriate to judge depreciation on an asset which is regularly maintained to such a standard that the estimated residual value is equal to or greater than its net book value.

In January 1987, the ASC published a revised SSAP12 based, in general, on the principle of ED37. The revised version of SSAP12 clarifies many of the provisions of the original standard and deals with issues (such as split depreciation and supplementary depreciation) which were not previously addressed.

The principal differences between ED37 and the revised standard are:

- the standard, unlike ED37, does not contain specific provisions regarding the depreciation of assets which are maintained to a high standard;
- the standard does not require the reinstatement of fully depreciated assets still in economic use;
- where asset lives are revised and the adjustment to accumulated depreciation would have a material result on future results if spread, the revised standard requires the adjustment to be recognised in the period in which the revision takes place. Usually, however, recognition over the remaining life of the asset should not have a material effect on the results. ED37 required all adjustments to be recognised over the remaining useful life of the asset.

The interactions and power relations preceded and surrounded ED 37 and SSAP12 (Revised) manifested themselves in a variety of ways which are depicted in a diagrammatic form in Figure 6.5 and described as follows.

In 1985, the ASC, in its January meeting, noted the written submission from the ICAS's Accounting Standard Committee on 'the Statement of Intent on the review of SSAP12 -Accounting for Depreciation'.

In the February meeting, the ASC considered a proposed exposure draft (ED37) of a revised SSAP12 'Accounting for Depreciation'. Subject to some minor amendments, the exposure draft was approved for publication on 28 March. A comment deadline of 30 September was approved. At the same meeting, it was noted that, an SSAP12 dealt only with accounting for depreciation, a possible topic for future study would be 'Accounting for fixed assets.'

Professor C.Nobes (85.1) criticised the SoI on Depreciation for allowing and encouraging revaluations in historic cost financial statements. He argued that 'the present state of affairs on valuation in the UK is chaotic... There is a wide range of problems concerned with depreciation and disposals for which there are few hard and fast rules. Because of all this, companies can choose from a wide range of figures for net assets and for profit. The result is confusion for the inexpert reader of financial statements and lack of comparability even for the

expert.' He suggested that 'A practical solution might be to ban revaluations from HCA financial statements and to make audited information on some current-value basis (with rules for its calculation) compulsory in the notes to the financial statements of all public companies. This retains such advantages of historic cost as there may be and it provides current values for analysis of financial statements. The forthcoming revisions of SSAP 6, SSAP12 and SSAP16 represent a splendid opportunity for us to sort this out.'

Professor C.Nobes (85.2), under the title 'Depreciation: can a new standard clear the way?', argued that split depreciation was legal, and that it was probably not contrary to the letter of SSAP12. He referred to his monograph in which he investigated the arguments about split depreciation in greater detail.

It was reported (85.3) that Woolworth Holdings, which created a controversial plan to cut its depreciation charge, had altered last year's figures to restate extraordinary items after the standard setters' reform... Woolworth's company secretary Nigel Whitaker (85.4) said: 'Last year we treated property disposals as extraordinary items but as a result of an exposure draft, we have treated them as exceptional. We have identified various bands of profit. The ASC's exposure draft aimed to tighten the distinction between exceptional and extraordinary items, which had come into disrepute.'

A press report (85.5) announced that the ASC now approved and

issued for comment ED37, its proposed revision of SSAP12, 'Accounting for Depreciation'. The exposure draft followed a Statement of Intent issued late last year, and few changes had been made to the proposals contained in that document.

In another press report (85.6), it was said that the ASC had issued for comment ED37 'Accounting for Depreciation', '...a proposed standard to replace SSAP12, currently in force. The purpose of the revision was twofold: to put an end to certain controversial practices which have been developed in the respect of depreciation, and to clarify the way in which depreciation was calculated and charged.'

It was reported (85.7) that 'ED37's proposals, if promulgated as a standard, are unlikely to result in any significant changes in the way in which most enterprises account for depreciation: the revision is intended as a clarification of the provisions in SSAP 12 and a codification of best practice.'

Under the title 'ASC under fire over new depreciation standard', a press report (85.8) said: 'Indeed experts predict that the new standard (Revised SSAP12) will lead to companies flouting its requirements and -possibly more seriously- still getting clear reports from their auditors. The problem arises because the standard says that the full amount, of any permanent fall in the value, of an asset must be charged to the profit and loss account -whether or not the asset had previously been revalued. So this could lead to charges going through the profit and loss account,

depressing profits while revaluation surpluses on the same assets are lying in reserves.' Ken Wild (85.9), technical partner at Touche Ross, said: 'this is fine provided the cause of the fall is different from the cause of the increase in value -due, say, to a change in technology.' 'But if it is simply a reversal of the increase the deficit should go straight to the revaluation reserve', he said. Susan Baker (85.10), ASC secretary of the depreciation standard working party, said: 'It depends whether the reversal is treated as a permanent diminution in value or as revaluation.' 'Only the former is covered by the standard. But a decision as to how it should be treated will, she said, depend on the outcome of the asset-revaluation working party's machinations.' 'No deadline for a report has been set although it does have high priority' she said. Matthew Patient (85.11), Deloitte Haskins and Sells technical partner, said that this made the standard a 'nonsense'. He agreed that simple reversals should go straight to reserves but claimed that the proposed standard currently prohibited that. 'Not only could the standard produce false results in companies accounts, it could also deter them from doing revaluations', he said. He argued that the ASC should postpone the release of the revised standard until the asset revaluation working party had reported. 'It is all part of the same problem, how to account for revaluations. So in the meantime the ASC shouldn't come out with half-baked ideas. It is wrong to go on with a revised SSAP before all the problems have been dealt with', Mr Patient indicated.

Professor J.Grinyer (85.12) under the title 'ED37 - a House

Built on Sand?' argued that the lack of a clearly articulated theory of accounting produces statements which are often inconsistent and incoherent-like ED37. He suggested that the problems of the draft would, of course, disappear if practitioners could find a clear theoretical foundation in earlier standards, from which the basic assumptions that underlied ED37 could be implied. Regrettably such a foundation did not exist; indeed its absence was probably the most important shortcoming in the whole accounting standards programme.

Professor H.Edey (85.13) commented on ED37, arguing that 'economic considerations had been ignored in ED37.' He wrote: 'The exposure draft states that the assessment of residual value at the end of an asset's life should be based on prices ruling at the time of acquisition or revaluation (para 12). It is no doubt right to exclude here the effects of possible future inflation. But it seems wrong to ignore expected changes in relative prices... One can also query the exposure draft's treatment of changes in an asset's expected life..... A more fundamental and no doubt controversial question arises in connection with the assessment of 'recoverable amount' (paras 13 and 19).. '

Professor Baxter (85.14), commenting on Professor C.Nobes Booklet 'Depreciation Problems in the Context of Historic cost Accounting', said that his opening paragraph stated that 'the profession has chosen (for better or worse) to retain historic cost as the primary system of accounting'. He therefore sited his dicussion within that system (and indeed seemed himself to favour

it). This tethered the argument to a somewhat sterile area; the rules of historical cost stemmed, after all, from clerical convenience rather than principle, and lack the logic needed for solving new problems. Good advocacy was here wanted on an 'unworthy client'.

J.Pearcy (85.15), a Deputy Chief Accountant of ICI and a former member of the ASC, commenting on ED37, argued that ED37 was a definite improvement on SSAP12. Some doubtful points had been clarified and rigidities removed whilst retaining the main thrust of SSAP12, which has worked well. However, there were still some relatively minor problems which demanded another look before the proposals should be converted into a stanatand. But the proposals in ED36 about revalued assets did require some hard thinking by the ASC.

The ASC, in its December meeting, received a report from the Working Party on Accounting for Depreciation. It was agreed that the Working Party should prepare a revised standard based, in general, on the principle of ED37. The Chairman of the working party undertook to consider in finalising the revised standard, various points raised by members of the Committee.

In addition to the interactions and power relations mentioned above, the ASC received (during the period from May to October 1985) the written comments from 89 organisations and individuals. Some extracts from these written comments lend support to the following points.

(1) There was interaction between ED37 and other EDs and SSAPs

'Whatever goes into the final standard must give recognition to the debate on SSAP16 bearing in mind that the ED deals with several points relevant to CCA.'

(British Railways Board)

'It (ED37) is not consistent with ED36, which proposes that the profit and loss account should reflect the difference between the sale proceeds and the depreciated original cost on disposal of an asset.'

(Steetley PLC)

'This paragraph (para 1-7) effectively makes agreement on ED35 a prerequisite for the reconsideration of SSAP12. Does the rejection of ED35 and the continuing confusion over the future of current

cost accounting therefore make ED37 ill-conceived and mistimed?'

(South Western Accountancy Tuition Limited)

'In our response to ED36, given the importance of revaluation surpluses to both statements, we suggested that ED36 and ED37 should be developed and issued in parallel, and we now repeat that recommendation.'

(Unilever PLC)

'.. Thus , if an asset is 'realised ' by consumption ED37 states that the related revaluation surplus must not be transferred to

profit, but if it is realised by Sale ED36 states that the related revaluation surplus must be transferred to profit. This inconsistent.'

(J.D.Blake, Lecturer in Financial Accounting)

(2) There were interactions between companies themselves

'As only a small number of commercial bodies generally comment on these issues, we are sending a copy of this letter and enclosures to a number of other public companies and interested parties in the hope that they may add their observations on the subject.'

(Max Lewinsohn of Dominion International Group plc)

'With reference to the above exposure draft (ED37), we would write in broad support of the comments made by Mr Max Lewinsohn, Chairman of Dominion International Group plc, made to you in his letter of 30 August 1985....As stated in Mr Lewinsohn's Letter, 'if companies are permitted to revalue assets at will and if the incremental depreciation arising from these accounting adjustments is charged against profits, it becomes very difficult to make comparisons between companies or to judge individual reported results.'

(Mercantile House Holdings PLC)

'Mr Lewinsohn, the Chairman of Dominion International Group PLC, has passed to the Chairman of our company, a copy of his letter of 30th August 1985 with his comments on the above exposure draft...I have some sympathy with the comments made by Mr Lewinsohn and would like to submit for your consideration my own views as follows...'

'... A copy of the comments on ED37 from Mr M.Lewinsohn at Dominion International Group PLC was recently passed to me. Since I believe his comments to be a little off beam, I felt bound to respond to him directly. Copies of his comments and my response are enclosed.'

(Guinness PLC)

'..I read with interest the copy of your submission, I believe that ED37 is not so inflexible as you appear to believe. I have attempted to illustrate this view below by reference to your own company.'

(Letter from Guinness PLC to M.Lewinsohn of Dominion International Group PLC)

(3) Some of these written submissions were built on the argument of academic articles

'I am dissatisfied with the proposed statement of standard accounting practice for depreciation. Professor Grinyer in his article in the July edition of Accountancy explains the failure of ED37 to provide a sufficiently clear operational guide to the fundamental elements of accounting for depreciation and its lack of an adequate theoretical basis for its recommendations. I do not propose to restate these arguments but instead rather aim to raise two practical problems which any company implementing the proposed depreciation procedures would have to consider...'

(Pfizer Limited)

'The theoretical weaknesses in ED37 are described in Professor Edey's article in The Accountant of 24 July 1985. I can do no

better than to draw this excellent article to your attention and to say that, for my own modest part, I endorse every point the Professor makes.'

(M. J. Graham, Chartered Accountant works for Governent)

'I enclose a copy of my article in Accountancy on ED37, which expresses some of my observations concerning the exposure.'

(Professor J. Grinyer)

(4) Some of these written comments were built on discussions at the local levels

'The Chartered Association of Certified Accountants set up a working party under the Chairmanship of Professor C. Nobes to consider the ASC exposure draft, 'Accounting for Depreciation'.

(The Charered Association of Certified Accountants)

'The TAC view has been ascertained after receiving submissions from local District TACs and after a debate of the national TAC committee. The TAC would like to express their thanks to Mr Jeffery Bowman and Miss Susan Baker, chairman and secretary to the ASC working party responsible for revising SSAP12, for their attendance at and contribution to the TAC debate on 18 July 1985.

(Technical Advisory Committe of ICAEW)

In 1986, J. Percy (86.1), Deputy Chief Accountant of ICI and a former member of the ASC, reported on the results of some work he had done on the relationship between discounted cash flow projections and charges for depreciation.

In the February meeting, the ASC considered the text of a revised SSAP12. Various minor wording amendments were agreed. As there were insufficient members present to allow the document to be approved, it was agreed that the text should be approved by a postal ballot. The need for a separate project on fixed assets and revaluations was referred to. It was agreed that the Planning Sub-Committee would consider, at its next meeting, what priority should be given to such a project.

The ASC, in its March meeting, noted that a project on fixed assets/revaluations had been added to the work programme, and that the Planning Sub-Committee had agreed that it should be the next project to be commenced.

In a press report (86.2), it was said that companies which flout the new depreciation standard could soon find themselves breaking the law with the publication last week of a consultative document by the DTI. The document could bring company law in line with the revised SSAP12. A major change in the new standard is the outlawing of the controversial practice of 'split depreciation.' According to the report, the DTI was calling for consultation on this issue because of 'differences of opinion among companies, and in the accountancy and legal profession.' Both the DTI and the ASC denied that the ASC had asked for legal backing for the standard. P.Holgate (86.3), secretary to the ASC, said: 'The consultative document and the revised SSAP12 are in line with each other. But we have not made a request for backing.' He said: 'the question of split depreciation has been clear in Europe for sometime. In 1981

the UK law did not interpret it very clearly.' A spokesman for the DTI (86.4) said: 'the ASC wrote to us a long time ago before SSAP12 was revised. We do not view that we are giving them legal backing. But our thinking has been running in tandem. We have issued this consultative document to get our point of view on record and to see if there is a substantial volume of opinion in favour.'

It was reported (86.5) that 'there is some suspicion over the DTI's latest move to stop what is regarded as an abuse of the 1981 Companies Act. Many people think it is just trying to shore up the work of the ASC's newly-approved revision of SSAP12 on depreciation with its consultative paper outlawing 'split depreciation' and the write-off of goodwill (or indeed anything other than asset write-downs) against revaluation reserves.' Bob Willott (86.6) of Spicer and Pegler, former ICAEW technical director, regarded the DTI's thrust as entirely misconceived. 'It is based on the false assumption that the EEC Fourth Directive was in favour of producing P&L accounts which mixed up historical cost accounts with revaluations. I think the Fourth Directive implies the opposite', he said. Willott supported the line of Deloitte's in Woolworths' 1983 accounts, splitting the depreciation of revalued assets into two components- the historical cost and the revalued elements, and charging the latter, not to the profit and loss account but directly to revaluation reserves.

The ASC, in its May meeting, noted that the revised text of SSAP12 'Accounting for Depreciation' had been sent to CCAB Councils and to date approved by four out of the six. However, the English

Institute's Technical Committee had concluded that it could not recommend the standard to its council. The Chairman explained that the Planning Sub-Committee would consider this matter in early June and report to the ASC in more detail on 25 June.

A press report (86.7) revealed that 'A row is brewing between the ASC and Deloitte Haskins and Sells over the revised depreciation standard due to be issued this autumn. The standard has been sent to the accountancy bodies for approval, having been passed by the ASC.' In a letter to the ASC, M. Patient (86.8), technical partner of Deloitte Haskins and Sells, spelled out his complaints about the standard, claimed that the standard -SSAP12- dealt with only some of the problems of revalued assets leaving others to be dealt with by a working party set up to consider the subject. So the ASC was going at the matter with 'half-baked ideas'. Patient said: 'companies are forced to take the 'good news' of an upward revaluation to reserves while charging the bad news to profits.' A reply from the ASC (86.9), maintained that the standard only covered a permanent diminution in value, not simply a downwards revaluation. However, it had not decided how a downwards revaluation should be treated and explained that this depended on the decision of the revaluation working party.

A press report (86.10) revealed that the ASC had forwarded a revised version of SSAP12, Accounting for Depreciation, to the Consultative Committee of Accountancy Bodies for approval. The report indicated the differences between ED37 and the revised SSAP12.

In the June meeting, the ASC Chairman reported the latest position with regard to the consideration by the CCAB Councils of the revised SSAP12 'Accounting for Depreciation.' The revised standard had been approved to date by four councils but the ICAEW's Technical Committee had decided that they could not recommend it to their Council. Three representatives of the ASC had met representatives of the ICAEW and agreed that amendments should be made. These amendments were to be considered by the Technical Committee in early July and by the ASC on 30 July. Following this, the amended version would need to be re-submitted to the six councils. The Committee confirmed that work should continue on The Review of SSAP12 'Accounting for Depreciation'.

The ASC, in the July meeting, considered two amendments to the text of the revised SSAP12. The amendment to paragraph 20, as set out in the agenda papers, was approved. An amendment to paragraph 18 was also approved. The amendment differed from the version in the agenda papers to the extent that two sentences of explanation concerning the reference to SSAP6 were added to paragraph 18 of the standard. It was noted that the amendment would be circulated to the CCAB Councils.

In the September meeting of the ASC, the Chairman -in respect of the draft SSAP12 (Revised)- approved by the Committee, reported that the effective date of the draft standard had been amended to 1 October 1986.

Salisbury-based brewer Gibbs Mew (86.11) stated, in its

accounts for the year ended 31 March 1986: 'Freehold land and non-industrial buildings including licensed premises are not depreciated as the maintenance cost charged against profits includes an element of partial reinstatement which, in the opinion of the directors, makes good any depreciation required by SSAP12. ' Whitbread (86.12) in its report for the year ended 1 March 1986, explained that: 'the nature of the licensed trade requires that in order to protect that trade, freehold licensed premises are maintained in such a state of repair that the aggregate of their residual values is at least equal to their book amounts. In the opinion of the directors, any depreciation of these properties would not be material.' Chiswick brewer Fuller, Smith & Turner (86.13) made a similar statement in its accounts for the 52 weeks ended 28 March 1986: 'the nature of the licensed trade requires that freehold licensed premises are maintained in such a state of repair that their aggregate values are not less than the total book values.' Marston Thompson & Evershed (86.14), in its report for the year ended 31 March 1986, stated: 'It is the company's policy to maintain public houses to a high standard of repair. In the view of the directors such properties do not normally fall out of use because the high level of maintenance expenditure obviates major deteriorations. Current experience indicates that in those exceptional circumstances where public houses are disposed of they normally realise at least book value.' 'Depreciation, which in the opinion of the directors is not material, is therefore not provided in public houses except for leasehold premises, where the unexpired terms of the leases are 100 years or less, which are amortised over the terms of the leases.'

It was reported (86.15) that the Stock Exchange Quotations Department review of the year ended 31 March 1986, concerning compliance with accounting standards, found that, as before, SSAP12, Accounting for Depreciation, and SSAP10, Funds Flow Statements, were the most frequent subjects of qualified audit reports. SSAP19, Accounting for Investment Properties, had given rise to a number of qualifications because companies had not obtained a professional valuation of the properties in accordance with the standard.

In the November meeting of the ASC, the Chairman reported that the draft SSAP12 (Revised) had been approved by five of the CCAB Councils and that the sixth, the ICAS, had raised several matters which were currently under consideration.

P.Holgate (86.16), a manager in the technical department of Deloitte Haskins and Sells, argued that the revision of SSAP12 on accounting for depreciation had prompted the ASC to get its teeth into the revaluation of fixed assets. He said that 'Although the revised SSAP12 deals with certain aspects of revaluations, such as the requirement to charge the entire depreciation on a revalued asset in the profit and loss account, the revised standard does not attempt to deal comprehensively with the problems posed by the revaluation of fixed assets. To deal with these broader issues, the ASC has set up a new working party on accounting for fixed assets and revaluations..... Among the issues the working party could deal with were: (1) the cost of fixed assets, (2) policies for revaluations, and (3) the detailed mechanics of revaluations and

the use of the revaluation reserve.'

In 1987, It was reported (87.1) that a revised standard on depreciation has been issued by the ASC. The new version prohibited the use of split depreciation and supplementary depreciation. The ASC Chairman Michael Renshall (87.2) said: 'The revised version of SSAP12 Accounting for Depreciation clarifies many of the provisions of the original standard deals with issues such as split depreciation and supplementary depreciation which were not previously addressed.'

P.Holgate (87.3), a manger in the technical department of Deloitte Haskins and Sells, discussed the requirements of the revised SSAP12, highlighting variations from the original standard. Commenting on this article, M.Haskes (87.4) wrote: 'We have an asset accounting software package (AIMS) which complies with the requirements of appropriate accounting standards (SSAP12 revised,) P.Holgate's survey of the revised SSAP12 .. did, however, identify one aspect of the standard for which the appropriate accounting treatment is unclear. This relates to the ability to base the residual value of an asset at prices prevailing at the date of revaluation...I would be grateful if someone could clarify this situation in order that we can confirm that our software handles all requirements correctly.'

It was reported (87.5) that the ASC has published a revised version of SSAP12, Accounting for Depreciation. The finalised document it was suggested 'which is based largely on ED37 should

not result in any major changes in the way in which companies account for depreciation'.

A press report (87.6) said that 'The sorry tale of SSAP12 continues -with the ASC's seal of approval still drying, the long awaited revised version of Accounting for Depreciation has already run into controversy, even before its publication date.' It said that the proposal was, it was hoped, tight enough to stop an increasing number of companies which were not charging depreciation on buildings in particular on pubs and hotels. But the ASC decided it was dropped from the finalised SSAP -only to be reinstated in the accompanying (revised) technical release.' One large firm technical partner (87.7) said 'The ASC's apparent inability to make its mind up has caused dismay. This can only lead to a further crisis of confidence in the standard setting process.' Graham Stacy of Price Waterhouse (87.8) said: 'Persuading businessmen they have got to depreciate buildings is an irrelevancy to them.' 'Whatever the academic argument in favour, the profession has lost some standing with businessmen because they have been nitpicking at depreciation of buildings'he added. Matthew Patient of Deloitte Haskins & Sells (87.9) said that 'I don't believe it warranted issuing because it is such a weak and watery document.'

In a press article (87.10) it was argued that 'last week's publication of Financial Reporting 1986-87: A Survey of UK Reporting Practice ..shows up again the loopholes and gaps between theory and practice in statements of standard accounting practice. Depreciation and revaluations of fixed assets is the first subject

for the chopping block, ... What gives the survey great weight is the fact that the conclusions that are reached are not simply the armchair views of the authors. The survey is based on, and incorporates, the financial reports of 300 industrial and commercial companies.'

It was reported (87.11) that a technical release had been issued by CCAB/ASC on the revised version of SSAP12. The report reproduced part of the text of this technical release.

It was reported (87.12) that because some commentators on ED37 expressed concern that this proposal might represent a loophole by permitting non-depreciation of many types of property, in addition to investment properties and freehold land, the ASC dropped it from the revised SSAP12. However, in the technical release accompanying the standard, the ASC recognises that there could be circumstances in which it might not be appropriate to charge depreciation, such as where the estimated residual value was equal to or greater than its net book value, or its estimated economic life was either infinite or such that any depreciation charge would be insignificant.

P.Ebling (87.13) a member of the ASC secretariat highlighted some important areas dealt with in the new revised SSAP12. These were the depreciation of revalued assets, the depreciation of buildings and revisions to asset lives.

Professor D.Egginton (87.14) examined some evidence on company

practice and questioned whether SSAP12 went far enough. He concluded that 'In an ideal world companies would review asset lives as part of their overall investment planning, taking into consideration changes in demand and technology which affect the lives of their existing assets. The evidence suggests that such an approach is the exception rather than the rule. It therefore becomes particularly important that accounting standards and the attentions of auditors should ensure that the needs of users of accounts are satisfied...'

R. Munson (87.15) (Partner and a member of the ASC and of the Institute's Technical Committee), commenting on SSAP12 (Revised), argued that 'There has been extensive debate in the profession and the business community as to whether it is ever acceptable not to depreciate fixed assets which nevertheless wear out. The problem has usually concerned property assets.' After discussing five areas of difficulties, he concluded that '..All I ask at this stage is that organisations which do not charge depreciation on assets which might be expected to wear out clearly explain in their accounts the rationale for the policy they have adopted.'

The conclusion from this section is that ED37 was issued in April 1985 and SSAP12 (Revised) was issued in January 1987. Both prohibited the use of split depreciation and supplementary depreciation. These visible events were preceded and surrounded by interactions and power relations during the period from September 1984 to 1987.

ED37 was preceded by interactions about SoI which took the form of "talks to the press" by auditors, companies' directors and ASC representatives. The issuing of SoI prior to the issuing ED37, it should be noted, reflected the effect of the wider context of interaction at the more general level (discussed in the previous chapter) on the interactions at the specific level (Depreciation Standard). This is because the the review of the process of setting accounting standard in July 1983 recommended issuing a SoI prior to issuing ED.

SSAP12 (Revised) was preceded by interactions and power relations which led to some differences between ED37 and SSAP12 (Revised). These interactions and power relations manifested themselves in a number of different ways such as press reports and comments, talks to the press by officials, letters to the ASC, meeting , publishing annual reports of some companies, and published articles.

In addition to these interactions, the written comments on ED 37 were received during the period from May to October 1985. These written comments lend support to the the following points: (1) there was interaction between ED37 and other EDS and SSAPs, (2) there were interactions among the companies themselves, (3) some of these written comments were built on the argument of academic articles, and (4) some of these written comments were built on discussions at the the local level.

6.6 CONCLUDING COMMENTS

The analysis introduced in the previous sections, shows the manner by which interactions and power relations are exercised in the process of setting depreciation standard. This power, it can be argued building on Section 5.5, has disciplinary, relational, and positive aspects.

It is disciplinary because it is exercised through disciplinary apparatuses/techniques. These techniques, as we have seen in the previous sections, were: published articles in the financial press, letters to the press, press conferences, talks to the press by officials, formal and informal meetings between the ASC and finance directors and other persons concerned with financial reporting, press comments, press news about the progress of the standard, conferences, issuing consultative documents (i.e Discussion Paper, SoI, and ED) issuing publications about the standard such as 'Survey of Published Accounts', and 'Accountants Digest', written submissions to the ASC and publication of some of them in the financial press, and publishing the annual reports of some companies and audit reports.

These disciplinary techniques rendered the views of companies and standard setters (about the standard) visible and governable. This visibility increased, as indicated in the previous chapter (Section 5.5), by the ASC's movement towards the open policy about its work. It is, also, magnified through the professional and financial press. As we have seen in section 6.2 most interactions

and power relations about this standard were mediated through the press (see element 1979, 1980, 1981 in Figure 6.2).

The prevailing of these disciplinary techniques, it should be noted, does not deny completely the existence of non-disciplinary techniques. As demonstrated in section 6.3 (extracts from written submissions on ED26), these disciplinary techniques, in some cases, were accompanied by some non-disciplinary ones (such as threat of non compliance with the standard).

Power exercised in the setting of depreciation standard is relational in a sense that it is exercised from a variety of points rather than, as the previous studies -discussed in Chapter 4- suggested, something that companies have and the ASC lacks. This power, as demonstrated in the previous sections, is a complex strategy spread throughout the network of interactions. It is, as Foucault stressed, a multiplicity of often minor processes, of different origin and scattered location, which overlap, repeat or imitate one another, support one another, distinguish themselves from one another.

This concern with power as relational helps us, as discussed in Section 5.5, to explain our rejection of reducing all power (exercised about the depreciation standard) to class domination (Property companies domination), as the previous studies -discussed in Chapter 4- suggested. All these studies would maintain that the exemption from the depreciation standard (given in ED26 and SSAP19) was the result of the lobbying behaviour of BPF. This is

misleading. As demonstrated in this Chapter (Sections 6.2 and 6.3) such exemption to property companies was connected with a network of power relations in which property companies and other interested groups were involved. These interested groups (other companies, auditors, academics, and other regulators) supported, intentionally or otherwise, the case of property companies. This does not deny that property companies represented themselves as a class in the interactions about the depreciation standard. But this class (represented by BPF) required firstly a dynamic exercising of power primarily on its own members. Thus the techniques of power exercised in setting the depreciation standard initially applied on individuals companies by BPF (such as, issuing guidance notes, written submissions, meeting, etc.).

Power exercised in the setting of depreciation standard is positive, in a sense that it produced knowledge through which much more understanding about the nature of the depreciation problems was gained for all involved in the interactions about the standard. This knowledge led to the changes following the issuing of first exposure draft (ED 15) in January 1975. These changes, in turn, led to the acceptability of the standard. This acceptability has a positive effects for both sides (i.e the companies and the ASC).

The previous sections, also, demonstrated that the interactions and power relations about the depreciation standard (at the specific level) to be fully understood, need to be placed within the wider context of interactions and power relations about

the process of setting accounting standards on the more general level. As shown in Section 6.1 the lack of interactions about the depreciation standard during the period (1969 - 1974), in comparison with the following periods, is linked to the lack of interactions (at the more general level). On the other hand, as shown in Section 6.3, the intensive interactions and power relations during the period (1978-1981) was connected to the open policy adopted by the ASC at the more general level. Also, introducing new consultative documents (i.e Discussion Paper, SoI) prior to issuing an exposure draft, in the revised standard setting process in July 1983 (at the more general level) was applied on the depreciation standard. As we have seen in Section 6.4 the ASC issued a Discussion Paper and SoI prior to issuing ED37.

Furthermore, the previous sections demonstrated, again in contrast to the previous studies, that the interactors in the setting of the depreciation standard utilised more than one way of interactions such as a written comment followed by a meeting; a meeting followed by a memorandum; and a letter followed by a meeting then by an article. In other words they repeat the interaction in a different way. This, in turn, demonstrated that the interactions about this standard was not only manifested through the written submissions, as the previous studies suggested. Rather a variety of ways were involved. And in certain stages of the history of the standard, the written submission as a way of interaction did not exist. As shown in Figure 6.3, after issuing SSAP12 in December 1977 through to issuing ED 26 in September 1980, intensive interactions and power relations manifested themselves in a variety

of ways which excluded written submissions. These ways of interactions and power relations were connected, as demonstrated in Section 6.3, with the issuing of ED26 with the permanent exemption for the investment properties.

The failure of the previous studies to capture this complex and dynamic interactions, it can be argued, is due to adopting a scientific approach with its concern with the visible and static interactions in the form of written submissions. Following this approach, all these studies examined only the written submissions following the issue of EDs. But, this study, by adopting, a dynamic and complex Foucauldian approach succeeded, to a greater extent, in capturing these invisible interaction in all stages on the history of the standard. This includes before and after issuing the EDs, SSAPs and even the Discussion paper and SoI, demonstrating that at certain stages of the standard particular forms of interactions prevailed. As we have seen in terms of the interactions for 1978 in Figure 6.3, meetings were the prevailing way of interaction, but in 1979, and 1980 (again in Figure 6.3), the prevailing form of interaction was press reports and comments and talks with the press. However, in 1981 (from Figure 6.3 again) the written submission was the prevailing form of interaction. This change was possibly due to the acceptability of ED26 by the companies and others. In the stages of the reviewing of the standard from 1982 to 1987, the prevailing form of interaction was the written submissions. This was possibly because of the issuing of additional consultative documents at these stages (i.e the Discussion Paper and SoI) and also due to resolving many of the

problems associated with SSAP12 since issuing ED26 in September 1980.

6.7 CONCLUSION

In this chapter we have tried -utilising Foucauldian genealogical analysis, and the material available in the professional and financial press and the ASC documents- to trace the micro-powers (techniques of power) exercised in the setting of depreciation standard during the last twenty years (1969 -1988). This enables us to demonstrate and lend support to the following points.

Firstly, the issuing of the first exposure draft on depreciation (ED15) in January 1975 and the consequent changes though to 1988, as visible events during this period, were preceded and surrounded with invisible interactions and power relations between the ASC and companies' finance directors (and other directors) and other interested parties.

Secondly, the role of UK companies' finance directors (and other directors) in the setting of the depreciation standard was not just a reactive role in terms of written submissions to the ASC, but also, and may be more importantly, it was an interactive role in which different forms of interactions were involved. This, in turn, demonstrates that interactions and power relations were exercised at all stages of the history of the standard. They were

exercised not only after issuing EDs, as the previous studies suggested, but also before and after issuing the Discussion paper, SoI, EDs and SSAPs. In addition, it is illustrated that in certain stages of the history of the standard, some forms of interactions were prevailed.

Thirdly, this role of UK companies' finance directors (and other directors) in the setting of the depreciation standard, can only be fully understood within the wider context of interactions and power relations between the ASC and all persons and groups involved in this process.

Fourthly, the interactions and power relations at the specific level (eg. the depreciation standard), to be fully understood, need to be placed with the wider context of interactions and power relations about the process of setting accounting standard at the more general level.

Fifthly, and finally, power exercised about the depreciation standard has disciplinary, relational, and positive aspects.

CHAPTER 7

INTERACTIONS AND POWER RELATIONS ABOUT

The LEASING STANDARD (SSAP 21)

7.0 INTRODUCTION

The previous chapter discussed the interactions and power relations surrounding the depreciation standard where there was more than one ED, SSAP, and other documents (i.e discussion paper, SoI). This chapter will discuss the historical development of the leasing standard where, as shown in Figure 7.0, there was only one ED (ED29, October 1981) and one SSAP (SSAP 21, July 1984). Although this gives the appearance of simplicity for the leasing standard, it is, in fact, very complex in the sense that the topic of leasing has been considered by the ASC since 1974, but the exposure draft was published (after 7 years) in October 1981. This exposure draft was followed, (after 3 years) by the standard (SSAP 21) in July 1984.

Considering the complexity of this standard, and based on the analysis of the wider context of interactions and power relations concerning the process of setting accounting standards discussed in chapter 5, this chapter has two inter-connected purposes.

Firstly, to argue and demonstrate -based on the material available in the financial press and the ASC documents-, that the

issuing of the leasing exposure draft (ED29) in October 1981, and the following standard (SSAP21) in July 1984, as visible events during this period, were preceded, surrounded, and succeeded with invisible interactions and power relations between the ASC and finance directors (and other directors) of the companies. These interactions and power relations were accompanied and supported by interactions and power relations between the ASC and other interested groups.

This will, and in contrast to the previous studies discussed in Chapter 4, both illustrate and lend support to the following points: (1) the role of UK companies finance directors (and other directors) in setting the leasing standard is not just a reactive role in terms of written comments to the ASC, but also, and may be more importantly, it is an interactive role in which different ways of interactions are involved; (2) this role of UK companies' finance directors (and other directors) in the process of setting leasing standard, can be fully understood within the wider context of interactions and power relations concerning the standard setting process on the more general level.

Secondly, and building on the above first purpose and the analysis of section 5.5, to demonstrate that power exercised about the leasing standard has disciplinary, relational, and positive aspects.

The design and content of this Chapter is summarized in Figure 7.0. Sections 7.1 and 7.2 (each section is concerned with each

event depicted) address the first purpose. Section 7.3 is devoted to the second purpose.

7.1 ISSUING ED29 IN OCTOBER 1981

ED29 'Accounting for Leases and H.P.C.' was published in October 1981. Its main proposal was that finance leases should be capitalised in the accounts of the lessee, and it also contained provisions for accounting by lessors (such as prohibiting grossing up of regional development grants).

This exposure draft, as a visible event at that time, it will be argued and demonstrated in this section, was preceded and surrounded by invisible interactions and power relations -during the period from 1971 to 1981- between the ASC and organisations and persons concerned with financial reporting.

These interactions and power relations manifested themselves in a variety of ways which are depicted in diagrammatic form in Figure 7.1 and described as follows.

In 1971, the ASC, in its meeting held on 14 April 1971, noted the contents of a letter from the Secretary of the Institute of Chartered Accountants in Ireland requesting the Steering Committee to place the subject of leasing on its work programme. It was agreed that the Technical Committee should be asked to advise and the secretariat was asked to inform the Irish Institute of the work

so far carried out on this topic.

In 1972, E.Gillet (72.1) of Bowmaker Ltd, under the title 'Leasing - in perspective' discussed leasing in relationship to other sources of finance, arguing that equipment leasing is an advantageous method of medium-term finance. Commenting on this article, F. Millbank (72.2), under the title 'Leasing - an accountant's view' said that 'What is really surprising is that Mr Gillett did not produce a straight DCF evaluation of the project under leasing and compare the return with that of a straight purchase.'

In 1973, A.Landes (73.1) of Lex Vehicle Leasing Ltd., under the title 'Vehicle leasing and contract hire', argued that 'Contract Hire in this country (UK) is comparatively new- but it has huge growth potential.... To appreciate the reasons for the change of policy the real advantages of this facility must be understood.'

In 1974, D. Gibson (74.1), a member of the Permanent Commission on Standardisation of the European Federation of Financial Analysts' Societies, argued that financial analysts are becoming increasingly disturbed by the hidden gearing and ratio distortions arising out of the growth of lease financing.' He concluded that 'It is only with much greater information that the UK analyst will be enabled to highlight satisfactorily the impact of leasing on any given company's financial posture and also make valid structural comparisons between companies relying heavily on

lease financing with those who have yet to wet their feet in this controversial financing technique.'

The Equipment Leasing Association (ELA), in a memorandum on accounting for leases in November 1974, asked the ASC to set out the investment period method as a standard for lessors.

In December 1974, a Sub- Committee was appointed with the following terms of reference: "to prepare one or more draft Statements of Standard Accounting Practice on Accounting for Leases and Hire Purchase Transactions".

The membership was as follows:-

P.Rutteman (Chairman -Arthur Young McClelland Moores & Co.

N.C.Elliot - Josolyne-Bennett & Co.

J.Harrison -Thomson McLintock & Co

D. Hegarty - Business and Accounting Tutors Ltd.

G.Jenkins -Mercantile Leasing Co.Ltd

H.Rypma -Rank Xerox Ltd

Professor J. Samuels -University of Birmingham

H.Sergeant -Hodgson, Harris & Co.

R.Young -Lombard North Central Ltd

In 1975, a press report (75.1) said 'Members of the ASC denied this week that pressure was being put on them to recommend the investment period method as most appropriate for equipment lease accounting.' A challenge to the investment period method, the report said, came in a report on equipment leasing circulated privately by stock brokers Greene & co. Simon Knott (75.2), of

Greene & Co., criticised submissions to the ASC working party from the Equipment Leasing Association and major accountancy firms which posed investment period accounting. The method, Knott wrote, is 'based on the fallacy that tax considerations can be taken into accounting in determining return.' It had also 'created management problems' in areas of return on employed capital, asset management, risk management and interest fluctuation clauses', Knott said. P. Rutteman (75.3), the chairman of the working party on leasing, denied pressure was being put on the ASC. He said: 'We are discussing the matter with several other accounting firms but no pressure is being put on the Institute.' A spokesman for the ASC (75.4) said it was taking evidence from more than one interested party before releasing an exposure draft which could appear in six months.

A press report (75.5) revealed that a sub-committee of the ASC was considering the problem of accounting for leases in the accounts of lessor and lessee companies. Among other things, the Sub-Committee would be considering a recommendation by the ELA that lessors should in future use for financial leases the 'investment period' method of accounting. The report explained 'investment period' method and its effects on the companies' accounts.

A press report (75.6) said that 'The ELA faces a head-on clash with the ASC over its exposure draft on accounting for leasing.' The report said that the ELA's Memorandum to the ASC recommended the investment period method of accounting by lessors. But the ASC considered that the Association's method did not take sufficient

account of any leases that might run into bad debt. The Association (75.7) pointed out in its annual report that it nominated two members of the working party and : 'The Association was content to leave the working party to consider the memorandum on its merits, in the knowledge that the Association's two nominees would be well capable of explaining it in such detail as might be required.' It said that 'Some interest was attracted when the memorandum became known, and some commentators expressed criticism -that the method is insufficiently conservative and makes inadequate provision for default. In the view of the Association these criticisms are not sound. Any desirable method of accounting should be neither conservative nor over-stanting, but accurate.'

In 1976, a preliminary report on accounting for leases was noted in the March meeting of the ASC. It was agreed that detailed papers on lessor and lessee accounting would be sent to the technical committee of the member bodies during April. Also, it was agreed that before a standard could be published, it would be desirable to have discussions with the Inland Revenue.

R.Chadder (76.1) of Peat, Marwick, Mitchell, discussed how the leasing topic has monopolised thinking in the US for the better part of 20 years, and how the various systems worked.

The Sub-Committee on Accounting for leasing completed its work in April 1976. It held 18 meetings.

Copies of the papers prepared by the Sub-Committee have been submitted to the Technical Committees of the CCAB bodies for

comments.

During the time when the papers were being prepared the Committee of London Clearing Bankers and the Equipment Leasing Association were studying the subject. The Sub-Committee was kept in touch with the views of these other bodies as members of the Sub-Committee also served on the committees of the CLCB and the ELA.

Speaking at the ELA's annual dinner, Mr G.Dodsworth (76.2), chairman of the ELA, said that 'Leasing now accounts for nearly 10 percent of all capital investment in plant and machinery in the UK. This, he said, must be compared with a figure closer to 25 percent in the US, but in Britian the leasing industry was enjoying a faster rate of growth.

A press report (76.3) said that the American Financial Accounting Standards Board had issued for public comment a revised draft of a proposed standard on accounting for leases. This modified in several important respects the provisions of its first exposure draft (issued in August 1975). The report revealed that 'In this country, work continues on two proposed statements of Standards Accounting Practice on Leasing. It is likely that the new standard will distinguish between leases which are 'capital leases' and those which are 'operating leases'. It will be probably be necessary for 'capital leases' to be recorded in the balance sheet of a lessee company both as an asset and as an obligation to pay future rentals; whereas leases which are not capital leases, ie operating leases, will not be capitalised.'

ELA submitted a memorandum, dated 3 November 1976, on the intened draft exposure draft on accounting for leases and hire purchase. It said: 'That document was supplied to us in confidence. We appreciate the privilege of commenting on it, but because it was supplied to us in confidence it has been seen only by the Management Committee and the Taxation & Accountancy Sub-committee of the Association. We believe that their views are fully representative of our membership as a whole, but we do make the point that we have not consulted our members generally. we should like to be able to do so as soon as confidential restrictions may be lifted.' The ELA said:

'Our observation are in three parts. First, we comment on one major issue where we have not found ourselves able to agree with the draft exposure draft -the proposal that the leased asset should be capitalised in the balance sheet of the lessee. Then we comment on some other points of general application. Finally, we comment on points of detail...'

The ICAS, in its comment, dated 8 November 1976, on the draft papers, said that 'these comments insofar as they express opposition to the method of accounting proposed for capital leases and the inclusion of leased assets in the balance sheets of lessee companies, represent the views of the ICAS.'

D. Hegarty, a member of the working party committee on leasing standard, discussed with Mr D.Rowe, a member of the Irish Technical committee of the ICAI, the draft exposure draft on accounting for leases.

In 1977, T.Clark (77.1), of Lloyds leasing and Vice-Chairman of the ELA, argued that 'Following its recent rapid growth, leasing has become a generally accepted method of financing the acquisition of capital equipment. However, there has not as yet emerged any one generally acceptable method of accounting for a financial lease in the books of either the lessor or the lessee.'

G.Jenkins (77.2), of Mercantile Credit Company and a member of the ASC working party on leasing, discussed how the user of equipment leasing would be able to ascertain the most advantageous tax position that could be created.

J.Carty (77.3), a member of the staff of the Technical Directorate of the ICAEW, under the title 'Accounting for Finance Leases-The Investment Period Method', pointed out that 'In recent years the investment period method (IPM) has been developed as a means of accounting for finance leases...' He argued that 'IPM does not introduce new principles into accounting as it is an approximation of the actuarial method which is of long standing. It has the merit of relating results to cash flows rather than to some arbitrary apportionment and brings management accounting and external reporting on to the same approach.'

P.Rutteman (77.4), Chairman of the ASC working party on leasing, under the title 'Lease Accounting for Lessees- To Capitalize or Not?' discussed the arguments for and against capitalization, concluding that 'There is, of course, a natural reluctance to change accepted practice, but here it seems that

substance should prevail over the form. The substance of a finance lease is the purchase of an asset by instalments and the accounting should reflect this. The lack of ability to obtain legal title is surely just a matter of form.'

T. Smith (77.5) UK General Manager, Security Pacific International Leasing (Europe) Inc., discussed the substantial advantages of industrial leasing for the user, the manufacturer, and also for those in the intermediary field of plant hire.

D. Hill (77.6) of Hambros bank, under the title 'When it Pays to Lease', discussed the advantages of leasing from the lessor's point of view. He concluded that evaluation of new investment should never ignore leasing - which had established itself as a major medium-term investment in commercial and industrial projects which were urgently needed to improve Britain's productive capacity for the promised upturn in trade.

The British Institute of Management (77.7) had issued a report entitled 'The Lease-Buy Decision' which covered the use of hire purchase and leasing in 202 UK companies for three main types of vehicles, machinery, and office equipment. The report also discussed the tax implications, the relative cost of leasing, the budgetary aspects of leasing, and other non-financial aspects which a company should consider. The report aimed to provide a practical introduction to the subject and help companies to understand the advantages and disadvantages of alternative methods of financing. The contents included a useful 'summary for busy executives' and

definitions of technical terms.

The ELA (77.8) produced a booklet on equipment leasing. This booklet contained chapters on the advantages of leasing, leasing terms, 'what is leased', and definitions. The booklet also contained an outline of the development of leasing in the UK and a chapter on the Association itself.

The Technical Advisory Committee of the ICAEW submitted, on 21 April 1977, its views on the two draft proposed SSAPs on accounting for Leases and Hire Purchase Transactions, which had been prepared by a drafting Sub-Committee. It had taken account of views expressed by members of the Institute through the main Technical Advisory Committee and the District Technical Advisory Committees of the English Institute, and of a report submitted by the drafting sub-committee. Considerable resistance to the principle of capitalisation of leases and to the proposed accounting treatment was expressed by members when considering the sub-committee's draft papers. It recommended, among other things, that the two papers should be combined into one exposure draft and the draft should not cover leased land and buildings.

In the May meeting of the ASC, preliminary discussions were held on two papers prepared by a drafting sub-committee. General support was expressed for the proposals in the papers. It was agreed that:-

(a) before a standard was issued on this subject the taxation position would need to be clarified with the Inland

Revenue;

- (b) ASC should hold meetings with representatives of lessor and lessee companies before an exposure draft was issued to discuss the main principles in the papers;
- (c) it was possible that the papers could be simplified in format by placing some of the explanatory material in appendices;
- (d) the precautions in the lessor paper concerning losses in the course of contracts may need to be strengthened.

It was agreed that discussion would continue at the next meeting.

The ASC, in its June meeting, considered a draft exposure draft on accounting for leases by lessee companies. It, also, received a report on progress made on the draft exposure draft on accounting by lessor companies.

In the November meeting of the ASC, discussion continued on the draft papers on leasing. It was agreed that meetings would be held with financial directors of lessee and lessor companies to test their reactions to the proposals before any decision was taken on the question of issuing the papers as exposure drafts.

In 1978, a press report (78.1) revealed that 'the ASC will be trying to produce a final draft on leasing this month when it meets around 35 finance men from leasing companies and another 35 from lessors. The first meeting, on 9 February, will be with representatives of the major banks and leasing companies. And on

22 February, the ASC will meet leading industrial and commercial companies involved as lessees.' The report said that the one major problem area left on leasing was on sale and leaseback agreements. And the ASC would include hire purchase and credit sale agreements in the draft, which might cause some surprise to some of the companies involved.

Another press report (78.2) said that '...Further meetings are in prospect between the ASC and industry representatives to discuss the treatment of leased assets in lessees' accounts. This is an area at present with no specific disclosure requirements.'

ELA in a letter, dated 3 march 1978, to the ASC argued that the accounting treatment prescribed in SSAP4 was not adequate, and asked for some modifications. It said that '...Grossing up of grant income has already been adopted in the accounts of certain major lessors with the full agreement of their auditors, while other lessors have met resistance to this approach. We now seek a change in the current accounting standard to recognise that if grants are not grossed up and assets not shown gross in the balance sheet in a lessor's accounts the accounts of leasing companies will not accurately reflect the true nature of leasing transactions. In reply to this letter, P.Rutteman, chairman of the working party on leasing, said (in a letter dated 17 March, 1978): 'You may recall we discussed briefly in our working party meetings the question of 'Negative Leases' to which he (C.Jenkins, of ELA) refers and our views were divided. C.Jenkins told us that Mercantile Credit uses the approach suggested in the ELA letter for the very reasons

explained there in but I was not convinced and I believe other members of the committee also felt it is not entirely correct. ...In summary, therefore, I do not think an exception should be made for lessors in respect of SSAP4 because it results in a distortion of the tax charge actually suffered by the lessor.'

The Society of Investment Analysts (78.3) said that 'the rapid growth of leasing has left the accounting profession 'in disarray'. 'As a result of the lack of any applicable accounting standard, the Society said, companies using leased assets may use widely different accounting methods and may not disclose enough information to give a reasonable idea of the assets they control or the cost of these assets.' Commenting on this a press report (78.4) said that 'Investment analysts tend to favour the level of disclosure required in the USA under FASB statement 13 which, for instance, generally requires that a capital lease should be accounted for as a transfer of ownership of property. This means that the lessee will acquire an asset and incur a liability. In the UK, the ELA takes a very different view, fearing that the position of the lessor would be undermined by the US assumption that he has made a sale of the assets to the lessee.'

In the March meeting of the ASC, reports of the meetings held with representatives of lessee and lessor companies in February 1978 were noted. A discussion was held on the future course of action on the proposed exposure draft prepared by a sub-committee. It was agreed that:-

(a) separate exposure drafts be prepared on the lessee and

lessor aspects of the subject;

- (b) if possible the two exposure drafts should be published at the same time, unless this would give rise to a delay in the publication date;
- (c) the distinction between a finance lease and an operating lease should be based on the concept of 'substance over form';
- (d) the exposure draft should include a clear definition of a finance lease and there should be a rebuttable presumption that leases falling within the definition were financial leases;
- (e) consideration should be given to taking legal advice on the question of whether the future finance charges which would be included in the lessee's balance sheet would rank as borrowing for the purposes of calculating borrowing limits for debenture deeds;
- (f) enquiries should be made about the problems of the definition of borrowing limits amongst trustees and financial directors;
- (g) consideration should be given to providing transitional arrangements for existing leases;
- (h) the disclosure requirements for lessees should be made as similar as possible to those for existing borrowings i.e capital element plus interest rates;
- (i) the draft text of the lessee exposure draft should be considered again at the next meeting;
- (j) further consideration must be given to building in safeguards to the lessor exposure draft where the investment period method of accounting is to be used;

- (k) bad debts must be dealt with in the lessor exposure draft;
- (l) in the explanatory section adequate hurdles must be set up to justify the use of the investment period method along the lines adopted in SSAP9.

It was agreed that a sub-committee should be set up consisting of Messrs P. Rutteman, R. Young, P. Gibbs and Professor H. Edey to give further consideration to the lessor paper.

In the June meeting of the ASC, a draft exposure draft on lessee accounting was discussed. It was agreed that the paper should be revised in the light of comments made by members and circulated as a voting draft.

A press report (78.5) revealed that the ASC held a meeting with financial directors and the senior officials of lessor companies on 9 February 1978, and another meeting with those of major lessee companies. Most of the representatives of lessor companies, according to the report, were companies in the leasing industry heavily involved with the ELA. There was clearly a desire on the part of lessor companies to retain the method currently recommended by the ELA: the investment period method.

The ASC, on 7 April 1978, wrote to approximately fifty major companies, seeking their views as to how their borrowing powers would be affected by the capitalisation of lease commitments. The majority of replies received indicated that no major problems would result. The following are extracts from some of these replies.

'..What is being proposed will bring no problems to soundly financed companies.'

(BOC International Ltd, 17 April, 1978)

'.. the proposed treatment would not put the company in breach of any previous agreements and would not in present circumstances cause problems to the company in raising funds.'

(BPB Industries Ltd, 18 April, 1978)

'..We would like to say that we endorse the proposals which are contained in your attachments; you will notice from the enclosed copy of our latest published accounts that our own practice anticipates general acceptance of your proposed principles.'

(British Leyland Ltd)

'..it therefore follows that such an exposure draft would not put our company in breach of previous agreements.'

(Cavoods holdings Ltd, 2 June, 1978)

'..As a Company we have already opted to capitalise such leasing transactions and have found no adverse effect

(United Biscuits (UK) Ltd, 18 April, 1978)

'..Provided that there is general acceptance of the principles of the proposed exposure draft within the City institutions, we are confident that our particular circumstances should not present any difficulties....'

(J. Bibby & Sons Ltd, 11 May, 1978)

In the June meeting of the ASC, a draft exposure draft on lessee accounting was discussed. It was agreed that the paper should be revised in the the light of comments made by members and circulated as a voting draft.

A press report (78.6) revealed that 'Discussions are continuing on two possible exposure drafts on leasing. If these are approved, they will probably go out in the autumn.'

Another press report (78.7) revealed that 'The accountancy bodies' rule-making body (ASC) has decided to seek the views of the Inland Revenue before bringing out an exposure draft on leasing. Normally the ASC produces its draft of a new standard and tax matters are sorted out during the exposure period, but tax treatment is such an essential part of the leasing business that all sides want the Revenue's views before anything is published.'

A press report (78.8) said that 'The ELA is getting fed up waiting for the exposure draft on accounting for leasing.' The Association's annual report (78.9) pointed out in more restrained terms that it 'still awaits the publication of an exposure draft and that it hopes one will be published shortly.' L.Christmas, of the ELA said: 'We're frustrated by this. In particular, the Association wants a draft which sets down the investment period method of accounting as a standard for lessors.' 'We've been waiting for over two years now so that our members can use it and have it accepted by the public' he said. Jim carty (78.11), secretary of the ASC, said that they had been working very hard on

the draft. 'We hope to publish it in October, November time', he said.

In a press report (78.12), it was revealed that 'the ELA, under its new chairman T.Clark, has come out firmly against the exposure draft on accounting for leasing now being prepared by the ASC.' The report said that 'The draft which is due to go before the ASC within the next few months is expected to call for lessee companies to capitalise material leased items in their balance sheets. The ELA considers this treatment misleading and wants the lease commitments shown only in the notes to the accounts.'

R.Berg (78.13), of Peat, Marwick, Mitchell & Co., under the title 'Some problems of tax relief on equipment leasing', discussed how leasing was both a cause and an effect of the massive erosion of the corporate tax base.

It was reported (78.14) that 'In the near future the ASC is likely to issue two EDs on Leasing-one dealing with lessor, and other with the lessee. Surprisingly, they are expected to cover in addition credit sales and hire purchase. These have long been subjects to controversy both inside and outside the profession....'

A press report (78.15) said that 'The UK leasing industry is likely to be upset by the forthcoming exposure draft on accounting for leases, scheduled for publication in the next two months. The ASC is likely to insist that leases be capitalaized...' 'Leasing pressure groups are naturally reluctant to accept anything which

they feel would prejudice the growth of the industry, and a sustained campaign against the draft is therefore a distinct possibility.'

It was reported (78.16) that '.. No draft has yet been issued by the ASC but leading accountants involved in the standard setting process have dropped some broad hints recently that the ultimate exposure draft will recommend the capitalisation of leases in the accounts of the lessor. This would mean the end of leases as a source of off balance sheet finance and would closely follow the latest American pronouncement FAS13.' But B.Munro of Williams and Glyn leasing (78.17) said that 'we favour full disclosure in the accounts, but this should be by way of a comprehensive note.' 'This is the view of most industrial users' he said. 'Nor do I think it right that we should slavishly follow the US practice', he added. 'We are in the common market and should be much more open to European influence. Leaseurope, the umbrella body for the industry stated quite clearly last year that it was against the capitalisation of leases', Munro said.

A press comment (78.18) discussed the long awaited exposure draft on accounting for leasing in the light of FAS13 and the international standard on leasing. The report said that the main problem facing the IASC seemed to be the legislative background in many of its member countries. On lessee accounting, for example, it was generally accepted that there was a need for disclosure of information about leasing contracts taken out by companies. 'It would be an easy option,' said Rutteman (78.19), 'to disclose the

extent of leasing agreements in a note to the accounts and that is not what is not wanted' 'Another problem is the interaction of any standard on leasing with other standards in member countries. It is impossible to produce a standard in a vacuum,' said Rutteman.

J. West (78.20), a director of Williams and Glyn's Leasing Company Ltd, commenting on the press comment (78.18) and on Rutteman (78.19) said that 'I am unhappy over the bias of the leading article on the question of whether or not lessees should capitalise leased assets in their balance sheets. In particular you quoted P. Rutteman, senior technical partner at Arther Young McLellands Moore, without mentioning the fact that he is chairman to the working party of the Accounting Standard Committee looking into accounting for leasing and chairman of the International Accounting Standards Committee considering the same subject. I should like to repeat P. Rutteman's opinion. 'It would be an easy option to disclose the extent of leasing arrangements in a note to the accounts by note and this is not what is wanted'. One wonders whether it is appropriate for the chairman of these two committees to make such a categorical statement. Moreover, there are very many people throughout the UK who feel that in taking every opportunity to publicise his views on lease capitalisation, Rutteman appears to be adopting steamrolling tactics to ensure that his opinion prevails. Let me draw your attention to the following groups who I know are opposed to capitalisation by lessees: (1) The group of Scottish finance directors has made a public statement opposed to capitalisation, (2) similarly, the ELA has made a public statement opposed to capitalisation, (3) The debenture and loan stock

sub-committee of the Association of corporate trustees is opposed to capitalisation, (4) Several district technical advisory committees of the ICAEW have opposed the capitalisation argument....' In replying to J.Wests' article, P.Rutteman (78.21), said 'I read John West's article..with interest. In that article he takes me to task for saying that "it would be an easy option to disclose the extent of leasing arrangements in a note to the accounts, but that is not what is wanted". The quotation was taken from an interview discussing the case for and against capitalisation of leased assets by the lessee. In that context, I was suggesting that ASC had decided in favour of capitalisation -it was merely an expression of what I see as the trend in accounting thought and practice as regards lease accounting, not only in the UK but also in some other European countries, the USA and Canada.' 'The reference in the headline to the ASC's steamrolling tactics is I think a little unfair, in that in developing this exposure draft the ASC has probably gone further than it has before in seeking comment from interested parties in the preparation process' said Rutteman. 'In my view both the supplement on leasing (78.18) and John West's article (78.19) were useful contributions to the debate on the issues involved, and I am sure that both points of view on capitalisation of leases by lessees should be fully discussed before the ASC published an exposure draft on this subject', he said.

In 1979, B.Picking (79.1), a partner of Arthur Andersen, under the title ' The reality of Leasing ', discussed the problems which were created by the most commonly used method of project financing.

A press report (79.2) revealed that 'It is likely that the leasing exposure draft will split the problem in two and propose separate standards, one for the lessor and one for the lessee. P. Rutteman (79.3), chairman of the ASC's working party, confirmed that 'the ASC will be asked to support the capitalisation of assets in the lessee's books.' P. Wyman of Deloitte (79.4) said that this capitalisation of assets in the lessee's books could prompt the Inland Revenue to change the tax position on leases, which currently gives the capital allowances to the lessor....but D. Wainman (79.5), a partner in Whinney Murray, denied that this was likely. He supported the capitalisation principle, because, he said, 'it recognises the substance, if not the legal form' of the transaction.

A press report (79.6) said that 'The European investment community seems increasingly impatient with the inability of UK accountants and the leasing industry to agree an accounting standard.' A spokesman of the Society of Investment Analysts (79.7) said that 'the accounting profession is in disarray... with the recent rapid growth in leasing current accounting procedures were unsatisfactory.' 'companies using leased assets may use widely different accounting methods, and may not disclose enough information to give a reasonable idea of the assets they control or the cost of these asset', he said.

In the July meeting of the ASC, an introduction to the state of development on the leasing paper (prepared by the working party) was given by P. Rutteman. Members of the Committee were asked

to study the paper for the September meeting.

In a press report (79.8), it was revealed that 'The long awaited statement on lease accounting is one step nearer after an Accounting Standards Committee meeting earlier this week where the findings of the reporting sub-committee were discussed ...' Chairman of the sub-committee set up to look at the topic, P.Rutteman (79.9) said the meeting was called 'to discuss the main principles.' 'it is very difficult to give an adequate and accurate account of the economic consequences of leasing without capitalisation'. But A.McDonald (79.10) -deputy secretary of the ELA- said: 'We are firmly in favour of some form of disclosure, but we think that the best way to do it is through a note to the accounts'. He was disappointed that the ASC had taken so long to do anything about lease accounting - 'they have been at it for years', he said. But the ASC secretary J.Carty (79.11) had promised that an exposure draft should be produced by September.

In a press article (79.12), it was argued that 'the scope of the leasing business is immense after a period of considerable growth. But the wind of change is sweeping through the industry and, particularly since the budget, there has been a certain amount of gloom about the future. The first big change came in the budget with the withdrawal of the 100% first year capital allowances from the car leasing companies. And the second change -being considered by the Accounting Standards Committee to capitalise leased assets, in their accounts.'

J. Franks and S. Hodges (79.13) (of London Business School), in a report appearing in the latest issue of the National Westminster Bank's quarterly review, argued that 'the major proportion of financial leasing is tax leasing. The leasing industry should not be entirely happy with this state of affairs.' They suggested that the government 'should consider whether the current system of taxable allowances is an effective one for encouraging industry.'

S. Heath (79.14) discussed, in an article, the views of the ASC and ELA on the proposed exposure draft on accounting for leases, concluding that 'It remains to be seen once the exposure draft has been made public just what will be the reaction of the majority of accountants in industry whose co-operation will be needed to make the standard work.' Commenting on this article, J. Damer (79.15), Director -Secretary of ELA, said that 'The detailed reasons why the ELA opposes the capitalisation of leased assets in the balance sheets of lessees are well stated in the article by Sean Heath (17 August).... The article, however, gives the impression that the ELA is conducting a campaign against capitalisation. This is simply not true. The way in which leased assets are dealt with in the accounts of lessees is a matter primarily for the accountancy profession, lessees and for others concerned with the assessment of company accounts. Nevertheless, it is right that we should state our views publicly on this matter. They are, in fact, also widely supported by lessees and by many members of the accountancy profession.'

A press report (79.16) revealed that 'An exposure draft on leasing is to be considered by the ASC on 13 September, and if it is approved, we may expect it to be published in November.'

In the September meeting of the ASC, discussion continued on a proposed exposure draft on accounting for leases. It was agreed that finance leases should be capitalised in the financial statements of lessee companies. It was agreed that guidance notes should be prepared to explain the requirements of the exposure draft and that the proposed exposure draft and guidance note should be considered again at a later meeting.

A press report (79.17) revealed that 'the ASC will attempt to finalise the exposure draft on lease accounting by the end of this month... The draft has come down on the side of capitalising leases in line with the recommendation from the working party.'

The ASC, in its October meeting, noted correspondence with the Inland Revenue on the tax effects of leasing in which the Inland Revenue made assurances that there would not be any change in the tax treatment of laws as a result of issuing a standard on leasing. It noted that legal advice was being taken to see whether obligations in capitalised leases would be considered to be borrowings under the Companies Acts and debenture trust deeds.

A press report (79.18) said that following the assurance from the Inland Revenue that there would not be any changes in the tax treatment of laws as a result of issuing a standard on leasing, the

ASC could be expected to forge ahead on the exposure draft. Rutteman (79.19) said: 'It is likely to be very different from the disastrous' US leasing standard.' 'We have learned from the American experience. Our statement is closer to the Canadian standard, avoiding the rigidity of the US rules', he added.

Another press report (79.20), under the title 'Lessee accounting to be floated as FAS13 sinks,' revealed that 'Firm guidance on lessee accounting is due out before the end of the year. And the exposure draft, already drawn up but awaiting final approval by the ASC, has, as expected, come down firmly on the side of capitalising leased assets.' The report said: 'But on the eve of the UK's attempt to put the debate on a new footing, important lessons might be learned from the failure of the US to devise a satisfactory standard...' But J.Carty (79.21), Secretary of the ASC, criticised the FASB approach for its emphasis on detailed rules rather than principles. He said: 'If you put the emphasis on the letter of the guidelines then people are bound to look for loopholes.' 'We are aiming for a very short standard which deals with major principles, plus a set of guidelines. The US approach in contrast has been to say "we must define everything" ' Carty added.

The ICAEW (79.22) organised a conference on 16 November, to discuss the proposals of the Exposure Draft on Leases.

J.Glynn (79.23), under the title 'Accounting for Leases - The Case for Capitalisation,' argued for capitalisation of leases in the

lessees' accounts. He pointed out that 'The UK accounting profession decided to consider the question of accounting for leases in 1973. However, the expected exposure draft has yet to be issued... Not the least of reasons for the delay has been the objections to the rumoured proposals from the leasing industry, notably the ELA.'

C.Rickwood (79.24) under the title 'Accounting for Leases 2- Some Problems of Standardisation', pointed out that consistency and comparability are dominant among the arguments concerning the reporting effects of lease capitalisation. He argued that the tax structure in the UK inevitably introduced a number of complexities into the treatment, and any recommendation for lease capitalisation would need to take this into account.

A.MacDonald (79.25), Deputy -Secretary of the ELA, under the title 'A Distinct Financial Facility Requiring Its Own Accounting Standard, argued that 'Though leasing of plant and equipment has been around for quite some time, it is only recently that it has grown to economic importance. It is not surprising that now for the first time there is felt to be a need, in the UK as elsewhere, for a standard of accounting for this facility.' Commenting on J.Glynn's (79.23) and on C.Rickwood's (79.24) articles, he said that the article of Mr J.Glynn referred to delay in publishing an exposure draft, and suggested that this delay was due to the ELA. But the ELA was as enthusiastic as anybody else for the publication of an accounting standard; the question was rather one of getting that standard right. MacDonald said: 'In the earlier part of Mr

Glynn's article there were a number of assertions about the nature of a lease. If these assertions are accepted, then the arguments later for capitalisation flow with some logic; but to accept the assertions seems to beg the very question that is in dispute. It seems to the ELA -and to others- that a lease is neither a loan against security, nor a deferred sale in disguise...There are also problems of capitalisation related to establishing the capitalised value for the leases asset. The calculations are complex. They were examined to some extent in the Mr C.Rickwood's article and the only further point to be made is that in making the calculations there are options, what becomes of comparability, which is surely the object of developing an agreed accounting standard? A note will be required...' MacDonald concluded 'It is not suggested here that all problems can be avoided by avoiding capitalisation. ..But it is felt those problems will be better faced by accounting for a lease as what it is ..a lease.'

Under the title 'Accounting for Leases- the lessor's problem', I.Lawson (79.26), of Touche Ross & Co., discussed how lessors should allocate profit at accounting periods covered by their leases. He concluded 'A leasing standard must impose one satisfactory and comparable method of accounting for leases in the accounts of lessors, and only where another method gives a result which is not materially different should it be allowed. If the ASC can produce an Exposure Draft based on an actuarial approach that will lead to such a standard, I will be only too pleased to wish it well.'

In the November meeting of the ASC, the proposed exposure draft and accompanying guidance notes were discussed. It was agreed that members should be invited to submit written comments on the exposure draft and guidance notes to the secretariat by 30 November 1979. The texts of both documents will be revised in the light of comments made by members and submitted for approval as a voting draft.

A press report (79.27) revealed that 'The ASC is nearing the end of its deliberations on a leasing standard It has tentatively decided to issue an exposure draft requiring lessees to capitalise finance leases. A draft (together with draft guidance notes) was debated by ASC last week.' The press report discussed the contents of this exposure draft.

In 1980, the ICAEW (80.1) organised a conference on 31 January 1980, to discuss 'Accounting for Leases'. Reporting on this conference, a press report (80.2) said that '..Complexity of the problems and the strength of feeling on all sides, prompted D.Young, chairing the conference to draw the analogy with Rhodesia. And he described the man who has to sort it out, P.Rutteman, chairman of the ASC working party, as the 'Joshua Nkomo of leasing'. The report said: 'The key issues are: capitalisation of leases in lessees' accounts, distinction between operating and financial leases, and the treatment of lease income in lessors' accounts.' The press report revealed the views, expressed in the discussion, of P.Rutteman, chairman of the ASC working party, M.Gibbs, of stockbrokers Philips and Drew, T.Clark, chairman of the

ELA, R.Langrty of Shell, and M.Stuart, deputy managing director of International computers.

A special press report on leasing (80.3) said that 'after a long struggle, caused in part by the huge amounts of money involved, the ASC is approaching the final stages of issuing an exposure draft on leasing.' The report revealed the ASC thinking on lease accounting and lessee accounting by quoting extracts from the draft guidance notes under consideration at that time.

T.Clark (80.4), chairman of the ELA, under the title 'Meeting the 'grassroots resistance', gave his views on the latest proposals from the ASC on accounting for financial leasing. His argument was against capitalisation of leases.

A press report (80.5) revealed that the exposure draft on leasing would appear some time in the summer. The distinction between 'finance' (or capital) and 'operating' leases will be drawn , the former to be capitalised in the lessee's books. The draft standard would give examples to facilitate the categorisation of different types of leases.

It was reported (80.6) that 'The exposure draft on leases may be anticipated in September ..as this journal goes to press the latest, and we hope, the final draft will go before the ASC for approval.'

A press report (80.7) revealed that '..Also due for

publication this autumn is an Exposure Draft distinguishing between 'finance' and 'operating' Leases, the former to be capitalised in company accounts...'

Under the title 'Leasing: a key to raising capital', D.Johnston (80.8) discussed the advantages of leasing.

A press report (80.9) announcing the publication of the International Accounting Standard on Leasing, said that the standard was prepared by a working party chaired by P.Ruttman, who also headed the UK accounting committee's group on the subject. The UK draft together with detailed guidelines, should be published around the end of the year and would take substantially the same line as the international draft. The international draft proposed that lessees should capitalise finance leases.

In 1981, a press report (81.1) said that 'The ASC anticipates publication of ED29 'Accounting for Leasing', in April..The ELA and others have protested that the proposed distinction in accounting treatment between capital leases and others is too complicated to operate. The ASC is therefore preparing a section in the ED which will propose a simple straightline basis for the allocation of costs to accounting periods.'

A press report (81.2) said that 'An exposure draft on leasing can be expected by June. It will endorse the capitalisation of leases approach favoured in all previous discussions.' 'The exposure draft will be a refinement of the existing approach and it

will contain a section, for the special guidance of the small practitioner' the report said.

Another press report (81.3) said: 'The draft, ED29, is approaching its final stages and is expected to be made public before August....' The report said that suggestions that the draft had been deliberately held up to avoid it being introduced in the same financial year as SSAP16 had been described by ASC chairman T. Watts (81.4) as 'fair comment'. 'Of course it's a political decision when to go.' said Watts. 'We have acknowledged that many small companies may not be enchanted by the proposals. But we think it's time to open up the question and let the profession have an honest debate. We think it's a good proposal', he said.

The press report (81.3), also, said: 'A warning that the forthcoming exposure draft on accounting for leases may spark a grassroots revolt similar to the one which smashed ED18, the inflation accounting draft, has been sounded by the Equipment Leasing Association.' The ELA's assistant secretary, C.Ferrier (81.5), said that of all the submissions and opinions he had received on the draft, he had yet to see one which was in favour. 'The latest proposals have had only a limited circulation', said Ferrier. 'Though there may be a majority on the ASC in favour, it's a fair guess that there are a great many in practice who feel it is too complex and too theoretical and will want nothing to do with it.' he added. Watts (81.6) said: 'We have prepared the exposure draft to be issued with a full section of guidance notes, and we are ready to hear everyone's view. If our proposals are shot

down in flames then that's a part of the exposure draft process.'

In a press report (81.7), it was revealed that '..The ASC's draft, 'Accounting for Leases', formerly anticipated in the autumn of 1980 as ED28, will emerge very shortly as ED29. The delays and the extent of re-writing have become notorious...'

A report (by the chairman of the ASC) was circulated to the members of the ASC for the September meeting. The report said that although the ballot draft of ED29 was accepted by a majority of the members of the ASC, three senior members (John Grenside, David Hobson and Sir Douglas Morpeth) expressed such major reservations that it was necessary to consider the draft again at the ASC meeting on 16 September.

The reservations were concerned generally with the saleability of the proposals rather than technical issues; and in particular with the undesirable economic consequences which some fear might result in the overthrow and withdrawal of the proposals.

The chairman's report said that after discussion with the senior members concerned, it was suggested that: (1) the main exposure draft itself should remain unchanged, (2) the preface should be expanded to raise specifically the points mentioned in the report and explicitly to invite submissions on these points. These suggestions should be considered in the ASC meeting held on 16 september.

Attached with the chairman's report was a redraft of the preface for consideration.

It should be noted that in this preface of the draft standard, the connection between the emergence of that standard and the wider social context was recognised by the ASC.

As the preface of the draft said: 'The subject of accounting for leases has grown in importance over the past five years as companies have financed the use of a greater proportion of their fixed assets through lease agreements. The growth in leasing has been very significant both in monetary and in real terms ...Accounting standards are concerned with items which have a material impact on financial statements. So long as leasing remained a minor activity the need for an accounting standard did not arise. It is the growth in importance of leasing as a source of finance for industry and commerce that has made it necessary to consider the implications for financial reporting.'

In a press report (81.8), it was revealed that 'Even before the end of the ballot of members of the ASC, the clock was turned back on the forthcoming exposure draft on accounting of leases. Instead of publishing the documents, the ASC will debate the matter at its next meeting on 16 September. An attempt will then be made to reach agreement on a revised draft.' A spokesman for the ASC (81.9) said that the present draft, when issued for ballot, resulted in a substantial number of objections. 'We do not like publishing anything unless we have substantial support', he added. T.Watts (81.10), chairman of the ASC, said that recent criticism stemmed from the 'economic effects' of the proposed draft....' 'I believe the ASC must take these points into account- we must register these objections when we issue the document', he said.

'It's not the technical beauty of the thing that's in dispute at all - what is in dispute is its economic effect' Watts added.

The ASC, in its September meeting, noted the chairman's report.

Professor W. Baxter (81.11), under the title 'Accounting for leases - a critical preview' summarised the the ASC's Draft Standard 29 in its most recent version. Bearing in mind also the IASC's proposed international standard and the Standard No 13 of the US Financial Accounting Standard Board (FASB), he put forward various criticisms of the ASC's proposals from the standpoints of both lessee and lessor. He concluded that 'On the whole, lessors seem satisfied with ED29. But they engage in many different types of leasing and use many variations of the staple methods. Accordingly they argue for more time to try out methods during this development stage. A rigid standard seems more likely to stifle than to help long-run progress.'

It was reported (81.12) that 'The long-avited exposure draft on leasing, due to be published next Friday as ED29, breaks new ground for the accounting standards programme. For the first time, an ASC proposal will include an invitation to all interested parties to comment on the possible economic consequences of the accounting changes recommended by the standard-setters.' ASC chairman (81.13) said: 'But we want specific comments on the economic consequences of putting lease financing on the face of the balance sheet.' A spokesman for the ASC (81.14) said: 'All we've

had so far are unspecific grievances, such as fears that on-balance sheet financing will curb investment in plant or that changes in accounting treatment will lead to changes in the tax treatment of leasing. What we're saying is we need to see specific objections.' Asked, by the press, how significant this was, the spokesman said 'it was a sign that the ASC had realised its work could go beyond the boundaries of accounting techniques into the economic sphere.'

In the October meeting of the ASC, it was noted that ED29 'Accounting for Leases and H.P.C.' had been published.

A press report (81.15) said that 'The long-standing opposition of the leasing industry to the terms of the proposed accounting standard of leasing was this week showing signs of softening.' According to a spokesman for the ASC (81.16), discussions held with leaders of the Equipment Leasing Association on the eve of publication of the leasing exposure draft, ED29, found several areas of agreement. At the same time, the ASC spokesman claimed the lessors were showing increasing signs of disunity over the capitalisation of assets in the balance sheet. The spokesman said: 'some lessors have told us capitalisation is not a crucial issue for them.' 'A lot of the original opposition to it was based on the fear that it would lose them customers, but most of them now accept this is not likely', he said. 'What they are very keen on amending is the exposure draft's treatment of regional development grants. The lessors say this treatment makes their P and L accounts look very strange. The problem areas are not major points

and we're making progress toward an agreement', the spokesman said.

Senior ELA official A. MacDonald (81.17) said that the Association would make a public announcement of their views about the proposed exposure draft on accounting for leasing at the end of November.

A press report (81.18) said that 'After six years' soul searching and determined pressure from the leasing industry the ASC has finally come out and said it: financial leases must be capitalised in the accounts. P. Rutteman (81.19), Chairman of the ASC working party, said that financial lease gave companies 'in essence the full rights of enjoyment for the life of the asset'. Not capitalising then in balance sheet was wrong, he said, and most unhelpful to analysts and readers of financial statements 'Therefore assets acquired on finance leases should be treated as hire purchase with assets and liabilities stated?' G. Smith (81.20), of Royal Bank of Scotland Leasing, said that since title belonged to the lessor 'capitalisation would not present a true and fair view.' L. Christmas (81.21), chairman of the ELA, said that it was well known that they strongly objected to capitalisation- of course they were worried about losing their capital allowances. The press report revealed that 'the leasing industry is not undivided. Noted authority in leasing and former ELA chairman Mr T. Smith is in favour of capitalisation as were the two leasing representatives on the ASC Sub -Committee, Messr G. Jenkins of Mercantile Leasing and R. Young of Lombard North Central.' The chairman of the Society of Investment Analysts, K. Percy (81.22),

of Phillips and Drew, said that he is 'very much in sympathy and hope that it goes through without too much messing around.' M.Gibbs (81.23), also of Phillips Drew, said that capitalising finance leases was more realistic, but it might have a marginal adverse effect.

In a press comment (81.24), it was said that with the publication of their exposure draft 'Accounting for Leases' (ED29), the ASC have come out with their most important programme since ED24 on current cost accounting....' The press comment, supporting the capitalisation of finance leasees, said: 'It cannot be healthy to submerge vital information on the liquidity and gearing of a company in the footnotes, as at present....'

Announcing the publication of ED29 'Accounting for Leases', a press report (81.25) said that the methods of accounting put forward in the ASC's exposure draft were based on the consideration of substance over form, whereby transactions or other events should be accounted for and presented in accordance with their financial reality rather than their legal form.

Another press report (81.26) announcing the publication of ED29, argued that '..While admitting that there is nothing new or contentious about the proposals on hire purchase, the draft suggests that the proposals on leasing are new and contentious, although given the six years that ED29 has been in preparation the suggestions are not that novel.'

In a press comment (81.27), on the publication of ED29, it was argued that 'After no less than six years hard labour, the ASC has given birth to its exposure draft on accounting for leasing. Such a length of time does not necessarily mean it has produced a mouse, but the issues the draft raises are really rather familiar by now to any business which has plunged into leasing...'

W. Winter (81.28) said: 'Concerning the recent exposure draft on leasing, ED29, and the relevant editorial matter in your issue of 23 October (81.12), the current treatment in the respective balance sheets, surely, is that the lessor capitalises the tangible asset in which he has retained legal title and the lessee capitalises the goodwill in the benefit of the financial lease to which he has acquired legal title, both assets having precisely the same valuation at the outset of the agreement. This overcomes the problem of lessees purporting to have title in the same asset as the lessors when the treatment in the accounts is similar to that accorded to assets financed by hire purchase.'

In a press report (81.29) it was said that 'In a move which widens the already-massive rift between the UK leasing industry and the accountancy profession, the Equipment Leasing Association this week called on the Accounting Standards Committee to withdraw draft leasing standard, ED29.' In another press report (81.30), it was said that 'The ELA has delivered a bitter attack on accountants' proposed treatment of leases and hire purchase transactions. The Association claimed that plans by the ASC, which issues guidelines to the profession, are a threat to future capital investment. The

Association wants a temporary withdrawal of the proposals to allow more time for discussion of certain aspects. The Association (81.31) declared 'ED29 neither highlights these matters as discussion issues nor offers guidance on them and we believe that such a failure removes much of its authority.' 'Such unrealistic accounting rules would wipe out the pre-tax profits on many major and profitable contracts' the ELA said. 'Government measures to stimulate investment would be thwarted because lessors would be unwilling to take on development grant related business' the ELA added. But P.Rutteman (81.32) argued that the development grants issue was more a question of accounting for tax-free grants than for leases. He did not accept that the draft ignored points raised by the ELA. 'They have been very much involved all + rough' Rutteman said. 'If after six years they don't feel the draft is ready, I would be glad to know when they think it would be' he said. ASC under-secretary P.Holgate (81.33) commenting on the ELA's call for the withdrawal of the draft, said: 'they have missed the point. It is an exposure draft, not a standard; we have allowed a six-month period for discussion of these sort of points. The idea of withdrawal is peculiar.'

Parliamentary Under-Secretary of State at the DTI,
Mr.J.Wakeham (81.34), speaking at a reception for the 20,000 members of the Institute of Cost and Management Accountants, supported the views that issuing ED29 would not lead to change in tax treatment. He said 'There is no particular reason to anticipate such a change in response to changes in accountancy practice. There are many existing areas,' he added, 'Where tax practice does

not follow accountancy practice. 'The new exposure draft could only be seen as an improvement on a system which presently allowed 'off balance sheet presentation and failed fully to disclose assets and gearing' Mr Wakeham said.

L.Christmas (81.35), Chairman of the ELA, discussing the benefits of leasing, said that 'The leasing industry is unhappy about several aspects of ED29- not least the proposal that the lessor's assets should be shown on the balance sheets of lessees - 'capitalisation' by lessees.' He argued that 'Lessors are as keen as any one to see greater disclosure of lease commitments- but the ELA's proposal is that these should be disclosed by way of note to the accounts. This would be suitable for all types of leases, whereas the ASC's proposal applies only to some.'

M.MacBryde (81.36) of Hoare Govett, discussed how ED29 would help the users of the accounts of lessees. He concluded that 'Overall the ED's proposals are welcome. Lessee accounts will be more easily usable at last and those of lessors little changed. It is hoped that the need to explain the terms used by lessors will be realised by the ASC or the lessors themselves.'

A press comment (81.37) argued that 'The ELA will have to be more persuasive if it is to win big adjustments to the ASC's exposure draft on leasing.....' 'As for the ASC, it's exposure draft on leasing specifically invited firm evidence that its proposals would have detrimental economic effects. There is nothing substantive in the ELA's submissions to answer this

challenge' the press comment said.

On 2 December 1981 the Chairman and the Secretary of the ASC visited the FASB. The object of the visit was to communicate with both staff and FASB board members on the current matters being considered by the ASC and the FASB. One of the main matters arising from the discussions was the leasing topic. The project manager responsible for leasing explained that, in both the USA and Canada, as a result of the publication of a standard requiring the capitalisation of finance leases on the lessee's balance sheet, many organisations have changed the nature of the agreements. As a result more risks resided legally with the lessor and thus the lease did not fall within the definition of a finance lease. He predicted a similar response in the UK.

The ASC Consultative Group, in its meeting held on 16 December 1981, discussed (among other things) ED29 'Accounting for Leases and Hire Purchase Contracts' Mr P. Rutteman introduced the discussion by referring to the growth in leasing as a source of finance. He explained that most of the assets which were being financed by finance leases were not currently shown on the balance sheets of the lessees. He said that The chief objective of ED29 therefore was to require capitalisation of both assets and the obligation to pay future instalments in the case of finance leases. He acknowledged that ASC was aware of three main objections to this proposals: (a) economic consequence; (b) the definition of borrowing powers; and (c) the possible implications regarding tax allowances.

Mr J.G.Powell from RICS suggested that land and buildings should be excluded from the standard on leasing. Mr Rutteman said that land and buildings would rarely fall within the definition of finance leases. In almost all cases they would be operating leases. It was suggested that the standard should state this specifically.

Mr A.Jennings of The Bank of England asked whether there should be a requirement for the lessor and the lessee to agree on a symmetrical accounting treatment for any lease which is entered into. Mr Rutteman pointed out that there would be occasional examples in practice where the accounting treatment were not symmetrical; these however would be rare. It was noted that there would be some practical difficulty in enforcing such a requirement. Miss E. Llewellyn Smith of the Department of Trade reported the initial reactions of the Department of Trade as follows:-

(a) Difficulties could arise if the concept of substance over form introduced in this exposure draft were to become a general accounting concept.

(b) If the effect of the standard were to be a reduction in the extent of leasing resulting in a lower level of capital investment, this would cause concern.

(c) They hoped that the exposure period of ED29 will overlap with the publication of the Inland Revenue Green Paper on Corporate Taxation, as seems likely.

Mr G. Drysdale of The Institute of Chartered Secretaries and Administrators, noted that ED29 could have a serious effect on the

accounts of shipping companies. The chairman said that he hoped that the shipping industry would use the exposure period to consider the document and submit its comments to the ASC.

Mr S. Thornhill of The Committee of London Clearing Bankers asked for the definition of 'small' companies to be clarified in the standard.

Mr D. Morris of the Accepting Houses committee noted that ED29 contained little discussion of the accounting treatment of tax, in particular deferred tax, in the accounts of lessors. He proposed that a separate statement on deferred tax be issued for leasing companies covering the consequences of a major change in the rate of corporation tax or tax allowances.

This Consultative meeting was noted in the December meeting of the ASC.

In a press article (81.38), it was argued that 'Last week's attack by the leasing industry on the accounting profession's proposals for rules on presenting leases in the accounts of both lessors and lessees was hardly unexpected. But the force of the attack-calling for withdrawal of the draft standard, exposure draft 29, rather than just amendment to it -has caught some off-guard.' The article said that in many ways the response, prepared by the ELA, was a confusing document. It was difficult to avoid the feeling it had been prepared as a rationale for a decision made long ago to reject the draft standard. Yet it raised valid points of

detail, and some general issues of considerable importance.

A press report (81.39) said that despite six years of prior deliberation with the ASC, the ELA had demanded its withdrawal and more time to explore far reaching issues. The ASC, the report said, specifically called for evidence that its proposals would have adverse economic effect, which the ELA had not yet tried to produce.

The conclusion from this section is that there was a discourse, as illustrated in this section, about the growth of leasing as a source of finance and the advantages of such source of finance. This discourse as shown in Figure 7.1, manifested itself in the form of published articles [see (72.1), (73.1) (76.1), (76.2), (77.2), (77.5), (77.6), and (80.8)], reports published by other institutions [see (77.7) and (77.8)], and statements by the ELA [see (76.2)]. This discourse sometimes called explicitly for publication of an accounting standard on leasing [see (74.1) (77.1) (77.3)]. Involved in this discourse were leasing companies, users, auditors, financial press, profession and other representative bodies.

The outcome of these interactions and power relations was the issuing of ED29 which recommended the capitalisation of leases in the accounts of lessees. This treatment is similar to the views of the ASC and different from the views of ELA, although the leasing industry involved in the network of power relations with the ASC,

objected to such treatment [see ELA's letter -dated 3 November 1970, (79.10), (79.25), and (80.4). Such outcome, it can be argued, was facilitated by the support, intentionally or otherwise, by other persons and groups involved in the network of power relations [see for example (78.4), (79.5), and (79.23)]. It was also supported by the disciplinary techniques utilised by the ASC.

These disciplinary techniques were as follows-

- The Sub-Committee which undertook the original study comprised members drawn from finance companies, and manufacturers lessor, and lessee company, and academic and accountants in public practice.
- Early versions of the exposure draft were circulated for comments to the technical committees of the accountancy bodies, to trade organisations and companies concerned with leasing. Members of the ASC held discussions of these proposals with finance directors of major companies engaged in leasing both as lessors and lessees.
- the text of the proposed standard and accompanying guidance notes were made available for use at conferences and courses [such as (79.22) and (80.1)].

In addition, these interactions and power relations were facilitated by the ASC's move towards greater openness about its work at the period from 1978 to 1981. This openness, as indicated in chapter 5, was translated into intensive interactions and power relations, at the general level, during this period (1978-1981)

[see elements 1978, 1979, 1980 and 1981 in Figure 5.3]. This, in turn, was reflected in a form of intensive interaction at the specific level (leasing standard) during this period [see and compare 1978, 1979, 1980, and 1981 in Figure 5.3 and in Figure 7.1].

7.2 ISSUING SSAP21 IN JULY 1984

In July 1984, SSAP21 'Accounting for Leases and H.P.C.' was issued. It recommended capitalisation of finance leases in the accounts of lessees (as suggested by ED29), but it (and in contrast to ED29) allowed grossing up of regional development grants. The implementation date of this standard for lessors finance companies was the first of July 1984, but for lessees and hires was the first of July 1987.

This standard, as a visible event at that time, it will be argued and demonstrated in this section, was preceded, surrounded, and succeeded by invisible interactions and power relations between the ASC and finance directors (and other directors). These interactions and power relations were accompanied and facilitated (and sometimes complicated), intentionally or otherwise, by the interactions and power relations with the other interested groups (i.e auditors, academics, users and other representative bodies).

These interactions and power relations manifested themselves in a variety of ways which are presented digrammatically in Figure 7.2 and described below.

The written comments, on ED 29, were received (during the period from October 1981 to March 1982) from companies and others concerned with the exposure draft. The ELA, Housing Association, and the British Vehicle Rental & Leasing Association rejected in their comments the capitalisation of leases and the prohibition concerning the grossing up of regional development grants as suggested by the exposure draft. The ELA stated that 'The proposal that lessors should not be permitted to gross up Regional Development Grants is unacceptable..We continue to oppose the capitalisation of leases in the accounts of the lessee and to maintain that the information that is perceived to be necessarily declared can be adequately -indeed better- disclosed by way of a note...' The comment from the Finance Houses Association was that 'On the technical question whether or not Regional Development Grants should be shown grossed-up or not, we favour grossing-up...We continue to support those who oppose the capitalisation of finance leases in the accounts of the lessee....' British Vehicle Rental & Leasing Association expressed its view stating that 'We find the proposed standard to be unacceptable for two basic reasons. First, we reject without reservation the ASC's contention that finance leases should be capitalised in the accounts of lessees. Second, the proposed standard is far too complex and would be excessively costly to implement..' But the comments from the Committee of London Clearing Bankers (CLCB) were undecided on both issues (capitalisation and grossing-up). The CLCB stated that 'The Clearing Banks, in a Memorandum dated March 1978, a letter dated 29 the June, 1978 and again in a submission dated May 1980 have stated that in their opinion leased assets should not be

capitalised in the books of the lessee but that the lessee's full commitments under leasing contracts should be disclosed in a comprehensive note. A majority (Barclays and National Westminster dissenting) still believe that the ASC has not adequately recognised the unique nature of a lease as therefore remain unconvinced by the arguments given in ED29 that substance should take precedence over form and that legal ownership can be ignored.' The clearing Banks are divided on the treatment of Regional Development Grants (RDG's). The view of the majority (Lloyds and Midland dissenting) is that the exposure draft is correct in stating that RDG's should not be grossed up....' (The Committee of London Clearing Bankers).

The rejection of capitalisation of leases by these bodies was accompanied (to some extent), intentionally or otherwise, by the comments from some companies and others concerned with the exposure draft. The following extracts from the written submissions of different groups lend support to this point.

Comments from Companies

'We do have serious reservations as to whether with finance leases it is correct for the lessee to capitalize leases he can never own. We would prefer this information to be disclosed in notes form.'

(Hamilton Rentals Service Sales)

'After careful consideration, it is our view that the proposals to capitalise finance leases in the accounts of lessee companies

should be firmly rejected for the following reasons...'

(Booker McConnell PLC)

'I do not agree that lessee companies should show the asset in the balance sheet for items of plant where they are motor vehicles or plant required for production and/or hire. The asset is owned by the lessor company and should, in my opinion, only appear in their books in the balance sheet..'

(Eddison Plant Ltd)

'The basic concept of capitalising financial leases as recommended, is not accepted by the writer, and in fact, is considered to have a number of fundamental commercial disadvantages, as will be seen from the points made below.'

(Sulzer Bros'UK' Ltd)

'We have three principal criticisms of the proposal to capitalise leases;....'

(Trusthouse Forte Ltd)

'The exposure draft, in it's present form, is totally unacceptable. The concept of a company capitalising assets it does not own is unreasonable....'

(Thos.W.Ward PLC)

Comments from Companies' Representative Bodies

'To capitalise chattels which the company does not own as assets

in the balance sheet must result in a distortion of the true position ...'

(The Association of Corporate Trustees)

'We support the principle of disclosure of information on adequate notes to the accounts....'

(The Group of Scottish Finance Directors)

Comments from Professional Firms of Accountants

'We are concerned that compulsory capitalisation by lessees may be too sweeping a change from present practice.'

(Atkinson and Boyd)

'We do not accept the general principle that lessees should capitalise finance leases, because....'

(Dearden Farrow)

'We do not agree that assets which are not the property of the concern should be capitalised and shown on the Balance Sheet in the same manner as legally owned assets.'

(P.Noel Leonard & Co.)

Although the leasing industry (accompanied by some support from others) rejected capitalisation, most other companies and interested groups were supportive of the need to capitalise finance leases. The following extracts lend support to this point.

Comments from Companies

'This is to inform you that the Allied - Lyons group generally supports the proposals to disclose the effect of finance and operating leases in published accounts. ...As the exposure draft is founded on the concept of substance over form we would accept the grossing up of regional development grants in the accounts of lessors...'

(Allied-Lyons)

'In general we support the proposals set out in ED29 and, in particular, agree that it is appropriate to capitalise leases in the balance sheet of the lessee ...'

(Bank of England)

'BOC Group has followed that policy of capitalising finance leases for some years. We believe that the recording of obligations under finance leases in the way suggested by ED29 is the treatment most appropriate to the financial realities of such contracts, and that financial statements drawn up on this basis will give a truer and fairer view...'

(BOC Group)

'....I consider the adoption of the standard to be urgent and that it should come into being as soon as possible with full disclosure being made in the meantime...'

(H. Cox & Sons "Plant Hire Ltd")

'....We have no objection to capitalising leased equipment....'

(Delta)

'...In summary, we believe that in the interests of consistency, the UK standard should be more in line with the US standard (FAS13). In particular, we believe the additional criteria for deciding on capitalisation contained in FAS13 should also be contained in the UK standard.'

(Esso Petroleum Co. Ltd.)

'I support the principles upon which ED29 is based...Without capitalisation of finance leases by lessees an accurate return on operating capital employed cannot be calculated. The financing structure, which provides all the assets intended for use on a continuing basis by the company, is incomplete when leasing obligations are excluded....'

(Hoare Govett Ltd)

'....We therefore support the general principle that leases should be accounted for and presented in accordance with the proposals put forward in ED 29....'

(Imperial Chemical Industries PLC)

'As a general comment, I should like to say that the emergence of the exposure draft after such a long period of discussions was welcome by ICL. The absence of a definitive standard on leasing has led to many interpretation of our accounts, and consequent misunderstandings both within the Group and by the general

public...'

(International Computers Ltd)

'Our primary concern, as a company with both US and UK reporting obligations, is to ensure consistency of accounting, so far as possible, between the two. As a matter of broad principle, therefore, we welcome this Exposure Draft and would endorse its adoption as a Statement of Standard Accounting Practice...'

(Rank Xerox Ltd)

'We fully support the principles of lease capitalisation and in general consider that the exposure draft strikes the right balance by setting out the required practice without being unnecessarily detailed or inflexible...'

(Shell Centre)

Comments from Representative Bodies

'....The arguments for and against the capitalisation of finance leases in the accounts of lessees have been considered and the conclusion reached is that a neutral view is taken of the proposal in the draft standard...'

(Accepting Houses Committee)

'In the committee's view, bearing in mind the basic principle that accounts should address the substance rather than its form; the obligations under finance leases and the assets leased there under

should appear as capital items in the balance sheet...'

(City Capital Markets Committee)

'We have examined the captioned exposure draft and consider it represents a substantial improvement in accounting for leases and hire purchase contracts. We have no additional comments to make.'

(The Society of Investment Analysts)

'The CBI welcomes both the principle underlying ED29 and agrees with practically all of its detailed proposals....' (The Confederation of British Industry)

Comments from Professional Firms of Accountants

'...In general, we are in favour of the proposals contained in the proposed standard, although there is a minority view within this firm that finance leases should not be capitalised by lessees, but, full disclosure of future commitments should be made by way of note...'

(Ernst & Whinney)

'...In general we agree with the proposal to capitalise finance leases, however, we have considerable reservations about any extension beyond this of the concept of substance over form in the preparation of financial statements...'

(Moore, Stephens & Co)

'We are in broad agreement with the principal proposals of the draft standard....'

(Price Waterhouse)

'While we support the proposals for capitalisation of assets acquired under finance leases, we would nevertheless express some reservations with regard to the consequences of so significant a departure from the strict legal position...'

(Spicer and Pegler)

'The committee is broadly in agreement with the underlying principle of the capitalisation of assets acquired on finance leases and agrees that the exposure draft should be converted into an accounting standard...'

(The Stoy Hayward & Co)

'Although, we consider that the capitalisation of finance leases is the best method of presenting the user of financial statements with information on leasing activities, we recognise that it is not necessarily the only method of presenting a true and fair view.....'

(Deloitte Haskins + Sells)

'...The capitalisation of such leases (finance leases) should be the preferred, indeed, strongly urged, method but should not be made mandatory until it has achieved sufficient support to be regarded as generally accepted practice....'

(Peat, Marwick, Mitchell & Co.)

Comments from Other Representative Bodies of Accountants

'The Association supports the underlying principle of the proposals in that in the presentation of financial information the economic substance of transactions rather than their legal form should be shown....'

(The Association of Certified Accountants)

'The Accounting Standards Review Panel expressed general support for the substance over form principle underlying the provisions of the Exposure Draft. It was recognised that current practice did not provide adequate details of the assets and obligations of companies which used leasing as a source of finance and it was felt that the exposure draft would, to a great extent, improve the information available to users...'

(The Institute of Chartered Accountants of Scotland)

'This could be a good standard in principle, but the Committee feels that the inherent dangers of tax changes could be considerable and should be borne in mind before ASC proceeds with the proposals in their present form.'

(The Institute of Cost and Management Accountants)

'The committee were generally in agreement with the proposal that the lessee should capitalise assets acquired under a finance lease....'

(South West London Chartered Accountants)

Comments from Individuals

'...The case for capitalisation by lessees of finance leases is in my view undisputable...'

(H.C. Etheridge)

'...The concept of capitalisation of finance leases is acceptable ...'

(North West Society of Chartered Accountants,
Technical Advisory Committee)

'...I would agree with the broad principles underlying the accounting for finance leases as defined in the proposed standard...'

(S.P. Holmes)

'Please, in the general public interests, stick to your guns on this issue and attack all the other types of off balance sheet finance as soon as possible....You will be meeting strong opposition from self-interested parties, but I am sure that I speak for the silent majority'

(D.E. Midgley)

It should be noted that most of the accounting firms, in their comments, recommended prohibiting grossing-up of regional development grants as suggested by the exposure draft, but most of the companies and other representative bodies (which supported capitalisation) were in favour of grossing up as recommended by the

leasing industry. The following extracts from the written submissions support this.

Comments from Accounting Firms

'...Grossing up regional development grants results in a false picture and should be forbidden...'

(The Stoy Hayward & Co)

'...We agree with the proposals contained in ED29 that lessors should not gross up....'

(Deloitte Haskins + Sells)

'...We agree with ASC that the practice of grossing up regional development grants is not theoretically appropriate....'

(Peat, Marwick, Mitchell & Co.)

'...It is considered that the grossing up of Regional Development Grants in the accounts of lessors should not be permitted....'

(The Association of Certified Accountants)

Comment from Companies and other Representative Groups

'...As the exposure draft is founded on the concept of substance over form we would accept the grossing up of regional development grants in the accounts of lessors...'

(Allied-Lyons)

'...Grossing up of regional development grants: we believe this practice should be permitted....'

(International Computers Ltd)

'In our view users of accounts of leasing companies rely significantly on profits reported before tax and there will be distorted if RDG's are not grossed...'

(Accepting Houses Committee)

'As regards the treatment of regional development grants, we would prefer to see the continuation of the current practices adopted by most lessors of grossing up regional development grants....'

(City Capital Markets Committee)

'The CBI believes that grossing up as described in paragraph 21 should be permitted for the following reasons:-...'

(The Confederation of British Industry)

'...The general approach adopted in the Exposure draft is supported subject to the following commentsGrossing up of asset values for regional development should certainly be permitted in the accounts of the lessor....'

(The Midlands Industry Group of Finance Directors)

In addition to these written comments, the following were the other forms of interactions and power relations during 1982.

A press report (82.1) discussed the reasons for the ELA's

anger with ED29. T.Mitchener (82.2), ELA vice -chairman, argued that in spite of the time already taken by the ASC to produce the ED, fundamental issues remained unresolved, and it should therefore be withdrawn for further discussion. R.Browning (82.3), chairman of the ELA Taxation and Accountancy Sub-Committee, criticising the examples used by the ASC in its draft, said that 'They are pretty near five years out of date, and we should be quite delighted if we could make the level of profit the ASC suggests.' 'the examples need broadening out to display a level of variation more realistic and representative of current business', he added.

R.Speyer (82.4) of Touche Rose & Co., under the title 'What ED29 means to the lessee' set out simply the requirements of ED29 for the lessee.

D.Craik (82.5), assistant director of Student Education at the Scottish Institute, discussing funds statements and the problems of leased assets, said that '..To my mind we are going completely overboard when we contemplate capitalising leased assets.' He concluded 'I think that to capitalise, for balance sheet purposes, assets which a company has the use of but does not own is misguided and wrong...'

A press report (82.6) said that 'With the closing date for representation on the Accounting Standard Committee's exposure draft on leasing, ED29, only four weeks away, one of the strongest objections to the draft, the Equipment Association, appears to have mellowed its stance.' Another press report (82.7) said:

'Objections to capitalisation of leases in company accounts are no longer important...It would appear lessors have accepted the inevitability of an accounting standard based on ED29, whose main plank is capitalisation.' L.Christmas (82.8), speaking at the presentation of the ELA's annual report said: 'capitalisation would have very little effect on our business and its effects on volume is not relevant.' P.Rutteman (82.9), the chairman of the ASC's working party, welcomed this news, saying that 'It is very helpful that they are not taking the capitalisation issue so strongly.' But commenting on the ELA's remaining objection to ED29 -that the values of regional development grants should still be grossed up (ED29 would outlaw this) Rutteman said: 'I hope there will be room for compromise. We have an open mind.'

A course (82.10) on 'Accounting for Leases' was held on 18 March. This was organised by Trent Polytechnic and the Nottingham Society to consider the proposals in ED29. It was aimed at both accountants and auditors of companies with leased assets.

The ASC held, on 5 April, a public hearing on ED29 'Accounting for leases and H.P.C.'. Reporting on this public hearing, a press report (82.11) said '...Most criticism of ED29 at the ASC's public hearings came from the lessors represented by the ELA, the Finance Houses Association and the BPF. The report revealed the views of these groups. Another press report (82.12) said 'Controversy continues to surround ED29 'Accounting for leases and H.P.C.' -with significant opposition to many of its provisions, and a disagreement between two major accountancy firms on the treatment

of small companies.' The report revealed the views of BPF, Price Waterhouse, and Robson Rhodes. The BPF opposed lease capitalisation, saying that the application of ED29 'would result in a significant drop in the value of properties.' Price Waterhouse suggested that small companies should be exempted entirely from the requirements of the draft standard. But H.Hudson of Robson Rhodes, recommended that small companies should not have simplified methods or be exempted from the provisions of the draft. Mr H.Hudson (82.13) said 'If a company only has a small amount leased it does not really matter how it accounts for it'. 'If the principle is correct, and I think it is, it should be applied consistently', he said.

The ASC, in its meeting held on 28 April, received a report on a meeting of the International Accounting Standards Committee held in March. The main business of that meeting was the consideration and approval of an accounting on Leasing.

It was reported (82.14) that 'the UK's draft accounting standard on leasing got a fresh boost last week with the International Accounting Standards Committee's approval of its own standard on accounting for leases (IAS17), published in autumn 1982...'

E.Allan (82.15), under the title 'Should leasing stay off balance?', discussed the economic effects of ED29 on lessees in the light of a recent research report issued in US by the FASB on the effects of their own leasing standard.

P. Sober (82.16), a partner in Stoy Hayward and chairman of the Accounting Practices Committee of the BPF, argued that 'by including properties within the leasing requirements laid down by ED29, the ASC has gone beyond what it intended to do in dealing with special problems of leasing and hire purchase transactions with regard to equipment and other fixed assets...' He concluded that 'It is to be hoped that the ASC will grant the exemption of property leases from ED29, as otherwise information will be included in accounts that will not only be misleading and irrelevant, but could cause considerable damage to the investment community.'

A press report (82.17), revealed the views (expressed on the public hearings on ED29 of Touche Ross, Price Waterhouse, the BPF, the ELA and the Finance Houses Association.

In a press comment (82.18), under the title 'ED29: Is Substance over form being taken too far, 'it was argued that 'Whatever merits ED29 may have, they do not appear to include either simplicity or, so far as the management accountant is concerned, consistency of change.'

A press comment (82.19) asked 'what happens about leasing when a concern used a modified form of current cost accounting as its main accounts'. It suggested that the implications of ED29 on current cost accounts needed further consideration.

The ELA, according to a press report (82.20), said 'ED29 on

leasing will be substantially different by the time the ASC finishes its deliberations, The Association is 'hopeful' that it has persuaded the ASC on three main points: that leasing and hire purchase 'are different animals', that regional development grants should be shown in lessor's account grossed up so that they show the current pre-tax figure; and that leased assets should be shown on the balance sheet of the owner.'

L. Christmas (82.21) (chairman of the ELA), speaking at the ELA's annual dinner, said that 'Future growth in leasing business has lifted the leased assets total over the £10,000 million mark.'

S.Turk (82.22) of Deloitte Haskins & Sells, under the title 'Property Companies and ED29 -no case for exemptions' argued that 'they got away with it on depreciation, but we must not let it happen on leases.' Commenting on Mr Sober's article (82.16), he said 'I believe there is a danger that Mr Sober's article may confuse the reader over the provisions and effects of this ED. It gives the disturbing impression that the British Property Federation, having lobbied successfully for exemption from SSAP12, the EEC Fourth Directive and the Companies Act 1981 on this issues of depreciation of investment properties, now hopes for other similar exemptions.' In reply to this, Mr P.Sober (82.23) wrote '..Mr Turk seems to be under the impression that the BPF have lobbied the ASC in some Machiavellian way in the depreciation debate. The facts are that the ASC were convinced by the arguments that the BPF was able to put forward because they had a factual and logical basis and for no other reason. It is not correct to say

that exemption was granted for investment properties for, the EEC Fourth Directive and the Companies Act 1981... Turning to Mr Turk's strictures on my views, and those of the BPF, on property leases, he wishes to know why they are different from other leases. I cannot think of any other asset which is leased where the lease has:

- regular rental reviews;
- assignability;
- possible capital value;
- a life which goes well beyond any other form of asset that is leased;
- statutory protection to the tenant in any cases. The major area of operating lease activity is that of plant leasing and the above list clearly shows why property leasing is totally different from such leases.

The BPF is not, as Mr Turk implies, a lone voice in expressing concern for the affect on property leases of ED 29. A number of major institutions, including the Royal Institution of Chartered Surveyors, the British Multiple Retailers Assocition, the National Association of Pension Funds and the Hundred Group have each made their own submissions that ED29 is not relevant to property leases.....I am also unable to follow his views on the difference between commitments and liabilities. I am not sure a lending banker would understand the distinction he draws....'

The Planning Sub-committe, on its meeting held on 7 September 1982, placed the leasing topic on the top of the list of ASC programme.

The ASC, in its September meeting, considered a report on the comments on ED 29. The report explained that in the light of these comments, the following four options were available to the Committee:-

- (a) Proceed to a standard requiring capitalisation of finance leases along the lines of ED 29.
- (b) Proceed to a standard which requires only disclosure of lease commitments and certain other information for a transitional period of (say) three years and which requires capitalisation of finance leases after a three year period.
- (c) Proceed to a standard which requires only the disclosure of lease commitments and certain other information and undertake to review the standard after (say) three years.
- (d) Do not develop a standard on this subject.

After much discussion the Committee agreed by a majority (3 against) that it would like to see finance leases on the balance sheet and it would be prepared to go through necessary interim stages to achieve this. Therefore it was agreed that the working party would proceed with option(b). Also, it was agreed that consultation should take place with the committee's legal adviser to establish whether the inclusion in a lessee's balance sheet of an asset, the title to which belongs to the lessor, is legally justified. In addition consultation should take place with him and thereafter with the Department of Trade to see whether there was any prospect of extending the disclosure requirements of the Companies Acts so that they specifically included reference to lease commitments. The results of these discussions would be

reported back to the Committee.

P.Holgate (82.24), under the title 'Much comment, little consensus', discussed the comments received by the ASC on ED29. He argued that 'the comments were interesting in two main respects. Firstly, as with comments received on most exposure drafts, the letters contained a good deal of detailed suggestions, most of which were very well thought out. Secondly, on a more general level, the letters gave some considerable insight into the strategic considerations which currently face the ASC and into the way in which special interest groups present their arguments and organise support for their case. ..The reaction of commentators to the capitalisation proposal was extremely mixed. Perhaps surprisingly, there was more support for capitalisation from companies than from professional firms.

Also of particular interest were the letters received from certain representative bodies. The opposition to ED29 by the ELA had been widely reported and its letter of comment reflected its continuing opposition to capitalisation. Interestingly, however, it gave relatively little emphasis to this point and concentrated its attack on various aspects of lessor accounting, including the vexed question of how to treat regional development grants (RDGs) in the members' profit and loss accounts.'

A press report (82.25), under the title 'Leasing draft finds few friends', said that 'Leasing exposure draft has won only qualified approval from accountancy firms and has been sharply criticised by the leasing industry.' The press report said that

submissions to the ASC ran to 456 pages but the lack of clear consensus posed problems for the new-look Committee which must decide whether or not to embody ED29 as a full accounting standard.

Press reports (82.26) and (82.27), announcing the publication of the international accounting standard 17, 'Accounting for leases', said that the new standard closely followed the British Exposure Draft 29, and required lessees to capitalise finance leases -a move which had been opposed by bodies such as the ELA and Finance Houses Association.

D.Murrell (82.28), a partner in Peat, Marwick, Mitchell, discussed the criteria for choosing between the different forms of leasing.

G.Jenkins (82.29), director of Mercantile Credit Co., and a member of the ASC working party on leasing, discussed acquiring vehicles through leasing contract hire or hire purchase arrangements. He concluded that 'Tax aspects of acquiring vehicles through leasing contract hire or hire purchase arrangements must be considered carefully, for these will have an important bearing upon the decision to lease, to acquire by the hire purchase route, or to resort to other sources of borrowing..'

R.Evans (82.30), of Lambard North Central, discussed the evaluation of various vehicle funding options from outright purchase through to leasing or contract hire, using some cash flow analyses.

In 1983, R.Lister (83.1), discussed how leasing can affect borrowing power, concluding that 'Leasing possesses many real, especially fiscal, advantages. Financial managers will best further corporate soundness and profitability if they exploit these advantages. They should be duly sceptical about illusory attractions which could lead to mutually unsatisfactory or dangerous contracts.' This provoked comment from C.Tourick (83.2), financial controller of Armco Europe Fiance Ltd, who wrote 'Roger Lister's attack on the leasing industry (Accountancy Age, 20 January) contained far too many sweeping generalisations and largely ignored the many real benefits of leasing, benefits which have led to over £9 billion of leased assets being used by British industry.On the question of whether leasing impinges on borrowing powers set out in articles of associaton, I doubt whether this is true, and I regard the request by the Accounting Standards Committee in ED29, for evidence on this area to be submitted to them, as being a sign of their growing determination to scotch this recurrent claim for evermore. Leasing is still one of the most flexible, inexpensive and tax-efficient methods of asset financing available to UK companies.' Replying to this comment, R.Lister (83.3) wrote 'Colin Tourick ... recognises, as I do in my article...., that the impact of leasing on formal borrowing power as stipulated in the articles of Association and other places is an open question. But he presents no argument against my main contention -namely that, despite what the industry's publicity material often implies, leasing encroaches directly on effective borrowing capacity. I agree that leasing has many intrinsic advantages. The illusory attactions that are too widely promulgated

were my target.' Commenting on this reply, C.Tourick (83.4), said '... My main objection was that his (R.Lister) article, captioned 'the pros and cons of leasing', contained about four column-feet of (supposed) cons and only 1.5 column-inches of pros! However, I now feel that the honour of the leasing industry has been satisfied by the closing remarks in his letter, which include the sentence "I agree that leasing has many intrinsic advantages". '

A press report (83.5) said that 'the leasing industry continued its expansion last year with a six percent increase in business registered by members of the ELA.'

Key Note Publication (83.6), in its latest study, said that 'Future growth of the leasing industry largely depends on government fiscal measures and allowances, but in any case the implementation of ED29 will 'distort' the leasing market..' ' ED29, said the study, will mean that leases will have to be divided into those which are to be capitalised and those which are not...This may lead to an expansion of the operating market and consequent increase in equipment related risk to lessors.'

J.Clemison (83.7), under the title 'Vehicle leasing today' discussed how the face of vehicle leasing has changed.

The ASC working party on leasing, from September 1982 to June 1983, had held consultative meetings with representatives of:

The ELA.

The British Vehicle Rental and Leasing Association.

The Construction Plant-Hire Association.

Five major clearing banks (arranged by CLCB).

The Royal Institution of Chartered Surveyors.

Small Practitioners and representatives of small business.

Following these meetings, the working party prepared a report to the ASC, for its July meeting, about the leasing standard. It recommended the following Changes to the text of ED29.

- (a) Transitional provisions. Paragraph 65 permitted delaying implementation of capitalisation by lessees.
- (b) Disclosure requirements. The disclosure requirements, especially for lessee companies, had been reduced significantly.
- (c) Conceptual basis. The working party had reviewed the conceptual basis of the standard and amended the Explanatory Note to set out this aspect with greater clarity.
- (d) Lessors's income recognition. The proposed standard allows less choice of methods of income recognition than did ED 29.
- (e) A paragraph on sub-leases had been added.
- (f) Part 4 of the standard now dealt with the Companies Act.

The ASC, in its July meeting, considered a proposed standard on Accounting for Leases and H.P.C. Some detailed points were raised in relation to the draft standard but, in principle, the Committee expressed its support for the content of the standard. It was agreed, however, that as the standard had been developed

before ASC's recent review of the standard setting process had been completed, it would be sensible to discuss the standard with representatives of each CCAB Council whose unanimous approval is required before the standard can be issued. Particular note was taken of the concern expressed by the Irish Institute, because the Eire tax regulations regarding tax allowances differ in emphasis from those in the UK. The results of the discussions with the governing bodies would be reported at the September meeting of the Committee, at which a final vote on the standard would be taken.

A press report (83.8) revealed that the standard on leasing, which recognised the comments on ED29, was debated in the July meeting of the ASC and that with regard to the proposed capitalisation of finance leases by lessees gave ELA members concessions. P.Rutteman (83.9), chairman of the ASC working party, 'The comments were in favour of capitalisation.' He explained: 'The ELA were concerned about the treatment of regional development grants. We have given them a compromise on RDGs, allowing them to gross them up.' Commenting on the worries of BPF about considering property leases as finance leases (which warranted capitalisation under the proposed standard), Rutteman said 'We had made it clear that property leases would normally be operating leases.'

A press report (83.10) said that 'The ASC is facing one of its most difficult dilemmas for many years. It wishes to issue a standard on leasing, conformity with which it believes is essential if accounts are to show a true and fair view; but such a standard would probably mean the end of a major tax avoidance scheme in

Ireland and possibly damage industrial investment. Not suprisingly, the Irish Institute is unhappy about the prospect of the SSAP and, as the constitution of ASC requires approval of all its members bodies before it can agree a standard, the Irish have an effective, if embarrassing, veto.' The report discussed the problem in details.

H.Macnair (83.11), under the title 'The Leasing pattern', discussed how finance leasing gave rise to some overlooked tax points, considering the planning implications.

A press report (83.12) said that 'The standard on accounting for Leases and H.P.C., SSAP21, is ready to roll, but the ASC has delayed taking a final vote on the proposals to allow time to consider the position in respect of Eire tax regulations.. and concern has been expressed by the Irish Institute that the standard may have an adverse influence on forthcoming discussions with the Eire Revenue.' The press report revealed that 'I.Davison (82.13), chairman of the ASC, is to visit Dublin to discuss the matter before the next ASC meeting at the end of September.'

In the September meeting of the ASC, it was noted that during August and September a number of discussions had taken place with each of the CCAB member bodies with a view to identifying any problems with the standard which might result if any one of the members rejected the standard when it is considered formally by the CCAB. These discussions led to some minor amendments to the draft. It was also noted that the Council of the Irish Institute

had requested ASC to defer a final vote on the standard for six months in order to allow sufficient time to establish the Irish government's intentions regarding capital allowances on leased assets. Having considered the matter the ASC agreed, with one member dissenting, to submit the standard to the CCAB with the recommendation that it be issued as a statement of standard accounting practice. The ASC should refer to CCAB the constitutional problem which might arise if the Council of the Irish Institute is unable to support the promulgation of the standard.

The Committee approved, subject to a minor amendment, the text of a technical release to be published with the standard.

It was agreed that a small group of the ASC would review the draft guidance notes which had been prepared to support the standard. After they had reviewed the document and commented on it, the draft would be sent to all members of the committee for their approval prior to its publication.

A press report (83.14), under the title 'SSAP21 threatens tax-based leasing in Irish Republic, discussed the Irish problem with the proposed standard on accounting for leasing. The press report said that '..If the CCAB presidents know what is good for the profession, they will surely agree on November 7 to postpone approval of SSAP21. If they fail to do so, the Irish Institute, faced with the alternative of a revolt by many of its members, will almost certainly, even if reluctantly, use its veto powers and prevent approval of SSAP21.

In the November meeting of the ASC, it was noted the Councils of CCAB are to consider the Accounting Standard on Accounting for Leases and H.P.C. over the next few months and that the Council of the Scottish Institute had already approved the standard.

A press report (83.15) revealed that 'Presidents of the UK accountancy bodies have refused the call of the Irish ICA president M. Downes to delay the introduction of SSAP21, the accounting standard on leasing. Before Monday's quarterly meeting of the presidents of the CCAB Downes wrote to them urging them not to introduce SSAP21, until Ireland's Minister of Finance has decided on the future of tax-based leasing.' English ICA and CCAB president E. Ray (83.16) said after the meeting: 'CCAB is not the body that stops or starts accounting standard' He added that the presidents considered introducing a standard just for the UK but it 'would not do.'

A press report (83.17) said that 'The Irish government has told the Irish Institute that it will be making a statement on the future of tax-based leasing in late January or early February, much earlier than had been anticipated. The news means that the Institute's position on SSAP21 is greatly eased and that we may expect to see a solution to the problem soon after. However, the timing still means that a delay will have to occur; this has been solved by some tactical manoeuvring by Institute Secretary R. Donovan who has made sure that the agenda for December's Council meeting is already too full to allow time to discuss the standard. Instead, it will be considered at a meeting in January by which

time the Institute hopes to know which way the government will turn.'

A press report (83.18) said that 'the Irish Institute has been seeking to delay the standard pending expected Irish Budget proposals indicating changes in the way in which capital allowances will be granted. The standard (SSAP21) is OK for the Irish if there is no change in the tax treatment. At present, the Irish government is reconsidering the tax treatment of its leasing industry, and an announcement is due in January or February.'

In 1984, a press report (84.1) revealed that 'The Irish ICA has again blocked publication of SSAP21, the leasing standard, and effectively delayed its implementation by at least six months. The ASC was ready to release SSAP21 last August but it conflicted with Irish tax legislation and the Irish Institute exercised its veto. Institute president M. Downes (84.2) said: 'It leaves us in a difficult position but we cannot give the go-ahead until we have a clear indication of the legal position.' 'The problem', said the report, 'centres on the treatment of capital allowances. In the UK the lessor receives the allowance but in Ireland it is given to whoever bears the wear and tear. At present this is given to the lessor on the basis that depreciation is charged but a standard which obliges lessees to capitalise and depreciate finance leases may persuade the Irish government to withdraw the allowance from the lessor.'

Another press report (84.3) indicated that 'The Institute is

poised to implement the leasing accounting standard following the Irish finance minister's budget speech on Wednesday....So far the Institute has held back from adopting the standard, because the Irish government has failed to give a satisfactory policy statement on the tax treatment of leasing arrangements. D.Bourke (84.4), its technical director, said that 'one of the main problems is the obscurity of the current law. We need the assurances, because if we implement the standard and tax law is changed, then the cost of leasing may rise dramatically, with serious effects on companies and perhaps the whole economy'.

R.Owens (84.5), a director of Forward Trust Group, under the title 'Why SSAP21 isn't the answer', argued that many of the intrinsic problems in accounting for leasing made it difficult to arrive at an approach which would answer all questions. That being so, there should be sufficient latitude within the framework of a standard to facilitate the overriding test of 'true and fair'. He said 'I feel that this standard is too limiting in its application, and thus fails adequately to do the job required of it.'

A press report (84.6) said that 'The long-awaited leasing standard SSAP21 is still unlikely to come into force before 1 July despite proposals in the Irish Budget last week to abandon tax-based leasing...' Irish Institute President M.Downes (84.7) said: 'The Budget has gone a long way to clear the position. It is very indicative but not definitive of the government's thinking. We are hoping to clear the standard by the middle of the year and it could be in force by 1 July or 1 September.'

Another press report (84.7) revealed that 'the continued failure of the Irish ICA to approve SSAP21, the leasing standard, has sparked new concern for the future of the consultative committee of accountancy bodies and its role in the standard-setting process.' The ASC, according to the report, had long been concerned that its work could effectively be vetoed by the councils of the CCAB bodies -in this instance the standard has been blocked by the external problem of Irish tax legislation. A more likely solution to this problem would be a rule change to restrict the power of veto. Scots ICA president J.Shaw (84.9) said: 'The CCAB is now getting on for 10 years old and any organisation or institutions of that age is in pretty urgent need of an overall.' This shows how the leasing standard (on the specific level) would affect the process of setting accounting standard more generally.

In a press report (84.10), it was revealed that the Irish Institute is to withdraw objections to the leasing standard. D.Bourke (84.11), technical director of the Institute, said: 'It could be said that the budget statement has cleared up any doubts we had,' 'The Policy Committee will meet on 10 February and is expected to withdraw its objections to the standard', he added.

A press report (84.12) said that 'the Irish Institute is still delaying its decision on whether to approve SSAP21, despite the Irish Government's announcement last month that it intends to abolish tax-based leasing. The question was to have resurfaced at the Irish Council meeting on 10 February but this was cancelled at the last minute. The debate will now continue at the next meeting on 8

March.' 'Meanwhile the Institute, the report said, is canvassing the views of council members on how to proceed. The results are expected this week and they are likely to indicate that members want to postpone the decision for another month until the Irish Finance Bill is published at the end of March.'

Another press report (84.13) said that '....Because the Irish government has not yet released its revised tax proposals to ameliorate the problem arising over capitalisation of leased assets by lessees, the council of the Irish Institute has deferred its decision. It is to consider the matter at its next meeting, in March, by which time it is hoped that the Irish tax problem will have been resolved.'

S. Page (84.14), discussed the history of the Irish ICA's difficulties over SSAP21. He concluded that if this analysis was correct it would appear that there were no real obstacles to stop the Irish Institute from approving the leasing standard. But the saga raised a number of interesting questions:

- '-Is it right that the determination of what represents a true and fair view should be affected by tax?
- Can it be logical for leases to be accounted for one way in the UK (which includes Northern Ireland) and in a different way in the Republic of Ireland?
- Is it a satisfactory arrangement whereby an accounting standard, once approved by the ASC and by five of the six CCAB councils can be blocked by the sixth?'

Whatever the outcome of the leasing saga, said Page, these were

likely to be among the questions which were discussed by those concerned with setting standards in the UK and Ireland.

Lloyds and Scottish (84.15) (instalment credit, equipment leasing, factoring distribution and retailing) has in its accounts for the year ended 30 September changed accounting policy in respect of leased assets to bring it into line with the proposed SSAP21.

A press report (84.16), under the title 'SSAP21 still awaits the Irish?', said: '.. the Irish Institute still feels unable to confirm SSAP21 as full clarification may not come until the Finance Bill is passed. It is understood that the delay is not because of any technical objections by the Irish Institute.'

R.Ashton (84.17), Nottingham University academic, conducted a study to show how the new way of accounting for leases (proposed by SSAP21) affected significant financial ratios of the companies. He found that 'companies currently writing-off leasing directly in the profit and loss accounting will find that their gearing ratios deteriorate substantially if the proposed standard becomes mandatory.' A press report (84.18), commenting on this study, said that Ashton's results might conflict with another survey of 200 companies by Manchester University which generally found support for SSAP21. Ashton's results might be upset because his sample only covered larger companies which wanted to comply with ED29. N.MacDonald (84.19) (partner at Ernst and Whinney), commenting on Ashton's results, said: 'If he picked really big companies then

I would have guessed that result. If he had picked small or medium ones then I would not expect that line.' P.Rutteman (84.20) said that he would meet Ashton to investigate the very strange results thrown up by his field test of the standard.'

A press report (84.21) said that 'The ASC looks all set to finally approve the leasing standard at its meeting next week, once the Irish Finance Act has been published, probably at the end of this week.' D.Bourke (84.22), technical director of the Irish Institute, said that 'subject to there being no developments, they would give the go ahead at the end of the week.'

Another press report (84.23) said that 'The path should be cleared this week for the ASC to go ahead with the publication of its standard on the accounting treatment of leases. It has been delayed for months by the failure of the Irish Institute of Chartered Accountant to give its approval because of 'a conflict' between the standard and Irish tax law..' The report said that the ELA urged that the proposed standard be re-examined completely in the light of the changes to the corporate tax system. The ASC, however, had rejected this suggestion and was prepared only to amend the guidance notes.

In the May meeting of the ASC, it was noted that, although final approval had still to be obtained, it was almost certain that the proposed standard on 'Accounting for Leases and H.P.C.' would shortly be approved by the Irish Institute. Some minor changes to the proposed standard were approved, including a six month

postponement of its effective date because of the delay in its passage through the CCAB Councils. It was hoped that these changes could be approved by the CCAB Presidents on behalf of their Councils, so as to avoid further delay.

P.Holgate (84.24) (Under-Secretary to the ASC, and a previous secretary to the ASC working party which developed SSAP21), under the title 'Laying the ghosts in leasing's house of horrors', discussed some of detailed changes which had been made in SSAP21. These were: materiality, leases of land and buildings, disclosure of operating leases and tangibility.

Taylor and Turley (84.25), clarifying the nature of their study mentioned in a press report (84.18), said: '...Our study investigated the opinions of management in 200 UK companies on alternative methods of lease accounting which might be contained in an accounting standard. We also sought opinions on the possible effects of the introduction of a leasing standard. We found significant support for most of the proposals of ED29. In addition, respondents on the whole did not expect a standard requiring the capitalisation of finance leases to reduce significantly either the volume of leasing or Corporate investment. One factor which a considerable number of respondents suggested might help maintain investment was the writing of new leases in such a way as to circumvent a definition of a finance lease and thereby avoid capitalisation.'

In was reported (84.26), that 'many companies will risk an

audit qualification to their accounts rather than comply with the accounting standard on leasing due out next month, a leading member of the industry has warned. At a Leasing Digest lunch, the ELA's immediate past president, L.Christmas (84.27), who was on the ASC working party, said: 'Delayed implementation of capitalisation will cause people to wait and see and, when others seem to have trouble with it, they will not comply,' He said he did not see how 'a bare total in the balance sheet' could be more informative than a note in the accounts. 'All it means is more fees for accountants,' he added.

It was reported (84.28) that 'At a recent Council meeting of the Irish Institute, the long-awaited accounting standard on leasing, SSAP21, was given conditional approval. That is, approval was subject to there being no major changes in the wording of the Irish Finance Act...'

In the July meeting of the ASC, it was noted that the amendments to the proposed SSAP12 'Accounting of Leases and H.P.C.' approved by the ASC at its meeting on 30 May 1984 had been approved by (or on behalf of) the CCAB Councils, and that the Guidance Notes to SSAP21 had been unanimously approved for publication by postal ballot.

Announcing the publication of SSAP21, press reports (84.29), (84.30), and (84.31) said that the new standard required the capitalisation of leases (opposed by the ELA), but it permitted the grossing -up of RDGs. The reports said that the new standard

was accompanied by a technical release and guidance notes.

Other press reports, announcing the publication of SSAP21), discussed the controversy surrounded the publication of ELA statement. The aim of this statement was to help the ELA's members to cope with the transitional effects of the changes in the corporation tax structure.

One report (82.32) said that 'The Accountancy profession is split over the leasing industry's proposal that lessors should 'gross up' pre-tax profits in their accounts following the failure of the new leasing standard, published last week, to take account of post-Budget changes in corporation tax.' Another press report (84.33) said that 'Budget changes phasing out first-year allowances and reducing the rate of corporation tax have caused a lot of headaches for the leasing industry. So in an attempt to resolve some of the difficulties the ELA has just issued recommendations to its members on how they might deal with the accountancy problems raised. SSAP21 was published last week but does not touch on the Budget changes.' Also, a press report (84.34) said that 'The long-delayed leasing standard, SSAP21, was published last week but is already arousing controversy because of a rival statement of accounting practice from the ELA. The Association published its own recommendations two days before the ASC...' Furthermore, a press report (84.35) said that 'the exposure draft had already been upstaged by the ELA which the day before had produced its own standard to cope with the transitional effects on lessors of the changes in the corporation tax structure...'

The ELA recommendation was to rectify distortion of pre-tax losses

by grossing up the tax benefit by the appropriate rate of tax and treating it as additional rental income. At the same time any amount equal to this 'tax' should be added to the period's tax charge. This is consistent with the ELA's insistence on the grossing up of regional development grants- allowed as a treatment in SSAP21. G.Jenkins (84.36), vice chairman of the ELA, said: 'Our members face the problem of having to report pre-tax figures which will not give a reasonable and fair picture.' 'We don't want to distort pretax profit. There is a particular attitude in the readers of accounts in the UK. No one here pays much attention to the post-tax figure' he added. These recommendation were supported by some accounting firms. N.Macdonald (84.37), partner with Ernst and Whinney, said: 'In principle I am happy with the concept of equalisation. It can be right to have this distinction. There are times when you do the best you can and then disclose what you have done. You could argue for five or more different methods but equalisation is a sensible solution.'

R.Chadder (84.38), a Peat, Marwick parter, said that, though he accepted the grossing up will make it difficult for professional analysts, let alone the public, to understand the results of the major banks and their leasing associations for the next two years'. But other partners in a large accccounting firms were less supportive. One partner (84.39) said: 'It is not a method that I personally favour, though I can see the presentational attraction in it. We will probably go along with it, provided there is proper and full disclosure'. Another accounting firm (84.40) said: 'I don't think any company should gross up but now the big banks

tend to do it while small companies don't want to waste time on the equation.' said another (84.40).

T.Cooke and J.Glynn (84.41) under the title 'A lease Accounting Standard- But IS It Too Late?', discussed the problem areas relating to the adoption of SSAP21. He concluded that '...the Guidance Notes to SSAP21 provide adequate coverage of nine areas of concern. In many ways SSAP21 may have 'missed that boat'. The ASC placed lease accounting on their priority list in 1973, now, over a decade later, many of the reasons behind the expansion of lease finance have been removed and only the future will show whether SSAP21 will provide significant information to users of financial accounts. It is to be hoped that financial institutions in the UK and Ireland do not follow the US by slightly adjusting terms of contracts so that technically they fall outside the definition of a financial lease.'

N.Spinney (84.42), of the British Petroleum, under the title 'Accounting for leases and hire purchase Contracts- SSAP21 in practice', argued that SSAP21 would not find universal approval, but it had been steadily improved. Some worries had been resolved. He said SSAP21 deserved a welcome because it would remove some gaps from financial reporting.

A press report (84.43) said that 'The ELA's formula for a 'convenient' rearrangement of pre and post tax profits in the accounts of lessors, while corporation tax rates fall, has met with a variety of responses.' 'It is another of those lovely little

games', commented B. Willott (84.44), of Spicer & Pegler 'designed for its commercial effect' In contrast, Roger Chadder (84.45) of Peat, Marwick, Mitchell said: 'The pre-tax profits are generally a more informative measure of performance than post -tax profits.' Mr Chadder indicated that he would nonetheless had preferred some recommendation to have come from the ASC. 'It is rather sad,' he said, 'that when there is a live and immediate issue, caused by a change in the tax laws, the ASC can not react quickly enough to produce its own views on the subject and it has to be left to the industry.' P. Holgate (84.46), ASC under-secretary, agreed that these problems were not addressed during the development of SSAP21 or relevant guidance notes. However, he emphasised that the ASC customarily does not deal with any transitional accounting matters and said that this issue fell into the category as it would persist only for a few years. Holgate challenged the ELA's drawing an analogy between leasing consequences and the grossing up of regional development grants.

In 1985, J. Galley (85.1) wrote: 'Sir,- Para 9 of SSAP21..refers to the purpose of the exposure draft, which requested comments on possible economic consequences of this proposals on whether capitalisation would, inter alia, cause a change in the tax treatment of leased assets such that capital allowances were given to the lessee instead of the lessor. While reading further on into the matter, I discovered that this clause appeared not to be answered. I would very much appreciate it if you would tell me whether in fact there is an answer to this issue.' Replying to this question, Accountancy (85.2), said: 'The point

raised in para 9 is answered in para 10, from line 2 onwards, to the effect that a mixture of views was submitted on the topic, and that the ASC concluded that the UK Treasury and Government are likely to be much more influenced by the possible economic consequences of a change in the rules than by the accounting treatment adopted. It was thus felt not necessary to discuss the matter further in the text of the standard.'

P.Taylor and S. Turley (85.3) had conducted a study investigated the opinions of management in a large sample of UK companies. The aim of the study was to obtain evidence of areas of controversy surrounding lease accounting standard on the subject and the likelihood of adverse effects on corporate investment. Reporting on this study, They (85.4), concentrated on the prospects for compliance with the main thrust of the ASC's chosen accounting practice, namely the capitalisation of finance leases by lessees. Taylor and Turley concluded that there was strong support for lease capitalisation and considerable agreement that it would provide information which would be useful in a number of important respects. This promised a substantial degree of compliance with the standard.

M.Jerrom (85.5), a managing director of Commercial & Capital leasing Ltd, argued that 'It was bound to happen. There never was a good case for regarding the property in assets under financial lease arrangements as belonging wholly to the lessor. The Revenue have hated the concept for years. Now ED29 and SSAP21 have sealed the fate. Only under leases which are purely operational will

assets be eligible to be classed as 'fixed assets' on a lessor's balance sheet. At the same time, all lease payments on financial arrangement will have to be amortised over the period of the lease, so all the 'gimmicks' for individual lessors involving 'lease-in short, lease-out long' do not work, never have worked and should be mopped up by the Inland Revenue if and when they have time.'

J.Carr (85.6) (chairman and executive vice president, finance, of Dataserv Inc and chairman of Premier Computers Ltd) under the title 'Why accounting for leases is inconsistent', argued that SSAP21 and FAS13 should be streamlined to reflect a straightforward commercial transaction. He said that leasing company's strength would not be easily identified from accounts prepared under existing accounting standards.

R.Leach (85.7), under the title 'SSAP21 in action' pointed out 'The standard is barely one year old and has applied at time when other factors are giving a fundamental effect on the leasing business. However, comments from lessors, lessees, accountants, the ASC, and the ELA indicate that objections to the standard are academic only, and that it has caused no major headache for lessors, lessees or anyone else.'

A press article (85.8), under the title 'SSAP21 - its impact on lessees', discussed the accounts of some companies, revealing the capitalisation of finance leases in their accounts. These companies were: Booker McConnell, Allied-Lyons, Unigate, and Reed International. The article concluded 'Over the next few months, as

companies issue accounts which have to comply with SSAP21, it will be interesting to see how many choose to defer capitalising finance leases until the last possible moment and how many decide to get it over with in one year by capitalising the finance leases and giving the required disclosure.'

R.Lister (85.9), under the title 'Upward trend of leveraged leasing,' argued that 'the impact of a leveraged lease on the debt capacity of the parties has to be measured. Conventional analysis fails to allow that the lessor's leverage resulting from the linked loan rises rapidly during the life of the lease. He concluded that leveraged leases required and rewarded careful analysis. They should be considered as a instrument of flexible and rapid growth.

It was reported (85.10) that 'the interpretation of SSAP21 applied to a car leasing scheme devised by Swindon-based P44 Leasing Ltd is causing concern among accountants. It has the support of its auditor, Roger Chadder of Peats. While the company itself writes the lease in such a way that it can be accounted for as an operating lease, some advisers argue that the lease should be regarded as a finance lease....'

A.Lennard (85.11), of Peat, Marvick in London, under the title 'Classifying leases: more guidance needed', said that the implementation period of SSAP21 had coincided with significant developments in the leasing industry as lessors reacted to the corporation tax changes introduced in the 1984 Finance Act. In the light of these changes, he argued, the crucial distinction between

finance and operating leases was not made clearly enough by SSAP21, with unfortunate results for lessees, lessors and their auditors.

In 1986, R.Luscombe (86.1), under the title 'A lease through the looking glass', argued that '.. At this stage perhaps I should express some misgivings as to my own interpretation of SSAP21. I mean, I know (or at least presume) that SSAPs are drawn up by most eminent persons who would never allow dogma to overtake common sense. Nonetheless, it does seem to be a little curious to call your own motor car a debtor in your balance sheet just because you lease it to somebody. It seems even more curious to show somebody else's motor car in your balance sheet as a motor car and apparently yours (although you have merely leased it yourself from the rightful owner) simply because you use it in your own business...'

A press article (86.2) said that 'While SSAP21 Accounting for Leases and H.P.C. has still to be brought fully into force, some companies are already capitalising their finance leases. The article discussed the accounts of Associated Paper Industries, Burton Group, Stainless Metalcraft and Rank Hovis McDougall companies, revealing the capitalisation of finance leases in their accounts.

A press report (86.3) revealed that the accounts of Sound Diffusion, the Sussex based electronic company, had been held up by problems in implementing the new accounting standard (SSAP21). P.Stonor (86.4) (the chairman of the company) said, in a letter to

shareholders, 'the application of SSAP21 had caused a 'prodigious amount of work for the company.' H. Brown (86.5), audit partner dealing with the company at Ernst and Whinny, agreed the SSAP had caused problems, but said: 'There are still some outstanding issues between us and the company.' Brown said the application of SSAP21 had caused particular problems for the company because it is a mixture of a sales and leasing business. 'They have totally revamped the whole basis of the accounts, and they have had to re-jig the whole of their leasing arrangements,' he said.

A press report (86.7) said that 'Companies which joined the leasing orgy following the 1984 Budget may not be regretting the effects on their profit and loss accounts. But those who abstained may now reap rewards by switching to finance lease capitalisation under SSAP21. The benefits are highlighted in the defence document of engineering group AE, which is fighting a £ 250 million bid from Turner and Newall. It has switched to using SSAP21 and produced an extra £2.4 million bid from Turner and Newall. It has switched to using SSAP21 as produced an extra £2.4 million profits for the already audited 1985 results. The boost in the year to 30 September should be worth the same again to projected earnings before tax of £28 million....'

It was reported (86.7), (86.8), and (86.10) that the availability of capital allowances on leases had been clarified by the Inland Revenue, with confirmation that SSAP21 on leases would not alter their tax position. This confirmation followed discussions with the ELA concerning misunderstandings about

entitlement to capital allowances in the cases of adopting SSAP21.

B.Picking (86.9), a partner in Arthur Andersen & Co., argued that SSAP21 keeps too many leasing transactions off the balance sheet. The distinction between finance and operating leases is artificial and open to abuse, concluding that '..It is to be hoped that the principle of substance over form embodied in the Institute's technical release (on Off Balance Sheet Finance, December 1985) will be applied equally to leasing transactions as to other forms of off balance sheet finance, and that SSAP21 will not fail for want of vigorous application.'

In 1987, it was reported (87.1) that 'Barclays Bank has changed its method of accounting for leases .. The change to the actuarial method of lease accounting brings the bank's policy into line with SSAP21 which takes effect on 1 July.' C.Wheeler (87.2), of Barclays, said: 'Barclays had been using the investment period method in accounting for its leases..' 'The actuarial method is more prudent than the one we were using. So we decided to change', he said.

A press report (87.3) revealed that 'Details of inconsistency by auditors in applying SSAP21 are to be presented to the ASC by the ELA. Leasing companies are finding that even within the same firms partners at different offices are coming to opposite conclusions about leases of the same type.' ELA chairman A.Outten (87.4) said: 'We would have welcomed a standard with greater definition.' But he was enthusiastic about an idea floated by Peat

Marwick partner Roger Chadder for an ASC-Authorised Committee to adjudicate in border line cases between operating and finance leases. This committee could be established by the ELA under the auspices of the ASC. ASC chairman Michael Renshall (87.5) said he was still waiting for the lessors' 'Shopping list'. 'But we are always receptive to sensible suggestions', he added.

The English ICA (87.6) (87.8) and (87.10) had issued a technical release on the implementation of SSAP21, the standard on leasing. SSAP21 become mandatory for periods beginning on or after 1 July 1987. The release drew attention to the problems of distinguishing between finance and operating leases.

Under the title 'Lease SSAP fails to please', a press report (87.7) said that 'A major battle is brewing between auditors and leasing companies over the application of leasing standard SSAP21. The widely-expected result is a call for a new lease accounting.' The report said that the Technical Committee of the English Institute had reminded auditors, in its technical release on the implementation of SSAP21, that complying with the letter of the standard (which came fully into force on 1 July 1987) might not be enough. The Institute had reminded auditors to apply the spirit rather than the letter of SSAP 21.

It was reported (87.9) that 'Binder Hamlyn have been sacked as auditors of computer leasing company IBL, following a row over the accounting treatment of leasing contracts. And a disagreement with Ernst and Whinney over the same subject led electrical leasing

company Sound Diffusion to ask the DTI for leave to produce audited accounts up to three months late. The report said that ' A joint working party of the English ICA and the ELA is expecting to produce a report on leasing contract accounting later this year...'

A press report (87.11) said that the publication of technical release on SSAP21 had come under fierce attack from top 20 firm Robson Rhodes. Jim Carty (87.12) (of Robson Rhodes), in a letter to Brian Worth (the Technical Committee chairman of ICAEW), wrote 'the document was unhelpful and we would recommend that the Technical Committee should not make any further public statements on matters of accounting principles.' He wrote 'We do not consider it a function of a junior committee of one of the sponsoring bodies of that Accounting Standard Committee to attempt in a unilateral way to amend, or place particular interpretations upon, statements of standard accounting practice. These should come, if anywhere, from the ASC itself'. Mr Carty (87.13) said 'TR 664 is worded in a very bad way. You could draw all sorts of conclusions from it. One of my clients thought it could be read to mean that SSAP2 could be disregarded.' Furthermore, he added, the busy practitioner was already inundated with enough paper from other sources. But, as the Institute (87.14) pointed out 'its Technical Advisory Service receives around 5,000 calls a year, many of which are from practitioners seeking advice on accounting standards.' G. Mitchell (of the ICAEW) said 'The ASC with its small resources could not possibly deal with all those queries,' 'and in any case, members are entitled to expect help from their Institute. The answers that we give are always cleared with the ASC' he said. The technical

release, he added, had been written by ASC staff and the ASC was 'delighted at gaining explicit support from one of its major constituency bodies'.

A press report (87.15) said that 'Companies are still in the dark about how to apply the leasing standard in practice, an expert warned this week.' R.Chadder of Peat Marwick McLintock, according to the press report, attacked guidelines issued in the summer by the English ICA. He singled out for criticism schemes being marketed by Forward Trust.

The English ICA (87.16) had approved a new software package that claimed to take '....the headache out of meeting SSAP21'. The software would produce balance sheet, profit and loss and notes to accounts in accordance with SSAP21. Complex calculations could be carried out automatically. G.Macmillan (87.17), Catsoft director, said: 'The new leasing standards are so complex that if you have more than about five leases it gets very hard to handle all the volumes manually. 'In Australia microcomputer software has played a crucial role in supporting the standard' he added.

The conclusion from this section is that SSAP was issued in July 1984. It insisted on capitalisation of finance leases in the accounts of lessee as suggested by ED29, but it allowed grossing up of regional development grant which was prohibited in the exposure draft.

This outcome, as a visible event at that time, was connected,

in one way or another, with the invisible interactions and power relations (which preceded and surrounded such event) between the ASC and finance directors of companies (and other directors) and others concerned with the standard. Also, this outcome was succeeded by interactions and power relations as shown in Figure 7.2, from July 1984 to the end of 1987. This was, partially, due to the delaying of implementation date of the standard for the lessees to the first of July 1987.

As illustrated in the section, the leasing industry involved in the network of the interactions and power relations about the standard, objected to the capitalisation of leases [see written submissions of the ELA, the Finance Housing Association, and the British Vehicle Rental & Leasing Associations, (82.2), (82.3), (83.6), and (84.5)]. But the standard brought a different treatment from that suggested by the leasing industry and similar to the one suggested by the ASC (i.e capitalisation). This can be understood in the light of the following.

Firstly, the ASC worked for a long time for this standard (about 11 years), utilising different disciplinary techniques such as formal and informal meetings, discussions (even in the early stages of the exposure draft), courses, public hearings, talks to the press by officials,...etc.

Secondly, the views of the ASC on capitalisations, was supported intentionally or otherwise, by the views of other interested groups, particularly from some leasing companies and

other types of companies [see written submissions from companies and other groups, (81.22), (81.22), (81.23), (81.24), (81.28), (81.34)], as well as with the issuing of the international standard in April 1982 which recommended capitalisation, [(82.6), and (84.15)].

Thirdly, and finally, the leasing industry itself was divided about capitalisation. For example Mr G.Jenkins of Mercantile leasing Ltd, Mr H. Rypma of Rank Xerox Ltd (see also written submission of his company), Mr Young of Lombard North Central, were all members of the ASC working party on leasing and all of them were in favour of capitalisation [see (82.8)].

On the other hand, the standard allowed grossing up of regional development grants as suggested by the leasing industry. This was, possibly, because of the unity of the leasing industry concerning this issue and the support, intentionally or otherwise, of this issue by the other types of companies and other representative bodies.

This outcome which required capitalisation (as suggested by the ASC) and allowed grossing-up (as recommended by the leasing industry) demonstrates that power in the process of setting the leasing standard is not possessed by the ASC or by leasing industry (or by any other group). It is rather exercised through a network of relations in which different groups are involved.

Finally, (SSAP21), somewhat unintentionally, was delayed for

one year (from July 1983 to July 1984) not because of any technical objections on the standard but because of Irish tax problem. And most of the interactions and power relations at this period were about this problem [see (83.12), (83.13), (83.14), (83.15), (83.16), (83.17), (83.18), (84.1), (84.3), (84.4), (84.6), (84.7), (84.8), (84.9), (84.10), (84.11), (84.12), (84.13), (84.14), (84.16), (84.23), and (84.28)].

7.3 CONCLUDING COMMENTS

The analysis introduced in the previous sections, shows the manner by which interactions and power relations are exercised in the process of setting the leasing standard. This power, it can be argued building on Section 5.5, has disciplinary, relational, and positive aspects.

It is disciplinary because it is exercised through disciplinary apparatuses/techniques. These techniques, as highlighted in the previous sections, were: published articles in the financial press, letters to the press, formal and informal meetings between the ASC and finance directors and other interested groups, press comments, press news about the progress of the standard, public hearings, written submissions to the ASC, and publishing the annual reports of some companies and audit reports.

These disciplinary techniques rendered the views of companies and other interested groups and standard setters (about the standard) visible and governable. This visibility increased, as

indicated Section 5.5, by the ASC's movement towards an increasingly open policy about its work. It was, also, magnified through the professional and financial press (see the 1978 element in Figure 7.1 and all elements in Figure 7.2).

Power exercised in the setting of the leasing standard was relational in a sense that it was exercised from all involved in this process including companies and other interested parties and the ASC. As illustrated although the leasing industry was involved in the network of power relations concerning the leasing exposure draft, the resulting exposure draft (ED21) brought a treatment (i.e capitalisation of leases in the accounts of lessees) which is similar to the views of the ASC. This does not mean, as the traditional model of power suggests, that the ASC has a power over the leasing companies, rather it means that this treatment was supported, intentionally or otherwise by other persons and groups involved in the network of power relations concerning this standard. Also when the standard was issued in July 1984, allowing grossing up of regional development grants as suggested by the leasing industry, does not mean that the leasing industry had power over the ASC. Rather it means that this treatment was supported, intentionally or otherwise, by the other types of companies and other representative groups.

Power exercised in the setting of the leasing standard is positive, in a sense that it produced a massive discourse for a long period of time (from 1971 to 1984) about the leasing topic through which much more understanding of the nature of this topic

was gained for all involved in the network of interactions.

In addition, the previous sections demonstrated that the interactions and power relations concerning the leasing standard (at the specific level) needs to be located within the wider context of interactions and power relations about the process of setting accounting standards at the more general level. As shown in the 1978 element in Figure 7.1 and the 1979, 1982, 1983 and 1984 elements in Figure 7.2) the interactions and power relations increased in the period from 1979 to 1984 in comparison with the previous period (1974-1977). This can be connected to the open policy adopted by the ASC at the more general level since 1978.

Furthermore, the previous sections demonstrate, in contrast to the previous studies, that interactions about this standard were not only manifested through the written submissions. But rather a variety of forms were involved. In fact, in certain stages of the history of the standard, the written submission as a form of interaction was not in existence. As shown in Figure 7.1, and 7.2 there were interactions about this standard 7 years before issuing the exposure draft(ED29). These interactions manifested themselves in a variety of forms which excluded written submissions. Also after issuing the standard (SSAP21 in July 1984) there were interactions which manifested themselves in a variety of forms which excluded written submissions.

7.4 CONCLUSION

This chapter was an attempt -utilising Foucauldian genealogical analysis, and the material available in the professional and financial press and the ASC documents- to trace the micro-powers (techniques of power) exercised in the setting of the leasing standard during the period from 1971 to 1988. In so doing, the Chapter demonstrated the following points.

Firstly, the issuing of the leasing exposure draft (ED29) in October 1981 and the following standard (SSAP21), as visible events during this period, were preceded and surrounded with invisible interactions and power relations between the ASC and finance directors (and other directors) of companies and other interested groups.

Secondly, the role of UK companies' finance directors (and other directors) in the setting of the leasing standard is not just a reactive role in terms of written submissions to the ASC, but also, and may be more importantly, it is an interactive process in which different forms of interactions are involved. This, in turn, demonstrates that interactions and power relations were exercised at all stages of the history of the standard. They were exercised not only after issuing the exposure draft, as the previous studies suggested, but also before and after issuing the exposure draft and the standard.

Thirdly, this role of UK companies' finance directors (and other

directors) in the setting of leasing standard can only be fully understood within the wider context of interactions and power relations between the ASC and all persons and groups involved in this process.

Fourthly, and finally, the interactions and power relations at the specific level (leasing standard) need to be placed within the wider context of the interactions and power relations concerning the process of setting accounting standards at the more general level to gain a full understanding of the process.

CHAPTER 8

CONCLUSIONS, IMPLICATIONS, LIMITATIONS,
AND FUTURE RESEARCH

In this concluding Chapter, first, the conclusions are presented; second, the limitations are addressed, third, implications are outlined and, finally, suggestions are made for future research.

CONCLUSIONS

This study has been concerned with understanding the interactions and power relations between UK companies through finance directors (and other directors) and those persons and organisations (who directly or indirectly are involved with the concern of UK companies) and the Accounting Standards Committee (ASC). This concern has been analysed at both the general level (interactions and power relations surrounding the process of setting accounting standards) and the specific level [i.e interactions and power relations surrounding the Depreciation Standard (SSAP12) and Leasing Standard (SSAP21)]. This focus was not intended to understand the motivation or interests of UK companies' finance directors (and other directors) in exercising power on the ASC, as the previous studies suggested. Rather the aim was directed to analyse the techniques/apparatuses through which power is exercised in the interactions between them. In other words, the study, was seeking to answer a very different question

from that asked by the previous studies. This question was: How is power exercised between UK companies' finance directors (and other directors) and other interested parties and the ASC ?

The contents of this study can be seen to be divided into three major sections. The first major section presented a case for, and outlined the nature of, a methodological approach based on Foucault's philosophy. Chapters 2 and 3 were devoted to addressing this concern. The second major section, was concerned with a critical review of the nature of the literature paying particular attention to its epistemological and methodological underpinnings. This was the concern of Chapter 4. Finally, the third section, and the most substantive part, was addressed to the application of this methodological approach in understanding the interactions and power relations between UK companies' finance directors (and other directors) and other interested parties and the ASC. Chapters 5, 6, and 7 were addressed to this concern.

In Chapter 2, the concern was primarily with Foucault's work more generally and its relevance in the context of this study. In the first part of the Chapter, an understanding of the underlying themes of Foucault's philosophy was presented. It was argued that Foucault's particular methodology -genealogy- enables him to introduce to the very root of thought new concepts of the relationship between power and knowledge, history, critique, and theory and practice. In the second part of the Chapter, the relevance of these new concepts to this study's concern were addressed. It was argued that these new concepts have great

potential as a methodological approach for understanding the interactions and power relations between UK companies and other interested parties and the ASC.

Building on the genealogical method discussed in Chapter 2, it was argued in Chapter 3 that Foucault's aim is not to provide a theory of power, or an account of its origins, source or foundations, but rather to describe, what he calls an "analytics of power" (i.e. the concrete mechanisms and practices through which power is exercised). The conclusion from this analysis was summarised in the following points. Firstly, power is not possessed by subjects, it is rather exercised in the relationships and consequent effect of one action on another. Secondly, following on from this, power cannot be localised in a definite number of elements or, more generally, in the State apparatus. There is no focal point, for Foucault, but an endless network of power relations. Thirdly, power relations are intentional but can be described without being attributed to particular subjects as their conscious intentions. Fourthly, power is not merely negative and repressive, but positive and productive. Fifthly, and finally, power relations are accompanied by resistances.

This Foucauldian analytics of power, it was argued in the second part of Chapter 3, has great potential as a methodological approach for the concern of this study. This is because there is no specific legislation in the UK accounting standards. The ASC is a wholly private body. No legal powers have been delegated to it by government. Given this situation, the operation of the standards

and the process of setting them can be characterised as an exercise of disciplinary power. Thus, the most appropriate way to understand this power, following Foucault's approach, is by asking the question: How is power exercised between UK companies and the ASC? The answer to this question, following again Foucault's approach, can be discovered by tracing the micro-powers in the setting of standards. In this way, by adopting the Foucauldian analytics of power, this study revealed the disciplinary, relational, unintentional, positive aspects of power exercised between UK companies and the ASC. This, in turn, will enrich our understanding about the standards and the process of setting them.

Through the lens of the Foucauldian approach -outlined in Chapters 2 and 3-, a critical review of the literature was presented in Chapter 4. The aim of this critical review was to demonstrate that the stock of knowledge of this literature is inadequate to satisfy the need of this study.

The reason for reviewing disciplines other than accounting and finance, as argued in Chapter 4, was that this study has many different aspects and concerns. These involve power, inter-organisational relationships, profession, regulation and accounting and finance. These aspects are addressed in the literature of different disciplines. The first two sections of Chapter 4 were devoted to addressing this literature. In the third section, the accounting studies, adopting a Foucauldian approach, were discussed and critically evaluated. The conclusions from this critical literature review was that this literature is

inadequate to satisfy the need of this study's concern. This was for two reasons. Firstly, because the literature does not ask the central question of this study: 'How is power exercised?'; and Secondly, because the literature suffers from epistemological and methodological problems. In addition, the studies adopting a Foucauldian approach were criticised for their partial analyses.

Thus by rejecting the existing literature in accounting and finance and other disciplines, (even those adopting a Foucauldian perspective), it was suggested that the Foucauldian approach summarised in chapter 2 and 3 had great potential as a basis upon which to build for the concerns of this study. Bearing in mind some of the problems of adopting this approach in other accounting studies, Chapters 5, 6, and 7 were devoted to applying a Foucauldian perspective to understanding the interactions and power relations between UK companies and other interested parties and the ASC.

Chapter 5 (based on a Foucauldian genealogical analysis and the material available in the professional and financial press and the ASC documents) was concerned with tracing and charting the micro-powers (techniques of power) exercised in the process of setting accounting standards -at a general level- during the last twenty years (1969 - 1988).

The analysis provided in Chapter 5 formed an important prelude and basis for the analysis of Chapters 6 and 7 in the sense that the interactions and power relations about particular

standards [i.e Depreciation Standard (SSAP12) -in Chapter 6-, and Leasing standard (SSAP21) -in Chapter 7-], need to be located within the wider context of interactions and power relations about the process of setting accounting standards at the more general level. This is because, it was argued, there are interactions between the general and specific levels of power relations in the process of setting accounting standards. In Chapters 6 and 7 (again utilising Foucauldian genealogical analysis, and the material available in the professional and financial press and the ASC documents) the concern was with tracing the micro-powers (techniques of power) exercised in the setting of these two standards during the last twenty years (1969 - 1988).

These micro-powers, as demonstrated in Chapter 5,6, and 7 were: published articles in the financial press, letters to the press, press conferences, talks to the press by officials, interviews by the press to officials, formal and informal meetings between the ASC and finance directors and other persons concerned with financial reporting, speeches by officials, press comments, press news about the work of the ASC, public hearings, conferences, published companies annual reports and audits reports, studies conducted by academics for the profession, issuing discussion papers (Corporate Report and Watts Report), issuing audio cassette/guidebook packages about accounting standards, courses carried out by the ICAEW in association with District Societies about the new accounting standards, giving oral guidance by the ASC, issuing publications about accounting standards, formation of new representative groups (such as The 100 Group, The Midland

Group, The Scottish Group of Finance Directors), and by representative bodies joining the ASC Consultative Group on the request of these bodies.

The analysis provided in these three Chapters illustrated and lend support to the following points.

Firstly, the role of UK companies' finance directors (and other directors) in the process of setting accounting standards at both the general and specific levels can only be fully understood within the wider context of interactions and power relations between the ASC and all persons and groups involved in this process.

Secondly, the creation of the accounting standard programme and the ASC in January 1970 and the changes following (as discussed in Chapter 5), the issuing of the first exposure draft on depreciation (ED15) in January 1975 and the changes which followed (as indicated in Chapter 6), and the issuing of the leasing exposure draft in October 1981 and the following standard [SSAP21] (as discussed in Chapter 7) as visible events during this period, were preceded and surrounded with invisible interactions and power relations between the finance directors of companies (and other directors) and other interested groups and the ASC.

Thirdly, the role of UK companies' finance directors (and other directors) in the setting of accounting standards at both the general and specific levels was not just a reactive role in terms

of written submissions (visible reaction) to the ASC, but also, and may be more importantly, it was an interactive role in which different forms (visible and invisible) of interactions were involved. This, in turn, demonstrated that interactions and power relations were exercised at all stages of the history of the standard. They were exercised not only after issuing EDs, as the previous studies suggested, but also before and after issuing Discussion Papers,, SoI, EDs and SSAPs. In addition, it was illustrated that in certain stages of the history of the standard, some forms of interactions prevailed.

Fourthly, the interactions and power relations at the specific level (with regard to the depreciation standard and the leasing standard), to be fully understood, need to be placed within the wider context of interactions and power relations concerning the process of setting accounting standard at the more general level.

Fifthly, and finally, power relations between UK companies and others and the ASC at both the general and specific levels has disciplinary, relational, positive aspects. The relations of power, at the specific level, depend upon the nature of the standard and the time in which it was issued. Even within the same standard, these relations of power were different from time to time.

LIMITATIONS

Although this study has attempted to reveal the invisible

interactions and power relations between the ASC and finance directors of companies (and other directors) within the wider context of interactions with the other interested parties, these invisible interactions are arguably not fully captured due to the following reasons. Firstly, considering the invisible nature of these interactions, it is not possible for any study to fully capture such invisibility. Secondly, the limitation of time and space of this thesis restricted the investigation to only two accounting standards. To fully capture the different nature of interactions in each case there is a need for a comprehensive analysis of all the standards. Thirdly, because of the inability to obtain access to all the material needed for this study (such as the minutes and agenda papers of the ASC working parties) on the two chosen standards. The access limitation of the study to only the minutes and agenda papers of the ASC meetings did not reveal in great detail the activities of the sub-committees. Fourthly, by concentrating on only the documentary data the study is unable to reveal the undocumented invisible interactions and power relations. Fifthly and finally, the study is limited by the data collected from the ASC and the financial press, and there is a need to examine data from the companies themselves and their representative bodies to reveal in greater depth how these companies and the representative bodies interact, directly or indirectly, with each other and with the ASC. There is a need to examine data about meetings held on the local levels about accounting standard through the district societies. Sixthly, and finally, regarding the Foucauldian model of power (i.e. analytics of power) adopted in this study it is uncertain about the applicability of this model

in other contexts, particularly in other countries where the legal power in the form of laws and the interference by government in regulation is at a higher level. Despite these acknowledged limitations the study has arguably made marked and significant inroads into uncovering some of the seemingly more important interactions and power relations between the various parties involved.

IMPLICATIONS

The analysis provided in this study has a number of wider implications. These are described briefly below.

Firstly, accounting standards and the process of setting them are political not because they may have political consequences or be politically useful -as the previous research, discussed in Chapter 4, suggested- but because they have their conditions of possibility dependent upon power relations. The analysis provided in this study lends support to this point in a sense that the creation of the accounting standards programme and the ASC in January 1970 and the changes that followed (as illustrated Chapter 5); the issuing of the first exposure draft on depreciation in January 1975 and the changes which followed (as indicated in Chapter 6); and the issuing of the exposure draft on leasing in October 1984 and the following standard (as illustrated in Chapter 7) were the effect of complex interactions and power relations.

Secondly, any changes in the formulation of accounting

standards, both generally and in specific cases, were produced neither through a 'pure' accounting theory nor a 'pure' accounting practice. It was rather the outcome of interactions between theory (where there is much academic involvement in this process as illustrated in the study) and practice (where there is much involvement from companies' finance directors and auditors and others in this process) in a continuous historical process. This, in turn, leads us to suggest that accounting theory (produced by academics), and accounting practice (produced by companies and auditors) are not separable as the previous studies suggested. Such studies tended to contrast accounting theory on the one hand with accounting practice on the other. The analysis of this study suggests that accounting theories are themselves fragments of reality in a dynamic, complex relation with accounting practice. This does not mean that this study denies totally such dichotomous relationships, rather it demonstrates the complexity of reality. It is suggested in this study that these traditional dichotomies -accounting/finance theory and accounting/finance practice- limit the play of thought and action by organising their contents, and, in turn, limit our understanding of the accounting/finance phenomenon -or any other social phenomenon. To put it another way, such divisions fail to account for the extremely complex configuration of the reality of these phenomenon.

Thirdly, any accounting/finance phenomenon -or any other social phenomenon- to be fully understood, needs to look for the visible factors, as well as, and may be more importantly, the invisible ones laying underneath such phenomenon. As illustrated in

this study there were a variety of invisible forms of interactions and power relations in the process of setting accounting standards at both the general and specific levels.

Fourthly, to be fully understood, any accounting/finance phenomenon -or any other social phenomenon - should be located within its social context. One example to support this point is that the professional and financial press -in the UK context in contrast to the US, played an important role, as a mediator, in exercising power in the process of setting accounting standards at both the general and specific level. Accordingly, it is misleading, as the previous studies have suggested, to understand the UK process by adopting models which are borrowed from other contexts such as the US or Canada.

Fifthly, to capture the dynamic and complex nature of our accounting/finance phenomenon -or other social phenomenon, there is a need to utilise a rich and insightful methodological approach (such as the Foucauldian approach as well as others). It is not appropriate, given the complexity of the focus to use a scientific approach to understand this dynamic since it restricts the investigation to the visible, simple, and static nature of the phenomenon. By utilising richer and more dynamic approaches, as illustrated in this study, the hidden, complex nature of the accounting/finance phenomenon -and other social phenomenon-, will be revealed.

Sixthly, since the interactions and power relations differ

from one standard to another and from time to time, as illustrated in this study, there is a need to explore these relations of power in other different cases to enrich our understanding about these processes.

Seventhly, this study has wider implications for other disciplines such as the sociology of professions, philosophy, organisation theory, and regulation theories. As argued in this study, these theories ignore the disciplinary, relational, positive aspects of interactions and power relations in their concern. There is, however, an arguable need to consider these aspects in these theories.

Eighthly, and finally, the empirical exploration of this study suggests a modification to even Foucauldian thought. The suggestion is that disciplinary power is exercised through its invisibility, but at the same time imposes a compulsory visibility on both the subject and object of power (not only on the object of power as the Foucauldian model suggested).

FUTURE RESEARCH

In the light of the limitation of this study, it is suggested, for further research, to repeat this study, attempting to collect much more data about these interactions and power relations from the companies and their representative bodies as well as from the local level of the district societies. Also, this study can be repeated with other standards to learn different lessons from

each case, and, in turn, to enrich our understanding about this complex and dynamic process. In addition, this study can be repeated in other contexts to examine the applicability of the Foucauldian model of power in different contexts. For example this study could be repeated in other countries such as the US and Germany where there are different degrees of government involvement (legal power) in the process of setting accounting standards. Furthermore, the Foucauldian approach adopted in this study also has a potential application in other accounting and finance topics and other managerial problem areas, particularly those studies seeking to explore the interactions and power relations underlying processes of changes. Finally, the message of this study for future research is that any research project can be conducted using many different theoretical and methodological approaches. The positivist approach (where the researcher reviews the literature, in an uncritical manner, in an attempt to pick up some variables, then tests these variables using mathematical models and controlled empirical data) is not the only approach for conducting research. As illustrated in this study, there are other different methodological approaches (such as the critical Foucauldian approach and others) which can capture what the positivist approach cannot. In these alternative approaches, as seen in this study, the literature is not taken for granted, it is, on the contrary, critically evaluated. Through this critique, as illustrated in this study, the real development of our knowledge can be possible.

FIGURES

FIGURE 1.1

THE APPLICATION OF DIFFERENT METHODOLOGICAL APPROACHES
IN ACCOUNTING AND FINANCE STUDIES

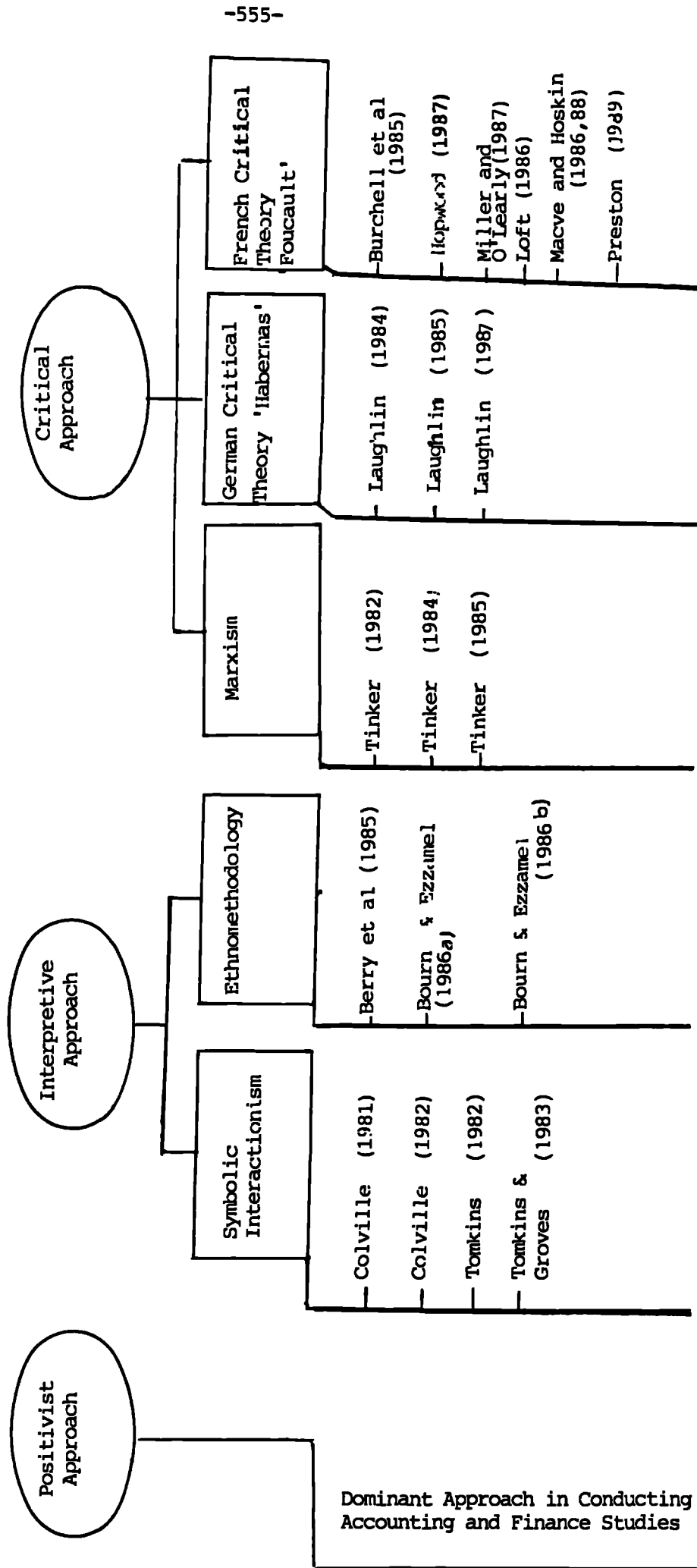
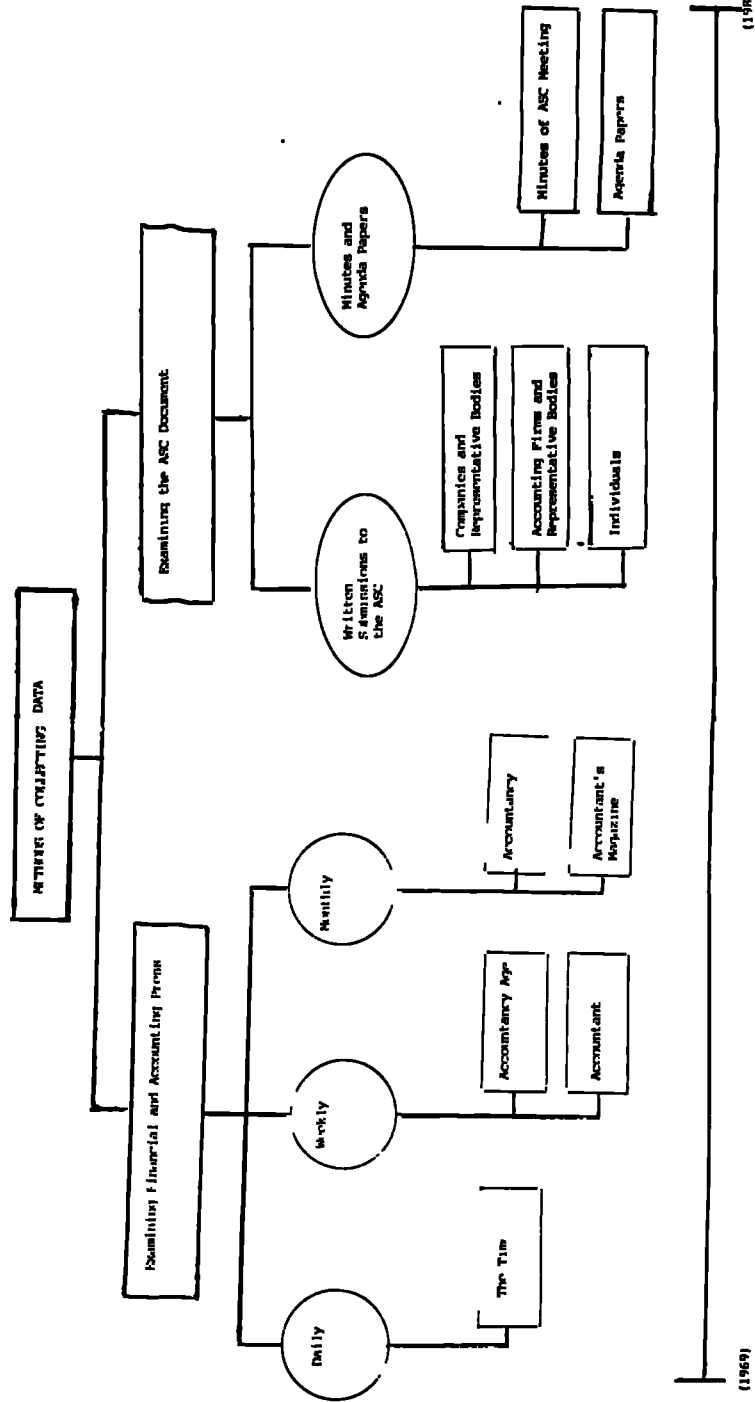

FIGURE 1.2
METHODS OF COLLECTING DATA



(1988)

(1989)

FIGURE 1.3
THE STRUCTURE OF THE STUDY

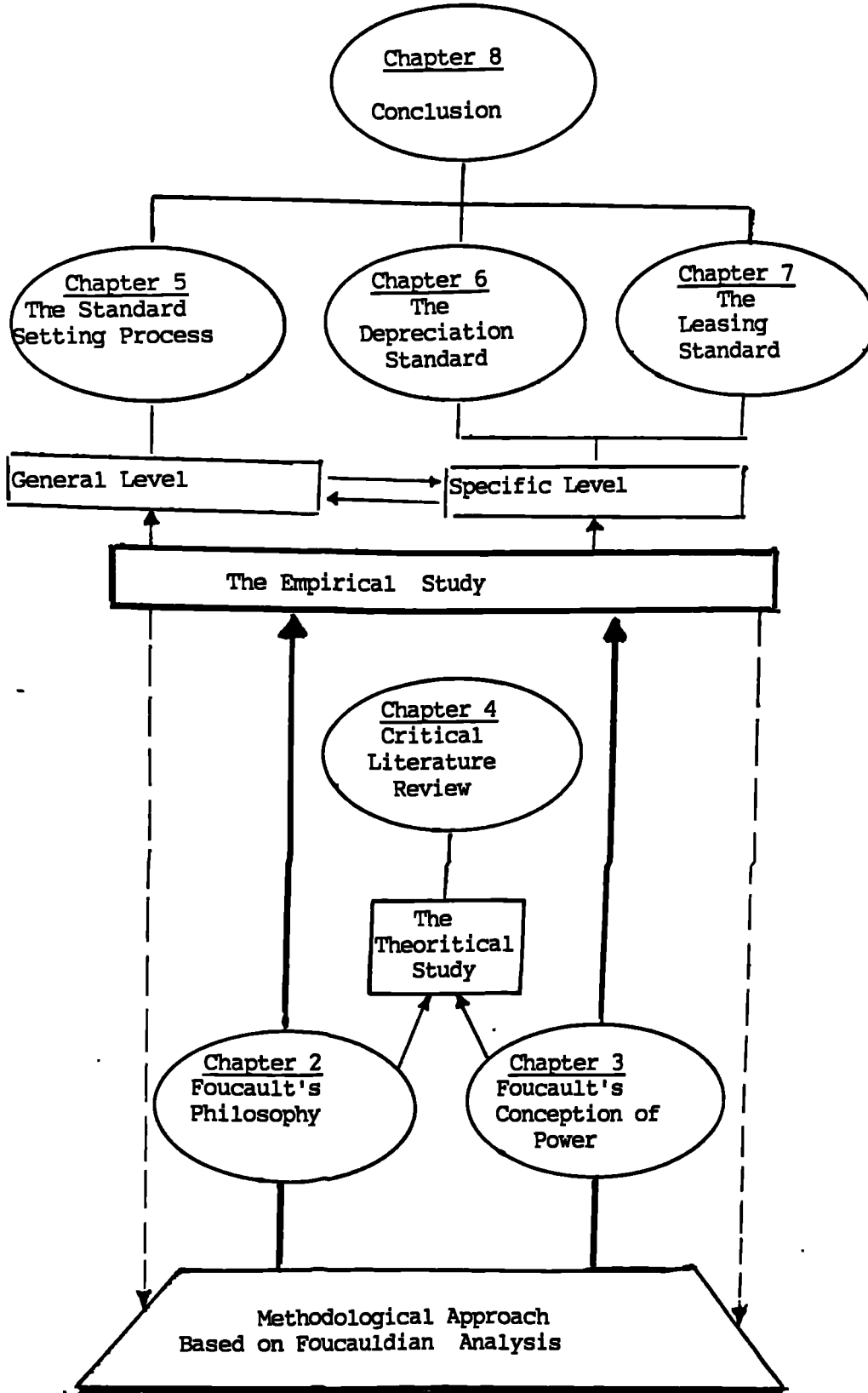

FIGURE 4.0
CRITICAL LITERATURE REVIEW: CHAPTER DESIGN
AND TRACING POSSIBLE CONNECTIONS TO THE RESEARCH CONCERN

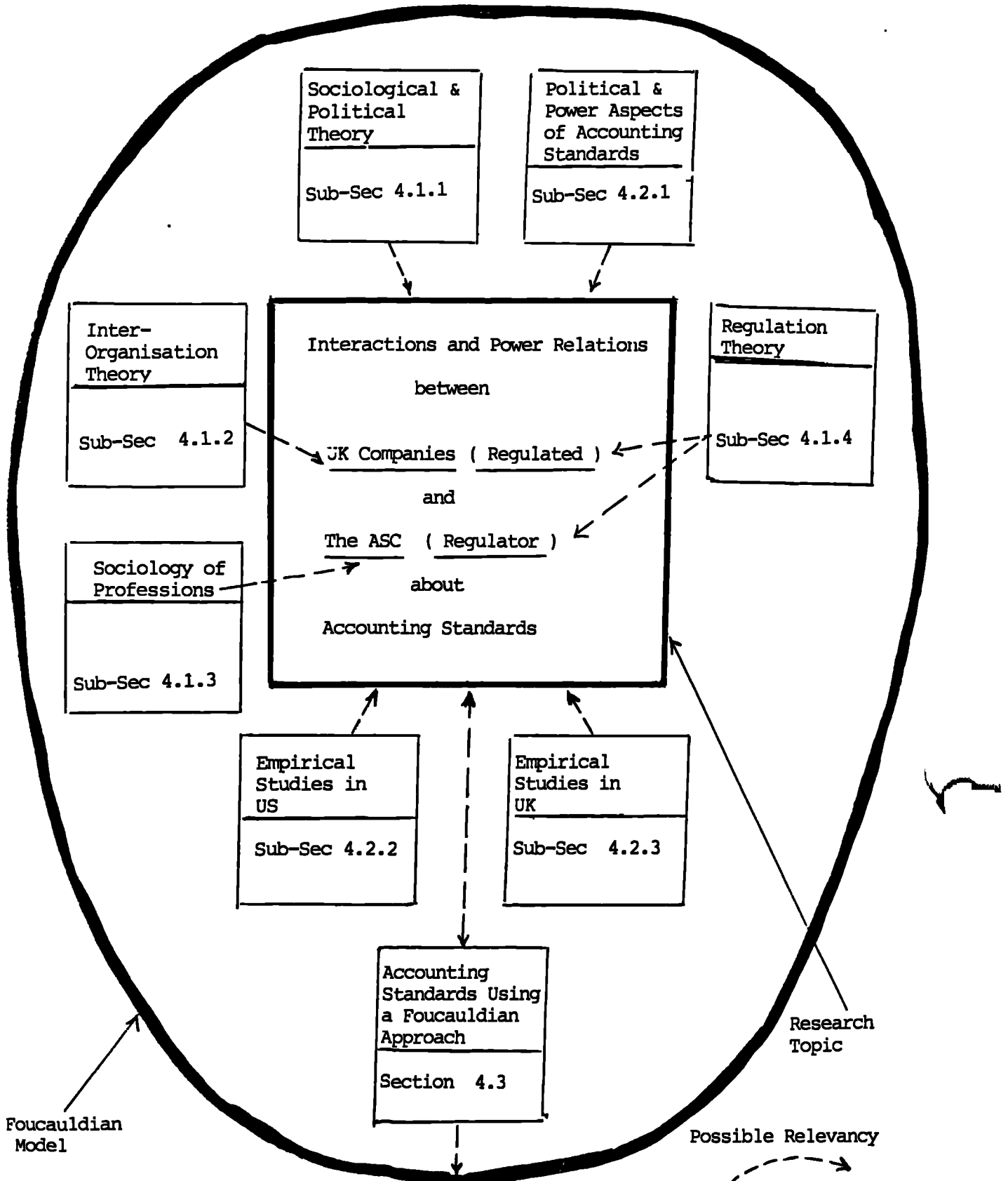

FIGURE 5.0
CHANGES IN THE ABC AND THE STANDARD SETTING PROCESS
(1969-1988)

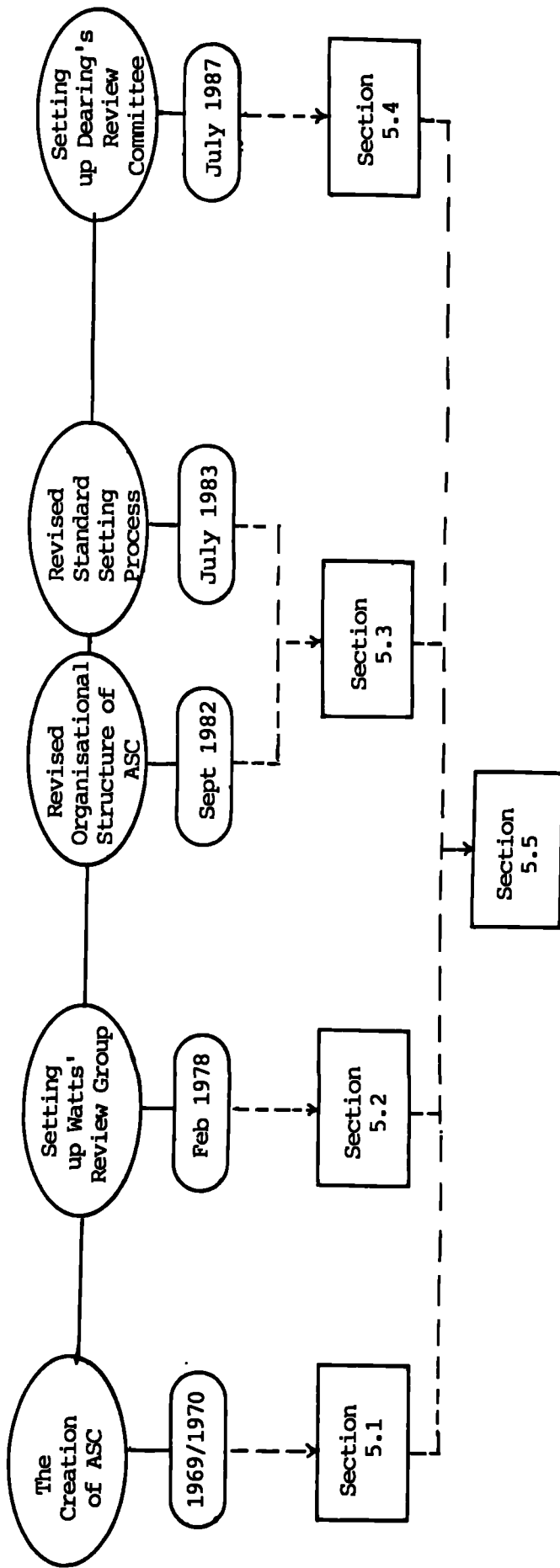

FIGURE 5.1
INTERACTIONS AND POWER RELATIONS ABOUT ICAEW'S STATEMENT OF INTENT
AND THE CREATION OF THE ASC (1969/1970)

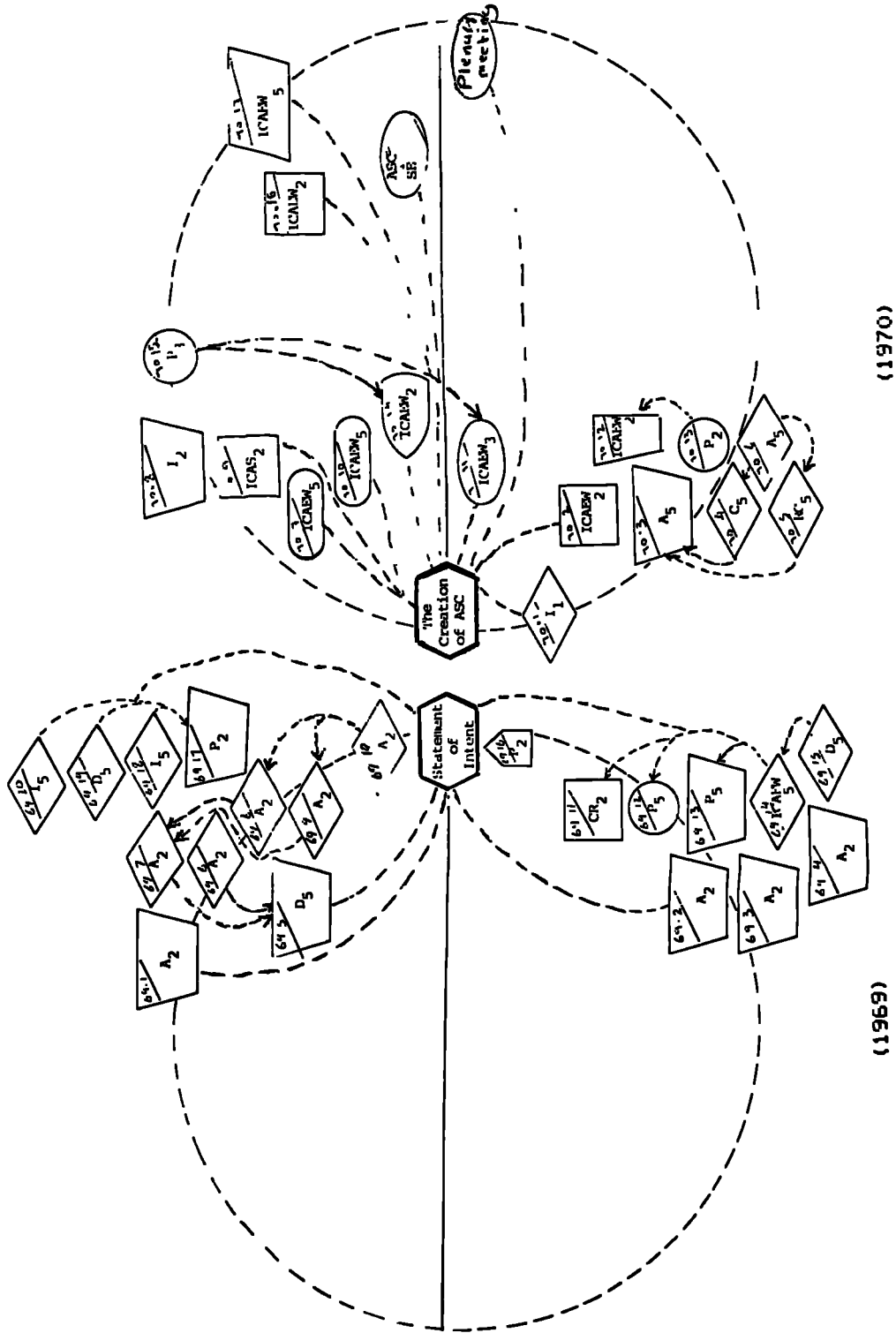

FIGURE 5.2
INTERACTIONS AND POWER RELATIONS ABOUT
SETTING UP WATTS' REVIEW GROUP IN FEBRUARY 1978

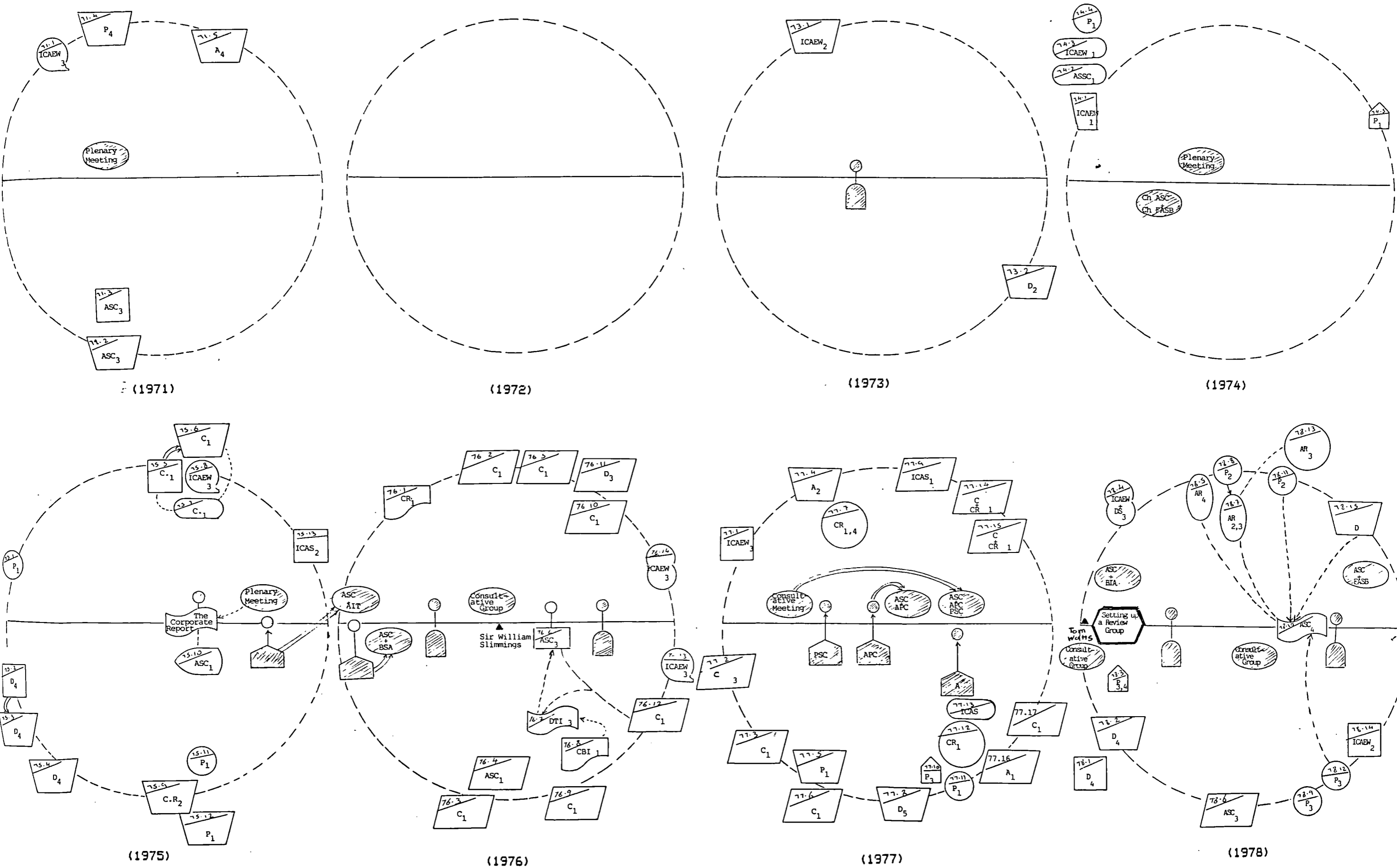

FIGURE 5.3

INTERACTIONS AND POWER RELATIONS CONCERNING

THE REVISED ORGANISATIONAL STRUCTURE OF THE ASC (SEPTEMBER 1982)

AND THE REVISED STANDARD SETTING PROCESS (JULY, 1983)

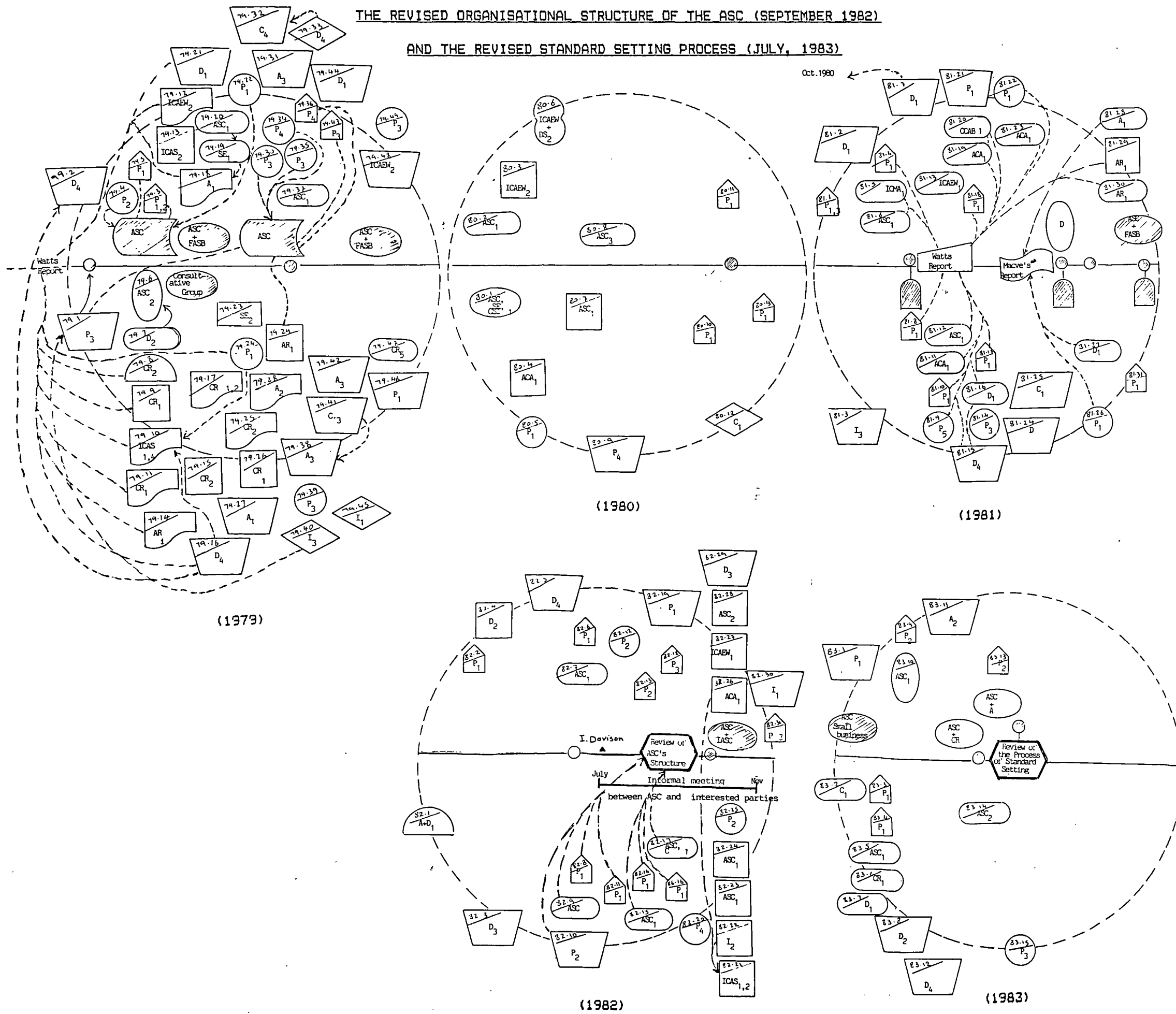

FIGURE 5.4

INTERACTIONS AND POWER RELATIONS RELATED TO SETTING UP DEARING'S
REVIEW COMMITTEE IN NOVEMBER, 1987

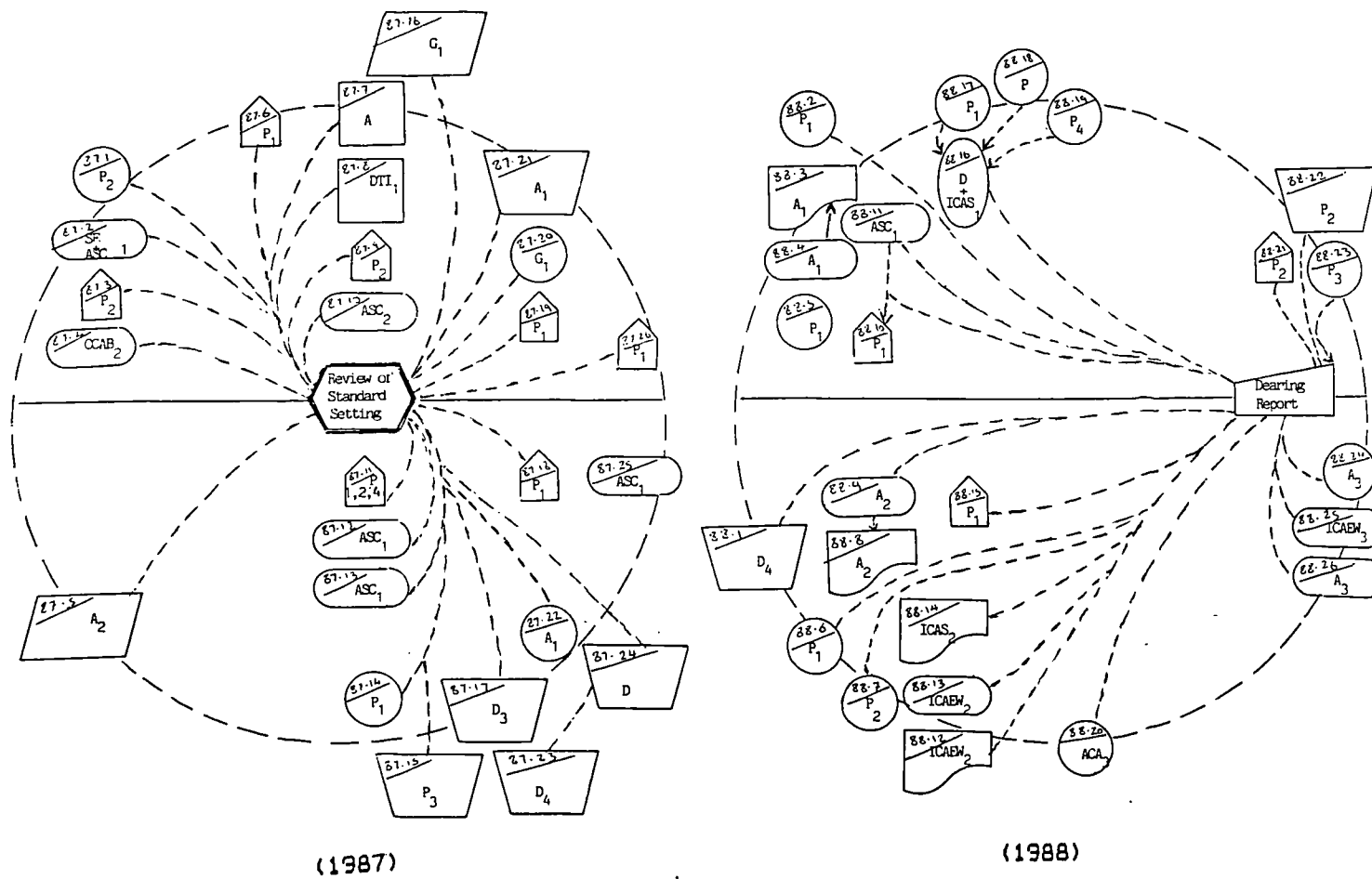
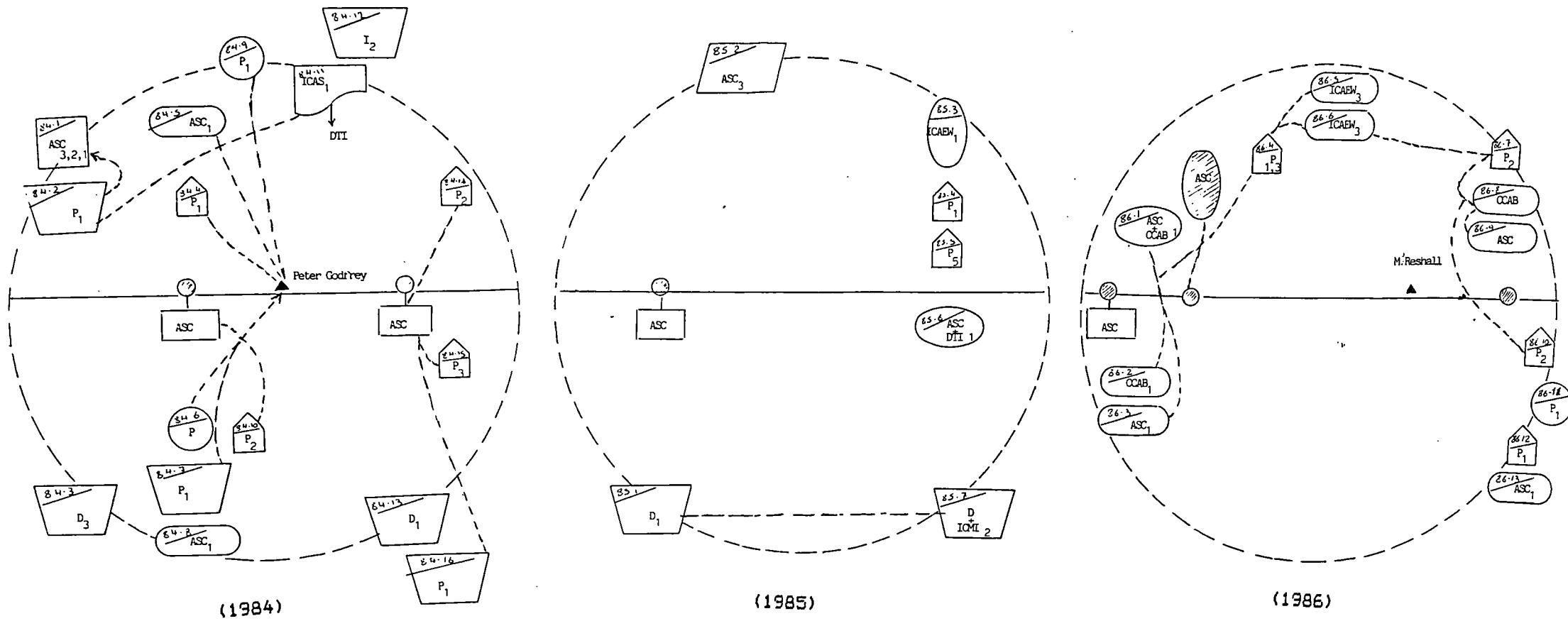

FIGURE 6.0
CHANGES IN THE DEPRECIATION STANDARD
(1969-1988)

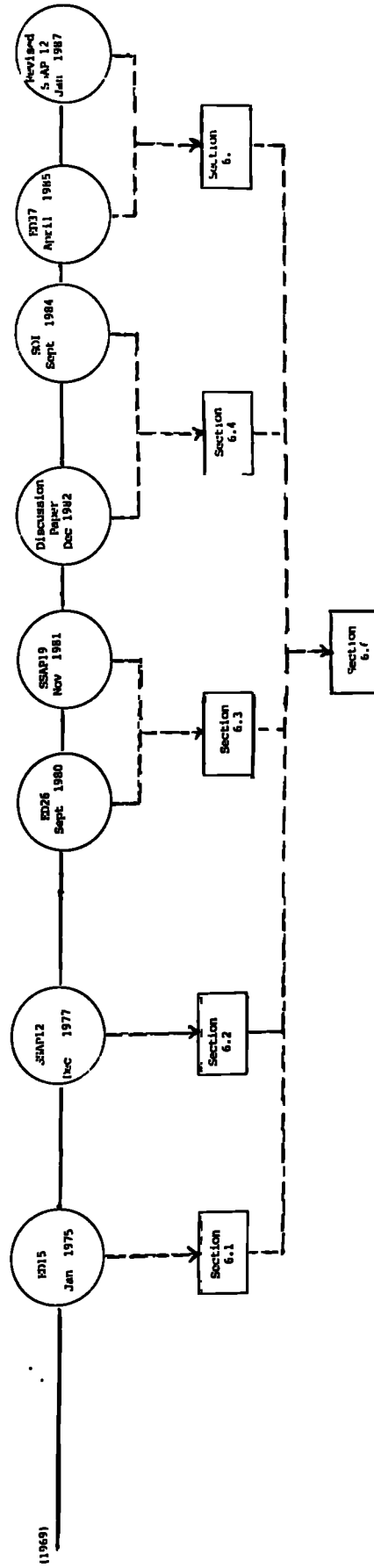

FIGURE 6.1
INTERACTIONS AND POWER RELATIONS
RELATED TO ISSUING ED 15 IN JANUARY 1975

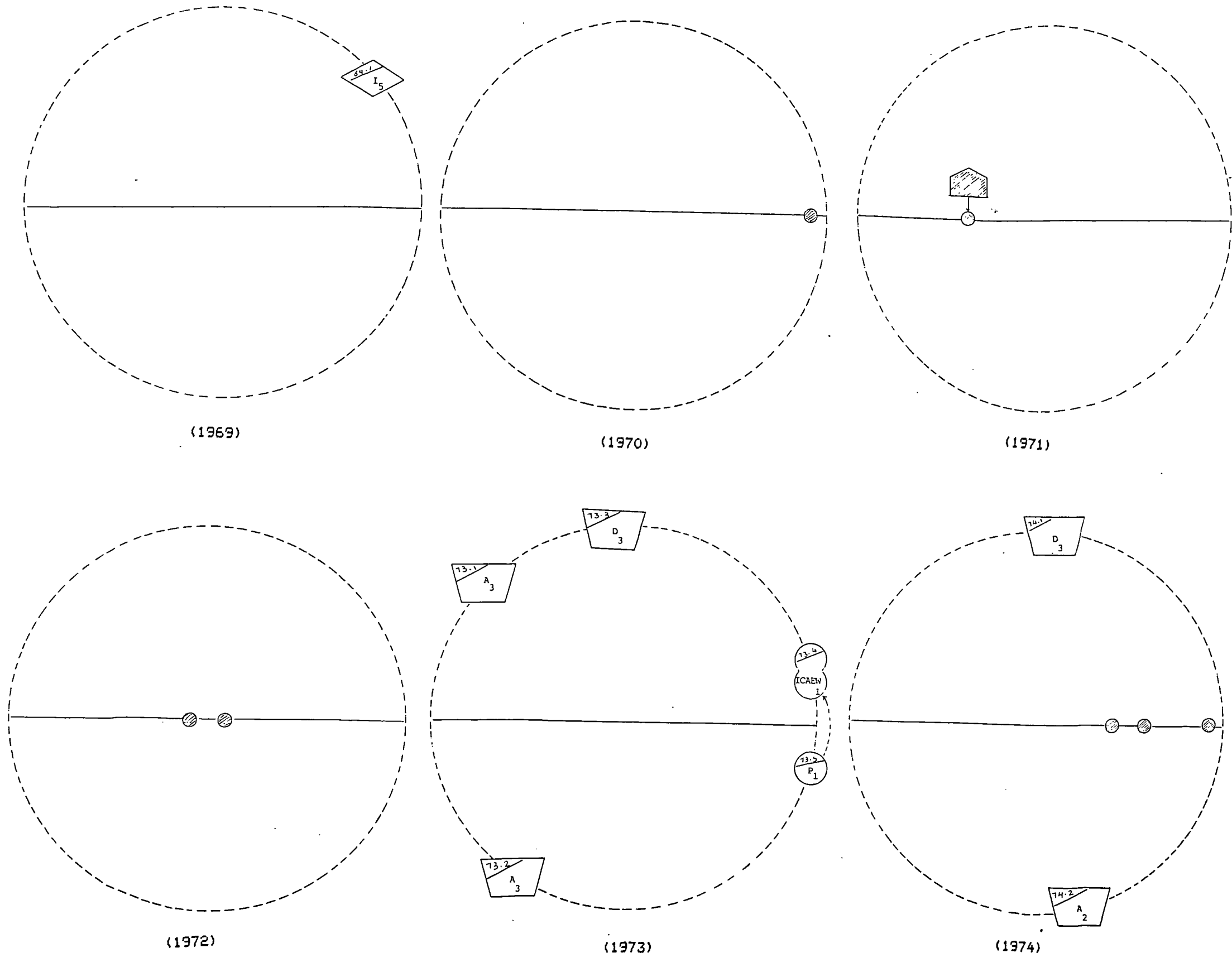

FIGURE 6.2
INTERACTIONS AND POWER RELATIONS
RELATED TO ISSUING SSAP 12 IN DECEMBER 1977

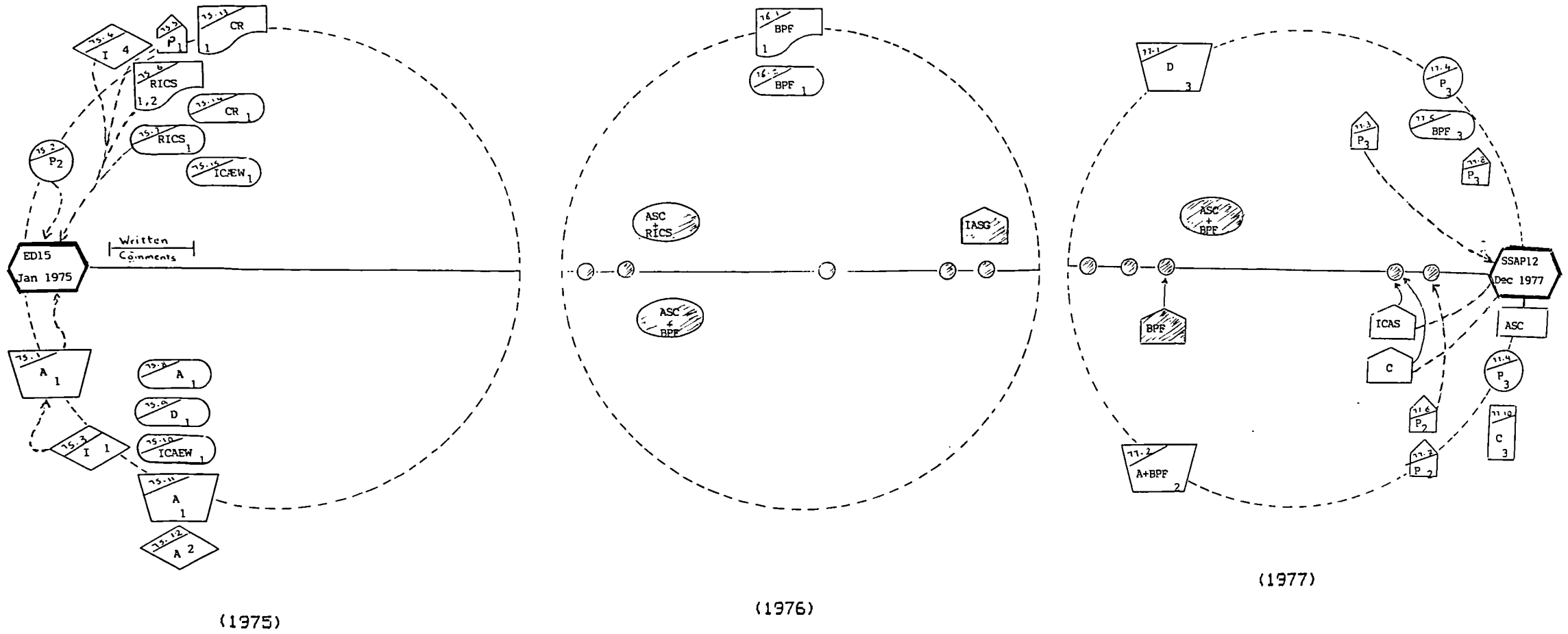

FIGURE 6.4
INTERACTIONS AND POWER RELATIONS RELATED TO ISSUING
THE DISCUSSION PAPER 'A REVIEW OF SSAP 12' IN DECEMBER 1982
AND SOI IN SEPTEMBER 1984

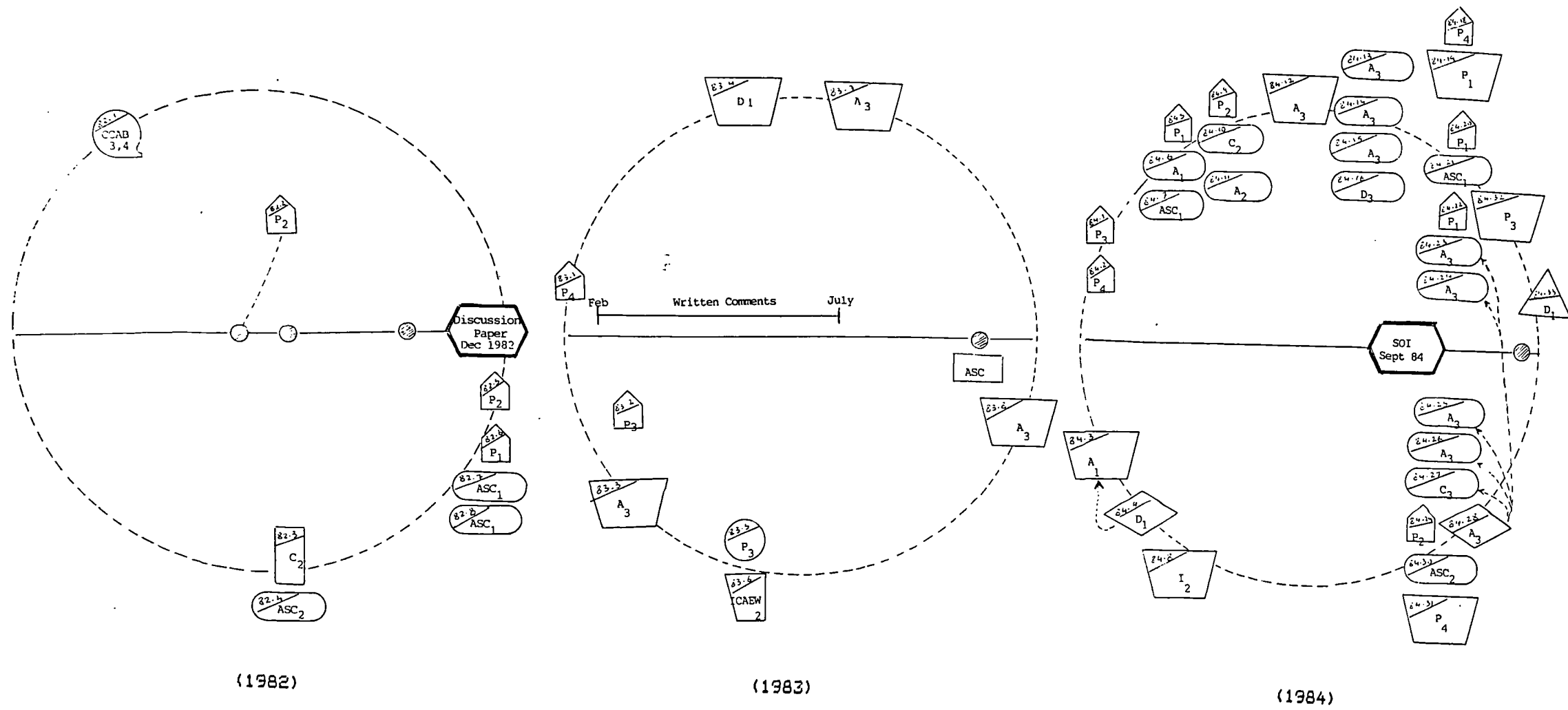

FIGURE 6.5
INTERACTIONS AND POWER RELATIONS
RELATED TO ISSUING ED37 IN APRIL 1985
AND SSAP 12 (REVISED) IN JANUARY 1987

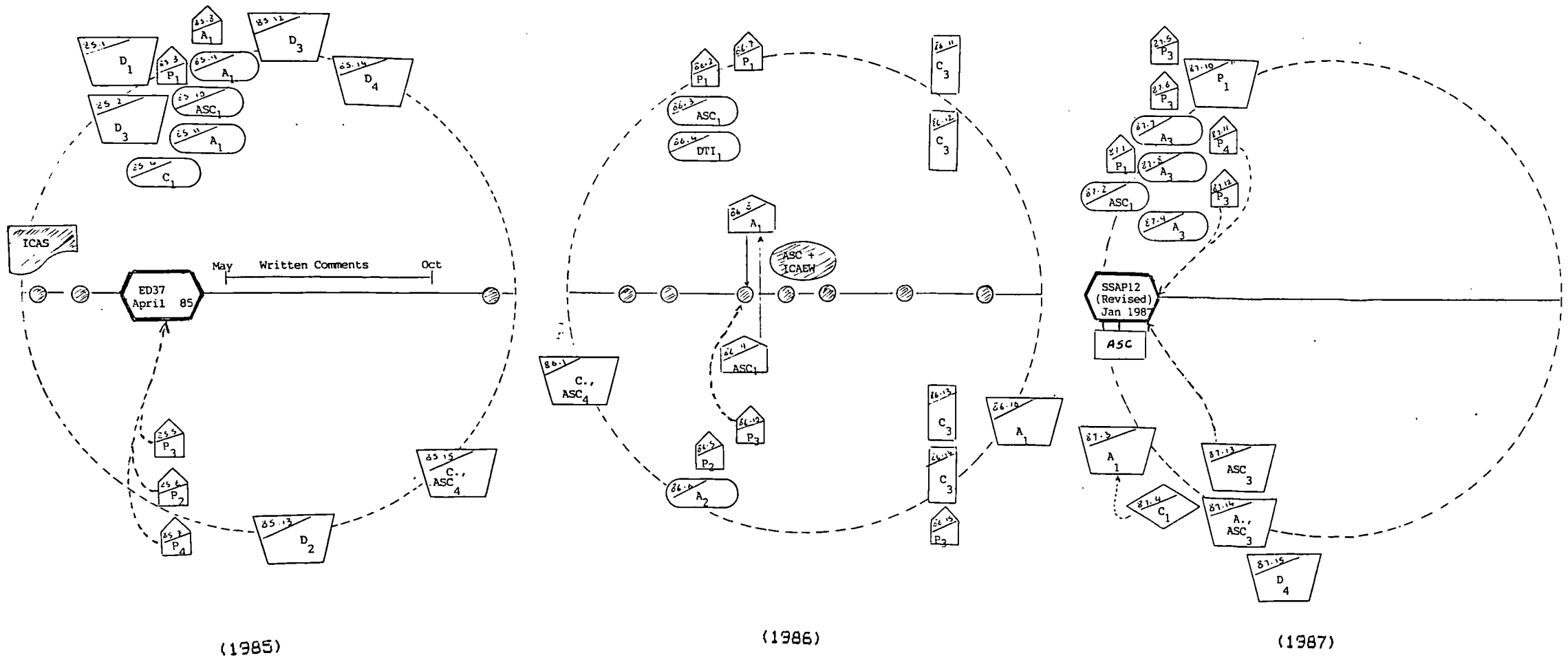

FIGURE 7.0
THE HISTORY OF THE LEASING STANDARD
(1971-1987)

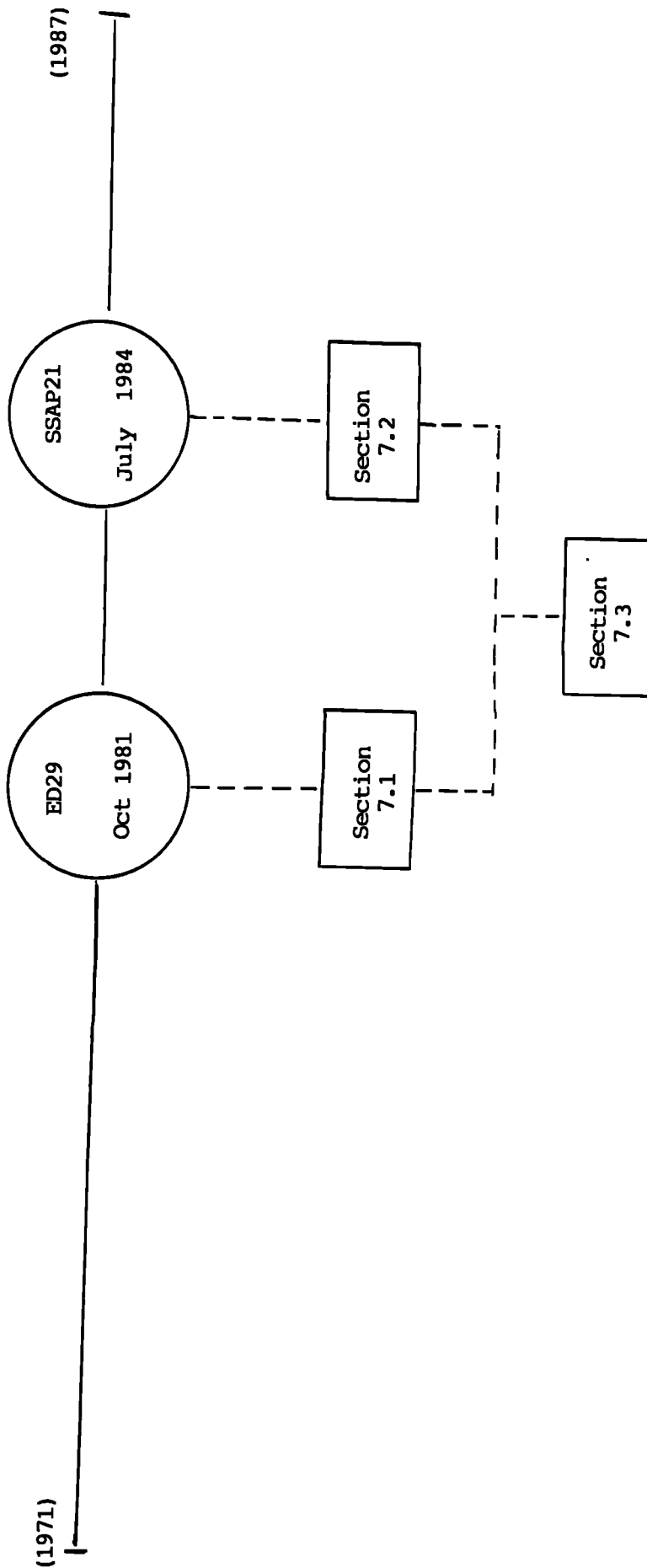

FIGURE 7.1
INTERACTIONS AND POWER RELATIONS
RELATED TO ISSUING ED 29 IN OCTOBER 1981

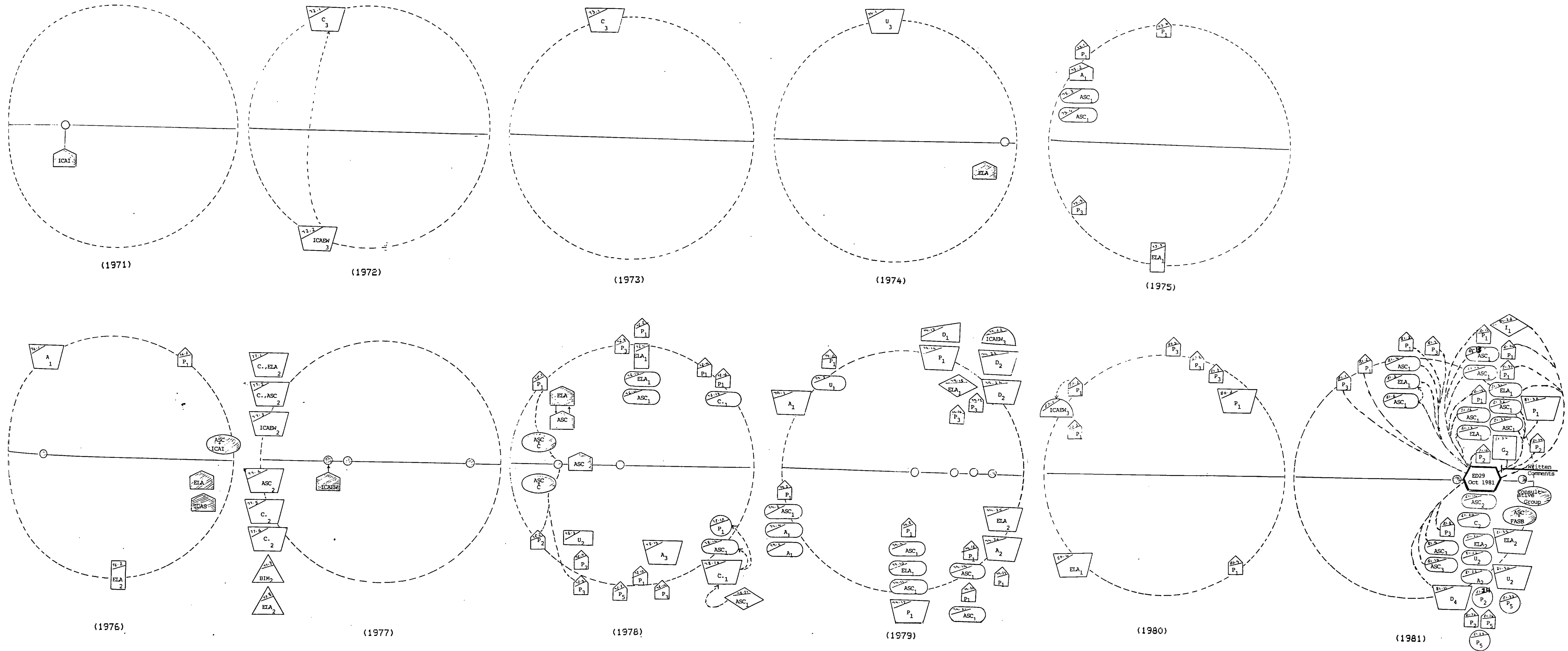
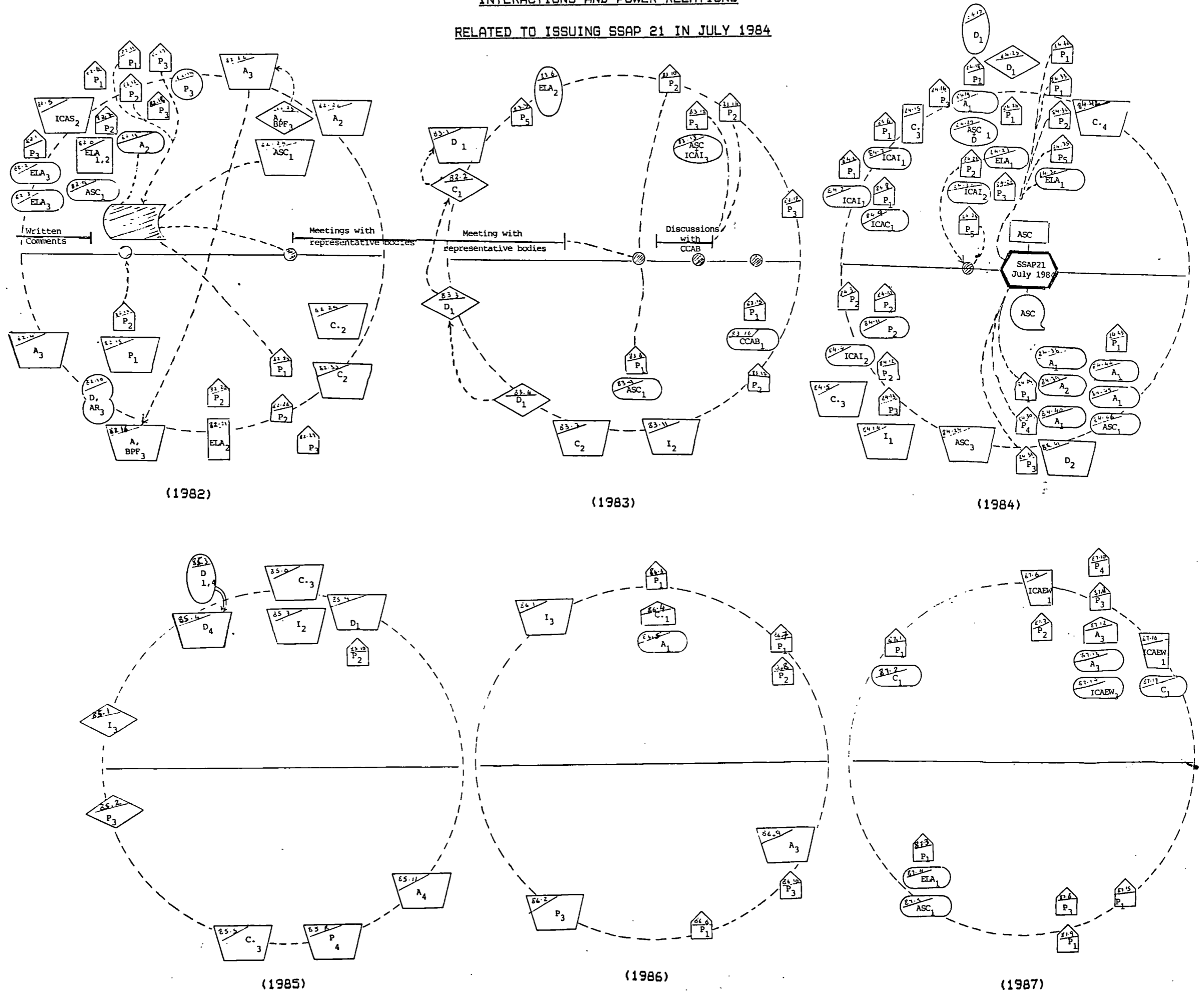

FIGURE 7.2
INTERACTIONS AND POWER RELATIONS
RELATED TO ISSUING SSAP 21 IN JULY 1984



APPENDICES

APPENDIX (A)

Letters Requesting Access to the ASC Material

Our Ref: RCL/WR

9th February, 1989

Mr. D. Wright,
Secretary,
The Accounting Standards Board,
P.O. Box 433,
Chartered Accountants Hall,
Moorgate Place,
London,
EC2P 2BJ

Dear Mr. Wright,

I write to ask whether a Ph.D. student of mine can consult certain Accounting Standards Committee minutes of meetings plus draft pronouncements of selected sub-committees.

My student, Mr. Ibrahim Ibrahim, is currently exploring the interactions between the ASC and outside organisations in the formulation of a number of standards with particular reference to 'Accounting for Depreciation' and 'Accounting for Leases'. He has already undertaken extensive searching of the popular accounting press and has a reasonable grasp of the meetings that were held and the reactions of various industrial and other organisations to the different ASC proposals. However, he now needs to look at these different interactions from the ASC's viewpoint as registered in and through the collective decisions of the ASC and its sub-committees addressed to these two standards.

We have reasonably detailed information of the specific meetings in which we are interested. These can be supplied if required but basically they cover, as far as we can tell, a time span of 1973 to 1987 with regard to Accounting for Leases and 1975 to 1987 with respect to Accounting for Depreciation. However, these dates may need to be extended if other relevant meetings of which we are currently unaware were held.

Can I also register three further points in relation to our request. Firstly, our intention is to look at only group outputs from the ASC and the respective sub-committees. The project does not need to ascribe comments and decisions to particular individual members of the various committees. We are concerned with group outputs in terms of agreements and draft exposure drafts and standards. Secondly, we will, of course, accept and acknowledge complete confidentiality with regard to any of the material to which we are allowed access. The material will appear in Mr. Ibrahim's thesis but if we publish any papers from his doctorate incorporating any details we have gathered from the ASC then we will clear this with you before any form of publication. Thirdly, you have our complete assurance that the study will in no way do harm to the ASC.

· It is, in effect, an historical study which will provide a new and
· hopefully interesting dimension on the formulation of accounting
standards but will have no implied or actual criticism of these
processes.

We do hope you will allow us access and look forward to hearing whether
this is possible. To aid our case I spoke to Professor John Arnold the
other day concerning this project. He was very supportive of our
endeavours and expressed his willingness, if this would be helpful, to
discuss any points with you concerning our request. In addition both Mr.
Ibrahim and I would be willing to come to London to clarify our intention
as well as to allow you to judge our trustworthiness.

I look forward to hearing from you.

Yours sincerely,

Dr. Richard C. Laughlin,
Lecturer in Accounting and Financial Management

c.c. Professor J. Arnold

The Accounting Standards Committee

P.O. Box 433
Moorgate Place London EC2P 2BJ
Telephone 01-628 7060
Telegrams Unravel London EC2
Telex 884443
Facsimile (Group 3) 01-920 0547

The Institute of Chartered Accountants in England and Wales
The Institute of Chartered Accountants of Scotland
The Institute of Chartered Accountants in Ireland
The Chartered Association of Certified Accountants
The Chartered Institute of Management Accountants
The Chartered Institute of Public Finance and Accountancy

Dr Richard C Laughlin
Lecturer in Accounting and
Financial Management
The University of Sheffield
School of Management and
and Economic Studies
Crookesmoor Building
Conduit Road
SHEFFIELD, S10 1FL

Our ref TDW/jj AS/G

Your ref RCL/WR

Date 10 February 1989

Dear Dr Laughlin

Thank you for your letter of 9 February 1989 requesting access to certain ASC papers.

I am naturally keen to encourage bona fide research into ASC topics and to respond positively to research requests from academics. However, working party proceedings are strictly confidential. Obviously, some of the information on the project files is non-sensitive and could be made available. Unfortunately, ASC files are merely chronological, and confidential material is not segregated. I cannot, therefore, allow outsiders unrestricted access to files. The ASC's slender resources preclude me from devoting staff time to searching files on behalf of outside researchers.

On the other hand, minutes and agenda papers relating to meetings of the ASC itself do receive a limited circulation and cannot reasonably be regarded as fully confidential. These papers would include successive drafts presented to the ASC for consideration and approval, the Secretarial papers explaining the thinking behind the various proposals and any changes of direction, and the minutes recording the ASC's views at the time. These agenda papers are held on a separate chronological file and I would be prepared to allow Mr Ibrahim access to these volumes. This would, of course, be on the basis of the undertakings you gave in your letter as to confidentiality, attribution and no harm to the ASC.

Only the most recent files are held at Moorgate Place. Older files are held at the Institute's Milton Keynes location, while the oldest files are, I believe, held in an external commercial archive. Until recently, our policy was to destroy dead project

Page 2

Dr Richard C Laughlin

files after two years, so I cannot guarantee that the information I am offering is, in fact, still available. However, I think it unlikely that the historical record of ASC meetings would have been discarded.

I hope this is helpful to you. Please get in touch with me if you would like to proceed.

Yours sincerely

Desmond Wright

Desmond Wright
Secretary
Accounting Standards Committee

Our Ref: RCL/WR

16th February, 1989

Mr. D. Wright,
Secretary,
Accounting Standards Committee,
P.O. Box 433,
Moorgate Place,
London,
EC2P 2BJ

Dear Mr. Wright,

Thank you for your letter of 10 February concerning our request for access to certain ASC papers.

Thank you so much for your willingness to allow Mr. Ibrahim to gain access to the minutes and agenda papers relating to meetings of the ASC. This material will be very valuable for Mr. Ibrahim's research and we gratefully accept your kind offer of access. We will, of course, treat this material with the confidentiality and promises indicated in my letter.

We quite understand the administrative and confidential problems you highlight in your letter concerning access to the project files and working party proceedings. We would not want you to bear any additional administrative cost in spending time and energy sorting out these files into confidential and non-confidential material. However, could we keep open the possibility of requesting particular specific pieces of information from these files if the investigations of the main ASC material leads us to this need? Obviously you will have the final say as to whether our request either is or can be satisfied.

On a more practical level Mr. Ibrahim would like to start looking at the ASC material in early April if this is possible. In this connection would you like to arrange a meeting for either both of us or just Mr. Ibrahim to come to see you to discuss how best to proceed?

With thanks again for your assistance.

Yours sincerely,

Dr. R.C. Laughlin,
Lecturer in Accounting and Financial Management

The Accounting Standards Committee

P.O. Box 433
Moorgate Place London EC2P 2BJ
Telephone 01-628 7060
Telegrams Unravel London EC2
Telex 884443
Facsimile (Group 3) 01-920 0547

The Institute of Chartered Accountants in England and Wales
The Institute of Chartered Accountants of Scotland
The Institute of Chartered Accountants in Ireland
The Chartered Association of Certified Accountants
The Chartered Institute of Management Accountants
The Chartered Institute of Public Finance and Accountancy

Dr R C Laughlin
Lecturer in Accounting and
Financial Management
The University of Sheffield
School of Management and
Economics Studies
Crookesmoor Building
Conduit Road
SHEFFIELD, S10 1FL

Our ref TDW/jj AS/G
Your ref RCL/WR
Date 17 February 1989

Dear Dr Laughlin

Access to ASC papers

Thank you for your letter of 16 February 1989.

You are quite welcome to request specific information from working party files, but it is unlikely that I would be able to spare the resources to retrieve it.

Mr Ibrahim may start to examine the ASC material at any time, provided we have two or three days' notice in which to retrieve the files from storage. I do not think we need to meet to discuss how best to proceed. I am sure the arrangements will be simple and can be made by telephone.

Yours sincerely

Desmond Wright

Desmond Wright
Secretary
Accounting Standards Committee



The University of Sheffield

School of Management and Economic Studies

Crookesmoor Building
Conduit Road
Sheffield S10 1FL
Tel: (0742) 768555

Our Ref: RCL/WR

27th February, 1989

Mr. D. Wright,
Secretary,
Accounting Standards Committee,
PO Box 433,
Moorgate Place,
London,
EC2P 2BJ

Dear Mr. Wright,

Research Access to ASC Papers

Thank you for your letter of 17 February concerning access for Mr. Ibrahim to the minutes and agenda papers of meetings of the ASC.

As I indicated in my letter of 16 February Mr. Ibrahim is unlikely to want to start looking at the material until early April. As suggested in your letter I will ask him to contact you by telephone a week or so before he would like to start work.

Please accept my sincere thanks for allowing Mr. Ibrahim access to this material. Please also feel free to contact me at any time (on extension 6806 or via my secretary Mrs. Wendy Rodgerson on extension 6579) if you need to discuss any further points either before or during Mr. Ibrahim's survey of the files.

Yours sincerely,

Dr. R.C. Laughlin

APPENDIX (B)

Code Used in the Study

CODE

Accountancy Age	1
Accountant	2
Accountancy	3
The Accountant's Magazine	4
The Times	5
Other Journals	X
Companies Finance Director	C
Companies Managing Director)	C.
Representative of Companies	CR
Accounting Firm / Auditor	A
Representative of Auditors	AR
Academic	D
Users of Accounts	U

Individual

I

Press

P

Government

G

Article

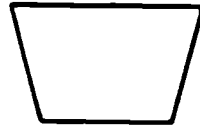

letter to the Press

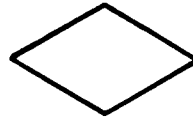

Press Comment

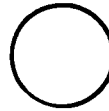

Meeting



Speech / Lecture



Talk to Press



Interview



Issuing Statement / Press Release



Press Conference



Issuing Guidance Notes



Publication by ICAEW



Publication By Other Institutions

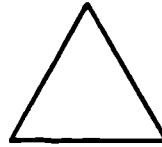

Press Report



Written Submission



Discussion Paper



Report



Decision

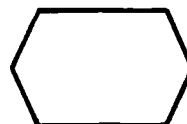

Letter

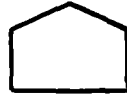

ASC's meeting



Joining the ASC Consultative Group



Conference



Formation of a New Representative Group

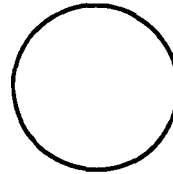

Courses



Study / Research about Accounting Standards



Company's Annual Report



Auditor's Report



Public Hearing



Comment on

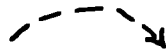

Based on



Send to



Connection



Not Published



BIBLIOGRAPHY

GENERAL REFERENCES

- Abdel-Khalik, A., R., and Ajinkya, B.B., Empirical Research in Accounting: A Methodological Viewpoint (American Accounting Association, 1979).
- Ackoff, R.L., and Emery, R.E., On Purposeful System (Chicago: Aldine-Atherton, 1972)
- Aplin, J.C., and Hegarty, W.H., 'Political Influence: Strategies Employed by Organizations to Impact Legislation in Business and Economic Matters', Academy of Management Journal, Vol.23, (1980), pp.438-450.
- Armstrong, P., 'The Rise of Accounting controls in British Capitalist Enterprises', Accounting, Organisations and Society, (1987), pp.415-436.
- Armstrong, M.S., 'The Politics of Establishing Accounting Standard, The Government Accountants' Journal, (Summer, 1976), pp.8-13.
- Arrington C. E. and Francis J. R. 'Letting The Chat Out of the Bag: Deconstruction, Privilege and Accounting Research' Accounting, Organisations and Society, Vol.14, Nos.1/2, (1989), pp. 1-28.
- Bachrach, P., and Baratz, S., 'The Two Faces of Power', American Political Science Review, (1962), pp. 947-952.
- Bachrach, P., and Baratz, S., 'Decisions and Non-decisions: An Analytical Framework', American Political Science Review, (1963) pp.441-51.
- Bachrach, P., and Baratz, S., Power & Poverty - Theory & Practice, (Oxford: Oxford University Press, 1970).
- Bariff, M.L and J.R Galbraith, 'Intraorganizational Power Considerations for Designing Information system', Accounting, Organisations and Society, (1978) pp.15-27.
- Bartlett, R.W., Power Base Attribution and the Perceived Legitimacy of Managerial Accounting (Ann Arbor: UMI Research Press, 1983).
- Bhasker, R., The Possibility of Naturalism (Brighton: Harvester Press, 1979).
- Bernstein, M.H., Regulating Business By Independent Commission (Princeton, N.J.: Princeton University Press, 1955).
- Bernstein, R.J., Beyond Objectivism and Relativism: Science, Hermeneutics, and Praxis, (Philadelphia: University of Pennsylvania Press, 1983).
- Berry, A., Capps, T., Ferguson, P., Hopper, T. & Love, A., 'Management Control in and Area of the National Coal Board', Accounting, Organisations and Society, Vol.10, (1985) pp.3-38.

- Berry, A.J., Capps, T., Cooper, D., Hopper, T., and Love, E.A., 'The Ethics of Research in a Public Enterprise' in Heller, F. (ed) The Use and Abuse of Social Science, (London: Sage, 1986), pp.85-98.
- Birnbaum P.H., 'Political Strategies of Regulated Organisations As Functions of Context and Fear', Strategic Management Journal, Vol.6, (1985), pp.135-150.
- Boland,R., 'Discussion of "Accounting and the Construction of The Governable Person" ', Accounting and Organisations and Society, Vol. 12, No.3 (1987) pp.267-272.
- Bonis,J., 'Organization and Environment', in Lockett, M., and Spear, R. (eds), Organizations as Systems, (The Open University Press, 1980).
- Booth, P. and Cocks, N., 'Power and the Study of the Accounting Profession' in Cooper, D.J. and Hooper, T.M.(eds) Critical Accounts, (London: Macmillans, 1990).
- Bourn, M.and Ezzamel, M. 'Costing and Budgeting in the National Health Service', Financial Accountability and Management, Vol.2, (1986a), pp.53-71.
- Bourn, M. and Ezzamel, M., 'Organisational Culture in Hospitals in the National Health Service' Financial Accountability and Management, Vol.2, (1986b) pp. 203-225.
- Bromwich, M., The Economics of Accounting Standard Setting, (London: Prentice Hall International, 1985).
- Brown , P.R., A Descriptive Analysis of Select Input Bases of the Financial Accounting Standards Board, Ph.D. dissertation, University of Texas at Austin, 1979.
- Brown, P.R., 'A Descriptive Analysis of Select Input Bases of the Financial Accounting Standards Board', Journal of Accounting Research, (1981), pp.232-46.
- Brown,P.R., 'FASB Responsiveness to Corporate Input', Journal of Accounting, Auditing and Finance, Vol.5, No. 4 (Summer 1982), pp.282-290.
- Burchell, S., Clubb, C., Hopwood, A., Hughes, J. & Nahapiet,J., 'The Roles of Accounting in Organisations and Society', Accounting, Organisations and Society, (1980), pp. 5-27.
- Burchell S., Clubb, C. and Hopwood, A., 'Accounting in its Social Context: Towards a History of Value Added in the United Kingdom', Accounting, Organisations and Society, Vol. 10, (1985), pp.381-413.
- Burggraaff, J.A., 'The Political Dimensions of Accounting Standards Setting in Europe' in Bromwich, M. and Hopwood,A.G.(eds) Accounting Standards Setting -An International Perspective, (London: Pitman, 1983).

- Burrell, G. & Morgan, G., Sociological Paradigms & Organisational Analysis, (London: Heinemann, 1979).
- Christenson C., 'The Methodolgy of Positive Accounting' The Accounting Review, Vol. 58, (1983), pp. 1-22.
- Chua, W.F., 'Radical Development in Accounting Thought', Accounting Review, (1986a), PP. 601-632.
- Chua, W.F., 'Theoretical Constructions Of and By the Real', Accounting, Organisations and Society, (1986b), pp. 583-598.
- Chua, W. F., 'Of Gods and Demons, Science and Idelogy', Advances in Public Interest Accounting, Vol.2, (1988), pp.29-46.
- Chua, W.F., Love, E.A., and Puxty, A., 'Introduction' in Chua,W.F. Love,E.A. and Puxty A. (eds.) Critical Perspectives in Management Control, (London: Macmillan, 1989) pp.3-8.
- Colville, I., 'Reconstucting "Behavioural Accounting" ', Accounting, Organisations & Society, Vol. 6, (1981),pp.119-132.
- Cook, K.S., 'Exchange and Power in Network of Inter-Organizational Relations', in Benson,J.K.(ed.) Organization Analysis: Critique and Innovation, (Beverly Hills: Sage, 1977).
- Cook, K.S., Shortell,S.M., Conrad,D.A., and Morrisey,M.A., 'A Theory of Organizational Response to Regulation: The Case of Hospitals', Academy of Management Review, Vol.10, No.2,(1985), pp. 193-205.
- Cooper D. J., Hayes D.C., and Wolf, F., 'Accounting in Organised Anarchies: Understanding and Designing Accounting Systems in Ambiguous Situations',Accounting, Organisations and Society, Vol.6, (1981), pp. 175-191.
- Cooper, D. J., 'Tidiness, Muddle and Things: Commonalities & Divergencies in Two Approaches to Management Accounting Research', Accounting, Organisations and Society, Vol. 8, (1983) pp. 269-268.
- Cooper, D.J. and M.J. sherer, 'The value of Corporate Accounting Reports: Arguments for a Political Economy of Accounting', Accounting, organisations and Society, (1984), pp.207-32.
- Cooper, D., Love, E.A., Puxty, A., and Willmott, H., 'The Regulation of Social and Economic Relations In Advanced Capitalist Societies: Towards a Conceptual Framework for a Cross National Study of the Control of Accounting Policy and Practice' Paper Presented at the Interdisciplinary Perspectives on Accounting Conference (University of Manchester, July 8-10, 1985).

- Cooper, D., Lowe, E.A., Puxty, A., Robson, K., and Willmott, H., 'Regulating the UK Accountancy Profession: Episodes in a Changing Relationship between the State and the Profession, Paper presented at the Second Interdisciplinary Perspectives of Accounting conference (University of Manchester, July 11-13, 1988).
- Cooper, D., Puxty, A., Lowe, E.A., and Willmott, H., 'The Accounting Profession, Corporatism and the State', in Chua, W.F., Lowe, E.A. and Puxty, A., (eds) Critical Perspectives in Management Control, (London: Macmillan, 1989), pp.245-270.
- Cousins, M., and Hussain, A., Michel Foucault: Theoretical Traditions in the Social Science (London: Macmillan, 1984).
- Cousins, M., and Hussain, A., 'The Question of Ideology: Althusser, Pecheux and Foucault' in Law, J. (ed), Power, Action and Belief (London: Routledge & Kegan Paul, 1986).
- Craib, I., Modern Social Theory: From Parsons To Habermas, (Brighton: Harvester Press, 1984).
- Dahl, R.A., 'The concept of Power', Behavioral Science, Vol.2, (1957), pp.201-21.
- Davidson, A.I., 'Archaeology, Genealogy, Ethics' in Hoy, D.C. (ed) Foucault: A Critical Reader, (Oxford: Basil Blackwell, 1986).
- Demski, J.S., 'The General Impossibility of Normative Accounting Standards', The Accounting Review, (April, 1977), pp.308-321.
- Demski, J.S., 'The Choice Among Financial Reporting Alternatives', Accounting Review, April 1974, pp.221-32.
- Demski, J. S., 'Positive Accounting Theory: A Review', Accounting, Organisations and Society, (1988), pp. 623-629.
- Devs, P., 'Power and Subjectivity in Foucault', New Left Review, No.144, (1984).
- Devs, P., 'The Nouvelle Philosophie and Foucault', in Gane, M. (ed.) Towards A Critique of Foucault, (London: Rowledge & Kegan, 1987).
- Donnelly, M., 'Foucault's Genealogy of Human Sciences' in Gane, M., (ed) Towards A Critique of Foucault, (London: Rowledge & Kegan, 1987).
- Downs, A., 'The Economic Theory of Political Action in a Democracy', Journal of Political Economy, (February, 1957).
- Dreyfus, H., and Rabinow, P., Michel Foucault: Beyond Structuralism and Hermeneutics, (Brighton: Harvester Press, 1982).
- Dreyfus, H., and Rabinow, P., 'What Is Maturity? Habermas and Foucault on 'What Is Enlightenment' in Hoy, D.C. (ed) Foucault: A Critical Reader (Oxford: Basil Blackwell, 1986).

- Duncan, R. 'Characteristics of Organisational Environments and Perceived Environmental Uncertainty', Administrative Science Quarterly, Vol.17, (1972) pp.203-213.
- Elliot, P., The Sociology of the Professions, (New York: Macmillan, 1972).
- Findlay, M.C. & Williams, E.E., 'A Positivist Evaluation of the New Finance', Financial Management, (1980), pp.7-17.
- Findlay, M. C. & Williams, E.E., 'A Post Keynesian View of Modern Financial Economics: In Search of Alternative Paradigms' Journal of Business Finance and Accounting, (1985), PP.1-18.
- Fine, B., 'Struggles Against Discipline: The Theory and Politics of Michel Foucault', Capital and Class, Vol.9, (1979), pp.75-95.
- Fischer, D.W. 'Strategies Toward Political Pressures: A Typology of Firm Responses' Academy of Management Review, (1983), Vol. 8, pp.71-78.
- Foucault, M., The Order of Things, (London: Tavistock, 1970).
- Foucault, M., The Birth of the Clinic, (London: Tavistock, 1973).
- Foucault, M., The Archaeology of Knowledge, (London: Tavistock, 1977a).
- Foucault, M., Discipline and Punish, (London: Allen Lane, 1977b)
- Foucault, M., The History of Sexuality, Vol. 1, An Introduction, (London: Allen Lane, 1979).
- Foucault, M., 'Questions of Method: An Interview with Michel Foucault's', Ideology and Consciousness, No.8, (1980), pp.11-12.
- Foucault, M., Afterword: the Subject and Power, in Dreyfus, H., and Rabinow, P., Michel Foucault: Beyond Structuralism and Hermeneutics (Brighton: Harvester Press, 1982).
- Foucault, M., 'Disciplinary Power and Subjection' in Lukes (ed), Power, (Oxford: Basil Blackwell 1986).
- Gallhofer, F., Haslam, J., Lowe, E.A., Cooper, D.J., Puxty, A., Robson, K., and Willmott, H.C., 'Reflections on Accounting Regulation Centered on the Federal Republic of Germany and the Broader Political Dimensions of Accounting Regulation: Problematizing Research in International Accounting', Paper presented at the Second Interdisciplinary Perspectives on Accounting Conference, (University of Manchester, July 11-13, 1988).
- Gane, M., Towards A Critique of Foucault (London: Routledge & Kegan, 1987).
- Gerboth, D.L. 'Research, Intuition and Politics in Accounting Inquiry', The Accounting Review, (July, 1973).

- Giddens, A. & Turner, J.H., Social Theory Today, (Cambridge: Polity Press, 1987)
- Glaser, B.G., and Strauss, A.C., The Discovery of Grounded Theory: Strategies for Qualitative Research, (New York: Aldine Publishing Company, 1967).
- Goldstein, J., 'Foucault among the Sociologists: the Disciplines' and the History of the Professions', History and Theory, (1984), pp.170-192.
- Gorden, C., Power/Knowledge: Michel Foucault, (New York: Pantheon, 1980).
- Groves, R., Poole, H., and Broder, P.L., 'Professional Commitments of the Practising Chartered Accountant in Modern Britain', Accounting and Business Research, (Autumn 1984), pp.319-331.
- Haring, J.R., 'Accounting Rules and "the Accounting Establishment"', Journal of Business, (1979), pp.507-19.
- Harrison, G.L. and McKinnon, J.L., 'Culture and Accounting Change: A New Perspective on Corporate Reporting Regulation and Accounting Policy Formulation', Accounting, Organisations and Society, Vol.11, No.3, (1986), PP.233-252.
- Herring, E.P., Public Administration and the Public Interest, (New York: McGraw-Hill Book Co., 1936).
- Hesse, M., 'Theory and Value in the Social Sciences', in Hookway, C., and Pettit, P. (eds), Action and Interpretation: Studies in the Philosophy of the Social Sciences, (Cambridge: Cambridge University Press, 1978).
- Hines, R.D. 'Popper's Methodology of Falsificationism and Accounting Research', The Accounting Review, (October, 1988), pp.657-662.
- Hope, A., 'Accounting Policy Theory or Pragmatism or Both', Submission on the Accounting Standards Committee's Documents, Setting Accounting Standards, Vol.II, (London: Accounting Standard s Committee, 1979), pp.541-68.
- Hope, T., and J. Briggs, 'Accounting Policy Making: Some Lessons From the Deferred Taxation Debate', Accounting and Business Research, (1982), pp.83-96.
- Hope, T. and R. Gray, 'Power and Policy Making: The Development of an R & D Standard', Journal of Business Finance and Accounting, (1982), pp.531-58.
- Hopper, T., and Powell, A., 'Making Sense of Research into the Organisational and Social Aspects of Management Accounting: A Review to its Underlying Assumptions', Journal of Management Studies, (September, 1985), pp.429-465.

- Hopwood, A., 'Towards an Organisational Perspective for the Study of Accounting and Information Systems', Accounting, Organisations and Society, Vol. 3, (1978), pp.3-13.
- Hopwood, A., 'On Trying to Study Accounting on the Contexts on which it Operates', Accounting, Organisations and Society, Vol. 8, (1983), pp. 287-305.
- Hopwood, A., 'Accounting and the Pursuit of Efficiency', in Hopwood, A. & Tomkins, C., Issues on Public Sector Accounting (London: Philip Allan, 1984) pp. 167-187.
- Hopwood, A., 'The Tale of a Committee that Never Reported', Accounting, Organisations and Society, Vol. 10, (1985), pp.361-377.
- Hopwood A., 'Editorial', Accounting Organisations and Society, Vol. 4, (1979), pp. 145-147.
- Hopwood, A., The Archaeology of Accounting Systems, Accounting, Organisations and Society, Vol.12, No.3, (1987), pp.207-234.
- Horngern, C.T., 'Accounting Principles: Private or Public Sector?' Journal of Accountancy, (May, 1972), pp.37-41.
- Horngern, C.T. 'The Marketing of Accounting Standards', Journal of Accountancy, (1973), pp. 61-66.
- Horngern, C.T., 'The Marketing of Accounting Standards', in Sterling, R.R. (ed.), Institutional Issues in Public Accounting, (Lawrence, KS: Scholars Book Co., 1975).
- Horngern, C. T., 'Will FASB be here in the 1980's ?', Journal of Accountancy, (November, 1976), pp.90-95.
- Horwitz, B.N. & Kolodny, R., 'The Economic Effects of Involuntary Uniformity in the Financial Reporting of R&D Expenditures', Journal of Accounting Research, (Supplement, 1980), pp.38-74.
- Hoskin K. W. and Macve R., 'Accounting and the Examination: a Genealogy of Disciplinary Power', Accounting, Organisations and Society, Vol. 11, (1986), PP. 105-136.
- Hoskin, K., and Macve, R., 'The Genesis of Accountability: The West Point Connections', Accounting, Organisations and Society, Vol.13, (1988), pp.37-73.
- Hoy, D.C., 'Power, Repression, Progress: Foucault, Lukes, and the Frankfurt School' in Hoy, D.C. (ed) Foucault: A Critical Reader, (Oxford: Basil Blackwell, 1986).
- Hussein, M.E. and Ketz, J.E., 'Ruling Elites of the FASB: A Study of the Big Eight', Journal of Accounting, Auditing and Finance, (1980), pp. 345-67.
- Hussein, M.E., 'The Innovative Process in Financial Accounting Standards Setting', Accounting, Organisations, and Society, (1981), pp.27-38.

- Ibrahim, I.A.G., The Application of Influence Theory in the Setting of Accounting Standards in the UK and Its Use as Evidence for Organisations Concern with External Financial Control, MA Thesis, University of Sheffield, 1986.
- Jaskow, P. and Noll,, R. 'Regulation in Theory and Practice: an Overview', Social Science Working Paper No. 213, California Institute of Technology, May 1978.
- Katz, D.L., and Khan, R.L., The Social Psychology of Organisational Performance', (New York: Wiley, 1966).
- Keat R. and Urry J., Social Theory as Science (London: Routledge and Kegan Pall, 1982).
- Klein, L. A., The Influence on the Financial Accounting Standards Board: An Analysis of Responses to the Exposure Draft on Segment Reporting, Ph.D. Disertation, Pennsylvania State University 1978.
- Kelly-Newton, L., Accounting Policy Formation: The Role of Corporate Management, (Philippines: Addison- Wesley, 1980).
- Kirk, J., and Miller, M.L., Reliability and Validity in Qualitative Research, (California: sage Publications, 1986).
- Knights, D. and Vurdabakis, T. 'Insurantal Technologies and the Social Constitution of Risk and Subjectivity', Paper presented at the Interdisciplinary Perspectives on Accounting Conference, (University of Manchester, July 11-13, 1988).
- Kolakowski, L. Positivist Philosophy (Harmondsworth: Penguin, 1972).
- Laughlin, R., 'On the Nature of Accounting Methodology', Journal of Business Finance and Accounting, Vol. 8, (1981), pp. 329-351.
- Laughlin, R., The Design of Accounting Systems: A General Theory with an Empirical Study of the Church of England, Unpublished Ph.D Thesis, University of Sheffield, 1984.
- Laughlin, R., 'Accounting Systems in Organisational Contexts: A case for Critical Theory', Accounting, Organisations and Society, Vol.12, No.5, (1987), pp.479-502.
- Laughlin, R., 'The Social Contextual Base of Accounting: An Analysis of the Accounting Systems of the Church of England, University of Sheffield Working Paper, 1986.
- Laughlin, R., and Puxty, A. 'the Decision Usefulness Criterion: Wrong Cart, Wrong Horse?', AUTA Review, (Spring, 1981), pp.43-87.
- Laughlin, R., and Puxty, A. 'Accounting Regulation: An Alternative Perspective', Journal of Business Finance and Accounting, Vol.10, No.3, (1983), pp.451-479.

- Laughlin, R. and Puxty, A., 'The Socially Conditioning and Socially Conditioned Nature of Accounting: A Review and analysis Through Tinker's 'Paper Prophets', British Accounting Review, Vol. 18, (1986), pp. 77-90.
- Laughlin, R., Love, E.A., and Puxty, A.G., 'Designing and Operating a Course in Accounting Methodology: Philosophy, Experience and some Preliminary Empirical Tests', The British accounting Review, Vol. 18, (1986), pp. 17-42.
- Laughlin, R., 'Accounting and Organisational Change', Paper presented at the Interdisciplinary Perspectives on Accounting Conference, (University of Manchester, July 11-13, 1988).
- Laughlin R., and Love, E.A., 'Critical Analysis of Accounting Thought: Prognosis and Prospects for Understanding and Changing Accounting Systems Design', in Cooper D.J. and Hopper T.M. (eds.) Critical Accounts, (London: Macmillans, 1990).
- Law, J. (ed.), Power, Action and Belief, (London: Routledge and Kegan, 1986).
- Lawrence, R. P., and Lorsch, J.W., Organizations and Environment, (Homewood: Richard Irwin, 1967).
- Lemert, C., and Gillan, G., Michel Foucault: Social Theory and Transgression (New York: Columbia University Press, 1982).
- Loft, A., Understanding Accounting in its Social and Historical Context: The Case of Cost Accounting in Britain, 1914-1975, Unpublished Ph.D. Thesis, University of London, 1986.
- Loft, A., 'Towards a Critical Understanding of Accounting: The Case of Cost Accounting in the U.K., 1914-1925', Accounting, Organisations and Society, (1986), pp.137-169.
- Love, E.A., Puxty, A., and Laughlin, R. 'Simple Theories for Complex Processes: Accounting Policy and the Market of Myopia', Journal of Accounting and Public Policy, Vol. 2, (1983), pp.19-24.
- Lukes, S., Power: A Radical View, (London: Macmillan, 1974).
- Lukes, S., Power, (Oxford: Basil Blackwell, 1986).
- MacArthur, J.B., An Empirical Analysis of Incentives for Managements' Lobbying Behaviour on Proposed Accounting Standards in the UK, Unpublished Ph.D Thesis, University of Wales, 1985.
- MacArthur, J.B., 'An Analysis of the Content of Corporate Submissions on Proposed Accounting Standards in the UK' Accounting and Business Research, Vol. 18, No. 71, (1988a), pp.213-226.
- MacArthur, J.B., 'Some Implications of Auditor and Client Lobbying Activities: A Comparative Analysis', Accounting and Business Research, Vol.19, No.73, (1988b), pp.56-64.

- MacAvoy, P. W., The Economic Effects of Regulation (Cambridge: MIT press, 1975).
- Mackenzie, B. D., Behaviourism and the Limits of Scientific Method (London: Routledge and Keagan Paul, 1977).
- Macve, R., A Conceptual Framework for Financial Accounting and Reporting the Possibilities for an Agreed Structure, (London: Institute of Chartered Accountants in England and Wales, 1981).
- Markus, M.L. and Pfeffer, J., 'Power and the Design and Implementation of Accounting and Control Systems', Accounting, Organisations and Society, (1983), pp.205-18.
- May, G., and Sundem G.L., 'Research for Accounting Policy: An Overview', Accounting Review, (October, 1976), pp. 747-763.
- McHugh, P., 'On the Failure of Positivism', in Douglas, (ed) Understanding Everyday Life, (New York: Aldine Publishing 1971) pp. 320-335.
- McNeil, K., 'Understanding Organizational Power: Building on the Weberian legacy', Administrative Science Quarterly, Vol. 23, (1978), pp. 65-90.
- Mensah, K., E., 'The External Organizational Environment and Its Impact on Management Information System', Accounting, Organisations and Society, Vol. 6, No.4, (1981), pp.301-316.
- Merino, B. D. & Nelmark, D.M., Disclosure, Regulation and Public Policy: A Soci-Historical Re-Appraisal, Journal of Accounting and Public Policy, 1982, pp.33-57.
- Meyer, P.E., 'The APB's Independence and its Implications for the FASB', Journal of Accounting Research, (1974), pp.154-67.
- Miller, P., Domination and Power, (London: Routledge and Kegan,1987).
- Miller, P. & O'Leary, T., 'Accounting and the Construction of the Governable Person', Accounting, Organisations and Society (1987), pp.235-265.
- Miller, P. & Rose, N., 'The Tavistock Programme: The Government of Subjectivity and Social Life', Sociology, (1988), pp.171-192.
- Miller, P., 'On The Interrelations between Accounting and The State', Working Paper, 1988.
- Miller, P., 'Managing Economic Growth Through Knowledge: The Promotion of Discounted Cash Flow Techniques', Working Paper, 1989.
- Miller, P., 'Political Rationalities and Technologies of Government', Working Paper, 1989.
- Miller, P. and O'Leary, T., 'Hierarchies and American Ideals, 1900-1940', Academy of Management Review, 1989.

- Minson, J., 'Strategies for Socialists? Foucault's Conception of Power', Economy and Society, Vol.9, No.1, (February, 1980), pp.1-43.
- Mintick, B.M, The Political Economy of Regulation: Creating, Designing, and Removing Regulatory Forms (New York: Columbia University Press, 1980).
- Mitroff, I.I, & Kilmann, R.H., Methodological Approaches to Social Sciences, (New York: Jossey Bass Publications, 1978).
- Moonitz, M., Obtaining Agreement on Standards in the Accounting Profession, (Florida: American Accounting Association, Studies in Accounting Research No.8: 1974).
- Morgan, G., Smircich, L., 'The Case for Qualitative Research', Academy of Management Review, Vol. 5 (1980) pp.491-500.
- Morris, M., and Patton, P., Michel Foucault: Power, Truth, Strategy, (Sydney: Feral Publications, 1979).
- Morris, P., Power: A Philosophical Analysis (Manchester: Manchester University Press, 1987).
- Neimark, M., and Tinker, T., 'The Social Construction of Management Control Systems', Accounting, Organisations and Society, Vol. 11, (1986), pp. 369-395.
- Newman, D. P., 'An Investigation of the Distribution of Power in the APB and FASB', Journal of Accounting Research, (1981a), pp.247-62.
- Newman, D. P., 'The SEC's Influence on Accounting Standards: The Power of the Veto', Journal of Accounting Research, (Supplement 1981b) pp.134-56.
- Otley, D., 'A Strategy for the Development of Theories in Management Control', in Chua W.F., Lowe, E.A. and Puxty, A. (eds), Critical Perspectives in Management Control, (London: Macmillan, 1989).
- Outhwaite, W., New Philosophies of Social Science: Realism, Hermeneutics and Critical Theory, (London : Macmillan, 1987).
- Peltzman, S., 'Toward a More General Theory of Regulation', The Journal of Law and Economics, (August, 1976), pp.211-240.
- Perks, B. and Radcliffe, G., 'The Implementation of SSAPs with Particular Reference to SSAP15', (Belfast: Queens University of Belfast, manuscript not dated).
- Perrow, C., Organizational Anaysis: A Sociological View, (Belmont, California: Wadsworth, 1970).
- Pfeffer, J., and Salancik G., The External Control of Organizations, (New York: Harper & Row, 1978).

- Porter, M.C., The Role of Constituency Responses in Setting Accounting Standards, Ph.D. Dissertation, Texas A&M University, 1979.
- Pratt, V., The Philosophy of the Social Sciences, (London: Methuen, 1978).
- Preston, A.M., 'The Taxman Cometh: Some Observations on the Interweave between Accounting and Inland Revenue Practice', Accounting, Organisations, and Society, Vol.5, No.3, (1989), pp.389-413.
- Posner, R.A., 'Theories of Economic Regulation', Bell Journal of Economics and Management Science, (1974), pp.333-358.
- Post, J. E., Corporate Behavior and Social Change, (Reston: Reston Publishing, 1978).
- Post, J. E., and Mahon, J.F., 'Articulated Turbulence: The Effect of Regulatory Agencies on Corporate Responses to Social Change', Academy of Management Review, (1980), Vol.5, No.3, pp.399-407.
- Poster, M., Foucault, Marxism and History, (Oxford: Polity Press, 1984).
- Poster, M., 'Foucault and the Tyranny of Greece' in Hoy, D.C., (ed) Foucault: A Critical Reader, (Oxford: Basil Blackwell, 1986).
- Poulantzas, N., Political Power and Social Classes, (New Left Books, 1973).
- Poulantzas, N., State, Power, Socialism, (London: New Left Books, 1978).
- Puxty, A., Decision Usefulness in Accountancy: A Contribution to a Critical Theory of the Professions, Unpublished Ph.D.thesis, University of Sheffield, (1984).
- Puxty A., 'Social Accounting as Immanent Legitimation: A Critique of A Technicist Ideology', Advances in Public Interest Accounting, Vol. 1, (1986), pp.95-111.
- Puxty, A., Willmott, H., Cooper, D., and Love, A. 'Modes of Regulation in Advance Capitalism: Locating Accountancy in Four Countries', Accounting, Organisations and Society, Vol.12, No.3 (1987), pp.273-291.
- Puxty, A., 'The Accountancy Profession in the Class Structure' in Cooper, D.J. and Hooper, T.M.(eds) Critical Accounts, (London: Macmillans, 1990).
- Puxty, A. and Chua, W.F., 'Ideology, Rationality and the Management Control Process', in Chua W.F., Love, A., and Puxty, A Critical Perspectives in Management Control, (London: Macmillan, 1989), pp.115-140.
- Quirk, P., Industry Influence on Federal Regulatory Agencies, (Princeton, N.J.: Princeton University Press, 1981).

- Rabinow, P., The Foucault Reader, (London: Penguin Books, 1984).
- Rajchman, J., Michel Foucault: The Freedom of Philosophy, (New York: Columbia University Press).
- Richardson, A.J., 'Accounting Knowledge and Professional Privilege', Accounting, Organisations and Society, Vol.13, PP.381-396.
- Roberts, J., and Scapens, R.W., 'Accounting Systems and Systems of Accountability -Understanding Accounting Practices in their Organisational Contexts', Accounting, Organisations and Society, Vol. 10, (1985), pp. 443-456.
- Roberts, J., 'The Possibilities of Accountability', Paper presented at the Second Interdisciplinary Perspectives in Accounting Conference, (University of Manchester, July 11-13, 1988).
- Roberts, J. and Scapens, R.W., 'Accounting as Discipline' in Cooper, D.J. and Hooper, T.M.(eds) Critical Accounts, (London: Macmillans, 1990).
- Robson, K., 'Accounting and the UK Social: An Episode', Paper presented at the Second Interdisciplinary Perspectives on Accounting Conference, (University of Manchester, July 11-13,1988).
- Robson, K. and Cooper, D., 'Power and Management Control', in Chua, W.F., Lowe, E.A., and Puxty, A. (eds) Critical Perspectives in Management Control, (London: Macmilln, 1989).
- Robson, K. and Cooper, D., 'Understanding the Development of the Accountancy Profession in the United Kingdom' in Cooper, D.J. and Hooper, T.M.(eds) Critical Accounts, (London: Macmillans,1990).
- Rockness, H.O. and L.A. Nikolai, 'An Assessment of APB Voting Patterns', Journal of Accounting Research (1977), pp.145-67.
- Selto, F.H. and Frankes, J.E., 'A Positive Model of Lobbying Before the FASB- The Cases of R&D and Interest Costs' Working Paper, University of Denver, 1981.
- Selto, F.H. and H.d Grove, 'Voting Power Indices and the Setting of Financial Accounting Standards: Extentions', Journal of Accounting Research, (1982), pp.676-88.
- Selto, F.H and H.D. Grove, 'The Predictive Power of Voting Power Indices: FASB Voting on Statement of Accounting Standards Nos. 45-69', Journal of Accounting Research, (1983), pp. 619-22.
- Sheridan, A., Michel Foucault: The Will to Truth, (London: Tavistock, 1980).
- Silverman, D., Qualitative Methodology and Sociology, (Aldershot: Gower, 1985).

- Sikka, P., Willmott, H. and Love, E.A. 'Guardians of Knowledge and Public Interest: Evidence and Issues of Accountability on the UK Accountancy Profession', Accounting, Accountability and Auditing, 1989.
- Smart, B., Foucault, Marxism and Critique, (London: RKP, 1983a).
- Smart, B., 'On Discipline and Social Regulation: a Review of Foucault's Genealogical Analysis' in Garland, D., and Young, P. (eds) The Power to Punish: Contemporary Penalty and Social Analysis, (London: Heinemann Educational, 1983b).
- Smart, B., Michel Foucault, (Chichester: Ellis Horwood, 1985).
- Smith, C., Whipp, R., and Willmott, H., 'Case-Study Research in Accounting: Methodological Breakthrough or Ideological Weapon?', Advances in Public Interest Accounting, Vol.2, (1988), pp.95-120.
- Smith, H.L., and Stephen. S.M., 'A Theory of Organizational Response to Hospital Regulation: A Reply', Academy of Management Review (1985), Vol.10, No. 2, pp. 332-336.
- Stigler, G. J., The Theory of Economic Regulation, Bell Journal of Economics and Management Science, (Spring, 1971), pp. 3-21.
- Solomons, D., 'The Politicization of Accounting', Journal of Accountancy, (November 1978), pp.65-70.
- Sonnenfeld, J.A., Corporate Views of the Public Interest: Perceptions of the Forest Products Industry, (Boston: Auburn House, 1981).
- Strauss A.L., Qualitative Analysis for Social Scientists, (Cambridge : Cambridge University Press, 1987).
- Sutton, T.G., Corporate Management's Role in the Setting of Accounting : An Analysis with Empirical Tests, Unpublished Ph.D Dissertation, University of Washington, 1980.
- Sutton, T.G., 'Lobbying of Accounting Standard-Setting Bodies in the UK and the USA: A Downsian Analysis', Accounting, Organisations and Society, Vol. 9, (1984), pp.81-95.
- Taylor, C. 'Foucault on Freedom and Truth', in Hoy, D.C. (ed) Foucault: A Critical Reader, (Oxford: Basil Blackwell, 1986).
- Thompson, I.D., Organizations in Action, (New York: McGraw-Hill, 1967).
- Thompson, I.D. and McEwen W.J., 'Organizational Goals and Environment: Goal-Setting as an Interaction Process', American Sociological Review, Vol.23, (1958), pp.23-31.
- Tinker, A. M., Merino, B.D., and Neimark, M.D., 'The Normative Origins of Positive Theories: Ideology and Accounting Thought', Accounting, Organisations and Society, Vol.7, (1982), pp.167-200.

- Tinker, A.M., 'Theories of the State and the State of Accounting: Economic Reductionism and Political Voluntarism in Accounting Regulation Theory', Journal of Accounting and Public Policy, Vol. 3, (1984), pp.55-74.
- Tinker, A.M., Paper Prophets: A Social Critique of Accounting (London: Holt Rinehart & Winston, 1985).
- Tomkins, C. R., 'The Use of Accounting Information in a Social Services Department and a Police Force: A Comparison of Two Case Studies, Discussion Paper, School of Management, University of Bath, 1982.
- Tomkins C. & Groves, R., 'The Everyday Accountant & Researching His Realities', Accounting, Organisations and Society, Vol. 8, (1983), pp. 361-374.
- Tonkin, D.J., 'Politics & Accounting Standards', Accountancy, (April, 1981), pp.133-134.
- Tonkin, D.J., Professional Accounting Standards Setting Processes in the UK, Ph.D.Thesis, University of Glasgow, 1983.
- Trigg, R., Understanding Social Science, (Oxford: Basil Blackwell, 1985).
- Ungson G.R., James C. and Spicer B.H. 'The Effects of Regulatory Agencies on Organizations in Wood Products and High Technology/Electronics Industries', Academy of Management Journal, Vol. 28, No.2, (1985), pp.426-445.
- Walzer, M. 'The Politics of Michel Foucault', in Hoy, D.C.(ed) Foucault: A Critical Reader, (Oxford: Basil Blackwell,1986).
- Watts , R.L & Zimmerman, J.L., 'Towards a Positive Theory of the Determination of Accounting Standards', The Accounting Review, (January 1978), pp.112-134.
- Watts, R. L., & Zimmerman, J.L., 'The Demand for and Supply of Accounting Theories: the Market for Excuses', The Accounting Review, (April 1979), pp.273-305.
- Watts, R.L.& Zimmerman, J.L., Positive Accounting Theory, (Englwood Cliffs, NJ: Prentice-Hall,1986).
- Watts, R.L. & Zimmerman, J.L., 'Positive Accounting Theory: A Ten Year Perspective', Accounting Review, Vol.65, No.1 (January, 1990),pp. 131-156.
- Whitley, R., The Transformation of Business Finance into Financial Economics: The Roles of Academic Expansion and Changes in U.S. Capital Markets, Accounting, Organisations and Society, (1986), pp.171-192.
- Whitley, R.D., 'The Possibility and Utility of Positive Accounting Theory' Accounting, Organisations and Society Vol.13, (1988), pp.631-645.

- Webb, F.J., Campbell, D.T., Schwartz, R.D., and Sechrest, L., Unobtrusive Measures: Non-reactive Research in the Social Sciences, (Chicago: Rand McNally, 1966).
- Wickham, G., 'Power and Power Analysis: Beyond Foucault?', in Gane, M. (ed.) Towards A Critique of Foucault, (London: Rowledge & Kegan, 1987) pp.149-179.
- Willmott, H.C., 'Paradigms for Accounting Research: A Comment on Tomkins and Groves' "Everyday Accountant and Researching his Reality" ', Accounting, Organisations and Society, (1983), pp.389-406.
- Willmott, H.C., 'Organising the Profession: A Theoretical and Historical Examination of the Development of the Major Accountancy Bodies in the UK, Accounting, Organisations and Society, (1986), pp. 555-580.
- Willmott, H.C., 'Serving the Public Interest? A Critical Analysis of a Professional Claim', in Cooper ,D.J. and Hopper, T.M. (eds) Critical Accounts, (London: Macmillans, 1990).
- Wilson, J.Q., The Politics of Regulation, (New York: Basic Books, 1980).
- Winch, P., The Idea of a Social Science and Its Relation to Philosophy, (Routledge & Kegan Paul, 1970).
- Wolf, E., and Tanna S., Understanding Accounting Standards (London: ICAEW,1988).
- Yin, R.K., Case Study Research: Design and Methods, (California: Sage, 1984).
- Zeff, S.A., The Rise of 'Economic Consequences', The Journal of Accountancy, (December,1978),pp. 56-63.
- Zeitz, G. (1980), 'Interorganizational Dialectics', Administrative Science Quarterly, Vol.25, (1980), pp.72-88.

REFERENCES USED IN THE EMPIRICAL STUDY

Chapter 5

(69.1)	The Accountant,	9 August, pp 170-72
(69.2)	The Accountant,	20 September, pp 347-49
(69.3)	The Accountant,	27 September, pp 387-89
(69.4)	The Accountant,	4 October, pp 416-419
(69.5)	The Times,	11 September, p 22
(69.6)	The Accountant,	11 October, p 479
(69.7)	The Accountant,	11 October, pp 479-80
(69.8)	The Accountant,	27 November, p 746
(69.9)	The Accountant,	27 November, p 746
(69.10)	The Accountant,	25 December, p 904
(69.11)	The Accountant,	27 November, p 747
(69.12)	The Times,	21 November, p 26
(69.13)	The Times,	21 November, p 26
(69.14)	The Times,	28 November, p 29
(69.15)	The Times,	4 December, p 27
(69.16)	The Accountant,	12 December, p 11
(69.17)	The Accountant,	25 December, p 904
(69.18)	The Times,	19 December, p 23
(69.19)	The Times,	22 December, p 19
(69.20)	The Times,	29 December, p 19
(70.1)	The Times,	2 January, p 19
(70.2)	The Accountant,	5 March, p 354
(70.3)	The Times,	10 March, p 27
(70.4)	The Times,	23 March, p 24
(70.5)	The Times,	17 March, p 26
(70.6)	The Times,	1 April, p 22
(70.7)	The Times,	5 March, p 354
(70.8)	The Accountant,	16 April, pp 639-641
(70.9)	The Accountant,	9 April, p 531
(70.10)	The Times,	30 April, p 21
(70.11)	Accountancy,	June, pp 407-408
(70.12)	The Accountant,	30 April, p 629
(70.13)	The Accountant,	30 April, p 629
(70.14)	The Accountant,	7 May, p 685
(70.15)	Accountancy,	June, pp 407-408
(70.16)	The Accountant,	17 September, p 24
(70.17)	The Times,	11 November, p 27
(71.1)	Accountancy,	March, p 106
(71.2)	Accountancy,	May, pp 239-244
(71.3)	Accountancy,	May, pp 239-244
(71.4)	The Accountant's Magazine	May, p 207
(71.5)	The Accountant's Magazine	September, pp 476-486
(73.1)	The Accountant,	26 April, p 565
(73.2)	The Accountant,	14 December, p 19
(74.1)	Accountancy Age,	25 January, p 1
(74.2)	Accountancy Age,	25 January, p 1
(74.3)	Accountancy Age,	25 January, p 1
(74.4)	Accountancy Age,	December, p 20
(75.1)	Accountancy Age,	24 January, p 6
(75.2)	The Accountant's Magazine,	January, pp 25-30
(75.3)	The Accountant's Magazine,	February, pp 73-81
(75.4)	The Accountant's Magazine,	February, pp 73-81
(75.5)	Accountancy Age,	18 July, p 3
(75.6)	Accountancy Age,	18 July, p 3
(75.7)	Accountancy Age,	18 July, p 3
(75.8)	Accountancy,	August, pp 42-47

(75.9)	The Accountant,	24 July, p 96
(75.10)	Accountancy Age,	22 August, p 1
(75.11)	Accountancy Age,	22 August, p 1
(75.12)	Accountancy Age,	22 August, p 7
(75.13)	The Accountant,	11 December, p 654
(76.1)	Accountancy Age,	19 March, p 1
(76.2)	Accountancy Age,	28 May, pp 14-15
(76.3)	Accountancy Age,	4 June, pp 12-13
(76.4)	Accountancy Age,	16 July, pp 10-12
(76.5)	Accountancy Age,	27 August, pp 12-13
(76.6)	Accountancy,	August, p 4
(76.7)	Accountancy,	August, p 4
(76.8)	Accountancy Age,	10 September, p 1
(76.9)	Accountancy Age,	10 September, pp 14-16
(76.10)	Accountancy Age,	22 October, pp 14-15
(76.11)	Accountancy,	October, pp 96-100
(76.12)	Accountancy Age,	3 December, pp 20-21
(76.13)	Accountancy,	December, p 26
(76.14)	Accountancy,	December, p 26
(77.1)	Accountancy,	January, p 5
(77.2)	Accountancy,	7 January, pp 10-11
(77.3)	Accountancy Age,	11 February, pp 18-19
(77.4)	The Accountant,	7 April, p 390
(77.5)	Accountancy Age,	22 April, p 11
(77.6)	The Accountant's Magazine,	July, p 274
(77.7)	Accountancy Age,	17 June, p 1
(77.8)	The Times,	5 July, p 19
(77.9)	Accountancy Age,	12 August, pp 18-19
(77.10)	Accountancy,	August, p 8
(77.11)	Accountancy Age,	16 September, p 1
(77.12)	Accountancy Age,	23 September, p 3
(77.13)	Accountancy Age,	23 September, p 3
(77.14)	Accountancy Age,	23 September, pp 20-21
(77.15)	Accountancy Age,	14 October, pp 22-23
(77.16)	Accountancy Age,	25 November, p 2
(77.17)	Accountancy Age,	9 December, pp 16-17
(78.1)	The Accountant's Magazine,	February, p 87
(78.2)	The Accountant's Magazine,	February, p 78
(78.3)	The Accountant's Magazine,	February, p 42
(78.4)	Accountancy,	February, p 36
(78.5)	The Accountant's Magazine,	May, p 188
(78.6)	Accountancy Age,	June, pp 18-19
(78.7)	Accountant,	22 June, p 858
(78.8)	Accountant,	22 June, p 858
(78.9)	Accountancy,	August, p 1
(78.10)	The Accountant's Magazine,	September, p 368
(78.11)	The Accountant,	28 September, p 385
(78.12)	Accountancy,	October, p 4
(78.13)	Accountancy,	September, p 8
(78.14)	The Accountant,	23 November, p 694
(78.15)	Certified Accountant,	December, pp 381-82
(79.1)	Accountancy,	January, pp 50-51
(79.2)	The Accountant's Magazine,	January, pp 10-12
(79.3)	Accountancy Age,	2 February, p 2
(79.4)	The Accountant,	15 March, p 317
(79.5)	Accountancy Age,	23 March, pp 4-5
(79.6)	Accountancy Age,	16 March, p 3
(79.7)	Accountancy Age,	16 March, p 3
(79.8)	The Accountant,	15 March, p 318
(79.9)	Accountancy Age,	16 March, p 3

(79.10)	The Accountant's Magazine,	March, p 103
(79.11)	Accountancy Age,	6 March, p 7
(79.12)	The Accountant,	19 April, p 518
(79.13)	The Accountant,	5 April, p 423
(79.14)	The Accountant,	19 April, p 491
(79.15)	The Accountant,	19 April, p 490
(79.16)	The Accountant's Magazine,	May, pp 201-203
(79.17)	Accountant,	13 May, p 695
(79.18)	Accountancy Age,	25 May, p 1
(79.19)	Accountancy Age,	25 May, p 1
(79.20)	Accountancy Age,	25 May, p 1
(79.21)	Accountancy Age,	18 May, p 18
(79.22)	Accountancy Age,	13 May, p 9
(79.23)	The Accountant's Magazine	July, pp 285-287
(79.24)	Accountancy Age,	8 June, p 10
(79.25)	The Accountant,	21 June, p 79
(79.26)	Accountancy Age,	1 June, p 2
(79.27)	Accountancy Age,	15 June, pp 18-19
(79.28)	The Accountant,	12 July, p 32
(79.29)	Accountancy Age,	15 June, pp 18-19
(79.30)	The Accountant,	26 July, p 1
(79.31)	Accountancy,	July, pp 46-48
(79.32)	The Accountant's Magazine,	July, pp 285-287
(79.33)	The Accountant's Magazine,	August, p 336
(79.34)	Accountancy,	July, pp 46-48
(79.35)	Accountancy,	July, pp 285-287
(79.36)	The Accountant's Magazine,	August, p 316
(79.37)	Accountancy Age,	17 August, p 2
(79.38)	Accountancy,	August, p 2
(79.39)	Accountancy,	August, p 316
(79.40)	Accountancy,	August, p 48
(79.41)	Accountancy,	September, p 56
(79.42)	Accountancy,	September, pp 50-54
(79.43)	Accountancy,	September, p 4
(79.44)	Accountancy Age,	28 September, pp 14-17
(79.45)	Accountancy Age,	26 October, p 14
(79.46)	Accountancy Age,	9 November, p 15
(79.47)	The Times,	14 November, p 15
(79.48)	The Accountant,	22 November, p 734
(79.49)	Accountancy,	November, p 448
(80.1)	Accountancy Age,	1 February, p 1
(80.2)	Accountancy Age,	1 February, p 1
(80.3)	The Accountant,	7 March, p 1
(80.4)	Accountancy Age,	7 March, p 1
(80.5)	Accountancy Age,	7 March, p 1
(80.6)	The Accountant,	3/10 January, p 34
(80.7)	Accountancy Age,	16 May, p 3
(80.8)	Accountancy,	June, p 8
(80.9)	The Accountant's Magazine,	June, pp 245-247
(80.10)	Accountancy Age,	26 September, p 1
(80.11)	Accountancy Age,	31 October, p 1
(80.12)	Accountancy Age,	10 October, p 3
(80.13)	Accountancy Age,	14 November, p 1
(81.1)	Accountancy,	January, p 20
(81.2)	Accountancy Age,	27 February, p 26
(81.3)	Accountancy,	February, p 11
(81.4)	Accountancy Age,	6 March, p 1
(81.5)	Accountancy Age,	6 March, p 1
(81.6)	Accountancy Age,	6 March, p 1
(81.7)	Accountancy,	April, p 133

(81.8)	Accountancy Age,	3 April, p 1
(81.9)	The Times,	5 May, p 17
(81.10)	Accountancy Age,	8 May, p 3
(81.11)	Accountancy Age,	8 May, p 3
(81.12)	Accountancy Age,	8 May, p 3
(81.13)	Accountancy Age,	1 May, p 3
(81.14)	Accountancy,	June, p 23
(81.15)	Accountancy,	June, pp 176-177
(81.16)	Accountancy,	June, pp 176-177
(81.17)	Accountancy Age,	26 June, p 3
(81.18)	Accountancy Age,	12 June, p 1
(81.19)	Accountancy Age,	12 June, p 1
(81.20)	Accountancy Age,	12 June, p 1
(81.21)	Accountancy Age,	12 June, p 13
(81.22)	Accountancy Age,	31 July, p 1
(81.23)	Accountancy Age,	31 July, p 1
(81.24)	The Accountant's Magazine,	July, pp 216-222
(81.25)	Accountancy Age,	7 August, p 3
(81.26)	Accountancy Age,	9 October, p 13
(81.27)	Accountancy Age,	9 October, p 13
(81.28)	Accountancy Age,	6 November, p 1
(81.29)	Accountancy Age,	27 November, p 2
(81.30)	Accountancy Age,	27 November, p 2
(81.31)	Accountancy Age,	4 December, p 3
(82.1)	Accountancy Age,	21 January, p 13
(82.2)	Accountancy Age,	11 February, p 3
(82.3)	Accountancy,	March, p 123
(82.4)	The Accountant,	22 February, p 3
(82.5)	The Accountant's Magazine,	May, pp 157-159
(82.6)	Accountancy Age,	3 June, p 1
(82.7)	Accountancy Age,	3 June, p 1
(82.8)	Accountancy Age,	10 June, p 11
(82.9)	Accountancy Age,	10 June, p 11
(82.10)	The Accountant,	10 June, p 2
(82.11)	Accountancy Age,	15 July, p 1
(82.12)	The Accountant,	17 June, p 11
(82.13)	The Accountant,	19/26 August, p 2
(82.14)	Accountancy Age,	15 July, p 1
(82.15)	Accountancy Age,	15 July, p 1
(82.16)	Accountancy Age,	9 September, p 3
(82.17)	Accountancy Age,	9 September, p 3
(82.18)	Accountancy,	September, p 30
(82.19)	Accountancy Age,	30 September, p 11
(82.20)	The Accountant's Magazine,	October, p 350
(82.21)	The Accountant,	4 November, p 3
(82.22)	The Accountant,	4 November, p 3
(82.23)	Accountancy Age,	4 November, p 1
(82.24)	The Accountant,	18 November, p 5
(82.25)	The Accountant,	11 November, p 6
(82.26)	Accountancy Age,	25 November, p 2
(82.27)	Accountancy Age,	25 November, p 2
(82.28)	The Accountant,	25 November, p 2
(82.29)	Accountancy,	November, p 98
(82.30)	Accountancy Age,	30 December, p 15
(82.31)	Accountancy,	November, p 12
(83.1)	Accountancy Age,	20 January, p 13
(83.2)	Accountancy Age,	20 January, p 13
(83.3)	Accountancy Age,	10 February, p 17
(83.4)	Accountancy Age,	27 February, p 3
(83.5)	Accountancy Age,	27 February, p 3

(83.6)	Accountancy Age,	27 February, p 3
(83.7)	The Accountant,	9 February, p 4
(83.8)	The Accountant,	31 March, p 12
(83.9)	The Accountant,	3 March, p 2
(83.10)	The Accountant,	3 March, p 2
(83.11)	The Accountant,	7 April, pp 11-12
(83.12)	The Accountant's Magazine,	April, pp 147-148
(83.13)	The Accountant,	2 June, p 2
(83.14)	The Accountant,	2 June, p 2
(83.15)	Accountancy,	July, p 13
(84.1)	Accountancy Age,	16 February, p 2
(84.2)	Accountancy Age,	16 February, p 2
(84.3)	Accountancy,	February, pp 129-131
(84.4)	Accountancy Age,	17 May, p 1
(84.5)	Accountancy Age,	17 May, p 1
(84.6)	Accountancy Age,	24 May, p 13
(84.7)	Accountancy Age,	24 May, p 13
(84.8)	Accountancy Age,	24 May, p 13
(84.9)	Accountancy Age,	28 June, p 9
(84.10)	The Accountant,	7 June, p 1
(84.11)	Accountancy Age,	8 August, p 3
(84.12)	The Accountant,	22 September, p 14
(84.13)	Accountancy Age,	9 October, p 17
(84.14)	The Accountant,	4 October, p 10
(84.15)	Accountancy,	November, p 17
(84.16)	Accountancy Age,	15 November, p 11
(85.1)	Accountancy Age,	28 March, p 1
(85.2)	Accountancy,	May, p 9
(85.3)	Accountancy Age,	November, p 2
(85.4)	Accountancy Age,	November, p 2
(85.5)	The Times,	16 October, p 23
(85.6)	The Times,	16 October, p 23
(85.7)	The Accountant,	13 November, p 3
(86.1)	Accountancy Age,	20 February, p 17
(86.2)	Accountancy Age,	20 February, p 17
(86.3)	Accountancy Age,	20 February, p 17
(86.4)	Accountancy Age,	12 June, p 13
(86.5)	Accountancy,	July, p 5
(86.6)	Accountancy,	July, p 5
(86.7)	The Accountant,	26 November, p 2
(86.8)	The Accountant,	26 November, p 2
(86.9)	The Accountant,	26 November, p 2
(86.10)	The Accountant,	17 December, p 5
(86.11)	Accountancy Age,	4 December, p 16
(86.12)	Accountancy Age,	4 December, p 1
(86.13)	Accountancy Age,	4 December, p 1
(87.1)	The Accountant,	4 February, p 1
(87.2)	Accountancy Age,	5 February, p 1
(87.3)	The Accountant,	4 February, p 1
(87.4)	The Accountant,	4 February, p 1
(87.5)	The Accountant,	4 February, p 1
(87.6)	Accountancy Age,	21 May, p 1
(87.7)	Accountancy Age,	16 July, p 14
(87.8)	Accountancy,	August, p 5
(87.9)	The Accountant,	July, p 2
(87.10)	The Accountant,	July, p 2
(87.11)	Accountancy Age,	9 July, p 20
(87.12)	Accountancy Age,	9 July, p 20
(87.13)	Accountancy Age,	9 July, p 20
(87.14)	Accountancy Age,	July, p 8

(87.15)	Accountancy,	16 July, p 14
(87.16)	Accountancy Age,	6 August, p 4
(87.17)	Accountant,	September, pp 114-116
(87.18)	Accountancy Age,	1 October, p 1
(87.19)	Accountancy Age,	8 October, p 17
(87.20)	Accountancy Age,	15 October, p 16
(87.21)	Accountancy Age,	15 October, p 4
(87.22)	Accountancy Age,	15 October, p 18
(87.23)	The Accountant's Magazine,	October, pp 22-24
(87.24)	The Accountant's Magazine,	October, pp 24-26
(87.25)	Accountancy Age,	3 December, p 17
(87.26)	Accountancy Age,	10 December, p 1
(88.1)	The Accountant's Magazine,	January, pp 20-23
(88.2)	Accountancy Age,	February, p 2
(88.3)	Accountancy Age,	11 February, p 1
(88.4)	Accountancy Age,	11 February, p 1
(88.5)	Accountancy Age,	25 February, p 17
(88.6)	Accountancy Age,	25 February, p 16
(88.7)	The Accountant,	3 March, p 2
(88.8)	The Accountant,	3 March, p 2
(88.9)	The Accountant,	3 March, p 2
(88.10)	Accountancy Age,	24 March, p 3
(88.11)	Accountancy Age,	24 March, p 3
(88.12)	The Accountant,	April, p 4
(88.13)	The Accountant,	April, p 4
(88.14)	The Accountant,	April, p 4
(88.15)	Accountancy Age,	12 May, p 15
(88.16)	Accountancy Age,	26 May, p 1
(88.17)	Accountancy Age,	26 May, p 1
(88.18)	Accountancy Age,	21 June, p 17
(88.19)	The Accountant's Magazine,	July, p 5
(88.20)	Accountancy,	July, p 21
(88.21)	The Accountant,	November, p 3
(88.22)	The Accountant,	December, p 6
(88.23)	Accountancy,	November, p 3
(88.24)	Accountancy,	December, p 6
(88.25)	Accountancy,	December, p 6
(88.26)	Accountancy,	December, p 5

Chapter 6

(69.1)	The Times,	28 November p 29
(73.1)	Accountancy,	February, pp 14-17
(73.2)	Accountancy,	March, p 66
(73.3)	Accountancy,	June, pp 24-26
(73.4)	Accountancy Age,	7 December, p 1
(73.5)	Accountancy Age,	14 December, p 7
(74.1)	Accountancy,	July, p 98
(74.2)	The Accountant,	22 August, pp 235-236
(75.1)	Accountancy Age,	24 January, pp 16-17
(75.2)	The Accountant,	9 January, p 29
(75.3)	Accountancy Age,	7 February, p 8
(75.4)	The Accountant's Magazine,	March, p 126
(75.5)	Accountancy Age,	11 April, p 1
(75.6)	Accountancy Age,	11 April, p 1
(75.7)	Accountancy Age,	11 April, p 1
(75.8)	Accountancy Age,	11 April, p 1
(75.9)	Accountancy Age,	11 April, p 1
(75.9)	Accountancy Age,	11 April, p 1

(75.10)	Accountancy Age,	11 April, p 1
(75.11)	Accountancy Age,	11 April, p 1
(75.12)	The Accountant,	10 April, p 477
(75.13)	Accountancy Age,	9 May, p 3
(75.14)	Accountancy Age,	9 May, p 3
(75.15)	Accountancy Age,	9 May, p 3
(76.1)	Accountancy Age,	28 May, p 3
(76.2)	Accountancy Age,	28 May, p 3
(77.1)	Accountancy,	February, pp 40-45
(77.2)	The Accountant,	14 April, p 417
(77.3)	Accountancy,	August, p 8
(77.4)	Accountancy,	October, p 1
(77.5)	Accountancy,	November, p 1
(77.6)	The Accountant,	13 October, p 443
(77.7)	The Times,	6 October, p 24
(77.8)	Accountancy,	December, p 4
(77.9)	Accountancy,	December, p 4
(77.10)	Accountancy,	December, p 15
(78.1)	The Accountant,	5 January, p 3
(78.2)	The Accountant's Magazine,	January, pp 2-3
(78.3)	Accountancy Age,	February, p 1
(78.4)	Accountancy,	February, p 137
(78.5)	The Accountant's Magazine,	February, p 79
(78.6)	Accountancy Age,	February, p 1
(78.7)	Accountancy Age,	February, p 1
(78.8)	Accountancy,	April, p 14
(78.9)	Accountancy,	April, p 14
(78.10)	Accountancy,	May, p 12
(78.11)	Accountancy,	May, p 12
(78.12)	Estates Gazette,	1 July, p 1
(78.13)	Accountancy Age,	28 July, p 11
(78.14)	Accountancy Age,	21 July, p 1
(78.15)	Accountancy Age,	21 July, p 1
(78.16)	The Accountant,	22 June, pp 826-827
(78.17)	Accountancy Age,	28 July, p 11
(78.18)	Accountancy Age,	20 October, p 2
(78.19)	Accountancy Age,	10 November, p 1
(78.20)	Accountancy Age,	10 November, p 12
(78.21)	Accountancy,	November, p 113
(78.22)	The Accountant,	2 November, p 579
(78.23)	Accountancy Age,	15 December, p 3
(78.24)	Accountancy,	December, p 15
(78.25)	Accountancy,	December, p 15
(78.26)	The Accountant,	21/28 December, p 837
(78.27)	The Times,	12 December, p 22
(79.1)	Accountancy Age,	19 January, p 8
(79.2)	Accountancy Age,	16 February, p 1
(79.3)	Accountancy Age,	16 February, p 1
(79.4)	Accountancy Age,	16 February, p 1
(79.5)	Accountancy Age,	16 February, p 1
(79.6)	Accountancy Age,	16 February, p 1
(79.7)	Accountancy Age,	16 February, p 2
(79.8)	Accountancy Age,	16 February, p 2
(79.9)	Accountancy Age,	16 February, p 2
(79.10)	Accountancy Age,	30 March, p 1
(79.11)	Accountancy Age,	30 March, p 1
(79.12)	Accountancy Age,	27 April, p 2
(79.13)	Accountancy Age,	27 April, p 2
(79.14)	Accountancy Age,	27 April, p 2

(79.15)	Accountancy,	April, p 23
(79.16)	Accountancy,	April, p 23
(79.17)	Accountancy Age,	4 May, p 1
(79.18)	Accountancy Age,	4 May, p 1
(79.19)	Accountancy Age,	4 May, p 1
(79.20)	Accountancy Age,	4 May, p 1
(79.21)	Accountancy Age,	18 May, p 2
(79.22)	Accountancy Age,	18 May, p 2
(79.23)	Accountancy Age,	1 June, p 3
(79.24)	Accountancy Age,	1 June, p 3
(79.25)	Accountancy Age,	1 June, p 3
(79.26)	Accountancy Age,	1 June, p 3
(79.27)	Accountancy Age,	1 June, p 3
(79.28)	Accountancy Age,	1 June, p 3
(79.29)	Accountancy Age,	22 June, p 3
(79.30)	Accountancy Age,	22 June, p 3
(79.31)	Accountancy Age,	22 June, p 3
(79.32)	Accountancy,	June, p 9
(79.33)	Accountancy,	June, p 9
(79.34)	Accountancy Age,	13 July, p 2
(79.35)	Accountancy Age,	13 July, p 2
(79.36)	Accountancy Age,	13 July, p 2
(79.37)	Accountancy Age,	13 July, p 8
(79.38)	Accountancy Age,	20 July, p 1
(79.39)	Accountancy Age,	20 July, p 11
(79.40)	Accountancy Age,	20 July, p 11
(79.41)	Accountancy Age,	17 August, p 2
(79.42)	Accountancy Age,	31 August, p 2
(79.43)	Accountancy Age,	31 August, p 2
(79.44)	Accountancy Age,	31 August, p 2
(79.45)	Accountancy Age,	31 August, p 2
(79.46)	Accountancy Age,	31 August, p 2
(79.47)	Accountancy Age,	31 August, p 2
(79.48)	Accountancy Age,	31 August, p 2
(79.49)	Accountancy,	August, p 11
(79.50)	Accountancy,	August, p 21
(79.51)	Accountancy,	November, p 129
(79.52)	Accountancy,	December, pp 50-52
(79.53)	Accountancy,	7 December, p 3
(79.54)	Accountancy,	7 December, p 3
(79.55)	Accountancy,	7 December, p 3
(80.1)	Accountancy Age,	1 February, p 1
(80.2)	Accountancy Age,	11 April, p 1
(80.3)	Accountancy Age,	7 March, p 12
(80.4)	Accountancy Age,	11 April, p 1
(80.5)	Accountancy Age,	16 May, p 1
(80.6)	Accountancy Age,	16 May, p 1
(80.7)	Accountancy Age,	16 May, p 1
(80.8)	Accountancy Age,	16 May, p 1
(80.9)	The Accountant's Magazine,	May, pp 188-189
(80.10)	Accountancy Age,	6 June, p 1
(80.11)	Accountancy Age,	6 June, p 1
(80.12)	Accountancy Age,	4 July, p 1
(80.13)	Accountancy Age,	4 July, p 1
(80.14)	Accountancy Age,	4 July, p 1
(80.15)	Accountancy Age,	4 July, p 12
(80.16)	Accountancy Age,	4 July, p 12
(80.17)	Accountancy Age,	4 July, p 12
(80.18)	Accountancy,	August, p 20
(80.19)	Accountancy Age,	26 September, p 4

(80.20)	The Accountant,	25 September, p 488
(80.21)	Accountancy Age,	26 September, p 4
(80.22)	The Times,	22 September, p 17
(80.23)	Accountancy Age,	17 October, pp 24-25
(80.24)	Accountancy Age,	17 October, pp 24-25
(80.25)	Accountancy Age,	7 November, p 2
(80.26)	Accountancy Age,	7 November, p 2
(80.27)	Accountancy Age,	7 November, p 2
(80.28)	The Accountant's Magazine,	November, pp 445-446
(80.29)	Accountancy,	November, p 10
(80.30)	Accountancy Age,	5 December, p 2
(80.31)	Accountancy Age,	5 December, p 2
(80.32)	Accountancy,	December, p 19
(80.33)	The Accountant,	11 December, p 909
(81.1)	Accountancy Age,	29 May, p 3
(81.2)	Accountancy Age,	29 May, p 3
(81.3)	Accountancy Age,	29 May, p 3
(81.4)	Accountancy Age,	29 May, p 3
(81.5)	Accountancy Age,	24 July, p 3
(81.6)	Accountancy Age,	31 July, p 9
(81.7)	Accountancy Age,	27 November, p 3
(81.8)	Accountancy Age,	27 November, p 3
(81.9)	Accountancy Age,	27 November, p 3
(81.10)	Accountancy Age,	4 December, p 11
(81.11)	Accountancy Age,	4 December, p 11
(81.12)	Accountancy Age,	4 December, p 11
(81.13)	The Accountant's Magazine,	March (1982), p 85
(82.1)	Accountancy,	March, p 5
(82.2)	The Accountant,	8 July, p 2
(82.3)	The Accountant,	8 July, p 2
(82.4)	The Accountant,	8 July, p 2
(82.5)	The Accountant,	16 December, p 5
(82.6)	Accountancy Age,	16 December, p 2
(82.7)	Accountancy Age,	16 December, p 2
(82.8)	Accountancy Age,	16 December, p 2
(83.1)	The Accountant's Magazine,	January, p 3
(83.2)	Accountancy,	February, p 5
(83.3)	Accountancy,	February, pp 138-139
(83.4)	Accountancy Age,	
(83.5)	Accountancy,	May, p 18
(83.6)	The Accountant,	12 May, p 622
(83.7)	Accountancy,	August, p 91
(83.8)	Accountancy,	December, p 100
(84.1)	Accountancy,	January, p 15
(84.2)	The Accountant's Magazine,	January, p 5
(84.3)	Accountancy Age,	12 January, p 18
(84.4)	Accountancy Age,	2 February, p 13
(84.5)	Accountancy Age,	15 March, p 2
(84.6)	Accountancy Age,	15 March, p 2
(84.7)	Accountancy Age,	29 March, p 2
(84.8)	The Accountant,	29 March, p 3
(84.9)	The Accountant,	5 April, p 1
(84.10)	The Accountant,	5 April, p 1
(84.11)	The Accountant,	5 April, p 1
(84.12)	Accountancy,	June, pp 15-16
(84.13)	Accountancy,	August, p 18
(84.14)	Accountancy,	August, p 18
(84.15)	Accountancy,	August, p 18
(84.16)	Accountancy,	August, p 18

(84.17)	Accountancy,	September, p 18
(84.18)	The Accountant's Magazine,	October, p 386
(84.19)	Accountancy Age,	4 October, p 15
(84.20)	Accountancy Age,	6 December, p 2
(84.21)	Accountancy Age,	6 December, p 2
(84.22)	Accountancy,	October, p 10
(84.23)	Accountancy,	October, p 10
(84.24)	Accountancy,	October, p 10
(84.25)	Accountancy,	October, p 10
(84.26)	Accountancy,	October, p 10
(84.27)	Accountancy,	October, p 10
(84.28)	Accountancy,	October, pp 60-61
(84.29)	The Accountant,	4 October, p 1
(84.30)	The Accountant,	4 October, p 1
(84.31)	The Accountant's Magazine,	October, pp 401-402
(84.32)	Accountancy,	November, p 16
(84.33)	Accountancy Age,	6 December, p 2
(85.1)	Accountancy Age,	28 March, p 12
(85.2)	Accountancy,	March, pp 110-111
(85.3)	Accountancy Age,	4 April, p 2
(85.4)	Accountancy Age,	4 April, p 2
(85.5)	Accountancy,	April, p 24
(85.6)	The Accountant,	11 April, p 7
(85.7)	The Accountant's Magazine,	April, p 153
(85.8)	Accountancy Age,	15 May, p 15
(85.9)	Accountancy Age,	15 May, p 15
(85.10)	Accountancy Age,	15 May, p 15
(85.11)	Accountancy Age,	15 May, p 15
(85.12)	Accountancy,	July, pp 14-15
(85.13)	The Accountant,	24 July, p 11
(85.14)	The Accountant's Magazine,	September, p 417
(85.15)	The Accountant's Magazine,	November, pp 495-496
(86.1)	The Accountant's Magazine,	January/February, pp 28-30
(86.2)	Accountancy Age,	10 April, p 3
(86.3)	Accountancy Age,	10 April, p 3
(86.4)	Accountancy Age,	10 April, p 3
(86.5)	The Accountant,	21 April, p 2
(86.6)	The Accountant,	21 April, p 2
(86.7)	Accountancy Age,	15 May, p 2
(86.8)	Accountancy Age,	15 May, p 2
(86.9)	Accountancy Age,	15 May, p 2
(86.10)	Accountancy,	May, p 22
(86.11)	Accountancy,	October, p 35
(86.12)	Accountancy,	October, p 35
(86.13)	Accountancy,	October, p 35
(86.14)	Accountancy,	October, p 35
(86.15)	Accountancy,	October, p 40
(86.16)	Accountancy Age,	11 December, p 14
(87.1)	Accountancy Age	22 January, p 3
(87.2)	Accountancy Age	22 January, p 3
(87.3)	Accountancy Age	15 January, p 15
(87.4)	Accountancy Age	15 January, p 15
(87.5)	Accountancy,	February, p 41
(87.6)	Accountancy,	February, p 7
(87.7)	Accountancy,	February, p 7
(87.8)	Accountancy,	February, p 7
(87.9)	Accountancy,	February, p 7
(87.10)	Accountancy Age,	5 March, p 15
(87.11)	The Accountant's Magazine,	March, p 57

(87.12)	Accountancy,	March, p 33
(87.13)	Accountancy,	March, p 26
(87.14)	The Accountant's Magazine,	March, p 26
(87.15)	The Accountancy,	April, p 30

Chapter 7

(72.1)	Accountancy,	April, pp 24-25
(72.2)	Accountancy,	April, pp 29-30
(73.1)	Accountancy,	May, p 56
(74.1)	Accountancy,	June, pp 52-54
(75.1)	Accountancy Age,	14 February, p 3
(75.2)	Accountancy Age,	14 February, p 3
(75.3)	Accountancy Age,	14 February, p 3
(75.4)	Accountancy Age,	14 February, p 3
(75.5)	Accountancy,	February, p 16
(75.6)	Accountancy Age,	20 June, p 2
(75.7)	Accountancy Age,	20 June, p 2
(76.1)	Accountancy Age,	19 March, p 18
(76.2)	The Accountant,	8 July, p 31
(76.3)	Accountancy,	October, p 5
(77.1)	The Accountant,	20 January, p 79
(77.2)	The Accountant,	20 January, p 80
(77.3)	The Accountant,	20 January, p 83
(77.4)	The Accountant,	20 January, pp 87-88
(77.5)	The Accountant	20 January, pp 88-89
(77.6)	The Accountant	20 January, pp 91-92
(77.7)	The Accountant	20 January, p 92
(77.8)	The Accountant	20 January, p 92
(78.1)	Accountancy Age,	3 February, p 1
(78.2)	The Accountant	16 February, pp 194-195
(78.3)	The Accountant	8 March, p 289
(78.4)	The Accountant	8 March, p 289
(78.5)	Accountancy	March, p 4
(78.6)	The Times,	5 June, p
(78.8)	Accountancy Age,	7 July, p 2
(78.9)	Accountancy Age,	7 July, p 2
(78.10)	Accountancy Age	7 July, p 2
(78.11)	Accountancy Age,	7 July p 2
(78.12)	Accountancy Age,	28 July, p 11
(78.13)	Accountancy,	August,
(78.14)	Accountancy,	August, p 21
(78.15)	Accountancy Age,	13 October p 3
(78.16)	Accountancy Age,	10 November, p 19
(78.17)	Accountancy Age,	10 November p 19
(78.18)	Accountancy Age,	17 November, p 15
(78.19)	Accountancy Age,	17 November p 15
(78.20)	Accountancy Age,	24 November, p 15
(78.21)	Accountancy Age	8 December, p 2
(79.1)	Accountancy Age,	5 January, pp 8-9
(79.2)	Accountancy Age	26 January p 1
(79.3)	Accountancy Age	26 January p 1
(79.4)	Accountancy Age	26 January p 1
79.5	Accountancy Age	26 January p 1
79.6	Accountancy Age	2 March p 3
79.7	Accountancy Age	2 March p 3
79.8	Accountancy Age	27 July p 2
79.9	Accountancy Age	27 July p 2
79.10	Accountancy Age	27 July p 2
79.11	Accountancy Age	27 July p 2

(79.12)	Accountancy Age,	27 July, p 11
(79.13)	Accountancy Age,	10 August, p 3
(79.14)	Accountancy Age,	17 August, pp 16-17
(79.15)	Accountancy Age,	17 August, pp 16-17
(79.16)	Accountancy,	September, p 22
(79.17)	Accountancy Age,	19 October, p 2
(79.18)	Accountancy Age,	26 October, p 1
(79.19)	Accountancy Age,	26 October, p 1
(79.20)	Accountancy Age,	26 October, p 15
(79.21)	Accountancy Age,	26 October, p 15
(79.22)	Accountancy,	September, p 24
(79.23)	The Accountant,	November, p 629
(79.24)	The Accountant,	8 November, p 664
(79.25)	The Accountant,	22 November, p 731
(79.26)	The Accountancy,	November, pp 116-118
(79.27)	Accountancy Age,	22 October, p 487
(80.1)	Accountancy,	January, p 21
(80.2)	Accountancy Age,	8 February, p 3
(80.3)	Accountancy Age,	15 February, pp 27-32
(80.4)	Accountancy Age,	8 February, p 3
(80.5)	Accountancy,	July, p 20
(80.6)	Accountancy,	August, p 20
(80.7)	Accountancy,	September, p 17
(80.8)	Accountancy Age,	3 October, p 13
(80.9)	Accountancy Age,	31 October, p 1
(81.1)	Accountancy,	March, p 11
(81.2)	Accountancy Age,	3 April, p 3
(81.3)	Accountancy Age,	19 June, p 1
(81.4)	Accountancy Age,	19 June, p 1
(81.5)	Accountancy Age,	19 June, p 1
(81.6)	Accountancy Age,	19 June, p 1
(81.7)	Accountancy,	July, p 23
(81.8)	Accountancy,	September, p 21
(81.9)	Accountancy,	September, p 21
(81.10)	Accountancy,	September, p 21
(81.11)	The Accountant's Magazine,	September, pp 294-96
(81.12)	Accountancy Age,	9 October, p 1
(81.13)	Accountancy Age,	9 October, p 1
(81.14)	Accountancy Age,	9 October, p 1
(81.15)	Accountancy Age,	23 October, p 1
(81.16)	Accountancy Age,	23 October, p 1
(81.17)	Accountancy Age,	23 October, p 1
(81.18)	The Accountant,	22 October, p 487
(81.19)	The Accountant,	22 October, p 487
(81.20)	The Accountant,	22 October, p 487
(81.21)	The Accountant,	22 October, p 487
(81.23)	The Accountant,	22 October, p 487
(81.24)	The Accountant,	
(81.25)	The Accountant,	
(81.26)	The Times,	17 October, p 21
(81.27)	The Times,	19 October, p 17
(81.28)	Accountancy Age,	6 November, p 12
(81.29)	Accountancy Age,	27 November, p 1
(81.30)	Accountancy Age,	27 November, p 1
(81.31)	Accountancy Age,	27 November, p 1
(81.32)	Accountancy Age,	27 November, p 1
(81.33)	Accountancy Age,	27 November, p 1
(81.34)	The Accountant,	12 November, p 573
(81.35)	The Accountant,	19 November, p 617

(81.36)	The Accountant,	19 November, p 635
(81.37)	The Times,	25 November, p 19
(81.38)	Accountancy Age,	4 December, p 11
(81.39)	The Accountant,	3 December, p 680
(82.1)	Accountancy,	January, p 7
(82.2)	Accountancy,	January, p 7
(82.3)	Accountancy,	January, p 7
(82.4)	Accountancy,	January, pp 112-114
(82.5)	The Accountant,	18 February, pp 222-225
(82.6)	Accountancy Age,	4 March, p 4
(82.7)	Accountancy Age,	4 March, p 4
(82.8)	Accountancy Age,	4 March, p 4
(82.9)	Accountancy Age,	4 March, p 4
(82.10)	Accountancy,	March, p 26
(82.11)	Accountancy Age,	25 March, p 2
(82.12)	The Accountant,	22 April, p 5
(82.13)	The Accountant,	22 April, p 5
(82.14)	The Accountant,	22 April, p 5
(82.15)	Accountancy Age,	29 April, p 15
(82.16)	Accountancy,	April, pp 56-57
(82.17)	Accountancy,	May, pp 4-5
(82.18)	Accountancy,	May, p 18
(82.19)	Accountancy,	June, p 20
(82.20)	The Accountant,	1 July, p 5
(82.21)	The Accountant,	1 July, p 8
(82.22)	Accountancy,	July, pp 126-127
(82.23)	Accountancy,	September, p 50
(82.24)	Accountancy Age,	30 September, p 22
(82.25)	Accountancy Age,	30 September, p 3
(82.26)	The Accountant,	9 September, p 318
(82.27)	Accountancy,	September, p 6
(82.28)	The Accountant,	4 November, p 625
(82.29)	The Accountant,	4 November, pp 626-27
(82.30)	The Accountant,	4 November, p 629
(83.1)	Accountancy Age,	20 January, p 20
(83.2)	Accountancy Age,	17 February, p 11
(83.3)	Accountancy Age,	2 March, p 11
(83.4)	Accountancy Age,	17 March, p 11
(83.5)	The Accountant,	24 February, p 250
(83.6)	The Accountant,	14 April, p 495
(83.7)	The Accountant,	26 May, p 691
(83.8)	Accountancy Age,	28 July, p 3
(83.9)	Accountancy Age,	28 July, p 3
(83.10)	The Accountant,	4 August, p 2
(83.11)	The Accountant,	18 August, p 24
(83.12)	Accountancy,	September, p 5
(83.13)	Accountancy,	September, p 5
(83.14)	The Accountant,	27 October, p 4
(83.15)	Accountancy Age,	10 November, p 3
(83.16)	Accountancy Age,	10 November, p 3
(83.17)	The Accountant	23 November, p 1
(83.18)	Accountancy,	December, p 4
(84.1)	Accountancy Age,	26 January, p 2
(84.2)	Accountancy Age,	26 January, p 2
(84.3)	The Accountant,	26 January, p 2
(84.4)	The Accountant,	26 January, p 2
(84.5)	Accountancy,	January, p 49
(84.6)	Accountancy Age,	2 February, p 2
(84.7)	Accountancy Age,	2 February, p 2

(84.8)	Accountancy Age,	16 February, p 1
(84.9)	Accountancy Age,	16 February, p 1
(84.10)	The Accountant,	2 February, p 2
(84.11)	The Accountant,	2 February, p 2
(84.12)	The Accountant,	16 February, p 2
(84.13)	Accountancy,	February, p 15
(84.14)	Accountancy Age,	23 February, p 18
(84.15)	Accountancy,	March, p 34
(84.16)	Accountancy,	April, p 25
(84.17)	Accountancy Age,	17 May, p 3
(84.18)	Accountancy Age,	17 May, p 3
(84.19)	Accountancy Age,	17 May, p 3
(84.20)	Accountancy Age,	17 May, p 3
(84.21)	The Accountant,	24 May, p 1
(84.22)	The Accountant,	24 May, p 1
(84.23)	The Times,	22 May, p 21
(84.24)	Accountancy,	May, p 134
(84.25)	Accountancy Age,	7 June, p 13
(84.26)	Accountancy Age,	28 June, p 3
(84.27)	Accountancy Age,	28 June, p 3
(84.28)	Accountancy,	June, p 19
(84.29)	Accountancy Age,	16 August, p 1
(84.30)	The Accountant's Magazine	August, p 304
(84.31)	Accountancy,	September, pp 16-17
(84.32)	Accountancy Age,	23 August, p 3
(84.33)	Accountancy Age,	23 August, p 9
(84.34)	The Accountant,	23/30 August, p 1
(84.35)	The Times,	16 August, p 13
(84.36)	Accountancy Age,	23 August, p 9
(84.37)	Accountancy Age,	23 August, p 9
(84.38)	Accountancy Age,	16 August, p 1
(84.39)	The Accountant,	23/30 August, p 1
(84.40)	The Accountant,	23/30 August, p 1
(84.41)	The Accountant,	9 /16 August, pp 13-16
(84.42)	The Accountant's Magazine	September, pp 346-50
(84.43)	Accountancy Age,	23 August, p 3
(84.44)	Accountancy Age,	23 August, p 3
(84.45)	Accountancy Age,	23 August, p 3
(84.46)	Accountancy Age,	23 August, p 3
(85.1)	Accountancy,	January, p 52
(85.2)	Accountancy,	January, p 52
(85.3)	The Accountant's Magazine	April, pp 183-185
(85.4)	The Accountant's Magazine	April, pp 183-185
(85.5)	Accountancy,	May, p 111
(85.6)	Accountancy,	July, pp 119-120
(85.7)	The Accountant,	16 July, p 25
(85.8)	The Accountant's Magazine	August, pp 364-65
(85.9)	Accountancy Age,	19 September, p 34
(85.10)	The Accountant,	18 September, p 3
(85.11)	The Accountant's Magazine,	November, pp 486-489
(86.1)	Accountancy,	March, p 17
(86.2)	Accountancy,	March, p 52
(86.3)	Accountancy Age,	3 July, p 3
(86.4)	Accountancy Age,	3 July, p 3
(86.5)	Accountancy Age,	3 July, p 3
(86.6)	Accountancy Age,	3 July, p 3
(86.7)	Accountancy Age,	28 August, p 1
(86.8)	The Accountant,	12 November, p 29
(86.9)	Accountancy,	November, pp 29-30
(86.10)	Accountancy Age,	6 November, p 16

(87.1)	Accountancy Age,	19 February, p 2
(87.2)	Accountancy Age,	19 February, p 2
(87.3)	Accountancy Age,	5 March, p 3
(87.4)	Accountancy Age,	5 March, p 4
(87.5)	Accountancy Age,	5 March, p 5
(87.6)	Accountancy Age,	9 July, p 2
(87.7)	The Accountant,	July, p 56
(87.8)	Accountancy,	September, p 6
(87.9)	Accountancy Age,	6 August, p 3
(87.10)	The Accountant's Magazine	September, p 7
(87.11)	Accountancy,	September, p 6
(87.12)	Accountancy,	September, p 6
(87.13)	Accountancy,	September, p 6
(87.14)	Accountancy,	September, p 6
(87.15)	Accountancy Age,	22 October, p 3
(87.16)	Accountancy Age,	12 November, p 3
(87.17)	Accountancy Age,	12 November, p 3