

“Montgomery and his Legions:” A Study of
Operational Development, Innovation and
Command in 21st Army Group, North-West
Europe, 1944-45

Charles James Forrester

Submitted in accordance with the requirements for the degree of Ph.D.

The University of Leeds School of History

December, 2010

The candidate confirms that the work submitted is his own and that appropriate credit has been given where reference has been made to the work of others. This copy has been supplied on the understanding that it is copyright material and that no quotation from the thesis may be published without proper acknowledgement

The right of Charles James Forrester to be identified as Author of this work has been asserted by him in accordance with the Copyright, Designs and Patents Act 1988

© 2010, The University of Leeds and Charles James Forrester

Acknowledgements

I would like to express my gratitude to those who gave me access to family-held papers; in particular my thanks go to Mr George Barker for access to the letters and papers of his father General Sir E.H. Barker. My thanks are also due to Mr John Brown for a copy of the diary of his father Captain J.R. Brown; Mrs Penelope Cameron (née Whistler) for supporting my work in materials held in the West Sussex Record Office relating to her father General Sir L.G. Whistler; Mr David Rennie and Mrs Elizabeth Preston (née Rennie) for papers and materials relating to their father Major-General T.G. Rennie and the Earl of Rosse, for sight of papers of his father, Captain the Earl of Rosse. My appreciation is also due to those who gave me time for interviews, and also corresponded with me during my research for this thesis: (Major) Charles Farrell; General Sir David Fraser; (Lieutenant) Timothy Gilpin; (Captain) the Earl of Harrington and Sir (Major) Carol Mather. I also appreciate the help I received from Mr Patrick Delaforce who was an officer with British armour in North-West Europe and is the author of many books on the units and formations of 21st Army Group. I thank several authors of biographies and other works for discussion of their works and materials, in particular Sir John Baynes and Professor Ken Startup for discussions regarding General Sir Richard O'Connor, also Mr Ian Daghish, and Colonel Robin McNish. I also acknowledge the help of: Colonel Brian Leishman; Colonel I.H. McCausland and Colonel Roddy Riddell. I would also like to thank the following and their staffs: the National Archives; the National Army Museum; the Imperial War Museum and the Liddell Hart Centre for Military Archives, King's College, London. I also acknowledge the assistance of other archivists, librarians and experts across the British Isles, especially Mr David Fletcher of the Tank Museum; Mr James Stevenson at Lincolnshire Archives and Mr Ralph Thompson, The Light Dragoons (15th/19th King's Royal Hussars) Museum Collection. Finally, I recognise the help of staff and friends at the University of Leeds, School of History, particularly Ms Maria Di Stefano, Postgraduate Secretary, and my supervisor, Professor John Gooch.

Abstract

This thesis considers armour and infantry unit organization and structure in the British Army during the Second World War, specifically in Montgomery's 21st Army Group in North-West Europe. The strengths and weaknesses of how corps and divisions responded to Montgomery's command system – and in particular the commonality of doctrinal practice – has become an issue of debate among historians. This thesis examines and analyses the factors that produced both an effective weapon and a functional doctrine for combining armour and infantry. It does this by tracking how 21st Army Group moved from 'anarchy' to 'problem solving' under Montgomery's direction.

It shows that far from being either authoritarian or anarchic, Montgomery's ultimate command system actually encouraged commanders to use their initiative within the goals set out by Montgomery in late 1944 in a series of pamphlets. He believed in the imposition of doctrine, but this overlooks mid-July to end-of-September 1944 when he was open to the 'bubble-up' of new ideas: albeit post-pamphlets the subsequent price of uniformity of doctrine was a certain apparent inflexibility. By late 1944 when Montgomery's 21st Army Group 'stood at the door of Germany', armour-infantry co-operation practice is shown to have involved the coordination of armour originally intended to play different roles; infantry, and artillery on the basis of commonly agreed upon understandings which had been reached by an essentially collaborative process. Once set out in Montgomery's pamphlets, however, no deviation from this framework was subsequently permitted. Simultaneously, success in action depended on commanders exercising their initiative to be proactive to a greater extent than has hitherto been suggested: Montgomery wanted to constrain choices yet he allowed armoured commanders enough freedom of action to respond to challenges within the 'master plan'.

This thesis thus makes an original contribution to the debate on Montgomery's command style, and its consequences, and more widely on the role of a great commander.

CONTENTS

	page
Acknowledgements	iii
Abstract	iv
Contents	v
List of figures and maps	viii
Abbreviations	ix
Introduction	1
Chapter 1: The Army, Armour, and Montgomery before 1944.	21
British thought and thinking about motorization and armoured divisions before 1940	23
Training, teaching and the principles of war	32
The threads of experience in 1941-42	33
Montgomery – the developing mind ...	36
... and the ‘uneducated mind’	45
Chapter 2: ‘A Technique, a Mystery and Almost a Vocabulary’. Desert-Influenced Methods of Combat, ‘D-Day’ and the Early Campaign in Normandy	52
The legacy of the western desert, lessons of north Africa, and the creation of doctrine	56
Early battles for Caen: manoeuvre (PERCH) and pitched battle (EPSOM)	66
Chapter 3: The Defeat of the German Panzers: Further Responses to the Problems of Fighting in Normandy	83
GOODWOOD: infantry and armour tactics and employment	86
BLUECOAT: middle-level command responses to new problems of combat	95
TOTALIZE: high level command responses	111

Chapter 4: From ‘Anarchy’ to Problem-solving (1): Dimensions of Operational Practice in Late 1944 and Before the Rhine Crossing	119
The strategic and operational scene after Arnhem	121
Interactions within the corps-division-brigade hierarchy	123
Command, doctrine and organization for and in the advance to the Rhine	140
Chapter 5: From ‘Anarchy’ to Problem-solving (2): Montgomery’s Management and its Practical Expression, September 1944 to April 1945	159
New circumstances and new ideas	165
The perceived need for and importance of doctrine	165
The orchestration of response	168
Montgomery’s two pamphlets of November and December: What the doctrine actually said	171
Factors affecting the doctrine’s shape, and its application	183
The pamphlets: their doctrine in action	185
Conclusion	198
The factors that produced a functional doctrine	200
‘Bubble up’	203
From ‘anarchy’ to problem solving	207
Roles of commanders old and new in the development of doctrine	210
Operational development, innovation and command-and-control in the context of the move from anarchy to problem solving	213
A different explanation	220

Bibliography	224
Primary sources (Unpublished)	224
Primary sources (Published)	227
Secondary sources	235
Appendix I: Analytical Framework of the Choices Available to Armoured Commanders Co-operating with Infantry as to Proximity and Purpose – mid- 1920s to mid-1940s	247
Appendix II: Note on Approaches, Sources and Methods	252
Appendix III: The Terrain of Normandy	258
Appendix IV: Tank Descriptions	260
Appendix V: The Independent Armoured Brigades (1945)	261

Figures and Maps

	page
Figure 0.1: The selection of commanders including Montgomery	19
Map 2.1: Operation EPSOM	75
Map 3.1: Operation BLUECOAT	97
Figure 3.1: The ‘old’ or standard organisational structure	102
Figure 3.2: The ‘new’ or emergent organisational structure	102
Map 3.2: Operation TOTALIZE	114
Figure 5.1: The development of new doctrine, mid- to late 1944	165
Figure 6.1: The process of translation of experience into method, late 1944	208
Figure 6.2: Metamorphosis of experience into method (Effect)	216
Figure App.I.1: Proximity versus purpose for armour infantry co-operation	250
Figure App.II.1: the commanders of 7th Armoured Division and component Brigades over time in North-West Europe	256
Figure App.II.2: the same data as Figure AppII.1 but showing how extending down to regimental/battalion commands can help to complete the picture	257
Photo App.III.1 Typical ‘bocage’ countryside of the Calvados region southwest of Caen	258
Photo App.III.2 Close up of the bocage countryside	258
Photo App.III.3 The apparently more open countryside south of Caen towards the town of Falaise	259
Photo App.III.4. A typical Normandy farm just outside Falaise	259
Appendix IV: Tank descriptions – including pictures	260
Fig App.V. Types A & B Independent Armoured Brigade, 1945	261

Abbreviations used in text

2 pdr	British 2-pounder tank/ anti-tank gun
6 pdr	British 6-pounder tank/ anti-tank gun
17 pdr	British 17-pounder tank/ anti-tank gun firing AP/HE
25 pdr	British 25-pounder gun/Howitzer
88	German 88mm calibre tank/ anti-tank gun
A/T (AT)	Anti tank
AGRA	Army Group Royal Artillery
AP	armour-piercing shot
APC	Armoured personnel carrier
Armd Div	Armoured Division
Armd Bde	Armoured Brigade
Armd Recce Regt	Armoured Reconnaissance Regiment
Armd Rgt	Armoured Regiment
BGS	Brigadier, General Staff
Bty	(artillery) battery
C-in-C	Commander in Chief
CLY	County of London Yeomanry
CO	commanding officer
CRA	Commander, Royal Artillery
Div	Division
DLI	Durham Light Infantry
DP	dual purpose (able to fire AP and HE)
FSR	Field Service Regulations
GHQ	General headquarters
GOC	General Officer Commanding
GTB	Guards' Tank Brigade
H	Hussars (retained in the title of some armoured regiments, e.g. 15/17th King's Royal Hussars)
HE	high explosive shell
HJ	<i>Hitlerjugend</i> (also refers to the 12th SS Panzer Division 'Hitlerjugend')
Inf.	Infantry
Inf. Bn	Infantry Battalion
IT	Infantry Training Manual
KRRC	King's Royal Rifle Corps
KSLI	King's Shropshire Light Infantry
MEC	Middle East Command
MG Coy	Machine Gun Company
MGRAC	Major General, Royal Armoured Corps
Motor Bn	Motor Battalion
MTP	Military Training Pamphlet
PzKpfw	<i>Panzerkampfwagen</i>
RAC	Royal Armoured Corps

RAF	Royal Air Force
RT	radio telephone
RTR	Royal Tank Regiment
SP	Self-propelled
Tac HQ	tactical (forward) headquarters
TVC	troop carrying vehicle
USAAF	United States Army Air Force
Y (Yeo.)	Yeomanry (retained in the title of some armoured regiments, e.g. Northhants Yeo.)

INTRODUCTION

The ability of 21st Army Group to integrate its combat arms has not yet been fully explored and satisfactorily explained. In particular, this is true with respect to its ability to reach a common understanding of how the traditionally understood role of armoured divisions was to be unified with the traditional infantry tank role. The former's role was principally to provide for fast moving exploitation after a breakthrough, while the latter's was to support the infantry in breaking into and consolidation. The new unified role was that armour should be equally capable of performing both or either roles (see Appendix I). This study examines and analyses the factors that produced a functional doctrine for armour, infantry and associated instruments and did just what was necessary to bring them 'up to scratch'. Thus, this thesis is concerned with armour-infantry organization and structure in the British Army in the Second World War, in particular with regard to Bernard Law Montgomery's 21st Army Group in North-West Europe, 1944-45. It is specifically concerned with the British contribution to this Anglo-Canadian army group.

The traditional British understanding of the roles of both arms of British armoured warfare – the independent tank and armoured brigades which had the role of close infantry support, and the armoured divisions which were intended by the War Office to incorporate a more mobile role – needed to be reconciled with the requirements of the changing operating environments of North-West Europe. The effect is not at issue, but views of Montgomery's leadership and command range between two apparently opposed views which have emerged: one that he was an authoritarian top-down leader and commander who imposed his views, and the second that the British Army in Normandy under his command suffered from, or some would say revelled in and benefited from, doctrinal indiscipline. This thesis will address the issue of how and when 21st Army Group moved from doctrinal 'anarchy' to problem

solving under Montgomery's direction, and who else – if anyone – may have been involved in the process.

Thus, it examines operational development, innovation and command-and-control in this army group in order to explore how units and formations actually worked to solve tactical problems on the ground. At issue are the development of ideas among Montgomery and his subordinates at a high level in 21st Army Group about how the problems of fighting with armour and infantry should be tackled and the practice of combining or integrating armour and infantry by 'their' army group. These then translate back down into lower-level commanders' decisions on when, where and how to fight with infantry and armour at the divisional and brigade levels. Thus the thesis investigates how a group of 'effervescent' commanders interrelated, and what the effect of those inter-relationships was in the formulation of a workable doctrine.

While the literature on Montgomery, 21st Army Group and the campaign in Europe is extensive, attention has re-focused, or become more sharply focused on doctrine.

Military doctrine is the understanding of the methods of actual fighting accepted at any given time. Doctrine, it has been said, ensures – or should ensure – that 'everyone knows the right thing to do and that they all do the same things in the same circumstances'.¹ Doctrine can thus be considered the 'synapse' connecting the working of strategy across the levels of war. It is intended to be the vital articulation between previous thinking, past experience and the present military problem to be solved. It is, therefore, not fixed or immutable but rather something which can change or move all the time. Output of doctrine – the methods of actual fighting – was continually moving as commanders struggled to adjust doctrine to the correct lessons from operations. The two processes worked together at the operational level. It has become very much an established way of analysing war to divide it into levels,

¹ J. Gooch, preface to T. Harrison Place, *Military Training in the British Army, 1940-1944: From Dunkirk to D-Day* (London: Frank Cass, 2000), viii.

strategy and tactics being the other two. However, they are rather artificial levels. In practice, they bleed into one another. The operational level of war concerns the activities of armies and corps. How a campaign is fought is determined at this level. It is also an interface which connects individual, tactical battles with overall strategic aim and intentions. Thus, it should be noted that the terms operational and operational command as used here are not specific to corps commanders only but apply also to the commanders of divisions and brigades to the extent that they were ‘concerned with the direction of military resources to achieve the objectives of military strategy’ at their level.²

The literature on Montgomery and 21st Army Group has gone through several phases over time, providing alternative explanations of how he commanded and the doctrinal basis of this Army Group’s activities. Initially, the late 1940s saw the publication of a large number of typically uncontroversial British unit and formation histories and personal accounts.³ Then, several American accounts appeared that focused on the 1944-45 inter-Allied disputes over strategy and command and seemed to threaten the respect on the British side for Montgomery’s prowess.⁴ For a long time, the 1944-45 disputes between

² Ministry of Defence, *Design for Military Operations – The British Military Doctrine*, (London: HMSO, 1989), p.38.

³ Exemplified by: Anon [Maj. E. Palamountian], *Taurus Pursuant: A History of the 11th Armoured Division*, (privately published, Germany, c.1945); Anon, *Summary of Operations June 1944-1945: 49 (West Riding Reconnaissance Regiment, Royal Armoured Corps* (privately published, Neuenkirchen, [Germany], May 1945; Anon [Lieut-Col. J.G. Hooper], *The River Rhine to the Baltic Sea: Operations of VIII Corps, March-May 1945* (privately published, Hamburg, [Germany], July 1945); Anon [Brigadier W.S. Clarke], *The Story of 34th Armoured Brigade* (privately published, Germany c.1945); Anon [? Maj. G. Courage], ‘Campaign Diary’: *The 15th/19th The King’s Royal Hussars, North-West Europe, 1944-45* (privately published, 15th/19th H RHQ Palestine, 1946); A. Borthwick, *Battalion: A British Infantry Unit’s Actions from El Alamein to the Elbe 1942-44* (London: Bâton Wicks, 2001 [1946]); Brig. M. Carver, *The History of 4th Armoured Brigade* (privately published, Gluckstadt, [Germany], 1945/Aldershot: Gale & Polden, 1945); J. Forbes, *6th Guards Tank Brigade: The Story of Guardsmen in Churchill Tanks* (Sampson Low, Marsden, [n.d.]); Lieut.-Col. G.S. Jackson, *Operations of Eighth Corps: Normandy to the River Rhine* (London: St Clements Press, 1948); M. Lindsay, *So Few Got Through: With the Gordon Highlanders from Normandy to the Baltic* (Barnsley: Leo Cooper, 2001 [1946]); Capt. J. Stirling, *D-Day to VE-Day from My Tank Turret: A Personal Account, written between D-Day 1944 and May 1945* (privately published by the author, Axbridge BS26 2LN, [n.d.]).

⁴ The most important were Eisenhower’s and that of Brigadier General W. Bedell Smith, his chief of staff: Gen. D.D.Eisenhower, *Crusade in Europe* (London: Heinemann, 1948) and

American and British commanders (Eisenhower and Montgomery) would be reprimanded by many American and British scholars. The publication of the American and British national, official histories, however, saw stakeholders united against the perceived threat of Soviet aggression. In these histories the relative strengths of armies were measured quantitatively. There was little attempt to appraise combat performance for reasons having to do with Cold War ideological imperatives. During the 1950s and 1960s, a school of British historical writing developed that sought, mainly through operational narratives, to refute American criticism of Montgomery and to emphasise the achievements of 21st Army Group in the wider Allied campaign. Narratives including the Official British History, by Ellis, and its forerunner by North, put forward the view that the performance of 21st Army Group gave 'little occasion for adverse criticism'.⁵ A study of Montgomery's career stated that: 'Britain was splendidly served by the men Montgomery put in charge of his corps and divisions'.⁶ The Official History's narrative had little to say about issues of command and control, or experience, or what had been learned in 21st Army Group since D-Day. Wilmot, however, was more critical of British 'drive'.⁷ Thus, there was little attempt at this stage to appraise operational development, or innovation and command in 21st Army Group objectively.

By the 1980s, a new wave of interpretations began to appear. Historians began, for almost the first time, to go into specifics on the Western Allies' armies' capabilities and performances in the North-West Europe campaign, and at the same time to posit multi-factorial explanations of outcomes. The historiography entered a new phase, one of objective reconsideration, as this new wave of interpretations emerged, for example, the work of Weigley, D'Este, Hastings, Lamb, and

Brig. Gen. W. Bedell Smith, *Eisenhower's Six Great Decisions: Europe 1944-45* (New York: Longmans, Green, 1956).

⁵ Maj. L.F. Ellis, *Victory in the West, vol. I: The Battle of Normandy, vol. II: The Defeat of Germany*, History of the Second World War, UK Military Series (London: HMSO, 1962, 1968); J. North, *North-West Europe, 1944-45: The Achievement of 21st Army Group* (London: HMSO, 1953). See, for example, Ellis, *Victory in the West: Normandy*, p.491.

⁶ R. Lewin, *Montgomery as Military Commander* (London: Batsford, 1971), p. 265.

⁷ R.W.W. 'Chester' Wilmot, *The Struggle for Europe* (London: Collins, 1952).

Millett and Murray.⁸ The centre ground of the earlier debate, that is the disputes over theatre strategy, gave way to new considerations and new questions. For the first time, historians attempted to appraise the British senior command, in most cases coming to rather negative conclusions and disparaging the performance of the British contribution to 21st Army Group.

For Max Hastings, ‘the focus of debate about [...] disappointments in Normandy should not be upon Montgomery [...] but upon the subordinate commanders and formations who fought the battles.’⁹ In Normandy, D’Este argued, ‘both Montgomery and Dempsey were altogether too considerate in retaining commanders who did not measure up’, while ‘Montgomery’s frequent habit of bypassing Dempsey to give orders directly to his own subordinates also, at times, limited subordinates’ freedom to exploit opportunities for a breakthrough and show that they could ‘measure up’.¹⁰ Even in his most recent work on the war in Europe, Hastings still argues that the British had only one corps commander – Horrocks – ‘who could be considered competent’. At divisional level too, Hastings holds that British general officers did not match those of America or Germany.¹¹

Also in the 1970s and 1980s there were the revelations of the secret of ‘Ultra’ code-breaking.¹² The help which the most senior Allied commanders had known that they were receiving from the code-breakers at Bletchley Park included being able to read certain types of German messages. This revelation contributed to the scrutiny and the

⁸ R.E. Weigley, *Eisenhower’s Lieutenants: The Campaigns of France and Germany, 1944-45* (Bloomington: Indiana University Press, 1981); C. D’Este, *Decision in Normandy: The Unwritten Story of Montgomery and the Allied Campaign* (London: Collins, 1983); M. Hastings, *Overlord: D-Day and the Battle for Normandy* (London: M. Joseph, 1984; Pan, 1999); R. Lamb, *Montgomery in Europe: Success or Failure?* (London: Buchan & Enright, 1983) and *Military Effectiveness, vol. I: The First World War, vol. II: The Interwar Period, vol. III: The Second World War*, ed. by A.R. Millett and W. Murray (Boston: Unwin Hyman, 1988).

⁹ Hastings, *Overlord*, p.172.

¹⁰ D’Este, *Decision in Normandy*, pp. 289, 352 and 388.

¹¹ M. Hastings, *Armageddon: The Battle for Germany 1944-45* (London: Macmillan, 2004), p. 32.

¹² Examples of this genre include: R. Lewin, *Ultra Goes to War* (New York: McGraw-Hill, 1978); also R. Bennett, *Ultra in the West: The Normandy Campaign 1944-45* (London: Hutchinson, 1979), the secret having been revealed by Winterbotham in *The Ultra Secret* (1974).

revision of the uncritical acclaim which they had previously received. However, whether the fact that commanders could read this intelligence made their day-to-day decision taking substantively easier or more difficult is moot: they certainly had a great deal more information on which to make their decisions. Arguably, while the information was often useful in major campaign movements this was not always the case later in the campaign in the battle for Germany: for example 'Ultra provided very little operational intelligence during the Veritable action' and it helped other levels of command little with the small-unit-type defence with which 21st Army Group had to contend in early 1945.¹³

By the early 1990s, most historians of the campaign accepted that – for reasons that were many and complex, and not always clear – British performance in combat on occasions left much to be desired. Many interpretations focused on combinations of factors which to a greater or lesser degree included an alleged dearth of operational and tactical skills combined with an aversion to risk-taking on the part of British divisional generals compounded, more often than not by Montgomery's over-control. However, there were counter arguments that represented a challenge to the revisionist paradigm – many from surviving participants.¹⁴ Most, to some degree, held that British quantitative superiority was pitted against German qualitative superiority (particularly in the case of their most modern armour) and that this, and the other factors (including much of the terrain of the Normandy countryside) which contributed to the difficulties of conducting offensive operations, invalidates the criticism levelled against British troops and their commanders.

Historians today seek to provide fuller explanations of British operational and tactical failure and success in North-West Europe, for example Murray and Millett, Stephen Hart, French, Harrison Place,

¹³ Bennett, *Ultra in the West*, p.216; R. Bennett, 'Ultra and some Command Decisions', *Journal of Contemporary History*, 16 (1981): 131-151 (p.141).

¹⁴ Exemplified by K. Tout, *Tank: 40 Hours in Normandy* (London: Robert Hale, 1985), *Tanks, Advance!* (London: Robert Hale, 1987) and also P. Delaforce's divisional histories, such as *Black Bull: From Normandy to the Baltic with the 11th Armoured Division* (Stroud: Sutton, 1993).

Jarymowycz, Russell Hart, Copp, and Buckley.¹⁵ There has been a swing back to the view that the performance of Montgomery's army group has been greatly underrated. An important expression of this view is in Copp's two books on the campaign which, although on the Canadians, have much to say about doctrine, structures and issues relating to the British. In particular, he cites the Simonds operational policy document from February 1944.¹⁶ In the context of the creation of the doctrine the British and Canadians would employ in Normandy, Simonds's directive is highly informative. Simonds took the best available 'policy' and wrote it up, undoubtedly directed at lower level commanders, putting it together with what can be seen as an attempt by the Canadian commander to relate tactical doctrine and strategic aims and intentions in some determination of 'how we will fight'. If the evidence for the view that the performance of British troops has been greatly underrated is to be definitely established however, Copp concedes that

a great deal of work needs to be done [;] we need studies of the British Army at corps, divisional and brigade level so that we have a firm base for addressing questions about leadership, command, combat motivation and combat effectiveness.¹⁷

The collection in which Copp's chapter is published, however, just focuses on Normandy, which essentially was a period of learning and experimentation with the new methods. It does not – by definition – deal with the later institutionalization of the lessons learned which happened

¹⁵ W. Murray and A.R. Millett, *A War To Be Won: Fighting the Second World War* (Cambridge, MA: Belknap Press, 2000); S. Hart, *Montgomery and "Colossal Cracks": The 21st Army Group in Northwest Europe, 1944-45* (Westport, CT: Praeger, 2000); D. French, *Raising Churchill's Army: The British Army and the War against Germany, 1919-45* (Oxford: Oxford University Press, 2000); Harrison Place, *Training in the British Army, 40-44*; R.J. Jarymowycz, *Tank Tactics: From Normandy to Lorraine* (Boulder: Lynne Rienner, 2001); R. Hart, *Clash of Arms: How the Allies Won in Normandy* (London: Lynne Rienner, 2001); T. Copp, *Fields of Fire: The Canadians in Normandy* (Toronto: University of Toronto Press, 2003) and *Cinderella Army: The Canadians in Northwest Europe* (Toronto: Toronto University Press, 2006), and J. Buckley, *British Armour in the Normandy Campaign 1944* (London: Cass, 2004) and *The Normandy Campaign 1944: Sixty Years On*, ed. by J. Buckley (London: Routledge, 2006).

¹⁶ Simonds's 'Operational Policy – 2 C[ana]n[dia]n Corps' document is reproduced in Appendix A in T. Copp, *Fields of Fire*.

¹⁷ T. Copp, 'The 21st Army in Normandy: Towards a new balance sheet', in *Normandy: Sixty Years On*, ed. by J. Buckley, pp. 11-21 (pp. 11 and 19).

after Normandy and can be shown to have continued until the end of the war. Questions as to why difficulties such as those experienced in combining combat arms together existed; whether they were solvable, or solved in particular have become major bones of contention. The volume of the historiography relating to Montgomery's ability and authority doctrinally as Commander, 21st Army Group reflects both the scholastic importance and the intensity of the debate about the subject.

Published first-hand accounts by senior commanders who are significant for this thesis by virtue of the specific contributions they made constitute a higher-level narrative of considerable importance.¹⁸ Although 'lower level' narratives, of which there were many published around 2000 and in immediately subsequent years, can be used as a source of information *inter alia* about what happened on the ground, they can also be used to provide insight into the technical difficulties of conducting operations by those who worked to solve tactical problems at the small unit level.¹⁹ Further, they contribute usefully to the debate not only at the level of detail but also where and when they comment upon the practical implications of command decisions and working practices.

Hart's work played a pivotal role in moving discourse beyond the revisionism of the 1980s and 1990s. He stresses the impact that manpower shortages and concerns over troop morale exerted on Montgomery's generalship, and argues that, when these factors are considered, it is clear that he handled 21st Army Group in North-West

¹⁸ Accounts by individuals who were corps, armoured division or independent armoured brigade commanders in the campaign are: Maj.-Gen. A.H.S. Adair, *A Guards' General: The Memoirs of Major General Sir Allan Adair BT, GCVO, CB, DSO, MC, JP, DL* (London: Hamish Hamilton, 1986); FM Lord Carver, *Out of Step: The Memoirs of a Field Marshal* (London: Hutchinson, 1989); Lieut.-Gen. Sir B.G. Horrocks, *A Full Life* (London: Collins, 1960), and, with E. Belfield and Maj.-Gen. H. Essame, *Corps Commander* (London: Sidgwick & Jackson, 1977) and Maj.-Gen. G.P.B. Roberts, *From the Desert to the Baltic* (London: William Kimber, 1987).

¹⁹ For example: Bill Bellamy, *Troop Leader: A Tank Commander's Story* (Stroud: Sutton, 2005); R. Boscawen, *Armoured Guardsmen: A War Diary, June 1944-April 1945* (Barnsley: Leo Cooper, 2005); C. Farrell, *Reflections 1939-45: A Scots Guards Officer in Training and War* (Edinburgh: Pentland Press, 2000); S. Hills, *By Tank into Normandy: A Memoir of the Campaign in North-West Europe from D-Day to VE Day* (London: Cassell, 2002); S. Jary, *18 Platoon* (Carshalton Beeches, Surrey: Sydney Jary, 1987); Maj.-Gen. R. Leakey, with Col. G. Forty, *Leakey's Luck: A Tank Commander with Nine Lives* (Stroud: Sutton, 1999); P. White, *With the Jocks: A Soldier's Struggle for Europe* (Stroud: Sutton, 2001).

Europe more effectively than many scholars have suggested. Hart argues that the generalship of Montgomery's subordinate army and corps commanders was 'highly competent', and that their methods 'mirrored' those of Montgomery.²⁰ He is at pains to emphasise 'the extent of consensus that existed within 21st Army Group concerning operational techniques'.²¹ Hart's more recent work concentrates on Montgomery and his two subordinate Army commanders. He analyses the operational methods used by Montgomery, Lieutenant-General M.C. Dempsey and Lieutenant-General H.D.G. Crerar. He argues that 21st Army Group conducted this campaign more effectively than some scholars had argued previously and that the generalship of Montgomery and his two subordinate army commanders was 'both appropriate and competent'. He points out that:

This assertion combines two interconnected subarguments: first, that Montgomery handled the 21st Army Group more appropriately than some of the existing literature has recognized; and second, that historians can only appreciate fully how the 21st Army Group conducted the campaign by examining its two highest command echelons rather than by focusing solely on Montgomery.²²

Hart does not, however, provide an integrated operational analysis at the corps and divisional levels, as he recognises.²³ Focussing only at the army commanders and 'operational'/corps commander level (as in the case of Hart) cuts out the lower and middle levels of command, where as this thesis will show it can be demonstrated that thoughts and actions also eventually influenced strategy. While Hart's work, self-evidently attaches little importance to the lower (tactical levels) of command in shaping doctrinal practice, that of Buckley by contrast arguably attributes much: 'the 8th Army's method of integrating tanks and infantry, for example, was soon seen to be unworkable and was quickly replaced by other tactics, often methods developed in Normandy

²⁰ S. Hart, 'Field Marshal Montgomery, 21st Army Group, and North West Europe, 1944-45' (doctoral thesis, University of London, 1995), p. 285.

²¹ *Ibid.*, p. 290.

²² Hart, *Montgomery and "Colossal Cracks"*, 44-45, p. 2.

²³ *Ibid.*, pp. 1 and 2.

between armour and infantry commanders following experience in battle'.²⁴

Buckley challenges the revisionist view of Normandy as a failure for British armour. His starting point is that too much previous analysis has assumed failure simply because it not follow the pattern set by the Germans in 1939-42. Buckley basically accepts the argument that the doctrine inculcated in training in the UK prior to D-Day was sometimes flawed and at times quite damaging. The most notable example of this was the attempt by Montgomery to impose his view of infantry-tank co-operation tactics upon 21st Army Group following his appointment in 1943.²⁵ Thus, Montgomery's failure to impose a common interpretation of doctrine would appear to be due in part at least (although there was more to it than this) to the unwillingness of his senior and intermediate commanders to deviate from their rigorous training. Nevertheless, Buckley argues that both independent brigades and divisional brigade groups had developed workable tactics for infantry-armour co-operation by the mid-point of the campaign in Normandy.²⁶ The British Army's approach was to be 'flexible and non-dogmatic'. Montgomery's attempts to eliminate any potential confusion by having one straightforward doctrine came at the price of inflexibility. However, although Montgomery's 8th Army doctrine did have a deleterious impact, this was less damaging than it might have been because of unit and formation commanders' discretion. Thereafter: 'what some have argued was a weakness in the [...] approach to doctrine – indiscipline – was to prove a considerable advantage for the armoured units as they attempted to grapple with the operational difficulties thrust upon them by the Normandy campaign'.²⁷ Montgomery's failure to impose a top-down dominance created a situation in which everybody was in charge of his own doctrine. However, this was not the case by late 1944.

French and Harrison Place offer apparently contradictory interpretations of how Montgomery commanded and the commonality –

²⁴ Buckley, *British Armour, Normandy*, 44, p.212-213.

²⁵ *Ibid.*, pp. 5 and 212.

²⁶ *Ibid.*, p. 102; Buckley, in *Normandy: Sixty Years On*, ed. by J. Buckley, p. 87.

²⁷ Buckley, in *Normandy: Sixty Years On*, ed. by J. Buckley, p. 80.

or otherwise – of doctrinal practice. French exemplifies further the shift away from defining combat capability solely in terms of available combat power, that is by numbers of units or volumes of equipment, toward a definition which focuses on the complex interaction of conceptual, material, and moral elements. He continues: ‘but combat capability not only depends on how these elements interact with each other; it also depends on how together they synergise with enemy forces’.²⁸ French seeks to provide an explanation of British operational and tactical failure and success against the German Army in the Second World War. His argument may be summarized as follows. In the 1920s and 1930s, the leadership of the British Army’s solution to problem of military success at the level of major warfare without the heavy losses sustained in the First World War was a conception of fighting that was technologically progressive and tactically innovative – that is, it embraced wholly motorized and a limited mechanized mobility and the necessity of combined arms operations. However, the army entered the Second World War with neither the necessary equipment nor an appropriate doctrine to properly implement this vision. Moreover, prevailing culture and attitudes left inculcation of the army’s understanding of the methods of fighting and training to achieve a sufficient level of fighting capability to the discretion of unit commanding officers. French asserts the British Army’s commitment to ‘autocratic, top-down managerial control’.²⁹ Flowing from this assertion, he is much concerned with formal interactions and institutional relationships and has little to say about the interplay and interrelationships between protagonists at the different levels.

There is wide agreement that the ability to conduct combined arms warfare was vital to success for major armies in the Second World War.³⁰ Indeed, it has been argued that ‘the [British] army’s integration of combat arms raises the most serious questions about British

²⁸ French, *Raising Churchill’s Army, 1919-45*, p. 11.

²⁹ *Ibid.* p. 283.

³⁰ J.M. House, *Combined Arms Warfare in the Twentieth Century* (Lawrence: University Press of Kansas, 2001).

operational effectiveness [in the Second World War].³¹ French states clearly that the British Army failed to use their tanks ‘in co-operation with other arms’ and that it was ‘not until the middle of the Normandy campaign that the army finally abandoned the last remnants of its pre-war conviction that tanks and infantry within armoured divisions could and should operate separately’.³² French gives much of the credit for this and other improvements of the army’s fighting capability later in the Second World War to Montgomery. Montgomery

did not create the army’s operational doctrine, but he did insist that formations under his command practised a common interpretation of it. The outcome was that by the second half of the war, the British possessed what was in some respects a military machine capable of considerable flexibility on the battlefield.³³

Contrarily, Harrison Place, exploring the doctrine and training for attack at the unit, or minor tactical level argues that ‘unsteady though progress towards a well-founded tactical method was before 1944, the process degenerated into a shambles when Montgomery began to throw his weight about 21 Army Group’.³⁴ While Harrison Place concedes that it would be unfair to blame Montgomery entirely for the tactical errors into which tank-infantry co-operation fell, he argues that Montgomery’s intervention to change established practice before D-Day made the situation worse. However, ‘the problem facing 21 Army Group was not merely a matter of bad doctrine; it was also a matter of doctrinal indiscipline [...] units and formations pleased themselves when it came to tank-infantry co-operation tactics’.³⁵

Buckley seems to be saying that the two opposing interpretations cannot be reconciled, and it might thus be assumed that he has therefore chosen to come at the issue from a new direction. Buckley does, however, represent a helpful jumping off point for this thesis, in effect coming to some sort of a mid-point position between these two schools of historiography. This helps us to understand and focus on the

³¹ W. Murray, ‘British Military Effectiveness in the Second World War’, in Millett and Murray, *Military Effectiveness: Second World War*, p. 110.

³² French, *Raising Churchill’s Army, 1919-45*, pp. 221 and 269.

³³ *Ibid.*, p. 261.

³⁴ Harrison Place, *Training in the British Army, 40-44*, p.154.

³⁵ *Ibid.*, p. 164.

dimensions of the problem. The weighting that should be given to Montgomery's role remains unclear, however: as does how, when, and to what effect corps, divisions and brigades responded to Montgomery's command system. What is left unresolved by Buckley's contribution, therefore, is what weight to actually give Montgomery in the outcome. Buckley does not tell us about the management process.

As the lessons of Normandy began to be disseminated within 21st Army Group, Montgomery's pamphlets of late 1944, especially *Some Notes on the Conduct of War* and *The Infantry Division in Battle* and *The Armoured Division in Battle*, became part of the ongoing process. This process has been extensively examined by historians, yet the importance of Montgomery's pamphlets as a record of this process has often been neglected. It is not to be argued that the pamphlets were driving doctrine; rather they were a documentation of what corps and division commanders were already practicing.

Montgomery's pamphlets appeared on a scene where there were and would continue to be War Office publications in a number of series. Nevertheless, what happened in 21st Army Group in late 1944 and 1945 was that subordinates, now steeped in ideas which Montgomery believed had come to be accepted as the right ones, adopted 'his' methods. The first three months of 1945 were then a period of testing and a settling in period; of the new and old offensive techniques, the context or backdrop for which was the advance to the Rhine and preparation for the final assault on Germany. By the time of the assault across the Rhine, at the end of this period, the situation was that all commanders were conducting the campaign in this new way for 21st Army Group's final advance to the Baltic and the Elbe. The methods of armoured warfare in North Africa had been found not to be applicable in North-West Europe and had been replaced.

Montgomery believed that these new methods should be in commanders' minds as a kind of mental map which actually supplied a very narrow range of options by which commanders could orientate themselves into situations, that is a framework for action which also carried the negative sanction of dismissal if commanders did not

attempt to comply with it. Thus, while commanders could and did have an informed pragmatism – indeed were encouraged to use their initiative which would allow commanders orientational precision of thought as to what were the really important factors at any one time, and a general permission to act accordingly – Montgomery felt he had to continue to keep a tight grip on what was going on underneath him in terms of command.

In short, if the questions raised by the literature are consolidated and rephrased to ask: how did Montgomery's process of command function to move from a situation of doctrinal anarchy as identified by Harrison Place (back) to one of doctrinal uniformity, as argued by French; then it may be resolved. We know this doctrinal anarchy ceased to be the case by the mid-point of the Normandy campaign (sic. Buckley). Asking this question in this way, it is anticipated, will resolve the apparently irresolvable issue of the relationship between the authoritarian command style of Montgomery and the doctrinal indiscipline which existed at the start of the Normandy campaign.

Thus, the historiography differs in fundamental and important ways and some important questions are left as yet unanswered. Furthermore, there are a number of dimensions of the problem, particularly at the level of the corps, divisions, tank brigades and independent armoured brigades of 21st Army Group, which have yet to be fully explored. To resolve these debates, or at least to develop them in new ways, requires analysis of the strengths and weaknesses of Montgomery's command system, of how corps and divisions responded to it, and of the effectiveness of the weapon they forged and used between them.

The central interpretive proposition of this thesis is that the apparent problem posed by the historiography has obscured the central question which is how Montgomery's command produced a functional doctrine by late 1944. What has been lacking, therefore, is a comprehensive and satisfying explanation of how all the various processes worked and interacted and interrelated over time to produce not only the desired

output, that is a common doctrine, but also the desired outcome which was success at the campaign level.

A more productive way of understanding what was happening is to see it as a more complex process which accommodated both top-down imposition and apparent weak command and control. Practice changed as the campaign developed and this study will assess the extent to which the commanders of the tank brigades and independent armoured brigades, corps, and divisional commanders were drivers of these changes as part of a wider process under Montgomery's direction. Two propositions are advanced to facilitate deeper analysis of the issues. The first is that there was more direct communication between Montgomery and corps and divisional commanders and brigade commanders concerning operational doctrine, best practice and lessons learned than has hitherto been recognised. This leads directly on to the second, which addresses how that communication happened in practice. This thesis presents evidence for the 'bubbling up' of operational methods from below the corps and the divisional levels, originating at the brigade level. It will be shown that Montgomery was actually more open to the second dimension – the bubbling up, the internal, the cohort acting, the interactive – than has been supposed.

The task of this thesis requires both a conventional focus on command and a cross-level study of Montgomery's command as mediated through a small group of commanders. Further, to analyse this question more completely, this thesis will draw on evidence from the context of the entire North-West Europe campaign, not just Normandy.

The issues laid out at the outset of this Introduction as to whether or not the development of operational fighting capability, and in particular the capacity to conduct combined arms warfare, had any basis in a common doctrine of all arms has divided scholars, but the key to understanding how the outcome developed lies in understanding the ways in which the two processes of fighting and the creation of doctrine interrelated. Alongside this stands the new light this thesis will throw

on how such doctrine may have been created. A third interrelated contribution is in answering how Montgomery commanded, and whether, and to what extent, doctrine was imposed or generated. In this way the debate about how Montgomery commanded can be resolved.

There was a set of relationships as well as a development of practice. It is necessary to describe and analyse these, focusing on the qualities and contributions made by individuals and the levels at which they made their contributions. It is then necessary to analyse how, to what degree, and with what consequences those contributions were mediated up through the system and had their effects.

The term armour-infantry co-operation has come to mean for many the tactical level, whereas this thesis looks at the success of armour-infantry co-operation at this level and relates it to changes in brigade and divisional structures. It is clear from the context of the campaign that the innovation and flexibility of British brigades and divisions must be taken into account in any explanation of that success. To understand how 21st Army Group fought the series of operations and actions which constituted the North-West Europe campaign it is necessary to view them not specifically in terms of tank-infantry co-operation doctrine but in the wider setting of general British military doctrine, problems and thought, as well as of commanders' decisions and of how they used the equipment they had. Thus, it is also necessary to consider how armoured and infantry formations were organized, so that the groupings and structures at the tactical level were correct to facilitate armour-infantry co-operation as traditionally understood and as practised in 21st Army Group prior to late 1944.

It is in the development of British armoured warfare doctrine from the late 1930s as well as the experiences of fighting earlier in the War – mainly in North Africa – that the roots of the underlying understanding of the main protagonists involved in this study are to be found. To produce an understanding of the different types of experience possible, a small group of commanders are classified as members of one of three groups: successful commanders who had fought in North Africa and were bound by the 'lessons' they learned there; commanders who had

fought in North Africa but who were not bound by or to the lessons learned from previous victories; and commanders who had not fought in the desert.

The story ends, for the purposes of this thesis, with the successful implementation of Montgomery and 21st Army Group commanders' apparently 'co-created' armour-infantry doctrine. This then allowed 21st Army Group to progress from the first footstep and tank track on German soil to the Elbe and the Baltic without further reviewing its doctrine for the handling of forces of armour, infantry, and associated instruments in the face of new challenges. This thesis will demonstrate how the interaction of Montgomery, key commanders, and 'circumstances' led to the emergence of a new framework for action through which previous experience could be brought to bear to gain both operational initiative (what Montgomery called 'the Initiative') and tactical initiative whereby commanders could use their initiative to solve problems on the ground.

The corps commanders, armoured division commanders, commanders of independent armoured and tank brigades and infantry division commanders who, in addition to Montgomery, are important enough to make them key members of a small group of commanders for the purposes of this study include: Major-General A.H.S. Adair, Guards Armoured Division; Lieutenant-General E.H. Barker, 49th Infantry Division and later VIII Corps; Lieutenant-General G.C. Bucknall, XXX Corps to August 1944; Brigadier R.M.P. Carver, 4th Armoured Brigade; Brigadier W.S. Clarke, 34th Armoured Brigade; Major-General G.W.E.J. Erskine, 7th Armoured Division; Brigadier W.D.C. Greenacre, 6th Guards Tank Brigade; Major-General E. Hakewill Smith, 52nd Infantry Division; Brigadier the Hon. W.R.N. Hinde, 22nd Armoured Brigade; Lieutenant-Colonel/acting Brigadier P(atrick) R. C. Hobart, Guards Armoured Division, 7th Armoured Division; Major-General L.O. Lyne, 50th Infantry Division, then 59th Infantry Division and later 7th Armoured Division; Lieutenant-General Sir R.N. O'Connor, VIII Corps to

December 1944; Major-General T.G. Rennie, 3rd Infantry Division and later 51st Infantry Division; Major-General G.P.B. Roberts, 11th Armoured Division; Major-General G.L. Verney, 6th Guards Tank Brigade and later 7th Armoured Division; Major-General L.G. Whistler, 3rd Infantry Division; and Brigadier A.D.R. Wingfield, 34th Tank Brigade, acting CO 8th Armoured Brigade, and 22nd Armoured Brigade.³⁶

It should be noted that this thesis is specifically concerned with the contribution of the British Army (i.e. English, Scottish, Welsh and Irish units) to the principally Anglo-Canadian 21st Army Group, which also included 1st Polish Armoured Division. Several of Montgomery's offensives were led, at levels of command which are particularly focused on in this thesis, by Canadian generals. Canadian forces formed Canadian II Corps, 2nd British Army until late July 1944, when 1st Canadian Army became operational. The GOC Canadian II Corps, Lieutenant-General G.G. Simonds, is an individual of particular importance. However, as this thesis is not a study of Canadian battle doctrine in Normandy thus Simonds was not added to the list of commanders for study in this thesis. Similarly, what can rather arbitrarily be defined as Canadian operations are, in general, omitted in terms of analysis or commentary. However, it is necessary to bring in Operation TOTALIZE (7-10 August 1944). TOTALIZE, which although Canadian driven involved British forces (about a third of the force) and saw the introduction of many of the issues previously identified, is examined because of the contribution of this operation in particular to the story of 21st Army Group operational technique.

Although the seventeen individuals focussed upon held twenty senior independent (i.e. Brigade, Divisional or Corps) commands they are actually linked, for example Erskine, Verney and Lyne successively commanded 7th Armoured Division, and Barker replaced O'Connor as GOC VIII Corps, as shown in Figure 0.1.

³⁶ See APPENDIX II for an explanation of the selection of the corps commanders, divisional commanders, and commanders of independent tank (later armoured) brigades who compromise this group.

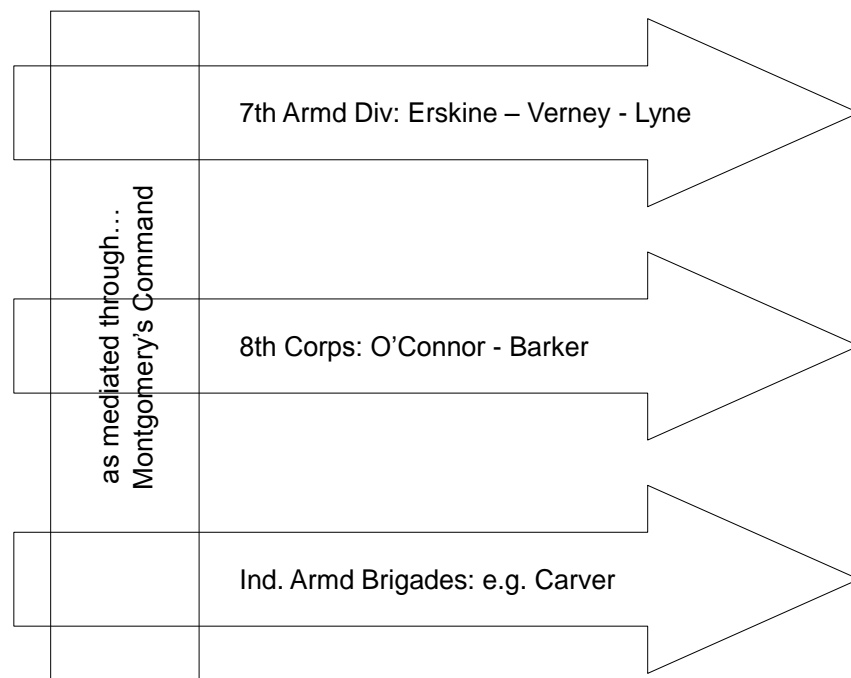

Figure 0.1: The selection of commanders including Montgomery

The commands of the other commanders selected parallel the commands shown in Figure 0.1. The independent commands of, for example, Clarke (34th Armoured Brigade) parallel Carver's command of 4th Armoured Brigade, as shown. To pursue 'bubble up' operational methods it is also necessary to go down to the level of the regimental COs and below where and when appropriate. For example, and following on from Figure 0.1, 7th Armoured Division can be extended downwards (in terms of rank) to include: Hinde, Wingfield, Hobart, and so on and right down to the level of Major B.E.L. Burton and Captain J.R. Brown, who were, respectively, the second-in-command of an infantry battalion and an artillery Command Post Officer, and who in each case wrote accounts which have been used as primary sources.³⁷ Many significant papers have been traced and examined for these commanders, including some not explored before by historians. Extending the search to regimental and, or battalion commands helps to complete the picture for an infantry point of view.

³⁷ See Figure Appendix II.2.

Finally, investigating armour-infantry organization and structure in 21st Army Group in the campaign in Europe and preparation for it has to begin before 1944, around 1937-38, because that is when the first armoured divisions were established and the problems began; and, in order to understand more fully Montgomery and his fellow commanders' decisions regarding integrating armour and infantry, it is necessary to look back to the formation of their ideas.

This thesis thus attempts to assess how Montgomery's command produced a functional, workable and adaptive doctrine for armour, infantry and associated instruments by late 1944 by examining and analysing operational development, innovation and command-and-control in 21st Army Group. Operational development, innovation and command in 21st Army Group emerges as a complex phenomenon: driven by a 'bubble-up' process of ideas and, ultimately, a top-down system of management. However, the thesis presents a picture of a process that was both a complicated and also a complex one. The same factors and issues need to be simultaneously understood from different perspectives. No one part should be understood in isolation from the processes surrounding it or indeed from its own position within the continuum of development over time. The thesis thus contributes holistic understanding of the creation of doctrine to the literature on Montgomery, 21st Army Group and the campaign in Europe.

CHAPTER ONE

THE ARMY, ARMOUR, AND MONTGOMERY BEFORE 1944

It has been widely accepted that the British Army's defeat in North-West Europe in the summer of 1940 at the hands of the German Army was not offset by its victories over the Italian Army in the winter of 1940-41. The reasons for the British Army's inability to counter the organization and techniques of the German armed forces in 1940 are said, by the military commentator and writer B.H. Liddell Hart and by those historians who follow his lead, to include the conservatism and resultant inability of the higher echelons of British Army command between the two world wars to fully comprehend the scope and meaning of armoured warfare and the failure to adopt an appropriate doctrine and organization while the opportunity was still within reach.¹

However, the Army's victories over the Italians are held to embody 'a record in armoured mobility that has never been equalled'.² Yet Britain, the country which had invented the tank, went to war in 1939 without an effective armoured force, unlike Germany, where as the 1940 German campaign against France and the Low Countries would show, armour capable of strategic deep penetration had been developed, although 'the victors were at first just about as surprised as the vanquished'.³ The British Army, however, was completely motorised, that is not dependent on horse transport at all or on foot-mobility alone. Every arm of service and support was equipped with means of transport and movement utilizing the internal combustion engine to provide or

¹ See R.H. Larson, *The British Army and the Theory of Armoured Warfare, 1918-1940* (London and Toronto: Associated University Press, 1984), pp. 102-104.

² Capt. Sir B.H. Liddell Hart, *History of the Second World War* (London: Papermac, 1992 [1970]), pp. 116-127 (p. 124).

³ K.-H. Frieser, with J.T. Greenwood, *The Blitzkrieg Legend: The 1940 Campaign in the West* (Annapolis: Naval Institute Press, 2005 [1996]), p. 2.

improve mobility.⁴ This was completely unlike the German Army. The highly armoured and mechanised *Panzerwaffe*, or armoured force of the *Wehrmacht*, was only the most modern element of the German army. There were actually two armies within the *Wehrmacht*: ‘on the one hand, the ten Panzer and six motorized infantry divisions, and on the other hand, the actual army that looked rather old-fashioned and had inferior equipment’.⁵ The main mass of the *Wehrmacht* proceeded at the pace of the foot soldier and which still used animals to draw part of its logistics and artillery.⁶ The British Army thus had important differences in comparison to the German Army which could be significant not only for tactics but also operationally, that is not only for where and when to fight but for commanders’ choices of how to fight. It had a movement capability using unarmoured vehicles that gave it at least a notional capacity to compensate for its shortcomings in armour. However, German armoured divisions were combined arms teams. Armour and infantry both worked together all the time – infantry were integral, as a result of experience gained from the breakthrough at Sedan during the 1940 campaign in the west.⁷ The armoured divisions’ infantry was usually equipped with a suitable panzergrenadier vehicle. Nevertheless, the operational insights and innovative tactical applications of Montgomery and Lieutenant-General R.N. O’Connor, allowed them to excel in the offensive use of motorised logistics in the beginning of the Second World War and achieve significant strategic advantages without tanks (for example: Montgomery in the defence of the Yser canal during the Flanders campaign in 1940) or at most with limited tank support (for example, O’Connor in his Libyan campaign, 1940-41).⁸

⁴ See, for example, B. Bond, *British Military Policy between the two World Wars* (Oxford: Clarendon Press, 1980), Chapters 5 and 6: pp. 127-190. Following Liddell Hart, Bond emphasises the high opportunity cost of this.

⁵ K.-H. Frieser, *The Blitzkrieg Legend*, p. 31.

⁶ See R.L. DiNardo and A. Bay, ‘Horse-Drawn Transport in the German Army’, *Journal of Contemporary History*, 23 (1988), 129-142: ‘[a]lthough the army increased its number of panzer and motorized infantry divisions, it was still primarily dependent on horses [...] to the tune of 4000 per week in April of 1940 (p. 130)’.

⁷ Frieser, *The Blitzkrieg Legend*, p. 174.

⁸ For a detailed examination of this subject, see C.J. Forrester, ‘Great Captains and the Challenge of Second Order Technology: Operational Strategy and the Motorisation of the

The infantry, however, could draw on lessons of combat experience that had been first learned from 1917-18, which were already comprehended – at least in doctrinal terms. Therefore, in order to come to a completely rounded understanding of the ideas of Montgomery and others for the combining of tanks and infantry just before the war and early in it, and the problems left behind from that time, it is necessary to focus on the essentially competing demands in the 1920s and 1930s of those wishing to modernise the army – that armour be developed to become the predominant arm – and the desire of most of those in charge of the army to create a modern army with tanks in a way that ensured the continued existence and importance of the infantry arm and infantry divisions, alongside the new armoured divisions, and the problems that this created.

British Thought and Thinking about Motorization and Armoured Divisions before 1940

Between the wars, Britain lost the earlier tank lead which it had gained in the First World War and, for various reasons, did not concentrate on developing a modern armoured force like the German *panzerwaffe*. Further, it was widely held in the British Army between the two world wars that motorization, applied to operations at the level of small, colonial wars, could provide commanders with the capacity to execute wide lateral movements speedily. Much of its equipment emphasised characteristics of mobility over fire-power – which would be found very useful early in the Desert War because of the ability of widely dispersed columns to move over great ranges and achieve effects out of all proportion to their actual weapon power. Tanks' fire-power became a subsidiary consideration to mobility, which imposed an important constraint on their effectiveness in action.

At the level of major warfare the future role of tanks was, however, an issue of great contention. The debate in Britain was paralleled

British Army before 1940', (unpublished master's thesis, University of South Africa, 2002) in which detailed references to sources used may be found.

elsewhere – particularly in Russia, France and Germany. It is possible to delineate at least five categories of attitudes towards British Army mechanization, excluding those who simply did not think seriously about their profession:

[t]he revolutionaries who believed with Fuller that the tank was an invention of overwhelming importance which would dominate future land warfare [;] reformers; they supported a thorough revision of tactical doctrine but neither their ends nor their means were as drastic as Fuller's [;] progressives [;] thoughtful officers who appreciated the tactical shortcomings revealed in the First World War but were largely content to work for improvement in their own arms or areas of experience [; t]he fourth category, who may be termed conservatives, were not opposed to mechanization *per se* but disapproved of the concept of independent armoured formations [; and t]he fifth and final category [who] were opposed not merely to the tank but also to the mechanization of transport.⁹

However, sufficient for this thesis is a tri-part categorization, as follows. In the period between the world wars there was an expectation among a first category, some military writers and soldiers with a desire to modernise the British Army, that armour should be developed to become the predominant arm of the Army.¹⁰ Few of them, or of like-minded German, French or Russian counterparts, considered that there could be any satisfactory substitute for the tank and large modern armoured forces.¹¹ Some emphasised the need for an offensive infantry element with dedicated transport – ideally tracked and armoured – which would contribute to the armoured battle by moving into the gaps created by the tanks to overcome and clear defended obstacles. All saw armoured forces as the primary means of achieving breakthrough and eventually success in future war on land.

Many of Britain's senior soldiers took a different view and thus fall into our second category. They were often far from antagonistic to tanks or to the permanent establishment of tank forces, however. Their view

⁹ Bond, *British Military Policy*, pp. 130-33.

¹⁰ Some of the more prominent, apart the military commentators and theorists, J.F.C. Fuller and Liddell Hart, included the (then) middle-ranking officers, Lieut.-Col. C. Broad, Maj. P.C.S. Hobart, Col. G. Lindsay, Maj. G. leQ. Martel, and Maj. F. Pile.

¹¹ Some important contenders for the establishment of such forces were Marshal M. Tuchachevsky, DeGaulle – then a Lieutenant Colonel, and *Oberstleutnant* (Lieutenant Colonel) H. Guderian – Russian French and German, respectively.

was that the proper employment of tanks did not require the development of the kind of armoured forces for which the 'modernists' hoped. Instead, they sought to improve co-operation between tanks and existing arms. What they wanted was more tanks on the battlefield at the speed of infantry brought to battle by mechanical transport. The important feature to note about this motorised transport of infantry was the virtual abandonment of any official consideration of a fighting role for infantry in motorised transport working with tanks to carry out specifically 'armoured' tasks, operating together in permanent all-arms formations. Infantry was 'in-house' in armoured divisions, it was not yet integral with the armour. Infantry tanks required to be more heavily armed and armoured than other tanks. This firmed up the distinction in Britain between 'Infantry' tanks, intended for close-support of infantry, and 'cruiser' tanks, intended for traditional cavalry-type general armoured tasks. The role of motorised transport in major warfare would remain primarily the movement of men, guns, and supplies. This reflected earlier thinking and experience.

A final category of senior commander can be distinguished. These were thoughtful officers who perceived that movement utilizing the internal combustion engine was significant not only for tactics but also operationally, and needed only to be understood and brought to an adequate level of efficiency, workability, and mobility. They held the tank to be only one weapon rather than the operationally decisive one under all conditions. However, these practitioners did not see motor transport simply in the logistic sense. They understood its potential for the strategic movement of forces; including during the course of a battle in order to affect its outcome. This realization constituted a notional alternative employment of mechanical transport, additional to its logistic uses. Montgomery and O'Connor can be placed in this latter category.

Montgomery is rightly ranked among the most notable British Second World War commanders. O'Connor is less well-known, in part because of his own disregard for publicity. In view of O'Connor's high profile departure from command of VIII Corps in Montgomery's 21st Army Group in late 1944, it is relevant to investigate the extent to which

their careers, experiences and ideas overlapped earlier and at the start of the war. Montgomery established his reputation as a field commander during the British Army's Flanders campaign of 1940. O'Connor commanded the forces which defeated the Italians in the British Army's First Libyan Campaign, 1940-41. Montgomery's and O'Connor's initiative and thoughtful use of the mobility at their disposal contributed in one case to the deliverance of significant British forces from destruction at the hands of a German Army with a superior, modern tank force and in the other to the destruction of a larger and well-equipped Italian force.

Interestingly, Montgomery was less closely involved with experimental formations of all arms in the 1920s, or the early armoured divisions in the 1930s than many other of the protagonists dealt with in this thesis. Earlier, O'Connor had been involved with the Aldershot Experimental Brigade in 1921-22. The Experimental Brigade, also known as the 5th Brigade, included infantry, tanks and artillery. Brigadier (as he then was) E.H. Barker, arguably even less well-known, will nevertheless occupy an important place in this thesis. A more junior commander in Palestine in 1938-39 than Montgomery and O'Connor, he had played a key role in the formation of the first British armoured division back in England. He became a member of the War Office Committee on Mechanical Transport (the so-called 'Finch Committee') after Dunkirk. As Montgomery explained to Barker (in classic Montgomery style and with characteristic turn of phrase) he had been appointed 'to keep Finch straight; he [Finch] is quite useless and has already been pushed out of his Division; it is very necessary that you should stand up to him, say what you think in no uncertain voice, and force it through'.¹² Although other commanders had begun their military careers, these three, Montgomery, O'Connor, and Barker can be taken as illustrative of the three most important types of commander for the purposes of this thesis: each of these three types falls within the latter category of commander between the wars, as above. Compared

¹²Barker MSS, Montgomery to Brig. E.H. Barker, 15 October 1940.

with O'Connor's celebrated departure from command, Barker experienced a promotion that was equally spectacular.

Throughout the 1920s and 1930s the British Army had been trying to assimilate the lessons of the First World War into its doctrine but also anticipate how the latest military technology might alter the conduct of war.¹³ During the period between the two world wars the British Army lost the tank advantage it had had and fell behind other major powers in the development of armoured forces, and, instead, it was decided to motorise the entire British Army to include each of the traditional arms: it was desirable, therefore, that the mobility of every arm be improved through general motorization and by a limited mechanization.¹⁴

In the late 1920s the British Army had established an experimental formation of approximately brigade size and set up exercises to test procedures for the close co-operation of infantry, tanks and artillery in a wholly mechanised force, the feasibility of operations conducted at a tempo determined only by the speed of the constituent elements, and the administration of such a fast-moving force. It included tanks, two-man tankettes, armoured cars, guns drawn by artillery tractor and a machine gun battalion carried in six-wheeled lorries, as well as motorised ancillary and support units. It lasted for just two years.

¹³ See French, *Raising Churchill's Army, 1919 -45*, pp.12-30, who argues convincingly that 'it is quite erroneous to conclude that the army waited until the establishment of the Kirke committee in 1932 to learn the 'lessons' of the First World War (p. 30)', and also 'Doctrine and Organisation in the British Army, 1919-1932', *Historical Journal*, 2, (2001), 497-515, where he comments that '[i]t was with some justification that, in 1929, a former director of military operations, Sir Frederick Maurice, wrote in his semi-official textbook, *British Strategy: a study of the application of the principles of war* that 'it is we who are leading the way to the recreation of the mobile striking force' (p. 513)'.

¹⁴ See Bond, *British Military Policy*, pp. 146-150 and 161-190 for a full background to the reasons for this, in order of priorities, and the negative effect that 'when Britain went to war in September 1939, [...] she was sadly lacking in anything resembling the German Panzer division (p. 161)'. He comments elsewhere, however, that it was 'greatly to [e.g. Hore-Belisha,] the War Minister's credit that a field force of five divisions was wholly motorised (i.e. not dependent on horse transport) and ready to be sent to France soon after the outbreak of war', B. Bond, 'The Army between the Two World Wars 1918-1939', in D. Chandler and I. Beckett (eds.), *The Oxford Illustrated History of the British Army* (Oxford: Oxford University Press, 1994), p. 277. For advances made in the design and efficiency of the Army's motorised transport in the 1920s and 1930s see D.J. Sutton and J.S.M. Walker, *From Horse to Helicopter: Transporting the British Army in War and Peace 1648-1989* (London: Leo Cooper, 1989), pp. 119-132.

Trials were discontinued in favour of allowing the rest of the Army to catch up in the application of modern methods of transport to all arms.

In 1932, the War Office Committee on the Lessons of the Great War (the so-called 'Kirke Committee') suggested that the key to the problem of converting a 'break in' into a 'break through' lay with creating a highly mobile reserve containing a powerful punch which would include 'a sufficiency of cavalry or lorry borne infantry'.¹⁵ Towards the end of the 1930s, newly-mechanised cavalry regiments were combined with the Royal Tank Corps battalions to form the Royal Armoured Corps (RAC). Originally, the cavalry were to have been given a mixture of light tanks, trucks and lorries, so that some regiments could act as motorised infantry. Instead, the entire cavalry was mechanised, to carry out the traditional light cavalry roles using light tanks. Mechanization of the cavalry, a commander of great importance for the purposes of this thesis, Captain the Hon. W.R.N. Hinde (as he then was) wrote, would replace the old light cavalry, which was only acceptable because 'the duties of the Divisional Cavalry Regiment remain constant, and only a modification of tactics is necessary to fit a Mechanised regiment to carry out the duties of a horsed Regiment'.¹⁶ In 1935, for example, despite the fact that the Mobile Division of 1934 was in effect without any infantry support because the duty of the motorised infantry was close reconnaissance, he had concluded that 'examining the composition of the Mobile Division it would appear to be a well balanced force'. Further, if the infantry were not there to support the tanks, which they were not, neither was it the role of the tanks of the Mobile Division to defend the motorised infantry. That was the role of 'obstacles and A/T guns on all the approaches fr[om] which attack may be expected'.¹⁷ All this reflected the view which was widespread within among regiments such as Hinde's 15th/19th Hussars at the time that the cavalry was being mechanised for its traditional roles of long-range reconnaissance,

¹⁵ London, UK National Archives (UKNA), WO33/1297, *Report of the Committee on the Lessons of the Great War* (October 1932), p. 20.

¹⁶ Lincoln: Lincolnshire Archives (LA), 16 Elwes, 1/B/1, Capt. W.R.N. Hinde, Individual Training essay on 'The Mechanised Divisional Cavalry Regiment', 28 February 1937.

¹⁷ LA, 16 Elwes, 1/B/1, Capt. W.R.N. Hinde, Individual Training essay on 'The Mobile Division', 23 March 1935.

pursuit, and economy-of-force operations. Hinde's was always essentially a light cavalry, 'armour-only' approach to tank warfare. His perspective did not change – or changed very little – between that time and 1944.

The inclusion of Motor Battalions during the formation of armoured divisions was intended to make the armour more effective, but armoured divisions had more tanks than infantry, with the tanks and infantry organised separately. All this did not reflect a commitment to create a new 'elite' force with the capacity for armoured warfare, as in Germany. Instead, it was an attempt to revive the concept of the Army as a mixed force, utilizing a greater number of tanks but not necessarily employing them as its pre-eminent arm.¹⁸

However, many of Britain's most senior soldiers in the War Office and the Army at this time tended to adhere to attrition as the strategy most appropriate for major warfare (where the aim was the imposition through superior force of such a loss of personnel and equipment on an enemy that he could no longer fight). Motorization, it was held, could influence operations, tactics and logistics in the execution of attrition strategy but it did not have a strategic function or role per se. In the First World War guns had developed into new categories. An important problem with which British artillerymen had to contend, particularly on the Western Front, arose from the requirement for better mobility for larger weapons and their heavier ammunition, and more rapid deployment. It was concluded that the substitution of motor tractors for animal traction could be a solution. The infantry's problem on the Western Front had not been the inability to penetrate enemy positions so much as inability to exploit this. It was thought that, because of the depth of the modern battlefield, physical exhaustion had played its part in bringing attacks by foot-mobile only infantry to a halt. Motorization thus could be part of the solution.

The provision of better logistical supply to the front lines had been another significant problem on the Western Front. Although rations and

¹⁸ An important source for accounts of many participants in all these developments is: "Mechanisation of the British Army 1919-1939" (London: Department of Sound Records, Imperial War Museum (IWM), 1976-77).

stores usually had to be manhandled into the trenches, mechanical transport was employed to vastly increase the amount of supplies which could be brought forward from railheads to troops in the front line. Now, it was held, these could be moved by mechanical transport in greater quantities and at several times the speed of horse-drawn vehicles. Complete motorization could be a solution to problems of mobility in three functional areas: the transportation of men and weapons to the battlefield, the transportation of men and weapons on the battlefield to where they would dismount before moving forward engage to the enemy, and the transportation of supplies. These so-called dominant personalities argued that reform and reorganization directed toward the creation of a motorised army led by tanks rather than of an armoured force was what was required. Thus, the British Army motorised to improve mobility and bring artillery and infantry into action closer to the centre of the battle to make possible the practice of combined-arms tactics, and to improve logistical efficiency.

The British Army, however, did not heed those promoting the primacy of the tank and disregarded their challenge to the Army to adopt the desired doctrine and organization while the opportunity was still within reach. Thus, there was a lack of adequate tanks in sufficient numbers in 1940. Although the first British armoured divisions of the late 1930s were heavily tank-orientated, failure to develop an adequate principal gun, reluctance to move from riveted to cast or welded construction, and failure to develop a standard engine of sufficient power, all meant that those tanks intended to engage in specifically armoured operations had significant shortcomings. However, more 'conservative' contenders, who adhered to an attrition strategy, were able to take considerably more sanguine views of developments. They could, for example, point to what the Army had done to recognise and rectify shortcomings in reaching sufficient standards of mobility for the infantry and adapting tactical techniques and operational concepts.¹⁹

¹⁹Gen. Sir Archibald Montgomery-Massingberd, Chief of the Imperial General Staff (CIGS) from 1933 to 1936, is an example. London: Liddle Hart Centre for Military Archives [LHCMA], Montgomery-Massingbeard Papers, 159, *The Autobiography of a Gunner*, unpublished memoir, n.d., p. 53. See also Larson, *The British Army*, pp. 185-86; J.P. Harris,

Both Montgomery and O'Connor were effective and skilful and their contrasting employment of the troop-carrying capacity of mainly unarmoured vehicles was to achieve strategic advantages. Both were effective and skilful. It will be noted here, however, that both also utilised motorization in a different but related way: to substantiate their understanding of the principles which must underlie effective command under modern conditions, and of the practices by which it should be managed, that is control. Montgomery's, O'Connor's and Barker's early military experiences were clearly important for the development of the leadership strengths, particularly the command and operational skills and insights which they would demonstrate later. Barker later said

I was always round the line. I mean I always have been even as a Divisional Commander. I was always round the line. If you see your chaps you know what they are doing. Not like the early days of the First World War when we were, I never saw my Brigadier in the trenches. I never saw my Divisional Commander ever and in those days one did not go round and see the troops.²⁰

One point upon which Montgomery and O'Connor were agreed was that the absence of senior commanders' forward presence had negatively affected the Army's efficiency in the First World War by producing military situations in which command and control had tended to become separated. However elaborate their information-gathering means, it had been difficult for senior commanders to grasp where the opportunity for outcome lay. Junior commanders had been compelled to repeatedly order their men to undertake frontal assaults against prepared defensive positions and as O'Connor discovered at first-hand during the Passchendaele campaign of 1917, heavy losses were often a result. Such experiences led O'Connor, like Montgomery, to emphasise the importance of training, not only for efficiency but for minimizing casualties. Effective operational command, that is the commander's

Men, Ideas and Tanks: British Military Thought and Armoured Forces, 1903-1939 (Manchester: Manchester University Press, 1995), p. 257. Harris, in 'The British General Staff and the Coming of War 1933-39', *Bulletin of the Institute of Historical Research*, 59 (November 1986), 196-211 makes it clear that, although 'a natural conservative', Montgomery-Massingberd 'intended to develop a mechanized field force which, fighting alongside Continental allies, could meet the Germans on equal terms (p. 199)'.

²⁰ Liddle Collection (1914-1918), University of Leeds, GS0086 Barker (General) Sir Evelyn, Tape 467: interview recorded with Peter Liddle.

responsibility for controlling the battle as a whole, demanded senior commanders' forward presence. This would ensure the most effective use of information on such things as the enemy's whereabouts, capabilities and intentions and on any vulnerability of the enemy to flanking and surprise movements. In the Second World War both made their own forward presence whenever possible a cornerstone for their conduct of operations. However, this was completely contrary to what *Field Service Regulations* stated for higher commanders.²¹

Training, Teaching and the Principles of War

For the guidance of its commanders, the War Office published *Field Service Regulations (FSR)* which was a sort of primer which summarised the principles or methods by which certain results could be attained. Eight 'principles of war' were drafted for *FSR, Volume II, Operations* (1920) by Colonel (later Major-General) J.F.C. Fuller. These were: Maintenance of the objective, Offensive action, Surprise, Concentration, Economy of force, Security, Mobility, and Co-operation. It was essential to decide the aim or object of any military operation and relentlessly to pursue it. The ultimate military objective in war was the destruction of the enemy's forces on the battlefield. Victory could only be won by offensive action. A commander's concept of operations, plans and dispositions must surprise his adversary in order to effect a greater concentration of force than the enemy at the decisive time and place. Therefore, in accordance with the principle of security, information on such things as his whereabouts, capabilities and intentions had to be kept from the enemy. Raids and other diversions which did not immediately contribute to the object of having more force than the enemy at the point of contact must be avoided, in accordance with the principle of economy of force. Mobility, permitting the concentration of superior force at the right time and place, was important, as was the

²¹ Higher commanders were expected to place themselves 'beyond the reach of distraction by local events', War Office, *Field Service Regulations, Volume II, Operations* (London: HMSO, 1920), pp. 146-7.

need to ensure that all services and all parts of the Army co-operate. For the first time, an official publication identified a ‘terse list of operational dictums, each identified by a title, that claimed to be the “principles of war”’.²² *FSR* was revised in 1924, 1929 and 1935. A quasi-official compendium to accompany *FSR* illustrating the content of each principle or method by means of examples from military history was also produced. The numbering of chapters and sections in this accompanying volume corresponded with that of *FSR*.²³ Changes to *FSR* itself were the product of technological developments and experience gained in manoeuvres and Staff Exercises.

The Threads of Experience in 1941-42

Montgomery’s and O’Connor’s methods were rooted in the experience of the British Army, expressed in *FSR*, except, arguably, with respect to risk. O’Connor first used such a forward command, control, communications, and intelligence (C3I) system in a basic form in the Western Desert. Between 1942 and 1945, Montgomery would make this the basis of his system for controlling ever-larger, fully modernised, mechanised and armoured formations, eventually splitting his headquarters into three parts, Tactical, Main and Rear, and placing himself at the small and mobile ‘Tac HQ’ well forward in the battle area. One of the roughly thirty to forty vehicles which might make up Tac HQ at any one time was Montgomery’s office caravan. However, O’Connor’s insistence on commanding from near the front line eventually resulted in his capture on 6/7 April 1941 when his car was ambushed by a German patrol.

At the beginning of the war Montgomery and O’Connor still held the

²² J.A. Alger, *The Quest for Victory: The History of the Principles of War* (Westport, CT: Greenwood Press, 1982), p. 122. The idea that the principles of war were few in number and were capable of being simply expressed goes back to Jomini.

²³ For example, Maj. H.G. Eady, *Historical Illustrations to Field Service Regulations, “Operations”, 1929* (London: Sifton Praed, 1930).

view that the consolidation of British military motorization, together with the improvements in radio and wireless – with which the British Army was experimenting – could be utilised for the purpose of maintaining close personal contact with their subordinates and reintegrating command with control.²⁴ The availability of command vehicles with good communications and suitably powered staff cars, they understood, made it possible for the commander to be able to leave his headquarters and move rapidly around his command, visiting his subordinate commanders to make operational decisions immediately and personally, while in theory remaining in contact with his staff.²⁵ Montgomery's own often retrospective view however, was that application of his own rule of remaining 'balanced' always allowed him the flexibility to cope with risk. The test of operations in 1940 and 1941 showed that Montgomery and O'Connor were effective leaders and skilful commanders, who understood the capability for manoeuvre provided by the motorization of the British Army before 1940. O'Connor's North African operation, COMPASS was to be a large-scale raid but O'Connor's planning could allow for the possibility of exploitation. His plan was to surprise the Italians by passing through a gap identified in their defensive line and take the enemy camps in detail from the rear. COMPASS was the blueprint for his last North-West Europe operation as GOC VIII Corps, by which time Montgomery's high command would not allow him to take such risk.

An important feature of both Montgomery's and O'Connor's earlier operations was the contrasting employment of motorised transport to achieve significant strategic advantages even without tanks or at most

²⁴ O'Connor (like Guderian) had trained as a signals officer. The feasibility of controlling fast-moving forces by voice communication from a command vehicle had been demonstrated as early as the "Mechanised Force" manoeuvres of 1927 and 1928.

²⁵ K. Startup, in his dissertation profiling O'Connor's life and career, states: "O'Connor was the epitome of the front line commander, who is completely at ease when conducting a campaign from the back seat of a staff car, with only a small headquarters truck nearby", 'General Sir Richard O'Connor, A Profile of his Life and Career', (unpublished master's thesis, Virginia Polytechnic and State University, 1977), pp. 112-113. Montgomery famously used a number of the Tourer versions of the Humber 'Snipe' Mk. 2 staff car during the war.

with limited tank support. In both of these instances, motorization gave the British Army the capacity to offset the shortcomings in armour, doctrine and organization which it had at the beginning of the Second World War. Although Montgomery and O'Connor were dedicated to being true professionals in spirit as well as in name, they were nevertheless able to understand the need for avoiding simple adherence to prescribed military practice in favour of a thoughtful approach. They accordingly grew to be modernizing, progressive commanders whose imaginative approaches early in the war enabled them to respond to the disadvantages imposed upon the British Army by the lack of a modern really suitable armoured force. They were able to take advantage of what they had and to adapt it away from stereotyped concepts of logistical or tactical employment which they replaced with beneficial operational and strategic utilization. However, the effects of employing fighting methods influenced by the apparent 'lessons' of O'Connor's victory over the Italians became more and more pernicious later in the Desert War. Although Montgomery eventually changed these methods, they influenced the formulation of fighting methods and doctrine in Middle East Command (MEC) in significant ways up to the middle of the war. A simplified version of the MEC argument runs as follows. The Cyrenaica campaign showed that 'an army should be primarily designed for mobile armoured action'.²⁶ What emerges is that, while new armoured weapons were important so were insight, imagination, initiative, originality, and dynamic leadership, for it still requires thought to apply advanced equipment and weaponry, or when an army is faced with difficult or new problems of fighting – a lesson that the British Army had to learn after Dunkirk and the early desert victory at Beda Fomm. This was something the importance of which Montgomery was arguing as early as the 1920s and 1930s, before the army was fully modernised, armoured and mechanised.

²⁶ War Office: *Middle East Training Pamphlet No. 10: Lessons of Cyrenaica Campaign, December 1940-February 1941, ([?]April 1942), Part III, Section 1, para. 8, p. 41.*

Montgomery – the Developing Mind ...

Montgomery, it has been suggested, was encouraged by the inadequacy of the Staff College, Camberley, where he was a student from 1920 to 1921, to see his potential as a teacher and trainer to the British Army.²⁷ One of the most important things to note about Montgomery in the 1920s and 1930s was authorship.²⁸ What Montgomery was concerned with in the 1920s and 1930s has to be looked at in the wider context of the British Army trying to assimilate the lessons of the First World War into its doctrine but also to anticipate how the latest military technology might alter the conduct of war. However, others who feature in this thesis and who obtained the coveted psc certificate between the two world wars (denoting that an officer had attended the Staff College) were very positive about the quality of the professional training which they received.²⁹

Montgomery, it has been said, had by the mid-1920s a clear idea of the sort of army Britain should have.³⁰ Nonetheless, the future role, equipment and organization of tank forces was an issue of great contention. The categorization of groups that can be distinguished in terms of their attitudes to or views on this major issue faced by the British Army in the 1920s and 1930s provides the background, or context for Montgomery's writings and what others were writing. Earlier in this chapter it was suggested that the portrayal of most soldiers in the War Office and on the General Staff as members of a category that may be termed 'conservatives' were opposed to tanks and anti the establishment of tank forces is incorrect. The labelling of this group and their categorization as being opposed to the establishment of tank forces is largely a creation of Liddell Hart's. If there was a lack of adequate tanks in sufficient numbers, and an unhelpful bifurcation in armoured

²⁷ N. Hamilton, *Monty: The Making of a General 1887-1942* (London: Hamish Hamilton, 1981), p. 153, *The Full Monty: Montgomery of Alamein 1887-1942* (London: Penguin, 2001), p. 132.

²⁸ See, for example, Hamilton's *Monty: Making of a General*, pp. 174-75.

²⁹ See, for example, IWM, Lyne Papers, 71/2/4, Maj.-Gen. L.O. Lyne, unpublished memoir, n.d., Ch. 1, p. 1.

³⁰ Hamilton, *Monty: Making of a General*, p. 183.

doctrine when the British Army went to war again in 1939, far from turning its back on new military technologies, in the 1920s and 1930s the General Staff developed the idea of a small, professional, completely motorised army with many tanks. It is important to see where Montgomery stood in relation to all of this and to what extent he can be seen as typical of a group of officers. Montgomery's growing authorship, widening correspondence with other military thinkers, and enthusiastic acceptance of a Staff College instructorship have been pointed to as evidence that, from at least the mid-1920s, he was increasingly anxious to study the past to draw lessons for the future.³¹ This suggests that a helpful start for an investigation of Montgomery's developing mind in the 1920s and 1930s can be made by identifying the nature of the issues in his writings of those years. Montgomery's military writings of the inter-war period – published and unpublished – make it possible to identify his most important ideas of these years in order to come to valid conclusions with respect to his developing mind in the 1920s and 1930s.³²

Montgomery's first major piece of writing – a five-part series of articles which appeared in the *Antelope* between January 1925 and January 1926 – addressed the subject of the growth of modern infantry tactics. At the very outset, Montgomery made clear his now abiding conviction that, to be successful in battle you must be superior at the point where you intend to strike the decisive blow and it has been stated that: 'no clearer or more concise statement of Montgomery's primary tactical belief would ever be made'.³³ This is important; but hardly surprising. Nevertheless, an apparently questioning stance over the development of tank warfare in Montgomery's thinking in the last of the

³¹ Hamilton, *Monty: Making of a General*, p.192.

³² Montgomery's major published works – the 1920s and 1930s: 'Letter of Advice to a newly appointed Adjutant in the TA', *Army Quarterly* 9 (October 1924); Maj. _____, 'The Growth of Modern Infantry Tactics', *Antelope* (1925, January – 1926, January), 'Some Problems of Mechanicalisation', *Antelope* 2 (October 1926); Lieut.-Col. _____, *Infantry Training Manual*, Vol. 2, (London: War Office, 1931); Brig. _____, 'The Problem of the Encounter Battle as affected by Modern British War Establishments', *Royal Engineers Journal* (September 1937), 'The Major Tactics of the Encounter Battle', *Army Quarterly* 26 (July/August 1938), Gas Trials Report, (London: War Office, 1938, September).

³³ Hamilton, *Monty: Making of a General*, p. 175.

articles on tactics for the *Antelope* can serve as a point of departure from which to expound both Montgomery's tactical and organizational thoughts about tanks at this time. While it has been argued that Montgomery

congratulated Liddell Hart on his 'Model Army' article, he did not really agree with Hart's emphasis on armour. In the end, he felt, all wars become a confrontation between infantry – and the training of this infantry, its ability to move with cohesion, and to co-operate with artillery, tanks, engineers and aircraft, would determine the outcome.³⁴

This is important, because of Liddell Hart's critique of Montgomery's approach to tactics – based on Montgomery's omission of exploitation in attack – and 'diagnosed' by Liddell Hart as early as 1924.³⁵ Taking issue with the interpretation that Montgomery did not really agree with Liddell Hart's emphasis on armour, it is argued here that what Montgomery did not agree with was Liddell Hart's theory of armoured warfare; in essence, the idea of the deep thrust as an alternative to the strategy of attrition, based around the capabilities of an army in which armour was the principal arm, and utilizing the offensive capabilities of the tank coupled with surprise and unorthodox action to produce a decision. Montgomery addressed the issue of the army's reorganisation further in an outline sketch of the subject of some problems of motorization and mechanization, or 'mechanicalisation' as it was called then, at the end of 1926. Again writing in the *Antelope*, Montgomery argued that modern conditions demanded increased mobility, and this should be motor mobility – the horse should be abolished from war. Thus, infantry should be provided with motor transport, which, providing mobility, would facilitate the concentration of superior force at the right time and place. The power of the modern defence, however, would require the generation of firepower sufficient to allow the attacking infantry to gain ground. This, Montgomery concluded, required effective artillery-tank-infantry co-operation: 'additional mechanical support is [...] necessary.

³⁴ Ibid., p.183. See Capt. B.H. Liddell Hart, 'The Development of the "New Model" Army: Suggestions on a Progressive, but Gradual Mechanicalization', *Army Quarterly* 9 (October 1924), 37-50. Montgomery's first published article, on the subject of training the Territorial Army, was in the same number.

³⁵ Hamilton, *Monty: Making of a General*, p. 168.

[...] In modern war organised resistance can only be overcome by mechanical means, i.e., tanks, great weight of artillery, etc.’³⁶

Where Montgomery differed from Liddell Hart is that Montgomery’s strategic philosophy emphasised the mobility of modern warfare and the strategic philosophy of the concentrated thrust, as opposed to Liddell Hart’s emphasis on mobility and concept of the deep thrust, which would always (according to the Liddell Hart theory) produce, or result in an armoured exploitation. Montgomery was always more concerned to outfight an enemy than to outmanoeuvre him. Montgomery did become converted to the idea of specialised armoured spearheads, but this was not to Liddell Hart’s idea of tank-only armoured spearheads, in a first echelon of heavy tanks, as outlined in his ‘New Model Army’ article of 1924.³⁷ By the end of the Second World War, Montgomery’s tanks would be the spearhead of armoured formations that comprised tanks and infantry. Between the two world wars, however, Montgomery did not agree with the notion that armour should be developed to become the predominant arm of the army. The tank, he felt, was only one – but a very important – weapon.

With his invitation in 1929 to revise the *Infantry Training Manual, Volume II (IT II)* Montgomery at last got the chance to revise the pamphlets, booklets and lectures he had given since the War of Independence in Ireland in a new form that would, if well done, become official army doctrine for the next five years at least.³⁸ The ‘17th Infantry Brigade Summary of Important Instructions’ and the 49th (Territorial Army) Division ‘Tactical Notes’ and Training Lectures of 1923 and 1924 are important, therefore, because of the facet of military service for which, in the Inter-war years, Montgomery was to become increasingly well known in army circles: training.³⁹ They are also important because of Liddell Hart’s critique of Montgomery’s approach to tactics – based on

³⁶ Maj. B.L. Montgomery, ‘Some Problems of Mechanicalisation’, p.196.

³⁷ Capt. B.H. Liddell Hart, ‘The Development of the “New Model” Army’, pp. 42-43.

³⁸ Hamilton, *Monty: Making of a General*, p. 212.

³⁹ *Ibid.*, p. 164; Brev.-Maj. B.L. Montgomery, ‘17th Infantry Brigade Summary of Important Instructions’, (Cork: H.Q. 6th Division, 1921), ‘Tactical Notes for use in the West Riding Area and 49th (West Riding) Division, TA’, (York: H.Q. [?]49th Division, 1923), 49th Division Training Lectures, (York: H.Q. [?]49th Division, 1924, January – March).

Montgomery's omission of 'Exploitation' following a breakthrough by an all-arms force based around tanks. In Montgomery's revision of the army's manual on infantry training, which was published in 1931, he acknowledged that there would be cases where tanks, rather than infantry, would be used as the primary arm of assault to break through static defences. This view would, however, appear to be very different from, for example, the Liddell Hart one of an armoured breakthrough followed up and supported by infantry.

It was as a particularly good trainer of troops that Montgomery increasingly impressed his superiors.⁴⁰ There were, of course, various existing army training manuals and *FSRs* in print; but, it has been suggested, Montgomery recognised the fundamental failing of such volumes: they laid down the principles of warfare, but did not give methods by which commanders could train their units to achieve these principles.⁴¹ This is being over favourable to Montgomery. It is hard to find evidence that *FSR* were supposed to do this. Thus, one can legitimately ask if Montgomery really identified a gap – or was he claiming one to advance himself and his own ideas? There definitely were new training methods introduced and attempts began to co-ordinate and standardise training from 1917. The evidence appears to suggest that as late as 1937-38, Montgomery in his instructions for individual training issued as commander of the 9th Infantry Brigade did not propose to lay down detailed instructions as to how his subordinate commanders should train their battalions 'since the needs of battalions vary and what suits one battalion does not always suit another' – though '[w]ith a view to studying some of the many problems involved the Brigade Commander will conduct a study week for officers' – and he

⁴⁰ See Montgomery Papers, BLM 8/1-9, for copies made by Montgomery of his confidential army reports. His superiors agreed that Montgomery was not only an excellent trainer of troops he was also, in Burnett-Stewart's view, 'full of ideas', while Wavell gave it as his opinion that Montgomery had 'one of the clearest brains [...] in the higher ranks'. However, coming to a more completely rounded understanding of what kind of person Montgomery was by 1939 also means taking on board further comments of these two commanders, including, from Wavell, the sobriquet of being 'an enthusiast in all he does', which may have been what led some, such as Burnett-Stewart, to gain the impression of 'a rather imperious commander'.

⁴¹ Hamilton, *Monty: Making of a General*, p. 168.

hoped it would be possible to arrive at a definite doctrine which would serve as a basis for further instruction within battalions.⁴² Secondly, setting up Liddell Hart's theory of exploitation as the standard by which Montgomery's revision of *IT II* should be judged is not helpful. In fact, the British Army – and Montgomery reflects this – distinguished clearly between consolidation and exploitation – a subsequent action, which might or might not be decided on unless troops and fire-power were available for this task. Further, as will be explained in subsequent chapters, the British view – which continued throughout the Normandy fighting in 1944 although Montgomery became a convert to the idea that there should be a single 'general purpose' or 'battle tank' – was that the role of armour consisted of two alternatives, infantry-support and exploitation, each requiring a different sort of tank.

Montgomery, it has been held, simply did not agree that modern battle would ever revert to the trench warfare of 1914-18; it was, however, largely axiomatic in the British army of the 1920s and 1930s that it should not – the development of means of movement utilizing the internal combustion engine had increased the basic speed of warfare. Montgomery believed that the challenge of modern weapons, mobile tactics, combined arms action, and effective command in modern, fast-moving war meant that it was necessary to study the problem of the mobile encounter battle, because: 'owing to the immense power of modern weapons and to the mobility of armoured units, recovery from a bad initial start is very difficult. It may be possible to recover, but against a good enemy, it will only be with heavy losses. It is for this reason that a good enemy is so difficult to fight--he makes you pay very dearly for mistakes'.⁴³ Operational and tactical doctrine had to take account of this: 'therefore a commander must decide *before* contact is gained how he will fight the battle – only then will he force his will on the enemy'. The importance of a definite, 'proper plan from the very beginning' was stressed.⁴⁴ Montgomery did not agree with senior

⁴² IWM, Montgomery Papers, BLM 11 and 13, 11/1, '9th Infantry Brigade Instructions for Individual Training, 1937/38', pp. 1 and 4.

⁴³ Brig. B.L. Montgomery, 'The Problem of the Encounter Battle', p.340.

⁴⁴ *Ibid.*, p.342.

officers' conviction that battles could always be reduced to a set of discrete phases – therefore his insistence on fighting to a 'proper' (i.e. appropriate) plan.

For Liddell Hart the new concept of war and the revival of the art of generalship were both essential for success. The causes of military conservatism were the failure to study military problems scientifically and an emphasis on technique rather than art.⁴⁵ Montgomery argued that 'we have adopted a material solution in the hopes that it will solve for us the problems of the battlefield; but it will not do so unaided. We must also overhaul our tactics – the tactical and material solutions must go hand in hand – we must in fact develop a new technique'.⁴⁶ Thus, while warfare involving armour is a struggle for competitive advantage mentally as well as materially it was 'do-able' by all officers having 'a good knowledge of the technique of staging the many and varied operations that their unit may be called on to undertake in war'.⁴⁷ Further, therefore, technological superiority or inferiority alone do not make the outcome of war inevitable. However, Montgomery thought at this time that 'in thinking out the problem it must be remembered that a wholly mechanised unit or sub-unit is easily held up by obstacles covered by A.T. weapons, and that in order to defeat these tactics it will be necessary to have immediately available *sub-units that can operate on foot across country, using covered approaches and outflanking the resistance*'.⁴⁸

By the late 1930s, a concentration on planning and the commander's forward presence to an extent commensurate with his responsibility for controlling the battle as a whole had become the core of Montgomery's military thinking. He must be prepared to command his mobile, armoured forces himself rather than leaving it to a specialised cavalry commander.⁴⁹ Effective operational command demanded senior commanders' forward presence at critical periods, when important

⁴⁵ Larson, *The British Army*, pp. 97-98.

⁴⁶ Montgomery, 'The Problem of the Encounter Battle', p. 340.

⁴⁷ *Ibid.*, p. 341.

⁴⁸ *Ibid.*, p. 342. (Emphasis added).

⁴⁹ Hamilton, *Monty: Making of a General*, p. 264; Montgomery, 'The Problem of the Encounter Battle', p. 346.

decisions might be required. This would ensure the most effective use of information on such things as the enemy's whereabouts, capabilities and intentions and on any vulnerability to flanking and surprise movements. He must take with him the necessary means to exercise command. British military motorization, together with improvements in radio and wireless would, in the Second World War, make it possible for the commander to be able to leave his headquarters and move rapidly around his command, visiting subordinate commanders to make operational decisions immediately and personally, while remaining in contact with his staff and his subordinate commanders of the various service and support arms. This of course was not always a good thing. One has the sense that commanders on both sides swanned hither and thither in the Western Desert, 1941-42. The importance of all this is that, from 1942, Montgomery would seek to make this the basis of his system for controlling formations under his command. Montgomery's 'Encounter Battle' article did arouse some controversy and the following year, 1938, he would be asked to reply, in the *Army Quarterly*, to the most important criticisms made of it, but in the article Montgomery did not manage to resolve the problem of the need for suitable commanders capable of handling armour.

'It is important to counter any tendency to regard gas as an abnormal feature of war', Montgomery wrote that same year in his 9th Infantry Brigade Individual Training Instructions. He had written in 1926 that gas would drive the horse from the battlefield. In 1938 he believed he had demonstrated that an effective defence was possible: soldiers could withstand a gas attack – and go on fighting. The main body of Montgomery's Gas Trials Report, of September 1938, was a thirty-nine page answer to a detailed War Office questionnaire. But, in a seven-page introduction, Montgomery set out the problem, disposed of the anxiety surrounding the threat, and set forth the defensive and protective measures required to meet it. The 'Report on Gas Trials' shows that Montgomery was open to the use of 'new' weapons such as gas and tanks. More importantly, and in parallel with his approach to other technical developments, it shows his emphasis on a thoughtful

approach over ‘the tendency [...] to endeavour to provide a definite answer to every problem that can arise; this tendency, if proceeded with, would merely provide a rigid doctrine which would break down in war’.⁵⁰

Montgomery’s prescriptions – the proper responses, as he envisaged them, to the challenge of modern weapons, mobile tactics, combined arms action, and effective command in modern fast-moving war – need to be looked at in the wider context of the British Army’s attempt to predict how the latest technology and weapons might alter the conduct of future war. The British Army was now wholly motorised. It was necessary, Montgomery wrote at this time, to be ‘thoroughly conversant with the handling of the re-organised infantry units and sub-units’.⁵¹ It has been said that, by 1925, when Montgomery’s first major piece of writing appeared, ten years of staff duties and study had given him a clear idea of the sort of army Britain should have: in the end, he felt, all wars become a confrontation between infantry – and the training of this infantry, its ability to move with cohesion, and to co-operate with artillery, tanks, engineers and aircraft, would determine the outcome. By the mid-1930s, it has been suggested, Montgomery’s tactical concept of war had fully matured: ‘not spectacular for its novel ideas, but for its unity of conception and the absolute clarity with which Bernard put over this vision’.⁵²

There are issues of substance here about what Montgomery was saying and believed. Some writers, pre-eminently Hamilton, have judged Montgomery by the two artificial yardsticks of Liddell Hart’s formula for the ‘correct’ use of tanks, and his portrayal of most of the senior officer corps as anti-mechanisation ‘donkeys.’ A new perspective on Montgomery shown here puts him in a different light. Montgomery was not, in fact, coming from, or a contender in this armoured warfare debate and whereas Hamilton accepts Liddell Hart as the standard by which Montgomery is to be judged this thesis places Montgomery in the context of British operational and tactical doctrine, his fellow officers, both armoured and infantry, and the challenge of the latest military

⁵⁰ IWM, BLM 12/1, ‘Report on Gas Trials’, 1938, Section 1, p. 1.

⁵¹ IWM, BLM 11, ‘9th Infantry Brigade Instructions for Individual Training’, p. 4.

⁵² Hamilton, *Monty: Making of a General*, pp. 248-49.

technology. This section has shown Montgomery to be a thoroughly professional, progressive soldier, undoubtedly – but of great importance precisely because he did not allow himself to be marginalised to a position of commentating from outside the army or from the sidelines of its mainstream development. Montgomery's thoughts and actions can fairly be held to have been inextricably bound up with reversing the army's fortunes in the Second World War. However, much about armoured warfare was new to him; it would take some years, working things out, before he arrived at his 'winning formula' of dynamic leadership PLUS straight thinking.

... and the 'Uneducated Mind'

Montgomery arrived in the Middle East in mid-1942 with the conviction that what was required was 'an armoured Corps; it must never hold static fronts; it would be the spearhead of all our offensives'. By the time of the drive for Tripoli in early 1943 he considered that 'there must be only one type of Corps, and it must be able to handle armoured formations, un-armoured formations, or any combination of the two types. There is no such thing as an Armoured Corps'.⁵³ Between 1940-41 and his appointment as Commander, 21st Army Group in 1943, Montgomery continued developing his own ideas on armoured warfare. They changed from what they had been previously and then changed again. Most importantly for the purposes of this thesis, they at first included no clear idea of uniformity of armour-infantry doctrine: armour and infantry had different tasks to perform on the battlefield. Quite naturally, El Alamein was his template for the successful offensive battle. It began in a highly traditional way with infantry attacks supported by artillery. The need for armour to remain 'free to choose its own battlefield', a point pertaining to the general

⁵³ S. Brooks, ed., *Montgomery and the Eighth Army: A Selection from the Diaries and Correspondence of Field Marshal the Viscount Montgomery of Alamein, August 1942 to December 1943* (London: The Bodley Head/Army Records Society, 1991), pp. 20 and 121.

conduct of battle operations, supports the argument that he was still finding his way with armoured warfare, that is that the tanks could and should be freed from the need to defend the infantry. In Montgomery's view at this time, 'a really heavy concentration of artillery fire, put down on a carefully thought out plan, will so neutralise the enemy that infantry *unsupported by armour* will be able to gain their objectives without difficulty, provided formidable wire obstacles do not exist'.⁵⁴ While infantry were not always necessary to defend tanks: 'armoured divisions will always be hampered in battle by enemy anti-tank guns [...] artillery fire will be a great aid in overcoming such opposition. [...] ; such fire will neutralise the enemy detachments, while the tanks, *either alone or in co-operation with infantry*, manoeuvre so as to destroy the detachments with M.G. fire prior to and whilst closing with the anti-tank guns'.⁵⁵ When it came to the tactics of the offensive battle, thus, 'armoured divisions should not be used for the "break-in" battle; they should be launched for the "break-through"; in the 'Dog-fight' after the 'break-in', 'operations will take the form of a hard and very bloody killing match, in which you aim to reduce the enemy's strength [through alternating thrusts] to a state which so cripples him that a final blow will cause the complete disintegration of the whole enemy army'. Success would come from 'two or three infantry brigades [which] should always be in reserve available for such action'. Then, 'when it becomes clear that the time for the "break-through" is approaching, armoured and mobile troops must be in reserve ready to be launched into the enemy rear areas. The final blow is then put in on an axis which is likely to give good results and where opposition is expected to be weak. The penetration thus made must be rapidly developed and the armoured forces launched; these armoured forces must be prepared to fight their way forward into open country, should the infantry attack not open the way completely'.⁵⁶

⁵⁴ Gen. Sir B.L. Montgomery, *Some Brief Notes for Senior Officers on the Conduct of Battle* (December 1942), p. 6. (Emphasis added.)

⁵⁵ Gen. Sir B.L. Montgomery, *Conduct of Battle*, p. 7. (Emphasis added.)

⁵⁶ Gen. Sir B.L. Montgomery, *Conduct of Battle*, pp. 9-10

More than problems of doctrine, or organisation, however, Alamein confronted him with a problem that is not so much one of leadership as it was of command. Montgomery's diary notes for the opening of the Battle of El Alamein, 23-24 October 1942 open up the core of this problem:

I gained the impression during the morning that the Armoured Divisions were pursuing a policy of inactivity; they required galvanising into action, and wanted determined leadership. There was not that eagerness to break out into the open on the part of Commanders; there was a fear of casualties; every gun was reported as an 88 mm.

I was beginning to be disappointed somewhat in LUMSDEN [Commander, X Corps, Montgomery's corps de chasse], BRIGGS (1 Armd Div) and FISHER (2 Armd Bde), and also in GATEHOUSE [10th Armoured Division].

But the main lack of offensive eagerness was in the North; both 9 Aus Div and 51 Div were quite clear that I Armd Div could have got out without difficulty in the morning.

LUMSDEN was not displaying that drive and determination that is so necessary when things begin to go wrong; there was a general lack of offensive eagerness in 10 Corps.⁵⁷

Lumsden and his armoured commanders disagreed with Montgomery's ideas for the use of armour. Montgomery's original plan envisaged the armour of Lumsden's X Corps helping to open up a corridor through the German defences by night. The armoured commanders were markedly reluctant, concerned that if the mines could not be lifted in time, their tanks would be caught in daylight hemmed in by mines and easily destroyed by enemy anti-tank guns before they could get forward to ground where they could bring on a battle with the enemy tanks. This opposition swayed Montgomery into changing his intentions and fixing on a plan which would rely on simultaneous attacks by infantry to help clear routes through which the armour could advance. However, when daylight came on 24 October, neither 1st nor 10th Armoured Divisions, etc. were in a position to exploit. Montgomery continued to urge his armoured commanders to get their divisions through the minefields, but little attempt was made to comply and Lumsden did little to bring pressure on them to act in accordance with Montgomery's commands.

⁵⁷ S. Brooks, (ed.), *Montgomery and the Eighth Army*, p. 74

Lumsden's was outspoken in his disagreement with Montgomery's plans to use armoured divisions to break through frontally, to which it can be added that 'Lumsden of course was a completely different character: extrovert, coloured scarf, cavalryman, fly-whisk – Monty's *bête-noir*, that sort of chap'.⁵⁸

As Montgomery noted in the Conclusion to his diary notes on 'The Battle of Egypt 23 October-7 November 1942' 'the training of Commanders by their superiors was unknown; there was no firm doctrine of war on which to base training'.⁵⁹ Montgomery could recognise – perhaps because of the authoritarian streak in his own personality – that there was a requirement to shape everybody according to the same mental recipe. But, he also recognised, a lot of the time people were not taking any notice of his ideas and not doing things in the way he wanted. This recognition was what was behind his first foray into pamphlet literature intended for very senior officers in the 8th Army. As he explained to Brooke: 'there is much to be learned from these two battles [the defensive battle of Alam Halfa and his offensive battle, El Alamein], and together I think they provide the material for a very short and quite small pamphlet on the "Conduct of Battle". This might be given to all Generals, and perhaps Brigadiers, and would be a good doctrine for the whole Army'.⁶⁰

However, the process of teaching his commanders 'how we will fight our battles, and therefore how we must adjust our training' was not actually as straightforward as he initially thought it would be.⁶¹ At high level in the British Army, what official policy was tended to depend on who was perceiving it and from what perspective, and senior officers were allowed wide latitude to interpret doctrine as they saw fit. Montgomery recognised as much in his second pamphlet for senior officers: 'I do not expect for a moment that all senior commanders will agree with what I say'.⁶² Further, a military 'culture' existed which left inculcation of the Army's, army commander's, or higher commander's

⁵⁸ This description of Lumsden was provided to the author by Lieut. Col. R.R. McNish.

⁵⁹ S. Brooks, (ed.), *Montgomery and the Eighth Army*, p. 82.

⁶⁰ *Ibid.*, p. 83.

⁶¹ *Ibid.*, p. 94.

⁶² Gen. Sir B.L. Montgomery, *Some Notes on High Command in War* (January 1943), p.1

understanding of the methods of actual fighting and training largely to the discretion of unit commanding officers. So, Montgomery, by 1943, was half-way there as a good teacher and trainer because he had the conception of the need for it, and a method: 'in the Eighth Army I concentrate on the Generals. If they know their stuff, they will teach the soldiers'.⁶³ However, finding ways to get people to buy into his conception was equally important. Montgomery seems to have had some difficulty doing that. Individuals can be representative of experience, as well as formations, units and organizations. Many of Montgomery's senior armour commanders had a very different past experience from Montgomery's own, not only because they were tankers in background but also because the experience of some stretched back to the early fighting under O'Connor. Hence the two pamphlets Montgomery wrote in North Africa. The fact that the second is so much shorter than the first – a mere nine pages – probably represents a definite attempt by Montgomery to give commanders a greater incentive to read it.

In retrospect, it is possible to see the views of many of Britain's senior soldiers between the world wars as ill-founded because of a failure to perceive that the army might need not only mobility but also the particular combination of mobility and offensive power associated with modern, mechanised-armoured forces, that is combined-arms mechanised forces. In the 1920s and 1930s, the army developed concepts and an organization to fight a future major war – but not the next war. Nevertheless, the capability of the 1937-43 type of British infantry battalion to move by vehicle gave a workable capacity for tactical and strategic mobility which was to have significant operational, strategic effects in the hands of certain commanders in 1940 and into 1941.

⁶³ S. Brooks, (ed.), *Montgomery and the Eighth Army*, p. 196.

In the light of the way the German Army fought with tanks and infantry early in the Second World War, among the most serious shortcomings of doctrine and organization that can be identified with respect to the early British armoured divisions until well into 1942 are inappropriate initial concepts for the tactical employment of tanks and infantry together, the imbalance between the amount of armour and the number of available infantry, and the unsuitable organization whereby armour and infantry were organised separately. Montgomery was not someone somehow 'waiting in the wings' with a pre-thought-out 'off the shelf' correct solution for these problems when war came again.

For Montgomery, as an army, then army group commander, finding really suitable subordinates who were not only content specialists having an armour background, but who saw completely eye-to-eye with him on the handling of armour, and who also possessed the necessary forceful decisive leadership was a challenge that would take some time to overcome.

It took Montgomery some time to realise what was going wrong. He was not really closely involved with tank developments in the interwar period or with directing armour in the battle for France in 1940. What one is looking at is an uneducated mind, arriving at the problem in 1942 inexperienced in armoured warfare. Montgomery was half-way there by the middle of the war in his conception of the need for training. However, even on the eve of and in the course of his great victory, the Battle of El Alamein he had trouble getting his armour to deliver what he wanted them to. This was not because of a lack of senior officers' training. It might be said that Montgomery's experience and mental outlook had not prepared him for the challenge of armoured warfare. What can be said, however, is that Montgomery's 'model' for armoured warfare differed from O'Connor's victories in 1940-41 in its evolution during 1942-43.

The limitations of development that the formation of British armoured divisions around 1937-38 left set up problems that had to be faced by people in the war. The initial development had been to motorise the infantry. The problem had been perceived as mobility. In

North Africa it was still perceived to be the problem there. The solution was yet to come. In North-West Europe it would become clear that the problem was not just how to get the infantry from where they were to where they wanted to be but how to fight together. Much that is of significance happened between 1940-41 and 1943-44 that produced a coordinated doctrine in North-West Europe in 1944-45. What was lacking, what it is that still had to happen, is the subject of the chapters which follow, starting with the ill-starred influence of desert-influenced fighting methods and doctrine in Normandy.

CHAPTER 2

‘A TECHNIQUE, A MYSTERY AND ALMOST A VOCABULARY’.¹ DESERT-INFLUENCED METHODS OF COMBAT, ‘D-DAY’ AND THE EARLY CAMPAIGN IN NORMANDY

In Normandy, there were eight principal 21st Army Group operations in the Anglo-Canadian sector. They were: PERCH (10-14 June 1944), EPSOM (26-30 June), CHARNWOOD (8-11 July), GOODWOOD (18-20 July), SPRING (25 July), BLUECOAT (30 July-6 August), TOTALIZE (7-10 August) and TRACTABLE (14-16 August). They are looked at, where necessary in the context of overall operational development, to get the full view across 21st Army Group of what was working and what was not working. It must also be noted that the issue of selection of operations is further focussed by the issues of finding commanders for whom primary data could be accessed (see Appendix II). Furthermore, the thesis is not designed to be a comprehensive overview of Normandy operations: this story of lessons learned is then contextualised as the overall story unfolded through the liberations of the Low Countries and the invasion of Germany. Thus the operations chosen are designed to be representative ‘snapshots’ of what was going on at that period in the campaign. The early Normandy operations were breakthrough attempts, aimed at capturing roads leading to Caen. Later operations were aimed at capturing roads leading on from Caen.

Villers-Bocage and the defeat suffered by the ‘Desert Rats’, 7th Armoured Division (Operation PERCH), has been widely held to epitomise the failings of British armour during the early fighting in the *bocage* countryside in Normandy.² Conventionally, historians have

¹ IWM, Erskine Papers, 75/134/1, Lieut.-Gen. Sir G.W.E.J. Erskine, ‘[M.E.] Active Service Diary’, [n.d.], p. 10.

² Buckley, *British Armour, Normandy*, 44, pp.11-23; Ellis, *Victory: Normandy*, p.256; D’Este, *Decision in Normandy*, p.183; Hastings, *Overlord*, pp.162-3; Harrison Place, *Training in the British Army, 40-44*, p.154; French, *Raising Churchill’s Army, 1919-45*, p.269.

concentrated on the sharp contrast between action before and after that time. Past experience appeared to suggest that what was wanted for decisive victory was not only better tanks and tank crews, but also more tanks than the enemy. The emphasis was on manoeuvre by armoured-only forces to destroy the enemy tank force, employing mobility, speed, and surprise. Once that was achieved there would be little role for infantry in the defeat of enemy tanks. Available firepower prevailed, and covered the need to address a flawed armour-infantry doctrine which allowed the principle of separately brigaded armour and infantry (although there was much more to it than this). The 7th Armoured Division had gained its reputation in open country operations in the Western Desert of North Africa but fighting in the close, congested terrain of North-West Europe required a very different approach to both operations and techniques.³ Historians have highlighted a number of 'key issues' centred on armoured doctrine in the Normandy campaign, apparently expressed in the Villers-Bocage experience. These included problems concerning the use of armoured divisions, the precise role of independent armoured brigades, and the effectiveness of armour-infantry co-operation. Three key arguments or explanations have been offered for these failings, relating respectively to the conceptual, material and moral elements of military effectiveness. Further, it has been suggested that too much analysis has assumed failure because of the way the British fought with armour in 1944, which was not the same way as the Germans in 1939-42.⁴ Furthermore, failure was assumed because they did not employ the panzergrenadier model for armour-infantry organization and structure. Yet the Villers-Bocage battle was just one action and, thereafter, armoured formations proved flexible enough to adapt. It has been argued that both independent brigades and divisional brigade groups had developed workable tactics for infantry-armour co-operation by the middle point of the campaign in

³ See Appendix III Figures 1 and 2

⁴ Buckley, *British Armour, Normandy*, 44, p. 5. That way is well summed-up in the phrase 'the 1940 Panzer way'. This author is indebted to D.F.S. Fourie, Professor Extraordinarius of the University of South Africa for this phrase, personal communication to the author, 6 May 2009.

Normandy.⁵ The implications of these new tactics for armour-infantry unit organization and structure had yet to be fully explored. However, within this time scale, some change happened faster in the tank and armoured brigades and as this chapter will demonstrate the explanation hitherto given is incomplete. After looking at the creation of doctrine for the invasion, the chapter will examine how this actually played out on the ground, thus moving from a consideration of doctrine at a conceptual level to relate this to actual events on the ground.

As the war progressed, battle lessons learned by the army in the North African and Italian campaigns, commanders' experiences of fighting in Libya, Tunisia, and Italy, and developments in weapons technologies all played a part in the creation of doctrine for the assault on North-West Europe. For three years however, the Western Desert was the only active theatre of operations in which the RAC was engaged in specifically armoured operations and operations only in support of infantry, its two principal roles at the level of major warfare. The important victory at El Alamein in the Western Desert gave Montgomery great influence to shape the process of learning lessons from North Africa. Nevertheless, the evidence that is presented suggests that for a sizeable number of officers in the RAC many lessons from current experience of desert warfare against the Italians and the Germans – even after Alamein – served merely to confirm the soundness of doctrine and methods deriving from earlier, pre-war thinking and experience. For this reason they held that these lessons must have universal application. Brigadier the Hon. W.R.N. Hinde and Major-General G.W.E.J. ('Bobby') Erskine were representative of this type of thinking. Hinde's command of 22nd Armoured Brigade, 7th Armoured Division is a yardstick for desert-influenced methods of combat in Normandy. Further, in a period when doctrine was being changed at lower level, his involvement in the process by which it was being criticised, or created, may be considered as a baseline against which the involvement of others can usefully be compared. Erskine commanded 7th Armoured Division during the Battle of Normandy, having successfully commanded the

⁵ Buckley, *British Armour, Normandy*, 44, p.102.

same division in Tunisia. He took command of the division there in January 1943 after service as a commander and staff officer in the Western Desert and was a widely respected commander. However, in the later desert war and in the Tunisian campaign the need for more infantry was felt acutely, but how this might play out in north-west France was by no means clear. Also, many tank veterans of the Italian campaign where all had to be done across narrow fronts, in line ahead were absolutely horrified at the idea of fighting *en masse* 'the 1940 Panzer way', or the way the British fought in 1941 and 1942.

In Normandy, the breakout was preceded by two months of intense, static warfare. It was a trying time for all commanders, at every level. There were failings in performance, documented by junior commanders, which were recognised very quickly by senior officers on the ground. Further, as will be shown, Major-Generals G.P.B. Roberts and L.G. Whistler, two divisional commanders of particular importance who made their names as highly successful commanders in the Western Desert, were important as – respectively – an instigator and a driver of further tactical change in Normandy, and, thus, are representative of different types of officer than Hinde and Erskine. Neither Roberts nor Whistler was bound by or to the lessons learned from previous victories. Furthermore, the first-hand accounts from command at the divisional and brigade levels hint at the existence of a group of officers at high level who never believed that desert practice was necessarily 'best practice'.

Another division in XXX Corps during EPSOM, June 1944 was 49th (West Riding) Infantry Division commanded by the equally respected Major-General E.H. Barker. He did not serve in the desert and took command of 49th Infantry Division in the UK in April 1943. After hearing of Erskine's dismissal from command of 7th Armoured Division in August 1944, Barker, who had criticised the action at Villers-Bocage and believed that 'his [Erskine's] chaps did make a pretty good mess of the party on the right of the British', expressed long-standing doubts about the relevance of warfare as practised in North Africa to the

conditions in North-West Europe. 'I always felt that B[obby]'s desert training would not be any good in this form of warfare'.⁶

The Legacy of the Western Desert, Lessons of North Africa, and the Creation of Doctrine

The dissemination of tactical doctrine was, as always, primarily the responsibility of the War Office. In practice, however, senior officers were allowed wide latitude to interpret the army's understanding of the methods of actual fighting as they saw fit. Further, training to achieve a sufficient level of fighting capability was left largely to the discretion of unit commanding officers.

During his period as Chief Instructor at the Senior Officers School in 1940-1 Colonel L.O. Lyne found great difficulty in keeping a 'reasonable balance in our teaching of tactics between the impressive early German victories, the evolution of our own army for future operations in Europe and the very specialised conditions of the fighting in the Western Desert'.⁷ High-level commanders could and did disagree both with each other and with the War Office on the lessons of battle in North Africa and the 'correct' way to fight with men, tanks and guns at the level of major warfare. Senior officers were allowed considerable latitude to interpret doctrine as they saw fit because it was recognised that official doctrinal publications could inevitably only present an ideal set of circumstances, which might all too infrequently be realised in combat. Lyne's description of the way in which the army as an institution attempted to adjust its doctrine to a variety of different experiences was an accurate reflection of the situation at the time. Official armour doctrine was for these reasons still in a state of flux on D-Day.

As General M.O'M. Creagh's instructions to 7th Armoured Division show, the armoured division of 1940-42 was not intended to assault heavily defended enemy positions but to fight tank battles in

⁶ Barker MSS, Maj.-Gen. E.H. Barker to his wife, 5 August 1944.

⁷ IWM, Lyne Papers, 71/2/4, Maj.-Gen. L.O. Lyne, unpublished autobiography, [n.d.], Ch. IV, 'The Senior Officers School 1940-41', p. 3.

manoeuvre. Creagh considered that although ‘in the main, in the past, we have not been engaged in tank versus tank battles; in the future, we are bound to be. The desert lends itself to this form of attack’.

Creagh’s view was that ‘the attack on a defended position will rarely be the objective of an armoured unit, it should be circumvented wherever possible’.⁸ Reflecting this intended role, armoured divisions lacked an integral infantry element beyond the motor battalion attached to each armoured brigade. Nevertheless, adaptation proved possible, utilising this (augmented) battalion to provide the nucleus of mixed, light mobile forces.

In a situation where the enemy was in great strength but largely tied to static defences – as the Italians were in Libya, 1940-41 – an improvisation in the form of Jock columns developed into a tactical system, ideally suited to prevailing conditions. Named after Major-General J.C. Campbell, the originator of the idea, the Jock column was a mixed force – typically a few light tanks or armoured cars, guns and lorry-borne infantry – designed and organised for mobility, surprise and combined arms action. Campbell was commander of the 7th Armoured Division’s Support Group, 1941-42. His ideas and those of Lieutenant-General W. H. E Gott, successively commander of 7th Armoured Division and then XIII Corps in 1941-2, continued to have a very powerful influence even after the initial stages of the campaign in the Western Desert. After Alamein, Major-General Erskine wrote, ‘I don’t think either he [Gott] or Jock Campbell will ever be forgotten. Those two held the field under terrible conditions for years’.⁹ Erskine did not actually arrive in the desert until February 1942. In his view, in the absence of a viable armoured force, Gott and Campbell had used their guns and infantry ‘to the maximum extent permitted by the circumstances’.¹⁰ Columns had, however, insufficient supporting infantry to take and hold ground and were certainly not able to defend it

⁸ LHCMA, Roberts Papers, North Africa 1941-1943, ‘7 Armoured Division Training Memorandum No 1’, 13 August 1941, paras 2 and 5. Creagh was GOC from December 1939 until September 1941.

⁹ Barker MSS, Brig. G.W.E.J. Erskine to Brig. E.H. Barker, 26 November 1942.

¹⁰ Bovington, Tank Museum Archive (TMA), RH4 7AD: 2960-73, Lieut.-Gen. Sir G.W.E.J. Erskine to Mr J.H. Yindrich, 5 July 1952.

against enemy tanks. Nevertheless, combining the capability of motorised infantry to move over great ranges, and the mobility and hitting power of the 25-pdr gun, when used correctly, columns 'could make themselves a very great nuisance and give the enemy a feeling of great insecurity on his open [desert] flank'.¹¹ Erskine believed that 8th Army's success in 1941 despite its inferior tanks and poor anti-tank guns was entirely the result of Gott's skilful methods. 'Since we were at a disadvantage in a stand up fight we had to adopt other methods'.¹² Thus, although Erskine did not experience the 1941 desert battles first-hand he was satisfied that his conclusions, 'drawn as a result of those who had experience', both accurately reflected the challenges faced by armour and confirmed the fundamental soundness of the methods employed to meet them.

However Roberts, who commanded 3rd Royal Tank Regiment (3rd RTR), 7th Armoured Division in the Western Desert in 1941 and went on to take temporary command of 7th Armoured Division in 1943 prior to Erskine, believed that 'having had too easy a time against the Italians and learnt some rather false lessons, one has to admit, in retrospect, that we were still feeling our way regarding armoured warfare and had not, even after Battleaxe [15-17 June, 1941], appreciated the important factors'.¹³ Erskine and Roberts between them commanded two of the three standard British armoured divisions in Normandy and Roberts, unlike Erskine, was successful in both North Africa and North-West Europe. In North Africa, Roberts recognised that it was mainly the enemy anti-tank gun that was damaging and destroying British tanks; Erskine did not and thus found it difficult to conserve his tanks to engage and destroy the enemy tanks. The differing lessons drawn by these two senior operational commanders from the fighting in North Africa 1940-43 influenced their approaches both before D-Day and during the early stages of the Normandy campaign.

¹¹ IWM, Erskine Papers, 75/134/1, 'Active Service Diary', p. 16.

¹² Ibid., p.18.

¹³ Roberts, *Desert to Baltic*, p. 51. Undertaken with forces numerically superior to Rommel's, including in armour, BATTLEAXE's failure brought about significant command and organizational changes.

The methods employed to address the challenges of tank armour that was inferior in quality, tank guns inferior in performance and an infantry not confident of meeting an armoured attack without tank support because of the inferiority of their anti-tank guns involved the use of mobility, speed and surprise to attempt to destroy Rommel's armour in a decisive tank versus tank encounter (e.g. BATTLEAXE), having manoeuvred 'to force him to attack on our terms advantageous to his [i.e. disadvantageous to him]'.¹⁴ For Erskine the principal offensive goal was to neutralise the enemy's armour and 'see it off'. This always required offensive action relying on tanks' mobility more than their firepower. This reflected previous thinking and experience. This desired outcome was not always achieved because 'there was too much respect of [i.e. for] tanks in the case of our infantry and of 88mm guns in the case of our tanks'.¹⁵ The problem was thus one of morale and method as well as of technology. The enemy's chief tactic was to use some of his tanks as bait to lure the British tanks on to concealed anti-tank batteries, then counter-attack with tanks while using more of his tanks to find weak spots in the British defence – generally infantry positions.¹⁶ Erskine was able to engender a strong morale but not to solve the problem of method. As he afterwards acknowledged, 'we should have used the infantry – with their 25 pdrs – to neutralise the 88s and not charged on them as we did only too often'.¹⁷

The experience of fighting the German army in the Western Desert forced a major reappraisal of the structure of an armoured division in mid-1942. British armour was forced to seek methods of engaging the infantry protecting the enemy's anti-tank guns. Although War Office doctrine still dictated that armour and infantry be kept separate, the number of armoured brigades in the armoured division was cut to one and an infantry brigade was added. A further British response was the

¹⁴ IWM, Erskine Papers, 75/134/1, 'Active Service Diary', p.18.

¹⁵ *Ibid.*, p.19.

¹⁶ For Rommel's decision to use anti-tank guns in this way, see P. Collier, *The Second World War (4) The Mediterranean 1940-1945* (Oxford: Osprey, 2003), pp. 38-39; for Rommel's view of tanks' chief role, see B. Pitt, *The Crucible of War: vol. I: Wavell's Command* (London: Cassell, 2001 [1980]), p. 302.

¹⁷ TMA, RH4 7AD: 2960-73, Erskine to Yindrich, 5 July 1952.

development of the infantry box, protected by artillery and minefields. A 'Brigade box' was designed to be a more or less self-contained anti-tank barrier, around which British armour would be free to pivot or manoeuvre. In the Alam Halfa battle (31 August 1942), 133rd Brigade, 44th Infantry Division, provided the 'pivot' for Montgomery's defeat of Rommel's attempt to break through the El Alamein line. Brigadier Whistler, who temporarily commanded 133rd Brigade during this battle, described the role of pivot as follows: 'our armour to the West and some more to the South East and us for the Boche to bump his head against'.¹⁸ To provide 10th Armoured Division with its additional infantry 133rd Brigade was detached from 44th Infantry Division and re-equipped as lorried infantry in September 1943 – but little appears to have been done within 10th Armoured Division to understand the joint handling of infantry and armour. Before D-Day, Whistler was moved from command of 131st Brigade, the divisional lorried infantry brigade of 7th Armoured Division, in accordance with Montgomery's policy to put a few experienced commanders in inexperienced formations. Therefore, this was less an indication of the success of new techniques than of the fact that he was a proven leader with recent battle experience. However, depriving 7th Armoured Division in this way of many experienced officers contributed to the parlous state the division found itself in at Villers-Bocage. Whistler proved very capable when faced with the new operating environment of North-West Europe.

The discussion must now focus again on technology, as well as tactics because the introduction of the American M4 Sherman tank in time for the Battle of El Alamein greatly helped to ease the problem of tank guns inferior in performance, that is the lack of a principal gun which allowed British tanks both to engage and defeat enemy tanks and anti-tank guns.¹⁹ The 75mm dual purpose (DP) gun provided armoured divisions with enough firepower to prevail in the Western Desert in the manner envisioned by the War Office. However, it also allowed the principle that there should be separate armoured and infantry brigades

¹⁸ Chichester: West Sussex Record Office (WSRO), Whistler Papers, 9/48, Brig. L.G. Whistler, personal diary, 17 Aug-13 September 1942.

¹⁹ TMA, RH4 7AD: 2960-73, Erskine to Yindrich, 5 July 1952.

to be maintained, and find its way into North-West Europe.²⁰ Further, in the North African desert campaign after El Alamein more infantry were found to be necessary to assist in the cracking and exploitation of delaying positions. However, as Erskine acknowledged later: 'I don't think this means that Armoured Divisions had changed their role [...] I certainly always felt the Armoured B[rigade] was the predominating element while I commanded 7th Armoured Div[ision]'.²¹

Turning to Roberts, and how he saw things after the German army had intervened in the desert war, it was, as he recognised, mainly the German anti-tank gun that was the problem. Against the less powerful German infantry anti-tank guns what was needed was a high explosive (HE) shell to defeat them by engaging the defending infantry concentrations. However, where and when the German divisions deployed a small number of 88mm guns, this tactic (HE rounds) was insufficient since no British tank could close sufficiently to be able to deliver a HE round. Thus, the 25-pdr, referred to by Erskine, became a fundamental part of the British combined arms mix for armoured warfare from mid-1941. It became apparent to Roberts, however, that 'what was required was a method of defeating the A/T gun, necessitating a greater co-operation between all arms, particularly between the tanks and the artillery, and a gun in the tank which could deal with A/T guns'.²²

The solution was better tactical co-operation between better anti-tank guns and tanks, and a tank gun capable of firing HE as well as AP shot. In the interim, tanks should no longer lead assaults, although in Operation CRUSADER (November 1941 – January 1942), for example, at Sidi Rezegh, the newly arrived 22nd Armoured Brigade was lured into making a head-on assault against well dug-in anti-tank guns without adequate artillery and infantry support, losing a major proportion of their new cruiser tanks. In the absence of an adequate British tank and anti-tank gun, however, tanks – particularly the American M3 Grant

²⁰ IWM, Erskine Papers, 75/134/3, '7 Armd Div Op Order No 6', 23 July 1944.

²¹ TMA, RH4 7AD: 2960-73, Erskine to Yindrich, 5 July 1952. This quote is interpreted to refer to Erskine's entire period in command, i.e. up to August 1944.

²² Roberts, *Desert to Baltic*, p. 51.

tank – could still be effective against German tanks. It is important to note that Roberts himself never had to fight with older British equipment.²³ He was moving from a problem of technology to a problem of method. He was associated particularly with the appearance of the Grant tank which had a 75mm gun in a side sponson, capable of firing a HE shell. For a short period from early to mid-1942 the 75mm guns in the British tanks (Grants) were superior in anti-tank capability to any guns mounted in German tanks. It was only in mid-1942 that the Germans installed a long-barrelled high-velocity 50mm gun on some Panzer IIIs giving the resultant PzKpfw IIIJ the same penetration power as their 50mm towed anti-tank gun. This was followed by the appearance of the new long-barrelled high-velocity 75mm gun on the PzKpfw IVF later in 1942.

In early 1942, Roberts endeavoured to put his case 'for a [bigger] British tank gun which would at least penetrate the front of a Panzer IV at 1000 yards' to Lieutenant-General G. Le Q. Martel, Commander, RAC (MGRAC).²⁴ Martel desired changes in organization and tactics to conform to the newer concepts of a combined arms armoured division which would lose one armoured brigade but have an infantry brigade added. His ideas did not include planning for a gun larger than a 6-pdr on any British tank. Roberts thought that Martel based his ideas largely on the action of a single battalion of infantry tanks in France in 1940, took little account of the experience and recommendations of others, and was a 'menace': 'he just has no idea of a modern tank battle!'²⁵ Roberts envisaged British tanks in firm defensive positions able to destroy the most modern German tanks with long range fire with little need for co-operation between British infantry and tanks.²⁶ His principal offensive goal was the destruction of the enemy anti-tank gun and he was prepared to employ his tanks' firepower and mobility, in conjunction with other arms, to achieve this but to use his (superior) firepower to destroy enemy tanks from static positions. This reflected

²³ Ibid., p. 87.

²⁴ Ibid., pp. 108-9.

²⁵ LHCMA, Roberts Papers, Letters Home 1940-1944, Brig. G.P.B. Roberts to his father, 29 January 1943.

²⁶ Roberts, *Desert to Baltic*, p. 65.

lessons learned from immediate experience – and Roberts’s intimate connexion with the handling of armour in the field to that time.

In late 1942, Roberts came fully to understand the vulnerability of armour against strong and well prepared defences after Rommel had retreated to a new defensive line at Mersa Brega.²⁷ After Alamein, in the offensive pursuit and exploitation phase, even the Sherman was vulnerable. Therefore, infantry were required to lead the assault. Roberts himself conceded that he did not have much knowledge of infantry but in his temporary command of 7th Armoured Division he now realised how important infantry was for offensive armoured tactics. At that point – effectively the end of the desert war – Roberts did not have a clear idea of how this should work out in practice but he already knew it was important.²⁸

In Tunisia, Roberts recognised that with the growing availability of equipment such as the Sherman which made all the difference to tactics and capabilities, he had an opportunity of putting across his ideas, which came from his experience with both 8th Army and 1st Army. In April 1943, it seemed to Roberts that there was a good possibility of getting through the Kournine pass on a divisional plan, but this would require much closer co-operation between armour and infantry, because ‘there would be chaos if the armour alone attempted it’.²⁹ The problem was not now primarily one of equipment deficit or inferiority; it was one of devising ways for all arms to operate as a tactical offensive whole and in the context of a new operating environment which offered new possibilities to the defending enemy, and where it was very difficult for armour to operate alone. What was needed was an improved way of working with the infantry.

The independent tank and armoured brigades were intended to provide, or be available to provide, close support for infantry divisions in the assault phase of operations in North-West Europe. War Office doctrine argued that the independent Tank Brigades, equipped with the heavily armoured A22 Churchill infantry support tank, were best suited

²⁷ Ibid., p. 117.

²⁸ Ibid., pp. 127 and 129.

²⁹ Ibid., p. 144.

to close assault operations. Some sixteen months before D-Day, however, Montgomery held, in a letter to the Vice-Chief of the Imperial General Staff, that 'a heavy infantry tank is not wanted'.³⁰ The lessons he drew from 8th Army's experience of tank-infantry co-operation in the desert varied considerably from those reported by 1st Army in Tunisia. Its commander, Lieutenant-General Anderson, wrote thirteen months before D-Day:

I think my type of country brought out more things which apply to Europe than does desert fighting [:] the great importance of night work; use of concentrated art[iller]y; need for much more skill in using our mortars; the fact that old hands of the last war reacted to the threat from open flanks far more actively than did youngsters (we always had flanks wide open!); *value of Churchills*; need for infantry in an armoured div[ision] to be intensely pugnacious & quick in attack[.]³¹

It had been the War Office's original hope that all independent brigades would be equipped with Churchills but not enough of these could be produced. Consequently, the Sherman was pressed into service, creating the distinction between tank and armoured brigades; but Montgomery and his 8th Army staff were resistant to any doctrinal distinction between armoured brigades largely equipped with Sherman tanks and tank brigades equipped with Churchills.³² Subsequently, Montgomery overrode the experience of 1st Army and discounted the value of its commander. 'I am sorry about Kenneth [Anderson]', Barker wrote to his wife after D-Day, 'but he and M[ontgomery] never got on and it would be an impossible situation for everyone if K[enneth] was in it'.³³ Attempts which had been made within 21st Army Group to develop specific tactics for Shermans to be used in the infantry support role were effectively blocked after Montgomery's arrival.

However, very soon after the invasion of Normandy it was coming to be believed that the objectives of an army tank battalion could be to use the Churchill's cross-country ability to get into positions where it could

³⁰ IWM, Montgomery Papers, BLM 117/2, Montgomery to Lieut.-Gen. A.E. Nye, 28 August 1943.

³¹ Barker MSS, Lieut.-Gen. K.A.N. Anderson to Maj.-Gen. E.H. Barker, 30 May 1943. (Emphasis added.)

³² Buckley, *British Armour, Normandy*, 44, pp.15-16 and 78.

³³ Barker MSS, Maj.-Gen. E.H. Barker to his wife, 26 June 1944.

not easily be seen, with the object of closing the gap between the superior performance of the German 88mm or long 75mm guns and the Churchill's own armament in order better to support the assaulting infantry.³⁴ This could have drawn on the experiences of tank brigades in the Tunisian campaign, which also led to the conclusion that 'the tank must not be tied rigidly to moving at infantry speed but must move where they can best support the infantry by fire, either direct or from flank and hull-down positions'.³⁵ This might be considered analogous not to the methods of armour-infantry co-operation which had evolved in the Western Desert but more to those of air-ground co-operation. The two strands of thought demanded roles for the tanks which would prove contradictory. This was compounded by a failure to resolve the issue of what might be the most appropriate tactics for different types of tank.

Official doctrine emphasised the idea of close physical proximity. The November 1943 pre-Montgomery doctrine of 21st Army Group (General Sir B.C.T. Paget, C-in-C) for the co-operation of tanks with infantry divisions, authored by Brigadier H.E. Pyman, BGS (Training) 21st Army Group, was that an all-tank assault echelon would be unusual. Montgomery's initial idea was that the tanks should go first, well ahead, and the infantry should follow.³⁶ Pyman's doctrine appears to have made an impact on 6th Guards Tank Brigade and particularly on 3rd Tank Battalion Scots Guards in training.³⁷ This was, however, before Montgomery's intervention and before the problems in Normandy had become apparent when doctrine was 'unlearned' and changed again. However, the doctrine constructed by Pyman and Paget is illustrative of competing sets of ideas regarding minor tactics, yet another unhelpful obstacle to be surmounted.

³⁴ Farrell, *Reflections*, 39-45, p. 75.

³⁵ War Office, Notes from Theatres of War (NTW) No. 16, *North Africa, November 1942-May 1943*, (October 1943), Part III, Section 2, para. 4.

³⁶ Montgomery, address at Headquarters, 21st Army Group, 13 January 1944, quoted in *Montgomery and the Battle of Normandy: A Selection from the Diaries, Correspondence and other papers of Field Marshal the Viscount Montgomery of Alamein, January to August 1944*, ed. by S. Brooks (Stroud: The History Press/Army Records Society, 2008), p. 28; Harrison Place, *Training in the British Army, 40-44*, e.g. p. 151.

³⁷ Timothy Harrison Place, 'Tactical Doctrine and Training in the Infantry and Armoured Arms of the British Home Army, 1940-1944' (doctoral thesis, University of Leeds, 1997), p. 224.

Early Battles for Caen: Manoeuvre (PERCH) and Pitched Battle (EPSOM)

In the process of fighting from 6 June, the supposed lessons of North Africa were displaced by new experiences. It was soon evident to some that the methods utilised in the North African desert were not going to work in Europe. Within days of the initial landing it was plain that specific operations were not going well. In the British/Canadian sector, gains anticipated on D-Day had not all been achieved. Expected progress in consolidating the bridgeheads established on D-Day had still not been made. There even seemed to be a chance that operations to create the conditions for a breakout might stall completely, the military situation return to a stalemate such as had existed in the First World War and the theatre turn into a campaign of attrition. Operation PERCH (12-15 June 1944), the daring 'right hook' manoeuvre aimed at Villers-Bocage and the vital high ground to its northeast was intended to drive a wedge between German forces in western Normandy and Caen – preventing reinforcement of Caen. This was to be achieved by XXX Corps with divisions that had served so well in North Africa, foremost among them the 'Desert Rats'. Montgomery argued, however, that this had all been anticipated and was just part of his original plan, namely that remorseless pressure rather than remarkable progress by the British would force the Germans to commit their armoured reserves on the left while he built up for a breakthrough by the Americans on the right.³⁸ Villers-Bocage was never in itself an important objective to Montgomery. The defeat at Villers-Bocage was a setback. However, the consequent failure of PERCH set up a pattern which shaped the future of the Normandy campaign. The British were forced to recognise that the resolute German defence and the dense anti-tank defences which they had put in place in the difficult terrain required new operational and tactical methods if they were to be overcome. The setback at

³⁸ Montgomery, *Normandy to Baltic*, p.167; *Memoirs*, p. 254.

Villers-Bocage was largely created by imprecision as to Montgomery's subsequent intentions at the interface of concept and execution.

The commander of XXX Corps in June 1944 was Lieutenant-General G.C. Bucknall, whose previous service had been in Italy where he had established a reputation as a successful divisional commander. When Erskine took command of 7th Armoured Division in Tunisia in 1943, command of the division's 22nd Armoured Brigade went to Brigadier W.R.N. Hinde. The British force at Villers-Bocage was composed of two regiments of this brigade and elements of 131st Brigade, the divisional lorried infantry brigade. Hinde was, therefore, the commander 'on the spot' at Villers-Bocage. It is useful to recall here the idea of Jock columns, and the fact that the desert war had been a war where movement, speed and surprise were very important, particularly in its early stages. This experience coloured Erskine's approach. The first task was to push through 50th Infantry Division on to Tilly. Erskine afterwards described his task thus:

After some unsuccessful stabs at Tilly, I suggested the use of the Division's mobility round the right flank of 50 Div. I was sure there was a soft spot here and had in fact reconnoitred routes and had a cut and dried plan for a swoop on Villers Bocage.³⁹

The thrust by 22nd Armoured Brigade at Villers-Bocage on 13 June 1944 drew heavily for its inspiration on the idea that finding an empty or open flank was tactically very important and also on the use of an armoured column to drive in the enemy rearguards. Erskine appreciated, however, that if successful, such an armoured manoeuvre also deprived the enemy of the possibility of defence in depth, with beneficial results that facilitated the subsequent operations.⁴⁰ Such a column would, however, be in a parlous position if ambushed by German units with heavy armour as happened on Operation PERCH. When it was decided that the situation was becoming untenable and that 22nd Armoured Brigade must be withdrawn from Villers-Bocage, the Desert Rats contracted into a small defensive box position near Amaye. It was decided that 22nd Armoured Brigade should withdraw

³⁹ TMA, RH4 7AD: 2960-73, Erskine to Yindrich, 7 August 1952.

⁴⁰ TMA, RH4 7AD: 2960-73, Erskine to Yindrich, 5 July 1952.

from it during the night of 14/15 June. Heavy artillery fire had helped keep the box intact during 14 June. This was not the desert, however. Captain J.R. Brown, serving with 3rd Regiment Royal Horse Artillery., the divisional artillery attached to 131st Brigade, 7th Armoured Division, recorded:

Our troops began to feel their way forward over country where our O[bservation]P[ost]s found observation difficult and by early in the afternoon our forward troops (the tanks) were beyond the town of Villers Bocage leaving pockets of enemy behind. Then the trouble started and it was evident that one division could not hope to break through the strong enemy positions.⁴¹

Because of the nature of the country it was difficult for the artillery to provide accurate fire support. Even though there was a successful anti-tank defence at Villers-Bocage which thus apparently confirmed lessons which had been learned by 7th Armoured Division in the desert and Tunisia, in particular during the Medenine battle in March 1943, it was not what was required. In Erskine's view, 'the [Medenine] battle proved conclusively that infantry armed with the 6 pdr anti-tank gun was a match for the German Mk IV and the days when Inf[antry] were constantly over-run were finished' and this held true with respect to anti-tank defence at Villers-Bocage.⁴² Success at Medenine had been 'in fact the end of Rommel and a fitting reward for a 2000 mile chase'.⁴³ Reflecting official policy the armour and infantry had been brigaded separately and were required to fight the same battle separately: 'the two Arm[oure]d B[riga]des [22nd and 8th] were positioned [...] in such a way that they could work in co-operation [... while the infantry] will be prepared to fight their own fight with their A[nti-] T[an]k guns'.⁴⁴ Erskine was attempting to use the same North African methods he had been using at Medenine and these did not work so well in Europe. In the earlier fighting during Operation PERCH the tanks went first and the infantry came up later. This was found to be ineffective. It was

⁴¹ Mr J.F. Brown, Capt. J.R. Brown, 'Diary of events in Europe – 1944 and 1945'. Unpublished chronological narrative.

⁴² TMA, RH4 7AD: 2960-73, Erskine to Yindrich, 5 July 1952.

⁴³ IWM, Erskine Papers, 75/134/1, Maj.-Gen. G.W.E.J. Erskine to his wife, 10 August 1943.

⁴⁴ IWM, Erskine Papers, 75/134/3, 7th Armoured Division – 'Lessons from Recent Operations', 13 March 1943.

Bucknall who realised that leading with infantry would pay best in the *bocage* type of country.⁴⁵ However, at that stage of the campaign it was still the norm that senior officers were permitted wide latitude with respect to methods.

The paradox of Villers-Bocage was that the successful anti-tank defence of the box did vindicate lessons learned in the desert and Tunisia, in particular during the Medenine battle. Although no wire or minefields protected the British positions at Medenine, the infantry were well dug-in, in well-sited defensive positions and well equipped with anti-tank guns, including some of the new 17-pdrs. As Erskine put it: ‘22nd Arm[oure]d B[riga]de were spoiling for a fight and we had a very successful little party in capturing Medenine and some very important high ground overlooking it’.⁴⁶ This had included defeating a German counter-attack which was led by tanks, showing that infantry need not be overrun by tanks if they had sufficient, well placed anti-tank weapons. While effective this was, however, incompatible with the kind of fire and movement tactics and the quicker tempo for sequencing operations as between defence and attack now being demanded by Montgomery, who considered Erskine had been ‘too long on the same line’.⁴⁷ Montgomery was conscious that the burden of the offensive in North-West Europe would have to be carried by 21st Army Group until the end of the campaign. It was also evident to others: ‘The whole thing is to keep this battle fluid and not allow it to crystallise’, Barker wrote to his wife.⁴⁸

As Bucknall, XXX Corps commander, understood it PERCH ‘was intended to be a sharp blow in the spirit and manner in which F.M. Montgomery wished these dog-fights in the struggle to establish the Bridgehead [...] and was NOT a major attack with all forces combined to

⁴⁵IWM, Bucknall Papers, folder marked ‘Op PERCH’ 80/33/1, Lieut.-Gen. G.C. Bucknall to Mr Chester Wilmot, 29 March 1947.

⁴⁶TMA, RH4 7AD: 2960-73, Erskine to Yindrich, 27 June 1952.

⁴⁷IWM, Erskine Papers, 75/143/1, Montgomery, Confidential Report on Erskine, 3 August 1944.

⁴⁸Barker MSS, Maj.-Gen. E.H. Barker to his wife, 12 June 1944.

achieve a major Army object'.⁴⁹ He viewed the operation only in relation to the development of some means of breaking out of the stagnation threatening his front. All this flowed from Bucknall's apparent belief that

the main battle was proceeding for the capture of CAEN. 'PERCH' was a subsidiary op[eration] to free the front of 30 Corps (and incidentally act as a diversion). [Therefore] 30 Corps was under restriction as regards art[iller]y amm[unition] expenditure & material & was definitely precluded from launching at this moment into a 'Corps Battle', which might compromise the Army Com[man]d[er]'s plan, lead to a requirement for additional t[roo]ps to patch up or extricate, or increase art[iller]y amm[unition] expenditure.⁵⁰

He believed that his decisions reflected Montgomery's concept of operations for this particular operation.

Bucknall almost understood Montgomery's operational methods, or understood them in theory. However, Montgomery was a very 'modern' commander in the speed at which he moved to change his plan in response to changing tactical situations. Further, more rapid tempo in sequencing between phases and operations was a factor in Montgomery's response to new tactical and operational problems in Normandy. If there was a flaw in Bucknall's understanding it was that he continued to think of Villers-Bocage and PERCH in terms of a subsidiary action or sideshow. There were no sideshows.

Hinde's reaction to the Villers-Bocage setback and the failure of PERCH was criticism that the close country did not call for the tanks and infantry of the armoured divisions' armoured brigades but instead called for infantry supported by the independent tank brigades. While he drew no lessons from 22nd Armoured Brigade's operations from 6 to 15 June to correct what had been exposed as a flawed approach to operations, some middle ranking officers evidently saw the importance of doing so, as will be seen in the next chapter. Further, most modern historians accept Montgomery's own account and the older accounts

⁴⁹ IWM, Bucknall Papers, 80/33/1, Bucknall to Wilmot, 29 March 1947. (Capitalised in original.)

⁵⁰ IWM, Bucknall Papers, 80/33/1, Bucknall to Wilmot, 15 April 1947. (Underlined in original.)

that the objective was to seize Villers-Bocage and then advance beyond it and into the flank of Panzer *Lehr* and that for Montgomery and General Dempsey PERCH was directly connected with the battle of Caen.⁵¹ However, Hinde held a significantly different view of the operation; to him PERCH ‘was never connected in my mind with any enveloping move against Caen, and I am perfectly clear that it was never represented to me that for that reason it was vital that it should succeed.’ It appeared to him that ‘General Dempsey’s view of the significance of this operation was not appreciated by subordinate commanders, and that is possibly understandable in view of the extreme speed with which the whole operation was laid on’.⁵² Although it was Montgomery’s and Dempsey’s intention to push 7th Armoured Division on to the high ground northeast of Villers-Bocage at Point 213 (in 1944, now Point 217) and then on towards Evrécý to envelop the German line and make it untenable, this did not filter through to the commanders in 22nd Armoured Brigade, whose instructions were to capture Villers-Bocage and Point 213.⁵³

Hinde was able to analyse the problem as being one that the armoured division was unsuited to address but he was not able to propose the solution. Thus, after D-Day he commented that ‘the need for more inf[antry] was felt at once’. However, the fact that ‘inf[antry] can only see to the next hedge and t[an]ks possibly to the next hedge but one makes maint[enance] of direction and keeping touch of exceptional difficulty’. Further, the difficulty encountered in fixing the locations of German anti-tank guns and other positions meant that the country ‘was unquestionably one for inf[antry] supported by a few t[an]ks and not for t[an]ks with a small supporting component of inf[antry]’.⁵⁴ In other words, the close country called for infantry

⁵¹Hastings, *Overlord*, pp.307-08; D’Este, *Decision in Normandy*, pp.199-200; Harrison Place, *Training in the British Army, 40-44*, p.154; Buckley, *British Armour, Normandy, 44*, p.24; R. Neillands, *The Battle of Normandy 1944* (London: Cassell, 2002), pp.99-102, Montgomery, *Normandy to Baltic*, p. 213; Wilmot, *Struggle for Europe*, pp. 307-08; Ellis, *Victory in the West: Normandy*, p. 254.

⁵² LA, 16 Elwes, 3/5, Brig. W.R.N. Hinde to Mr Chester Wilmot, 10 May 1947.

⁵³ LA, 16 Elwes, 3/5, Lieut.-Col. J. Lever [second-in-command, 22nd Armoured Brigade, June 1944] to Brig. W.R.N. Hinde, 17 November 1947.

⁵⁴ LA, 16 Elwes, 3/5, Brig. W.R.N. Hinde, ‘22 Armd Bde Ops 6-15 Jun 44’, pp. 2 and 9.

supported by the heavy tanks of the independent tank brigades in place of the old heavy cavalry, not for the tanks and infantry associated in the armoured brigade of an armoured division which should continue to act as light cavalry.

If what Hinde was saying in 1944 was influenced by 'armour-only' cavalry ideas of the 1930s in this way, then the desert had shown that they could work in an ideal set of circumstances. Thus he was able to write of 'hare-ing after the Bosch [sic] as fast as we can go'.⁵⁵ The problem was that in northern Tunisia, Italy and Normandy they could not work in anything less than ideal circumstances, a conclusion also reached by Hinde: for example, the nature of the terrain in northern Tunisia and southern Italy favoured the defence.⁵⁶ However, Montgomery's ultimate outflanking of the Mareth Line in Tunisia in March 1943 which led to the Gabes Gap and Wadi Akarit battles in April 1943 appeared to substantiate his belief that while strategic surprise was not always possible tactical surprise was. As a cavalryman, Hinde would have been very comfortable with just such a manoeuvre: 'things have gone extremely well and the Mareth line as a line is finished'.⁵⁷ Hinde was made a member of the Distinguished Service Order for his role in the advance from the Wadi Akarit to Sfax and secured a bar to his DSO during the advance from Medjez el bab to Tunis. As Erskine put it: 'we had some very interesting and profitable fighting through Sfax and Sousse ... [T]he tanks never had better fun ... [W]e cut off a great many Germans who were facing 51 Div on the road and did not realise we were on their flank and behind them'.⁵⁸ One may reasonably infer that Hinde shared this view, for he evidently excelled at that type of fighting.

In Italy, terrain and the way in which the Germans harnessed the topographical characteristics of the Italian peninsula meant there was no effective way to bring to bear the superiority the Allies enjoyed in tanks and artillery and airpower. If stalemate was to be avoided, the

⁵⁵ LA, 16 Elwes, 2A/6, Brig. W.R.N. Hinde to his mother, 20 January 1943.

⁵⁶ LA, 16 Elwes, 2A/21 and 2A/35, Brig. Hinde to his mother, 28 April 1943 and 26 October 1943.

⁵⁷ LA, 16 Elwes, 2A/12, Brig. Hinde to his mother, 29 March 1943.

⁵⁸ TMA, RH4 7AD: 2960-73, Erskine to Yindrich, 27 June 1952.

series of German defensive lines running across Italy meant the only alternative to hard slogging was to outflank by sea. There was no other alternative. Thus, battles in Italy could be ‘static and bloody affairs which involved protracted efforts to break strongly-held defensive positions. [...] On the other hand, these campaigns witnessed bold amphibious strokes, accompanied by the innovative application of force in complex joint and combined operations’.⁵⁹ Eisenhower’s and Alexander’s conclusion on the advantageousness of an amphibious landing near the Italian capital had, as its basis, the concept of applying the principal of concentration or mass, to bring to bear Allied superiority in tanks, artillery and airpower by outflanking the heavily fortified Gothic line. Indeed, the Anzio operation and the Arnhem operation can be seen as outcomes of attempts to solve very similar problems at the level of theatre strategy, both of which foundered on the practicality of a link up of the assault and relieving forces. In the Sicily and Italian campaigns, at the operational and tactical levels however, the use of tanks was limited for the most part to close support of the infantry. Some infantry and armour commanders saw the necessity of learning lessons from this.⁶⁰ However, as Hinde’s first letter from Normandy after D-Day made clear, he had learned no practical operational or tactical lessons from his experience in Italy, commenting ‘it is an infantryman’s country, far from easy for us and we shall be glad to see something a bit more open’.⁶¹

At the highest command level, Operation PERCH was understood strategically as an armoured exploitation to create an untenable situation ‘in the field’ for the enemy. However, at the operational level and at the level at which the operation translated into fighting this was not understood. The reason for this was a systemic failure to ensure that those at all levels of senior command – especially those closest to the actual fighting – at once possessed a common approach to

⁵⁹ ‘Allied fighting effectiveness in North Africa and Italy, 1942-1945’, flyer for conference conducted in partnership between the History of Warfare Group, Department of War Studies, King’s College London and the Imperial War Museum, 18-19 July 2008.

⁶⁰ See, for example [Brig. G.H.A. Macmillan], ‘Co-operation between arms in the attack’, War Office, Current Reports from Overseas (CRO) No.16, (September 1943), Section 1.

⁶¹ LA, 16 Elwes, 2A/42, Brig. Hinde to his mother, n.d. but probably 20 June 1944.

operational methods flowing from a common understanding of how to fight and at the same time could put into practice moving from observation, orientation and decision to action at the pace Montgomery now demanded. Montgomery was asking a lot, but he had to in order to get the job done. Bucknall, the commander of XXX Corps saw the operation as a strategic diversion. Erskine seems to have had a conception of penetration as a tactical opportunity to exploit the mobility of an armoured division from his experience at Sfax and after, but also a limited conception of what Villers-Bocage was all about and a practical inability to see how to use his experience in North Africa in the face of ‘infantryman’s country’. The very considerable differences in the conception of the operation up and down the chain of command were magnified by the differences of experience and of the interpretation of that experience which commanders brought into play when called on to carry it out.

Whereas Villers-Bocage had been an armoured brigade attack, what followed at Fontenay-le-Pesnel on 25 June 1944 (Operation EPSOM) was an infantry attack with an independent armoured brigade supporting. XXX Corps was given the task of covering the right flank of VIII Corps’ advance during the EPSOM offensive with a preliminary, southward thrust to secure the high ground overlooking VIII Corps’ attack area: this task carried the codename MARTLET.

EPSOM was the operation which took the British over the River Odon, creating a distinct salient into the enemy line that was nevertheless narrower than was planned. However, it failed to also cross the River Orne and to cut Caen off from the south. In what would become familiar in subsequent operations, well-concealed German anti-tank guns picked off Allied tanks, whilst longer range 88mm fire from high ground blocked the advance. Further, more and more of the tanks and infantry of VIII Corps had to be employed protecting exposed flanks rather than securing additional ground. Furthermore, the operation saw ‘a number of problems emerge over infantry-tank co-operation’.⁶² In

⁶² J. Buckley, ‘British armoured operations in Normandy – June-August 1944’ in *Normandy: Sixty Years On*, ed. by J. Buckley, pp. 74-89, (p. 84).

particular, during EPSOM, no way was found to overcome the German gun positions on the ridge tops to allow tanks to capitalize on their gains on the lower slopes between the valleys of the River Odon and the River Orne. The operation failed to achieve almost any of its objectives but 'though it had undermined the German ability to prepare a major counterattack in the area, as arriving reinforcements had to be fed piecemeal into the battle to block British progress'.⁶³

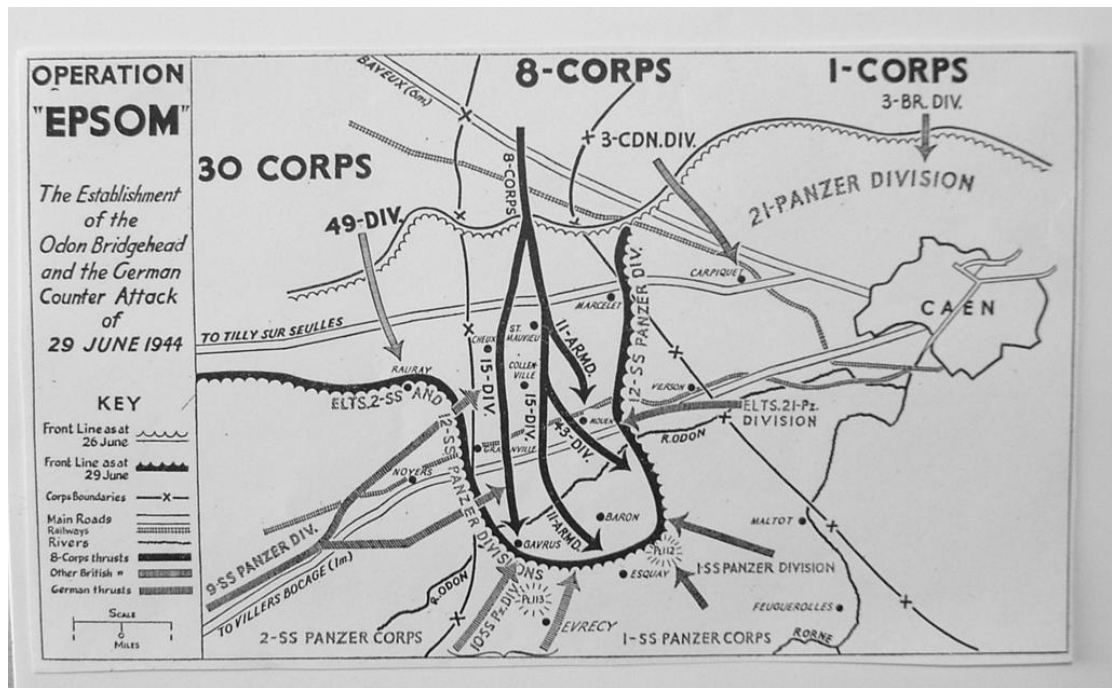

Map 2.1: Operation EPSOM⁶⁴

MARTLET (a subsidiary action of EPSOM, 25-28 June 1944) was to be carried out by 49th Infantry Division in its first major battle as a complete division. Tank support was to be provided by having 8th Armoured Brigade under command. Lieutenant S. F. Hills, of 'C' Squadron, Nottinghamshire Sherwood Rangers Yeomanry, 8th Armoured Brigade, highlighted the differences between North African experience and tank warfare in the Normandy countryside:

How some of our desert veterans longed for the open spaces of Libya and Tunisia, where tanks could manoeuvre and

⁶³ Buckley, *British Armour*, 44, p. 29.

⁶⁴ Jackson, *Eighth Corps: Normandy to Rhine*, p.117

fight an altogether different type of battle to this close-range slugging match of attrition in which they were now involved [...]. The main difference, apart from the ranges at which the respective battles were fought was the nature of the ground. In rolling desert, when attacking or defending tanks remained hull-down and invisible in small depressions, there were advantages for both sides. Furthermore, tanks could move at speeds which made them difficult targets, and there was no danger of an infantryman with a hand-held Panzerfaust suddenly popping up from nowhere to fire at close quarters. The bocage therefore posed unfamiliar and disconcerting problems, even for experienced crews.⁶⁵

The divisional plan was for an advance on a two-brigade front with each brigade supported by tanks: 146th Brigade on the right (west) and 147th Brigade on the left (east). The method to be employed for this was that ‘arm[oure]d sq[ua]dro[ns] will move f[or]w[ar]d after b[attalio]ns at telescope[periscope] first light to s[up]p[ort] the attack in the villages’. The attack was to be accompanied by an exceptionally heavy barrage, including naval guns and the guns of VIII corps – one gun to less than ten yards of front – and strong air support was anticipated ‘incl[uding] rocket[-firing] aircraft which can be over the target within 5 min[ute]s of briefing’.⁶⁶ The attack went in at 0415 on 25 June in a thick mist which it was thought would help the attackers. An hour and a half later Barker wrote to his wife:

I hear the visibility is bad as there is a thick ground mist in the valley but that is to our advantage as his Panthers can't see. I gave the chaps a very strong barrage as I wanted to see that those going in for the first time had all the support I could give them. [...] It's a lovely fine morning with no wind so I shall be getting full support from the air which is quite large.⁶⁷

In fact, there would be no air support because of bad weather over the airfields in England. Further, the mist did not protect the advancing tanks and infantry. German mortars had been pre-registered on terrain features which assaulting infantry would obviously attempt to use for cover. This type of frontal attack where the troops followed a heavy

⁶⁵ Hills, *Tank into Normandy*, p. 102.

⁶⁶ IWM, Barker Papers, P78, 49th British Division Operations Orders, No. 3, 21 June 1944, paras. 5, 9 and 15.

⁶⁷ Barker MSS, Maj.-Gen. E.H. Barker to his wife, 25 June 1944.

barrage was reminiscent of 1915-17, and without air support, required reserves of infantry on a similarly large scale. It also required that the tanks and infantry know what was expected of them and commanders knowing what was happening to other brigades of the division if the attack was to be successfully pressed home. The infantry led the attack, a format which did not accord with the changes that Montgomery had brought to established doctrine before D-Day to make it reflect the official experience of 8th Army: that in combined tank and infantry attacks the tanks should lead and the infantry should follow.⁶⁸ It was essential for infantry and tanks to attack together. However, according to Hills's account of the Sherwood Rangers' battle 'tanks and infantry lost contact and everything became confused [...] with enemy tanks of 12 SS Panzer dug in defensively to the east of the town, and we did not have enough infantry to take the village.'⁶⁹

The official history demonstrates the slowness with which the operation went forward in its second phase: 'for some reason that is not explained a second battalion did not go forward to pursue the attack until nine o'clock in the evening'.⁷⁰ An important factor explaining the slowness with which the second assault was launched was that there were problems in marrying up tanks and infantry for it. An important technical issue had not been resolved – using the Shermans for infantry support:

[T]he infantry was in single file on our right, the wrong side for our turret-mounted machine-gun. They were moving cautiously, alert to strange noises and trying to pick out landmarks in the darkness. We passed all the ground we had passed earlier in the day and still there was no response from the enemy. Perhaps we had taken him by surprise. Then suddenly a machine-gun opened up, the infantry scattered and bullets hit the tank like the rat-a-tat-tat of a hammer. I ordered the tank to slew right and [the gunner] opened up with his machine-gun on the enemy and then fired two high-explosive shells which set the two-story building alight.⁷¹

⁶⁸ *Contra* Harrison Place, *Training in the British Army, 40-44*, p.149.

⁶⁹ Hills, *Tank Into Normandy*, p.103.

⁷⁰ Ellis, *Victory in the West: Normandy*, p.277.

⁷¹ Hills, *Tank into Normandy*, pp.103-04.

Instead of the tanks and infantry moving together in a group, a more appropriate tactic using the fast, thinly armoured Shermans would have been for infantry to locate the enemy's strong points or tanks first in order to direct the Shermans onto them, rather than the infantry and the Shermans waiting to receive the enemy's fire. The failure of Montgomery and his ex-8th Army staff to develop specific tactics for Shermans of the independent armoured brigades in the infantry support role was at this early stage of the fighting now rebounding against those units of 21st Army Group which had not yet formulated their own plan for action.

The next day, 26 June, Barker planned a triple attack in a general south easterly direction to secure the higher ground between Fontenay and Rauray; 'the original plan remains in force [...] but for the moment without quite such an ambitious tempo'.⁷² Armour was to support infantry on to their objectives, then to exploit. As Barker saw it, the attack the previous day was the first to break the 'strong crust' the Germans had been able to build up during the delay in getting men and equipment ashore following the storm of 19-22 June, which severely damaged the infrastructure of the Mulberry artificial harbours. Armoured and infantry units had experienced great difficulties in co-operating with each other, however, over and above an insufficiency of infantry. Thus, while

[o]n the whole it was most satisfactory [... u]nfortunately the Boche took a lot of turning out of FONTENAY & was in some strongly fortified houses at the East end and which the Battalion in that sector couldn't clear so I had to put through another B[attalion] in the evening when they found the Boche had withdrawn after the hammering we gave them. We knocked out 6 tigers & 2 panthers and 4 other tanks & took quite a few prisoners-all first class troops of 12SSPzDiv. I'm frightfully pleased with my chaps - they did excellently and are full of fight. [...] News just in that chaps on my left getting on well & my chaps feeling forward against small groups of tanks. These Tigers and Panthers are a nuisance as they have very heavy armour & one has to get a side shot at them.⁷³

⁷² IWM, Barker Papers, P78, '49 Div Operational Instruction No 7', 26 June 1944.

⁷³ Barker MSS, Maj.-Gen. E.H. Barker to his wife, 26 June 1944.

Thus, although acknowledging success regarding the capture of Fontenay, Barker recognised that beneath the surface difficulties in combined arms co-operation left so much to be desired that the pace or tempo at which it had been attempted to conduct operations was impracticable despite the qualities of the troops, generally aggressive tactics and generous artillery support. Orders that 8th Armoured Brigade with 1st Battalion Tyneside Scottish of 70th Brigade would drive in behind the enemy and capture Rauray – that is, exploit – were cancelled in favour of a more ‘deliberate’ advance.⁷⁴

Barker’s claims that his troops ‘knocked out 6 Tigers & 2 Panthers & 4 other tanks’ reflects the fact that at Fontenay, the British troops were up against some German troops equipped with what Buckley describes as ‘the most feared and infamous German tanks of the Normandy campaign [which] were the Tiger and Panther’.⁷⁵ Two panzer battalions in positions behind the German defenders of Fontenay numbered over forty Panthers in their order of battle. Two companies of Tigers were available for defending Rauray, as part of the reserve of I SS Panzer Corps.⁷⁶ German tanks were numerous. The problem was less the virtual impregnability of the most modern German armour to direct fire, or even the capacity of the German armour collectively to counter-attack and also inflict tactical and operational defeats (as on 7th Armoured Division at Villers-Bocage), but rather its apparently endless capability to re-deploy even after, as Barker put it, a ‘hammering’ to block any British strategic penetration as at Fontenay, where the Rauray ridge was not completely taken by the time EPSOM was launched. This happened again during Operation CHARNWOOD (8-11 July 1944), when although the British and Canadians succeeded in breaking into Caen, they could not dislodge 12SS Panzer from positions which denied 21st Army Group access to the open country south of the town. German long-range tank fire from excellently camouflaged positions tended to make the security

⁷⁴ IWM, Barker Papers, P78, ‘49 Div Op Instr No 7’, 26 June 1944; Lieut.-Col. F.K. Hughes, *A Short History of 49th West Riding and Midland Division* (Barnet, Herts.: Stellar Press, 1957), p. 25.

⁷⁵ Buckley, *British Armour, Normandy*, 44, p.117.

⁷⁶ See, for example T. Saunders, *Operation Epsom: VIII British Corps vs 1st SS Panzerkorps* (Barnsley: Leo Cooper, 2003), p. 27.

of British tanks a function of their distance from the enemy. Barker's tanks were incapable of knocking out a Tiger or a Panther except at close-range from the side or back and as he clearly recognised, this required first that his infantry locate these tanks, deal with the anti-tank weapons protecting them and thereby create a secure route of advance for the British tanks. His reference to infantry infiltrating forward against small groups of tanks and then his tanks getting a side shot at them suggest that tanks and infantry had begun to work more closely together in order to deny the German tanks their advantage of long range fire. Initial difficulties in practising combined arms tactics were clearly comprehended by the end of June 1944.

Shortly afterwards, Brigadier A.D.R. Wingfield was appointed to temporary command of 8th Armoured Brigade. Barker told him that it was the army's policy that he should learn something about tank fighting in this very enclosed bocage country of Normandy so that he could pass on this experience to 34th Tank Brigade when he rejoined it. By the end of the day [3 July] his impression was that:

8th Armoured Brigade [...] *had* learnt some useful lessons, such as the need to stay as close to the infantry as possible to avoid danger from snipers and bazookas [...] and to spray the trees with bursts of machine-gun fire when entering a wooded area. It had also been discovered that the Sherman tanks [...] were penetrated by the German 50mm [A/T] guns at these short ranges – unlike the long-range battles in the Desert – and that the Tiger and Panther tanks always scored with their first round [...] due to the excellence of their telescopic sights.⁷⁷

The shortcomings of the Sherman tank in the infantry support role were beginning to be well understood by the end of June-early July. This quotation from Wingfield is further evidence that shows that the process of adaptation had begun to deliver lessons over a week before the midpoint of the campaign. Barker's acknowledgement of his long-standing doubts about the relevance of desert-influenced methods of combat to Normandy and his sympathetic reference to Anderson and his difficulties with Montgomery indicate the existence of a group of officers

⁷⁷ IWM, Wingfield Papers, PP/MCR/35, Brig. A.D.R. Wingfield, unpublished memoirs, 1980 [on microfilm], pp.245-46. (Emphasis added.)

who did not support the idea that 8th Army practice was necessarily best practice – or perhaps, more accurately, were not even influenced at first hand by desert practice.

In June-July 1944 two operations exemplified many of the basic problems faced by 21st Army Group in combining, or integrating armour and infantry for offensive operations. Fontenay – although just one Normandy action like Villers-Bocage – nevertheless demonstrates many of the difficulties faced by 21st Army Group subsequently in operations to take Caen using mainly firepower-intensive and attritional methods, as opposed to manoeuvre-oriented ones of the kind attempted at Villers-Bocage.

Improved armour-infantry and artillery co-operation could be a solution to the problem of the enemy enjoying the possibility of long-range tank fire from well-camouflaged positions well protected by anti-tank weapons. This improvement could be facilitated by a new organization and structure. Innovations in Normandy such as the brigade groups composed of mutually supportive infantry battalions and armoured regiments introduced by Roberts and 11th Armoured Division and the Guards Armoured Division in late July/early August 1944 would sometimes prove highly effective and successful, as will be shown.

British success in the desert and later on clearly owed as much to Montgomery's imposition of the principle of combined arms co-operation on his subordinates as it did to the superiority or otherwise of British materiel at the time. His further attempt to impose 8th Army tactical methods on 21st Army Group before D-Day was unfortunate; nevertheless, shortcomings were quickly recognised in Normandy by many subordinate commanders on the ground – reflecting the general approach characterizing the way the British Army attempted to adjust official War Office doctrine to new challenges. Solutions drew from general British doctrine. However, as will be shown in subsequent chapters, as the campaign progressed and the problems of fighting in Normandy became more apparent a further process would engage both

Montgomery and subordinate commanders at many levels in his army group. Together they would shape a generic and ultimately successful 21st Army Group tactical doctrine. By early July, however, with the invasion forces no more than 15 miles or 24 kilometres inland at any point, much remained to be resolved.

CHAPTER 3

THE DEFEAT OF THE GERMAN PANZERS: FURTHER RESPONSES TO THE PROBLEMS OF FIGHTING IN NORMANDY

The problems of fighting in Normandy displaced the supposed lessons of previous victories in North Africa. The consequence of this was that much of what people thought would be valuable ceased to be so, and was discarded. Roberts, though he made his name as an innovative commander in the Western Desert, was not bound by or to his experience there. An important driver of further tactical change in Normandy, he quickly identified the changes in doctrine and organization he thought were required. A study of the creation of War Office doctrine alone throws insufficient light on the process(es) by and through which doctrine was created in 21st Army Group in action. One important part of that process was the 'bubble up' of operational methods from below which derived not only from the corps and divisional levels but which developed at the brigade level. This is a dimension of the experience in Normandy which historians have largely hitherto neglected. Further, a study of War Office doctrine published at the time cannot completely elucidate the operational and tactical methods utilised by Montgomery's army group or the responses to the problems of fighting in Normandy. What people did was not what the doctrinal manuals or instructions necessarily said they ought to be doing.

Although there was a broadly common approach to operational methods between Montgomery and his most senior commanders, there were differences of approach as well. Commanders at the corps and divisional levels could also differ with each other in their approaches to the problems of fighting. It was at the level of command nearest to the actual fighting, that is the battalion COs and brigadiers, that the process of seeking to determine the correct lessons from operations was often and widely instigated. The first level of command at which the lessons from operations began to be garnered was at this 'third level of

management', corresponding to the level of the brigade commander in the command structure. The role of the brigadier in what proved to be the very resilient brigade-divisional-corps structure of the army group was of very considerable importance in shaping final doctrine. This was particularly true in the case of brigadiers with independent tactical commands, that is the commanders of the independent tank and armoured brigades. Part of their role was to reconcile the expectations of the armour and the infantry as to what the other could achieve.

Throughout the fighting in Normandy in mid-1944, Montgomery's overriding and declared aim was the destruction of the enemy's armour.¹ This required continuous pressure, taking ground wherever possible to secure space in which to manoeuvre in order to maintain that pressure, thereby forcing the enemy to commit his armoured reserves. Whether these two aims were always part of an overall concept of operations to build up for a breakthrough by the Americans or whether Montgomery hoped for a 'British breakthrough' is not a question that will be considered here. The important factor here is rather that whereas merely defensive success in Normandy could be enough for the German Army in the West it could not be for 21st Army Group. Whilst both British and German reserves of troops were finite, a lengthy campaign of attrition, which might favour the defender, had to be avoided. For offensive operations to succeed, and succeed quickly, the potential fighting power of Montgomery's legions would have to be applied successfully, and always sooner rather than later. If British armoured forces could be driven 'headlong into, and through' gaps torn in the Germans' defence, it would be almost impossible for the Germans to secure a ruptured front before mobile war overwhelmed their remaining forces.² This required a high tempo of operations, that is the speed with which plans were both made and carried out had to be counted in

¹ See, for example, FM the Viscount Montgomery, *Memoirs* (London: Collins, 1958), pp. 222 and 254.

² IWM, Montgomery Papers, BLM 94/8, Montgomery to Maj.-Gen. F.E.W. Simpson [Director of Military Operations], 2 August 1944.

‘minutes instead of hours and half hours instead of days’.³ This, in turn, required the active involvement and engagement of middle and lower ranking commanders up and down the hierarchy, as well as the highest level. The combined efforts of all levels of command were necessary before the challenge of defeating the German panzers was tackled and overcome by Montgomery and his legions in the mid-summer of 1944. There were new formations and fresh equipment. To complete the picture, this chapter deals first with units and formations of VIII Corps during Operation GOODWOOD.

This attempt to break out of the bridgehead was not only an epic battle but also a major operation which was a strategic offensive as well. It was not, however, an operation which was managed in a new way. The first part of this chapter deals with a particular vertical slice of command charged with undertaking the GOODWOOD battle at the sharp end. It looks at on-the-ground commanders’ experiences of the lack of a British ‘panzergrenadier’ vehicle in time for GOODWOOD and starts to address the implications this had for limiting the scope of armour-infantry co-operation. This illustrates the dilemmas of middle and lower level commanders in providing tactical leadership during the operation – from the level of those conducting operations at the brigade and divisional levels. The course of GOODWOOD convinced many armoured and infantry commanders in armoured divisions at various different levels that tactical and organizational changes were required. The combined efforts of all arms were necessary. This in turn required willing, close involvement and engagement from the middle and lower level armour and infantry commanders involved. Montgomery’s further contribution – that the combined efforts of all levels of command were also necessary – would be more fully addressed in time as his understanding of the need to develop initiative by those lower down grew.

Focusing specifically on the armoured divisions and their problems reflects the important role accorded them in Operation GOODWOOD.

³ IWM, Carver Papers [not catalogued fully at time of writing], Lectures and Articles on Armoured Warfare, 1940s, Lieut.-Col. R.M.P. Carver to Maj.-Gen. P.C.S. Hobart, 27 July 1943.

Thereafter the armoured divisions sought to apply the lessons of their accumulated experience in Normandy, and the independent armoured brigades developed the fruits of their ongoing learning in the final British 2nd Army strategic offensive in Normandy, Operation BLUECOAT. These lessons were: the employment of the specific organization of armour and infantry by 11th Armoured Division and the Guards Armoured Division; the advantages of closer armour-infantry co-operation for independent armoured and tank brigades; and operating on a wider front to allow the armour to use its mobility to best effect in the attack and not to be tied down in defending flanks. BLUECOAT also shows us the beginnings of a pattern of command changes by Montgomery to replace commanders who did not come up to scratch. The Anglo-Canadian operation TOTALIZE, likewise ‘included many innovations intended by Simonds to rectify the operational difficulties thus far encountered by the Anglo-Canadian forces’.⁴

GOODWOOD: Infantry and Armour Tactics and Employment

Back in England, in command of 11th Armoured Division for the invasion, Roberts anticipated a need for closer armour-infantry co-operation. However, he did not foresee the extent to which it would become vital. Before the invasion, he believed that, ‘due to the fact that the t[an]ks can deal with A[nti-] t[an]k guns themselves, the Inf[antry] B[rigade] must be all the more on its toes and quick in order to keep up and maintain momentum’.⁵

Thus, unusually, 11th Armoured Division did practise organisation for armour- infantry co-operation in England. As the soon-to-be commander of its infantry brigade, Lieutenant-Colonel J.B. Churcher, CO, 1st Battalion of the Herefordshire Regiment, recalled: ‘whilst up on the Wolds we started to develop the first armoured infantry cooperation

⁴ Buckley, *British Armour, Normandy*, 44, p. 40.

⁵ LHCMA, Roberts Papers, Tanks 1943-1944, ‘Notes on Armoured Divisional Tactics’, 13 December 1943, by Maj.-Gen. G.P.B. Roberts.

in attack. It took quite a lot of developing because neither the junior leaders in the infantry nor the troop leaders in the armour knew how to set about the problem so it had to be worked out more or less from scratch. In the end we got the drill properly organised [in the course of] Operations on the Continent'.⁶ After reaching the invasion beaches on D+9/10, the division's motorised infantry brigade, 159th Infantry Brigade, and its armoured brigade, 29th Armoured Brigade 'practised the organisation of armoured-infantry cooperation. To get this right it was essential that Squadron Leaders and company commanders, troop leaders and platoon commanders should know the exact drill for marrying up with armour and moving into battle. We found this time extremely useful and it was essential for our future operations'.⁷ It is difficult to get away from the idea that this training was 'drill'-based, rather than based on any clear doctrine for co-operation between the two arms. Thus, although training in Yorkshire differed from early desert tactics, also – it may be inferred – it was still not quite what was right for Normandy, and had to be changed there.

The premise that the tanks could deal with enemy anti-tank guns themselves would be shown to be incorrect in Normandy. Yet, during EPSOM (the Odon offensive) the gist of the instructions to the infantry brigade was to 'move on D plus 20 and *follow up* the advance of the armoured Brigade'.⁸ As Roberts admitted, the infantry of 15th (Scottish) Infantry Division and 11th Armoured Division 'rather went their separate ways'.⁹ This was also the perception of his infantry brigade commander; taking over from elements of the 15th Division, thus 'the Brigade was situated astride the Rover [sic] Odon when at that moment the Armoured Brigade decided to withdraw in toto and we were left on our own to face the music'.¹⁰

⁶ LHCMA, Churcher Papers, 1, 'The Memoirs of Major General J. B. Churcher CB DSO & Bar', [n.d.], Chapter VI: 'The Invasion of Europe – The Normandy Bridgehead – The Break out and the Advance to Antwerp', pp. 30-31.

⁷ *Ibid.*, pp. 33-34.

⁸ *Ibid.*, p. 34. (Emphasis added).

⁹ Roberts, *Desert to Baltic*, p. 164.

¹⁰ Churcher, 'Memoirs', p. 35.

The upcoming GOODWOOD operation was a plan for a breakout from the bridgehead which had existed since D-Day east of the River Orne. It was an assault spearheaded on the ground by the massed tanks of the three standard British armoured divisions in Normandy, grouped in VIII Corps. I Corps was to attack at the same time and protect the left flank of VIII Corps. Thus, on 18 July 3rd Division took part in Operation GOODWOOD, the only British infantry division to do so. Whistler, the division's commander wrote afterwards: '(T)he op[eration] started with a really terrific air bombardment followed by a race forward of the Armour'.¹¹ Without denying the contribution of 3rd Division to the operation, it is the 'race forward' of the armoured divisions brought together under VIII Corps, particularly of the leading division, 11th Armoured Division, that is examined most closely here. As Churcher explained, 'the 11th was to be the leading one and as it turned out I myself was the right hand leading Brigade'.¹² To take 11th Armoured as the example, the armoured brigade had three armoured regiments and a motor battalion, equipped with carriers and armoured half-tracks, and the infantry brigade had three infantry battalions mounted in troop carrying vehicles (TCVs) and a machine gun company.

Events would show difficulties on GOODWOOD that went to the heart of the problems of command, doctrine and organization in the British armoured divisions. The GOODWOOD plan established certain kinds of objectives for the operation. These were influenced by considerations not only that, because fresh infantry reserves would soon not readily be available, armoured divisions would do the job instead, but also that, because the ground was good open 'tank country', armour could make a very good job of it. However, this involved the armour and the infantry doing different things. Roberts, for example, suffered considerable misgivings when he learned the plan for GOODWOOD, and was critical of the fact that the armour and infantry had been given separate objectives. The objective given to 159th Brigade was to take the villages of Cuverville and Démouville, two villages immediately in

¹¹ WSRO, Whistler, personal diary, 28 July 1944.

¹² Churcher, 'Memoirs', p. 38.

front of the start line. His complaint was that he would have little infantry to clear the way for his tanks – thus showing that he was already revising his pre-invasion ideas of the way armour-infantry co-operation would operate.¹³ He was so concerned about the error of this decision that he recorded his view in writing, but O'Connor did not alter the plan. Unbeknown to Roberts, however, O'Connor's original instructions to his chief of staff had stated that the 'task of 11 Arm[oure]d Div[ision], [is] to seize the villages of CUVERVILLE and DEMOUVILLE, getting their armour through simultaneously'.¹⁴ Thus, O'Connor's original concept of operations, which differed from the plan that was finally adopted, shows he well understood the need to have infantry and armour co-operate more closely together. In fact, O'Connor wanted them to have armoured vehicles in which they could be carried forward across this unusually open battlefield and keep as close up with the advancing armour as possible, and 'must have also been extremely aggravated by Dempsey's refusal to let him use armoured gun carriers as infantry personnel carriers'.¹⁵ From an infantry perspective, as expressed by Lieutenant-Colonel G.R. Turner-Cain, Churcher's successor as CO of the Herefords, of the

smaller picture as seen with the Inf[antry] B[attalio]n on its feet. At this stage we had no A[rmoured] P[ersonnel] C[arrier]s and if we had to get out of our Troop Carrying Vehicles (3-tonners fitted with seats) we were on our feet. We were not yet closely and intimately associated with our Arm[oure]d Reg[imen]ts., they were still Desert War minded [sic] and saw themselves galloping forward at tank speed leaving their Infantry to mop up and catch up as best they could.¹⁶

Thus, in addition to the lack of a practical means to 'keep up', there was an expectation among the infantry that the tanks would move forward because this was the fashion in which they had advanced in the desert,

¹³ Roberts, *Desert to Baltic*, p. 171.

¹⁴ LHCMA, O'Connor Papers, 5/3/17, O'Connor to Brig. H. Floyd, Bt. [Brigadier General Staff (BGS), VIII Corps - his Chief of Staff], 14 July 1944.

¹⁵ J. Baynes, *The Forgotten Victor: General Sir Richard O'Connor KT, GCB, DSO, MC* (London: Brassey's, 1989), p. 211. See also: T. Copp, *Fields of Fire*, p. 144.

¹⁶ LHCMA, Maj. Gen. G.R. Turner Cain, Memoir, '1st Bn The Herefordshire Regiment route and battles from the Normandy bridgehead to the R Elbe in Germany, June 1944 to April 1945, including route maps and CO's pocket maps for specific incidents', [?] 1992, p. 10.

and because they had in the past been given orders to do this in Normandy.

The perception of the importance of the job of the infantry brigade commander can be gained from the following comments: 'Jack (Churcher) has gone up one. He is a most wonderful leader and in no small way responsible for giving the Bosche [sic] a continuous bloody nose right across the Brigade front'.¹⁷ This must, however, be interpreted through Roberts' assessment of Churcher, where Roberts had to consider Churcher's influence on the performance of the whole division:

Jack Churcher proved to be meticulous in his planning of operations, such as crossing a river and forming a bridgehead on the other side, in fact at anything set-piece. He was not so good in a fluid battle, but the troops under him felt that he looked after them and the brigade itself went well. The most difficult problem was that those outside his brigade did not always see eye to eye with him, in particular the commander of the armoured brigade, Roscoe Harvey, and I often had to act as mediator.¹⁸

Thus, a factor influencing how the plan was carried out was that the two brigade commanders did not always see 'eye-to-eye', leading to a lack of understanding between the two brigade commanders, of which Roberts was aware. In Churcher's 'narrative': 'there was considerable return fire from the Germans but we managed to advance and continue the advance all day [18 July] till eventually we reached the area of Le Mesnil Frementel where we found that the armoured brigade had come to a halt and the whole Divisional attack had not yet got beyond the approximate line of the railway line running eastward from Caen'.¹⁹ Thus, by the time on the evening of 18 July when Robert's infantry had reached a position near Le Mesnil Frémentil where they were not far behind the armour, it was clear that the armoured advance had come to a halt, with gains far short of expectations. That the armoured and infantry brigades would initially have to fight separate battles was, of course, expected. What was not planned for was the difficult situation

¹⁷ Lieut.-Col. G.R. Turner Cain to his wife, 7 July 1944, quoted in Turner Cain 'Memoir ...', p. 7.

¹⁸ Roberts, *Desert to Baltic*, p. 165.

¹⁹ Churcher, 'Memoirs', p. 39.

experienced by the armour in dealing with the German strong points, gun positions further back and anti-tank guns on their flanks as well as German counter-attacks with tanks. These difficulties were exacerbated by traffic congestion in the bridgehead, which delayed the other armoured divisions from getting forward and allowing all the armoured divisions to operate more or less together and simultaneously. From below, as Roberts recognised, Churcher inspired confidence – such commanders are likely to get tasks done. However, it can be inferred from Roberts' comments after the war (in his memoir, which, coming after his interview at Staff College in 1979, may be held to be his final mature reflection on the subject) that he thought Churcher was unable to respond to situations spontaneously, in particular to the really difficult situation in which the armoured brigade found themselves on 18 July, even though it was not his fault:

Cuverville was cleared by 1015 hours, but when this was reported to Corps, the corps commander ordered that it was to be held by the regiment that had cleared it until relieved [...]. I think that, having heard of this order I should have got hold of Brigadier Churcher on the radio, and instructed him either to use the reserve battalion (4th KSLI) or the Herefords who were in the woods on the left to take on the task of capturing Démouville.²⁰

On the 19th July, although GOODWOOD would not be terminated for another day, the division 'moved more cautiously'.²¹ The three infantry regiments of 159th Brigade were now available. As Churcher put it:

159 Brigade was asked to attack on the west side of the railway line and capture the villages of Bras and Hubert Folie. ... [C]areful plans were laid on for the armour to support them onto their objective. This was successfully achieved ...Meanwhile the Armoured Brigade had tried to continue their advance with no success....I was told to remain on the ground while the Armoured Brigade was withdrawn for refitting.²²

On the day 11th Armoured moved back across the Orne, Turner Cain mused that: 'providing the Hun continues to fight us with his present

²⁰ Roberts, *Desert to Baltic*, p. 179.

²¹ Anon. [Maj. Edgar Palamountain], *Taurus Pursuant: A History of 11th Armoured Division* (Germany: Privately published, c.1945), p. 26

²² Churcher, 'Memoirs', p. 39

intensity, and we continue to destroy him, it does not seem to matter how little distance we actually advance'.²³ However, Montgomery's strategy was not just about attrition, or static warfare. GOODWOOD was intended to make ground to secure the space in which to manoeuvre in order to maintain pressure on the Germans and prevent them disengaging their panzer divisions and being able to have in hand a strategic armoured reserve. Thus, while Turner Cain can be said to have had part of the final answer – that is Montgomery's wish to engage enemy armour and 'write it down' – his somewhat static means of doing was neither providing the tempo required nor making the most of the armour's ability. The main problem lay in the apparent lack of armoured warfare-mindedness on the part of the infantry commanders. This was the lack of initiative to be proactive which would, as this thesis will show, become the hallmark of all successful armoured commanders. That this ran deep in the infantry and was actually there is substantiated in the quotes from Turner Cain.

Having looked at the consequences for the tanks of the lack of infantry it is also necessary to look at the consequences for the infantry of having some tanks. Putting 2nd Northamptonshire Yeomanry (2nd Northants Yeo) under command of 159th Brigade was intended to help the infantry to take the two villages, Cuverville and Démouville, as Roberts explained:

I thought it might hurry things up a bit if I gave 159th Brigade some armour to support them. So I put the 2nd Northants Yeomanry under their command....[T]hey were trained as the divisional reconnaissance regiment and equipped with Cromwell tanks, but ...I felt they would be of some help. In view of the tremendous hammering these two villages would have received from the air and from artillery concentrations, I thought they could be dealt with fairly quickly. Consequently, I concentrated my attention on the armoured brigade's advance.²⁴

How this actually worked out on the ground is related by Turner Cain, CO Herefords, 159th Brigade:

²³ Lieut.-Col. G.R. Turner Cain to his wife, 22 July 1944, quoted in Turner Cain 'Memoir ...', p. 14.

²⁴ Roberts, *Desert to Baltic*, pp. 171-2.

The villages were only about 1km apart and offered good protection and concealment for enemy A/Tk guns with their Inf[antry] support. Additionally there were farmsteads with their own fringe of trees every 500m....So our education at the hands of the enemy began....Their fire pinned us down in the open until we had worked a platoon or a company into position to carry out an attack supported by the odd Northants Yeomanry tank. It meant very slow progress with the gap between our Arm[oured] B[rigade] and ourselves opening all the time.

This was until 'we were told to get a b----y move on and to catch up with our tanks'.²⁵

Roberts 'giving' of armour to the infantry apparently did not 'hurry things up' at all, and the reason for this was a lack of proper training on the part of the armoured reconnaissance regiment that he gave them. However, while this deprived the armoured brigade of its armoured reconnaissance regiment, a further important technical issue could be resolved which did not require new equipment, which was that armoured reconnaissance did not especially require the Cromwell because the Sherman was essentially of equivalent performance in this theatre. Yet, there was more than one reason for depriving the armoured brigade of its armoured reconnaissance regiment happening. Once the decision had been taken to abandon their reconnaissance role, the way was clear for the armoured and infantry brigades to set up new structures and a new organization.

But providing the infantry with untrained armour did not help them, while depriving the armour of infantry support resulted in great tank losses. When Roberts tried – or was forced to try – to fight the battle with great weight of armour unsupported by infantry from the infantry brigade, this did not solve the problem of dealing with the enemy anti-tank guns: 'there were so many 88s around and about the various villages that they were all inter-supporting with their long effective range and we were quite unable to advance without the guns on the flanks being neutralised'.²⁶

The lesson of GOODWOOD as seen by Turner Cain was that

²⁵ Turner Cain, 'Memoir ...', p. 11.

²⁶ Roberts, *Desert to Baltic*, p. 178.

releasing Armoured Regiments to operate on their own with only light Infantry protection (8RB in 29 Armoured Bde) had been finally learned on the Caen-Bourgeois ridge. [...] The Tanks realised that for their close protection Infantry had to be with them at all stages of an attack or advance. The Armour could not afford to wait for Infantry who, embossed in Troop Carrying Vehicles completely unarmoured, were a mile or more behind and had to disembus and move up on their feet. [...] The solution to close co-operation in 11 Armoured Division when Infantry and tanks operated together in Squadron and Company groups, was to mount the Infantry on the outside of the tank and to travel as such until it was essential for the Infantry to get off and operate on their feet to protect the tanks or clear the enemy from dugouts.²⁷

Afterwards, Roberts recognized further flaws in the plan: ‘the real set-back was the enemy gun position along the Bourgeois ridge ... These were scarcely touched by the bombing and were out of range of the majority of the Corps artillery which was on the west side of the River Orne’.²⁸ As Turner Cain put it: ‘with the German A/Tk defence in great depth it is not easy to know when you are through their defences as there always seem to be more A/Tk guns further back to take toll of our guns [i.e. tanks]’.²⁹ In other words, the layered German line of resistance, consisting of both fixed and mobile anti-tank defences, extended much further back than anyone had really allowed for.

However, GOODWOOD set Roberts thinking. Further organisational changes were required to make closer the co-operation between the armour and the infantry. This had now to come down to lower levels, to the troop/platoon level, if the organisation was to reflect the minor tactics for the attack now necessitated by the situation. However, it had to go up as well, and take in the two brigadiers in charge of each brigade. Their job would not be co-operation, so much as coordination of armour, infantry, artillery and tanks for and in the attack. This was an ad hoc, flexible organisation, not a permanent establishment, dictated by the situation ‘on the ground’ and responsibility devolved to either brigadier on the ground. This did not mean a defensive

²⁷ Turner Cain, ‘Memoir ...’, p. 13.

²⁸ Roberts, *Desert to Baltic*, p. 184.

²⁹ Turner Cain, ‘Memoir ...’, p. 16.

operational strategy would not sometimes be appropriate. However the potential was there for a different kind of offensive action when the time was right because everyone now knew what to do.

BLUECOAT: Middle-Level Command Responses to New Problems of Combat

The adjutant of an infantry regiment correctly reflected on the earlier part of the campaign that, particularly when it involved moving away from official War Office doctrine, ‘nobody would learn from the experiences of others’ who were in contact with the enemy.³⁰ In Normandy, it was coming to be believed that the Churchill tank’s cross-country ability had to be used to get into positions where it could not easily be seen, with the object of closing the gap between the superior performance of the German tank and anti-tank guns and the Churchill’s own armament.³¹ Despite Peace’s observation above, from the rank of Captain, some middle-level commanders were open to learning from ongoing experience. Brigadier G.L. Verney, who commanded 6th Guards Tank Brigade, saw the value of learning lessons – ‘the idea’ [that an officer go to Normandy as an observer of tank fighting] came from, I believe, our Brig[adier] Verney and he must have persuaded Commander 30 Corps Gen[eral] Bucknall’, Major C. O’M. Farrell, who was thus selected, recalled.³² Verney sent Farrell to report to 6th Guards Tank Brigade before the brigade embarked for Normandy. Farrell tried to convey the newly emerging conclusions in separate talks to the other officers of the 6th Guards Tank Brigade’s three battalions. In them he tried to put across the need to forget at all costs their training based on manoeuvres on Salisbury Plain and the Yorkshire moors, itself drawn from Western Desert tactics. Armour-infantry co-operation depended, in Farrell’s asseveration many years later, on the human networking and

³⁰ IWM Sound Archive, Reference no.18048, Capt.T.H. Peace [adjt, 5th Bn Wiltshire Regt, Normandy, 1944], reel 3.

³¹ Farrell, *Reflections*, 39-45, p. 75.

³² [Maj.] C. O’M. Farrell to the author, 5 September 2005. Verney departed to become GOC 7th Armoured Division in August 1944.

common agreements and understandings of tactical procedures between the officers of the armour and infantry units.³³ ‘Nearly all the fighting’, he explained, ‘was at Squadron level – detached to an infantry brigade’.³⁴ However, as a result of 6th Guards Tank Brigade’s initiation into combat in support of the 15th (Scottish Division), with whom they had trained intensively, during the Caumont battle as part of Operation BLUECOAT (30 July-8 August 1944) it became apparent that indeed what was required was that tanks and infantry co-operate symbiotically to best effect rather than necessarily closely on the battlefield. BLUECOAT involved a British thrust south from Caumont, intended to increase pressure on the Germans and prevent them from transferring armour against the Americans. ‘It seemed that the only hope was to take a chance and push on alone, and follow up with infantry later as best we could,’ Verney later recalled, referring to the activities of 6th Guards Tank Brigade at Caumont.³⁵ Verney was referring here to Phase Three of the operation. On another occasion he explained that during the second phase ‘first the [4th Tank Battalion] C[oldstream] G[uards] CO and then the S[cots]G[uards] CO called me up on the RT and asked if they were to stay with the Inf[antry] or go on close to the Barrage’.³⁶ This latter manoeuvre, in which Verney was willing to implement ideas that had come to be accepted in 6th Guards Tank Brigade as the right ones, was, when viewed purely from the point of view of the published War Office pamphlets, ‘highly unorthodox’.³⁷ This demonstrates not only the substantive content of 6th Guards Tank Brigade’s learning in the early part of the campaign but something of the on-the-spot decision-making involved as well. Contrary to some opinions, 6th Guards Tank Brigade did not act more in the nature of an armoured brigade than the infantry support brigade they actually were, thereby

³³ Farrell, *Reflections*, 39-45, p. 56.

³⁴ [Maj.] C. O’M. Farrell to the author, 5 September 2005.

³⁵ Quoted in I. Daghish, *Operation Bluecoat: The British Armoured Breakout* (Barnsley: Leo Cooper, 2003), p. 44.

³⁶ LHCMA, Verney Papers, Verney 1/3, ‘Notes for Lectures to Gds Trg Bn Pirbright (1948), No 1 – Caumont’, by Maj.-Gen. G.L. Verney, p. 11.

³⁷ Daghish, *Bluecoat*, p. 42.

believed 'the infantry was not now meeting serious opposition'.⁴⁰ Nor was there a feeling among the tanks that the infantry was not required, indeed 'the battle would not have been a success if they had not been determined to fight their way up to us'.⁴¹

The innovation in late July 1944 of brigade groups composed of mutually supportive infantry battalions and armoured regiments of armoured divisions was particularly associated with Major-General A.H.S. Adair of the Guards Armoured Division and Roberts of 11th Armoured Division. However, while the practice of co-operation was improving, unit organization and structure still left much to be desired in mid-August, at least in the case of the Guards Armoured Division with their particularly exclusive regimental traditions, for whom the idea of cooperation between the different arms of infantry and 'cavalry' was 'revolutionary'.⁴² According to Lieutenant R.T. Boscawen, a Troop Leader who commanded a Sherman tank in the 3rd Irish Guards/1st Armoured Coldstream Guards group, Guards Armoured Division during Operation GROUSE (10-13 August 1944): 'there was no real plan except just keep behind the infantry. I had fully expected the battle to go like this'.⁴³ The Guards Armoured was a Sherman-equipped armoured division, and as Captain the Earl of Rosse, serving with the Guards Armoured Division's 32nd Brigade Headquarters, put it: 'it was felt that the Guards Armoured needed some strengthening. Consequently the 3rd Scots Guards with their Churchills were put in support of us, and gave invaluable assistance in the small but difficult operation which culminated in the capture of the village of LE BAS PERRIER by the 5th Coldstream and 1st Welsh'.⁴⁴ At Chênedollé and Le Haut Perrier the role of 3rd Tank Scots Guards' 'S' Squadron (Maj. Farrell) was to support two companies of 1st Battalion Welsh Guards (an infantry battalion of the Guards Armoured Division) in their attack on Le Bas Perrier, then to

⁴⁰ BAOR Battlefield Tour: *Operation BLUECOAT: 8 Corps operations south of Caumont 30-31 July 1944*, (June 1947), p. 39; Lieut.-Col. C.I.H. Dunbar.

⁴¹ LHCMA, Verney Papers 1/3, 'Pirbright (1948), Caumont', p. 18.

⁴² DGLISH, *Bluecoat*, p. 71.

⁴³ Boscawen, *Armoured Guardsmen*, 44-45, p. 87.

⁴⁴ Birr, Co. Offaly, Ireland, Birr Castle, Rosse MSS, T/46-48, Capt. the Earl of Rosse, 'The Story of 32 Guards Brigade Headquarters 31 July - ', p 5.

support 5th Battalion Coldstream Guards (another infantry battalion of that division) to a further exploitation to dominate the line of the Vire-Chênedollé-Vassy road, which appears at the bottom of map 3.1 on page 97. At Chênedollé 6th Guards Tank Brigade did not operate with 15th Infantry Division; the Welsh Guards had not been trained in armour-infantry co-operation let alone with 6th Guards Tank Brigade.⁴⁵ However, the attack succeeded when Chênedollé was reached in the evening of 11 August, the Churchills of 'S' Squadron having progressed in line in front of the infantry to protect them.⁴⁶ Farrell's contention, therefore, that 6th Guards Tank Brigade (independent as opposed to the Guards Armoured Division or any other armoured division) did not have to push for this integration – 'we [i.e. 6th GTB] already had it with 15 Scot[ish] Div[ision] and anyone else who we supported' – would appear to have some substance to it.⁴⁷ It is helpful at this point to consider some of the possible reasons for this.

It will be recalled that the separate armour and infantry brigades notion was allowed to find its way into Normandy, having been taught before D-Day as a universal armour-infantry technique to 21st Army Group in England preparing for the invasion. The infantry and the armour in an armoured division were separate. It will be remembered that the infantry brigade had three infantry battalions mounted in lorries and a machine gun company and the armoured brigade had three armoured regiments and a motor battalion, equipped with carriers and armoured half-tracks. Thus, both had the 'triangular' structure or organization with which the British armoured divisions started the campaign. However, as the example of Roberts and 11th Armoured Division makes clear, throughout the war the tactics used within an armoured division and its organization were continually changing. While Roberts had earlier perceived a need for closer armour-infantry co-operation, the way it would work out in practice, the particular

⁴⁵ Indeed, the relevant entry in Rosse's diary can be read as inferring that the 1st WG and 6th GTB attacks were only loosely connected – except that the task of 6thGTB was to support the infantry, Rosse MSS, T/45, Rosse, personal diary, 11 August 1944.

⁴⁶ See, for example L. Fortin, *British Tanks in Normandy* (Paris: Histoire & Collections, 2005), p. 50.

⁴⁷ [Maj.] C. O'M. Farrell to the author, 5 September 2005.

reasons for the need for it, and the ramifications for unit organization and structure would not be those which he had foreseen. This highlighted wider shortcomings in the way battles were fought during the EPSOM offensive. This was unsatisfactory, particularly after his corps commander, O'Connor, had made it clear that 'you may find that for a period you may be forced to do the work more properly allotted to an [independent] Armoured Brigade'.⁴⁸ This was the same problem Erskine had been faced with less than a month before. Hinde had also identified the problem with respect to 7th Armoured Division. The problem being threefold: the need for more infantry, difficulties caused by lack of training with the infantry, and the difficulty encountered in fixing the locations of German anti-tank guns: in short, the close country called for infantry supported by the tanks of the independent tank and armoured brigades, not for the tanks and infantry associated in the armoured brigade of an armoured division, which were better suited to exploitation.

The role of an independent armoured brigade charged primarily with infantry close-support did not greatly appeal to Roberts, just as it did not appeal to Erskine and Hinde, as it seemed to rob the armoured division of the opportunity for exploitation. At that point, early in July, however, Roberts continued to think that 'with closer co-operation between the infantry and the armour, we might get along reasonably well'.⁴⁹ Operation GOODWOOD in mid-July was the turning point. Roberts thought that it was not until Operation BLUECOAT in late July/early August that the organization of the division was got right, and that was an organization of complete flexibility which at the shortest possible notice could be altered from an armoured brigade and an infantry brigade to two mixed brigades, each of two armoured regiments and two infantry battalions (see Figures 3.1 and 3.2 on p.102).

The armoured regiments and infantry battalions of 11th Armoured Division already co-operated on a troop/platoon basis. This was standard co-operation procedure for minor tactics in the attack,

⁴⁸ Ibid., p. 241.

⁴⁹ Ibid., p. 168.

practised to a greater or lesser extent and in broadly similar ways in all the armoured divisions, as Roberts later acknowledged.⁵⁰

Nevertheless, when O'Connor then directed Roberts that he must be prepared for the very closest of tank-infantry co-operation on a troop/platoon basis Roberts recognised the order as a seal of approval on the organization he had already set in place.⁵¹ This new type of tactical formation, which Roberts christened 'homogeneous brigades', embodied the principle of tactical co-operation in a way its author thought most appropriate in the light of 11th Armoured's experience in Normandy.⁵² Roberts's homogeneous brigade groups also embodied beneficial insights that related to the principal of the economy of force. As British tactical doctrine made clear, application of the principle of the economy of force – and concentration of superior force at the decisive time and place – required a proper appreciation of the balance between offence and defence. For offence and defence we can substitute 'tank' and 'anti-tank'. What Roberts had set in place was an organizational development, a type of force structure designed to facilitate the combined arms tactics necessary for success in the *bocage* and bocage-like countryside of Normandy. The triangular armoured and infantry brigade-structure that permitted for example, two armoured regiments or infantry battalions 'up, one in support' was changed to one similar to what is known in modern military parlance as a 'square' configuration – a mutually-reinforcing one of one armoured regiment and one infantry battalion. Finally, while it is incorrect to say that 6th Guards Tank Brigade acted during BLUECOAT more in the manner of an armoured brigade of an armoured division it can properly be said that from BLUECOAT onwards 11th Armoured Division was equally capable of both infantry-support and exploitation.

⁵⁰ Ibid., p. 185.

⁵¹ Daghish, *Bluecoat*, p. 72.

⁵² BAOR Battlefield Tour: *Operation BLUECOAT*, (June 1947), p. 47: Maj.-Gen. G.P.B. Roberts.

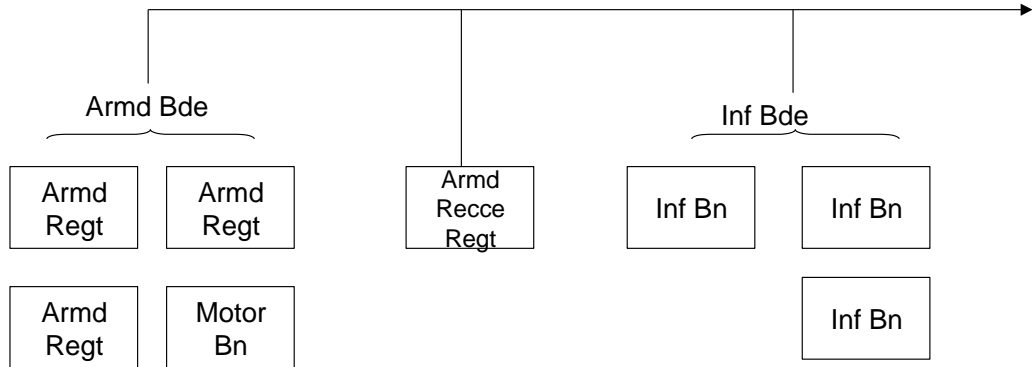

The organisational structure of a typical armoured division prior to the introduction of the 'homogeneous' structure – showing how the infantry and armour were organised largely separately (with the exception of the one infantry motorized battalion in the armoured brigade).

Fig 3.1: The 'old' or standard organisational structure

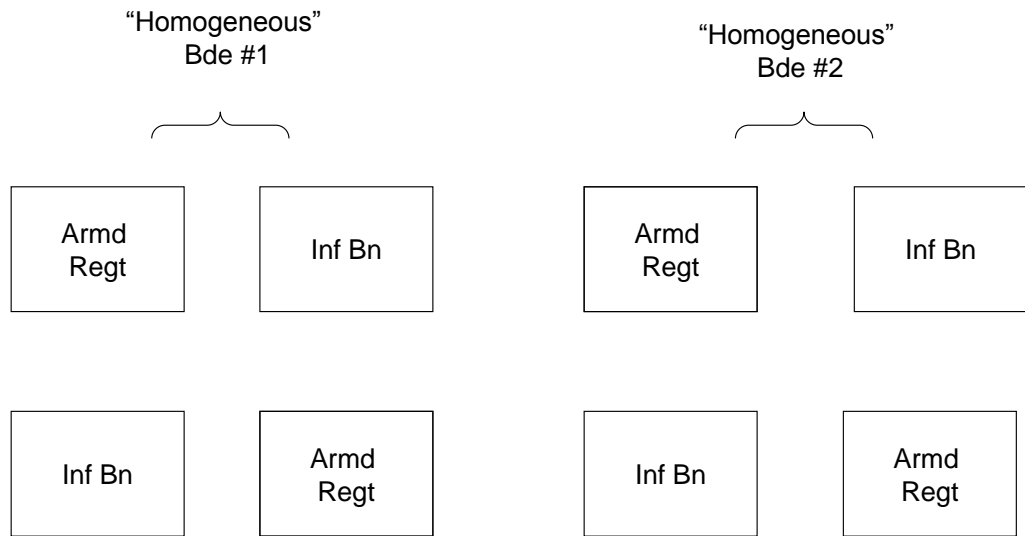

11th British Armd Division, Operation BLUECOAT, August 1944

- In these changes, introduced by Roberts, the 'fourth' Armd Regt was found by changing the role of the Armd Recce Regt; the 'fourth' Inf Bn was the original Armd Bde's Motor Bn.

Fig 3.2: The 'new' or emergent organisational structure

The Guards Armoured Division, newly arrived in the Caumont area for BLUECOAT, would, O'Connor assumed, be able to emulate the flexibility of the other armoured division in VIII Corps. Adair, recognizing that the Guards Armoured's tanks might indeed have to fight in the *bocage*, had already begun to contemplate the need for 'a system whereby the infantry was always right up with them'.⁵³ Rosse and Hill state that 'experience gained [in BLUECOAT – the Caumont offensive] led us to adopt a different organisation from any that we had ever practised; during the years of training we had found increasingly that under European conditions, as opposed to those of the desert, tanks and infantry needed to work in close co-operation down to the lowest level'.⁵⁴ However, an account by Rosse written contemporaneously with events must be interpreted as implying that they were trained in one way in the UK prior to Normandy, which did not equip them with the right organisation or an understanding of the organisation which would have worked, and that thus, when they got to Europe it differed from both desert and training.⁵⁵ Some commentators suggest that the Guards Armoured's new structure reflected that of 11th Armoured Division.⁵⁶ There is little doubt that the Guards also had some success with their new structure during the closing stages of the Normandy campaign. It was not until after the fighting in Normandy, however, that 'it was considered that each brigade should control an equal proportion of infantry and armour'.⁵⁷ In this instance the earlier of the two versions is followed as it appears to throw new light on why the Guards Armoured did not adopt the same organization as 11th Armoured at once.

The Churchill-equipped fighting regiments in Normandy were mainly supplied with Mk IVs and Mk VIs. However, the availability within 6th Guards Tank Brigade of Mk VII and VIII models, the so-called 'heavy

⁵³ Adair, *A Guards General*, p. 147; Capt. the Earl of Rosse and Col. E.R. Hill, *The Story of the Guards Armoured Division* (London: Geoffrey Bles, 1956), p. 55.

⁵⁴ Rosse and Hill, *Guards Armoured Division*, p. 83.

⁵⁵ Rosse MSS, T46/48, Rosse, 'The Story of 32 Guards Brigade Headquarters 31 July - ', p. 8.

⁵⁶ Buckley, *British Armour, Normandy*, 44, p. 99.

⁵⁷ Rosse and Hill, *Guards Armoured Division*, p. 83.

Churchill' with maximum armour thickness increased, meant the 'survivability' of these tanks was greater than the Sherman tanks of the Guards Armoured Division. Three quarters of 1st Armoured Coldstreams' Shermans were lost during GROUSE in an area defended by numerous anti-tank guns and several tanks. This serves as a reminder that equipment, as well as doctrine, training and organization, has to be taken into consideration in explaining failure or success. As Rosse, serving with Guards Armoured, reflected at the time: 'this type of operation, against dug-in enemy with tanks and anti-tank guns, is impossible for the Shermans with their thin armour to compete with, and we were tremendously impressed by the performance of the Churchills'.⁵⁸

Turning now to the independent armoured brigades later in the Normandy campaign, developing the fruits of their earlier learning, over and above these questions of organization and equipment there was a lesson that had been learned about co-operation between all arms. As 4th Armoured Brigade's Brigadier, R.M.P. Carver, expressed it: 'whereas I found that my lack of previous direct personal experience of tank-versus-tank fighting in the desert was no handicap to me, it was clear that the greater knowledge I had of the characteristics of other arms, derived from my experiences on divisional and corps staffs, stood me, my regiment and my supporting infantry, gunners and sappers in good stead'.⁵⁹ This supports the view that to some extent the key to success in integrated tactics was not what you knew but who you knew how to work with. Nevertheless, in Normandy, Carver was also faced with new problems of combat, which were linked to further equipment and organization issues and how best to utilise the forces he had at his disposal. As a result of experience fighting in Sicily during the Italian campaign, Carver appreciated that

speed [i.e. the 'mobility' of mobile warfare] is not attained so much by actual m.p.h. as by [...] above all a spirit in all ranks that every minute is vital if the war is to be won in time and that there is always a way of solving every

⁵⁸ Rosse MSS, T/46-48, Rosse, 'The Story of 32 Guards Brigade Headquarters, 31 July -', p. 5.

⁵⁹ Carver, *Out of Step*, p. 176.

problem if you are determined to do so. ... It is just as necessary to make a plan to combine fire and movement with tanks as it is with infantry. *The big difference is the speed with which the plan is both made and carried out.*⁶⁰

At the beginning of July 1944, 4th Armoured Brigade was part of VIII Corps, engaged in close support and counter-attacking in defence of VIII Corps' salient. In early July Carver identified the problem of creating an effective anti-tank defence where 'a[n]t[i]- t[an]k guns or tank pos[itio]ns 1000-3000yds on the flanks which are the real menace to tanks accompanying the infantry' had not been effectively dealt with and then when the enemy counter-attacked British defences the British tanks had to 'rush up in a hurry, knowing next to nothing of what is going on' and also the conditions for further action by the armour, that is that tanks would not get shot up by enemy anti-tank guns from the rear as they went forward.⁶¹

During Operation JUPITER (10-11 July 1944) to extend the VIII Corps bridgehead over the Odon towards the Orne, the 'exploitation' role was to be undertaken by 4th Armoured Brigade, for the first time. Second in command of 44th Battalion Royal Tank Regiment (44th RTR), 4th Armoured Brigade was Major R. Leakey, an outstanding commander whose first-hand account serves to put the problem identified by Carver in its context within JUPITER:

It was towards the middle of July that we had our worst spell. It started with an attack against a hill called Point 112 in which we were supporting an infantry Brigade. Although the attack was successful, the Germans counter-attacked, and retook the vital hill. By this time the infantry and ourselves were so reduced in numbers and so tired that it was all we could do to take the lower slopes.⁶²

On 10 July, Carver fought for and secured assurances of ample medium and heavy artillery support '[Major-General G.I.] Thomas [GOC 43rd Infantry Division] having tried to fob me off with smoke screens'. Smoke screens were regarded as one of the quickest and most economical ways of achieving results. Carver also insisted that Thomas's infantry and the

⁶⁰ IWM, Carver Papers, Lectures and Articles on Armoured Warfare, 1940s, Lieut.-Col. R.M.P. Carver to Maj.-Gen. P.C.S. Hobart, 27 July 1943. (Emphasis added.)

⁶¹ TMA, RH5 4AB: 1646, '4 Armoured Brigade Lessons from Operations – Operation 'Jupiter''.

⁶² Leakey, with Col. G. Forty, *Leakey's Luck*, p. 126.

Churchill tanks of 31st Tank Brigade should clear and secure the wood on the reverse slope of Hill 112 before he would launch 4th Armoured Brigade, led by the Scots Greys' Shermans and 2nd Battalion King's Royal Rifle Corps (2nd KRRC) to take the village of Maltot beyond the hill.⁶³ In the event, the infantry and their supporting tanks suffered considerable losses.

In addition, 2nd KRRC and a battery of self-propelled guns from 91st Anti-Tank regiment, under command 4th Armoured Brigade, failed to eliminate the threat from the flanks posed by the enemy's anti-tank guns. The Greys too, lost a considerable number of tanks, although the self-propelled guns of 144th Anti-Tank Battery (144th SP A/T Bty) helped their Shermans knock out two German Panther tanks. On 11 July the Greys with 5th Battalion Duke of Cornwall's Light Infantry from 43rd Infantry Division succeeded in reaching Hill 112. They were nevertheless ordered to withdraw in the evening because of losses of men and tanks, despite the Greys with the assistance of the self-propelled anti-tank guns successfully destroying four German self-propelled anti-tank guns.⁶⁴ Experience in the Italian campaign, Carver believed, showed that the advantages associated with the Sherman's capability to fire 75mm HE, which had provided British armour with sufficient firepower to prevail in the open operating environment of the desert in the manner envisaged by the War Office, could be substantially offset when close, congested country constituted the operating environment 'as few targets were seen and the shells exploded on contact with the nearest tree or bush'. Further, Carver believed 'such targets [tanks or anti-tank guns in forest cover] were never accurately located and could not be seen from the tank'. Rather, he thought, they were dealt with more accurately and more effectively by concentrations from the supporting artillery, with no loss of speed. Fire from tanks could not cover the area nor produce the concentration needed.⁶⁵ An

⁶³ Carver, *Out of Step*, p. 193.

⁶⁴ Narrative detail is drawn from P. Delaforce, *Monty's Mauraunders: Black Rat 4th Armoured Brigade and Red Fox Mask 8th Armoured Brigade* (Stroud: Sutton, 1993), pp. 77-80 and Fortin, *British Tanks, Normandy*, pp. 42-46.

⁶⁵ London, UK National Archives (UKNA), Erskine Papers, WO236/7, '1st Royal Tank Regiment Lessons, 30 October-3 November 1943' by Lieut.-Col. R.M.P. Carver.

additionally important point is the distinction Carver drew between supporting the attack by the infantry of 43rd and 15th Infantry Divisions and the direct support of the infantry: 31st Tank Brigade did most of the direct support of the infantry. This is an example of the further bubbling up of appropriate tactics for the Shermans in the infantry-support role.

The utilization of self-propelled anti-tank guns is interesting here because they were initially in short supply in 21st Army Group, and, in fact, there was only one weapon, the American M10 (also known as the Wolverine). Many M10s were adapted, like the American Sherman tank, to take the British 17-pdr anti-tank gun, an extraordinarily potent weapon which, in 1943 replaced the 6-pdr as the main British anti-tank gun.⁶⁶ In this form they were known as the 17-pdr SP gun 'Achilles'. They equipped 144th SP A/T Bty. The M10 'Wolverine' and Achilles were mainly issued to anti-tank units in armoured divisions at this time. Due to their relative scarcity initially, they were operated by members of the Royal Artillery before D-Day and throughout the fighting in North-West Europe. While it was recognised that the self-propelled 17-pdr was not so effective an answer as the only answer in tanks, the Sherman Firefly, nevertheless 'Second Army was compelled to reckon in every 17-pr to redress the balance'.⁶⁷ Thus, while 'in theory and usually in practice, the artillery was an arm of remote fire-support', in this particular case this was not so.⁶⁸ The 17-pdrs had proved their worth and were being utilised well in the operations at the beginning of July, for example assisting the tanks to restore infantry positions which were being over-run by tanks. One of the reasons for failure on JUPITER did not lie with the weapon itself but with those responsible for tactical leadership, who had failed to utilise its full potential offensively. This became apparent to Carver. 'If we all start thinking hard and pool our

⁶⁶ For the specifications of the 17-pdr see C. Henry, *British Anti-tank Artillery 1939-45* (Oxford: Osprey, 2004), pp. 17-20.

⁶⁷ Jackson, *Eighth Corps: Normandy to Rhine*, p. 26.

⁶⁸ Harrison Place, *Training in the British Army, 40-44*, p. 4. For generally excellent reasons, Harrison Place excludes formal consideration of the Royal Artillery.

ideas,' Carver suggested in his appreciation of German defence methods of 25 July 1944, 'we shall outwit the enemy'.⁶⁹

The key problem was that of converting an initial break into the enemy's defensive system into a breakthrough. The British Army distinguished clearly between consolidating the gains made as the basis for further offensive action, and exploitation – a subsequent action which might or might not be decided upon depending on whether troops and firepower were readily available for this task. Carver identified key weaknesses in implementing this doctrine. He appreciated that 'if our tanks succeed in penetrating his [the enemy's] main A[nti-] t[an]k defence, he relies on bringing further progress to a halt by cutting off the tanks from their soft stuff, guns and supporting infantry'.⁷⁰

The armoured and infantry brigade COs offered different answers to the problem of how the process of defending against enemy tanks could be made dynamic so that defence itself became mobile rather than static.⁷¹ If anti-tank protection was the 'framework of defence' as official British 1943 doctrine had it – and all were agreed that it was – then in the words of Lieutenant-Colonel A.A. Cameron of the 3rd County of London Yeomanry 'to knock out enemy tanks in general terms needs the 17 pr gun'. This, however, left aside or sidestepped the important question of whether the anti-tank gun was primarily an armour or an infantry weapon. Proceeding from the above point of agreement, however, Lieutenant-Colonel G.P. Hopkinson, commanding 44th RTR recommended that 'the infantry should be accompanied in their attack by S[elf-] P[ropelled] A[nti-] t[an]k Art[iller]y which in our opinion should be an infantry as well as an Arm[oured] Div weapon. The early introduction of HE will also produce for the Inf[antry] their own Inf close support gun'. The CO of 2nd KRRC Lieutenant-Colonel R.B. Littledale's preferred solution was for 'anti-tank fire to be provided by tanks or SP anti-tank guns, until infantry weapons [towed 17-pdrs] are dug in'.

⁶⁹ TMA, RH5 4AB: 1938, '4 Armd Bde Trg Memo no 2' by Brig. R.M.P. Carver, 25 July 1944, para. 5.

⁷⁰ Ibid., para. 2.

⁷¹ These may be found among 5 pages of suggested answers to '4 Armd Bde Trg Memo No 2' re tactics by Brigade COs, from which the quotes in this paragraph are taken, TMA, RH5 4AB: 1938.

Hopkinson, therefore, wanted the infantry to be able to look after their own protection, leaving the armour free for what was, in effect, the armoured division's role of exploitation. From an infantryman's perspective, Littledale not unnaturally wanted to keep the protection of the tanks.

Within 4th Armoured Brigade it had 'become abundantly clear in recent operations that the only anti-tank weapon in which all arms and particularly the infantry have full confidence is the 17 pr on a tracked chassis whether it is called a tank or a SP anti-tank gun.'⁷² In other words, the Sherman Firefly, armed with the 17-pdr gun or the British-modified M10 Achilles, also armed with the 17-pdr, were the only weapons in which the infantry had complete confidence. Normally, the main target of an anti-tank gun was indeed the tank although the 17-pdr did latterly fire a useful HE shell, and was therefore also effective as a field gun. The general teaching was that tanks which had led or supported the advance to an objective should be relieved there as soon as possible by self-propelled anti-tank guns, which should in their turn be relieved by towed anti-tank guns dug in. This reflected the doctrine intended to govern the employment of self-propelled anti-tank artillery as laid down in the 1943 War Office Military Training Pamphlet No.41 *The Tactical Handling of the Armoured Division and its Components*, in force throughout the fighting in Normandy: that 'the light armour provided, together with good cross-country performance, make such guns suitable for employment in support of the attacking brigade, especially for consolidation, and as a mobile reserve'.⁷³

This was not helpful because of the distinction made between consolidation and exploitation. Carver's criticism of the sequencing outlined was that it had seldom been possible or effective because there simply were not enough self-propelled 17-pdrs to relieve the tanks, it was seldom possible to bring up towed anti-tank guns and dig them in in daylight, and it was very difficult to site towed anti-tank guns so that they were both concealed and able to cover the ground in front of and on

⁷² TMA, RH5 4AB: 1938, 'Anti-tank defence' by Brig. R.M.P. Carver, 1 August 1944.

⁷³ London: War Office, Military Training Pamphlets (MTP series) No. 41, (1943), Part 1, *The Tactical Handling of Armoured Divisions* (July 1943), Ch. III, Section 9, para. 40.

flanks. Even when dug in, however, the towed 17-pdr was very vulnerable to HE fire. This all added up to one thing, Carver noted: ‘under present conditions effective anti-tank defence of the infantry’s forward positions can NOT be provided by anything else but tanks or SP guns equipped with the 17 pr’, that is, in practice, the Sherman Firefly or the Achilles, and Carver found himself ‘forced to use up tanks for the anti-tank defence of static positions for lack of SP anti-tank guns’.⁷⁴ Therefore, he thought the War Office doctrine was wrong.

The conclusions Carver drew from all this were firstly – as Hopkinson, the commander of 44th RTR had suggested – that anti-tank regiments of infantry divisions should be equipped with self-propelled guns.⁷⁵ Carver went out of his way to accommodate the demands of Littledale, the infantry commander of 2nd KRRC, by stressing that the tanks would continue to defend the infantry from enemy tanks in the absence of an adequate number of self-propelled guns until the number and quality such guns could be increased, in spite of the wastage in very valuable tank commanders which it imposed as a result of casualties from mortar and HE fire.⁷⁶ Secondly, self-propelled anti-tank gunners must get out of their heads the idea that their true role was as a mobile reserve as per War Office teaching, and that anti-tank protection of forward defence lines was the job of the towed gun.⁷⁷ The tanks, in other words, were best trained and equipped to provide the mobile reserve, and what self-propelled anti-tank guns there were should be used to release as many tanks as possible for this job. Thus, instead of being used in an offensive mobile role operating in support of friendly tanks chasing and eliminating enemy tanks, the self-propelled anti-tank gun’s tactical role according to Carver should be flank protection and reinforcement of the anti-tank defence of armoured and infantry units in a largely static role the role in fact envisioned by the War Office for the towed 17-pdrs. These should now be relegated to the role of creating an anti-tank defence in depth, where they would not be subject to accurate

⁷⁴ TMA, RH5 4AB: 1938, ‘Anti-tank defence’, paras 2, 3 and 4. (Emphasis original.)

⁷⁵ Ibid., para. 5.

⁷⁶ Ibid., para. 8.

⁷⁷ Ibid., para. 5.

mortaring or HE fire from tanks. Self-propelled anti-tank gunners should act offensively. Their role was not to 'sit and wait' but to carry out continuous observation, and generally be offensive by, amongst other things, carrying out indirect HE shoots using the capability of the 17-pdr to fire a HE shell. All these were appropriate tactics, in the light of the vulnerabilities of the towed 17-pdr, often towed forward by an unarmoured - or at best lightly armoured - vehicle with the added difficulty for the crew of manoeuvring a gun of over 4000lbs weight after the towing vehicle withdrew. Finally, Carver recommended the design of a self-propelled anti-tank gun armed with the best possible anti-tank gun, that is the 17-pdr, and included a specification for the weapon.⁷⁸

The Valentine tank went out of production in 1943, but a number were adapted to carry the 17 pounder gun in an open, rear-facing fighting compartment. The resultant vehicle was given the official title of SP 17-pdr Valentine, although it was usually referred to as the Archer. None saw service in Normandy. It can be surmised that reports and requirements such as Carver's were subsequently heeded at the highest levels of command as existing Archers were issued to the anti-tank battalions of the British armoured divisions in the autumn of 1944.

TOTALIZE: High Level Command Responses

On 8 August 1944 1st Canadian Army launched Operation TOTALIZE, an offensive aimed at Falaise. TOTALIZE included many innovations, intended to rectify the difficulty met until then by the Anglo-Canadian forces: 'how to get the armour through the enemy gun screen to sufficient depth to disrupt the German anti-tank gun and mortar defence, in country highly suited to the tactics of the latter combination.'⁷⁹ A successful break-in – Simonds knew – would bring his forces almost immediately into contact with the Germans' armoured

⁷⁸ Ibid., para. 6.

⁷⁹ TOTALIZE: Appreciation and Outline Plan by G.O.C. 2 Cdn Corps, 1 August 44, quoted in Canadian Military Headquarters Historical Section, Report No. 65 (*Canadian Participation in the Operations in North-West Europe, 1944*), 23 December 1953 <http://www.dnd.ca/hr/downloads> [accessed 22 March 2011] (Para. 17).

second line of defence. In the preparations for D-Day Simonds had given considerable thought to the problem of breaking into the strong German line, breaking through, and exploiting this into a breakout.⁸⁰ He also appreciated that a number of 21st Army Group's operations had achieved break-ins but had been unable to maintain the advance.

The attack, Simonds believed, 'must be carefully organized and strongly supported by all available artillery'. He knew that 'the essence of the German system of defence is the counter-attack'. Thus, 'the defeat of these counter-attacks must form part of the original plan of attack which must include arrangements for artillery support and the forward moves of infantry supporting weapons – including tanks – on the objective'. Further, as 'there is bound to be a pause during this phase when the leading troops on the objective are going to be without the full support of the artillery [t]his is the period at which the employment of all available air support is most useful to tide over the gap'. Simonds saw the infantry division as the 'sledge hammer' in the attack. The armoured division was to be a 'weapon of opportunity', capable of dealing with enemy rearguard positions and developing a breakout, but too weak in infantry to carry out an attack in depth and 'still retain fresh infantry to co-operate with the armour in more fluid operations for which it is specially designed'.⁸¹

Simonds' plan addressed the problem of breaking through the German defences in three ways. First and most significantly for the purposes of this thesis, II Canadian Corps' leading forces did not suffer from inadequate levels of infantry support. The initial penetration was made by infantry and armour together. In TOTALIZE, the direction and objectives of the operation could not be disguised. Nevertheless, Simonds was keen to effect surprise. Thus, the operation began at nightfall and Phase One continued through the hours of darkness. The assaulting infantry was carried forward in half-tracks and armoured

⁸⁰ Simonds set out the technique that he intended to employ in his operational policy directive of February 1944. Simonds is the only one of Montgomery's corps commanders for whom we have such a document – which is why it warrants mention in this thesis' introduction.

⁸¹ Lt.-Gen. G.G. Simonds, 'Operational Policy – 2 Cdn Corps', paras 13 and 16, quoted in T. Copp, *Fields of Fire*, Appendix A, pp. 273, 274 and 275.

vehicles specially modified to carry infantry (Kangaroos). His instruction to his divisional commanders amplified his plan: 'the infantry accompanying the armour to first objectives in Phase One must go straight through with the armour. [...] The essentials are that the infantry shall be carried in bullet and splinter-proof vehicles to their actual objectives'.⁸² Second, airpower would play a more complete and integrated role by providing fire support deep into German-held territory when the advance would be carried beyond the range of the artillery. Third, there was also an aerial bombardment, intended to deal with the main, second German defensive line. With these factors in place Simonds hoped to achieve a breakthrough, at which point his two armoured divisions would be introduced into the battle in an exploitation role.

TOTALIZE was the first operation that British or Canadian troops of infantry divisions would be carried into battle in vehicles with comparable armoured protection and mobility as the tanks they accompanied.⁸³ However, although TOTALIZE was innovative in this and other respects, it was also a strictly timetabled operation, as well as one in which Simonds retained tight control of the forces employed.⁸⁴ On the morning of 8 August, II Canadian Corps had in effect breached the German lines. The advance was halted until the second bombing raid had taken place. A considerable delay ensued, allowing the Germans to plug the gap created by British-Canadian forces. Further, II Canadian Corps also required time to reorganize and gather itself for further operations. Momentum may have been lost, but it would have been contrary to Simonds' approach not to take the time to bring up the Canadians' anti-tank guns, coordinate their defences, so as to be ready

⁸² Lt.-Gen. G.G. Simonds to Maj.-Gen. R.F.L. Keller [GOC 3rd Canadian Division], 2 August 1944, quoted in *Canadian Participation in the Operations in North-West Europe, 1944* (Para. 19).

⁸³ Interestingly, Simonds would pioneer the use of another form of this tactical combination – this time using the amphibious Sherman DD in tandem with the Landing Vehicle Tracked, or Buffalo, during Operation INFATUATE (1-5 November 1944) – the attack on Walcheren island in the Scheldt estuary.

⁸⁴ These aspects of Simonds' operational approach have been noted as factors contributing to the failure, before TOTALIZE of the Canadian operation, SPRING (25 July 1944): B.H. Reid, *No Holding Back: Operation Totalize, Normandy, August 1944* (Toronto: Robin Brass Studio, 2005), p. 56.

to meet a German counter-attack. Furthermore, the inexperience of the two armoured divisions, intended to spearhead Phase Two of TOTALIZE, further militated against success.⁸⁵ Finally, the fact was that no one on the Allied side was aware of the presence of a number of 88mm guns south of the general line from Bretteville-sur-Laize to St. Sylvain.⁸⁶

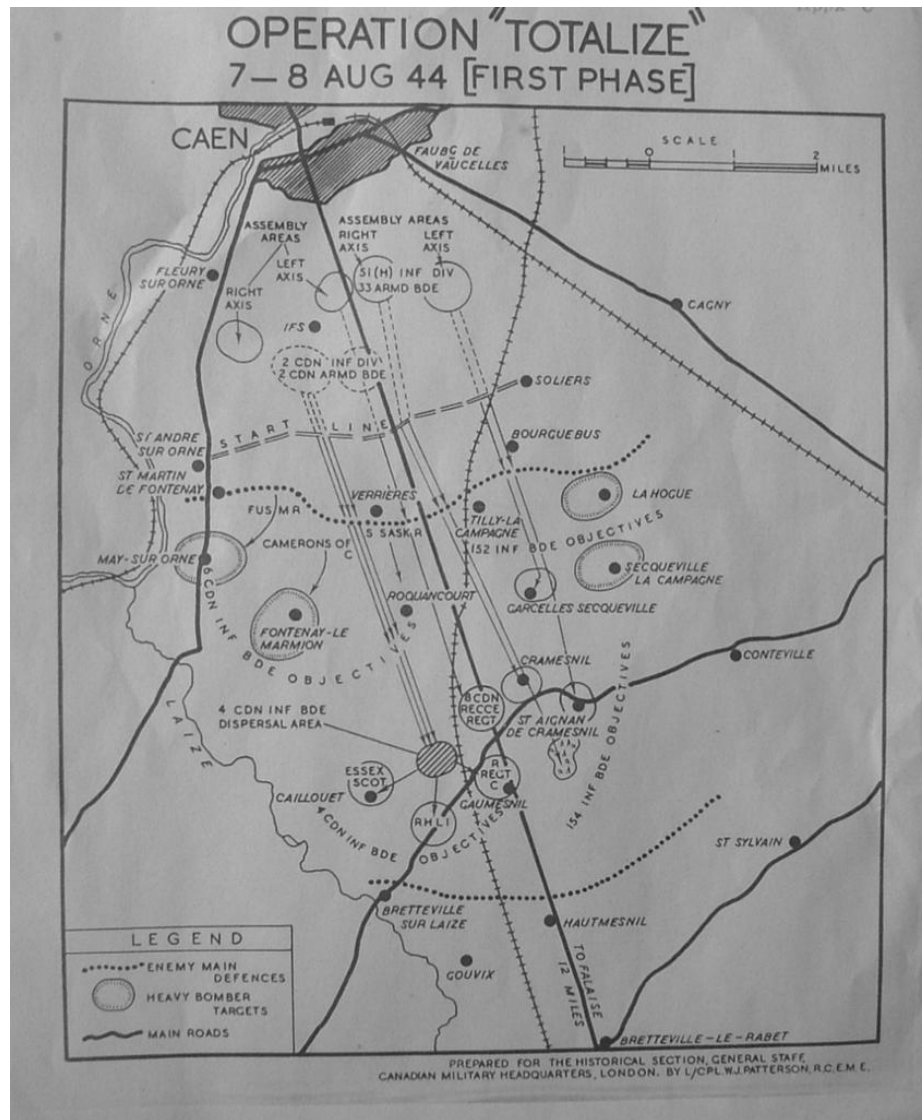

Map 3.2: Operation TOTALIZE⁸⁷

⁸⁵ This was unlike other Canadian armoured formations employed in TOTALIZE, such as 2nd Canadian Armoured Brigade, which had accumulated considerable experience of fighting in Normandy.

⁸⁶ Reid, *No Holding Back*, p.171.

⁸⁷ *Canadian Participation in the Operations in North-West Europe, 1944*, Historical Section, Canadian Military Headquarters Historical Section, Report No. 65: Appendix "C". This photographic reproduction is of an official work that is published by the Government of Canada and that the reproduction has not been produced in affiliation with, or with the endorsement of the Government of Canada.

Looking from the outside in, among many experienced middle-level commanders there was a recognition that what was the right thing to do could now be accepted: in particular, getting everyone to sing from the same hymn sheet by instructing and integrating replacements in battlefield tactics; allowing subordinates to understand as much of the big picture as could be understood; and disseminating useful innovations as widely as possible.⁸⁸ As a Squadron Commander of the Sherbrooke Fusilier Regiment who took part in TOTALIZE put it, 'men fight their battle on what they're told to do, and you've got to keep ensuring in the back of your mind that they do understand what they're supposed to do'.⁸⁹ The most significant thing TOTALIZE tells us is the failure of the top-down control and execution of operations. Simonds's great contribution was to mould a form of co-operation for the advancing armour and infantry, whereby they were given the technical means to attack together, which could be successfully exploited by tactical commanders. However, the big-picture problem in terms of operational technique was getting everyone up and down the levels of command to sing from the same hymn sheet. Simonds browbeat his commanders, the armoured commanders in particular, for what he saw as a lack of aggressive spirit, if not something far worse.⁹⁰ TOTALIZE is a classic example of how responsibility for failure was put onto subordinate commanders rather than understood by the higher commander involved as endemic to the system for tactical command and control.

On 14 and 15 August 1944, as part of Operation TRACTABLE, the continuation of TOTALIZE, 4th Armoured Brigade was under 53rd (Welch) Infantry Division, which was struggling through very dense country to cut the main road from Condé to Falaise. Major-General R.K. Ross, GOC 53rd Infantry Division wanted to advance by moving one infantry brigade through another in a series of coordinated, set-piece infantry-cum-armour attacks. Carver, however, appreciated that if the

⁸⁸ C.L. Mantle and Lt.-Col. L. Zaporzan, 'The Leadership of S.V. Radley-Walters: The Normandy Campaign', *Canadian Military Journal*, 1 (2009), 56-67 (pp. 59 and 63).

⁸⁹ Maj.-Gen. S.V. Radley-Walters, quoted in Mantle and Zaporzan, 'The Leadership of S.V. Radley-Walters', p. 60.

⁹⁰ Reid, *No Holding Back*, p. 237.

armour could push on as fast as possible to seize objectives that would increase the pressure, tightening the encirclement of the enemy, the results would justify the risks. The 44th RTR dashed ahead of the infantry of the Welsh division and by last light on 15 August had cut the Falaise road from the west, leaving 4th Battalion Royal Welch Fusiliers to catch up as best they could during the night. In a very different context, this was the same decision Brigadier Verney had taken at Caumont. It shows, moreover, that Carver no longer felt bound by or to the need for an anti-tank effort involving all arms to create the conditions for exploitation by the armour which he had previously identified would be usual. By that point however, the German front in Normandy was breaking up, so, as the War Diary reflected the need to create these conditions no longer existed.⁹¹

The insights, imagination and initiative of commanders at the hitherto largely neglected divisional level thus played an important part in shaping final doctrine. In these two chapters in particular the selection of operations looked at could influence the analysis. However, different operations in Normandy show different things. All these actions demonstrate many of the issues discussed: while some show the need for change, importantly, some show lessons being learned. What Roberts and Adair had set in place was a force structure to improve armour-infantry co-operation within armoured divisions in order to facilitate the combined arms tactics necessary for success in Normandy, themselves organised around the concepts of tank-cum-infantry offensive action and anti-tank defence. This organizational development was also an innovation, and a highly effective and successful one. Further, the homogeneous brigade concept, which was also adopted and adapted in TOTALIZE/TRACTABLE, interacted with what Montgomery believed was required – as would be brought out more fully in *The Armoured Division in Battle* (December 1944) – and that was the

⁹¹ UKNA, WO171/601/300247, 4th Armoured Brigade War Diary, 19 August 1944.

ubiquitous use of armour, that is all armoured brigades, whether independent or in divisions to be equally capable of undertaking the roles of close-support of infantry, pursuit and exploitation.

The roles played by the creative brigadiers of independent armoured brigades identified and discussed here provide a further demonstration that the creation of doctrine was a much more general, collaborative process than many historians have supposed or been willing to concede. Although Carver and 4th Armoured Brigade's purpose remained that of close co-operation with infantry divisions, his solution, in which 4th Armoured Brigade concentrated on close co-operation tactics between its Sherman tanks and its 'own' infantry, with this motor battalion in M5 and M9 half-tracks, would be conducted at a speed of thought and action which was new and not necessarily in close proximity to other attacking infantry from infantry divisions. This was an answer in-part to the problem of how the process of defending infantry – but also the tanks – against enemy tanks and anti-tank weapons could be made dynamic so that defence itself became mobile rather than static. It applied particularly to the independent armoured brigades. Unlike the independent tank brigades, they could field this twin-attack team by employing their supporting motor battalion of infantry. The key weapon in this was the 17-pdr gun, however mounted, rather than the general War Office teaching that tanks which had led or supported the advance to an objective should be relieved as soon as possible by self-propelled anti-tank guns, which should in turn be relieved by towed anti-tank guns dug in. The key ingredient of Carver's thinking was to compress consolidation and exploitation into one phase. He realised that in British attempts at a breakthrough the real problem was the fragility of flank protection. His overall solution of a combined and integrated armour-infantry assault interacted with Montgomery's ideas coming from the top and helped remake the template for the operation of tanks and infantry in the set-piece battles conducted by 21st Army Group. Tanks would abandon their concentration on supporting fire from the flanks. The self-propelled guns would do this, being got forward quickly, while the tanks would be released for a further advance. Doctrine did

not come from the top: it is possible to see in the doctrine Montgomery worked out in December 1944 resonances, echoes and elements of their ideas or perhaps, more accurately of ideas which had come to be accepted as the right ones among brigadiers and the COs of armoured regiments of independent armoured brigades. Thus, the argument that the rigidity of hierarchy and line of command in general and an authoritarian, top-down control of operations was significantly harmful to the efficiency of armoured units in action in Normandy has to be weighed against the evidence for this essentially collaborative creation of doctrine.

CHAPTER 4

FROM 'ANARCHY' TO PROBLEM-SOLVING (1): DIMENSIONS OF OPERATIONAL PRACTICE IN LATE 1944 AND BEFORE THE RHINE CROSSING

In the process of fighting from D-Day, many ideas were displaced by new experiences. What some commanders within 21st Army Group thought would be valuable ceased to be so. In response to the problems of fighting from the beaches of Normandy to the borders of Germany, in mid- to late 1944 armour doctrine was being challenged, criticised and changed in 21st Army Group by commanders at lower level. This somewhat anarchic situation persisted throughout the fighting in Normandy and during the subsequent fighting in Belgium and southern Holland, up to the end of 1944. The two-way interaction between lower level commanders and those alongside and above them continued to operate to shape operational doctrine. Montgomery's efforts to elucidate the lessons of the campaign played no small part in creating this doctrine; though contributors below the higher levels of command also played an important part in producing the ultimately successful methods of combat which would later take 21st Army Group across the Rhine to the Baltic and the Elbe in 1945. The creation of doctrine was the result of the interaction of several factors: the actions of Montgomery, who 'managed' the output, of other officers at differing levels in the chain of command, and of 'circumstances'.

Montgomery emphasised the need to learn from combat experience, in part expecting his commanders to learn from their own experiences. However, he believed that, from his experience, he had the fundamentals of an effective operational doctrine. He was, therefore, not so much interested in the acquisition of operational lessons; he was more interested in ensuring the assimilation of tactical ones. He was interested in people who could tell him what would work. The interaction of Montgomery, key commanders and circumstances led to the emergence of a new framework for action through which previous

experience could be successfully reinterpreted and brought to bear effectively. This framework drew its inspiration from the general way the British Army attempted to adjust official doctrine to lessons learned from operations. Whilst being unique to Montgomery and 21st Army Group, it appears to have been generic within the whole of that Group under Montgomery's command.

Circumstances have consequences, which produce new circumstances. There had been heavy static fighting in Normandy. Then there was an advance at tremendous speed into the Low Countries. September 1944 is the first time there was a pause in which to take stock. The defeat at Arnhem had significant consequences for the operational and tactical methods of 21st Army Group. Montgomery had his ideas – those of 21st Army Group, and he developed them in doctrinal pamphlets in November and December 1944. In these pamphlets, which he designed to be authoritative aids to the implementation of this 'new' doctrine, he identified the problems of fighting with the tools at his disposal and indicated how he believed they should be tackled in the remainder of the war against Germany. Although the pamphlets appeared over Montgomery's name and with his authority, he worked with others to produce them. Montgomery's pamphlets on the armoured and infantry divisions of late 1944 may thus be seen as an outcome of a process that both embodied and reflected the desired doctrine and one in which senior officers at higher levels were less involved. Further, the pamphlet writing process itself provided the intellectual and doctrinal substance of his command system.

The other part of his command system was actually managing the people to do it. The uniformity of 21st Army Group doctrine at any one time is sometimes confused with assumptions that it was constant over time. In a similar way, while there was a general dynamic in which Montgomery sought to impose his view and while that view was ostensibly accepted at corps and divisional level, a more complex set of relations between people, circumstances and equipment developed which meant it was not that simple. In this process, in shaping a new

framework for action through which previous experience could be successfully reinterpreted the importance of contributors below the higher levels of command has hitherto been largely overlooked. The most modern historiography still describes the approach to tactical doctrine as apparently anarchic.¹ Rather, it was Montgomery's adoption of a problem-solving approach – which he adopted in response to the problems of fighting in Normandy and through the Low Countries – in which he emphasised the importance of context but also, importantly, allowed for the diverse views of other commanders to be managed, which led to success in North-West Europe.

The Strategic and Operational Scene after Arnhem

The circumstances that transpired during September 1944 had important consequences, both for Montgomery and for the British Army, which would affect the strategic and operational scene in late 1944. September began with Montgomery's promotion in rank to Field-Marshal but his effective demotion with regard to planning, from the role of overall Allied commander on land which he had exercised throughout the fighting in Normandy, to that of commander of the Anglo-Canadian 21st Army Group. Eisenhower assumed the role of Land Forces Commander, in addition to his role as Supreme Allied Commander. Also, against all expectations, the Germans managed to re-establish a front. This brought to a head disagreements between Allied commanders over strategy. The month ended with Arnhem: the attempted opening up by airborne troops of a narrow corridor to include the vital bridges over the Dutch waterways, along which the armour of XXX Corps could quickly pass to burst into the north German plain. It was now clear that the war was not likely to be over by Christmas and the end of 1944.²

¹ T. Copp, '21st Army Group in Normandy: towards a new balance sheet' in Buckley, ed., *Normandy: Sixty Years On*, p. 15.

² General Sir David Fraser, *And We Shall Shock Them: The British Army in the Second World War* (London: Hodder & Stoughton, 1983), pp. 342-43.

After his failure at Arnhem, Montgomery realised that to make the final assault on Germany – that is, for the crossing of the Rhine to be successful – it would first be necessary to destroy the German forces between the Maas and the Rhine. Nevertheless, it was, he explained to Eisenhower and other high Allied commanders at Maastricht on 7 December 1944 ‘essential that we force mobile war on the Germans by the spring or early summer [of 1945]. They have little transport, little petrol, and tanks that cannot compete with ours in the mobile battle. Once the war becomes mobile, that is the end of the Germans’.³ The fighting in the Ardennes confirmed that the pursuit phase of the campaign post-Normandy was over. The increasing numerical superiority of the Allies in armoured fighting vehicles and transport vehicles as well as improvements to the armament, protection and speed of British tanks, and the rapid Allied advance across France to the borders of Germany itself could not, though, obscure deficiencies in the British practice of mobile combined-arms tactics with tanks, anti-tank artillery and infantry which had highlighted command, doctrinal and organizational shortcomings.

From the end of September 1944, Montgomery’s aim was to improve the performance of his armoured and infantry divisions in battle in order to wrest the initiative back from the German Army now that, contrary to expectations, it had managed to re-establish itself as an effective fighting force. The backdrop was the operations of Montgomery’s 21st Army Group in North-West Europe in the last three months of 1944 to clear the Scheldt estuary of enemy forces and make possible the opening of the large Belgian port of Antwerp to Allied shipping, consolidate the narrow corridor retained by Allied forces after the survivors of Arnhem had been withdrawn, and also secure better positions for his forces from which to advance into Germany in 1945. It is in the relationship between Montgomery’s general theories and the actual physical circumstances that commanders – and their ideas – faced that the answers to the questions of how the creation of doctrine

³ Montgomery, *Memoirs*, p. 302.

depended on personalities, which personalities, and with what consequences are to be found.

Different units and formations tended to lay the blame for their troubles on one another.⁴ In reality, outcomes were the consequence of the inter-relationships between three variables which were in play throughout this period: 'generalship', or operational art and tactical skills; the impact on the Germans of the imposition of relentless pressure via mobile war; and 'ground', or best utilization of time and space factors. Together they resulted in the infantry supporting the tanks with quick action and an altogether more intimate armour-infantry co-operation being achieved during the advance through Belgium and Holland into Germany in the last three months of 1944. Montgomery's goal was the highest possible attainment on each of these variables and the best balance of all three by the time of his offensive into the Rhineland in February and March 1945.

Interactions within the Corps-Division-Brigade Hierarchy

Montgomery had earlier decided that Lieutenant-General B.G. Horrocks was the man to command the pursuit of the German armies defeated in Normandy. He recommended Horrocks be appointed to the command of XXX Corps and had regrouped it for that task and for MARKET-GARDEN.⁵ O'Connor and VIII Corps were to play an important but subsidiary role and operate on the right of XXX Corps. O'Connor had played just such a pursuit role following up a retreating enemy in 1940-41 so he 'began to wonder whether he was out of favour' with Montgomery.⁶

⁴ Exemplified in the two accounts by 11th Armoured Division and by the East Yorkshire Regiment, a part of 3rd Infantry Division, of the liberation of Overloon and Venraij in October 1944: Anon. [Maj. Edgar Palamountain], *Taurus Pursuant: A History of 11th Armoured Division* (Germany: Privately published, c.1945), p.70; Lieut.-Col. P.R. Nightingale, *The East Yorkshire Regt. (Duke of York's Own) in the War 1939/45* (Howden: Mr. Pye Books, 1998 [1952]), p. 227.

⁵ Baynes, *Forgotten Victor: O'Connor*, p. 225.

⁶ *Ibid.*, p. 226.

During the Winter of 1944-45 O'Connor's VIII Corps carried out what the corps history calls useful though unspectacular operations and closed up to the line of the River Maas.⁷ The first of these operations was CONSTELLATION, the last of VIII Corps operations to be launched in North-West Europe under his command. Afterwards Roberts, a leading subordinate of O'Connor, charged him with not understanding the relationship between armour and ground in late 1944 Europe and supported Montgomery's decision to prefer Horrocks because this was just the sort of operation Horrocks 'would like and excel at'.⁸

The professional criticisms of the abortive Operation GATWICK demonstrated O'Connor's perceived shortcomings. Coming immediately before CONSTELLATION, Operation GATWICK was to clear the Reichswald by using 3rd Division (VIII Corps). When O'Connor visited Whistler, one of his divisional commanders, in the early days of October, Whistler told him that he would require extra troops because the ground was so obviously unsuited to the employment of armour as a 'force multiplier'. Whistler's tirade in his diary against 'chinagraph warriors who make marks on the map without reference to sense' reflected his misgivings that GATWICK would require more troops than O'Connor appeared to envisage.⁹ Whistler's view of Horrocks was that 'he is moderately practical', compared to O'Connor, 'our chinagraph king [who] fights all his battles on it and they are generally inaccurately marked into the bargain'. 'I take a dim view and would sooner have a different master', he concluded.¹⁰ As with GOODWOOD, neither Roberts nor Whistler fully recognised just how little leeway O'Connor had to alter Montgomery's master plan in the case of GATWICK. It was not until Montgomery decided, after due consideration, that it would require too many troops in view of the current operations farther west to clear the Antwerp approaches that the operation was cancelled. This episode raises questions both about the extent to which a genuine consensus on

⁷ Anon. [Lieut.-Col. J.G. Hooper], *The River Rhine to the Baltic Sea: Operations of Eighth Corps, March-May 1945* (Germany: Privately published, c.1945), p. 7.

⁸ Hastings, *Overlord*, p. 275; Roberts, *Desert to Baltic*, p. 196.

⁹ WSRO, Whistler Papers, 9/48, personal diary, 6 October 1944.

¹⁰ WSRO, Whistler Papers, 9/48, personal diary, 25 September and 6 October 1944. (Emphasis in original).

operational methods existed at high level and about what events such as O'Connor's departure tell us of Montgomery's method of command.

The critical factors were now different and to conduct military operations successfully now needed different structures. Roberts correctly identified the important factors and the related process-challenge issues involved. Military operations were now 'quite different to anything we had met before', he explained; 'now we came up against natural obstacles, sometimes fortified and sometimes not, but when held by the Germans they needed a lot of effort. To deal with this situation, we organised ourselves again into 'mixed' brigade groups'.¹¹ The related concerns of the maintenance of high morale and the avoidance of heavy casualties were further issues to address, and achieving objectives which needed a lot of effort was 'not very easy'.¹² In the middle of December 1944, Whistler reproached himself with 'now finding fault with a unit [in 8th Brigade] that takes too great care of the lives of its men. I am sure it results in heavier casualties and lower morale somehow'.¹³ In his Christmas message, Whistler declared: 'Splendid as has been the support given by all arms of the Division, it is that small number of men in the Rifle Companies of the Infantry Battalions who have to take the ground and hold it'.¹⁴ Behind this lay the belief that by holding back a commander might actually incur more casualties, likely to be heaviest among the infantry. Yet, everywhere there was a shortage of trained infantry replacements, so that in mid-December he could see 'no way of producing the result'.¹⁵

Objectives could, however, be achieved at least cost. 3rd Division's task in CONSTELLATION was to attack southeast from Oploo, seize the two small towns of Overloon and Venraij set among the woods on the outskirts of marshland, and thus draw in enemy reserves. There were thus to be two parts to 3rd Division's task: first the capture of Overloon and then the capture of Venraij. The Division's part in

¹¹ Roberts, *Desert to Baltic*, p.214.

¹² Ibid. p.214.

¹³ WSRO, Whistler Papers, 9/48, personal diary, 12 December 1944.

¹⁴ Quoted in N. Scarfe, *Assault Division: A History of the 3rd Division from the Invasion of Normandy to the Surrender of Germany* (Staplehurst: Spellmount, 2004 [1947]), pp. 193-4.

¹⁵ WSRO, Whistler Papers, personal diary, 12 December 1944.

CONSTELLATION was planned at Divisional HQ on 10 October, orders going out that afternoon for the next day. Bad weather postponed the operation until 12 October. 8th Brigade was to carry out the first task and 9th Brigade the second. Concentration of force on a narrow frontage with units echeloned in depth ensured the maximum offensive power at the point of break-in. Having fresh units ready to exploit the success gained was also important, and 185th Brigade would be ready to assist either phase and exploit the success of the second. The countryside was flat and suited the defence. It was to be yet another close-quarter infantry slogging match. It was equally obvious that these attacks would require the strongest support. To provide it, the division had two battalions of 6th Guards Tank Brigade, with whom they had practised crossing water obstacles and dealing with counter-mortar problems in September. 'Unless something funny happens very soon I am going to have a very satisfactory battle as far as planning is concerned. I expect to set the troops off on the right foot anyway and that is all I aim to do ever', Whistler noted.¹⁶

Whistler's interpretation of the principle of concentration relied on artillery and air power rather than fire power from armour to carry the attack forward. The guns of 25th Field Regiment and all the guns of 11th Armoured Division, 15th (Scottish) Infantry Division, and VIII Corps' Army Group Royal Artillery (8thAGRA) were added to that of the division's three field regiments. Fire support from the air was to be provided by Typhoons of 83 Group RAF and Marauders of the USAAF.

At this point, it is appropriate to look at how O'Connor handled CONSTELLATION. Strikingly, this was the one occasion on which O'Connor operated outside of the straightjacket imposed by Montgomery and his methods. CONSTELLATION was not a typical 'Montgomery plan'. It placed great emphasis on the element of surprise, for example: attacking first in one sector and drawing off enemy forces would facilitate the success of a surprise attack in another sector. Similarly, O'Connor planned to mask the presence of 15th Infantry Division and take full advantage of the element of 'surprise' by drawing the bulk of

¹⁶ WSRO, Whistler Papers, personal diary, 6 October 1944.

the enemy northwards before a thrust by this division came in from the south, that is from the enemy rear. In so doing he was reprising his Operation COMPASS (September 1940), when nobody had expected the British to come from behind, that is the major turning of a flank – the sort of move O'Connor performed in 1940. The initial three phases would take the town of Venraij, and place 11th Armoured Division and 7th US Armoured Division in positions from which they would be able to carry out the fourth phase, when the two armoured divisions and 15th Division were to converge on Venlo. 11th Armoured had made several thrusts into the Peel marshland from the north, towards Venraij, at the end of September. From these it was apparent before CONSTELLATION began that terrain was a factor which would impact adversely on armour's ability to carry out its intended role of rapid exploitation. As Roberts put it: 'it became clear that we were not going to get anywhere until a carefully planned *full scale attack* was made'.¹⁷ Roberts' 'full scale attack' is taken to mean a well supported assault including all arms (and possibly also across a wider salient). It was becoming apparent to these two divisional commanders, Whistler and Roberts, that it was difficult to conduct new-type operations, where the infantry and their supporting tanks faced a resourceful enemy who contested every inch of ground, without incurring heavy casualties. The solution that would emerge emphasised closer tank–infantry unit and formation organization and structure and anti-tank artillery co-operation tied in appropriately to tactical fire plans and support from field, medium and heavy artillery as well as from the air.

On 12 October and for the next three days, in appalling weather and over adverse terrain, 3rd Division and 11th Armoured Division manoeuvred into position and drew the enemy northwards, as intended. By 16 October, elements of the two divisions were ready to catch the Germans in a pincer movement around Venraij and 7th US Armoured Division was about to be launched into action when 15th Division was withdrawn to take part in the clearance of the Scheldt estuary. Limited advances were made on 17 October, and Venraij itself was captured.

¹⁷ Roberts, *Desert to Baltic*, p.219. (Emphasis added).

However, without 15th Division, further movement in the Maas pocket was impossible and VIII Corps adopted defensive positions along its extended front. Roberts thought that the operation went well ‘until 15th (Scottish) Division had to be withdrawn’.¹⁸

This view sits uneasily with Whistler’s description of the operation: ‘bags of mines and desperate mud. Churchills bogging down everywhere. Bridges collapsing – in fact every bloody thing quite bloody’.¹⁹ The infantry and their supporting tanks faced an enemy who contested every inch of ground. Whistler thought the Commanding Officer of 6th Guards Tank Brigade ‘first class’. However, in conditions which impeded armoured movement, infantry of 8th Brigade went on without the tanks of 4th Grenadier Guards ‘which was particularly good show’. The tanks of 4th Grenadier Guards took a long time to get forward, however, and the infantry had to push on by themselves – partly because the ground was so unsuitable for tanks and had been heavily mined. Whistler tried to get one of the Grenadier officers who had been ‘pretty poor’ replaced, and felt that the Commanding Officer, armoured-trained but with an infantry background, could not be relied on ‘to do the right thing’. At one point, he noted: ‘had all my guns taken from me and now have lost the air support. Life is a little difficult when such things happen in the middle of a battle’.

What frustrated Whistler, was that he could control and manage only the components of which he was in command. This compares with Barker’s creation of Clarkeforce later in October 1944 (see below), as an important step which broadly pointed in the direction of the creation and employment of proto modern ‘battlegroups’.

In response to what he considered an arbitrary intervention to remove one of his subordinate commanders, General Lindsay Silvester, commanding 7th US Armoured, O’Connor asked to be relieved of his command on 20 October. In the meantime, Whistler’s relations with O’Connor had begun steadily to improve: ‘since [O’Connor’s Chief of Staff] Harry Floyd has left the little man [O’Connor] has completely

¹⁸ Ibid., p.219.

¹⁹ WSRO, Whistler Papers, 9/48, personal diary, 18 October 1944 [and subsequent quotations in this paragraph].

changed [...] he and I are now very good friends and begin to understand each other'.²⁰ Thus, support among and between fellow commanders seems, by this time, to have been based chiefly on the ability to get the job done. Factionalism would appear not to have been as important in O'Connor's removal as has been suggested.²¹ On 27 November 1944 O'Connor received his official posting as GOC-in-C Eastern Army India and on 30 November started to hand over his command to Lieutenant-General Barker, formerly GOC 49th Division. In December, VIII Corps held the entire 2nd Army front on the Maas from Culijk in the north to Maesyck in the south. Constant patrolling, minefield reconnaissance and shelling were carried out to harass the enemy, but apart from this VIII Corps was again static.²²

The ability of the British Army to overcome the Germans continued to depend on its ability to mount successful combined arms operations. It is therefore appropriate at this juncture to begin to make some assessment of the generalship at the end of 1944 of the particular subordinate commanders discussed hitherto and its interaction with the other variables at play. O'Connor had had little leeway to alter Montgomery's master plan as Montgomery allowed his corps commanders little scope in the planning of operations. Equally, when O'Connor did gain a certain amount of leeway in the planning of CONSTELLATION he showed the insight, imagination and dynamic leadership that he had shown in desert warfare against the Italians. Further, although it can be fairly concluded that O'Connor had vast operational experience and although this was not exploited to the full by Montgomery, whether in the conditions prevailing in Europe in late 1944 this was a wrong experience – and therefore not actually exploitable at

²⁰ WSRO, Whistler Papers, 9/48, personal diary, 26 October 1944.

²¹ Badsey has suggested that factionalism played a significant and underrated part in O'Connor's removal from command, suggesting that it was not until Floyd, whose background was in the glamorous 15th/19th Hussars, had been removed from O'Connor's side, being promoted and posted to Italy, that O'Connor himself was finally levered out of his command; see S. Badsey, 'Faction in the British Army: Its Impact on 21 Army Group Operations in Autumn 1944', *War Studies Journal*, 1(Autumn 1995), 13-28 (p. 19).

²² [Hooper], *Eighth Corps: Rhine to Baltic*, p. 8.

that time – is a moot point, as will become apparent.²³ The existence of a genuine consensus on operational methods at high level – irrelevant at the time by virtue of Montgomery’s salience at every level of command and the way he sought to mediate his ideas through his corps and divisional commanders – also becomes questionable. The importance of the example of O’Connor – not the only one because Bucknall was also deemed to have performed badly but very interesting in the light of O’Connor’s undoubted ability – is in how it illuminates Montgomery’s method of command.

Montgomery’s way of trying to produce ‘the result’ was ruthlessly to remove from command officers he thought were likely to be in disagreement as he sought to impose a mould of agreement or consensus. Thus he got rid of people who seemed to question the methods he promulgated or could not perform them. His treatment of O’Connor was an example of the former, and of Bucknall of the latter. A key question, therefore, is whether O’Connor’s record of handling VIII Corps indicates any real differences between him and Montgomery. While the operational methods both men adopted were the same in basic character insofar as neither had any option but to employ operational techniques that put a premium on minimising casualties, there were also at least three important differences in their respective approaches.

First, they differed in their views on the way infantry accompanying armour should be tactically mounted. As the British armoured division moved towards a balance of fewer tanks and more motorised infantry, the lorried infantry, or Motor Brigade appeared. Back in England after Dunkirk, Montgomery and Brooke organised things so that each of the new armoured divisions had at least one brigade of lorry-borne infantry. These were based on standard battalions, carried in a new type of vehicle – soft-skinned and not armoured. The concept of mechanised infantry in their own bullet-proof cross-country vehicles was one to

²³ COMPASS epitomises what militaries today call the deep thrust or deep penetration. Deep penetration constitutes part of the essential character of the NATO general strategy known as the AirLand Battle. Many of O’Connor’s ideas on equipment only came into their own in the 1950s when his active career was over, e.g. the 1950s can be thought of as the ‘APC decade’ – epitomised (in the British Army) by the introduction in the ‘50s of the Saracen and Trojan armoured personnel carriers.

which O'Connor became a convert to during the Normandy fighting, championing their introduction. It will be recalled that, before Operation GOODWOOD began he had anticipated the need for the infantry to keep up with the tanks and at the same time be protected against enemy fire, which made movement by lorry unsatisfactory. On 16 October 1944, as CONSTELLATION was moving into what should have been its final phase, he wrote to his old Cameronian friend Major-General J.F. Evetts, a special adviser to the Ministry of Production, asking him to press for the development of an 'armoured carrier for the carriage of infantry into battle'.²⁴ This was a 'hard' or engineering approach to problem-solving. Montgomery, on the other hand, rather than wait to explore whether or not there was sufficient time to develop new vehicles, put his faith in the first instance in what a member of his staff has described as his '“training' philosophy”', a common doctrine incorporating better techniques of armour-infantry co-operation, widely understood and brought to an adequate level of efficiency through training.²⁵ This 'soft' approach – the view that it is not what you have but how you use it – reflected Montgomery's method of command. If the ideal technical equipment had been available it might be argued that Montgomery would not have needed to have gone down this road of 'being better', as opposed merely to 'having better'. The solution that would emerge in actuality emphasised morale and addressed equipment and numbers as well as the way the Germans were now fighting.

Secondly, the two men differed over what Montgomery termed 'the Initiative'. Where O'Connor was prepared to work within existing norms and practices, and leave decisions on the actual methods of fighting to unit commanding officers, Montgomery was not. Thus, for Operation SPRING (25 July 1944), even though he believed his armoured commanders had not developed the knack of combining armour and infantry in a mutually supporting manner, O'Connor felt the need to do no more than advise Adair to 'remember what you are doing is not a

²⁴ LHCMA, O'Connor Papers, 5/4/52, Lieut.-Gen. Sir R.N. O'Connor to Maj.-Gen. J.F. Evetts, 16 October 1944. O'Connor's 'cap badge' was The Cameronians (Scottish Rifles).

²⁵ [Major] Sir Carol Mather [Liason Officer, F.M. Montgomery's Tac. H.Q., 1944] to the author, 22 October 2005.

rush to Paris – it is the capture of a wood by combined armour and infantry'.²⁶ During BLUECOAT, both Roberts and Adair divided their divisions into two brigade groups. The new 'mix' of infantry battalions and armoured regiments in mutually supporting combinations worked. O'Connor was extremely pleased with these armoured commanders, praising Adair and Roberts – the latter who he recognised had been 'bewildered at the start by infantry' – to his confidant, erstwhile BGS and now Alexander's Chief of Staff in Italy, Lieutenant-General Sir John Harding, not only for doing well but also for learning a great deal.²⁷ Ultimately, however, what constituted 'good tactics' was left to the discretion and judgement of unit commanding officers. O'Connor was much more prepared than Montgomery to work in this way. Montgomery, by contrast, was seeking more of a step-change within the existing culture and the norms and practices of the Army. As will be seen in the next chapter, to Montgomery the Initiative meant that operations developed according to a predetermined plan. It was necessary quickly to gain the Initiative, and then to keep it by 'ascertaining the facts of the situation *at that time*, and then making [...] plans to deal with the problem'.²⁸ Of course, at high level this would likely involve major decisions. For Montgomery, however, each commander, however senior or junior, must be clear as to the points which mattered on his own level. It was crucial for a commander to position his ready reserves appropriately so as to block anticipated enemy countermoves swiftly. Skill in grouping, and the precept that initiative in quick re-grouping to meet the changing tactical situation played a large part in successful battle operations, ensuring that operations developed according to plan. Thus, the Initiative was also one of Montgomery's general principles and a central part of his doctrine

²⁶ LHCMA, O'Connor Papers, 5/3/32, Lieut.-Gen. Sir R.N. O'Connor to Maj.-Gen. A.H.S. Adair, 24 July 1944.

²⁷ LHCMA, O'Connor Papers, 5/3/37, Lieut.-Gen. Sir R.N. O'Connor to Lieut.-Gen. Sir Allan ('John') Harding, 19 August 1944.

²⁸ Montgomery, 'The battle of Alamein', in *The Sunday Times Book of Alamein and the Desert War*, ed. by D. Jewell, (London: Sphere, 1967), p.70. (Emphasis in original).

of command. It was, he believed, by the 'initiative of subordinates that the battle is finally won'.²⁹

A final difference between Montgomery and O'Connor was in the nature of the role the two envisaged for the armoured division in battle. In CONSTELLATION 3rd Division was to operate towards Overloon and Venraij; 11th Armoured would pass through them and advance on Amerika to the right and Horst on the left, after which a further thrust was envisaged in the direction of Venlo. O'Connor was thus prepared to contemplate an exploitation of this 'empty' flank by the armoured division. However, a sizeable number of the tanks of 15th/19th King's Royal Hussars (15th/19th H) which tried to operate unsupported towards Amerika on 19 October were destroyed by Panzerfausts or Panzerschreck anti-tank rocket-launchers, or anti-tank guns. They could perhaps gain, but certainly not hold, their objective. By this time, Montgomery opposed the concept that armoured divisions should operate independently to attempt the major turning of a flank and any idea that tank units should manoeuvre independently and unsupported. Instead, he saw the armoured division as a combined arms force that would seize key terrain in order to use the advantages of being on the defensive when the enemy counterattacked. Montgomery's was the more integrated concept. But, this meant changing the 'geometry' of the whole system, and putting aside the separate armoured brigade and infantry brigade structure of armoured divisions in favour of more fluid arrangements, while still maintaining 'balance'. Thus, Montgomery's solution to the problem of balance with this organisation of forces – and indeed now generally – was to change the existing notion of a force balanced by reserves to one so balanced that there will never be any need to react to enemy thrusts with large reserves. The homogeneous-brigade organisation had been put in place by several armoured divisional commanders. This approach used up what had traditionally been considered reserves. Montgomery's contribution was to make the homogeneous brigade concept reconcilable with his concept of balance.

²⁹ Montgomery, *Memoirs*, p. 81.

In Roberts' view, O'Connor's handling of CONSTELLATION was 'the best he had shown in the campaign'.³⁰ O'Connor's biographer believed that his record of handling VIII Corps in battle indicated that he merely had to catch up with tactical lessons missed during his captivity as a prisoner of the Italians.³¹ Later, he revised that judgement, believing that O'Connor 'learnt much in N.W. Europe, but was too old, and could not have gone on any longer than he did'.³² Roberts's praise for O'Connor's handling of CONSTELLATION, when, in comparison with earlier operations, he was under Montgomery's control, confirms that O'Connor – for whatever reason – had some difficulty operating within the straightjacket imposed by Montgomery and his methods. This fits with Baynes's later insight, which seems the more perceptive judgement. Thus, Montgomery seems to have decided that O'Connor was somewhere in a grey area between seeming to question the emerging methods and 'failing'.

However, in assessing how effectively O'Connor overcame the enemy opposition in the Maas pocket and achieved the objective of clearing it set for him, account must be taken of the fact that the temporary removal of 15th Division to support the Tilburg offensive was due to circumstances entirely beyond his control: the shortage of trained infantry. The withdrawal of 15th Division in turn underlines the pressure Montgomery was under, in the face of increasing American numerical predominance, to secure not only the defeat of Germany but also a high profile role for Britain in that defeat. Time was not a tool at his disposal: the terrain was against his troops; and the Germans were fighting with determination and skill. O'Connor was most definitely not incompetent, but Montgomery's readiness to let him go has been widely accepted as the equivalent of relieving him of his command. Barker's apprehension that he too 'might be pushed off to India or some bloody place with no interest like this' is evidence which supports this view.³³ More importantly, it shows that there was a more general feeling in the

³⁰ Roberts, *Desert to Baltic*, p. 220.

³¹ Baynes, *Forgotten Victor: O'Connor*, p. 183.

³² Lieut Col. Sir John Baynes, Bt. to the author, 5 July 2004.

³³ Barker MSS, Maj.-Gen. E.H. Barker to his wife, 26 October 1944.

air that this is what happened to people who did not toe the line and operate within the mould of uncritical consensus which Montgomery was trying to create.

Barker was the only divisional commander in Montgomery's 21st Army Group to be appointed to corps command during the campaign in North-West Europe. Without looking back too far, it is necessary to investigate the particular kind of past experience Barker represented and how that combination related to that amalgam of qualities, capabilities and attitudes that Montgomery wanted in his corps commanders. It will be recalled that in the 1920s and 1930s the British Army experimented to produce an army capable of mobile combined arms action. These were not experiments in which Montgomery was directly or even closely involved. Others, such as Barker, were more closely involved in the practical combination or integration of the various arms.³⁴ The decision had been taken to discard the tank lead in favour of motorising the entire army. Thus at the start of the Second World War the British Army was entirely motorised but lacked a large modern armoured force. A large British armoured force had then been built up, and by mid- to late 1944, the pressing question was how to use not only the armoured divisions but also the independent brigades which were its largest component part. Experience and practice from the Western Desert informed training in the UK. It was official policy, however, and recognised in the Home Forces that the application of lessons from the desert needed some caution. The appointment of Barker (by Brooke on Montgomery's recommendation, and over a number of other candidates who were considered) can be seen as representing the re-emergence of the influence of that part of the army which had never been committed in the Mediterranean theatres, as opposed to the (ex-) 8th Army in North Africa and Italy, and with it of

³⁴ Indeed, it can be argued that Barker's most significant contribution to innovation was c.1938-39, as Commander, 2nd Battalion, King's Royal Rifle Corps, in Palestine and the UK. The battalion became the Motor Battalion of 1st Cavalry Brigade, which together with 2nd Cavalry Brigade formed what was renamed the 1st Armoured Division in 1939. The units which had originally innovated the 'motor battalion' doctrine were inappropriately committed by the BEF high command during the battle for France in 1940.

pre-war concepts of more balanced tank-inclusive mixed forces and of the light infantry tradition rather than that of mechanised infantry.

On 26/27 October 1944, the Germans launched a counter-attack in the Meijel area in O'Connor's VIII Corps sector, striking the thinly held positions at Meijel, southeast of Eindhoven with two mechanised divisions. Strong German attacks westward from Meijel on 28 October were broken up by artillery which O'Connor had sent to the 7th US Armoured. On the most crucial day of the battle, 29 October, it was once again concentrated artillery fire that decimated the attacking Germans. O'Connor was content with merely pushing the enemy back towards the Maas until a proper operation could be organised to clear the whole of the Maas pocket.³⁵ On this date also, Barker on his own authority as the infantry divisional commander, decided to launch Clarkeforce in an attack on Roosendaal as part of the ongoing struggle to capture the Scheldt estuary in south-western Holland in the face of fierce enemy resistance.³⁶ The British I Corps (49th Division attached) had been tasked to clear the large rectangle some forty miles wide and thirty miles in depth of southern Holland to the line of the river Maas, while II Canadian Corps cleared the Scheldt estuary. On 20 October, I Corps advanced with 49th Division, which had 34th Tank Brigade under command in the centre, directed on Roosendaal (Operation REBOUND). The axis of 49th Division's advance was from Wuestmalle, through Brecht, Wustwezel, Nieumoer and Esschen to Roosendaal, a distance of about twenty miles. Barker's plan was to launch an armour-cum-infantry force through a gap made by the division supported by the tanks of the tank brigade, to gain ground and act as a spearhead to the division whose main bulk would follow up and take over as opportunity occurred. In the operations that took place (Operation THRUSTER), Clarkeforce performed as envisaged.

³⁵ XII Corps was to be involved as well as VIII Corps. Operation NUTCRACKER began on 14 November in XIII Corps' area. On 19 November VII Corps started to advance and the task of clearing the pocket was slowly completed by the beginning of December.

³⁶ Under the command of Brig. W.S. Clarke, 34th Tank Brigade.

Both these apparently minor operations were of considerable tactical and operational importance.³⁷ Despite its inevitable failure after Allied numerical superiority was brought to bear, the German attack on Meijel with two mechanised divisions demonstrated that the German Army could still mount a surprise counterstroke against weakly defended sections of the Allied line. Even though Barker's armoured force was held up by German self-propelled guns and anti-tank ditches 'so we didn't get the rush through we hoped', the performance of Clarkeforce showed Montgomery a way in which his numerical superiority in tanks – most of them in independent brigades – could be brought to bear, opening up again the possibility of mobile operations on a decisive scale.³⁸ Equally, Barker knew how Montgomery wanted him to fight: he seems to have needed no convincing. Barker, who as a then divisional commander appears to have had no direct involvement in the drafting of the pamphlets which Montgomery was soon to produce, thought that their content was self-evident as a result of his own experience of the fighting.³⁹ Thus, the thinking of subordinate commanders, derived from their experiences of actually fighting on the ground with these tools, was congruent with Montgomery's thinking.

The raid by two troops of 9th Royal Tank Regiment (9thRTR) during REBOUND-THRUSTER to harass enemy positions on the right flank in the Hiebart-Steenhoven area on 22 October can be seen as a move conforming to Montgomery's alternate thrusts technique. Like Whistler, Barker relied on artillery and air power to ensure success without taking

³⁷ In support of this argument, Carver noted that '34 Tank Brigade under 49 Div[ision ...] achieved a great deal, again with tanks as the primary arm, supported by infantry'. IWM, Carver Papers, Lectures and Articles on Armoured Warfare 1940s, 'Comments on Lt. Col. [Alan] JOLLY [RTR]'s letter'. Perrett's historical account also notes: 'these operations are unique in the history of infantry/tank operations, for they involved the use of Churchills in an *exploitation* role' (B. Perrett, *Through Mud and Blood: Infantry/Tank Operations in World War II*, (London: Robert Hale), 1975, p. 233 – emphasis original).

³⁸ Barker MSS, Maj.-Gen. E.H. Barker to his wife, 27 October 1944.

³⁹ Barker MSS, Maj.-Gen. E.H. Barker to his wife, 2 November 1944. It is in this light that we should interpret the following: 'I have had no reply from Monty to my letter [of 26 October, saying he would prefer to stay with 49th Division rather than take over command of VIII Corps as Montgomery wanted] and don't expect one. Instead he has sent me a personal signed copy of a pamphlet he has written on the Conduct of War and the Infantry Div[ision] in battle. Having glanced through I feel it is quite unnecessary *for me* to read it!!!'. (Italics added, exclamation marks original.)

heavy infantry casualties. In the face of a determined German counter-attack in the Aerle-Nieuwerk area earlier in October, he recorded that ‘my guns have had a lot of shooting these last two days and I’ve had the RAF loose on several targets to help keep the Boche in order’. In November he noted: ‘I fear the Yanks do it with undue casualties – they simply don’t know how to use their artillery.’⁴⁰ The employment of 9thRTR in support of 56th Brigade to create an initial breach in the enemy defences was in accordance with prevailing British principles for the employment of a heavy tank unit armed with heavy, or infantry, tanks. It is important to note however that, in Clarkeforce, Barker believed he had created a separate ‘armoured force’, to be employed in a different manner from that of a conventional tank brigade. In his farewell message to 49th Division he spoke of a ‘classic advance’ towards Tilburg, and later to Roosendaal and Willemstadt. This should be taken literally to refer to the ‘classic’ fast-moving British tank-infantry advances of April 1918. The speed at which the phases of the operation were pursued to attempt to keep up the momentum of advance is what is particularly important here. And while, clearly, command was not decentralised to the armoured commander, equally clearly Barker understood Clarke’s command to be an independent one in battle, with the overall command of all the elements of Clarkeforce resting with the tank formation. Clarke’s verdict was that ‘under such circumstances the fullest tank-inf[antry] cooperation could only be natural and automatic’.⁴¹

While Roberts and Whistler were both trying to deal with the problem of how to win their battles without heavy casualties in this unfavourable operating environment, their divisions were actually fighting separate battles within the single VIII Corps plan. Whistler’s 3rd Division was fighting its battle with its ‘own’ armour, 6th Guards Tank Brigade, in accordance with the prevailing British tank-infantry co-operation doctrine, that is that an infantry division would fight with an independent armoured or tank brigade. Furthermore, Whistler, because

⁴⁰ Barker MSS, Maj.-Gen. E.H. Barker to his wife, 8 October 1944; 19 November 1944.

⁴¹ Barker MSS, Brig. W.S. Clarke to Lieut.-Gen. E.H. Barker, 16 December 1944.

he believed the infantry's role was the hardest, was prepared to push infantry forward without tanks and rely only on artillery and airpower when he thought this was absolutely necessary for success. In the flat, low lying land between rivers and canals – themselves important barriers to movement – tanks were prey to anti-tank guns firing at long range, while the Germans' extensive use of minefields between these water obstacles further enhanced the security of the fixed anti-tank defences they had prepared. However, reliance on artillery firepower, while an important ingredient of the solution, was actually increasingly incompatible with the fluid, mobile, armour-cum-infantry operations which Montgomery now additionally wished to impose on the enemy as soon as possible.

Doctrinally and organisationally, therefore, there were still problems that had to be solved. The earlier innovation of mixed brigade groups composed of mutually supporting infantry and armour only applied to the armour and infantry of the armoured divisions. The infantry divisions had to rely on the independent tank brigades for support. Montgomery's idea was to make all the tank brigades into armoured brigades each capable of tactical infantry co-operation and exploitation. Barker's contribution – the lessons inherent in the two operations described – was to develop the role of tank brigades away from simply the close support of infantry in attack or defence. It was, therefore, an innovative tactical application of the armour of a tank brigade which tied in very well with what Montgomery envisaged as the new role for tank/armoured brigades. This was the employment of armour-with-infantry in fluid mobile warfare of the kind Montgomery thought most appropriate in the circumstances, as opposed to the kind O'Connor wished to impose on the Germans. Montgomery's solution to realise his operational level aims was ingenuity or conceptual superiority, and the outfall of this, at the tactical level, was that he saw the need to manage the expectations of infantry and armour as to what the other could achieve in order to ensure effective coordinated armour-infantry co-operation. Although the process of co-creation of doctrine was a process which was open to new ideas, once the new doctrine was formulated

there was little scope for further Initiative (that is at the level of doctrine) which would result in methods, or the Master Plan being altered. There was however always scope for individual initiative at the level of problem solving to suit the context. Lines of command were invariably inflexible but the new doctrine of command stressed the requirement for this kind of initiative at every level. Changing tactical problems emphasised the necessity for subordinates to be problem-solving in terms of the general intentions expressed in the given plan within a methods framework that would now be set out in Montgomery's pamphlets which encapsulated 21st Army Group thinking and practice and subordinates were encouraged to go beyond the official War Office textbook approach.

Command, Doctrine and Organization For and In the Advance to the Rhine

By the winter of 1944-45 the putting into practice of operational doctrine on the ground had changed. To understand and illustrate in detail what had happened requires exploring practice in four dimensions: that of an independent armoured brigade (Carver and 4th Armoured Brigade) operating as the armoured brigade of an armoured division (Roberts and 11th Armoured Division); of an armoured division (Lyne and 7th Armoured Division); of an independent armoured brigade (Clarke and 34th Armoured Brigade) operating in the infantry-support role; and of an independent armoured brigade (6th Guards Armoured Brigade) operating in a new way.

New 'best practice' was embodied in the methods employed by 4th Armoured Brigade, and its activities provide a checklist of these methods.⁴² By early 1945, 7th Armoured Division had recovered from its 'stickiness' in time to play a significant part in the battle for Germany. For this reason, 7th Armoured Division's performance (out of the three British standard armoured divisions in 21st Army Group) is selected for most attention. Substantive progress in a process of improvement was because of its new commanders and the new

⁴² Carver, *History 4th Armoured Brigade*.

methods. By the time of the assault across the Rhine, at the end of the 'into Germany' phase, the situation for 21st Army Group's final advance to the Baltic and the Elbe was as follows: for some significant players of sufficient importance to have made them members of a small group of commanders for the purpose of a study of operational and tactical development and innovation, the new offensive techniques replaced the old. Further, key examples make it clear that new and replacement commanders coming to prominence were tending to adopt the new methods.

Since mid-December 1944, 4th Armoured Brigade had been the armoured brigade of an armoured division, under command 11th Armoured Division in place of 29th Armoured Brigade which had gone to re-equip with British Comet tanks instead of their American Shermans.⁴³ This shows that the Sherman-equipped independent armoured brigades were now regarded as being completely interchangeable with the armoured brigades of armoured divisions. In Normandy, tank-mounted 17-pdrs had been in short supply but this new development reflected the growing availability of Sherman Fireflies: each of 4th Armoured Brigade's armoured regiments now had twenty-four, a proportion which had doubled since D-day and Fireflies now made up half of each troop.⁴⁴ It was now possible to engage and defeat the German heavy tanks and tank destroyer variants on more equal terms.

Operation VERITABLE and its subsequent development Operation BLOCKBUSTER, launched into the Reichswald Forest east of Nijmegen on 8 February 1945 with a view to possessing all the ground west of the Rhine during the Anglo-Canadian offensive into the Rhineland, and which culminated as British and Canadian forces reached the river Rhine, constituted the scene for the further testing of the new offensive techniques. VERITABLE/BLOCKBUSTER began on 26 February 1945 when II Canadian Corps started its attack on the Germans' defensive

⁴³ Ibid., p. 35; Roberts, *Desert to Baltic*, p. 221. (The Comet was the last and most successful of Britain's wartime Cruiser tanks. The Comet had thicker armour than the Sherman and a high velocity 77mm gun. See also Appendix IV)

⁴⁴ Ibid., p. 36. (The Firefly was an American Sherman tank armed with a British 17-pdr gun instead of the standard 75mm. See also Chapter 3 and Appendix IV).

system east and south-east of the Reichswald. Carver's brigade was operating as the armoured brigade of 11th Armoured Division, the right division of II Canadian Corps. The new homogeneous armoured-infantry division now consisted of two brigades, each of two armoured regiments and two infantry battalions.⁴⁵ In conformity with this, to create the homogeneous armoured-infantry organization, 4th Armoured Brigade's 3rd/4th County of London Yeomanry armoured regiment (3rd/4th CLY) were 'loaned' to 159th Brigade, 11th Armoured Division's 'in-house' infantry brigade, in exchange for the 4th Battalion King's Shropshire Light Infantry (4th KSLI) coming to 4th Armoured Brigade. The 15th/19th H from 11th Armoured's Armoured Reconnaissance Regiment was employed as the 'fourth' armoured regiment required to make up the two homogeneous brigade-structure. 4th Armoured Brigade participated in the attack on 'the Schliessen [*sic*. Schlieffen?] line' (1-3 March 1945) during BLOCKBUSTER when it found itself in 'thick woods, full of bazookas [*sic*] and infantry, supported by a few SPs'.⁴⁶ This attests to the Germans' continued extensive use of tank-hunting parties as in the Reichswald. It also provides clear evidence of the nature of the techniques now being employed to overcome terrain and enemy. In their main characteristics they were those which were generalised by Montgomery. The exposition of the combat narrative demonstrates that the methods employed in breaching the Schlieffen line embodied new best practice.

The importance which Montgomery and others attached to achieving a higher tempo of operations has already been noted. Montgomery's obsession with remaining 'balanced' throughout his operations was a product of his need to keep the Initiative, and constantly to create new reserves so that he had the troops on hand to mount the next thrust. Thus a most important way momentum was maintained during the Schlieffen battle entailed moving armoured regiment-infantry battalion groups through each other: that is passing each group through its predecessor. In the fighting in Normandy, even experienced

⁴⁵ See Figure 3.2.

⁴⁶ *Ibid.*, p. 36. This could refer to the 'Schliessen line', or, more probably to the 'Schlieffen position' in said defence line around which the heaviest fighting took place.

commanders had sometimes been caught out this way. Thus, Major-General T.G. Rennie who had commanded 6th Black Watch in the desert, 154th Brigade in Sicily and 3rd Division on D-Day had assumed that the capture of Tilly-la-Campagne during TOTALIZE [7-8 August 1944] – once it had been bypassed and cut off – would require only one battalion of 152nd (Highland) Brigade, without tank support.⁴⁷ The other two battalions of the brigade as well as the other brigades, were given other tasks. In the VERITABLE operation, Rennie's 51st (Highland) Infantry Division was tasked with clearing the south-west corner of the Reichswald on a 5,000 yard from a start line east of Nijmegen, for which he employed 154th Infantry Brigade with 5th/7th Gordon Highlanders in support.

The 1th Battalion Black Watch start the attack, and occupied Breedeweg. [...] It was dark as she come on the surroundings of the forest, and come in heavy fightings with the German 122th Grenadier Regiment and the advance was stop here. One Battalion of the reserve brigade, the 7th Argylls and Sutherland Highlanders take over the attack [...]⁴⁸

Thus, by the time of his penultimate battle, Rennie had learned from earlier mistakes.

Early in the evening of 26 February 1945, the Royal Scots Grey (Greys) and 4th KSLI crossed their start line and soon made their first objective. The attack was continued through the night of 26/27 February. By the morning of 27 February, they had reached the railway line south-west of Udem. At first light, 44th Royal Tank Regiment (44th RTR) and 2nd KRRC passed through the Greys and 4th KSLI. Thick woods ran all along an open right flank. About midday, 3rd/4th CLY and 3rd Battalion Monmouthshire Regiment (3rd MONS) passed through 3rd Canadian Division, which had taken most of Udem, to capture the ridge south-east of the town. By late afternoon, they had reached the upper slopes of the ridge, 44th RTR and 2nd KRRC clearing the woods on the right flank and linking up with them. Fighting

⁴⁷ B. Reid, *No Holding Back: Operation Totalize, Normandy, August 1944* (Toronto: Robin Brass Studio, 2005), p. 187; S. Hart, *Road to Falaise* (Stroud: Sutton, 2004), p. 28.

⁴⁸ Mr David Rennie, 'The Battle of the Reichswald', account of events by Adrien Van Nerkoven, Mayor of Tilburg, nr Nijmegen, Holland. [unpublished].

continued during the night. By early afternoon the following day, 3rd/4th CLY and 159th Brigade Group succeeded in forming a bridgehead over the stream beyond the ridge. The 159th infantry, (1st Herefords) and 2nd KRRC were then relieved by infantry of 3rd Canadian Division. In late evening, 15th/19th H and the Herefords passed through and just beyond the forward positions they met the first Schlieffen defences.

On 1 March, 4th Armoured Brigade concentrated east of the stream, under cover of smoke, its supporting artillery coming into action. Following an unsuccessful attack by a single squadron of 159th Brigade Group to break out of the bridgehead east of the small stream beyond and south of the Gochfortzberg feature earlier in the day, it was decided that a hard blow should be launched in accordance with the principles of surprise and concentration. In mid-afternoon, 4th Armoured Brigade attacked the Schlieffen line, 44th RTR and 2nd KRRC on the right and the Greys and 4th KSLI on the left. While the right group made slow but steady progress, the left group was unable to get forward until they had turned north, established a new start line and re-started their advance. This took till well into the night. Meanwhile 44th RTR and 2nd KRRC had closed right up to the line.

The dispositions and manoeuvres by means of which contact was made with the enemy are as significant for present purposes as are those which are part of the fighting. Thus 4th Armoured Brigade, concentrated in full-strength east of the stream, attacked the line mid-afternoon in two groups, seeking to gain surprise through unbalancing the enemy with this method of attack and confusing him as to ultimate plans and intentions. The essence of Montgomery's military doctrine was to 'unbalance the enemy by manoeuvre while keeping well balanced [oneself]'.⁴⁹ The emphasis he placed on employing the alternative thrusts approach flowed from all of this, as did his view of the armoured division.

During the night the Greys and 4th KSLI attacked southwards. It is significant that, having seized the Hochwald feature and the high

⁴⁹ Montgomery, *A History of Warfare* (London: Collins, 1968), p. 22.

ground north of Sonsbeck on the morning of 2 March, the Greys and 4th KSLI prepared to receive, then decisively defeated, a counterattack by the enemy and consolidated their gains, creating a firm base for a further bound forward, because of Montgomery's view, seen earlier, of an armoured formation as a combined arms force that would seize key terrain in order to use the advantages of being on the defensive when the enemy counterattacked. In the afternoon, that night, and the following morning, 44th RTR and 2nd KRRC successfully cleared the southern end of the line, which effectively ended 4th Armoured Brigade's battle of the Schlieffen. The whole battle epitomises what will later be seen as the classic 'new style' action in the spirit of Montgomery's pamphlets, where he would write that the armoured commander must therefore have: 'a clear tactical picture in his mind at all times in order that he may grasp quickly a fleeting opportunity'.⁵⁰

It is important to note that Operation TOTALIZE (7-9 August 1944), mounted by Lieutenant-General Simonds' II Canadian Corps – to which 4th Armoured Brigade was now attached for BLOCKBUSTER as part of 11th Armoured Division – had involved a plan for a daring tank-cum-infantry night attack in conjunction with aircraft which took the enemy by surprise. Simonds' concept for TOTALIZE was to crack the German defences in two phases and then to exploit towards Falaise with his armour. The idea that fighting around the clock with armoured forces could be an answer and should be usual was something new. British armour in Normandy usually withdrew just behind the front line to laager once darkness fell; also, the overnight 'First Phase' advance was a one-off in the plan for the TOTALIZE operation.⁵¹ In the present battle, 4th Armoured Brigade operated by day and by night. The initiative of Roberts and Carver in pressing the advance by day and by night was new best practice.⁵² In Carver's and indeed, the other accounts of this

⁵⁰ *Armoured Div. in Battle*, para. 2.

⁵¹ Canadian Military Headquarters Historical Section, Report No. 169, (*Operations Totalize and Tractable*), 7 January 1949 <http://www.dnd.ca/hr/dhh/Downloads/cmhq/cmhq.169.pdf> [accessed 6 December 2005] (para. 18).

⁵² *Armoured Div. in Battle*, paras. 41 and 46.

combat episode by those at this middle level of command ‘all went like clockwork’.⁵³

After completing his work for Montgomery on *The Infantry Division in Battle* (November 1944), Lyne commanded 7th Armoured Division for the remainder of the war against Germany. In October 1944, Whistler asked himself ‘what can have happened to the Desert Rats. Their name stinketh to heaven’.⁵⁴ Although they had played a prominent role in the advance across France and Belgium, there was a widespread perception among 21st Army Group commanders that when it came to anything but the exploitation role – as during the ‘Great Swan’ across France and Belgium – 7th Armoured was a ‘problem’ division. This was the situation Montgomery sought to address in November 1944 with Lyne’s appointment.⁵⁵ Lyne’s career was unique among Montgomery’s lieutenants – he was the only commander in 21st Army Group to command infantry divisions and then an armoured division – and it is intensely interesting for this reason. Certainly, the weight of evidence suggests that, so far as re-organization and changes in respect of armour were concerned, Lyne was an ‘implementer’ rather than an ‘innovator’.

From an analysis of Lyne’s command and operational decision-making it is possible to further establish how Montgomery wished the armoured divisions to function in the remainder of the war. If the Sherman-equipped independent armoured brigades were now regarded as interchangeable with the armoured brigades of armoured divisions, the corollary was the expectation that the armoured brigades of armoured divisions would now be able effectively to discharge the independent armoured brigades’ role of infantry support. It had previously been thought that to compensate for their slow movement whilst closing the range, as the role of infantry support demanded, a heavily armoured tank would be required.

⁵³ Carver, *History 4th Armoured Brigade*, p.37.

⁵⁴ WSRO, Whistler Papers, 9/48, personal diary, 6 October 1944. O’Connor felt the same in August 1944.

⁵⁵ IWM, Lyne Papers, 71/2/4, Maj.-Gen. L.O. Lyne, unpublished autobiography, [n.d.], Ch. X, ‘Command of the 7th Armoured Division – The last gallop’, p. 1.

The first task Lyne set himself was to return 131st Infantry Brigade to full strength. By this time the shortage of trained infantry was so chronic that the number of rifle companies in each battalion had fallen to two, of between one and three platoons each. Informal, more direct communication with Montgomery apparently allowed Lyne to fill out the four rifle companies in each battalion to full strength, each composed of three platoons.⁵⁶

For Lyne, the most important thing now was ‘to get the relationship between infantry and armour back onto a proper basis’.⁵⁷ He quickly realised that a certain amount of mutual distrust existed between infantry and armour. From his past experience in Normandy, Lyne had concluded that ‘the importance of infantry working with tank units, with whom they have previously trained and been able to establish a basis of mutual confidence, cannot be too strongly stressed’.⁵⁸ Accordingly he now started a system of affiliation between armoured regiments and the ‘new’ infantry battalions – 2nd Battalion Devonshire Regiment (2nd Devons) and 9th Battalion Durham Light Infantry (9th DLI) – to ensure closer co-operation. This reflected past British experience and was now standard practice.

In Normandy, the infantry brigade in 7th Armoured Division and the armoured brigade co-operated at times very closely. This was not as close as the level of co-operation developed in Roberts’ 11th Armoured, however. Nevertheless, elements of the two brigades had been mixed so that they formed armour-infantry groups of mutually supporting individual tanks and infantry.⁵⁹ In Normandy, these were not formally brigade groups as such, but they were in essence. A reasonable case can be made that they reflected a view among the armour in 7th Armoured that co-operation with the infantry would always be a temporary arrangement. Towards the end of 1944, Montgomery’s removal of ‘blockers’ such as Erskine and Hinde represented a definite

⁵⁶ IWM, Lyne Papers, 71/2/4, unpublished autobiography, Ch. X, pp.1 and 4.

⁵⁷ Ibid., p.3.

⁵⁸ IWM, Lyne Papers, 71/2/4, unpublished autobiography, Ch.VIII, ‘Command of 59th (Staffordshire) Division – Normandy’, p.11.

⁵⁹ IWM, Burton Papers, 94/8/1, Maj. B.E.L. Burton [second-in-command, 1/5th Queens, 131st Brigade, 7th Armoured Division], ‘Diary of a Regimental Officer’, July 6-16, 1944.

and determined attempt to replace people who had one kind of past experience as practitioners. In spite of this, Lyne was aware of 'a tendency in some quarters [i.e. among the armour] to regard the Division as so veteran and battle-worthy that re-training to meet new conditions was unnecessary'. This Lyne 'firmly stamped on'.⁶⁰ Brigadier A.D.R. Wingfield was CO 22nd Armoured Brigade from November 1944. His view at that time was that

an armoured division is the modern strategic cavalry; and, as such, is designed for strategic reconnaissance and exploitation. In these operations (Alan and Colin) the role of 7th Armoured Division was exploitation; but in the early stages of the attack (Alan) its tanks were used for close support of the infantry assault. This was justifiable in the event as the enemy resistance had not been unduly strong, and had been brief. Heavy tank casualties had not been incurred and the tanks had been released from that role as early as possible. Furthermore, the distance to the final objective was comparatively short. Had those factors not prevailed I doubt whether an armoured brigade could have completed the two tasks successfully.⁶¹

This was a concept which among other things still reflected the 'cavalry concept' of armoured warfare and the doctrinaire British view of the roles of armour as alternates – either infantry-support or cavalry/exploitation – requiring two different types of formation each equipped with a different kind of tank. Lyne was trying to implement a different view: that these must be seen as alternating roles of all armoured formations. Finding a fourth armoured regiment by moving the 8th Hussars (8th H), whose task had been reconnaissance, into 22nd Armoured Brigade, Lyne adopted the homogeneous brigade group structure – in practice, if not in theory.

By this stage, there was nothing particularly new in this. This type of brigade group was associated with Roberts particularly but also with Adair of Guards Armoured, as well as with 4th Canadian and 1st Polish armoured divisions. But in at least two significant ways, re-organization of 7th Armoured under Lyne involved or reflected new best practice, as

⁶⁰ IWM, Lyne Papers, 71/2/4, unpublished autobiography, Ch.X, p.3.

⁶¹ IWM, Wingfield Papers, PP/MCR/35, Brig. A.D.R. Wingfield, 22nd Armoured Brigade, notes on operations ALAN and COLIN (October 1944), quoted in his unpublished memoirs, 1980 [on microfilm], pp. 294-95.

enunciated by Montgomery formally in his pamphlets, as we shall see in the next chapter.

The first was the attempt by Lyne to address, if not once and for all then certainly before the resumption of mobile operations and the final assault on Germany, what an armoured division like 7th Armoured was for. This involved addressing the position adopted by Hinde following the early difficulties in Normandy, that the country was ‘unquestionably one’ for the infantry supported by tanks, not for tanks of an armoured division such as 7th Armoured with a small supporting component of infantry.⁶² Lyne conceded that ‘the country [ahead] did not hold out much hope of successful armoured Divisional tactics as usually taught in the training pamphlets’. However, this was not what was now being taught in 21st Army Group. Lyne was at pains to rub in that ‘our job was to fight and succeed in any kind of country under any conditions’; and to make it clear that the shortage of trained infantry everywhere meant an armoured division could not ‘allow itself the luxury of keeping a certain type of formation [i.e. the armoured brigades] “on ice” for a particular form of operation’.⁶³ Close co-operation with infantry had hitherto been primarily the responsibility of 21st Army Group’s tank brigades – mainly equipped with the Churchill. Montgomery had long decided that this was unsatisfactory. In November 1944, Lyne duly established the 7th Armoured Division Battle School ‘with much enthusiasm’.⁶⁴ From his viewpoint, it ‘played a particularly important part in training junior leaders of both armour and infantry in a common doctrine’.⁶⁵ What was required, Montgomery believed, was armoured formations capable of ‘ubiquitous’ use, equipped and trained accordingly.⁶⁶ Lastly, as a result of experience gained during 7th Armoured Division’s participation in Operation BLACKCOCK (15-21 January 1945) to eliminate the German salient south-west of the river

⁶² See this thesis, Chapter 2.

⁶³ IWM, Lyne Papers, 74/2/1, unpublished autobiography, Ch. X, p. 6.

⁶⁴ IWM, Wingfield Papers, PP/MCR/35, unpublished memoirs, p. 305.

⁶⁵ IWM, Lyne Papers, 71/2/4, unpublished autobiography, Ch. X, p. 5.

⁶⁶ *Armoured Div. in Battle*, e.g. para. 6. The term ubiquitous refers to the role of armoured brigades. The sense here is different from some other contemporary usages by Allied commanders, e.g. Adm. Raymond Spruance USN. It is not meant to mean that armour could be everywhere – because it could go anywhere.

Roer between Roermond and Geilenkirchen, Lyne reorganised the (131st) Infantry Brigade H.Q. and included the necessary command tanks and signal facilities to put it on an equal footing with the (22nd) Armoured Brigade and capable of commanding any combination of infantry and armour.⁶⁷ In Lyne's view, during Operation BLACKCOCK 'the tanks had succeeded in giving really good close support to the infantry'.⁶⁸

What Lyne did was to reorganise the two arms in a force structure which embodied a better balance between armour and infantry, while simultaneously attempting to encourage in each arm a better, more realistic expectation of what the other could achieve, through nurturing a common doctrine. However, the ubiquity of role of the Sherman-equipped armoured brigades did not bring about the eclipse of the tank brigades equipped with the Churchill that Montgomery had anticipated. The example of Clarke and 34th Armoured Brigade operating in the infantry-support role during Operation VERITABLE demonstrates further good coordination and makes it clear as well that this was also perceived to come from 'training together and getting to know the inf[antry]'.⁶⁹ However, the Churchill-equipped brigades' role was also undergoing a process of redefinition to go with their re-designation as 'armoured brigades'. Churchill-equipped armoured brigades took on a new lease of life. It will be recalled that in Normandy it had come to be believed that the objectives of a Churchill-equipped tank brigade could be to use the Churchill's cross-country ability to get into positions where it could not easily be seen, with the object of closing the gap between the superior performance of the German 88mm or long 75mm guns and the Churchill's own armament in order better to support the assaulting infantry. The example of Greenacre and 6th Guards Armoured Brigade also makes it clear that for and in the advance from the Rhine new and replacement commanders coming to prominence were tending to adopt these new methods.

⁶⁷ Ibid., para. 21.

⁶⁸ IWM, Lyne Papers, 71/2/4, unpublished autobiography, Ch. X, p.11.

⁶⁹ IWM, Greenacre Papers, 94/33/1, Guards Brigade Papers 1944-1946, 34th Armoured Brigade Conference, 4 March 1945, Minutes, para.4.

For VERITABLE, two of 34th Armoured Brigade's armoured regiments were placed under command 53rd Division and the third was put under command 51st Division. Ross, GOC 53rd Division, laid it down that armour would predominate in the attack over the open ground from the start line to the forest, and would put the infantry into the Reichswald. However, it was also laid down that 34th Armoured Brigade would support 53rd Division 'in all phases of the op[eration]', that is not just in the tank brigades' traditional role of assisting the infantry to break into the enemy's fixed defences and then retiring.⁷⁰ Ross wanted close tank support to the infantry inside the forest both by day and night. The task of 9th RTR, therefore, lay solely in the forest, in support of 160th Infantry Brigade. This required not only the closest co-operation between tanks and infantry but also posed new problems of method (forest fighting tactics and night advances through bush, a type of terrain 'reckoned as tank-proof hitherto').⁷¹ A number of Brigade Conferences were held by Brigadier Clarke to 'determine means of overcoming the several particular problems of the attack', which included participation of the representative of 30th Armoured Brigade, 79th Armoured Division (specialised armour).⁷² Relevant factors in the approach to the Reichswald included not only the importance of the actual ground (open) but also its state (mud and mines). Clarke was determined, if necessary, to expend a complete squadron of tanks from 147th Regiment RAC (147th RAC) getting through the mud and mines before giving up the attempt to lead the infantry to the edge of the Reichswald. The 'going' was such that 79th Armoured Division units failed to cross the start line on 53rd Division's front.

The 34th Armoured Brigade history singles out for particular prominence the performance of 9th RTR in the Reichswald during the night 8/9 February, 1945, when the regiment carried out a fighting advance of 2000 yards with 160th Infantry Brigade to capture the

⁷⁰ IWM, Greenacre Papers, 94/33/1, Brig. W.S. Clarke, Op. VERITABLE: 'Gist of Outline Plan as affecting 34 Armoured Brigade', para.3.

⁷¹ Anon. [Brig. W.S. Clarke], *The Story of 34 Armoured Bde* (Privately published, Germany, c.1948), p. 13.

⁷² IWM, Greenacre Papers, 94/33/1, Operation VERITABLE: 'Report on 34 Armoured Brigade Ops from D-Day to end of the Reichswald Forest Phase', p. 2.

Stoppelberg feature, arriving on the objective ‘up with their infantry’.⁷³ However, to put the infantry on to their objective – that is into the Reichswald – it had been necessary to attack across an ‘open’ area. In this process, tanks of 147th RAC which had got across an anti-tank ditch took up firing positions in buildings, conforming to the new methods of tank fighting with Churchill-equipped armoured brigades practised by 6th Guards Tank Brigade. Later, in the south-eastern corner of the Reichswald, tanks of 147th RAC took up fire positions and fired heavily from the west on a well-sited, well-defended position which had resisted all attempts to take it the previous day, while infantry from 7th Royal Welsh Fusiliers attacked from the south-west. Both these actions can be seen as representing the convergence of the experience of the two armoured brigades (34th and 6th Guards), that is, that the official doctrine which emphasised the close physical proximity of the two arms was inappropriate in these new sets of circumstances.

At first sight the formations and tactics employed by 34th Armoured Brigade in the battle of the Reichswald apparently had the outward appearance of best practice as enunciated in official doctrine and even Montgomery’s own pre-D-Day doctrine. However, closer inspection reveals a multi-layered set of reactions to circumstances, which drew both from the more recent experience of Churchill-equipped armoured brigades in Normandy and the encouragement to commanders at lower level to exercise their initiative and be proactive when confronted by new circumstances and new problems of fighting. Thus, it can be seen to be illustrative of the doctrine recently institutionalised by Montgomery. Lieutenant-Colonel P.N. Veale, CO, 9th RTR, in a report – endorsed by Clarke – on close support to infantry in forest fighting, concluded that ‘[or]m[at]ions and tactics must be varied as much as conditions allow’.⁷⁴ This reflected the new general doctrine or best practice for tank-infantry unit organization and structure in Montgomery’s army group.⁷⁵

⁷³ [Clarke], *34 Armoured Bde*, p. 14.

⁷⁴ IWM, Greenacre Papers, 94/33/1, Lt.-Col. P.N. Veale, ‘ASPECTS OF CLOSE SP TO INF IN FOREST FIGHTING’, para.7.

⁷⁵ *Conduct of War & Infantry Div. in Battle.*, para.51.

However, to return to the issue of the typicality or otherwise of each or any of these Churchill-equipped independent armoured brigades it is helpful to compare the tactics and performance of 6th Guards Armoured Brigade with those of 34th Armoured Brigade. These two brigades were, in effect, representative of the 'heavy' armoured brigades of 21st Army Group, and the development, post-Normandy, of specific operational tasks and generic tactics for them is critical. It is important to also bear in mind that 6th Guards Armoured Brigade had, since the Battle of Normandy, a new commander, Brigadier W.D.C. Greenacre, who succeeded Brigadier Sir W. Barttelot (killed in action), who in turn replaced Verney.

With the renaming of the Churchill tank brigades as Independent Armoured Brigades came a re-organization, for which appropriate concepts of tactical handling, as well as suggestions to further improve the new organization, were developed through informal communication between Churchill armoured brigade commanders. These drew on their reflections on recent experience, as well as on the new general 21st Army Group doctrine for armour-infantry co-operation, which itself drew upon the interaction of ideas of those closest to the actual fighting with those developed at high level, including, ultimately, Montgomery himself.

Thus, during a visit by the MGRAC, G.W. Richards, Montgomery's Tank Advisor, to Greenacre at 6th Guards Armoured Brigade Headquarters on the morning of 7 March 1945, Clarke (34th Armoured Brigade) was also present. Back at his own 34th Armoured Brigade Headquarters later that day, Clarke wrote to Greenacre referring to an agreement the two of them had made during or after Richards' visit 'to "belly ache" in unison on our joint woes', enclosing an account of 34th Armoured Brigade's participation in VERITABLE.⁷⁶ We can deduce that Greenacre and Clarke were of one mind – and that *that* was why Clarke was sending him the description of 34th Armoured Brigade's 'recent ramble in the woods', because: 'what befell there might interest you in

⁷⁶ IWM, Greenacre Papers, 94/33/1, Operation VERITABLE: 'Report on 34 Armoured Brigade Ops' and covering letter, Brig. W.S. Clarke to Brig. W.D.C. Greenacre, 7 March 1945.

certain places'. They were thinking along the same lines: 'we shall be in different Corps for the next operation [PLUNDER – the Rhine Crossing] but shall no doubt continue to have the same difficulties', that is ones common to Churchill-equipped armoured brigades.

'I think', Clarke wrote, 'we impressed the MGRAC [Richards] with the need for an overall increase [...] so that we may, for a change, own our own [specialised armoured and engineer equipment such as armoured] bridgelayers'. They agreed in that aim, and also on the desirability of increasing the firepower of the new armoured brigades: 'I will attack Jorrocks [Horrocks] next time I see him on the score of one separate field regiment [of SP artillery] to one tank brigade'. This was what would later become a recognised 'establishment' norm for the Independent Armoured Brigades.⁷⁷

The exposition of the combat narratives in this chapter shows that the methods employed by 21st Army Group came to demonstrate new best practice. After Arnhem Montgomery realised there would be no easy or rapid advance into Germany. The ability of the British Army to overcome the Germans continued to depend on its ability to mount successful combined arms operations. Command, doctrinal and organizational shortcomings had to be addressed. His aim was to improve the performance of his infantry divisions and armour in battle across all three of the variables at play throughout this period. To realise his operational level aims Montgomery chose to rely on ingenuity or conceptual superiority. Following on from this, at the tactical level, he sought to shape and manage the expectations of infantry and armour as to what the other could achieve in order to ensure effective coordinated armour-infantry co-operation. He was interested in people who could tell him what would work. His main idea was to be so quickly responsive to circumstances as to be able to bring about a change of circumstance.

⁷⁷H.F.Joslen *Orders of Battle Volume 1 United Kingdom and Colonial Formations and Units in the Second World War 1939-1945*. (London: H.M.S.O., 1960), 2 vols. Vol. 1, p.10.

While there had been a general dynamic, or process in which Montgomery sought to impose his tactical view, and while that view was ostensibly accepted at corps level and at divisional level, a more complex set of relations between people, circumstances and equipment meant that contributors from below higher levels of command – and below the corps and divisional levels in the case of the commanders of independent tank and armoured brigades supporting divisions – were also important in the course of shaping the final doctrine. To a greater extent than might hitherto have been supposed, the development of armoured-cum-infantry tactical doctrine was collaborative among these commanders and between commanders and the Commander-in-Chief: this co-creation, by Montgomery and key members of a small group of 21st Army Group commanders, of doctrine for the final assault on Germany was the main factor which both influenced and helped bring about the outcome whereby all corps commanders and divisional commanders utilised the same methods.

Commanders who realised that these lessons were the right ones, such as Barker, needed no convincing. Further, therefore, the thinking of 'rising' subordinate commanders not directly involved in the drafting of Montgomery's pamphlets, derived from their experiences of actually fighting on the ground with infantry and armour, was congruent with the thinking expressed therein. Furthermore, however, the way in which Montgomery sought to achieve a uniformity of practice was through the effective dismissal or removal of those 'blockers', that is those with a different kind of past experience; another process was also in operation: how Montgomery commanded, and tried to ensure that his system worked with 'everybody singing from the same hymn sheet' by means of his pamphlets, through his conferences, through what he said and wrote to his commanders on other occasions, and through arrangements such as Lyne's 7th Armoured Division ad hoc 'Battle school'. There is a complementarity between the processes. They were simultaneous and interlocking.

Montgomery thus intervened in several ways. One was to institutionalise doctrine – intended to be the vital articulation between

previous thinking, past experience and the present military problem to be solved. Another was to remove from the pool or team those with past experience as practitioners who had been found wanting. The most modern historiography still describes the approach to tactical doctrine as apparently anarchic. This may indeed be correct for early to mid-1944. However, by the end of 1944, it would be more accurate to say this apparent permissiveness remained only within the actual parameters of a more ordered 21st Army Group approach to tactics as well as to operational-level tasks that had developed as events unfolded. Further, once it had developed within 21st Army Group those who could not or would not work within it, among whom Bucknall was in the former category and O'Connor in the latter, either were removed or effectively removed themselves from command and were replaced with those who could. 'Rightness' can be seen in the later actions of Adair, Carver, Barker, Roberts, Clarke, Greenacre and Lyne, particularly in the role of Lyne as an implementer closely tied to Montgomery. Whistler could follow and adapt.

Thus, the apparent permission which remained was actually only permission to act within a commonly understood set of guidelines. These guidelines required the subordinate commander to act according to Montgomery's principle of war, The Initiative, and his principle of command, the initiative. Thus, the view that Montgomery moved from prescription to an authoritarian approach in and after Normandy is a gross over-simplification. What he laid down was the necessity to be problem-solving. This allowed for a 'crossover' to War Office doctrine, but only in so far as this was not incompatible with 21st Army Group doctrine at any one time.

Finally it has to be made clear that Montgomery's belief that it was by the initiative of subordinates that the battle was finally won did not mean the subordinate commander altering the master plan. Rather, it meant his ascertaining the facts of the situation, then making plans to deal with the problem. It was a problem-solving approach within the given plan.

The apparent problem posed by the historiography, of whether it was a top-down dominated scene or a superficially subordinate but actually quite anarchic scene, is an incorrect way to look at the problem as far as doctrine and operations are concerned. The suggestion in Carver's account of BLOCKBUSTER and others by those at this middle level of command that everything went 'like clockwork' indicates a clear connection for them between the ideas behind the conduct of this operation and its outcome. The simple conclusion which can be drawn is that the separation of Montgomery and the innovators and the drivers of innovation on the one hand and the implementers on the other had now reduced so much that asking if change came from the top down only or whether it was the product of a superficially subordinate but apparently 'anarchic' situation, so far as the process of innovation was concerned, is simply a redundant question by this time. All were doing something new but they were interpreting it and doing it in their own way.

This achievement of Montgomery's goal of a widening spiral of improvement across operational and tactical skills, in conducting the type of operations he now thought were necessary, in the given battle-space, at the tempo he desired led to the emergence of a new framework for action, through which previous experience could be successfully reinterpreted and brought to bear effectively. This was a different way to bring experience to bear. The orientation that previously sufficed was experience of 'what to do' but by late 1944 and into early 1945 the experience of 'quick thinking' within the goals of the master plan was the solution rather than any specific course of prescriptive action.

Terrain and conditions – including the very bad weather, which deprived the attackers of really effective air support – together with ferocious opposition from the Germans and in particular the threat posed to British tanks by the Germans' extremely clever tactical use of self-propelled guns and hand-held, hollow charge weapons, all hampered rapid progress during the Winter 1944-45 battles. However, whether the result of operational decision-making was a decision to mount a series of infantry and armoured attacks as Roberts and Carver

did with 4th Armoured Brigade, or to find a way around, as when Lyne decided to attempt to achieve surprise by a break-in on the British advanced left flank with 7th Armoured Division and thus take the main enemy positions astride the Sittard-Roermond road from the rear, lessons learned by British commanders from armoured-cum-infantry operations in the final months of 1944 show a dynamic relationship between problem-solving and the framework within which problems could and should be solved. This framework reflected what had come to be recognised as the 'right' tactical methods. It owed much to Montgomery's efforts to further elucidate what he regarded as the really important operational lessons to be learned from the campaign, and to his attempts to enforce a mould of consensus.

CHAPTER 5

FROM 'ANARCHY' TO PROBLEM-SOLVING (2): MONTGOMERY'S MANAGEMENT AND ITS PRACTICAL EXPRESSION, SEPTEMBER 1944 TO APRIL 1945

Following on from the apparent 'anarchy' or lack of control in the summer of 1944, divisional, corps and brigade commanders responded to Montgomery's command system and reflected in their methods the way that had become accepted and that way he now wanted them to fight. The 'set-piece', or large-scale deliberate assault battle employing the full concentration of offensive resources, was what we may now call 'Montgomery's strategy' or selected military method, that is, his adopted style of war-fighting. This was a recognizable strategy: as Montgomery and his legions fought their way into Germany, the maximum use was made of all available firepower. At the operational level, Montgomery's emphasis on the set-piece battle as his chosen style of war-fighting placed the relative superiority of the British Army in matériel against the relative weaknesses of the Germans in matériel.

The weight of firepower and emphasis on other material factors which the British were able to employ in a highly organised, intricate and balanced way by that late stage of the campaign were not capable of being equalled by the Germans. However, the Germans had shown themselves to be adept at accommodating their material inferiority and achieving effects out of all proportion to their actual weapon power. In addition, the delayed launch of the converging American operation, GRENADE meant that fighting during VERITABLE (8 February-10 March 1945) took on an attritional quality. The problem was to regain the Initiative by resuming more mobile operations. This, in turn, required subordinate commanders to exercise their initiative to be proactive.

Institutional practices were still highly resistant to a commonality of practice, and to a uniformity of practice in combining or integrating

armour and infantry. Combining and recombining, in a flexible and rapid manner was to prove to be required in a situation where it was necessary to overcome the dense anti-tank defences which the Germans had put in place in North-West Europe. To make the 'model' fully explicatory the previous chapter has filled out the substance of Montgomery's active contribution: how he intervened to institutionalise a meld of those ideas that had come to be widely agreed upon by him and key commanders. It is now necessary to turn to how that meld of ideas – not War Office doctrine – was expressed, and fed or translated back into the expression of doctrine in 21st Army Group. The operation of a military culture which permitted apparent anarchy became translated into a new framework for action, which at the most basic level gave rise to standard operating procedures or routines. The core value became the Initiative/initiative because, as Montgomery recognised, there was no such thing as a 'normal' battle.

A process existed for feeding 'lessons learned' into a corpus of many different types of doctrinal publications. This reflected the perceived need for the importance of doctrine. In the Second World War, Montgomery was not alone in comprehending the importance of the Initiative in planning and conducting operations.¹ However, in his pamphlets, at the end of 1944 Montgomery attempted to systematise his methods. We can thus speak of, and identify, his 'principles of war'. This format drew its broad inspiration from the general way the army attempted to adjust official doctrine to lessons learned from operations. This was an approach with roots in the previous thinking and experience of the British military, as first expressed in *FSR* of 1920 where initiative was considered not to be a principle of war in its own right. However, by late 1944, gaining the Initiative had become one of Montgomery's principles of war.

Carver, reflecting Montgomery's views, further developed his views post-Normandy, as demonstrated in his command of 4th Armoured Brigade. It was essential to prevent the Germans regaining balance and

¹ Slim did so too: 'in war it is all-important to gain and retain the initiative, to make the enemy conform to your action, to dance to your tune', Field-Marshal the Viscount Slim, *Defeat into Victory*, unabridged ed., (London: Cassell, 1956), p. 292 .

securing a ruptured front before mobile warfare overwhelmed their remaining forces in the final phase of the campaign. Carver was thinking strategically:

The great art is first to be able to judge correctly which are the most important factors at any one time: secondly to choose the right moment for decision, decide then stick to it. [...] When the decision is to be made, it must be made immediately, which it can only be if you have kept yourself well informed and have been looking ahead all the time. [...]if a commander has not the mental courage to make decisions without delay and to stick to them, if he hovers or constantly changes his mind, the result will be a loss of the initiative and confusion.²

It can be seen that responses were becoming more rapid in terms of the speed with which plans were being both made and carried out and hence more effective. This was not a rising tide which 'raised all boats' in terms of a fast decision-action cycle by all commanders across the board. A problem remained from the time of the early fighting in Normandy when, still trying individually to learn from and to apply War Office doctrine 'nobody would learn from the experiences of others' and instead in practice applied principles at a remove from current practical lessons. In the later stages of the campaign, in the case of a division such as 52nd (Lowland) Infantry Division which had not seen action in the Normandy fighting or indeed in the pursuit phase thereafter, there were also problems learning quickly enough from current experience. This had created a gulf between the ideas that those responsible for tactical leadership were looking for and what was said in official written doctrine. It still did not solve the problem of everybody 'singing from the same hymn sheet' of a strong common doctrine of all arms. The fall out of this was that Montgomery, aware that superiority in matériel on its own was not enough to guarantee success, also sought conceptual superiority in the area in which doctrine, actual systems and their proper utilization on the battlefield.

Montgomery sought to edge his legions away from repetitive tactical repertoires, not only with the intention of imposing mobile war on the

² IWM, Carver Papers, Lectures and Articles on Armoured Warfare 1940s, Brig. R.M.P. Carver, 'Command Of An Independent Armoured Brigade – Some of the More Important Points', p.5.

enemy per se but also of creating the relationship between conceptual and material superiority which would bring material superiority to bear to greatest effect in changing circumstances. There would thus be a vital interplay between securing the Initiative in operations and the institutionalization of tactical conceptions which, against the baseline of the standard tactical methods which best comprised the action of all arms, emphasised decentralised on-the-spot decision-making, and required commanders to exercise their initiative to be proactive. This was intended to reduce the need for orders. Always, however, whatever was done had to be within the aims and objectives of what Montgomery called 'a master plan': this was a design for operations, utilizing the dimension of the air as well. In this way, Montgomery hoped to bring tactics into line, or as much into line as was necessary, to realise his operational conception of mobile war as a further development from the set piece battle, once the conditions for break out had been created: where the opposition was organised, but not continuous, either in a firm front, or in depth. Finally, there would be a pursuit, presenting even greater opportunities for speed of thought and action. New 'best practice' within the ground-rules Montgomery had laid down in the pamphlets was seen to be embodied in the methods employed by Carver's 4th Armoured Brigade, Greenacre's 6th Guards Armoured Brigade, and Barker's VIII Corps after the Rhine Crossing.

The advance into Germany and the breaching of the Rhine barrier itself preparatory to the advance from the Rhine was important for the command, operational and tactical development that took place. Under Montgomery's general direction, this yielded a specific doctrine as a framework for action and – more importantly – a specified manner or general style of command as the framework of action. The reason this took as long as it did, in addition to circumstances in the progress of the campaign, lay in the historical experience of the Army as an institution. Nevertheless, the western defences of Germany were successfully breached in late 1944-early 1945 and the Rhine reached in early 1945.

Montgomery's belief that adaptability depends almost entirely on people and their training was to be made a precept or key part of what

the doctrine actually said. The armour to hand was a factor influencing the development of the new tactical doctrine which was being created. Thus, the shape of final doctrine was influenced by adaptations at lower level to employ the different types of tank available to best effect. According to Montgomery's 'capital tank' idea, making the Sherman tank – and all other models of tanks – a multi-role tank would best match tactics and a tank that was available to operational aims and intentions. What the Churchill-equipped armoured brigades did was thus indicative of what was acceptable new practice rather than being illustrative of Montgomery's preferred organization and best practice for *all* armoured units. The different type of tanks available was an important factor affecting both the shape and application of the final doctrine.

New Circumstances and New Ideas

There was a powerful sense of the need for speed, strategically, operationally, tactically, and individually if the war was to be won in time; in order to achieve this it was necessary to maintain a pattern of action that was offensive. Montgomery exercised personal command. He communicated either directly or through senior intermediaries with his senior commanders. Thereafter, within the general limits of the framework of his instructions or plan, these subordinates could do as they liked to realise his intentions. Frequently, however, the lack of accompanying detailed, specific written orders from Montgomery had allowed confusion to creep in as to his actual aims and intentions, and created the exact opposite of gaining and holding 'the Initiative' that Montgomery wanted.

Innovation with respect to integrating and combining armour and infantry was initiated primarily in the armoured arm. This was where the need was greatest. The processes by and through which doctrine was created in 21st Army Group in action involved the brigade and divisional levels because, as the levels of management closest to the actual fighting, they were in the first instance the level of learning how

to do it with the equipment to hand, and the available manpower. Within the command chain the drive for operational and tactical innovation was push-pull, and went in both directions. Commanders at lower level had challenged, sometimes criticised and were also changing previous doctrine in response to the problems of fighting in Normandy.

While the need for speed permeated the entire command structure, commanders at different levels could be working from different planning systems towards different planning objectives because of different past experiences which were in play. Some were simply bound by or to the lessons from previous victories.³ Further, this dynamic sometimes led to a lack of new thinking by more junior officers.⁴ However, operational and tactical challenges provided the seedbed for the growth of new ideas. The reasons for the genesis of ideas were both operational and tactical. Operationally, manoeuvre-oriented methods instigated on the basis of previous experience in the armoured arm had failed: thus a 'business-as-usual' approach was clearly not going to be sufficient. Tactically, the Germans could be well dug-in, they were well-protected in well-camouflaged positions, and their tanks still enjoyed some advantage of long-range fire. They were not going to be easy to dislodge and their dense anti-tank defences were not going to be overcome by the use of armour alone. What Montgomery wanted from his commanders was the introduction of better combined-arms practice and for all officers proactively to exercise initiative in order to secure the Initiative. Figure 5.1 provides a diagrammatic representation of where the three experience groups were in mid- to late 1944, at the start of the process of new doctrine being developed under Montgomery's direction. The three groups had become two by mid- to late 1944 as the value of both 'desert training' and War Office related doctrine were increasingly discarded in favour of new solutions to new problems of combat, learned at first hand, or from those who were in contact with the enemy. These new solutions were tried out and found sufficient and acceptable practice.

³ Bucknall, Erskine, and Hinde, for example.

⁴ For example, the actions of 52nd Division at Drierwalde and Hopsten, as shall be seen later in this chapter.

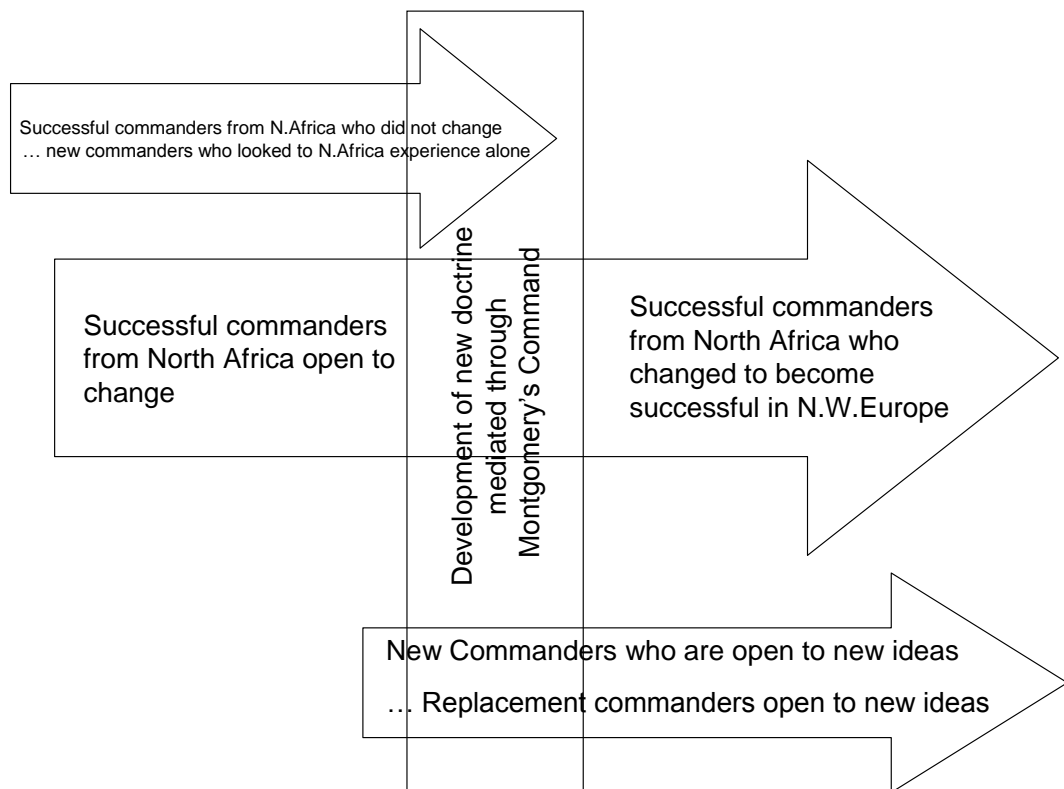

Figure 5.1: The development of new doctrine, mid- to late 1944

The large British armoured force fielded by 21st Army Group in June 1944 had been a force divided by doctrine. War Office policy was officially to accept the doctrines of two contending schools of thought as to the 'true' purpose of armoured formations; that tanks might be used in close co-operation with infantry, or that they might operate independently. However, in practice the functions of tanks were seen as alternatives: either infantry-armour co-operation or exploitation, each requiring a different type of tank: the type of tank, cruiser tanks or infantry tanks, with which a formation was principally equipped made its intended battlefield role clear.

The Perceived Need For and Importance of Doctrine

Within a military culture which emphasised the learning of the correct lessons – which higher leaders (brigade commanders and above)

were regarded as being able to learn for themselves, then teach subordinates – doctrinal publications appeared in a number of different series, each with its own function within the overall purpose of doctrinal dissemination. Doctrinal publications – of which there were many – inevitably presented ideal sets of general circumstances, and also principles or methods by which it was understood that certain results or objects might be achieved. Although it was emphasised that, in order to follow through the lines of doctrine, principles should be adapted to situations according to the circumstances, in practice junior officers were taught to reason according to a series of prescribed steps to form an appreciation of the situation. There was often a lack of adequate guidance for junior commanders on how to apply principles of war at their level, according to the circumstances of the moment. This meant that they leaned on heavily formulaic principles of war. Traditionally, junior commanders had little freedom of action. This can be contrasted with senior officers’ planning procedures. Senior officers, often brigade commanders and above, had been traditionally allowed great latitude to permit maximum possible freedom of action so that nothing was allowed to interfere with the intention to complete the particular task in hand which was part of an overall and wider plan. As the early stages of the Battle of Normandy had demonstrated, this freedom had frequently resulted in failure by corps commanders to gain and hold ‘the Initiative’, and loss of initiative and confusion by even divisional commanders, let alone their brigade commanders. This doctrine, or lack of it, did not empower subordinates to act in the way Montgomery now wanted after Arnhem.

In 1940 and 1941, as a commander in the UK, Montgomery’s predilection for teaching people ‘lessons’ led him to organise ‘study weeks’. Between 7 and 12 October 1940, for example, all unit commanders down to battalion COs were required to contribute to, or at least participate in Montgomery’s V Corps Study Week:

The study week was a huge success. I think everyone enjoyed it; it went with a “bang” from start to finish and we all learned a great deal. The night operation scheme was

voted great value and I am grateful to you for the preliminary work you put into it.⁵

His determination that the lessons of his campaigns should be properly understood and disseminated has been duly noted:

Ensuring that the right lessons were spread as widely as possible was clearly a task to which Montgomery was deeply committed. He carried out this duty through his pamphlets and memoranda; by means of letters and the circulation of his diary notes, containing his thoughts on the lessons of his battles, written as soon as they were won; and through his lectures and personal contacts.⁶

However, the army's doctrine had to adjust to a variety of different experiences, the importance of which was not easy to work out. In expounding his 'lessons', Montgomery did not shy away from putting himself at loggerheads with official policy and established doctrine. For example, Major-General L.O. Lyne had witnessed a visit by Montgomery to the Senior Officers' School, Minley Manor, Camberley on 25 October 1940 when

a student brandished one of the military training pamphlets, which the War Office produced as a guide on tactical problems, and pointed out that what General Montgomery said was the exact opposite of what was laid down in the pamphlet. General Montgomery looked at him in pained astonishment, [...] he strongly advised him to take notice of what he had said, which he knew to be right, rather than what an anonymous author at the War Office thought was right.⁷

Montgomery's centrality resulted in his interpretation of what would work and what would not work being given official prominence within 21st Army Group over other earlier views. Although Montgomery imposed the importance of co-operation between the two arms – armoured and infantry – his actual template for how this would evolve or be implemented did not survive the initial fighting in Normandy and itself changed because, as circumstances would show, what was required in North-West Europe was proto-type battle groups, and not the tank regiment and the infantry battalion as separate entities.

⁵ Barker MSS, Montgomery to Brig. E.H. Barker, 15 October 1940.

⁶ S. Brooks, (ed.), *Montgomery and the Eighth Army*.

⁷ IWM, Lyne Papers, 71/2/7, unpublished autobiography, Ch.IV, pp.7-8.

We have seen Montgomery facing the Normandy problem, and how he tried to resolve that. Normandy represented a new experience: it also represented a new operating environment. Beyond the close, confined country the terrain was – for the most part – apparently wide, yet there were no fast-flowing tank versus tank battles even in the wide open fields where such actions might have been possible.⁸ Firepower on its own could not prevail. Operations called for large-scale infantry attacks with armour supporting. It was necessary to learn again from new experience what would work in this new situation and under the demands of being in action. Now he had a completely new and different problem. This had to be solved. In addition to this situation, Montgomery also had to deal with the different experiences of his subordinate commanders.

In late 1944, three instructional, training pamphlets were produced and circulated within 21st Army Group. Two, *Some Notes on the Conduct of War and The Infantry Division in Battle* (November 1944) and *The Armoured Division in Battle* (December 1944), were sent to the commanders of corps and divisions, often with a short personal dedication.⁹ The third, *Some Notes on the Use of Air Power in support of Land Operations and Direct Air Support*, dealt with the roles of air power in the tactical, land battle. A fourth pamphlet, *High Command in War* appeared in June 1945. There was, Montgomery felt, a definite requirement for his pamphlets. They were needed and should be produced at once ‘whilst the lessons of the campaign were fresh in all our minds’.¹⁰

The Orchestration of Response

Montgomery was a very ‘modern’ commander in the speed at which he was willing to revisit conventional wisdom to react to current circumstances. Afterwards, he wrote:

⁸ For example see Appendix III photographs 3 and 4.

⁹ Montgomery also sent copies to top figures, including Churchill, UKNA, PREM 3/316.

¹⁰ IWM, Lyne Papers, 71/2/4, unpublished autobiography, Ch.IV, p.1.

once a fighting machine has been trained thoroughly in the basic principles of warfare, it will have no great difficulty in operating successfully. *It is of course essential that commanders at all levels should be versatile and mentally robust and that they should not adhere rigidly to preconceived tactical methods.*¹¹

Montgomery developed this view in his pamphlets. Although each of them appeared over Montgomery's name and with his authority, we know that some of their preparation was entrusted to others; in the case of *The Infantry Division in Battle* to Major-General L.O. Lyne; and, apparently, in the case of *The Armoured Division in Battle* initially to Lieutenant-Colonel, A/Brigadier P.R.C. Hobart.¹² Lyne had great experience in infantry command. Having commanded 169th Infantry Brigade in England, Iraq, North Africa and Italy, 1942-44, he commanded 59th Infantry Division in North-West Europe until it was disbanded to provide replacements for other divisions. Similarly, Hobart was a greatly experienced – albeit junior – armoured commander. Hobart was certainly available for the work in late 1944: 'for ten relatively peaceful weeks, until the middle of January, the [7th Armoured] division was almost entirely motionless, initially guarding the west bank of the River Maas and later the east bank'.¹³ This may have been the principal reason why Montgomery at first chose such a junior officer.¹⁴ The pamphlet went through several iterations and Roberts was involved in its preparation: 'I spent a night with Monty recently; I had to go to discuss this pamphlet on Arm[oure]d Div[ision] tactics I have been told to write. The first edition was almost entirely torn up!; I have now re-written most of it & am heartily sick of the sight of it!'¹⁵

¹¹ Montgomery, *El Alamein to the River Sangro* (London: Book Club Associates, 1973 [1948]), p.103. (Emphasis added.)

¹² [Maj.] Sir Carol Mather [one of FM Montgomery's Liaison Officers] to the author, 22 October 2005.

¹³ P. Delaforce, *Churchill's Desert Rats: From Normandy to Berlin with the 7th Armoured Division* (Stroud: Sutton, 1994), p.124.

¹⁴ Montgomery's choice of Hobart was not on account of Hobart's acquaintance and correspondence with Liddell Hart, Correspondence between BHLH and various members of the Hobart family, including Lieut.-Col. P.R.C. Hobart, LHCMA, Liddell Hart Papers, LH1/376. It is not easy to think - or see - why that should have influenced Montgomery.

¹⁵ LHCMA, Roberts Papers, Letters Home 1940-1944, Maj.-Gen. G.P.B. Roberts to his father and mother, 12 November 1944.

Montgomery had his own ideas, but his main idea was to be so quickly responsive to circumstances as to influence a change of circumstance. These pamphlets are evidence for how, in the light of his experience of the combat performance of his armoured and infantry divisions since D-Day, Montgomery thought the problems of fighting with these tools should be tackled during the remainder of the war against Germany. They have been neglected, or treated somewhat cursorily, by some historians.¹⁶ They were never intended to formulate or state precisely a complete theory of strategy. However, Montgomery's principles for major-level warfare as he formulated them in *Some Notes on the Conduct of War and The Infantry Division in Battle* and *The Armoured Division in Battle* added up to a coherent operational method. His ideas – in the pamphlets – reflected experience. His 'principles of war' and other war-fighting principles in turn gave rise to standard tactical methods which combined the action of all arms.

It is not possible to understand how 21st Army Group conducted the campaign through focusing solely on Montgomery: modern research has stressed that a large degree of similarity existed between the operational methods of the three highest command levels.¹⁷ However, within that mould of consensus there was also disagreement. Whether or not Montgomery's experience was congruent with the experiences of subordinates responsible for tactical leadership actually fighting on the ground with these tools, or with official War Office doctrine, can be decided with reference to the pamphlets, among other types of evidence. The ideas which came to be widely accepted as the right ones in 21st Army Group Montgomery institutionalised, and then enforced, as doctrine.

Montgomery worked with others to produce these pamphlets, notably, Major-General Lyne. This shows that they were a synergistic not an individualistic product. Lyne found the process easy and congenial: 'he [Montgomery] would always find time to see me whenever

¹⁶ Jarymowycz's *Tank Tactics: Normandy to Lorraine*, for example, makes not a single reference to them, although Jarymowycz quotes widely from War Office pamphlets.

¹⁷ See, for example S. Hart, 'Field Marshal Montgomery, 21st Army Group, and North West Europe, 1944-45' (doctoral thesis, University of London, 1995), pp. 262-3.

I asked for an interview. His clear and logical thinking and quick grasp of essentials and discard of all unnecessary detail made my task [at 21st AG Tac HQ, Eindhoven, September-October 1944] near much easier than it could otherwise have been'. Lyne visited nearly all the corps and divisional commanders in the Army Group and ran the ideas past them. This also shows that the evolution of doctrine within 21st Army Group was more synergistic with the experience of fighting and with commanders' experiences of actually fighting on the ground than has sometimes been supposed. Although he sometimes got 'rough handling if their minds were too preoccupied with present operations', Lyne got much useful advice and help from those he consulted. He recognised the value of trying out the ideas as he was working them out, as 'these roles in battle and the basic points in each role were naturally the subject of considerable difference of opinion amongst Corps and Divisional Commanders'.¹⁸ He visited O'Connor at VIII Corps Headquarters at Mierloo on 8 October, for example, as O'Connor was preparing to launch CONSTELLATION, and O'Connor lent him papers he had written on tactical problems met in Normandy.¹⁹

Lyne consulted widely among the corps and divisional commanders, but the conceptual imprint was predominantly that of his master. The armoured brigade commander when Lyne commanded 7th Armoured Division later, thought him a "Monty Yes-man".²⁰ It may have been the case, therefore, that in selecting Lyne Montgomery chose someone he knew would reflect his views. It would only be surprising if it were otherwise.

Montgomery's Two Pamphlets of November and December: What the Doctrine Actually Said

Some Notes on the Conduct of War and The Infantry Division in Battle was the first of Montgomery's pamphlets on how to conduct modern war

¹⁸ IWM, Lyne Papers, 71/2/4, unpublished autobiography, Ch. IX, 'Writing a Book – Command of 50th (N) Division, N.W. Europe', pp. 1-4.

¹⁹ LHCMA, O'Connor Papers, 5/3/60, Maj.-Gen. L.O. Lyne to Lieut.-Gen. Sir R.N. O'Connor, 9 October 1944.

²⁰ IWM, Wingfield Papers, PP/MCR/35, unpublished memoirs, p. 299.

by which the lessons of Normandy began to be circulated in 21st Army Group. A war, it asserted at the outset, was won by victories in battle. No victories would be gained unless commanders sorted out clearly in their own minds those essentials which were vital for success, and ensured that those things formed the framework on which all action was based. A body of general doctrine based on sound and well-founded operational principles – some determination as to how an army should fight – was fundamental for success in war. Principles had to be rigorously translated into operational planning, that is decisions on how an army or a force would fight in a particular situation or set of circumstances.

Application of his rational analysis to military historical examples and – more particularly – to recent experience in the Second World War suggested to Montgomery that the conduct of war was subject to regulating principles which were few in number and capable of being simply expressed. These identified prerequisites for successful military action. Certain points were fundamental, and to neglect any of them would probably lead to failure. They would apply, in a greater or lesser degree, to all commanders at all times. In a keynote address after assuming command of 21st Army Group Montgomery spoke of ‘the things that matter i.e. the basic fundamental principles on which everything is based: the 7 principles of war[.]’²¹ His thoughts developed as a consequence of the fighting in Normandy, and by November 1944 he believed that it was possible to formulate eight such principles. ‘I consider’, he wrote, ‘that these points form the principles of modern war’.²²

As presented in *Some Notes on the Conduct of War*, Montgomery considered the eight principles of war in late 1944 to be:

Air Power;
Administration;
Morale;

²¹ Montgomery, address to the general officers of the armies under his command at Headquarters, 21st Army Group, St. Paul’s School, London, 13 January 1944, quoted in *Montgomery and the Battle of Normandy* ed. by S. Brooks (London: Bodley Head, 2008), p.27.

²² *Conduct of War & Infantry Div. in Battle, Conduct of War*, paras. 1, 2 and 3.

The Initiative [new 8th principle];
 Surprise;
 Concentration;
 Co-operation;
 Simplicity.

The great importance of some of his principles, Montgomery believed, had come to the fore only since the beginning of the War, and of others only since the start of the North-West Europe campaign. Nevertheless, Montgomery was precise as to the content of each principle. Later, he wrote: ‘the last four [principles] are old stagers and can speak for themselves’.²³ These principles were not peculiar or unique to Montgomery. Some, like the principles of surprise, concentration, and co-operation, go back to Jomini and were also included in the 1920 *FSR* list, deriving from experience in the First World War. By 1918 the General Staff recognised that firepower dominated the battlefield, but firepower alone could not destroy an enemy who was properly dug in. Their solution to this problem depended on the co-operation of all arms to overwhelm the enemy by weight of fire and enable the attacking infantry to manoeuvre without incurring unacceptably high losses. The British Army motorised to bring artillery and infantry into action closer to the centre of battle on the Western Front and to improve logistical efficiency.

The principle of simplicity also related to a particular strain of experience of the First World War. Operations on the Western Front between 1916 and 1918 had seemed to prove that co-operation could be achieved only by unity of control and careful planning to co-ordinate the work of supporting arms with the movement of troops across the battlefield. Planning, even of highly complex operations, had to remain as simple as possible, because the more complex a plan, the greater the chance that things would go wrong. The hierarchy in which Montgomery ranked his principles is one way they can be differentiated from other modern lists including War Office doctrine and Fuller’s 1920 list.

²³ 21st Army Group pamphlet, *High Command in War* (June 1945), quoted in Alger, *Quest for Victory: Principles of War*, p. 253.

Looking at Montgomery's most important principles of war in order to understand better their origin, and how they 'hang together', makes it easier to see how they formed a unified operational method, and also how they picked up on principles already established in British doctrine. Further, it makes clearer the relationship between Montgomery's principles of war – as listed above – and his war-fighting principles – which include a wider, more encompassing range of elements including, for example, command. In particular, it will show the importance of The Initiative – now ranked a principle – unlike the early 1944 list, where it was not.

A prerequisite for any successful military operation, or combined operation, was the use of *air power* to destroy or degrade the enemy air force's capacity to intervene in the ensuing battle. Air support was always vital in the tactical land battle but because fire support from the air was weather-dependent the aim should be to win with ground-based fire support. The air force's contribution of firepower was of great importance in assisting offensive operations by armoured divisions. Between the two world wars, the proper employment of aircraft in war as well as command and control arrangements for army air support was the subject of bitter debates between the two services. Army commanders sought the ultimate in close air support – aircraft under their direct control, in a ground attack role in the immediate battle zone – as being more important than other forms of combat aviation. RAF leaders emphasised air superiority, interdiction, long-range bombing, and centralised air force command and control. The first formal study of air power in relation to land warfare was Slessor's *Air Power and Armies* in 1936.²⁴ An important reason for the significant improvement in British combat performance in North Africa was more effective army-air force co-operation during 1942.²⁵ Generals Wavell and Auchinleck never appreciated fully the interdependence of air-ground operations and the necessity of a culture change. 'I was very much heartened to discover', Air Marshal Sir Arthur Tedder wrote, 'that co-operation with

²⁴ Gp Capt. J.C. Slessor, *Air Power and Armies* (Oxford: Oxford University Press, 1936).

²⁵ R. Hart, *Clash of Arms*, p.124.

the Army had further improved, thanks, at least in part, to the lead given by Montgomery on this subject'.²⁶ The change came about after Montgomery's appointment to command the 8th Army. Principles espoused by Air Marshal Sir Arthur Conningham and the Western Desert Air Force system became the model for the application of tactical air power elsewhere in North Africa and in North-West Europe.²⁷ Montgomery had long understood the role and value of direct air support in wrecking an enemy command system and isolating a battlefield. Though only a qualified success, the Battle of Amiens, in August 1918, at which Montgomery was present as a staff officer with 47th Division, demonstrated the enormous potential that air forces had to isolate a battlefield and make a decisive impact on operations taking place on the ground. In 1926, he noted the vulnerability to air attack of lorry columns moving reserves to join the battle – a perceptive appreciation of the role and value of directly supportive air interdiction.²⁸ Further, Montgomery's role was important because he was willing to concede air control. Also, Montgomery believed that the massed use of air power in support of ground forces was a battle-winning factor.

Montgomery felt that the tank's role demanded full use of their firepower and mobility – which in turn depended on the tanks being kept supplied and maintained. Thus, another prerequisite was good *administration*. Administrative arrangements in the rear must have a very definite relation to what it was intended to achieve at the front if a force including armour was to be kept supplied and problems of logistical breakdown avoided. The importance of problems of mobility and supply in operations was well-understood. This can be traced to British experience in the First World War, British military thinking

²⁶ Lord Tedder, *With Prejudice: The War Memoirs of Marshal of the Royal Air Force Lord Tedder* (London: Cassell, 1966), p. 355.

²⁷ The author is indebted to Ross Mahoney, University of Birmingham, for information on Conningham's principles for Army-Air Force co-operation, 'Allied fighting effectiveness in North Africa and Italy, 1942-1945' KCL/IWM conference, 18-19 July 2008, Session 7: The air power contribution to land operations, Q&A.

²⁸ Maj. B.L. Montgomery, 'Some Problems of Mechanicalisation', 196.

between the world wars, and also to British experience in North Africa.²⁹ The motorization of logistics was a major achievement of the British Army before 1940. By late 1944, administration became crucial: keeping tanks supplied with fuel and ammunition, and mechanically fit had become a major problem. Montgomery's focus on the importance of administration provided excellent logistic support that sustained British fighting power in North-West Europe.

Montgomery also believed that 'the big thing in war is morale'.³⁰ A high, confident *morale*, based on a firm but fair discipline, the self-respect of the individual soldier, mutual confidence between soldiers and commanders, soldiers' confidence in their weapons and equipment, a sense of the justness of the cause for which they fight, and the spirit of the offensive was also a prerequisite. His military training at Sandhurst and his service before the First World War was at the time when the influence of General (later Field-Marshal Sir) Henry Wilson was crucial in the transmission to the British Army of an approach to war which flowed from the Napoleonic model as interpreted by Clausewitz and Foch.³¹ Wilson, 'a life time Francophile [...] hit it off from the start with [...] Foch, his French opposite number'.³² Foch had placed great emphasis on the psychological factors in war. However, his later view did not conflate this belief with adherence to an approach to war derived

²⁹ Wavell considered 'common sense', based on 'a really sound knowledge of the 'mechanics of war', i.e., topography, movement and supply' to be a fundamental requirement of sound generalship, and did his best to put this dictum into practice in the Middle East, Gen. Sir A. Wavell, *Generals and Generalship*, The Lees Knowles Lectures for 1939 (London: Times, 1941), p. 8 quoted in H.E. Raugh, *Wavell in the Middle East 1939-1941: A Study in Generalship* (London: Brassey's, 1993), p. 255; Professor Kenneth Startup whose 1977 MA dissertation remains an essential reference work for O'Connor said 'I well remember how Sir Richard emphasised to me that his greatest challenges were transport – and water, (closely related matters, of course)', Professor K. Startup, personal communication to the author, 13 July 2004; Gen. Sir David Fraser to the author, 30 June 2004, Fraser, *And We Shall Shock Them*, pp. 115-116.

³⁰ Forrester, 'Great Captains and the Challenge of Second Order Technology: Operational Strategy and the Motorisation of the British Army before 1940', pp.77-79; Montgomery, *Conduct of War & Infantry Div. in Battle*, p.1; '21st (British) Army Group in the Campaign in North-West Europe 1944-45', *RUSI Journal*, Vol.90, no.560 (November 1945): 430-54, esp.452.

³¹ Larson, *The British Army*, pp.47, 49.

³² K.Jeffery, *Field Marshal Sir Henry Wilson*, (Oxford: Oxford University Press, 2006), p.73.

from Clausewitz or Foch.³³ He had learned the importance of careful planning, as well as meticulous logistical preparation as a staff officer with 33rd and 47th divisions in General Sir Herbert Plumer's 2nd Army in 1917 and 1918. Montgomery's later views did not easily reconcile with his earlier training. The key to high morale was success in battle with casualties held at acceptable levels. The strengths of 21st Army Group, which were firepower and movement, if employed to maximum effect, would ensure that any operation launched would have the best chance of success possible with the least possible number of casualties.

Finally, Montgomery was concerned with remaining balanced throughout his operations. It was necessary to quickly gain, and to keep, *the Initiative* and constantly to create new reserves. The enemy commander must discover that he had the wrong plan, and the wrong dispositions. One's own dispositions must be flexible enough to be altered in response to the developing tactical situation but a force must be so well balanced and poised that enemy thrusts could be disregarded. A military situation which was untenable for the enemy was achieved by launching a hard blow, with all arms *co-operating*, on a narrow front, in accordance with the principles of *surprise* and *concentration* – particularly if opportunities could be created for armour to penetrate into the enemy's rear areas to dislocate his lines of communication. Planning was vital. A good plan was a *simple* plan. The first requirement of a simple plan was that each component part of the force should have its own task to carry out, and its operations should not be dependent on the success of other formations or units.³⁴

There were other points which were important but which were not principles of war. The most centrally important of these was that each commander, clear as to the points which mattered on his own level, must exercise his initiative to be proactive. Commanders of large formations must give careful thought to disposing their forces to best effect, in accordance with the overall plan. Skill in grouping and initiative in quickly re-grouping to meet the changing tactical situation

³³ Montgomery, *History of Warfare*, p.472.

³⁴ *Conduct of War & Infantry Div. in Battle, Conduct of War*, paras. 4-16; *Armoured Div. in Battle*, paras. 10, 12, 14 and 16.

played a large part in successful battle operations, and was required of commanders of both large formations and smaller units.³⁵ Montgomery had attacked at Alamein along a series of different thrust lines, but with the reserves necessary to exploit success. He employed this technique again at Mareth (Tunisia 1943) and around Caen during his attempts to take the city (June and August 1944). Montgomery's temporary loss of the Initiative, at Arnhem, must be acknowledged. However, he moved to recover quickly.

All commanders must be conversant with the operational handling of both the armoured and the infantry division and with the employment of artillery. Between the two world wars there was an expectation among some military writers and soldiers that armour should be developed to become the predominant arm of the army. The tank, Montgomery felt, was only one, albeit very important, weapon. The operational handling of tanks required no more skill than that required for any other weapon and certainly no special skill. Armour would not be developed to become an élite among his legions.

What *The Armoured Division in Battle* had to say about the role for armoured divisions under modern conditions completely contradicted what was said in *MTP No. 41 The Tactical Handling of the Armoured Division and its Components* (1943), Part 1, *The Tactical Handling of Armoured Divisions* (July 1943), which outlined their place in the War Office's concept of operations. That place was the mobile role:

It is a mounted, hard-hitting formation primarily constituted for use against hastily prepared enemy defences, for exploitation of initial success gained by other formations, and for pursuit. It is designed for use in rapid thrusts against the enemy's vitals, rather than hammer blows against his organised defences.³⁶

Thus, the roles of an armoured division included a wide sweep round an enemy's flank to strike his rear communications and cut off his retreat; a rapid pursuit through a breach made in the lines by other formations so as to effect the complete destruction of the enemy; co-operation with

³⁵ *Conduct of War & Infantry Div.in Battle, Conduct of War*, paras. 17 – 34.

³⁶ *MTP No.41, Part 1* (July 1943), Ch.I, Section 2, para.5.

other arms in the defence, usually by counter-attack and to hold the enemy off at arms' length and prevent him interfering with operations.³⁷

This contrasted sharply with Montgomery's view in *The Armoured Division in Battle* of what an armoured division was essentially for and its tactical roles, which flowed from his definition of a tank as 'an armoured vehicle designed to carry about fire-power'.³⁸ For him, the armoured division was to be used for 'hammer blows' or 'colossal cracks'; the mobile role was less important. *The Armoured Division in Battle* presented the armoured division as a combined arms force. In an attack on a main enemy defensive area which had been partially or wholly broken into by other arms, the armoured division would maintain the momentum of the attack by driving in the enemy rearguards and seizing key terrain (usually high ground) on which to establish infantry – anti-tank defences in order to release the tanks to retire or take part in a further attack.³⁹

It is possible to see here resonances, echoes and elements of ideas which by December 1944 had come to be accepted as the right ones in 21st Army Group and which can be associated with particular commanders, for example Carver. SP anti-tank gunners must lose the idea that their true role was as a mobile reserve as per War Office teaching, and that anti-tank protection of forward defence lines was the job of the towed gun. The tanks were best trained and equipped to provide the mobile reserve, and what self-propelled anti-tank guns there were should be used to release as many tanks as possible for this job. Thus, instead of being used in an offensive mobile role as tank-hunters, their tactical role should be flank protection and reinforcement of the anti-tank defence of armoured and infantry units in a largely static role, the role in fact envisioned by the War Office for the towed 17-pdrs. Thus:

The first aim of the attack is to capture ground, the second to hold it. Supporting weapons must be got up quickly to help the reorganisation. Initially the tank is the best supporting weapon as it has fire power and mobility. But

³⁷ Ibid., Section 3, para. 7.

³⁸ *Armoured Div. in Battle*, Introduction, para.3.

³⁹ Ibid., para. 30.

anti-tank guns must be got forward quickly so as to free the tanks, and allow them to be rallied in not less than squadron packets. These [i.e. the tanks] are then available to deal with counter attacks, and for a further mobile and offensive role.⁴⁰

It is also possible to see the influence of Roberts's 'homogeneous brigades' idea. Roberts invented the term. This new type of tactical formation embodied the principle of tactical co-operation in a way its author thought most appropriate in the light of 11th Armoured Division's experience in Normandy. Thus:

In close country or when anti-tank devices abound, the infantry brigade closely supported by tanks should lead. In order to achieve this close support, it will probably be best to group the division so that there are two homogeneous brigades.⁴¹

The armoured division was particularly suited for employment in the fast moving, fluid battle after the breakout, in which its capacity to engage and defeat such enemy tanks as survived was likely to prove decisive. Recent battle experience, however, showed that it was usually the enemy anti-tank gun or self-propelled gun, dug-in and lying in wait, which did the damage and not the enemy tank.⁴² There was still no fast-flowing battle. One of the reasons for this was that by removing the turret from a tank the Germans could accommodate a bigger gun in a fixed superstructure. This had the added advantage of a low silhouette.

However, Montgomery felt no plan for the employment of armour would be sound that does not exploit to the full tanks' characteristics of firepower, armoured protection and mobility, in that order.⁴³ The general technique or governing tactical principle must be movement, accompanied by fire directed against the enemy. British armour should not be used as self-propelled artillery because that would vitiate the

⁴⁰ Ibid., paras 5 and 62 (quoted).

⁴¹ *Armoured Div. in Battle*, para.64.

⁴² Ibid., para. 8.

⁴³ While working in Verney's papers this author was intrigued to find that Verney had made alterations and annotations on his personal copy of *The Armoured Division in Battle* e.g., inverting Montgomery's list of the main characteristics of an armoured division and placing 'mobility' first, which makes Verney's removal from command of 7th Armd Div in late 1944 easier to understand.

principle of ‘fire and movement’.⁴⁴ In terms of firepower, *The Armoured Division in Battle* demonstrated that Montgomery had become a convert to the idea that there should be only two types of tank: the dual purpose ‘capital’ tank, for fighting, and the light tank, for reconnaissance.⁴⁵ In laying down such a policy for 21st Army Group Montgomery was advocating something which was new – the desert appearing to many merely to confirm the soundness of the RAC’s existing doctrine and methods. It was also further at variance with War Office policy, which was officially to accept the bifurcation in armoured doctrine.

Montgomery’s ‘ubiquitous’ use of armour – he hoped – would allow flexibility when planning the battle and not force a commander to keep a percentage of his armour unemployed at important phases, and increase speed of action. ‘Ubiquitous’ is used in *MTP* No. 41 to describe the ‘infinite variety of tasks’ which infantry could undertake.⁴⁶ However, considerable preparation and planning was to precede each operation to ensure the best use of available firepower.

The purpose of enumerating the roles in battle of the armoured and infantry divisions as well as the basic points of tactical tank-infantry co-operation was to provide guidance as to those fighting techniques and procedures deemed of particular importance by Montgomery, in order to ensure that the two types of division were employed in the best way possible. Improved armour unit-infantry unit co-operation, tied in appropriately to tactical artillery fire plans and fire support from the air, could be a solution to the problem of the enemy enjoying the possibility of long-range tank, or tank hunter fire from excellently camouflaged positions well-protected by anti-tank weapons – the problem which had tended to make the security of British tanks a function of their distance from the enemy. An informed pragmatism was required of commanders as to how these points should be applied ‘in action’. Success in battle was what mattered.

The set piece attack to break into, or through, a main enemy defensive area was the most important role of the infantry division. Its

⁴⁴ *Armoured Div. in Battle.*, paras.10, 11 and 13.

⁴⁵ *Armoured Div. in Battle*, paras. 5 and 6.

⁴⁶ *MTP* No.41, Part 1 (July 1943), Ch. II, Section 5, para.22.

other potential roles included the follow-up of an enemy force conducting a fighting withdrawal, temporary defence, the crossing of a contested water obstacle and an assault landing on an enemy held coast. The success of a set piece attack in depth flowed in the first instance from the successful manipulation of adequate reserves: fresh troops must be ready to go through in the wake of the assaulting infantry and tanks and maintain the momentum of the attack even if the attacking troops had not got all their objectives. Although not the primary – or even a suitable – role for an armoured division, the tanks of an armoured division could contribute to maintaining the momentum of the attack by attacking the enemy's flanks, and where a gap had been achieved in the enemy's defences by other tanks and the infantry, by moving through it to create the conditions for a strike at the enemy's lines of communication. Secondly, the start line must be secure: if it was not the enemy might be able to disrupt the whole plan of attack. Thirdly, the assaulting troops must be assisted forward by adequate and well-directed air and artillery fire support. Fourthly, assaulting infantry and tanks must keep close up to this supporting fire and be ready to assault the enemy immediately it lifted. Fifthly, supporting armour must keep touch with the assaulting infantry; anti-tank guns must be got forward quickly. Finally, once the attack had started, the enemy must be given no respite in which to reorganise and collect reserves. After the enemy had been driven from his defensive positions and the battle was now mobile, the principal roles of the armoured division in battle were exploitation and pursuit. In an armoured division, the Armoured Reconnaissance Regiment – equipped principally with Cromwells, later Comets – was an additional armoured regiment.⁴⁷

The basic points of how tanks and infantry should co-operate, according to *The Infantry Division in Battle* were firstly, infantry and tanks should 'marry up' early; secondly, before every attack tank officers should personally and carefully observe the ground in order to assess tanks' ability to get over the country between the start line and the

⁴⁷ *Conduct of War & Infantry Div. in Battle*, paras. 8, 9, 13-21; *Armoured Div. in Battle*, paras. 12, 23-38.

objective and note obstacles placed by the enemy; thirdly, the formation adopted would depend on topography, among other factors: in open country tanks would usually lead on to the objective and in close country infantry would lead; fourthly, the first task of the tank working with infantry was to destroy enemy unarmoured troops – not to engage enemy tanks; fifthly, good communications were essential between the two arms; finally, tanks' need for ammunition, fuel and maintenance would always limit the length of time they could spend 'in action'.

In addition to its special training in the reconnaissance role it was now laid down that the Armoured Reconnaissance Regiment of an armoured division should be practised in co-operation with infantry.⁴⁸ How this worked out in practice is explained as follows: 'we carried them [the Hereford Regiment infantry] on the back of our tanks'.⁴⁹ It can be assumed that the concession that under certain conditions the infantry could lead closely supported by tanks was a tactical lesson learnt in the fighting in Normandy (and southern Holland): often poor tank country, hedgerows, orchards and stone farm buildings of Normandy and canal bends, deep ditches and buildings in southern Holland gave the enemy enfilade fire and excellent cover for anti-tank weapons.

Factors Affecting the Doctrine's Shape, and its Application

The British official view was that the medium tank function consisted of two alternatives, infantry-support and exploitation, each requiring a different sort of tank. There were also light tanks for reconnaissance and similar missions.

⁴⁸ *Conduct of War & Infantry Div. in Battle*, paras. 50-57; *Armoured Div. in Battle*, paras. 5 and 6.

⁴⁹ The Earl of Harrington, interview with the author, February 2004. Capt. the Earl of Harrington commanded 4th Tp, 'B' Sqn, 15th/19th H, Armd Recce Regt, 11th Armd Div. He is referring to action during the advance to the river Aller during 13-14 April 1945. The tanks referred to were still Cromwells. 'B' Sqn did not re-equip with Comets until the end of April, Anon. [?Maj. G. Courage], *'Campaign Diary': The 15th/19th The King's Royal Hussars, North West Europe, 1944-45* (RHQ, Palestine, 1946), p. 29, personal copy of Maj.-Gen. Sir W.R.N. Hinde, made available by Mr Ralph Thompson, The Light Dragoons (15th/19th King's Royal Hussars) Museum Collection, Newcastle-upon-Tyne.

Some British tanks (e.g. Cromwell, Challenger and Comet) were viewed as being 'cruisers' intended to engage and defeat enemy tanks in specifically armoured operations, in fluid and mobile warfare. British improvements to the American Sherman tank proved ultimately to be one of the best solutions to the problem of getting a powerful gun into the field where it could tackle the best German tanks.

The other British tanks (e.g. Churchill) were Infantry ('I') tanks, intended only to operate in support of infantry in both the assault and defence, and deal with enemy support weapons, including enemy tanks. Churchills were given extra armour to compensate for their slow movement. The I tanks – resembled in these respects the British 'heavy' tanks of the 1914-18 period.

Two different types of tank did not fit with Montgomery's doctrine of use for them. This had organizational implications. Close co-operation with infantry had hitherto been primarily the responsibility of the I tanks of 21st Army Group's tank brigades under GHQ command, as opposed to the cruisers of the armoured brigades. Thus, tank brigades and armoured brigades, reflecting their different intended functions, were equipped differently. Montgomery had long decided that this was unsatisfactory. All references to (Army) Tank Brigades now disappeared.

Different views existed lower down the chain of command. Carver's view, in a document which can be dated to the last three months of 1944, was that

if the number of tank formations available for an army is limited by man-power and production, there must be as many capable of carrying out the pursuit as the communications of the country and the transport available can maintain. If you can afford to have more tanks than that, as we have had, then they should be tanks primarily designed for the support of inf[antry]. Unless however you have sufficient of the latter, you may never be able to create the conditions as a result of which pursuit occurs. If the tank b[riga]des, 6 Gds, 33 and 34 and previously 31, had been equipped with really good 'I' tanks, the conditions in which the "cruiser" tanks could have been employed would have occurred earlier and more often. I maintain therefore that an army or group of armies, can afford in a European

theatre of war to have both an 'I' tank and a cruiser tank, and that it will profit by having them.⁵⁰

Despite Carver's view, Montgomery wanted a multi-role tank. What was required, Montgomery believed – this was brought out more fully in *The Armoured Division in Battle* – was armoured formations, equipped with a multi-role tank, equally capable of undertaking the roles of close support of infantry, exploitation and pursuit, and trained accordingly. Further, by late 1944, Montgomery had concluded that the Churchill's slowness rendered it unsuitable as a capital tank. A true multi-role tank was not yet however available.⁵¹ Therefore, he did the next best thing, in the light of his view that it is easier to change tactics than it is to change technology, which was to insist on the 'ubiquitous' use of armour irrespective of the type of tank with which a formation was equipped. The writing was, therefore, intended to be clearly on the wall for 21st Army Group's tank brigades with the publication of the earlier pamphlet. The 34th Tank Brigade – to cite just one example – re-equipped and reorganised, was re-designated 34th Armoured Brigade in February 1945.

The Pamphlets: their Doctrine in Action

We now need to switch from pamphlets and theoretical writings to detailed actions. The crossing of the Rhine in 1945 it is generally held – for obvious reasons – represented a further important turning point in the chronology of the 1944-45 North-West Europe campaign. Here, the phrase 'the advance to and from the Rhine' is used to give an overall shape to campaign events, including 21st Army Group's advance from

⁵⁰ IWM, Carver Papers, Lectures and Articles on Armoured Warfare 1940s, Brig. R.M.P. Carver, 'Comments on Lt-Col. JOLLY's letter', p. 2, Col. Jolly was at that time Commander, 144th RAC, 33rd Armoured Brigade. In April 1945, Jolly became Chief of Staff, 79th Armoured Division.

⁵¹ Even the Comet tank, the last and by far the best of the line of Britain's 'cruiser' tanks and the last British tank design of the war to see action, probably could not fully embody all Montgomery's requirements for a capital tank any more than the Cromwell had, or the 17-pdr-equipped Challenger stop-gap design which replaced it; predictably, similar adaptations were made for Comet.

the western borders of Germany to the banks of the Rhine and, once over the Rhine, the final assault on Germany. These also mark a crossover from the penultimate to the final phase of the campaign. Thus, although they were different phases of the campaign, analytically they should be seen as one framing contextual event, or turning point.

Secondly, although less obvious, the first phase or advance into Germany, then the advance from the Rhine can be taken to represent an important metaphorical watershed in the progress of the campaign over time for 21st Army Group as well, for the following reason. In the last three months of 1944, the 21st Army Group pamphlets on the armoured and infantry divisions were intended by Montgomery to be the summation of the principles of war as he understood them. They were also, in practice, syntheses of the methods which had come to be widely accepted as the right ones among commanders whose opinion he valued.⁵² These pamphlet 'primers' summarised the principles or methods by which it was known – by Montgomery and his senior officers – that certain results could be achieved. Thus, this period saw the emergence of the final doctrine for the final 'from the Rhine' phase of the campaign. Further, the winter of 1944-45 was a testing or settling in period for the new techniques. Initially, the new and the old offensive techniques existed alongside each other. The importance of the Rhineland battles in early 1945 is that they were the 'laboratory' for the wider adoption of the new techniques by 21st Army Group. The backdrop was the advance to the Rhine and preparation for the final assault on Germany; and the projection on to the east bank of the Rhine of sufficient infantry and armour to establish a secure and viable bridgehead.

There is a final way in which the crossing of the Rhine marked an important watershed for 21st Army Group, which requires the 'before' and 'after' to be considered together (with much less attention or emphasis placed on the actual crossings themselves than has been usual). New tactical problems in 1945 served to unpick some of the

⁵² See also IWM, Montgomery Papers, 126/57, Montgomery to Lieut.-Gen. R.M. Weeks [Deputy Chief of the Imperial General Staff], 21 February 1945, for more evidence that Montgomery worked with others in this way.

threads in the tapestry as woven by late 1944. The changing nature and context of operations put at issue whether the new doctrine and system Montgomery outlined in late 1944 could survive the transition to a new and different type of warfare across the Rhine on the north German plain in the spring of 1945.

The case of Barker and VIII Corps both before and after the Rhine Crossing demonstrates what Montgomery was after from a corps commander. Montgomery was interested in people who could tell him what could work, in tactical lessons, rather than operational ones. Thus, we find that Barker 'spent most of the day [12 Jan 1945] writing a paper for Monty on the Div[isional] Reconnaissance Reg[imen]t reorganization'.⁵³ A Corps Commander was not allowed much leeway in the planning of operations, as Barker soon found out: 'Bimbo [Dempsey] came over this a.m. to talk futures which were completely changed this eve[ning]. I'm getting v[ery] annoyed with these continual changes. It's been going on ever since I took over here. However I suppose it must be but its damnably annoying'.⁵⁴ 'I always knew a Corps was a poor[?] job except when actually in active operations', he explained (9 March 1945). Even as a corps commander, Barker was not allowed latitude to change the master plan.

The speed of the advance was now paramount; at the operational level it was essential to prevent the Germans regaining their balance. However, there was also a change to a different kind of warfare. Battles became a matter of deploying and attacking small groups of the enemy defending key points or finding a way around them, as Barker noted:

Boche opposition is purely packets of chaps holding centres of roads and trees and some demolitions. I've now got an Airborne [Division], and an Arm[oure]d Div[ision] so I'm getting set for a quick run in a N.E. direction. Opposite Jorrocks [Horrocks] and Neil [Ritchie - GOC XII Corps] the para boys [the German First Parachute Army and/or the HJ] are still putting up a good fight but are getting worn down and reduced in numbers.⁵⁵

⁵³ Barker MSS, Lieut.-Gen. E.H. Barker to his wife, 12 January 1945.

⁵⁴ Barker MSS, Lieut.-Gen. E.H. Barker to his wife, 12 February 1945.

⁵⁵ Barker MSS, Lieut.-Gen. E.H. Barker to his wife, 28 March 1945.

Each parachute brigade within the Airborne Division had attached a Churchill tank squadron from 4th Tank Grenadier Guards, 6th Guards Armoured Brigade.

Allowing for the fact that VIII Corps was launched against German Army Group H's weak left flank, by 31 March his corps had bridged and crossed the River Ems and were making for the Ems Canal 'which no doubt will have all bridges blown – we already know that one is. Then Osnabr[ú]ck. [...] We have been going too fast'.⁵⁶ The significance of this remark is that, despite problems such as the Germans' extensive use of demolitions, Barker still showed himself well able to take advantage of opportunities for rapid advance.

The German Army was, however, capable of determined resistance by individual units, battalions or divisions until the very end of the war: on 1 April Barker recorded: 'the Boche continue to put up a fight with quite a number of 88s. All sorts of training battalions are being identified and the prisoners range between all ages'.⁵⁷ This is almost certainly a reference to the defence of Lengerich by NCO officer candidates. These men, offering strong resistance, were aided by the thick woods which made observation, and artillery and close air support difficult. However, the advance to Osnabrúck, which began on 3 April 1945, represented an important milestone – the Germans had no hope of organizing a firm defensive line before the next water barrier, the Weser, at which point and by which time VIII Corps would have advanced 125 miles from the Rhine.

34th Armoured Brigade did not take part in PLUNDER or in the advance from the Rhine, but during the course of operations across the Rhine it became apparent to Greenacre that additional firepower would be necessary to address the problem that even the up-gunned Mk VII version of the Churchill in 34th and 6th Guards armoured brigades, which featured many design improvements but was too narrow to take the larger turret required for the 17-pdr gun, 'in its present form cannot shoot it out with the Tiger or Panther owing to the superior gun and

⁵⁶ Barker MSS, Lieut.-Gen. E.H. Barker to his wife, 31 March 1945.

⁵⁷ Barker MSS, Lieut.-Gen. E.H. Barker to his wife, 1 April 1945.

frontal armour carried by these two German types. For this reason it was always necessary to have attached a b[at]t[er]y or t[roo]ps from an S.P. A[nti] T[an]k Reg[imen]t equipped with 17 Pdr guns to give protection to the tanks if attacked by enemy armour'.⁵⁸ It was Greenacre's view afterwards that:

it is seldom that an Independent [Churchill-equipped] Arm[oure]d B[riga]de [operating in the infantry-support role] will fight as a B[riga]de for the reason that this conflicts with the principles of war as laid down by C-in-C 21 Army G[rou]p and F.S. Reg[ulation]s Viz:- [The] large numbers of tanks in a B[riga]de are likely to nullify "Surprise", and are difficult to Concentrate. Cooperation with other arms is not made easier and therefore the Plan loses its most essential characteristic "Simplicity" ⁵⁹

Greenacre's view as expressed here, however, represents the 'official' perspective. In practice, over the Rhine, in the advance to Múnster, 6th Guards Armoured Brigade (less 4th Tank Grenadier Guards) was to operate for the first time under its own Brigadier and not in support of an infantry division. The task given 6th Guards Armoured Brigade Group was to make a rapid breakout carrying the paratroops of 513th Parachute Regiment, US 17th Airborne Division on the tanks. Greenacre had little or no rest or sleep for three or four nights at this time. They were 'irretrievably committed to get on'.⁶⁰ In the face of this overwhelming need to get on, inevitably there were tactical mistakes: outside Múnster, the two rearmost tanks of a troop were hit from close range by concealed 88s which had let the head of the column go through and then pounced on the tail, which might not have happened had the time been taken to reconnoitre.⁶¹ In the advance from the Rhine to Múnster by the Coldstreams and the Scots Guards of 6th Guards Armoured Brigade Group, with the American paratroops riding on the tanks, the Armoured Brigade was, however, thus operating in a

⁵⁸ IWM, Greenacre Papers, 94/33/1, 'Lessons from the Campaign in France, the Low Countries and Germany from an Independent Armd Bde point of view, June 44-May 45', by Brigadier W.D.C. Greenacre, p.4, para. g.

⁵⁹ Ibid., p.1, 'General [remarks]'.
⁶⁰ IWM, Greenacre Papers, 94/33/1, ms notes on the advance of 6th Guards Armoured brigade from Wesel to Múnster, 26 March-2 April 1945, by Brig. W.D.C. Greenacre.

⁶¹ [Lieutenant] T.E.P. Gilpin [Tank Commander, 'S' Sqn, 3rd Tk SG, 6th Gds Armd Bde Gp, 1945] to the author, 10 Dec 2005; P. Forbes, *6th Guards Tank Brigade: The Story of Guardsmen in Churchill Tanks* (London: Sampson, Low, Marsden, [n.d.], p. 137.

new role. The implicit lesson Greenacre drew was that 6th Guards Armoured Brigade had fulfilled the requirement of 'ubiquity' demanded by Montgomery for all armoured brigades and that a Churchill-equipped armoured brigade was 'capable of swift inclusion in the order of battle for any particular operation', so long as the issues of the Churchill's lack of a really first class anti-tank gun, as well as the need for armoured engineers were addressed – as had been the case in 6th Guards Armoured Brigade Group.⁶²

Because Carver was on the same wavelength as Montgomery he too did not end up getting the sack as did other commanders who differed from Montgomery in this way. Like Greenacre, he is indicative of a specific type of brigadier: however, Carver in particular was one who was creative in the process of learning lessons over a longer period of time and applying them at a more general level than his own specific unit. Because of the success of these new lessons he was able to hold on to his job, despite the fact that he did not agree with Montgomery on everything.

At the end of March 1945 Carver, acting as he had during the Udem-Sonsbeck battle in the Reichswald, again formed two armoured/infantry battle-groups, the infantry of one being carried in Kangaroos – in effect APCs. Having reached Ochtrup on 3 April 1945 4th Armoured Brigade were switched to the command of 52nd Infantry Division to turn east for Rheine, cross the Dortmund-Ems canal and continue the advance beyond. It was an unsatisfactory period for an armoured brigade which had been in action in Normandy: 52nd Division, which had not, was 'not an easy formation to work with'. The reasons included: 'their commander, Major-General Hakewill-Smith, was elderly, 49 years old, and their methods [...] pedestrian[:] Hakewill-Smith's 'order groups' [...] were dominated by his Commander Royal Artillery'.⁶³ Complete dependence on artillery firepower, to be effective, called for rapid forward movement even in a direct frontal assault. In Carver's view, 52nd Division's commanders lacked the speed of thought and action essential

⁶² IWM, Greenacre Papers, 94/33/1, 'Lessons from France, the Low Countries and Germany', p. 1.

⁶³ Carver, *Out of Step*, pp. 214-5.

for mobile operations. This was also Montgomery's view, from his TAC HQ now at Rheine. He sent Major P. Earle, his new Liaison Officer, who had come as a replacement for the wounded Major Mather, to see Hakewill Smith, 'to find out why he [Hakewill Smith] was getting on so slowly'.⁶⁴

In addition, in 52nd Division, commanders did not have realistic expectations of what the tanks could achieve in the light of the difficulties that they faced. These difficulties came particularly from hand-held weapons and anti-tank guns in built up areas which were the strategic nodal points through which they had to operate because of being largely road-bound.⁶⁵ Some officers at lower level thought that the tanks were letting them down because of not actually fully comprehending the new understanding of the roles of armour and infantry in the changed conditions of combat.⁶⁶ The lessons Carver drew from grouping an armoured regiment and a motor battalion in half-tracks, and an armoured regiment and an infantry battalion in Kangaroo APCs in the April 1945 battles were that:

in execution [of] a deliberate attack, full use must be made of mobility to achieve surprise in time and direction, of the armour of the arm[oure]d personnel carrier to protect the inf[antry] in their approach as close to the objective as possible, and of the immense fire-power [of tanks] available to reduce the infantry's task as far as possible to the mopping up of demoralized defenders and protection of the tanks from close-range A Tk weapons. Converging attacks from the enemy's flank or rear offer the best prospects of success.⁶⁷

These lessons were counter to the approach which prevailed among 52nd Division officers. The allocation of a squadron of Kangaroo APCs

⁶⁴ Maj. P. Earle, personal diary entry, 8 April 1945, quoted in A. Horne with D. Montgomery, *The Lonely Leader; Monty 1944-45* (London: Macmillan, 1994), p. 325.

⁶⁵ Carver, *Out of Step*, p. 215.

⁶⁶ London, National Army Museum (NAM), Hakewill-Smith Papers, 9012-28-41-1, 'Actions Of Drierwalde And Hopsten On The Nights 4/5 and 6/7 April by 156 (West Scottish) Bde', Attack [on Dreirwalde] by 'B' Coy 6 Cameronians (Capt McNeill); by 'D' Coy [on Hopsten] (Capt Watson). These criticisms were omitted from the accounts of the fighting in Dreirwalde and Hopsten in the history of 52nd Division; G. Blake, *Mountain and Flood: History of the 52nd (Lowland) Division*, (Glasgow: Jackson, Son & Co, 1950).

⁶⁷ IWM, Carver Papers, Papers relating to 4th Armoured Brigade and 7th Armoured Division, Brig. R.M.P. Carver, 'Operations of 4th Armoured Brigade 14-19 Apr 45', Part II: 'Lessons', p.23.

to allow infantry accompanying tanks armoured mobility – the difference between poor practice and very good practice in spring 1945 – was not repeated while 4th Armoured Brigade was under command of 52nd Division.

After its deployment at the end of October 1944, Hakewill Smith's 52nd Division had performed creditably in a number of important operations in North-West Europe.⁶⁸ On its deployment, 52nd Division had a unique advantage over other divisions at that time: it retained most of its original officers. They had experienced the period of training in the UK. However, they now faced the special challenge of tactical learning informed by lessons from current experience of action, at the very stage of the campaign when there were few experienced officers to be spared from other divisions to spread their experience to 52nd Division. Thus, although 52nd Division's late deployment to theatre was a factor affecting the new doctrine's application by those charged with tactical leadership in what had been 'the last major reserve formation in the British Army', despite the shortcomings identified by Carver, by eventually performing in the manner envisaged by Montgomery they were considered to have acquitted themselves well enough. Indeed, in the view of one senior commander, by the last battles of the campaign 52nd Division was to become 'one of the best divisions in Twenty-first Army Group'.⁶⁹ The inference can be made that this success can be put down to 52nd's willingness to learn from the pamphlets (among other sources and means of communication) to bring themselves quickly up to speed.

The climax of Carver's achievement with his battle-groups in carrying out Montgomery's wider plans was 4th Armoured Brigade's breakout of the Aller bridgehead north-east of Verden on 14 April 1945. Montgomery could now implement his plans for 21st Army Group's final advance northwards to the Baltic. Advancing to victory, well-planned, surprise encircling movements combined firepower and mobility to great effect. The breakout, carried out by 4th Armoured Brigade at

⁶⁸ Pre-eminently, Operation INFATUATE (1-5 November 1944) – the attack on Walcheren island in the Scheldt estuary by Commandos and 52nd Division.

⁶⁹ Horrocks, *Corps Commander*, p. 216.

Westerwalsede, which was heavily defended by German anti-tank guns, showed just how far the British Army had come from the days when the German '88' gun line had so often confounded their best attempts to find success in armoured warfare.

Ten months after PERCH – when 22nd Armoured Brigade, 7th Armoured Division had been attacked while it was strung out through Villers-Bocage – elements of 6th Guards Armoured Brigade which had recently occupied Stadensen during the battle for Uelzen were attacked by *Panzer-Division Clausewitz*, the last panzer division created by the Wehrmacht. The 22nd Armoured Brigade was attacked when the leading tanks and infantry transport were stationary and backed up; when they had arrived the night of 14/15 April 1945, the Churchills, the S.P.s and the Infantry transport of the Coldstreams had been forced to cram themselves into the village street, nose to tail. As at Villers-Bocage this had added considerably to the difficulties: German S.P.s and half-tracks, having got into Stadensen 'proceeded to play havoc with anything they saw'.⁷⁰ However, although there were undoubted British failings at Stadensen, 'as [German] tracked vehicles tried to get away, they were struck by the Coldstream tanks, ably assisted by the M10.s [tank destroyers mounting the 17-pdr] and by the 6 pdrs. of the Infantry'.⁷¹ The enemy who remained in houses were dislodged with H.E. fire the speed at which operations were conducted was maintained. The success of the resumed assault on and capture of Uelzen maintained the momentum of the British advance to the Elbe – now only some thirty miles ahead – and denied the Germans the possibility to organise any further strong opposition west of the Elbe in sufficient time.

In his assumption that well-founded principles of war are important, and fundamental to the capacity for success in war, Montgomery's approach to the conduct of war was rooted in the experience of the

⁷⁰ Forbes, *6th Guards Tank Brigade; Churchill Tanks*, p. 169.

⁷¹ *Ibid.*, p. 169.

British Army expressed in *FSR*. However, his principles of war did not directly come out of *FSR*. British doctrine identified principles as a broad set of tools. It is possible to distinguish between Montgomery's principles of war and the other centrally important points – best described as Montgomery's war-fighting principles – which added up to a coherent operational method. Montgomery's approach was in broad conformity with the way the British Army looked at principles. Further, the roots of some of his ideas can be tracked down to specific core principles in prevailing, general British doctrine. Fire-power became embedded into it as a result of the experiences of World War One. The carefully staged conduct of battle, based on superior firepower and with all arms co-operating, was the major characteristic of this way of fighting. However, it was Montgomery's recognition of the importance of, and the need for an institutionalization of, a problem-solving approach which emphasised the importance of context which led to success in North-West Europe.

A concept of operations which emphasised a 'master plan' in which as little as possible was left to chance and to which subordinate commanders were required to adhere unwaveringly left correspondingly little scope for independent initiative as far as planning of operations was concerned. Further, an unhelpful carry-over from Normandy – and before – was the cumbersomeness of command arrangements whereby each arm retained separate headquarters. This negatively affected the efficiency of armoured units. Furthermore, the armoured commander was subject to the infantry commander in an independent tactical command, with only one exception of which this author is aware – the case of Clarkeforce in October 1944.⁷² However, in the final stages of the campaign the armoured regiment commander was often placed in command of the group. Nevertheless deployment, using established routines for combining infantry and armour, took considerable time –

⁷² In support of this argument that the case of Clarkeforce was the opposite of what the text - which relays the official position as to what would be usual - says, Carver noted that '34 Tank Brigade under 49 Div[ision ...] achieved a great deal [...] with tanks as the primary arm, supported by infantry'. IWM, Carver Papers, Lectures and Articles on Armoured Warfare 1940s, 'Comments on Lt.Col. JOLLY's letter'.

with consequent loss of the advantage of surprise and perhaps also of the fleeting opportunity to achieve a breakthrough.

If this almost guaranteed that it was difficult for the armoured commander to act 'independently', this was not what Montgomery was essentially after. Although he recognised that a large force of armour which had broken into the enemy's rear could have 'great moral effect', he did not believe that armour should operate independently. This was inter-related for him with making his plan, which ensured not only crude material and numerical superiority but also – based on intelligence information that had been processed and analysed, as well as his own insight, imagination and initiative – the best weight of firepower and numbers applied at the decisive point, at the right moment for decision.

For the above reasons, there *was* little scope in Montgomery's system for decisions which resulted in the master plan being altered. There would be no *new* plan, unless Montgomery so decided. There was however always scope for individual initiative on the part of subordinates. This involved a problem-solving approach within the envelope of the overall plan. Changing tactical problems emphasised the necessity for subordinates to be problem-solving in terms of the general intentions expressed in the given plan and if necessary to go beyond the official textbook.

In his pamphlets, Montgomery identified the problems of fighting with the tools at his disposal – infantry and tank divisions and supporting air power – and indicated how he believed they should be tackled in the remainder of the war against Germany. Armoured brigades, whether part of an armoured division or independent, equipped with the same sort of tank, all equally capable of undertaking the roles of infantry-support, pursuit and exploitation – combined with an appropriate concept of tactical handling, to improve armour-infantry co-operation – should be and were enshrined as part of the solution. Fire support from the air, as well as from artillery, was also part of the

solution, because this concept was an integrated air battle-land battle.⁷³ However, new tactical problems in 1945 served to unpick some of the threads in the tapestry he had woven. With his failure at Arnhem, Montgomery had realised there would be no easy or rapid advance into Germany. As a result he had come to recognise that changes in tactical practice were required to deny the enemy the possibility of security by timely withdrawal across the Rhine. Thus, the doctrine outlined in November and December 1944 reflected the lessons of the past but projected them forward into the immediate future as the means to meet and overcome the new challenges that were now evident.

For Montgomery, it was vital to retain the principle of the Initiative. In Normandy, the Germans, fighting determinedly, were also discovered to be adept at the speedy redeployment of their superior armour to block any British penetration. An important thread in the tapestry had come loose. Manoeuvring to bring firepower to bear on the enemy was the essence of Montgomery's method. In the last months and weeks of the war this was now actually more difficult. The opposition was organised, but not continuous, either in front or depth. Henceforth, the campaign was going to be a matter of deploying and attacking small groups of the enemy defending key points or finding a way around. Although German formations were rarely up to strength they retained cohesion. This explains the shift from Montgomery's change in perception of 'initiative' (as something that is essential for success in battle) to 'Initiative' as a main principle of war.⁷⁴ The principle that infantry, tanks and self-propelled artillery should co-operate together to a closer degree had been established but the need for subordinates to exercise their initiative became imperative if the necessary momentum or tempo for

⁷³ On 8 February 1945, for example, numerous attacks would be made on 'known enemy headquarters and their signal systems' including a rocket-firing Typhoon attack against 1st German Parachute Army HQ at Emerich, as well as attacks on railway lines and traffic heading for the Rhine. Further, at the time of the Rhine Crossing in March 1945, AVM Broadhurst, commanding 83 Group, had air control of the battlefield in a semi-circle of fifty miles radius beyond the Rhine, Ellis, *Victory in the West: Normandy*, pp.260 and 287.

⁷⁴ cf. Montgomery's address at St. Paul's School, London, January 1944, quoted in Brooks, *Montgomery and Normandy*, p.27 with the list in *Notes on the Conduct of War* of November 1944.

practising this in mobile operations was to be achieved and maintained. It was this combination that would finally break the cohesion of the Wehrmacht in the west.

The orientation that previously sufficed was experience of 'what to do'. By late 1944 and into early 1945 the experience of 'quick thinking' within the goals of the master plan, rather than any specific action, was the solution. Because of the lessons learned, the new doctrine that was institutionalised was intrinsically able to cope with a different type of warfare and thus was successful. As Montgomery advanced to and began to undertake his successful crossing of the Rhine, because of the initial innovation there was no further need to innovate. The doctrine he had created could now handle, adapt to, and account for the change in the kind of warfare that 21st Army Group confronted in the final months of the war in Europe.

CONCLUSION

This thesis has proposed a new interpretation of how 21st Army Group produced a functional doctrine for armour, infantry and associated instruments by late 1944 and implemented this in early 1945. It has been shown that investigating the subject of armour-infantry unit organization and structure in 21st Army Group in North-West Europe 1944-1945, had to begin before 1939 with the development of British doctrine, problems and thought with respect to armoured warfare from the late 1930s as well as with the experiences of fighting earlier in the War – mainly in North Africa, Italy, and then in the initial days and weeks of the Normandy campaign. The story then developed through ‘late Normandy’ and ‘after Normandy’ has described a series of events in late Normandy where individuals were coming up with different ideas at different levels of command, whereas by after Normandy the ideas – which can be associated with particular individuals – had widely come to be accepted as the right ones in 21st Army Group. In short, 21st Army Group moved from a situation of doctrinal anarchy to one of doctrinal uniformity – it did this under Montgomery’s direction. A series of figures has been used throughout the thesis in order to make more clear the path of this particular set of historical issues (Figures 6.1 and 6.2 below are developments of Figure 5.1, and 0.1, designed to show how the effect and the process changed over time). The doctrine of late 1944 then reflected the lessons of the previous six months’ fighting but projected them into 1945 as the means to overcome the problems that were now evident. This close examination of how a group of ‘effervescent’ commanders interrelated, and what the effect of those inter-relationships was in the formulation of a workable doctrine, then ends with a series of examples of the new doctrine in action.

Instead of looking at whether Montgomery imposed a doctrine from the top or whether the doctrinal situation was one of apparent anarchy,

the thesis is based on the proposition that this apparent problem posed by the historiography was not the most helpful way to look at the problem. A more productive way is to see that what was happening was a more complex process which accommodated both. This thesis demonstrates how the process worked and supports the central interpretive proposition that the apparent problem posed by the historiography has obscured the central question which needed to be addressed, which is how Montgomery's command produced a functional doctrine by late 1944.

In order to draw the threads of this thesis together, it is necessary finally to look at the whole tapestry rather than the individual threads and address what story can ultimately be told about the role of Montgomery, the contribution of others, and their ability collectively, to produce the functional doctrine identified. It has been seen what this contributes to the historiographical debate about the strengths and weaknesses of Montgomery's command system, how corps and divisions responded to it, and the effectiveness of the weapon they shaped and used between them and it will now be shown how the new insights of this thesis can be used to re-interpret and explain operational development, innovation and command in 21st Army Group. The conclusions that have been drawn from the research findings are that the command hierarchy functioned to produce new lessons more appropriate to North-West Europe and that the genesis of these ideas was both bottom-up as well as top-down. The translation of experience into method involved a problem-solving approach within agreed-upon frameworks of common understandings which, once established, then became non-negotiable. Montgomery moved from dogma towards being a 'reflexive' commander by taking on board others' experience, but also responding to the unfolding situation and encouraging other commanders to do the same – albeit in what can be considered a somewhat inflexible manner. Notwithstanding, it was Montgomery's adoption of a problem-solving approach which emphasised understanding the importance of context (*i.e.* the relationship between circumstances obtaining in a given situation and the goals of the master

plan), and the use of initiative to make plans to deal with the problem within the envelope of the master plan which led to success in North-West Europe. In sum, he did not tell commanders how to fight; he told them how to think, so that they could decide how to fight.

The Factors that Produced a Functional Doctrine

This study set out to investigate the factors that produced a functional doctrine for armour, infantry and associated instruments and did just what was necessary to bring them ‘up to scratch’: these factors were identified as: Montgomery; key commanders; and ‘circumstances’ – what they were and how they changed from situation to situation. The situation changes from: Normandy (*bocage*); ‘late Normandy’, Belgium/Holland; ‘into Germany’ and 21st Army Group’s final advance to the Baltic and the Elbe. Also changing the circumstances was the Germans’ fighting capacity and methods, and the kind of problems they presented, including different German tank types. The type of fighting could vary tremendously. The German armoured defence in depth which also attempted to use armoured manoeuvre to restore ruptured fronts in Normandy gave way after an advance at great speed to the linear-type anti-tank defences of the Siegfried Line which formed Germany’s western border defences. Finally, there was fighting where there was little or no front at all, but small groups of the German armed forces fighting determinedly with traditional heavy weapons, or new-technology hollow-charge ones.

Early in Normandy armoured division commanders had been frequently called on to assist in assault-type operations which had nothing to do with their intended role of armoured exploitation at all. However, the role of an independent armoured brigade charged primarily with infantry support (i.e. operating within quadrants 1 or 2 of Figure Appendix I.1) did not appeal to armoured commanders later on in Normandy any more than it had at the start – despite different (new) commanders. In other words, they were on the whole happy to accept the official bifurcation in armoured doctrine. This was unhelpful in

sequencing the phases of operations. It did not allow operations to develop at the tempo that Montgomery and some armoured division commanders now understood was required. Nevertheless, among armoured division commanders too, responses to the new tactical problems in Normandy were also intensifying to the point of expression. There were corresponding bubble-up developments in armoured divisions. It was a traditional performance goal of the infantry of armoured divisions to be mobile, but the infantry's principal role was not seen as a protective one for the tanks. In early-Normandy, reflecting War Office policy at the time, the armour and the infantry were brigaded separately, largely because it was thought that the infantry would advance more slowly, and firm up gains made by the tanks. Armour and infantry were de facto mutually exclusive organizations. In terms of this concept of armour-infantry co-operation, early in the campaign the official view was that the infantry were intended to come into action only in tandem with the tanks, not be in action fully alongside and close to the tanks, to protect them. Important early setbacks in operations using manoeuvre-oriented or attrition-based methods provided the impetus for innovation with respect to combining and integrating armour and infantry in the British armoured divisions.

In the case of commanders of armoured divisions and commanders in them, responses to the interlinked dilemmas of purpose and practice had initially ranged from the critical to the creative. Some commanders of armoured forces were critical when armoured divisions were called on to fight in confined country, or complained that they were often forced to deploy over too narrow an area – Hinde being a good example. To realise the purposes to which armour could be put to best effect no longer rested on the perceived capabilities of the two arms in attack and defence however, but on experience, and took action away from the ideas that tanks protected infantry (quadrants 1 and 2 of Figure Appendix I.1) – and took action into quadrants 3 and 4. The conclusions reached by creative armoured division commanders such as Roberts were different from those reached by other commanders in both

types of the independent brigades, and stemmed from a different basic concern: their tanks' security.

What people thought they could do related to their equipment amongst other factors. Montgomery had come to believe that a multi-role, or 'capital' tank was required; it would be an important battlefield weapon. On the battlefield, however, there was no mass availability of a true multi-role tank. Yet, later on, new tanks were becoming available: the best Britain could produce, although they were intended for 'armoured division-type' tasks rather than infantry co-operation (e.g. the Comet was a cruiser tank). O'Connor had also identified the need for really suitable armoured vehicles in which the infantry could be carried forward into battle. In the interim, what Montgomery could do was to get everybody to think along similar lines: the major-generals commanding divisions and also the brigadiers commanding the two types of independent brigades, to produce commonality across the levels of command to ensure 'ubiquity'. According to Montgomery's 'capital tank' idea, making the Sherman tank – and all other models of tanks – a multi-role tank would best match tactics and a tank that was available to operational aims and intentions. Montgomery realised however that this development would need to be complemented by managing expectations among the infantry and the armour as to what the other could achieve, so that the effect of what they could achieve together would be maximised. A situation had arisen in which the perception had grown among tanks and infantry that it was the job of the other to defend them as they did their job of attacking. This was what Montgomery was trying to change, replacing it with the idea that there should be one common, offensive purpose. Thus he developed his functional doctrine.

In mid- to late 1944, circumstances changed, requiring new responses. After Normandy, British armour, moving at breakneck speed, spearheaded the power drive across northern France into the Low Countries in August and September 1944. Then circumstances changed again. The performance of Clarkeforce in southern Holland in October 1944 showed Montgomery a way in which his numerical superiority in

tanks – most of them in independent brigades, including the three independent tank brigades principally equipped with Churchills – could be brought to bear, opening up again the possibility of mobile operations on a decisive scale. The critical factors were now different. To conduct new-type operations successfully needed different structures; and if necessary new commanders. A new set of relationships, a new pattern of command, and a new development of practice emerged to meet the challenge. Montgomery intervened and commanded. There was an official process in which Montgomery pulled everything together. There was also now, for the first time need for a uniform doctrine that answered the ‘big’ problem of method: the introduction of fluidity into the action of major formations. As importantly, however, rather than telling people how to do things, Montgomery insisted on the importance of people coming up with their own answers with regard to problem solving, and on the interlinkages between problem solving and getting to the overall aim, which was the relentless imposition on the Germans of the condition, ‘mobile war’. He did not want to tell commanders how to fight; he wanted to tell them how to think, so that they could decide how to fight. Armoured formations proved flexible enough to adapt thereafter. This in its turn influenced and interacted with how Montgomery made his choices of subordinate commanders.

‘Bubble up’

We now know that there had been a significant amount of more informal communication between Montgomery and subordinate commanders than previously identified. His desired output, that is a common doctrine, and also the desired outcome which was success at the campaign level, were to be the result of the interaction and interrelationship of a variety of processes that were at work during the campaign, which have been identified. The ‘Montgomery factor’, whilst identifiable and analysable, was ultimately inseparable from the other ingredients. Montgomery managed the output and created commonality, managing different groups of people at differing levels in

the chain of command. Montgomery was thinking about how to supervise and guide people to try and ensure that correct lessons were learned as quickly, as well and as widely as possible. He was looking for ways in which what he regarded as really important lessons could be adapted to new experience.

The 'bubble up' which has been seen within 21st Army Group armoured units which had been in action since D-Day, and as eventually demonstrated in Carver's command of 4th Armoured Brigade, shows that commanders of independent armoured brigades such as Carver were looking beyond or, rather considering in a different way, the immediate 'how-to' problem of utilizing the capabilities of the Sherman tank and the 'in-house' infantry the Brigade had at their disposal to greatest effect. Both Carver (Shermans) and Verney (Churchills) as noted in Chapter 3 arrived at the idea that the physical proximity of the two attacking arms was not always necessary (see also Appendix I). The sacred cow that had to be sacrificed was the central tenet of traditional or classic British tank-infantry co-operation doctrine: that physical proximity of the two arms was required, a fact recognised by some prior to D-day but illustrated 'in action' by the conduct of the independent brigades. Verney and 6th Guards Tank Brigade (Churchills), acting on their own authority to move separately, were moving away from proximity with their infantry during BLUECOAT (thus taking action into quadrant 2 of Appendix I). At that stage their action was still underpinned by the view that the role of the tanks was to support and protect the infantry. Carver, however and 4th Armoured Brigade (Shermans) were taking action clearly into quadrant 3 during JUPITER, with the infantry ranging ahead to 'protect' the tanks. This also allowed for the possibility of action taking place in quadrant 4 where infantry might also operate in close proximity with tanks to protect them, as also realized in the armoured divisions.

Too often in the armoured divisions, however, the requirement for more infantry derived from a defensive rationale rather than from awareness of the need to get away from the idea of defence towards mutual supportiveness. Finally, though, it was beginning to appear to

British commanders that the side that could most effectively manipulate available infantry reserves would win the day.

Carver's solution can best be described as integrated armour-cum-infantry tactics, built around the configuration and capabilities of an independent armoured brigade. These Sherman-specific tactics required changing the existing view of how armour-infantry co-operation worked, because the role of the infantry was now also to defend the tanks. Carver interpreted his role in this way, even when tasked with direct support of infantry. Further, however, an innovative aspect of Carver's solution was to develop a means of armoured assault different from War Office teaching. Thus, at another cut, his solution was a 'grand tactical' conception, and had application for 'operational-level' tasks as well.

Up to late 1944, however, commanders still expected only to be guided by high level views on how to combine armour and infantry. In late 1944 the principle of separate forms of organization for armoured brigades and infantry brigades was abandoned in favour of homogeneous brigades. The homogeneous brigade of late 1944-early 1945 can usefully be considered as a proto-type battle group. These were mutually-reinforcing combinations of armour and infantry, and were an organizational development designed to facilitate the combined-arms tactics necessary for success in the *bocage* countryside of Normandy. It was only in late 1944 that all armoured division commanders really began to accept the idea of 'square' proto-type battle groups which required an integral infantry component, although most were using this broad idea by August 1944. Roberts' homogeneous brigade concept interacted, however, with what Montgomery believed was required, which was the ubiquitous use of armour.

Overcoming having to use inferior equipment (in some cases) can fairly be held to be a demonstration of the skill of many British commanders. Equally some commanders could fairly be held responsible by Montgomery for a lack of quick thinking at a number of critical early junctures. This had led to a lack of fast action; wherein, arguably, the fleeting opportunity for breakthrough had been missed.

Further, in the armoured advance into the Low Countries in September-October 1944 armoured divisions under commanders with the capability of producing new ideas and organization tended to revert to a 'normal' (i.e. pre-Normandy) structure, commensurate with a pursuit phase of operations. The war had not however been won in Normandy. By analysing the command changes in certain corps and divisions, an obvious break with existing norms and practices of command-and-control can be seen. The previous situation (in Normandy) had been one in which decisions on the actual methods of fighting were largely left to unit commanding officers. Thus, in figure 0.1 the vertical 'Montgomery' rectangle starts the process, but the lower ranking officers take it forward and Montgomery does not – at that point – interact with and cross the horizontal 'subordinate commander' arrows centrally. This state of affairs was replaced post-Normandy by one where military pamphlet literature emerged in the field as a means to convey specific tactical and organizational ideas which reflected collective experience, from which no deviation was permitted – or required. Thus it can be established that Montgomery's evaluation of the performance of his armoured divisions was that their performance on the ground in Normandy had not been all that he had hoped for. This was particularly true with respect to divisions which had fulfilled his expectations in North Africa: 7th Armoured Division being a classic case.

With the need to fight through the Siegfried Line after the failure of the Arnhem operation, Montgomery realised exactly the level of close co-operation that would be required between armour and infantry and he really gripped the problem. In short, the problems of fighting in Normandy, and the bubble-up responses from commanders, gave rise to three sets of responses from Montgomery: firstly there was a pattern of command changes in certain corps and divisions; then there was a step-change within the existing culture and the norms and practices of the Army; and finally there was also the production of Montgomery's pamphlets as the means to convey and disseminate specific tactical and organisational ideas because at the start of the campaign some

commanders had produced these new lessons in a more or less isolated manner.

From 'Anarchy' to Problem Solving

Once the invasion had begun, the time for a learning process was short. Commanders in 'early Normandy' had three different kinds of experiences which influenced the development of doctrine and practice in different ways. There was a group of successful commanders who had fought in North Africa, who did not change their methods and continued to fight with methods of combat derived mainly from Western Desert tactics. When they got to Normandy, they thought that desert practice was what should be carried out there. Those in a second group of commanders fought in North Africa too, had also gained their high reputations in the desert, but were not bound by or to the lessons learned from previous victories in Libya, Tunisia, or Italy and when they arrived in Normandy were open to new ideas in a new operating environment. A third group was comprised of new commanders who had served with the Home Forces and not fought in the desert or overseas between Dunkirk and D-Day (shown in Figure 5.1). This led to a development of practice in response to the problems of fighting in North-West Europe where complexity which is illustrated in Figure 6.1 (below) had to be simplified and all three groups brought into line behind a single concept, or individualist protagonists jettisoned.

The replacement of lessons from past experience by current experience of what would work was conducted at many different levels of the corps-division-brigade hierarchy as the push inland appeared to slow down. In this situation, the experience of those who had never served in the desert, and not been influenced at first hand by desert practice, was both necessary and important as desert-influenced methods of combat floundered in the *bocage* countryside of Normandy. They implemented a way which crystallised as a recognizable, unified approach within 21st Army Group – the new way that emerged in Normandy, formed from a realisation that desert practice applied to very

special circumstances; it did not apply to Normandy. The new amalgam emerged from the three groups, which, towards the end of 1944, were influencing the development of doctrine and practice in different ways. By also examining the issue of when 21st Army Group moved from ‘anarchy’ to problem solving under Montgomery’s direction, this thesis has demonstrated that in the relatively short space of four or five months, while the fighting was so hard, commanders were still able to learn and implement complex lessons.

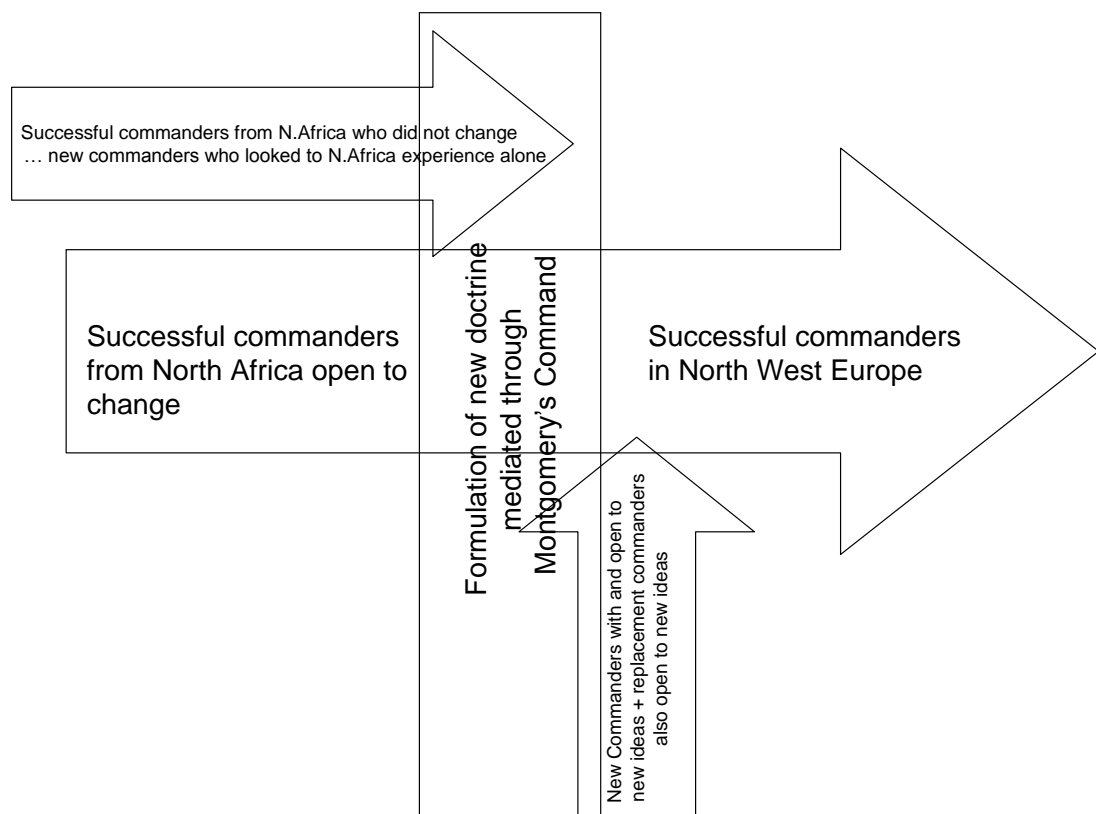

Figure 6.1: The process of translation of experience into method, late 1944

In the example from Normandy of Roberts and O’Connor, O’Connor was apparently leaving the initiative to subordinates to suggest what they wanted to do in a continuation of the ad hoc responses. In the case of Roberts and Montgomery and the production of Montgomery’s pamphlets, Montgomery was not only the Field Marshal holding the

whole thing together and ensuring that things were moving forward in the right direction in terms of his operational aims and intentions, he also took an active role in shaping the methodology of how things should move forward at the level of the actual fighting. This is evident, not only in actions but in the production of these pamphlets.

Armour-infantry doctrine for the final assault on Germany would soon be based around principles enunciated in Montgomery's pamphlets on the infantry and the armoured divisions of November and December 1944. A complex set of actors in interaction produced this doctrine. It was also shaped by how Montgomery commanded to produce a uniformity of method. The process resulted in one of the three bodies or groups (those attempting to fight with desert-influenced methods) being sidelined, and the other two being brought together in a collective understanding. The commanders open to change and the new and replacement commanders with ideas and open to change both contributed to the formulation of new doctrine, that is overlap with and fed through the vertical 'Montgomery' rectangle (which has now assumed the centrality it would have henceforward), and also fed into the single emergent grouping which comprised successful higher and senior-to-middle level commanders.

By utilising the best available knowledge and experience at his disposal, not just his own knowledge or ideas, Montgomery ensured that the creative responses to the problems of the fighting in north-west France and latterly in North-West Europe were taken on board and a structure provided for these to be institutionalised. Montgomery's ideas validated and absorbed the experiences of commanders at the sharp end whose opinions he valued. He put them together with his own ideas through a process which allowed the output to be synergistic. Thus, as armour and infantry were working together in new ways which neither arm could have delivered entirely on their own, this process was one which could not have been delivered by any one commander on their own – this includes Montgomery.

Roles of Commanders Old and New in the Development of Doctrine

The timeframe and relation of individuals within and to it was as follows. As commanders attempted to push inland the initial XXX Corps (Bucknall) operation resulted in the defeat suffered at Villers-Bocage by 7th Armoured Division. For Erskine, 7th Armoured Division, and in particular for Hinde, commander of the division's armoured brigade, this experience not only demonstrated that the difficult nature of the Normandy terrain assisted the Germans' resolute defence against their tactics, it also set up a pattern that was to be frequently repeated in the Normandy campaign in which German armour demonstrated an apparently endless capability to rapidly re-deploy and block any British advance with (in the case of the most modern German tanks) the further capability to engage and destroy British tanks with long-range fire, from often excellently camouflaged positions. This made the security of British tanks a function of their distance from the enemy and called into question the supposed lessons of North Africa.

Hinde was a key middle ranking commander during the fighting in Normandy who was also representative of the first group of officers described in the thesis, that is successful commanders from North Africa who did not change their methods and thus had to go (see also below, Figure 6.2). Further, Hinde's involvement in the process by which doctrine was being criticised, created, and changed below the higher levels of command during the Battle of Normandy may be considered as a baseline against which the involvement of others may be compared. A significant, creative role in the process of learning of lessons after the Villers-Bocage battle was played by Carver. Carver had initially gained his reputation as a first class commander in the Western Desert, but he had learned new lessons as was evident during his command of the independent 4th Armoured Brigade later in the Normandy fighting. Another division in XXX Corps in June 1944 was 49th Division commanded by Barker. It is an observation of importance that Barker did not serve in the desert.

Comparison shows that these three groups of commanders – those who did not change from previous lessons, those who were open to change, and those new to the field – initially displayed characteristically different methods of fighting. However as time progressed, in response to problems of fighting in Normandy and in terms of the development of new doctrine, there developed an identifiable subgroup who followed a way which became crystallised as a recognizable, unified approach within 21st Army Group (see figures 5.1 and 6.1).

Roberts, GOC 11th Armoured, a divisional commander of particular importance, made his name as an innovative commander in the Western Desert and was an important instigator of further tactical change in Normandy as also noted above. However, innovations such as the brigade groups of mutually supportive infantry battalions and armoured regiments were particularly associated with Adair, GOC Guards Armoured Division, who had not fought in the desert or overseas. O'Connor is also an important figure here. A successful commander in North Africa, it is debatable whether he was or was not bound by or to the lessons learned from previous successes. However, the inference that can be drawn from the evidence considered is that eventually he lost Montgomery's confidence because he seemed to question the methods Montgomery promulgated.

Some other commanders were also important and therefore worthy of note for recognizing and implementing innovation. Whistler is a good example of a commander who was actively implementing the process of innovation but who was not himself an innovator – thus his command of 3rd Division after Rennie (also important) was wounded shortly after D-Day is of interest because he has been shown to have been attempting to address problems of fighting while being able to control and manage only the components of which he was in command. Rennie, who was killed during the Rhine crossing leading 51st Division, is a further example of an implementer rather than an innovator. Both Whistler and Rennie were outstanding commanders who fitted in no less well to Montgomery's scheme of things for being implementers, rather than innovators, because of their proven leadership skills and intense

pugnacity. The 'implementer/innovator' model is a useful and hopefully striking one in terms of its power to explain the 'Middle Management' concepts used in the thesis: Instigators and Drivers of Innovation; Implementers; and Blockers. In terms of the situation at the very end of 1944/early 1945 the Blockers had gone, so that there now remained only two groups of commanders – 'Innovators' and 'Implementers'.

By the time of the catastrophic operational defeat inflicted on the German Army in August 1944 which led to the Allied breakout from Normandy, Western Desert-style tactics had been shown wanting and most commanders adhering solely to desert-influenced methods of combat had been ousted. Erskine, for example, was relieved of his command and instead Verney promoted from commanding 6th Guards Tank Brigade to the command of 7th Armoured Division. Lyne took over 7th Armoured Division from Verney in November 1944. The findings indicate, however, that Lyne was an implementer rather than an innovator so far as re-organization and changes in respect of armour were concerned. New and replacement commanders could be open to fresh ideas, or conceivably (though this was increasingly unlikely) bring in new ideas themselves. Alternatively, they could be commanders who simply implemented the new 21st Army Group tactical method. Wingfield, the second-in-command of 34th Tank Brigade, having temporarily commanded 8th Armoured Brigade before returning to 34th Tank Brigade, is an example of a commander who was open to fresh ideas. He would eventually come to command 22nd Armoured Brigade in 7th Armoured Division.

A completely new commander in theatre was Hakewill Smith. Hakewill Smith and 52nd Division were only committed to the campaign in September 1944. He and his division exemplify the problems of replacement commanders and formations in learning from current experience – because of the gulf between the ideas which those responsible for tactical leadership were looking for and what was said in official written War Office doctrine. Nevertheless, the example of Greenacre and 6th Guards Armoured Brigade makes it clear that for and in the advance from the Rhine new and replacement commanders

coming to prominence were tending to adopt the new methods that can be considered collectively to have been 'Montgomery's' 21st Army Group tactical method. Commanders new and old played important roles in the developments described here.

Operational Development, Innovation and Command-and-Control in the Context of the Move from Anarchy to Problem Solving

This section addresses the main investigation of the thesis. This allows us to start to draw together the strands and findings concerning the ways in which the translation of experience into method was innovative. As the prime instigator of the process, Montgomery worked with others in ways that can now be fully appreciated. However, this finding does not indicate what might be called a 'Round Table': there is no evidence to suggest that this group of effervescent individuals engaged with each other – certainly at the higher levels – except through Montgomery and his agents in this process, such as Lyne. Consequently, it appears reasonable to argue that the effect in the formulation of a functional doctrine was that at the end of 1944 Montgomery was more open than has been supposed to the bubbling up of new ideas that worked which originated at, or below the divisional level. His main contribution in terms of ideas was to be so quickly responsive to circumstances as to influence a change of circumstance. The new way that emerged after Arnhem, was composed by people on the spot, including Montgomery but all working under Montgomery's direction in new ways with more direct (though heavily informal) communication than has hitherto been recognised between Montgomery and corps, divisions, and brigades. Montgomery used individuals such as Lyne as a conduit to allow bubble up, even if there was little communication directly back from Montgomery (on these matters) to divisional level or below. Thereafter, that is from late 1944, this complex approach which included both formal and informal elements was the basis on which Montgomery was content to leave things to the initiative of subordinate commanders.

Thus, it was Montgomery's adoption of a problem-solving approach in a way which emphasised the importance of the relationship between circumstances obtaining in a given situation and the goals of the master plan ('context') which led to success. Subsequently, and after the sidelining of blockers, the remaining commanders were all innovators at different times and in their own different ways, thereby providing the means to overcome the problems of command, doctrine and organization which had already been highlighted as they struggled to adjust ideas on armoured warfare (including those of the War Office) to current circumstances. In the case of Montgomery, he also had to reconcile these reactions and responses with his general theories.

Montgomery's approach to war was a traditional British one in recognising the importance of principles, and issues related to the experience of the First World War such as firepower, administration, and so on. It was not the extent, but rather the depth of his innovations that is their particularly defining feature. The way these elements joined together called for a new orientation. What the War Office offered through its training and publications was textbook knowledge, supplemented by concrete examples from military history: the whole point of this exercise being to teach commanders how to fight battles. There are no examples in Montgomery's pamphlets except for some references to current experience. What this says is that he wanted to facilitate what we would now call 'out of the box' thinking, unconstrained by unhelpful examples from past successes. Thus, what Montgomery wanted the pamphlets to do was to inculcate an understanding of how to think: he did want to constrain the options that armour and infantry commanders came up with to solutions that delivered certain ends in terms of the big picture in 1945, one of which was speed in mobile war. However, he got people in the two arms at different levels to work in new ways under his direction. Because of the lessons learned, the new doctrine that was institutionalised was intrinsically able to cope with a different type of warfare and thus was successful. It was thus Montgomery's adoption of a problem-solving-within-context approach which led to success in North-West Europe.

The orientation of 'quick thinking' within the goals of the master plan was by then the solution rather than any alteration of the master plan.

Montgomery institutionalised emergent organizational change. He changed the way the armoured arm functioned in terms of the requirements of fluidity of major formations and ubiquity of armoured formations. This was a new framework for action which at the most basic level gave rise to standard operating procedures. However, the core value became the 'Initiative/initiative' for the reasons given in Chapter 4 and 5. By late 1944, the Initiative had become one of Montgomery's principles of war. By the end of the war, 21st Army Group was also capable of considerable flexibility on the battlefield with respect to co-operation between armour and infantry. The key thing about Montgomery and innovation is that he moved from dogma towards being a 'reflexive' commander by taking on board others' experience, but also responding to the unfolding situation and encouraging other commanders to do the same. The process henceforth became command plus co-creation, within a framework of common understandings. Figure 6.2 represents the effect of this diagrammatically: the effect was that the factors producing change had been optimised to meet the challenge of the final assault on Germany.

Montgomery had always sorted and sifted his commanders, but now he sorted and sifted them in terms of who could tell him what worked, and who were skilled at using available equipment to best effect. The process of this happening was shown in Figure 6.1 (with new commanders coming in) but the effect – through the centrality of Montgomery – is shown here in Figure 6.2. His active contribution was to impose the idea that, although a functional doctrine for armour, infantry, and associated instruments would have a number of different practice aspects which related to the capabilities of the various arms in terms of their contributions of different types of firepower and mobility, there should be a unity of purpose. Multiple types of organisation mean multiple changes, but converging towards a single 'mean'. It improved the fighting chances of 21st Army Group in ways that had not been tried

before in terms of a functional doctrine which covered armour, infantry, and associated instruments.

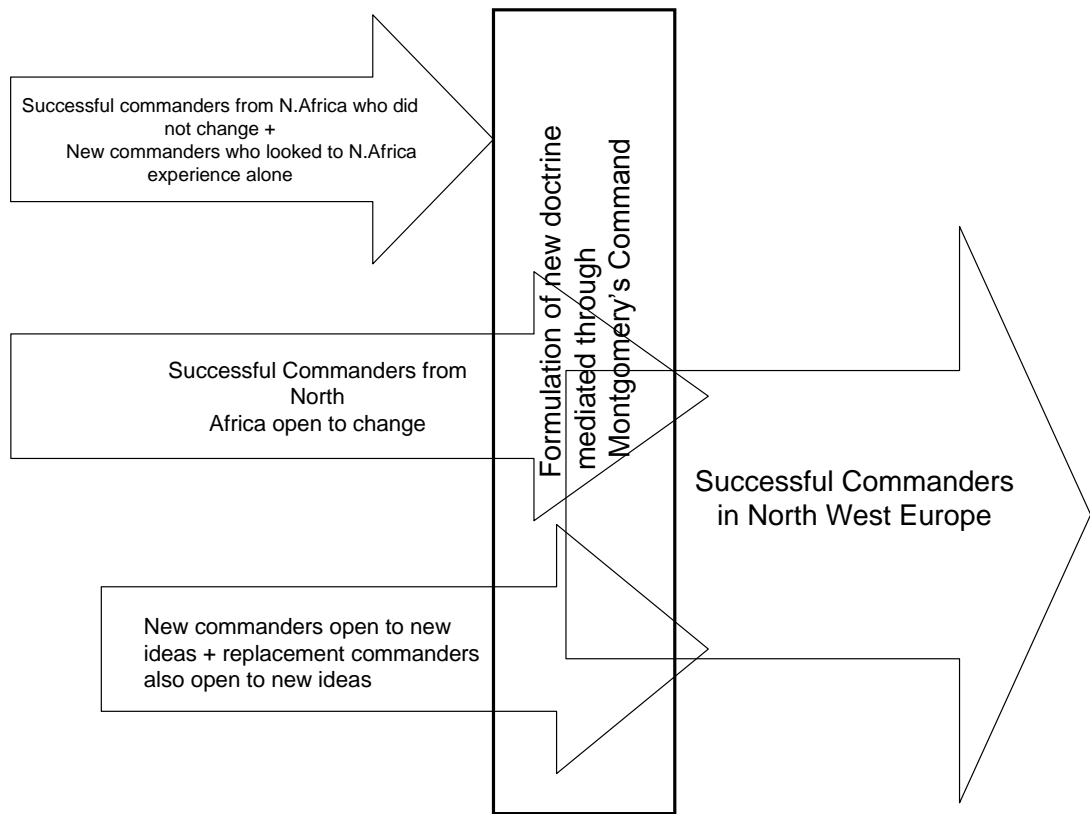

Figure 6.2: Metamorphosis of experience into method (Effect)

Montgomery's solution in practice was to adapt tactics as if the 'capital tank' existed. This is where his insistence on the need for the change in thinking styles came from. Montgomery optimised all those factors he could optimise. Hence his transposition of the term 'ubiquity' from the traditional infantry role, and the use he made of it as a concept: by which he meant 'not tied to one role or the other'. Thus, Montgomery's was a holistic approach to the use of armoured divisions. However, the importance of the artillery and its role in assisting the other arms to achieve a breakthrough was affirmed as an important characteristic of 21st Army Group's way of fighting.

The problem remained, however, as to just how local success on the battlefield could be turned into a driver for or coordinated with success at campaign level. Montgomery's first step in this process was to make sure that there was a uniform understanding among commanders regarding decision making and outcomes in the context of his aims and intentions.

The manner in which the armour and infantry of armoured divisions could be used to best effect was perceived as the mutual defence of each by the other in offensive tactical groupings of armoured regiments and infantry battalions. This was the solution to the problem of how the process of defending against enemy tanks and anti-tank guns could be made dynamic so that defence itself became mobile rather than static for armoured divisions. Thus, the unity of purpose that underpinned new best practice emphasised not only fluidity of major formations (which pointed in the direction of modern 'battlegroups'), but also offensiveness. Defence too moved – or needed to move – at the speed of the attack, and any apparently static defence was purely temporary and transitory. The role of tank brigades had long been bound up with what had been traditionally understood to be a distinct phase of operations, which ended with the infantry established on their objectives. Barker's promotion, subsequent to the success of Clarkeforce, the armour-cum-infantry force pushed through a gap made by 49th Division supported by the tanks of 34th Tank Brigade, signalled the ongoing commitment to the battle that was now expected of the tank brigades as well. For all senior officers, and the commanders of every type of armoured formation, this had considerable implications for speed of thought and action within operations and the sequencing between phases of operations.

Montgomery ruthlessly removed from command those officers he thought were likely to be in disagreement as he sought to impose a mould of consensus. He intervened to stress and institutionalise the importance of connexions between 'output' at the different levels of command and his aim at the 'operational' level and common

understandings of same. In sum, Montgomery institutionalised doctrine.

Thereafter, he was content to leave things to the initiative of subordinate commanders. Therefore, superficially, what Montgomery was doing and the way the command structure worked would appear to be quite similar, and thus compatible with existing culture and the norms and practices of the Army. However, it was underpinned by different understandings. Commanders working with Montgomery needed to think at two levels: the tactical – their problems, and the offensive use of the armour, infantry, and associated instruments at their disposal to solve them; but also at the strategic – how their problems and solutions fitted into Montgomery's aim and intention to gain and hold the Initiative. Further, Montgomery wanted all commanders to think like two types of commander, like an armoured and like an infantry commander. Montgomery was after what can be called 'initiative-within-the Initiative': he wanted to gain and hold 'the Initiative', and required individuals to use their initiative, which would relate output to outcome in the way that he wanted, as expressed generally in the relationship of his principles of war and his war-fighting principles. These, when joined together, facilitated the capacity for success in war, as expressed in his pamphlets. The final doctrine was appropriate and because of the initial innovation there was no further need to innovate. The British Army successfully responded to each new set of challenges within the demands of the high-intensity warfare which characterised the close of the campaign.

The translation of experience into method involved a problem-solving approach within agreed-upon frameworks of common understandings which then became non-negotiable. That 21st Army Group performed as well as it did in North-West Europe was due not only to the individual adaptability of various commanders at different levels, or simply to material advantages; it was due also to its collective ability under Montgomery's direction to institutionalise changes in thinking styles to accommodate changing styles of warfare. Montgomery sought to bring about orientational change among those he could communicate with or

to directly with the aim of bringing about organizational change on as wide a level as possible. The fighting chances of armour and infantry which led assaults, on the ground were improved through the introduction of fluidity of major formations. This emphasised the idea of armour's flexibility of role, but also that infantry had a protective role vis-à-vis armour. Commanders were encouraged to change their thinking styles so to incorporate elements of each arm's individualised tactical thinking styles within a common framework. This was a 'combat multiplier' or battle-winning factor. This included quick thinking and fast action, but not flexible tactical command as in the panzer divisions. Indeed, it can be argued that given the circumstances that prevailed, 21st Army Group not only performed well but as well as they could have. In effect, Montgomery optimised all those factors which he could optimise. While this became synonymous with truly massive levels of artillery firepower, fire support from the air, and meticulous logistical preparations, it was not the whole story. The two arms would have one combat mission. Montgomery brought this about through both command changes and the institutionalisation of a common doctrine.

The effectiveness of the response was that the two arms, armour and infantry, were shaped to become a combined arms force, within an all-arms team that also included the artillery. However, arising from the fact that any initial fire plan for a breakthrough is almost entirely indirect fire, a number of things were understood from experience from early Normandy. First, it was understood that complete dependence on artillery fire support, to be effective, called for fast forward movement if troops were to reach their objectives before the effects of covering fire had worn off. This frequently presented armoured commanders with the dilemma of whether to stay with the infantry or go on close to the barrage. Secondly, it was understood that enemy anti-tank guns and tanks beyond the range of artillery support, supporting the enemy from flank and rear, were not always destroyed, leaving tanks accompanying the infantry vulnerable, and making it difficult to convert a break-in into a break-out.

Formations which arrived in theatre after the Normandy campaign at first attempted to operate on the basis of textbook artillery-based tactics, but initially without the speed of thought and action necessary to overcome the 'last 200 yards' problem, when artillery could not be used. Further, however, the response in theatre in later Normandy and into the Low Countries of massed remote artillery fire support was being adapted to localised available all-arms firepower. The new roles for tanks and other armoured fighting vehicles as recorded by Montgomery in *The Armoured Division in Battle* allowed 21st Army Group to do this. Problems, especially in 1945, were the dispersed nature of the enemy and the fluid nature of operations. This did not supersede the standing arrangements whereby the fire of an infantry division's three affiliated Field Artillery Regiments could if necessary be switched onto supporting one brigade, or heavier fire from further back called down on a target. It did not therefore set aside the important role of the artillery as an arm. It did, however, address the situation that armour was not integral to infantry divisions and brigades, and that tanks and infantry had not been integrated in armoured divisions – British armour had not been used to working together with infantry in any intimate way. And so Montgomery recognised that there could be situations where infantry and armour could fight their way forward together without the need to wait for artillery or air support (air support being an independent variable). This would contribute to his gaining, holding and retaining the Initiative. This called for commanders on the spot to exercise their initiative to be proactive to bring his plans to a successful conclusion and to fight their way forward in this manner.

A Different Explanation

Historians today seek to provide comprehensive and satisfying explanations of British operational and tactical failure and success in North-West Europe. In order to provide such explanations, questions have been raised by a significant number of important contemporary historians about whether or not the development of the capacity to

integrate combat arms in 21st Army group had any basis in a common doctrine; how such doctrine may have been created; and how Montgomery commanded, that is, whether doctrine was imposed or generated. Certainly, initial shortcomings in the operational methods in 21st Army Group, and their impact on the effectiveness of armoured forces, would have mattered less if understood more and always incorporated into planning by all senior commanders employing armoured forces. This was offset by the fact that commanders at lower level had developed workable armour-infantry co-operation tactics, as this thesis shows, before the middle point of the campaign. Therefore, what some have argued was a weakness in the Army's approach to doctrine – that is indiscipline – was to prove a considerable advantage for the armoured units as they attempted to grapple with the operational difficulties thrust upon them by the Normandy campaign. While true, the fighting in Normandy was only one phase of the North-West Europe campaign. Thus, it would be more accurate to say this was the approach at that time, but that this process was not an open-ended one in terms of the progress of the campaign over time. As the lessons of Normandy were disseminated and institutionalised, they became the basis or core of a new 21st Army Group 'official' doctrine or orthodoxy from which no repetition of the earlier permissiveness would be allowed or tolerated, because it was not needed.

What is argued in this thesis is that Montgomery recognised that finding ways to get people to depart from their rigorous training and buy into his conceptions – particularly at the interface of thinking and execution – was very important. Also important was the challenge of finding really suitable subordinates who were not only specialists having an armour background or a knowledge of the use of armour, but who also saw completely eye-to-eye with him on the handling of armour and equally possessed the necessary forceful decisive leadership. This recognition by Montgomery led to the production and circulation within 21st Army Group of the instructional pamphlets, *The Conduct of War and the Infantry Division in Battle* and, *The Armoured Division in Battle* in late 1944.

Montgomery was asking a lot from his subordinate commanders, yes, but it is important to understand also what he was prepared to settle for if he thought they were on the right wavelength and going in the right direction, as is shown by the example of Carver. There was another management process working here, or rather the two processes working together. Commanders, however senior, who could or would not practice Montgomery's methods as he promulgated them, found their services dispensed with regardless of their other competence or generalship. This is the significance, for example, of O'Connor's removal from VIII Corps and can also be seen in the examples of Bucknall, Erskine and Hinde.

There were differences of approach that affected the practice of armour-infantry co-operation differently during and subsequent to the Battle of Normandy. There was the unofficial process in which subordinate commanders were challenging, criticizing and changing doctrine in response to the problems of fighting in Normandy on the basis of their practical experiences. Montgomery, often through intermediaries he appointed and attached to Tac HQ to assist him in the production of his pamphlets, such as Lyne, made himself personally au fait with these challenges and criticisms. Then, there was the official process within 21st Army Group in which Montgomery pulled all of these ideas together, stressing the importance of connections between 'output' at the different levels of command, his aim at the 'operational' level and the need for a general understanding of the latter. This was what went out published over his name in the pamphlets. Thus, Montgomery's pamphlets were a synergistic as well as an individualistic product and they were also congruent with commanders' experiences of fighting on the ground. By late 1944, Montgomery and 21st Army Group had developed its operational methods in a way that was both coherent, generic in terms of the problems of fighting the campaign in North-West Europe, and successful. By 1945 lessons were no longer being learned, but the learning that had been acquired was most certainly being implemented, even though a different solution was now required to respond to unfolding circumstances.

This thesis has shown that Montgomery moved from dogma towards being a 'reflexive' commander by taking on board others' experience, but that he also responded to the unfolding situation, encouraging other commanders to do the same. It has also attempted to resolve the apparently irresolvable issue of the relationship between the authoritarian command style of Montgomery and the doctrinal indiscipline which existed at the start of the Normandy campaign.

In the Introduction it was noted that the process of resolving this issue was complex: the result of that process was that 21st Army Group fought operations and actions determined by doctrine. From 'others' or below there was an unofficial process whereby armoured warfare doctrine was being challenged, criticised and changed. Then, from Montgomery, there came an official process of dynamic leadership which pulled it all together by institutionalizing doctrine and inculcating a unified mindset. The characteristic of this mindset was a style of what can be called straight thinking, or as Lyne identified it, clear and logical thinking, a quick grasp of essentials and discard of all unnecessary detail. The institutionalization of doctrine resulted first in the production of a set of ideas; secondly, in a style and speed of thinking applied to the application of those ideas, and finally, the willingness of individual commanders to use their initiative to solve the challenges within the constraints imposed by Montgomery.

LIST of SOURCES and BIBLIOGRAPHY

PRIMARY SOURCES (UNPUBLISHED)

PRIVATE ARCHIVES

Mr G.W. Barker. Papers of his father, General Sir E.H. Barker KCB, KBE, DSO, MC including 485 letters to his wife and letters from Field Marshal Montgomery (2), General K.A. Anderson (2), General G.C. Bucknall (1), General J.T. Crocker (1), General G.W.E.J. Erskine (1), General Sir B.T. Paget (2), and Field Marshal Lord Templer (1), and many less well-known military figures (e.g. Brigadier W.S. Clarke, C.O. 34th Tank Brigade). There are daily diaries for 1944 and 1945. There are also photographs, newspaper cuttings and a certain amount of audio-visual material.

Lieutenant-Colonel Sir John Baynes, Bt.. Papers of Lieutenant-General Sir R.N. O'Connor KT, GCB, DSO, MC placed in the care of Sir John by Major W.J. O'Connor.

Mr J.F. Brown. Diary of his father, Captain J.R. Brown relating to his service with 3rd Regiment Royal Horse Artillery, 7th Armoured Division, 1944-45.

Mr D. Rennie. Papers of Adrian Van Nerkoven, Mayor of Tilburg, nr Nijmegen, The Netherlands, and other material relating to Major-General T.G. Rennie CB, CBE, DSO placed in the care of C. Forrester.

The Earl of Rosse. Papers of his father, Captain the Earl of Rosse MBE relating to his service with the Guards Armoured Division and his most extensive correspondence and material relating to Rosse and Hill, *The Story of the Guards' Armoured Division*.

NATIONAL ARCHIVES, KEW, SURREY

Cabinet Office Papers

CAB 106, Historical Section: Archivist and Librarian Files

Prime Minister's Office Papers

PREM 3, Operational Correspondence and Papers

War Office Papers

WO 32, General Series
 WO 33, 'O' and 'A' Papers
 WO 171, War Diaries of Units and Formations in 21st Army Group
 WO 193, Directorate of Military Operations Records
 WO 199, Home Forces Papers
 WO 205, Headquarters Papers, 21st Army Group
 WO 219, Supreme Headquarters Allied Expeditionary Force Papers
 WO 231, Directorate of Military Training Papers
 WO 232, Directorate of Tactical Investigation Papers
 WO 236, Papers of General Sir G.W.E.J. Erskine
 WO 277, Historical Monographs
 WO 279, Miscellaneous printed material (handbooks, manuals, and pamphlets)

IMPERIAL WAR MUSEUM, LONDON

Department of Documents

Papers of Field Marshal the Viscount Montgomery of Alamein
 Papers of Lieutenant-General Sir E.H. Barker
 Papers of General G.C. Bucknall
 Papers of Field Marshal Lord Carver
 Papers of Brigadier E.E.E. Cass
 Papers of Brigadier J.C. Cunningham
 Papers of Lieutenant-General Sir G.W.E.J. Erskine
 Papers of Brigadier W.D.C. Greenacre
 Papers of Brigadier C.B.C. Harvey
 Papers of Major-General L.O. Lyne
 Papers of Major-General G.H.A. Macmillan
 Papers of Major-General Sir G.I. Thomas
 Papers of Brigadier A.D.R. Wingfield

Department of Sound Records

Captain T.H. Peace. Reference no. 18048

 LIDDELL HART CENTRE FOR MILITARY ARCHIVES,
 KING'S COLLEGE, LONDON

Papers of Major-General J.B. Churcher
 Papers of Major-General F.W. de Guingand
 Papers of Lieutenant-General Sir M.C. Dempsey
 Papers of Brigadier J. Drummond
 Papers of Brigadier T. Hart Dyke
 Papers of Colonel G.G. Elliot

Papers of Captain Sir B.H. Liddell Hart:
 Major-General Sir P.C.S. Hobart
 Major General P.R.C. Hobart
 Papers of Colonel T.G. Lindsay
 Papers of Field-Marshal Sir A.A. Montgomery-Massingberd
 Papers of Major J.F.A. North
 Papers of Lieutenant-General Sir R.N. O'Connor
 Papers of General Sir H.E. Pyman
 Papers of Major-General G.P.D. Roberts
 Papers of Lieutenant-Colonel A.M. Sprot
 Papers of Major General D.E.B. Talbot
 Papers of Major-General G.R. Turner Cain
 Papers of Major-General G.L. Verney

LIDDLE COLLECTION (1914-1918), UNIVERSITY OF LEEDS

GS0086 Barker (General) Sir Evelyn Tapes 465 and 467: interview
 recorded with Peter Liddle, September 1977

LINCOLNSHIRE ARCHIVES, LINCOLN

16 Elwes, Papers of Major-General Sir W.R.N. Hinde

NATIONAL ARMY MUSEUM, LONDON

Papers of Major-General Sir E. Hakewill-Smith

TANK MUSEUM LIBRARY AND ARCHIVE, BOVINGTON

RH4 7AD Notes re History of 7th Armoured Division apparently compiled
 by J.H.Yindrich in 1952 during the preparation of a book that was never
 published, including correspondence with Lieutenant-General G.W.E.J.
 Erskine
 RH5 4AB War Diary, associated notes, and other material, 4th Armoured
 Brigade
 RH5 RAC Royal Armoured Corps Half-Yearly Reports, (Jan-June 1945)
 RH88 RAC Material relating principally to officer training in the armoured
 arm, 1939-45, including a summary of the activities of the RAC Training
 Branch in the War Office
 92 Biography Carver (2 boxes) Miscellaneous Papers of Field Marshal Lord
 Carver

WEST SUSSEX RECORD OFFICE, CHICHESTER

Papers of General Sir L.G. Whistler

WWW SOURCES

Canadian Military Headquarters Historical Section, *Report No. 65*
(*Canadian Participation in the Operations in North-West Europe, 1944*) (3
December 1953) <<http://www.dnd.ca/hr/dhh/Downloads> [accessed 22
March 2011]

Canadian Military Headquarters Historical Section, *Report No.169*
(*Operations Totalize and Tractable*) (7 January 1949)
<<http://www.dnd.ca/hr/dhh/Downloads/cmhq.169.pdf>> [accessed 6
December 2005]

Kettle Creek Corporation, 'The OODA "Loop" Sketch', *Defence and the
National Interest* (13 March 2006) <<http://www.d-n-i.net>> [accessed 9
November 2007]

Richards, C. And C. Spinney, eds, *Colonel J.R. Boyd: "Patterns of Conflict"*
(27 February 2005) <<http://www.d-n-i.net>> [accessed 5 November 2007]

PERSONAL SOURCES

Lieutenant Colonel Sir John Baynes, Bt., letter to the author, 5 July 2004

[Major] C. O'M. Farrell, letter to the author, 5 September 2005

[Captain] General Sir David Fraser, letter to the author, 30 June 2004

[Lieutenant] T.E.P. Gilpin, letter to the author, 10 December 2005

[Captain] the Earl of Harrington, personal interview at his home,
Ballingarry, Co. Limerick, Ireland, 6 February 2004

[Major] Sir Carol Mather, letter to the author, 22 October 2005

PRIMARY SOURCES (PUBLISHED)

OFFICIAL PUBLICATIONS

British Army of the Rhine (B.A.O.R.), *Battlefield Tour: Operation
BLUECOAT: 8 Corps operations south of Caumont 30-31 July 1944*, June
1947

_____, *Battlefield Tour: Operation PLUNDER: 12 British Corps crossing
the River Rhine 23-25 March 1945*, December 1947

- Ellis, Major L.F., *Victory in the West, vol. I: The Battle for Normandy* (London: HMSO, 1962)
- _____, *Victory in the West, vol. II: The Defeat of Germany* (London: HMSO, 1968; repr. London: Imperial War Museum, 1994)
- Joslen, Lieutenant-Colonel H.F., *Orders of Battle: Second World War 1939-45*, 2 vols (London: HMSO, 1960)
- Ministry of Defence, *Design for Military Operations: The British Military Doctrine* (London: HMSO, 1996)
- North, J., *North-West Europe, 1944-45: The Achievement of 21st Army Group* (London: HMSO, 1953)
- War Office, *Field Service Regulations, vol. II, Operations* (London: HMSO, 1920)
- _____, *Field Service Regulations, vol. II, Operations - General* (London: HMSO, 1935)
- _____, *Military Training Pamphlets, 1938-45*
- _____, *Middle East Training Pamphlet No. 10: Lessons of Cyrenaica Campaign, December 1940-February 1941, [?]April 1942*
- _____, *Current Reports from Overseas, 1941-45*
- _____, *Notes from Theatres of War, 1941-44*

8th ARMY PUBLICATIONS

- General Sir B.L. Montgomery, *Some Brief Notes for Senior Officers on the Conduct of Battle*, December 1942
- _____, *Some Notes on High Command in War*, January 1943

OFFICIAL 21st ARMY GROUP PUBLICATIONS

- 21st Army Group (pre-Montgomery) [Brigadier H.E. Pyman and others], *The Co-operation of Tanks with Infantry Divisions in Offensive Operations*, November 1943
- General Sir B.L. Montgomery with others, *Notes on the Employment of Tanks in Support of Infantry in Battle*, February 1944 [November 1943]
- Field Marshal B.L. Montgomery with Major-General L.O. Lyne, *Some Notes on the Conduct of War and The Infantry Division in Battle*, November 1944

_____ with Lieutenant-Colonel A/Brigadier P.R.C. Hobart, later with Major-General G.P.B. Roberts, *The Armoured Division in Battle*, December 1944

_____ with others, *Some Notes on the Use of Air Power in Support of Land Operations and Direct Air Support*, December 1944

_____, *High Command in War*, June 1945

PRIVATELY PUBLISHED

Anon., *Summary of Operations June 1944-May 1945: 49(West Riding) Reconnaissance Regiment, Royal Armoured Corps* (privately published, Neuenkirchen [Germany], May 1945.

_____, *The Story of the 79th Armoured Division* (privately published, Hamburg [Germany], July 1945)

_____ [Lieutenant-Colonel J.G. Hooper], *The River Rhine to the Baltic Sea: Operations of VIII Corps, March-May 1945* (privately published, Germany, c.1945)

_____ [Major E. Palamountain], *Taurus Pursuant: A History of 11th Armoured Division* (privately published, Germany, c.1945)

_____ [Brigadier W.S. Clarke], *The Story of 34 Armoured Brigade* (privately published, Germany, c. 1945).

_____ [? Major G. Courage], *'Campaign Diary': The 15th/19th The King's Royal Hussars, North-West Europe, 1944-45* (privately published, RHQ 15th/19th H, Palestine, 1946)

Jary, S., *18 Platoon* (Carshalton Beeches, Surrey: Sidney Jary, 1987)

Stirling, J. Captain, *D-Day to VE-Day from My Tank Turret. A Personal account, written between D-Day 1944 and May 1945* (Privately published by the author, Axbridge BS26 2LN, [n.d.])

MEMOIRS, PERSONAL ACCOUNTS, AUTOBIOGRAPHIES AND PUBLISHED DIARIES

Adair, A.H.S., *A Guards' General: The Memoirs of Major General Sir Allan Adair BT, GCVO, CB, DSO, MC, JP, DL* (London: Hamish Hamilton, 1986)

Bellamy, Bill. *Troop Leader: A Tank Commander's Story* (Stroud: Sutton, 2005)

Belchem, Major-General D., *All in the Day's March* (London: Collins, 1978)

- _____, *Victory in Normandy* (London: Chatto and Windus, 1981)
- Borthwick, A., *Battalion: A British Infantry Unit's Actions from El Alamein to the Elbe, 1942-45* (London: Bâton Wicks, 2001[1946])
- Boscawen, R., *Armoured Guardsmen: A War Diary, June 1944-April 1945* (Barnsley: Leo Cooper, 2005)
- Brooks, S., ed., *Montgomery and the Eighth Army: A Selection from the Diaries and Correspondence of Field Marshal the Viscount Montgomery of Alamein, August 1942 to December 1943* (London: The Bodley Head/Army Records Society, 1991)
- Brooks, S., ed., *Montgomery and the Battle of Normandy: A selection from the Diaries, Correspondence and other Papers of Field Marshal the Viscount Montgomery of Alamein, January to August 1944* (Stroud: The History Press/Army Records Society 2008)
- Bryant, A., *Triumph in the West: 1943-1946: Based on the Diaries and Autobiographical Notes of Field Marshal the Viscount Alanbrooke, KG, OM* (London: Collins, 1959)
- Carver, Field Marshal Lord, *Out of Step: Memoirs of a Field Marshal* (London: Hutchinson, 1989)
- Churchill, W.S., *The Second World War*, 6 vols (London: Folio, 2000 [1948-54])
- De Guingand, Major-General F., *Operation Victory* (London: Hodder & Stoughton, 1947)
- _____, *Generals at War* (London: William Heinemann, 1964)
- Danchev, A. and D. Todman, eds, Brooke, *War Diaries 1939-45: Field Marshal Lord Alanbrooke* (London: Weidenfeld & Nicholson, 2001)
- Eisenhower, D. D. General, *Crusade in Europe* (London: William Heinemann, 1948)
- Farrell, C., *Reflections 1939-45: A Scots Guards Officer in Training and War* (Edinburgh: Pentland Press, 2000)
- Fraser, General Sir D., *War and Shadows* (London: Allen Lane/Penguin, 2002)
- Hills, S., *By Tank into Normandy: A Memoir of the Campaign in North-West Europe from D-Day to VE Day* (London: Cassell, 2002)
- Henderson, J.R. with J. Douglas-Home, *Watching Monty* (Stroud: Sutton, 2005)

Horrocks, Lieutenant-General Sir B.G., *A Full Life* (London: Collins Fontana 1960)

_____ with E. Belfield and Major-General H. Essame, *Corps Commander* (London: Sidgwick & Jackson, 1977)

Leakey, Major-General R. with Colonel G. Forty, *Leakey's Luck: A Tank Commander with Nine Lives* (Stroud: Sutton, 1999)

Lindsay, M., *So Few Got Through: With the Gordon Highlanders from Normandy to the Baltic* (Barnsley: Leo Cooper, 2000 [1946])

Mather, Sir C., *When the Grass Stops Growing: A War Memoir* (Barnsley: Leo Cooper, 1999)

Montgomery of Alamein, Field Marshal the Viscount, *El Alamein to the River Sangro, Normandy to the Baltic* (London: Book Club Associates, 1973[1947])

_____, *The Memoirs of Field Marshal the Viscount Montgomery of Alamein* (London: Collins, 1958)

_____, 'The Battle of Alamein', in *The Sunday Times Book of Alamein and the Desert War*, ed. by D. Jewell (London: Sphere, 1967), pp 61-94

_____, *A History of Warfare* (London: Collins, 1968)

Pyman, Major-General H.E., *Call to Arms* (London: Leo Cooper, 1971)

Roberts, Major-General G.P.B., *From the Desert to the Baltic* (London: William Kimber, 1987)

Ross, P., *All Valiant Dust: An Irishman Abroad* (Dublin: Lilliput, 1992)

Slim, Field Marshal the Viscount, *Defeat into Victory* (London: Cassell, 1956)

Bedel Smith, Brigadier General W. *Eisenhower's Six Great Decisions: Europe 1944-45* (New York: Longmans, Green, 1956)

Swaab, Jack, *Field of Fire: Diary of a Gunner Officer* (Stroud: Sutton, 2007 [2005])

Tedder, Marshal of the RAF Lord, *With Prejudice: The War Memoirs of Marshal of the RAF Lord Tedder* (London: Cassell, 1966)

Tout, K., *Tank: 40 Hours in Normandy* (London: Robert Hale, 1985)

_____, *Tanks, Advance!* (London: Robert Hale, 1987)

Wavell, General Sir Archibald, *Generals and Generalship* (London: Times, 1941)

White, P., *With the Jocks: A Soldier's Struggle for Europe 1944-45* (Stroud: Sutton, 2001)

Wilson, A., *Flame Thrower* (London: William Kimber, 1956)

BIOGRAPHIES, etc.

Baynes, J., *The Forgotten Victor: General Sir Richard O'Connor KT, GCB, DSO, MC* (London: Brassey's, 1989)

Horne, A. with D. Montgomery, *The Lonely Leader: Monty 1944-45* (London: Macmillan, 1994)

Ogilvie, G., *Picts and Porridge: An Ogilvie Family History*, Chapter 15: 'Cousins Courageous' Major-General T.G. Rennie (Christchurch, NZ: Alan Gibbs, 2002)

REGIMENTAL, CORPS, DIVISIONAL, UNIT HISTORIES AND ACCOUNTS

Barclay, Brigadier C.N., *The History of the 53rd (Welsh) Division in the Second World War* (London: William Clowes & Sons, 1956)

Barker, Lieutenant-Colonel A.J., *The East Yorkshire Regiment* (London: Leo Cooper, 1971)

Beale, P., *Tank Tracks: 9th Battalion Royal Tank Regiment at War 1940-45* (Stroud: Budding Books, 1997)

Bidwell, Brigadier S., *Gunners at War: A Tactical Study of the Royal Artillery in the Twentieth Century* (London: Arrow, 1972)

Blake, G., *Mountain and Flood: The History of the 52nd (Lowland) Division 1939-1946* (Glasgow: Jackson & Son, 1950)

Boardman, Captain C.J., *Tracks in Europe: The 5th Inniskilling Dragoon Guards 1939-1946* (Salford: City Press Services, 1990)

Brereton, J.M., *The 4th/7th Royal Dragoon Guards 1685-1980* (Catterick: Home Headquarters 4th/7th Dragoon Guards, 1982)

Bryant, A., *Jackets of Green: A Study of the History, Philosophy, and Character of the Rifle Brigade* (London: Collins, 1972)

- Carver, Brigadier R.M.P., *The History of 4th Armoured Brigade* (privately published, Gluckstadt [Germany], 1945/Aldershot: Gale & Polden, 1945)
- Delaforce, P., *Black Bull: From Normandy to the Baltic with the 11th Armoured Division* (Stroud: Sutton, 1993)
- _____, *The Fighting Wessex Wyverns: From Normandy to Bremerhaven with the 43rd (Wessex) Division* (Stroud: Sutton, 1994)
- _____, *Churchill's Desert Rats: Normandy to the Baltic with the 7th Armoured Division* (Stroud: Sutton, 1994)
- _____, *The Polar Bears: From Normandy to the Relief of Holland with the 49th Division* (Stroud: Sutton, 1995)
- _____, *Monty's Iron Sides: From the Normandy Beaches to Bremen with the 3rd Division* (Stroud: Sutton, 1996)
- _____, *Monty's Mauraunders: Black Rat 4th Armoured Brigade and Red Fox 8th Armoured Brigade* (London: Chancellor Press, 2000)
- _____, *Monty's Highlanders: 51st Highland Division in World War Two* (London: Chancellor Press, 2000)
- _____, *Battles with Panzers: Monty's Tank Battalions 1RTR & 2RTR at War* (Stroud: Sutton, 2003)
- _____, *Marching to the Sound of Gunfire: North West Europe 1944-45* (Stroud: Sutton, 2003 [1996])
- _____, *Monty's Northern Legions: 50th Northumbrian and 15th Scottish Divisions at War 1939-1945* (Stroud: Sutton, 2004)
- Fletcher, D., *Vanguard of Victory: The 79th Armoured Division* (London: HMSO, 1984).
- Forbes, P., *6th Guards Tank Brigade: The Story of Guardsmen in Churchill Tanks* (London: Sampson, Low, Marsden, [n.d.])
- Hallam, J., *The History of The Lancashire Fusiliers 1939-45* (Stroud: Sutton, 1993)
- Howard, R., *Beaten Paths are Safest: From D-Day to the Ardennes – Memories of the 61st Reconnaissance Regiment, 50th (TT) Northumbrian Division* (Studley: Brewin Books, 2004)
- Hughes, Lieutenant-Colonel F.K., *A Short History of 49th West Riding & Midland Division* (Barnet, Herts.: Stellar Press, 1957)

- Jackson, Lieutenant-Colonel G.S., *Operations of Eighth Corps: Normandy to the River Rhine* (London: St Clements Press, 1948)
- Johnson, M.K., *The King's Own Yorkshire Light Infantry 1857-1968* (Stroud: Tempus, 2000)
- King's Royal Rifle Corps, *The King's Royal Rifle Corps – 1755-1955* (Winchester: RHQ K.R.R.C., 1955)
- Liddell Hart, Captain B.H. *The Tanks: The History of the Royal Tank Regiment and its Predecessors*, 2 vols (London: Cassell, 1959)
- McNish, Lieutenant-Colonel R.R., *Iron Division: The History of the 3rd Division 1809-2000*, 3rd rev. edn. (Salisbury: HQ 3(UK) Division., 2000 [1978])
- Neillands, R., *The Desert Rats: 7th Armoured Division 1940-45* (London: Orion, 1991)
- Nightingale, Lieutenant-Colonel P.R., *The East Yorkshire Regt. (Duke of York's Own) in the War 1939/45* (Howden, East Yorks: Mr. Pye (Books), 1998 [1952])
- Perrett, B., *Through Mud and Blood: Infantry/Tank Operations in World War 11* (London: Robert Hale, 1975)
- Rosse, Captain the Earl of and Colonel E.R.H. Hill, *The Story of the Guards Armoured Division* (London: Geoffrey Bles, 1956)
- Scarfe, N., *Assault Division. A History of the 3rd Division from the Invasion of Normandy to the Surrender of Germany* (Spellmount: Staplehurst, 2004 [1947])
- Thompson, R. *The 15/19 The King's Royal Hussars* (Huddersfield: Quoin Publishing, 1989)
- Verney, Major-General G.L., *The Desert Rats: The History of the 7th Armoured Division 1938-1945* (London: Hutchinson, 1954)
- _____, *The Guards Armoured Division: A Short History* (London: Hutchinson, 1955)
- Wake, Major-General Sir H. and Major W.F. Deedes, *Swift and Bold. The Story of The King's Royal Rifle Corps in the Second World War 1939-1945* (Aldershot: Gale & Polden, 1949)
- Wilson, E., *Press on Regardless: The Story of the Fifth Royal Tank Regiment in World War Two* (Staplehurst: Spellmount, 2003)
- Woolcombe, R., *Lion Rampant* (London: Chatto & Windus, 1955)

ARTICLES

Harrington, General C. and Major D.L. Waterworth, 'The Battle of s'Hertogenbosch, October 1944', *British Army Review* 80 (August 1985), 35-42

Liddell Hart, Captain B.H., 'The Development of the "New Model" Army: Suggestions on a Progressive, but Gradual Mechanicalization', *Army Quarterly* 9 (October 1924), 37-50

Montgomery, Major B.L. 'Some Problems of Mechanicalisation', *Antelope* 2 (October 1926), 196-99

_____, Brigadier, 'The Problem of the Encounter Battle as Affected by Modern British War Establishments', *Royal Engineers Journal* (September 1937), 339-354

_____, 'The Major Tactics of the Encounter Battle', *Army Quarterly* 26 (July 1938), 268-272

_____, Field Marshal, 'Twenty-First (British) Army Group in the Campaign in North-West Europe 1944-45', *Journal of the Royal United Services Institute* 90 (November 1945), 430-454

SECONDARY SOURCES

BOOKS AND MONOGRAPHS

Alger, J.I., *The Quest For Victory: The History of The Principles of War* (Westport, CT: Greenwood Press, 1982)

Anon., *Britain's Modern Army* (London: Odhams, c.1944)

Badsey, S., *D-Day: From the Normandy Beaches to the Liberation of France* (London: Tiger, 1994)

Barnett, C., *The Desert Generals* (London: Pan, 1962)

Baverstock, K., *Breaking the Panzers: The Bloody Battle for Rauray, 1 July 1944* (Stroud: Sutton, 2002)

Beevor, A. *The Battle for Normandy* (London: Penguin/Viking, 2009)

Belfield, E. and H. Essame, *The Battle for Normandy* (London: Pan, 1983)

- Bennett, R., *Ultra in the West: The Normandy Campaign 1944-45* (London: Hutchinson, 1979)
- Bidwell, S. and D. Graham, *Firepower: British Army Weapons and Theories of War, 1904-1945* (London: Allen & Unwin, 1982)
- Bishop, C., *Panzer Grenadier Divisions 1939-45*, (Stroud: Spellmount, 2007)
- Bond, B., *Liddell Hart: A Study of his Military Thought* London: (Cassell, 1977)
- _____, *British Military Policy between the Two World Wars* (Oxford: Oxford University Press, 1980)
- Bouchery, J., *The British Soldier from D-Day to VE-Day [The British Tommy in North West Europe, 1944-1945]*, 2 vols (Paris: Histoire & Collections, 2006 [1998])
- Bredin, Brigadier A.E.C., *A History of the Irish Soldier* (Belfast: Century, 1987)
- Brower, C. ed., *World War Two in Europe: The Final Year* (New York: St. Martin's Press, 1998)
- Buckley, J., *British Armour in the Normandy Campaign* (London: Frank Cass, 2004)
- _____, ed., *The Normandy Campaign 1944: Sixty Years On* (London: Routledge, 2006)
- Carver, Field Marshal Lord, *Dilemmas of the Desert War: A New Look at the Libyan Campaign 1940-42* (London: Batsford, 1986)
- _____, *The Imperial War Museum Book of the War in Italy 1943-1945* (London: Sidgwick & Jackson, 1991)
- _____, *Britain's Army in the 20th Century* (London: Pan, 1999)
- Chant, C., *Artillery of World War 11* (Hoo, Kent: Grange, 2001)
- Collier, P., *The Second World War (4) 1940-1945 The Mediterranean* (Oxford: Osprey, 2003)
- Copp, T., *Fields of Fire: The Canadians in Normandy* (Toronto: University of Toronto Press, 2003)
- _____, *Cinderella Army: The Canadians in Northwest Europe* (Toronto: University of Toronto Press, 2006)
- Cowper, M. and N. Bogdanovic, *The British Army: The Definitive History of the Twentieth Century* (London: Cassell, 2007)

- D'Este, C., *Decision in Normandy: The Unwritten Story of Montgomery and the Allied Campaign* (London: Collins, 1983)
- de Lannoy, F., *21st Army Group* (Bayeux: Heimdal, 2003)
- Daglish, I., *Operation Bluecoat: The British Armoured Breakout* (Barnsley: Pen & Sword, 2003)
- _____, *Operation Goodwood: The Great Tank Charge July 1944* (Barnsley: Pen & Sword, 2004)
- _____, *Over the Battlefield: Operation Goodwood* (Barnsley: Pen & Sword, 2005)
- Doherty, R., *Irish Generals in the British Army in the Second World War* (Belfast: Appletree Press, 1993)
- Doubler, M., *Closing with the Enemy: How GIs Fought the War in Europe, 1944-45* (Lawrence: University Press of Kansas, 1994)
- Dunphie, C., *The Pendulum of Battle: Operation Goodwood July 1944* (London: Leo Cooper, 2004)
- Eady, Major H.G., *Historical Illustrations to Field Service Regulations, Operations, 1929* (London: Sifton Praed, 1930)
- Ehrman, J.P., *Grand Strategy, vol. V: August 1943-September 1944* (London: HMSO, 1956)
- _____, *Grand Strategy, vol. VI: October 1944-August 1945* (London: HMSO, 1956)
- Ellis, J., *The World War 11 Databook* (London: BCA, 2003 [1993])
- Fletcher, D., *British Tanks of WWII, (2): Holland & Germany 1944/1945* (Hong Kong: Concord, 2001)
- Ford, K., *El Alamein 1942: The Turning of the Tide* (Oxford: Osprey, 2005)
- Fortin, L., *British Tanks in Normandy* (Paris: Histoire & Collections, 2005)
- Forty, Colonel G., *The First Victory: General O'Connor's Desert Triumph Dec 1940- Feb 1941* (London: Guild Publishers, 1990)
- _____, *British Army Handbook 1939-1945* (Stroud: Sutton, 2002)
- _____, *The Desert War* (Stroud: Sutton, 2002)
- _____, *Villers Bocage* (Stroud: Sutton, 2004)

- Fraser, General Sir D., *And We Shall Shock Them: The British Army in the Second World War* (London: Hodder & Stoughton, 1983)
- French, D., *Raising Churchill's Army: The British Army and the War against Germany 1919-1945* (Oxford: Oxford University Press, 2000)
- _____ and B. Holden Reid, eds, *The British General Staff: Reform and Innovation 1890-1939* (London: Frank Cass, 2002)
- Frieser, K.-H., with J.T. Greenwood, *The Blitzkrieg Legend: The 1940 Campaign in the West* (Annapolis, MD: Naval Institute Press, 2005 [1996])
- Fuller, Major-General J.F.C., *The Conduct of War, 1789-1961* (London: Eyre & Spottiswoode, 1961)
- _____ with Admiral Sir R. Bacon and Air Marshal Sir P. Playfair, *Warfare Today: How Modern Battles are Planned and Fought on Land, at Sea, and in the Air* (London: Odhams, 1944)
- Gilbert, A. ed., *The Imperial War Museum Book of the Desert War 1940-42* (London: Sidgwick & Jackson, 1995)
- Gorman, Major J.T., *The Army of Today*, rev. edn (London: Blackie, 1941)
- Griffith, P., *Forward into Battle: Fighting Tactics from Waterloo to Vietnam* (Chichester: Anthony Bird Publications, 1981)
- Hamilton, N., *Monty: The Making of a General 1887-1942* (London: Hamish Hamilton, 1982)
- _____, *Monty: Master of the Battlefield 1942-1944* (London: Hamish Hamilton, 1983)
- _____, *Monty: The Field Marshal* (London: Hamish Hamilton, 1986)
- _____, *The Full Monty: Montgomery of Alamein 1887-1942* (London: Penguin, 2001)
- Harris, J.P., *Men, Ideas and Tanks: British Military Thought and Armoured Forces, 1918-1939* (Manchester: Manchester University Press, 1985).
- Harrison Place, T., *Military Training in the British Army, 1940-1944: From Dunkirk to D-Day* (London: Frank Cass, 2000)
- Hart, R., *Clash of Arms: How the Allies Won in Normandy* (London: Lynne Rienner, 2001)
- Hart, R. and S. Hart, *The Second World War (6) Northwest Europe 1944-45* (Oxford: Osprey, 2002)

- Hart, S., *Montgomery and "Colossal Cracks": The 21st Army Group in Northwest Europe, 1944-45* (Westport, CT: Praeger, 2000)
- _____, *Road To Falaise* (Stroud: Sutton, 2004)
- _____, *Sherman Firefly vs Tiger, Normandy 1944* (Oxford: Osprey, 2002)
- Hastings, M., *Overlord: D-Day and the Battle for Normandy* (London: Pan, 1999)
- _____, *Armageddon: The Battle for Germany 1944-45* (London: Macmillan, 2004)
- Hay, I., *Arms and the Men* (London: HMSO, 1950)
- Henry, C., *British Anti-tank Artillery 1939-45* (Oxford: Osprey, 2004)
- House, J.M., *Combined Arms Warfare in the Twentieth Century* (Lawrence: University Press of Kansas, 2001)
- Humphrys, J., *Monty's Men: The British Soldier and the D-Day Campaign* (London: National Army Museum, 1994)
- Irving, D., *The War between the Generals* (Harmondsworth: Penguin, 1982)
- Jarymowycz, R.J., *Tank Tactics: From Normandy to Lorraine* (London: Lynne Rienner, 2001)
- Jeffery, K., *Field Marshal Sir Henry Wilson: A Political Soldier* (Oxford, Oxford University Press, 2006)
- Keegan, J., *Six Armies in Normandy: From D-Day to the Liberation of Paris* (London: Pimlico, 1992)
- Lamb, R., *Montgomery in Europe 1943-45: Success or failure?* (London: Buchan and Enright, 1983)
- Larson, R.H., *The British Army and the Theory of Armoured Warfare, 1918-40* (London: Associated University Press, 1984)
- Latawski, P., *Falaise Pocket* (Stroud: Sutton, 2004)
- Lewin, R., *Montgomery as Military Commander* (London: Batsford, 1971)
- _____, *Ultra Goes to War* (London: Grafton, 1988)
- Low, A.M., *Tanks* (London: Hutchinson, c.1942)
- Lucas, J. and J. Barker, *The Killing Ground: The Battle of the Falaise Gap August 1944* (London: Batsford, 1978)

- Luttwak, E.N., *Strategy: The Logic of War and Peace* (Cambridge, MA: Belknap Press, 1987)
- Luvaas, J., *The Education of an Army: British Military Thought, 1815-1940* (London: Collins, 1965)
- McInnes, D. and Sheffield, G.D., eds, *Warfare in the Twentieth Century: Theory and Practice* (London: Unwin Hyman, 1988)
- McKee, A., *The Race for the Rhine Bridges: 1940, 1944, 1945* (London: Souvenir Press, 1971)
- Macksey, K., *Armoured Crusader: A Biography of Major-General Sir Percy Hobart* (London: Hutchinson, 1967)
- _____, *Tank Force: Allied Armour in the Second World War* (London: Macdonald & Co, 1970)
- _____, *Beda Fomm: The Classic Victory* (London: Pan/Ballantine, 1972)
- _____, *Tank Tactics 1939-1945* (New Malden, Surrey: Almark, 1976)
- Mansoor, P.R., *The GI Offensive in Europe: The Triumph of American Infantry Divisions, 1941-1945* (Lawrence: University Press of Kansas, 1999)
- Maurice, Major-General Sir Frederick, *British Strategy: A Study of the Application of The Principles of War* (London: Constable, 1935)
- Messenger, C., *The D-Day Atlas* (London: Thames & Hudson, 2004)
- Millet, A. and W. Murray, eds, *Military Effectiveness, vol. I: The First World War* (London: Unwin Hyman, 1988)
- _____, *vol. II: The Interwar Period* (London: Unwin Hyman, 1988)
- _____, *vol. III: The Second World War* (London: Unwin Hyman 1988)
- Moorhead, A., *Montgomery: A Biography* (London: Hamish Hamilton, 1946)
- _____, *The Desert War: The North African Campaign 1940-1943* (London: Sphere, 1968)
- Murray, W. and A. Millet, *A War to be Won: Fighting the Second World War* (Cambridge, MA: Belknap Press, 2000)
- Neillands, R., *The Battle of Normandy 1944* (London: Cassell, 2002)
- _____, *Eighth Army: From the Western Desert to the Alps, 1939-1945* (London: John Murray, 2004)

- _____, *The Battle for the Rhine 1944* (London: Weidenfeld & Nicolson, 2005)
- Newell, C.R., *The Framework of Operational Warfare* (London: Routledge, 1991)
- Parry, D., *D-Day: 6.6.44 The Dramatic Story of the World's Greatest Invasion* (London: BBC Books, 2004)
- Pemberton, Brigadier A.L., *The Development of Artillery Tactics and Equipment – Second World War 1939-45*, (repr. Smalldale, Derbyshire: Military Library Research Service, 2005 [1950])
- Penrose, J., ed. *The D-Day Companion* (Oxford: Osprey, 2004)
- Pitt, B., *The Crucible of War, vol. I: Wavell's Command* (London: Cassell, 2001)
- _____, *vol. II: Auchenleck's Command* (London: Cassell, 2001)
- _____, *vol. III: Montgomery and Alamein* (London: Cassell, 1961)
- Pogue, F.C., *The Supreme Command* (Washington D.C.: Office of the Chief of Military History, 1954)
- Posen, B., *The Sources of Military Doctrine: France, Britain, and Germany between the World Wars* (Ithaca, NY: Cornell University Press, 1984)
- Raugh, H.E., *Wavell in the Middle East 1939-1941: A Study in Generalship* (London: Brassey's, 1993)
- Reid, B.H., *No Holding Back: Operation Totalize, Normandy, August 1944* (Toronto: Robin Brass Studio, 2005)
- Rosen, S.P., *Winning the Next War: Innovation and the Modern Military* (Ithaca, NY: Cornell University Press, 1991)
- Rottman, G.L., *World War 11 Infantry Anti-Tank Tactics* (Oxford: Osprey, 2005)
- Russell, Lieutenant Colonel J. with R. De Normann, *No Triumphant Procession: The Forgotten Battles of April 1945* (London: Arms & Armour Press, 1994)
- Saunders, T., *Operation Epsom: VIII British Corps vs 1st SS Panzer corps* (Barnsley: Leo Cooper, 2003)
- Short, N., *Hitler's Siegfried Line*, (Stroud, Sutton, 2002)
- Simpkin, R., *Mechanized Infantry* (Oxford: Brassey's, 1980)

- Simpson, A., *Directing Operations: British Corps Command on the Western Front 1914-18* (Stroud: Spellmount, 2006)
- Sixsmith, Major-General E.K.G., *British Generalship in the Twentieth Century* (London: Arms & Armour Press, 1970)
- Slessor, Group Captain J.C., *Air Power and Armies* (Oxford: Oxford University Press, 1936)
- Smart, N., *Bibliographical Dictionary of British Generals of the Second World War* (Barnsley: Pen & Sword, 2005)
- Smithers, A.J., *Rude Mechanicals: An Account of Tank Maturity during the Second World War* (London: Leo Cooper, 1987)
- Smyth, Sir J., *Bolo Whistler: The Life of General Sir Lashmer Whistler* (London: Frederick Muller, 1967)
- Stacey, Colonel C.P., *Official History of the Canadian Army in the Second World War, vol. III: The Victory Campaign* (Ottawa: The Queen's Printer, 1960)
- Sutton, D.J. and J.S.M. Walker, *From Horse to Helicopter: Transporting the British Army in War and Peace 1648-1989* (London: Leo Cooper, 1989)
- Taylor, D., *Villers-Bocage through the Lens of the German War Photographer*, 3rd ed., (London: *After the Battle*, 2005)
- Thompson, Major General J. *The Imperial War Museum Book of Victory in Europe: The North-West European Campaign, 1944-45* (London: Sidgwick & Jackson, 1994)
- _____, *The Victory in Europe Experience* (Carlton, 2005)
- Thompson, R.W., *Montgomery the Field Marshal: A Critical Study* (London: Allen & Unwin, 1969)
- Tout, K., *In the Shadow of Arnhem: The Battle for the Lower Maas, September – November 1944* (Stroud: Sutton, 2003)
- Trythall, A.S., *'Boney' Fuller: The Intellectual General, 1878-1966* (London: Cassell, 1977)
- Warner, P., *Horrocks: The General who led from the Front* (London: Sphere, 1985)
- Wavell, General Sir Archibald, *Generals and Generalship* (London: Times, 1941)
- Weigley, R., *Eisenhower's Lieutenants: The Campaign of France and Germany, 1944-45* (Bloomington: Indiana University Press, 1981)

Wilmot, R.W.W. ('Chester'), *The Struggle For Europe* (London: Collins, 1952)

ARTICLES AND CHAPTERS

Badsey, S., 'Faction in the British Army: Its Impact on 21st Army Group Operations in Autumn 1944', *War Studies Journal*, 1(Autumn 1995), 13-28

Blumenson, N., 'Normandy Campaign', in *The Oxford Companion to World War 11*, ed. by I.C.B. Dear (Oxford: Oxford University Press, 1995), pp. 804-812

Bond, B., 'The Mechanization of the British Army in the 1930s: The Impact of Technical Innovation on a Conservative Institution', *Militärhistorisk Tidskrift*, 187 (1983), 115-124

_____, 'The Army between the Two World Wars 1918-1939', in D. Chandler and I. Beckett (eds.), *The Oxford Illustrated History of the British Army* (Oxford: Oxford University Press, 1994), pp. 263-278

Bourne, J.M., 'British Generals in the First World War', in *Leadership & Command: The Anglo-American Experience since 1861*, ed. by G.D. Sheffield (London: Brassey's, 1987), pp. 93-116

Buckley, J., 'British armoured operations in Normandy – June-August 1944', in *The Normandy Campaign 1944: Sixty Years On*, ed. by J. Buckley (London: Routledge, 2006), pp. 74-79

Copp, T., 'The 21st Army Group in Normandy: Towards a new balance sheet', in *The Normandy Campaign: Sixty Years On*, ed. by J. Buckley (London: Routledge, 2006), pp. 11-21

Dallas, Captain G. McG. 'The 1 R.H.F. Battle Group', *Journal of the Royal Highland Fusiliers*, 12 (Summer 1981), 43-44

DiNardo, R.L. and A. Bay, 'Horse-drawn Transport in the German Army', *Journal of Contemporary History*, 23 (1988), 129-142

French, D., 'Colonel Blimp and the British Army: British Divisional Commanders in the War against Germany, 1939-1945', *English Historical Review*, 111 (1996), 1182-1201

_____, "Tommy is No Soldier": The Morale of the Second British Army in Normandy, June-August 1944', *Journal of Strategic Studies*, 19 (1996), 154-178

- _____, 'Discipline and the Death Penalty in the British Army in the Second World War', *Journal of Contemporary History*, 33 (1998), 531-545
- _____, 'Doctrine and Organisation in the British Army, 1919-1932', *Historical Journal*, 44, 2, (2001), 497-515
- _____, 'The Mechanization of the British Cavalry between the World Wars', *War in History*, 3 (July 2003), 296-320
- Fourie, D.F.S., 'Operation Desert Storm: Strange Battlefields, Stranger Weapons', in *Crisis in the Gulf: A Conference held by the Department of Political Sciences, UNISA*, ed. by A.M. Faure and others (Pretoria; UNISA, 1991), pp. 6-14
- Gooch, J., 'Military Doctrine and Military History', in *Challenges of High Command in the Twentieth Century*, ed. by John Gooch (The Strategic and Combat Studies Institute. The Occasional, No.30, September 1997), pp. 5-7
- Grissom, A., 'The Future of Military Innovation Studies', *Journal of Strategic Studies*, 29, 5, (2006), 905-934
- Hall, D.I., 'From Khaki and Light Blue to Purple: The Long and Troubled Development of Army/Air Co-operation in Britain 1914-1945', *Journal of the Royal United Services Institute*, 147 (2002), 78-83
- Handel, M.I., 'Leaders and intelligence', *Intelligence and National Security*, 3, (1988), 3-39
- Harris, J.P., 'The British General Staff and the Coming of War 1933-39', *Bulletin of the Institute of Historical Research*, 59 (November 1986), 196-211
- Hart, S., 'Montgomery, Morale, Casualty Conservation and "Colossal Cracks": 21st Army Group's Operational Technique in North West Europe, 1944-45', *Journal of Strategic Studies*, 19 (1996), 132-53
- Heathcote, T.A. 1999. 'Montgomery-Massingberd, Sir Archibald Amar, GCB, GCMG (1871-1947)' in T.A. Heathcote, *The British Field Marshalls 1763-1997: A Biographical dictionary* (Barnsley, S. Yorks: Leo Cooper): 219-221
- Holmes, R., 'The Battle of Normandy, 1944', in *Great Battles of the British Army as Commemorated in the Sandhurst Companies*, ed. by D.G. Chandler (London: Arms & Armour Press, 1993), pp. 190-206
- Howard, M. 'Leadership in the British Army in the Second World War: Some Personal Observations', in *Leadership & Command: The Anglo-American military Experience since 1861*, ed. by G.D. Sheffield (London: Brassey's, 1987), pp. 117-127

- _____, 'The Use and Abuse of Military History', *RUSI Journal of the Royal United Services Institute for Defence Studies*, 138 (February 1993), 26-30
- McNish, Lieutenant-Colonel R.R., 'El Alamein in Perspective', *The Rousillon Gazette*, (Winter 1993), 5-10
- Mantle, C.L. and Lt.-Col. L. Zaporzan, 'The Leadership of S.V. Radley-Walters: The Normandy Campaign', *Canadian Military Journal*, 1 (2009), 56-67
- Murray, W., 'British Military Effectiveness in the Second World War', in A.R. Millett and W. Murray, eds, *Military Effectiveness, vol. III: The Second World War* (Boston: Allen & Unwin, 1988), pp. 90-135
- O'Balance, Major E., 'The Development of British Armoured Doctrine', *An Cosantóir: The Irish Defence Journal*, 25 (July 1965), 357-363
- Pimlott, J., 'The Crossing of the River Rhine', in *Great Battles of the British Army*, ed. by D.G. Chandler (London: Arms & Armour Press, 1993), pp. 221-236
- Strachan, H., 'The British Way in Warfare', in *The Oxford Illustrated History of the British Army*, ed. by D.G. Chandler (Oxford: Oxford University Press, 1994), pp. 417-434
- Winton, Lieutenant Colonel H.R., 'The Evolution of British Mechanised and Armoured Doctrine', *Journal of the Royal United Services Institute*, 130 (1985), 57-65

THESES AND DISSERTATIONS

- Dickson, P., 'Command relations in the Northwest Europe Campaign 1944-45' (unpublished master's thesis, Acadia University, 1985)
- Forrester, C., 'Great Captains and the Challenge of Second Order Technology: Operational Strategy and the Motorisation of the British Army before 1940' (unpublished master's thesis, University of South Africa, 2002)
- Harrison Place, T, 'Tactical Doctrine and Training in the Infantry and Armoured Arms of the British Home Army, 1940-44' (doctoral thesis, University of Leeds, 1995)
- Hart, S., 'Field Marshal Montgomery, 21st Army Group, and North West Europe, 1944-45' (doctoral thesis, University of London, 1995)

- McMahon, T., 'Operational Principles: The Operational Art of Erwin Rommel and Bernard Montgomery' (unpublished master's thesis, US Army Command and General Staff College, 1985)
- Palazzo, A. 'Tradition, Innovation, and the Pursuit of the Decisive Battle: Poison Gas and the British Army on the Western Front, 1915-1918' (doctoral dissertation, Ohio State University, 1996)
- Simpson, A. 'The Operational Role of British Corps Command on the Western Front, 1914-18' (doctoral thesis, University of London, 2001)
- Startup, K., 'General Sir Richard O'Connor: A Profile of his Life and Career' (unpublished master's thesis, Virginia Polytechnic And State University, 1977)
- Wilson, D., 'The Development of Tank-Infantry Co-Operation Doctrine in the Canadian Army for the Normandy Campaign' (unpublished master's thesis, University of New Brunswick, 1992)

UNPUBLISHED

- D. Fletcher 'Operation Plunder: British Armour on the Rhine', lecture by the Tank Museum's expert, at the Tank Museum, Bovington, 21 April 2005
- Professor D.F.S. Fourie, e-mail to the author, 6 May 2009
- Lieutenant Colonel R.R. McNish, personal interview at the West Sussex Record Office, Chichester, 13 September 2004
- R. Mahoney, 'Allied fighting effectiveness in North Africa and Italy, 1942-1945', King's College, London/Imperial War Museum conference, 18-19 July 2008, Session7: The air power contribution to land operations, Q&A, 19 July 2008
- Professor G. D. Sheffield, 'Generals and Historians: The Battle of the Somme after Ninety Years', lecture at the Military History Research Seminar, School of History, Leeds University, 17 October 2006
- Professor K. Startup, e-mail to the author, 13 July 2004

Appendix I: Analytical Framework of the Choices Available to Armoured Commanders Co-operating with Infantry as to Proximity and Purpose – mid- 1920s to mid-1940s

The functional specificity of units and formations, that is the dedicated organization of units and formations tasked to carry out the function of the Army tank brigades, independent armoured brigades, and armoured divisions came under pressure in Normandy.

Army tank brigades operated independently (and are referred to hereafter as independent tank brigades), as did independent armoured brigades. The armoured division was also an independent command. The armoured brigade of an armoured division was not an independent command. Reflecting the bifurcation in British armoured warfare doctrine, the traditional functions of the independent tank and armoured brigades had been seen primarily as close-support to infantry divisions and those of the armoured divisions as fast-moving exploitation.

Nobody went in with entirely the right solution to how the problems presented by such a diversity of roles might be overcome. Initially, the impetus for innovation with respect to integrating or combining armour and infantry was different in respect of the independent brigades and the armoured divisions. However, dilemmas of purpose (what the different types of organization were actually for) interlinked with issues of practice (the tasks the two types of formations were actually called on to carry out) and vice versa. At issue were best armour-infantry co-operation practice and the purposes to which armour could be put to best effect. These applied to the entire armoured force at the start of the campaign, with the exception of specialised armour whose task was never in doubt¹.

¹ The purpose of the specialised armour, which was mostly grouped in 79th Armoured Division was always clear: to assist in the break-in phase of operations which involved attacks on fixed enemy defences. 79th Armoured Div is not dealt with in this thesis for reasons which are covered in Appendix II.

The interlinked problems of practice and purpose can helpfully be explored in terms of the options available to British commanders at the time. These related initially to the perceived capabilities of the two arms in attack and defence. To carry out each of armour's alternative purposes, the options for the tanks were traditionally seen as being either closeness with the infantry or separation from them. Two practical contradictory conceptions for tanks tasked with infantry support held sway: firstly that armour-infantry co-operation required the close proximity of the tanks, and secondly that the tanks' purpose was infantry co-operation which could be realised by the separation of the two arms. Early in the campaign they were drawing heavily for guidance on the War Office's attempts to adjust tactical doctrine to lessons learned from operations through its various series of official pamphlets. Nevertheless, brigade commanders and above were always permitted considerable leeway to adopt a down-to-earth approach and adjust tactical doctrine to lessons learned from operations where this appeared to make sense. Thus, early developments in Normandy had about them something of on-the-spot decision-making to discard 'established' practice through pragmatism, which characterised all the early tactical improvisations.

In traditional infantry attacks supported by artillery and tanks against fixed defences, a shortcoming in any artillery fire support plan in the attack arises from the fact that the barrage or concentration, which is almost entirely indirect fire, must be lifted while the assaulting troops are some distance short of their target to avoid friendly casualties. They were then vulnerable to enemy machine gun fire etc, all too often without an effective counter-measure, because the tanks accompanying them were themselves vulnerable to enemy weapons. The solution that would emerge reaffirmed the importance of fire support in the attack, and included appropriate tactical fireplans which would coordinate support from field, medium and heavy artillery (as well as from the air). These plans would continue to be coordinated by the Commander, Royal Artillery (CRA) at Division. In most barrage-led attacks, however a point came when the infantry faced a choice between fighting forward with

their own weapons or not going forward. To maintain the momentum of the attack, immediate fire support had to be available. The solution that would emerge emphasised closer tank-infantry-anti-tank artillery co-operation as the means to maintain the momentum of the attack, after having broken into but not out of German defences. However, reliance on artillery fire power, while an important ingredient of the solution, was increasingly incompatible with the fluid, mobile, armour-cum-infantry operations which Montgomery additionally wished to impose on the enemy as soon as possible.

In terms of the dimensions of combat mid- to late 1944, the most difficult dilemma of armour-infantry co-operation doctrine and practice was how to combine to best effect; the idea that armour was an independently-acting arm was redundant. However, in armour-infantry co-operation, the purpose of the tanks was perceived to be to protect and defend the attacking infantry. Tanks used their firepower and armoured mobility to do this. It can be argued that it was, as yet in early Normandy, by no means widely perceived that the corollary applied: that the purpose of the infantry was, in turn to protect the tanks with their weapons. Not until later on was the purpose of armour-infantry co-operation perceived in terms of support, each of the other. Thus, early in the campaign, the understanding was largely that the role of tanks in armour-infantry co-operation was support of infantry. These would be infantry tanks; long in vogue. This type of tank was represented in the British Army in North-West Europe by the British Churchill tank in a variety of marks and variants. The independent tank brigades were equipped with the Churchill. However, American Sherman tanks were also used in the infantry support role by independent armoured brigades. The organisation and structure of these Sherman-equipped independent armoured brigades was intended to make their infantry support role clear.²

There was a strongly held view that the task of infantry support required the close proximity of the tanks. While this reflected most previous thinking and experience, some experience from the North

² For a brief description of tank types, see Appendix IV.

African theatre and from the early fighting in Normandy could be held to support a different view. This view was that, in order to do their job in a close congested operational environment which gave the enemy ample opportunity for enfilade fire in addition to the advantage in long-range fire, the tanks should separate themselves from the infantry, take advantage of all protection the terrain could offer in order to protect themselves, and move into positions which allowed them to close the range between themselves and enemy tanks: this allows the following understanding of the interaction of ideas and choices facing commanders, as is shown in figure Appendix I.1.

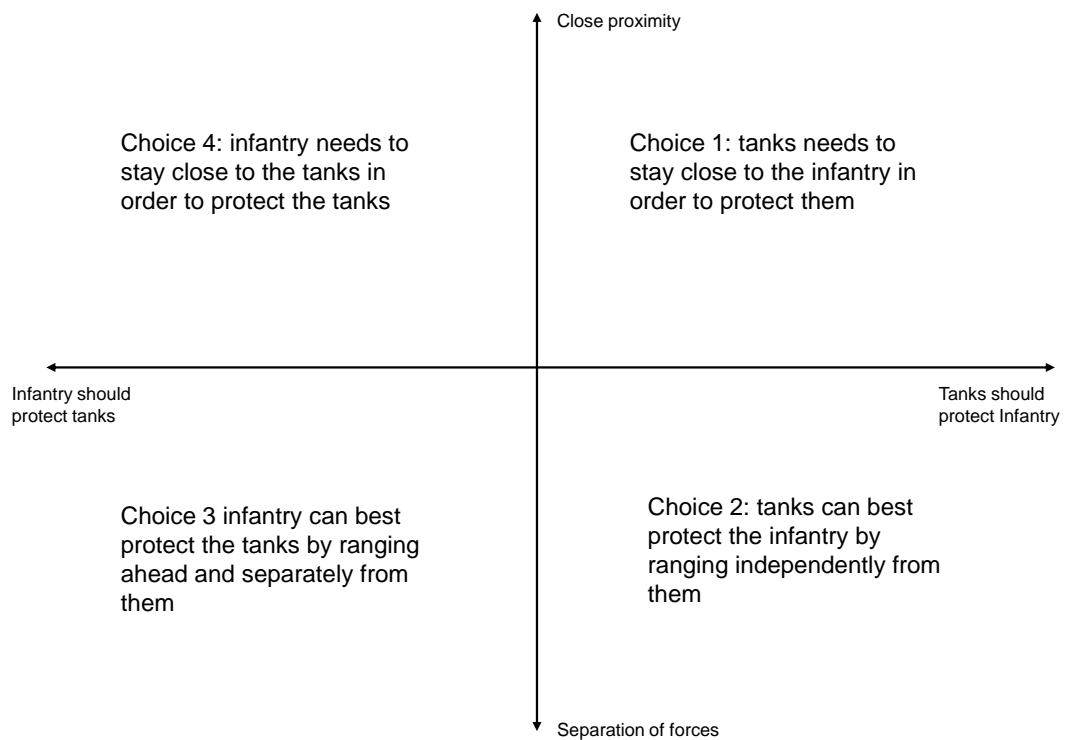

Figure App.I.1: Proximity versus purpose for armour infantry co-operation

The specific type of operation Churchill-equipped tank brigades were intended to undertake was not in dispute at the start of the campaign, although it was Montgomery's long-standing view that a heavy tank (i.e., the Churchill) would not be required.³ It was also Montgomery's prior view that there would not be any need to have different approaches for

³Montgomery would reaffirm this view in his 'Memorandum on British Armour: No 2', 21 February 1945, para. 6, p. 2.

these two (Churchill and Sherman) types of independent brigades. In Normandy, the Churchill-equipped independent tank brigades, that is the formations charged primarily with close support of infantry, were making great efforts to develop appropriate tactics, within the framework by which the British Army always tried to adjust its tactical doctrine to lessons learned from operations. Follow-up formations – Churchill tank brigades slated for Normandy, such as 6th Guards Tank Brigade, which arrived in late July 1944 as part of the last wave of British armoured reinforcements – can be seen (in this thesis) to have been making efforts to develop appropriate tactics within the same framework while still in England. Also, the Sherman-equipped independent armoured brigades intended for close support of infantry were struggling to develop suitable tactics while in Normandy, initially within the bounds set by the traditional framework described above (i.e. operating only within choice – or quadrant – 1 in figure App.I.1). Within the apparently on-the-spot decision making process in Normandy, a clear pattern emerged – taking action very much into quadrant 2.

In parallel developments, the commanders of the armoured brigades of the Sherman-equipped independent were also faced with the problems of fighting in the *bocage* (see App.III Photographs 1 and 2). In the case of the commanders of these brigades however, the problem of armour-infantry co-operation in the *bocage* was linked to the equipment and organization issue, and how best to utilise the forces they had at their disposal. This was being addressed by creative brigadiers (and also by armoured division commanders), taking the action into quadrants 3 and 4 as will be seen in the chapters of this thesis.

Appendix II: Note on Approaches, Sources and Methods

The reader may benefit from an explanation of the approach used to produce this thesis. It was found useful to turn ‘inside out’ the idea that Montgomery has to be related to his subordinate commanders through hierarchy and the chain of command. For the purposes of this study, Montgomery’s input is thus taken as a *sine qua non* at each and every level of command. Examining the levels from junior to senior commanders and vice versa, to establish how different commanders influenced issues in different ways, is helpful. From the point of view of focus, this process then starts with the corps or the divisional commanders and subsequently moves up or down. This allows us to extend investigation beyond Montgomery and to understand better what was happening.

We know what Montgomery was seeking in terms of the progress of the war over time because we have many sources for this. This was relentless pressure, to create the conditions for a breakout and, thereafter, imposition on the Germans of the condition, mobile war. Therefore we can know – or reasonably infer – what he was seeking from his commanders. From this, we can generate new insights about them in the context of process that is, what they were actually doing and how they did it.

Further explanation is required to justify the selection of the actual corps commanders, divisional commanders and brigade commanders, etc. who are important enough to make them members of a small group of commanders for the purpose of this thesis.

The 21st Army Group was formed on 9 July 1943 to command 2nd British Army and 1st Canadian Army for the invasion of North-West Europe: the Commander-in-Chief (GOC-in-C) 21st Army Group for the Invasion and throughout the North-West Europe campaign was General (from September 1944, Field-Marshal) Sir B.L. Montgomery. Between 6 June 1944 and the surrender of German forces to Montgomery in May

1945 seven lieutenant-generals held corps commands in five British corps: E.H. Barker, F.A.M. Browning, G.C. Bucknall, J.T. Crocker, B.G. Horrocks, Sir R.N. O'Connor and N.M. Ritchie. However, the number of corps commanders can be reduced from seven to six, and of corps from five to four, if I British Airborne Corps is omitted (for reasons which will be explained below). The reason there are six commanders in the four corps in 2nd Army is that Lieutenant-General Sir R.N. O'Connor was succeeded as VIII Corps commander in December 1944 by Lieutenant-General E.H. Barker and Lieutenant-General B.G. Horrocks succeeded Lieutenant-General G.C. Bucknall as GOC XXX Corps in August 1944.

Including 1st 4th Airborne Divisions for completeness (Urquart, Gale, and Bols), 22 major-generals commanded British divisions in North-West Europe up to May 1945. Of these divisional commanders, only one, Barker, rose to become a corps commander. General Barker commanded 49th (West Riding) Division in England and North-West Europe, 1943-44, then VIII Corps, 1944-45.

In this period, some 131 individuals held brigade commands in 21st Army Group. This includes independent tank, and armoured brigades – important in any investigation of the subject of armoured-cum-infantry tactics because the role of a tank brigade was that of infantry close-support. For completeness this number still includes Commando brigades and Parachute and Airlanding Brigades. Of this total, three were appointed from brigade to divisional command: C.M. Barber (46th Brigade) to command of 15th (Scottish) Division; L.G. Whistler (131st Brigade) to command of 3rd Infantry Division; and G.L. Verney (6th Guards Tank Brigade) to command of 7th Armoured Division. If those whose story properly belongs with that of the Airborne Forces are omitted, the list of relevant figures who were brigadiers becomes shorter. For the purposes of this study it was decided to omit commanders whose story properly belongs with either that of the Airborne Forces or the Commandos and this was done as a preliminary first step.

The next step in the process of selection was to generate a list of corps, divisional, and armoured and infantry brigade commanders. The list was refined in two ways: it was reduced to a list of commanders who

appeared, based on the historiography, to be an important part of the story of operational development, innovation and command in North-West Europe. To complete this step, the names of other significant commanders not yet included but who appear also to have been part of the story were added to the list: these names were added by utilising primary sources and using new source material critically to re-examine the list generated by the current historiography.

A simple success/failure typology was applied to the later Second World War (1944 -45) military careers of those short listed as potentially researchable commanders. As Professor Sir Michael Howard has observed 'the military historian knows what is victory and what defeat, what is success and what failure' ('The Use and Abuse of Military History', *RUSI Journal* 138 (February 1993): 28). Howard's assertion was meaningful enough to serve as a launch pad from which to take this further step. This produced two new lists, innovative commanders, and commanders who were demonstrably not innovative. This process further focussed the list on those who were from an armoured background or who commanded armoured units simply because innovation was primarily required in the armoured arm: British armoured doctrine was still in a state of flux even in mid-1944, at the start of the Normandy campaign. Therefore, in order to find out what innovations there were, that is new ways which would prove to be better, and how they occurred, it was necessary to begin to focus on the thoughts, activities and actions of armoured commanders and commanders in a position to direct armour. Some determination as to the availability of primary source material with respect to the individuals completed this step.

Selection of the two lists described above, and passing the names through the filter of armoured commanders and commanders who were in a position to direct armour, yielded a final working list of corps commanders, armoured division/ brigade/ regiment commanders, and independent armoured and tank brigade commanders for whom data is

available. This list contains the names of those who were innovative and those who were not. The final working list was¹:

Major-General A.H.S. ADAIR (Guards Armoured Division);
 Lieutenant-General E.H. BARKER (49th Infantry Division and later VIII Corps);
 Lieutenant-General G.C. BUCKNALL (XXX Corps to August 1944);
 Brigadier R.M.P. CARVER (4th Armoured Brigade);
 Brigadier W.S. CLARKE (34th Armoured Brigade);
 Major-General G.W.E.J. ERSKINE (7th Armoured Division);
 Brigadier W.D.C. GREENACRE (6th Guards Tank Brigade);
 Major-General E. HAKEWILL SMITH (52nd Infantry Division);
 Brigadier the Hon. W.R.N. Hinde (22nd Armoured Brigade, [7th Armoured Division]);
 Lieutenant-Colonel/acting Brigadier P(atrick) R. C. HOBART (GSO1 [Senior Staff Officer]; Guards Armoured Division, Commander, 1st Royal Tank Regiment; 22nd Armoured Brigade [7th Armoured Division]);
 Major-General P(ercy) C.S. HOBART (79th Armoured Division);
 Lieutenant-General B.G. HORROCKS (XXX Corps from Aug 1944);
 Major-General L.O. LYNE (50th Infantry Division, then 59th Infantry Division and later 7th Armoured Division);
 Major-General G.H.A. MACMILLAN (15th Infantry Division, then 49th Infantry Division, then 51st Infantry Division);
 Lieutenant-General Sir R.N. O'CONNOR (VIII Corps to December 1944);
 Major-General T.G. RENNIE (3rd Infantry Division and later 51st Infantry Division);
 Major-General G.P.B. ROBERTS (11th Armoured Division);
 Major-General G.L. VERNEY (6th Guards Tank Brigade and later 7th Armoured Division);
 Major-General L.G. WHISTLER (3rd Infantry Division);
 Brigadier A.D.R. WINGFIELD (Second- in-Command, 34th Tank Brigade; then acting Commander, 8th Armoured Brigade; and later Commander, 22nd Armoured Brigade [7th Armoured Division]).

A decision was taken to omit in principle commanders who had been written about very extensively already, where this would not diminish

¹ The rank indicated was the highest held during the campaign. The individual was the commander of the listed unit/ formation(s), except where otherwise indicated. The term 'commander' is therefore omitted, except when an aid to clarity.

representativeness of particular success or notable failure. In addition, while historiographical evidence suggested Major-General P(ercy) C.S. Hobart (79th Armoured Division: the parent formation of the specialised armour) was important, yet other evidence which had to be given credence suggests his importance as an innovator was limited in respect of what this thesis set out to research with regard to armour infantry cooperation. Thus, to draw together the historiography and the primary data it was decided to omit specific commanders.

To pursue 'bubble up' operational methods it was necessary also to go down to the level of the regimental COs and below and this material was also used as a primary source where and when appropriate. By utilising the records of more junior commanders, a more complete picture could be built up. The command of 7th Armoured Division at the divisional and brigade levels, for example, is shown in Figure Appendix II.1, indicating in tabular form all commanders and highlighting those for whom papers have been traced and located.

7th Armoured Div	
Erskine	
Verney	
Lyne	
22nd Armoured Bde	131nd Infantry Bde
• Hinde	• Ekins
• Gregson	• Pepper
• Mackeson	• Freeland
• Swetenham	• Cox
• Cracroft	• Spurling
• Paley	• Brind
• Wingfield	• Freeland
	• Spurling

Fig. AppII.1: (after Joslen, *Orders of Battle*) showing the commanders of 7th Armoured Division and component Brigades over time in North-West Europe. Commanders for whom papers have been located are indicated, by bold typeface: no papers have been traced for any commander of the infantry brigade.

Figure App II.2, however, shows in diagrammatic form how it has been possible to remedy this lack of commanders from the infantry side to some extent through searching the IWM Documents Archive and other archives, producing a commander of some seniority on the infantry side.

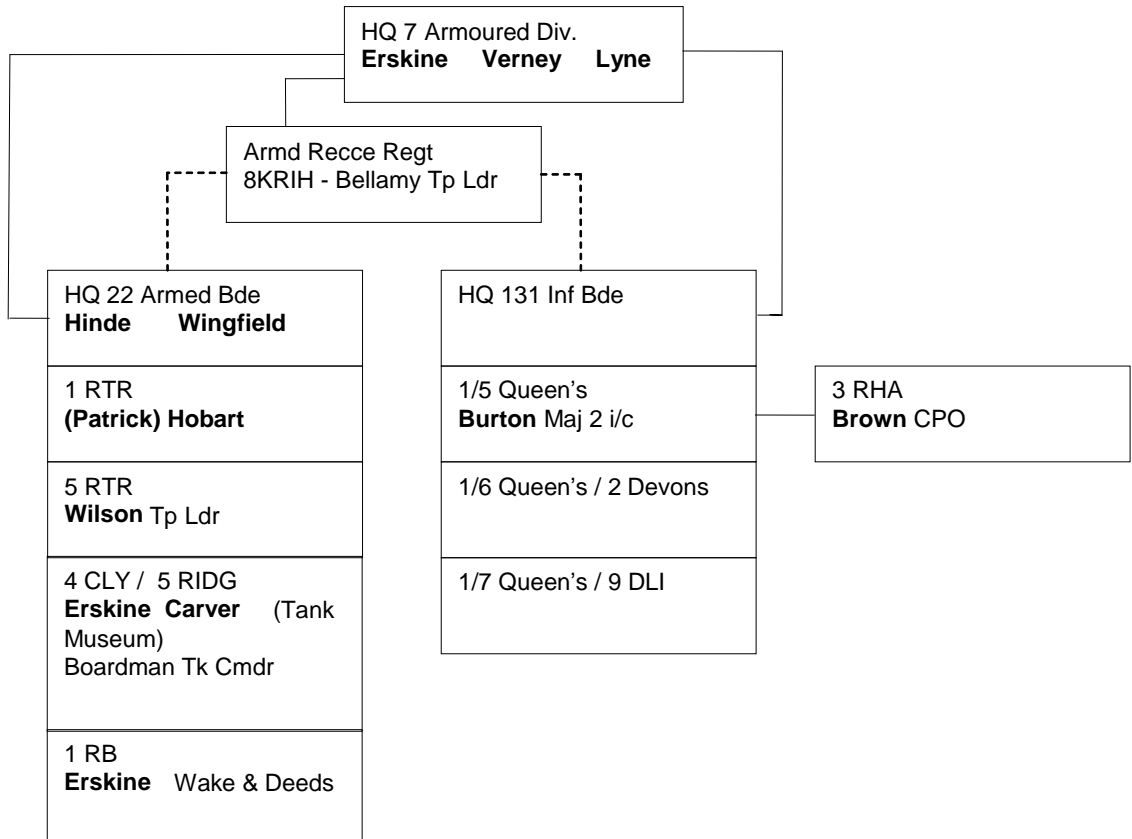

Fig. App.II.2: the same data as Fig.App.II.1 but showing how extending Joslen’s list to regimental/battalion commands can help to complete the picture. The bold typeface indicates unpublished, primary sources with the other names indicating additional sources such as published memoirs.

Thus, Figure Appendix II.2 shows that, by utilising the records of more junior commanders, a more complete picture may be built up – with the caveat that the commanders from the different arms may not match exactly in terms of their responsibilities and areas of command.

APPENDIX III: The Terrain of Normandy



App III.1 Typical ‘bocage’ countryside of the Calvados region southwest of Caen, looking north towards Thury-Harcourt – the river is the Orne.



AppIII.2 Close up of the steep sided fields / lanes typical of the bocage countryside, Calvados region



App.III.3 The apparently more open countryside south of Caen towards the town of Falaise, looking west/northwest towards “the bocage”



App.III.4. A typical Normandy farm just outside Falaise – the crops and stone buildings provided good cover for the defence, these buildings concealed a Tiger tank according to one local who was a child there in 1944

Appendix IV: Tank descriptions

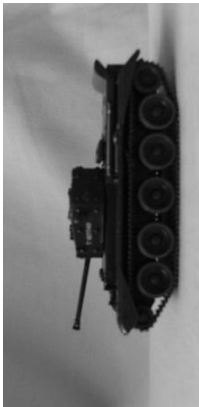

Cromwell Mk IV

A cruiser tank, the Mk IV version had an improved 75mm gun, good protection, and the new Rolls-Royce Meteor engine which gave it impressive speed. It was a match for the Pz.Kpfw.IV. The Comet was a development of the Cromwell.



Churchill Mk VII

An infantry tank, the Mk VII version had its maximum front armour thickness increased, compensating for its slow speed. Even if it lost several of its wheels, the tank remained operational. The Mk VII used a 75mm gun.

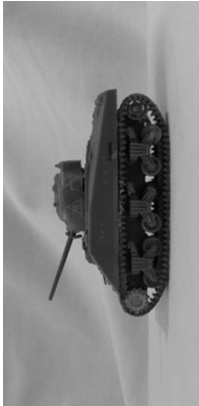

M4A4 Sherman

Even though the 75mm gunned Sherman medium tank could not penetrate a Tiger's or a Panther's front armour even at point-blank range (i.e. requiring a side-on shot), availability in large numbers made it the backbone of the armoured divisions in 1944.



Sherman "Firefly"

This up-gunned variant of the standard Sherman mounted the long-barrelled British 17-pdr anti-tank gun and was capable of dealing with a Tiger or a Panther. This gun was also used to equip the M10 SP Achilles.



Pz. Kpfw. IV

The Panzer IV was a medium tank, which larger guns and thicker armour kept in the front line throughout the war.



Pz. Kpfw. V "Panther"

The Panther was an outstanding tank with well-sloped armour, good speed, and a highly effective 75 mm gun capable of penetrating the front armour of a Sherman at 1,093yds (1000m).



Pz. Kpfw. VI "Tiger"

The Tiger was a formidable tank, particularly when employed defensively. Its 88mm gun could puncture the front armour of a Sherman at ranges in excess of 1,968yds (1800m).



Jagdpanther

The mobile and well-protected Jagdpanther SP anti-tank gun was also armed with a powerful and highly accurate 88mm gun.

Appendix V: The Independent Armoured Brigades (1945)

In January 1945, the Army Tank Brigades were re-designated Independent Armoured Brigades. There already were, however, Independent Armoured Brigades. These brigades were now known as Type 'A' if they included a battalion of motorised infantry and Type 'B' if they did not include infantry. Thus, what had been an Independent Armoured Brigade prior to January 1945 was now an Independent Armoured Brigade, Type 'A', and what an Army Tank Brigade as an Independent Armoured Brigade, Type 'B'.

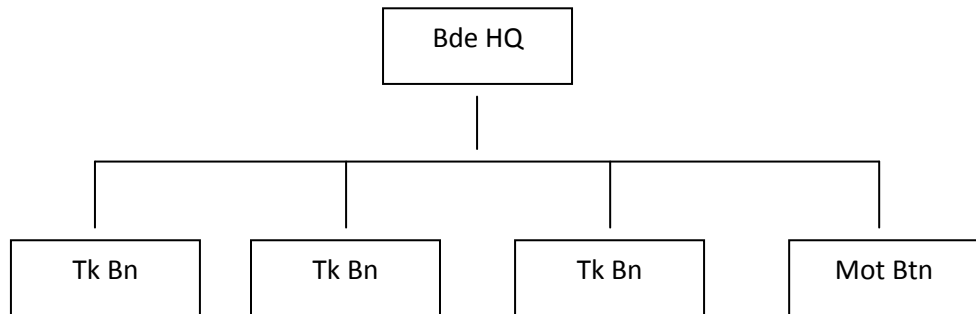

Fig. App.V.1 Type 'A' Independent Armoured Brigade, 1945

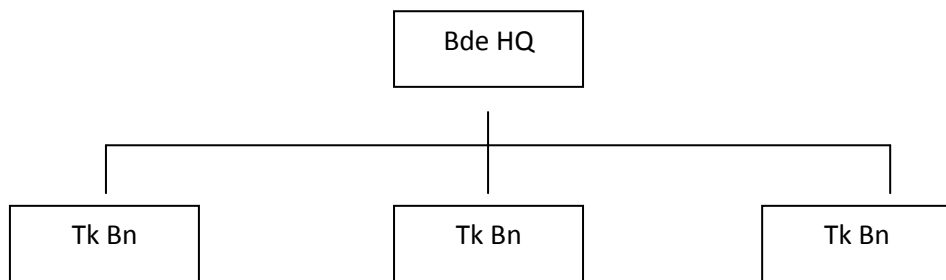

Fig. App.V.2 Type 'B' Independent Armoured Brigade, 1945

Sources:

H.F. Joslen, *Orders of Battle, Second World War: 1939-1945* (London: HMSO, 1960), p. 142 and J. Bouchery, *The British Soldier, 1944-45, vol. 2, Organisation, Armament, Tanks and Vehicles* (Paris: Histoire & Collections, 2001), p. 26.