



The  
University  
Of  
Sheffield.

**A qualitative study of workflow and information systems within Emergency  
Departments in the UK.**

**By:**

Eliza M Mazlan

A thesis submitted in partial fulfilment of the requirements for the degree of  
Doctor of Philosophy

The University of Sheffield  
Faculty of Social Sciences  
Information School

JANUARY 2017

## TABLE OF CONTENTS

<b>CONFERENCE PAPERS AND POSTER.....</b>	<b>i</b>
<b>DOCTORAL CONSORTIUM .....</b>	<b>i</b>
<b>LIST OF FIGURES.....</b>	<b>ii</b>
<b>LIST OF TABLES.....</b>	<b>iv</b>
<b>LIST OF APPENDICES.....</b>	<b>v</b>
<b>GLOSSARY OF ACRONYMS.....</b>	<b>vii</b>
<b>GLOSSARY OF TERMS .....</b>	<b>x</b>
<b>FLOW CHART DIAGRAM KEYS.....</b>	<b>xv</b>
<b>ACKNOWLEDGMENT .....</b>	<b>xvi</b>
<b>ABSTRACT .....</b>	<b>xvii</b>
<b>CHAPTER 1: INTRODUCTION.....</b>	<b>1</b>
1.1. Overview.....	1
1.2. Background to the research .....	2
1.3. Importance of the research.....	5
1.4. Aim of the research .....	7
1.5. Objectives .....	7
1.6. Structure of thesis .....	7
<b>CHAPTER 2: LITERATURE REVIEW .....</b>	<b>9</b>
2.1 Introduction.....	9
2.2 Literature review methods.....	9
2.3 Health Information Technology .....	10
2.4 HIT integration into healthcare workflows .....	12
2.4.1 Unintended consequences of HIT implementation .....	12
2.4.2 Workflow – an introduction .....	15
2.4.3 Workflow-related research outside healthcare .....	16
2.4.4 Workflow-related research in healthcare .....	19
2.5 Emergency Department Information System (EDIS).....	26

2.5.1.	Characteristics and information behaviour in emergency care setting .....	26
2.5.2.	HIT in emergency care .....	27
2.5.3.	Emergency Department (ED) workflow.....	29
2.5.4.	England National Programme for IT .....	34
2.6	Frameworks .....	36
2.6.1.	Socio-technical framework.....	36
2.6.2.	Computer Supported Cooperative Work (CSCW) .....	40
2.6.3.	CSCW and HIT .....	41
2.7	Synthesis.....	47
2.8	Limitations of existing research.....	49
2.9	Conclusion and research questions.....	51

## **CHAPTER 3: RESEARCH METHODOLOGY .....52**

3.1	Introduction.....	52
3.2	Research philosophy .....	52
3.3	Research methodology.....	53
3.3.1.	Research approach .....	53
3.3.2.	Qualitative methods.....	55
3.4	Methods .....	58
3.4.1.	Gaining access to the research settings .....	58
3.4.2.	Ethical considerations.....	59
3.4.3.	Pilot study and immersion in the fields.....	60
3.4.4.	Data collection methods .....	62
3.4.5.	Sampling and recruitment.....	70
3.4.6.	Saturation .....	72
3.4.7.	Triangulation .....	74
3.4.8.	Data analysis.....	75
3.4.9.	Triangulation of interviews and observational field notes with documentary sources	81
3.4.10.	Research trustworthiness.....	81
3.5	Methodological limitation .....	83
3.6	Conclusion .....	84

## **CHAPTER 4: RESEARCH SETTINGS .....85**

4.1	The adult Emergency Department (ED) .....	85
4.1.1	Description .....	85
4.1.2	Physical layout .....	85
4.2	The paediatric Emergency Department (ED).....	87
4.2.1	Description .....	87
4.2.2	Physical layout .....	87
<b>CHAPTER 5: CASE STUDY 1 – ADULT ED .....</b>		<b>89</b>
5.1	Components of the ED workflow .....	91
5.1.1.	Emergency care services .....	91
5.1.2.	Members of the ED team .....	93
5.1.3.	Patient flows.....	96
5.1.4.	Collaborative work processes.....	100
5.2	Information artefacts in supporting the ED workflow .....	118
5.2.1.	Information artefacts .....	119
5.2.2.	Characteristics of the information artefacts in supporting collaborative work.....	129
5.2.3.	Integration issues of the information artefacts into the ED workflow .....	136
5.3	Synthesis.....	146
5.3.1.	Patient trajectory.....	146
5.3.2.	Collaborative work processes.....	151
5.3.3.	Information artefacts in supporting the ED collaborative work .....	158
5.4	Conclusion .....	160
<b>CHAPTER 6: CASE STUDY 2 – PAEDIATRIC ED .....</b>		<b>161</b>
6.1	Components of the ED workflow .....	163
6.1.1.	Emergency care services .....	163
6.1.2.	Members of the ED team .....	165
6.1.3.	Patient flows.....	168
6.1.4.	Collaborative work processes.....	169
6.2	Information artefacts in supporting the ED workflow .....	183
6.2.1.	Information artefacts .....	183
6.2.2.	Characteristics of the information artefacts .....	188
6.2.3.	Integration issues of the information artefacts into the ED workflow .....	193

6.3	Synthesis.....	197
6.3.1.	Patient trajectory.....	197
6.3.2.	Collaborative work processes.....	199
6.3.3.	Information artefacts in supporting ED collaborative work.....	204
6.4	Discussion .....	205
6.4.1.	The workflows .....	205
6.4.2.	Variability in the patient care processes .....	208
6.4.3.	Information artefacts in supporting the collaborative work processes.....	210
6.4.4.	Impact of information fragmentation on work processes .....	213
6.5	Conclusion .....	215

## **CHAPTER 7: DISCUSSION .....216**

7.1.	Introduction.....	216
7.2.	Socio-technical approach in understanding workflow-related components of emergency care delivery .....	217
7.3.	The ED workflow: A socio-technical perspective .....	218
7.3.1.	Time-related care processes .....	218
7.3.2.	Clinical work of the ED workflow .....	219
7.3.3.	Non-clinical work of the ED workflow.....	220
7.3.4.	Hybrid information infrastructure vs. paper-less infrastructure.....	222
7.4.	Some socio-technical recommendations .....	227
7.4.1.	Designing for integrated implementation.....	227
7.4.2.	Designing for multiple roles .....	228
7.4.3.	Designing for awareness .....	229
7.5.	ED workflow and the National Programme for IT .....	234
7.6.	Conclusion .....	236

## **CHAPTER 8: CONCLUSIONS.....238**

8.1	Introduction.....	238
8.2	Research questions.....	239
8.3	Contribution to new knowledge.....	240
8.3.1.	Emergency care workflow .....	241
8.3.2.	EDs in the UK .....	242
8.3.3.	Methodological issues.....	244

8.4	Implications for practice.....	244
8.5	Implications for future research.....	245

<b>BIBLIOGRAPHY .....</b>	<b>247</b>
---------------------------	------------

<b>LIST OF APPENDICES.....</b>	<b>269</b>
--------------------------------	------------

## **CONFERENCE PAPERS AND POSTER**

Mazlan, E. and Bath, P. (2015). A case study of a collaborative physical artefact at an emergency department. *The Proceedings of 17<sup>th</sup> International Symposium on Health Information Management Research*. 24<sup>th</sup> June – 26<sup>th</sup> June 2015. York, United Kingdom. pp. 133-144.

Mazlan, E. and Bath, P. (2014). Emergency department information systems and workflows - A Pilot Study (Poster). *The Proceedings of Medical Informatics Europe 2014 Conference*. 31 Aug - 3 Sept, 2014. Istanbul, Turkey. pp. 1199.

Mazlan, E. and Bath, P. (2012). Impact of health informatics implementation on clinical workflow: A Review. *The Proceedings of World Congress on Engineering and Computer Science Conference*. 24 - 26 Oct, 2012. San Francisco, USA. pp. 1352-1360.

## **DOCTORAL CONSORTIUM**

7th Doctoral Consortium on Sociotechnical Issues in Biomedical Informatics, 14<sup>th</sup> November, 2014. Washington, D.C., USA.

**LIST OF FIGURES**

Figure 3.1: Observation template ..... 67

Figure 3.2: Triangulation ..... 75

Figure 3.3: Research Onion - adapted from Saunders et al. (2012) ..... 84

Figure 4.1: Adult ED floor plan ..... 86

Figure 4.2: Paediatric ED floor plan ..... 88

Figure 5.1: Themes and sub-themes of the findings ..... 90

Figure 5.2: ED multidisciplinary members ..... 94

Figure 5.3: Patient flow ..... 99

Figure 5.4: Blood test investigation work process ..... 108

Figure 5.5: X-ray/scan investigation test work process ..... 110

Figure 5.6: ED workflow components ..... 118

Figure 5.7: Rich picture representation of the information artefacts for the investigation test work process ..... 139

Figure 5.8: Rich picture of the information artefacts for registration process ..... 141

Figure 5.9: Rich picture showing the information artefacts for the coding process ..... 143

Figure 5.10: Overall patient trajectory and major unit patient trajectory ..... 148

Figure 5.11: Minor injuries unit patient trajectory ..... 149

Figure 5.12: Patient trajectory for CDU patients ..... 151

Figure 5.13: Collaborative work processes at the major unit ..... 153

Figure 5.14: Collaborative work processes at the minor injuries unit ..... 154

Figure 5.15: Investigation tests work process ..... 155

Figure 5.16: Collaborative work processes at the CDU ..... 157



Figure 5.17: Coding work process .....	158
Figure 6.1: Themes and sub-themes of the findings .....	162
Figure 6.2: ED multidisciplinary members .....	165
Figure 6.3: Blood test investigation work process .....	176
Figure 6.4: X-ray/scan investigation test work process .....	177
Figure 6.5: Collaborative work processes .....	183
Figure 6.6: Computerised information artefacts and its functionalities .....	188
Figure 6.7: Information artefacts for investigation test work process .....	194
Figure 6.8: Information artefacts for coding process .....	195
Figure 6.9: Patient trajectory for non-resuscitation patients .....	198
Figure 6.10: Overall collaborative work processes .....	200
Figure 6.11: Investigation test work process .....	202
Figure 6.12: Observation work process .....	203
Figure 6.13: Coding work process .....	203
Figure 6.14: The contributing socio-technical elements to workflow and work process	
Variations .....	215

**LIST OF TABLES**

Table 3.1: Documentary evidence ..... 70

Table 3.2: Participant groups ..... 72

Table 3.3: Assignments of codes and categories to vignettes ..... 78

Table 5.1: Forms and their purposes ..... 121

Table 5.2: Computerised information artefacts and electronic databases ..... 128

Table 5.3: System functionalities and the corresponding information artefacts ..... 129

Table 6.1: Forms and its purpose ..... 185

Table 6.2: ED processes and their corresponding information artefacts in the two EDs..... 212

Table 7.1: Workflow requirements and proposed solutions ..... 234

## **LIST OF APPENDICES**

Appendix 1a: IRAS form (Adult ED)

Appendix 1b: IRAS form (Paediatric ED)

Appendix 2a: Letter of access (Adult ED)

Appendix 2b: Letter of access – extension (Adult ED)

Appendix 3: Project authorisation (Adult ED)

Appendix 4: Letter of access (Paediatric ED)

Appendix 5: Project authorisation (Paediatric ED)

Appendix 6: Research protocol (Adult ED)

Appendix 7: Data protection approval (Adult ED)

Appendix 8a and 8b: Independent Scientific Review 1 and Independent Scientific Review 2

Appendix 9a: Insurance certificate (Adult ED)

Appendix 9b: Insurance certificate (Paediatric ED)

Appendix 10: Ethical approval

Appendix 11: Interview guide

Appendix 12a: Information sheet (Adult ED)

Appendix 12b: Information sheet (Paediatric ED)

Appendix 13: Consent form

Appendix 14: Participant profile

Appendix 15a: Invitation letter

Appendix 15b: Summary of results (Adult ED)

Appendix 16: Evaluation sheet (Adult ED)

Appendix 17: Manchester triage score

Appendix 18a: ED card (Adult ED)

Appendix 18b: ED card for major trauma (Adult ED)

Appendix 19: ED card (Paediatric ED)

Appendix 20: Trauma card and medical card

## **GLOSSARY OF ACRONYMS**

A&E	Accident and Emergency
AAU	Acute Assessment Unit
AI	Artificial Intelligence
ATMIST	Age and sex, Time of incident/Time of arrival, Mechanism of injury, Injuries suspected, Signs and Treatment form
BM	Blood Glucose Measurement
BT	British Telecom
CAS	Casualty
CDU	Clinical Decision Unit
CDSS	Clinical Decision Support System
CiC	Consultant in Charge
CPOE	Computerised Physician Order Entry
CRB	Criminal Records Bureau
CRIS	Computer Radiology Information Solution
CRS	Care Record Service
CS	Computer Science
CSCW	Computer-Supported Cooperative Work
CT scan	Computer Tomography scan
CWA	Cognitive Work Analysis
DBS	Disclosure and Barring Service
DoH	Department of Health
DVT	Deep Vein Thrombosis

ECG	Electrocardiogram
ED	Emergency Department
EDIS	Emergency Department Information System
EHR	Electronic Health Record
EKG	Electrocardiogram
EM	Emergency Medicine
EMR	Electronic Medical Record
ENP	Emergency Nurse Practitioner
GP	General Practitioner
HCI	Human Computer Interaction
HDU	High Dependency Unit
HIS	Health Information Systems
HIT	Health Information Technology
ICE	Integrated Clinical Environment
ICT	Information Communication Technology
ICU	Intensive Care Unit
IT	Information Technology
ISR	Independent Scientific Review
IRAS	Integrated Research Application System
MAU	Medical Assessment Unit
MRI scan	Magnetic Resonance Imaging scan
NICU	Neonatal Intensive Care Unit
NHS	National Health Service

NiC	Nurse in Charge
NSTS	NHS Strategic Tracing Service
OR	Operating Room
PACS	Picture Archiving and Communication System
PCS	Patient Centre System
PCIS	Patient Care Information Systems
PTS	Patient Tracking System
RIS	Radiology Information System
RFID	Radio-frequency Identification
SAU	Surgical Assessment Unit
SCR	Summary Care Record
SSM	Soft Systems Methodology
URMS	University Research Management System
WIFI	Wireless Fidelity

## GLOSSARY OF TERMS

Accident and Emergency (A&E) department	A medical treatment facility specialising in emergency medicine which is commonly found in a hospital. Also known as Emergency Department (ED), emergency room or casualty department.
Attending physician	The term used for doctors in the United States and Canada. They are also responsible for the supervision and teaching of medical students and resident doctors (see also: resident physician)
Ambulant patient	Patients who can walk or move about
Analgesic	Painkiller
Artificial Intelligence (AI)	Intelligence exhibited by machines or software
Blood Glucose Measurement (BM)	Measurement of blood glucose levels
Capillary blood samples	Blood samples that are collected via pricking the skin
Casualty	Equivalent term to Accident and Emergency (A&E) department and Emergency Department (ED) which is still being used informally in the UK
Clinician	Health professionals such as doctors, nurses and nurses practitioners
Computer Science	Study of algorithms in the representation, processing, storage, communication of, and access to information
Consultant doctor	A senior doctor who practises in one of the medical specialties. Responsible in patient care as well as the teaching and training of students and junior doctors
Criminal Records Bureau (CRB) checks	Checking of someone's criminal record usually done for people applying for certain jobs or in the adoption process. Now known as Disclosure and Barring Service (DBS) checks
CT scan	Uses of x-ray radiation and a computer to create detailed images inside of the human body. Also known as Computerised Axial Tomography







	(CAT) scans
Department of Health (DoH)	Ministerial Department of the UK Government responsible for government policy on health and adult social care
Deep Vein Thrombosis (DVT)	Pain, swelling and tenderness in mostly the calves of the legs
Earache	Common problem particularly in children, usually caused by a minor infection
Electrocardiogram (ECG)	A test for recording electrical activity and rhythm of the heart
Emergency Department (ED)	A medical treatment facility specialising in emergency medicine, commonly found in a hospital. ED is the recommended term after the Emergency Medicine was recognised as a medical specialty. Also known as Accident and Emergency (A&E) in the UK.
Emergency Medicine (EM)	A medical specialty specialising in treating patients with acute illnesses or injuries
Haematology Department	Hospital department that diagnoses and treats patients with blood disorders ranging from iron deficiency to leukaemia
Healthcare professional or healthcare provider	Individuals who provide healthcare services within all branches of healthcare such as medicine, surgery, nursing and pharmacy. Examples include doctors, nurses and psychiatrists
Health Informatics	Field that is concerned with the optimal use of healthcare information via Information Communication Technology (ICT)
Hospice	A type of care that focuses on the palliation of chronically and terminally ill patients
Human Computer Interaction	Scientific study of people's interactions with computers
Human Factor Design	Scientific discipline that study human physical, social, biological and psychological characteristics in order to design optimised devices or systems in terms of health and safety

Information artefacts	Information resources in which the information is recorded on physical objects where the value of the information depends on both the contents and the objects. Information artefacts also include computerised information systems
Information Communication Technology (ICT)	Integration of telecommunications (e.g. telephone lines and wireless signals), computers, software, middleware, storage, and audio-visual systems, which enable users to access, store, transmit, and manipulate information
Integrated Research Application System (IRAS)	An online system for preparing regulatory and governance applications for health and social care research in the UK
Junior doctor	Graduate doctors in postgraduate training working towards becoming a consultant or a GP
Medical patient	Patient who comes to the ED with minor or major illnesses
Magnetic Resonance Imaging (MRI)	Scan that uses strong magnetic fields and radio waves to produce detailed images of the inside of the body
National Health Service (NHS)	Publically funded healthcare system overseen by the Department of Health (DoH)
Nurse in Charge (NiC)	Also known as a charge nurse. Responsibilities include performing clinical care such as assessing patients as well as ensuring sufficient nursing staffing and delegating breaks
Emergency Nurse Practitioner (ENP) or Nurse practitioner	Advanced practice registered nurses qualified to make diagnosis, order treatments, prescribe medicine and make referrals within their scope of practice
Non-ambulant patient	Patient who cannot walk or move about
NVivo	A computer software package to analyse qualitative data
Operating Room (OR)	A facility within a hospital where surgical operations are carried out in a sterile environment. Also known as the Operating Theatre

Paediatric	Medical specialty that manages medical conditions of babies, children and young people
Picture Archiving and Communication System (PACS)	Information systems to manage, store and distribute digital images (e.g. CT, MRI, x-ray and ultrasound scans)
Poding system	Pneumatic tube system in hospitals that can be used to transport blood tubes containing blood samples
Presenting complaint	Concise statement describing symptoms, problems or conditions which are reasons for medical encounters
Radiology Department	Hospital department that provides medical imaging services
Resident physician	The term used for doctors in the United States and Canada, who practise medicine in a hospital or a clinic under direct or indirect supervision of attending physician (see also: attending physician)
Resuscitation	An act of reviving a person to return him/her to consciousness
Rich pictures	Graphical representation to depict real situations containing layouts, connections, relationships, causes and effects through the use of images such as cartoon representations and symbols, and texts such as keywords and titles.
Salbutamol	Medicine which is used to treat asthma
Shop floor	An area of an Emergency Department (ED) where clinical care is delivered
Steristrips	Adhesive strips used to close the edges of a small wound to encourage the skin to heal
Swimlane flowchart	Format of flow diagrams that distinguishes job sharing and responsibilities of sub-processes
Trauma patient	Patient who come to an ED with minor or major injuries
Triage	Process of determining the priority of patient treatments based on the

	severity of their condition
Hospital Trust	Provides secondary health services within the National Health Service (NHS). Also known as acute trust.
Ubiquitous computing	A concept in software engineering and computer science where computing is made to appear anytime and everywhere
Ultrasound scan	A procedure that uses high-frequency sound waves to create images inside the human body
Vital signs	Measurements of the bodies most basic functions: body temperature, pulse rate, respiration rate and blood pressure
Venous blood samples	Blood that is obtained through venepuncture
Venepuncture	Collection of blood from a vein
WIFI	Accessibility or connection to a network using radio waves
X-ray	A type of radiation that can pass through the body to produce inside images

**FLOW CHART DIAGRAM KEYS**

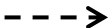
Symbol	Meaning
	Start/End
	Process
	Decision
	Connector
	Flow line direction
	Flow line direction (exceptions)

## **ACKNOWLEDGMENT**

The study described in this thesis was designed and executed by the author; however, none of this would have been made possible without the guidance and support from the following individuals and organisation.

First of all, the research was financially supported by a PhD scholarship awarded by the Islamic Development Bank. The author is greatly indebted by the opportunity given by this organisation. Without them this study would not have been possible.

To the research supervisor, Professor Peter Bath of the Information School, University of Sheffield, for guidance. To the field supervisors, Professor Steve Goodacre, Professor in Emergency Medicine, School of Health and Related Research, University of Sheffield and Dr. Shammi Ramlakhan, Honorary Senior Clinical Lecturer, School of Health and Related Research, University of Sheffield, for helping the author to gain access to the Emergency Departments and their staff. I am also very grateful and indebted to Dr. George Turner and Dr. Azmin for offering me their expertise during the re-writing process of the thesis. I would also like to thank all the research participants who took part in the study as well as the administrative staff and IT support staff in the Information School, University of Sheffield.

And most importantly, to my husband and my children; for tolerating me, giving me their unconditional love and endless support, and sticking with me until the very end. This thesis is dedicated to them. Not forgetting my parents, my brother and my sisters, thank you very much.

## ABSTRACT

**Background:** Health Information Technology (HIT) has the potential to improve the quality and efficiency of healthcare delivery and reduce costs. However, the integration of HIT into healthcare workflows has experienced a range of issues during its implementation. It can adversely impact healthcare workflows, therefore reducing efficiency and safety in healthcare delivery. As healthcare settings are characterised by its own workflow, an in-depth understanding of the workflows of where the HIT to be implemented is crucial in order to avoid complexities that can arise. As there is a lack of research investigating an overall ED workflow, both clinical and non-clinical processes and practices, this research aims to gain an in-depth understanding of emergency care workflow which includes the work processes and practices of its clinicians and non-clinicians and its information artefacts.

**Methodology:** This research employed a fieldwork case study approach analysing the work processes and practices of clinicians and non-clinicians in the delivery of emergency care. The approach was used in order to capture the situated nature of the ED workflow. The study was conducted in two emergency care settings located in the UK. Data were collected using semi-structured interviews, non-participant observations and documents. A multiple triangulation technique: data triangulation and within-methods triangulation were employed in order to gain an in-depth understanding of the topic. The data were analysed using thematic analysis.

**Findings:** The emergency care workflow consisted of multidisciplinary ED team members' work processes. These work processes were comprised of collaborative clinical and non-clinical tasks and activities in delivering care treatment governed and defined by time-related activities, organisational rules, exceptions and variability. The workflow was supported by both computerised systems and non-computerised information artefacts, such as non-electronic whiteboards and paper-based records and forms, which needed to be used in conjunction with each other. Additionally, the hybrid implementation had also been utilised to support collaborative work of the clinicians and non-clinicians, hence giving the implication that HIT systems should not be designed as purely technical system focusing on single users, but also as a collaborative work system.

**Conclusion:** An ED workflow consists of interrelated care processes, clinical and non-clinical processes. These processes are executed semi-autonomously by clinicians and non-clinicians and governed by time-related organisational constraints, variable and exception-filled, relying on hybrid information architecture. The architecture presented workflow with a number of integration issues. However, its implementation does not only support the functionalities for the delivery of emergency care processes but also the collaborative practices of the clinicians and non-clinicians.

**Keywords:** Emergency Department, healthcare workflow, collaborative work, HIT



# CHAPTER 1: INTRODUCTION

## 1.1. Overview

The field of Health Information Systems deals with the application of Information and Communication Technology (ICT) in healthcare, which supports the management and transmission of health information of various user groups such as healthcare professionals, patients and policy makers (Subiya & Masoodul, 2015). The computerised information systems in healthcare, also known as Health Information Technology (HIT), includes applications such as Electronic Medical Records (EMR), Electronic Health Records (EHR), Computer Provider Order Entry (CPOE) and Picture Archiving Communication Systems (PACS) (Jamal, McKenzie, & Clark, 2009). These applications can be found across a range of healthcare domains: primary care, secondary care, pharmacy, laboratory and research (Mettler & Raptis, 2012).

In its early stages, when the diffusion of technology within healthcare was still relatively limited, HIT was primarily used for financial and accounting purposes of medical transactions (Haux, 2010). As for patient record systems, they have been largely conceptualised and designed as data repositories with capabilities such as enhanced storage, smart search functionalities and multi-location accessibility (Berg & Toussaint, 2003). As the ICT field progresses, and as healthcare providers moving rapidly to embrace the technology, HIT has become more than just an information storage and retrieval tool. Considerable attention is now being directed towards the potential of HIT in improving the efficiency and quality of healthcare delivery, and ensuring patient safety (Nykänen et al., 2011; Sicotte et al., 2009). Given the importance of healthcare delivery, it is important to consider the challenges that are faced in the development of HIT systems, both from the point of developing and implementing such systems, but also from gaining a better understanding from a research perspective.

In many cases, the model of healthcare work that the HIT is to support is mainly based on the software designer's simplistic perspective (Ajmi et al., 2015; Berg, Aarts, & Van der Lei, 2003). In reality, healthcare workflows are situated and interactive, although there are pre-defined routine and standard operating procedures (Bjørn & Rødje, 2008; Park, Lee, & Chen, 2012). Re-interpretation is required in the light of sudden changes and unforeseen circumstances. The main challenge is to design a system that can support the situated work of the healthcare professionals and research is required to understand the complexities of this better. To address this issue, many studies investigating healthcare work have been conducted in actual healthcare settings, instead of the traditional approach of obtaining system requirements, such as software development methodology

or clinical trials (Bjørn & Rødje, 2008; Bossen, Jensen, & Witt, 2012; Dexheimer & Borycki, 2014). This approach, however, has introduced yet another issue. These types of study can be tightly tied to the contextual elements of the study settings hence giving the perceptions that findings are not applicable outside the study context (Unertl, Novak, Johnson, & Lorenzi, 2008). Nevertheless, such studies can contribute significantly to the field, where methods/approaches used or general theories formulated can be adopted in related studies. It is also a challenge in developing computer-based information systems for dynamic healthcare systems. In dynamic systems, change and chaos are common. Seemingly insignificant changes in one part of the system can have a dramatic impact on the entire healthcare system (Effken, 2002). Therefore, as healthcare systems are susceptible to these continual changes, it is difficult for designers to design such computerised systems. With HIT being continuously adopted by healthcare providers, the challenges with developing, implementing and using it will continue to grow (Ammenwerth, Gräber, Herrmann, Bürkle, & König, 2003). Understanding these issues from a research perspective will help to inform the design of HIT systems and their implementation in different health care settings.

## **1.2. Background to the research**

Despite the documented benefits of computerisation of healthcare systems in improving efficiency and quality of healthcare delivery (Buntin, Burke, Hoaglin, & Blumenthal, 2011; Caldwell, Katz, & Pascarella, 2011; Handel, Wears, Nathanson, & Pines, 2011; Hillestad et al., 2005; Jamal et al., 2009), concerns about the impact of HIT applications such as EMR, EHR, CPOE and PACS, on clinical workflow abound. The integration of HIT into healthcare workflow has remained an on-going challenge, where complexities and unintended consequences resulting from the integration have frequently being reported. These include the introduction of workflow blocks and workarounds (Koppel, Wetterneck, Telles, & Karsh, 2008; Patterson, Rogers, Chapman, & Render, 2006), work redundancy (Abraham, Kannampallil, & Reddy, 2009; Saleem et al., 2011), increased documentation time (Banet, Jeffe, Williams, & Asaro, 2006; Park et al., 2012) and introduction of errors (Ash, Berg, & Coiera, 2004). These complexities and unintended consequences have been theorised as the result of a poorly designed HIT that has been due to a lack of understanding of the healthcare workflow.

It has also been argued that one-size-fits-all HIT solutions can result in healthcare professionals having to adapt to a new way of working due to the complexities when using the technology (Abraham et al., 2009; Eason, 2010). This is because healthcare settings, such as Emergency Departments (ED), Intensive Care Units (ICU), Operating Rooms (OR) or out-patient settings each have their own inherent workflow. The individual workflow of these settings is mainly characterised

by patient flow, patient condition and type of care given. Therefore, HIT that is used in these settings is different, as it needs to support different patient care processes and practices. Constructive workflow analyses are needed to inform the effective design and implementation of HIT. As stated by Ammenwerth, Iller, and Mahler (2006), HIT is comprised of technological systems which are embedded in socio-organisational settings characterised by different organisational workflow.

Before proceeding with discussion on workflow-related studies, it is necessary to understand what the *workflow* term represents. Not all workflow-related studies (e.g. in Section 2.4.3 and Section 2.4.4) explicitly defined what the term means. Studies that do provide the definition do so in numerous ways. For example, Cain and Haque (2008) loosely defined the term as “set of tasks-grouped chronologically into processes- and the set of people or resources needed for those tasks, that are necessary to accomplish a given goal” (p. 1). They further elaborate that “An organization’s workflow is comprised of the set of processes it needs to accomplish, the set of people or other resources available to perform those processes, and the interactions among them” (p. 1). Workflow is also simply defined “as typical sequence of work activities” (Flanagan et al., 2011, p. 427).

Zheng et al. (2010), on the other hand, provides a rather ‘non-typical’ definition: workflow as “hidden regularities embedded in the sequential order of a series of clinical task execution” (p. 455). They claim that workflow can be collectively determined by “individual physicians’ practice styles, regulatory requirements, team coordination needs, and even the physical layout of a medical facility” (p. 455). Similarly, Lee and Shartzter (2005) also included non-tangible aspects (i.e. interaction) as part of a workflow: “An important part of workflow is the interactions among staff as they fulfil their tasks using available resources” (Lee and Shartzter, 2005, p.1). Although an exact definition of the term seems to be lacking and not explicitly defined in many workflow-related studies, there appears to be some agreement regarding what constitutes workflow. It can include: work processes, practices and activities which are sequentially executed by availability of resources (actors and artefacts).

With the various definitions of the term, it is important to clarify how the term is used in this thesis. The term will be used in its broadest sense to refer to the execution of work processes and practices using sets of resources (actors and artefacts), relationship and interaction among actors, as well as interaction of actors with the artefacts. The general aim of workflow-related research discussed in this thesis is to gain an in-depth understanding of the situated work of professionals working in the work domain.

There are no specific approaches that can be used to gain an understanding of workflow. There are also different motivations and methodological orientations towards conducting workflow-related research. For example, some workflow-related studies are designed to investigate the impact

of HIT implementation on specific processes within the clinical workflow. Such studies are valuable in understanding the complexities and unintended consequences resulting from a HIT implementation so that improvements to system design can be suggested. Guite, Lang, McCartan, and Miller (2006), for instance, investigated an ED nursing assessment and referral process which is part of an ED workflow, as part of the re-design effort of an EHR. Similarly, Park et al. (2012) conducted a qualitative study at an ED to study the impact of a clinician documentation system, which is part of an EMR, on the documentation process and practices of the clinicians. There are also open-ended workflow studies not linked to any HIT implementation. These studies for example, are carried out to investigate the collaboration, coordination or communication practices of the overall workflow. For example, Kuziemyky and Varpio (2011) conducted a qualitative exploratory study at a hospice to get an in-depth understanding of inter-professional collaborative and communication practices during clinical activities such as team rounds, patient admissions and patient discharges. Similarly, Bardram and Bossen (2005b) investigated the coordination practices of the clinical staff while on ward duty and on-call activities at a haematology ward. These two studies share commonalities in that the studies were conducted not-linked to any specific HIT implementations. Rather, the focus was to obtain an in-depth understanding of the collaboration and coordination practices of the clinicians. Studies on communication practices among clinicians and information seeking activities which are part of a healthcare workflow can also be found (Benham-Hutchins & Effken, 2010).

Workflow-related studies based on the usage of non-computerised information artefacts are also fairly common, as it is theorised that understanding the implicit functionalities afforded by these non-computerised information artefacts are pre-cursors to successful design of their electronic counterparts and, hence, successful integration into clinical workflows. These non-computerised information artefacts include paper-based forms (Xiao, 2005), medical records (Bringay, Barry, & Charlet, 2006; Cabitza, Simone, & Sarini, 2009) and dry-erase whiteboards (Bisantz et al., 2010; Bjørn & Hertzum, 2011). In Unertl et al. (2008), based on their review on workflow-related studies, stated that determining which workflow elements to consider is intrinsically linked to the individual study. These workflow elements can include “the people performing actions (actors), the physical and virtual tools the actors are using (artefacts), specific details of the actions being performed (actions), characteristics that describe the actions (characteristics) and the end products of the actions (outcomes)” (p. 270).

This research was designed to obtain an in-depth understanding of an emergency care workflow, with the focus on the clinical and non-clinical processes and practices, as well as how the Emergency Department Information System (EDIS) was being utilised to support the workflow. The study was conducted in two Accident and Emergency (A&E) departments (referred to as Emergency

Departments (ED) in this thesis), at two urban hospitals in the UK. This study seeks to provide an in-depth understanding on the work processes that formed the workflow and the work practices of the ED team members. Such understanding is crucial in designing computerised systems that can support the workflow, eliminating the complexities that can arise from using them, and hence contributes to the efficiency and safety of patient care delivery. The effective functioning of an ED is dependent on the introduction of technology that support the work processes (Laxmisan et al., 2007).

### **1.3. Importance of the research**

Overcrowding is a common problem in an ED. It is an issue faced by EDs worldwide (Di Somma et al., 2015). Overcrowding can negatively affect efficiency and safety of care delivery. For example, it can caused adverse clinical outcomes (Bernstein et al., 2009), delays in patients receiving medications such as antibiotic and analgesic (Hoot & Aronsky, 2008) and longer patient waiting times for receiving treatments (Pines et al., 2007; Pines & Hollander, 2008). Patient mortality has also been reported as a result of overcrowding (Richardson, 2006; Sprivulis, Da Silva, Jacobs, Frazer, & Jelinek, 2006). In the UK, ED overcrowding has become a national concern (Benger & Willett, 2013; Iacobucci, 2013b).

One intervention that could improve efficiency of care to overcome ED overcrowding is the implementation of HIT (Batley, Osman, Kazzi, & Musallam, 2011). HIT ensures accessibility to patient information and provide support for clinical decision making in a timely manner. Delays in receiving test results can cause failures in medical diagnostics (Ferris et al., 2009) and insufficient patient information can delay in-patient transfer (Abraham & Reddy, 2010). However, a suitable technology for the established workflow is critical to avoid the complexities and unintended consequences which can arise from a non-seamless integration of HIT into the workflow.

Before the technology can effectively be designed to support its workflow, however, it is important that entire components that form the workflow be identified. This study is designed to obtain an in-depth understanding of an ED workflow where the overall and overarching question is “what characterises an ED workflow”. This includes answering the question: “what is the entire component that makes up the workflow, in addition to clinical processes performed by the obvious members of an ED team, i.e. the clinicians. It is argued that the clinical processes of the workflow cannot be separated from the non-clinical processes. Because a workflow is embedded and regulated with organisational and national requirements, there is a need to understand the inter-connectedness and inter-relatedness of these processes and how the execution of the processes is

governed by these requirements. In other words, the execution of an ED workflow is dependent on the execution of both clinical processes and non-clinical process of ED heterogeneous team members and at the same, are intertwined with local and national operating procedures. Furthermore, clinical workflow is commonly cited in the literature as being fluid and interactive, which requires re-interpretation by the clinicians (Berg, 2003; Feufel, Robinson, & Shalin, 2011). However, as healthcare delivery also constitutes of non-clinical processes, it is also argued that fluidity can happen across the entire workflow. Thus, this study also seeks to identify the possible variability and exception that can surface in both the clinical and non-clinical processes. ED components should also be looked at from the perspective of the resources, i.e. the multi-disciplinary team members and the existing EDIS implementation. The ED multi-disciplinary team members extend more than just clinical members involved in a clinical workflow. The overall workflow is as much clinical as it is organisational. Therefore, understanding of their roles and responsibilities and how their semi-autonomous work practices is being supported by the existing legacy systems can contribute for greater understanding of the overall ED workflow. All these issues are of great importance in developing our understanding of an ED model of care.

The failure of the standard solution proposed by the UK national IT programme has lead others to suggest that a socio-technical approach be used in understanding Trust's diverse processes, practices and previous implementation (Clegg, Wyatt, Elliott, & Sinclair, 2010; de Lusignan & Aarts, 2008; Eason, 2010). Responding to this suggestion, this study is designed to gain an in-depth understanding of an emergency care workflow and its supporting information artefacts within the socio-technical framework. In doing this, two qualitative case studies were performed in an adult ED and a paediatric ED where each ED is under the management of different NHS Trusts. This method then leads to another research question: "What are the differences and similarities in the workflows of the two settings?" The UK's government documents have briefly mentioned that Trusts have adopted their own non-technical and technological solutions in order to improve patient flow in their EDs (Department of Health, 2004a). This inadvertently meant that UK EDs can have different workflows. It is thus necessary for such differences to be recognised as the National Programme for IT has its roots in imposing standardised IT solutions. Standard technological solutions that fail to recognise healthcare professionals' varying work practices and existing implementation can result in requirements and expectations of the settings not being met, which inadvertently lead to unintended consequences (Ellingsen & Monteiro, 2006). This research calls for a more comprehensive approach in understanding emergency care workflow to include both the clinical and non-clinical processes and practices, and how these processes and practices are being supported by existing EDIS implementation.

#### **1.4. Aim of the research**

This overall aim of this study is to gain an in-depth understanding of Emergency Department (ED) workflow in relation to its information systems. This includes the work processes and practices of its clinicians and non-clinicians, and how the workflow is being supported by existing information artefacts. The results are examined from the perspective of collaborative work utilising the Computer Supported Cooperative Work (CSCW) field of study.

#### **1.5. Objectives**

The objectives of the study are:

1. To identify and describe the components which make up the ED workflow. These components include both clinical and non-clinical care processes of multi-disciplinary team members.
2. To provide an analysis on the similarities and differences of how the care processes are executed in emergency care settings.
3. To identify the computerised and non-computerised information artefacts used.
4. To provide a socio-technical analysis of how the information artefacts support the delivery of collaborative emergency care, taking into consideration its strengths and limitations.
5. To discuss some key socio-technical design requirements for emergency care systems that can appropriately support collaborative processes of the ED clinicians and non-clinicians.

#### **1.6. Structure of thesis**

The overall structure of the thesis takes the form of eight chapters including this chapter. The introductory chapter presents an overview of the research field and background of the study. The aim and the specific objectives of the research as well as the research questions are also discussed.

Chapter 2 provides a more extensive review on the theoretical dimensions of the research. It includes the justification and importance of conducting healthcare workflow-related research in order to inform HIT system design, what this type of studies typically entails as well as their

methodological approach. As this study was conducted in emergency care settings in the UK, a background on the UK health system and the implementation of a national IT programme to improve healthcare delivery is also discussed. The research questions that were developed following the literature review are also presented at the end of the chapter.

Chapter 3 presents the methodological approach of the study in which the format of the chapter follows the Saunders, Lewis, and Thronhill (2012) research onion model. The description of where the research took place is in Chapter 4. As this study was conducted in two emergency care settings, the findings obtained are discussed separately in Chapter 5 and Chapter 6. This method is adopted in order to allow for comparisons to be made between the two settings. Chapter 7 discusses common characteristics of emergency care work by triangulating the findings from the individual studies. Finally, Chapter 8 concludes the thesis and presents the research implication on practice and provides suggestion for future research.



## **CHAPTER 2: LITERATURE REVIEW**

### **2.1 Introduction**

Given the aim and objectives of the study, this chapter reviews the relevant literature on the topic area. The review starts with a background on Health Information Technology (HIT); its associated terms and benefits. It then goes on to discuss the workflow-related problems of HIT implementation in clinical settings and the importance of conducting workflow-related studies for seamless integration of HIT into clinical work. This also includes examples of workflow-related research conducted in other industries as well as in healthcare settings. As this study was conducted in emergency care settings in the UK, Section 2.5 discusses the characteristics of emergency care delivery as well as workflow-related studies which have been conducted specifically in emergency care settings. In the same section, issues related to the UK healthcare system and the implementation of the UK national IT programme, i.e. the National Programme for IT, for healthcare delivery including in emergency care was also discussed. Further, the theoretical frameworks, socio-technical framework and Computer Supported Cooperative Work (CSCW) used in the study are discussed in Section 2.6. The chapter ends with Section 2.7 to Section 2.9 synthesising the reviewed literature, setting out the limitations of existing research and listing the research questions.

### **2.2 Literature review methods**

The references cited in the thesis were identified via a comprehensive literature search. A search strategy was developed to identify relevant academic research articles and UK government documents: White papers and Green papers. Databases used include: Pubmed/Medline, ACM Digital Library, ScienceDirect, Web of Knowledge, Scopus and CINAHL, as well as Google Scholar and Google. Only articles that were published in English were reviewed.

A broad set of terms related to computerised information systems in healthcare were used to maximise sensitivity. Analysis of the index terms used to describe the retrieved articles was also conducted to identify relevant terms. The terms used include: electronic health records, electronic medical records, health information technology, CPOE, medical informatics, emergency medicine, emergency department, accident and emergency and medical workflow. Other terms related to CSCW, UK IT programme and qualitative research such as CSCW, collaborative work, cooperative work, qualitative research, case study and National Programme for IT were also used. In addition,

related citations and references within the retrieved articles were also reviewed. The search started in October 2011 and was repeated until the conclusion of the research in January 2017.

### **2.3 Health Information Technology**

The term HIT and HIS have been used interchangeably to represent computerised information systems in a healthcare context (Faggioni, Neri, Castellana, Caramella, & Bartolozzi, 2011; Kuhn & Giuse, 2001; Kuziemyk & Varpio, 2011). A broad definition of HIT offered by Friedman and Wyatt (2000) simply describes HIT as computerised systems that collect, store and retrieve healthcare data, for example, clinical workstations. It also includes systems with intelligent processing, such as knowledge-based systems. A more comprehensive definition is offered by Jamal, McKenzie and Clark (2009) where they define HIT as “a broad array of technologies involved in managing and sharing patient information electronically rather than through paper records” (p. 27). Health IT is another term commonly used to refer to computerised information systems in healthcare (Parente & McCullough, 2009; Zheng et al., 2010). In this thesis, for the purpose of consistency, the term HIT will be used to refer to any computerised information systems used in a healthcare context.

There are two components of HIT: ICT component and application component. The ICT component includes hardware (e.g. workstations), wireless devices (e.g. sensors and scanners), wireless connection (e.g. Bluetooth and WIFI) and Artificial Intelligence (AI) (Goldstein & Blumenthal, 2008). The application component includes Electronic Health Record (EHR), Clinical Decision Support System (CDSS), Computerised Physician Order Entry (CPOE) and Electronic Medical Record (EMR). Patient tracking and electronic documentation (Pallin, Sullivan, Kaushal, & Camargo, 2010; Wong, Caesar, Bandali, Agnew, & Abrams, 2009) as well as Picture Archiving and Communications Software (PACS) and Radiology Information System (RIS) (Faggioni et al., 2011) are also examples of HIT applications. These HIT applications can be found across a range of healthcare domains such as primary care, secondary care, pharmacy, laboratory and research (Mettler & Raptis, 2012). In secondary care, for example, the Emergency Department Information System (EDIS) can contain in part or in full HIT applications such as EMR (Abraham et al., 2009; Batley et al., 2011), CPOE (Banet et al., 2006), PACS (Hripcsak, Sengupta, & Wilcox, 2007) and patient tracking (Aronsky, Jones, Lanaghan, & Slovis, 2008; Hertzum & Simonsen, 2014).

Each HIT application serves certain functionalities. EMR and EHR allow healthcare providers accessibility to patient data. EMR is an electronic repository of patient data from one practice, for example in an ambulatory setting (Siika et al., 2005), in-patient settings (Abraham et al., 2009; Feufel

et al., 2011; Lin, Harris, & Zalis, 2010) and out-patient settings (Bates, Ebell, Gotlieb, Zapp, & Mullins, 2003; Gadd & Penrod, 2001). In contrast, EHR can be accessed by multiple healthcare providers (Häyrinen, Saranto, & Nykänen, 2008). PACS and RIS manage, store and distribute digital images (e.g. CT, MRI, x-ray and ultrasound scans) and reports (Faggioni et al., 2011). CPOE systems are used for medical orders such as medications, laboratory and radiology orders (Aarts, Ash, & Berg, 2007). Finally, CDSS is a system designed to aid clinical decision making, for example, by issuing flags or triggers during clinical diagnoses and medication ordering, and is usually integrated with a CPOE system (Berlin, Sorani, & Sim, 2006; Bright et al., 2012). An information system used at specific settings can comprise some of these HIT applications. For example, an EDIS can have an EMR system and a CPOE system (Rothenhaus, Kamens, James, & Coonan, 2007). HIT applications such as PACS and RIS are commonly found in radiology departments (Modrák & Modrák, 2013).

The benefits of HIT have been well documented in a number of review and clinical studies. A systematic review of 257 studies on the impact of HIT such as EHR, CPOE and CDSS on quality, efficiency and costs of medical care concludes that HIT has benefits in improving efficiency and quality of care delivery, for example in increased adherence to clinical guidelines (Chaudhry et al., 2006). An update to the review, in Buntin, Burke, Hoaglin, and Blumenthal (2011), also demonstrated a similar outcome, namely benefits relating to the quality and efficiency of healthcare delivery. Moreover, the combination of CPOE for medication administration process and CDSS for decision making process was found to reduce medication errors, adverse drug reactions and medication turnaround time (Cordero, Kuehn, Kumar, & Mekhjian, 2004; Georgiou et al., 2013; Kaushal, Shojania, & Bates, 2003). Other benefits of CPOE include legibility of orders and remote accessibility (Niazkhani, Pirnejad, Berg, & Aarts, 2009) as well as shorter time to complete and clarify medical orders (Banet et al., 2006).

Benefits in relation to the usage of EMR have also been documented. The systematic review by Hillestad et al. (2005) on potential benefits of EMR on health, savings and costs, concludes that an effective implementation of an EMR improves efficiency and safety in healthcare delivery by enabling savings in the prevention and management of chronic diseases. The study also estimated that with a 90% adoption rate, HIT is able to provide cost savings in areas such as reduced hospital length-of-stay and nursing administrative time. In addition, doctors and nurses of an ED positively perceived entering, accessing and reading data from an EMR as it helped them to complete their work faster compared to a paper and pen system (Likourezos et al., 2004). Furthermore, an EMR system that is integrated with a hospital-wide information system can efficiently coordinate care between the ED and hospital (Reddy et al., 2009).

The quality of data and centralised storage capability of a HIT also enables efficiency and safety in healthcare delivery. For example, using PACS enables better diagnostics through the availability of superior quality of x-ray/scan images (Modrák & Modrák, 2013). This in turn contributes to improved patient safety and reduced operating costs as radiation doses on patients can be reduced. Additionally, a centralised repository for all imaging data allows data to be available in any physical location (Faggioni et al., 2011). Meanwhile, distributed accessibility on centralised data storage through the usage of an electronic whiteboard allows more time to be spent on patient-provider interactions (Hertzum & Simonsen, 2013).

However, despite these documented benefits, HIT adoption has remained low. In England, for example, implementation of a EHR in secondary care is slower than what was being envisioned (Robertson et al., 2010). Similarly, the acquisition of ICT in Massachusetts US EDs is also limited (Pallin, Sullivan, Auerbach, & Camargo, 2010). These slow uptakes have been contributed to issues such as complexities and unintended consequences associated with its integration into healthcare workflows.

## **2.4 HIT integration into healthcare workflows**

### **2.4.1 Unintended consequences of HIT implementation**

Integration of HIT into healthcare workflows is complex and can contribute to unfavourable workflow effects. To date, numerous studies on HIT implementations in in-patient settings and out-patient settings have reported unfavourable workflow effects. This includes complexity in using the systems and unintended consequences arising from its usage.

Increased documentation time is one of the most common unfavourable workflow effects. Park, Lee and Chen (2012) found that implementation of an electronic documentation system as a part of an EMR at an ED had significantly altered the documentation practice of its doctors primarily by increasing documentation time and responsibility for the resident doctors. As a result of these changes, patient-doctor interaction and doctor-nurse work collaboration were negatively affected. Similarly, Banet et al. (2006) reported that an electronic documentation of a CPOE system at an ED had caused the nursing staff to spend more time using the computers for both documentation tasks and laboratory and medication ordering tasks. Gadd and Penrod (2001) found that after 6-months post-implementation of an EMR at six out-patient settings, the doctors' overall optimism of the EMR decreased due to the time required for documentation purposes.

Redundancy or duplication of work is another possible side-effect. In a study of an EMR at an ED, the clinicians found themselves having to enter the same information in two separate electronic forms and to transition between paper-based artefacts and the EMR, in order to coordinate their work activities (Abraham et al., 2009). Having to transfer information from paper-based records into an EHR is also another example of redundancy of work (Saleem et al., 2011). However, redundancies may be considered positive if they are part of a failsafe method, for example to ensure that there is no missing data (Saleem et al., 2011). Other workflow-related issues in the usage of healthcare technological systems include: the need to unnecessarily manoeuvre different screens, templates and forms as well as the need to manage systems alerts or pop ups (Saleem, 2009); the need to have typing ability (Zandieh, 2008; Saleem, 2009); and the need to enter data during interaction with patients (Linder, 2006).

Studies on CPOE implementation have mainly highlighted the introduction of workflow blocks and workarounds. Workflow blocks are mainly designed to ensure patient safety, although its purpose can be undermined by users performing a workaround. A workaround is an “informal temporary practices for handling exceptions to normal work flow” (Kobayashi, Fussell, Xiao, & Seagull, 2005, p. 1561). In other words, workarounds can be performed to circumvent system workflow blocks. For example in Patterson, Rogers, Chapman, and Render (2006), a workflow block is implemented in a CPOE system to avoid adverse reactions of a drug combination on patient conditions and to avoid allergic reactions on patients. However, the CPOE users were found to perform a workaround to avoid the block. Similarly, a multi-method study on an implementation of a CPOE system in five nursing homes found that medical workarounds were constantly being performed during a medication ordering process (Vogelsmeier, Halbesleben, & Scott-Cawiezell, 2008). The workarounds which are performed to override the intentional blocks imposed by the CPOE system for an inappropriate dosing, can affect patient safety. However, despite a potential hazard for patient safety, workarounds are common practice when using a CPOE system (Koppel et al., 2008). A CPOE implementation also revealed other type of unintended consequence. A study conducted on a CPOE implementation at five healthcare organisations which the authors described as organisations that had successfully used commercially or locally developed CPOE had caused “changes in the power structure of the organization” (Ash, Sittig, Campbell, Guappone, & Dykstra, 2006, p. 11). The redistribution of power occurred between the non-clinical staff (e.g. quality assurance staff) and clinical staff (e.g. doctors) where the former group felt that they had gained power

as the CPOE succeed while the latter group perceived that they were losing power and autonomy over its usage.

In addition to medical workarounds resulting from CPOE implementations, the implementation of HIT applications such as EMR and EHR reported a different type of workaround, i.e. paper workarounds. Unlike medical workarounds that could affect patient safety, paper workarounds can cause inefficiency in the care delivery as it can result in unnecessary pauses and delays. A study found that although at times papers were used to assist clinicians to do their work, in other cases paper-based alternatives were also used to circumvent, i.e. to work around, an intended EHR design (Saleem et al., 2009). This is due to the fact that the EHR “was not sufficiently designed and does not efficiently support clinicians’ work and/or is not aligned with clinicians’ natural workflow” (Saleem et al., 2009, p. 624). This finding corresponds to other studies on EMR and EHR implementations which found that a paper workaround was employed to ensure task completion, to save time to complete tasks and to perform tasks without the need to ask for help from other staff (Tucker, 2009), as well as a memory aid as a result of increased documentation time (Park et al., 2012). Paper-persistence can also be a result of an implementation of other HIT applications such as a patient tracking system (Vezyridis, Timmons, & Wharrad, 2011).

HIT has also impacted collaboration practices among healthcare providers. Saleem et al. (2011) found that a computerised consult management system, an application package that is part of an EHR that handles referral requests between primary care and specialty care, resulted in a communication gap among the clinicians. Another study conducted at two EDs, each with different degrees of reliance on an EMR system found that the ED that depended heavily on the EMR suffered negatively on the coordination of parallel works and continuity of work among members of the team (Feufel et al., 2011). An implementation of a CPOE system at community and academic hospitals reduced the collaboration among the attending and resident doctors (Aarts et al., 2007). This is because clinical orders can only be entered by the attending doctors as opposed to in the previous practice prior to the CPOE implementation, where the attending and resident doctors normally collaborate together.

Perhaps a more serious consequence reported is the introduction of errors. In Ash, Berg, and Coiera (2004), a Patient Care Information System (PCIS) which consisted of a CPOE system, a medical records system and a patient information system “seemed to foster errors rather than reduce their likelihood” (p. 105). The study indicated the possibilities of occurrences of two types of errors: errors during the entering and retrieving of information, and errors during

the communication and coordination of healthcare activities. According to the authors, the reason for this is that the interface design of the PCIS was not able to support the interruptive nature of the healthcare processes and tasks, coupled with the need to adhere to a very structured information entry and retrieval. This appears to be in agreement with Berg (2003), who argues that information that is highly structured prevents clinicians from communicating in their own 'language' by producing information that is highly context-dependent.

These studies have shown that HIT that does not support its inherent workflow can result in work processes that require workarounds, contain unnecessary pauses and delays, and are time consuming as well as contain gaps and errors. Otherwise, HIT is able to eliminate redundant information that is often introduced during care delivery (Hughes, 2008) and accessibility to a more organised and structured information (Abraham et al., 2009).

#### 2.4.2 Workflow – an introduction

To avoid the complexities and unintended consequences resulting from HIT implementations (e.g. in Section 2.4.1), constructive workflow analysis is crucial in order to inform an effective design and implementation of HIT (Abraham & Reddy, 2010). As points out by Leu et al. (2007), "Understanding the full clinical context for health IT to the level of task, resources, and workflow is a necessary prerequisite for successful adoption of health IT ..." (p. 372).

As there is a lack of a precise definition for the term and what constitutes workflow-related research, Unertl et al. (2008) reviewed 127 sources on workflow-related studies conducted between January 1995 and January 2008 in various industries (e.g. healthcare, manufacturing, offices). In their review, they found no standard definition for the term. Instead, a number of terms such as *work processes*, *work practices* and *modelling* are commonly associated with workflow-related studies. From the review, they developed a framework (the Workflow Elements Model) consisting of elements that can be considered in research investigating workflow regardless of field of study or researcher perspectives. The framework elements include: context/spatiality (e.g. physical or virtual workspaces and organisational), aggregation (relationship and interaction among tasks and actors) and temporality (coordination of events across time). More specifically, the framework is composed of "the people performing actions (the actors), the physical and virtual tools the actors are using (artefacts), specific details of the actions being performed (the actions),

characteristics that describe the actions (characteristics) and the end products of the actions (the outcomes)” (Unertl et al., 2008, p. 6). They further proposed that these elements not be treated in a strict way and that they depend on individual research projects. This stance seemed to be demonstrated in workflow-related research.

As demonstrated in Section 2.4.3 and Section 2.4.4, some studies, in order to gain an understanding of a workflow, investigate the impact of technological implementations and/or non-computerised information artefacts on the workflow. For instance, Banet et al. (2006) investigated the impact of a nursing documentation system (i.e. an artefact) on medication, laboratory and radiology orders (i.e. processes) of an EDs nursing staff (i.e. actors). In another study, Feufel et al. (2011) made a comparison of a hybrid-based system (electronic and paper systems) and an electronic-system, both of which are artefacts which support clinical workflow of doctors and nurses (i.e. actors). It is also important to note that not all workflow-related studies explicitly state or identify in diagrammatic format the specific processes that formed the workflow but rather describe the workflow in generic description such as nursing workflow or clinical workflow. The scope within the workflow can also vary. While others concentrate on specific processes within a workflow for example documentation process (Park et al., 2012) or patient transfer (Abraham & Reddy, 2010), there are also some studies that focusing on a more general aspect of workflow such as coordination practices (Cabitza et al., 2009; Feufel et al., 2011).

#### 2.4.3 Workflow-related research outside healthcare

The concept of studying workflow and the interaction between workflow and technology has longstanding roots in industries outside of healthcare. Heath and Luff (1992) conducted a study of collaborative work and task coordination of people working in line control rooms at the London Underground. The work was conducted based on a theory that failure to understand organisational collaborative work can result in failure of technological implementation despite advances being made in the technical field. Similarly, such study was also conducted in a business industry such as in an airline operation room (Berndtsson & Normark, 1999; Goodwin & Goodwin, 1996) and in a trading room (Heath, Jirotko, Luff, & Hindmarsh, 1993). In addition to the business sector, other industries such as manufacturing (Bowers, Button, & Sharrock, 1994; D’Souza & Greenstein, 2003) and banking (Hughes et al., 1999) also benefited from workflow-related research. The general aim of these studies was to provide constructive analysis of the work processes and practices (e.g. collaborative work, staff



interaction with various non-technological tools and technology) at the study settings in order to provide recommendation for system design.

Workflow-related research is still on-going, manifesting itself in the implementation of various types of technology including mobile and interactive technologies. For example, in the manufacturing industry, Mark and Su (2010) conducted an analysis on work processes of mobile workers of a large manufacturing organisation. The analysis focused on how the workers assembled their mobile offices, how they sought resources and how they synchronised their work across different time zones using technologies such as emails and mobile phones. This study utilised the CSCW field in putting forward design implications of ubiquitous systems in supporting collaborative nomadic work (CSCW is discussed further in Section 2.6.2). Other workflow-related research include analysing work processes in the news industry (Raviola & Norbäck, 2013), the business sector (Selvaraj & Fields, 2010), software development (Blincoe, Valetto, & Damian, 2015), architectural work (Vyas, van der Veer, & Nijholt, 2013) and the insurance sector (Vaast & Walsham, 2005).

In regards to methodological approach, most qualitative studies employed a data triangulation technique where multiple data sources are used. For example, Vyas et al. (2013), in addition to performing observation, also interviewed 15 research participants and analysed video-recorded collaborative design sessions. The aim of the study was to analyse the work practice of architectural and industrial designers in order to propose a system design for ubiquitous computing in design studios. For the interviews, the participants included students and lecturers, the head of a design company, and junior and senior designers. The participants were asked questions regarding their on-going design projects and to give accounts of their everyday design activities. This included asking the participants how they performed brainstorming activities, methods that they used to come up with design concepts and the tools that they used during design activities. In addition, the researchers also attended several week-long design courses. The study also involved analysing video recordings of four design project sessions and several discussion sessions. Analysing video recordings gives the study the advantage of capturing work related practices and activities that observation alone could have missed. The interviews, observation field notes and video recordings were analysed and an affinity diagram was created to explore emerging patterns in the data where three themes were then developed. Observations coupled with interviews allow systematic analysis of work activities supported by various non-technological tools and technologies (Heath & Luff, 1992).

Similar qualitative techniques were also used in the study by Mark and Su (2010) to understand the role of ubiquitous infrastructure for nomadic workers of a manufacturing company. Twenty-two semi-structured interviews and a week-long shadowing was conducted. Some of the interviews were telephone interviews. Telephone interviews were conducted in order to capture the nomadic workers' activities while they were at home, in hotels and different worksites. The interviews also included capturing information on projects they were working on, sources of stress, amount of travel, technology used, and methods of being reached and reaching others. The week-long shadowing was conducted at one of the work sites to gain a detailed understanding of the problems faced when the participants were working at a non-routine location. During the shadowing process, the participants' activities were identified and time-stamped. In addition, the artefacts used, interaction activities performed, locations the participants visited and problems encountered were also documented. Each shadowed participant was typically observed for four hours. The researchers believed that a triangulation of both interviews and observations allowed them to derive a rich narrative of the work of the nomadic workers. The study, however, suffers from a severe limitation. The shadowing technique was only done for seven days for a number of participants working at only one location. As this study aimed to study work activities of workers who were constantly on the move across multiple geographically areas with different time zones, shadowing performed at only a single location might not be able to generate a rich understanding of nomadic work. However, the telephone interviews conducted while these participants were on the move might be able to supplement the 'missing' data.

In investigating social interaction among university staff members in their daily non-work activities, in addition to conducting interviews, Vyas et al. (2015) also employed observation techniques where they used videos and cameras to capture the participants' activities. The observations were conducted at various locations such as the staff room, printing room and the cafeteria. The study has the advantage of using technologies such as cameras and videos where all data was recorded and potentially not be missed. Thus, the interpretation of the data can be conducted accurately and in more detail. However, using such technologies during observation can also have its own setbacks. Videos can cause participants to feel that the activity is intrusive (Fitzpatrick & Boulton, 1994) and this may change their behaviour (Holloway & Wheeler, 2010). Photographs can be subjected to 'airbrushing' techniques where a photographic print can be removed and only snap-shots of times can be captured (i.e. photographs freeze the situation in time) (Bauer & Gaskell, 2000). The use of field notes in recording observation, on the other hand, can be subjected to

observer's bias (Fitzpatrick & Boulton, 1994). A study by Vyas et al. (2015) also employed a method called an 'organisational probe', consisting of participatory tools such as disposable cameras, sets of coloured pencils, postcards, maps, markers and magazines. These tools were used by the participants to create a personalised workbook and a logbook of their activities. This method aimed to realistically capture the participants' social and playful practices and to engage them in the design process.

The workflow-related studies discussed here mainly used a data triangulation technique in the context of the participants, i.e. participants were interviewed and observed. Additionally, investigator triangulation was also adopted, for example in Vyas et al. (2015), where more than one researcher is involved in the same study (Denzin, 1970).

#### 2.4.4 Workflow-related research in healthcare

Within a healthcare domain, workflow-related research can be found across various in-patient settings (e.g. ED, ICU, OR, hospital wards) and out-patient settings (e.g. speciality clinics and general practices). Depending on the aim of the research, some studies, although conducted at specific settings, have the aim of developing HIT-related information system models or theories non-specific to the studied setting. For example, Kuziemyky and Varpio (2011) conducted a qualitative exploratory study at a nine-bed hospice in order to gain an in-depth understanding of the healthcare professional collaborative processes and practices at the hospice. This involves understanding on why and how they collaborate, who they collaborate with and methods used in the collaborative practice. The study then proposed a generic model that can be used in the design of any HIT applications for collaborative care regardless of healthcare settings. Similarly, Bardram and Bossen (2005b) also proposed a generic model that can be used as a guideline to design non-specific HIT applications that can support healthcare workers who are on the move. Cabitza, Simone, and Sarini (2009), on the other hand, proposed a more specific model for an HIT application, an EPR, which can be used at any types of healthcare setting, i.e. in-patient and out-patient settings. Their proposed design is based on the study of the usage of coordinating mechanisms afforded by a set of paper-based records at two in-patient settings: Internal Medicine and Neonatal ICU (NICU) in supporting clinical workflow at the settings.

However, some researchers argue that one-size-fits-all solutions for different healthcare settings can result in healthcare professionals having to adapt to a new way of working or to

face unintended consequences or complexities in using the technology (Abraham et al., 2009; Eason, 2010). This is because healthcare settings have its own individual workflows where patient care processes and practices are mainly characterised by patient flow, condition and type of care required. For example, in EDs patient flow and patient condition are unpredictable. Patients can come at any time with varying levels of injuries and illnesses and the ED clinicians need to make diagnoses or to stabilise patients with vague symptoms in a very restricted time period (Amouh et al., 2005; Reddy & Jansen, 2008). This means that patient care process at an ED can span only in hours as patients need to be quickly diagnosed and treated. In contrast, in an ICU, patient condition is fairly predictable. ICU patients are already diagnosed but need to be stabilised, and they are treated until their condition is no longer critical which can be in matters of days or weeks (Reddy & Jansen, 2008). However, flow of patients to the ICU is unpredictable in comparison to patients visiting out-patient clinics at a hospital. For example, oncology patients go to oncology clinics with appointments, before, during and after treatment, based on referral from general practitioners or specialists (Schmidt, Wagner, & Tolar, 2007). In this case, diagnosis has already been made. Although similar to ICU patients in the sense that patients already have their diagnosis, their visits to out-patient clinics are already scheduled, hence very predictable.

Whether the aim of the research is to produce a one-size-fits-all solution or otherwise, workflow-related research is multifaceted. There are various approaches (i.e. quantitative, qualitative and mixed-method methodology) and scope within the workflow that can be studied. In Campbell, Li, Mori, and Osterweil (2008), a quantitative work-sampling method was used to identify task performed by clinical team members, i.e. nurses, medical residents and medical faculty at a labour and delivery unit (i.e. a labour ward) of a hospital. Although a quantitative study, a work sampling method can be used only to identify the tasks or activities performed and does not however, record the amount of time spent on those activities (Fontaine, Speedie, Abelson, & Wold, 2000). In the study, the work sampling method was used to identify the tasks the clinicians performed at pre-determined and discrete time intervals in order to make inferences regarding the overall time the clinicians spent performing the tasks, in a given time period. In terms of the scope of the workflow, the study was conducted at pre- and post-implementation stages of an EHR to study its impact on clinical work of the clinical staff.

Quantitative workflow-related studies can also be done to measure the amount of time spent on specific tasks but instead of using a work sampling technique, a time-motion observation technique is used. In Carol et al. (2008), the method was used to both identify and

quantify the amount of time the nursing staff spent on processes related to medication administration. The processes include obtaining and verifying orders, documentation and management of orders received from doctors as well as time spent on non-related medication tasks such as time spent communicating with patients and family members. The aim is to inform the design of a new medication system, i.e. a CPOE system to be used for the entire tertiary medical centre. These quantitative studies used structured observation as a data collection method. A structured observation requires a highly structured data collection instrument where for example, details such as activities and actions of the observed participants as well as locations of where the activities are executed are explicitly stated in the instrument and the data statistically analysed (Carol et al., 2008). A highly formatted observation instrument provides the advantage that all observed behaviours be documented as observers know specifically what to observe (Carayon & Wetterneck, 2005; Koppel et al., 2008). It can also limit potential disharmony among multiple observers in a case of when multiple observers are used (Carol et al., 2008).

A questionnaire is another quantitative technique that is similar to structured observation in that it contains closed-ended items. For example, a self-administered questionnaire was used to measure nursing staff's perceptions on the impact of an EDIS on the nursing workflow 12 months post-implementation (Banet et al., 2006). The questionnaire included questions on the amount of time spent documenting patient care; amount of time taken for medication and laboratory test ordering; number of verbal orders and time taken to verify doctors' orders, where following options were used: Much less = -2, Less = -1, About the same = 0, More = 1 or Much more = 2, as responses.

A qualitative approach, on the other hand, is used to provide a more descriptive analysis of the workflow such as communication challenges, gaps, collaboration techniques as well as challenges or issues in regards to technological implementation that support the workflow. For example, in Guite, Lang, McCartan, and Miller (2006), the approach was used to identify problems faced by nursing staff during nursing assessment and referral process when using an online form which is part of an EHR being implemented at an ED. From the analysis, they concluded that the form did not fit into the overall ED admission process and was creating unnecessary and duplicated referrals. The findings were then used to redesign the old online form. As a result, the new form is well integrated into the workflows of the ED nurses and related departments where unnecessary and duplicate referrals were eliminated. Horsky, Gutnik, and Patel (2006) also conducted a study on a nursing workflow at an ED, but without focusing on any existing information system. In the study, they characterised the nursing task

into four main categories: pre-triage; triage; ED transfer; and registration. They used smaller sub-tasks for each of the main task categories and created a recommendation for each of the problematic sub-tasks. For example, in the triage category the tracking of patient sub-tasks caused duplication of work which resulted in inaccurate updates. They suggested an integrated tracking system with an automatic update via Radio Frequency Identification (RFID). For an ED transfer category, one of the tasks was to find available beds for patients. When there were no beds available, the main ED area became overcrowded. To solve this problem, they suggested electronic tracking that signals bed availability. Overall, they suggested RFID technology for automating updates in real time. They also recommended system integration that can do automatic updates to save time in entering known data, and instant messaging on workstations for the division of work. The qualitative approach was also adopted in providing interpretation to coordination challenges during documentation processes (Park et al., 2012), inter-departmental patient transfer (Abraham & Reddy, 2010), OR management (Plasters, Seagull, & Xiao, 2003) and emergency medical services (Reddy et al., 2009). Coordination is also studied on aspects of temporality or time (Bardram, 2000; Reddy, Dourish, & Pratt, 2006), spatiality or space (Scupelli, Xiao, Fussell, Kiesler, & Gross, 2010), workaround (Kobayashi et al., 2005) and communication (Benham-Hutchins & Effken, 2010; Wong et al., 2009). These studies collectively provide an understanding of coordination practices, such as what are the clinical processes and how these processes are coordinated among staff across physical space and time afforded by computerised and/or non-computerised information artefacts, as well as on issues related to communication and workaround during coordination activities.

Workflow-related research is also multi-faceted in the sense that workflow can be investigated in relation to a single information artefact or multiple information artefacts in supporting their workflows. These artefacts can be in the form of pre- and post-implementation of computerised systems (Bisantz et al., 2010; Carol et al., 2008; Park et al., 2012; Vishwanath, Singh, & Winkelstein, 2010), comparative studies between a computerised system implementation and a hybrid system implementation at separate settings (Feufel et al., 2011) or computerised systems (Reddy, Shabot, & Bradner, 2008). Workflow-related studies based on the usage of non-computerised information artefacts are also fairly common as it is theorised that an understanding on implicit functionalities afforded by these non-computerised information artefacts are pre-cursors to successful design of their electronic counterparts, hence successful integration into clinical workflows. These non-computerised information artefacts include paper-based forms and medical records (Bansler et al., 2016; Bringay et al., 2006; Cabitza et al., 2009; Xiao, 2005) and dry-erase whiteboards (Bisantz et al.,

2010; Bjørn & Hertzum, 2011). There are also studies conducted on issues or challenges in the workflow without focusing on any information artefacts (Abraham & Reddy, 2010; Campbell et al., 2008; Kuziemsky & Varpio, 2011). Regardless of whether or not the studies are designed to incorporate the existing implementation of the information infrastructure in the interpretation of the findings, the main aim is to gain an in-depth understanding of the workflows in order to design or to improve existing HIT design that can seamlessly be integrated into healthcare workflows.

Workflow-related research at in-patient settings can also be carried out at various levels of healthcare work. This includes overall clinical workflow (Bjørn & Hertzum, 2011; Campbell et al., 2008; Kuziemsky & Varpio, 2011) or specific part of an overall clinical workflow such as the medication administration process (Carol et al., 2008), referral process (Guite et al., 2006) and triage process (Bjørn & Rødje, 2008; Castner, 2011). Studies can also be conducted on integrated processes that span multiple settings (Abraham & Reddy, 2010; Reddy et al., 2009). In addition to in-patient settings, researchers have also examined workflow in out-patient settings. Similar to in-patient settings, such studies can also be carried out on specific processes within the overall workflow such as diagnostic testing processes (Hallock, Alper, & Karsh, 2008), chronic disease management (Unertl, Weinger, Johnson, & Lorenzi, 2009) and prescribing practices (Johnson & FitzHenry, 2006).

In regards to methodological approach, these qualitative fieldwork studies also employed similar sociological inquiry methods used in workflow-related research in industries outside healthcare (discussed in Section 2.4.3). However, observation conducted via video recording employed by studies such as Heath and Luff (1992); Vyas, Dix and van der Veer (2015) and Vyas et al. (2013) cannot be found. Most common methods employed are non-participant observations (recorded in field notes as opposed to using video recording) and interviews. Observation is conducted via a shadowing technique or a general observation without focusing on specific individuals. In Kuziemsky and Varpio (2011), for example, non-participant observation and semi-structured interview techniques were employed to gain an in-depth understanding of inter-professional collaboration during patient care activities at a hospice. Both techniques were used to identify clinician and non-clinician processes and tasks during team activities such as team rounds, patient admissions and discharges.

Similarly, Park et al. (2012) employed a combination of non-participant general observation, shadowing and semi-structured interviews to identify system's users, and conflicts or breakdowns in a clinical documentation workflow. During non-participant

observation, the clinical documentation process was observed at various locations in the ED such as at patient waiting rooms, front desks, triage, nursing stations and a charting room. Two researchers (i.e. investigator triangulation) stayed in the same locations to observe ED activities and how different information artefacts, such as paper charts, and the electronic system, were used to support the clinicians' documentation process. Twenty-one clinicians were also shadowed to gain an understanding of their behaviour changes during the EMR deployment period. Semi-structured interviews, on the other hand, were centred on the doctors' understanding of their work practices, their opinions regarding the EMR and their perception on the effects of the EMR on their work practices. Semi-structured interviewing was also adopted in Abraham et al. (2009) to identify peripheral activities surrounding the usage of an EMR. Peripheral activities are secondary activities resulting from the use of the EMR which needed to be performed by the clinicians. The semi-structured interview questions were focused on two main themes: EMR usage behaviour and the challenges the clinicians faced with the current workflow.

Feufel et al., 2011 also adopted a qualitative approach, shadowing and opportunistic interview, in order to compare and contrast clinicians' work practices at two EDs. The shadowing was performed by different investigators: one investigator at each ED. During shadowing, the researchers took handwritten notes and asked clarifying questions (opportunistic interviewing) when appropriate. In opportunistic interviewing, questions asked were related to observations for the purpose of clarification and verification. Data analysis started with identification of instances (e.g. how and when during the workflow patient records are used) in relation to patient record technologies and work practice coordination. These instances were identified in order to compare and contrast the clinicians' work practice based on the usage of two different types of patient records, a fully electronic patient record system and a hybrid system, in supporting the clinical workflow. Adopting investigator triangulation can potentially decrease potential bias in gathering, reporting, coding or analysing (Thurmond, 2001). This is because having more than one investigator can potentially keep them honest, hence improve credibility (Lincoln & Guba, 1994). In this study, however, it can potentially lead to inconsistencies in the collected data as different observers were allocated at separate settings. As a result each observer provided their own interpretation of what was observed. However, they claimed that this technique of triangulation did not limit the ability to identify common patterns across the investigators' data in order to compare and contrast the differences of the implementation. Other studies that had adopted investigator



triangulation however, allocated multiple observers at a single setting as opposed to allocating different observers in different settings (Abraham et al., 2009; Park et al., 2012).

In addition to these common techniques (unstructured observation and semi-structured/opportunistic interview), the usage of prototyping techniques has also been documented. For example, in order to design digital whiteboards with de-identified patient information to support care coordination of nursing staff at a surgical ward, Gjære and Lillebo (2014) developed a prototype model of a digital whiteboard where 15 surgical ward nurses demonstrated how the prototype can be used using role-played scenarios. Simulation is also another technique that can be incorporated. Borycki, Mn, Kushniruk, Kuwata, and Kannry (2006) claim that a simulation technique allows both clinicians and developers to determine the impact of HIT implementation on clinical workflow prior to actual systems being deployed. Qualitative techniques can also include attending expert-users meetings and management meetings (Bossen et al., 2012; Koppel et al., 2008). Other techniques include documentary sources such as minutes of meeting (Koppel et al., 2008; Vogelsmeier et al., 2008), computer logs (Harrison, Koppel, & Bar-Lev, 2007), paper-based patient records (Cabitza et al., 2009), and information artefacts such as dry-erase whiteboards (Bjørn & Hertzum, 2011). In these qualitative studies one common aspect can be inferred. Instruments used for observation and interviewing are not entirely unstructured or open-ended, but were structured towards the objectives of the individual research.

In addition to sociological inquiry methodology where the context of implementation plays a significant part in understanding the workflow, workflow-related research can also be conducted using a more 'traditional' software engineering methodology. In Ajmi et al. (2015) for instance, a structured observational tool was used to document patient journeys of an ED. An acceptance testing on the developed models was then conducted with one of the staff. Similarly, Salimifard, Hosseini, and Moradi (2013) employed a software modelling and simulation tool in order to develop a generic model of emergency care workflow. In the study, an initial model was developed from a literature study. Further, information required for simulation was then collected from sampling the ED processes while interviewing technique was used to verify the simulation results. These studies, which oriented toward software engineering methodologies, mainly aim to create an idealised model of healthcare workflow for use in computer simulation, as opposed to studies that adopted sociological inquiry methodology that aim to capture the situated nature of healthcare workflows.

Healthcare workflow-related studies can inform various aspects of the workflows such as efficiency of healthcare processes and activities, identification of healthcare processes and activities and healthcare professionals working practices, as well as challenges they are facing as they deliver healthcare work. Understanding of such issues may avoid complexities and unintended consequences (as discussed in Section 2.4.1) resulting from technological design and implementation. HIT that attempts to change how work is done, or in conflict with existing ways in which work is done can result in failure. To increase adoption, HIT must support their inherent workflows. As claimed by Ash and Bates (2005), “when clinicians have access to larger amounts of information with which to make decisions, and when the system fits their workflow, they tend to use it” (p. 9).

## **2.5 Emergency Department Information System (EDIS)**

Having reviewed the literature on the integration of HIT into healthcare workflows, this section focuses on research examining information systems in Emergency Departments, the setting for the study described in this thesis.

### **2.5.1. Characteristics and information behaviour in emergency care setting**

An ED is a dynamic clinical setting characterised as being unpredictable in terms of patient flow and patient condition. The unpredictability of patient flow caused by non-urgent visits, frequent-flyer patients and ambulance diversions can lead to ED overcrowding (Hoot & Aronsky, 2008). ED overcrowding is also caused by patients who cannot be transferred to in-patient hospital beds (Clancy, 2007) and delays in speciality referral (Baig, Mian, Najeeb, & Shahzad, 2015). Overcrowding can have serious consequences on the efficiency and safety of emergency care. For example, it can lead to adverse clinical outcomes (Bernstein et al., 2009), delays in patients receiving medications, such as antibiotics and analgesics (Hoot & Aronsky, 2008) and longer patient waiting times for receiving treatments (Pines et al., 2007; Pines & Hollander, 2008). Patient mortality has also been reported as a result of overcrowding (Richardson, 2006; Sprivulis et al., 2006).

Therefore, in emergency care it is crucial that information be obtained in a timely manner. Different types of information serve different purposes. For example, information on patient medical history and their plan of care is to decide or review treatments given to

patients (Haleh Ayatollahi, Bath, & Goodacre, 2013), while organisational information is needed to coordinate care within ED organisational framework (Reddy & Spence, 2006). Furthermore, the availability of information, such as discharge summaries, improves the overall patient care process and previous investigation results reduces the requests for more tests (Rogg, Rubin, Hansen, & Liu, 2013; Stair, 1998). This information can come from a variety of sources. Information sources range from paper-based forms and records, non-electronic information artefacts and computerised information systems (Haleh Ayatollahi et al., 2013), as well as from direct communication with fellow colleagues (Reddy & Spence, 2008).

However, as a result of synchronous communication with fellow colleagues, interruption is frequently reported in EDs. One study found that ED doctors were interrupted on average every 9 to 14 minutes (Laxmisan et al., 2007). Similarly, Westbrook et al. (2010) reported that doctors were interrupted 6.6 times in an hour. A comparative study on interruption between emergency care doctors and doctors in primary care found that doctors at an emergency setting were interrupted 9.7 times in an hour compared to only 3.9 times an hour for primary care doctors (Chisholm, Dornfeld, Nelson, & Cordell, 2001). A study conducted in an ED in the UK found that the rate of interruptions was the highest when a consultant was teaching, followed by when he was writing clinical notes (Allard, Wyatt, Bleakley, & Graham, 2012). Interestingly, in this study, interruptions also happened during coffee and lunch breaks. However, such interruptions at times can be necessary to deliver safe patient care. For example, Ayatollahi et al. (2013) found that although information such as blood test results can be obtained from a computerised system, verbal communication with fellow colleagues was the quickest source of information in life-threatening situations. Furthermore, the complexity of information needs and lack of domain expertise can also be causes of collaborative information seeking practice in EDs (Reddy & Spence, 2008). Staff working in a dynamic work situation “must seek, collect, integrate, analyse and disseminate information from multiple domains and resources under multiple stringent constraints” (Sonnenwald & Pierce, 2000, p. 462).

#### 2.5.2. HIT in emergency care

HIT has a prominent role in supporting efficient and safe emergency care delivery. Significant ICT investment has been made by a number of countries at a national level to achieve efficient and safe healthcare delivery, including in emergency care. This includes the former National Programme for IT in the UK (Department of Health, 2006) and the

interoperable EHR in Canada (Protti, 2009). Many empirical studies have also demonstrated significant benefits from computerisation in EDs. For example, an electronic tracking board can efficiently reduce patient length of stay by making patient data more organised and accessible (Boger, 2003). An electronic whiteboard system that displays patient information in real time and integrates with other systems, such as CPOE and EPR, serves as a pivotal information centre for all staff, therefore improving overall ED operational efficiency (Aronsky, Jones, Lanaghan, et al., 2008). Rapid accessibility and real-time display of patient information, integration with other systems as well distributed and automated broadcasting of electronic whiteboards have seen rapid replacement of their manual counterparts (Aronsky, Jones, Lanaghan, et al., 2008; Bjørn & Hertzum, 2011; Hertzum, 2011, 2012). Less time is needed to complete laboratory and radiology orders when using a CPOE system (Banet et al., 2006) and reduced risk of errors from implementation of alarms or reminders for late arriving laboratory results (Cai, Kohane, Fleisher, & Greenes, 2002) have also been reported. In contrast, the unavailability of information can have serious consequences for patient safety. Delays in receiving test results can cause failures in medical diagnostics (Ferris et al., 2009) and insufficient patient information can delay in-patient transfer (Abraham & Reddy, 2010).

However, the adoption of HIT, for example in the UK (Sheikh et al., 2011), Canada (Gagnon et al., 2009) and the US (Pallin, Sullivan, Auerbach, et al., 2010), has been slow despite its benefits. This is because the seamless integration of HIT into clinical workflows, including into emergency care workflow, has remained an on-going challenge. A number of studies have highlighted the complexities and unintended consequences arising from technological implementation in EDs. Park et al. (2012), for instance, found that the implementation of an EMR had altered the documentation practice between the attending physicians and resident physicians. They also found an emergence of a paper-based practice as a workaround mechanism and an increase in clinical documentation time. Persisting and added paper-based practices were also recognised as a result of the implementation of a computerised patient tracking system (Vezyridis et al., 2011). A computerised system for emergency care is also weaker in facilitating workload assignment (Feufel et al., 2011). Other reported workflow effects include the introduction of peripheral activities such as transition between multiple artefacts and increased distance travelled between locations, both of which affect the continuity in the care processes (Abraham et al., 2009). More recent studies on HIT implementation in emergency care settings have shown that it had caused changes to doctors' existing practices, such as changes to the sequence of information access and changes to test management work process (Callen et al., 2014), the usage of personal notes as memory aid

(Park, Chen, & Rudkin, 2015) as well as a decrease in patient-clinician interactions (Hertzum & Simonsen, 2014). These workflow effects can result in inefficiency in the care processes as well as adversely affecting patient safety.

An optimally designed HIT may, for instance, provide better accessibility to complete patient information or test results, and so avoid longer waiting times in the ED, hence avoiding overcrowding. Therefore, the critical aspect of transitioning from a paper-based system or a hybrid system to computerised systems is implementing the most appropriate technology for the established workflow without adding unnecessary complexity to an emergency care workflow.

### 2.5.3. Emergency Department (ED) workflow

Many empirical studies conducted in real emergency care settings are designed to gain an in-depth understanding on emergency care delivery. Similar to other workflow-related research discussed in Section 2.4.3 and Section 2.4.4, the scope studied within the emergency care workflow can vary. It can focus on a more general workflow such as nursing workflow, clinical workflow or on specific care processes.

Bjørn and Hertzum's study (2011), for instance, primarily described the tasks of nursing staff, such as triage nurse and charge nurse, which are part of a nursing workflow, in relation to the use of dry-erase whiteboards. The triage nurse is responsible for assessing patient according to level of urgency and segregating them to two main streams (i.e. acute and fast-track). Meanwhile, a charge nurse is responsible for organising most of the work in the ED, such as assigning who is in charge of managing incoming patients, assigning nurses for examinations and treatment of patients, bed management as well as nursing breaks. In general, a charge nurse is mainly responsible for the management side, while nurses are responsible for the clinical aspects of the nursing workflow. Bjørn and Hertzum's study (2011) also identified the multiplicity of the nursing workflow in the management of multiple patients entering the ED, i.e. multiple tasks for individual nurses as well as arrays of treatment for multiple patients, hence adding to the complexity of the nursing workflow. The study also inadvertently highlighted the role of a charge nurse as primarily responsible in the management side of the clinical workflow. This was also briefly mentioned in Feufel et al. (2011). The non-clinical work of a clinical workflow can also include supervision tasks, for example, supervision given by attending doctors to resident doctors (Park et al., 2012).

The clinical workflow of doctors and nurses can also get complicated not just because of multiplicity of patients' medical conditions and clinicians' work processes. Feufel et al. (2011) found that socio-cultural conditions such as "frequent flyers" who occupy bed space or addicts who may not need medical intervention are also factors or elements of an ED workflow that can influence clinicians' practices. The patient's personal background, such as their ability to pay (e.g., their insurance provider), as well as the distance they have travelled to receive emergency care can also be part of the mix. Additionally, clinical workflow also extends across space where doctors and nurses have to carry out their work in multiple areas.

An ED workflow can also be studied from the perspectives of a single process. In Bjørn and Rødje (2008), for instance, the situated nature of an ED triage work process was extensively described. From the study, it can be inferred that the process does not simply involve sorting or prioritising patients according to their acuity level using an organisation determined triage index (i.e. Canadian Triage & Acuity Scale). The process involves many challenges and dealing with complex aspects. These are partially determined by the need to triage various patients with myriad conditions, and 'matching' the patients' presenting conditions against available resources. The usage of myriad tangible information artefacts also contributed to the complexity of the process. The process is, at times, prone to interruption, in that triage needs to be temporarily halted in order for the triage nurse to attend to other urgent matters. The triage work is also not as straightforward and can be influenced by the current status and busyness of the ED. This can mean that exceptions often need to be made. One interesting exception that was described in the study was when an acute patient was triaged to a lower category of the triage scale. Although the patient's condition was serious which required fast medical intervention, he was assigned to a lower category triage scale. This was because there were more patients waiting to receive treatment in the higher priority group, but in order to 'speed up' his treatment he was assigned to a lower triage scale. This demonstrates that a triage process is not a static process. Embedded within the triage workflow are probably unregulated practices of the clinicians. Another study documented additional time for a triage process, (i.e. more than the published estimation) nursing staff are required to complete a triage process (Castner, 2011), signifying the complexity of the process.

In their study, Abraham and Reddy (2010) found that an ideal patient transfer workflow of ED patients to in-patient hospital beds may not be achieved at all times. Such unpredictability can be caused by the existence of hierarchical power structure within an overall hospital workflow, as well as conflicting workflows between an ED and in-patient hospital units. The ineffectiveness of information technologies was also found to hamper the

patient transfer process. These problems more often caused ED patients to overstay resulting in additional ED resources. Workflow practices can also be influenced by the clinicians' organisational skills and medical knowledge (Kessler, Kutka, & Badillo, 2012).

These studies have collectively shown the 'messiness' and fluidity of emergency care clinical workflow. A process at times could not simply 'branch' to another pre-determined process. Additionally, a number of challenges can develop within the processes which require reinterpretation from the clinicians of their work. The multiplicity of work tasks and the frequency of exceptions also seem to be common themes. Some of these studies have also inadvertently indicated roles of clinical staff in executing non-clinical activities. However, there is often a lack of clarity regarding the situated nature of non-clinical processes and practices, such as where within an overall workflow such processes fit or what are the practices associated with these processes. Others have also suggested that studies focussing on non-clinical work of non-clinical staff (e.g. medical secretaries, assistants and porters) in EDs and other healthcare settings are relatively rare (Bossen, Jensen, & Udsen, 2014; Bossen et al., 2012; Spence & Reddy, 2007). Studies that do include the role of non-clinical staff have been limited to a specific care process instead of an overall ED workflow, or solely on the non-clinical work of a specific group, i.e. medical secretaries. For example, in Bjørn and Rødje's (2008) study, the work of registration clerks during a triage process was only briefly mentioned (Bjørn & Rødje, 2008). Spence and Reddy (2007) identified the pivotal role of a unit secretary as a gatekeeper in the execution of ED activities. Similarly, Bossen et al. (2012) differentiated the work of medical secretaries at the pre- and post- implementation stages of an EHR. Little attention has been given to details and specificity of non-clinical aspects of an emergency workflow. Three main questions still remain in regards to an overall emergency care workflow:

1. Where do non-clinical processes of non-clinical staff, such as medical secretaries, fit into the overall workflow of emergency care?
2. Are these processes also contributed to the fluidity of the workflow?
3. What other non-clinical processes that clinical staff can be responsible for in addition to supervision of their junior counterpart?

This study aims to fill this gap. Instead of focusing only on specific clinical processes or only on the work of non-clinical staff of an ED workflow, this study intends to look at the overall emergency care workflow and processes involving both clinicians and non-clinicians. This allows for the inter-connectedness of the processes that formed an overall emergency

care workflow to be constructed, as well as developing an understanding of the situated nature of the overall workflow. ED team members are multi-disciplinary members of clinicians and non-clinicians, where they work semi-autonomously, yet inter-dependently, for the completion of the workflow (Murphy & Reddy, 2014; Reddy & Spence, 2008). A useful model is that of Ajmi et al. (2015) who developed a comprehensive model of an ED workflow with major stages, activities and actions of a patient journey; again, the model primarily depicts the clinical processes of a patient trajectory. Moreover, the model only captures a static representation of a patient journey rather than the situated nature of emergency care delivery. The 'messiness' of an emergency care work is not reflected in the model. For example, one of the processes that formed the workflow is simply being described as how patients are examined for their vital signs, whether the results obtained will determine if further care is required. The issues or complexity surrounding the specific process are not identified or discussed. The model only depicts the 'ideal' case scenario, i.e., a test is performed and the result obtained will determine the next path in the patient trajectory. Meanwhile in Salimifard et al. (2013), the process flow model developed is primarily based on an ED patient flow intended for process improvement and remodelling. In process improvement, the aim of the model is to be used for simulation so that the bottlenecks that can have an effect on patient flow can be identified. Hence, the model is not a representation of the situated nature of emergency care workflow. Essentially, both workflow models developed from these two studies (Ajmi et al., 2015; Salimifard et al., 2013) are static representations of an ED workflow. Furthermore, most of the ED workflow-related studies were conducted in US and European EDs, which often have different organisational elements to that in the UK.

In the UK, EDs are managed by hospital Trusts which have their own authority and governance arrangement (GOV.UK, n.d.). Patients are guaranteed access to EDs 24 hours a day, seven days a week, placing a high demand on the service. Furthermore, an ED is also categorised based on the emergency care services delivered. EDs can be categorised as Type 1, Type 2 or Type 3 (Department of Health, 2004a). A Type 1 department is 24-hour consultant-led with full resuscitation facilities. A Type 2 department is also consultant-led but with a single specialty, for example, dental. Type 3 can be a doctor-led or a nurse led department which treats minor injuries and illnesses without prior appointments and can be part of a main ED or at separate location. Like any other EDs worldwide, overcrowding is also an issue in UK EDs (Di Somma et al., 2015). Studies analysing statistical data have shown that emergency attendances in the UK EDs are increasing steadily. There has been an 11% growth in



emergency attendances from 2008-09 to 2013 but, during the same period, there was only a 3.2% growth in the population (Iacobucci, 2013a). More recent figures show an increase of more than 10% in attendances for January 2016 compared to the same month in the previous year (NHS England, 2016). In January 2016, there was also an increase of 4.6% in the total emergency admissions (i.e. hospital admission via Type 1, Type 2 and Type 3 EDs) and an increase of 6.1% of emergency admissions via Type 1 ED, as compared to the same month in 2015 (NHS England, 2016).

In order to ensure the safety and efficiency of emergency care, the DoH introduced a target that 95% of patients must be seen and treated within four hours (UEC Review Team and ECIST, 2013). Prior to the 95% target, which was lowered in 2010, the initial target was set at 98%. Despite the decrease, many Trusts in England are still continually failing to meet the target. Figures published in August 2011 indicated that nearly 70% of Trusts had failed to meet the target (Mooney, 2011). Between January and March 2013 nearly 40% of Trusts were still unable to meet the target, an increase of 50% from the October to December 2012 period (Iacobucci, 2013b). A more recent figure shows that in January 2016, only 88.8% of patients were seen within four hours (NHS England, 2016).

As a result, Trusts began to implement their own solutions to meet the target. For example, an ED in Newcastle upon Tyne Hospitals NHS Trust experienced a delay in obtaining senior opinions for acutely sick children (Department of Health, 2004a). The delay accounted for 10% of all patients waiting for more than four hours. In order to reduce the figure, they ran a collaborative programme in which a paediatric clinical fellow was relocated to the ED department to support the senior house officers between 11 am to 6 pm. Paediatric nurses from other parts of the hospital also worked alongside the ED team. The Trust also established a separate walk-in centre from the main ED for minor injuries patients. This is an example of a 'see and treat' practice, whereby patients with minor injuries or illness are assessed, treated and discharged without the need to refer to other clinicians (unless necessary). Several other Trusts established Clinical Decision Units (CDU), or observation areas, for patients who required a period of observation before making decisions to admit the patients (Department of Health, 2004a). This ensures that patients are placed and managed in the appropriate setting, without the constraints of the four-hour rule. In the context of UK emergency care, another question remains to be answered: do these methods employed by these individual Trusts in order to improve the adherence to the four-hour rule determine the ED workflow or organisation of work processes and practices of its clinicians and non-clinicians?

#### 2.5.4. England National Programme for IT

At the national level, in order to improve efficiency and safety in healthcare delivery including emergency care, the National Programme for IT was introduced in 2002 by the DoH (Department of Health, 2006). The National Programme for IT was the largest single IT investment in the UK. The programme contained a number of HIT implementations and if it had been successful, it could have had a significant and positive impact on the delivery of patient care and substantial financial benefits to all healthcare settings including EDs. The technological systems in the programme include the NHS Care Records Service which was designed to replace local NHS computer systems with integrated systems offering healthcare professionals accessibility to EPR (Department of Health, 2006). The Summary Care Record (SCR) and HealthSpace are also part of the Care Record Service (Greenhalgh, Stramer, et al., 2008). The SCR contains summaries of patient clinical details such as medication and allergies. HealthSpace, on the other hand, is for patients where they are able to access their own records via the internet. These systems can efficiently and safely support healthcare delivery, for example, in reducing the amount of time staff must spend taking patient medical histories.

In the past, the procurement and implementation of IT in NHS organisations were locally managed by the Trusts (Department of Health, 2006). Local procurement and implementation mean that systems were being supplied and configured by different suppliers with differing levels of functionality, hence Trusts with their own legacy systems. For the national programme, however, procurement and implementation was centrally managed by Connecting for Health, an agency within the DoH (up until 2013). The work of Connecting for Health was then taken over by the Health and Social Information Centre (now called NHS Digital) (Department of Health, 2017). Connecting for Health was mainly responsible for delivering the programme by negotiating contracts with four main suppliers (BT, Accenture, Fujitsu and CSC). These four main suppliers were in turn supported by other suppliers. To ensure that the best contract is secured, Connecting for Health adopted a number of approaches in the management of the suppliers. For example, in order to reduce the size of individual contracts and to increase the number of potential suppliers, the National for IT Programme is delivered through Local Service Providers at five geographical clusters (West Midlands, North East, Southern, East Midlands and London) (Department of Health, 2006). In this way, Connecting for Health was able to reduce the impact if any single supplier failed to deliver. Additionally, instead of taking a “big bang” approach to implementation a more gradual approach was taken. The Local Service Providers initially provided a degree of

functionality and progressively built the whole system until its completion in 2010 (Department of Health, 2006).

However, despite the approaches taken by Connecting for Health and Local Service Providers, as well as with strong ministerial support, the national programme was not successful. The full costs of the programme remain uncertain and the benefits were disappointing (Department of Health, 2013). Although some parts of the programme were successfully delivered (e.g. PACS and N3) (Eason, 2009; Robertson et al., 2010), other main systems, such as the Care Record Service encountered severe difficulties. It was reported that the first hospital Trust to implement an EPR (part of the Care Record Service) experienced a performance drop of 20% at its ED (O'Dowd, 2014). Four early adopters of SCR had informed the programme of their decision to opt out from the implementation or to have a limited access to SCR (Greenhalgh, Stramer, et al., 2008). The March 2010 deadline for system deployment in the North East, West Midlands, East Midlands and North East clusters were not met (Cruickshank, 2010). As a result, in September 2011, the UK Government announced that the National Programme for IT was to be dismantled (Department of Health, 2013). However, some components of the programme remained in place with separate management and accountability structures. The failure of the National Programme for IT raised doubts as to whether the DoH vision of a paperless NHS can be achieved by 2018.

Studies conducted in regards to the national programme suggest that a centralised approach and top-down implementation by Connecting for Health which mainly focused on technical aspects could be one of the reasons why the programme failed (Clegg, 2008; Sheikh et al., 2011). Having integrated IT solutions that conform to NHS requirements has a higher priority over having a system that is well integrated with existing practice. The resulting complexities lie when common technological solutions are to be implemented into heterogeneous organisations: the diversity of Trusts' organisational characteristics including the methods used by individual Trusts to achieve care efficiency, the existing legacy systems as well as workflows and practices of different medical specialities (i.e. in-patient settings and out-patient settings). For example, in the case of SCR implementation in five NHS Trusts, it was concluded the solution must be tailored to suit individual Trusts varied work processes and work practices (Robertson et al., 2010). This requirement should not be bypassed as the transformation from paper-based practices to a paperless system places an impact on existing working practices. Another study on the implementation of SCR found that clinicians did more data entry than they normally do (Sheikh et al., 2011). As a result, some of the clinicians reported that constant use of computers was not what they were expecting.

The mismatch between the technical systems and clinical work and workflows has led others to suggest that more studies should be done to understand the context of the implementation, particularly using the socio-technical approach (Clegg, 2008; Cresswell & Sheikh, 2009; de Lusignan & Aarts, 2008; Eason, 2009). This approach can be used to understand how people, technology and the process of care interact (Aarts & Gorman, 2007). In addition, research conducted in regards to medical work and workflows views the suitability of a socio-technical approach as healthcare delivery more often than not takes place in unintended and unpredictable ways (Reddy, Pratt, Dourish, & Shabot, 2003; Weigl, Müller, Vincent, Angerer, & Sevdalis, 2012). Section 2.6 discusses the socio-technical approach in detail.

The national scale IT implementation of the National Programme for IT provided an opportunity to examine processes and practices that are part of healthcare workflows. The critical aspect should be selecting and implementing the most appropriate technology for the established workflows without adding unnecessary complexities and unintended consequences to existing workflow. Although the failure of the programme was also caused by other factors such as a lack of communication between Connecting for Health and Trusts (Department of Health, 2013), a lack of understanding of healthcare workflow can also result in a lack of adoption (de Lusignan & Aarts, 2008; Eason, 2010).

## **2.6 Frameworks**

### **2.6.1. Socio-technical framework**

The notion behind adopting a socio-technical approach in HIT development (or any other information systems) is that HIT is seen as a socio-technical system. A socio-technical system is not seen as purely technical systems with technical functionalities, used in supporting healthcare work processes (Aarts & Gorman, 2007). In a socio-technical framework, healthcare delivery is produced through the interaction of healthcare systems users, technologies and care processes. Berg, Aarts, and Van der Lei (2003) emphasise the importance of recognising these dependencies. They argue that the socio-technical systems cannot be partitioned into social aspects for social scientists and technical aspects for information technologists. To demonstrate this, they give an example of doctors placing a medical order (i.e. medication order) to be executed by nurses. At first glance, the clinical process seems to be a simple linear process: a doctor conceives an order, writes it down and a

nurse carries it out. However, in real life this can be a more complex process. Medical ordering process involves more than just one person: for example, a doctor submits a request to one other person, such as a nurse, who carries out the task. In other word, the process is not as 'linear' or 'straightforward'. Instead, it often arises out of a collective discussion among healthcare professionals, for example nurses often suggest the right dosage to doctors. Nurses may even administer the medication before the doctor formally requests it. Therefore, this 'messy' nature of healthcare work should be recognised in order to achieve a seamless integration of technology into healthcare workflow. Similarly, a manifesto for a socio-technical approach put forward by Clegg, Wyatt, Elliott, and Sinclair (2010) in regards to computerisation of UK healthcare systems, points out that social and technical elements of work systems need to be jointly designed. Focusing on only one aspect means that no improvements in healthcare delivery can be achieved. Therefore, the framework can be used to understand the relationship between technical systems and the social context where the technical systems are embedded.

However, according to Berg et al. (2003), there is "no such thing as 'the' socio-technical approach" (p. 297) and that the socio-technical framework can be incorporated with other fields such as CSCW, human factor design, participatory design and Human Computer Interaction (HCI). This strongly suggests that these fields can offer different lenses in providing their interpretation and understanding of socio-technical issues. In Gurses and Carayon (2009)'s study, the framework was incorporated with the human factor design principles. These were used to identify performance obstacles of ICU nurses in their work environment. Understanding of the ICU nurses' obstacles when doing their job is a part of the redesign effort aimed to eliminate the obstacles faced. In participatory design, users are given the lead in the design process (Doherty, McKnight, & Luz, 2010; Vyas et al., 2013) whereas in HCI, the focus is on the interaction of people with the technology (Antonia, Munaz, & Botia, 2013; Park et al., 2015). Instead of analysing user interaction with the technology, in CSCW the focus is more on the interaction and collaboration of users among themselves and how the system technical features can be utilised to support it (Schmidt & Bannon, 2013).

Building on these diverse backgrounds, the framework has also been utilised in evaluating the successes and failures of HIT implementations on healthcare workflow. In Bossen et al. (2012), the socio-technical approach was utilised together with CSCW field in identifying whether cooperative work among medical secretaries in regard to pre- and post-implementation of an EHR, were achieved or otherwise. Similarly, the framework was also used to understand the impact of a CPOE system on the collaboration practice of the clinical

users (Aarts et al., 2007) and the impact of an EMR implementation on the doctors' documentation process (Park et al., 2012). The framework can also be used to gain an in-depth understanding of the usage of non-technological information artefacts in supporting collaborative patient care processes for the purpose of designing its computerised counterparts. These include artefacts such as paper-based medical records (Bansler et al., 2016; Cabitza et al., 2009), dry-erase whiteboards (Bjørn & Hertzum, 2011) and tangible artefacts used in architectural design work (Vyas et al., 2013).

In regards to the National Programme for IT in the UK, studies conducted at early adopter hospitals have also utilised the socio-technical approach in order to understand the failures or challenges of the program implementation. In Sheikh et al. (2011), they recognised changes to clinical and administrative work processes as one of the barriers to successful implementation of the EHR at the study settings. Similarly, Greenhalgh, Hinder, Stramer, Bratan, and Russell (2010) found that disbandment of HealthSpace, an EPR system accessible via the internet, was a result of the system functionalities that did not align with the users' expectations and practices. Vezyridis et al. (2011) found that although the patient registration and tracking system provided the nursing staff with real-time updates on patient location and treatment progress, paper-based practices still existed particularly in relation to the nurses' interaction with patients. The failures or unintended consequences of these HIT implementation and the national programme in general has led others to suggest that the framework be used in understanding Trust's diverse processes and practices prior to the implementation of a wide-scale IT solution offered by the national programme (Clegg et al., 2010; de Lusignan & Aarts, 2008; Eason, 2010). An effective HIT works synergistically with the norms and expectations of the healthcare practices, existing information architectural implementation and the environment in which it will be used. Benefits of HIT depend not only on the technical aspects of the design (e.g. intuitive, user-friendly user interface, functionalities) but also on the seamless integration of the technological systems with existing work processes and practices. Understanding and optimising these socio-technical components is critical to a fluid transition towards HIT.

In regards to methodology, a number of approaches can be adopted ranging from: experimental studies and clinical trials (Borycki & Lemieux-Charles, 2008) to 'traditional' software development methodologies. However, experimental studies and clinical trials have been criticised for failing to gain a deeper understanding of the social settings where the systems are going to be introduced (Kaplan, 2001). Meanwhile, the 'traditional' software development approach such as Soft Systems Methodology (SSM) has its root in systems

engineering rather than in social sciences therefore, its strength is to develop information system models with technical requirements (Baxter & Sommerville, 2011). A formative approach such as Cognitive Work Analysis on the other hand, is based on the prediction of what a system *could* do as opposed to how work *should* be done or how work *is* done (Horsky et al., 2006). In addition to these approaches, modelling approach can also be adopted. In system modelling, a workflow is studied in order to create idealised models (as opposed to 'situated' models) of work for use in computer simulations (Lim, Worster, Goeree, & Tarride, 2013; Salimifard et al., 2013). Such idealised models can only "provides a view of how processes should occur" (Hayes, Lee, & Dourish, 2011, p. e173). Although, these approaches place socio-technical systems as the ultimate end goal in the design process, they are not well suited for understanding and designing around the complex, non-routine and exception-filled of healthcare workflow (Reddy et al., 2003). This is because these approaches predominately focus on the technical features and system constraints. Therefore, they are deemed suitable for patient information storage and retrieval systems, instead of information systems that can efficiently support healthcare delivery.

Therefore in this research, in order to capture the situated nature of emergency care workflow, a workplace analysis utilising typical sociological inquiries is adopted (the methodology for this study is discussed in details in Chapter 3). This approach can be used to observe healthcare professionals in their actual work settings while they carry their day-to-day work activities (Abraham & Reddy, 2010; Bossen et al., 2014; Feufel et al., 2011). This allows for understanding of how they actually work rather than what process definition says they ought to work (Doherty et al., 2010). This approach has also been widely adopted in understanding socio-technical issues at various workplaces such as airlines operating room (Berndtsson & Normark, 1999; Goodwin & Goodwin, 1996; Selvaraj & Fields, 2010), trading room (Heath et al., 1993), courtroom (Elliott, King, Hall, & Arbor, 2005) and university (Vyas et al., 2015).

Socio-technical approaches can be used at pre- and post-implementation technological systems. In doing so, more often integrates other fields of study such as CSCW, human factor and HCI in providing their interpretations. In this research in order to answer the research questions put forward in Section 2.9, the CSCW field adopting the fieldwork approach is deemed suitable in providing understanding on socio-technical aspects of collaborative emergency care processes. This is based on the premise that HIT should be designed to support collaborative work of multiple users instead of tasks of individual users.

### 2.6.2. Computer Supported Cooperative Work (CSCW)

CSCW is an interdisciplinary field of study where its research community includes participants from computer science, information technology, sociology, anthropology and business (Coovert & Thompson, 2001). Due to its interdisciplinary nature, the field has been applied in the development of various technological systems across various domains such as e-research community (Jirotko, Lee, & Olson, 2013), social interaction (Vyas et al., 2015), engineering design (Jones et al., 2012), collaborative writing (Calvo, O'Rourke, Jones, Yacef, & Reimann, 2011; Kim, Mohan, & Ramesh, 2014), collaborative learning (Lavou, Molinari, Prie, & Khezami, 2015), e-professional communities (Antonia et al., 2013; Sohlenkamp & Chwelos, 1994) and architectural work (Vyas et al., 2013).

In addition, research involving CSCW can fall within the technical framework (i.e. technology-centric) or the social framework (i.e. work-centric). In the technical framework, the focus of the research is on designing computer technology that can better support people working together where the main emphasis is on technology such as cloud computing (Weng et al., 2016), web technologies (Antonia et al., 2013), communication technologies (Saunier, Balbo, & Pinson, 2014), ubiquitous computing (Jones et al., 2012) and distributed computing (Jirotko et al., 2013). In general, research within this realm focusses on the elicitation of technical requirements or on the technical design of computerised systems for collaborative work. Research that falls within the social framework, on the other hand, places more emphasis on the understanding of collaborative work, hence complementing the socio-technical framework. Such combination allows an investigation of socio-technical issues from the perspective of cooperative work.

Although with two different frameworks, the CSCW field does not typically address either component while neglecting the other. An ideal collaborative work system is depended on the optimisation of the system technical features (e.g. notification and alert systems), electronic tools (e.g. video conferencing, text chat, email, calendars, large display) or technologies (e.g. cloud computing, ubiquitous computing) that fit into the social characteristics of collaborative work. As pointed out by Pratt et al. (2004), the goal is to understand the relationship between technical systems and collaborative work. The field has provided conceptual understanding of various types of cooperative work: collaborative work for people who are geographically distributed (Luz, Masoodian, & Cesario, 2015); people who are co-located within the same building (Erickson, Danis, Kellogg, & Helander, 2008); people who are on the move (Mark & Su, 2010); people who have to collaborate synchronously (Vyas



et al., 2013) or asynchronously (Lan, Cheng, Lan, Sung, & Chang, 2015); involving homogenous group members (Vyas et al., 2013) or heterogeneous group members (Kuziemy & Varpio, 2011).

Healthcare information system design provides a rich domain for CSCW research as HIT is targeted for health professionals that must work collaboratively. This is because healthcare work is a highly collaborative undertaking, consisting of the heterogeneous and semi-autonomous work activities of healthcare professionals. As a result, there is a growing interest in the Health Informatics community to understand the issues surrounding healthcare workflow and collaboration in these environments (Kane & Luz, 2015).

### 2.6.3. CSCW and HIT

HIT is not just a tool to collect and store data during patient care trajectory. HIT applications as well as non-computerised information artefacts used at healthcare settings are embedded with features such as standard headings (Berg, 2003), visibility, overview and contingency management (Bardram, Hansen, & Soegaard, 2006), annotations (Bringay et al., 2006; Xiao, Schenkel, Faraj, Mackenzie, & Moss, 2007), resource management (Neale, Carroll, & Rosson, 2004) and multiple view of information (Reddy et al., 2008). All of these features allow for collaborative work to be carried out among healthcare professionals. As iterated by Reddy, Pratt, Dourish, and Shabot (2003), “clinical systems are not simply information repositories of patient data but rather are integral part in the collaboration amongst health care workers” (p. 443). This has lead others to suggest that CSCW discipline be incorporated into the development and implementation of HIT (Pratt et al., 2004; Scupelli et al., 2010).

Pratt et al. (2004) for instance demonstrated the synergy between the two fields by using an EMR as an example, which they broadly defined as any system that supports electronic collection of health information. From their review, they proposed three areas where understanding of collaborative healthcare work can be used in the design and implementation of HIT. One of the areas suggested is on creating systems and organisational structures that can motivate healthcare professionals to use the technology, for example an incentive structure for user group at all levels: small groups, individuals and institutions. They argue that such structures can play an important role in encouraging the use of HIT, as HIT is benefited by various healthcare professionals (e.g. doctors, nurses) as well as organisation, differently. They also proposed that there should be an in-depth understanding of the

healthcare workflow. In particular, the technology must be effectively integrated into users actual work processes and practices. Although according to Pratt et al. (2004), a workflow can reflect processes which need to be coordinated for successful completion of work and can include standardised operating procedures, it is in fact a mixture of routine work and exceptions. As a result, tensions can exist between actual work which is not routine and the organisational desire for standardisation.

Another proposed aspect of collaborative work is on mechanisms or practices that can effectively be employed by collaborating users. The objective is to produce and maintain an accurate representation of current events and required tasks as well as what is going on around them. Essentially, for collaborative work to materialise, people need to be aware of each other activities, a concept known as awareness. It is defined as “understanding of the activities of others, which provides a context for your own activity” (Dourish & Bellotti, 1992, p.107). Awareness is rooted in the collaborative actors work practices where they share intentionally or unintentionally detailed information about their activities in order for processes and activities to be coordinated (Reddy et al., 2008). Understanding awareness involves the understanding of what information it is, who/what it is for and methods in obtaining it. As a result of these understandings, suitable mechanisms or technological tools to support its provision can be determined. For example, awareness on patient condition or awareness on team members activities could be implemented via technological tools such as electronic whiteboards or mobile devices, whereas charting system within an EHR can provide an awareness on activities such as medication change or cancelled procedures (Kuziemyk & Varpio, 2011). Mechanisms within various technological tools can also support the provision of different awareness. For example, message displaying feature can be triggered to display awareness information on time-related activities, whereas colours can be used to highlight certain information on patients with life threatening conditions (Cabitza et al., 2009). Other mechanisms such as annotations (Bringay et al., 2006), event notification system (Gjære & Lillebo, 2014) and clinical reminder system (Aronsky, Jones, Raines, et al., 2008) can also be implemented to achieve awareness of the activities of collaborative actors. Different technologies can also provide varying level of awareness. An internet for instance, provides a higher level of awareness in comparison to telephone (Ray, Parameswaran, Chan, & Yu, 2008).

Much can be learnt in regards to socio-technical aspects of collaborative work and practices. Studies conducted in regards to healthcare collaborative work have contributed to design concepts for HIT system design. In doing so, a number of approaches can be adopted. Healthcare professional collaborative work can be studied from perspectives of a single

information artefact to homogenous/heterogeneous information systems. It can also include methods used or practices practised by healthcare professionals. In investigating cooperative work from heterogeneous groups of information artefact for example, Xiao (2005) reviewed a number of studies conducted at collaborative work settings in regards to the usage of tangible information artefacts. These information artefacts include “flight strips” used by air traffic controllers (Berndtsson & Normark, 1999), heterogeneous non-integrated workflow machines used in a printing industry (Bowers et al., 1994), a large computerised wall map (Pettersson, Randall, & Helgeson, 2004) and a dry-erase whiteboard in a hospital ward (Bardram & Bossen, 2005a). From the review, characteristic of the information artefacts that support cooperative work were identified. These artefacts facilitate articulation of work without explicit articulation efforts and allow people to easily integrate their contributions. Tangible artefacts also provide a close physical proximity and support for asynchronous and non-verbal communication. In addition, artefacts such as a large computerised wall map and dry-erase whiteboards can publically display awareness information, provide a shared accessibility and provide flexibility in supporting cooperative work.

Healthcare settings are information-rich environment with diverse range of information artefacts. Xiao (2005)’s review on the role of tangible artefacts as collaborative tools is well complemented by empirical studies of other physical objects and non-digital information artefacts used at various healthcare settings. This includes information artefacts such as work schedules, examination sheets and dry-erase whiteboards used in a hospital ward (Bardram & Bossen, 2005a), non-computerised patient records in an Internal Medicine and a Neonatal ICU settings (Cabitza et al., 2009), as well as dry-erase whiteboards in an ED (Bjørn & Hertzum, 2011) and ORs (Lasome & Xiao, 2001; Scupelli et al., 2010; Xiao et al., 2007). In Bardram and Bossen (2005a) for example, the aim was to obtain an understanding of how coordination of clinical work activities are achieved through heterogeneous groups of tangible information artefacts such as whiteboards, work schedules, examination sheets, post-it notes and personal notes. They found that each of the artefacts represents important context-specific information require for short-term work coordination between staff as opposed to patient records which are valuable tools for long-term coordination. The short-term coordination requires the clinical staff to plan, schedule and update status. This is important whenever they are taking care of patients’ hygiene, administration of medicine or when clinical investigation and treatment such as radiology and chemotherapy are given, and hence reliance on multiple artefacts. A whiteboard for instance, provides information such as patient names, their room and bed number, their hygiene-regime and which nurses are taking care of the patients. Post-it notes

on the other hand, were used by the doctors and team-leaders during morning rounds to write up new tasks, prescriptions or examinations and were put on the whiteboard or given to the nurses. Collectively these artefacts coordinated the ward activities by enabling the staff to locate patients and other staff, supporting the planning and division of work, maintenance of continuous work coordination and keeping of a status overview.

Non-electronic or dry-erase whiteboard is another very common type of information artefact in many healthcare settings. It plays a crucial role in coordinating activities and supporting communication among healthcare professionals. In Xiao et al. (2007), instead of focusing on multiple tangible artefacts, they investigated the collaborative role of a dry-erase whiteboard, at a six-bed OR. The whiteboard is used in the management of surgeries which include planned and cancelled surgeries for existing patients and unexpected surgeries for newly admitted patients. The study identified various methods and mechanisms used to communicate task status and to coordinate tasks-related workflow. For example, magnetic case strips in three different colours were used to represent the urgency level of the surgeries. A dot is also marked besides the magnetic case strip to indicate status information. Positions of the magnetic case strips are also changed to indicate a transition to another task. These mechanisms signify the uncertainty of the collaborative work at the OR dictated by for example, ever-evolving patients (patients scheduled for planned surgeries vs. emergency surgeries), staff and organisational circumstances. Characteristics of the collaborative work indicated by the usage of the whiteboard also include planning and tracking of resources. By using this method, nursing staff can pick their own cases by negotiating with others, understanding the requirements of the cases and assessing their workload.

Scupelli et al. (2010) on the other hand, found that physical location of whiteboards can play a pivotal role in achieving collaboration. One of the whiteboards which is placed at a remote location discourages a face-to-face communication around the whiteboard. On the other hand, another whiteboard located next to a nurse station appeared to motivate greater interaction. In conclusion, the whiteboards serve two types of collaborative practice of the clinicians' (i.e. nurses, surgeons and anaesthesiologists) workflow: asynchronous and impromptu (ad-hoc) collaborations. From these findings, they proposed three design principles in regards to physical location: One, there should be connectivity between information hubs (e.g. a whiteboard and a nursing station) to facilitate interaction among staff. Second, the space adjacency and visibility between the information hubs that allow for mutual visibility and accessibility to facilitate monitoring and updating of information. Third, an adequate access area around the whiteboard should be allocated as well positioning the whiteboard at staff-

only area for privacy of patient information. The authors assert that the proposed features are useful for the OR clinicians. The main reason is that staff can unintentionally stop at the location to look for information or whenever they exchanged information informally with other staff members.

In their study, Scupelli et al. (2010) proposed choosing physical locations that can effectively support asynchronous and impromptu collaborations. Their findings are quite an opposite to an earlier study by Bardram and Bossen (2005b). In this study they pointed out that cooperative work is achieved when people are mobile in their work. They established that work mobility is a profound characteristic of work in healthcare settings. This is because, x-rays, blood samples and tissues are sent back and forth across physical locations and staff. Staff members are also consistently mobile, moving from work stations to patient beds. Therefore, in order for coordination to be achieved across the spatial dimension of healthcare work, it needs to have “the right configuration of people, resources, knowledge and place in order to carry out tasks” (Bardram & Bossen, 2005b, p. 136). In other word, people, resources, knowledge and place must be correctly configured for task achievement. Similarly, other studies have suggested that cooperative work can be achieved through joint interpretation when healthcare providers are participating in face-to-face communication as seen in medical meetings (Luz, 2011). However, for healthcare professionals who are geographically distributed, sufficient access to a centralised repository is needed to satisfy requirement of access to people, resources, knowledge and place (Luz et al., 2015).

Based on their study of dry-erase whiteboards, Bjørn and Hertzum (2011) found that collaborative work of the clinicians is mainly semi-autonomous and interdependent. Additionally, one process can constitute of multiple activities or steps executed by different people, which need to be coordinated. For example, a patient can be seen by a team of consultant external to the department hence ‘consultant management’ become part of the collaboration practice. Consultant management practice involved activities of submitting requests to various specialities, receiving the requests and completion of the requests. Therefore, another concept of cooperative work is introduced, artefactual multiplicity. The concept implies the multiple functionalities as well as the relations between the multiple functionalities, within a single artefact. It was found that the linkage between these multiple functionalities is important for task coordination as healthcare work is semi-autonomous and interdependent. They also iterate that the multiplicity of an artefact does not imply fragmentation. Instead, it should be seen as interlinked of collaborative activities which are co-existed and organised through a single information artefact.

Studies conducted in relation to the usage of tangible information artefacts (e.g. post-it notes, dry-erase whiteboards) in supporting healthcare workflow, have demonstrated that cooperative work can be achieved by via linkages of multiple artefacts (Bardram & Bossen, 2005a), methods or mechanisms employed (Xiao et al., 2007), spatial characteristics of work (Bardram & Bossen, 2005b; Scupelli et al., 2010) and multiplicity of an artefact (Bjørn & Hertzum, 2011). These studies have also shown that collaborative work and practices can vary among healthcare settings. For example, collaborative work at an ED more often involved external collaboration and multiple tests, hence multiple processes (Bjørn & Hertzum, 2011) as opposed to collaborative work at an OR which mainly deal with admitting patients for surgeries and conducting the surgeries (Scupelli et al., 2010). Nevertheless, it is evident that levels of uncertainty and the ad-hoc nature of collaborative healthcare work still remain and can cause potential difficulties. As such computerised systems design for healthcare collaborative work must be able to support this.

The studies discussed thus far in this section provided their interpretation of collaboration from the perspectives of the information artefacts used by the collaborating healthcare professionals. Another possible approach of understanding collaboration is by focusing on the healthcare work itself. Schmidt, Wagner, and Tolar (2007), for instance, conducted a comparative analysis of collaborative work practices at two oncology clinics. From identifying the work of the oncology clinics, they provided a detailed interpretation of the variations and commonalities of the work practices between the two settings. Their interpretation of variations and commonalities of collaboration focusses on the characteristics of the setting, mechanisms and coordinative practices that are being employed to achieve collaboration as well as the type of information artefacts that are being used in supporting the oncology work. The findings indicate that although both settings are comparable settings in the sense that both are involved in the provision of treatment against tumours which include care processes such as administering of chemotherapy in multiple cycles, and taking of blood tests for the purpose of monitoring the state of the patient, the work practices embedded within these processes differ. The differences can be seen in the staffing and work organisation. One clinic is staffed with nurses, doctors and interns. As a result, it is common practice that the interns are responsible to take blood tests and record patient medical history, while nursing staff is responsible in managing the reception counter, receiving patients and checking what needs to be done. In contrary to the other clinic, reception counter is managed by a secretary while nurses and doctors are more involved in clinical work in the consultation rooms. One characteristic of healthcare collaborative work this study has shown is that

healthcare processes between two very similar speciality clinics were performed differently. Such variation can also exist in the same healthcare setting where a work process can be performed by a number of professions. In Kuziemyk and Varpio (2011) for instance, they found that because each healthcare professional has its own strengths and weaknesses. It is therefore important that team members be aware of what each staff is trained to do and is capable of doing in order to ensure patient safety. Similarly, Bjørn and Rødje (2008) also studied aspects related to work practices of collaborative healthcare professionals. Their study provided an in-depth understanding of triage work practices at an ED, specifically how these practices constitute a mechanism for assessing and sorting patients. The study concluded that although a triage process is a single process, it is comprised of multiple activities performed by various staff in managing patient trajectories within the physical space and over specific time frames. In this context, patients are delegated into designated space and according to time limit depending on assessed urgency and availability of resources.

Healthcare collaborative work is not comprised of isolated, singular events. Rather, these complex events involve a multiplicity of work processes and practices of healthcare professionals. Their work is not a 'straightforward' two-way collaboration, but a 'web of collaboration' of heterogeneous staff with varying levels of medical backgrounds, skills, experiences and knowledge (Kuziemyk & Varpio, 2011). Making the collaboration more complicated is the need to manage patient trajectory across space and time (Bjørn & Rødje, 2008), while taking into consideration urgency of care (Cabitza et al., 2009; Scupelli et al., 2010); availability of resources (Abraham & Reddy, 2010); demands from other patients (Bjørn & Rødje, 2008); and changes in patient condition (Bjørn & Hertzum, 2011).

A high degree of collaboration among healthcare professionals is thus required to maintain healthcare workflows in order to ensure safe and efficient care delivery. It is crucial that that HIT be designed to support such collaboration. However, one common theme still remains in regards to healthcare collaborative work. Many of these studies have been designed primarily in understanding collaborative work of clinical staff. Although clinical workflow can be the main component of healthcare collaborative work, the non-clinical processes, activities and practices also formed the overall healthcare work system. Thus, HIT must also be designed to support this.

## **2.7 Synthesis**

Studies have shown that HIT applications such as EMR, EHR, PACS and CPOE can improve efficiency and safety in healthcare delivery (Hillestad et al., 2005; Modrák & Modrák, 2013; Reddy et

al., 2009). However, despite reported benefits the integration of HIT into healthcare workflow has been a concern. Empirical studies have reported unfavourable workflow effects as a result of such integration. This includes increased documentation time (Banet et al., 2006; Park et al., 2012), introduction of workarounds (Patterson et al., 2006), communication breakdown (Saleem et al., 2011), introduction of secondary activities (Abraham et al., 2009), increased coordination effort (Feufel et al., 2011) and redundancies or duplication of work (Saleem et al., 2011). It is theorised that these workflow effects are due to system design that fails to support its inherent healthcare workflow.

Healthcare workflow is complicated due to differences in healthcare setting (e.g. ED, ICU, OR and out-patients settings like speciality clinics) contextual characteristics. The contextual characteristics which are mainly contributed by patient flow and patient condition mean that each setting has its own individual workflow. For example, an ED is characterised as being unpredictable in terms of patient flow (i.e. patients can come at any time) and variability in patient condition. Therefore, ED clinicians have to face this unpredictability to make timely diagnoses (Amouh et al., 2005). In contrast to an ICU, patients in the ICU are already diagnosed but need to be stabilised until their conditions are not critical (Reddy & Jansen, 2008). Therefore, HIT that work in the ICU or in other hospital settings does not mean it will work in an ED as the patient care processes of these settings can vary. In socio-technical system thinking, HIT is a socio-technical system whereby the social aspects of medical work are linked with the technical component (Berg et al., 2003). As supported by Ammenwerth et al. (2006), HIT is comprised of technological systems embedded in socio-organisational settings characterised with organisational workflows. Therefore, a one-size-fits-all HIT to be used for an entire hospital can result in negative workflow effects (Abraham et al., 2009). HIT for emergency care, for instance, should be designed to support the emergency care processes and practices of ED clinicians who have to deal with unpredictability in patient flow and patient condition. In delivering emergency care, ED clinicians communicate synchronously and asynchronously where the communication is interruptive (Allard et al., 2012; Westbrook et al., 2010) and information is sought collaboratively (Reddy & Spence, 2008).

The integration of HIT into healthcare workflow has remained an on-going challenge. Studies are being conducted empirically at various healthcare settings such as ED, ICU, OR and out-patient settings for the purpose of gaining an in-depth understanding of the healthcare workflow to inform system design or for system re-design (Section 2.4.4, Section 2.5.2 and Section 2.5.3). Such studies can provide an in-depth understanding of work processes, tasks and practices of clinicians and non-clinicians who are part of the workflow. It can also include an understanding on the characteristics of information artefacts, computerised and non-computerised, in supporting the workflow. Healthcare



workflow-related studies are also interdisciplinary where fields such as CSCW, Human Factor Engineering and participatory design can be incorporated. According to Unertl et al. (2008), a “cross-disciplinary workflow research presents enormous opportunity for improving the fit between technology and work” (p. 271).

## **2.8 Limitations of existing research**

Section 2.5 indicated that many of the existing workflow-related studies conducted in emergency care settings had been predominantly designed to investigate specific clinical processes such as the triage process (Bjørn & Rødje, 2008; Castner, 2011), the consultation process (Kessler et al., 2012) and patient transfer (Abraham & Reddy, 2010). Moreover, the focus of these studies is only on clinical staff members, i.e., doctors and nurses (Bjørn & Hertzum, 2011; Feufel et al., 2011). It has been suggested that studies on the non-clinical work of non-clinical staff (e.g. medical secretaries, assistants and porters) in EDs and other healthcare settings is rare (Bossen et al., 2014, 2012; Spence & Reddy, 2007). Questions still remain on where non-clinical processes or non-clinical work fit into the overall emergency care workflow. Instead of looking only at specific clinical processes or only on the work of non-clinical staff, this study intends to look at the overall emergency care workflow and its processes, involving both clinicians and non-clinicians. The ED team members are multi-disciplinary, consisting of clinicians and non-clinicians, where they work semi-autonomously yet inter-dependently, for the completion of the overall care process (Murphy & Reddy, 2014; Reddy & Spence, 2008). Therefore, it is important to gain an understanding of the inter-connectedness of both the clinical and non-clinical processes that form an overall emergency care workflow. It is also important to identify and understand how the existing information artefacts, computerised and non-computerised, are used to support the overall workflow. As stated by Bisantz et al. (2010), to successfully design new systems “requires a careful understanding of the functions afforded by the old systems and the manner in which the manual systems supported clinical work” (p. 39).

In addition, these studies were conducted in the US and in the European ED which have different organisational elements to those in the UK. There are a number of studies investigating the adoption of HIT in the UK (e.g. Greenhalgh, Wood, Bratan, Stramer, & Hinder, 2008; Sheikh et al., 2011). The resources available on workflow-related studies in the UK emergency care settings are scarce. In the UK, the emergency care service is accessible 24 hours a day, seven days a week, and in addition, EDs are categorised according to different types (i.e. Type 1, 2 or 3) depending on the emergency care service provided. These EDs are managed by hospital Trusts, with their own governance arrangements. An increasing trend in emergency attendance has placed a high demand

on the service where overcrowding is frequently reported. In order to ensure patient safety, the DoH had introduced a target that 95% of patients be seen and treated within four hours (UEC Review Team and ECIST, 2013). As a result, hospital Trusts have begun to implement their own solutions in order to meet the target and at the same time improving flow of patient thus avoiding overcrowding. Additionally, at the national level, the implementation of HIT has been addressed in a number of NHS information strategies, the latest one being the National Programme for IT. HIT has been instrumental in ensuring the availability of information in order to provide safe and efficient care. However, the implementation of the programme has not been successful (Department of Health, 2013). One of the reasons for the failure is due to the top-down approach where the main aim was to implement an integrated solution that conforms to NHS requirements instead of a system that is well integrated into existing workflows (Clegg, 2008). Studies conducted at early adopter hospitals have also shown resistance in the acceptance of the proposed technological solutions due to negative workflow effects (Robertson et al., 2010; Sheikh et al., 2011; Vezyridis et al., 2011).

HIT is a socio-technical system and in order for it to be successfully implemented, the diversity of Trusts' organisational characteristics and previous implementations, practices of different medical specialities (e.g. outpatient settings, ED, ICU) and individuality of the care setting (e.g. EDs with different working practices) should be carefully analysed. This has lead others to suggest that more studies should be conducted to understand the context of the implementation, particularly using the socio-technical approach (Clegg et al., 2010; Cresswell & Sheikh, 2009; de Lusignan & Aarts, 2008; Eason, 2009). The socio-technical approach can be used to understand how people, technology and process of care interact (Aarts & Gorman, 2007). The national scale IT implementation approach of the National Programme for IT provides an opportunity to examine the ED processes and practices so that the most appropriate technology for the established workflow can be implemented.

Therefore, this study intends to fill three main gaps:

- i. There are limited studies on workflow-related research that examines the work processes of clinicians and non-clinicians and how these processes are inter-connected to form an overall emergency care workflow;
- ii. There are limited studies on the usage of existing information implementation at emergency care settings in the UK and how this can affect the top-down approach of the UK national IT programme; and
- iii. No studies were found that compare and contrast the workflow of different emergency settings in the UK.

## 2.9 Conclusion and research questions

This chapter has reviewed relevant literatures on HIT and healthcare workflows, as well relevant studies conducted in domains outside healthcare. As the research was conducted in the UK, the review also discussed NHS information strategies, particularly the National Programme for IT in implementing technological solutions in the UK healthcare system, including in emergency care. Arising from the gaps in the literature (discussed in Section 2.8), the research questions originally posed in Chapter 1 have been developed further, into an overall research question is:

What characterises an ED workflow?

And more specific research questions:

1. What are the clinical and non-clinical processes that form an overall ED workflow and how do these processes connect as a whole? Is the execution of the inter-connected processes 'fixed'?
2. Who are the other members that form the ED team, in addition to doctors and nurses? What roles do these members play in the workflow?
3. What are the characteristics of the existing implementation in ensuring/limiting overall functioning of the workflow?
4. What are the differences and similarities in the execution of care processes of different emergency care settings in the UK?

In order to answer these research questions, a fieldwork case study approach was adopted. The approach is suitable to capture the situated nature of emergency workflow in order to answer questions such as 'what', and 'how' of socio-technical issues that include interaction of people, technologies and processes (Bonnie Kaplan & Maxwell, 2005). The next chapter, Chapter 3, discusses the adopted research methodology in detail.

## **CHAPTER 3: RESEARCH METHODOLOGY**

### **3.1 Introduction**

Having reviewed the literature and identified the need for conducting the research in Chapter 2, this chapter describes the socio-technical research approach to answer the research questions put forward, and provides justification for the chosen approach. It starts off with the philosophy underpinning the research. Also discussed are the methods used in analysis, triangulation, sampling and recruitments and obtaining research trustworthiness.

### **3.2 Research philosophy**

Research methodology is defined as a systematic approach in conducting research to accomplish its aims and objectives (Creswell, 2009). One example of an approach that can be used in conducting research is the research onion framework by Saunders, Lewis, and Thronhill (2012). The research onion framework contains a list of steps to conduct effective research. There are six layers within the framework. The most outer layer is the research philosophies (e.g. positivist, interpretivist) follows by approaches (e.g. deductive, inductive), strategies (e.g. experiment, case study), choices (e.g. mixed method, multi-method) and time horizons (cross-sectional, longitudinal). The inner core of the onion is the research procedures and techniques which constitutes the data collection methods and analysis. This framework is used to demonstrate the methodology employed in this research.

There are three components to the research philosophy: ontology; epistemology; and axiology. Ontology refers to what exists in the world and composition of reality (Bryman, 2006). The ontology of the study is the emergency care delivery consisting of the clinicians and non-clinicians, workflow processes and practices, information artefacts and interaction among these components. In order to derive the participants' perceptions, experiences and opinions in regards to their work in delivering emergency care (thus capturing the situated nature of an ED workflow), the epistemology is to employ a workplace analysis conducted at actual emergency care settings. Meanwhile, epistemology refers to "how we know it" (Creswell, 2009, p. 6). The methodology predominantly adopted qualitative sociological inquiry techniques. Adopting qualitative approach means that the study was moved towards value-laden, i.e. the axiology, which pertains to the judgement of value of the researcher (Saunders et al., 2012). This is perhaps one of the main weaknesses of qualitative research as the results obtained could potentially be subjected to researcher bias. However, the

qualitative methodology has the advantage of providing a rich description of the phenomena under study (Pope, Ziebland, & Mays, 2000).

Research employing a qualitative framework tends to be pluralistic with respect to paradigms. It can be based on paradigms such as interpretive, constructivist and critical theories (Punch, 1998; Weaver & Olson, 2006). A constructivist approach is usually combined with an interpretive approach (Creswell, 2009). It perceives that the reality is based on the individuals living in the world in which they develop subjective meanings. Critical theories on the other hand focus “on the oppositions and contradictions” (Myers, 2007, Section 3, para. 9). As was discussed in Chapter 1, the aim of this study is to gain an in-depth understanding of emergency care delivery processes performed by the clinicians and non-clinicians, and how these processes were being supported via the information artefacts. The phenomenon studied is rooted in the actual working experiences of the participants in the emergency care settings. It was, therefore necessary to determine the participants’ perceptions, experiences, practices and opinions where questions such as what, how and why needed to be asked and their way of working need to be observed. This can be answered through qualitative methods, allowing for the situated nature of emergency care delivery to be captured. Therefore, a constructive approach was the most appropriate for this research. In addition, constructivism is in line in conducting healthcare information systems research where a qualitative approach is derived from a constructivist paradigm (Friedman & Wyatt, 2000).

In order to produce an in-depth understanding of an ED workflow and its relevant issues, this study adopted an inductive approach. It started from an investigation conducted at two EDs. It then progressed from these two particular cases by producing a conceptual understanding of an emergency care workflow. In an inductive approach, the research does not begin with a theory, instead a theory or a pattern of meanings is generated at the end and tends to be more interpretive (Saunders et al., 2012). From an epistemological stance, the inductive approach is based on a constructivism framework (Creswell, 2009).

### **3.3 Research methodology**

#### **3.3.1. Research approach**

As discussed in Section 2.6.1, socio-technical understanding of an emergency care workflow can be embedded in the settings. Conducting a workplace analysis by utilising typical sociological inquiry techniques allows the situated nature of an ED workflow to be captured. In order to perform a workplace analysis, this study is conducted via a fieldwork approach

involving two cases, i.e. two emergency care settings. In a fieldwork approach, the researcher was required to gather data “in the wild”, a technique that is an opposite with studies conducted in a laboratory setting (Furniss et al., 2015). The approach has widely been adopted in order to gain understanding of the situated nature of healthcare work at settings such as an ED (Bjørn & Hertzum, 2011; Feufel et al., 2011; Park et al., 2015, 2012), hospice (Kuziemy & Varpio, 2011), hospital wards (Abraham & Reddy, 2010; Bardram & Bossen, 2005a, 2005b; Cabitza et al., 2009) and out-patient settings (Schmidt et al., 2007; Unertl et al., 2009).

In this research, the fieldwork was undertaken at EDs in the UK. This is a detailed study involving two separate social units with their own physical space and clear boundaries. A case study can be a unit, location, community and an organisation (Bryman, 2012). This study aims to gain an in-depth understanding of the situated nature of emergency care work, therefore the approach is also suitable to explore a phenomena in its natural context (Crowe et al., 2011). According to Baxter and Jack (2008), a case study design is suitable when the researcher cannot manipulate the behaviour of the participants and the study needs to cover contextual conditions that are relevant to the phenomena being investigated. Hence, it can be used to explain, describe and explore phenomena in the context in which they occur (Yin, 2013).

It has also been established that the philosophical underpinnings of a case study can be based on a constructivist paradigm which recognises that the truth is relative and thus, is built on the premise of the social construction of a reality (Baxter & Jack, 2008). A case study approach was chosen because, the focus of the study is to answer the ‘what’ and ‘how’ questions (as put forward in Section 2.9). Also, in order to capture the situated nature of an emergency care workflow, there was a need to cover the contextual conditions of the EDs and that there was no clear separation between the workflow (i.e. the phenomena) and the context (i.e. the EDs).

Another important feature of this approach is the ability to use multiple data sources. As suggested by Yin (1999), to enhance the quality of case study research, data collection should involve a broad variety of techniques which includes documentary evidence, archival analysis and direct field observations. Crowe et al. (2011) also reiterate that a case study approach typically involves multiple data sources. This study employed the data triangulation technique which enables the researcher to obtain a more in-depth understanding of the investigated phenomena than a single method would have provided. The triangulation technique is discussed further in Section 3.4.7.

To conduct case study research, cases should be selected based on the purpose of the research (Yin, 2013). This study aims to obtain an in-depth understanding of emergency care delivery. Therefore, the focus was to select a 'typical' emergency care setting. This study was conducted at two EDs where both have the characteristics of:

- The ED staff need to provide quick and efficient care, safely to all patients;
- The EDs treat a wide variety of cases ranging from minor cases to critically ill or injured patients;
- The EDs faces unpredictability in terms of patient flow and patient condition; and
- The ED staff work collaboratively using various information artefacts in order to deliver care.

In regards to time horizons, a research can either be a longitudinal or cross-sectional (Saunders et al., 2012). The objectives of the research can be achieved during the duration of the PhD study, thus the cross-sectional time horizon was adopted. The case study approach also supports this strategy (Payne & Payne, 2004a).

### **3.3.2. Qualitative methods**

#### **3.3.2.1. Data collection methods**

Qualitative methods are suitable for answering 'what', 'how' and 'why' questions. These questions bring to the forefront the care processes and practices of the staff in the settings and the role of the information artefacts in supporting the EDs workflow. It has been acknowledged that sociological understanding of complex practices in natural environments (as opposed to laboratory setting) where the technologies are to function is crucial. It is argued that, without such knowledge the adequate functioning of the technological systems might not be achieved (Berg et al., 2003; Reddy et al., 2008; Reddy, Pratt, Dourish, & Shabot, 2003). The chosen approach, i.e. qualitative case studies in analysing the workflow elements, emphasised the situated nature of these complex practices. The analysis was largely focused on the operational, socio-technical issues that can be affected by the functionalities of technological systems. Therefore, commonly used methods for sociological inquiries in investigating healthcare workflows

in Health Informatics were used (Reddy et al., 2008). These methods include qualitative interviewing, observation and document analysis.

These inquiry techniques when used at fieldwork settings can yield enormous contextual information on healthcare professionals, working practices, challenges, medical exceptions, use of information artefacts and processes of care. Park et al. (2012) employed a combination of non-participant observation and semi-structured interviews to identify system's users, and conflicts or breakdowns in a clinical documentation workflow. During the non-participant observation, the clinical documentation process was observed at various locations in the ED such as at patient waiting rooms, front desks, triage, nursing stations and a charting room. Semi-structured interviewing was also adopted in Abraham et al. (2009) to identify peripheral activities surrounding the usage of an EMR. The semi-structured interview questions were based on two main themes: EMR usage behaviour and challenges clinicians faced with the current workflow. Similarly, Abraham and Reddy (2010) employed qualitative interviewing and observation to develop an understanding of work activities of hospital departments involved in patient transfer workflow. The methods were used to capture events that arise in the workflow and to identify challenges faced in the workflow. All these studies also incorporated opportunistic or informal interviews as part of their observations. This method of interviewing allows for clarification to be obtained while observations were being conducted. In regards to obtaining data via observation, the most typical technique is non-participant observation, a technique useful for researchers who do not have a medical qualification to participate in clinical work.

Attending expert users and management meetings (Bossen et al., 2012; Koppel et al., 2008) and reviewing of organisation documents (Koppel et al., 2008; Vogelsmeier et al., 2008) have also been documented. In these qualitative fieldwork studies one common aspect can be inferred. Instruments used for observation and interviewing are not entirely unstructured or open-ended, but were structured towards the objectives of the individual research.

#### 3.3.2.2. Data analysis

Past studies on healthcare work and workflow commonly involved thematic analysis. Abraham and Reddy (2010) started off their analysis by performing a line-by-



line analysis of the collected data. Codes were then developed based on theoretical constructs and were constantly compared and grouped together based on their similarities. Other studies also employed a similar approach where codes were developed based on theoretical constructs related to activities, work practices, interruptions and breakdowns in healthcare workflows (Abraham et al., 2009; Feufel et al., 2011; Park et al., 2012).

In a thematic analysis, units of data (e.g. sentences or paragraph) referring to a concept are given a particular code (Braun & Clarke, 2006). A framework analysis is one variant of thematic analysis that provides a systematic and robust approach to analysing qualitative data (Ritchie & Spencer, 1994). In addition, this technique is suited for research with specific research questions and a limited time frame (Srivasta, 2009). Framework analysis involves five highly inter-connected steps: familiarisation; identifying a thematic framework; indexing; charting; and mapping and interpretation. This technique was adopted in this study to perform a thematic analysis on the collected data.

#### 3.3.2.3. Triangulation

Triangulation involves multiple data sources, investigators, theoretical perspectives, data analysis and methodological approaches (Denzin, 1970; Thurmond, 2001). In line with the constructivist approach of this research, this method was used to obtain multiple perspectives on emergency care delivery and the usage of information artefacts. It has been argued as to what is the value or significant of triangulation as it can produce a significant amount of data that could be difficult to analyse (Thurmond, 2001). However, many have seen triangulation in a more positive light. Triangulation can be used to give an in-depth understanding of the investigated phenomena (Fontana & Frey, 2011; Holloway & Wheeler, 2010), to ensure comprehensiveness of the findings (Bryman, 2006) and to ensure validity (Flick, 2009).

The use of at least one type of triangulation technique is very common in the study of healthcare work. The most common being the within method triangulation, i.e. non-participant observation and opportunistic interviews of a qualitative research approach (Abraham et al., 2009; Feufel et al., 2011; Kuziemyk & Varpio, 2011). In this research, this variation of triangulation is also adopted as the researcher feels that in

order to conduct field study with the objective of gaining contextual information regarding emergency care work, observation has to be paired with at least opportunistic interviewing (triangulation is discussed in detail in Section 3.4.7). Another quite common variation of triangulation is the investigator triangulation. In Feufel et al. (2011), in order to compare and contrast clinicians' work practices at two EDs, one observer was allocated at each ED. Although investigator triangulation can potentially decrease bias in gathering, reporting, coding or analysing (Thurmond, 2001), this technique of triangulation, i.e. different observer at different study setting, can cause potential disharmony in the collected data as each observer provided their own interpretation of what was observed. Other studies that have adopted investigator triangulation but at a single setting can also be found (Park et al., 2012). In this case, investigator triangulation was employed mainly to obtain comprehensive understanding of the investigated phenomena. In this research, it is not possible to adopt this variation of triangulation as this is a PhD study involving only a single researcher. Multi-site study (i.e. place triangulation) can also be used as a basis of comparison (Feufel et al., 2011). In this research, this variation of triangulation was adopted not just to obtain a comprehensive understanding on emergency care delivery but also to make comparisons between two emergency care settings.

It is believed that the triangulation technique adopted in this research has allowed not only a comprehensive understanding to be obtained on the investigated phenomena and as a basis of comparison, but to also allow for the transferability of the approach used (transferability is discussed in Section 3.4.10).

## **3.4 Methods**

### **3.4.1. Gaining access to the research settings**

Gaining an understanding of emergency care work required access to EDs. Conducting research at NHS organisations requires that research be supervised and overseen by an employee at the organisation. Negotiation of access at the initial site (i.e. an adult ED) was first established by the research supervisor who contacted (via email) a clinical consultant in Emergency Medicine working at the adult ED, who is also a researcher at the School of Health and Related Research at the University of Sheffield. Following communication between the researcher's supervisor and the consultant, a meeting was organised. The meeting was

attended by the research's supervisor, consultant and researcher. During the meeting, the discussion was directed towards the possibility of conducting the research at the adult ED and the processes required to do so. Other related matter discussed briefly included what the research would be on. The consultant agreed to become the researcher's field supervisor. The researcher kept in touch with the field supervisor during the process of producing the research protocol and submitting the required documentation (as listed in Section 3.4.2).

Similarly, the same method was employed by the research supervisor to establish a request for access to the paediatric ED. From the initial contact, a number of possible field supervisors were suggested. Upon deciding on which one to pursue, the researcher then established communication via emails. The chosen contact was a consultant at the paediatric ED and also a teaching staff member with the School of Health and Related Research at the University of Sheffield. Through emails, the requirements to conduct the research and research topic were discussed. Although the adult ED and paediatric ED are under the management of separate hospital Trusts, the requirements for access permission were essentially similar.

#### **3.4.2. Ethical considerations**

According to Punch (1998), "all social research involves ethical issues" (p. 281). This involves getting permission prior to conducting research or entering the field for data collection, respecting the rights of the participants to participate in the study and to withdraw from the study while the study takes place, as well as the rights of participants for privacy and confidentiality (Holloway & Wheeler, 2010; Punch, 1998). The UK Department of Health (DoH) requires that ethical reviews be conducted before any research can be done on patients, care professionals, tissues, organs or data (Department of Health, 2005). In addition, the Research Governance Framework for Health and Social Care's principles and requirements also need to be taken into account in order to conduct any healthcare research in the UK.

This study required both research governance and research ethics approvals. Research governance approval was obtained from the Research Departments of two different trusts: NHS Foundation Trust A for the adult ED and NHS Foundation Trust B for the paediatric ED. Both the research governance approvals (Appendix 1a and Appendix 1b) were requested via the Integrated Research Application System (IRAS). IRAS is an online research application system for applying access permissions for health and social care research in the UK. The

purpose of a governance approval was to ensure the well-being of research participants and to ensure the quality and continuation of the research. The Letter of Access (Appendix 2a and 2b) and project authorisation (Appendix 3) for the adult ED were received on 15th May 2013. The Letter of Access (Appendix 4) and project authorisation (Appendix 5) for the paediatric ED were received on the 30th Jan 2015. Prior to gaining research governance approval, the researcher was required to do the following:

- To produce a research protocol – (Appendix 6)
- To submit research governance approvals, i.e. IRAS forms (Appendix 1a and Appendix 1b)
- To request the University of Sheffield Research and Innovation Services to act as project sponsor and further to register the project in the University Research Management System (URMS)
- To apply for an enhanced CRB check
- To apply for Data Protection approval - (Appendix 7)
- To complete an Independent Scientific Review (ISR) - (Appendix 8a and Appendix 8b)
- To get Clinical Director and Principal Investigator approvals
- To apply for a Research passport and Insurance – (Appendix 9a and Appendix 9b)

Research ethic approval was also required because of the involvement of human participants and generally covered the rights and well-being of the research participants. This includes the right to be well-informed of the purpose of the study, the right to participate or not to participate, the right to withdraw at any time during the study, the right to be informed of the result of the research and confidentiality issues. As both of the studies only involved NHS staff (i.e. no patient involvement) University of Sheffield ethical approval was sufficient as opposed to NHS ethical approval. Ethical approval (Appendix 10) was received from the University of Sheffield on the 23rd April 2013.

### **3.4.3. Pilot study and immersion in the fields**

The pilot study started during the first case study in the adult ED. The researcher entered the field with broad questions in mind, such as what is the ED workflow; who was working in the ED besides doctors and nurses, and how care processes were delivered. The pilot study was comprised of five participant semi-structured interviews, and a number of

observations that were conducted over the duration of a month, for three to four times a week. From the pilot study, the interview guide (Appendix 11) was slightly adjusted. For example, questions were categorised based on two main themes: work processes and information artefacts. There was also a need for specific questions to be asked based on staff specific roles such as doctors who held the Consultant in Charge (CiC) role. This method is adopted based on similar qualitative workflow-related research conducted in an ED in the US where its interview guides was also loosely structured according to themes (Abraham et al., 2009). The researcher also identified potential research participants and a multitude of information artefacts. The information artefacts include forms and paper-based records as well as organisational documents such as the ED guidelines and computer manuals.

At the start of the research at each setting, the researcher was given a general tour by the gatekeepers, i.e. the field supervisors. The tours provided the researcher with general knowledge of the physical layout of the setting as well as the opportunity to be introduced to some of the staff. Conducting field study research like in emergency care setting where speed of care and patient safety are the main priorities meant that the researcher had to face a number of challenges and difficulties. One of these challenges was the lack of knowledge of what medical work typically entails. This especially had an effect on understanding some of the medical terms used by the research participants during the semi-structured and opportunistic interviews. For example, when the term 'resus' was encountered for the first time, the researcher had to request clarification for its meaning. The researcher also needed to spend at least three to four times a week between five to seven hours each time in order to get used to the environment and at the same time to familiarise herself with medical world. One day of the week was also allocated to reviewing and reflecting on the observation field notes and transcribing the interviews. Slowly, the researcher began to understand the nature of emergency work.

Aside from a lack of understanding of emergency care work, the researcher also had to face the challenge of recruitment of the research participants. The researcher was very fortunate because at both EDs the field supervisors had initially helped in getting some of the research participants. In this way, the study was introduced by someone known to the potential participants, thus getting the ball rolling. From thereon, the snowballing technique (snowballing is discussed further in Section 3.4.5) was used. The role played by the field supervisors had tremendously helped the researcher not only in gaining access to the settings in order to conduct the research, but also to the research participants. However, the researcher still needed to persevere. There were days that no one could be interviewed and

observations were the only method used. Nevertheless, the observation technique provided the researcher the means to observe the contextual work of the care providers and to gain familiarity with the physical layouts, patient flows and information artefacts in use. Gaining the trust of the staff was also a challenge. This was probably due to the feeling that they were being intruded upon as well as concerns regarding patient privacy. In order to overcome this, the researcher made sure the goals of the study were clearly communicated whenever asked and that the study was sanctioned by the Trusts. It was also necessary for the researcher to ensure that the research activities were un-obstructive and that the researcher placed herself in areas that were not in the way of the staff and patients. Additionally, the researcher made sure to wear her ID badge (provided by the Trusts) at all times to prove that the researcher's presence was legitimate. During less busy periods, whenever possible, the researcher participated in informal chats with some of the nurses and doctors.

#### **3.4.4. Data collection methods**

The research employed three data collection methods: interviewing, observation and documentary sources. These are commonly used sociological inquiry techniques particularly effective in understanding the way people actually work rather than the way in which process definitions say they ought to work (Baxter & Sommerville, 2011; Doherty et al., 2010). Therefore, a deeper understanding of the intricate and contextual details of the workflow can be obtained. In particular, the methods played a crucial role in this study as it helped in obtaining a rich description of the interdependencies among the processes, practices and resources (i.e. staff and other resources). These methods are also typically employed in other workflow-related research conducted at healthcare field settings (Abraham et al., 2009; Park et al., 2015, 2012;Unertl et al., 2009).

At the adult ED, data collection took place from 21<sup>st</sup> May 2013 to 11<sup>th</sup> December 2013 with an exception of one interview which was conducted in June 2014. At the paediatric ED, data collection took place from 07<sup>th</sup> February 2015 to 23<sup>rd</sup> April 2015. Data was collected mostly on weekday mornings and afternoons, and a Saturday morning.

#### 3.4.4.1. Interviewing

Two types of interviewing techniques were used in the study, semi-structured and opportunistic interviews. Interviewing is a “very good way of accessing people’s perceptions, meanings, definitions of situations and constructions of reality” (Punch, 1998, p. 174). Although interviews can also be conducted in a group setting (i.e. focus group), this technique was not possible as arranging convenient times for a number of participants was difficult in emergency care settings.

The purpose of the semi-structured interview was to pursue specific lines of inquiry, to follow up on aspects that had been mentioned by others, and to seek clarification on matters arisen from observation where a semi-structured interview guide (Appendix 11) was used. In the interview guide, the questions were grouped according to two themes. The first theme was related to processes and activities related to the emergency care delivery. The second theme was related to the information artefacts used by the participants. The identification of the themes is orientated by the objectives of the research. Organising the interview guide according to themes related to the objectives of the research is a common technique adopted in other workflow-related studies (Abraham et al., 2009; Abraham & Reddy, 2010; Feufel et al., 2011; Park et al., 2012). The guide was designed to gain an understanding of the setting workflow, the work processes and activities of the participants which included their roles and responsibilities, and the information artefacts used.

The interviews which were guided by the semi-structured interview guide (as opposed to structured or unstructured interviews) offered the researcher two advantages. Firstly, the flexibility to capture the research participants’ interpretation of their work without subjecting them to pre-determined categories. Secondly, it offered the researcher the possibility of having more control so that only aspects relevant to the research questions were discussed. During the interviews, a continuous effort was made to ensure that the voice of the research participants was obtained.

No appointments were set prior to the semi-structured interview sessions. This was because setting up appointments for research participants who were working in busy healthcare settings was not deemed suitable. This is based on the advice of the field supervisor at the adult ED; instead of sending emails to invite staff to participate, researcher should approach potential participants face-to-face as this approach could result in higher response rate. However, understanding of their busy schedules and respects should be recognised when adopting this approach. Researcher typically arrived early in the mornings in order to get a

head start. Potential participants were approached during less busy time or during their breaks. As time went by, the researcher found that most early mornings were the best times to approach research participants for interviews as they were most often less busy, although there were other times of the day that researcher were able to recruit participants for interviews. It is also important to recognise the contribution of the field supervisors in helping the researcher to have access to the staff for interviews (as well as access to organisational documents). As they are a part of the workforce, their effort in introducing the researcher to the workforce have been fruitful in gaining trust and acceptance, making it easier in the recruitment process. The interview sessions took place in private locations or in their office. Most of these interviews were conducted on a one-to-one basis with one exception. On the request of the participants, interviews with the reception staff was either conducted one-to-one or in a group of two.

All interviews were electronically recorded and the duration ranged from approximately 15 minutes to 40 minutes. Prior to the start of the interview sessions, the ethical issues needed to be addressed first. The participants were provided with an information sheet (Appendix 12a and Appendix 12b). The information sheet contained information regarding the study, such as who the researcher was, the purpose of the study, why they were chosen as research participants, the risks involved in taking part in the study and the confidentiality of their contribution to the study. If they agreed to participate, they were asked to sign a consent form (Appendix 13) and to complete a participant profile (Appendix 14). They were also informed that the sessions were electronically recorded.

During the interview sessions, the researcher tried to elicit the participants' views, experiences and opinions in their own terms rather than establishing a rigid order of asking questions. Participants were also given ample time to respond to the questions asked. Additionally, they were free to ask for clarification; although care was taken to avoid leading questions in order to ensure the trustworthiness of the research. Flexibility was also required in terms of questions being asked. For example, some senior doctors or nurses had additional roles such as CiC and NiC. There was therefore a need to inquire what these roles were and how these roles were carried out. The researcher also tried to cover as many questions as possible within the available time, as the participants could leave at any time during the sessions, for example, when they were needed for clinical care or if their break had ended. As a result, the length of the interview sessions varied from participant to participant.



Meanwhile, opportunistic interviews were carried out during observations in order to obtain clarification and verification of the participants observed activities (observation is described in Section 3.4.4.2). This line of inquiry is also commonly adopted in other workflow-related research in healthcare (Feufel et al., 2011; Patterson et al., 2006). Additionally, instead of the researcher only documenting what was being observed, it allowed the researcher to become more engaged with the research participants when appropriate. This line of inquiry can generate more in-depth understanding of the phenomena observed. No interview guide was developed for the opportunistic interview as the researcher was only asking ad-hoc questions. Because the ad-hoc nature of this line of enquiry, not all of the opportunistic interviews were able to be electronically recorded. However, the information obtained was recorded in the field notes.

As the opportunistic interviews were conducted while participants were doing their work, the researcher tried to be as brief as possible and focused on questions that were only generated during the particular observations. For example, while doing an observation at the adult ED, the researcher noticed that a nurse was updating a whiteboard at one of the clinical units using different coloured marker pens. The researcher then asked the nurse was there any particular reasons why the different coloured marker pens were allocated at the whiteboard. This specific question allowed the researcher to find out why different coloured of pens were used and whether it was mandatory that colours were used to represent certain types of information. Another example, at the paediatric ED, the researcher noticed that in a clean utility room, a group of clinicians was having a discussion while going over a patient list written on a dry-erase whiteboard. The researcher then asked one of the other staff who was not participating in the meeting what is the meeting all about. From the one opportunistic question asked, the researcher was informed it is the daily clinical review meeting, the same meeting which was described in the ED handbook.

However, a number of opportunistic interviews which involved computer system demonstration usage took longer as the participants were willing to demonstrate to the researcher how they used the system. This type of ad-hoc interviews can last for approximately 40 minutes. For example, at the adult ED, a reception staff member demonstrated what computerised systems were used during a coding process. She demonstrated step-by-step what was done and what issues she had to face while accessing different computerised systems. She also demonstrated how ED patients were registered. On a different occasion, the researcher also managed to get an overview of how triaging was done for ambulance patients at the adult ED. The pit stop doctor demonstrated how computerised

systems were used and what information he needed in order to get ambulance patients triaged. On both of these occasions, the researcher was able to gain an in-depth understanding of the processes which were part of the workflow as well as the usage of the information artefacts. These longer opportunistic interview sessions were electronically recorded. Similarly, at the paediatric ED, a nurse demonstrated how she used the computerised systems during her day to day work as nurse. A junior doctor also demonstrated how she used the same computerised system. From both of these opportunistic interviews, the researcher was able to gain data from different perspectives, a nurse's and a doctor's, and how the same computerised system was used in their daily tasks. In addition, some of the participants had several opportunistic interviews over the course of the observations.

Opportunistic interviewing offered a number of advantages to the research process. First, the researcher did not need to schedule separate time from participants' very busy schedules. At the same time participants were still able to do their tasks as questions were only asked 'on the fly'. Second, it was a workflow study and questions related to the participants' work processes and activities were some of the main questions. During the semi-structured interviews, questions such as 'describe what you do as a nurse' were asked, but during the opportunistic interviews, questions such as 'why did you do that just now?', 'can you show me how you use the information system?' or 'is it common what you did just now?' were asked. The two types of questioning allowed richer understanding on the topic. Third, because of the brief nature of this line of enquiry, the same participants can participate in multiple opportunistic interviews and, both opportunistic and semi-structured interviews.

#### 3.4.4.2. Observation

Observation involves both listening and looking at everyday face-to-face interactions, both verbal and visual which provides data on the social contexts of the study and how people within the context interact (Wallace, 2005). In this study, a semi-structured observation template was used to guide the observation (Figure 3.1) and field notes were used to document what was observed. The template includes a number of components: the when and where of the observation had taken place, and the description of the location, people and activities. The 'who', 'what', 'where', 'when' and 'why' questions are commonly used to guide the observation method (LeCompte, Preissle, & Tesch, 1997).

**Title:** Qualitative Study of Clinician and Non-Clinician Use of Emergency Department Information System (EDIS) and Interaction with EDIS

- *To include diagram of the setting* -

**Field note number:**

**Date:**

**Time started:**

**Time ended:**

**Description of setting and activity:**

**Task:** describe the location, the people within it, giving visual pictures of events, situations and verbatim narratives of individuals' accounts of their perceptions and ideas in context.

**Themes to look out for:**

1. Medicine objects – patient (patient history and affiliation), healthcare teams (consultants, students, nurses, admin staff)
2. Work practice – communication (face-to-face vs. electronic), collaboration (e.g. between doctors & nurses), coordination (e.g. doctors' tasks with nurses' works), power & autonomy
3. Work tasks according to professions (doctors, nurses, admin, etc.)
4. How EDIS users articulating the actual work tasks with the pre-set workflows
5. Patient trajectories (the sequence of encounters a patient has with the healthcare system), clinical pathways
6. Pressure on the system e.g. 4-hour waiting time, unpredictability etc.
7. Information needed/exchanged
8. Interruption/team work/team coordination

**Observer's comments:**

Actions, feelings, interpretation, preconceptions, hunches or working hypotheses, future areas of enquiry & emerging ideas. Every single action, feelings, etc. should be written as a new paragraph.

Figure 3.1: Observation template

During the observations, the researcher acted as a passive observer. In this observation technique, the role of the researchers is solely as an observer and they are detached from the situation (Holloway & Wheeler, 2010). This technique is also known as non-participant observation. This observation technique is particularly useful when the research is looking to provide a description and to conceptualise the 'taken for granted' practices employed by people as they go about doing their daily work (Fitzpatrick & Boulton, 1994). This technique was also chosen as the researcher did not have any medical degree and knowledge to participate in clinical activities. It also allowed the researcher to be non-obstructive and rely on the research settings, research participants and information artefacts as sources of data. In

addition, the researcher also made sure not to impose any interruptions during patient care activities. Observations were stopped when necessary or when requested. This was to make room for the staff and patients as the settings can become very busy.

As stated in Section 3.4.3, at the start of the research in both settings, the researcher was given a tour of the settings by the gatekeepers. Both tours provided the researcher the initial knowledge of the settings' physical layout (physical layouts of the settings are described in Chapter 4). Following the tours, the researcher determined specific locations where observations can be conducted. These locations include the reception office, patient waiting areas, ambulance bay, triaging areas and clinical areas. Choosing multiple locations has been suggested in other workflow-related studies employing observational method (Park et al., 2012). Observations were conducted at these areas multiple times during the weekdays in the adult ED. In the paediatric ED, observations were conducted on Tuesdays and on one Saturday. The times of observation varied to include both mornings and afternoons. The events observed include ambulance patient handover process, clinical care activities, non-clinical care activities such as patient registration and coding, patient transfer, staff interaction and communication among themselves as well as staff interaction with information artefacts. This allowed understanding of the EDs' workflow and practices from variety of perspectives. As the observations progressed, the researcher improved the description of the events and was able to determine further events to observe. However, due to patient confidentiality, the researcher was not permitted to observe direct interaction between clinicians and patients, although the researcher was able to observe it from a distance.

Observations were documented in field notes. The field notes included all the observed events including the staff as well as future areas of enquiry and emerging ideas. In the field notes, a running record of themes to be explored, what to observe next, and questions to ask for interviews and opportunistic interviews were also documented. Since everything that happened in the settings was potentially an important piece of data, the researcher strived to write the most comprehensive notes possible. However, attempts were made to avoid introduction of any biases and self-opinions. The field notes were handwritten while observations were taking place. The notes were then computer-typed on the same day. If this was not possible, the notes were typed not more than three days after the observations to avoid any information loss as the events observed can still be fresh in the researcher's memory. Additionally, computer-typed field notes can also be properly organised for analysis and can include more detailed description, questions or thoughts. Due to restriction set by both settings, none of the observations were video recorded or captured on cameras.

The observation technique offered a number of advantages to the research process. It provided an opportunity for the researcher to identify prospective participants to be interviewed. Additionally, existing questions for the semi-structured interviews were also enhanced or added based on the observations. For example, specific interview questions in relation to some of the roles that research participants were responsible for, were added later. This was necessary as some of the consultants had an additional role as CiC, in addition to their clinical roles. Some senior nurses also resumed roles as NiC or coordinating nurse. At the adult ED, the researcher also noted that in an observation, the patient flow champion was also a qualified nurse (wearing the same uniform) and was able to clarify the difference between the role of a nurse and a patient flow champion during the semi-structured interview with the patient flow champion. Additionally, conducting observation allowed the researcher the chance to identify the information artefacts used during the care processes and to be able to gain clarification in terms of its usage during care processes in opportunistic interviews.

#### 3.4.4.3. Documentary sources

As the objective of the research is to also include an understanding of non-computerised information artefacts in supporting an emergency care workflow, paper-based forms and non-electronic patient documentation (i.e. the ED card) were also part of the documentary evidence for the research. Documentary sources can include both published and unpublished documents ranging from formal to informal documents which are not deliberately produced for research purposes (Holloway & Wheeler, 2010). However, they can still be used to inform research as they are part of the social world of the participants (Payne & Payne, 2004b). They have the advantage of being less susceptible to bias.

In addition to the paper-based forms and patient documentation, ED guidelines and protocols, computer manuals and public-display notice boards and electronic displays were also valuable sources of data. The information within these documents provided insight into the organisational elements of the workflow. For example, ED guidelines provided detailed insights on emergency care work. Computer manuals provided information on system functionalities. They also provided step-by-step instructions on how to perform certain processes, for example, patient registration. The contents of these documents are discussed in detail in Chapter 5 and Chapter 6. Table 3.1 lists the documents collected from each ED.

Table 3.1: Documentary evidence

Adult ED	Paediatric ED
Paper-based records, i.e. all forms and two types of ED card	Paper-based records, i.e. all forms and two types of ED card
A&E guidelines and protocols	Emergency department handbook
Public display notices	Public display notices
Computer manuals and documents related to computerised systems: PTS screen shot, Patient Centre System (PCS) user guide, Integrated Clinical Environment (ICE) user guide and Computer Radiology Information Solution (CRIS) Workflow & Glossary of Terms	Computer manuals and documents related to computerised systems: Integrated Clinical Environment (ICE) user guide, Medway Clinical manual, Filefast reference guide

Using documentary evidence as a source of data has its own advantages. Documentary sources can be as effective and often more cost effective than other data collection methods such as surveys and interviews (Mogalakwe, 2006). Similarly, Yin (1999) argues that documentary sources provide a broad coverage of time and events, and are not created as a result of the study. This is particularly useful as sources such as the ED guidelines and protocols clearly specified how emergency care should be carried out regardless of the time of day. As discussed in Section 3.4.4.2, observation could not be carried out in the evenings and weekends, therefore such guidelines are able to overcome this limitation. Additionally, in case study research, documentary sources can be used in addition to interviews and observations (Payne & Payne, 2004a) and as a triangulation technique (Punch, 1998).

### 3.4.5. Sampling and recruitment

Selecting a sample for a quantitative study or qualitative study is sufficient as it is not necessary or possible to study everyone and everything (Punch, 1998). However, the sample chosen must be representative enough to represent the whole population. The purpose of sampling in quantitative study and qualitative study is different. A quantitative study values generalisation for the whole population by having samples that are randomly or probability

selected (Sandelowski, 1995). On the other hand, in a qualitative study obtaining a deep understanding is necessary and sampling can include artefacts, documents and data.

In this study, research participants were recruited using purposive and snowball sampling techniques with a variation strategy, heterogeneous sampling. The purpose of the sampling technique was used to identify the research participants based on their known group membership (e.g. doctors, nurses, porters). This is because the objective of the research is to gain an understanding of both clinical and non-clinical processes of an ED workflow, which were performed collaboratively among heterogeneous members. In a purposive sampling, a sample is chosen deliberately with some intention based on the judgement of the researcher, for example on the basis of group membership, experience or knowledge (Holloway & Wheeler, 2010). Greenhalgh and Taylor (1997) also emphasise that “to gain an in-depth understanding of the experience of particular individuals or groups; we should therefore deliberately seek out individuals or groups who fit the bill” (p. 741).

Further participants were then introduced by the initial research participants through the snowball sampling. In the snowball sampling, the initial participant assisted the researcher to find other prospective participants. This technique was used because engaging research participants in a busy healthcare setting was difficult. In addition, obtaining a high number of research participants was also a challenge. In order to achieve a higher response rate, gatekeepers who were also part of the sites’ workforce also assisted the researcher in the recruitment process. The snowballing technique can be used when participants are difficult to recruit or inaccessible, or when participants anonymity is needed (Holloway & Wheeler, 2010).

The study also employed a heterogeneous sampling technique. This technique seeks as much variation as possible in choosing the samples where the participants differ from each other on a major aspect (Holloway & Wheeler, 2010). This technique was chosen because the aim of the study was to identify clinical and non-clinical processes performed by an ED multidisciplinary team. This required as much variation as possible. The participants included both the clinical staff, for example, doctors and nurses of various grades and roles. It also included the non-clinical staff, for example, reception staff and porters. This type of non-probability samplings was chosen in order to provide the researcher with a complete understanding of the ED workflow.

Table 3.2 depicts the participant category at each research site. At the paediatric ED clinical technicians, porters, patient flow champions and housekeeping were not members of

the ED team. Nursing staff from a non-NHS organisation, i.e. external nurse, was also not found at the paediatric ED.

Table 3.2: Participant groups

<b>Staff</b>	<b>Category</b>	<b>Adult ED</b>	<b>Paediatric ED</b>
Doctor	Consultant	3	3
	Middle grade doctor	1	1
	Junior doctor	2	2
Nurse	Sister/Nurse practitioner	1	1
	Charge nurse/coordinating nurse	1	1
	Staff nurse	4	2
	External nurse	1	Non-applicable
Medical student		1	1
Care support worker		1	1
Clinical technician		2	Non-applicable
Reception staff		3	2
Patient flow champion		1	Non-applicable
Porter		1	Non-applicable
Housekeeping		1	Non-applicable
<b>Total</b>		<b>23</b>	<b>14</b>

### 3.4.6. Saturation

Saturation is achieved when additional data does not reveal any additional results. There are two types of saturation: data saturation and theoretical saturation. Data saturation is reached when new data adds to data redundancy, whereas theoretical saturation is reached when no new concepts can be added to the study (Holloway & Wheeler, 2010).



However, there is no clear guidance on how to determine when a saturation point has been reached for qualitative research. Holloway and Wheeler (2010) for instance, stated that qualitative research is very specific to the research setting in which sampling is purposive, and a larger sample size can result in less depth. They further stated that 14 to 20 samples from a heterogeneous group are sufficient. They also emphasised that there are no specific guidelines and rules to signify when saturation has been achieved; but it is often a matter of judgement of the researcher. Sharing this view is Harry Walcott, one of the pioneer qualitative researchers interviewed in Baker and Edwards (2012). He iterates that saturation can be achieved by interviewing only one respondent who is the 'person of interest'. It can also be as many respondents as possible, as long as different answers were obtained. He concluded that "we can't establish frequencies but we should be able to find the RANGE of responses" (Baker & Edwards, 2012, p. 4). Another researcher interviewed, Uwe Flick, argues that although epistemological consideration of the research project can influence saturation, other external factors should also be considered. This includes time to complete a research project and, finding and keeping in contact with the participants.

From an epistemology stance, this study achieved saturation when it was found that the new data could not reveal any new concepts, i.e. theoretical saturation. When observations were repeatedly conducted at one location, no new events could be observed. For example, one of the locations at the adult ED was the ambulance bay. Conducting observation multiple times at the ambulance bay only revealed similar events: patients arrived via ambulance accompanied by ambulance staff who then lined up the patients in a queue for triaging and while waiting for the patients turn to be triaged, they went to the reception office for the patient registration process. This observed event was a 'typical' event observed at the ambulance bay. While in interview sessions, subsequent participants did not offer any new information. For example, the doctors and nurses interviewed typically provided similar responses when asked to describe their work. However, external factors such as availability of resources as suggested by Uwe Flick in Baker and Edwards (2012) also influenced the saturation process. This study was limited in terms of time and resources and the researcher has to take this into consideration. In addition, collecting data in emergency settings was very challenging. Therefore, it was not possible to obtain a high number of research participants. Nevertheless, this research managed to acquire a total of 37 research participants of a team of clinicians and non-clinicians. As argued by Holloway and Wheeler (2010), 14 to 20 samples from a heterogeneous group is sufficient for qualitative research.

### 3.4.7. Triangulation

This study employed two types of triangulation techniques: data triangulation and within-method triangulation as shown in Figure 3.2. The use of triangulation has been suggested to enhance validity of a study although it cannot guarantee it (Holloway & Wheeler, 2010). Triangulation can also provide an in-depth understanding and descriptive interpretation of the phenomena under study (Fontana & Frey, 2011; Holloway & Wheeler, 2010) as well as completeness of the findings (Bryman, 2006; Thurmond, 2001).

Data triangulation involves the use of multiple data sources from a different space, person and time (Denzin, 1970). Space referred to collecting data from two emergency settings, an adult ED and a paediatric ED. Conducting research at two research sites allowed for an in-depth understanding of an emergency care workflow covering both adult and paediatric patients. As this is a qualitative case study research where the criterion is on transferability rather than generalisability, space triangulation also allowed for the same methods/concepts developed from the first research setting, i.e. the adult ED applicable to the second research setting, i.e. the paediatric ED. Data was also triangulated using person triangulation. As the ED teams consisted of clinical and non-clinical members, obtaining data from the heterogeneous group of staff that formed the ED multidisciplinary team allowed the ED workflow concepts to be understood from their perspectives. However, due to restrictions imposed by both Hospital Trusts, data triangulation in terms of time was not possible. The researcher was only able to collect data during the weekdays, from 8 am to 5 pm, and some evenings until 7 pm.

In a within-method triangulation, more than one research method of a research approach are used (Thurmond, 2001). In this study, a combination of qualitative interviews, observations and documentary sources were used. The use of an interview and observation together allowed completeness of the data, for example, in the situation where some of the research participants cannot express their views clearly due to lack of understanding of the questions. The use of observation and documentary sources also improved the completeness of the data. For example, while conducting an observation at the paediatric ED, the researcher observed a discussion attended by a coordinating nurse and some nurses and doctors lead by the CiC of the day. From the documentary analysis of ED guidelines (documentary evidence) and a confirmation received from an opportunistic interview, the researcher found that the mini-meeting was a daily review held at specific times every day. The triangulated data from the observation, a documentary source and an opportunistic interview allowed the

identification of a specific work process in the setting. Similarly, in interviews, participants provided their interpretation how they used the computerised information systems in their daily work. The usage of the computer manuals, i.e. the documentary evidence, further allowed the researcher to obtain a more complete usage of the computerised information systems in terms of the functionalities.

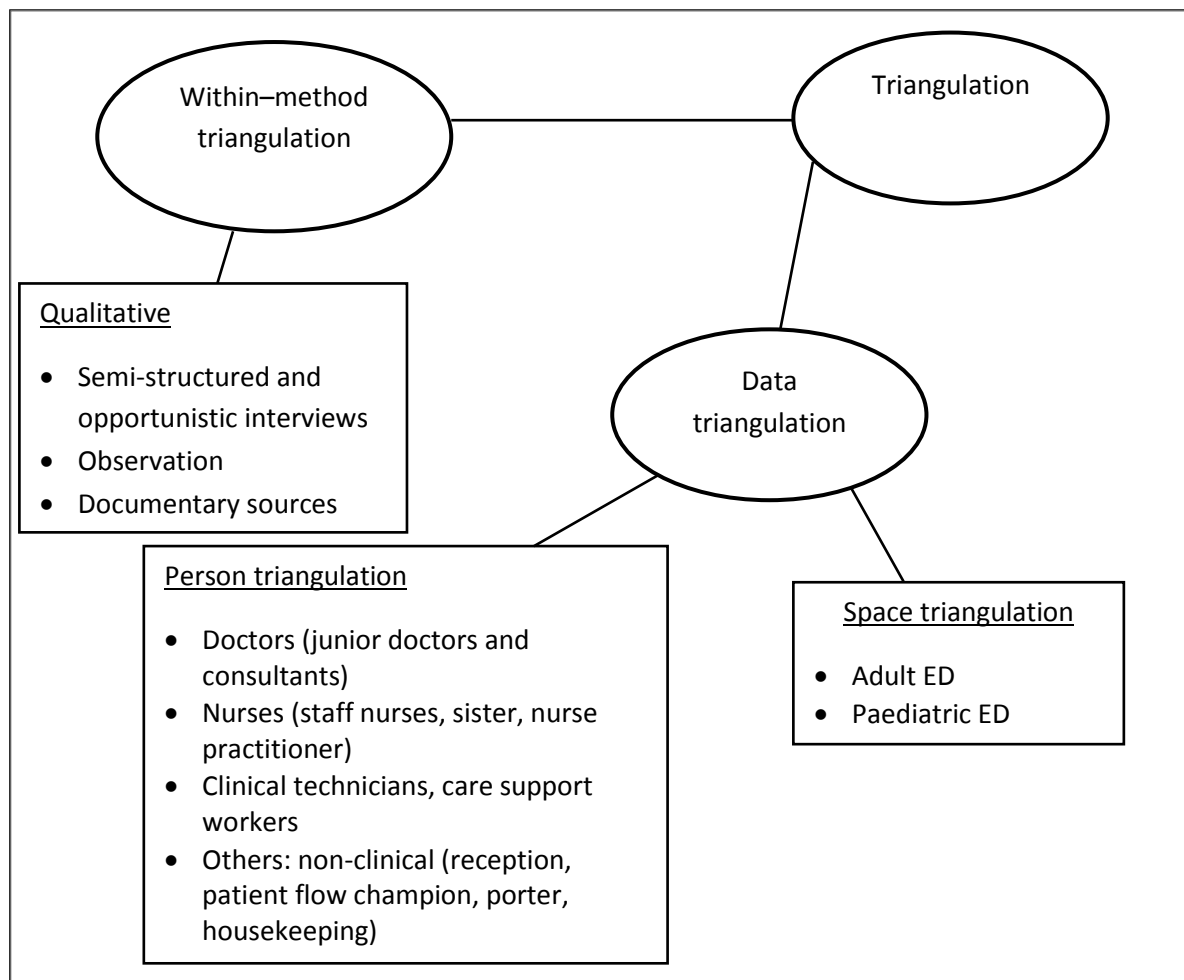

Figure 3.2: Triangulation

### 3.4.8. Data analysis

The data analysis process for the study was an on-going iterative process while data was being collected. The cyclic process of data collection and data analysis allows for the research questions to be updated. According to Pope, Ziebland and Mays (2000), qualitative research which begins with broad or general research questions can eventually lead to more specific

research questions as data is collected. The cyclic process had also allowed for certain lines of enquiry to be developed in greater depth. Nonetheless, once data collection ended, there was still much analytical work to do.

The qualitative data analysis used in this study is the thematic analysis (Braun & Clarke, 2006). It has the potential to provide a rich and detailed account of the data. In a thematic analysis a theme “captures something important about the data in relation to the research question, and represents some level of patterned response or meaning within the data set” (Braun & Clarke, 2006, p. 84). In a thematic analysis, instances of a theme cannot be based on the frequency that a term or a phrase appears in the data as the content analysis approach (Hsieh & Shannon, 2005). As such, aspects of relevance to the research questions can be captured. There are two ways that themes can be identified. It can be identified inductively where the coding process is done “without trying to fit into pre-existing coding frame or the researcher’s analytic preconceptions” (Braun & Clarke, 2006, p. 85). This method bears similarity to the grounded theory approach (Payne & Payne, 2004c). Although a data driven analysis technique, the researcher cannot code in an epistemological vacuum (Braun & Clarke, 2006). In contrast to this approach, the ‘theoretical’ approach is driven by the researcher’s theoretical or analytic interest; therefore, it is explicitly analyst driven (Braun & Clarke, 2006).

This study adopts a hybrid approach: combination of inductive and deductive techniques to identify the themes. As suggested by Braun and Clarke (2006), the flexibility of a thematic analysis should not be restricted. By combining the hybrid approach, an attempt was made to allow relevant themes to emerge directly from the data, while at the same time making sense of the themes through the theoretical resources from workflow-related studies. Additionally, by adopting this approach the possibility of not capturing important aspects of the phenomena under study with the sole use of an inductive technique could be avoided (Sarker and Sidorova, 2006).

In doing the thematic analysis, the five-step process of the Framework Analysis was used (Srivasta, 2009). The steps are: 1) Familiarisation; 2) Identifying a thematic framework; 3) Indexing; 4) Charting; and 5) Mapping and interpretation. These steps were taken to analyse all data sources: interviews, observations and documentary evidence. However, these steps were not followed in a linear fashion but rather iteratively, and in a reflective manner. This included the researcher moving back and forth across empirical data and the theoretical resources.

### Step 1: Familiarisation

Familiarisation involves the process of immersing oneself with the data by listening to the recordings, reading the transcripts and studying the field notes (Braun & Clarke, 2006). During this stage, the researcher spent hours immersing herself in the raw data. This involved listening to all of the recorded interviews and reading the verbatim interview transcripts. Familiarisation also involved the process of reading, commenting and reflecting on the handwritten observation field notes and, subsequently the field notes were then computer-typed. Given that the researcher transcribed most of the interview recordings, documented all the field notes and subsequently computer-typed the field notes had allowed the researcher to fully immerse herself with the collected data thus gaining a holistic sense of the empirical data. The documentary sources were also subjected to the familiarisation process where all documents were read, commented and reflected on.

During the familiarisation process, emerging ideas and issues were also recognised. These ideas were relevant to the understanding of emergency care work which was further incorporated during the analysis stage. As a result, most of these ideas were reflected in the findings.

### Step 2: Identifying a thematic framework and Step 3: Indexing

Once the researcher was familiarised with the data, the coding process started. During the coding process, data was examined line-by-line in order to identify initial codes and categories. It was an iterative process: initial codes and data segments were compared and further analysed to allow for the development of new codes and categories and the refinement of existing codes and categories. During this process, codes were annotated at the margins of the text. The codes were then copied to another word document to allow for easy groupings of similar codes. It is an iterative process where developed codes were checked and re-checked resulting in a reconsideration of previous choices: giving a segment multiple codes or fully removing a segment to a different code. The codes that overlapped or had similar content were double-checked by looking at the segments included in each code. The checking and re-checking of categories provides insightful interpretation (Polit & Beck, 2013). Examples of codes include patient arrive via ambulance, walk-in patient arrival, staff doing registration process, staff using Manchester triage, staff doing observation and using information artefacts

to do documentation. These codes were then created as NVivo notes for the next step, i.e. charting. Table 3.3 lists some of the sample codes and its related vignettes.

Table 3.3: Assignments of codes and categories to vignettes

Vignettes	Data sources	Codes	Categories
A number of ambulance patients arriving via the ambulance entrance. Some are on stretchers and some on wheelchairs. All are assisted by the ambulance staff.	Observation documented at ambulance bay (Adult ED)	Patient arrive via ambulance	Patient flow into the ED
Walk-in patients arriving from the main entrance. Most patients are accompanied by family/relatives. One patient with a family member went straight to the registration counter. Some prefer to find some place to seat first and their family members go to registration on their behalf.	Observation documented at the main waiting area (Adult ED)	Walk-in patient arrival	Patient flow into the ED
Two reception staff members are busy registering walk-in patients. Questions such as what is your health problems, where are you staying and who is your GP seem to me very common.	Observation documented at the main waiting area (Adult ED)	Staff doing registration for walk-in patients	Organisational work process
An ambulance crew 'presenting' a patient to a registration staff, communicating basically the same information required from walk-in patients while referring to a document on a clipboard.	Observation documented from inside the registration office (Adult ED)	Staff doing registration for ambulance patients	Organisational work process
A reception staff doing a coding process. <i>"This is only part of it, actually and what this is, is the doctors when they do the coding [on the ED card] miss investigations off the back of the [ED] card. What they are supposed to do is tick them, when somebody has a CT or whatever of these, they forget to tick them. Don't ask me why, I've no idea why, but it is very common"</i>	Observation at a reception office and opportunistic interviewing with a reception staff (Adult ED)	Coding process using an ED card and several computer applications running concurrently on a computer	Negative impact of a hybrid information implementation on coding process

<p><i>“When the patient arrives, on the pit stop, one of the consultants is there ... if he [pit stop doctor] thinks that the patient needs a blood [test] so that he [pit stop doctor] can request blood [blood test] from the pit stop</i></p>	<p>Opportunistic interviewing with a clinical technician (Adult ED)</p>	<p>Triage assessment for ambulance patients by pit stop doctor</p>	<p>Clinical process</p>
<p><i>“it will be one of the nurses round here [at the main department] that will do it. And so they'll just triage the patient as they would round there [at the Patient Assessment Room] and just complete it on the computers round here”</i></p>	<p>Interview with a nursing staff (Paediatric ED)</p>	<p>Triage assessment performed at other location besides the patient assessment room</p>	<p>Clinical process</p>
<p><i>“... if I am in charge [as a CiC] and I want to know what's going on with this patient, so the only way to do that is if somebody [doctors] has put their name on it [using Medway], so now I know this is Jane Doe [anonymised patient], if that [doctor's name] wasn't there I would have to go find the patient, find the [patient ED] card, open the notes, look at the writing and see who [doctor] has seen her, so if it's on here [Medway] I don't have to do any of that do I? ...So that bit with just the doctors name is actually quite important because [it] tells you who is responsible, the initial clinician for the patient and the department has 50 or 20 or whatever patients and half a dozen, a dozen clinicians, or more” (Consultant A).</i></p>	<p>Opportunistic interviewing with a consultant on how he used the Medway computerised system (Paediatric ED)</p>	<p>Analysing workload assignment using the Medway computerised system</p>	<p>Utilising a computerised system in supporting resource management task</p>

The thematic framework was constructed by collating these codes. This is also an iterative process where themes were reviewed in relation to the coded segments and the entire data set. The final thematic framework consists of two main themes with sub-themes. The first theme discusses the ED workflow as components of services, staff, clinical and non-clinical processes. This includes discussion on the roles and responsibilities of the multidisciplinary members of the team as well as the execution of clinical and non-clinical processes. The second theme discusses the functionalities of all information artefacts,

characteristics of the information artefacts in supporting the collaborative nature of emergency work as well as issues faced with existing information architecture implementation. Overall, the construction of the thematic framework was iterative which was continuously refined as analysis proceed (Ritchie & Spencer, 1994).

#### Step 4: Charting

NVivo was used during the charting process. Prior to the actual charting process, word processor files of the verbatim interview transcripts and observation field notes were exported to NVivo. One of the steps in the charting process was moving the textual data from its original textual context to NVivo nodes. These nodes were created to represent the categories and codes developed in Step 3. As pieces of data from the interview transcripts and observational notes were being charted, nodes or sub-nodes were continuously updated and refined. Refinement of categories is the norm in a qualitative analysis (Flanagan et al., 2011).

NVivo was a very valuable tool in supporting the charting process. The tool made it feasible to refine the initial coding framework and went through several iterations. However, it was the researcher who came out with the coding framework and made sense of the data.

#### Step 5: Mapping and interpretation

During mapping and interpretation, concepts are defined and associations between themes are determined in order to provide an explanation and interpretation of the findings (Pope et al., 2000). During this process, the researcher interpreted the data as a whole. This included defining the concepts, finding associations, providing explanations and developing strategies to support the interpretation with literatures. This process also included devising the workflow diagrams. The interpretation from each case study is summarised and discussed in the findings and discussion chapters. This also includes discussion on the similarities and differences of each case study findings.



#### **3.4.9. Triangulation of interviews and observational field notes with documentary sources**

Documentary sources obtained from the research settings were used to triangulate the analysis of the interviews and observational field notes. For example, the ED guidelines obtained from both EDs were useful in providing an in-depth understanding of the organisational aspects of the research settings, for example the myriad roles clinical staff can be assigned to. Other documents such as the main patient care documentation, i.e. the ED cards, and order request forms were also used to complement the overall analysis.

The codes generated from the analyses discussed in Section 3.4.8, were assigned to the contents of these documents. For example, the description on the responsibility of a CiC taken from the ED guidelines obtained from the adult ED was assigned to category 'ED team members'. Therefore, the category within the theme 'ED workflow' also consists of the description of a CiC role from the ED guidelines and hence complementing the data from the interview transcripts and field notes. Codes were also assigned to other documents, such as the forms and computer manuals. For example, a PTS screen shot obtained from the adult ED was categorised under the 'information artefacts' category. This was used to provide a detailed description on system content and usage. This technique allowed the researcher to fully describe or support the interpretation given by both the interview and observation data.

#### **3.4.10. Research trustworthiness**

Trustworthiness is used to demonstrate the reliability and validity of qualitative research (Holloway & Wheeler, 2010). It encompasses four criteria: credibility; transferability; dependability; and confirmability. Credibility is the most important criterion and means that the findings are the 'truth' and accurate in the social context or phenomena being studied. In this research, the credibility was achieved in two ways: members checking activity and reflexivity (Holloway & Wheeler, 2010). The member checking activity was conducted at the adult ED after the analysis was completed. During the member checking activity, an invitation letter (Appendix 15a), result summary (Appendix 15b) and evaluation sheet (Appendix 16) were sent to the participants in order to obtain their feedback and to confirm that the findings were valid. The analysis was revised based on the feedbacks received. However, only five responses were received out of the 23 research participants. The low response rate was partly due to the busy nature of the ED. In addition, some of the participants were no longer accessible. The external nurse and the medical student had left, thus the member checking

feedback cannot be obtained from them. In addition to member checking activity, the researcher strived to provide detail description of the data collection and analysis processes as suggested by Baxter and Jack (2008). This is demonstrated in Section 3.4. The section demonstrates the procedures taken in conducting the research in order to show how the conclusion of the research was reached. Another method to achieve credibility is reflexivity (Holloway & Wheeler, 2010). Reflexivity is the awareness of the interaction between researchers and participants, as well as researchers' values and past experiences which could shape the process and outcome of the research. In this research, reflexivity was possible because the researcher does not have any prior experience working in healthcare organisations which could have an influence on the research process and findings.

The second criterion of trustworthiness is transferability which means that the findings or the concepts developed in the current qualitative research are relevant or applicable to similar situations. In this research, transferability was demonstrated by collecting rich data using the multiple triangulation approach discussed in Section 3.4.7. The multi-site study provided an opportunity for transferability as methods/concepts developed from the first research setting, i.e. the adult ED applicable to the second research setting, i.e. the paediatric ED. The methods adopted and concepts developed can also be transferred to the study of other emergency care settings with similar organisational and information infrastructure implementation.

The third criterion of trustworthiness is dependability. This refers to the consistency and accuracy of the research findings resulting from an analysis that is thoroughly performed, in which the context is sufficiently described (Holloway & Wheeler, 2010). This ensures that the research can be repeated. The dependability of the research was established by maintaining complete records of all the research phases, starting from the initiation to the conclusion of the research. This included all the documents related to the application process, data collection instruments, interview recordings and verbatim transcripts, field notes and documentary sources. All these documents provided a full picture of the research process.

The final criterion is confirmability. Confirmability may be interpreted as an equivalent to objectivity (Holloway & Wheeler, 2010). It means that the findings are not the result of the researcher's biases, prior assumptions and/or values. In this research, confirmability was achieved by limiting the researcher's own knowledge or assumptions while data collection was conducted. For example, during the interview sessions leading questions were avoided. Instead, the researcher waited for the participants to think of what and how to respond to the

questions and allowed time for them to add or elaborate as needed. Additionally, prior to the data collection, both the interview guide (Appendix 11) and observation template (Figure 3.1), were discussed with the research supervisor.

### **3.5 Methodological limitation**

As listed in Table 3.2, a diverse range of staff were interviewed to reflect a full range of the opinions of the EDs multidisciplinary team. However, obtaining a high number or a similar number of participants for each group was not possible. This was because the number of participants for each group was not the same. For example, there were more nurses than care support workers. Engaging participants was also a challenge as EDs are a busy work environment and staff may not have regarded the study as a high priority, particularly compared to caring for patients.

Conducting non-participant observation in busy settings also has its limitations. First, it was not possible to observe the participants and events all of the time. However, as many observations were conducted as possible. This included observations on the interaction of staff with information artefacts such as when members of staff used the whiteboards, the ED cards or any of the computerised systems. Observations also involved observing events such as the overall emergency care activities. The researcher was also not permitted to directly observe provider-patient interactions due to patient confidentiality and privacy. However, for further exploration and elucidation, opportunistic interviews (discussed in Section 3.4.4.1) were conducted whenever possible. Participants also participated in semi-structured interviews, which prompted the participants to cover issues which otherwise might remained unobserved.

Also, due to accessibility restrictions imposed by the Trusts, observations at the adult ED were conducted in the weekday mornings, afternoons and some evenings. At the paediatric ED, observation was conducted once a week on Tuesdays and on one Saturday, 8.30 am to 7 pm. These observations however, were repeated multiple times, and at various locations within the department and triangulated with interview methods and analysis of documentary evidence such as the ED organisational documents. The triangulation technique discussed in Section 3.4.7 provided a detailed description on the ED workflow and its supporting information artefacts.

The data collection and analysis were performed by a one researcher (the PhD student), as this is the nature of a postgraduate study. However, to reduce bias, the process of collecting and analysing the data were discussed with the research supervisors. The validity of the results was also checked by employing the triangulation technique (discussed in Section 3.4.7) and carrying out the

member checking activity (at the adult ED). It was also not feasible to conduct a larger scale study because of limited time and funding. Gaining access to UK healthcare settings required extensive procedures which included CRB check, ISR, research governance and ethical approvals (discussed in Section 3.4.2). Moreover, this is a qualitative research whereby transferability instead of generalisability is sought.

### 3.6 Conclusion

This chapter has discussed the methodology for the current research according to the research onion framework by Saunders et al. (2012). This is summarised in Figure 3.3. The methodology adopted was discussed in detail, in addition to other workflow-related studies conducted using the fieldwork approach. Following that, the qualitative data collection methods, e.g. interviewing, observation, documentary sources, sampling and recruitment, were presented. The next chapter, Chapter 4, describes the case study settings where the research was conducted.

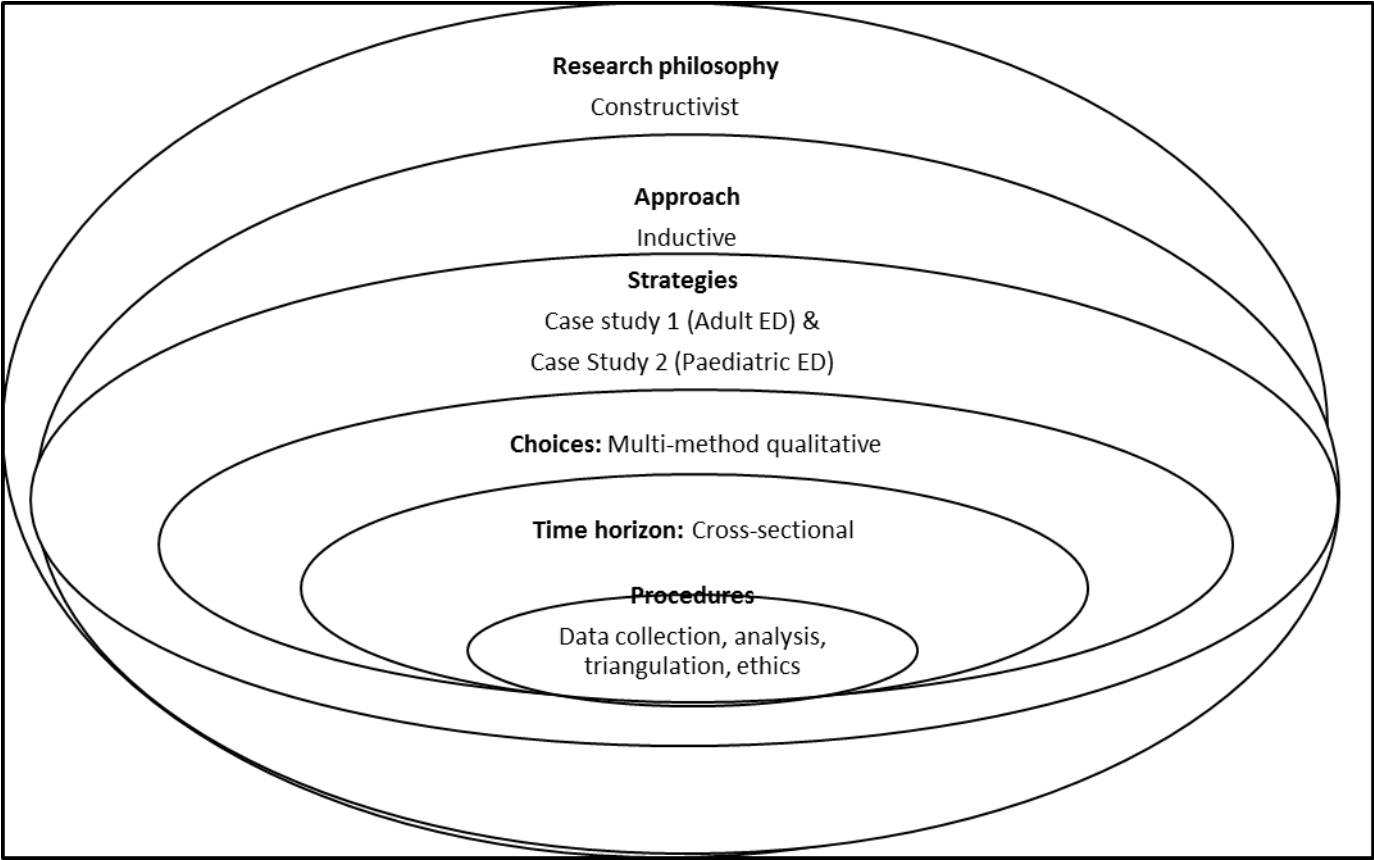

Figure 3.3: Research Onion - adopted from Saunders et al. (2012)

## CHAPTER 4: RESEARCH SETTINGS

### 4.1 The adult Emergency Department (ED)

#### 4.1.1 Description

The adult ED is a Type 1 ED located in South Yorkshire, England. It provides emergency care for adults of 16 years and above, 24 hours a day, 365 days a year.

The ED provides care from minor injuries and medical illnesses to life threatening emergencies. It also includes specialised services: a Chest Pain Observation Unit and Deep Venous Thrombosis (DVT) Unit. In addition to providing emergency care, the department also provides teaching and research. Staffing at the ED includes eleven consultants, an ED manager, a matron and a nurse consultant.

#### 4.1.2 Physical layout

Figure 4.1 shows the floor plan of the department. There are three main clinical areas: minor injury unit, major unit (comprised of blue sub-unit, red sub-unit and resuscitation sub-unit) and Clinical Decision Unit (CDU) (These units are further elaborated in Chapter 5). Each clinical unit and sub-unit has its own nursing station and patient beds. Patients are assigned to these clinical units depending on the severity of their illnesses or injuries. The process of assigning patients to the clinical units is also discussed further in Chapter 5. In addition to the clinical units, there are ambulance bay, waiting areas, triage room, reception counter and office. Patients arriving via ambulance go through their emergency care trajectory starting from the ambulance bay. Walk-in patients wait at the main waiting area adjacent to the main entrance. Triage room is used for triaging walk-in patients and the reception counter is where a patient registration is conducted.

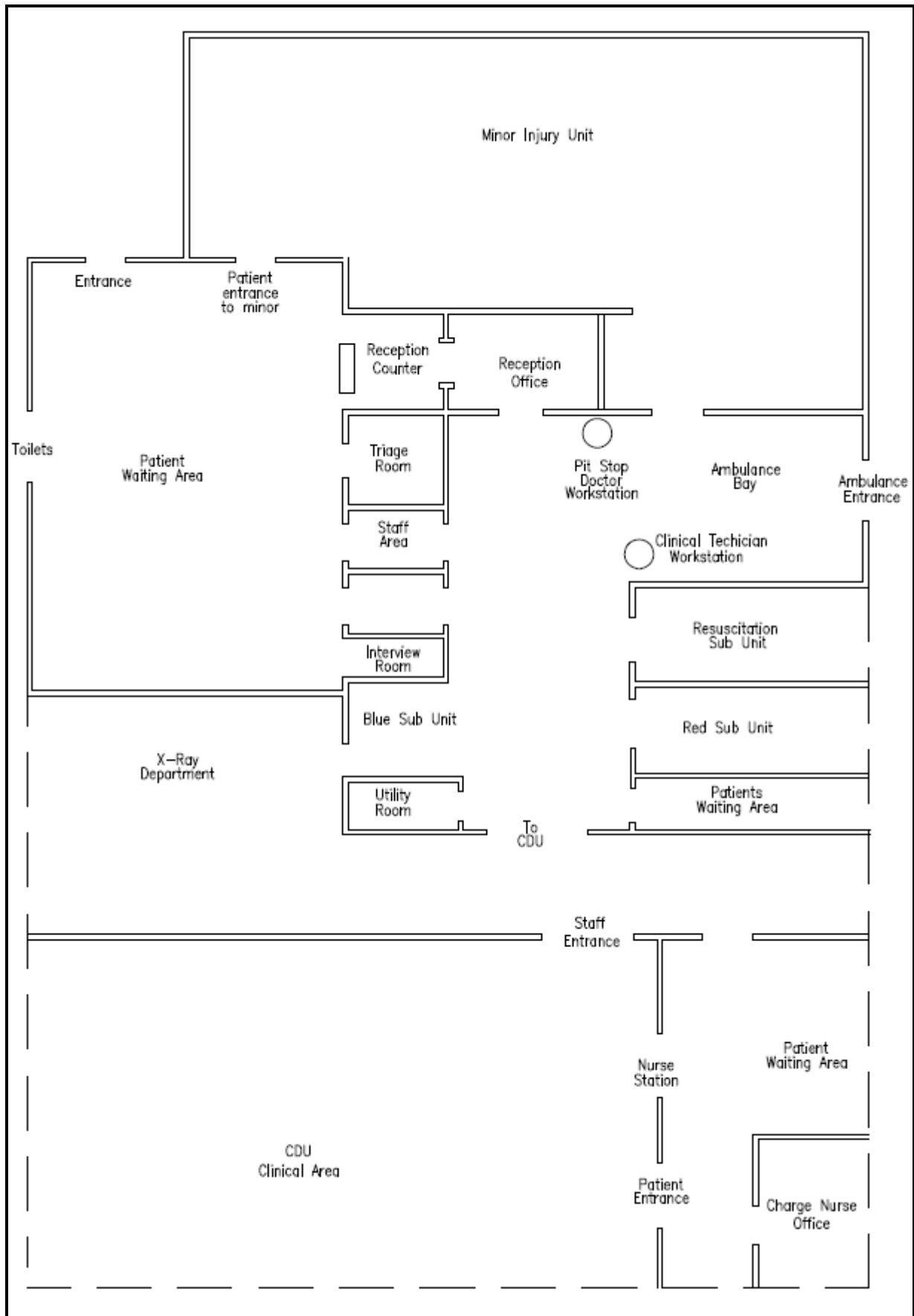

Figure 4.1: Adult ED floor plan

## **4.2 The paediatric Emergency Department (ED)**

### **4.2.1 Description**

The paediatric ED is also a Type 1 ED located in South Yorkshire, England. It provides emergency care for infants and children below 16 years old, 24 hours a day, 365 days a year. It receives approximately 52,000 children every year (Sheffield Children's NHS Foundation Trust, 2016). Staffing at the ED includes approximately 20 clerical/reception, 68 nurses and 26 doctors. In addition to providing emergency care, the department also provides teaching and research.

### **4.2.2 Physical layout**

Figure 4.2 shows the floor plan of the ED. The ED is divided to two main areas: waiting area and main department. The waiting area is where patients wait prior to being called by staff to receive care. The triage nursing room, reception counter as well as two consultation rooms are part of this area. Adjacent to this section is the main department. The main department and the waiting area are separated by a double door. It houses the clinical areas, nursing workstation, clean utility room and radiology waiting area. The clinical areas are: a resuscitation room with two beds, trolley bay with six beds, High Dependency (HD) area, treatment bays A to D, a play room and two consultation rooms. Patients are assigned to receive treatment at one of the clinical areas depending on whether they are ambulant or non-ambulant. This is discussed further in Chapter 6. A nursing workstation is adjacent to the clean utility room which is a room where nurses are based. The radiology waiting area is where ED patients wait prior to be called by a radiologist from the Radiology Department for x-ray/scan examinations.

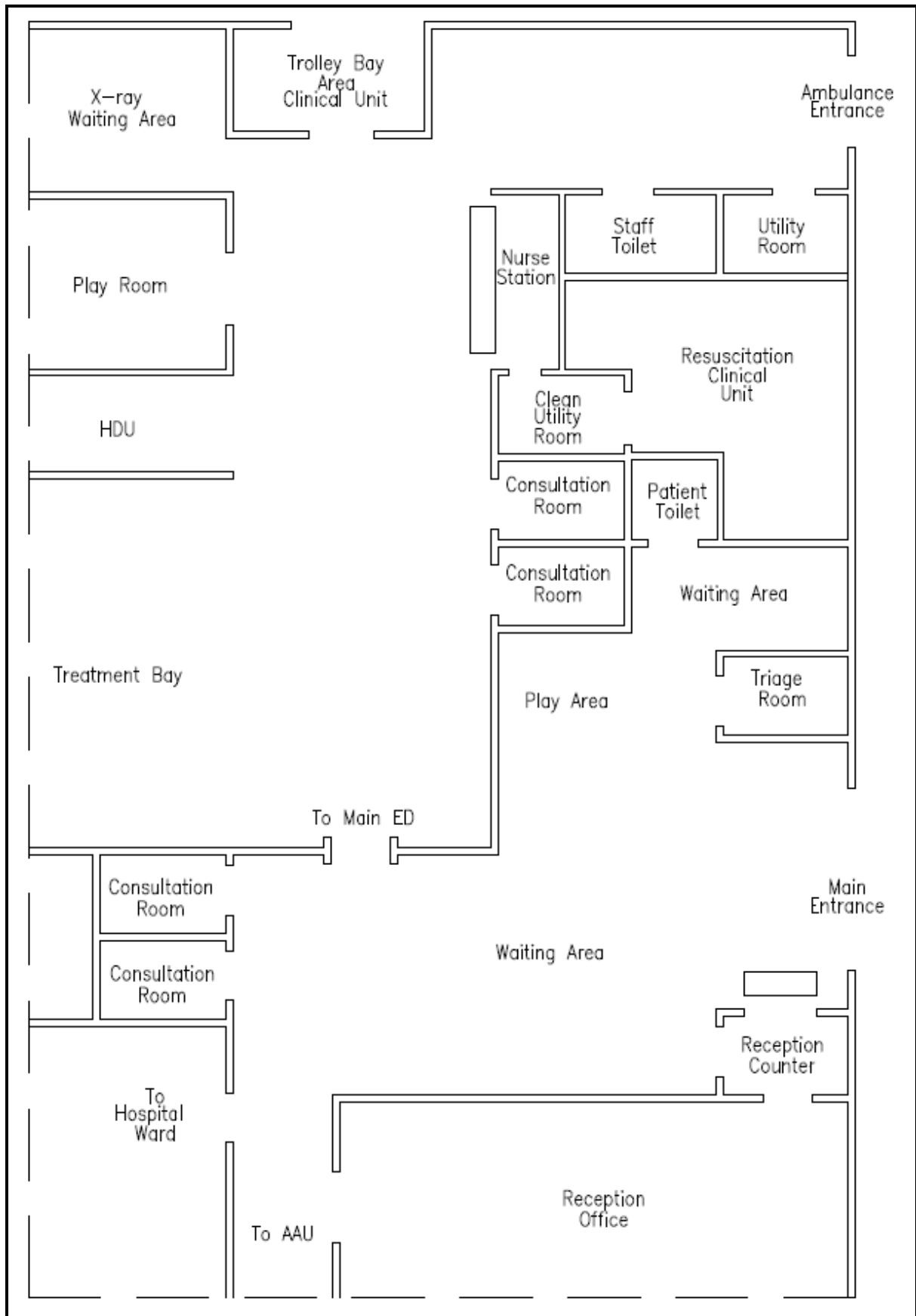

Figure 4.2: Paediatric ED floor plan



## **CHAPTER 5: CASE STUDY 1 – ADULT ED**

Having introduced the contextual description of the research settings in Chapter 4, this chapter presents the case study findings in the adult Emergency Department (ED). The findings are presented according to two main themes. The first theme describes the components that make up the ED workflow, which includes the emergency care services provided and the collaborative work processes of the heterogeneous staff members. The second theme describes the functionalities afforded by the information artefacts and issues associated with their integration into the ED workflow. The themes and sub-themes are graphically presented in Figure 5.1 including the section number within the text. Following the discussion of these themes, a synthesis summarising both themes is discussed in Section 5.3.

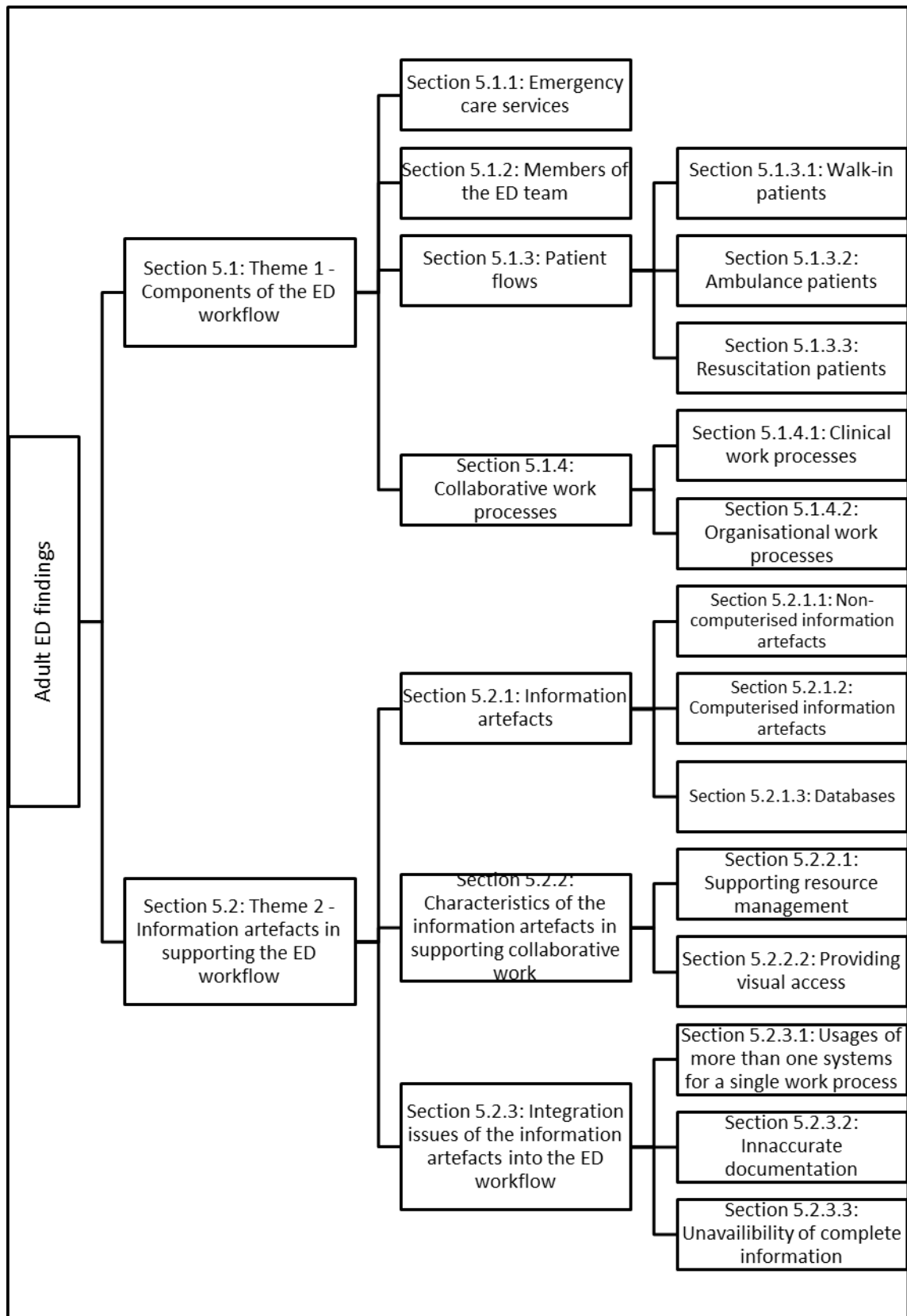

Figure 5.1: Themes and sub-themes of the findings

## 5.1 Components of the ED workflow

This theme represents the components of the adult ED workflow. Its organisation is based on the broadly defined workflow term given in Section 1.2. The section also highlights the emergency care services provided by the ED. The construction of this theme is based on the analysis of the field notes, documentary evidence and interviews, as explained in Chapters 3 and 4. An in-depth understanding of the workflow is necessary to move on to the next themes, which describe to what extent the workflow was supported by the information artefacts.

### 5.1.1. Emergency care services

The vignette below is one of the researcher's first observations. It shows that the adult ED covers quite an extensive physical space comprising several clinical areas which are clearly labelled: ambulance bay, minor injuries unit, resuscitation unit, red unit, blue unit and Clinical Decision Unit (CDU):

*“Walking along the corridor of the main department area, I pass the ambulance bay. Parallel to the ambulance bay is the minor injuries unit. The first door after the ambulance bay is the resuscitation clinical area. The word ‘resuscitation’ is written on the wall just above the door. Opposite the resuscitation clinical area is the blue clinical area. There is no door, but the area is still physically separated from the corridor. I then walk a bit further. On the left is the red clinical area. The area is separated by a double door but the door is open. I then pass a double door which is also open, walk to another double door which leads to an area labelled CDU. This is quite a big department but all these areas were clearly labelled so anybody can tell where they are”.*

Patients are assigned to these clinical units depending on the severity of their medical conditions or injuries. Segregating patients to different clinical areas according to the level of injuries and illnesses is common practice in emergency settings (Feufel et al., 2011; Park et al., 2012). From an opportunistic interview with a nurse, she stated that the major unit was for patients who are critically ill or injured, where the resuscitation blue and red units are categorised as the major unit. Each of these sub-units contains individual treatment areas separated by curtains. The red and blue sub-units are for patients with less life-threatening conditions. Critically ill or critically injured patients, who require immediate and one-to-one emergency care, receive treatment from the resuscitation sub-unit. Meanwhile, the minor injuries unit is for patients with less severe injuries and illnesses. These include patients requiring treatment for small cuts, for example, or patients requiring treatment for minor

illnesses, such as localised infections and eye/ear problems (Opportunistic interview – Doctor D). The unit also consists of individual treatment areas separated by curtains.

Another clinical area, the CDU, functions slightly differently. This is because only some patients, either from the minor injuries unit or the major unit, are sent to the CDU to wait for further actions/decisions. For example, patients from the major unit or minor injuries unit were sent to wait for blood test results and/or scan results, to be transported to other wards, to wait for mental health input or to wait for the discharge response team (public display notice). Unlike the other two units where patients were allocated trolleys while receiving treatment, CDU patients were only allocated to trolleys as needed, while the rest waited at the seated area. CDUs, or otherwise referred to as observation units, are not common clinical areas that can be found in all UK EDs (Woloshynowych et al., 2006). However, a CDU or an observation unit can be a promising way for managing patient flow. For example, a CDU can allow for additional time for proper investigations to be conducted, thereby preventing unsafe discharges (Cooke, Higgins, & Kidd, 2003). Additionally, observing chest pain patients for up to 23 hours in a CDU can potentially save resources as opposed to admitting them to an Intensive Care Unit (ICU) (Institute of Medicine, 2006).

Delivering emergency care is governed by rules and protocols so that patients receive treatment within an acceptable time frame and in a safe manner. In the adult ED, there are a number of time-related target rules applicable to all patients as well as patients with certain categories. For example, the four-hour target rule is imposed on all patients receiving emergency care in the UK, where the purpose is to reduce patient waiting times (UEC Review Team and ECIST, 2013). This means that patients receiving treatment from the minor injuries unit and major units are all to receive treatment within the four-hour limit. However, there are concerns regarding its implementation. Too much emphasis on it could mean that patients who can safely receive treatment in far less than four hours can be overlooked (Department of Health, 2004a). It also places patient care within a more restrictive time frame (Woloshynowych et al., 2006).

In addition to the nationally imposed time target, the ED has also implemented its own time-related rules. For example, a twelve-hour bed wait is imposed on CDU patients or patients who have received a decision for discharge (i.e., either home discharge or in-hospital admission) where they cannot wait more than twelve hours in the CDU or for hospital beds (interview with a patient flow champion). There is also a target described as a *chest pain rule-*

out which is only applicable to chest pain patients (opportunistic interview with Reception staff A).

In addition to the time-related target rules, the ED workflow also includes trigger points. Triggers points are mainly situations indicating that the ED is reaching its full capacity. From the documentary analysis of the ED's guidelines and protocols, there are seven trigger points that the ED team have to be aware of. Whenever any of these trigger points are encountered, plans, such as the reshuffling of nursing resources, should be devised:

- i. More than five patients waiting for beds;
- ii. Waiting in excess of two hours to see a doctor in Majors [red, blue and resuscitation sub-units];
- iii. Waiting in excess of two hours to see a clinician in Minors (for more than 5 patients);
- iv. Notification of the imminent arrival of a trauma case where the wait in the department is already two hours or more;
- v. Any patient in the ED blue or red team corridor (as the cubicles are full);
- vi. Resus [resuscitation] at full capacity; and
- vii. CDU at full capacity.

#### 5.1.2. Members of the ED team

It is frequently cited in the literature that ED team members are multidisciplinary, including clinical staff and non-clinical staff. Doctors and nurses, for instance, are clinical staff members while a secretary is a non-clinical member (Reddy & Spence, 2006). Similarly, as expected, the clinical members at the adult ED also consisted of doctors and nurses. Unlike in EDs in the USA, where doctors are categorised as either attending physicians or resident physicians (Park et al., 2012), doctors in the adult ED are categorised according to grades: junior doctors, middle grade doctors and consultants (Figure 5.2). Nursing staff, on the other hand, can include sisters, Emergency Nurse Practitioners (ENP) and staff nurses. Other members or support staff includes clinical technicians, care support workers, porters, patient flow champions, reception staff and housekeeping staff.

In addition to delivering clinical care, clinical staff members can also be assigned to perform other duties. For example, some senior clinical staff members can resume roles, such as the Consultant in Charge (CiC), pit stop doctor, Nurse in Charge (NiC) and triage nurse. Doctors at the consultant level have the additional CiC and pit stop doctor roles while the NiC

role is assigned to senior nursing staff, i.e. sisters. A CiC and NiC frequently work together in managing staff work assignments or re-assigning staff according to changing workloads (ED guidelines and protocols). A CiC also holds an advisory role where he/she is responsible to supervise and give advice to junior doctors. In contrast, a pit stop doctor's role is a clinical role responsible to provide triage to ambulance patients.

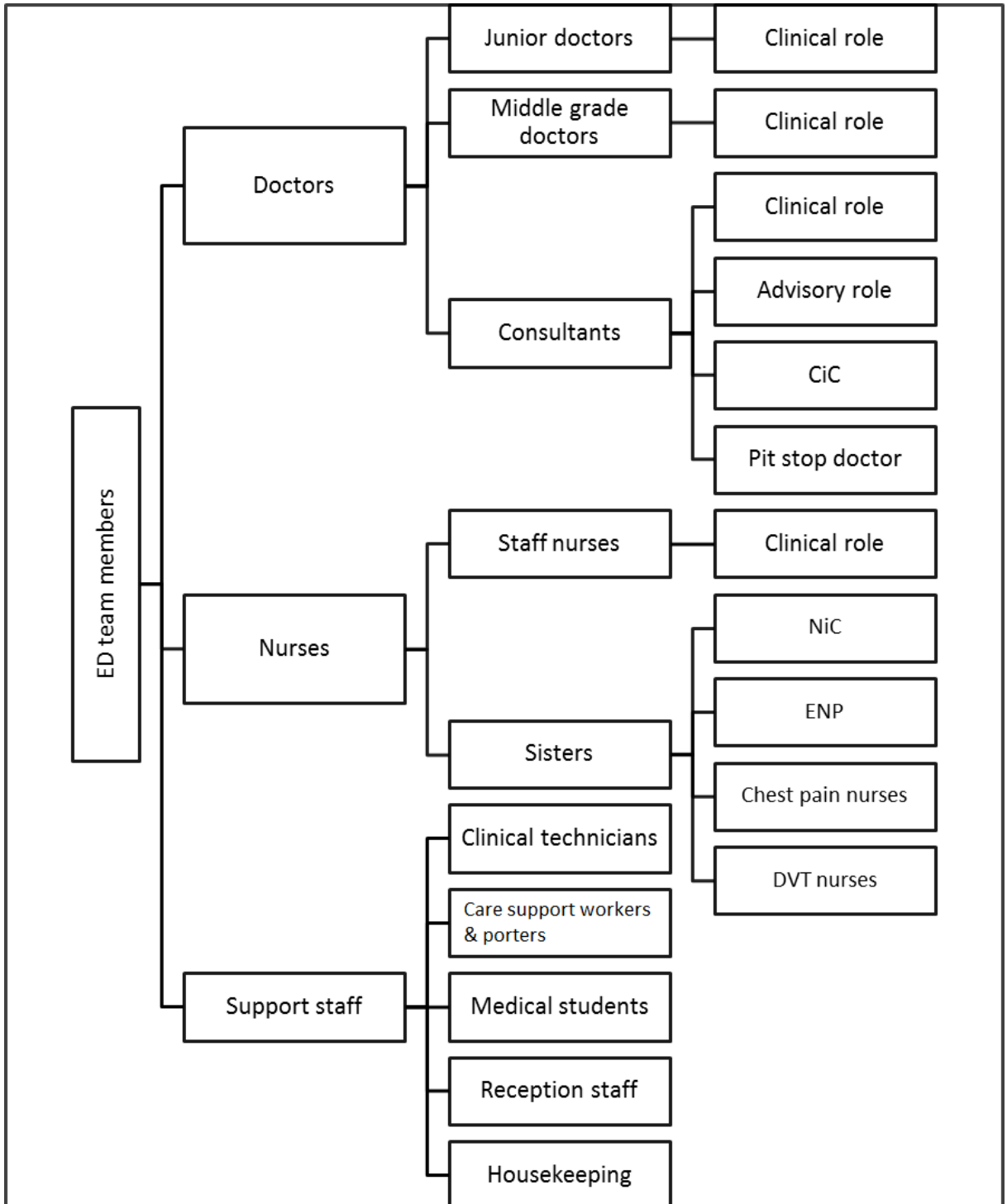

Figure 5.2: ED multidisciplinary members

From the researcher's observations, support staff, such as porters and care support workers, also played an important role in patient care. For example, both were responsible for transporting patients within the ED and to hospital wards. Housekeeping staff were responsible for cleaning the clinical units and beds. They also served as a link between patients and nursing staff. Registration staff performed administrative duties such as registration, filling and billing.

Patient flow champions seem to be a unique position in the ED. The patient flow champion interviewed was also a qualified member of the clinical staff, but without clinical responsibility. She collaborated with a NiC in making sure that there were enough clinical resources so that patients can be appropriately attended to. This involved constantly ensuring that patients that are 'booked' (i.e. registered) were seen by clinical staff and their plan of care generated. Once a plan of care is in place, treatment can be delivered and decisions for discharge can be made. If there was an inherent delay due to an increase in patients or shortage of clinical members, an adjustment to staff allocation would have to be made:

*"We'd keep going... looking round every so often to the red team, so every half an hour or 20 minutes, so we'd keep going round saying, this patient hasn't had anything else done to them, they're still waiting for the doctor to come down or they're still waiting for treatment to be done – is there a problem, do you need some help. So they might need another nurse put into red team or blue team for that short period of time. There might be too short a workload for them. so we'd ask the Sister in Charge [NiC] to see if she can send another nurse to help out and get the treatments done or go with somebody to CT scan... our job, really, is to stop breaches and keep an eye on patients what's in the department" (Patient flow champion A).*

Her task also included assessing bed availability at hospital wards so that ED patients who are to be hospitalised can be transferred:

*"we have to attend a bed meeting so that everybody knows how many beds are in the hospital at that point of time in the day. So I will come back down to A&E and say there's gonna be 30 beds on the MAUs [Medical Assessment Unit], there's gonna be 10 beds on surgical assessment unit [SAU], say, for example. I know for a fact that there should be a bed for the patients, what I've just flagged up or the doctors have flagged up to go to surgical assessment unit, whether it be for orthopaedic with a broken bone or whether it be an abdominal pain" (Patient flow champion A).*

From the observations and information written on the staff whiteboard, members of staff, such as doctors, nurses and care support workers were assigned to work at either a sub-unit of the major unit, a minor injuries unit or CDU per particular shift. However, in the CDU, only nurses and care support workers were permanently allocated, while doctors were only

called to the unit when there was a need to make decisions regarding discharge. Other members such as patient flow champions, clinical technicians, porters and housekeeping were assigned to work across all clinical units.

### 5.1.3. Patient flows

There are two modes of entry to the ED. Patient who came on their own, i.e. walk-in patients and patients who were transported via the ambulance service, i.e., ambulance patients. The patient's mode of arrival together with the severity of their illnesses/injuries determines the paths or trajectories of the care.

#### 5.1.3.1. Walk-in patients

Walk-in patients arrived at the ED via their own transport. It was observed that as patients arrived, they went to the reception counter located in the waiting area to register their visits. Upon completion of their registration they were sent to wait in the waiting area. Patients were then called for a triage by a nursing staff located in a triage room at the waiting area. According to an opportunistic interview with a member of the reception staff, there was no specific time limit for how long patients can be waiting prior to triage and that triage was normally done as soon as possible. Normally, walk-in patients are triaged to receive treatment from the minor injury unit. However, such scenarios cannot be frequently expected, as patients at times were presented with certain circumstances. According to a staff nurse, some walk-in patients can also require immediate treatment and be assigned to receive treatment from the major unit instead of the minor injuries unit:

*“Some patients also walked in even though it is not a minor injury. So, not all that walk in are in the minor injuries. Some maybe were just outside the hospital and they felt bad and they [patients] just went straight into hospital. Not all of them [patients] are from ambulance. Some of them [patients] have been taken by family or came here by taxi” (Aux nurse G).*

Although it is expected that walk-in patients receive treatment at the minor injuries unit, this is not always the case. It is often cited that emergency care is unpredictable (Allard et al., 2012), and one of the unpredictable factors encountered at the adult ED was that walk-in patients can at times be sent to receive treatment from



the major unit instead of from the minor injuries unit. Once patients are called into the minor injuries unit, treatment can then be delivered. Some walk-in patients end their trajectory at the minor injury unit while others can be sent to the Critical Decision Unit (CDU) for further care.

#### 5.1.3.2. Ambulance patients

From the observations conducted at the ambulance bay, patients arriving via the ambulance service went into the ED via a separate entrance from the walk-in patients. When they arrived, they were put in a queue (while lying on stretchers or sitting in wheelchairs) to be triaged by a pit stop doctor situated at the ambulance bay. Similar to walk-in patients, the duration of time that patients had to wait for a pit stop doctor assessment can vary. From the observations, at times ambulance patients can be triaged almost straight away and at other times they would have to wait.

Ambulance patients were normally sent to receive treatment from any of the sub-units within the major unit. However, ambulance patients can also sometimes receive treatment from the minor injury unit. It was observed on a number of occasions that patients were wheeled off to the minor injuries unit via the staff entrance to the unit instead of being transported to the major unit. According to a nurse, the ambulance service can just be a mode for transportation instead of being used for emergency situations:

*“Not everyone that calls the ambulance needs to be seen straight away. Not all these people could not make their own way to the hospital or they come by ambulance unnecessarily and some of those people do get triage into the waiting room [i.e. minor injuries unit]”* (Charge nurse A).

Upon finishing their treatment at the major unit, some patients were sent to the CDU. In the majority of cases, the CDU is their final destination in their care trajectory. However, some patients can be transferred back to the major unit if their condition deteriorates. During an observation, one patient located in one of the treatment area in the CDU had to be transferred back to the major unit. During the event, an alarm was raised by a nurse in the CDU and a few doctors from the major unit ran to the CDU. They decided to transfer the patient quickly back to the major unit. Following the observed event, a nurse commented in an opportunistic interview that such transfer was

necessary so that treatment for the patient can be continued at the suitable clinical area:

*“She [was] epileptic so she was brought here, so, but the thing here is we don’t really have all the facilities if they [patients] become really poorly that is why poorly patients should really not go here [@CDU] because this is just a holding bay. So, she [the patient] brought to resus [resuscitation sub-unit] now” (Aux nurse G).*

In a separate interview, another nurse also described a similar event to what was observed. She stated that all patients sent to the CDU should be in a stable condition but those that deteriorate needed to be transferred to the main unit (i.e. major unit) immediately:

*“...if someone was really poorly they [patients] shouldn’t really be down here [at CDU]. We do have situations because patients are patients, where maybe you’ll have somebody who’s had a scan of their head because they [patients] have had a fit, and sometimes they [patients] will come down here [to the CDU] and they [patients] will have another fit so we pull the emergency alarm and they [patients] get whizzed back up to the main department [major unit]” (Staff nurse E).*

#### 5.1.3.3. Resuscitation patients

From the observations, resuscitation patients arrived via ambulance in a critical condition, and were often unconscious. At times the ED received courtesy calls from the ambulance service prior to their arrival. Resuscitation patients required immediate resuscitation and were attended to by a resuscitation team. Upon arrival, they bypassed the pit stop triage. Instead, they were immediately transported by the ambulance staff to the resuscitation sub-unit where emergency care started immediately. However, it was highly unlikely that resuscitation patients were sent to the CDU. They were either kept at the resuscitation sub-unit until their condition became non-critical, or sent to surgical theatre for surgery or hospital wards for further treatment.

The patient trajectory can be quite unpredictable because of a patient’s condition and personal circumstances. Although it is expected that walk-in patients receive treatment from the minor injuries unit and ambulance patients receive treatment from the major unit, their circumstances can dictate otherwise. In dealing with unforeseen exceptions, the healthcare professionals need to provide re-interpretation to the common practice (Berg & Toussaint,

2003). Figure 5.3 shows the ED patient flow (keys to the symbols are also on page xv). The dashed lines in the flowchart depict the possible variability in the flow as some patients can be presented with certain circumstances which require re-assessment of the flow.

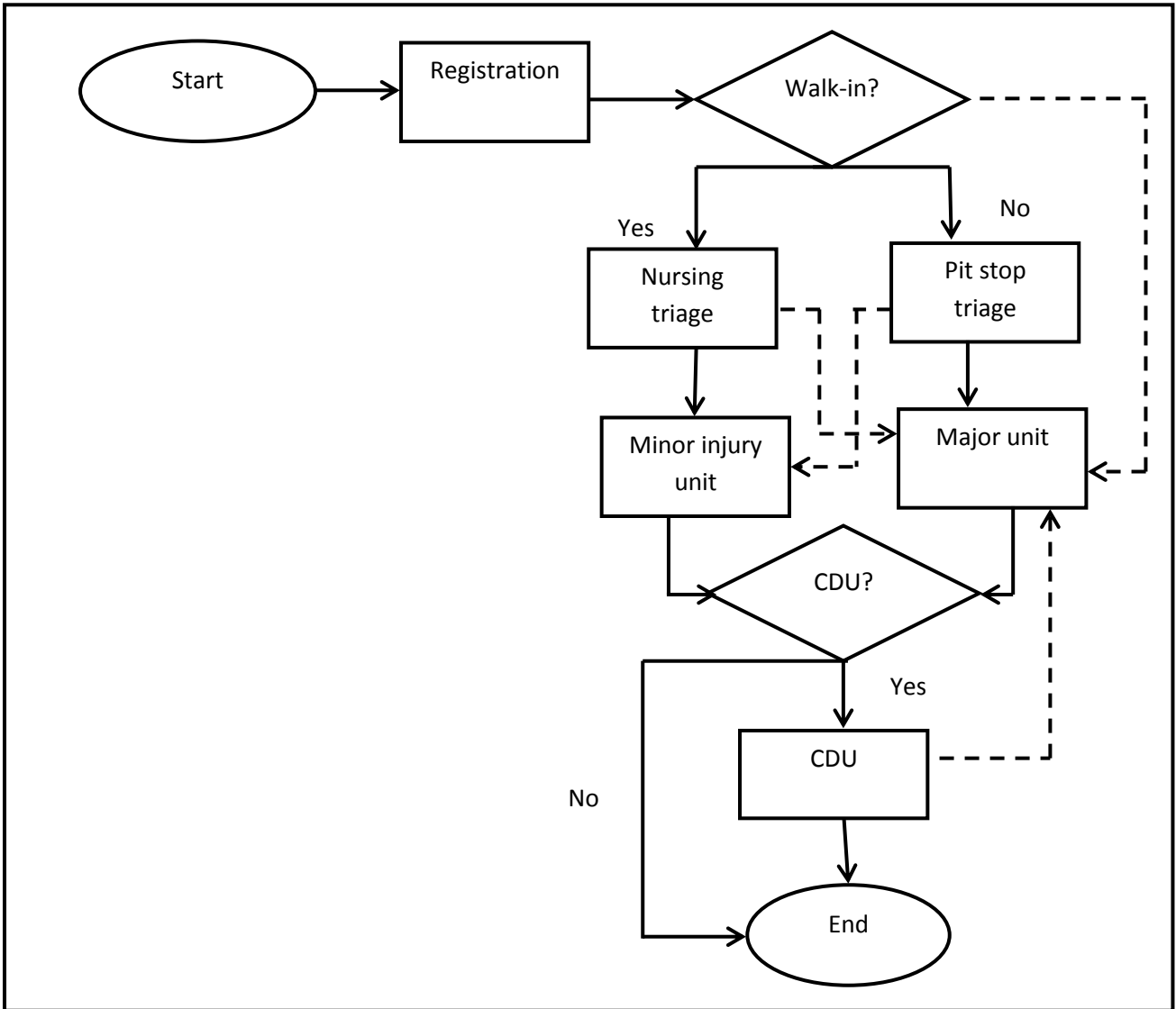

Figure 5.3: Patient flow (Keys to the symbols: ovals mark the start/end, rectangles represent processes, diamonds represent decisions, arrows represent normal flows and dashed arrows represent exceptions)

#### 5.1.4. Collaborative work processes

This section highlights the ED work processes with emphasis on the task and activities which formed the ED workflow. The adult ED work processes were similar to ED work processes discussed in the literature (Chan, 2000; Hertzum, 2011; Rothenhaus et al., 2007; Vezyridis et al., 2011). They can be categorised to two types: clinical and organisational work processes. Clinical processes included triage, assessment, treatment, observation and discharge. Organisational processes included patient flow and resource management, patient registration, coding and documentation, and billing. These processes are closely linked and conducted in parallel for many patients. Although different members of a team have different motivations for completing their tasks and activities (Strauss, Fagerhaugh, Suczek, & Wiener, 1985), collaboration among them is crucial in order to deliver patient care safely and efficiently.

##### 5.1.4.1. Clinical work processes

Clinical processes consist of activities related to providing clinical care ranging from making a diagnosis based on the patient condition to stabilisation. It also includes medical decision in discharging patients to home or hospital wards.

##### a. Triage

At the adult ED, triage is performed for both walk-in patients and ambulance patients, with an exception to resuscitation patients. Aronsky et al. (2008) describe a triage as “a fast-paced process that prioritizes the allocation of limited health care resources to patients in greatest need” (p. 16). During triage, regardless of whether they are walk-in patients or ambulance patients, the process is essentially the same. It involved a quick assessment of the patient’s presenting condition in order to determine the next course of action for the patients:

*“... they [patients] have come in and they [patients] have gone through triage which is they [patients] have gone through either the nursing triage if they [patients] have driven [walk-in patients] here or they [patients] have gone through pit stop [transport by ambulance] which is where the [pit stop] consultant will just briefly hear the story, scan them [patients] over and decide where they [patients] should go which is what triage is all about, is deciding where people should be in the department...” (Staff nurse E).*

From the observations, triage for walk-in patients was performed by nursing staff. During the process, a triage nurse briefly assessed the patient condition and history. Nursing triage for walk-in patients also involved assigning patients to six different streams (public display notice):

- i. Emergency Nurse Practitioner (ENP);
- ii. Patients returning from investigation;
- iii. ED doctor;
- iv. Psychotherapist;
- v. Review clinics; and
- vi. Speciality team (DVT and chest pain units).

These streams essentially categorise patients according to the treatment that they are going to receive. For example, patients who are assigned to the ENP stream are treated by the ENP nurse first and then the ED doctor only if necessary. The review clinics stream is for patients who returned for follow-up care such as wound dressing. The speciality team stream is for patients who needed to be seen by specialised nursing for Deep Venous Thrombosis (DVT) and chest pains. As stated in Chapter 4, the adult ED also provided specialised services, i.e., a Chest Pain Observation Unit and DVT Unit and the speciality stream is dedicated for such patients. The streaming technique adopted by the adult ED is probably a way to improve patient flow. Streaming of minor injuries patients reduced the number of patients waiting more than one hour by 30% (Department of Health, 2001).

It is a common practice and frequently cited that a triage process at EDs is commonly performed by nursing staff (Aronsky, Jones, Raines, et al., 2008; Castner, 2011; Janssen et al., 2011). However, at the adult ED, although walk-in patients were triaged by the nursing staff, ambulance patients were triaged by ED doctors with a consultant rank. A consultant assigned to do triage of ambulance patients is referred to as a pit stop doctor. However, triage by a pit stop doctor was only available at certain times contributing to yet another variability in the delivery of emergency care:

*“there is always a triage nurse 24 hours a day, 7 days a week, 365 days a year. The pit stop doctors are sort of, more of a Monday to Friday. I think on the weekends are more of a 9 till 6 or 9 till 7 systems” (Charge nurse A).*

A triage by a pit stop doctor is similar to the nursing triage where the patient presenting condition was assessed. It is frequently observed that a pit stop doctor triage was conducted in a presence of ambulance staff. The pit stop doctor triage also involved two additional decisions: determining which sub-unit of the major unit patients were to be assigned to and the ordering of clinical investigations.

*“When the patient arrives, on the pit stop, one of the consultants is there ... if he [pit stop doctor] thinks that the patient needs a blood [test] so that he [pit stop doctor] can request blood [blood test] from the pit stop and either one of the other doctors like in major, they [doctors in major unit] go to see the patient. If they [doctors in major unit] think, if the blood is not already requested by a consultant [at the pit stop], they [doctors in major unit] can request by themselves so ... and then we [clinical technicians] can do the blood [blood test] and everything” (Clinical technician A).*

However, according to an opportunistic interview with a pit stop doctor, the practice of requesting an investigation test during a pit stop assessment was just to speed up the care process and that it was usually done only to help out the clinical team in the major unit. This shows that a pit stop triage is not just about allocating resources, such as bed assignment in a major unit, but also formulating a care plan for the patients. This is an interesting work practice as the triage process is commonly referred to as assessing patients’ medical conditions and allocating limited resources based on the severity of their condition (Aronsky, Jones, Raines, et al., 2008). Because of the individual practices of the pit stop doctors, this inadvertently also contributes to the variability in the care process.

During pit stop triage, it was also observed that a pit stop doctor works collaboratively with the ambulance crews and porters. Collaborative work between a pit stop doctor and ambulance crews was a handover activity where the care of the patients was transferred to the ED from the ambulance service. Collaborative work with the porters, on the other hand, was a request for patient transfer, i.e. from the ambulance bay to the radiology department or to the major unit.

*“The doctor [pit stop doctor] will tell us [porters]... there are the different team[s], the blue team, red team. So if we [porters] are going to take [the patient] to the blue team, we [porters] say blue team. If it is x-ray, to x-ray, they [pit stop doctors] are just going to tell us x-ray and there is a card [Diagnostic imaging order form] provided by the doctor ... And then they [pit stop doctors] will tell me so whether they [pit stop doctors] want it [the patient] straight to the x-ray and then they [pit*

stop doctors] *will say 'straight [to] x-ray and after that red [sub-unit] or blue [sub-unit]'* (Porter A).

b. Assessment, treatment and observation

Direct clinical care tasks included assessment performed by both doctors and nurses. At each of the clinical units the type of emergency care treatment given differs. For example, in the minor injuries unit, direct clinical care included assessments and treatments for DVT and chest pain patients given by DVT nurses and chest pain nurses, respectively. It can also include ENP nurses' and ED doctors' assessments and treatments for new attendance or returning patients.

Meanwhile, in the major unit, i.e., the blue and red sub-unit, clinical care is conducted slightly differently. Patients at these sub-units have to undergo two additional steps: nursing assessment performed using the Manchester triage Score (Appendix 17) and consequently doctor assessment. The Manchester triage Score is a national triage for triaging process (Ganley & Gloster, 2011). Nursing assessment is an initial assessment performed by nursing staff to be conducted prior to patients being attended to by doctors. It is essentially another triage process (after the pit stop doctor assessment) for the major unit patients. The assigned triage score placed the patients into a queue to be seen by doctors according to their level of urgency:

*"If you are working within the department [major unit] you are assessing patients when they [patients] first come through from the Ambulance Service [pit stop triage] or from triage [nursing triage] so getting a general medical history, what they [patients] have come in for, taking vital signs, ECG's, and if anything is highlighted you then triage them [patients] with the Manchester Triage Score. Then they [patients] are put into a queue to see one of the doctors..."* (Staff nurse C).

The doctor's assessment was then performed based on the urgency level provided by the score. However, variability can happen as sudden clinical decisions must be made during a nursing assessment because of the patient's condition. For example, in an interview with a member of the nursing staff, she described a dire situation where she thought that the patient would have to be attended to by a doctor straightaway instead of going through yet another triage (i.e. nursing assessment). In such cases, she would have to inform a doctor so that the patients can be seen immediately:

*"Sometimes I have had people [patients] come in and they describe their symptoms and I immediately was like something is wrong here, and I will go*

*straight to a doctor and say this patient needs to be seen right now” (Staff nurse E).*

There can also be occasions when patients need to be moved to another sub-unit which was better equipped to handle certain types of cases. This transfer was initiated after patients had initially been assigned to a different sub-unit during a pit stop doctor triage. The scenario below was given by a nurse working at the ED. According to this informant, initially the patient was assigned to a major non-resuscitation sub-unit. However, when she conducted a Manchester triage assessment during the nursing assessment, she soon realised that the patient was having a heart attack. Instead of continuing her assessment, she immediately transferred the patient to a resuscitation sub-unit where the patient was treated immediately by a dedicated resuscitation team:

*“I had like a patient last week who I did the ECG and she had some chest pain... she was having a really bad heart attack so we need to act really quickly... that is my assessment as a nurse, I looked at the full picture and she was sweaty and grey and just looked really poorly and clutching her chest, did the ECG, massive heart attack so I got hold of her and pushed her straight into resus [resuscitation sub-unit] at the end so she could go on all the monitors and be seen straight away” (Staff nurse E).*

There were also times when nursing assessments and doctor assessments did not follow one after another. Instead, doctors immediately did their assessment due to an increased volume of patients coming in and a shortage of nursing staff:

*“Sometimes if it’s more, if it’s quicker you can do my assessment before the team nursing assessment...That’s unusual but it’s increasingly common because of the volume of patients coming through. There is an inherent delay for nursing assessments after they have been allocated [to the major unit]. So rather than having downtime where you are waiting for a nurse to do an assessment then to be seen by a doctor, the doctor can see the patient” (Consultant F).*

As described by Consultant F, the doctor’s assessment without a nursing assessment can avoid downtime in an event where there was a shortage of nursing staff, hence speeding up the care process. The practice also contributed to the variability in the patient care trajectory.

While nursing assessment involves assigning Manchester triage scale, doctor assessment includes conducting an initial examination and coming up with a patient care plan to be executed collaboratively among nurses, care support workers and clinical



technicians. The treatment plan is in the form of clinical investigation orders and observations for nurses, clinical technicians and care support workers. Clinical investigations included orders for blood tests, x-rays/scans and ECGs. The investigation results received could initiate new cycles of further clinical investigations, observations and treatments, justifiable admission to wards, home discharge or referral to other speciality. While waiting for investigation results, some patients were sent to the CDU while others remained in the major unit. Subsequently they were discharged home or to hospital wards.

According to a care support worker, an observation that is a part of patient care plan involved tasks such as:

*“base line obs [observation], bm’s [base line monitoring], hygiene of patients, hydration of patients to make sure obviously that they have had something to eat and their hygiene needs, if they need any help with that we do that as well” (Care support worker A).*

There are occasions when these clinical activities are performed with the help of non-clinical staff members. For example, a patient flow champion occasionally became involved in clinical work, although her responsibility is to ensure smooth patient flow within the ED. This is possibly due to the fact that a patient flow champion is also a qualified nurse. In the event of a nursing shortage, she can be of valuable help to the nursing staff. However, in doing so, her actual responsibility may not be fully met:

*“We [patient flow champions] occasionally do hands on [clinical work], we [patient flow champions] will help to do log rolls, we [patient flow champions] will do some observations, but what they’re saying is, if we [patient flow champions] did get involved with clinical work, then if you’re gone for half an hour, lots of people [patients] can come through A&E department [ED] and there’s nobody keeping an eye on that” (Patient flow champion A).*

At the resuscitation sub-unit, although part of the major unit, the care trajectory is different. Patients were treated immediately upon arrival as they were unconscious and/or critically ill/injured. Instead of working on specific clinical tasks or processes one after another, a resuscitation care team worked together simultaneously:

*“...the patients in resus [resuscitation] they are a bit more ill. You generally tend to have direct input... So resus [resuscitation] they [patients] come, they [patients] have a parallel assessment” (Consultant F).*

Similarly, a nurse described her work at resuscitation sub-unit as, “we [nurses] just take part in the team [resuscitation team] doing what is necessary at the time” – Nurse C.

Treatment processes at the CDU are also different in comparison to the minor injuries and major units. For example, CDU patients who were transferred from the major unit or minor injuries unit were mostly waiting for investigation results, further decisions or required further monitoring. Therefore, nurses needed to make sure that patients’ test investigation results were back so that they can be reviewed by doctors. Doctors can then make a decision for discharge:

*“...in CDU it is a lot about management and patient flow so if patients have come down from the majors [blue, red and resuscitation sub-units] department [to the CDU] you obviously are still monitoring their health, any needs they may have as a patient and making sure they are safe and they are okay basically but your main responsibility after that is to making sure the doctors have come down and reviewed them [patients] when they need to be reviewed. Making sure their [patients] blood results are back, a lot of them [patients] have come down following having blood tests... Other things like they [patients] have come back from scans, if they [patients] have had a CT head or something like that” (Staff nurse E).*

In the CDU, more emphasis is placed on patient management by keeping up to date with the availability of investigation results. In contrast, in the minor injuries and major units, performing patient assessments are the main priorities. Regardless of how the processes are executed, it is a priority that patients received their treatment accordingly and that there is a continuous flow and throughput of patients so that fewer patients accumulated in the department.

c. Investigation test ordering

Various types of investigation tests can be conducted in order to arrive at a medical decision. Investigation results are needed for doctors so that they could make clinical decisions which include decisions for home discharge or to hospital wards. ED patient flow relies greatly on these clinical decisions. Once clinical decisions are made, patients can then be moved out from the ED, hence making space for other patients.

From the observed activities of the care support workers and clinical technicians, investigation orders included blood test and x-rays/scans investigations, and ECGs. This work process contained multiple activities: request, execution, transfer and availability.

Doctors and ENP submitted blood test requests to nurses, clinical technicians or care support workers. They then executed the request by obtaining blood samples from patients and submitting the samples to the laboratory. The availability of the results was informed by nursing staff, clinical technician or care support workers to the doctors. According to a nurse, by informing doctors of availability of blood test results, doctors could thus engage in other clinical activities and not have to constantly check whether the investigation results were back or not:

*“...we [nurses] just make sure that everyone is seen and not forgotten and chasing up doctors to give back results to the patient... It saves the doctors a job if they [doctors] are busy elsewhere, we [nurses] can then say we [nurses] have had a look and they [results] are not back or we [nurses] have had a look and they [results] are back so you [doctor] need to come and review the patient” (Staff nurse C).*

Since blood test investigation can also be executed by a care support worker and clinical technician, they also expressed a similar view on the matter, i.e., informing doctors of investigation tests availability can be very helpful to the doctors:

*“...the doctors, they [doctors] can view [blood test results] by themselves but sometimes if they [doctors] are busy and the patient is in need to go to any other ward and we [clinical technicians] can trace the blood and tell the doctor the blood has arrived and this is the blood, they [doctors] request so yes, it [is] going to be a bit helpful for the doctor” (Clinical technician A).*

*“We [clinical support workers] tend to chase bloods and results for doctors so that when they [results] are back, we can then get the doctors to come down and review the patients and either move them on wherever they [patients] are going or discharge them [patients]” (Care support worker A).*

However, blood test investigation to be conducted care support workers is limited to those that have been trained to perform the medical procedure. According to Care Support Worker A, she has had the necessary training in order to do the job and that not all support workers were trained for such a procedure:

*“I do because I’ve been here for a long time, and I’ve been trained a long time to do them but we have new support workers that don’t do bloods, don’t do ECG’s” (Care Support Worker A).*

Figure 5.4 represents a process flow diagram for blood test investigation work process between doctors and clinical technicians, nurses or care support workers (keys to the symbols are also on page xv). A blood test request is submitted via a paper-based

blood order form by doctors to either clinical technicians, nurses or care support workers. They then execute the order. Blood test tubes are transferred via a poding system (pneumatic tube system used to transport blood tubes containing blood samples) and the request is submitted online. They are also responsible for checking results availability. Once results are available, they then inform the doctors or ENPs who requested the tests so that a clinical decision can be made.

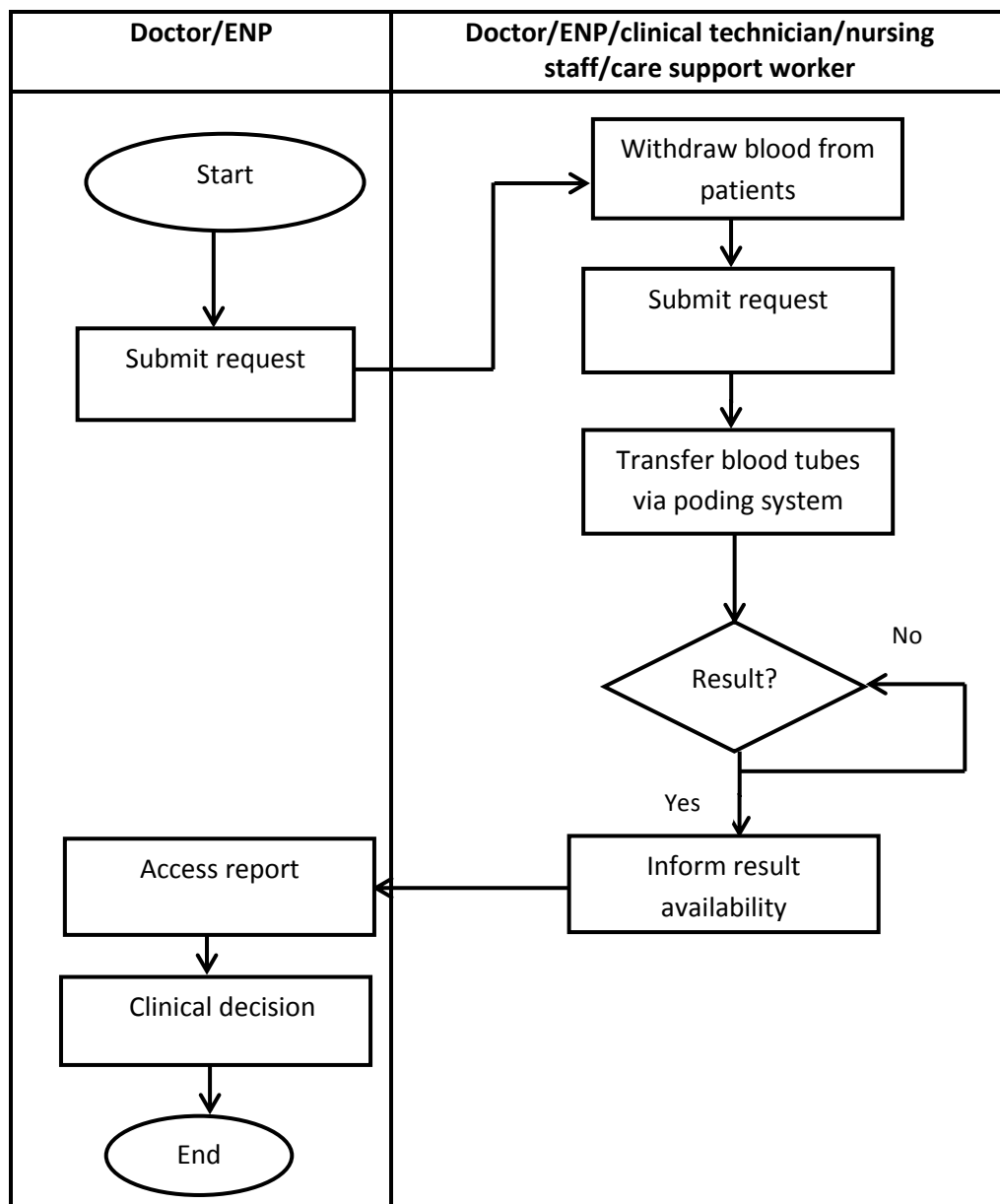

Figure 5.4: Blood test investigation work process (Keys to the symbols: ovals mark the start/end, rectangles represent processes, diamonds represent decisions and arrows represent normal flows)

With regards to x-ray/scan investigation test ordering, collaboration between porters as well as care support worker with doctors was observed. Figure 5.5 depicts an x-ray/scan test investigation work process where a doctor submits a request for the test via a paper-based form (keys to the symbols are also on page xv). The form can be handed over to any available porter or place at the whiteboard allocated for porters. Porters or care support workers then transferred the patients to the radiology department and handed the form over to the radiology personnel. Their task was marked as completed when patients were transported back to the ED. Scan images were submitted via the CRIS by the radiology department. ED doctors then reviewed these images via PACS and provide their interpretation. This was then sent back to be verified the radiology department so that a full report can be made which is accessible via the ICE.

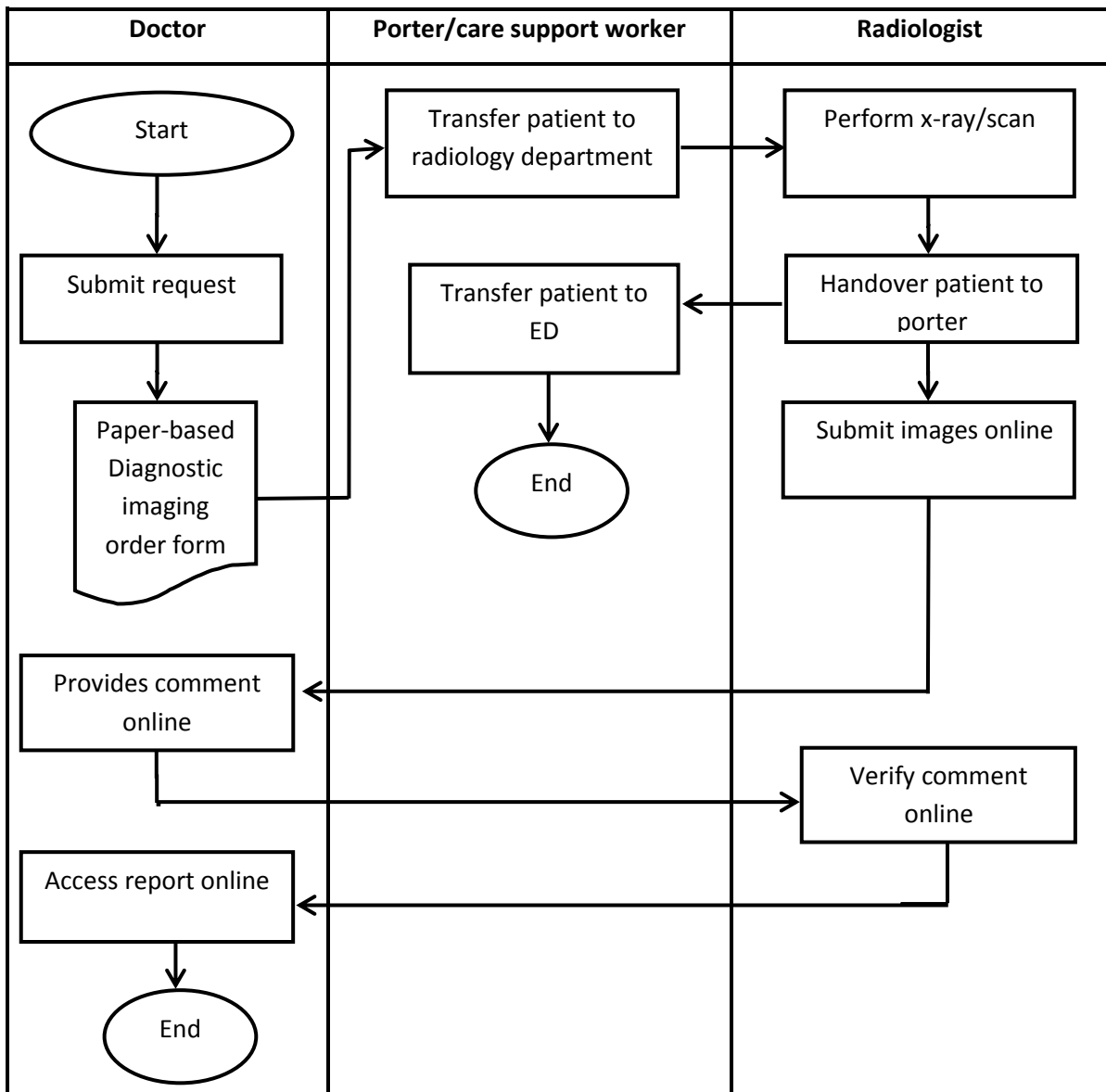

Figure 5.5: X-ray/scan investigation test work process (Keys to the symbols: ovals mark the start/end, rectangles represent processes, diamonds represent decisions and arrows represent normal flows)

X-ray/scan investigation reports are expected to become available while patients are still receiving treatment in the ED. However, there are times when investigation results only became available after the patients are discharged home. According to a reception staff member, at times there can be cases where radiologists reported worrying results on patients who had already been sent home. Having received this kind of report, she had to consult a doctor so that a follow up can be conducted as necessary:

*“...one of the thing that I particularly do, if when a patient had an x-ray, the card goes to the x-ray to be reported on [the] back by the radiologist. If that patient being*

*discharged and they [patients] have got a fracture or it not need be a fracture, it could be any other medical problem that is through from the x-ray and we [reception staff] have to, or get what we call an angular slip and we [reception staff] would then go with the patient record so the doctor to say that there was a problem with an x-ray and you know, how they [doctors] would like us [reception staff] to proceed with it because obviously there is something not right so it can't just be ignored, it has to be followed up" (Reception staff A).*

Delays in the availability of investigation results, such as the radiologist results described by Reception Staff A, required that further action be taken. It is particularly important for follow up to occur as failure to report on the investigation after patients are discharged may have consequences on patient safety (Russ et al., 2010). This type of unexpected collaboration would therefore contribute to variability in the care process, i.e. collaboration between reception staff and clinicians in a test investigation work process.

d. Seeking advice and consultation request

It was a common scenario to observe doctors constantly interacting with each other. This interaction involved clinicians seeking advice from each other in regards to patient treatments. This could involve junior doctors seeking advice from their senior counterparts. According to a consultant, as a senior member of the team, he was required not only to provide direct clinical care to patients but also responsible to give advice to other doctors and nurses:

*"[In] Majors and minors [units], I essentially do two roles, I take the next card, or the next patient waiting as well as supervision and giving advice under doctors and clinicians and nurses as well in that area" (Consultant F).*

e. Referral

A referral also needs to be made external to the ED. It is a request for another speciality team to attend and treat the ED patients. Once a patient is being referred, the decision for discharge lies with the speciality team instead of the ED doctors (A&E Guidelines and protocols).

f. Discharge

The decision for discharge can only be made by doctors or ENPs. Patients can either be discharged home or to hospital wards such as the Medical Assessment Unit (MAU), Surgical Assessment Unit (SAU) or surgical theatres. Regardless of where patients were discharged to, discharge summaries (GP letters), were sent to the patients' GP (Opportunistic interview with Reception staff A).

5.1.4.2. Organisational work processes

Organisational work processes are normally categorised as non-clinical work performed by non-clinical members (Reddy & Spence, 2006). At the adult ED, organisational processes generally involved the management of resources such as beds and staff, and non-clinical processes such as registration, transfer, coding and billing.

a. Registration

From the observations and interviews with reception staff members, the registration process was performed only by reception staff for all ED patients. Normally, walk-in patients registered their visits on their own or with the help of relatives. However, for ambulance patients, their registration was assisted by ambulance crews. Throughout the researcher's observation at the registration office, ambulance crews were constantly going in and out of the reception office. They were seen assisting the registration staff during the registration process by communicating patient details and then submitting a copy of the ambulance sheet.

The registration process included the assignment of an ED number and the recording of non-clinical information such as name, mode of transportation, GP information and home address. However, returning patients, i.e. patients who came back for the same problem, used the same ED number although they were still required to register again:

*"Every time they come back for a new incident, they [patients] get a new number [ED number]. If they [patients] come back with a problem, say last week they [patients] came in with a sprained ankle, and this week you have come back because that ankle is no better, you would get that number [ED number] and re-use it as a follow up*



*because it is not a new incident, it is the same incident and it is a follow up to that incident” (Reception staff A).*

However, the registration process is not as ‘predictable’ as ones could have thought (Ajmi et al., 2015). For example, a member of the reception staff upon identifying very ill patients who required immediate attention during registration had to alert the triage nurse in order for triage assessment to be conducted straight away:

*“We [reception staff] do kind of triage them [patients] at reception desk in case there is any serious case and we [reception staff] do actually flag it up to the triage nurse to get them [patients] in a bit quicker... We [reception staff] kind of look – especially people with chest pain, shortness of breath, paleness, PV bleeds, heavy PV bleeds, heavy PR bleeds, we will flag [verbally]” (Reception staff B).*

As described by Reception staff B, there were a number of symptoms that patients can come with which require immediate care. Flagging the triage nurse meant that these patients did not have to wait for triage and therefore patients can receive treatment as soon as possible. Although it is frequently mentioned that exceptions are frequently dealt with by clinicians (Berg, 2003; Kobayashi, Fussell, Xiao, & Seagull, 2005), in this case, exception had to be exercised by a non-clinical staff member, i.e. a member of the reception staff.

#### b. Patient transfer

Patient transfer involved the moving of patients within the ED, for example from the ambulance bay to the major unit or from the ambulance bay to the radiology department:

*“the [pit stop] doctor will see when the ambulance bring them [patients], they, [the pit stop] doctor will see and then he [pit stop doctor] will assess which team he [pit stop doctor] going to send ... and then they [pit stop doctors] will tell me, so whether they [pit stop doctors] want it straight to the x-ray and then they [pit stop doctors] will say straight x-ray and after that red or blue” (Porter A).*

Patients can also be transferred from the ED to the hospital wards upon a decision for discharge from the doctors. This transfer was commonly executed by a porter accompanied by a nurse or a care support worker. Alternatively, transfer can also be

executed by nursing staff or a care support worker without a porter. Interestingly enough, one nursing staff commented that a patient flow champion was also occasionally involved in transferring patients to hospital wards:

*“Patient Flow [patient flow champion], quite often come they [patient flow champions] usually come down and say, ‘you need to get this patient to the ward’ and if we [direct care team] are too busy there’s too many assessments, which is a big priority really, then they [patient flow champions] will either take [transfer to wards] them themselves [patient flow champions]” (Staff nurse E).*

A patient with a medical decision for hospital discharge is no longer bound by the four-hour rule. However, it is still important that patients be transferred in a timely manner as delays can create bottlenecks in the department (Abraham et al., 2009).

c. Coding and billing

From the observation, in addition to conducting patient registration, registration staff members were also required to complete a coding process. The coding process is a process whereby invoices can then be generated for billing purposes. The process involves updating the computerised PCS from the information obtained from patients’ ED cards. It is a manual process whereby reception staff identifies from patients’ ED cards all the investigations that have been carried out, diagnosis given, medical procedures performed and medication administered (PCS user guide).

According to a member of the reception staff, once coding was completed, GP letters can then be produced. The purpose of the GP letters was to inform the patients’ GP of the patient ED visit:

*“once we do our coding, and we’ve completed everything it will ask if you want to send a GP letter which we do and basically that we just give them a standard briefing to say that that patient has attended the A & E Department, what investigations that we’ve had, the diagnosis and the disposal, whether they’ve been admitted or referred back to GP” (Reception staff B).*

d. Ensuring patient flow

Throughout a patient’s trajectory, emergency care has to be delivered within a stipulated time frame according to the target rules and trigger points (as described in

Section 5.1.1). This task is performed collaboratively with a patient flow champion, NiC and CiC, by making sure that all patients upon arrival at the ED are triaged, received their treatment and consequently discharge (A&E Guidelines and protocols). According to a patient flow champion whose main task is to ensure smooth patient flow, staff members needed to constantly monitoring each other's work activities, helping out whenever necessary and submitting request for additional human resources if necessary:

*"We [patient flow champions] would keep going... looking round every so often to the red team [and other teams], so every half an hour or 20 minutes, so we [patient flow champions] would keep going round saying, these patients haven't had anything else done to them [patients], they [patients] are still waiting for the doctor to come down or they [patients] are still waiting for treatment to be done – is there a problem, do you need some help. So they [care team] might need another nurse put into red team or blue team for that short period of time. There might be too short a workload for them [care team]. So we would ask the sister in charge [NiC] to see if she can send another nurse to help out and get the treatments done or go with somebody to CT scan" (Patient flow champion A).*

In ensuring patient flow, a patient flow champion can also request additional help from non-ED staff members. This practice was usually exercised when there was an overflow of ED patients that needed to be transferred:

*"...if the whole department is just starting to get really full, they [patient flow champion] will bring staff down from other [hospital] wards to come and start doing transfers, so that's quite helpful" (Staff nurse E).*

e. Resource management

Resource management is also an important part of the ED workflow. The management of staffing resources at the ED is the responsibility of consultants with a CiC role and senior nurse with a NiC role (ED guidelines and protocols). Although a CiC role is yet another task needed to be performed, it is not performed in isolation of clinical tasks. As indicated by a consultant, the management of resources was done in parallel with clinical work:

*"When I did CiC I do several things. So you do the usual roles in terms of allocating staff. You liaise, well I liaise with the nurse in charge of any problems but I also see patients..., the main difference from how I function when I'm just clinical, because I still see patients when I'm in charge" (Consultant F).*

Resource management also included formulating a plan to anticipate any surges of patients and allocating staff to any units that have long queues of patients waiting to receive treatment:

*“...when I become a CIC the main thing I did was sort of made sure we had a plan in case we got surges in patient presentations with injuries. You allocate, so I move around clinicians a lot just based on where queues are building up so I don’t leave it static but those are, you know you don’t need to be constantly doing that”* (Consultant F).

During the course of the data collection in the ED, the role that housekeeping staff played was unexpected. It was expected that the housekeeping staff would be in charge of taking care of the cleanliness of clinical units including the beds, hence partly contributing to the availability of beds. However, in one of the opportunistic interviews with a member of the housekeeping personnel, it was revealed that she was also instructed to provide assistance to patients’ relatives:

*If there is a lot of family we all just get them a drink and go and you know just keep checking that they [patient family] are all right, you know, because sometimes they [patient family] want to stay a long time or if they [patients] are, somebody [patient] has gone to theatre [surgical theatre], we [care team] will get relatives here [ED department] until they [the patients] come out from theatre [surgical theatre] and then I have to take them [patient family], you know, to theatre [surgical theatre], where they [the patients] are”* (Housekeeping A).

This practice inadvertently contributes to the availability of nursing resources at times when their skills are needed the most for clinical activities.

f. Teaching and learning

As the adult ED is also in a teaching hospital, it was not surprising to see medical students being part of the ED team. However, medical students are restricted in terms of which care processes that they can be involved with. For example, a medical student stated that she was mostly involved in executing the investigation test work process:

*“like lots of blood and coagulation and we do like a lot of clinical skills, say, like taking ECGs from patients and we also get to talk to patients before the doctors and maybe doing some brief examinations and then explain our findings to the doctors before they [doctors] see the patients”* (Medical student A).

The practice of teaching and learning depends on specific instructions issued by the doctors. Although medical students could have skills in conducting certain medical procedures, they would not be able to contribute to the care process unless directed by doctors. The same medical student indicated that doctors usually give a list of specific patients that she and other medical students had to attend to, together with instructions on what to do:

*“the doctors will tell us like ‘all these patients in these beds, this is their names, this is their date of birth, go and have a chat with them, so then, we just go and have a chat” (Medical student A).*

This theme has provided an insight into the components that make up the ED workflow. Figure 5.6 summarises the ED workflow components discussed. The theme has also provided insight of the collaborative work processes of the heterogeneous members of the ED team, unexpected events or practices that can affect the ‘normal’ or expected trajectory or flow of work. In the next theme, the information artefacts in supporting the ED work processes are discussed.

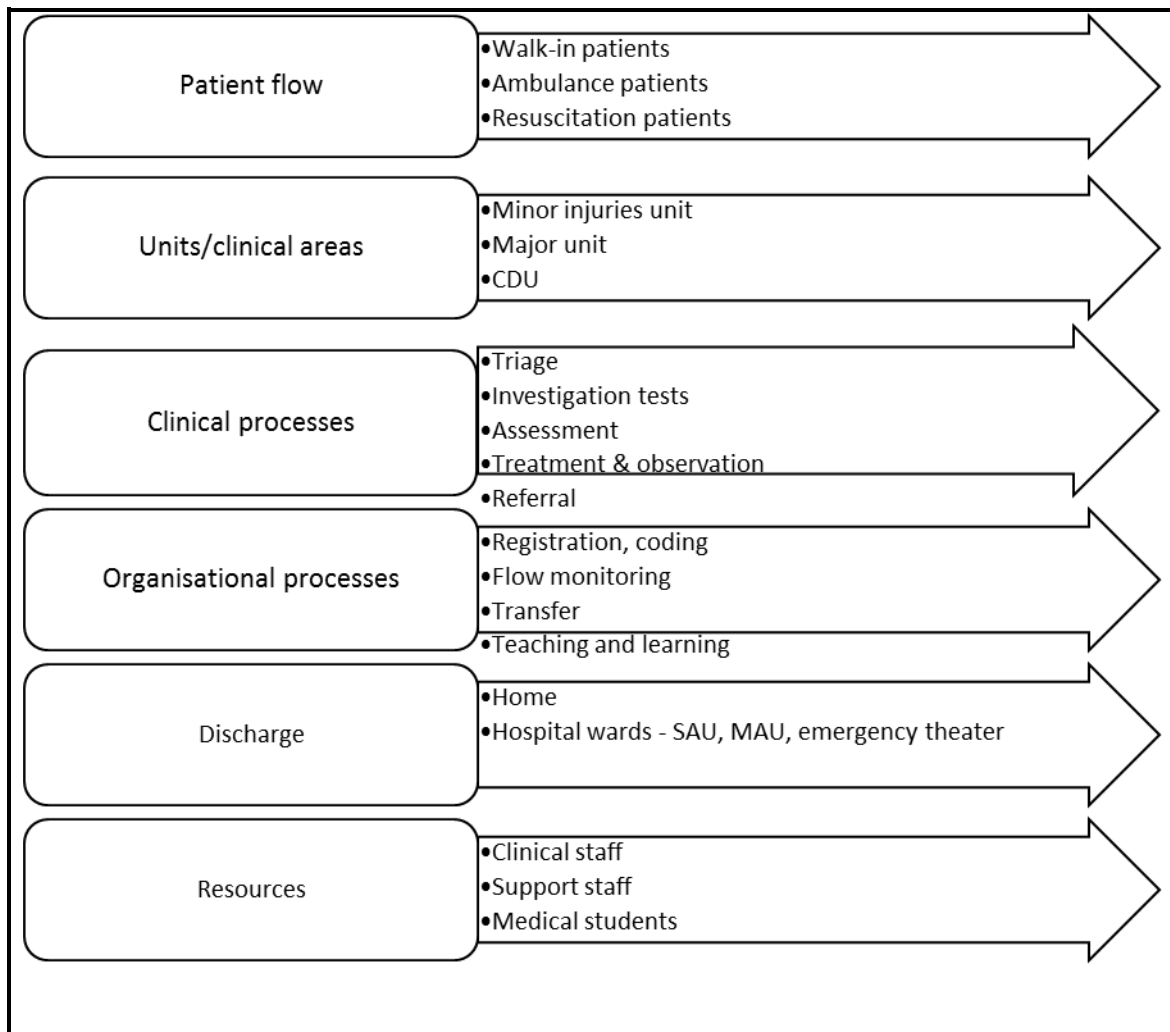

Figure 5.6: ED workflow components

## 5.2 Information artefacts in supporting the ED workflow

Both computerised and non-computerised information artefacts formed an important component of the workflow. One of the approaches that can be used to gain an understanding of the workflow is by looking at how the existing information architecture supports the workflow (Bjørn & Hertzum, 2011; Feufel et al., 2011; Sicotte et al., 2009). Similarly, Bisantz et al. (2010) point out that the “successful design of these new systems requires a careful understanding of the functions afforded by the old systems and the manner in which the manual systems supported clinical work” (p. 39). Such understanding can be useful in understanding of design features which can lead to efficiency and safety of care delivery. As this study is conducted in an emergency care setting with its

own legacy systems, looking at how these systems have been utilised for its workflow can be beneficial to inform system design for new systems as offered by the National Programme for IT.

#### 5.2.1. Information artefacts

Identifying and accessing information urgently are crucial in EDs. The adult ED still relied on hybrid information architecture to support care delivery. This includes various non-computerised information artefacts such as paper-based records and forms, dry-erase whiteboards as well as multitude of computerised information systems.

##### 5.2.1.1. Non-computerised information artefacts

###### a. ED cards

At the adult ED, the documentation system is a paper-based documentation system known as ED cards (Appendix 18a Appendix 18b). There are two versions of the ED card: non-trauma ED (i.e. normal ED cards) and trauma ED cards where each type is used for a different patient category. For example, the majority of non-trauma medical patients were allocated the normal ED card while major trauma patients assigned to resuscitation sub-unit were allocated the trauma ED card:

*“...there is a trauma card but the other resus [resuscitation], the non-trauma resus [resuscitation] patients have a normal ED card... The minority of patients, trauma patients would only constitute a small percentage of our workload, major trauma patients. So the majority, so 80% of the patients through resus [resuscitation] will have a normal ED card” (Consultant F).*

From the documentary analysis of a non-trauma ED card, the card includes non-direct care information such as demographic information, mode of arrival, place of incidents and presenting complaints. Direct clinical information includes information related to clinical care. For example, there is a nursing assessment section for nursing staff and a clinical notes section for doctors. A Sister, for example, documented any advice that she gave to patients as well as any advice that she received from doctors:

*“If I give advice to a patient, then I would certainly document that... if I’ve asked a consultant for advice and he has advised that I do x, y, z, I would document on that [ED] card” (Sister B).*

The documentation system is also used by support staff. For example, a care support worker also documented any information related to the task assigned to her:

*“when I’ve done their observations, when I’ve given them something to eat, if a patients been soiled, and I’ve had to clean them up. If a patient has been aggressive, or more confused, if we do any type of observation, you know we put all that on”* (Care support worker A).

The documentation system takes in the format of structured and un-structured information. For example, information such as referrals, admission, medications, discharge and follow-up information are more open-ended. Meanwhile, the final part is in a structured format used to document diagnosis, patient group, treatment and special case information. The ED card for trauma patients is slightly different. The content of clinical information is structured differently. For instance, the clinical information is structured into sections such as “Incident details”, “Procedure at scene”, “Other specialty”, “Secondary survey” and “Summary of injury”, where some of these sections require the information to be presented graphically instead of in a text format. The final part which is the structured format is identical to the non-trauma ED card.

#### b. Forms

Paper-based forms still play a significant role in the delivery of emergency care at the adult ED. Similarly, other healthcare settings, such artefacts are still quite common (Saleem et al., 2011). As shown in Table 5.1, each paper-based form serves different functions within the care process.



Table 5.1: Forms and their purpose

Name	Purpose
Ambulance sheet	Assisting reception staff to perform patient registration for patients brought by the ambulance service
Pit stop and Emergency Department Ambulance handover and assessment forms	Initial assessment forms used by a pit stop doctor to perform triage assessment
Diagnostic imaging order form	Form for requesting diagnostic imaging service
Blood order form	Form for requesting a blood test
Appointment cards	Cards used for referral to other specialties such as the hand centre, fracture clinic and nurse practitioner
Guidelines and protocols	Internet-accessible documents and printed copies, such as ED policies and guidelines.

c. Whiteboards

A dry-erase whiteboard is also another common information artefact found in many healthcare settings including ED settings (Bjørn & Hertzum, 2011). From the observations, the researcher found a total of six dry-erase whiteboards located in multiple areas, with the exception of the minor injuries unit. Two whiteboards were located at the main ED area, one each in the blue, red and resuscitation clinical areas (of the major unit) and one in the CDU. These whiteboards can be categorised to two main types: non-clinical whiteboards, i.e. staff whiteboards, and clinical whiteboards. The information written on these whiteboards is structured according to a set of pre-printed headings. For example, the staff whiteboard located at the main ED area contained pre-printed headings: “Consultants on Call”, “Pit Stops”, “Major Read”, “Major Blue”, “Resus” [resuscitation], “Trauma Team”, “Nurse in Charge”, “Chest Pain Nurse”, “CT Nurse” and “Triage”; all of which indicate staff assignment information. The information on staff who are on-call and staff who are assigned to work for the red team (red sub-unit), the blue team (blue sub-unit), the resuscitation team (resuscitation sub-unit) and the trauma team, can all be obtained from the whiteboard. According to observations and an opportunistic interview with a staff nurse, this information was updated daily by

a NiC. Another staff whiteboard, also located in the main ED area, is a smaller-sized whiteboard which contained a list of porters who are on duty on particular days. From the observations, the information was updated daily by the porters themselves (by writing their names) when they reported for duty. They then erased their names when they finished their shift for the day.

Clinical whiteboards located at the red, blue and resuscitation sub-units of the major unit and the CDU serve a dual-purpose. Each whiteboard contained the clinical information of the patients located at the particular units as well as staff assigned to the unit. Similar to the staff whiteboards, the contents of the clinical whiteboards are also guided by pre-printed headings. For example, pre-printed headings on the CDU whiteboard correspond to the treatment areas within the area: Trolley bay (1-11); Treatment area (1-2); Observation area (1-6). Patient names, their movements (e.g. patient at radiology unit) and time of arrival at the unit were documented under these sections:

*“I put the time that their obs [observation] were last done, their [patients] observations, and then it's moved across to the other section if they [patients] have gone for a CT scan or an x-ray just so you know that the patients not in your team, that they [patients] are in x-ray” (Staff nurse D).*

Additionally, clinical whiteboards also included information such as patient dietary requirement and medical conditions:

*“There's some additional information [on the whiteboard] like if they [patients] can eat, there's notes on them [patients] so if there is somebody with diarrhoea or an infectious disease” (Consultant F).*

However, according to a senior member of the nursing staff, clinical whiteboards should not contain any confidential information. This response somehow contradicts the response above from Consultant F who listed medical condition such as infectious diseases to be part of the information on a clinical whiteboard:

*“... as long as they don't contain any confidential information. So you couldn't put what was wrong with the patient, but you could just scribble on repeat ECG [Electrocardiogram], please” (Sister B).*

d. Pigeon holes and in/out trays

Like any other information systems, pigeon-holes and in/out trays are also important components of the information architecture. This is because the accessibility of the ED cards is ensured by placing them in the pigeon holes and in/out trays. From the observations, these artefacts were located at nursing stations at the blue, red, resuscitation sub-units and the CDU. There were also pigeon holes located in the reception office allocated for each of the ED doctors. These artefacts are used to store ED cards of different status. For example, pigeon holes in the clinical areas were used to store ED card for patients who were still receiving treatment. In addition, according to an opportunistic interview with a member of the reception staff, the pigeon holes in the reception office were used to pass an incomplete ED card to the doctors. The in/out trays, on the other hand, were used as a holding place to transport ED cards for patients who had finished their treatment.

5.2.1.2. Computerised information artefacts

Computerised systems are also part of the resources within the workflow. Some of the systems are clinical systems while others are non-clinical systems.

a. Patient Tracking System (PTS)

The PTS is a tracking system and the most widely used computerised information system at the ED. From the observations, it was used by everybody from clinicians to support staff where its usage PTS ranges from obtaining and updating clinical information of patients (i.e. patient care plan) in order to deliver clinical care as well as obtaining non-clinical information for non-clinical purposes. Both clinicians and non-clinicians alike emphasised that the most common usage of the PTS was to track patient location. Determining patient location including their movement within the ED was necessary in order to deliver clinical care as well as to entertain requests from relatives:

*"...the tracking system [PTS] is a system that tracks all the patients in the department, according to their time of arrival...The IT system [computerised PTS] helps by telling us where they [patients] are in the department..."* (Consultant C).

*"[From the PTS] People [staff] know where they [patients] are, the receptionist can find if any relatives phone up, they [receptionist] can see, oh the patient is in blue*

[sub-unit], so they [receptionists] can put the phone call to blue team” (Patient flow champion A).

*“I look where patients are. You know, for anybody who is enquiring, relatives or if somebody asked me where is Mrs so and so and then I will go to the computer [PTS] and find out where they [patients] are...”* (Housekeeper).

Another common usage of the PTS is to keep track of patient clinical status, i.e. patient care plan. A patient care plan can include for example, clinical information related to the patient presenting complaint and any clinical tests ordered:

*“[Referring to the updates made on the PTS] Yeah if a patient came in with chest pain and they [patients] would be experiencing chest pain for however long we [nurses] would just write – if they [patients] were waiting for blood results we’d write [on the PTS] ‘chest pain rule out’, ‘has had an x-ray’, ‘has had blood taken and is now waiting results’”* (Staff nurse C).

Similarly, a doctor updated the PTS with information whenever he has attended the patients:

*“For us [doctors], it’s more a case of for the responsibility of recording the fact [in the PTS] that we [doctors] are about to see them [patients] and where we [doctors] are likely to be admitting them [patients] to, if at all”* (Doctor E).

The information regarding the patient care plan is quite comprehensive although it is presented in a very structured format, i.e. a table format. Collectively these columns formed patient care which needed to be updated as patients go through the care process. It is very clear what information should be documented because of the highly structured format. For example, a column labelled “Referred to” contained referral information for the patients such as orthopaedics and diabetes/endocrine. If patients are to be monitored longer, the acronym CDU is used. Another column labelled “X-Ray” has the time patients are sent to the Radiology Department. There are also columns allocated to document the time that a patient is attended to by doctors.

In addition to the structured format, another very valuable feature of the PTS is the colour-coded feature. The colour-coded feature commonly known as a traffic light system is used to reflect timing information in relation to patient progress: from the time that patients have been registered to time of their discharge. They are five colours used to project patient clinical status within the expected four-hour clinical government

requirement. After one hour following registration, patient names are highlighted in white. After two hours, their names are changed to green. After three hours, their names are in yellow and finally, fifteen minutes upon expiration of the four-hour rule, their names are changed to red. If the four-hour limit is exceeded, their names turned to pink.

This feature is therefore, a very valuable way in providing awareness to try and ensure that a patient care trajectory does not exceed the governance requirement:

*“We use it [PTS] for our tracking systems so that we can log and ... how much time they [patients] got left in the department and acted to comply with the breach rules [target rules] and try to see our patients in a timely manner” (Doctor A).*

The use of the PTS as a time-tracking tool is clearly emphasised in the ED guidelines and protocols. The guidelines and protocols stated that it is a mandatory requirement that the PTS is regularly updated with the timing information.

b. Patient Focus Information (PFI) and Integrated Clinical Environment (ICE)

There are two clinical systems used for clinical test ordering. The Patient Focus Information (PFI) and Integrated Clinical Environment (ICE) can be used to submit blood test investigations and to check results availability. Different systems are accessible by different categories of staff. From the interviews of the clinical staff members and support staff, it can be gathered that the PFI was mainly used by clinical technicians and care support workers, while the ICE was used only by nurses and doctors.

Both the PFI and ICE systems can be used to submit blood test investigations and to check results availability. However, it appears that the ICE system seems to have more functionality in comparison to the PFI system (documentary analysis of the computer manuals for both systems). For example, the ICE system can also be used to access reports of x-ray/scan investigation tests in addition to blood test reports as well as to access patient records for patients who had been hospitalised at hospitals within the Trust. As confirmed by a care support worker with access to the system, she normally goes on the ICE system *“to have a look for old records for patients”*.

Although a PFI is a clinical system, it was also found that reception staff members have access to the system, but for organisational tasks. Reception staff B stated that she needed to use the PFI to produce GP letters upon completion of patient emergency care treatment:

*“there are just certain things that we have to go on PFI for, for example if we need the GP letters, the Accident and Emergency GP letters, we still have to use PFI to get those printed, yeah”* (Reception staff B).

Another member of the reception staff, in an opportunistic interview, stated that she needed to access the PFI system as part of a coding process.

c. Picture Archiving Communication System (PACS) and Computerised Radiology Information System (CRIS)

Both Picture Archiving Communication Systems (PACS) and Computerised Radiology Information Systems (CRIS) found at the ED are Radiology Information Systems (RIS). Although they are within the same category of HIT clinical application, they are separate systems with individual logins but interlinked purposes. PACS is used by doctors to view x-ray/scan images while the reports on these images are available via CRIS. According to Reception staff A, CRIS is only accessible by reception staff for coding purposes.

d. Patient Centre System (PCS)

From the documentary analysis of the PCS computer manual and an interview with Reception staff A, the PCS is only accessible by reception staff for patient registration and coding. During patient registration, upon documenting all the required details, ED cards can then be printed. The computerised information system is also used for the coding process where invoices are generated for billing purposes and patient records are updated.

#### 5.2.1.3. Databases

The EDIS also consisted of a number of electronic databases, each with different purposes. The NHS Strategic Tracing Service (NSTS), for instance, contained GP details and is used by reception staff during patient registration (Reception Staff A). Another database is used to store electronic version of the ED cards which are more than one week old. However, this particular electronic database can only be accessed via a computer allocated solely for the database (Reception staff A). Guidelines related to teaching, learning and research can also be obtained via the Trust Intranet system (Doctor A). Table 5.2 summarises the computerised information artefacts and electronic databases together with accessibility options and functionalities.

Table 5.2: Computerised information artefacts and electronic databases

<b>Systems</b>	<b>Staff accessibility</b>	<b>Task &amp; functionality</b>
Patient Centre System (PCS)	Reception staff	Patient registration
Patient Focus Information (PFI) System	Clinical technician, care support worker & reception staff	<ul style="list-style-type: none"> <li>i. ordering blood tests</li> <li>ii. viewing blood test results</li> <li>iii. printing blood tube labels</li> <li>iv. producing GP letters</li> </ul>
Patient Tracking System (PTS)	All staff	<ul style="list-style-type: none"> <li>i. patient location and movement</li> <li>ii. patient care plan (summary)</li> </ul>
Picture Archiving Communication System (PACS)	Doctor & (some) nurse	Viewing of x-ray and scan results (images)
Computerised Radiology Information System (CRIS)	Reception staff	Viewing of x-ray and scan reports
Integrated Clinical Environment (ICE)	Doctor & nurse	<ul style="list-style-type: none"> <li>i. viewing of patient information (patient records)</li> <li>ii. viewing of blood test, x-ray and scan reports</li> </ul>
NHS Strategic Tracing Service (NSTS)	Reception staff	GP information
Scanned ED cards	Doctor, nurse and reception staff	Old copies of ED cards (Scanned)
Internet and Intranet guidelines	Doctor	Research and information governance

As part of an EDIS, each information artefact has its specific functionalities. Table 5.3 maps the functionalities of an EDIS to the corresponding information artefacts at the adult ED.



Table 5.3: System functionalities and the corresponding information artefacts

<b>EDIS Functionalities</b>	<b>Adult ED</b>
Registration	PCS, NSTS, PTS, ambulance handover forms
Triage	ED cards, ambulance handover forms
Coding	PCS
Tracking (time and location)	PTS, whiteboards
CPOE system	ICE, PFI, blood order form
Radiology information system	PACS, CRIS, Diagnostic imaging order form
Clinical documentation	ED cards, scanned ED cards
Discharge (home or wards)	Copy of ED cards
Teaching and learning	Internet guidelines

### 5.2.2. Characteristics of the information artefacts in supporting collaborative work

As shown in Table 5.2, the EDIS, which consists of non-integrated information artefacts provides the technical functionalities for the execution of the clinicians and non-clinicians work processes. However, in addition to these technical functionalities, the EDIS also functioned indirectly as a resource management tool and visual tool.

#### 5.2.2.1. Supporting resource management

Resource management is an important characteristic in collaborative work (Bjørn & Hertzum, 2011). In the ED, information on resources such as staff and trolley areas, are conveyed in the computerised PTS as well as ED cards together with pigeon holes.

a. Patient Tracking System (PTS)

As discussed in Section 5.2.1.2, the PTS is one of the most accessible computerised information systems where its users ranged from clinical staff members to support staff members. Information including patient location and patient care plans obtained from the PTS allowed the clinical and non-clinical tasks of the ED team members to be carried out. In addition to providing clinical information, the PTS is also a resource management tool where it can be used to gauge the demand for resources, i.e. staff. For example, to a pit stop doctor, the PTS was used to estimate availability of staff (i.e. supply) based on the number of patients who had arrived to the ED but were yet to be allocated to the clinical units (i.e. demand):

*“We don’t have sort of board system [electronic board system] so we have to sort of rely on this [while showing the split PTS screens] to have an idea of, you know, how busy each department [unit] is...I look at this [PTS], I look this, I can tell that things are getting busy because you look at that [blue coloured columns besides patient name], these people [patients] all do not have allocation [registered patients that are not triaged yet]... So, means got one, two, three, four, five, six, seven, eight, nine, ten people [patients] not allocated yet [registered patients that are not triaged yet]. So, that means, they [patients] are somewhere around but not allocated [triaged] yet, so you know that these people [patients] are just need to be booked in or need to be sorted out, need to be triaged. So, that [the PTS] gives me an idea of how busy or how the department is getting busier because this gives you an indirect indicator that your supply and demand does not match, so that means people [patients] coming in is more than what you can triage them [patients]” (Consultant B).*

The pit stop doctor further commented that by having a general idea of how busy the clinical units were, he can decide how to provide a more detailed triage assessment. This involved generating a plan of care for the patients before the patients were assigned to the clinical unit, hence reducing the workload of the clinical care team at the clinical area. With patient care plans already in place, medical decision can be made or treatment can be delivered straight away:

*“Just let say if I have 7 people that are waiting to be seen there [while demonstrating the PTS split screen – blue sub-unit] and 7 people waiting to be seen there [while demonstrating the PTS split screen – red sub-unit] so I know and I have got 2 doctors, for example, so I know that [blue sub-unit] will be very slow and that [red sub-unit] will be very slow. So what I do is sometimes, I actually, I look at that [looking at the PTS split screens] and I actually see [perform triage assessment] the patients as though the patients were in there [@ the sub-unit] so there is a plan for them there already. So when they [patients] do go to the team [unit] everything [blood test*

request, scan request, observation needed, etc.] *is already done* [requested] *for them*" (Consultant B).

As a resource management tool, the PTS has provided the pit stop doctor with an overview of the case load and a case mix at the clinical units; an indication of how busy these units are. This means that necessary actions can be taken during pit stop assessment to reduce delays. According to Horsky, Gutnik, and Patel (2006), triaging also involves the cognitive tasks of estimating the number of patients in each area while also taking into consideration the level of urgency and the number of available doctors.

Similarly, the PTS is also a resource management tool to support staff. As stated in Section 5.1.1, some patients from the minor injuries unit and major unit can be sent to the CDU for further care. Patients who were sent to the CDU can either be assigned a trolley bay or to a seating area. The trolley bay area is a scarce resource at the CDU (or any other clinical units). From the PTS, a care support worker for example, who was expecting to receive patients transferred to the CDU, needed to know whether patients should be allocated to trolley bays or to a seating area. The use of the PTS allowed her to obtain such information so that such transfer can be managed appropriately:

*"...we look on patient tracking [PTS] to see if there are any patients to come down to CDU. If there's a patient to come down to CDU it will come up as 'CDU T' which is a trolley, or 'CDU S' which is a seat. We [care support workers] then click at the side of that name to say that we have a male or female trolley or a seat to accept that patient to come down"* (Care support worker A).

At times, clinical areas have limited resources in comparisons to the demand for them. To be able to use the PTS as a tool to obtain resource information is important in order to ensure that resources are utilised or appropriately allocated.

b. ED cards and pigeon holes

It was observed that ED cards and pigeon holes are to be used together as the latter provided accessibility to information documented in the ED cards. This technique also inadvertently allowed for the management of resources. Pigeon holes are a physical marker for trolley bays within clinical units. If, for example, a pigeon hole has an ED card stored, this can provide an indication of the unavailability of the trolley bay.

Pigeon holes also provide a physical marker for managing workload assignment among the clinical staff. For example, when a pigeon hole was empty (without an ED card), it was an indication that the patient was currently being attended to. Therefore, the discrete tasks of workload assignment among nurses and doctors are being facilitated by the availability of the ED cards placed in the pigeon holes. Acknowledging the interdependence among colleagues ensures the functioning of parallel work processes (Feufel et al., 2011).

#### 5.2.2.2. Providing visual access

Having visual accessibility to each other's work activities is an important characteristic in collaborative work (Xiao et al., 2007). In the adult ED, the non-computerised component of the hybrid EDIS have been useful in giving access to information related to the staff members work activities and their roles within the workflow, hence ensuring successful completion of inter-dependant processes.

##### a. Whiteboards

Both the staff whiteboards and the clinical whiteboards provided visual access and cues to each other's work activities on a need-to-know basis. This is because whiteboards serve as points of reference where their usage is based on a scheduled passing. From the staff whiteboard located at the main ED area for example, a patient flow champion who is required to work closely with a CiC and NiC, could easily find out which doctor and nurse had been assigned to these roles. The second whiteboard in the main ED area contains a list of porters who were on duty on a particular day. Interestingly, this whiteboard did not only convey information on the availability of the porters. From the observation conducted near the whiteboard, this whiteboard also served as a collaboration tool between doctors and porters where it acted as a 'document holder' for x-ray/scan request forms. The x-ray/scan request forms placed at the whiteboards provided porters with visual access to their tasks, as confirmed by other member of the team:

*"Like if some patients they need some kind of scans, they [doctors] request it for x-rays, they [doctors] fill up the x-rays form [Diagnostic imaging order form] for that patient, they [doctors] just leave that x-rays form over that white board and*

*the porter who got the request form and ... they [porters] can take that request and find the patient and take the patient to the x-rays department. When the x-rays done they [porters] can bring him [patient] back” (Clinical technician A).*

This method provided the porters with a visual cue that there were patients to be transported to the Radiology department. This is similar to other study where magnetic strips were used as part of an operating room whiteboard to indicate the task activity without having to explicitly write what the task is (Lasome & Xiao, 2001). This study indicates that in addition to information written on the whiteboards, other artefacts placed at the whiteboards also provide visual accessibility to tasks that needed to be executed allowing members of the team working in a close physical proximity to communicate implicitly.

Similarly, it was also observed that clinical whiteboards at the clinical areas provided visual access and cues to clinical team members. They can perform tasks at hand while still remaining aware of other members’ activities. Visual accessibility to information allows members of the team to continue performing current tasks yet still have accessibility to relevant information, similar to those found in other studies (Xiao et al., 2007).

Other studies have also demonstrated whiteboards as tools in facilitating interpersonal communication, collaboration, problem solving, shared awareness, visibility, contingency management and handoffs, characteristics important in collaborative work environments (Bardram et al., 2006; Lasome & Xiao, 2001; Xiao et al., 2007). However, quite surprisingly, in this study a nurse commented that the clinical whiteboard helped her *“to remember”*. She further elaborated that:

*“it is very hard when you get pulled in all directions, I will write sort of under the patient name, on the whiteboard, obs [observation] due at half past twelve so I can see when I next come back to the board [whiteboard]. It is gone half twelve I need to get in there and do those obs [observation], and I will come back and – so that is the only time when it is written for me is when I make a little note on the board [whiteboard]” (Staff nurse E).*

In this case, the notes written on the whiteboard can be used not only as a collaboration method with other nursing staff, but also as a reminder to perform one’s activity in due time.

b. Pigeon holes and in/out trays

From the observations, pigeon holes were located at each of the clinical area. These pigeon holes were used to store ED cards for patients in the unit. Similar to the dry-erase whiteboards, pigeon holes also provide visual accessibility to the clinical staff, in regards to patients who were currently receiving treatment in the unit.

In addition, each clinical unit also had in/out tray used to temporarily placed ED cards for patients who have been discharged:

*“In each working area [units] there is a tray which is for discharge cards [ED cards]”* (Staff nurse C).

Unlike the pigeon holes, the in/out trays are particularly useful for reception staff stationed at the reception office. This is because they need to know whenever patients have been discharged from the clinical areas in order for the ED cards to be collected from the clinical units for coding and billing purposes. Having such trays provided the visual access to their task as they move about the department to do the collection.

*“Just in the interval we [reception staff] go around [the clinical units] to check and bring the [ED] cards back and then put the information back in into the system [perform coding]”* (Reception staff A).

As a result, no direct communication with clinical staff members at the units needs to be established, hence eliminating possible interruption.

Pigeon holes located at the reception office also serve as visual accessibility in maintaining asynchronous collaboration, in particular collaboration between clinical members and non-clinical members. According to an opportunistic interview with a member of the reception staff, ED cards which were placed in the pigeon holes indicated incomplete ED cards which required the doctors to fully complete the cards before they could be filed:

*“...these [ED] cards in here, are in the doctors pigeon holes – let me show you. All those [ED cards] in there they belong to each – each doctor has a pigeon hole and they [ED cards] the ones that have not [completely] been coded”* (Reception staff A).

In this case, the pigeon holes are a mediated artefact particularly useful in achieving complete patient records. Although viewed as place holders for paper records,

pigeon-holes as well as the in/out trays are an integral part of the information architecture.

c. ED cards and other paper-based forms

Unlike whiteboards, pigeon holes and trays which serve as visual tools to support asynchronous collaboration, an ED card on the other hand, is a visual tool in face-to-face direct interaction. It was frequently observed that when doctors were consulting each other for advice, ED cards were used at all times to accompany the interaction. In such interaction, the portability of the ED cards is useful in providing visual accessibility to its contents as well as allowing the interaction to be conducted anywhere within the ED.

In addition, other paper-based artefacts such as clinical test ordering forms also facilitate direct interaction among group members. For example, blood order forms were frequently handed over to the clinical technicians or care support workers, where the forms served as a visual tool indicating the task to be performed. The same goes for an imaging order form which can easily be placed at the porter's whiteboard or given directly to them. These forms effortlessly facilitate articulation of multiple processes. Other studies have highlighted that paper-based documents can introduce legibility problems that could lead to inefficiency in care delivery (Niazkhani et al., 2009) or that dealing with fragments of paper-based outputs can make the care process a challenge (Feufel et al., 2011). However, in this study the visibility of the documents themselves conveniently supports the direct interactions among clinicians as well as between clinicians and support staff.

In achieving collaborative work, resources within the workflow must be managed accordingly and information be easily accessible in order to provide awareness of the activities of other team members. Therefore, HIT applications used in collaborative care should be designed not only to include functional requirements for clinical activities such as triage, ordering investigation tests or viewing test results, but also to incorporate requirements for collaborative work.

### 5.2.3. Integration issues of the information artefacts into the ED workflow

The ED workflow comprised of a number of computerised information systems and non-computerised artefacts such as paper-based documents and dry-erase whiteboards. Therefore, the synergistic use of these information artefacts is necessary for the execution of the ED work processes. However, the usage of myriad information artefacts has had negative implications for a number of work processes.

#### 5.2.3.1. Usages of more than one system for a single work process

The availability of myriad information artefacts has negatively affected the efficiency of a number of clinical and organisational work processes, namely test investigation ordering processes, patient registration processes and coding processes. The execution of these processes required the use of more than one computerised information system as well as paper-based forms.

##### a. Investigation test ordering

As discussed in Section 5.1.4.1, clinical test ordering is one of the clinical processes in the workflow. Although it can be categorised as clinical work, this work process is carried out by both clinicians and support staff (Figure 5.4 and Figure 5.5). Execution of this work process requires the use of a number of computerised information systems depending on the type of tests, as well as who is doing the ordering. In submitting blood tests requests, two different computerised systems can be used: PFI and ICE. According to opportunistic interviews with two clinical technicians, they stated that they have access to the PFI system. Nursing staff and doctors, on the other hand, had access to the ICE system. According to a nurse, she only had access to the ICE system although the PFI was, according to her, more commonly used for this purpose:

*“I personally use ICE because I’ve been trained in ICE in my previous job but the department generally uses PFI here” (Staff nurse C).*

Another nursing staff member, when asked which system she used for blood test requests also provided the same response:



*“They prefer PFI on here [at the ED] but I used to work at the [other hospital – name is anonymised], so I’m more, I prefer ICE” (Staff nurse D).*

The preference of using the PFI over the ICE system, however, according to a care support worker depended on individual preference:

*“I do PFI and I also do ICE because I’m phlebotomy trained. So I request bloods, mainly on PFI because that’s the one that I use mostly. Lots of people prefer PFI or prefer ICE; I think it just depends on your preference” (Care support worker A).*

The availability of more than one clinical systems in essentially doing the same thing, i.e. blood test ordering, has contributed to myriad of non-integrated systems. This, can lead to non-uniformity of practice (Jirotko et al., 2005).

Use of the PFI system, although preferred, also contributed to another negative workflow effect; to perform a single work process requires accessibility to various systems. In an opportunistic interview with a clinical technician while she was accessing the PTS, stated that she needed to obtain a piece of information from the PTS before she can proceed to submit a blood test order via the PFI system:

*“To find out [from the PTS] where patients are and to find out the hospital number just because the job I [submitting blood test requests] do I need to have the hospital number” (Clinical technician B).*

As for x-ray/scan investigation tests, yet another set of computerised information systems must be used. Although ordering and accessing the test results only involved clinicians (Figure 5.5), they still needed to access two separate systems, one system, i.e. the PACS to access the digital image of the tests, and another system, i.e. the ICE to access the report format of the test:

*“X-ray results are viewed on PACS, it is another different system. You can see if the x-ray has been reported on ICE... But you can view images and if you are able to interpret it, you can view it sooner on the PACS system” (Doctor D).*

The use of the computerised information systems for investigation tests work process also presents another challenge. None of these systems are accessible to medical students who are doing their trainings, and to the auxiliary nursing staff who are

hired to work at the ED on a need basis. When the researcher questioned an external ED staff which computerised systems she has access to, she responded:

*“We don’t. We don’t have passwords, we don’t have logins”* (Aux nurse G).

Similarly, according to Medical student A, although part of her training was to perform blood test investigations, she could not submit the blood test request via any of the computerised systems. Instead, she relied on the doctors to submit the request once the patient’s blood was obtained:

*“We just do the blood test and then we get the doctors to request them for us [via the computerised system]. So they [doctors] can do like, they [doctors] print out the labels and things like that and we stick them [labels] on it [blood tube]”* (Medical student A).

In the ED, four computerised information systems, PFI, ICE, PACS and PTS have to be utilised for a single work process, i.e. the clinical test work process. Figure 5.7 presents a rich picture representation of the investigation test work process together with its resources, both actors and systems (the figure does not show the sequence of steps for the process). The system to be used depends on what type of test needs to be ordered (i.e. blood test or x-ray/scan) and by whom. As for x-ray tests, orders can only be submitted offline (via a paper-based form). However, to access the results, two separate systems need to be used, i.e. PACS or ICE, depending on the type of result format.

The availability of more than one system in order to execute a single work process has contributed to more disparate information architecture. This can lead to the non-optimal utilisation of information (Barthell, Coonan, Finnell, Pollock, & Cochrane, 2004). In addition, non-accessibility restrictions on medical students and external staff members prevents the work process to be executed efficiently as it can restrict amount of information to staff (Haleh Ayatollahi, Bath, & Goodacre, 2009).

In view of this effect, a number of clinical staff suggested that a single computerised system for investigation test work processes be implemented. Such implementation can be better suited in order to ensure the continuity of the process:

*“I do think the system can be improved by integrating everything into one. Although they [the ED] have four different systems for things, so that’s the only thing to correct, to improve things... if we can order blood tests or radiology investigations via one system, like ICE, that would be better, rather than having PFI, you know, PACS and everything” (Doctor D).*

*“I think it would be useful to have a single system with a single log-in for that, which ran all the different things that you need to do. So, for example, if you wanted to order a chest x-ray or a blood test, look up results of previous x-rays and scans and previous blood tests that would be a better system to be able to order everything through a single system” (Doctor E).*

Studies have shown the benefits of an integrated implementation. For example, an integrated EDIS comprising electronic whiteboard, Electronic Patient Record (EPR) and Computer Physician Order Entry (CPOE) provides rapid access to more detailed information (Aronsky, Jones, Lanaghan, et al., 2008). Similarly, Hertzum (2012) theorised that an electronic whiteboard system in their study failed to achieve distributed usage among the doctors and nursing staff due to a lack of integration.

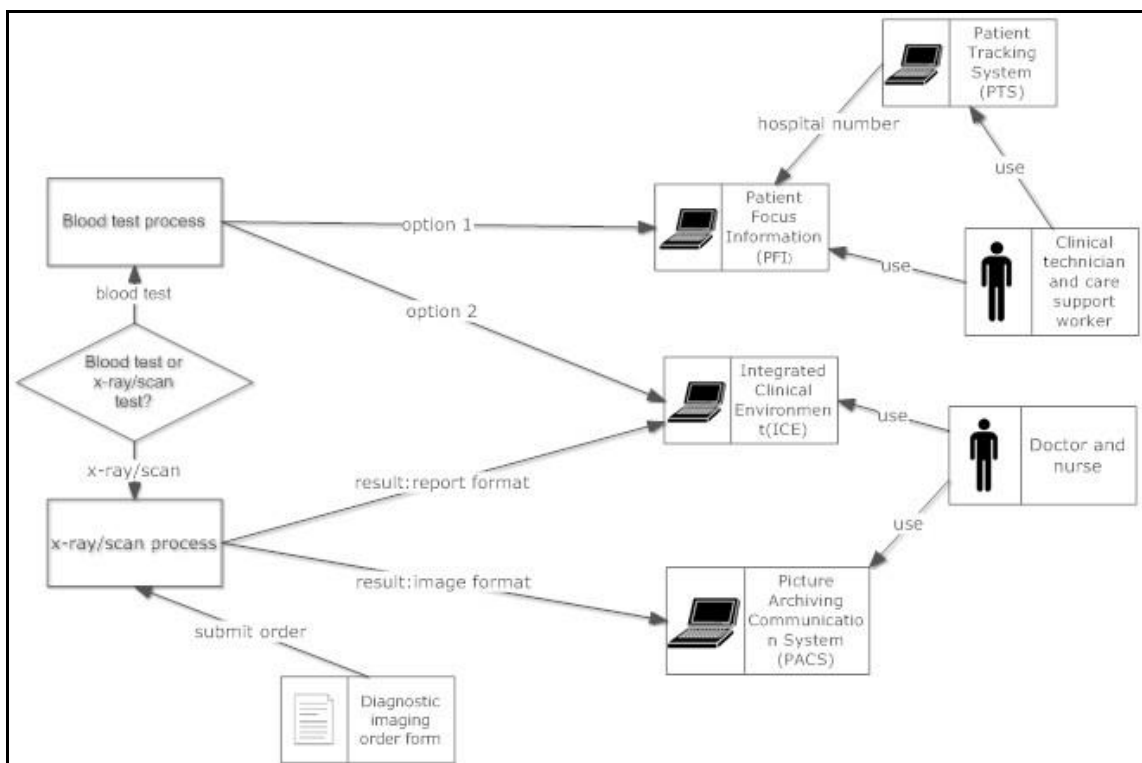

Figure 5.7: Rich picture representation of the information artefacts for the investigation test work process.

b. Patient registration process

As discussed in Section 5.1.4.2, the registration process can be categorised as an organisational work process. This work process is performed only by reception staff. Similar to the investigation test work process, more than one computerised information systems, as well as paper-based forms, need to be used to complete this process.

Three different computerised systems were used, PCS, NSTS and PTS, all of which had separate logins for the completion of patient registration process (Reception staff A). This process consisted of multiple tasks where each task involved accessing the three systems:

**Step 1:** Obtaining an ambulance sheet and searching from the PCS, patient demographic information. Information on the patient's clinical status was also recorded:

*"The patients arrive and we normally get a yellow sheet [ambulance sheet] from the ambulance service that they [ambulance crew] already filled in, not always filled in very well and so we need to take the name and date of birth and we search on those details [on the PCS] and then check to see whatever comes up if they [patients] live at that address and then we take the name, the address, the telephone number, the next of kin, religion, ethnic group, occupation, next of kin and family, last of all we then go on to the screen where we add the episodes which is what they [patients] are coming with that day, why they [patients] come to Accident and Emergency [ED] that day"*

**Step 2:** Patient details also included obtaining their GP information. Obtaining GP information required a search from the NSTS database which was not part of the PCS:

*"...we also have another system which NHS Strategic Tracing Service [NSTS] and well, I think it is a national system actually and that is to trace anybody GP that is in the A [A is anonymised city], absolutely everybody and if they [patients] are not registered, obviously, they [patients] are not there..."*

**Step 3:** After documenting all the information in the PCS, the patient was registered into the tracking system, i.e. the PTS:

*"...click on to another screen which is the department screen tracking system [PTS] which belongs, should appear A&E department for the whereabouts of the patients, click those details on to that screen which is totally separate from what we [reception staff] have been using [PCS]"*

**Step 4:** The patient ED card and labels were then printed:

*“...we have to produce the card [ED card], print the card [ED card] and some labels”*

Figure 5.8 shows a rich picture demonstrating the utilisation of various information artefacts during a registration process (the figure does not depict the sequence of steps for the process). The computerised systems, i.e. the PCS and PTS as well as a national database, i.e. the NSTS, are non-integrated systems. Therefore, the process requires the registration staff to separately login into multiple computerised information systems. It has been shown that HIT in emergency care with multiple logins can increase computer time and lead to user dissatisfaction (Likourezos et al., 2004). From the observations conducted at the reception office, registration conducted with assistance from ambulance staff, required the use of an ambulance sheet. Further, the type of ED card printed at the end of the registration process was depended on the type of patient injury.

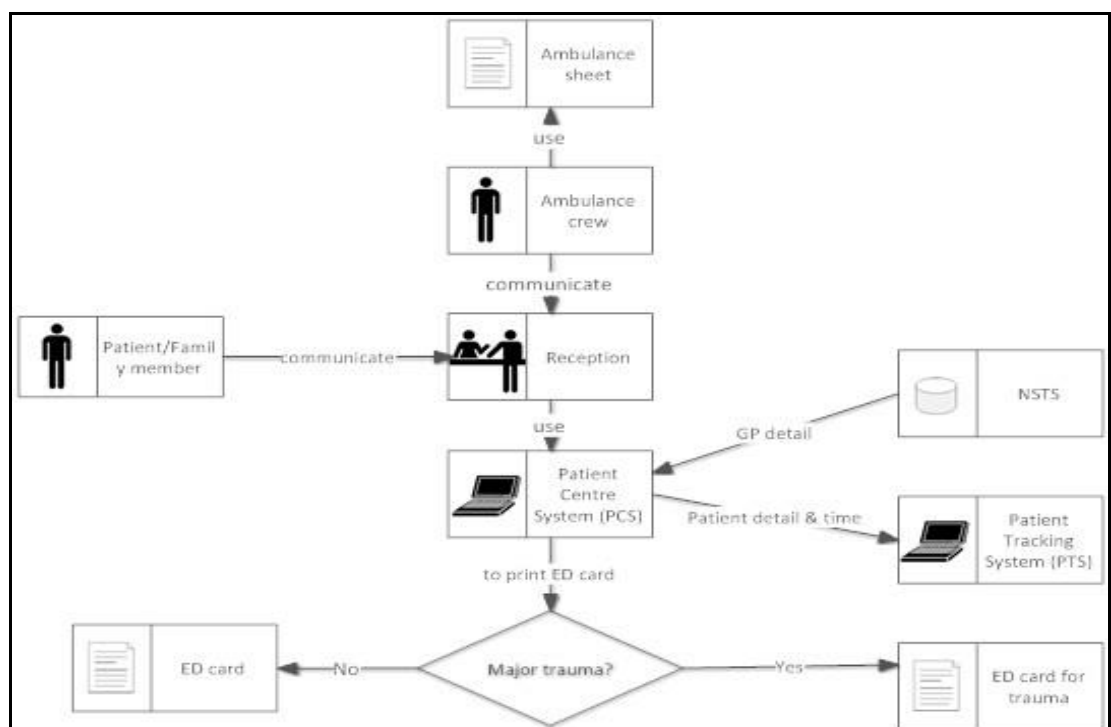

Figure 5.8: Rich picture of the information artefacts for registration process

c. Coding

As stated in Section 5.1.4.2, coding is an organisational process to generate invoices for billing and to ensure complete patient records. From an observation of a coding process performed by Reception staff A, this process required the use of computerised PCS, PFI and CRIS as well as the paper-based ED card. Any investigation tests and treatments documented in ED cards were manually transferred to the computerised PCS to generate invoices. However, a coding section on the ED cards were almost never completed by doctors as required:

*“This is only part of it, actually and what this is, is the doctors when they do the coding [on the ED card] miss investigations off the back of the [ED] card. What they are supposed to do is tick them, when somebody has a CT or whatever of these, they forget to tick them. Don’t ask me why, I’ve no idea why, but it is very common”* (Reception staff A).

As a result of an incomplete coding section of the ED cards, Reception staff A had to obtain the required information from two other systems, the PFI and CRIS. The PFI is for blood tests while the CRIS is used for radiology tests. This involved accessing the list of tests conducted on certain day according to patient attendance to the ED. Upon checking a list of blood tests conducted on the 19th from the PFI, Reception staff A can confirm that the patient had two types of blood tests, bio chemistry and haematology:

*“So I’m looking for the 19th, which is number three, and that tells me on that day this lady she had bio chem [chemistry] and haematology”* (Reception staff A).

She then clicked on another desktop icon, CRIS. CRIS was used to determine whether the patient has radiology tests performed or not. However, in order to use the CRIS, she needed to use the patient hospital number (instead of an ED number) which she had to obtain from the same system she used to obtain patient blood test, i.e. the PFI:

*“So I’m going to put that gentleman’s hospital number in because that [referring to CRIS] doesn’t recognise – because it’s a hospital wide system, it doesn’t recognise A&E numbers [ED numbers]; it only recognises a hospital number. So I’m going to put that in – and it’s still thinking about it – and I’m looking again for the 19th, and it’s telling me on that day that she had a chest x-ray”* (Reception staff A).

Figure 5.9 is a rich picture demonstrating the use of these multiple information artefacts in a coding process (the figure does not show the sequence of steps for the process). Both the PFI and CRIS sourced different information into the PCS. Updating of the PCS is a manual process carried out by reception staff. Invoices can then be generated upon completion of the process.

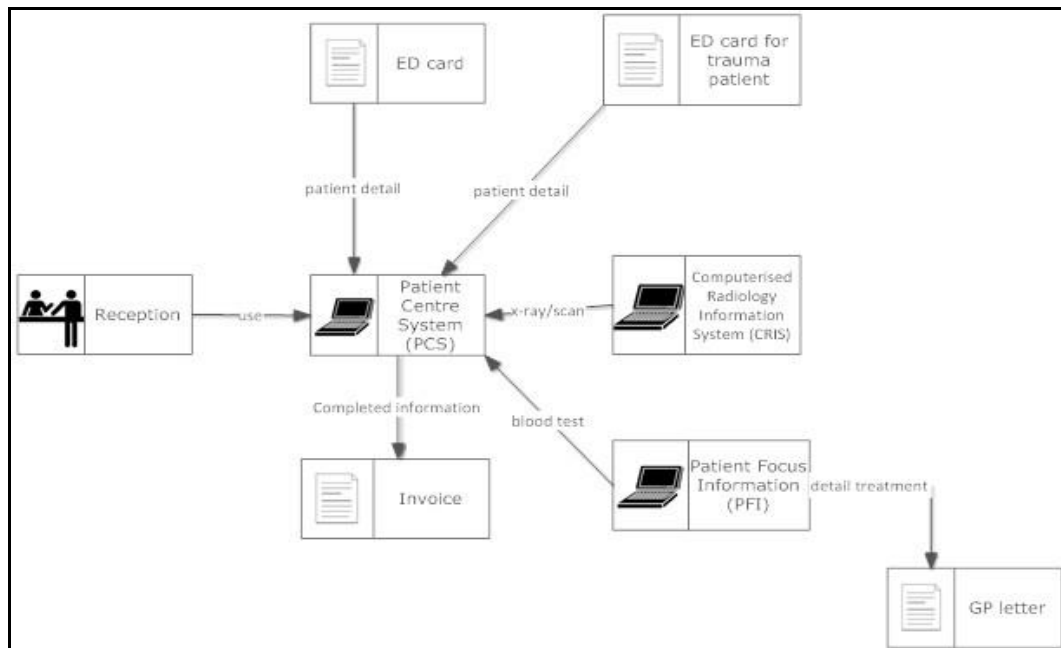

Figure 5.9: Rich picture showing the information artefacts for the coding process

Once the PCS was updated with treatment details to produce invoices, GP letters can also be produced. However, instead of using the PCS to produce the GP letters, the PFI was used. The coding process also did not just stop once the PCS was updated and invoices were generated. Whenever incomplete ED cards were encountered, they needed to be returned to the doctors via their pigeon holes located in the reception office. Once the ED cards were completed by the doctors, the PCS was updated again:

*“each doctor has a pigeon hole and they’re [ED cards] the ones that haven’t been coded. I will have coded them, only for financial reasons [in the PCS], not for any medical reason. Say that doctor comes along now, and does all those, they’ll be put there and the girls [other reception staff] will do them and put the diagnosis and everything that’s missing” (Reception staff A).*

Disparate information artefacts can negatively impact the delivery of care. Information can become more fragmented and become unavailable. As a result, there is a need to access more 'informal' sources (Reddy & Spence, 2008). It can also result in clinicians having to rely on other care providers to reduce mental efforts and additional time in order to find complete information (Abraham et al., 2009).

#### 5.2.3.2. Inaccurate documentation

Another study showed that fragmented information systems, part computerised and part non-computerised, can contribute to workarounds, errors and user dissatisfaction (Harrison et al., 2007). In this study, it was found that the ED hybrid information infrastructure can lead to inaccuracies in the documentation process leading to errors in reporting. It was a commonly observed event that throughout the clinical processes performed by the clinicians, both the computerised PTS and ED card needed to be updated and used concurrently. This is mainly because these artefacts are used for different purposes. The PTS is used mainly to track of patient movement and to obtain an overview of patient care plans (PTS screen shot analysis). The ED card, on the other hand, is the formal documentation system where comprehensive medical notes are documented (ED card analysis).

Updating two systems simultaneously while delivering clinical care can result in discrepancies. This in turn could affect accuracy in the reporting of any breaches:

*“So somebody [a doctor] can call a patient in at a certain time, and then they'll put down – I don't know say they call them in at 9 o'clock so they might click onto the patient, onto the tracking system [PTS], the doctor called them in at 9 o'clock, and they see the patient, do everything, then they [doctor] decide to write the [ED] card, well it might be quarter past nine by that time. Or half past nine, so then they're writing 9:30 time that they've seen the patient. So straight away there's a difference in timings and we've lost like 15. They do the same when they're discharging because sometimes it comes down to minutes that could be just the time that it's taken them to see the patient off, walk to the desk sit down and maybe get a phone call in between and then by the time they get writing the [ED] card and then click it off, they can have made it breach [of the four-hour target] simply because” (Reception staff C).*

As stated in Section 5.1.1, the four-hour target rule is a clinical governance that all UK EDs need to adhere to. In addition, any delay in discharging or admitting patients could lead to risks on patient safety and ED overcrowding. However, having to update



two separate systems during the entire patient trajectory had caused error in the documentation practice. This affects the efficiency and accuracy in the execution of this particular ED workflow component.

#### 5.2.3.3. Unavailability of complete information

Partial electronic implementation can also affect the availability of obtaining complete information. For example, obtaining patient location is crucial in the delivery of emergency care as patients are constantly being moved from clinical units to other areas of the ED. Patients can also be temporarily 'removed' from treatment bays:

*"patient moves that frequently from here to x-ray or if they are kept in a room or if they are in the side room, we need that side room for patients, they get move out to accommodate the [newly arrived] patients so we tend to do a lot of swapping around patients" (Clinical technician B).*

In order to obtain a patient's location, staff had to rely on both the PTS and clinical whiteboards. From the documentary analysis of a PTS screen shot, the PTS can only be used to determine which clinical unit patients are assigned to, i.e. minor, red, blue, resuscitation unit and CDU. However, in order to determine their exact location, i.e., which treatment bay within the clinical unit, the clinical whiteboards had to be used:

*"Tracking [PTS] doesn't tell you exactly where the patient is in red team [sub-unit] whereas the whiteboard does. So, they [PTS and whiteboards] kind of work together" (Staff nurse F).*

Similarly, another nursing staff commented that one artefact cannot do without the other:

*"I think if you remove the whiteboard from the nurse's station then you wouldn't necessarily know where patients were in the department. But equally the tracking system [PTS] is valid because everyone can see it wherever they [patients] are in the department" (Staff nurse C).*

Obtaining an accurate patient location is crucial for the ED workflow. However, obtaining this particular information required access to two separate information artefacts, the computerised PTS and the dry-erase clinical whiteboards. If the PTS were to become unavailable for technical reasons, the overall ED workflow could be affected.

Although the existing information architecture has continuously provided support for the ED workflow, this theme has demonstrated that a number of integration issues still remained. Other studies have reported that disparate systems can result in the non-optimal use of the information (Barthell et al., 2004) and introduction of ad-on tasks non related to patient care activities (Abraham et al., 2009). In this study, the disparate systems affected the continuity of tasks within a single process as well as affecting the accuracy and availability of obtaining complete information. Additionally, the 'option' to select which system to use for the same process can lead to more disparate systems. An ideal system is able to support continuous tasks by making available all pertinent information portable, locatable and accessible to all members of the group (Feufel et al., 2011).

### 5.3 Synthesis

This section synthesises the findings presented in Section 5.1 and Section 5.2. It is organised in relation to the ED patient trajectory across different clinical units, the work processes of the ED team members at the clinical units which formed the workflow and the information artefacts used.

#### 5.3.1. Patient trajectory

Patients receive treatment depending on the severity of their illnesses or injuries. At the ED, there are three units patients can receive treatment from: the minor injuries unit, major unit and CDU.

##### a. Minor injuries unit

The minor injuries unit is for patients receiving treatment for minor injuries such as cuts, and minor illnesses such flu. Figure 5.10 and Figure 5.11 are flowchart diagrams showing the patient trajectory at the start of emergency care and patients specifically assigned to the minor injury unit, respectively. The connector symbol A in Figure 5.10 leads to the patient trajectory at the minor injury unit in Figure 5.11. The dashed lines represent exceptions made to patients with deteriorating condition as they go through the care trajectory. For example, the dashed lines from *nursing triage process* to *bed allocated process* represents an exception that needs to be made for walk-in patients who are triaged to the major unit (instead of the minor injuries

unit). Most patients at the minor injuries unit are walk-in patients with occasional ambulance patients. All walk-in patients are required to register themselves prior to receiving treatment. During registration, details such as personal information and presenting complaints are taken. Registration also starts the clock for the four-hour rule.

Once registered, patients are sent to wait in the waiting area (Figure 5.10). They will then be called for triage by a triage nurse. During a nursing triage, patients are assigned to different streams based on the conditions and types of emergency care that they are going to receive. There are six different streams in total: ENP; patients returning from investigation; ED doctor; psychotherapist; review clinics; and speciality team. Assigning patients to the streams means that priority is given to those who require immediate care, i.e. patients might not be seen based on time of arrival and by ED doctors immediately. For example, patients assigned to the ENP stream are treated by an ENP nurse first, requiring an intervention from an ED doctor only if needed. The review clinics or follow-up stream is for patients who are returning for follow-up treatment such as wound dressing. The speciality team stream includes patients being seen by specialised nursing staff such as DVT and chest pain nurses.

Once triage is completed, patients are sent to wait again in the waiting room, prior to be called to the minor injuries unit clinical area. The clinical area contains trolley areas separated by curtains. Each patient is allocated an area while receiving their treatment. As shown in Figure 5.11 (keys to the symbols are also on page xv), during the course of the minor injuries treatment, assessments are performed and investigation tests, such as blood tests and x-rays/scans are ordered. The end of their care trajectory is either home or hospital discharge. Some patients are also sent to the CDU to wait for investigation results or for hospital beds if they are to be admitted. The connector symbol B (Figure 5.11) leads to patient trajectory in the CDU (Figure 5.12).

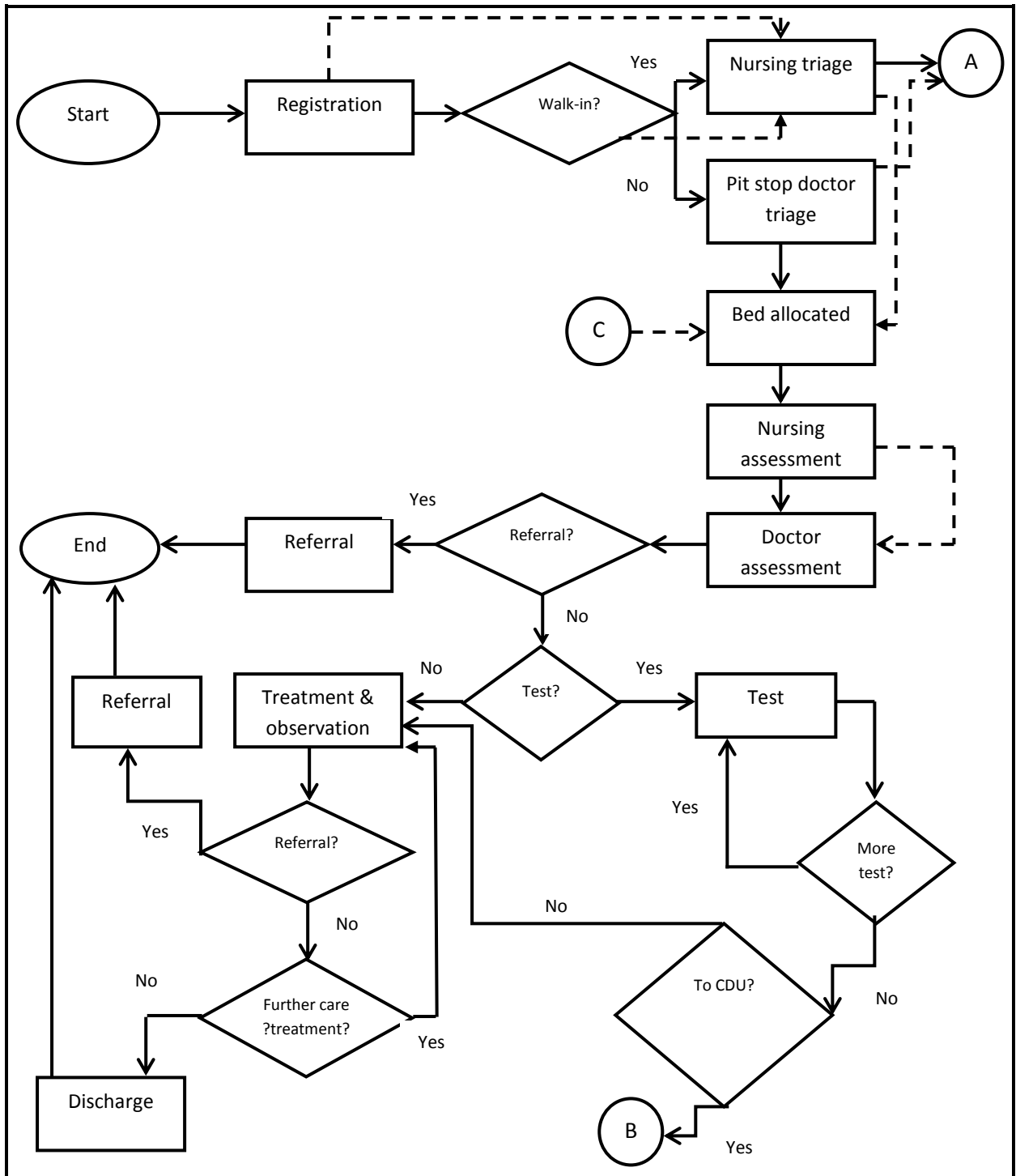

Figure 5.10: Overall patient trajectory and major unit patient trajectory (Keys to the symbols: ovals mark the start/end, rectangles represent processes, diamonds represent decisions, arrows represent normal flows, dashed arrows represent exceptions and circles represent connectors)

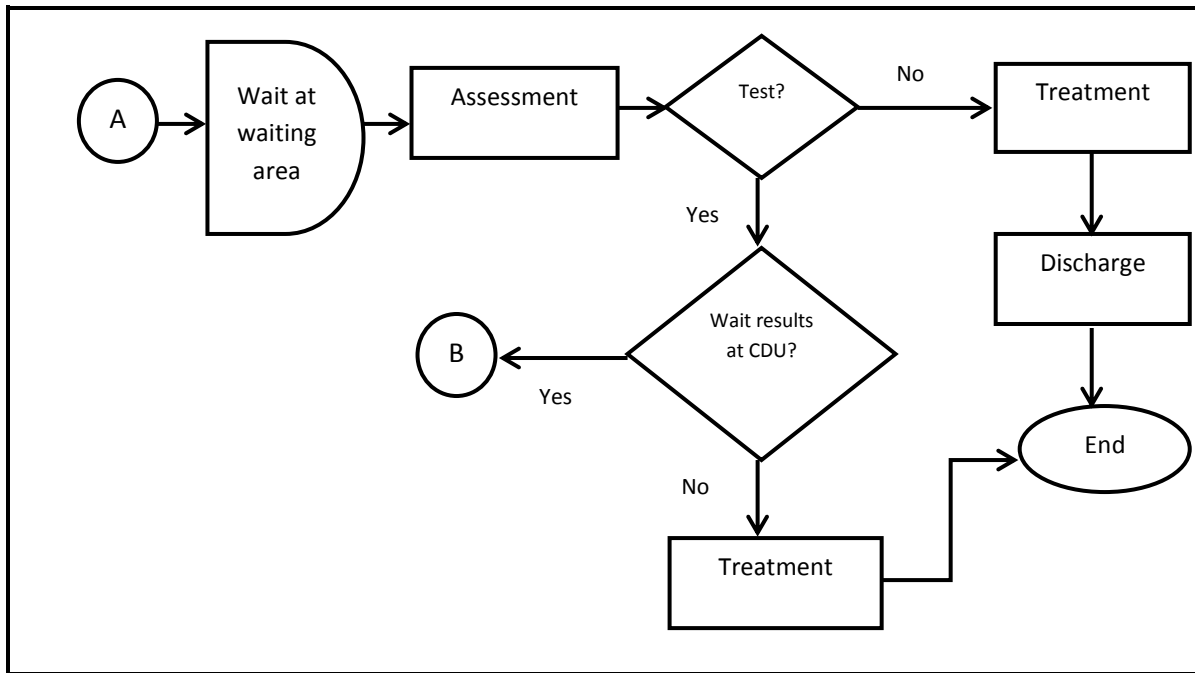

Figure 5.11: Minor injuries unit patient trajectory (Keys to the symbols: ovals mark the start/end, rectangles represent processes, diamonds represent decisions, arrows represent normal flows and circles represent connectors)

b. Major unit

The major unit is divided into three sub-units: red, blue or resuscitation. Each sub-unit is occupied with beds separated by curtains. The red and blue sub-units are essentially the same level and are allocated for patients with less life-threatening conditions. Meanwhile, critically-ill or critically injured patients who require immediate and one-to-one emergency care are sent to the resuscitation sub-unit. Patients from the major unit are more often the ambulance patients. Figure 5.10 depicts patient trajectory at the major unit. The patient registration process of major injury patients is assisted by the ambulance staff. Similar to the walk-in patients, the four-hour time limit starts as soon as they are registered. Once registered, they are triaged almost straightaway by a pit stop doctor situated at the ambulance bay. They do not have to wait at a waiting area but instead are transferred to any of the sub-units within the major unit. However, pit stop triage is only available for patients arriving at certain times of the day. Ambulance patients who arrive when pit stop triage is not available are triaged by triage nurse although the same method of triage is used (i.e. determining which sub-unit patients are sent to).

As shown in Figure 5.10, at the red and blue sub-units of the major unit, patients are assessed twice, firstly by nursing staff and finally by doctors. During a nursing assessment, a Manchester triage score (Table 5.1) is used to determine how soon the patients need to be seen by doctors for doctor assessment. The doctors are not supposed to see patients until after the nursing assessment. However, it has become increasingly common practice to have doctor assessment performed first when the volume of patients increased or if there is an inherent delay in performing nursing assessment. During the course of emergency care, investigation tests are ordered, treatments are administered and patient conditions are monitored. Referrals are also made to specialty teams (e.g. cardiologists and psychiatrists) in which case the decision for discharge lies on the specialty team instead of the ED doctors. The decision for discharge for non-referred patients can be home or hospital discharge. Some patients are also sent to the CDU. The connector symbol B in Figure 5.10 leads to patient trajectory at the CDU depicted in Figure 5.12.

Meanwhile in the resuscitation sub-unit, resuscitation patients are treated by a dedicated team of doctors and nurses. The resuscitation team work simultaneously to resuscitate and stabilise very ill patients.

c. Critical Decision Unit (CDU)

Figure 5.12 shows the trajectory for patients who are sent to the CDU. The CDU is where patients from the minor injuries unit and major unit are sent to wait for blood test results and/or scan results; to be transported to other wards; to wait for mental health input or to wait for the discharge response team. In general, patients sent to the CDU are in stable condition; however, patients who deteriorate while at the unit are sent back to the major unit (shown by dotted line to the connector symbol C). CDU patients are confined to a twelve-hour bed wait, in which case they can only be held in the CDU for a maximum of twelve hours. Chest pain patients are also sent to the CDU but they are not restricted to the twelve-hour bed wait. There are individual trolley bays areas and observation areas separated by curtains. However, not all patients who are sent to the CDU wait in these areas: some non-critical patients wait at the seated waiting area.

Staffing in this unit is slightly different from the other two units. Only nurses and care support workers are allocated to the unit at all times. Doctors are not assigned specifically to the CDU, although they are required to come and review patients once patients' test results

are available. Therefore, nurses allocated at the unit must keep track of patient investigation results and inform doctors of the availability of the investigation results. In addition, nurses and care support workers are responsible for providing observations on the patients, accompanying porters when patients are to be transferred to wards or to/from the radiology unit.

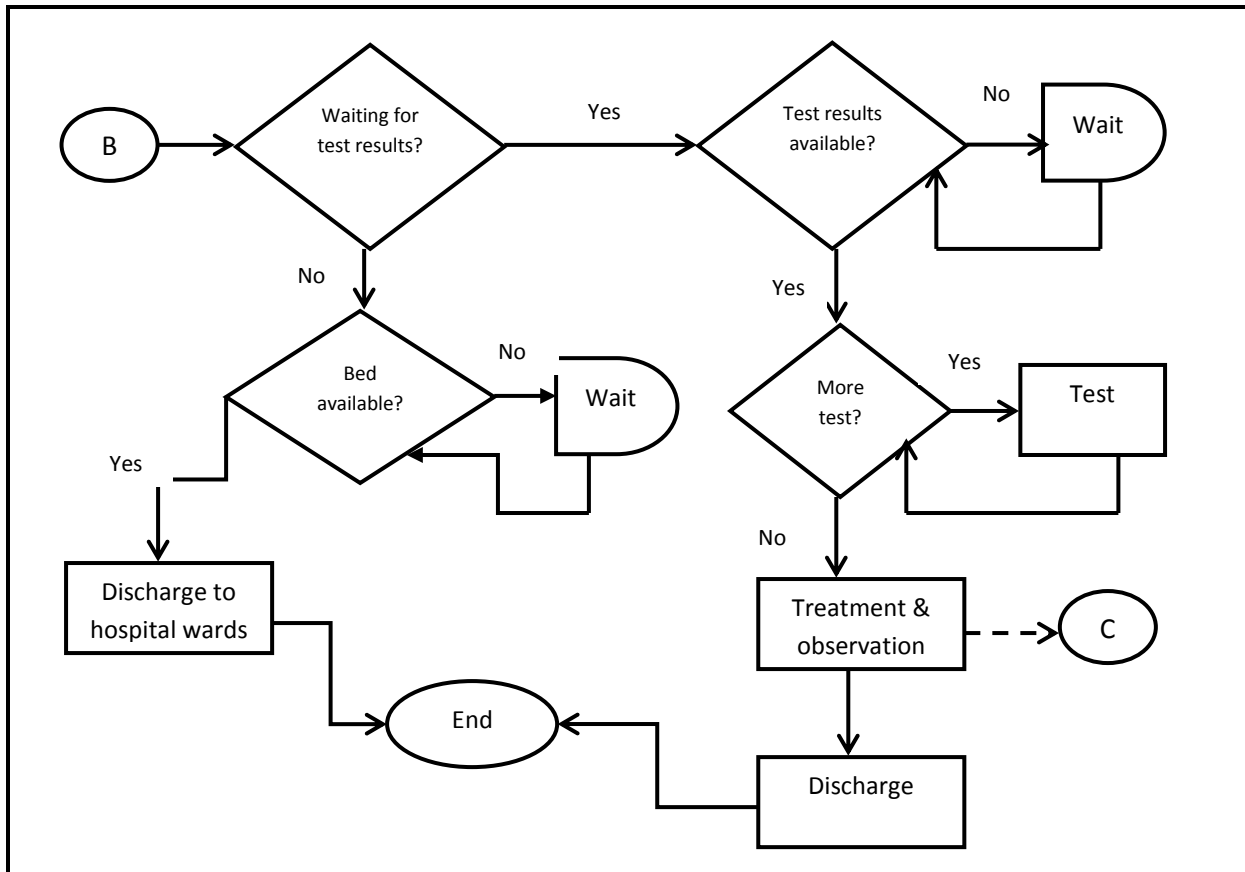

Figure 5.12: Patient trajectory for CDU patients (Keys to the symbols: ovals mark the start/end, rectangles represent processes, diamonds represent decisions, arrows represent normal flows, dashed arrows represent exceptions and circles represent connectors)

### 5.3.2. Collaborative work processes

As discussed in Section 5.1.2 and shown in Figure 5.2, the ED team is comprised of a multidisciplinary team of clinical and non-clinical members. Each member has their own roles and responsibilities. For example, a consultant can carry two additional roles, i.e. an advisory role, in addition to their clinical role in which they are responsible for providing advice to junior

doctors and nursing staff. Some of the consultants are also assigned a CiC role where they are in charge in managing patient flow together with a NiC and patient flow champion. “Medical work is comprised of tasks of individual providers as well as the tasks which connect collaborating providers” (Niazkhani et al., 2009 p. 540). In contrast, some staff members, such as a clinical technician, have a single role which is to execute clinical investigation tests requested by doctors.

Execution of the ED work processes require that these multidisciplinary members collaborate. It is crucial that collaboration be maintained in order to ensure continuous flow of the work processes. Figure 5.13 to Figure 5.17 are the swim lane flowcharts showing the roles and responsibilities of the staff members in executing ED collaborative work processes (keys to the symbols are also on page xv). Figure 5.13 shows the responsibilities of both clinical and non-clinical staff members in executing the processes for patients assigned to the major unit. The registration process is the initial process where all patients are registered and consequently triaged. The type of triage performed is based on the patient’s mode of arrival. Ambulance patients are triaged by a pit stop doctor while walk-in patients are triaged by a nurse. However, triage by pit stop doctors is only available at certain times of the day. When unavailable, it is taken over by nursing triage (shown as a dashed line from the *ambulance patient decision* to the *triage process* by triage nurse). As stated in Section 5.1.3, the major unit is mainly for ambulance patients while the minor injuries unit is for walk-in patients. Therefore, pit stop doctor triage result in patients being sent to the major unit. However this is not always the case. A small number of ambulance patients can also be triaged to the minor injuries unit. This is shown by the dashed line from the pit stop doctor triage to the connector symbol F. F is the continuation of care processes for minor injuries unit staff members in Figure 5.14. Similarly, nursing triage can also occasionally result in a small number of patients being sent to the major unit. This is shown by the dashed line from nursing triage to assessment by nursing staff at the major unit.



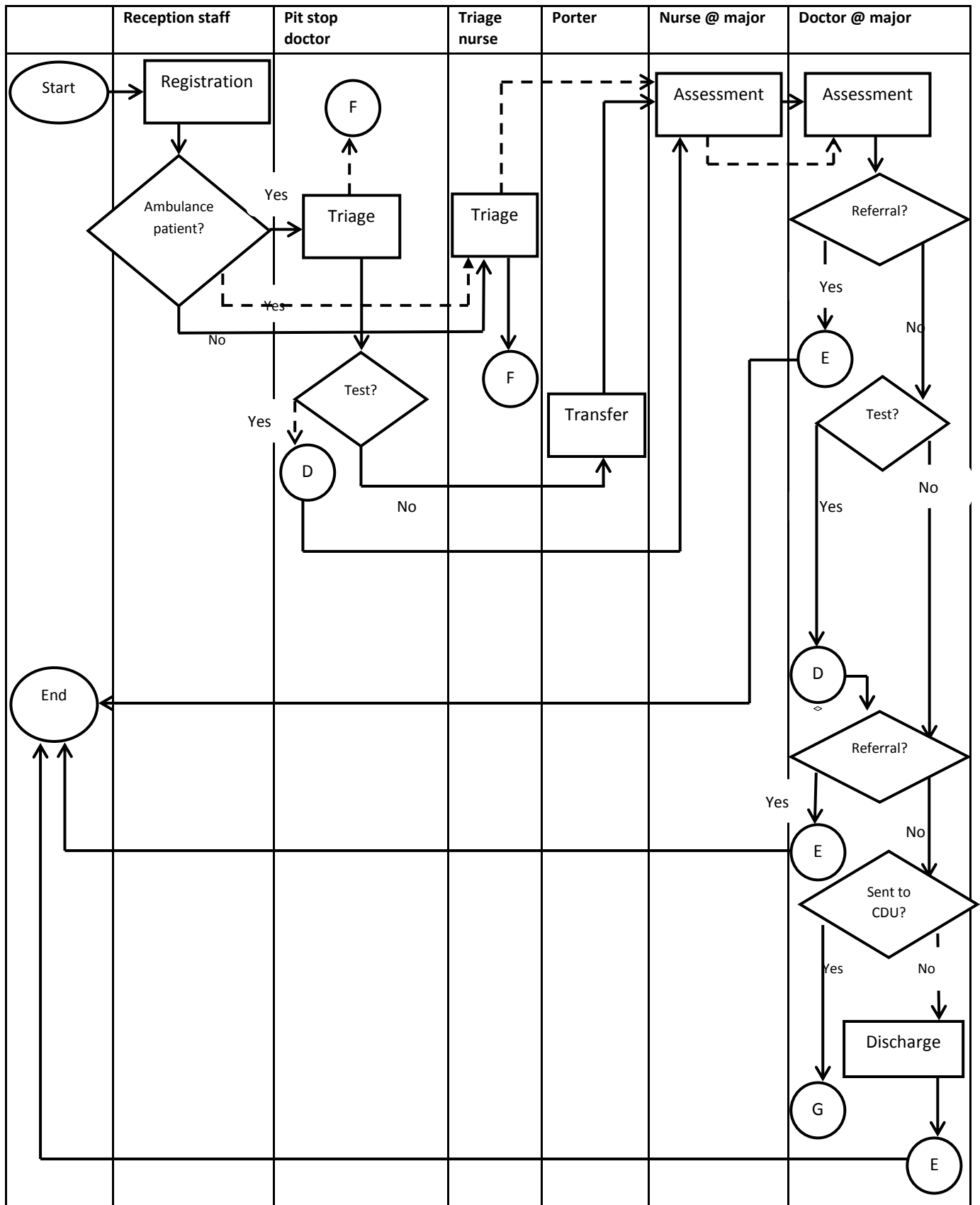

Figure 5.13: Collaborative work processes at the major unit (Keys to the symbols: ovals mark the start/end, rectangles represent processes, diamonds represent decisions, arrows represent normal flows, dashed arrows represent exceptions and circles represent connectors)

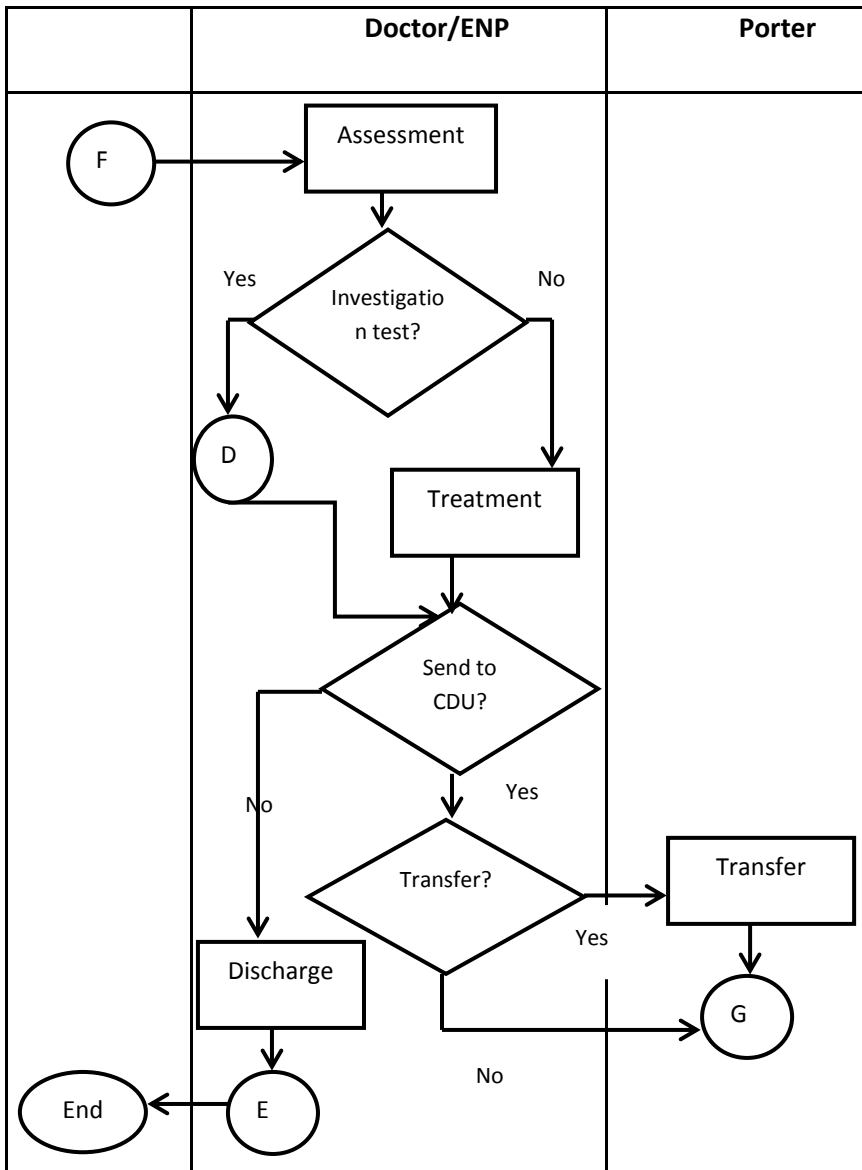

Figure 5.14: Collaborative work processes at the minor injury unit (Keys to the symbols: ovals mark the start/end, rectangles represent processes, diamonds represent decisions, arrows represent normal flows, dashed arrows represent exceptions and circles represent connectors)

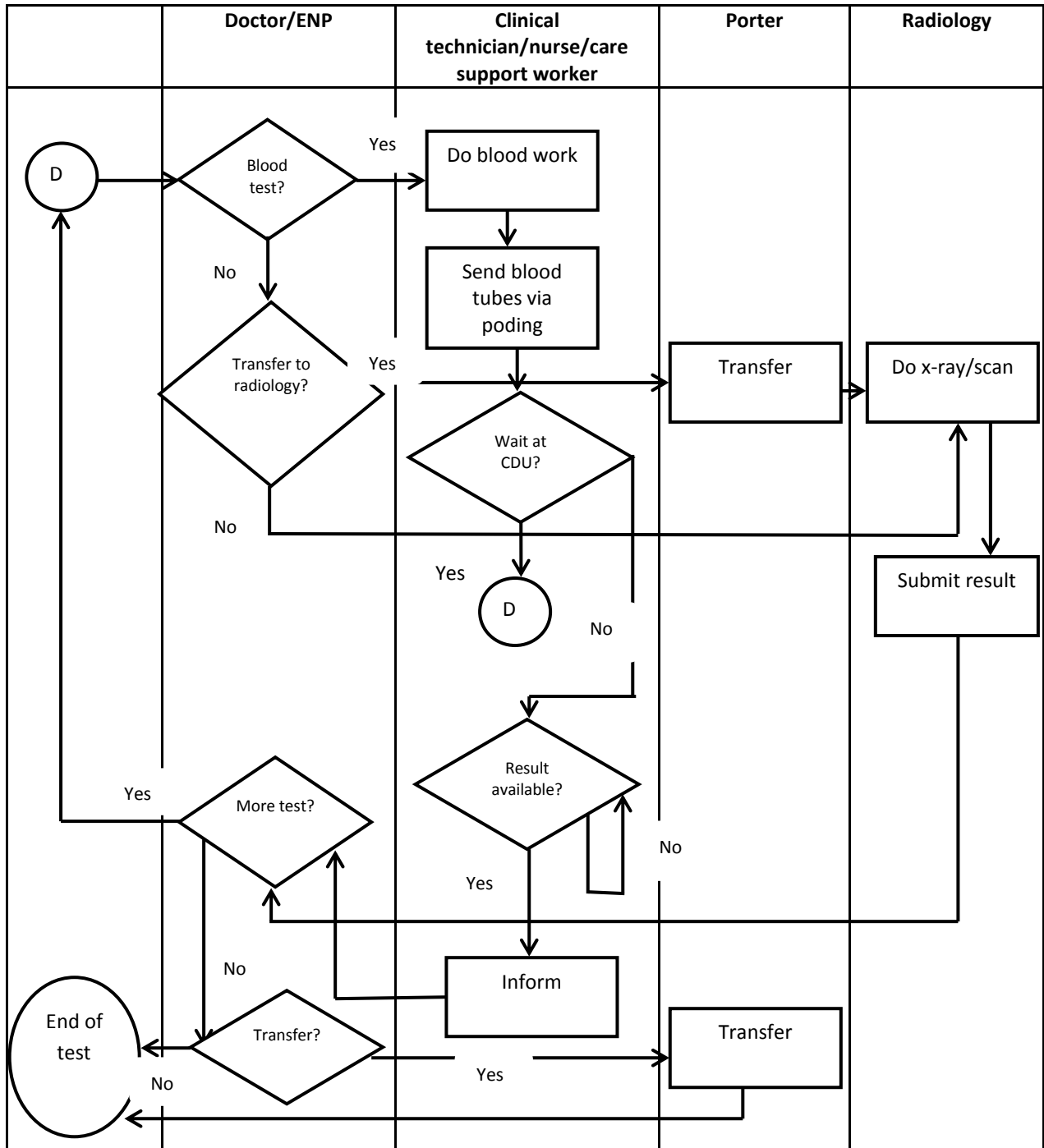

Figure 5.15: Investigation tests work process (Keys to the symbols: ovals mark the start/end, rectangles represent processes, diamonds represent decisions, arrows represent normal flows, dashed arrows represent exceptions and circles represent connectors)

The workflow at the CDU (Figure 5.16) is quite different compared to the workflow in the major unit (Figure 5.13) and minor injuries unit (Figure 5.14). This is because CDU patients are either waiting for investigation test results or hospital beds. The main process at the CDU is where the nursing staff must be kept updated on the availability of test results in order to inform doctors of the results. This is so that clinical decisions can be made. The decisions can include decision for more tests to be conducted, referral or discharge. The test investigation work process in Figure 5.15 can occur at either unit.

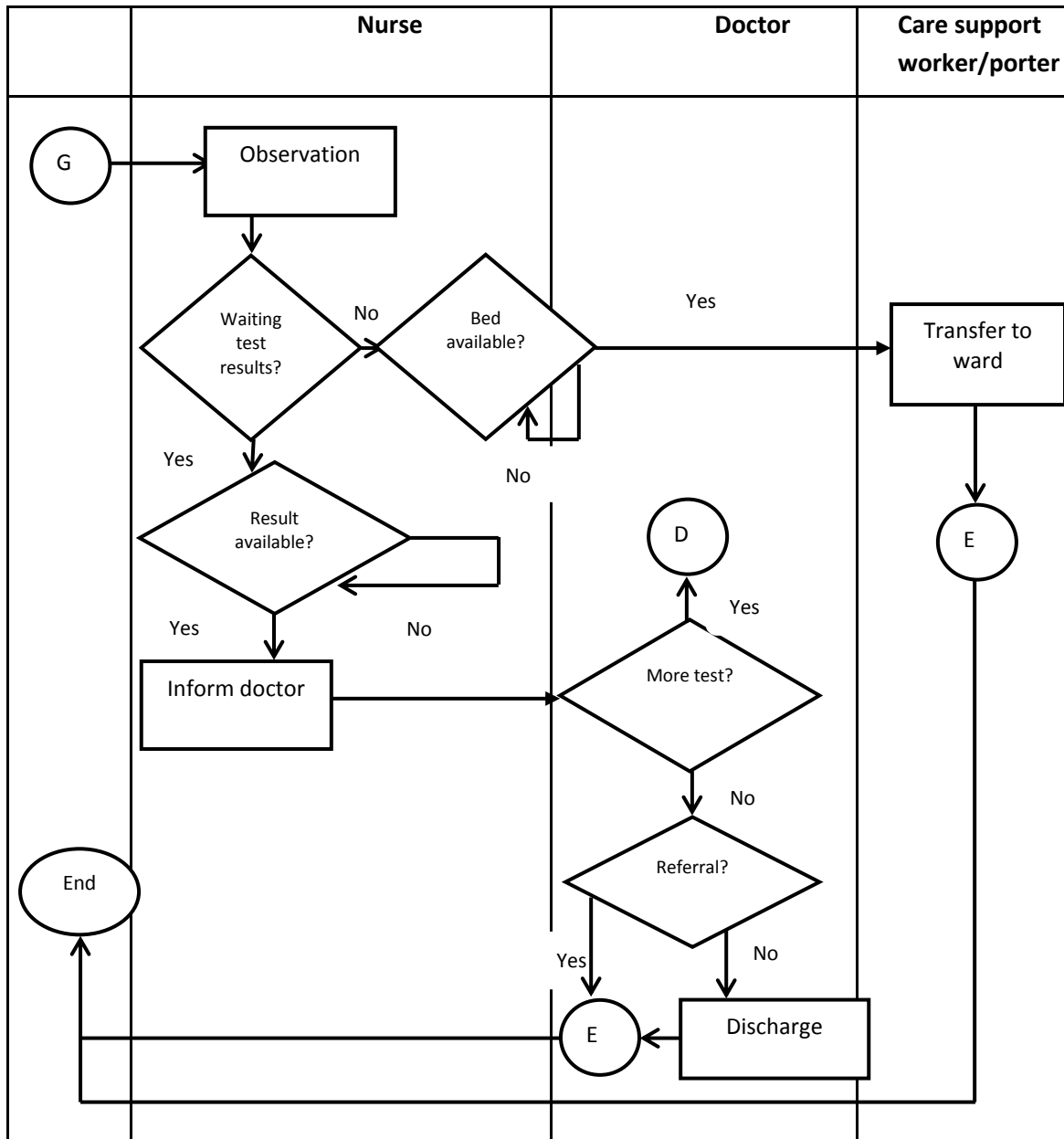

Figure 5.16: Collaborative work processes at the CDU (Keys to the symbols: ovals mark the start/end, rectangles represent processes, diamonds represent decisions, arrows represent normal flows, dashed arrows represent exceptions and circles represent connectors)

As for an investigation test process (Figure 5.15) and a coding process (Figure 5.17), these processes are primarily the responsibilities of support staff members such as clinical technicians, care support workers, porters and reception staff. Porters, for example, are responsible for patient transfer. This includes transferring patients who are not able to walk to the radiology unit (mostly major unit patients) or transporting patients from the CDU to hospital wards. Reception staff, on the other hand, is the main actor in the coding process

(Figure 5.17). However, when incomplete ED cards are encountered, they need to pass the ED cards back to the doctors.

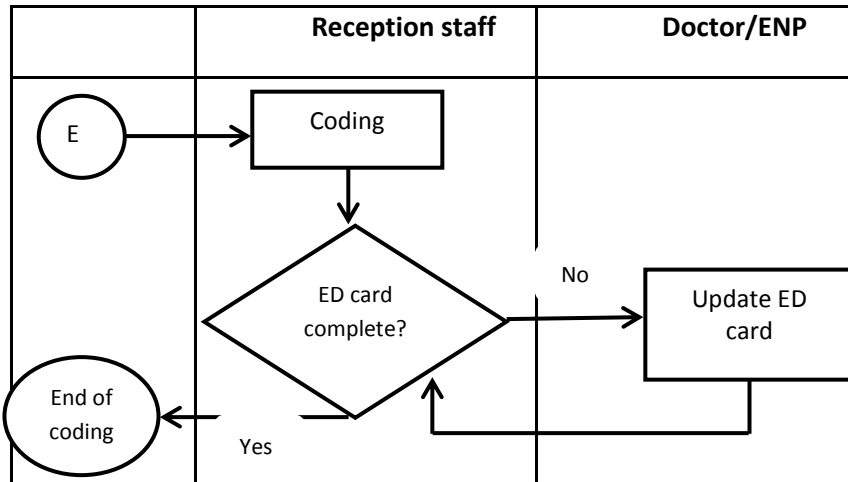

Figure 5.17: Coding process (Keys to the symbols: ovals mark the start/end, rectangles represent processes, diamonds represent decisions, arrows represent normal flows, dashed arrows represent exceptions and circles represent connectors)

Additionally, on certain occasions (not shown in any of the figures), housekeeping staff also participate in non-clinical care activities such as managing the well-being of patients' relatives. Similarly, medical students also participate indirectly in clinical processes such as the investigation test process. Within the overall workflow, ensuring that patients receive their treatment within four-hours, an organisational work process, is also executed. This is the responsibility of the CiC, NiC and the patient flow champion.

### 5.3.3. Information artefacts in supporting the ED collaborative work

As discussed in Section 5.3.2, the ED workflow consisted of clinical and non-clinical collaborative work processes. These work processes are executed semi-autonomously by staff of various roles. In order to support collaboration among staff members for an overall delivery of emergency care, the EDIS has to be able coordinate the processes. Many studies have emphasised that HIT should not be treated as purely storage and retrieval tools but also collaborative tools (Feufel et al., 2011; Park et al., 2012; Wong et al., 2009).

The role-based accessibility to the hybrid information system, particularly the computerised information systems, does not seem to foster seamless collaboration among ED team members. For example, the PCS is accessible by the reception staff almost entirely for registration and coding processes only, whereas the clinical staff and other support staff members have access to other computerised systems for clinical processes. Given that the emergency care processes are collaborative processes, the coordination of one process to another requires additional coordination efforts. For example, a registration process is completed by reception staff via the PCS, the next process, i.e. the triage process is continued on via a separate system, a paper-based system (i.e. the ED card), hence 'a gap' between the processes. The gap involves the 'transitioning' of the PCS to a paper-based system. Clinical processes are also continued with the utilisation of disparate computerised systems while at the same time tracking of patients have to be supported via other artefacts. On top of this, the disparate systems also affect the continuity of tasks within the same work process (as shown in Figure 5.7, Figure 5.8 and Figure 5.9)

However, the use of non-computerised information artefacts, particularly the clinical documentation system (i.e. the ED card) and the dry-erase whiteboards as well as the computerised PTS does, to a great extent, support the collaborative practice of the team members. The PTS is particularly useful in providing an overall assessment of the clinical units. A pit stop doctor particularly depends on the PTS in order to assign patients to the sub-unit within the major unit. A CiC can also use the PTS to determine how busy the clinical units are; an asynchronous collaboration between the pit stop doctor and clinical team in the major units. It is important that this information is known so that resources such as staff and beds can be adjusted as necessary. In contrast, the ED cards placed in the pigeon holes and in/out trays serve as a physical marker for managing workload assignments among staff members. For example, the ED cards in the out tray are for the reception staff while the ED cards in the pigeon holes are for the clinical members. Acknowledging the interdependence among group members ensures workload distribution and therefore, smooth functioning of the work processes (Feufel et al., 2011). In addition, the ED cards on their own also facilitate collaborative practice between junior doctors and senior doctors. The portability of the paper-based systems permits such collaboration to be easily conducted anywhere within the setting.

Characteristics such as visual access and cues afforded by these artefacts also allows for the execution of the collaborative work processes. The dry-erase whiteboards and paper-based forms placed at the whiteboard provide an indication to the staff members of what needs to be done. For example, the imaging forms placed at the porter whiteboard is a 'signal'

that there are patients to be transported to the radiology unit. Similarly, another study has shown that the use of 'external' objects on the whiteboard such as magnetic strips provide a visual cue for a task to be executed without having to write the indicated task activity explicitly (Lasome & Xiao, 2001).

#### **5.4 Conclusion**

This chapter presented the case study findings at the adult ED. This study provided an in-depth understanding of the adult ED workflow which does not only consist of interconnected processes or resources but also variability and exceptions of the care process. It also includes findings on how the workflow is being supported and issues concerning the integration of the hybrid information implementation. In Chapter 6, findings from a case study conducted at another emergency setting, a paediatric ED is presented. The study at the adult ED led to the study design in the paediatric ED.



## **CHAPTER 6: CASE STUDY 2 – PAEDIATRIC ED**

Similar to Chapter 5, this chapter discusses the findings from the second research setting, a paediatric ED. This chapter follows a similar format to that of Chapter 5. Figure 6.1 presents the relationship among the themes and sub-themes. The synthesis of the themes is discussed in Section 6.3. This chapter also includes a discussion (Section 6.4) on the similarities and differences between the first case study (i.e. the adult ED) and the findings of this chapter (i.e. the paediatric ED).

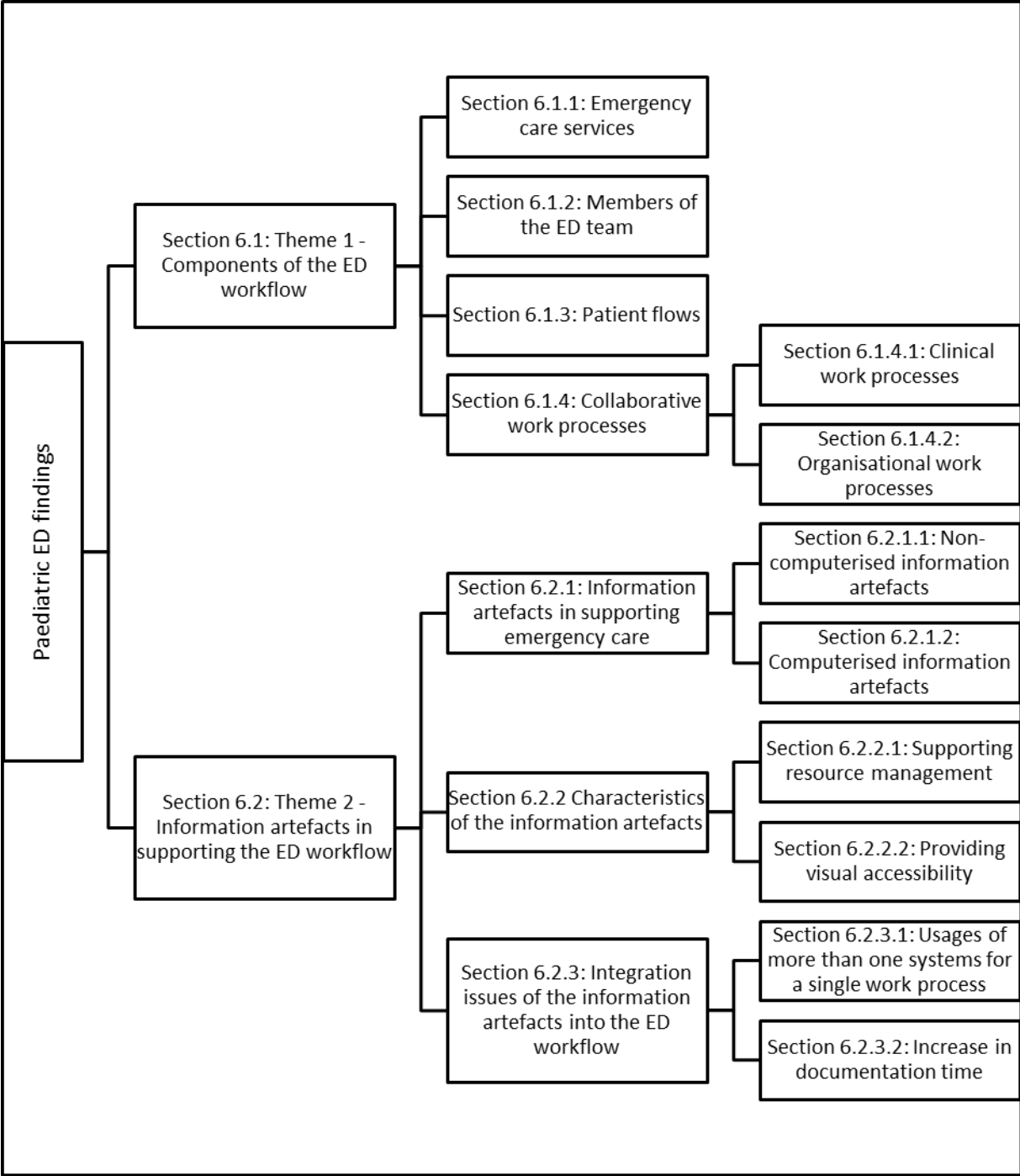

Figure 6.1: Themes and sub-themes of the findings

## 6.1 Components of the ED workflow

Similar to the first theme in Section 5.1, this theme contains categories that represent a broad definition of the workflow term.

### 6.1.1. Emergency care services

The paediatric ED provides emergency care service for infants and children below 16 years old. In order to deliver the service, patients are treated based on two categories. According to Doctor B, all patients attending the ED were categorised based on whether they were able to walk or not:

*“they [patients] don’t split between minors and majors so everybody just comes in, they [patients] are either ambulant or non-ambulant, that’s the only difference” (Doctor B).*

According to an opportunistic interview with Consultant A, this categorisation is to determine whether they need to be assigned a trolley or not along their care trajectory. As shown in Figure 4.2, the ED physical space consists of a number of clinical areas. Corresponding to the opportunistic interview given by Consultant A, it was observed that ambulant patients were first consulted by doctors in any of the consultation rooms or treatment bays area (excluding the trolley bay area). Upon completion of the initial consultation, if they required any further care, they were then moved to the play room. In other words, ambulant patients were not allocated a trolley permanently along their trajectory. In contrast, non-ambulant patients were allocated to the trolley bay area where they were allocated trolleys along their trajectory, i.e. they were not moved to any other areas. Similarly, resuscitation patients were sent to the resuscitation area and stayed there until the end of their trajectory.

Patients are also categorised based on their attendance type. Most attendance is an emergency attendance, i.e., patients without appointments. ED patients can also include patients who come with appointments to attend an ED review clinic or a nurse-led dressing clinic (ED handbook). The ED review clinic is a consultant-led clinic held Monday to Friday from 9.30 am, in which a maximum of 12 patients are seen daily.

The paediatric ED also has an observation unit, an Acute Assessment Unit (AAU), which is located adjacent the ED waiting area. In contrast to the CDU at the adult ED, the AAU is

classed as in-patient ward (“...it's a ward area, because it's got beds not trolley's it's an in-patient ward” - Nurse B). As an in-patient ward, ED patients are only sent there at the end of their emergency care trajectory, i.e., when they are formally discharged from the ED. It serves as a ‘transit’ area for the ED patients. Instead of patients being sent to hospital wards, those who needed to be observed for longer were sent to the AAU. Depending on patient condition, the duration that patients can be placed in the AAU can vary:

*“Once they [patients] have moved from the emergency department although it's part of the emergency department ... they [patients] are classed as being admitted to that ward and so we can transfer patients down to that inpatient [referring to AAU] to be observed and some might stay for just a few more hours, some might stay overnight” (Nurse B).*

Although the AAU is not part of the paediatric ED, both units work closely with each other in terms of sharing nursing resources. According to a senior nurse, she can be a charge nurse at the ED and AAU at the same time. Staff nurses can also be placed on a rotating basis between the AAU and the ED.

Similar to the adult ED, the emergency care trajectory is governed by time-related targets. The four-hour target imposed by NHS England is also applicable to the paediatric ED. There is also a Trust policy which requires patients to be triaged within 15 minutes of registration (ED handbook).

In delivering the paediatric emergency care service, exceptions sometimes must be made to accommodate unexpected situations. From documentary analysis of the ED handbook, it is stated that patients who are over the age of 16 should not be brought to the ED. However, the handbook specifically states that an exception should be made for patients (over the age of 16) who are still under active follow-up at the Trust’s hospital. Exceptions should also be made regarding any adults who require resuscitation care, in which case they should be treated until their condition is no longer critical. This description of exception corresponds to an event that the researcher happened to observe. During the event, a couple of doctors and a coordinating nurse ran towards the outsides of the ED. In an opportunistic interview with another nurse, it was mentioned that a man had just collapsed outside the hospital building. Upon evaluating the man, the clinical staff decided that he was not in a critical condition and was sent via ambulance to an adult ED. This shows that although this is a paediatric ED which provides emergency care for infants and children, emergency care must be given regardless of age when certain situations arise.

6.1.2. Members of the ED team

Figure 6.2 graphically displays the members of the ED team. The team is comprised of multidisciplinary members including doctors of various grades: junior doctors, middle grade doctors and consultants. Nursing staff includes senior nurses, staff nurses and Emergency Nurse Practitioners (ENP). Other members include non-clinical members such as care support workers and reception staff as well as medical students.

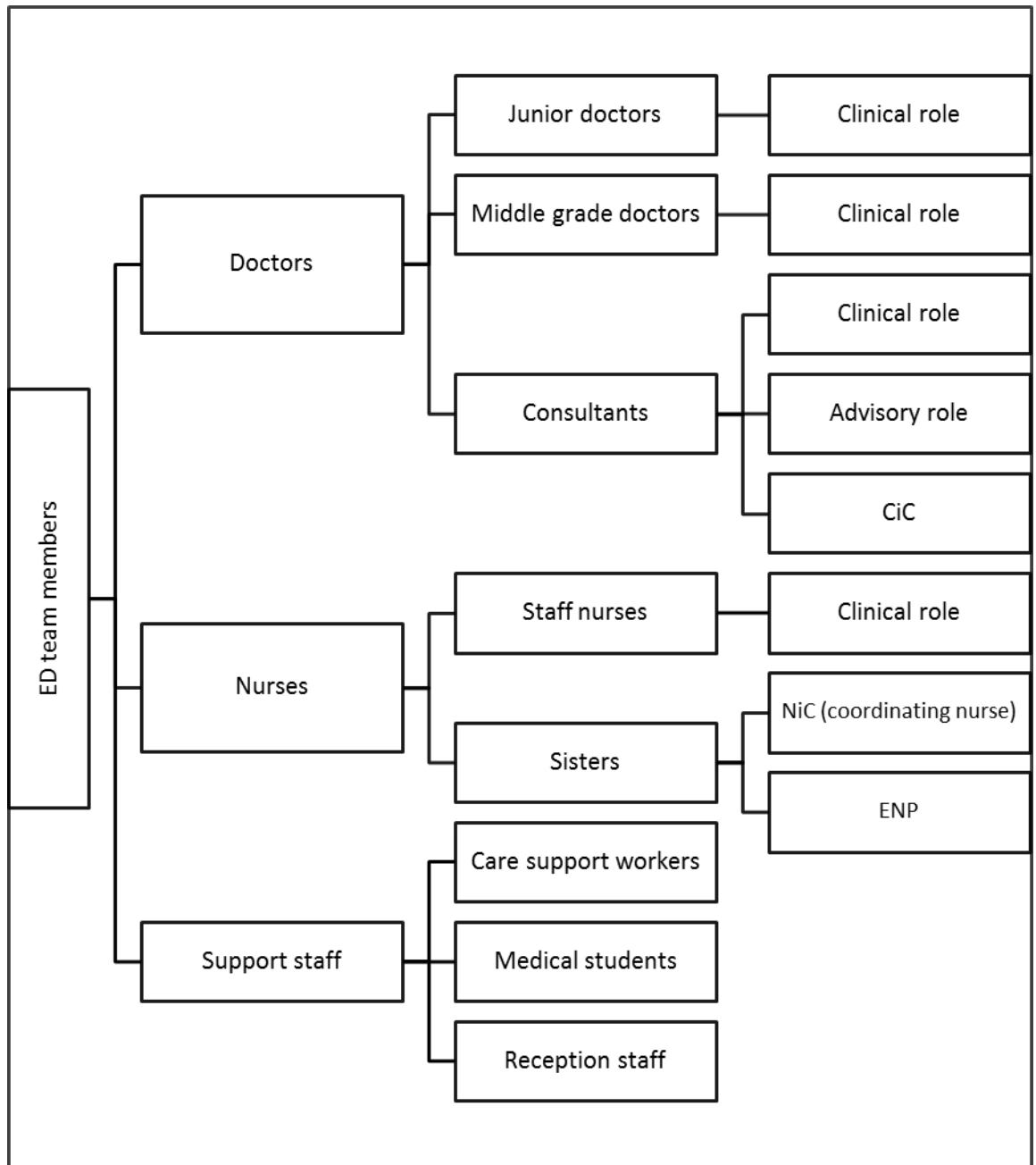

Figure 6.2: ED multidisciplinary members

Senior members of the team hold certain roles. For example, senior doctors can carry roles including medical coordinator and advisory roles. According to the ED Handbook, a medical coordinator role, or Consultant in Charge (CiC), is assigned to a consultant or a middle grade doctor on a daily basis, Monday to Friday from 9 am to midnight. Senior staff members assigned with the medical coordinator role are entrusted with additional non-clinical, indirect patient care responsibilities. Specifically, the tasks involved:

- i. Monitoring the four-hour target;
- ii. Reviewing management plans for category A and B patients (A and B are triage categories elaborated in Section 6.1.6.1);
- iii. Coordinating all medical care, providing an advisory role to other ED doctors;
- iv. Performing early assessment on patients who required facilitated discharges; and
- v. Managing resources such as staff and treatment areas.

An advisory role, on the other hand, is an assumed role for all senior doctors at all times. It is the Trust policy that this role is exercised by all senior staff in addition to their clinical role:

*“if I am on the shop floor then I will be seeing patient myself whenever I have available time to do so but at the same time I am available for advice and I’m available for advice and consultation with any of the nurses or the clinicians...”* (Consultant C).

The advisory role iterated by Consultant C conforms to the Trust’s policy stated in the ED handbook: *“The ED consultant is available for advice and support at all times”*. However, seeking clinical advices should be sought only from certain members of the team. It is the policy of the Trust that such advice not be sought from any junior levels clinicians, such as ED Senior House Officers (SHO) or junior doctors. In the event that no qualified doctors are available at the ED for advice and support, other specialities external to the ED such as the trauma team, crash team, medical team and surgical team can be consulted depending on the patient’s illnesses and conditions. The conditions specified stress the importance of an advisory role to be carried out only by qualified senior doctors and that the role is assumed to be with greater responsibilities and accountability.

Similarly, the ED nursing staff are also allocated various roles and tasks. This includes the triage nurse, coordinating role and resuscitation team members. According to a senior nurse,

these roles were assigned on a daily basis and a nurse can be assigned multiple roles within the same shift or be assigned to the ED observation unit, the AAU:

*“So if you do a fourteen hour shift ... we split up the day so sometimes you may do four hours in triage [as triage nurse], then you might come out of triage and be allocated for resus [resuscitation team] for the afternoon so you could do two [roles]. You might just be allocated to be down on the assessment unit [AAU], you might be allocated to coordinate [coordinating role] all day. It varies. You could have between one, no jobs and two jobs or maybe three” (Nurse A).*

The assignment of specific nursing roles to the nursing staff specific has to take into consideration the medical training of the nursing staff. For example, a triage nurse role required nurses to work for a certain number of years (*“as a triage nurse you have be qualified eighteen months before we let anyone triage here because you do need some experience in assessing children”* – Nurse A). Meanwhile, nursing staff members assigned to a resuscitation team needed a qualification on paediatric life support (ED Handbook).

As for the coordinating role, instead of having certain clinical training, the seniority of the nursing staff determines their eligibility for carrying out the role. Similar to the medical coordinator role, this is because a coordinating nurse role is assigned to a senior nurse only. Nursing staff with a coordinating role are required to work closely with a medical coordinator for ensuring smooth patient flow throughout the ED, as well as making sure that the four-hour rule is adhered to (ED handbook). To ensure smooth patient flow, this role involves the execution of non-clinical organisational tasks. As described below by a senior nurse who has held a coordinating nurse role, a nurse with a coordinating role was responsible for managing nursing resources throughout the patient care trajectory. In other words, the ED should be appropriately staffed to cover all aspects of patient care so that care can be delivered on time, efficiently and safely:

*“so when I’m in uniform my non-clinical work [coordinating nurse] is generally organising the flow of patients around the departments, making sure that children are managed appropriately by other staff, so allocating people [nursing staff] to look after the children that need to be observed in the department or need any interventions while they’re waiting to see medical staff. It’s ensuring that the staff in the department are covering all aspects of care for a patient in terms of observations, general care, pastoral care that sort of thing as well. I liaise with the senior doctor [CiC] that’s on to look at what our workloads are like... I will make sure clinically everything is covered across the department when I’m coordinating” (Nurse B).*

Nurse A, who is also a senior nurse with a coordinating role, also provided a similar comment regarding the role, which included managing nursing staff breaks:

*“I [as a senior nurse with a coordinating role] would decide on who’s going to lunch breaks as the coordinator and I have to make sure that I always leave a senior nurse in the department, someone who can triage and make sure it’s appropriately staffed for the level of work you’ve got but you sort of say to everyone, “Right this is what we are doing. You’re going for first lunch”, and then make sure that the people that are left in the department know what’s happening” (Nurse A).*

Some senior nurses are also an ENP (Emergency Nurse Practitioner). An ENP is a qualified nursing staff member who can provide emergency care independently without a doctor. Other members of the ED team include care support workers, reception staff and medical students. Care support workers mostly provide assistance to doctors and nursing staff. Although not a clinical member and only providing support for clinicians, they are, to a certain extent, clinically skilled workers. According to a care support worker, she is required to have knowledge in operating some of the clinical tools:

*“We learnt how to use the BM machine, ECG, we have to learn that, you know and things like that. Urine machine as well because they dip urines as well, also test urine ...” (Care Support Worker).*

Reception staff and medical students were also part of the ED team.

### 6.1.3. Patient flows

From a public display notice which graphically illustrated patient mode of entry, the ED patients can arrive via an ambulance service or as walk-in patients, corresponding to the researcher’s multiple observations of patient arrivals.

Patients who are in critical condition arriving via an ambulance service can be subjected to a certain degree of variation in their trajectory. Being alerted before the arrival of such patients allows certain preparations to be made in advance. For example, major trauma and cardiac arrest patients are notified to the ED by the ambulance service prior to their arrival to the ED so that a suitable team of clinicians (e.g. cardiac arrest or trauma teams) can be assembled (ED Handbook). Preparation also includes the clinicians preparing any simple drug calculations as needed. However, prior preparation done for these patients is not only



restricted to clinically-oriented tasks and the assembling of clinicians, but also in assembling in-patient hospital notes (ED handbook) which is possibly why their arrival was also being communicated to the reception staff members:

*“... normally a trauma patient will have a phone call through on the emergency phone to say trauma patient coming in or they’ll give us [ED team] a brief history so the front desk will be made aware that one is coming in” (Nurse A).*

According to an opportunistic interviews with reception staff members, their task was only restricted to patient registration. They were also required to submit requests for hospital medical records when necessary.

#### 6.1.4. Collaborative work processes

Although the work processes (e.g. registration, triage, coding) at the paediatric ED are very similar to those at the adult ED, the execution and organisation of these processes are not essentially the same. The differences have also resulted in the workflow and patient trajectory that are not an exact match.

##### 6.1.4.1 Clinical work processes

###### a. Triage

It was observed that the triaged process at the ED was conducted by a member of a nursing staff located in the patient assessment room regardless of patient mode of entry. It is the Trust’s requirement that triage be conducted within 15 minutes of patient registration (ED handbook). Triage is possibly the quickest clinical process. According to a senior nurse, triage involved a quick assessment of the patients where a triage category was assigned (*“trriage which is the assessment so you see every patient that comes through the department, that books in and you assess them [patient] and decide an appropriate [triage] category, so how quickly they [patients] need to be seen by a doctor”* - Nurse A). The triage scale (i.e. Manchester Triage in Appendix 17) is the national scale used for triaging ED patients (Ganley & Gloster, 2011), similar to the one used at the adult ED in the nursing assessment process. Its purpose is to *“rapidly sort patients arriving in the Emergency Department in order to prioritise the timing and*

*location of the care required*" (ED Handbook). This means that a priority is given to patients who need it the most.

In addition to assigning a triage category based on patient condition, the process also involves submitting a request for clinical tasks. For example, nursing staff observation can also be requested by a triage nurse during a triaging process:

*"normally the child that needs observations that the doctor has requested have already been requested by the nurse in triage so you kind of know that they will be needing longer periods of observation"* (Nurse C).

This particular finding is quite unexpected as studies on emergency triage commonly pointed out that the process of triage involves determining how soon patients should be seen (Aronsky, Jones, Raines, et al., 2008; Castner, 2011). This finding, however, indicates that in addition to assigning a triage category, the very specific allocation of resources to patients, i.e. assigning nursing staff to patients, was also done.

In terms of triage location, it was frequently observed that triage at most times, was performed in the patient assessment room located at the ED waiting area. This included ambulance patients who arrived at the ambulance bay (located in the main ED area). However, the location of triage is not rigid and that patient condition needs to be taken into consideration when conducting triage. According to a nurse, if a patient was not able to be triaged at the designated clinical area, triage can always be performed where the patient was allocated:

*"depending on how unwell the child is. So if the child is really unwell and needs to be kept on the trolley [in the main department] we will triage them on the trolley bay. If they are well enough to go round to triage then they will go round to triage [at the Patient Assessment Room] and see the triage nurse"* (Nurse C).

According the same nurse, a triage which had to be completed elsewhere can always be conducted by other qualified nursing staff instead of a triage nurse:

*"it will be one of the nurses round here [at the main department] that will do it. And so they'll just triage the patient as they would round there [at the Patient Assessment Room] and just complete it on the computers round here"* (Nurse C).

Triage practice can also be subjected to variability when facing a high influx of patients which consequently altered the overall workflow. In an event that patients cannot be triaged within the stipulated time (i.e. 15 minutes), an additional triage stream needs to be established:

*“we’ve got a protocol in place now where if there is a queue for triage longer than 15 minutes there needs to be a second nurse, so another nurse will go on and start doing that rather than having a big backlog of people waiting” (Nurse C).*

Surprisingly, a triage process although consistently observed is not a mandatory process when facing an increase in patient flux into the ED. This can also alter the care trajectory for certain patients. In an event where a triage nurse is busy or there is a queue for triage (i.e. patients must wait longer than necessary for triage), a separate stream needs to be created (ED handbook). Once these patients are assigned to the stream, they do not have to undergo the triaging process. However, this stream is only reserved for patients with minor injuries/illnesses. Selecting these patients require a quick visual assessment by a triage nurse. Patients who are assigned to this stream are seen by a dedicated ENP and/or doctor with a nurse. Although the main aim of the minor stream is to reduce patient waiting time, it can also serve to reduce handovers among clinicians (e.g. from nursing triage to doctors).

b. Assessment, treatment and observation

Essentially the severity of patient condition determines the priority and speed of care given. For example, from observations, resuscitation patients were brought straight to the resuscitation room to receive immediate care. Once in the resuscitation room, patients and the team remained in the room until the patients were discharged (i.e. transferred to a hospital ward for further care). As described by a doctor: *“resus [resuscitation] patients you end up treating differently because you treat straight away”* - Doctor B. These patients were treated solely by a dedicated team of clinicians led by a team leader:

*“In a resuscitation of a child I may be one part of a group of ten or so clinicians all who are caring for the same child and because I am a consultant, I am very likely to be leading that [resuscitation] team” (Consultant C).*

Otherwise, the care process for non-resuscitation patients was done on a one-to-one consultation between patients and doctors or ENP. This was a commonly observed type of care at the ED. Unlike resuscitation care, it is possible for a doctor to be treating multiple patients simultaneously:

*“... as the patients come through the department as it's their turn to be seen you just pick up a card [an ED card] and so if you then discharge the patient then yes it will just be one patient per doctor as you go through, so there might be five patients actively being seen at any one time by the five doctors but if say two of those doctors then want to keep those patients in for observation or for referral they'll still be attached to that name but they will carry on seeing the next patient but they will be in the department plan with the nurses to do observation while waiting for referrals so a doctor may have five patients in the department they [doctors] are responsible for but they [doctors] will keep on seeing new patients if they've time to depending on what needs to be done to them [patients]. So for example ... if it's something like a broken leg that's waiting for a bed in the orthopaedic ward and the orthopaedic doctor to come and see them [patients] it won't be much more for that doctor to do but their [doctors'] names will still remain attached to them [patients] but they [doctors] will carry on doing the next bit of work” (Consultant B).*

As a result of doctor consultation, some patients can require further care in the form of a nursing observation. Nursing observation was conducted by nursing staff upon request from doctors and may require a number of clinical tasks:

*“They [patients] don't need a nurse allocated unless they [patient] need a period of observation... so it's the doctors responsibility to come and tell the coordinator “I want this patient to either lie on a bed for observation” or “They are sitting in the playroom to catch urine sample” or “Can they have some salbutamol?” so then the [nurse] coordinator will say right okay, I'll allocate a nurse to them [patients] then” (Nurse A).*

*“the doctor will – once the doctor has seen them [patients] they will come and tell you so they'll find out who's looking after the patient and let you know that this child needs observations doing or needs a urine sample” (Nurse C).*

It was also frequently observed that prior to patients being attended to by doctors; patients were first seen by nursing staff, care support workers or medical students, for initial consultation. This practice, however, is not a must. During this process, patient history data was taken, weight was measured or, at times, urine samples were requested. However, which patients to be attended by the staff depend on their preference and clinical experience. According to Nurse A, she usually prepared patients who were triaged to category C. Her reasoning was that category C patients

needed to be seen by doctors sooner, and that they should be 'ready' (i.e. weight or patient history already available) before being attended to by doctors:

*"No so it depends on what needs to be done. So if they [patients] are triaged as a C [triage category] the chances are there's probably going to be a doctor that can call them [patients] fairly soon but sometimes there needs to be various jobs done on that patient so if the patient has come in and they [patients] are pyrexial and it's a baby it will need stripping off and weighing and setting up for a urine sample, given some paracetamol so there is no point in a doctor seeing that patient until they've had some paracetamol given so the nurse will probably call them [patients] round into the main department, do all those things and then say to the next available doctor "Can you see this one next...?" (Nurse A).*

In contrast, a medical student would normally choose patients triaged to a lower category, i.e. category D, as she felt that by doing so she would not be delaying Category C patients that should be attended to by doctors sooner:

*"Normally I do 'D' just because 'C'. I don't want to hold up any patient that needs to be seen [by doctors]... I think it would probably be best not to because then the next free doctor will see the patient instead of us sort of taking the history" (Medical student A).*

The execution of some clinical tasks can also be less rigid as staff clinical experiences can play a role. Some clinical tasks can be executed if necessary by nursing staff prior to being instructed by doctors:

*"you can look at a child and think actually you probably need to be BM [Blood Glucose Measurement] checked so you don't need a doctor to say I want you to do a BM [Blood Glucose Measurement], a triage nurse can say I want that done or as a nurse just looking after the patient you might think I'm going to do that. But I think some of that comes with experience" (Nurse A).*

Surprisingly, the execution of some clinically-related tasks can also be carried out by support staff, for example by a care support worker:

*"If there's any jobs, you know the jobs that show up on the [ED] card, like weight or blood sugars, urine, so just shout them [patients] and do the work that's on the [ED cards] – because [if] it comes off ECG or shout [call] them [patients] round, do an ECG" (Care Support Worker A).*

In addition to doctors, ENP can also treat and provide treatment, and consequently discharge patients. However, unlike doctors who can treat patients with all levels of illnesses and injuries, an ENP can only treat patients with minor injuries:

*“So say a child with – like the little girl that’s just come with a finger injury, or a child with a broken arm, I can call them [patients] through and request x-rays, I can give medications to take home and I can then treat, diagnose and diagnose fractures, make diagnosis, treat them [patients] and discharge them [patients]. So I do that as well. Okay so anything that’s a minor injury or minor illness” (Nurse B).*

However, such an encounter can also be a non-linear process, i.e. some patients that was initially attended to by ENPs can turn out to be more serious, therefore required doctors’ intervention. In this case the care of the patients is transferred to the doctors:

*“So I might say for example call a patient through that’s got, I don’t know, say if they have an earache or something like that and I’ve taken an earache through and I think it’s just a minor illness then when I start to examine the child I find things that are outside of my competence so perhaps they’ve developed a rash that might suggest that there might be some problems in terms of meningitis, septicaemia that sort of thing, if they are very unwell and I think it’s outside my competence I would go and discuss it with one of the doctors and hand that over to one of the doctors” (Nurse B).*

c. Investigation test ordering

Emergency care treatment also involves the conducting of investigation tests such as blood tests and x-rays/scans. From the observations, the execution of these tests involved a number of clinical staff and can span across hospital departments. For example, as shown in the flowchart in Figure 6.3 (keys to the symbols are also on page xv), blood tests can be completed at the ED or by the hospital phlebotomist. This can result in variability in the process. If it is to be done at the ED, one consultant commented, he usually did it himself or on occasion, requested nursing staff assistance (*“If I want the blood sample taking I either have to do it myself or I have to physically ask somebody [nursing staff] ... In many cases I just do it myself” – Consultant C).*

Although nursing staff assistance can be requested by doctors, such requests can only be executed by qualified nursing staff and taking into account the availability of nursing resources:

*“Band 6 [nurses] can cannulate and take blood, some of the Band 5 [nurses] are now being trained up to do that as well. We [nurses] wouldn’t say “Oh we [nurses] need to do all your blood tests” we can do a blood sugar very easily because that’s just a little finger prick with a machine. It would be a doctor’s decision if they want a full baseline blood and things taking, a nurse can do that if they [nurses] are free, so it depends on the workload of the nurse ... If you’re not qualified [to cannulate blood] you’d either ask one of the other nurses who can or you just say I can’t do it and no other persons free so the doctor would have to do it” (Nurse A).*

Blood samples taken at the ED are sent to the laboratories via the podding system (pneumatic tube system used to transport blood tubes containing blood samples) as quickly as possible to ensure they could be on the next available transport (RHH Microbiology workflow notice).

Alternatively, patients can also be sent to the hospital phlebotomist (*“So if you need blood tests there are phlebotomists [at the hospital] that the patient can go to and they [phlebotomists] will do it from a thumb prick – Consultant A*). However, the method can only be opted for within a limited timeframe. According to the ED handbook, requests for a hospital phlebotomist service can only be conducted during standard working hours, i.e. from 9 am to 4.45 pm, Monday to Friday.

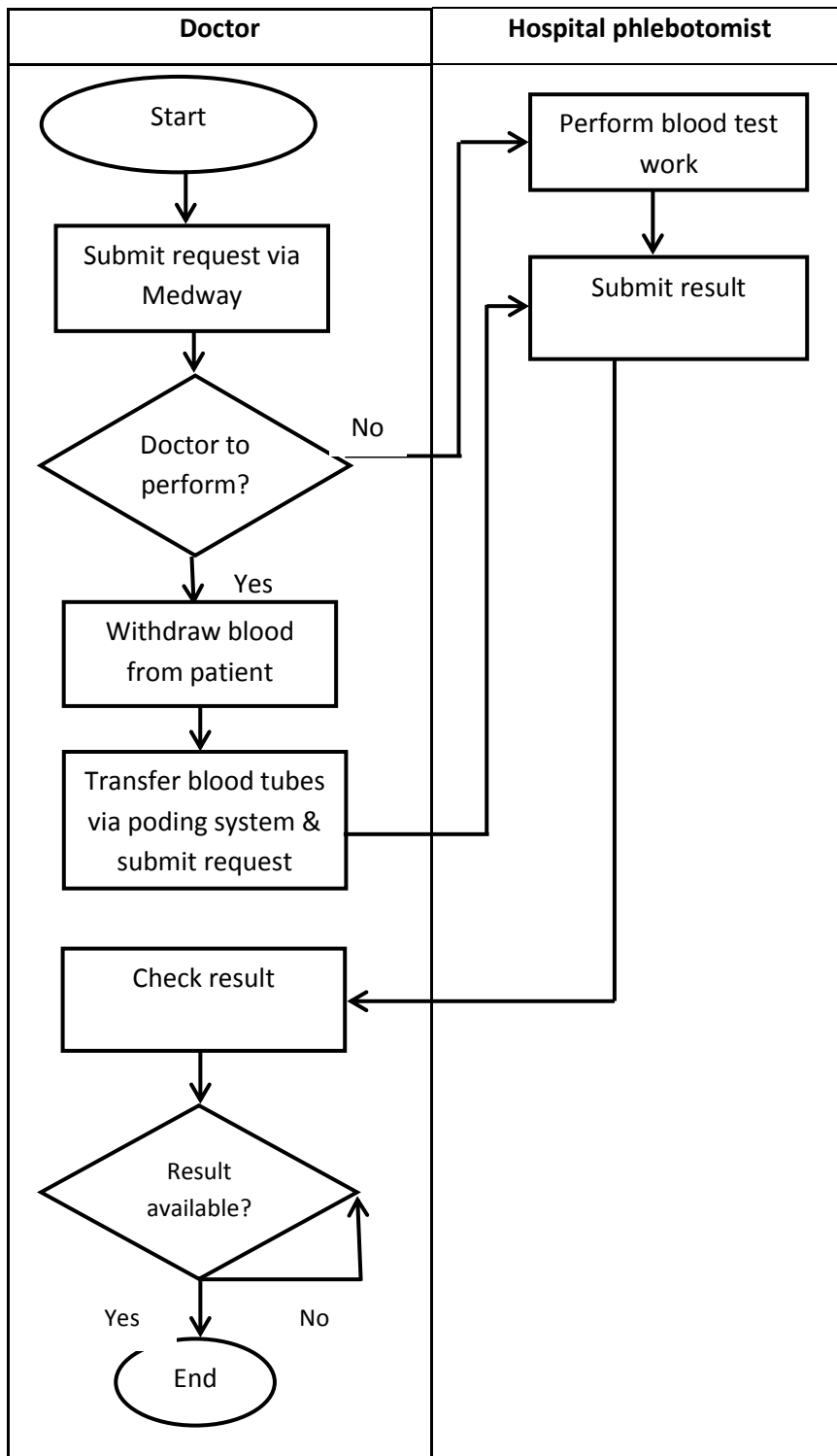

Figure 6.3: Blood test investigation work process (Keys to the symbols: ovals mark the start/end, rectangles represent processes, diamonds represent decisions and arrows represent normal flows)



Meanwhile, as shown in Figure 6.4 (keys to the symbols are also on page xv), the x-ray/scan investigation work process has to involve the hospital radiology department. The only variation existing in the process is dependent on whether the patients are ambulant or non-ambulant. From the observations, some patients that were not able to walk were transferred to the radiology department with a trolley or wheelchair by nursing staff or care support workers or carried by their own carers. Otherwise, patients were sent to wait at the radiology waiting area located within the main ED area. Radiologist from the adjacent room then called patients as their turn arrived (*“They [radiologist] come and get them [patients] so they [radiologist] come out and get them [patients]”* – Consultant D).

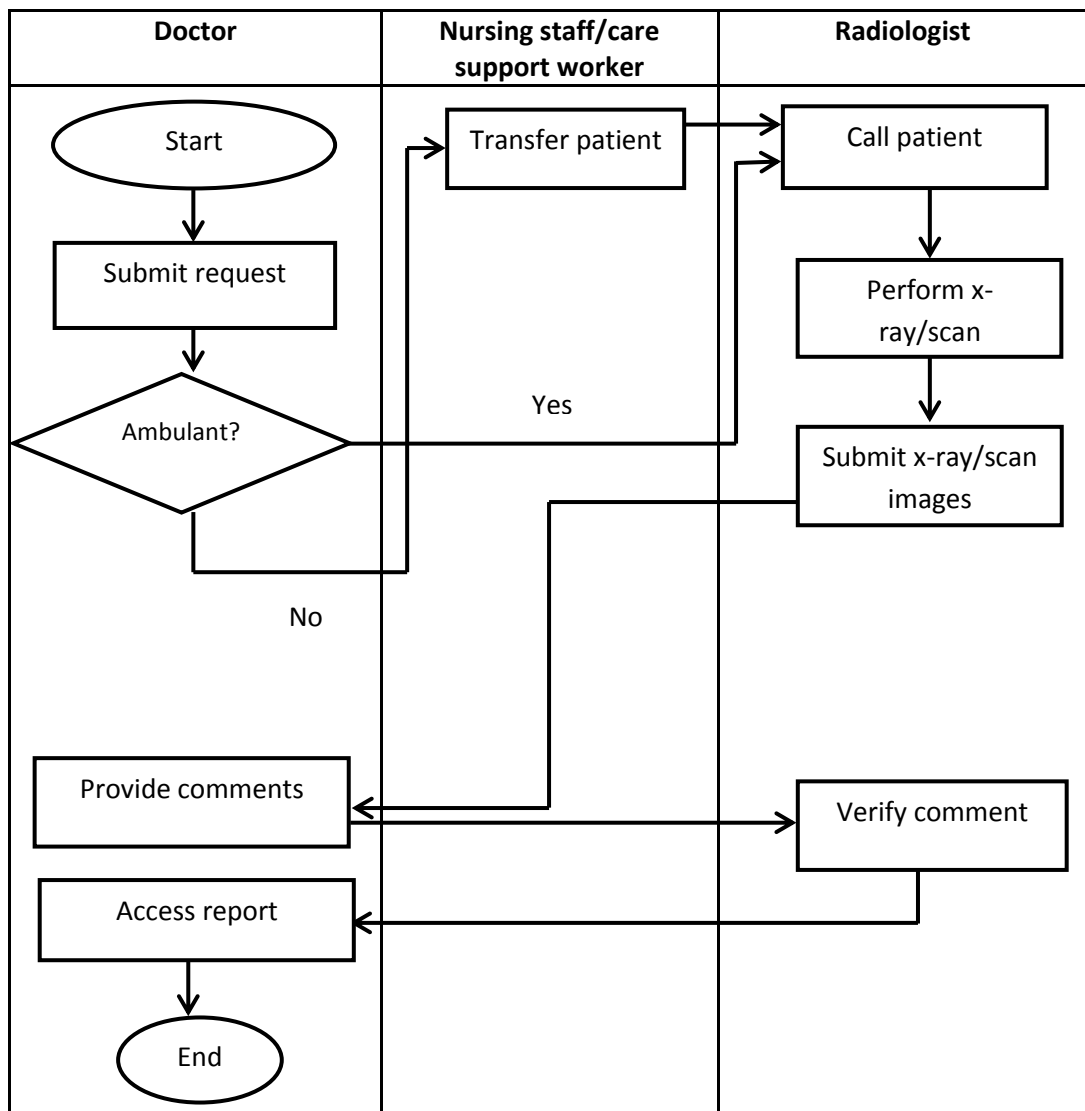

Figure 6.4: X-ray/scan investigation test work process (Keys to the symbols: ovals mark the start/end, rectangles represent processes, diamonds represent decisions and arrows represent normal flows)

Upon completion of the radiology tests, ED doctors were then required to provide their opinions, and final reports can then be completed by the radiology department.

d. Discharge

Upon receiving treatment, patients can either be discharged home or to a hospital ward for further treatment (*"The discharge method that's where we discharge them [patients] to a ward, home"* – Nurse A). Although the decision for discharge can only be made by doctors, nursing staff based on their experiences can 'predict' which type of discharge that some patients might go through:

*"I would never send a patient to a ward unless they've been seen, clocked and everything done, but sometimes because I've done the job for as long as I have and a lot of other nurses here have been in this job a long time, you just know the ones that aren't going to go home"* – Nurse A.

Although the decision for discharge remains the clinical decision of doctors and ENPs, the experience of the nursing staff could contribute to 'collective' decision of the discharge process.

6.1.4.2 Organisational work processes

a. Registration

From the observations, patient registration was performed by members of the reception staff. It was expected that patient demographic information is to be collected during the process as suggested by Rothenhaus, Kamens, James, and Coonan (2007). However, according to a member of the reception staff, the registration process was not merely collecting such information but also involved finding out the reasons that prompted their visit to the ED:

*"We [reception staff] gather all patient information, from name, date of birth, address, GP that they [patients] are registered with, ethnicity, religion and obviously what the present complaint is"* (Reception staff A).

It was also quite surprising to be informed that their task was not only to perform patient registration but also to be aware of patient condition so that clinical staff can be notified when care had to be given straight away which meant that such patients did not follow a planned emergency care trajectory:

*“If it's something urgent obviously if a child presents with breathing problems and is looking quite ill we [reception staff] would get the attention of the nursing staff immediately” (Reception staff A).*

From the observations, regardless of patient mode of entry, non-resuscitation patients underwent the registration process at the reception desk. The only difference was that ambulance patient registration process was assisted by ambulance staff. However, variation in terms of registration process and its location can be seen in the registration process for resuscitation patients. Instead of being conducted at the reception desk, reception staff had to go to the resuscitation room to obtain patient details from their carers. Each time this type of registration was observed, members of the nursing staff would inform the reception staff the arrival of very ill ambulance patients who required resuscitation care. This is because these patients arrived via the ambulance entrance and the ambulance staff had to remain in the resuscitation room instead of going to the registration desk. Upon being informed, the reception staff would then rush to the resuscitation room to begin taking patient details from their carers and ambulance staff. Apparently, this type of registration process was considered ‘delicate’ as the carer was very distracted and distraught, thus making it quite difficult to provide all the required information. As informed by an opportunistic interview with a reception staff, she would normally have to get back to the carers in order to obtain complete information but to proceed first with registering the patients with only partial information.

b. Coding

Coding is a process of documenting the treatments delivered, investigative clinical tests ordered and treatment administered. There are two main purposes of a coding process. The first purpose is to submit payment claims for the emergency care service provided and secondly to produce a GP letter.

According to Nurse A, coding had to be done by doctors who delivered the care. Nevertheless, it was a common practice for nursing staff to help out:

*“To be honest we [nurses] probably use it quite a lot because the doctors are really bad at coding their patients so if we say actually this patient is going to go to M2 we would say ‘admit SHE,’ put all that on and then when you press ‘save’ it will then come up and say ‘the patient is not coded’ so the doctors should really do their coding because they [doctors] know what they [doctors] have done but a lot of the times if you’ve been a nurse looking after him [a patient] you know if they [patients] have had bloods, you know if they [patients] have had an x-ray so you can just put all that in” (Nurse A).*

Another member of the nursing staff also commented on the same practice, that coding was supposed to be completed by doctors but it was common for nursing staff to also be involved:

*“It’s normally the doctor’s job to do their own coding but sometimes the nurses will have to do the coding” (Nurse B).*

Coding is then verified by reception staff. According to a member of the reception staff, verification involved checking the completeness of the coding information in the computerised system based on the documentation on paper-based documentation system. An incomplete coding information by clinical staff detected by reception staff can result in the repeat of the process:

*“The doctors code them themselves as they [doctors] go through the process but we [reception staff] validate the coding back here [at the reception desk]. So when it [ED cards] comes round here we [reception staff] check that certain things are inputted [into the Medway system], like treatment, any drugs within the department and anything like that, we [reception staff] just validate the fact that they’ve actually inputted it on there [Medway]. And then if they [doctors] haven’t input it we [reception staff] send them [ED cards] back down to them and make sure it’s [documented] in there” (Reception staff A).*

c. Ensuring patient flows

In order to avoid ED overcrowding, patients need to be seen, receive their treatment and decision for discharge. Like any other UK ED, the four-hour rule is an integral part of the paediatric ED emergency care processes. Adhering to the time limit is a collective responsibility of all team members together with senior clinical staff members with coordinating roles:

*“It's sort of everybody's responsibility, probably the coordinator of the shift and the consultants are the people who should be looking out for it the most. But that's why the coordinator role is really important; you don't really want it to get to that point of breaching” (Nurse A).*

In order to ensure that the time limit is being adhered to, a number of approaches are being practised. For example, nursing staff with a coordinating role frequently provided a reminder to doctors so that they were aware of their patients care trajectory:

*“...some of the nurses will come and tell you that your patient is closed to breaching [the four-hour target], have you got a [treatment] plan? So there is usually somebody, the nurse in charge is usually the one that comes around and tells you what” (Doctor B).*

A senior doctor who had been assigned a CiC role stated that when she was a CiC for the day, she would actively ensure that care plans for all patients in the department was in place, and that patients received their treatment and discharge appropriately:

*“I will make sure that there is a clear plan for the care of that patient and if it's required that the patient stays in the department for more than four hours for clinical reasons then that's fine. If they [patients] don't need to be in the department for more than four hours then I will find out if there is something that we can do to make sure that they [patients] are either admitted or discharged in a timely way” (Consultant C).*

Other approaches also include having regular meet-ups among staff members. For example, a daily senior review is to be held on a daily basis at 9/9.30 am, 4 pm and 9/9.30 pm where the purpose is to discuss clinical history, management plans and outstanding actions of critically ill/injured patients who might require a longer care process (ED handbook). From the observations of these meetings, the meetings were

not only attended by senior staff members or members with coordinating roles, but also by doctors who were in charge of the care process for critically ill/injured patients. It was observed that the care plan for these patients was discussed, including the possibility that these patients were to be held longer in the department.

d. Teaching and learning

Teaching and learning are also part of the processes within the ED workflow. From the observation, the ED also housed medical students who were on their medical training. Medical training can either be research-based training or emergency care medical training. An interview conducted with a medical student doing a research-based project in the ED as part of her medical programme revealed that while also doing a research-based activity, she also performed direct clinical tasks:

*“taking initial examinations [on the patients] and then present back [the results of the examination] to one of the doctors here” (Medical student A).*

Other medical students were also seen attending patients, with direct supervision from their senior counterparts.

Figure 6.5 shows the grouping of the collaborative work processes, clinical and non-clinical. These processes are performed collaboratively by the ED team for many patients in parallel. On the surface, these processes seem to be executed one after another, i.e. in that they constitute a straightforward linear process. However, in reality the execution of these processes is governed by time related targets, organisational policies as well as embedded with the practices and experiences of members of the team, all of which inadvertently contribute to variability.

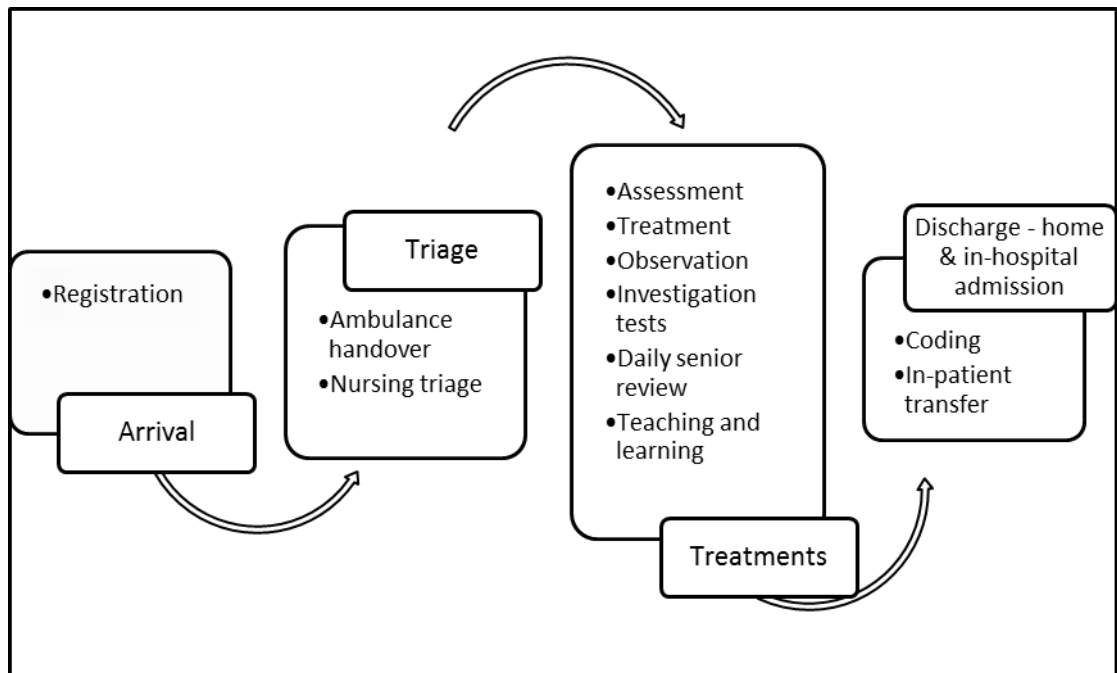

Figure 6.5: Collaborative work processes

## 6.2 Information artefacts in supporting the ED workflow

Similar to Chapter 5, this section also discusses how the existing information artefacts are being utilised in supporting the requirements of the collaborative work processes of clinicians and non-clinicians.

### 6.2.1. Information artefacts

#### 6.2.1.1 Non-computerised information artefacts

##### a. ED cards

The clinical documentation system at the ED is still a paper-based system known as ED cards (Appendix 19). From the documentary analysis of an ED card, there are several sections which are spread across four pages, where each section provides different types of information. Patient demographical information is mainly documented on the first page while clinical details such as triage assessment, doctor clinical notes and nursing notes are spread to other pages. In addition to an ED card, the patient documentation system also includes trauma cards and medical cards. These cards are used in conjunction with an ED card but only for resuscitation patients (Appendix 20).

b. Trays

From the observations, trays were located at various locations within the ED to place printed ED cards. These trays were clearly labelled to indicate which ED cards are to be put in specific trays. In addition, the trays were placed at locations where it was commonly accessible by the clinicians the cards were meant for. For example, within the nursing desk area where the doctors were usually seated, trays labelled 'C', 'D' and 'Discharge' can be found. 'C' and 'D' represent the triage categories C and D, respectively (triage category is discussed in Section 6.1.4.1) and were used to place ED cards for patients already triaged but waiting to be seen by doctors. The tray labelled 'Discharge' was for ED cards for patients already attended to by doctors and discharged by them. Another set of trays mainly for the nursing staff, labelled 'Treatment', 'Trolley bays/trolley obs' and 'Playroom', were located in the clean utility room. Whenever patients' ED cards were placed in these trays, it became the responsibility of the nursing staff to deliver the subsequent care activities. Additionally, 'Trolley bays/trolley obs' and 'Playroom' trays were used to place ED cards for patients who needed nursing observation in which the trays' labels corresponded to the location of the patients, i.e. at the trolley bay area or at the play room.

c. Forms

Paper-based forms can also be found at the ED. As shown in Table 6.1, each form serves a specific purpose. For example, The Age and sex, Time of incident/Time of arrival, Mechanism of injury, Injuries suspected, Signs and Treatment form (or in short ATMIST) is used to record any relevant information during an ambulance courtesy call to the ED. Similar to the trays, the form was also placed near a location where it is easily accessible for its purpose. The form which was kept on a clipboard near the phone "was designed primarily for trauma cases but is used also for medical cases phoned through" (ED Handbook). The Fast Track Registration form, accessible by being within reach of members of the reception staff at their workstations, was used to register severely injured or sick patients. This form is essentially a temporary medium to obtain patient details of patients who were unable to walk to the reception desk for a registration process.



Table 6.1: Forms and its purpose

Name	Purpose
ATMIST	To document patient information for patient handover by phone (i.e. courtesy call from ambulance crew). The form should be filed together with the trauma card.
Ambulance Assessment and handover form	Assisting patient handover to the ED
Fast Track Registration form	Assisting reception staff to record patient details during resuscitation cases.

d. Whiteboards

The ED was also equipped with a number of dry-erase whiteboards. From the observations, the main clinical whiteboard is the nursing whiteboard mainly used and updated by nursing staff. The whiteboard was horizontally positioned and the information can be read from top to bottom and left to right. The content is in a pre-structured table format with pre-printed headings. The pre-printed headings include Location, Name, Nurse and Doctor. Each individual row referred to a bed number in the trolley area. Primarily, the whiteboard contained the clinical status and location of a pool of patients who required further care, i.e. only patients who required nursing observation. Although the whiteboard can be classed as a clinical whiteboard mainly for the purpose of communicating clinical and tracking information, a small part of the whiteboard was also used to include information on nursing staff assignments. This includes nursing staff members who were in charge, on triage, assigned to the AAU and on the resuscitation team, for particular days/shifts.

The resuscitation room also housed another two clinical whiteboards. Unlike the whiteboard in the clean utility room, which served both as a staff and clinical whiteboard, the resuscitation whiteboards are only used for clinical care. Each whiteboard is allocated for a single patient (as opposed to a pool of patients). The format of the whiteboard is also semi-structured with pre-printed headings ('name', 'weight', 'energy', 'tube', 'fluids', 'adrenaline' and 'glucose'). The contents of these heading are also guided based on formulas written on a sheet of paper placed besides each of the whiteboards.

#### 6.2.1.2 Computerised information artefacts

A number of computerised information systems are used to support the delivery of emergency care.

##### a. Medway

Medway is the main computerised information system at the ED used by both clinical and non-clinical staff (Medway Clinical Manual). It has all the functionalities associated with emergency care. From the observations, the Medway system was accessible from a number of computer terminals located throughout the ED: two terminals at the nursing desk, two terminals in the clean utility room, one in the patient assessment room and one in each consultation room.

In terms of accessibility, there seems to be a preference of which computer terminals to use. Throughout the observation, the two computer terminals located at the nursing desk were mostly used by the ED doctors while the terminals in the clean utility room were used by nursing staff. Corresponding to these observations, a staff nurse commented in an opportunistic interview that one of the terminals in the clean utility room was allocated to a coordinating nurse while the other one can be used by other staff nurses:

*“... there’s a computer in the room there [pointing to the clean utility room], the nurse in charge [coordinating nurse] logs in on hers because she does most of the computer work when she’s in charge but then the computer next to it is not normally logged on so if you’re wanting to use it you can log on to that one [pointing to the other terminal]” (Nurse C).*

Further, the other terminals served a sole purpose. For example, the terminal located in the patient assessment room was solely used by triage nurses during the triage process. The two computer terminals at the reception desk were for reception staff to carry out the patient registration process.

The information within the Medway system is structured according to views (Medway Clinical Manual). The ‘Reception List’ view, for instance, lists every single patient already registered regardless of their care status. Patients in this list can be at any stage within their care trajectory including patients at the end of their trajectory, i.e.

patients who have been discharged. According to Reception staff A, from the 'Reception List' view, she was able to obtain an overview of status of all patients in the ED:

*“that [Reception List] tells me all the patients that are in the department at the moment and we like to keep that screen up because it tells you what's happening with that child at any one time. So we can see that child's been registered, triaged and is now being called and being seen by a doctor. If they go to a speciality it will say referred and then they become admitted it will say DTA which is Decision to Admit”.*

On the other hand, the 'Triage Patient List' view consists of only a sub-set of patients from the 'Reception List view' and is mainly used by a triage nurse. The view only consists of a list of patients who have been registered but are still waiting to be triaged. By right clicking on an individual patient entry, a triage nurse can choose from the sub-menu options to begin triaging the selected patient.

Another sub-set of patients from the 'Reception List' view is the 'Current Patient List'. This view is mostly used by doctors and nurses in the main ED area. Similar to the 'Triage Patient List' view, by clicking on the individual patient entry, doctors can begin to deliver treatment to patients.

b. Picture Archiving Communication System (PACS) and Integrated Clinical Environment (ICE)

PACS and ICE are clinical systems used only by clinical staff. PACS is a Radiology Information System (RIS) used to view x-ray/scan investigation results in an image format. On the other hand, the ICE is a CPOE system to order blood test investigations and to view the results.

c. Filefast

From a documentary analysis of the Filefast reference guide, Filefast is used by reception staff to track paper-based patient medical records. Medical records are tracked to determine the physical location of the records within the hospital (e.g. which clinics or doctors' room). Once the location of the medical records is determined, a

request for the records can be submitted via telephone to the clinics where the records are located.

Figure 6.6 shows computerised information systems and its functionalities. The Medway system has the most functionality which provides support for the overall workflow.

Medway	PACS	ICE	Filefast
<ul style="list-style-type: none"> <li>•Registration               <ul style="list-style-type: none"> <li>• New attendance registration</li> <li>• Appointment booking</li> </ul> </li> <li>•Triage               <ul style="list-style-type: none"> <li>• Assigning triage category</li> <li>• ED cards printing</li> </ul> </li> <li>•Monitoring               <ul style="list-style-type: none"> <li>• Location</li> <li>• 4-hour target &amp; 15-minutes triage</li> </ul> </li> <li>•Treatment               <ul style="list-style-type: none"> <li>• Treatment request</li> <li>• Treatment completion</li> </ul> </li> <li>•Referral</li> <li>•Discharge               <ul style="list-style-type: none"> <li>• In-hospital</li> <li>• Home</li> </ul> </li> <li>•Coding</li> </ul>	<ul style="list-style-type: none"> <li>•X-ray/scan images viewing</li> </ul>	<ul style="list-style-type: none"> <li>•Blood test ordering and results availability</li> </ul>	<ul style="list-style-type: none"> <li>•Medical records tracking</li> </ul>

Figure 6.6: Computerised information artefacts and its functionalities

## 6.2.2. Characteristics of the information artefacts

### 6.2.2.1 Supporting resource management

As demonstrated in Theme 1, the ED workflow consists of resources including staff members and clinical areas. In addition to providing the technical functionalities (e.g. registration, triage), the information artefacts at the paediatric ED are also utilised as a resource management tool. As a resource management tool, both the computerised Medway system and the main clinical whiteboard in the clean utility room place an emphasis on the discrete management of resources, i.e. the allocation of staff to patients. From the computerised Medway system, for instance, information on which

doctor is seeing a patient can easily be obtained from the 'Current Patient List' view (Medway Clinical Manual). Whenever a doctor started attending to a patient, he/she needed to make the assignment clear. The fact that such an assignment was made at the initial stage of a patient-doctor interaction demonstrated its importance in the process:

*"So if we can just use this patient [using a patient as example from patient list], so using the information that's on here we [doctors] would find them [patients] on here – it would be there ['Current Patient List'] – and then to do anything on the [Medway] system you have to right click [on patient's name] and then it gives you all of those options [displayed as sub-menus]. The first thing that we [doctors] would do is we would select See Patient and then you would find your name in there [a drop down list]. So that's my last name so then I would double click on [from the drop down menu] that to say that I had seen the patient which means that other people can tell who is seeing the patient."* (Doctor A).

The information on which doctor is seeing a patient not only provides an indication that a patient is under the care of a specific doctor, and that other doctors can instead attend other patients. This particular piece of information is also crucial in the management of patient flow, one of the ED organisational tasks performed by a CiC. A CiC needs to ensure that all patients have their care plan in place, which can only be developed once a doctor-patient interaction takes place. In order to keep track of this, a CiC emphasised the importance of knowing doctor-to-patient assignment whereby the system has provided an easier way to obtain such information:

*"... if I am in charge [as a CiC] and I want to know what's going on with this patient, so the only way to do that is if somebody [doctors] has put their name on it [using Medway], so now I know this is Jane Doe [anonymised patient], if that [doctor's name] wasn't there I would have to go find the patient, find the [patient ED] card, open the notes, look at the writing and see who [doctor] has seen her, so if it's on here [Medway] I don't have to do any of that do I? ...So that bit with just the doctors name is actually quite important because [it] tells you who is responsible, the initial clinician for the patient and the department has 50 or 20 or whatever patients and half a dozen, a dozen clinicians, or more"* (Consultant A).

The clinical whiteboard in the clean utility room also posed a similar characteristic in terms of the discrete assignment of resource but instead of a doctor to a patient assignment, the whiteboard is utilised in the management of nursing staff and support staff. As indicated in Section 6.2.1.1, the whiteboard is used to keep track of patients requiring nursing observations. Therefore, the main function of the whiteboard was to assign a nurse to the task:

*“any child that needs observations doing, urine samples or anything like that, we write them [patients’ name] on the whiteboard and then we allocate the nurse to them” (Nurse B).*

In addition to nursing staff assignments, the whiteboard was also used for any ad-hoc task assignments to the support staff. A care support worker commented that at times when her assistance was needed, it would be written on the whiteboard:

*“They usually put my name on the [white]board to assist, like again the relatives in resus [resuscitation] if a really bad case comes on” (Care Support Worker A).*

The paediatric ED is also equipped with a number of trays where ED cards are placed. The usage of these trays as a resource management tool is quite the opposite compared to the computerised Medway system and clinical whiteboard. For example, from the observations the trays labelled C and D were used to place ED cards for patients who were triaged to category C and D, respectively. Because these trays depicted an overview of patients according to their triage categories, resources such as doctors can be targeted to patients with the greatest need.

Information artefacts as a resource management tool provide an overview of overall ED workload or function as a discrete allocation of resources. At the paediatric ED, the computerised Medway system and the clinical whiteboards place an emphasis on the discrete allocation of resources such as doctor to patient assignment. The trays, on the other hand, are targeted to give an overview of the ED workload according to patient triage category.

#### 6.2.2.2 Providing visual accessibility

##### a. Whiteboards

The location and ease of use of the non-computerised information artefacts plays a significant role in providing visual accessibility to information at a point of care. For example, the main clinical whiteboard mainly used by nursing staff was placed in the clean utility room where nursing staff were usually stationed. The whiteboard containing information on patients who required nursing observation can easily be accessible in

passing or when required. In providing the visualisation to the information written on the whiteboards, various non-standardised methods are employed, depending on their personal preference. For example, some nursing staff preferred to use coloured marker pens to show different categories of information while others preferred to use only one colour:

*“It is personal preference as to who coordinates with what they want. Some people [nurses] write the [patient] names in one colour and then all the like jobs in another colour. Some people like if they’re referred to a different speciality in another colour. It’s personal preference as to how you bring things and how you coordinate... I think it can work if you’ve got surgical patients, trauma patients like put them [patients] in different colours but I get a bit like – I can’t concentrate if everything was a different colours I don’t like it. I can’t function like that. If I wasn’t coordinating I would never say to someone you can’t do that, but I just prefer it all in one colour. So it is personal preference” (Nurse A).*

It was also observed that a symbol ‘tick’ was used. When asked what the tick on the whiteboard represents, a nurse commented: *“It means that that action has been actioned so a tick means it’s done”*. Surprisingly even the usage of this specific symbol is itself subject to variation:

*“Some do a little box with a tick in it, I don’t bother with a little box I just tick it” (Nurse B).*

The ease of use of the whiteboard allows for flexibility to be exercised by individual nursing staff. However, this method could possibly introduce confusion especially to new members or members external to the ED (e.g. referral team). They may require assistance from the nursing staff in interpreting certain information, hence defeating the purpose of a whiteboard in supporting asynchronous communication.

Similarly, the resuscitation clinical whiteboards were also placed in a location within reach of the resuscitation team. As the content of the resuscitation whiteboards is guided mostly by formulas, the formula sheet was also placed beside each whiteboard, allowing the team members to simply use it whenever it is needed.

b. ED cards and trays

From the observations, at the end of the triage process, patients' ED cards were then printed. The printing of the ED cards from a printer located in the clean utility room is a visual indicator to the nursing staff of what needs to be done:

*"the [ED] cards that are printed out there [at the clean utility room] are some boxes at the bottom, I'll show you if you like, and it will like say weight observations, urine, drugs and it will have a tick in it if it needs to be completed. So as each [ED] card is printed out you need to check that there's nothing on it that needs doing. If it does then you need to go do it before you put them [ED cards] in the box [tray] to be seen by the doctor... If you just have a quick read on there as well because they may just need drugs but sometimes on here they might say what type of drugs, so it might say ... or whatever medicines they need on there"* (Nurse C).

Once the preliminary tasks were executed by the nursing staff, the ED cards were then placed in the trays according to the respective patient triage category. Again, the location of the artefacts plays a significant role in providing visual accessibility to the tasks. Trays were located within the nursing workstation. Although a nursing workstation, from the observations, the workstation was almost entirely occupied by doctors. Therefore, placing the ED cards in the trays allowed doctors to simply pick up the ED cards prior to assessing the patients.

Cues are also integrated within an artefact to provide visual accessibility to a completed task. On one occasion the following was observed: a medical student picked up an ED card from a tray at the nursing desk to perform an initial consultation. After the initial consultation, the ED card was put back in the tray and a message *"Seen by medical student"* was written on a stick-on note attached to the ED card.

The ED cards were also used whenever junior doctors were seeking advice from senior doctors. During the interactions, according to a doctor it was not a requirement that senior doctors and consultants put their signatures on the ED cards; however, the ED cards served as a medium of interaction: doctors can look or refer to its contents throughout the duration of the interaction.



### 6.2.3. Integration issues of the information artefacts into the ED workflow

#### 6.2.3.1 Usages of more than one systems for a single work process

As depicted in Figure 6.6, the paediatric ED relies on four computerised systems where each system has its own functionalities. Similar to the adult ED, the myriad availability of these systems requires the usage of more than one systems for the completion of a single work process.

##### a. Investigation test ordering

As shown in Figure 6.7 which depicts a rich picture representation of the investigation test work process, multiple computerised systems must be used to submit requests for clinical tests and to accessibility to the results. X-ray/scan and blood test requests, for instance, can be submitted online via the Medway system:

*“If we [doctors] want to order any tests like a blood test or an x-ray we can do that all on here [MEDWAY]. Then our computer system is linked to the x-ray computer system [PACS] so we would fill in an x-ray request and then it would print – the request would print in the x-ray department” (Doctor A).*

However, the submission of the blood test requests via the Medway system according to Consultant C was not automated:

*“It [blood test request] is not an automatically generated request so it doesn’t go to a work pile just because it’s gone on Medway” (Consultant C).*

The submission of the blood test request via the Medway is done so that forms and labels can be printed and the ordering process is ‘logged’ (ED handbook), but the actual requests were communicated via the printed forms and labels. The results can then be accessed via the ICE system (ICE user guide).

In contrast, for the x-ray/scan tests, the request can be automatically sent to the Radiology department as the Medway system is integrated with the hospital RIS:

“You go onto x-ray, clinical information, who is requesting it, date and time, and then jot down what the request is. When you’ve finished it shows you what your request is and then it prints remotely [at the Radiology department]” (Consultant A).

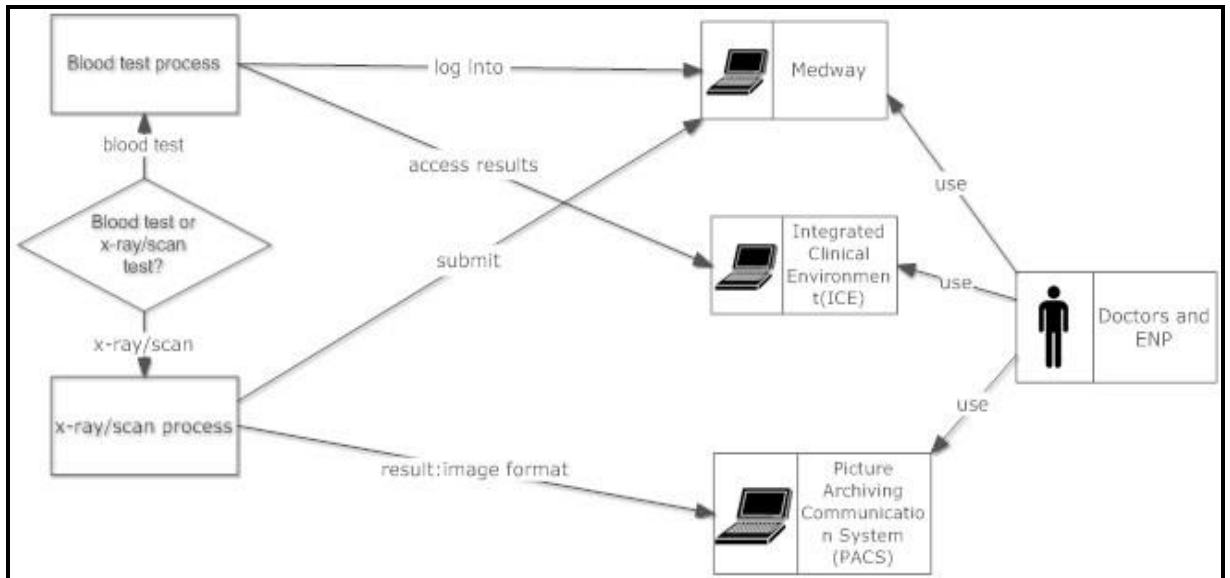

Figure 6.7: Information artefacts for investigation test work process

However, in order to access the image format of the investigation results, the PACS system had to be used. The purpose of accessing image formats of investigation results is so that the ED clinicians can provide their feedback. It is particularly *“essential for the radiologists to have some indication of what the original clinician thought of the x-ray”* and that the PACS must be used for that purpose (ED handbook).

b. Coding

Because of the hybrid implementation, the completion of the coding process must also be completed via a number of artefacts (Figure 6.8). From the observations, the first part of the coding was completed by doctors using the Medway system. This is when they have to ensure that all the tests ordered and treatments delivered were logged into the system. In doing so, they had to frequently refer to the formal documentation system, i.e. the ED cards. When this was completed, the coding task was then transferred to the reception staff. From the observation conducted at the reception desk, the specific task of the reception staff in the coding process was to ensure that the

documentation provided in the ED cards and the Medway system matched; no information can be missing from either artefact. This process also required them to flip through the ED cards while checking the Medway system.

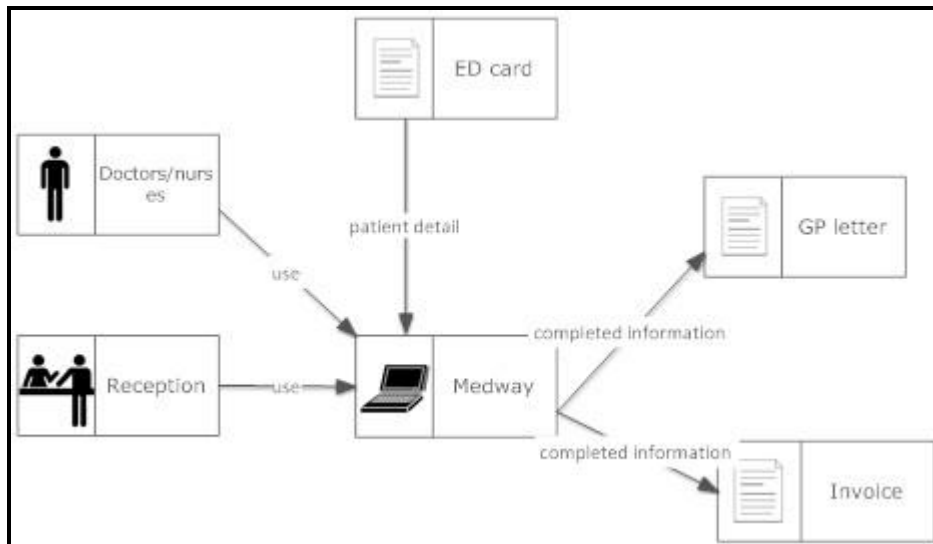

Figure 6.8: Information artefacts for coding process

### 6.2.3.2 Increase in documentation time

The Trust’s policy dictates that all clinical documentation is done in the non-computerised ED cards (ED handbook). In addition, the computerised Medway system also needs to be used for the purpose of tracking patient location and progress, the ordering of investigation tests and coding:

*“it’s not a fully electronic system we [doctors] have to write history and everything and examination on the [ED] cards, so handwrite that [ED cards] but for discharge and to order anything [investigation tests] it all has to go on the electronic system [Medway]. So it’s just slightly awkward dual systems” (Doctor B).*

However, one consultant felt that it was up to clinicians if they also wanted to use the computerised Medway system for clinical documentation but the ED cards must still be used:

*“This is the clinical notes [referring to ED an card]; you still have to write the clinical notes. You don’t do a history on here [Medway] – well you can if you want but you don’t do a history, you don’t write the examination on this [Medway]. So this isn’t –*

*for the practice of medicine you need to do certain things, a history of examination and the plan and you need to write what's your advice you give [on the ED cards]"* (Consultant A).

As a result of a hybrid information implementation, it was frequently observed that the ED doctors spent a significant amount of time completing ED cards after patients were discharged.

Disparate information systems can contribute to the inaccessibility of information (Barthell et al., 2004), therefore affecting the availability of information at a point of care. In addition, information may be fragmented: different pieces of information located in multiple sources may require a higher degree of collaboration among team members (Reddy & Jansen, 2008). In this study, however, there appears to be one advantage to the practice, the establishment of alternative options to access information. For example, a nurse commented that she can either refer to the computerised Medway system or ED cards if she wanted to find out whether a clinical observation was needed or what treatments doctors had prescribed for the patients:

*"If you go on 'view clinical notes' and 'triage' ['View Triage Details'] so this shows you obviously that they [patients] have not had any observations done but it will normally show the observations and what the [triage] nurses requested, so she's requested some observations to be done on this child and have her [patient's] weight done as well. So you can always check it on there [referring to Medway] as well as on the [ED] card that you've got" (Nurse C).*

In contrary to Nurse C, one doctor described the hybrid implementation as *"slightly awkward dual systems"* (Doctor B). The difference in the opinion between a doctor and a nurse could be because providing a comprehensive clinical documentation on only the paper-based system (i.e. the ED cards) is mandatory requirement of the workflow, explicitly emphasised by the Trust's policy (ED handbook). A doctor also similarly emphasised that *"for the practice of medicine, clinical documentation should be comprehensive and include information such as medical history, tests conducted and advice given"* (Consultant A). Therefore, for a doctor to constantly switching between a computerised system and a paper-based system can be seen as unnecessary. Switching between various information artefacts has been described as peripheral activity which in turn lead to challenges in the patient care process (Abraham et al., 2009).

## 6.3 Synthesis

### 6.3.1. Patient trajectory

Figure 6.9 illustrates the flowchart (keys to the symbols are also on page xv) for non-resuscitation patient trajectory. Both walk-in patients and ambulance patients go through similar processes. They are first registered by reception staff and consequently triaged by a triage nurse. During registration, ambulance patients are handed over by ambulance staff to reception staff while walk-in patients register themselves at the reception desk. The registration process starts the four-hour clock which means that patients need to receive treatment in four hours or less. All registered patients are then sent to wait in the waiting area to wait for triage. Triage is performed by a triage nurse at the patient assessment room which is part of the waiting area. It needs to be carried out within 15 minutes of registration. Once patients are triaged, they are sent to wait again in the waiting area. How long they have to wait to receive treatment is dependent on the assigned triage category. However, exceptions are made to those patients whose condition deteriorates while waiting, in which case they receive treatment sooner (shown by the dotted line in Figure 6.9). Non-ambulant patients are allocated to trollies while receiving treatment.

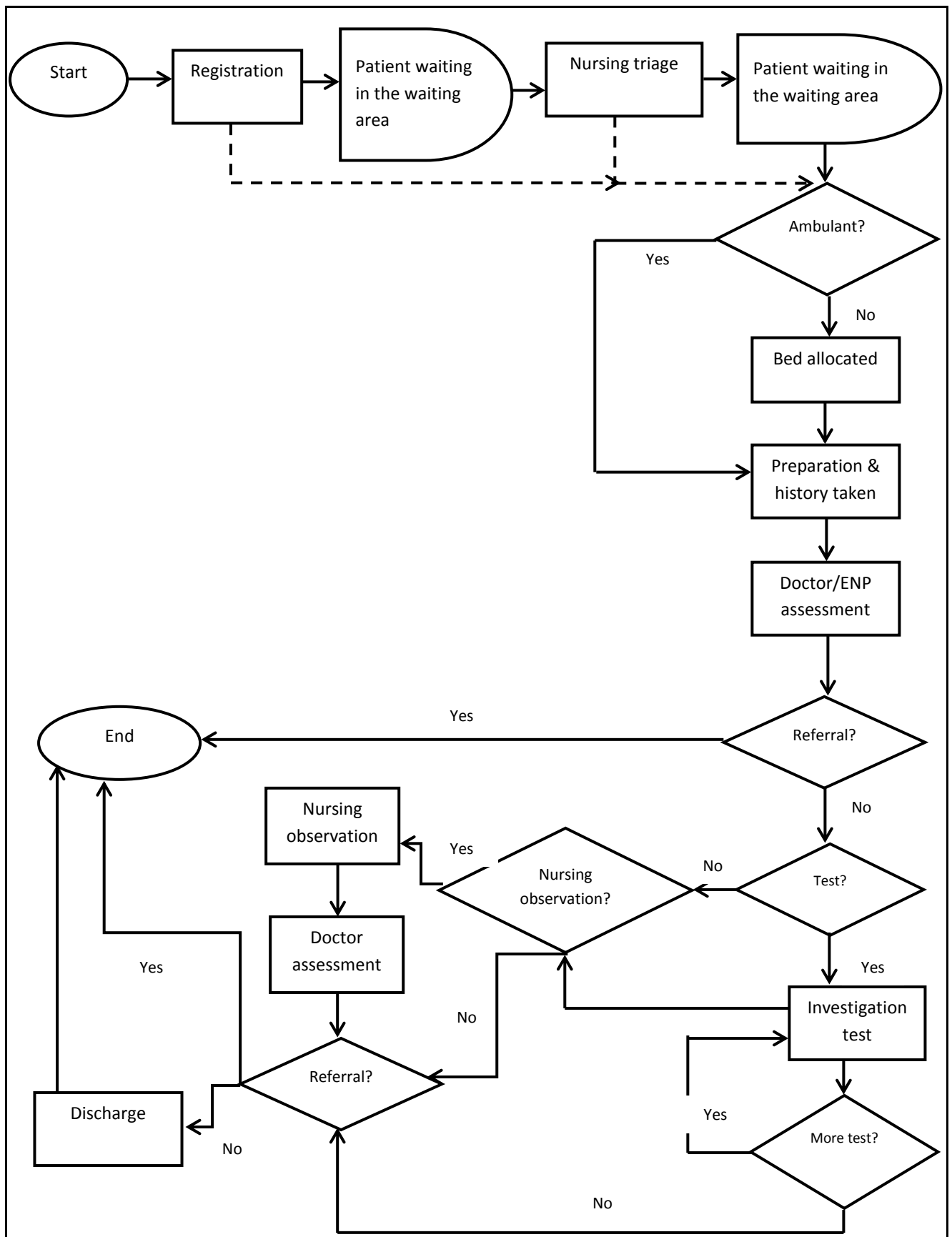

Figure 6.9: Patient trajectory for non-resuscitation patients (Keys to the symbols: ovals mark the start/end, rectangles represent processes, diamonds represent decisions, arrows represent normal flows and dashed arrows represent exceptions)

Patients then go through a series of assessments, treatments, observations and clinical tests. This includes preliminary assessment by nursing staff, care support workers or medical students. During preliminary assessment, weight measurements or blood glucose measurements can be taken. Patients who require a period of observation are allocated nursing staff. Patients can also be referred to other specialties, in which case the decision for discharge falls on the referral team instead of the ED doctors or ENPs. Referral can happen at any point in time during the care process, i.e. during an initial assessment or at a later time after tests and observations are conducted. Patients who are discharged by the ED clinical staff members can either go home or be moved to the hospital wards. Some patients who require further observation that might exceed four hours but might not need hospitalisation are discharged to the AAU.

However, the resuscitation patient trajectory is different (not shown in the Figure 6.9). Their registration and ambulance handover processes occur in the resuscitation clinical area instead of at the registration desk and, can occur simultaneously while treatment is given. Resuscitation patients are also not triaged. A team of clinicians work on them simultaneously until they no longer require resuscitation.

### 6.3.2. Collaborative work processes

The ED workflow consisted of clinical and organisational work processes performed by multidisciplinary members. The members consist of clinical and non-clinical staff with various roles and responsibilities. For example, a doctor with a consultant rank assumed the advisory role and can also be assigned a CiC role. A senior nurse can also carry out a coordinating role.

The ED work processes are comprised of collaborative tasks and activities of the multidisciplinary members where their execution is governed by time-related targets and exceptions. Figure 6.10 is the main swim lane flowchart (keys to the symbols are also on page xv) showing the clinical and organisational processes executed by members of the team. It commences with the registration process which is performed by reception staff and continues to the triage process performed by nursing staff. Normally patients are sent to the waiting area prior to being seen by doctors. However, when patient condition deteriorates while waiting, they can be sent straight away to receive care (as shown by the dotted line from the registration process to the 'ambulant patient?' decision symbol). After triage, patients can be claimed by either doctors or other members of the team which include medical students.

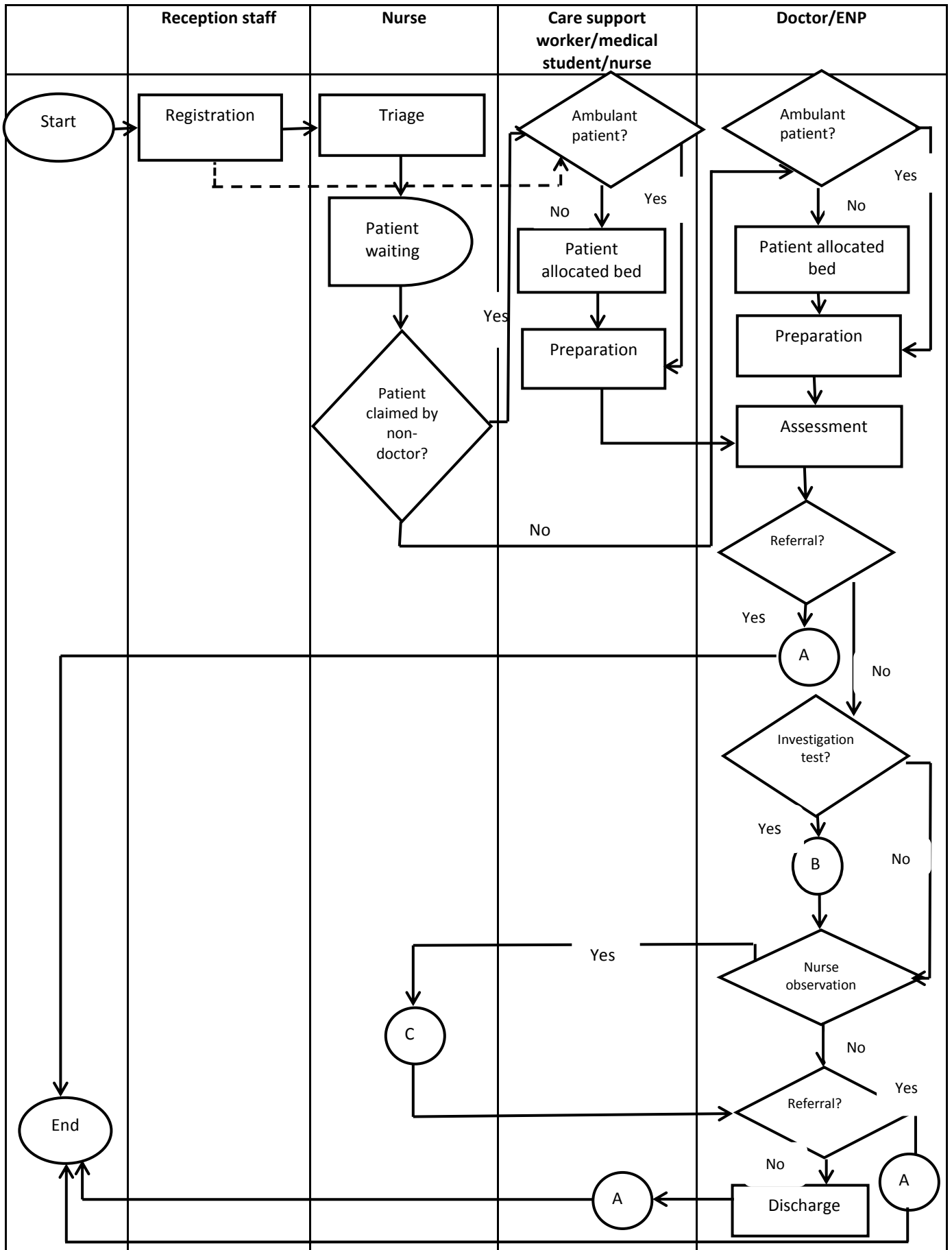

Figure 6.10: Overall collaborative work processes



During emergency care treatment, investigation and nursing observation can be ordered. These processes are shown in Figure 6.10 as an extension to connector symbols B and C, respectively (keys to the symbols are also on page xv). Referral outside the speciality of emergency medicine can also be made, in which case patient care is taken over by the referral team including decisions for discharge. Referral marks the end of the care workflow at the ED. The final part of the workflow is the coding process (shown as connector symbol A). This process is executed once patients are discharged to hospital wards or home, and referral.

Clinical processes such as assessment, investigation tests (Figure 6.11) and nursing observation (Figure 6.12) commence once patients are claimed from the waiting room. As for investigation tests, blood tests can be performed by either the ED clinical staff or the hospital phlebotomist. The collaborative processes end with a coding process in which both the doctors and reception staff are responsible (Figure 6.13). The dotted line represents occasional times when nursing staff are requested to do the coding. Alongside the care processes depicted in these figures, other processes include the monitoring of target rules as well as teaching and learning.

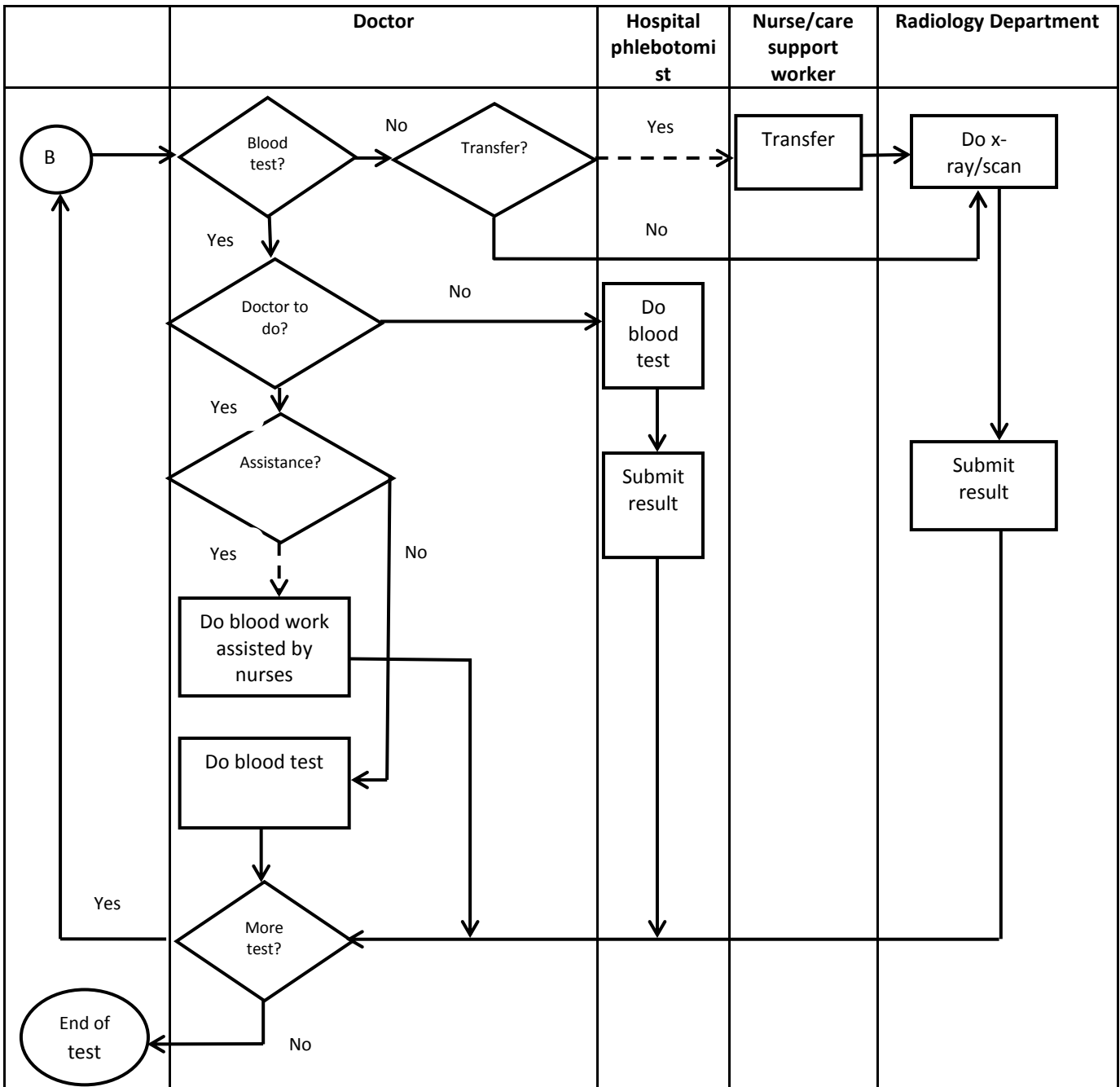

Figure 6.11: Investigation test work process (Keys to the symbols: ovals mark the start/end, rectangles represent processes, diamonds represent decisions, arrows represent normal flows, dashed arrows represent exceptions and circles represent connectors)

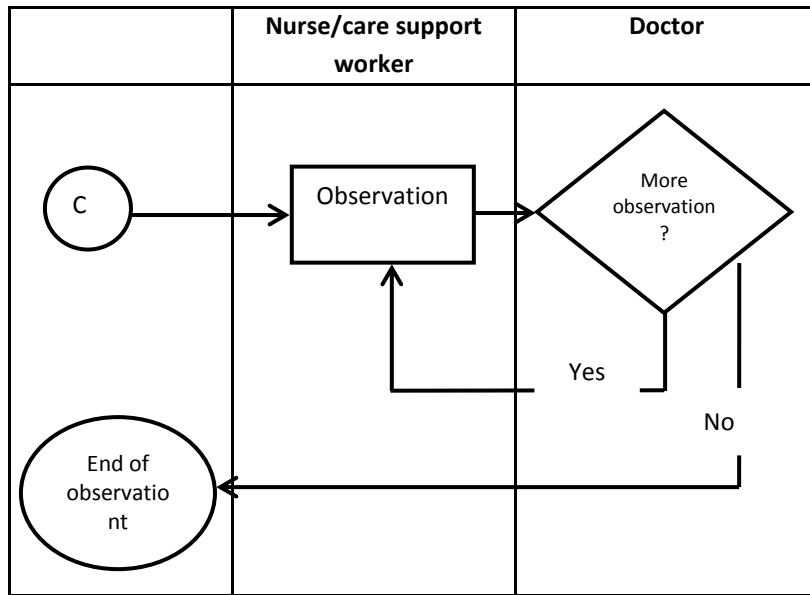

Figure 6.12: Observation work process (Keys to the symbols: ovals mark the start/end, rectangles represent processes, diamonds represent decisions, arrows represent normal flows and circles represent connectors)

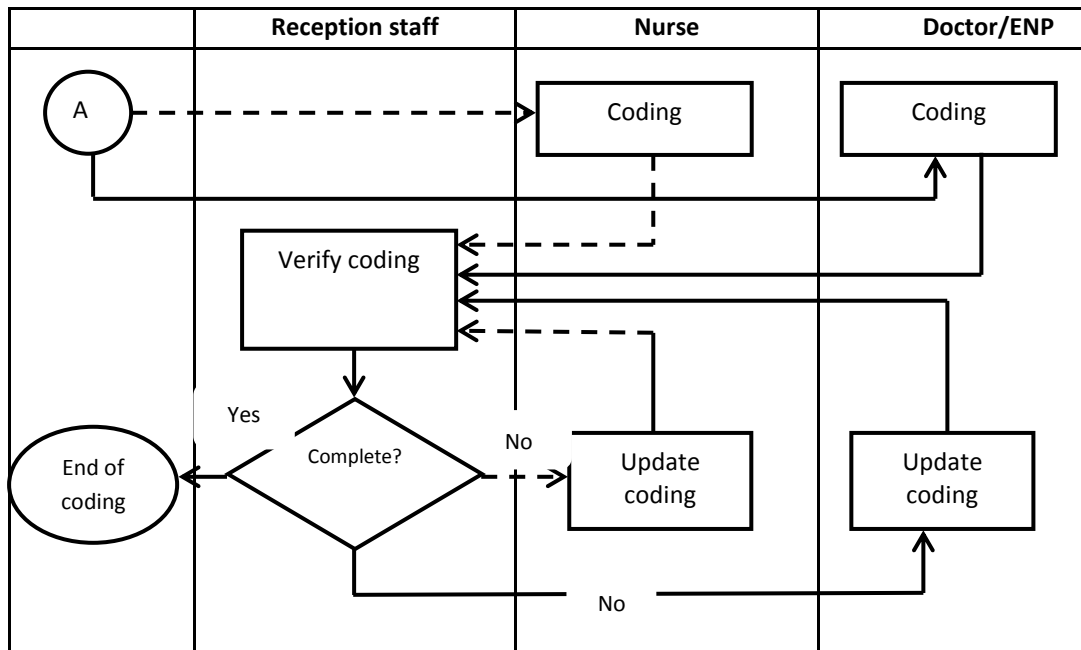

Figure 6.13: Coding work process (Keys to the symbols: ovals mark the start/end, rectangles represent processes, diamonds represent decisions, arrows represent normal flows, dashed arrows represent exceptions and circles represent connectors)

### 6.3.3. Information artefacts in supporting ED collaborative work

Very similar to the adult ED, both non-computerised and computerised information artefacts are used alongside each other to support the work processes. The non-computerised artefacts include paper-based documentation system, i.e. the ED card, trauma cards and medical cards, which are being used alongside various trays located throughout the ED. Other very important artefacts are the clinical dry-erase whiteboards, primarily use to support clinical work processes such as observation and treatment. Meanwhile, the computerised information systems include the Medway and Filefast as well as clinical ordering systems, ICE and PACS. These artefacts collectively provided the technical functionalities in the execution of the ED collaborative work processes. The Medway system for example, is used for the registration process and triage process. In registration work process, the Medway system is used to record information such as patient demographic data and presenting complaints. In triage work process, the system is used to document information such as baseline observation and medication administered, and consequently assigning a triage category. The Medway system is also a tracking system to make organisational decision such as the adherence to the 15-minute triage time and four-hour rule. However for clinical process such as clinical tests ordering, other computerised information systems, i.e. the ICE and PACS are used.

In addition to the technical functionalities, the artefacts also posed characteristics necessary in supporting collaborative work. One of the prominent characteristics identified is as a resource management tool. For example, the Medway system allows a discrete management of resources, namely providing a functionality to allocate a doctor to a patient. Similarly, a clinical whiteboard located in the clean utility room is used to assign nursing staff for patient observation. Information artefacts such as the clinical whiteboards and ED cards are also visual tools, for example, to signal the execution of a task or to specify the next task to be executed. It is also a visual tool in the teaching and learning process of medical students.

However, the hybrid implementation has contributed to a number of issues. One of the obvious issues is related to the usage of multiple systems for the completion of a single work process. For example, in the x-ray/scan test ordering process, multiple computerised systems must be used. The Medway system is used to submit test requests and the PACS to access test results (Figure 6.7). The coding process also has to rely on a number of information artefacts (Figure 6.8). Having to access multiple information artefacts to complete a single process affects the continuity of tasks within a process. The hybrid implementation has also resulted in

doctors having to update multiple systems throughout patient trajectory, i.e. the computerised Medway system and the formal patient documentation system, i.e. an ED card.

## 6.4 Discussion

As stated in Chapter 3, the study was conducted in two emergency care settings located in the UK. Despite having essentially similar work processes (i.e., triage, assessment, discharge and coding) and other workflow resources, differences were observed in the organisation of these work processes and the extent to which the information artefacts support the work processes and practices.

### 6.4.1. The workflows

As stated in Chapter 4, the adult ED and the paediatric ED are both Type 1 EDs in the UK providing care to adults and children respectively. In terms of physical space (illustrated by the floor plans in Figure 4.1 and Figure 4.2, respectively), both occupy an extensive physical space that includes registration, waiting and staff working areas. There are also clinical areas with a separate area for resuscitation patients, and further care areas such as the CDU in the adult ED and AAU in the paediatric ED. Although the work processes of the two EDs are essentially the same (e.g. registration, triage, investigation test work processes), there are a number of striking differences in terms of the overall organisation of these work processes and local practices within the processes. This finding is interesting yet quite surprising as both EDs are within the same ED category.

One of the obvious differences between the two EDs was the difference in the patient trajectory (as shown in Figure 5.10 to Figure 5.12 of the adult ED patient trajectory, and the flowchart in Figure 6.9 of the paediatric ED patient trajectory). These trajectories comprise of essentially similar care processes (e.g. triage, treatment, assessment, clinical test ordering and discharge), hence suggesting the common aspects of emergency care (Ajmi et al., 2015). However, the overall organisation of the work processes differs. This is mainly due to the fact that each ED has a different approach in segregating its patients according to the level of illnesses and injuries, as well as differences in their staff mix (Figure 5.2 and Figure 6.2) and staff work assignment. In the adult ED, patients are categorised as minor injury patients and major injury patients. In contrast, in the paediatric ED, patients are categorised as ambulant

patients and non-ambulant patients. Each category of adult ED, patient is assigned to individual clinical units (i.e. minor injury patients to the minor injuries unit and major injury patients to the major unit). These units are staffed with their own patient care team. Therefore, in each unit, patients are assessed by separate teams of clinicians where the execution of the care processes within each unit differs. This means that the patient care process is compartmentalised within the individual units. In the paediatric ED, the categorisation is primarily done to determine whether to allocate trollies to patients during their trajectory. There are no individual clinical units with separate teams of clinicians working independently. Therefore, the adult ED workflow is essentially more compartmentalised in comparison to the paediatric ED. Segregating patients according to their condition is a common characteristic of an emergency care setting (Feufel et al., 2011). Nevertheless, separation of teams of clinicians working independently on different groups of patients could also further characterise an emergency care workflow.

Differences are also noticeable in the execution of specific clinical processes like triage. Although a triage process is a standardised aspect in emergency care delivery and the usage of the Manchester triage score is a national requirement for UK EDs (Ganley & Gloster, 2011), how the triage process is conducted is essentially a local practice. For example, in the adult ED, the triage process is executed by nursing staff and pit stop doctors, depending on the patient's mode of arrival. Patients who arrived via ambulance (at most times) are triaged by pit stop doctors who are doctors of consultant rank while walk-in patients are triaged by nursing staff. For the ambulance patients, although a pit stop doctor assessment is a triage process, the process only involves allocation of patients to the clinical sub-units of the major unit. The Manchester triage score is not yet used at this stage. The triage score is used only after patients are assigned to the clinical units, i.e., during the nursing assessment process. As for the walk-in patients, the score is used together with the assignment of patients to streams. In contrast to the paediatric ED, regardless of the patient's mode of arrival, triage is performed only by a triage nurse using the score. In addition to using the score, some patients are allocated specific nursing resources for their further care trajectory. Moreover, in the situation where there is a high influx of patients into the ED, patients with minor injuries/illnesses are not subjected to triage. The execution of a blood test investigation work process also differs quite significantly. In the adult ED, it is a common practice that the process is executed with other staff members, i.e., clinical technicians, care support workers, medical students and nursing staff (as shown in the flowchart in Figure 5.4). In the paediatric ED, the process can be quite simple and more straightforward. At most times, the doctors would do the test

themselves with occasional help from the nursing staff (as shown in the flowchart in Figure 6.3). Requests can also be sent to the hospital phlebotomist. The clinical observation work process also differs between the two EDs. At the paediatric ED, upon patients being assessed by doctors, only some patients requiring further observation are allocated specific nursing staff (Figure 6.12). In contrast, in the adult ED, patients are under nursing observation at all times, either directly or indirectly (Figure 5.16). Similar to the clinical processes, the execution of the organisational processes also differs, for example, in the coding process (Figure 5.17 and Figure 6.13). In the adult ED, the coding process is primarily executed by reception staff, while in the paediatric ED coding is performed by clinical staff members. These differences show that in addition to a national requirement and common care processes, the local practices also play a role in the execution of these processes, therefore contributing to a more localised patient care process.

Differences can also be seen in the methods used to adhere to the national requirement, the four-hour rule. One of the methods employed to ensure that patients receive care within four hours is by sending patients who require extended care to an observation unit. Once patients are sent to the unit, the four-hour rule no longer applies. In the adult ED, the observation unit is known as the CDU: operationally, it is part of the ED. Patients who are sent to the CDU from the minor or major units for further observation, or to wait for investigation results are not discharged at that point from the ED, and therefore patients are still under the care of the ED team members. In the paediatric ED, patients who are expected to need longer care are discharged from emergency care to the AAU. Unlike the CDU which is part of the adult ED, the AAU is a separate unit from the paediatric ED. Therefore, patient care falls under the care of the AAU staff.

Besides the four-hour rule, each ED also has its own time-restricted activity, possibly to improve adherence to the four-hour rule and improve patient flow. For example, the adult ED has a 12-hour bed wait where patients who are to be discharged to hospital wards cannot wait longer than 12 hours to be transferred. In addition, minor injuries patients are also triaged to different streams depending on their presenting complaints. The streaming of minor injury patients was found to reduce the number of patients waiting more than one hour by 30% (Department of Health, 2001). The paediatric ED, on the other hand, has a 15-minute triage time, whereby patients cannot wait for more than 15 minutes to be triaged upon registration. In the adult ED, the organisational task of enforcing these time-related rules is allocated to staff with a specialised role, a patient flow champion, on a permanent basis. A patient flow champion then works collaboratively with clinical staff with CiC and NiC roles. Although a

patient flow champion is also a trained clinical staff, he/she does not carry out any clinical duties unless in exceptional circumstances. However, a slightly different approach is used in the paediatric ED. Any senior nurse can be allocated a coordinating role, a role that is assigned on a daily basis. In addition, the coordinating nurse is also in charge of managing nursing resources (e.g. nursing staff work assignments and breaks) while at the adult ED, the management of nursing resources is the task of a NiC.

An emergency care workflow is governed by a national requirement and common care processes. However, local practices, with regards to staff-mix, overall organisation of work and approaches adopted to improve patient flow, also characterised the workflow. Furthermore, this characterisation can be found across the overall trajectory of care processes, clinical and non-clinical.

#### 6.4.2. Variability in the patient care processes

The constructed workflow diagrams discussed in Section 5.3 and Section 6.3 of this thesis mainly reflect the routine processes of the EDs. However, the execution of these processes is not routine, and neither is it straightforward. It has been recognised that healthcare work is uncertain and can be variable because of the need to integrate exceptions into routine work (Abraham & Reddy, 2010; Berg, 2003). Although a number of exceptions identified can be reflected in the constructed workflow diagrams (represented by the dotted lines), there are other events which occur on an *ad-hoc* basis or arise from existing practices that are not possible to be graphically displayed. Healthcare settings consist of a mixture of routine work and exceptions, which make it difficult to build formal workflow models (Pratt et al., 2004). In this study, deviation from the 'normal' workflow is caused by a combination of patient conditions and existing local practices.

Patients whose condition deteriorated while waiting for treatment can be ushered straight into the clinical areas to receive treatment instead of continuing to wait, although initially they can be triaged to a lower category (i.e., non-urgent cases). Although this exception might seem mundane and logical, some of these exceptions were identified by non-clinical staff members. It might be expected that clinical decision concerning patient condition are being made by clinical staff members, however boundaries between the task and role cannot be very rigid (Berg, Langenberg, Berg, & Kwakkernaat, 1998). In this case, the non-clinical members might have dealt with these circumstances many times before and their



decisions are based on what they have previously experienced. Another exception that was identified, based on the deteriorating condition of a patient happened, specifically in the adult ED. This is partly because patient care is physically compartmentalised (i.e. minor injuries unit, major unit and CDU). This event required that the patient be transferred to a more appropriately equipped clinical unit. Therefore, the patient care process fell to another team of clinical staff with a different workflow, hence contributing to variability in the patient care process. Workflow in the paediatric ED can also differ depending on the patient's condition. For example, non-ambulant patients brought by the ambulance service are transported to the trolley area which is very close to the ambulance entrance (as shown in the floor plan of the paediatric ED in Figure 4.2). Thus, instead of triaging being conducted by a triage nurse located in the patient assessment room, the triage process became the responsibility of any qualified nursing staff located in the main area of the department. It is important to note here that only non-ambulant patients are transported directly to the trolley area. Patients that can walk are still instructed to have their triage at the patient assessment room, similar to walk-in patients.

There are also non-routine tasks which are common across the two EDs. For example, it is quite common for medical students to be involved in a number of clinical activities. This can include taking patient history and performing medical tests such as taking blood from patients. However, differences do exist between the two EDs in relation to this particular practice. In the adult ED, which includes patients that a medical student can attend to depending on explicit instructions from the doctors. In the paediatric ED, it was observed that medical students can decide who they want to attend to; one medical student pointed out that she would normally take patient history from patients that are triaged to a lower category (i.e., not very sick patients) as opposed to more sickly patients who are usually chosen by experienced nursing staff.

The role of support staff, such as care support workers and housekeeping staff, can also contribute to variability in the care process. According to a care support worker in the adult ED, not all care support workers are trained as phlebotomists, and therefore not all of them are allowed to perform certain medical tasks when requested by clinical staff. Additionally, housekeeping staff can also participate in the workflow implicitly. This is one of the most unexpected findings in the adult ED. A member of the housekeeping staff stated that, at times, she was instructed by nursing staff to assist the family members of very ill patients. This might seem insignificant in the care process but in order for her to execute the task, she needed to have access to information about the patient's location. 'External' help such as this can also free up certain resources, such as nursing staff, in a way that could reduce their multi-tasking

behaviour. However, this practice was not found in the paediatric ED. This could mainly be due to the fact that housekeeping staff are not a part of the ED team. Consequently, the higher staff-mix and roles in the adult ED contributes to even more variability in the care process. A patient flow champion, who was also a qualified clinical staff member, can get involved in the care process when the ED faced staff shortages. Further, the limited availability of pit stop doctors at only certain times of the day means that triage for ambulance patients is taken over by nursing triage.

Variability in the delivery of emergency care can be caused by a patient's condition, which requires that exceptions have to be made. It can also be caused by existing local practices. It is important that this variability be recognised to ensure that the information artefacts are able to support it. Information artefacts in each ED have been, to a certain extent, designed and adapted to support each ED work practice and the variability of the care processes that can happen.

#### 6.4.3. Information artefacts in supporting the collaborative work processes

Both EDs still rely on a hybrid information architecture, consisting of computerised and non-computerised information artefacts. With the exception of the CPOE and RIS systems (i.e. ICE and PACS), which are exactly the same systems, others are in-house legacy systems. Hence, the usage of these information artefacts in supporting the workflow varies quite significantly.

One of the main differences between the two EDs is the number of non-integrated computerised systems. In the adult ED, a greater number of non-integrated computerised systems could be found. As a result, more than one information artefact must be used to support a single work process. For example, the computerised PCS and PTS, as well as a non-integrated database, the NSTS, are all used in the registration work process (Figure 5.8). In contrast, only the computerised Medway was used in the paediatric ED. As for clinical documentation, although both EDs still operate paper-based systems, the documents used are not identical. In the adult ED, there are two types of documentation system, one for medical and minor trauma patients (Appendix 18a) and one for major trauma patients (Appendix 18b), where the usage of either type of ED cards depending on patient's condition. In the paediatric ED, although there is a separate document, i.e., a trauma card (Appendix 20), which is used for resuscitation patients, there is only a single documentation system (Appendix 19), regardless of the type of patient condition. If a trauma card is used, it has to be filed together with the

main document. Therefore, although the two EDs have the same paper-based clinical documentation system, their work practices in regards to clinical documentation process is in fact quite different. There are also differences in terms of the number of paper-based forms: more order-entry forms can be found in the adult ED (Table 5.1), in comparison to the paediatric ED (Table 6.1).

Other non-electronic artefacts such as dry-erase whiteboards, pigeon holes and trays can also be found in both EDs. How these artefacts are utilised, however, is not similar. For example, whiteboards can be found in each of the clinical units, whereby the information on the individual whiteboards is confined to the information within the particular units. In the paediatric ED, however, the main clinical whiteboard essentially depicted information only for selected patients (i.e., patients who require nursing observation) regardless of which areas patients are located. Therefore, whiteboards in the adult ED project information on a pool of patients while the whiteboard in the paediatric ED concerns only a specific group of patients. In contrast to the characteristic of whiteboards, individual pigeon holes in the adult ED represent information on a single patient as they store individual patient ED cards. However, in the paediatric ED, trays are used for the purpose of grouping similar patients (e.g., Tray C is used to place ED cards for patients triaged to category C).

Regarding the ward admission process, both EDs still rely heavily on direct communication with hospital wards. For example, requests for hospital beds can only be established via direct communication. In the adult ED, direct and consistent verbal communication between a patient flow champion and the hospital needs to be maintained. However, in the paediatric ED, hospital bed availability can be obtained from the computerised Medway system although request for these beds can only be made via telephone. Table 6.2 summarises the information artefacts used in both EDs in supporting the workflow processes. It is clear that a range of multiple information artefacts are needed to support both the clinical and non-clinical work processes.

Table 6.2: ED processes and their corresponding information artefacts in the two EDs

<b>Processes</b>	<b>Adult ED</b>	<b>Paediatric ED</b>
Registration	PCS, NSTS, PTS, ambulance handover forms	Medway, ambulance handover forms
Triage	ED cards, ambulance handover forms	Medway, ambulance handover forms
Tracking (time, location and clinical progress)	PTS, whiteboards	Medway, whiteboards
Investigation test – blood	ICE, PFI, blood order form	ICE
Investigation test x-rays/scans	PACS, CRIS, Diagnostic imaging order form	PACS, Medway
Clinical documentation	ED cards, pigeon holes, in/out trays	ED cards, trays
Discharge (home or wards)	Copy of ED cards	Copy of ED cards, Filefast

It is also crucial not to overlook the characteristics of these artefacts in implicitly supporting collaboration within the workflow. Although these artefacts are embedded with specific functionalities in supporting the workflow processes (e.g. Medway for registration and patient tracking), these artefacts are also utilised in supporting the less obvious components of the workflow, such as resource management and, teaching and learning. As a resource management tool, for instance, the overall management and monitoring of resources such as beds and staff, and discrete assignment of tasks can be carried out. In the adult ED, the clinical whiteboards and the computerised PTS emphasise the monitoring of overall ED and clinical unit workloads. Meanwhile, the clinical whiteboards and the computerised Medway system in the paediatric ED place an emphasis on the discrete assignment of tasks (e.g., nurse to patient assignment for observation, doctor to patient assignment). As a visual aid tool, pending tasks or subsequent tasks to be executed can be determined in passing. For example, information written on the whiteboards as well as documents placed at the whiteboards or in the mediated artefacts (e.g. trays), provides an indication that a certain task needs to be executed, in addition as a self-reminder system.

#### 6.4.4. Impact of information fragmentation on work processes

To a significant extent, the hybrid information implementation consists of technical functionalities and non-technical functionalities in supporting the workflow processes and collaborative work. However, such implementation has contributed to fragmented information which has negatively affected a number of clinical and non-clinical processes. In the adult ED, there are non-integrated computerised information systems ranging from the PCS and PTS for registration process and patient tracking, as well as PFI, ICE and PACS as clinical systems. As a result, a number of work processes such as the registration process and the coding process, require the use of multiple systems. In delivering clinical tasks, clinicians also need to rely on multiple artefacts including non-computerised information artefacts. Similarly, these scenarios can also be found at the paediatric ED. However, the degree of the fragmentation is more prevalent in the adult ED.

For example, in the registration process in the paediatric ED, the Medway system is used to record patient detail and patient tracking. There is no need to access a separate database and tracking system to complete a registration process, as is the case in the adult ED. During the registration process in the adult ED, the PTS and PCS, which are non-integrated computerised systems, are used in addition to another non-integrated system, a NSTS database (Figure 5.8). As a result, reception staff have to keep switching between multiple systems when carrying out the process. As for clinical processes in the paediatric ED such as the investigation test work process, an investigation order for x-rays/scans is submitted electronically via the Medway system. There is no need to use any paper-based order entry form, the method used at the adult ED (Figure 5.7 and Figure 6.7). For a blood test request, a separate computerised system, i.e., the ICE system is used, in addition to the computerised Medway system. The Medway is used to order the test (by printing the forms and blood tube labels) and the ICE is then used to access the results. Although in the adult ED, quite a similar scenario can also be found, the ED has more than one system, i.e., the PFI and ICE which essentially are the same systems to be used for ordering blood tests. Blood tests can be ordered either via PFI or ICE, depending on who submitted the order. The PFI is used if blood test ordering is performed by clinical technicians, while the ICE is used if orders are submitted by doctors and nurses. This has resulted to a non-standardised usage of myriad artefacts which are essentially for the same purpose.

The hybrid implementation not only affects specific clinical or non-clinical processes negatively, but also the process of identifying patient location, a problem that is also more

prevalent in the adult ED. In both EDs, patient tracking can be done via computerised systems. In the adult ED, the tracking system is the computerised PTS. However, its use to determine patient location must be accompanied by the dry-erase clinical whiteboards. This is in contrast to the paediatric ED in which the computerised Medway system alone is sufficient to provide patient location information. Another process affected by the hybrid implementation is the coding process. In the paediatric ED, coding is completed using only the computerised Medway system and clinical documentation system (i.e. an ED card) (Figure 6.8). Meanwhile, in the adult ED, completion of the process means utilising a greater number of information artefacts (Figure 5.9).

The ED workflow is supported by a combination of computerised and non-computerised information artefacts. However, in comparison, there are more computerised systems at the adult ED than in the paediatric ED. Consequently, the impact of information fragmentation in the paediatric ED, such as the need to use more than one system to complete a task (e.g. registration and coding processes) and the need to first access other artefacts for information to obtain complete information (e.g. obtaining patient location), is minimal. Other studies have shown negative consequences of fragmented information. For example, it can increase accessibility to more 'informal' sources (Reddy & Spence, 2008) and additional time to obtain complete information (Reddy et al., 2009). In this study, information fragmentations caused by the hybrid implementation, which consists of mostly non-integrated systems have affected the continuity of tasks within a single process as well as on overall workflow.

The comparison made between the two settings (i.e. in this Section 6.4) has shown significant differences in the workflow of the two settings. These are mainly contributed by the embedded practices which are governed by organisational elements. Figure 6.14 shows the socio-technical concepts found which have contributed to the variation in the workflows and processes. It is important that these variations be recognised in order to have HIT that can seamlessly be integrated into current practice (Balka, Bjorn, & Wagner, 2008). However, with such variation, the recurrent features of emergency care work still prevail, that emergency care work constitutes interconnected and interrelated clinical and non-clinical processes of multidisciplinary members, where at times exceptions must be made in light of patient situation. In addition, the workflow is also governed by organisational time-related constraints and supported by hybrid information architecture.

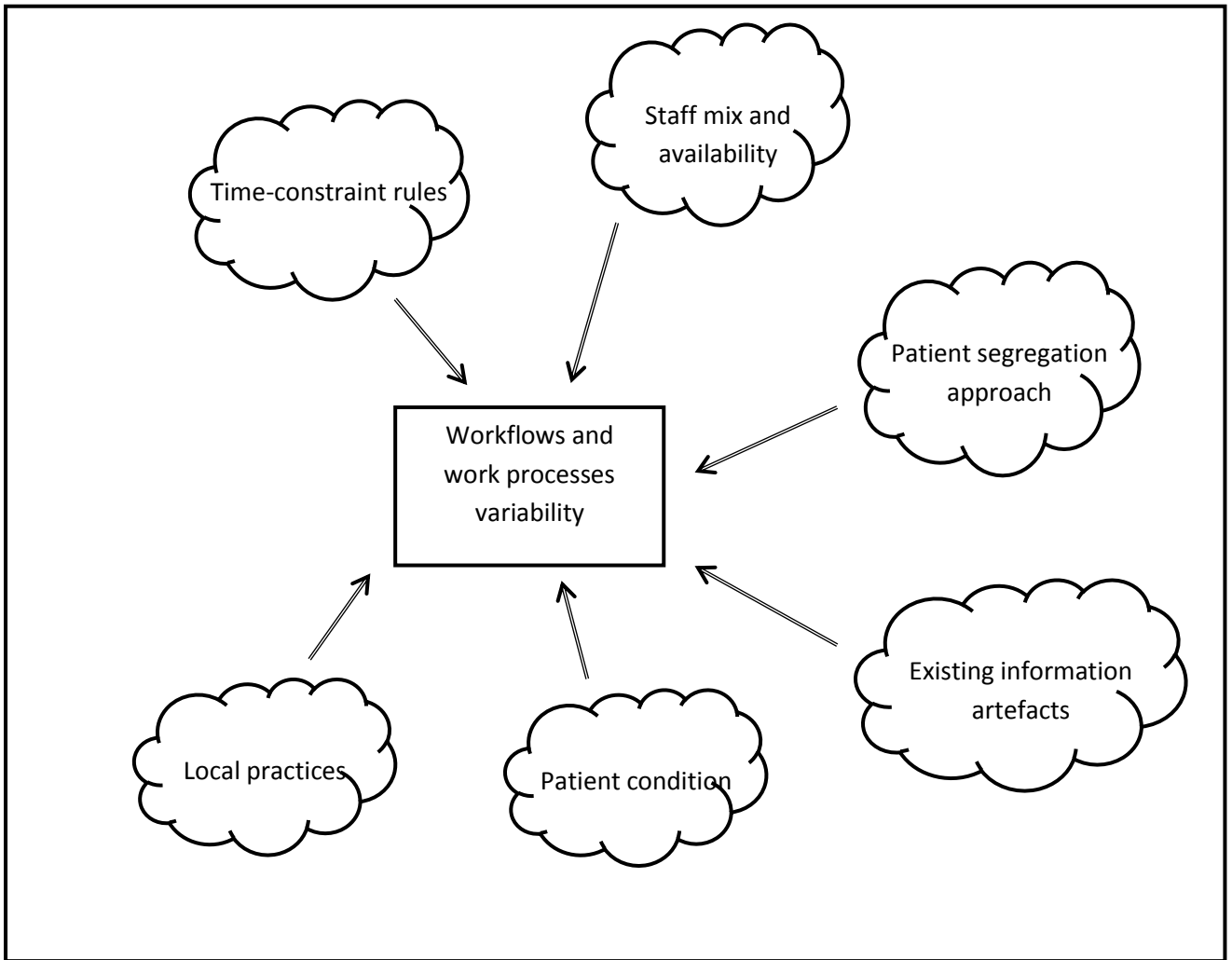

Figure 6.14: The contributing of socio-technical elements to workflow and work process variations

## 6.5 Conclusion

This chapter has presented the case study findings at the paediatric ED. A comparison between the findings at the adult ED and the paediatric ED was also discussed (Section 6.4). In Chapter 7, the characteristics of emergency care work are discussed by triangulating the findings from the two case studies.

## CHAPTER 7: DISCUSSION

### 7.1. Introduction

As explained in Chapter 2, the aim of this thesis is to gain an in-depth understanding of the Emergency Department (ED) workflow and work practices of both clinicians and non-clinicians, in addition to how the existing Emergency Department Information System (EDIS) is being utilised for the delivery of emergency care. The results, which are presented in Chapter 5 and Chapter 6 can be summarised as follows:

1. The emergency care workflow consists of the inter-connected and inter-related clinical and non-clinical processes and practices of the multidisciplinary members. The execution of these processes is governed by organisational practices, as well as being embedded with clinical exceptions and variation.
2. The multi-disciplinary members of the ED team include the obvious clinical members (i.e. doctors and nurses) as well as support staff who are responsible for clinically-related tasks and administrative tasks. There are also members of the team, particularly the senior clinical members, who are responsible in performing time-related administrative tasks.
3. The EDIS is comprised of computerised information systems, non-electronic artefacts and paper-based records and forms. The hybrid information architecture is crucial in the overall functioning of the workflow. Some integration issues existed in the existing implementation of the EDIS, although the non-computerised component has demonstrated characteristics that supported collaborative work.
4. The comparison made between the findings of the two study settings shows that although both settings have essentially similar processes and resources, differences can be seen in the organisation of the work processes, various practices in regards to some of the processes (e.g. triage) and the extent to which the information artefacts support the work processes and practices.

The next section, i.e. Section 7.2, re-iterates the importance of treating HIT as socio-technological systems. The remainder of the sections (Section 7.3 to Section 7.4) further discussed the findings from a socio-technical perspective of collaborative work. Specifically, Section 7.3



discusses the under-researched components of an emergency care workflow and further suggests some socio-technical design requirements for these components. As the research was conducted in the context of emergency care in the UK, Section 7.5 discusses the implementation of UK national IT programme on emergency care workflow.

## **7.2. Socio-technical approach in understanding workflow-related components of emergency care delivery**

As explained in the literature review (Section 2.6), Health Information Technology (HIT) has been considered by many as a socio-technical system (Berg, Aarts, & Van der Lei, 2003; Lawler, Hedge, & Pavlovic-Veselinovic, 2011; Reddy, Pratt, Dourish, & Shabot, 2003). Socio-technical systems consist of two components that are interrelated: the social features of work and the technical features of the system. Berg, Aarts, and Van der Lei (2003) emphasised that socio-technical systems cannot be partitioned into social aspects for social scientists and technical aspects for information technologists, but need to be considered as a whole. Therefore, determining the requirements for socio-technical systems requires a close examination of the work that the technical systems will be supporting, as well as the impact of the technology on the work (Baxter & Sommerville, 2011).

As discussed in Section 2.6.1, a number of approaches can be used in investigating workflow-related social-technical issues. These approaches have been adopted in such studies in order to gain an in-depth understanding of socio-technical issues in designing, implementing, and evaluating HIT (e.g. Abraham & Reddy, 2010; Feufel, Robinson, & Shalin, 2011; Park, Lee, & Chen, 2012; Reddy, Pratt, Dourish, & Shabot, 2003). In this study (as discussed in Chapter 3), a workplace analysis, utilising social science inquiry techniques, was used to gain an in-depth understanding of the situated nature of emergency care workflow. Using this approach the system requirements of a HIT can be viewed as being embedded in the users' work practices (Doherty et al., 2010). Generating system requirements using this approach is also based on the view that workflow models can be difficult to build in healthcare environments where healthcare work is filled with exceptions, and can be volatile and unpredictable (Reddy, Pratt, Dourish, & Shabot, 2003). Moreover, workflow modelling only "provides a view of how processes should occur" (Hayes, Lee, & Dourish, 2011, p. e173). Abraham, Kannampallil, and Reddy (2009) further suggested that to develop an HIT for emergency care, the complex and contextual nature of the care processes and its activities should be fully understood.

The findings presented in Chapter 5 and Chapter 6 are discussed according to four themes (Section 7.3.1 to Section 7.3.4) that make up the components of emergency care workflow. As other

studies (Bjørn & Hertzum, 2011; Feufel et al., 2011; Park et al., 2012) mainly focused on the clinical workflow of clinicians; the themes discussed include other under-researched part of an emergency care workflow. These themes should not however, be treated as separate components or 'standalone' components of the overall workflow, but regarded as part of the whole picture.

### **7.3. The ED workflow: A socio-technical perspective**

Essentially emergency care workflow constitutes of both clinical and non-clinical processes. On top of that, some clinical members were also responsible in carrying additional non-clinical tasks. The execution of these processes is further intertwining with organisational and national procedures, as well as existing information architecture.

#### **7.3.1. Time-related care processes**

An emergency care setting is a challenging environment, filled with unpredictability and volatility with regard to the volume of patients and patient conditions (Batley et al., 2011). It is additionally challenging where patient safety is a concern, and clinical decisions and treatments need to be delivered within specified periods of time. In the UK, the four-hour rule is a form of national clinical governance established by the Department of Health (DoH) to reduce patient waiting times in an effort to improve patient satisfaction (UEC Review Team and ECIST, 2013). So much emphasis has been placed in adhering to this rule that a target that 95% of ED patients need to be seen within four hours or being admitted to the ED has been introduced (UEC Review Team and ECIST, 2013). This has put additional pressure on care delivery. The four-hour rule and the set target are also measures that were implemented to avoid ED overcrowding. ED overcrowding, one of the most common issues in EDs worldwide, can affect patient safety (Di Somma et al., 2015). In addition to the four-hour rule, the workflow is also governed by other time-restricted targets specific to each ED. In the adult ED, for example, there is a 12-hour bed wait restriction, in which patients who are being admitted cannot wait more than twelve hours in the ED. In the paediatric ED, a 15-minute triage time was practised. Such targets are probably measures taken by EDs in the UK to improve care efficiency and, indirectly, to contribute to reaching the national target.

As a result, an ED workflow is not solely about the delivery of clinical care, but at the same time making sure that these time-related targets are being adhered to. This could be one reason why senior clinical members have been entrusted to additional non-clinical roles such

as a Consultant in Charge (CiC) and coordinating roles. Moreover, in the adult ED in this study, a specific position (i.e., a patient flow champion) was also created for this task. What further complicates a clinical role is that this role is entrusted to senior clinical staff members simultaneously with their clinical role and advisory role. They need to be aware of the overall load in the ED to ensure that patients do not build up in the area while at the same time attending to their own patients and handling questions or concerns from their junior counterparts. This shows that the tasks of clinical staff, particularly the senior doctors, involve more than delivery of direct clinical care as predominantly identified in other studies (Abraham et al., 2009; Ajmi et al., 2015; Bjørn & Hertzum, 2011; Hollingsworth, Chisholm, Giles, Cordell, & Nelson, 1998), but also include non-direct care activities. The research in this thesis has identified that these non-direct activities, for example, in maintaining smooth patient flow (i.e., so that there are no patient build ups) are just as crucial in order to ensure safe and efficient care delivery. In addition, although the time-related aspects of the clinical processes are primarily being carried out by senior members of staff such as the CiC, and staff with coordinating roles, processes such as patient transfer, triage, investigation test ordering, treatment and observation performed by other staff members are heavily intertwined with these time-related targets and activities, thus making them a collective task and effort for all team members. Therefore, EDIS must be able to support this 'not-so-obvious' component of an emergency care workflow. An ED workflow does not only consist of interrelated clinical care processes but also processes that are embedded with organisation time-constraint rules.

### 7.3.2. Clinical work of the ED workflow

The research revealed that ED clinical processes such as triage, assessment and treatment are mainly executed by doctors and nurses. This means that a patient goes through an emergency care trajectory being treated by the same group of clinicians in each stage of the trajectory. For example, all patients that go through triage, assessment and investigation test processes are seen by triage nurses for triage, nurses and doctors for assessments, and clinical technicians for blood test work. However, this is not always the case, as the care trajectory can be subjected to variation, in terms of who can perform specific processes (as shown in Figure 5.14 to Figure 5.16, Figure 6.11 to 6.13), depending on the skill sets of individuals within the same professional group. This is the result of staff members having different professional qualifications or having undergone different clinical training. For example, in the adult ED, not all care support workers are allowed to do blood work on patients. Some care support workers

with a certain professional qualification are allowed to undertake the task. This means that some patients can have their blood work performed by qualified care support workers, in addition to nurses and clinical technicians. In the paediatric ED, a care support worker interviewed was also responsible to carry out ECG and urine tests, common clinical tasks performed by nursing staff.

Similarly, the triage process in the paediatric ED can only be assigned to qualified nursing staff, meaning that not all nurses can be assigned for triage work. The same goes for treating resuscitation patients. Only members of the nursing staff with a certain level of qualification can be assigned to be part of a resuscitation team. Uncertainty in patient flow and volume can also contribute to variation in the care trajectory. For example, in the adult ED, patients assigned to the major unit undergo a nursing assessment and, subsequently, a doctor assessment. However, it is increasingly typical, according to Consultant F, that a nursing assessment has to be skipped due to an increasing volume of patients. Additionally, the execution of some of the clinical work is also embedded with organisational practices which inadvertently can alter a somehow 'fixed' care trajectory. For example, to a certain extent, clinical work can be assisted by medical students for the purpose of teaching and learning, as well as be assisted by different staff because of their clinical experience. A more experienced nursing staff can at times 'projected' that a patient would need to be hospitalised prior to the medical decision being made by a doctor. As a result, request for hospital bed can be made in advance, hence variability of the patient trajectory.

Clinical work can be very specific in terms of who can perform which processes (e.g. only doctors can make medical decisions) (Ajmi et al., 2015). However, the clinicians involved in a patient's care trajectory at any given time can vary depending on factors such as staff skill sets or staff availability. The unpredictable nature of an ED setting could also result in the variation of the trajectory.

### 7.3.3. Non-clinical work of the ED workflow

As depicted in Figure 5.2 and Figure 6.2, the ED team consists of heterogeneous staff members with both clinical and non-clinical roles. Senior clinical members, i.e., doctors and nurses, are also responsible for executing both clinical duties and non-clinical duties, such as teaching and supervising students, giving advice and supervising their junior counterparts. These added responsibilities are, in fact, an integral component of an ED workflow and could

often be overlooked, because the workflow has predominantly been characterised as clinician workflow in delivering direct clinical care to patients (Ajmi et al., 2015; Bjørn & Hertzum, 2011; Feufel et al., 2011). Overlooking this important component could result in an interpretation that the workflow is only fluid and interactive as a result of unpredictability of patient flow and patient condition (Reddy & Spence, 2008). However, these added responsibilities, like requests for advice, can also lead to additional 'disruption' to the flow of work for the senior clinicians. A self-audit study of a consultant in a UK ED found that requests for verbal advice was one of the most common interruption to the flow of clinical work (Allard et al., 2012).

It is also crucial to recognise the role of support staff, such as reception staff, in the workflow in making clinically-oriented decision. For example, reception staff are also responsible for identifying and handling medical exceptions. Exceptions in healthcare delivery are common (Koppel et al., 2008). In this study, although clinical exceptions were also identified and dealt with by the clinical staff members, exceptions were also handled by non-clinical members, particularly the reception staff. Their role in handling exception should not be overlooked as they are the first point of contact in the patient trajectory. And although patients have been triaged (i.e. priority assigned) by clinical staff, reception staff in particular need to make decisions as to whether patients who are currently waiting for treatment should be given priority to receive medical treatment or not, if their condition deteriorates, hence overriding the triage category assigned earlier in the patient trajectory. Making such a judgment correctly is crucial for patient safety. As stated by Berg and Toussaint (2003), healthcare workflows are situated and interactive, which require reinterpretation when faced with unforeseen circumstances. In addition, medical exceptions happened frequently, and are therefore handled intuitively based on work experience and prior knowledge (Kobayashi et al., 2005).

Reception staff work is also volatile with regard to their main task, i.e., registration process. It is a process that can in fact happen anywhere, spatially. To register a resuscitation patient, for instance, cannot at most times happen at the registration counter. A carer or patient's relative, who is the next available person to do registration on the patient's behalf, is most probably with the patient in the clinical area. Therefore, the non-clinical process can also be happening anywhere across the clinical area, not just fixed at the patient's first point of entry. In addition to patient registration, the reception staff are in charge of the coding process. This process requires them to scan through patient ED cards, a clinical documentation system, to make sure that completed invoices are generated, i.e., all the investigation tests that are ordered and treatment that is delivered are incorporated in the invoices. At the same

time, they also need to make sure that the clinical documentation is completed thoroughly by clinical members. These findings suggest that although reception staff are not clinical members, they require clinical knowledge, at least at a superficial level, to make the right clinical judgment and to ensure proper completion of the coding process. This is probably achieved through experience working in the environment, providing them with the 'technical' knowledge in executing these tasks.

The involvement of non-permanent staff members such as external staff, medical students, as well as housekeeping staff, in an ED workflow should also be factored in. External clinical staff members, employed on a need basis, are expected to participate in the workflow whenever they are employed. However, the workflow can be 'thrown' out of normal practice when they are not around. Similarly, medical students can also be a cause of 'disruption' to the normal flow of work. Whenever they are around, there is a need to include them in the care process as part of the teaching and learning process. In addition, there is also a possibility of an *ad hoc* involvement of unexpected members, such as housekeeping staff. This finding suggests that involvement of housekeeping staff as part of non-direct patient care relinquishes nursing staff for the task, and hence allowing them to concentrate on their clinical tasks. This indicates that although at times the ED workflow can be predictable in terms of the sequence of the processes and who is executing certain processes, to a certain extent it can also be variable. Lee, Tang, Park, and Chen (2012) also demonstrated a similar result: that the nursing team in an ED is dynamic and loosely formed. Actual work situations can often require constant and continuous renegotiation (Mills, 2003).

Many studies of HIT for emergency care have placed significant emphasis on integrating HIT into clinical workflow (Abraham et al., 2009; Aronsky, Jones, Raines, et al., 2008; Bjørn & Rødje, 2008; Feufel et al., 2011). This study has shown that an ED workflow is as much clinical and organisational, as well as being variable, uncertain and exception-filled. As shown in Figure 6.14, the ED workflow is driven by a number of contextual factors contributing to the fluidity of emergency care delivery.

#### 7.3.4. Hybrid information infrastructure vs. paper-less infrastructure

To move practices that are already deeply integrated with a particular information infrastructure to unfamiliar technological implementation is no trivial task. Therefore, it is important to look at an existing EDIS implementation and how it is utilised in supporting the

workflow. In the study, the ED workflow was supported by hybrid EDIS architecture. The computerised components of the hybrid implementation significantly supported the workflow processes, such as registration and patient tracking, as well as generating invoices (during the coding process). However, HIT can “accommodate domain and work requirements sometimes more, sometimes less effectively than old technology” (Feufel, Robinson, & Shalin, 2011, p. e94). To a certain extent, the non-computerised components have played a significant role in assisting the collaborative nature of the workflow.

This study found a number of non-technical characteristics of the non-computerised components of the hybrid implementation: the paper-based documentation system (i.e. the ED card) and the dry-erase whiteboards, in supporting ED collaborative work processes. These artefacts play a significant role in coordinating work activities among the ED group members. An ED card, for instance, functions more than just patient records. It is also a teaching and learning tool. Teaching and learning is one of the ‘not so obvious’ components of the workflow; nevertheless, it is a crucial component. The process can be accommodated flexibly, whenever and wherever, for instance, in a face-to-face interaction between junior clinical staff members (e.g. junior doctors and medical students) and senior doctors. Face-to-face interaction is a common method used by junior doctors in seeking advice from their senior counterparts in matters related to patient care as well as in achieving correct documentation. Obtaining a comprehensive and correct clinical documentation is constantly being emphasised during the coding process; part of the process was to ensure that ED cards be completed comprehensively. The ED guidelines issued by the Trust also stated the same requirements. As one consultant (i.e. Consultant A) described it: *“for the practice of medicine, clinical documentation should be comprehensive and include information such as medical history, tests conducted and advice given”*. As such, it was a common practice to observe that the documentation tool was constantly used as a tool to facilitate the teaching and learning practices. The practices can easily be facilitated as the portability of a non-computerised artefact permits the convenience and ease-of-use to in a face-to-face interaction. Because a face-to-face interaction allows information to be better contextualised (Benham-Hutchins & Effken, 2010), learning activities could be achieved more effectively.

The ED card also has the advantage in supporting direct interaction between clinical staff members and patients. The portability of a non-electronic documentation system means that patient-doctor interactions can be supported regardless of where it is about to happen. This is particularly useful as patients can be assigned to any areas of the ED to receive treatment. Moreover, in a face-to-face interaction, doctors can spend more time learning

about a patient's conditions and allowing treatment to become more visible to patients, therefore increasing patient satisfaction (Hertzum, 2011). Although the patient-doctor interaction may not have direct consequences on collaboration among team members, implementation of an electronic clinical documentation system could change an existing working practice whereby interaction with patients can happen flexibly throughout the care process. Therefore, if computerised documentation system is to be implemented, for example, as part of Summary Care Record service of the National Programme for IT, the functionality of the documentation system as a teaching and learning tool in facilitating face-to-face interaction should not be overlooked. Achieving this would probably require that sufficient number of computer terminals is allocated or dedicated rooms be allocated for such practices.

Another advantage of a non-electronic documentation system is that additional non-medical information can be incorporated non-permanently. This study found that stick-on notes were used by medical students to indicate that a patient had been initially attended to by them (Section 6.2.2.2). Using stick-on notes is a way of indicating that an activity had occurred (i.e. patient history has been documented by a medical student). Such notes do not just provide the information *per se* but serve as visual cues to an activity. This suggests that stick-on notes were used to provide visual cues to specify completion of a task, and therefore, the next task, i.e., patient assessment, could be carried out by doctors. They do not have to go through the ED cards to tell them that an initial consultation has already been completed. It is a faster and more visible way of indicating the completion of a task. The act of placing stick-on notes implicitly allows the generating of awareness information as part of the object of collaboration, i.e., an ED card. The stick-on notes which can be removed later do not contribute to additional patient information but rather as a tool to increase awareness. Increased awareness allows collaborative work to be carried out more efficiently (Kuziemyk & Varpio, 2011; Reddy, Dourish, & Pratt, 2001).

In addition to teaching and learning, management of resources is also an integral part of the workflow and the ED card has been utilised to support this. Management of resources can involve discrete task assignment or overall workload monitoring. The ED card when placed in trays or pigeon holes implicitly allows for tasks to be assigned to group members (i.e. discrete task assignment). For example, in the paediatric ED, ED cards placed in Tray C and Tray D indicated that they are patients still waiting to be seen by doctors while ED cards placed in the tray labelled 'Observation' were for nursing staff to conduct patient observation. As a resource management tool in discrete task assignment allows work to be coordinated without explicit communication that can result in team members being interrupted. Frequent interruption



increases task completion time and causes errors which can affect patient safety (Bailey & Konstan, 2006; Laxmisan et al., 2007). The ED card also allows for overall workload monitoring. For example, in an event where there are many ED cards in any of the trays, could be an indication that the ED is becoming overcrowded, thus necessary action such as allocating or adjusting necessary human resources can be taken care of by the CiC or NiC. A surge of patients coming to an ED can be unpredictable, therefore, collaborative tools that can assemble and manage resources enhance the work coordination of collaborative group members (Neale et al., 2004).

Besides the ED card, the dry-erase whiteboards also function as a resource management tool. For example, a clinical whiteboard in the paediatric ED clean utility room is used to assign nursing staff to patients, in addition to providing information on patient care. Flexibility can be exercised when it comes to its usage in achieving task allocation and coordination. This study found that nursing staff adopted their own techniques (e.g. any colour of pens or symbols) on how they write information on them. A possible explanation for this might be that the semi-structured format of the clinical whiteboards already dictates what specific information should be written, but as long as the required information is there, how the information is written is secondary. However, this technique can present a challenge to non-permanent staff members such as external staff and medical students. The interpretation of non-consistently represented information could result in non-permanent staff resorting to explicit communication, i.e., by asking other staff the meanings, thus defeating the purpose of the whiteboards as a medium for asynchronous collaboration. The coordination of activities afforded by dry-erase whiteboards and the utilisation of conventions such as arrows or ticks in achieving coordination is common (Bjørn & Hertzum, 2011). However, too much flexibility exercised in using these conventions could result in unnecessary interruptions. Moreover, as much as to support task coordination with other staff members, the information was also written as a self-reminder, i.e., to remind themselves of the tasks at hand (Section 5.2.2.2). The utilisation of the dry-erase whiteboard as a self-reminder system could be due to the fact that dry-erase whiteboards only hold information on patient care, non-permanently. Unlike the ED card which becomes part of patient records, none of the information written on dry-erase whiteboards can be permanently stored.

Other studies have also shown that information on dry-erase whiteboards have frequently been tied up to the physical location of the whiteboards in achieving an overall coordination of clinical workflow (Bjørn & Hertzum, 2011; Xiao et al., 2007). This is also a profound characteristic of almost all of the clinical whiteboards in both EDs: clinical

whiteboards were located in each sub-unit in the adult ED and resuscitation whiteboards in the resuscitation rooms in the paediatric ED. These whiteboards correspond to the information on patients assigned to the clinical units. In addition, in the paediatric ED, there is also a clinical whiteboard located in the clean utility room. The whiteboard contained information on all patients requiring nursing observation who were allocated to receive treatment in any of the areas within the ED, instead of in specific clinical units. Although the location of this one particular whiteboard is quite the opposite of the other clinical whiteboards, its location seems to be appropriate in supporting the overall workflow. One possible explanation for this is that the clean utility room was where the nursing staff normally 'hang-out'. Placing a whiteboard at a location frequently visited by them provides direct accessibility to the information for the work process they are responsible for executing. Ignoring subtle spatial characteristics of an information artefact can contribute to decreased collaboration among clinical staff members (Balka et al., 2008).

These findings suggest that the non-computerised component of the hybrid infrastructure implicitly provide the non-technical functionalities which support collaboration practices. This is because it can easily accommodate specific requirements of the workflow and its practices. Meanwhile, the computerised component, such as clinical ordering systems, has provided the functionalities to support the clinical processes. Both types of information artefacts have formed an integral part of the current practice, although one doctor (i.e. Doctor B) described the hybrid infrastructure as "*slightly awkward dual systems*". The hybrid infrastructure has contributed to a number of unintended consequences on both clinical and non-clinical work processes (as identified in Section 5.2.3 and Section 6.2.3). Negative workflow effects of a hybrid implementation identified in other studies include increased users' cognitive load which consequently reduces the amount of information accessed (E M Borycki & Lemieux-Charles, 2008) and the need to transition between multiple artefacts (Abraham et al., 2009). However, a paper-less NHS as envisioned by the Department of Health (DoH) (Department of Health, 2013), should be approached with caution. The focus should not solely be in eliminating a hybrid environment for the sake of utilising and benefiting the computerised capabilities, although studies have demonstrated the benefits of technological systems such as computerised whiteboard system and electronic documentation system. A computerised whiteboard system, for instance, allows rapid accessibility and real-time display of patient information (Aronsky, Jones, Lanaghan, et al., 2008; Vezyridis et al., 2011). However, a computerised whiteboard system can also decrease doctor-patient interaction and increase cognitive load (Hertzum & Simonsen, 2013). Similarly, an implementation of a computerised

documentation system is also associated with mixed reviews. While others have suggested that such system can provide easy access to accurate patient records (Wilcox, Lu, Lai, Feiner, & Jordan, 2010) and standardising practice (Menke, Broner, Campbell, McKissick, & Edwards-Beckett, 2001), some have associated its implementation as incompatible with a clinical workflow (Embi et al., 2013; Park et al., 2012).

As this study has shown, the subtle characteristics of the non-computerised systems have, to a large extent, supported collaborative practices that emergency care work entails. These findings are also in line with other studies which demonstrated that non-computerised artefacts can serve collaborative work better than their electronic counterparts (Feufel et al., 2011) and that interaction with non-computerised information artefacts is direct and flexible in achieving work coordination of collaborative practices (Bjørn & Hertzum, 2011; Xiao et al., 2007). Therefore, if moving towards a paperless system is considered as a way forward, the characteristics of the non-computerised component of the existing hybrid implementation should not be ignored. These characteristics need to be explicitly integrated when designing and implementing its computerised counterpart. Section 7.4 proposed some socio-technical suggestions that can be incorporated in achieving collaboration. Overall, computerised system must be adaptive to the collaborative practices of an emergency care workflow while, at the same time, providing all the technical requirements for emergency care delivery.

#### **7.4. Some socio-technical recommendations**

Having identified the characteristics of the workflow and the extent of usage of the hybrid EDIS implementation in supporting the workflow, this study proposes three design guidelines for a computerised socio-technical system that can support an ED model of care. These are discussed below.

##### **7.4.1. Designing for integrated implementation**

The existing hybrid information architecture consists of a myriad of computerised information systems for processes such as patient registration, patient tracking and clinical tests ordering. However, these computerised artefacts are not integrated which have contributed to a number of unintended consequences. For example, the execution of the patient registration process at the adult ED requires separate accessibility (i.e. separate logins) to two non-integrated computerised information systems and an external database (as illustrated in Figure 5.8). The clinical tests ordering process at both EDs requires accessibility to

different information systems for different types of investigation tests (Figure 5.7 and Figure 6.7). Moreover, the computerised information systems can be categorised as two types: clinical systems to support clinical processes such as investigation tests ordering, and non-clinical systems to support non-clinical work processes such as registration and coding. This topology has resulted in no continuity in the execution of the interconnected processes. As a result, direct communication and/or non-computerised information artefacts are needed to fill the gaps between the processes.

Therefore, this study proposes an integrated implementation incorporating the technical functionalities to support the ED work processes. An integrated system which allows accessibility to all related data fragments including patient records, triage information and investigation results could streamline both clinical and non-clinical work processes. A clinical test ordering process, for instance, can be supported by a single computerised information system regardless of type of test. An integrated implementation supports a more efficient and coordinated care processes (Callen et al., 2014) and allows for distributed accessibility (Faggioni et al., 2011). Having to obtain information from multiple systems can cause clinicians to resort to direct communication which in turn causes interruption (Kuziemyk & Varpio, 2011).

#### 7.4.2. Designing for multiple roles

In the current EDIS implementation, the separation between clinical and non-clinical roles was implicitly enforced by the non-integrated implementation. There are separate systems for clinical work processes and non-clinical processes. In the adult ED, for example, the ICE and PACS are Computer Provider Order Entry (CPOE) and Radiology Information System (RIS), respectively, for clinical tests ordering. These computerised information systems are only accessible by clinical staff members. The same exact CPOE and RIS systems are also used in the paediatric ED, and accessible only by clinical staff members. In the adult ED, the registration system was only accessible by reception staff. As a result, there was no continuity of the interrelated care processes. In addition, non-permanent clinical staff members have very limited accessibility to the computerised information systems. This could be due to the amount of time required for user training and the creation of accounts. As stated by a member of the auxiliary nursing staff in the adult ED, the only time she was allowed to access the ICE system was when she was given access by other nursing staff. Similarly, a medical student also expressed a similar concern. Although she was instructed to perform blood test on patients,

she could not complete the whole work process, i.e., submitting test orders online, without requesting help from other staff. This practice requires added collaborative effort among team members and led to interruptions. Interruptions can result in reducing the time clinicians spend on clinical tasks, and a failure or delay to return to the interrupted tasks (Westbrook et al., 2010). In addition, as discussed in Section 7.3.1, the clinical work and non-clinical work of the ED workflow are interrelated, where some clinical staff members can perform dual roles (coordinating roles and clinical roles), while others are only responsible for a single role. However, in the current implementation, regardless of whether clinical staff members are carrying dual roles or not, they have accessibility to both clinical and non-clinical computerised systems. Unlimited accessibility can potentially contribute to privacy issues on patient data (H Ayatollahi, Bath, & Goodacre, 2009).

The efficient use of an EDIS therefore needs to be explicitly linked to the roles for which staff members are responsible. To address the limitation of the current implementation, this study (in addition to having an integrated implementation as discussed in Section 7.4.1) suggests a role-based design methodology. Adopting this methodology reduces the visibility of the data or tasks to only authorised or competent group members. Regardless of an ED staff-mix, roles can be explicitly created and given only the required accessibility. For example, a consultant doctor who is responsible as a clinical member and as a CiC should have accessibility to tasks and information relevant to both roles, as opposed to a doctor with only a single role. An ambulance triage role can also be interchangeably assigned to either consultant doctors or nurses as required. This is particularly useful in the adult ED as triage is executed by different clinical members depending on the time of the day (i.e., the consultant only performed ambulance triage at specific time frames as opposed to nursing triage which is on a 24-hour basis). Roles can also be useful to restrict specific sets of tasks that specific group members can perform. For example, non-permanent staff such as medical students, can only be assigned a task to submit clinical orders. Instead of having accessibility to the overall process of ordering, submitting and viewing results of the investigation tests work process, they can only submit an order request.

#### 7.4.3. Designing for awareness

Awareness is “the understanding of the activities of others which provides a context for your own activity” (Dourish & Bellotti, 1992, p. 107). To achieve collaboration, awareness needs to be deliberately supported by HIT (Cabitza et al., 2009; Kuziemsky & Varpio, 2011).

This study proposes seven types of awareness that should be incorporated into system design for emergency care:

i. Team structural awareness

As illustrated in Figure 5.2 and Figure 6.2, the ED team members consist of clinical and non-clinical members. Some clinical members also carry non-clinical roles in addition to their clinical roles. For example, a senior staff member such as a consultant can carry a clinical role, a CiC role as well as an advisory role. There is also a specific role in managing patient flow, carried out by clinical members. Knowing the structural aspect of team organisation enables team members to go to the right person to establish collaboration.

ii. Team member awareness

An ED team consists of members from various disciplines and areas of expertise. Because of team heterogeneity, team members involved in taking care of individual patients can vary greatly. For example, some care support workers are qualified to withdraw blood from patients while others are not (Section 7.3.2). Therefore, some patients can have their blood drawn by care support workers while others have their blood taken by clinical technicians. Some patients can have their history taken by medical students while others can be seen by a doctor straightaway. It is therefore important that team members be aware of which team members are present and the scope of their responsibilities as professions involved in the care processes for individual patients at any given time can vary greatly.

Team member awareness also includes knowing other members' current and future tasks. For example, knowledge on whether nursing assessment has been performed or not allows doctors to perform their assessment based on the completion of the nursing assessment, hence coordination of work between doctors and nurses in performing patient assessments can be done inter-dependently without having to resort to direct communication. Explicitly including this level of awareness enables division of labour based on the unique skill sets of individual team members (Kuziemy & Varpio, 2011).

### iii. Resource awareness

In an ED setting, where resources such as staff and beds are scarce, and the arrival of patients is unpredictable, it is crucial that the resources are allocated efficiently to ensure safe and efficient care delivery. Resource awareness refers to information such as who is currently doing what or which clinical units have reached full capacity or availability of beds or staff. In the current hybrid implementation, resource awareness is implicitly conveyed by non-computerised artefacts. For example, ED cards that are placed in pigeon holes and patient detail written on the clinical whiteboards indicate that beds within the clinical units are being occupied. Similarly, an overflow tray allocated for ED cards indicates that the ED is filled with patients who have not been attended to by doctors. In addition, these artefacts were used as resource assignment tool, for example, assigning a bed to a patient or assigning nursing staff to a task. Resource awareness enables workflow planning and the division of labour, as well as specific measures to be taken to overcome the unavailability of resources. Lack of information on resource availability can affect care coordination (Reddy et al., 2009). This is further supported by Neale et al. (2004): in order for work to be coordinated, there should be a means for the allocation and monitoring of tasks, as well as the planning and scheduling of resources.

### iv. Patient awareness

ED patients can largely be categorised in terms of their condition. While some patients only need straight forward minor treatment (e.g. for cuts or minor illnesses), others might need more elaborate clinical investigations which consequently require a period of observation. Patient conditions can also deteriorate while receiving treatment. It is crucial for patient safety that members of staff have awareness of patient condition throughout their care trajectory so that appropriate steps can be taken when faced with unexpected situations. Patient awareness also corresponds to where patients are physically located during the emergency care trajectory as patients can be located across extensive physical space while waiting to receive treatment or while treatments are being delivered.

v. Workspace awareness

As patients are located across the physical space, so are the staff members. Within the physical space, staff members can be at the clinical units doing clinical activities, such as administering treatment, or at their work stations completing clinical documentation. Awareness of who is at specific locations, or the common areas where staff members usually are, enables members of the team to easily be reached. Therefore, determining where individual professions are located enables establishment of *ad hoc* collaboration. Achieving workspace awareness enables the assignment and coordination of collaborative activities dynamically (Hajizadeh, Tory, & Leung, 2013), as emergency care is spatially delivered across a large physical area.

vi. Temporality awareness

The delivery of emergency care is not only governed by the four-hour rule but also by other specific time related activities such as the 15-minute triage and 12-hour bed wait. Although these are not UK-wide clinical governance imposed by the DoH, they are implemented as part of an initiative to achieve smooth patient flow. This, in turn, helps in adhering to the four-hour rule. Awareness of the temporal aspects of the activities enables patients to receive care within specified timeframes. This is because, staff members awareness on the temporal features of their work enables them to plan, organise and coordinate their activities (Reddy, Dourish, & Pratt, 2006).

vii. Self-awareness

The multiplicity of patient care processes can further complicate the delivery of emergency care. A nurse, for example, can be responsible for providing care to multiple patients at the same time. Similarly, a clinical technician needs to draw blood from multiple patients, one after another. This multiplicity can contribute to errors or some patients being forgotten if self-awareness cannot be maintained. Self-awareness acts as a reminder for activities such as “what has been done” or “what do I do next”. In the current implementation, the flexibility afforded by non-computerised clinical whiteboards allowed self-reminder notes to be written without adhering to any particular format or convention.



Various mechanisms can be used to support the awareness information listed (i.e. i to vii). For example, in the current implementation, temporality and patient awareness is supported by the use of colours for the PTS at the adult ED and the Medway system in the paediatric ED. However, the PTS is still lacking in supporting other time-related activities such as the 12-hour bed wait. Similarly, the CPOE and RIS systems for blood and radiology test ordering lack the capacity for notifying the availability of test results. As a result, nursing staff members need to keep checking the systems in order to notify doctors when test results are available. This is an added collaboration effort which could be supported by having a notification system (Gjære & Lillebo, 2014) incorporated in the clinical ordering systems (i.e. the CPOE and RIS systems).

Team structural awareness and resource awareness, on the other hand, can be better suited by having a central visual display such as an electronic whiteboard which allows for visual accessibility. Although in the current implementation such awareness is supported by non-dry erase whiteboards (i.e. clinical and staff whiteboards), they were only located at certain locations. Thus, in order to obtain the information, staff members needed to walk to where the whiteboards are located. Electronic whiteboards can offer both centralised data access as well as distributed accessibility (Lopes, Balancieri, Teixeira, & Dias, 2014). In addition to centralised data access, the distributed accessibility of an electronic whiteboard by allocating sufficient computer terminals across the physical area can in turn support the provision of other forms of awareness such as team awareness, patient awareness and workspace awareness. Workspace awareness can also be supported with features such as a notification system (Heer & Agrawala, 2007) and a chat facility (Heer, Viégas, & Wattenberg, 2009). Self-awareness, on the other hand, can be better supported by means of electronic annotation (Bringay et al., 2006).

Awareness is a crucial aspect in achieving collaboration and should be incorporated deliberately in socio-technical systems for collaborative work (Cabitza et al., 2009). Lack of this can cause deterioration in the quality of patient care (Reddy, Shabot, & Bradner, 2008). Table 7.1 summarises the socio-technical requirements of the ED workflow and its corresponding proposed solutions.

Table 7.1: Workflow requirements and proposed solutions

Proposed solution	Integrated implementation	Role-based design	Awareness type
<b>Requirements</b>			
Time-related care processes	✓		Resource, self-awareness, temporality
Interrelated collaborative care processes	✓		Workspace, self-awareness, team structural and team member
Staff mix		✓	Team member, team structural
Multiple roles of senior staff members		✓	Team structural
Variation of clinical work		✓	Team structural, team member
Handling exceptions		✓	Patient
Roles of non-permanent staff members		✓	Team member
<i>Ad hoc</i> involvement of other staff members		✓	Team member, resource, workspace
Resource management	✓		Team member, resource, patient

## 7.5. ED workflow and the National Programme for IT

As discussed in Section 6.4, there are a number of differences when comparing the workflow of the adult ED and paediatric ED. The differences can be seen in terms of the overall organisation of the work processes, the staff mix, organisational practices as well as the information artefacts used. A possible explanation for this is that the EDs are managed by different hospital Trusts. Hospital Trusts are independent legal entities with their own governance arrangements (GOV.UK, n.d.). As a result, Trusts are able to implement their own measures and practices to deliver efficient and safe healthcare which includes emergency care. This has translated into the different approaches taken in adhering to the four-hour rule and achieving the government's target, as well as in ensuring the overall improvement of patient flow to avoid ED overcrowding. In the adult ED, for example, patients are segregated to minor or major units depending on the severity of their illnesses. Thus, two separate groups of clinical teams are allocated, one for each unit, allowing for simultaneous minor

and major treatments be delivered. There is also an observation unit, i.e., the CDU, and minor injuries patient stream. An ED observation unit can potentially contribute to the efficient utilisation of resources (Institute of Medicine, 2006) while the streaming of minor injuries patients was found to reduce the number of patient waiting time by more than one hour by 30% (Department of Health, 2001). The separate triage for walk-in patients and ambulance patients is also a local approach, possibly to improve patient flow. In the paediatric ED, there is the 15-minute triage and a similar observation unit, i.e., the AAU, despite the AAU being a separate entity from the ED. All of these characterised the workflow in each setting. Another contributing factor that could result in the variation in working practices and overall organisation of work is that each ED provides emergency care to different categories of patients: adult and children. Therefore, emergency care can include specialised treatments delivered to specific groups of patients. For example, the adult ED has services for Chest Pain Observation Unit and Deep Venous Thrombosis (DVT). Chest pain and DVT are conditions more prevalent in adults than children (NHS Choices, 2016).

Therefore, the diversity of Trusts and specialism (e.g. ED, ICU, wards) which can contribute to an individualised workflows and local practices meant that implementing a standardised solution of the UK National Programme for IT, a one-size-fits-all design, can result in a mismatch of the technical system and its workflow. Implementation could possibly contribute to unintended consequences or, in a worst-case scenario, affect patient safety. A technical system that serves a particular workflow well can be inappropriate in another (Robertson et al., 2010; Sheikh et al., 2011). Therefore, in order to achieve a seamless integration of a standardised solution with the workflow that it is meant to support, it is essential that local customisation is possible to be achieved. Although some parts of the national programme, such as PACS, has been considered a success (Sutton, 2011), the major application, the full electronic care record systems, faced severe difficulties (Eason, 2009). One possible reason for the success of PACS is that users can see direct benefits arising from its usage. PACS provides good quality images that can facilitate accurate diagnosis (Hurlen, Borthne, Dahl, Ostbye, & Gulbrandsen, 2012). However, in this study, it was found that the introduction of PACS had added to an already diverse range of technological artefacts for clinical tests ordering (blood test ordering requires a different information system). Moreover, the ordering and viewing of radiology tests had to be done via multiple systems. This is because PACS is a standalone system which can only be used to view image results, whereas the ordering must be done via a separate system. In the adult ED, a paper-based form was used (Figure 5.7) while in the paediatric ED, the computerised Medway system was used (Figure 6.7). In addition, as PACS can only be used to view the image results of the x-rays/scans, the actual report from the radiologists must be obtained from yet another standalone system, i.e., the ICE. The myriad technological artefacts do not only affect the

investigation test work process but also other work processes; a domino effect on the entire workflow. In the adult ED, in particular, completion of a coding process requires the use of multiple artefacts (Figure 5.9). This is because data is located across multiple non-integrated systems and a coding process requires access to all the information related to patient care. Therefore, in order to introduce yet another standardised computerised system, i.e., the full electronic care record system, could make the integration problem much worse. Hence, it is essential that existing IT infrastructure of the individual Trusts be taken into consideration when introducing another system. To introduce another component might not be a better approach, if it cannot be configured to integrate with existing legacy systems and, ultimately, the entire workflow. A standardised solution can give an impression of uniformity of practice (Jirotko et al., 2005), however its implementation needs to be tied up to local practices and existing information infrastructure.

In addition, the implementation of the national programme was known to adopt a 'big bang' rapid rollout approach (Department of Health, 2006). Although many modern technological systems can be configured to meet the need of its workflow, to achieve the correct configuration that can fit into the related workflow, the rapid, 'big bang' approach of the national programme could be seen as unrealistic. This is because introduction of a new technological system is not a simple 'plug and play' process. A rapid roll-out implementation prevents staff from fully understanding what the technological systems have to offer, hence limiting configuration to be done to meet local needs (Eason, 2010). This study has shown that the ED workflow is not just unique to the individual Trusts but also very volatile, exception-filled and variable. These workflow characteristics are faced on a day-to-day basis, hence staff reactions to using the technological tools need to be monitored for a certain period of time. This is so that adjustments or configurations that need to be made for local requirements can be identified and dealt with. Even a fully customised system requires an adaptation process from its users (Park et al., 2015). Failure to do so could result in workarounds which can have a negative implication on patient safety or decrease in adoption. Migrating to unfamiliar computerised systems is not a trivial task, and requires a period of adaptation.

## **7.6. Conclusion**

In this chapter, findings from both emergency settings, the adult ED (Chapter 5) and the paediatric ED (Chapter 6), were discussed from the perspective of socio-technical aspects of collaborative work. This study was conducted in two emergency care settings and employed multiple triangulation techniques allowing for an in-depth understanding of the topic to further suggest

system design for emergency care. This chapter also discussed the impact of the different emergency care workflow between the study settings on the implementation of the national programme.

## CHAPTER 8: CONCLUSIONS

### 8.1 Introduction

The aim of this thesis is to gain an in-depth understanding of an ED workflow which includes the work processes and practices of its clinicians and non-clinicians, and how the workflow is being supported by existing information artefacts. This study is important because an ED is characterised by being unpredictable in terms of patient flow (i.e., patients can come at any time). There is a huge variety in the conditions and severity with which they might arrive, including those that are immediately life-threatening (Reddy & Spence, 2008). Therefore, an effective and safe functioning of an ED is dependent on a HIT that is able to integrate well with the unpredictability of emergency care.

Previous studies conducted in emergency care settings have been carried out in order to gain an in-depth understanding of emergency care work; these include studies focusing on clinical workflow (Bjørn & Hertzum, 2011; Feufel et al., 2011) or specific clinical processes of the workflow (Bjørn & Rødje, 2008; Callen, Georgiou, Prgomet, Paoloni, & Westbrook, 2010), as well as on communication (Kilner & Sheppard, 2010) and interruptions (Westbrook et al., 2010). As most of these studies predominantly deal with the clinical aspects of emergency care delivery (e.g. challenges on a triage process or communication among ED clinicians), this study provides a novel contribution by examining the interrelatedness of work processes and practices (clinical and non-clinical) of an ED workflow, as well as how the workflow is being supported by the Emergency Department Information System (EDIS), and therefore fills the gaps identified in the literature in Chapter 2.

Motivated by these gaps in the literature, the intention of this study was to describe the emergency care workflow as a whole. In other words, the aim was to identify the components that constitute the workflow, as well as to identify the interrelatedness of the components and their characteristics. This includes both clinical and non-clinical processes as well as the resources, including human resources and information artefacts. In order to achieve this, the study undertook qualitative field work study in two emergency care settings located in the UK. From the findings at each setting, a comparison between the workflow of the two settings was also conducted. The results of this study make important contributions to the conceptual understanding of emergency care work. This chapter concludes the dissertation by summarising the main findings in relation to the research questions (Section 8.2), discusses its contribution to new knowledge (Section 8.3) and outlines the implications for practice (Section 8.4) and for further research (Section 8.5).

## 8.2 Research questions

1. What are the clinical and non-clinical processes that form an overall ED workflow and how do these processes connect as a whole? Is the execution of the interconnected processes 'fixed'?

An ED workflow consists of interrelated care processes, clinical and non-clinical processes. These processes are executed semi-autonomously by clinicians and non-clinicians and governed by time-related organisational constraints, two of which is a national requirement. Others include organisation specific constraints aimed to improve patient flow. Therefore, an ED workflow is not entirely contains flow of work of clinicians, but is interconnected with organisationally-related and non-clinical processes. In addition, an ED workflow also involves organisationally-related tasks in order for smooth functioning of the clinical workflow.

An emergency care workflow is also very volatile and not as straightforward. It is characterised with medical exceptions that need to be exercised in light of continually changing patient conditions, and also variable in terms of staff availability and experience. This means that the workflow is not static; processes do not just simply 'branch' to another. A lot can be 'happening' within certain processes that requires re-interpretation by the healthcare professionals involved.

2. Who are the other members that form the ED team, in addition to doctors and nurses? What roles do these members play in the workflow?

An ED workflow is not only comprised of clinicians, such as doctors and nurses responsible for performing clinical duties. Senior clinical members are also responsible for executing non-clinical processes such as resource management, supervision of their junior counterparts as well as monitoring of patient flow. Non-clinicians such as clinical support staff and reception staff are also an important component of the workflow. Their tasks are mainly organisational-related although some level of clinical knowledge is required. This shows that some clinical staff also involves in non-direct or non-clinical patient care processes. Similarly, non-clinical staff although primarily responsible for organisationally-related tasks, they are also required to exercise certain degree of clinical understanding.

3. What are the characteristics of the existing implementation in ensuring/limiting overall functioning of the workflow?

The workflow is supported by a hybrid information architecture. Primarily, the computerised components of the architecture provide support for a number of processes, including patient registration, clinical ordering, patient tracking and coding processes. The non-computerised components are mainly used as documentation system for patient records as well as a resource management tool. In addition to that, the non-computerised components are embedded with non-technical characteristics such as flexibility and ease-of-use that can easily be adapted to support collaborative practices of the workflow. However, the hybrid implementation has resulted in a number of integration issues such as the need to use more than one system for the completion of a single work process and the risk of inaccurate documentation. Therefore, in order to implement a paper-less environment, there is a need to leverage of what has worked in the existing implementation and, at the same time leveraging on the good features of the new technology.

4. What are the differences and similarities in the execution of care processes of different emergency care settings in the UK?

Essentially, the components that make up the workflow are similar. Processes such as registration, treatment, observation and coding are identical across the workflow in the adult ED and paediatric ED. However, the overall organisation of the processes and the practices are not quite the same. This is mainly due to the fact that each ED has a different approach to segregating its patients according to the severity of illnesses and injuries, as well as differences in their staff mix and staff work assignment.

### **8.3 Contribution to new knowledge**

The completion of this research has allowed the researcher to provide a number of new contributions to the current understanding of emergency care work in order to inform system design for computerised information systems in EDs. These are summarised according to their contribution to emergency care workflow (Section 8.3.1), EDs in the UK (Section 8.3.2) and methodological issues (Section 8.3.3).



### 8.3.1. Emergency care workflow

Previous studies conducted in EDs have contributed to an understanding of the clinical work of mainly doctors and nurses. Although the relevance of these studies (discussed in Section 2.5) in enhancing our understanding of emergency care work is clear, the majority of these studies focused primarily on the clinical work of clinical staff members such as doctors and nurses. This led others (e.g. Bossen, Jensen, & Udsen, 2014; Bossen, Jensen, & Witt, 2012; Spence & Reddy, 2007) to suggest that more research should be conducted to include non-clinical staff members.

In light of this suggestion, this study included non-clinical staff in order to gain an in-depth understanding of emergency care work. One of the novel findings related to the contribution of non-clinical staff in handling medical exceptions and their ability to read and understand clinical documentation. Medical exceptions have frequently been mentioned as characteristics of healthcare work mainly dealt with by clinical staff (Feufel et al., 2011; Xiao et al., 2007). However, in this study, medical exceptions were not only handled by clinical staff members but also non-clinical staff members. In regards to clinical documentation, other studies have shown the importance of such documentation in the clinical work of clinical staff (Feufel et al., 2011; Park et al., 2012). However, this study identifies that reception staff may also be required at certain times to be able to decipher clinical documentation, for example during the coding process.

In another aspect, senior clinical staff members, to be exact, the senior nursing staff and doctors were responsible for non-clinical duties, in addition to their clinical duties. These clinical duties were mainly to ensure that patients received care within the allocated amount of time imposed by the healthcare systems (i.e. NHS and Trusts). Emergency care delivery has mainly been referred to as the delivery of clinical care in a fast-paced manner in relation to patients' injuries and illnesses (Bjørn & Hertzum, 2011; Reddy & Spence, 2006). Although this characteristic is the main 'driving force' in the delivery of emergency care, it was also found that other time-related rules imposed by the healthcare system also characterised the care process.

With regard to an overall workflow within emergency care, this study specifically focused on the previously understudied sets of issues revolving the interconnectedness of clinical and non-clinical processes. Previous emergency workflow models have demonstrated a rather stable workflow; i.e., that the patient registration process leads to triage, clinical assessments and decisions (Ajmi et al., 2015; Salimifard et al., 2013); however, this study

identified that the flow of the processes is not as straightforward as this. Along the way of this trajectory, variability and exceptions occur. The workflow is embedded within organisational practices, driven by patient's presenting conditions and changes in their condition as well as availability of staff, all of which contribute to the fluidity of the workflow. The characteristics that contribute to the fluidity of the workflow are graphically shown in Figure 6.14. This thesis has therefore provided a novel insight into this previously unreported dynamic workflow.

### 8.3.2. EDs in the UK

A significant amount of the literature on the computerisation of healthcare work in the UK has mainly been on the implementation of different national programmes, the latest one relevant to this study being the National Programme for IT. The literature mainly highlighted the failures of the adoption of the computer systems as a result of a lack of integration of the computerised systems into healthcare work (Robertson et al., 2010; Sheikh et al., 2011). These studies further suggest that work processes and practices of healthcare professionals need to be understood so as to avoid unintended consequences resulting from the use of the computerised information systems, hence increasing their adoption. However, limited research was found with regard to the understanding of emergency care work in UK EDs. Moreover, these studies have mainly focused on clinical work in general, without explicitly pointing out what are the processes and work practices within the clinical work. For example, Allard, Wyatt, Bleakley, and Graham (2012) characterised interruptions faced by a clinical staff member, i.e. a consultant emergency physician. Vezyridis, Timmons, and Wharrad (2011), on the other hand, investigated the impact of a tracking system, which is a part of an EDIS, on nursing workflow. Although these studies have collectively provided an understanding of the clinical work of clinical staff members at UK EDs, they are lacking in terms of the specificity of the processes and practices involved in emergency care delivery.

This study has contributed to a better understanding of emergency care work in terms of both clinical and non-clinical processes that form the overall emergency care workflow. These interconnected processes are depicted in series of workflow diagrams, i.e., patient trajectory (Figure 5.10 to 5.12, Figure 6.9) and staff workflow (e.g. Figure 5.13 to 5.17, 6.10 to 6.13). Within these processes, the work practices and variability of the processes are also highlighted. Therefore, in addition to describing emergency care work as a triage process (Vezyridis et al., 2011) or clinical processes that are prone to interruptions (Allard et al., 2012),

this study makes an important contribution in highlighting what are the processes that make up the overall emergency care, how these processes are executed, who are responsible in executing these processes and possible variations that can exist in the execution of these processes. Moreover, emergency care work should not only be seen as being executed by clinicians, such as doctors and nurses, but also by clinical support staff, as well as non-clinical staff. Such staff contributes collectively in overall emergency care delivery.

Additionally, as a result of conducting the study at two EDs that are under the management of separate Trusts, this study has revealed that, although these EDs are comparable emergency care settings categorised as Type 1 ED, the care practices differ. Despite having essentially similar clinical and non-clinical processes which form the overall emergency care workflow, the flow of the work processes differ in addition to the work practices embedded within these processes (as shown in Figure 5.10 to Figure 5.12 vs Figure 6.9). For example, in the adult ED, the triage process is separated for walk-in patients and ambulance patients, whilst in the paediatric ED, regardless of the patient's mode of arrival, there is no separate triage process for these two groups of patients. Additionally, triage process was also conducted quite differently. Although both EDs used a national triage scale (i.e. Manchester triage), the stages where this national scale is used within the patient trajectory differs (Section 5.1.4.1 and Section 6.1.4.1). Another difference that was observed was the coding process. In the adult ED, coding is primarily performed by reception staff while in the paediatric ED this process is performed by the clinical staff. Section 6.4 discusses in detail the differences in the working practices embedded within these processes, between the two EDs.

With regard to the infrastructure of the information systems, both EDs rely on a hybrid implementation. These systems can be characterised as systems for documentation, clinical ordering, patient tracking and registration. However, because the level of integration among these systems differs, the EDs faced varying levels of unintended consequences that affected the processes. For example, the registration process as depicted in Figure 5.8 in the adult ED resulted in the utilisation of multiple information artefacts, a problem not faced in the registration process in the paediatric ED. On the plus side, a hybrid implementation has shown that information artefacts do not only represent clinical tools but also collaborative tools that support the collaborative work that emergency care delivery entails, including teaching and learning. These information artefacts (e.g., pigeon holes and dry-erase whiteboards) are also resource management tools and visual tools. Hence, implementation of the national

programme should not be seen as the implementation of technological solutions to support clinical processes but also as work systems that can ensure the smooth functioning of collaborative work. To impose a one-size-fits-all system with a big-bang approach may result in negative workflow effects and hence there may be resistance from healthcare professionals.

### 8.3.3. Methodological issues

Sociological inquiry techniques have been widely adopted in conducting research using the fieldwork approach where context plays a significant role (e.g. Abraham & Reddy, 2010; Feufel, Robinson, & Shalin, 2011; Park et al., 2012). However, although some of these studies utilise data collection methods such as observations and interviews (semi-structured or opportunistic), in this study, further sources of evidence were used. The availability of organisational documents, particularly the ED handbooks and guidelines, which outline matters related to the delivery of emergency care specific to the organisations (i.e. the Trust) have provided a more comprehensive interpretation of emergency care work that could otherwise be missed during the observations and interviews.

## 8.4 Implications for practice

In addition to making a contribution to new knowledge, as discussed in Section 8.3, the findings from this study provide important new insights for the development of information systems within the ED setting. In order to avoid unfavourable effects on workflow, from the implementation of HIT, there is a need for an in-depth understanding of the workflows of where the information systems are to be implemented. In contrast to more stable work environments such as banking (Reddy, Pratt, Dourish, & Shabot, 2003), emergency care workflow, as shown in this study, is complex, variable and uncertain. In addition, the workflow does not only constitute clinical processes but also non-clinical processes that are highly intertwined with each other. Therefore, system designers must pay attention to these contextual characteristics. This understanding could most probably be achieved if system designers play a more 'active' role 'in the field' by interacting with whole healthcare systems. This includes system designers broadening their focus from technical systems to include the interaction of healthcare work with the technical systems in obtaining requirements for system designs.

With regard to the national programme, the Connecting for Health agency (a central agency that was responsible for the procurement and implementation processes until 31<sup>st</sup> March 2013) and subsequent agency, i.e. NHS Digital, should take a gradual approach when it comes to system implementation. More time and effort should be allocated for the implementation phase. For example, effort should be made to understand the contextual elements of a workflow. As this study has shown, emergency care workflow is fluid and interactive in such a way that it is variable and exception-filled. Processes, for instance, do not simply branch to the next process. In addition, legacy systems are also important components of the workflow. Trusts have their own legacy systems as a result of past procurement processes (Department of Health, 2006). This study has shown that non-technological systems, in particular, play a significant role in supporting the overall functioning of the workflow. Despite this, the current implementation also presents certain integration issues. A better way of achieving seamless integration could be by giving more attention to existing systems by, for example, recognising their strengths and weaknesses, and at the same time exploiting the flexibility or capability of the new systems in order to support local integration.

Once implementation is already started, healthcare staff should be provided with sufficient time and space for learning and adaptation (Park et al., 2015). All these are necessary in order to have a HIT implementation that is configured to support local requirements and customisation, hence minimising/avoiding any workflow effects. This approach could also offer a deeper understanding of the mechanisms underlying healthcare information system acceptance which can then be used to develop more successful implementation strategies such as user training.

## **8.5 Implications for future research**

From this study, a number of additional workflows within the ED have been identified: patient transfer, patient referral and ambulance handover workflows. A transfer workflow involves the transferring of ED patients who are discharged to hospital wards while referral workflow requires obtaining consultation requests with speciality clinics. In both workflows, collaboration between the EDs and hospital wards or referral clinics needs to be established. It would be useful to examine how this collaboration is established among the departments. It has been shown that inter-departmental patient transfer workflow presents itself with challenges associated with both clinical and organisational aspects (Abraham & Reddy, 2010). Delays in obtaining in-patient hospital beds can result in ED patient being held up at EDs which inadvertently cause ED overcrowding (Erenler et al., 2014). A cross-departmental workflow study could include the identification of relevant tasks, processes or information needs within these workflows, as well as issues related to the

organisational aspects (e.g. bed allocation) of the workflow, the technologies and mechanisms used, the challenges faced (e.g. communication or coordinating challenges) or gaps in the current workflow. Similarly, the workflow of ambulance transfer could also be investigated using a similar approach to develop a better understanding of the intersection between the ED workflow and ambulance transfer workflow.

It is also equally important for the current research to be replicated in different ED categories in the UK in order to understand similarities and differences among different types. EDs in the UK can be categorised as Type 1, Type 2 and Type 3 (Department of Health, 2004b). A review of a government document (Department of Health, 2004a) also indicated that EDs often adopt their own measures or techniques to improve patient flow, hence there can be varying emergency care workflow and practices. As supported by this study, the two EDs investigated exhibit workflows that are not an exact match with each other, although they evidence similar clinical and non-clinical processes and staff mix. This could partly be attributed to measures implemented to improve patient flow. As a result, these workflows are embedded with varying organisational practices. It would be interesting to investigate the workflows of other EDs, particularly EDs in different categories like Type 2 and Type 3, in terms of the processes that form the workflow and their embedded practices, as well as their existing information architecture implementation.

This chapter, therefore, concludes the thesis by summarising the main findings in relation to the research questions, and in doing so also highlights the implications on future practice and research.

## BIBLIOGRAPHY

- Aarts, J., Ash, J., & Berg, M. (2007). Extending the understanding of computerized physician order entry: Implications for professional collaboration, workflow and quality of care. *International Journal of Medical Informatics*, 76 Suppl 1, S4-13. <http://doi.org/10.1016/j.ijmedinf.2006.05.009>
- Aarts, J., & Gorman, P. (2007). IT in health care: Sociotechnical approaches “To err is system”. *International Journal of Medical Informatics*, 76 Suppl 1, S1–S3. [http://doi.org/10.1016/S1386-5056\(07\)00078-0](http://doi.org/10.1016/S1386-5056(07)00078-0)
- Abraham, J., Kannampallil, T. G., & Reddy, M. C. (2009). Peripheral activities during EMR use in emergency care: A case study. In *AMIA Annual Symposium Proceedings* (pp. 1–5). Retrieved from [http://www.pubmedcentral.nih.gov/articlerender.fcgi?artid=2815495&tool=pmcentrez&render\\_type=abstract](http://www.pubmedcentral.nih.gov/articlerender.fcgi?artid=2815495&tool=pmcentrez&render_type=abstract)
- Abraham, J., & Reddy, M. C. (2010). Challenges to inter-departmental coordination of patient transfers: A workflow perspective. *International Journal of Medical Informatics*, 79(2), 112–22. <http://doi.org/10.1016/j.ijmedinf.2009.11.001>
- Ajmi, I., Zgaya, H., Gammoudi, L., Hammadi, S., Martinot, A., Beuscart, R., & Renard, J. M. (2015). Mapping patient path in the Pediatric Emergency Department: A workflow model driven approach. *Journal of Biomedical Informatics*, 54(2015), 315–328. <http://doi.org/10.1016/j.jbi.2014.12.004>
- Allard, J., Wyatt, J., Bleakley, A., & Graham, B. (2012). “Do you really need to ask me that now?": A self-audit of interruptions to the “shop floor” practice of a UK consultant emergency physician. *Emergency Medicine Journal*, 29, 872–876. <http://doi.org/10.1136/emered-2011-200218>
- Ammenwerth, E., Gräber, S., Herrmann, G., Bürkle, T., & König, J. (2003). Evaluation of health information systems—problems and challenges. *International Journal of Medical Informatics*, 71(2–3), 125–135. [http://doi.org/10.1016/S1386-5056\(03\)00131-X](http://doi.org/10.1016/S1386-5056(03)00131-X)
- Ammenwerth, E., Iller, C., & Mahler, C. (2006). IT-adoption and the interaction of task, technology and individuals: A fit framework and a case study. *BMC Medical Informatics and Decision Making*, 6(3). Retrieved from [http://www.pubmedcentral.nih.gov/articlerender.fcgi?artid=1352353&tool=pmcentrez&render\\_type=abstract](http://www.pubmedcentral.nih.gov/articlerender.fcgi?artid=1352353&tool=pmcentrez&render_type=abstract)
- Amouh, T., Gemo, M., Macq, B., Member, S., Vanderdonckt, J., Wahed, A., ... Thys, F. (2005). Versatile clinical information system design for emergency departments. *IEEE Transactions on Information Technology in Biomedicine*, 9(2), 174–183.
- Antonia, M.-C. M., Munaz, A., & Botia, J. (2013). Building and evaluating context-aware collaborative working environments. *Information Sciences*, 235, 224–241. <http://doi.org/10.1016/j.ins.2013.02.009>
- Aronsky, D., Jones, I., Lanaghan, K., & Slovis, C. M. (2008). Supporting patient care in the emergency department with a computerized whiteboard system. *Journal of American Medical Informatics Association*, 15(2), 184–195. <http://doi.org/10.1197/jamia.M2489.Introduction>

- Aronsky, D., Jones, I., Raines, B., Hemphill, R., Mayberry, S. R., Luther, M. a, & Slusser, T. (2008). An integrated computerized triage system in the emergency department. In *AMIA Annual Symposium Proceedings* (Vol. 2008, pp. 16–20). Retrieved from <http://www.pubmedcentral.nih.gov/articlerender.fcgi?artid=2656061&tool=pmcentrez&render type=abstract>
- Ash, J. S., & Bates, D. W. (2005). Factors and forces affecting EHR system adoption: Report of a 2004 ACMI Discussion. *Journal of American Medical Informatics Association, 12*, 8–12. <http://doi.org/10.1197/jamia.M1684.j>
- Ash, J. S., Berg, M., & Coiera, E. (2004). Some unintended consequences of Information Technology in health care: The nature of Patient Care Information System-related rrors. *Journal of American Medical Informatics Association, 11*, 104–112. <http://doi.org/10.1197/jamia.M1471.Medical>
- Ash, J. S., Sittig, D. F., Campbell, E., Guappone, K., & Dykstra, R. H. (2006). An unintended consequence of CPOE implementation: Shifts in power, control, and autonomy. In *AMIA Annual Symposium Proceedings* (pp. 11–15). Retrieved from <http://www.pubmedcentral.nih.gov/articlerender.fcgi?artid=1839304&tool=pmcentrez&render type=abstract>
- Ayatollahi, H., Bath, P. a, & Goodacre, S. (2009). Accessibility versus confidentiality of information in the emergency department. *Emergency Medicine Journal, 26*(12), 857–60. <http://doi.org/10.1136/emj.2008.070557>
- Ayatollahi, H., Bath, P. a, & Goodacre, S. (2009). Paper-based versus computer-based records in the emergency department: Staff preferences, expectations, and concerns. *Health Informatics Journal, 15*(3), 199–211. <http://doi.org/10.1177/1460458209337433>
- Ayatollahi, H., Bath, P. a, & Goodacre, S. (2013). Information needs of clinicians and non-clinicians in the Emergency Department: A qualitative study. *Health Information and Libraries Journal, 30*(3), 191–200. <http://doi.org/10.1111/hir.12019>
- Baig, M. A., Mian, A., Najeeb, F., & Shahzad, H. (2015). Overcrowding in the emergency departments: Challenges and opportunities for improvement. *Journal of Pakistan Medical Association, 65*(12), 1344–1345.
- Bailey, B. P., & Konstan, J. A. (2006). On the need for attention-aware systems: Measuring effects of interruption on task performance, error rate, and affective state. *Computers in Human Behavior, 22*(4), 685–708. <http://doi.org/10.1016/j.chb.2005.12.009>
- Baker, S. E., & Edwards, R. (2012). *How many qualitative interviews is enough? Expert voices and early career reflections on sampling and cases in qualitative research*. ESRC National Centre for Research Methods.
- Balka, E., Bjorn, P., & Wagner, I. (2008). Steps toward a typology for health informatics. In *Proceedings of the ACM 2008 Conference on Computer Supported Cooperative Work* (pp. 515–524). <http://doi.org/10.1145/1460563.1460645>
- Banet, G. a, Jeffe, D. B., Williams, J. a, & Asaro, P. V. (2006). Effects of implementing computerized practitioner order entry and nursing documentation on nursing workflow in an emergency department. *Journal of Healthcare Information Management, 20*(2), 45–54. Retrieved from <http://www.ncbi.nlm.nih.gov/pubmed/16669588>



- Bansler, J. P., Havn, E. C., Schmidt, K., M??nsted, T., Petersen, H. H., & Svendsen, J. H. (2016). Cooperative epistemic work in medical practice: an analysis of physicians' clinical notes. *Internal Journal of Computer Supported Cooperative Work*, 25(6), 503–546. <http://doi.org/10.1007/s10606-016-9261-x>
- Bardram, J. E. (2000). Temporal coordination – On time and coordination of collaborative activities at a surgical department. *Computer Supported Cooperative Work*, 9, 157–187.
- Bardram, J. E., & Bossen, C. (2005a). A web of coordinative artifacts: Collaborative work at a hospital ward. In *Proceedings of the 2005 International ACM SIGGROUP Conference on Supporting Group Work* (pp. 168–176).
- Bardram, J. E., & Bossen, C. (2005b). Mobility work: The spatial dimension of collaboration at a hospital. *Computer Supported Cooperative Work (CSCW)*, 14(2), 131–160. <http://doi.org/10.1007/s10606-005-0989-y>
- Bardram, J. E., Hansen, T. R., & Soegaard, M. (2006). Large interactive displays in hospitals – Motivation, examples, and challenges. In *Proceedings of the CHI 2006*.
- Barthell, E. N., Coonan, K., Finnell, J., Pollock, D., & Cochrane, D. (2004). Disparate systems, disparate data: Integration, interfaces, and standards in emergency medicine information technology. *Academic Emergency Medicine*, 11(11), 1142–8. <http://doi.org/10.1197/j.aem.2004.08.008>
- Bates, D. W., Ebell, M., Gotlieb, E., Zapp, J., & Mullins, H. . (2003). A proposal for electronic medical records in U.S. primary care. *Journal of American Medical Association*, 10(1), 1–10. <http://doi.org/10.1197/jamia.M1097>.
- Batley, N. J., Osman, H. O., Kazzi, A. a, & Musallam, K. M. (2011). Implementation of an emergency department computer system: Design features that users value. *The Journal of Emergency Medicine*, 41(6), 693–700. <http://doi.org/10.1016/j.jemermed.2010.05.014>
- Bauer, M. W., & Gaskell, G. (2000). Video, film and photographs as research documents. In *Qualitative Researching with Text, Image and Sound* (pp. 94–108).
- Baxter, G., & Sommerville, I. (2011). Socio-technical systems: From design methods to systems engineering. *Interacting with Computers*, 23(1), 4–17. <http://doi.org/10.1016/j.intcom.2010.07.003>
- Baxter, P., & Jack, S. (2008). Qualitative case study methodology: Study design and implementation for novice researchers. *The Qualitative Report*, 13(4), 544–559.
- Benger, J. R., & Willett, K. (2013). Improving urgent and emergency care in England. *BMJ (Clinical Research Ed.)*, 347(December), f7495. <http://doi.org/10.1136/bmj.f7495>
- Benham-Hutchins, M. M., & Effken, J. A. (2010). Multi-professional patterns and methods of communication during patient handoffs. *International Journal of Medical Informatics*, 79(4), 252–67. <http://doi.org/10.1016/j.ijmedinf.2009.12.005>
- Berg, M. (2003). The search for synergy: Interrelating medical work and patient care information systems. *Methods of Information in Medicine*, 42(4), 337–344. <http://doi.org/10.1267/METH03040337>
- Berg, M., Aarts, J., & Van der Lei, J. (2003). ICT in Health Care: Sociotechnical approaches. *Methods of Information in Medicine*, 42(4), 297–301. <http://doi.org/10.1267/METH03040297>

- Berg, M., Langenberg, C., Berg, I., & Kwakkernaat, J. (1998). Considerations for sociotechnical design: Experiences with an electronic patient record in a clinical context. *International Journal of Medical Informatics*, 52(1–3), 243–251. [http://doi.org/10.1016/S1386-5056\(98\)00143-9](http://doi.org/10.1016/S1386-5056(98)00143-9)
- Berg, M., & Toussaint, P. (2003). The mantra of modeling and the forgotten powers of paper: A sociotechnical view on the development of process-oriented ICT in health care. *International Journal of Medical Informatics*, 69(2–3), 223–234. Retrieved from <http://www.ncbi.nlm.nih.gov/pubmed/12810126>
- Berlin, A., Sorani, M., & Sim, I. (2006). A taxonomic description of computer-based clinical decision support systems. *Journal of Biomedical Informatics*, 39(6), 656–667. <http://doi.org/10.1016/j.jbi.2005.12.003>
- Berndtsson, J., & Normark, M. (1999). The coordinative functions of flight strips: Air traffic control work revisited. In *Proceedings of the International ACM SIGGROUP conference on Supporting Work Group* (pp. 101–110).
- Bernstein, S. L., Aronsky, D., Duseja, R., Epstein, S., Handel, D., Hwang, U., ... Asplin, B. R. (2009). The effect of emergency department crowding on clinically oriented outcomes. *Academic Emergency Medicine : Official Journal of the Society for Academic Emergency Medicine*, 16(1), 1–10. <http://doi.org/10.1111/j.1553-2712.2008.00295.x>
- Bisantz, A. M., Pennathur, P. R., Guarrera, T. K., Fairbanks, R. J., Perry, S. J., Zwemer, F., & Wears, R. L. (2010). Emergency department status boards: A case study in information systems transition. *Journal of Cognitive Engineering and Decision Making*, 4(1), 39–68. <http://doi.org/10.1518/155534310X495582>
- Bjørn, P., & Hertzum, M. (2011). Artefactual multiplicity: A study of emergency-department whiteboards. *Computer Supported Cooperative Work (CSCW)*, 20, 93–121.
- Bjørn, P., & Rødje, K. (2008). Triage drift: A workplace study in a pediatric emergency department. *Computer Supported Cooperative Work*, 17(4), 395–419. <http://doi.org/10.1007/s10606-008-9079-2>
- Blincoe, K., Valetto, G., & Damian, D. (2015). Facilitating coordination between software developers: A study and techniques for timely and efficient recommendations. *IEEE Transactions on Software Engineering*, 41(10), 969–985. <http://doi.org/10.1109/TSE.2015.2431680>
- Boger, E. (2003). Electronic tracking board reduces ED patient length of stay at Indiana hospital. *Journal of Emergency Nursing*, 29(1), 39–43. <http://doi.org/10.1067/men.2003.13>
- Borycki, E. M., & Lemieux-Charles, L. (2008). Does a hybrid electronic-paper environment impact on health professional information seeking? *Studies in Health Technology and Informatics*, 136, 505–510.
- Borycki, E. M., Mn, R. N., Kushniruk, A. W., Kuwata, S., & Kannry, J. (2006). Use of simulation approaches in the study of clinician workflow. In *AMIA Annual Symposium Proceedings* (pp. 61–65).
- Bossen, C., Jensen, L. G., & Udsen, F. W. (2014). Boundary-object trimming: On the invisibility of medical secretaries' care of records in healthcare infrastructures. *Computer Supported Cooperative Work: CSCW: An International Journal*, 23(1), 75–110. <http://doi.org/10.1007/s10606-013-9195-5>

- Bossen, C., Jensen, L. G., & Witt, F. (2012). Medical secretaries' care of records: The cooperative work of a non-clinical group. In *Proceedings of the ACM Conference on Computer Supported Cooperative Work, CSCW* (pp. 921–930). <http://doi.org/10.1145/2145204.2145341>
- Bowers, J., Button, G., & Sharrock, W. (1994). Workflow from within and without: Technology and cooperative work on the print industry shopfloor. In *Proceedings of the Fourth European on Computer-Supported Cooperative Work* (pp. 51–66).
- Braun, V., & Clarke, V. (2006). Using thematic analysis in psychology. *Qualitative Research in Psychology*, 3(2), 77–101.
- Bright, T., Wong, A., Dhurjati, R., Bristow, E., Bastian, L., Coeytaux, R., ... Lobach, D. (2012). Effect of Clinical Decision-Support Systems. *Annals of Internal Medicine*, 157(1), 29–43. <http://doi.org/10.7326/0003-4819-157-1-201207030-00450>
- Bringay, S., Barry, C., & Charlet, J. (2006). Annotations for the collaboration of the health professionals. In *AMIA Annual Symposium Proceedings* (pp. 91–95). Retrieved from <http://www.pubmedcentral.nih.gov/articlerender.fcgi?artid=1839608&tool=pmcentrez&render type=abstract>
- Bryman, A. (2006). *Mixed Methods*. Sage. London: Sage. Retrieved from <http://www.uk.sagepub.com/refbooks/Book228130>
- Bryman, A. (2012). *Social Research Methods* (4th ed.). New York: Oxford University Press. Retrieved from <http://www.amazon.com/Social-Research-Methods-Alan-Bryman/dp/0199588058>
- Buntin, M. B., Burke, M. F., Hoaglin, M. C., & Blumenthal, D. (2011). The benefits of health information technology: A review of the recent literature shows predominantly positive results. *Health Affairs (Project Hope)*, 30(3), 464–71. <http://doi.org/10.1377/hlthaff.2011.0178>
- Cabitza, F., Simone, C., & Sarini, M. (2009). Leveraging coordinative conventions to promote collaboration awareness: The case of clinical records. *Computer Supported Cooperative Work*, 18(4), 301–330. <http://doi.org/10.1007/s10606-009-9093-z>
- Cai, Z., Kohane, I., Fleisher, G. R., & Greenes, D. S. (2002). Computerized reminders to physicians in the emergency department: A web-based system to report late-arriving abnormal laboratory results. In *AMIA Annual Symposium Proceedings* (pp. 91–5). Retrieved from <http://www.pubmedcentral.nih.gov/articlerender.fcgi?artid=2244345&tool=pmcentrez&render type=abstract>
- Cain, C., & Haque, S. (2008). Organizational workflow and its impact on work quality. In R. G. Hughes (Ed.), *Patient Safety and Quality: An Evidence-Based Handbook for Nurses*. Rockville, MD: AHRQ Publication.
- Caldwell, B. D., Katz, R. D., & Pascarella, E. M. (2011). The use of focused electronic medical record forms to improve health-care outcomes. *Journal of the American Podiatric Medical Association*, 101(4), 331–4. Retrieved from <http://www.ncbi.nlm.nih.gov/pubmed/21817002>
- Callen, J., Georgiou, A., Prgomet, M., Paoloni, R., & Westbrook, J. (2010). A qualitative analysis of Emergency Department physicians' practices and perceptions in relation to test result follow-up. *Studies in Health Technology and Informatics*, 160(PART 1), 1241–1245. <http://doi.org/10.3233/978-1-60750-588-4-1241>

- Callen, J., Li, L., Georgiou, A., Paoloni, R., Gibson, K., Li, J., ... Westbrook, J. I. (2014). Does an integrated emergency department information system change the sequence of clinical work? A mixed-method cross-site study. *International Journal of Medical Informatics*, 83(12), 958–966. <http://doi.org/10.1016/j.ijmedinf.2014.08.010>
- Calvo, R. a, O'Rourke, S. T., Jones, J., Yacef, K., & Reimann, P. (2011). Writing tools on the Cloud. *IEEE Transactions on Learning Technologies*, 4(1), 88–97.
- Campbell, E. M., Li, H., Mori, T., & Osterweil, P. (2008). The impact of Health Information Technology on work process and patient care in labor and delivery. In K. Henriksen, J. B. Battles, M. A. Keyes, & M. L. Grady (Eds.), *Advances in Patient Safety: New Directions and Alternative Approaches* (pp. 1–13). Rockville: Agency for Healthcare Research and Quality.
- Carayon, P., & Wetterneck, T. (2005). Observing nurse interaction with medication administration technologies. In *Advances in Patient Safety: From Research to Implementation* (pp. 349–364). *Advances in Patient Safety: From Research to Implementation*: Agency for Healthcare Research and Quality.
- Carol, K., Bane, A. D., Featherstone, E., Hayes, J., Woolf, S., Hurley, A., ... Poon, E. G. (2008). Quantifying nursing workflow in medication administration. *Journal of Nursing Administration*, 38(1), 19–26.
- Castner, J. (2011). Emergency department triage: What data are nurses collecting? *Journal of Emergency Nursing*, 37(4), 417–22. <http://doi.org/10.1016/j.jen.2011.01.002>
- Chan, J. T. S. (2000). Computerisation of accident and emergency departments in Hong Kong. *Hong Kong Medical Journal*, 6(3), 276–282.
- Chaudhry, B., Wang, J., Wu, S., Maglione, M., Mojica, W., Roth, E., ... Shekelle, P. G. (2006). Systematic review: Impact of health information technology on quality, efficiency, and costs of medical care. *Annals of Internal Medicine*, 144, 742–752.
- Chisholm, C. D., Dornfeld, A. M., Nelson, D. R., & Cordell, W. H. (2001). Work interrupted: A comparison of workplace interruptions in emergency departments and primary care offices. *Annals of Emergency Medicine*, 38(2), 146–51. <http://doi.org/10.1067/mem.2001.115440>
- Clancy, C. M. (2007). Keynote address: Closing the research-to-practice gap in emergency medicine. *Academic Emergency Medicine*, 14(11), 932–5. <http://doi.org/10.1197/j.aem.2007.06.028>
- Clegg, C. (2008). The National Programme for IT (NPfIT) – Lessons from elsewhere.
- Clegg, C., Wyatt, J. C., Elliott, B., & Sinclair, M. (2010). A Manifesto for a socio-technical approach to NHS and social care IT-enabled business change – to deliver effective high quality health and social care for all. University of Leeds.
- Cooke, M. W., Higgins, J., & Kidd, P. (2003). Use of emergency observation and assessment wards: A systematic literature review. *Emergency Medicine Journal*, 20(2), 138–142. <http://doi.org/10.1136/emj.20.2.138>
- Coovert, M. D., & Thompson, L. F. (2001). *Computer Supported Cooperative Work: Issues and Implications for Workers, Organizations, and Human Resource Management*. (J. Barling & K. Kelloway, Eds.). London: Sage Publications.

- Cordero, L., Kuehn, L., Kumar, R. R., & Mekhjian, H. S. (2004). Impact of computerized physician order entry on clinical practice in a newborn intensive care unit. *Journal of Perinatology*, 24(2), 88–93. <http://doi.org/10.1038/sj.jp.7211000>
- Cresswell, K., & Sheikh, A. (2009). The NHS Care Record Service (NHS CRS): Recommendations from the literature on successful implementation and adoption. *Informatics in Primary Care*, 17, 153–160.
- Creswell, J. W. (2009). A framework for design. In *Research Design: Qualitative, quantitative and, mixed Methods approaches* (Second edi, pp. 3–28). London: Thousand Oaks.
- Crowe, S., Cresswell, K., Robertson, A., Huby, G., Avery, A., & Sheikh, A. (2011). The Case Study Approach. *BMC Medical Research Methodology*, 11. <http://doi.org/10.1177/108056999305600409>
- Cruickshank, J. (2010). *Fixing NHS IT. A plan of action for a new government*. 2020health.org. Retrieved from [www.2020health.org/export/sites/2020/pdf/2020itdocA4MASTERlow27-04.pdf](http://www.2020health.org/export/sites/2020/pdf/2020itdocA4MASTERlow27-04.pdf)
- D’Souza, M. E., & Greenstein, J. S. (2003). Listening to users in a manufacturing organization: A context-based approach to the development of a computer-supported collaborative work system. *International Journal of Industrial Ergonomics*, 32(4), 251–264. [http://doi.org/10.1016/S0169-8141\(03\)00066-0](http://doi.org/10.1016/S0169-8141(03)00066-0)
- de Lusignan, S., & Aarts, J. (2008). UK’s National Programme for IT welcomes recommendation for a more sociotechnical approach to evaluation: A commentary on the Greenhalgh evaluation of the summary care record. *Informatics in Primary Care*, 16(2), 75–77. Retrieved from <http://www.ncbi.nlm.nih.gov/pubmed/18713523>
- Denzin, N. . (1970). *The research act: a theoretical introduction to sociological methods*. Chicago: Aldine.
- Department of Health. (2001). *Reforming Emergency Care*. Retrieved from [http://webarchive.nationalarchives.gov.uk/20130107105354/http://www.dh.gov.uk/prod\\_consum\\_dh/groups/dh\\_digitalassets/@dh/@en/documents/digitalasset/dh\\_4058836.pdf](http://webarchive.nationalarchives.gov.uk/20130107105354/http://www.dh.gov.uk/prod_consum_dh/groups/dh_digitalassets/@dh/@en/documents/digitalasset/dh_4058836.pdf)
- Department of Health. (2004a). *Improving emergency care in England*. London. Retrieved from <https://www.nao.org.uk/wp-content/uploads/2004/10/03041075.pdf>
- Department of Health. (2004b). *The NHS Improvement Plan. Putting people at the heart of public services*. London. Retrieved from <http://1nj5ms2lli5hdggbe3mm7ms5.wpengine.netdna-cdn.com/files/2010/03/pnsuk3.pdf>
- Department of Health. (2005). *Research Governance Framework for Health and Social Care*. London. Retrieved from [https://www.gov.uk/government/uploads/system/uploads/attachment\\_data/file/139565/dh\\_4122427.pdf](https://www.gov.uk/government/uploads/system/uploads/attachment_data/file/139565/dh_4122427.pdf)
- Department of Health. (2006). *The National Programme for IT in the NHS*. London. Retrieved from <https://www.nao.org.uk/wp-content/uploads/2006/06/05061173.pdf>
- Department of Health. (2013). *The dismantled National Programme for IT in the NHS*. Lon. Retrieved from <http://www.publications.parliament.uk/pa/cm201314/cmselect/cmpublic/294/294.pdf>
- Department of Health. (2017). NHS Digital. Retrieved July 20, 2001, from <http://www.content.digital.nhs.uk/home>

- Dexheimer, J. W., & Borycki, E. M. (2014). Use of mobile devices in the emergency department: A scoping review. *Health Informatics Journal*, 1–10. <http://doi.org/10.1177/1460458214530137>
- Di Somma, S., Paladino, L., Vaughan, L., Lalle, I., Magrini, L., & Magnanti, M. (2015). Overcrowding in emergency department: An international issue. *Internal and Emergency Medicine*, 10(2), 171–175. <http://doi.org/10.1007/s11739-014-1154-8>
- Doherty, G., McKnight, J., & Luz, S. (2010). Fieldwork for requirements: Frameworks for mobile healthcare applications. *International Journal of Human Computer Studies*, 68(10), 760–776. <http://doi.org/10.1016/j.ijhcs.2010.06.005>
- Dourish, P., & Bellotti, V. (1992). Awareness and coordination in shared workspaces. In *Proceedings of the 1992 ACM Conference on Computer-Supported Cooperative Work* (pp. 107–114).
- Eason, K. (2009). The NHS National Programme for Information Technology: A socio-technical systems perspective. In W. Currie & D. Finnegan (Eds.), *Integrating Healthcare with ICT*. Radcliffe Publishing. Retrieved from [http://books.google.com/books?hl=en&lr=&id=-reBafOxdB4C&oi=fnd&pg=PA183&dq=The+NHS+National+Programme+for+Information+Technology:+a+socio-+technical+systems+perspective&ots=o9XNjDZGNz&sig=mmPmiyK3t7IEwqoBX6Je\\_laclpl](http://books.google.com/books?hl=en&lr=&id=-reBafOxdB4C&oi=fnd&pg=PA183&dq=The+NHS+National+Programme+for+Information+Technology:+a+socio-+technical+systems+perspective&ots=o9XNjDZGNz&sig=mmPmiyK3t7IEwqoBX6Je_laclpl)
- Eason, K. (2010). Information systems in health care – breaking down barriers or creating more? In J. Radcliffe & M. Dent (Eds.), *Dilemmas in Human Services*.
- Effken, J. (2002). Different lenses, improved outcomes: A new approach to the analysis and design of healthcare information systems. *International Journal of Medical Informatics*, 65(1), 59–74. Retrieved from <http://www.ncbi.nlm.nih.gov/pubmed/11904249>
- Ellingsen, G., & Monteiro, E. (2006). Seamless integration: Standardisation across multiple local settings. *Computer Supported Cooperative Work*, 15(5–6), 443–466. <http://doi.org/10.1007/s10606-006-9033-0>
- Elliott, M. S., King, J. L., Hall, W., & Arbor, A. (2005). A Common Information Space in Criminal Courts: Computer-Supported Cooperative Work ( CSCW ) Case Management Systems. In *Proceedings of the 38th Hawaii International Conference on System Sciences* (pp. 1–10). Retrieved from [file:///C:/Users/youyangh/OneDrive/Courtinnovation\\_2015/Paper/legal/HICSS05mecourts.pdf](file:///C:/Users/youyangh/OneDrive/Courtinnovation_2015/Paper/legal/HICSS05mecourts.pdf)
- Embi, P. J., Weir, C., Efthimiadis, E. N., Thielke, S. M., Hedeon, A. N., & Hammond, K. W. (2013). Computerized provider documentation: Findings and implications of a multisite study of clinicians and administrators. *Journal of the American Medical Informatics Association : JAMIA*, 20(4), 718–26. <http://doi.org/10.1136/amiajnl-2012-000946>
- Erenler, A. K., Akbulut, S., Guzel, M., Cetinkaya, H., Karaca, A., Turkoz, B., & Baydin, A. (2014). Reasons for overcrowding in the emergency department: Experiences and suggestions of an education and research hospital. *Turkiye Acil Tip Dergisi*, 14(2), 59–63. <http://doi.org/10.5505/1304.7361.2014.48802>
- Erickson, T., Danis, C. M., Kellogg, W. A., & Helander, M. E. (2008). Assistance: The work practices of human administrative assistants and their implications for IT and organizations. In *Proc. of CSCW'08* (pp. 609–618).
- Faggioni, L., Neri, E., Castellana, C., Caramella, D., & Bartolozzi, C. (2011). The future of PACS in healthcare enterprises. *European Journal of Radiology*, 78(2), 253–258. <http://doi.org/10.1016/j.ejrad.2010.06.043>

- Ferris, T. G., Johnson, S. a, Co, J. P. T., Backus, M., Perrin, J., Bates, D. W., & Poon, E. G. (2009). Electronic results management in pediatric ambulatory care: Qualitative assessment. *Pediatrics, 123 Suppl*, S85-91. <http://doi.org/10.1542/peds.2008-1755G>
- Feufel, M. A., Robinson, F. E., & Shalin, V. L. (2011). The impact of medical record technologies on collaboration in emergency medicine. *International Journal of Medical Informatics, 80*(8), e85-95. <http://doi.org/10.1016/j.ijmedinf.2010.09.008>
- Fitzpatrick, R., & Boulton, M. (1994). Qualitative methods for assessing health care. *Quality in Health Care, 3*(2), 107–113. Retrieved from <http://www.pubmedcentral.nih.gov/articlerender.fcgi?artid=1055206&tool=pmcentrez&render type=abstract>
- Flanagan, M., Arbuckle, N., Saleem, J. J., Militello, L. G., Haggstrom, D. a, & Doebbeling, B. N. (2011). Development of a Workflow Integration Survey (WIS) for implementing computerized clinical decision support. In *AMIA Annual Symposium Proceedings* (Vol. 2011, pp. 427–434). Retrieved from <http://www.pubmedcentral.nih.gov/articlerender.fcgi?artid=3243260&tool=pmcentrez&render type=abstract>
- Flick, U. (2009). *An Introduction to Qualitative Research* (4th ed.). Los Angeles: Sage.
- Fontaine, B., Speedie, S., Abelson, D., & Wold, C. (2000). A work-sampling tool to measure the effect of Electronic Medical Record implementation on health care workers. *Journal of Ambulatory Care Management, 23*(1), 71–85.
- Fontana, A., & Frey, J. . (2011). Interviewing: The Art of Science. In N. K. Denzin & Y. S. Lincoln (Eds.), *Handbook of Qualitative Research* (4th ed.). California: Sage.
- Friedman, C. P., & Wyatt, J. C. (2000). *Evaluation methods in Medical Informatics*. New York: Springer.
- Furniss, D., Randell, R., O’Kane, A. A., Taneva, S., Mentis, H., & Blandford, A. (Eds.). (2015). *Fieldwork for Healthcare: Guidance for Investigating Human Factors in Computing Systems*. Morgan & Claypool.
- Gadd, C. S., & Penrod, L. E. (2001). Assessing physician attitudes regarding use of an outpatient EMR: A longitudinal, multi-practice study. In *Proceedings of AMIA Symposium* (pp. 194–198). Retrieved from <http://www.pubmedcentral.nih.gov/articlerender.fcgi?artid=2243374&tool=pmcentrez&render type=abstract>
- Gagnon, M. P., Shaw, N., Sicotte, C., Mathieu, L., Leduc, Y., Duplantie, J., ... Legare, F. (2009). Users’ perspectives of barriers and facilitators to implementing EHR in Canada: A study protocol. *Implement Sci, 4*(20), 20. <http://doi.org/10.1186/1748-5908-4-20>
- Ganley, L., & Gloster, A. S. (2011). An overview of triage in the emergency department. *Nursing Standard, 26*(12), 49–56.
- Georgiou, A., Prgomet, M., Paoloni, R., Creswick, N., Hordern, A., Walter, S., & Westbrook, J. (2013). The effect of computerized provider order entry systems on clinical care and work processes in emergency departments: A systematic review of the quantitative literature. *Annals of Emergency Medicine, 61*(6), 644–653.e16. <http://doi.org/10.1016/j.annemergmed.2013.01.028>

- Gjære, E. A., & Lillebo, B. (2014). Designing privacy-friendly digital whiteboards for mediation of clinical progress. *BMC Medical Informatics and Decision Making*, *14*, 27. <http://doi.org/10.1186/1472-6947-14-27>
- Goldstein, M. M., & Blumenthal, D. (2008). Building an information technology infrastructure. *The Journal of Law, Medicine & Ethics*, *36*(4), 709–715.
- Goodwin, C., & Goodwin, M. (1996). Seeing as situated activity: Formulating planes. In E. Y. & M. D. (Eds.), *Cognition and Communication at Work* (Vol. pp, pp. 61–95). Cambridge: Cambridge University. Retrieved from [http://www.sscnet.ucla.edu/clic/cgoodwin/96for\\_plane.pdf](http://www.sscnet.ucla.edu/clic/cgoodwin/96for_plane.pdf)
- GOV.UK. (n.d.). NHS choices. Retrieved January 17, 2017, from <https://www.gov.uk/>
- Greenhalgh, T., Hinder, S., Stramer, K., Bratan, T., & Russell, J. (2010). Adoption, non-adoption, and abandonment of a personal electronic health record: Case study of HealthSpace. *BMJ (Clinical Research Ed.)*, *341*, c5814. <http://doi.org/10.1136/bmj.c5814>
- Greenhalgh, T., Stramer, K., Bratan, T., Byrne, E., Mohammad, Y., Wood, G., & Hinder, S. (2008). *Summary Care Record early adopter programme: An independent evaluation*.
- Greenhalgh, T., & Taylor, R. (1997). How to read a paper. Papers that go beyond numbers (qualitative research). *British Medical Journal*, *315*(7110), 740–743.
- Greenhalgh, T., Wood, G. W., Bratan, T., Stramer, K., & Hinder, S. (2008). Patients' attitudes to the summary care record and HealthSpace: Qualitative study. *BMJ (Clinical Research Ed.)*, *336*(7656), 1290–5. <http://doi.org/10.1136/bmj.a114>
- Guite, J., Lang, M., McCartan, P., & Miller, J. (2006). Nursing admissions process redesigned to leverage EHR. *Journal of Healthcare Information Management*, *20*(2), 55–64. Retrieved from <http://www.ncbi.nlm.nih.gov/pubmed/16669589>
- Gurses, A. P., & Carayon, P. (2009). Exploring performance obstacles of intensive care nurses. *Applied Ergonomics*, *40*(3), 509–518. <http://doi.org/10.1016/j.apergo.2008.09.003>
- Hajizadeh, A. H., Tory, M., & Leung, R. (2013). Supporting awareness through collaborative brushing and linking of tabular data. *IEEE Transactions on Visualization and Computer Graphics*, *19*(12), 2189–2197. <http://doi.org/10.1109/TVCG.2013.197>
- Hallock, M. L., Alper, S. J., & Karsh, B. (2008). A macro-ergonomic work system analysis of the diagnostic testing process in an outpatient health care facility for process improvement and patient safety. *Ergonomics*, *49*(5–6), 544–66. <http://doi.org/10.1080/00140130600568832>
- Handel, D. A., Wears, R. L., Nathanson, L. A., & Pines, J. M. (2011). Using information technology to improve the quality and safety of emergency care. *Academic Emergency Medicine*, *18*(6), e45–51. <http://doi.org/10.1111/j.1553-2712.2011.01070.x>
- Harrison, M. I., Koppel, R., & Bar-Lev, S. (2007). Unintended consequences of information technologies in health care — An interactive sociotechnical analysis. *Journal of American Medical Informatics Association*, *14*(5), 542–549. <http://doi.org/10.1197/jamia.M2384.Introduction>
- Haux, R. (2010). Medical informatics: Past, present, future. *International Journal of Medical Informatics*, *79*(9), 599–610. <http://doi.org/10.1016/j.ijmedinf.2010.06.003>



- Hayes, G. R., Lee, C. P., & Dourish, P. (2011). Organizational routines, innovation, and flexibility: The application of narrative networks to dynamic workflow. *International Journal of Medical Informatics*, 80(8), e161-77. <http://doi.org/10.1016/j.ijmedinf.2011.01.005>
- Häyrinen, K., Saranto, K., & Nykänen, P. (2008). Definition, structure, content, use and impacts of electronic health records: A review of the research literature. *International Journal of Medical Informatics*, 77(5), 291–304. <http://doi.org/10.1016/j.ijmedinf.2007.09.001>
- Heath, C., Jirotko, M., Luff, P., & Hindmarsh, J. (1993). Unpacking collaboration: The interactional organisation of trading in a city dealing room. In *Proceedings of the Third European Conference on Computer-Supported Cooperative Work* (pp. 155–170).
- Heath, C., & Luff, P. (1992). Collaboration and control: Crisis management and multimedia technology in London underground line control rooms. *Journal of Computer Supported Cooperative Work*, 1(1), 24–48.
- Heer, J., & Agrawala, M. (2007). Design considerations for collaborative visual analytics. *VAST IEEE Symposium on Visual Analytics Science and Technology 2007, Proceedings*, (February), 171–178. <http://doi.org/10.1109/VAST.2007.4389011>
- Heer, J., Viégas, F. B., & Wattenberg, M. (2009). Voyagers and Voyeurs: Supporting Asynchronous Collaborative Visualization. *Communications of the ACM*, 52(1), 87–97. <http://doi.org/10.1145/1240624.1240781>
- Hertzum, M. (2011). Electronic emergency-department whiteboards: A study of clinicians' expectations and experiences. *International Journal of Medical Informatics*, 80(9), 618–30. <http://doi.org/10.1016/j.ijmedinf.2011.06.004>
- Hertzum, M. (2012). The distributed use of electronic emergency-department whiteboards. *Studies in Health Technology and Informatics*, 180, 683–687. <http://doi.org/10.3233/978-1-61499-101-4-683>
- Hertzum, M., & Simonsen, J. (2013). Work-practice changes associated with an electronic emergency department whiteboard. *Health Informatics Journal*, 19(1), 46–60. <http://doi.org/10.1177/1460458212454024>
- Hertzum, M., & Simonsen, J. (2014). Effects of electronic emergency-department whiteboards on clinicians' time distribution and mental workload. *Health Informatics Journal*, 22(1), 3–20. <http://doi.org/10.1177/1460458214529678>
- Hillestad, R., Bigelow, J., Bower, A., Girosi, F., Meili, R., Scoville, R., & Taylor, R. (2005). Can electronic medical record systems transform health care? Potential health benefits, savings, and costs. *Health Affairs (Project Hope)*, 24(5), 1103–1117. <http://doi.org/10.1377/hlthaff.24.5.1103>
- Hollingsworth, J. C., Chisholm, C. D., Giles, B. K., Cordell, W. H., & Nelson, D. R. (1998). How do physicians and nurses spend their time in the emergency department? *Annals of Emergency Medicine*, 31(1), 87–91. Retrieved from <http://www.ncbi.nlm.nih.gov/pubmed/9437348>
- Holloway, I., & Wheeler, S. (2010). *Qualitative Research in Nursing and Healthcare* (3rd ed.). Willey-Blackwell.
- Hoot, N. R., & Aronsky, D. (2008). Systematic review of emergency department crowding: Causes, effects, and solutions. *Annals of Emergency Medicine*, 52(2), 126–36. <http://doi.org/10.1016/j.annemergmed.2008.03.014>

- Horsky, J., Gutnik, L., & Patel, V. L. (2006). Technology for emergency care: Cognitive and workflow considerations. In *AMIA Annual Symposium Proceedings* (pp. 344–348). Retrieved from <http://www.pubmedcentral.nih.gov/articlerender.fcgi?artid=1839672&tool=pmcentrez&render type=abstract>
- Hripcsak, G., Sengupta, S., & Wilcox, A. (2007). Emergency department access to a longitudinal medical record. *Journal of American Medical Informatics Association*, *14*(2), 235–238. <http://doi.org/10.1197/jamia.M2206>.Introduction
- Hsieh, H.-F., & Shannon, S. E. (2005). Three approaches to qualitative content analysis. *Qualitative Health Research*, *15*(9), 1277–1288. <http://doi.org/10.1177/1049732305276687>
- Hughes, J., O'Brien, J., Randall, D., Rodden, T., Rouncefield, M., & Tolmie, P. (1999). Getting to know the 'customer in the machine'. *Proceedings of the International ACM SIGGROUP Conference on Supporting Group Work*, 30–39.
- Hughes, R. G. (Ed.). (2008). *Patient Safety and Quality : An Evidence-Based Handbook for Nurses*. AHRQ Publication.
- Hurlen, P., Borthne, A., Dahl, F. A., Ostbye, T., & Gulbrandsen, P. (2012). Does PACS improve diagnostic accuracy in chest radiograph interpretations in clinical practice? *European Journal of Radiology*, *81*(1), 173–177. <http://doi.org/10.1016/j.ejrad.2010.08.043>
- Iacobucci, G. (2013a). *Minor units take a growing share of emergency department attendances*. *British Medical Journal* (Vol. 347). Retrieved from <http://dx.doi.org/doi:10.1136/bmj.f7233>
- Iacobucci, G. (2013b). *Nearly 40 % of hospitals missed emergency department waiting time target in last quarter, show figures*. *British Medical Journal* (Vol. 346).
- Institute of Medicine. (2006). *Future of emergency care: Hospital-based emergency care at the breaking point*. Washington D.C: National Academic Press.
- Jamal, A., McKenzie, K., & Clark, M. (2009). The impact of health information technology on the quality of medical and health care: A systematic review. *Health Information Management Journal*, *38*(3), 26–37. Retrieved from <http://www.ncbi.nlm.nih.gov/pubmed/19875852>
- Janssen, M. A., van Achterberg, T., Adriaansen, M. J., Kampshoff, C. S., Schalk, D. M., & Mintjes-de Groot, J. (2011). Factors influencing the implementation of the guideline Triage in Emergency Departments: A qualitative study. *Journal of Clinical Nursing*, *21*(3–4), 437–47. <http://doi.org/10.1111/j.1365-2702.2011.03921.x>
- Jirotko, M., Lee, C. P., & Olson, G. M. (2013). Supporting scientific collaboration: Methods, tools and concepts. *Computer Supported Cooperative Work: CSCW: An International Journal*, *22*(4–6), 667–715. <http://doi.org/10.1007/s10606-012-9184-0>
- Jirotko, M., Procter, R., Hartwood, M., Slack, R., Simpson, A., Coopmans, C., ... Voss, A. (2005). Collaboration and trust in healthcare innovation: The eDiaMoND case study. *Computer Supported Cooperative Work*, *14*(4), 369–398. <http://doi.org/10.1007/s10606-005-9001-0>
- Johnson, K. B., & FitzHenry, F. (2006). Case report: Activity diagrams for integrating electronic prescribing tools into clinical workflow. *Journal of the American Medical Informatics Association*, *13*(4), 391–395. <http://doi.org/10.1197/jamia.M2008>

- Jones, A., Moulin, C., Barthès, J. P., Lenne, D., Kendira, A., & Gidel, T. (2012). Personal assistant agents and multi-agent middleware for CSCW. In *Proceedings of the 2012 IEEE 16th International Conference on Computer Supported Cooperative Work in Design* (pp. 72–79). <http://doi.org/10.1109/CSCWD.2012.6221800>
- Kane, B., & Luz, S. (2015). Medical teamwork, collaboration and patient-centred care. *Behaviour & Information Technology*, 34(6), 543–547. <http://doi.org/10.1080/0144929X.2015.1033181>
- Kaplan, B. (2001). Evaluating informatics application - some alternative approach: Theory, social interactionism and call for methodological pluralism. *International Journal of Medical Informatics*, 64, 39–56.
- Kaplan, B., & Maxwell, J. (2005). Qualitative research methods for evaluating computer information systems. In J. G. Anderson & C. E. Aydin (Eds.), *Impact of Healthcare Information Systems* (Second ed., pp. 30–56). Springer. <http://doi.org/10.1007/0-387-30329-4>
- Kaushal, R., Shojania, K. G., & Bates, D. W. (2003). Effects of computerized physician order entry and clinical decision support systems on medication safety: a systematic review. *Archives of Internal Medicine*, 163(12), 1409–1416. <http://doi.org/10.1001/archinte.163.12.1409>
- Kessler, C., Kutka, B. M., & Badillo, C. (2012). Consultation in the emergency department: A qualitative analysis and review. *Journal of Emergency Medicine*, 42(6), 704–711. <http://doi.org/10.1016/j.jemermed.2011.01.025>
- Kilner, E., & Sheppard, L. A. (2010). The role of teamwork and communication in the emergency department: A systematic review. *International Emergency Nursing*, 18(3), 127–37. <http://doi.org/10.1016/j.ienj.2009.05.006>
- Kim, J., Mohan, K., & Ramesh, B. (2014). Functional and nonfunctional quality in cloud-based collaborative writing: An empirical investigation. *IEEE Transactions on Professional Communication*, 57(3), 182–203. <http://doi.org/10.1109/TPC.2014.2344331>
- Kobayashi, M., Fussell, S. R., Xiao, Y., & Seagull, F. J. (2005). Work coordination, workflow, and workarounds in a medical context. In *Proceedings of CHI 2005* (p. 1561). Portland, Oregon: ACM Press. <http://doi.org/10.1145/1056808.1056966>
- Koppel, R., Wetterneck, T., Telles, J. L., & Karsh, B.-T. (2008). Workarounds to barcode medication administration systems: Their occurrences, causes, and threats to patient safety. *Journal of the American Medical Informatics Association*, 15(4), 408–423. <http://doi.org/10.1197/jamia.M2616.Introduction>
- Kuhn, K. A., & Giuse, D. A. (2001). From hospital information systems to health information systems: Problems, challenges, perspectives. *Methods of Information in Medicine*, 40, 275–287. Retrieved from <http://www.scopus.com/inward/record.url?eid=2-s2.0-0141611075&partnerID=40&md5=c3840f7906fad9925d3855a459889e73>
- Kuziemsky, C. E., & Varpio, L. (2011). A model of awareness to enhance our understanding of interprofessional collaborative care delivery and health information system design to support it. *International Journal of Medical Informatics*, 80(8), e150-60. <http://doi.org/10.1016/j.ijmedinf.2011.01.009>
- Lan, Y.-J., Cheng, C.-C., Lan, J., Sung, Y.-T., & Chang, K.-E. (2015). Computer-Supported Cooperative prewriting for enhancing young EFL learners' writing performance. *Computer-Language Learning & Technology*, 19(192), 134–155. Retrieved from <http://ilt.msu.edu/issues/june2015/lansungchengchang.pdf>

- Lasome, C. E., & Xiao, Y. (2001). Large public display boards: A case study of an OR board and design implications. *Proceedings / AMIA ... Annual Symposium. AMIA Symposium*, 349–53. Retrieved from <http://www.pubmedcentral.nih.gov/articlerender.fcgi?artid=2243359&tool=pmcentrez&render type=abstract>
- Lavou, E., Molinari, G., Prie, Y., & Khezami, S. (2015). Reflection-in-action markers for reflection-on-action in computer-supported collaborative learning settings. *Computers and Education*, 88, 129–142. <http://doi.org/10.1016/j.compedu.2015.05.001>
- Lawler, E. K., Hedge, A., & Pavlovic-Veselinovic, S. (2011). Cognitive ergonomics, socio-technical systems, and the impact of healthcare information technologies. *International Journal of Industrial Ergonomics*, 41(4), 336–344. <http://doi.org/10.1016/j.ergon.2011.02.006>
- Laxmisan, A., Hakimzada, F., Sayan, O. R., Green, R. A., Zhang, J., & Patel, V. L. (2007). The multitasking clinician: Decision-making and cognitive demand during and after team handoffs in emergency care. *International Journal of Medical Informatics*, 76(11–12), 801–811. <http://doi.org/10.1016/j.ijmedinf.2006.09.019>
- LeCompte, M. D., Preissle, J., & Tesch, R. (1997). *Ethnography and Qualitative Design in Educational Research* (Second edi). Chicago, Illinois: Academic Press.
- Lee, J., & Shartzter, A. (2005). Health IT and Workflow in Small Physicians ' Practices. National Institute for Health Care Management Foundation.
- Lee, S., Tang, C., Park, S. Y., & Chen, Y. (2012). Loosely formed patient care teams: Communication challenges and technology design. *Proceedings of the ACM Conference on Computer Supported Cooperative Work, CSCW*, 867–876. <http://doi.org/10.1145/2145204.2145334>
- Leu, M. G., Cheung, M., Webster, T. R., Curry, L., Bradley, E. H., Fifield, J., & Burstin, H. (2007). Centers speak up: The clinical context for health information technology in the ambulatory care setting. *Journal of General Internal Medicine*, 23(4), 372–378. <http://doi.org/10.1007/s11606-007-0488-6>
- Likourezos, A., Chalfin, D. B., Murphy, D. G., Sommer, B., Darcy, K., & Davidson, S. J. (2004). Physician and nurse satisfaction with an Electronic Medical Record system. *Journal of Emergency Medicine*, 27(4), 419–424. <http://doi.org/10.1016/j.jemermed.2004.03.019>
- Lim, M. E., Worster, A., Goeree, R., & Tarride, J.-É. (2013). Simulating an emergency department: the importance of modeling the interactions between physicians and delegates in a discrete event simulation. *BMC Medical Informatics and Decision Making*, 13, 59. <http://doi.org/10.1186/1472-6947-13-59>
- Lin, A., Harris, M., & Zalis, M. (2010). Initial observations of electronic medical record usage during CT and MRI interpretation: Frequency of use and impact on workflow. *American Journal of Roentgenology*, 195(1), 188–193. <http://doi.org/10.2214/AJR.09.2946>
- Lincoln, Y. ., & Guba, E. . (1994). Competing paradigms in qualitative research. In N. . Denzin & Y. . Lincoln (Eds.), *Handbook of Qualitative Research* (pp. 105–117). Sage, Thousand Oaks.
- Lopes, D. T., Balancieri, R., Teixeira, H. M., & Dias, M. M. (2014). Electronic whiteboard in hospitals: A systematic review. *Journal of Health Information*, 6(4), 166–171.

- Luz, S. (2011). The non-verbal structure of patient case discussions in multidisciplinary medical team meetings. *ACM Transaction of Information Systems*, 30(3), 19–40. <http://doi.org/10.1145/0000000.0000000>
- Luz, S., Masoodian, M., & Cesario, M. (2015). Disease surveillance and patient care in remote regions: An exploratory study of collaboration among health-care professionals in Amazonia. *Behaviour & Information Technology*, 34(6), 548–565. <http://doi.org/10.1080/0144929X.2013.853836>
- Mark, G., & Su, N. M. (2010). Making infrastructure visible for nomadic work. *Pervasive and Mobile Computing*, 6(3), 312–323. <http://doi.org/10.1016/j.pmcj.2009.12.004>
- Menke, J. A., Broner, C. W., Campbell, D. Y., McKissick, M. Y., & Edwards-Beckett, J. a. (2001). Computerized clinical documentation system in the pediatric intensive care unit. *BMC Medical Informatics and Decision Making*, 1, 3. <http://doi.org/10.1186/1472-6947-1-3>
- Mettler, T., & Raptis, D. A. (2012). What constitutes the field of health information systems? Fostering a systematic framework and research agenda. *Health Informatics Journal*, 18(2), 147–156. <http://doi.org/10.1177/1460458212452496>
- Mills, K. L. (2003). Computer supported cooperative work. In *Encyclopedia of Library and Information Science* (pp. 666–677). <http://doi.org/10.1081/E-ELIS>
- Modrák, M., & Modrák, V. (2013). The effect of a PACS on patient radiation doses and operating costs in a radiology department: A practical study. *Procedia Technology*, 9, 1282–1287. <http://doi.org/10.1016/j.protcy.2013.12.143>
- Mogalakwe, M. (2006). The Use of Documentary Research Methods. *African Sociological Review*, (1), 221–230. <http://doi.org/10.1353/eas.0.0006>
- Mooney, H. (2011). *Two thirds of trusts in England fail to meet new accident and emergency target*. *British Medical Journal* (Vol. 343). Retrieved from <http://www.bmj.com/cgi/doi/10.1136/bmj.d5554>
- Murphy, A. R., & Reddy, M. C. (2014). Privacy Practices in collaborative environments : A study of emergency department staff. In *Proceedings of the 17th ACM Conference on Computer Supported Cooperative Work and Social Computing (CSCW'14)* (pp. 269–282). <http://doi.org/10.1145/2531602.2531643>
- Myers, M. D. (2007). Qualitative Research in Information Systems. *MISQ Discovery*, 13(June). <http://doi.org/10.3127/ajis.v13i2.37>
- Neale, D. C., Carroll, J. M., & Rosson, M. B. (2004). Evaluating Computer-Supported Cooperative Work: Models and frameworks. In *Proceedings of CSCW* (pp. 112–121). Chicago, Illinois.
- NHS Choices. (2016). Deep vein thrombosis. Retrieved January 17, 2017, from <http://www.nhs.uk/conditions/deep-vein-thrombosis/Pages/Introduction.aspx>
- NHS England. (2016). *A&E attendances and emergency admissions*. Retrieved from <http://www.england.nhs.uk/statistics/statistical-work-areas/ae-waiting-times-and-activity/>
- Niazkhani, Z., Pirnejad, H., Berg, M., & Aarts, J. (2009). The impact of computerized provider order entry systems on inpatient clinical workflow: A literature review. *Journal of the American Medical Informatics Association*, 16(4), 539–549. <http://doi.org/10.1197/jamia.M2419>

- Nykänen, P., Brender, J., Talmon, J., de Keizer, N., Rigby, M., Beuscart-Zephir, M.-C., & Ammenwerth, E. (2011). Guideline for good evaluation practice in health informatics (GEP-HI). *International Journal of Medical Informatics*, *80*, 815–827. <http://doi.org/10.1016/j.ijmedinf.2011.08.004>
- O’Dowd, A. (2014). *New e-records system leads to 20% drop in emergency department performance at Addenbrooke’s*. *British Medical Journal* (Vol. 349). Retrieved from <http://www.bmj.com/cgi/doi/10.1136/bmj.g7537>
- Pallin, D. J., Sullivan, A. F., Auerbach, B. S., & Camargo, C. a. (2010). Adoption of information technology in Massachusetts emergency departments. *The Journal of Emergency Medicine*, *39*(2), 240–244. <http://doi.org/10.1016/j.jemermed.2008.09.030>
- Pallin, D. J., Sullivan, A. F., Kaushal, R., & Camargo, C. a. (2010). Health information technology in US emergency departments. *International Journal of Emergency Medicine*, *3*, 181–185. <http://doi.org/10.1007/s12245-010-0170-3>
- Parente, S. T., & McCullough, J. S. (2009). Health information technology and patient safety: Evidence from panel data. *Health Affairs*, *28*(2), 357–360. <http://doi.org/10.1377/hlthaff.28.2.357>
- Park, S. Y., Chen, Y., & Rudkin, S. (2015). Technological and Organizational Adaptation of EMR Implementation in an Emergency Department. *ACM Transactions on Computer-Human Interaction (TOCHI)*, *22*(1), 1. <http://doi.org/10.1145/2656213>
- Park, S. Y., Lee, S. Y., & Chen, Y. (2012). The effects of EMR deployment on doctors’ work practices: A qualitative study in the emergency department of a teaching hospital. *International Journal of Medical Informatics*, *81*(3), 204–217. <http://doi.org/10.1016/j.ijmedinf.2011.12.001>
- Patterson, E. S., Rogers, M. L., Chapman, R. J., & Render, M. L. (2006). Compliance with intended use of bar code medication administration in acute and long-term care: An observational study. *Human Factors: The Journal of the Human Factors and Ergonomics Society*, *48*(1), 15–22. <http://doi.org/10.1518/001872006776412234>
- Payne, G., & Payne, J. (2004a). Case study. In *Key Concepts in Social Research* (pp. 32–36). London: Sage Publications. <http://doi.org/10.4135/9781849209397>
- Payne, G., & Payne, J. (2004b). Documentary methods. In *Key Concepts in Social Research* (pp. 61–67). London: Sage Publications.
- Payne, G., & Payne, J. (2004c). Grounded theory. In *Key Concepts in Social Research* (pp. 99–103). London: Sage Publications.
- Pettersson, M., Randall, D., & Helgeson, B. (2004). Ambiguities, awareness and economy: A study of emergency service work. In *Proceedings of the 2002 ACM conference on Computer supported cooperative work* (pp. 125–154).
- Pines, J. M., & Hollander, J. E. (2008). Emergency department crowding is associated with poor care for patients with severe pain. *Annals of Emergency Medicine*, *51*(1), 1–5. <http://doi.org/10.1016/j.annemergmed.2007.07.008>
- Pines, J. M., Localio, a. R., Hollander, J. E., Baxt, W. G., Lee, H., Phillips, C., & Metlay, J. P. (2007). The impact of emergency department crowding measures on time to antibiotics for Patients with community-acquired pneumonia. *Annals of Emergency Medicine*, *50*, 510–516. <http://doi.org/10.1016/j.annemergmed.2007.07.021>

- Plasters, C. L., Seagull, F. J., & Xiao, Y. (2003). Coordination challenges in operating-room management: An in-depth field study. In *AMIA 2003 Symposium Proceedings* (pp. 524–528). Retrieved from <http://www.pubmedcentral.nih.gov/articlerender.fcgi?artid=1480348&tool=pmcentrez&render type=abstract>
- Polit, D. F., & Beck, C. T. (2013). *Resource Manual for Nursing Research: Generating and Assessing Evidence for Nursing Practice. Journal of Chemical Information and Modeling* (9th Editio, Vol. 53). Philadelphia: Wolters Kluwer. <http://doi.org/10.1017/CBO9781107415324.004>
- Pope, C., Ziebland, S., & Mays, N. (2000). Qualitative research in health care: Analysing qualitative data. *British Medical Journal*, *320*(1), 114–116. Retrieved from <http://books.google.com/books?hl=en&lr=&id=EfAX3YYkrdcC&oi=fnd&pg=PR5&dq=Analysing+ qualitative+data&ots=NlgX9EhZf5&sig=5Hwrqw4Xkew1qNdkm5-20Bp8VTE>
- Pratt, W., Reddy, M., McDonald, D. W., Tarczy-Hornoch, P., & Gennari, J. H. (2004). Incorporating ideas from computer-supported cooperative work. *Journal of Biomedical Informatics*, *37*(1), 29–53. <http://doi.org/10.1016/j.jbi.2004.04.001>
- Protti, D. (2009). A comparison of how Canada, England and Denmark are managing their electronic health record journeys. In *Health Information Systems: Concepts, Methodologies, Tools, and Applications*. Idea Group Inc. Retrieved from <http://books.google.com/books?hl=en&lr=&id=WnBJSRtfVbYC&oi=fnd&pg=PA402&dq=A+Com parison+of+How+Canada+,+England+,+and+Denmark+are+Managing+their+Electronic+Health+ Record+Journeys&ots=BwrsINoTTg&sig=brAYz9iVsQ5TcQApdxubycLdFBY>
- Punch, K. F. (1998). *Introduction to Social Science Research: Quantitative and Qualitative Approaches*. London: Sage Publications.
- Raviola, E., & Norbäck, M. (2013). Bringing technology and meaning into institutional work: Making news at an Italian business newspaper. *Organization Studies*, *34*(8), 1171–1194. <http://doi.org/10.1177/0170840613492077>
- Ray, P., Parameswaran, N., Chan, V., & Yu, W. (2008). Awareness modelling in collaborative mobile e-health. *Journal of Telemedicine and Telecare*, *14*(7), 381–385. <http://doi.org/10.1258/jtt.2008.007013>
- Reddy, M. C., Dourish, P., & Pratt, W. (2006). Temporality in medical work: Time also matters. *Computer Supported Cooperative Work (CSCW)*, *15*(1), 29–53. <http://doi.org/10.1007/s10606-005-9010-z>
- Reddy, M. C., & Jansen, B. J. (2008). A model for understanding collaborative information behavior in context: A study of two healthcare teams. *Information Processing & Management*, *44*(1), 256–273. <http://doi.org/10.1016/j.ipm.2006.12.010>
- Reddy, M. C., Paul, S. a, Abraham, J., McNeese, M., DeFlicht, C., & Yen, J. (2009). Challenges to effective crisis management: Using information and communication technologies to coordinate emergency medical services and emergency department teams. *International Journal of Medical Informatics*, *78*(4), 259–69. <http://doi.org/10.1016/j.ijmedinf.2008.08.003>
- Reddy, M. C., Shabot, M. M., & Bradner, E. (2008). Evaluating collaborative features of critical care systems: A methodological study of information technology in surgical intensive care units. *Journal of Biomedical Informatics*, *41*(3), 479–87. <http://doi.org/10.1016/j.jbi.2008.01.004>

- Reddy, M. C., & Spence, P. R. (2008). Collaborative information seeking: A field study of a multidisciplinary patient care team. *Information Processing & Management*, 44(1), 242–255. <http://doi.org/10.1016/j.ipm.2006.12.003>
- Reddy, M., Dourish, P., & Pratt, W. (2001). Coordinating heterogenous work: Information and representation in medical care. In *Proceedings of the Seventh European Conference on Computer-Supported Cooperative Work* (pp. 239–258). New York, New York, USA: ACM Press. <http://doi.org/10.1145/143457.143468>
- Reddy, M., Pratt, W., Dourish, P., & Shabot, M. M. (2003). Sociotechnical requirements analysis for clinical systems. *Methods of Information in Medicine*, 42(4), 437–44. <http://doi.org/10.1267/METH03040437>
- Reddy, M., & Spence, P. R. (2006). Finding answers: Information needs of a multidisciplinary patient care team in an emergency department. In *AMIA Annual Symposium Proceedings* (pp. 649–653). Retrieved from <http://www.pubmedcentral.nih.gov/articlerender.fcgi?artid=1839749&tool=pmcentrez&render type=abstract>
- Richardson, D. B. (2006). Increase in patient mortality at 10 days associated with emergency department overcrowding. *Medical Journal of Australia*, 184(5), 213–216.
- Ritchie, J., & Spencer, L. (1994). Qualitative data analysis for applied policy. In A. Bryman & R. G. Burgess (Eds.), *Analyzing Qualitative Data*. London: Routledge.
- Robertson, A., Cresswell, K., Takian, A., Petrakaki, D., Crowe, S., Cornford, T., ... Marsden, K. (2010). Implementation and adoption of nationwide electronic health records in secondary care in England: qualitative evaluation. *British Medical Journal*, 341(4564), 1–12. <http://doi.org/10.1136/bmj.c4564>
- Rogg, J. G., Rubin, J. T., Hansen, P., & Liu, S. W. (2013). The frequency and cost of redundant laboratory testing for transferred ED patients. *American Journal of Emergency Medicine*, 31(7), 1121–1123. <http://doi.org/10.1016/j.ajem.2013.03.037>
- Rothenhaus, T. C., Kamens, D., James, M., & Coonan, K. (2007). *EDIS Functional Profile Working Group* (Vol. 1). Retrieved from <http://iom.edu/~media/Files/Activity Files/Quality/VSRT/HCDeliveryOrganizationSectorformatted.pdf>
- Russ, A. L., Saleem, J. J., Justice, C. F., Woodward-Hagg, H., Woodbridge, P. a, & Doebbeling, B. N. (2010). Electronic health information in use: Characteristics that support employee workflow and patient care. *Health Informatics Journal*, 16(4), 287–305. <http://doi.org/10.1177/1460458210365981>
- Saleem, J. J., Russ, A. L., Justice, C. F., Hagg, H., Ebright, P. R., Woodbridge, P. a, & Doebbeling, B. N. (2009). Exploring the persistence of paper with the electronic health record. *International Journal of Medical Informatics*, 78, 618–28. <http://doi.org/10.1016/j.ijmedinf.2009.04.001>
- Saleem, J. J., Russ, A. L., Neddo, A., Blades, P. T., Doebbeling, B. N., & Foresman, B. H. (2011). Paper persistence, workarounds, and communication breakdowns in computerized consultation management. *International Journal of Medical Informatics*, 80(7), 466–479. <http://doi.org/10.1016/j.ijmedinf.2011.03.016>



- Salimifard, K., Hosseini, S. Y., & Moradi, M. S. (2013). Improving emergency department processes using Coloured Petri nets. *Joint International Workshop on Petri Nets and Software Engineering*, 989, 335–349. Retrieved from <https://www.scopus.com/inward/record.uri?eid=2-s2.0-84924975082&partnerID=40&md5=d40be393040ea5f745028046318b8f87>
- Sandelowski, M. (1995). Focus on qualitative methods. Sample size in qualitative. *Research in Nursing & Health*, 18(2), 179–183.
- Saunders, M., Lewis, P., & Thronhill, A. (2012). *Research Methods for Business Students*. (4th, Ed.). Harlow: Pearson Education Ltd.
- Saunier, J., Balbo, F., & Pinson, S. (2014). A formal model of communication and context awareness in multiagent systems. *Journal of Logic, Language and Information*, 23(2), 219–247. <http://doi.org/10.1007/s10849-014-9198-8>
- Schmidt, K., & Bannon, L. (2013). Constructing CSCW: The first quarter century. *International Journal of Computer Supported Cooperative Work*, 22(4–6), 345–372. <http://doi.org/10.1007/s10606-013-9193-7>
- Schmidt, K., Wagner, I., & Tolar, M. (2007). Permutations of cooperative work practices: A study of two oncology clinics. In *Proceedings of the 2007 International ACM Conference on Supporting Group Work* (pp. 1–10). <http://doi.org/10.1145/1316624.1316626>
- Scupelli, P., Xiao, Y., Fussell, S. R., Kiesler, S., & Gross, M. D. (2010). Supporting coordination in surgical suites: Physical aspects of Common Information Spaces. In *Proc CHI 2010* (pp. 1777–1786). <http://doi.org/10.1145/1753326.1753593>
- Selvaraj, N., & Fields, B. (2010). Developing a framework of common information space (CIS): Grounded theory analysis of airport CIS. In *Proceedings of 16th International Conference, CRIWG 2010* (Vol. 6257, pp. 281–296). Maastricht, The Netherlands. [http://doi.org/10.1007/978-3-642-15714-1\\_21](http://doi.org/10.1007/978-3-642-15714-1_21)
- Children’s NHS Foundation Trust. (2016). Accident and Emergency Department. Retrieved June 20, 2016, from <https://www.childrens.nhs.uk/our-services/emergency-department.htm>
- Teaching Hospitals NHS Foundation Trust. (2016). Accident and Emergency Department. Retrieved October 1, 2016, from <http://www.sth.nhs.uk/services/a-z-of-services?id=3>
- Sheikh, A., Cornford, T., Barber, N., Avery, A., Takian, A., Lichtner, V., ... Cresswell, K. (2011). Implementation and adoption of nationwide electronic health records in secondary care in England: Final qualitative results from prospective national evaluation in “early adopter” hospitals. *BMJ*, 343, d6054. <http://doi.org/10.1136/bmj.d6054>
- Sicotte, C., Paré, G., Moreault, M.-P., Lemay, A., Valiquette, L., & Barkun, J. (2009). Replacing an inpatient electronic medical record. *Methods of Information in Medicine*, 48, 92–100. <http://doi.org/10.3414/ME0557>
- Siika, A. M., Rotich, J. K., Simiyu, C. J., Kigotho, E. M., Smith, F. E., Sidle, J. E., ... Tierney, W. M. (2005). An electronic medical record system for ambulatory care of HIV-infected patients in Kenya. *International Journal of Medical Informatics*, 74(5), 345–355. <http://doi.org/10.1016/j.ijmedinf.2005.03.002>
- Sohlenkamp, M., & Chwelos, G. (1994). Integrating communication, cooperation, and awareness: The DIVA Virtual Office Environment. In *Proceedings of CSCW’94* (Vol. 94, pp. 331–343).

- Sonnenwald, D. H., & Pierce, L. G. (2000). Information behavior in dynamic group work contexts: Interwoven situational awareness, dense social networks and contested collaboration in command and control. *Information Processing and Management*, 36(3), 461–479. [http://doi.org/10.1016/S0306-4573\(99\)00039-4](http://doi.org/10.1016/S0306-4573(99)00039-4)
- Spence, P. R., & Reddy, M. C. (2007). The “active” gatekeeper in collaborative information seeking activities. In *Proceedings of the 2007 International ACM Conference on Conference on Supporting Group Work* (pp. 277–280). <http://doi.org/10.1145/1316624.1316666>
- Sprivilis, P. C., Da Silva, J.-A., Jacobs, I. G., Frazer, A. R., & Jelinek, G. A. (2006). The association between hospital overcrowding and mortality among patients admitted via Western Australia emergency departments. *Medical Journal of Australia*, 184(5), 208–212.
- Srivasta, A. (2009). Framework analysis: A Qualitative Methodology for Applied Policy Research. *JOAAG*, 4(2), 72–79.
- Stair, T. O. (1998). Reduction of redundant laboratory orders by access to computerised patient records. *Journal of Emergency Medicine*, 16(6), 895–897.
- Strauss, A., Fagerhaugh, S., Suczek, B., & Wiener, C. (1985). *Social organization of medical work*. Chicago: University of Chicago Press.
- Subiya, K., & Masoodul, H. (2015). Information technology in medicine. *JK Practitioner*, 20(1–2), 47–48. Retrieved from <http://medind.nic.in/jab/t15/i1/jabt15i1p47.pdf%5Cnhttp://ovidsp.ovid.com/ovidweb.cgi?T=JS&PAGE=reference&D=emed13&NEWS=N&AN=2015093637>
- Sutton, L. N. (2011). PACS and diagnostic imaging service delivery - A UK perspective. *European Journal of Radiology*, 78(2), 243–249. <http://doi.org/10.1016/j.ejrad.2010.05.012>
- Thurmond, V. A. (2001). The point of triangulation. *Journal of Nursing Scholarship*, 33(3), 253–258. Retrieved from <http://www.ncbi.nlm.nih.gov/pubmed/11552552>
- Tucker, A. L. (2009). *Workarounds and resiliency on the front lines of health care*. Agency for Healthcare Research and Quality. Retrieved from <http://www.webmm.ahrq.gov/perspective.aspx?perspectiveID=78>
- UEC Review Team and ECIST. (2013). *Transforming urgent and emergency care services in England*. Retrieved from <https://www.england.nhs.uk/wp-content/uploads/2015/06/trans-uec.pdf>
- Unertl, K. M., Novak, L. L., Johnson, K. B., & Lorenzi, N. M. (2008). Traversing the many paths of workflow research: Developing a conceptual framework of workflow terminology through a systematic literature review. *Journal of the American Medical Informatics Association : JAMIA*, 17(3), 265–73. <http://doi.org/10.1136/jamia.2010.004333>
- Unertl, K. M., Weinger, M. B., Johnson, K. B., & Lorenzi, N. M. (2009). Describing and modeling workflow and information flow in chronic disease care. *Journal of the American Medical Informatics Association*, 16(6), 826–836. <http://doi.org/10.1197/jamia.M3000>
- Vaast, E., & Walsham, G. (2005). Representations and actions: The transformation of work practices with IT use. *Information and Organization*, 15(1), 65–89. <http://doi.org/10.1016/j.infoandorg.2004.10.001>

- Vezyridis, P., Timmons, S., & Wharrad, H. (2011). Going paperless at the emergency department: A socio-technical study of an information system for patient tracking. *International Journal of Medical Informatics*, *80*(7), 455–65. <http://doi.org/10.1016/j.ijmedinf.2011.04.001>
- Vishwanath, A., Singh, S. R., & Winkelstein, P. (2010). The impact of electronic medical record systems on outpatient workflows: A longitudinal evaluation of its workflow effects. *International Journal of Medical Informatics*, *79*, 778–791. <http://doi.org/10.1016/j.ijmedinf.2010.09.006>
- Vogelsmeier, A. A., Halbesleben, J. R. ., & Scott-Cawiezell, J. R. (2008). Technology implementation and workarounds in the nursing home. *Journal of the American Medical Informatics Association*, *15*(1), 114–119. <http://doi.org/10.1197/jamia.M2378.Background>
- Vyas, D., Dix, A., & van der Veer, G. C. (2015). Reflections and encounters: Exploring awareness in an academic environment. *Computer Supported Cooperative Work*, *24*(4), 277–317. <http://doi.org/10.1007/s10606-015-9225-6>
- Vyas, D., van der Veer, G., & Nijholt, A. (2013). Creative practices in the design studio culture: Collaboration and communication. *Cognition, Technology and Work*, *15*(4), 415–443. <http://doi.org/10.1007/s10111-012-0232-9>
- Wallace, S. (2005). Observing method: recognizing the significance and documentation in observational studies. In I. Holloway (Ed.), *Qualitative Research in Health Care* (pp. 71–85). London: Open University Press.
- Weaver, K., & Olson, J. (2006). Understanding paradigms for nursing research. *Journal of Advanced Nursing*, *53*, 459–469.
- Weigl, M., Müller, A., Vincent, C., Angerer, P., & Sevdalis, N. (2012). The association of workflow interruptions and hospital doctors' workload: A prospective observational study. *BMJ Quality & Safety*, *21*(5), 399–407. <http://doi.org/10.1136/bmjqs-2011-000188>
- Weng, S.-J., Gotcher, D., Wu, H.-H., Xu, Y.-Y., Yang, C.-W., & Lai, L.-S. (2016). Cloud image data center for healthcare network in Taiwan. *Journal of Medical Systems*, *40*(4), 89. <http://doi.org/10.1007/s10916-016-0430-8>
- Westbrook, J. I., Coiera, E., Dunsmuir, W. T. M., Brown, B. M., Kelk, N., Paoloni, R., & Tran, C. (2010). The impact of interruptions on clinical task completion. *Quality & Safety in Health Care*, *19*(4), 284–289. <http://doi.org/10.1136/qshc.2009.039255>
- Wilcox, L., Lu, J., Lai, J., Feiner, S., & Jordan, D. (2010). Physician-driven management of patient progress notes in an intensive care unit. *Proceedings of the 28th International Conference on Human Factors in Computing Systems*, (APRIL), 1879–1888. <http://doi.org/10.1145/1753326.1753609>
- Woloshynowych, M., Davis, R., Brown, R., Wears, R., Vincent, C., & Lyons, M. (2006). *Enhancing safety in accident and emergency care*.
- Wong, H. J., Caesar, M., Bandalí, S., Agnew, J., & Abrams, H. (2009). Electronic inpatient whiteboards: Improving multidisciplinary communication and coordination of care. *International Journal of Medical Informatics*, *78*(4), 239–247. <http://doi.org/10.1016/j.ijmedinf.2008.07.012>
- Xiao, Y. (2005). Artifacts and collaborative work in healthcare: Methodological, theoretical, and technological implications of the tangible. *Journal of Biomedical Informatics*, *38*(1), 26–33. <http://doi.org/10.1016/j.jbi.2004.11.004>

- Xiao, Y., Schenkel, S., Faraj, S., Mackenzie, C. F., & Moss, J. (2007). What whiteboards in a trauma center operating suite can teach us about emergency department communication. *Annals of Emergency Medicine*, 50(4), 387–95. <http://doi.org/10.1016/j.annemergmed.2007.03.027>
- Yin, R. K. (1999). Enhancing the quality of case studies in health services research. *Health Services Research*, 34(5), 1209–1224.
- Yin, R. K. (2013). How to start your analysis, your analytic choices, and how they work. In *Case Study Research: Design and Methods* (pp. 127–164).
- Zheng, K., Haftel, H. M., Hirschl, R. B., O'Reilly, M., & Hanauer, D. A. (2010). Quantifying the impact of health IT implementations on clinical workflow: a new methodological perspective. *Journal of the American Medical Informatics Association : JAMIA*, 17(4), 454–61. <http://doi.org/10.1136/jamia.2010.004440>

## **LIST OF APPENDICES**