

Openability of Vacuum Lug Closures

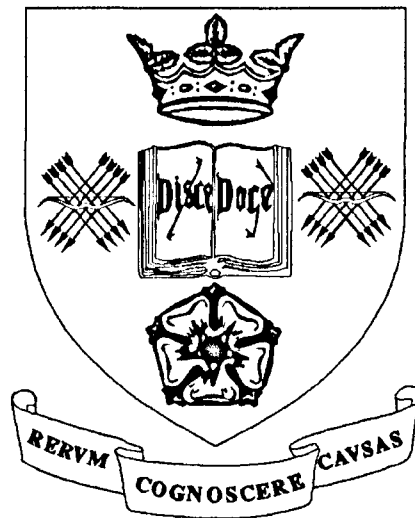

Robert Janson

May 2007

A thesis submitted for the degree of Doctor of Philosophy

Department of Mechanical Engineering

The University of Sheffield

Abstract

The Vacuum Lug Closure system, or VLC, is found on many widely available products such as jam, sauces and pickles. The closure has many useful advantages over other closure systems, and it is popular with both manufacturers and consumers. However, there are large groups of people that have great difficulty opening products packaged in jars with vacuum lug caps.

The goal of this project is to understand both the way in which consumers interact with the closure, and also how the closure system works. The torque that users can apply to a jar lid was measured using a torque sensor embedded in a modified jar. This was then compared to a calculated torque derived from grip measurements. This second type of test can be used to predict openability for any kind of closure by utilising simple and quick tests and mathematically adapting strength test data. By eliminating the need to perform more extensive tests, costs are kept to a minimum whilst ensuring that the results are still relevant to the problem. The results from both tests were compared with the measured forces required to open examples of consumer packaging found on sale.

The results from both tests agree reasonably well, but more data is required regarding the interaction between human skin and packaging materials. However the current required opening torques were found to be far too high for many users. It is suggested that a limit of 1 Nm torque should be used for future packaging designs to allow over 97% of the UK population to open jars. The optimal diameter of jar lid was found to be 73 mm.

Acknowledgments

A big thank you to Al, my supervisor, without your prompting and guidance this would probably never have been finished. Also thanks to Jen, Joe and Joe for the help and friendship you have given me over the years.

Emily – without your support and understanding this whole project would not have been possible. Thank you.

Finally thank you to everybody else who has been involved in any aspect of this work. Although there are too many of you to name, your input has been much appreciated.

Glossary

CAD	-	Computer Aided Design
FEA	-	Finite Element Analysis
Finish	-	Industry term for glass jar or bottle
GUI	-	Graphical User Interface
VLC	-	Vacuum Lug Closure

Nomenclature

Symbol	Description	Units*
T_S	Sticktion torque (from liner) (see Section 2.4.1.1)	Nm
T_F	Friction torque (from liner)	Nm
T_H	Torque applied by the hand	Nm
C	Total force due to liner compression	N
N_H	Pinch grip force applied by user	N
F_H	Friction force between cap & glass due to hand grip (N_H)	N
N_L	Normal contact force between glass lug & cap	N
F_L	Friction force between glass & cap due to contact force	N
P	Internal gauge pressure of the jar	Pa
θ	Thread helix angle	°
φ	Thread shape angle	°
n	number of lugs	-
r_s	Radius of sealing surface	m
r_t	Radius of glass cap contact point	m
r_c	Outer radius of cap	m
d	Outer diameter of cap (= $2 \cdot r_c$)	m
μ_s	Static coefficient of friction	-
	μ_{cg} = coefficient of friction between cap and glass	-
	μ_{lg} = coefficient of friction between liner and glass	-
	μ_{ch} = coefficient of friction between cap and hand	-

* a dash (-) in the units column indicates the value is dimensionless and has no units.

Table of Contents

Abstract	ii
Acknowledgments.....	iii
Glossary.....	iv
Nomenclature	v
Table of Contents	vi
Figures and Tables	ix
1 Introduction and Background.....	12
1.1 Packaging and the Packaging Industry.....	12
1.2 Packaging Functions.....	13
1.3 Closures	13
1.4 Vacuum Lug Closures	15
2 Previous Work.....	21
2.1 Introduction	21
2.2 Human Strength.....	21
2.3 Skin Friction	27
2.4 Packaging Opening Forces	30
2.5 Design Methodologies.....	31
2.6 Conclusions	35
3 Motivation and Research Drivers.....	37
3.1 Introduction	37
3.2 Brand Differentiation	37
3.3 Legislation	39
3.4 The Ageing Population.....	40
3.5 Inclusive Design	40
3.6 Lack of Specific Strength Data	41
3.7 Lack of Specific Opening Forces Data.....	42

3.8 Use of Tools	43
3.9 Conclusions	44
4 Aims and Objectives	45
4.1 Introduction	45
4.2 Aims and Objectives	45
4.3 Methodology	46
5 Analytical Analysis	48
5.1 Introduction	48
5.2 User Applied Force Analysis	48
5.3 Derivation of System Equations.....	51
5.4 Conclusions	55
6 Jar Opening Force Measurement	57
6.1 Introduction	57
6.2 Apparatus.....	58
6.3 Method.....	60
6.4 Results	62
6.5 Discussion and Conclusions.....	64
7 Wrist-Twisting Strength Measurement	66
7.1 Introduction	66
7.2 Aims and Objectives	66
7.3 Experimental Design	67
7.4 Method.....	74
7.5 Results and Discussion	85
7.6 Validation	98
7.7 Evaluation of Closure Performance.....	100
7.8 Conclusions	105
7.9 Further work	106
8 Hand Grip Strength Measurement	107
8.1 Introduction	107
8.2 Theory	108
8.3 Experimental Design	110
8.4 Method.....	119
8.5 Results and Discussion.....	120

8.6 Comparison with Measured Torque Data129

8.7 Conclusions134

8.8 Further Work135

9 Conclusions and Recommendations136

10 Further Research138

 10.1 Wrist-twisting Strength Measurement.....138

 10.2 Grip Strength Measurement139

 10.3 Skin Friction.....140

 10.4 Opening Force Measurement140

11 References142

12 Appendix 1146

 12.1 Torque Results for 30 mm Diameter Lid146

13 Appendix 2.....149

 13.1 Subject Numbers Breakdown.....149

Figures and Tables

Figure 1.1 A variety of closure examples.	15
Figure 1.2 Picture of various sizes of vacuum lug closures.	16
Figure 1.3 Diagram showing caps being placed on the jars on the capping line.	18
Figure 1.4 Diagram showing the closure being tightened onto the jar.	19
Figure 2.1 Graph showing predicted breakdown of UK population by age.	25
Figure 2.2 Friction rig used by Menardi.	28
Figure 2.3 Enlarged view of sample area on friction rig.....	29
Figure 2.4 3 Stranded approach to Inclusive design as developed by Langley.	34
Figure 5.1 Diagram of force system applied to a closure.	49
Figure 5.2 Cap diagrams showing internal forces between the cap and glass jar.....	52
Figure 5.3 Cap diagrams showing the forces applied by the user during opening.	53
Figure 6.1 CAD view of jar clamp during the design process.	59
Figure 6.2 Photograph of the apparatus used to measure required opening torque. ...	60
Figure 6.3 Graph showing sensor output whilst opening 75 mm jar.	62
Figure 6.4 Graph showing the required opening torques for samples of jars of various diameters.	63
Figure 7.1 CAD model of the 75 mm torque device.....	70
Figure 7.2 Photograph of the 75 mm torque device.....	76
Figure 7.3 Photograph of the initial testing equipment.....	77
Figure 7.4 Diagram showing the connections between the tester device components.	77
Figure 7.5 Photograph showing the improved testing equipment.....	78

Figure 7.6. Screenshot of the PicoLog software used for data collection.....79

Figure 7.7 Screenshots from the improved sampling computer GUI.80

Figure 7.8 Photograph of the fixed lid torque measuring device.....81

Figure 7.9. Opening torque measuring device in use.....83

Figure 7.10. Graph of mean applicable torque against age for a 55 mm VLC.....87

Figure 7.11 Graph of mean applicable torque against age for a 75 mm VLC.89

Figure 7.12. Graph of mean applicable torque against age for an 85 mm VLC.....91

Figure 7.13. Graphs of applied torque against lid diameter for each age group.....94

Figure 7.14 Graph showing the comparison between fixed lid and 'jar' measured torque.....96

Figure 7.15 Graph showing comparison between DTI opening torque measurements and the values obtained in this study for male subjects.99

Figure 7.16 2005 UK Population demographics.....101

Figure 7.17 Predicted 2070 UK Population demographics.....102

Figure 8.1 Diagram of force system applied to a closure.108

Figure 8.2 Jamar hand dynamometer110

Figure 8.3. Diagram showing the initial design of the grip measuring equipment...111

Figure 8.4. Finite Element Analysis of grip beams device.113

Figure 8.5. Photograph of the grip device.....115

Figure 8.6. Close up view of strain gauges on grip device.116

Figure 8.7. Grip device in use by an elderly female subject.....117

Figure 8.8. Plots of measured grip data and fitted curves for all age groups.....121

Figure 8.9. Ability surfaces for each age group.123

Figure 8.10 Plots showing the calculated torque limit a male aged 30-60 can apply to various sizes of jar lid compared to the required opening torque for various jars. Dotted lines show mean \pm 1 standard deviation for derived torque and 95% confidence bands for jar opening torque.....125

Figure 8.11. Plots showing the calculated torque limit a female aged 60+ can apply to various sizes of jar lid compared to the required opening torque for various jars. Dotted lines show mean \pm 1 standard deviation for derived torque and 95% confidence bands for jar opening torque.....125

Figure 8.12. Graph showing the torque applicable by a female subject aged 60+ when skin friction is set the lowest value that will just allow a jar of optimal size to be opened.127

Figure 8.13 Comparison between measured and calculated torque against diameter for young males.....129

Figure 8.14 Comparison between measured and calculated torque against diameter for older males.....130

Figure 8.15 Comparison between measured and calculated torque against diameter for young females.....131

Figure 8.16 Comparison between measured and calculated torque against diameter for older females.131

Figure 12.1. Graph of torque against age for a 30 mm ROPP closure.....147

Table 7.1 Table showing mass of test devices compared to original products.75

Table 7.2 Table showing the percentage of males and females currently and predicted to be unable to open various sizes of jar.103

Table 8.1. Table showing optimal size and corresponding required.....127

Table 13.1 Table showing the number of subjects in each age, gender and diameter group for torque-age analysis of the torque measurement investigation.149

Table 13.2 Table showing the number of subjects in each age, gender and diameter group for torque-diameter analysis of the torque measurement investigation.150

Table 13.3 Table showing the number of subjects in each age, gender and diameter group for the grip strength investigation.....151

1 Introduction and Background

The Vacuum Lug Closure (VLC) is commonly used in the food packaging industry. It is used with glass jars to package products such as jams, pickles and sauces. The closure has been used for many years on these types of products, and users often see its use as a mark of quality over similar products packaged in less traditional forms, such as soft pouches or plastic jars¹. It is therefore desirable to retain the appearance of the closure, in order to maintain this quality reputation and hence encourage sales. It does, however, have a reputation for being difficult to open, especially for the elderly or those with physical disabilities.

1.1 Packaging and the Packaging Industry

In 2004, the global packaging industry was worth US\$424 billion, and by 2007 this is predicted to rise to US\$470 billion². Food packaging makes up 38% of this market, with beverage packaging accounting for a further 18%. 10% of the total packaging is glass bottles and jars. In the UK, packaging accounts for 5% of the manufacturing industry.

From these figures it is clear that packaging is a major global industry, and it plays a significant part in the UK economy.

1.2 Packaging Functions

Packaging has several major functions, and a design must address all of these satisfactorily to be successful³. Firstly, packaging must protect the product and the environment. Depending on the product being contained, the packaging must prevent the product from contaminating its environment, and/or prevent the product from being contaminated or damaged itself by the environment. Some forms of packaging are also required to further protect or contain the product after opening, and must therefore be able to reseal or otherwise retain their integrity. The packaging must permit the user to access the product when required. If packaging fails to adequately provide these functions then it is useless – if the product is not protected then the packaging might as well not be there. However if the user cannot access the product then they have wasted their money purchasing it, and is therefore unlikely to purchase the same product again⁴. For consumer packaging, such as that used for food, this is in direct contradiction to packaging's third major function. The packaging used is often key in persuading consumers to buy the product. The openability and general usability of packaging is therefore of critical importance to successful package design.

1.3 Closures

A closure is defined as “a sealing or covering device affixed to or on a container for the purpose of retaining the contents and preventing contamination”⁵. From this definition, it can be seen that a closure has two primary functions – to keep a product inside a container, and prevent anything else from getting into that container. These two functions are best illustrated by looking at closures used in the chemical and food industries. It is often very important that a chemical does not leak from its container into the environment, to protect that environment from the chemical. In the food

industry, it is essential that the environment does not have access to the foodstuff in the container, to ensure the product will remain fit and safe for consumers.

Although it is critically important that a closure perform its sealing duties, the openability of a closure is also fundamental. A well sealing closure that cannot be opened is of no practical use, as a consumer will be unable to access the product that they have just purchased. A closure must therefore be designed to be as easy as possible to open whilst ensuring it provides an adequate seal and hence adequate protection.

1.3.1 Types of Closure

There are many different types of closure in use in many different industries. The choice of closure for a particular application depends mainly on the properties of the product to be contained (e.g. fill temperature, acidity, re-usability). The brand of goods being packaged also influences the choice of closure type, especially if more than one type of closure is suitable, as the type of closure used influences the subsequent style and form of the packaging. Child resistance and other requirements may also influence the closure choice. Some examples of different types of closures are given below in Figure 1.1.



Figure 1.1 A variety of closure examples.

Clockwise from top left: Child resistant push and twist closure, 'flip-up' cap, sports water bottle cap, squeeze and twist child resistant closure, squeeze and twist child resistant closure with internal spout, 28 mm beverage closure.

1.4 Vacuum Lug Closures

Vacuum Lug Closure (VLC) is a term used to describe a closure system comprised of a metal cap held on to a jar by a number of lugs or protrusions and by the action of a vacuum inside the container (see Figure 1.2). The jars are usually made from glass, however plastic jars can also sometimes be found. A soft sealing gasket is fitted into the cap before application to provide a hermetic seal between the metal cap and the

top sealing surface of the jar. Different sealing gasket materials are used depending on the product, and a wide range of sizes (27 – 110 mm) is available.

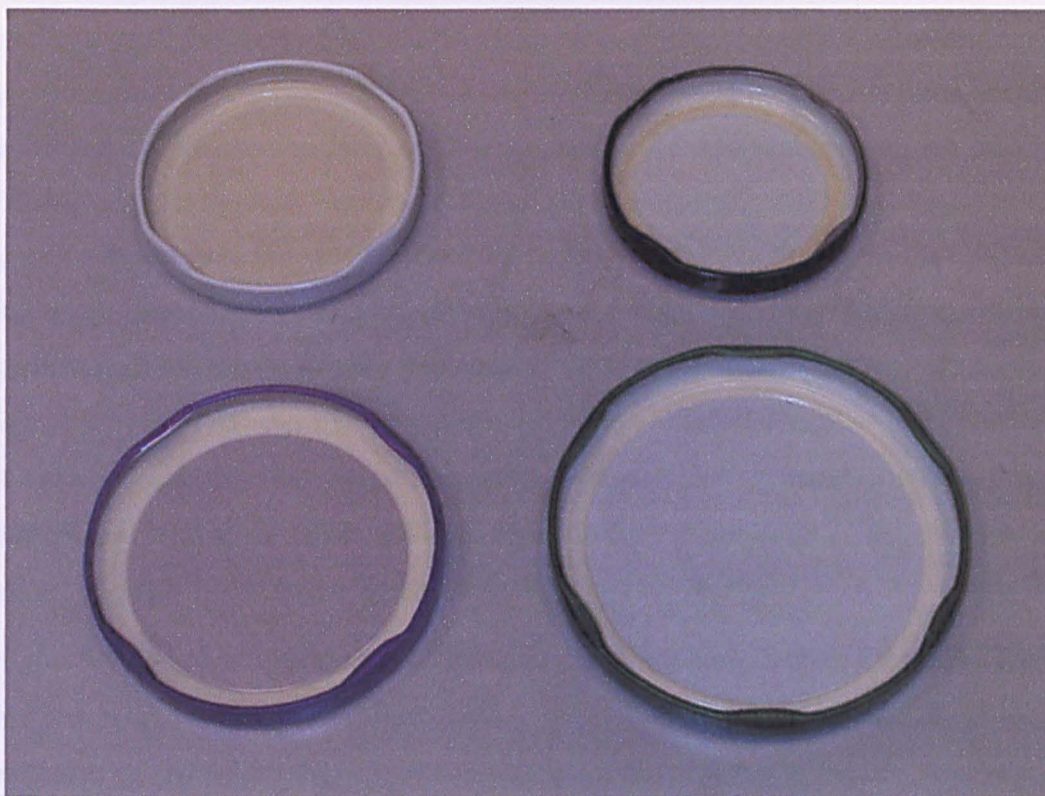

Figure 1.2 Picture of various sizes of vacuum lug closures.
Clockwise from top left 65 mm, 55 mm, 85 mm, 75 mm.

The caps themselves are made from either tinplate or tin-free steel. This is often coated with a lacquer to ensure the cap remains inert. The gauge of the caps is dependent on the configuration of the lugs and the diameter of the closure. Caps typically have four lugs, although this can vary (see Figure 1.2 above - the lower right cap has 6 lugs, the remaining caps have 4). Various types of liner gasket are used, the most common types being PVC and PLASTISOL. The liner material is usually flowed into the cap during manufacture and is non-removable. Additives are used in the liner to reduce costs (using packing materials to bulk out the liner) and improve openability (silicon based lubricants). Many liner materials require heat to soften them before they are applied to a finish to ensure that a good seal is formed.

1.4.1 Advantages and Disadvantages

There are many advantages to the VLC system. The closures are suitable for use with a wide range of products. Closures can be applied when the product is hot or cold, and by suitable selection of cap coating and gasket type both acidic and basic foods can be sealed. Tamper evidence can also be provided in the form of a button which is held down by the applied vacuum. If the seal is broken this button pops up indicating the seal has been compromised. The caps can be resealed many times unlike some other types of packaging (for example drinks cans, food pouches). This means that a consumer can use the jar to keep any contents not used immediately in good condition without having to transfer them to another container. The jar and closure can be re-used many times or recycled to reduce the impact on the environment. The caps can be applied at high speed (800 caps/min) and are cheap to produce⁶. They can also be painted or printed with logos for branding purposes if required.

Despite this long list of advantages, there are problems with the closure type. There are some products for which it is unsuitable as it relies on keeping a vacuum inside the container. Although the closure is suitable for use with many liquids, it cannot be used for carbonated drinks. The closures are also not ideal for dry foods, although they are sometimes used, as steam is often used during the capping process which would result in wetting the product.

The biggest disadvantage with the VLC is, however, not related to the type of product for which it can be used or the quality of the seal obtained. VLCs can be difficult to open, especially for people who are elderly or physically disabled. This puts products packaged with the closures at a disadvantage in the marketplace, as these groups of people often avoid buying such products.

1.4.2 Closure Application

Vacuum lug closures are applied at high speed by specialised machinery. The caps are fed down a chute above the line of jars. The leading edge of the jar then catches a lid (Figure 1.3) and pair of counter-rotating belts is used to tighten the cap (Figure 1.4). The belts run parallel with the line of jars, and give each closure in turn the $\frac{1}{4}$ turn required to fully apply the cap. A head load is applied to the cap as it is turned to ensure the liner is compressed to form a good seal. There is usually little control over the process – the system is adjusted until the caps seem to be applied correctly to the jars. This may result in variations in jar opening torque, both across different production lines and also for jars from a single capping machine.

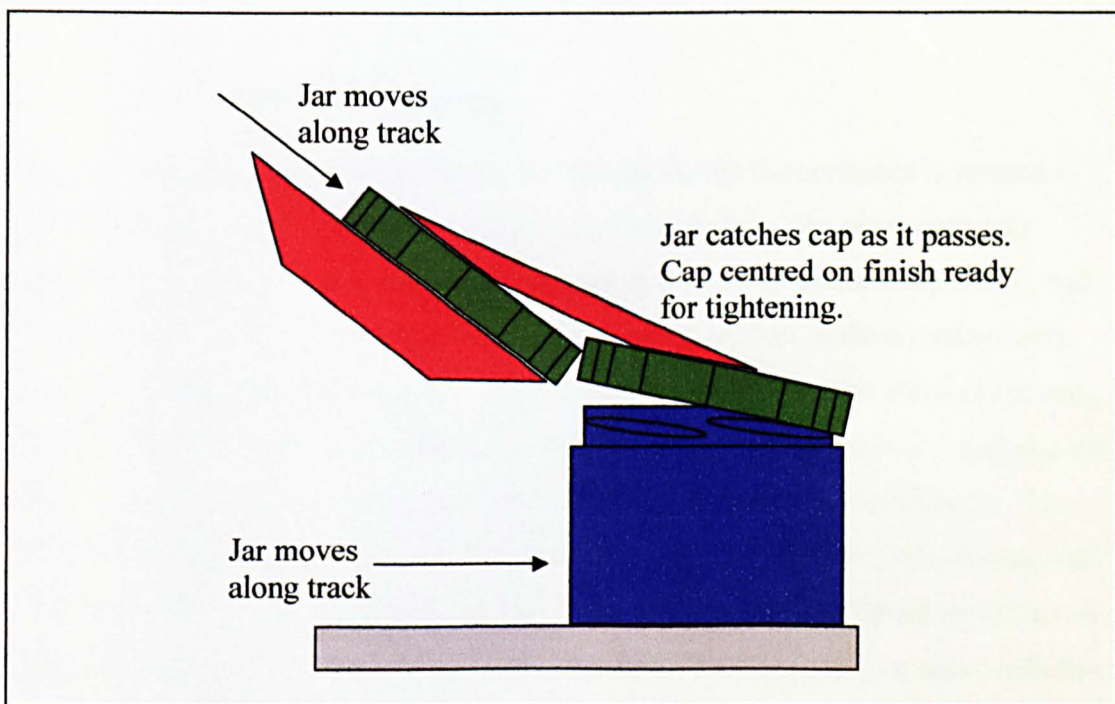

Figure 1.3 Diagram showing caps being placed on the jars on the capping line.

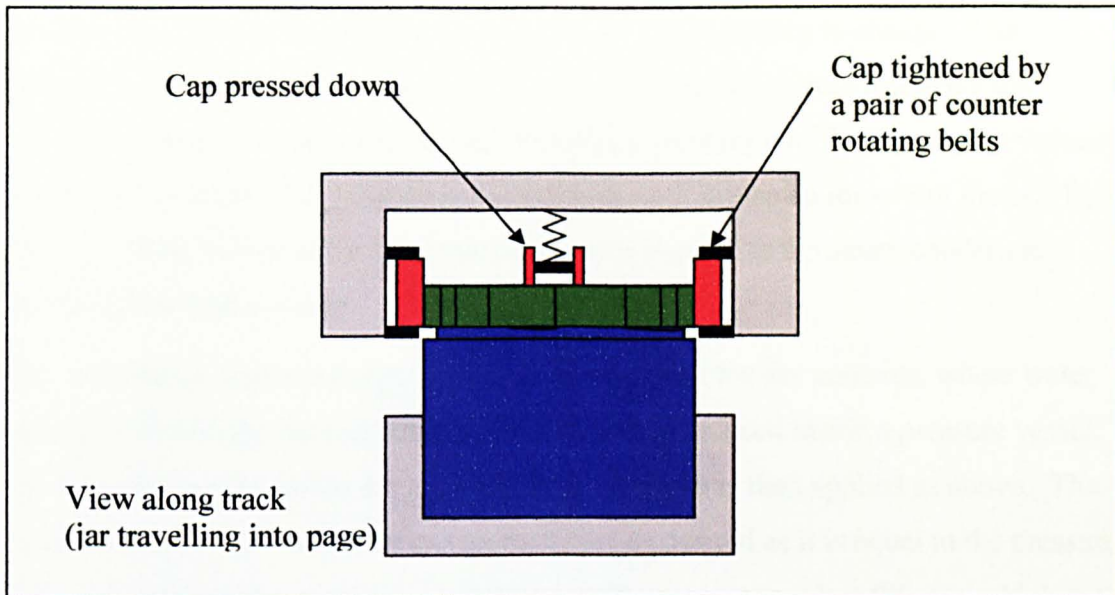

Figure 1.4 Diagram showing the closure being tightened onto the jar.

1.4.2.1 Vacuum Formation

There are two principle ways in which the vacuum inside the container is created – the mechanical vacuum capper and the stream-flow capper. The more common method is the stream-flow capper. The vacuum is formed by condensing steam, and as such is only suitable when a small amount of water present in the container after capping will not affect the contents. The jar passes through a steam atmosphere and the steam fills the headspace of the jar. The cap is then applied as above, trapping the steam. As the jar leaves the hot atmosphere it cools and the steam condenses. The volume of liquid water is far lower than that of steam, so as the jar cools, the vacuum is created. Most of the oxygen is expelled from the headspace by the steam jet, as all of the air is displaced by the steam. Reducing the level of oxygen in contact with the foodstuff in the jar minimises product degradation, giving steam vacuum sealed goods very long shelf lives⁷.

The level of the vacuum is dependent on a number of factors. The headspace volume (the empty space in the jar above the product) is of critical importance. A larger headspace means more steam is trapped in the container, resulting in a higher vacuum. For most products, the headspace volume is kept at around 6% of the

container volume to give a reasonable vacuum level. This is only a rough guide however, and due to the other factors listed here this is subject to change. The temperature of the product during the capping process can greatly influence the vacuum produced, as hot contents will contract when they cool increasing the vacuum level. The volume of air trapped in the product itself is also an important factor. This air will not be displaced by the steam jet but will expand as the steam condenses, lowering the final vacuum.

The mechanical vacuum capper system is mainly used for dry contents, where water present will damage the contents. The containers are placed inside a pressure vessel, which is then evacuated to the required level. The cap is then applied as above. The vacuum level in the containers can be easily set as desired as it is equal to the pressure in the chamber as the closure is sealed (unless the contents are hot-filled in which case the vacuum level will increase slightly as it cools). This type of machine is slower and more expensive than the stream flow capper.

2 Previous Work

2.1 Introduction

There has been much previous work in many key areas of this study. However, despite the prior work that has been performed there is still a need for the new study. In many cases, small variations in the test parameters mean that the results are not directly comparable to the packaging systems being investigated. However the ideas and results obtained from literature give a good indication of the best ways in which to conduct the new study and of the results that should be obtained.

2.2 Human Strength

Quantifying human strength is not an easy task. There have been many prior studies in the area, although few have been performed investigating the forces that people can apply to packaging. There are also several datasets available that list human ability for various actions. However it is not straightforward to derive the forces that can be applied to packaging from these datasets⁸. Opening packaging also often involves the use of more than one single action. Due to the complex ways in which the human body works, possible interactions inside a person's joints etc may influence the forces that can be exerted when more than one action is attempted at once. An example of this would be a grip and twist motion – a person may not be able to apply the same level of grip if they are also required to twist a closure. In this case a datasheet listing

applicable grip force and a sheet listing applicable twisting force would be useless to work out the forces subjects could apply when gripping and twisting. In a study of the strength of the UK population, the DTI noticed that ‘little or no correlation was found between the 6 [strength] measurements’ they performed⁹.

2.2.1 Grip Strength

There have been several previous studies of human grip strength. However the previous work in this area is always based on taking strength measurements using grip dynamometers (such as the work by Giampaoli et al¹⁰), which measure the grip force that a subject can apply to parallel bars across the palm of the hand. Other studies use pinch gauges, again measuring strengths not directly related to opening jars or bottles (Mathiowetz et al¹¹). This previous test data is therefore of no use in an analysis of packaging openability, as the forces recorded will not be the same as those the users apply when opening containers. This fact was noted by Fowler et al⁸, who stated that “clinical-type assessment techniques do not give an accurate measure of hand function”. A test based on shape geometries similar to packaging is therefore required to accurately determine the forces users can apply when gripping jar lids.

Similarly, Crawford et al¹² found that the forces that users could apply to objects depended on the geometry of the object. This therefore shows that strength measurements are very dependent on the geometry of the test. Tests on a variety of sizes of jar lid are therefore required to accurately determine the forces involved when gripping and subsequently opening packaging.

2.2.2 Wrist-Twisting Strength

Wrist-twisting strength, also referred to as ‘opening strength’ in some texts, is the unaided torque that a user can apply to an object. It is the action required to open many forms of consumer packaging, and is therefore the most important factor in determining openability.

There have been several previous studies designed to measure the torque that a person can apply to a jar lid. However there are areas that could be improved with each of

the tests. Studies by Imrhan¹³ and Rohles¹⁴ involved tests that were not representative of jar opening as they used fixed discs that were twisted with only one hand. Since this is not representative of the method used for opening jars, the results obtained will not be correct for use in their design. In 2002, the DTI published data related to the strength of people with dexterity disabilities¹⁵. They used an instrumented replica jar to test opening strength at various diameters, and identified that disabled subjects could generate around 40% of the torque produced by a non-disabled person in the trial. However, in this study the researchers changed the materials used for the test jar, and hence also changed its weight and surface finish. The material used to make the test equipment is important, because the friction forces between surfaces depend on the materials in contact and the surface finish of those materials. By using different materials to the ones used to make jars, the friction between a user's hand and the test device will be different to that between the user's hand and a jar or lid. This means that unless the test device is made from the same materials as the jars (or preferably from actual jars) the test will not accurately measure the actual force that a person could apply to a real jar. By altering the weight of the device they introduce another uncontrolled variable, which may affect the torque the user can apply to the lid. The extent of this effect would need to be verified using more testing however. Crawford et al¹⁶ found that the diameter of a lid affects the torque a user can apply. They also found users could apply more torque to square lids than round lids. However the test pieces used were made of nylon and were fixed to a hand held metal torque meter. Different diameter nylon lids were used, but the size of the torque meter was constant for all the tests. The maximum torque applied by the subjects may therefore have been limited by the torque they could apply to the 40 mm cylindrical steel torque meter, and not by the different nylon caps used. The results obtained therefore cannot be used with certainty, as these changes will affect the applicable opening torque.

In a study in 2002, Voorbij and Steenbekkers¹⁷ used a jar replica similar to that used by the DTI to test the maximum torque that could be applied to a 66 mm jam jar lid. However the test jar used was again made from different materials to real jars, and hence the results will be different from those generated in practice. Further testing of

the friction between human skin and various materials is needed to investigate more fully the effect of changing materials.

Fowler and Nicol¹⁸ developed a transducer to measure the forces acting in 3 dimensions on a single finger during everyday activities including opening a jar. They only measured the force on one finger under a set torque however, and did not measure the torque that a subject could apply. Chadwick and Nicol¹⁹ also developed an instrumented cylinder to measure the grip force during a variety of simulated household tasks. However, the cylinder diameter was only 30 mm and so the data obtained cannot be related to jar opening.

For all of the studies shown above, very few involved subjects over the age of 80. Those that included elderly subjects did so with them as a minority in the trials. Therefore despite the rapid increase in numbers for this demographic the needs of the older consumer is still not being considered. More information regarding this can be found in Section 2.2.3.1.

2.2.3 The Effect of Ageing

The problems of quantifying human strength as detailed above are made even worse when ageing is taken into account. It is well known that the human body degrades with increasing old age. Carmeli et al²⁰ identified that loss of strength and dexterity occur both due to natural ageing and also from certain disorders such as osteoporosis or rheumatoid arthritis. They also identified that specific actions may be affected by such changes. Any strength testing undertaken must therefore be performed on a wide cross section of society to check that the strength of the population is accurately determined. It is also important to check several different actions when measuring the strength of people at different ages, as certain actions may be more greatly affected than others.

2.2.3.1 The Ageing Population

As noted in section 2.2.3, the average strength of an average user decreases as the user gets older. Many elderly people complain that they are unable to open jars and other

packaging due to this fact. Improvements in healthcare and nutrition etc mean that people are living to older ages than ever before²¹. They therefore get comparatively weaker as they get older and older, meaning packaging must be made easier and easier to open to allow the oldest members of society to continue to be able to open it. However, for packaging designers the problem is made doubly worse by the fact that the population in many countries is also steadily getting older as a result of this longer life expectancy (and other factors such as low birth rates)²². In the UK it is estimated that by the year 2020, 50% of the adult population will be over the age of 50²². The fastest growing demographics in the population are also the oldest – the rate at which the number of 80+ and 90+ etc people is growing is much higher than the growth of the younger groups. This can be seen in Figure 2.1.

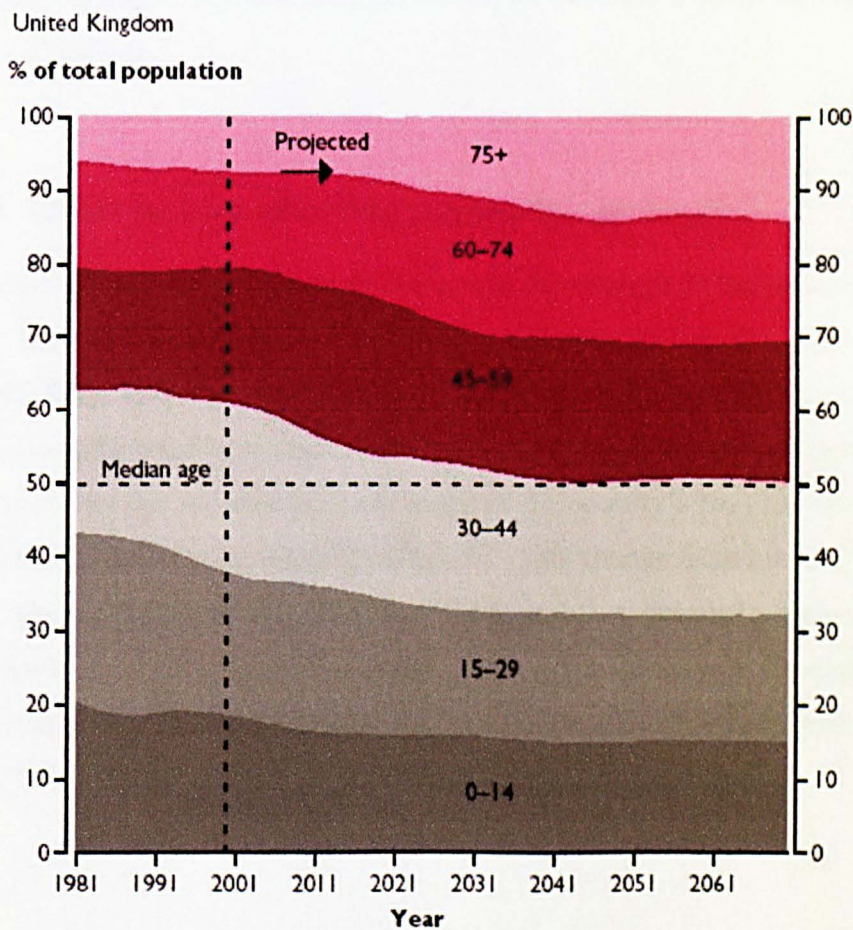

Figure 2.1 Graph showing predicted breakdown of UK population by age.
(UK Government Actuary Population Predictions)

This graph shows that the younger age bands shrink slightly, whilst the 45-59 and 60-74 bands increase in size slightly. The biggest change is observed in the oldest group however – the 75+ band is predicted to more than double in size by 2070.

2.2.3.2 Changes in Strength, Dexterity and Visual Acuity

The problem of difficult to open packaging is especially apparent when looking at elderly people or those with a disability. Old age or disabilities often reduce a subject's manual dexterity, meaning packaging that a younger, fitter or healthier person might have no trouble opening become impossible to gain access to. For example, an average 70 year old has similar strength to that of a ten year old child⁹. Similarly poor eyesight may also pose problems, for example if small tabs need locating on a package.

2.2.4 Other factors affecting population strength

Several other factors may contribute to changes in the strength of the population. Over time, activities undertaken by the population change, such as the nature of the work people do or the leisure activities they partake in. In the past, the bulk of the population was employed in manual work, such as mining or working in factories. However over time this has changed, and much of the country's population is now engaged in more clerical work based in offices²³. This change from manual to office work may have an impact on the strength of the population, because people are using their muscles less. Other changes in lifestyle, such as the increase in popularity of personal transport (eg cars) or availability of pre-prepared foodstuffs may also affect the general health and fitness of the population and hence its strength.

2.3 Skin Friction

Measuring human skin friction is a difficult task due to the many variables involved. The possibility of injury to the subject also dramatically increases the complexity of the task. Several studies have been performed (such as those by Naylor²⁴, Koudine et al²⁵, Highly et al²⁶, Asserin et al²⁷ and Sivamani et al²⁸). The above authors used a variety of types of apparatus to measure the frictional coefficients. However none of the above specifically used packaging materials. The bulk of the tests used sophisticated equipment to drag a pointer across various skin areas, whilst measuring the applied normal forces and resulting friction. The high cost of such equipment, due to the required failsafe devices and lack of portability mean such tests are expensive to perform. O'Meara and Smith²⁹ tested palmer skin friction against five grabrail materials by using a force platform embedded into the floor. Obviously this also suffers from the same problems as the above.

In May 2006, Carlo Menardi completed his Master's Thesis entitled 'Measuring Finger Friction'³⁰. This work involved the use of a specially designed rig to measure the frictional coefficients between human finger skin and several common materials. The rig used is shown in Figure 2.2.

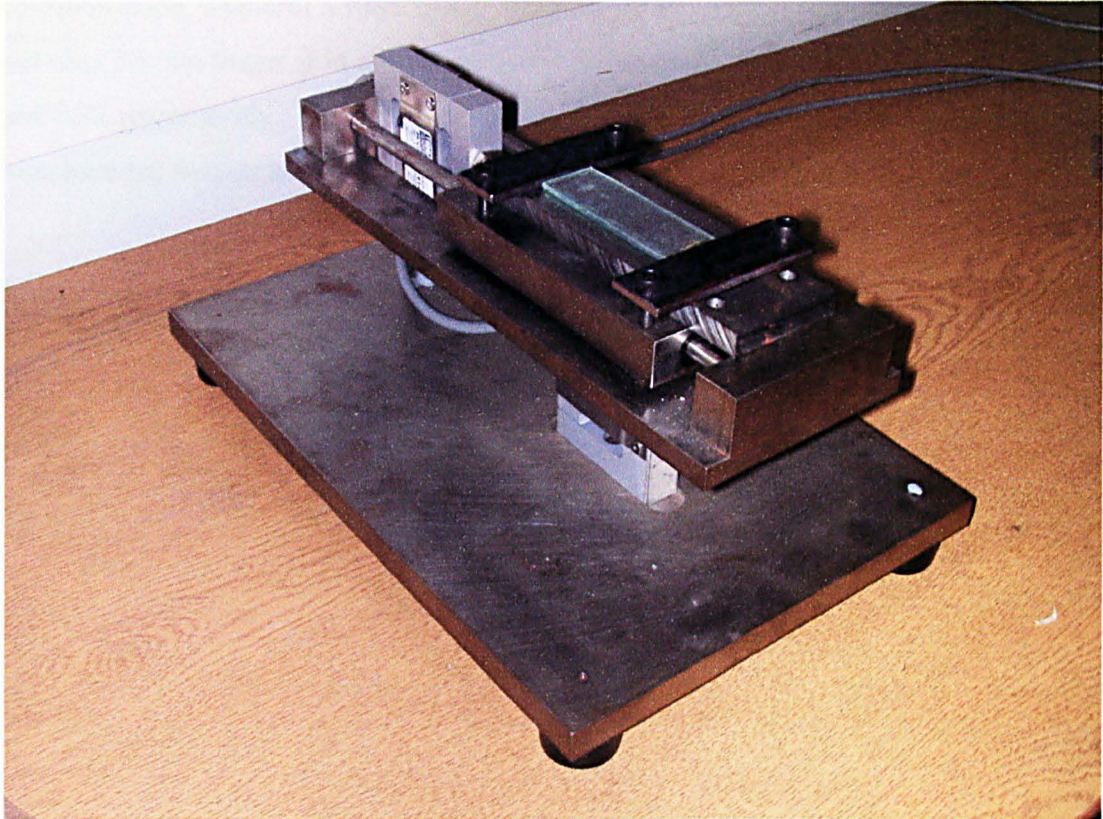

Figure 2.2 Friction rig used by Menardi.

The rig comprised a flat plate attached to a frame with two low friction roller bearings. The end of the plate was attached to the frame using a load cell, to allow the horizontally applied force to be measured. The whole frame was supported by a load cell to measure the vertically applied force. The sample of packaging material was fixed to the top plate, and the subject asked to run their finger along the material parallel to the roller bearings. An enlarged view of the top plate, showing the sample, support plate, load cells and base plate can be seen in Figure 2.3 below. The output from the load cells could then be used to determine the applied normal force and the friction force, and hence the friction coefficients. The surfaces used included two kinds of material used to make bottle and jar caps for packaging. The values found in this study can therefore be used directly in this analysis. This work simply uses a linear model for friction, although indicates that a more complex logarithmic model may be required as developed by Comaish and Bottoms³¹. Further work is needed for

this however, and only initial values were found in the study. As a first approximation, Menardi's work gives values for the static coefficient of friction between human finger skin and lacquered aluminium and lacquered tinplate as 0.26 and 0.32 respectively. No measurements were conducted for skin from any other locations (eg palmer skin).

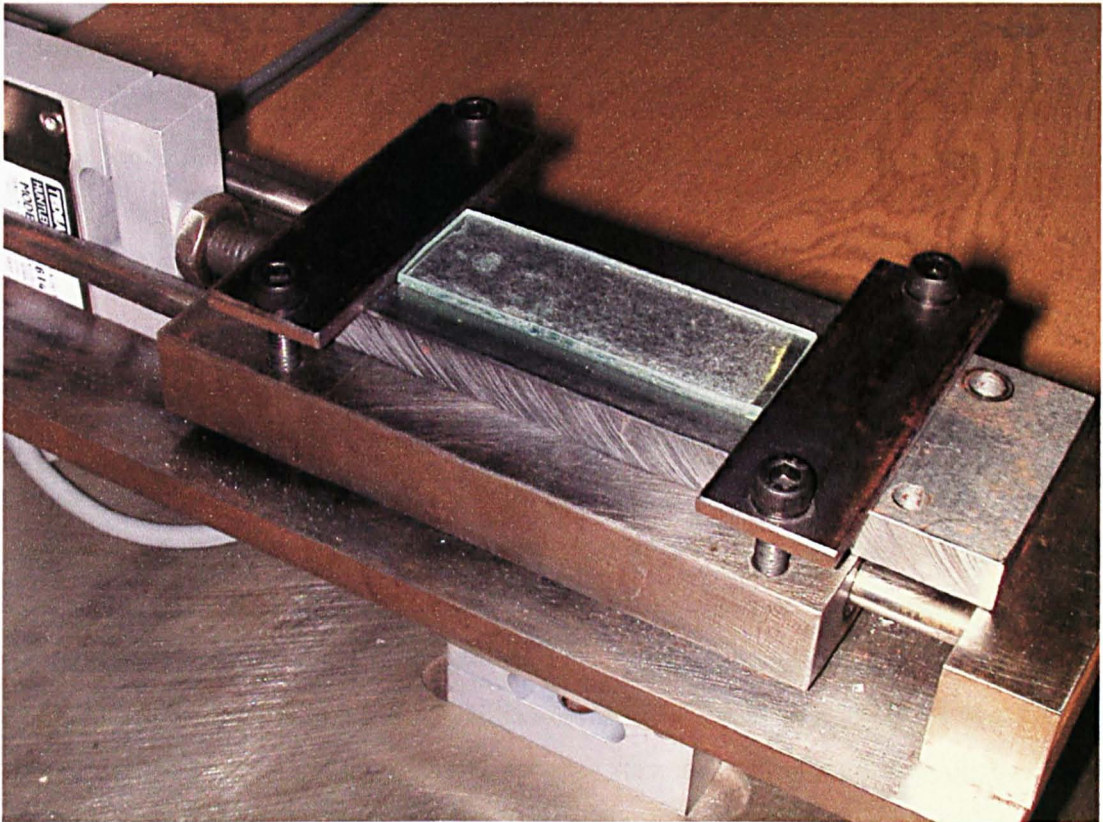

Figure 2.3 Enlarged view of sample area on friction rig.

2.4 Packaging Opening Forces

2.4.1 Vacuum Lug Closures

Despite the VLCs reputation for being hard to open, no prior large scale study could be found into the opening forces required for vacuum lug closures. Similarly, no industry targets or limits were identified. Observation of capping line machinery seemed to indicate that cap application was adjusted until the closure system sealed correctly, with little regard for later openability.

2.4.1.1 'Sticktion' Effects

In 2001, Sealy³² identified a compound known as PolyDimethylSiloxane on the sealing surface of the glass jar and the inside of the liner material of the cap. This substance is known to bond to glass, and so may be the reason behind the high opening torques. This effect, dubbed 'sticktion' has therefore been accounted for in the analytical analysis of the pack system (Section 5.3) by adding a separate term for it. Due to the way in which the PolyDimethylSiloxane is formed, the sticktion effects may be affected by various capping parameters such as the application torque and the capping temperature. The effect may also be time dependant. No attempt was made to quantify the formation of the compound or its effects on jar opening torque.

2.4.2 Other Forms of Packaging

For other forms of packaging there are industry guidelines for openability requirements. An example of this is the roll-on pilfer-proof closure (ROPP), as found on spirit and carbonated water bottles. However, in 2004, Langley³³ discovered that the opening targets were often far lower than the actual measured opening torques for the bottles. Obviously, industry targets are only of use if the products actually adhere to the limits set. Similarly however, targets are only of use if they are relevant and

achievable for the products to which they relate. The work in this study is therefore invaluable to determine the correct limits for VLCs.

2.5 Design Methodologies

2.5.1 Packaging Design

Traditionally, packaging was designed to preserve and protect the goods it contained during transit, in the retail environment and in the consumer's home. To maximise profits and keep selling prices as low as possible, the unit price of the packaging had to be kept to an absolute minimum. Consumer packaging also had to assist in selling the product by catching the eye of a consumer. In order to achieve the protection objective, strong, tight seals were often used. Additionally, opening instructions were often kept to a minimum to keep the visual appeal of the product. This meant that there were numerous types of packaging that many consumers found difficult to open.

More recently, the focus has shifted to the demands of the consumer rather than those of the manufacturer. The main drivers behind packaging design used to be that of cost to the manufacturer and potential impact on consumers. Nowadays however there is the additional factor of openability. In a recent survey conducted by a consumer magazine, 99% of the responses said that packaging 'has got more difficult to open in the last 10 years'⁴. Whether this is due to the packaging requiring higher opening forces or decreases in the strength of the users is irrelevant – the end result is still that users find it harder to access the goods they buy. Difficulties with perception can obviously be a problem for newer types of packaging, with consumers unable to understand instructions or find pull-tabs etc. However, there are still openability issues with more established forms of packaging that have been in use for many years, such as glass jars and bottles. Consumers know how to open these products, yet fail to open them purely because they cannot generate the forces required. It is unlikely that these types of packaging will be replaced in the near future, and so work must be done to enable more people to open them more easily. In order to ensure that the

packaging is designed inclusively, it is essential to understand fully the forces that are required to open them and the forces that consumers can generate.

Packaging, along with many other items, is often designed so that it can be operated effectively by the 95th percentile person³⁴. Tables of specific strengths and human body dimensions are available from various sources, including Adultdata³⁵ and Older Adultdata³⁶ from the DTI and the PeopleSize 2000 database (Open Ergonomics Ltd). These can be used to ensure that designs should be accessible. However, many of the tests that have been used to measure the data do not accurately represent the actions used to open packaging, and are therefore unsuitable for use in its design. The tests used also do not allow for any physical problems people might have – arthritis may prevent a user from using a certain form of grip for example, so they might have to resort to using a less effective, weaker grip for opening. Changing population demographics mean that 95th percentile data from tests carried out in the past may not accurately represent the true strength of the current population. These factors mean that existing generic strength data will over predict the forces that people can apply to packaging. Basing product design limits on these predictions will therefore exclude many people that should have been in the target groups.

2.5.2 Inclusive Design

There are several common definitions of Inclusive Design, although all convey the same basic message. Two such examples are given below:

“The design of mainstream products and/or services that are accessible to, and usable by, as many people as reasonably possible on a global basis, in a wide variety of situations and to the greatest extent possible without the need for special adaptation or specialised design”. (<http://www.tiresias.org/guidelines/inclusive.htm>)

“...a general approach to designing in which designers ensure that their products and services address the needs of the widest possible audience, irrespective of age or ability.” (Helen Hamlyn Research Centre)

This means that an inclusively designed product should be usable by as many people as possible, regardless of their physical or mental condition. Designing for everybody

is not feasible as some users will always be too weak, not dextrous enough or have a more severe disability preventing them from being capable of interacting with the product. However, inclusive designs should accommodate as wide a range of abilities as possible. With respect to consumer packaging, this means that packets should be able to be opened by as much of the target market as possible. It should be noted that the target market for a product does not necessarily include the whole of the population – there are certain users that either may be left out without causing problems or that need to be prevented from accessing the contents of the packaging. An example of this would be food containers, for which there is little benefit in ensuring young children are able to open the packages, as it is unlikely that young children will ever need to open them. Medical packages are also required to prevent openability by young children, but should allow easy access by as much of the adult population as possible.

In order to design inclusively, the forces required for opening should therefore be low enough for the target users to generate. Due to physical disabilities etc there will always be people in the target market that will never be able to apply the required forces, however low the boundaries are set. Therefore a limit must still be set that will exclude some people. In order to design inclusively, it is often stated that designs should be based upon 98th percentile data. If this data is used in the design process as a limiting factor, then 98% of the target market will definitely be able to open a product. Obviously, it is not sufficient simply to make products as easy as possible to open (again using packaging as an example). This approach could result in problems in many areas. Firstly, this approach would not guarantee that the design of a closure is inclusive – a certain type of closure may never be able to be made easy enough to open to be considered inclusive if despite the best efforts of the design team it cannot be made suitable for the weakest consumers to open. Conversely, manufacturers may waste considerable amounts of time and money making closures easier to open than necessary. If closures are too easy to open this may also cause additional problems during transportation etc, during which the containers may open accidentally.

Designing inclusively has several important advantages for a product. Firstly, the product is accessible to the widest possible market. Currently, many elderly people or people with a physical disability say that they will not buy certain products if they

have had difficulty with them in the past⁴. This reduces the size of the target market for a product, thus adversely affecting possible sales and hence profits. Conversely, if a company has a reputation for selling products that are designed inclusively and are easy to use, people may be more inclined to buy their products. This is obviously an advantage in competitive markets.

2.5.3 3-Stranded Approach to Inclusive Design

Using the Roll-On Pilfer Proof closure (as found on whiskey bottles etc) as an example, Langley et al³⁷ developed a methodology for the inclusive design or re-design of products. By following his three-stranded approach to design, the usability of the final product can be guaranteed. This is because the strength or ability of the consumer is used at the heart of the design process, and the product designed using this as a limit. By setting these human factors correctly all the target users can be accommodated.

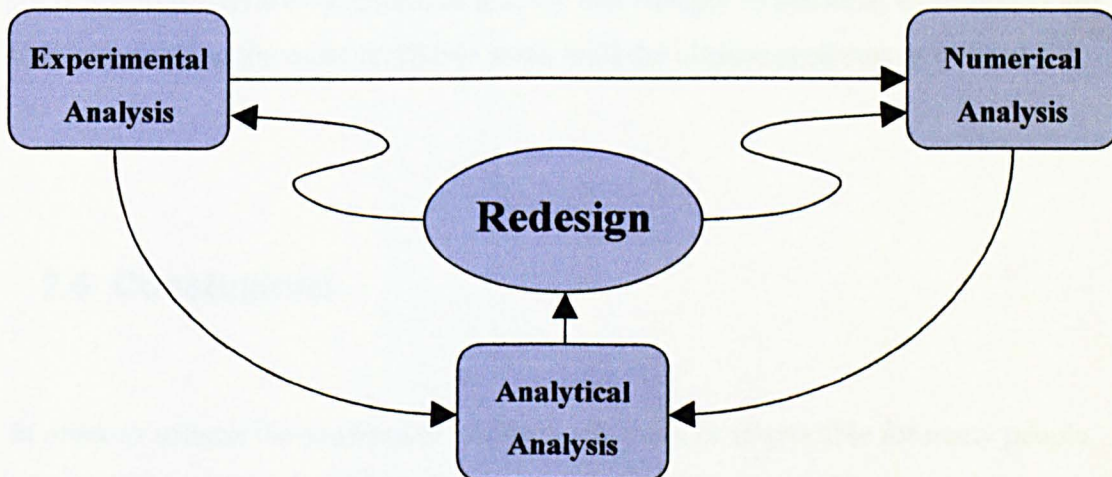

Figure 2.4 3 Stranded approach to Inclusive design as developed by Langley.

The method involves 3 main parts which are interlinked as shown in Figure 2.4. Firstly, experimentation is used to measure human ability for the required actions, and also material properties or dimensions for the product being considered. Acceptable limits for the closure operation must also be set, which would usually be influenced by the human ability terms (for example a force limit determined from human strength, or a size limit determined from a physical dimension). These properties are

then used in a numerical analysis of the proposed system. This involves computer simulations of the packaging system, and can be used to predict closure performance using input data from the experimental tests. The final phase is the analytical analysis, in which system equations are developed for the closure during the opening process. Values determined during the experimental and numerical work can be substituted into the equations, and used to predict acceptable limits for the remaining terms. Using a technique called Affine Analysis, the various parameters can also be ranked in order of their impact on the opening forces and the likely errors in the predicted torques. This ensures that any work required to improve the closure is focused in the most productive areas and that useful improvements can be made. The closure can be redesigned with an emphasis on optimising the parameters with most influence, then re-evaluated. If the new closure performs adequately then the process is stopped, if not the cycle can be repeated to again find the optimal parameter to focus on for a further redesign. The process is repeated until the closure performs within the design limits specified. Using this iterative process ensures that closures (or other products) are optimised as quickly and cheaply as possible, as resources are only expended in the most profitable areas until the closure performs as desired.

2.6 Conclusions

In order to address the problem of jars being difficult or impossible for many people to open, it is obvious that new tests must be designed and carried out to more accurately measure a person's strength when opening a VLC. The equipment must be designed to mimic the weight and surface finish of actual jars exactly in order to allow the measurement of the actual torque that a person can apply to the lid of a jar. Ideally, jars and caps from real 'off the shelf' products should be used to ensure that the friction characteristics will be identical whether the user is opening a jar or taking the torque test. Using both real lids and jars will ensure that the correct torque will be measured regardless of whether the applied torque is limited by slip on either the cap or the jar. The appearance and mass of the device should also be kept as similar as

possible to maintain the authenticity of the test, to avoid introducing another uncontrolled variable. Similarly the user should be able to take the test in the same situation as they would open a jar normally. The test should therefore not restrict the user to specific postures or put time limits on the task. It should be noted however that in order to produce a truly inclusive design, only the maximum torque that a subject can apply without causing themselves discomfort or injury should be recorded. A user should not have to hurt themselves in order to open packaging, and so levels of torque that can only be generated whilst hurting the user should not be considered. Data from such a test would be invaluable if a jar is to be designed inclusively. This will allow design limits to be determined that will ensure consumers will be able to open products. By creating products that perform to these limits it can therefore be guaranteed that the resultant products will be inclusive.

3 Motivation and Research Drivers

3.1 Introduction

There are several important reasons to undertake this study into the openability of vacuum lug closures. It is widely known that many people, especially the elderly, find jars hard to open⁴. However, to date, there has been little noticeable change in the design of jars or in their ease of use. As is the case for any consumer product, any changes are only likely to be made if there is a strong business case for making the change or if such a change is required by law. For consumer packaging it is possible that both such pressures exist. The reasons behind these pressures are outlined below.

3.2 Brand Differentiation

Increasingly, consumers have more and more choice over the brands of goods they buy. In years gone by, many people went to their local shop and bought whatever brand of goods they happened to stock. Nowadays however, the bulk of households travel to large supermarkets to do the majority of their shopping³⁸. These larger stores often carry multiple brands of the same types of items. This gives the user a choice not only over the type of goods that they buy but also over the specific manufacturer of those goods. As most trips to the supermarket involve a car journey, consumers can also choose the shop that they go to, further widening their brand options. The

rise in popularity and availability of internet shopping again gives consumers a wider variety from which to choose their purchases.

These changes in the way we shop ultimately mean that manufacturers need to find more and more ways to differentiate their products from others on the market and persuade consumers to buy theirs over other brands. Any negative image that their product may have is likely to result in fewer sales, as consumers will simply choose to buy something else instead³⁹. Obviously therefore, if a manufacturer's products have a reputation for being hard to open, people may decide to spend their money elsewhere. An initial informal survey into people's feelings about packaging confirmed this – many subjects, especially the elderly, said that they no longer buy food in jars as they found it too difficult to open. If a product is seen as easy to open and use it may have the opposite effect, as those who have difficulty with other brands may be influenced to change.

The positive influence above may be observed even if a product's 'easy to use' status is not specifically mentioned by the company in advertising the product⁴⁰. This was the case with the Ford Focus. This car was designed with the abilities of the older user in mind, using equipment such as third age suits to replicate the effects of ageing. As a result, the car was found to be very easy to use by all users, with clear dials and indicators and comfortable seats and access. The design methods employed were not advertised and the car was not targeted at the elderly market. However, the car became one of the highest selling models ever produced, and has won many awards for ease of use and driver satisfaction. This shows that a product can benefit from being easy to use and inclusively designed (see Section 3.5), even if this is not promoted as its primary selling point.

It can be seen from this that a product can gain a possible advantage in the marketplace by being easier to use than those from its competitors. Therefore if a company were to make their products easier to open than other similar brands it is likely they would increase their sales and hence improve their profits.

3.3 Legislation

Currently there are no direct legal requirements governing the forces required to open items of packaging. However, under UK law, the rights of people with disabilities are protected under the Disability Discrimination Acts (DDAs) of 1995 and 2005. The bulk of these Acts are concerned with the provision of services to members of the public. However, the DDA 1995 states that ‘the provision of services includes the provision of any goods or facilities’. Therefore supplying goods that a disabled person cannot open could be considered a breach of this Act, with potential serious legal consequences. As the Acts define a person with a disability as one with ‘a physical or mental impairment which has a substantial and long-term adverse effect on his ability to carry out normal day-to-day activities’, those people simply not strong enough to open everyday items such as food packaging could be considered disabled. The possibility therefore exists for any person consistently unable to open packaging to sue the food manufacturer or retailer under these Acts. The amendments to the DDA 1995 in 2004 and 2005 both extended the provisions of the original Act. It is possible therefore that future specific legislation could be brought into effect that specifically states limits for the forces required to operate products such as packaging. In order to produce any such legislation, the forces that can be applied by users to packaging (or any other system) must be accurately determined. Obviously in order to continue selling products (at least in the UK), manufacturers will need to comply with any such legislation, and in order to do so will need to undertake detailed studies to determine the forces required to open the packaging that they produce.

3.4 The Ageing Population

Due to many factors, such as improvements in healthcare and lower birth rates, the average age of the population of many countries is steadily rising. In the UK, the fastest growing sectors of the population are those containing the oldest members of society, and by the year 2020 50% of the adult population is expected to be over the age of 50²¹.

There are many studies that show that elderly adults, on average, are weaker than younger adults (such as those by Chadwick et al⁴¹, Crawford et al⁴² and those found in *Adultdata*³⁵ and *Older Adultdata*³⁶). The ageing of the population therefore results in a corresponding decrease in strength of the population, as there are a larger percentage of older, weaker adults. It is also well known that many people, especially the elderly, often struggle to open jars sealed with vacuum lug closures. The current trend towards an older, weaker population will therefore result in more and more people struggling to open packaging of this type. Research must therefore be done to investigate the effects of ageing on jar opening strength, so that work can be done to improve the openability of such closures and hence allow a greater proportion of the population to open the foodstuffs that they buy.

More information regarding the ageing of the population is shown in Section 2.2.3.1.

3.5 Inclusive Design

Inclusive design is, simply, designing products that *can* be used by everybody that *should* be able to use them. There are several common definitions of the term (see Section 2.5.2), however in essence they all say the same thing. The idea behind inclusive design is that if the ability of the weakest consumer in a target user group is considered during the design process, then all users in the group will be able to use

that product. Although the concept of inclusive design is not especially new, it is becoming more and more popular especially in recent years and is increasingly used as a 'buzz word' at design conferences⁴³.

Products designed inclusively should be able to be used by all the members of a target group. It should be noted that this is not necessarily the same as stating that a product should be able to be used by everybody. For example, an inclusively designed child proof closure should be accessible to elderly people or those with disabilities, but children should be specifically excluded from opening the closure. Similarly, few children need to be able to open food jars, yet elderly people should be able to open any jars they buy. In order to design a product inclusively, it is obviously of critical importance to know the relevant strengths or abilities of the target users. In the case of VLCs this information is not currently available, hence this research must be performed.

The importance of inclusively designed packaging is made more apparent when the ageing of the population as described in Section 3.4 above is considered. As the population ages and gets correspondingly weaker, non-inclusive designs will exclude larger and larger portions of society. Work is therefore needed to quantify the abilities of the population in order to ensure that packaging remains accessible to everybody.

3.6 Lack of Specific Strength Data

The forces that a human being can apply in any given situation are dependent on many factors. Obviously, the person in question has a huge impact on the forces that can be applied – a fit, healthy adult male is almost certainly able to apply higher forces than a young girl for example. However, there are several other factors that need to be considered before the forces that a specific user can apply in a specific situation can be predicted. Due to the complex ways in which the muscles and joints of the human body move, the strength of a person in one action does not necessarily

determine their strength when applied in a different action⁸. Therefore strength tests need to be performed for the specific actions used to open packaging. Previous studies into human strength tend to use standard tests which are not representative of the dimensions and actions used when opening packaging. Other tests used geometry similar to packaging, but substituted the materials used. These measures therefore cannot properly predict the forces that users can apply, and so a study to more accurately determine applicable opening forces must be carried out. A survey by the DTI of designers, ergonomomists, consumer safety groups and product testing labs indicated that there was a need for physical strength data for all age groups ‘that could be directly applied in the design process’⁹.

3.7 Lack of Specific Opening Forces Data

Although many manufacturers test samples of their products as they come off the packing lines, there is no information currently in the public domain regarding the forces required to open vacuum lug closures of various sizes. In order to gauge the effectiveness of current designs it is first necessary to measure the forces required to open the closures. This information can then be compared to measured human strength data in order to predict whether or not people will be able to open closures satisfactorily. Should the closures prove unacceptable from an opening force perspective the results can then be used together with an analytical analysis to indicate the parameters on which resources should be spent in order to gain most benefit.

3.8 Use of Tools

There are few sources of information regarding opening aids or tools designed to assist in the opening of jars. Organisations such as Age Concern or the Disabled Living Foundation offer help and advice to those that have difficulty opening packaging themselves. However no detailed performance analysis of the tools they recommend has been performed.

A study was performed by Taylor et al⁴⁴ into the performance of opening aids for food packaging. The methods by which the tools worked were analysed, and several different mechanisms of operation were identified. A large number of tools were tested, ensuring that several examples of each mechanism were chosen. The opening torque each subject could apply to a jar lid with their bare hands was first tested, using a modified jar. The base of the jar contained an embedded torque sensor, with the lid of the jar attached to the sensor. This device therefore allowed the accurate measurement of the torque applied to the lid relative to the base. The apparatus used is more completely described in Section 7. The subject was then given an opening aid, and the torque they could apply to the same device was then measured when the tool was also used. As real jar lids and bases were used in the device, any torque applied by hand or using a tool would be identical to the forces that could be applied to a real product. The study found that the opening aids did not greatly improve the torque that most younger users (below the age of 65) could apply to jars, especially for larger jar sizes. The older users had far more problems with the tools, and in many cases could not even attach them to the jar. It was frequently observed that subjects of all ages could apply higher torques unaided than they could when using a tool. The only tool that consistently increased the torque the elderly users could apply to jars consisted of a mounting plate to hold the base of the jar solidly, allowing the user to use both hands on the lid. When compared with the jar opening torque results found in Chapter 6, none of the tools allowed the elderly users to apply high enough forces to open many of the jars on sale. This problem was further compounded whenever any decontaminants were added into the testing. Adding flour or water to

the jar lids dramatically decreased the level of torque that could be applied to the jar lid using the tools. As contaminants such as these are common in the kitchen whilst cooking this further limits the usefulness of the tools tested.

From the results of the above study, it is obvious that work must be done to quantify fully the opening forces of jars and the forces that users can apply to jars during the opening process. As there are no reliable, effective aids available the only option is to redesign the closure system so that it is more accessible to users.

3.9 Conclusions

Due to the factors listed above, there is a need for research to quantify the current strength of the population. This study compares the forces that users can apply to the forces required to open vacuum lug closures of various sizes. By using new and more representative tests the research fills in the blanks left in current understanding about human strength and packaging openability. This information can then be used to demonstrate to manufacturers reasons for improving their packaging to make jars easier to open for everybody.

4 Aims and Objectives

4.1 Introduction

As shown in Chapter 2, there is a large gap in knowledge surrounding the way in which users interact with packaging. Although datasets exist containing information about the forces that people can apply, little of this information is directly relatable for use in packaging design due to changes in the materials or geometries involved. There is also little information about the levels of force that are required to open vacuum lug closures, and little insight into the parameters that affect the operation of the closure system. A study to fill in these gaps is therefore required.

4.2 Aims and Objectives

The aim of this project is to further the understanding of the interaction between users and the components of the vacuum lug closure system, with a view to making the closure easier to open in the future. More specifically, the project aims to investigate the forces that a consumer can apply to a jar lid during the opening process. The study also aims to better understand the forces that prevent a closure from opening, in order to suggest ways of improving the closure.

There are four main objectives to the project:

1. Develop an analytical model of the system. This will give insight into the way in which the closure works and may suggest possible areas for improvement. It also allows an affine analysis to be performed to properly rank the

parameters that affect opening, and hence allows resources to be concentrated in such a way as to maximise efficiency. The affine analysis will not be performed however as it requires values determined from numerical models of the system. These numerical models will also not be attempted due to time constraints. The analytical model will still be performed however as it may provide valuable information about the way the closure system works and will provide a useful foundation for future work.

2. Determine the forces required to open current jars. This gives an accurate benchmark to use when evaluating current jars and potential new designs.
3. Devise a new, realistic experimental test to determine the ability of the population when opening jars of various types, and obtain a useful database of measurements to predict population strength when opening jars.
4. Develop and evaluate a more transferable method of obtaining ability data for a population. If the data obtained can be used for multiple purposes, such as determining ability to open numerous types of packaging, this lowers the unit cost of each study into opening forces and hence reduces the overall expense of closure evaluation and redesign.

4.3 Methodology

Initially the intent for this project was to follow the methodology developed by Langley as outlined in Section 2.5.3. This method takes account of user ability in order to guarantee inclusivity for a design. However during the initial phase of the investigation it was realised that much of the information required to perform the numerical and analytical modelling was not available. As noted above, values for the human elements involved (e.g. grip strength and wrist-twisting strength) needed to be determined experimentally rather than be found from existing datasets. It was therefore decided to concentrate on determining these values accurately so that future studies may build on the knowledge and produce an effective re-design. Time

constraints prevented carrying out the required experimentation in addition to the extensive and complex numerical modelling needed to properly predict closure performance. As the analytical models also require information from the numerical studies this section also cannot be completed. However the initial work in this area will be attempted to allow insight into the ways in which a closure works and possible improvements. The numerical models will also be examined in order to give insight into possible reasons why the closures are hard to open.

5 Analytical Analysis

5.1 Introduction

As shown in Section 2.5.3, the performance of a closure can best be evaluated and improved by splitting the analysis into three parallel strands. The first of these involves an analytical analysis of the closure system, looking both at the forces in the closure itself and the forces applied by the user during the opening process. This can then be used together with the experimental and numerical strands of the investigation to rapidly predict the optimal improvements to make to the system.

5.2 User Applied Force Analysis

In order to open a closure, a system of forces must be applied by the user as shown in Figure 5.1. The two forces required are a torque (to turn the lid around) and a grip (to hold the lid securely, allowing the torque to be transferred to the lid). In the case of a vacuum lug closure, as found on jam jars etc, only the torque is required to actually open the closure. The grip force is required to allow the user to apply that torque to the lid. In order to open a closure successfully, the user must be able to meet the minimum required values for both the torque and the grip force.

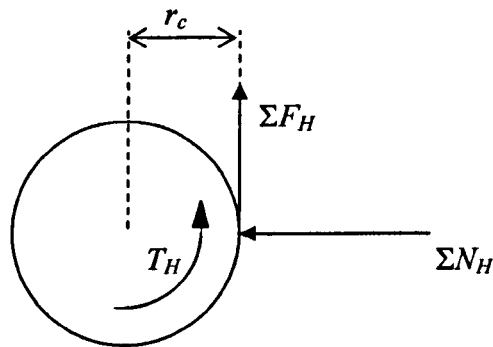

Figure 5.1 Diagram of force system applied to a closure.

The system of forces acting on the cap is shown in Figure 5.1 above. ΣN_H is the sum of all radially applied forces generated by the user gripping the jar lid. The forces that make up ΣN_H need not be equal and opposite about the lid, as at the instant the closure opens the jar may be accelerating in any direction. ΣF_H is the resulting friction force between the lid and the user's hand resulting from this grip as the user turns their wrist in relation to the closure. As frictional coefficients are independent of surface area⁴⁵, the number and area of the contact points between the hand and the closure do not need to be considered, and hence only the overall grip and frictional forces are required for the analysis. The torque T_H is a result of the forces ΣF_H acting around the cap. The outer radius of the cap is r_c .

T_H is dependent on the friction applied and the diameter of the cap, as shown in equation (5.2.1) below.

$$T_H = \Sigma F_H \times r_c \quad (5.2.1)$$

The value of ΣF_H is directly proportional to the value of ΣN_H . As the user applies a twisting force to the lid the friction force builds up towards a limiting value. The actual frictional force that the closure experiences may be lower than this limit, as the friction is purely a reactionary force. If the user does not twist the closure as hard or if the closure opens (thus removing the force the friction is acting against), the value

of the frictional force will be lower. The value of the friction force is given in equation (5.2.2).

$$\Sigma F_H \leq \mu_{ch} \times \Sigma N_H \quad (5.2.2)$$

where:

μ_{ch} = coefficient of static friction between the cap and the human hand.

Equations (5.2.1) and (5.2.2) can be combined to give a relationship between the torque applied to the closure, T_H , and the grip forces applied to the closure ΣN_H .

$$T_H \leq \mu_{ch} \times \Sigma N_H \times r_c \quad (5.2.3)$$

The torque required to overcome the forces holding the closed closed is T_O . If it is assumed that the force required to rotate an open lid is negligible in comparison to this torque, then T_O is also the force required to open the closure. If the closure is successfully opened, this implies equation (5.2.4).

$$T_H \geq T_O \quad (5.2.4)$$

In the limiting case, when the closure just opens and the force applied by the user is the lowest required to open the closure, this simplifies to equation (5.2.5).

$$T_{H \text{ min opening}} = T_O \quad (5.2.5)$$

Now if the cap is just on the point of slipping in the hand when the user is applying the minimum torque required to open the closure, equation (5.2.5) can be combined with equation (5.2.3) and rearranged to give (5.2.6). The grip force in the equation is now $\Sigma N_{H(\text{min})}$, the minimum grip force required to prevent the jar slipping in the hand.

$$\Sigma N_{H(\text{min})} = \frac{T_{H \text{ min opening}}}{r_r \times \mu_{ch}} = \frac{T_O}{r_c \times \mu_{ch}} \quad (5.2.6)$$

The above relationship shows that there is a minimum grip that needs to be applied to a closure in order to be able to generate the required torque to open that closure. The actual grip force required is dependent on two other factors – the diameter of the cap being opened and the coefficient of friction between the user's hand and the surface of the cap. A user must be capable of producing a grip force greater than $N_{H(\text{min})}$ in order to open the closure. Their wrist-twisting strength must also be higher than T_O so that they are capable of turning the lid with the required torque. If a user is not capable of

generating these levels of force they will either slip on the lid (if they cannot generate a high enough grip force) or they will be unable to turn the lid hard enough for opening (if they cannot generate a high enough torque).

5.3 Derivation of System Equations

Consider the system shown in Figure 5.2 and Figure 5.3. The first of these is diagram showing 3 views of a quarter cap. The cap has been drawn translucent to show the lug clearly, with forces being added to the most appropriate view for clarity.

Although the diagram implies a 4 lug cap, any number of lugs can be considered using the derived expressions.

Please refer to the Nomenclature list near the start of this document (page v) for a full list of the symbols used in this analysis.

The jar/cap considered has n lugs. The user applies a 2-point pinch force to the outside of the cap. The pinch force acts on 2 diametrically opposite points on the outer surface of the cap. The actual number of contact points is irrelevant; however by specifying a number of contact points simplifies the analysis to give a couple as the friction force used to open the closure.

First consider the forces in the system before the user opens the cap (shown in Figure 5.2 below).

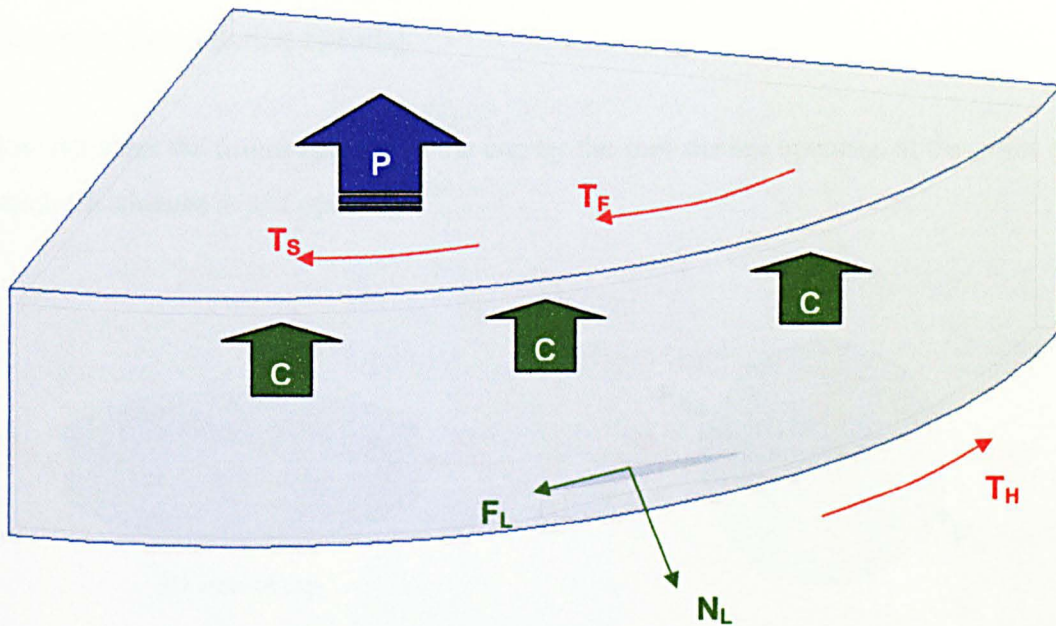

3D view of the quarter cap, showing lug position.

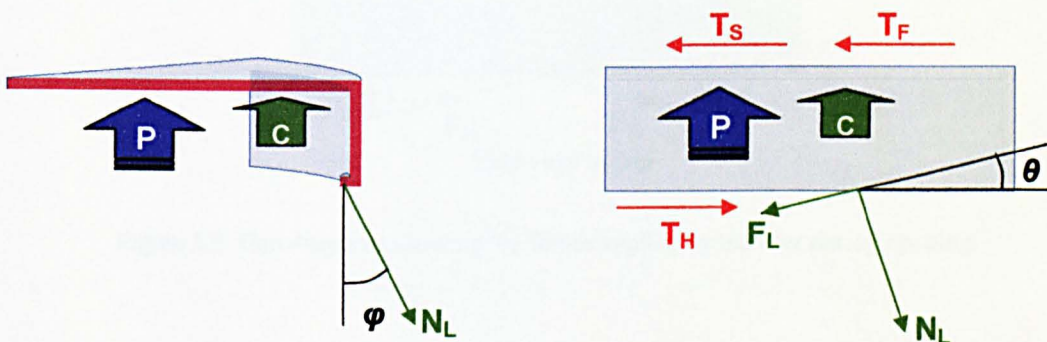

3D view of a slice of the cap through lug.

Side view, quarter cap.

Figure 5.2 Cap diagrams showing internal forces between the cap and glass jar.

Note the torque T_H in Figure 5.2 above is actually applied by the user and is not an internal system force. It is shown in the above diagrams for completeness – components of the the system torques T_S and T_F are purely reactionary, and only oppose the opening motion. Hence they do not exist in their current forms until the user attempts to open the closure (due to the geometry of the system a sealing torque may be present before opening, but it will not be of the same magnitude as during

opening). The user opening torque is therefore shown to justify the inclusion of all the system forces during opening.

Now consider the forces applied to the cap by the user during opening, at the point at which the closure is just opening.

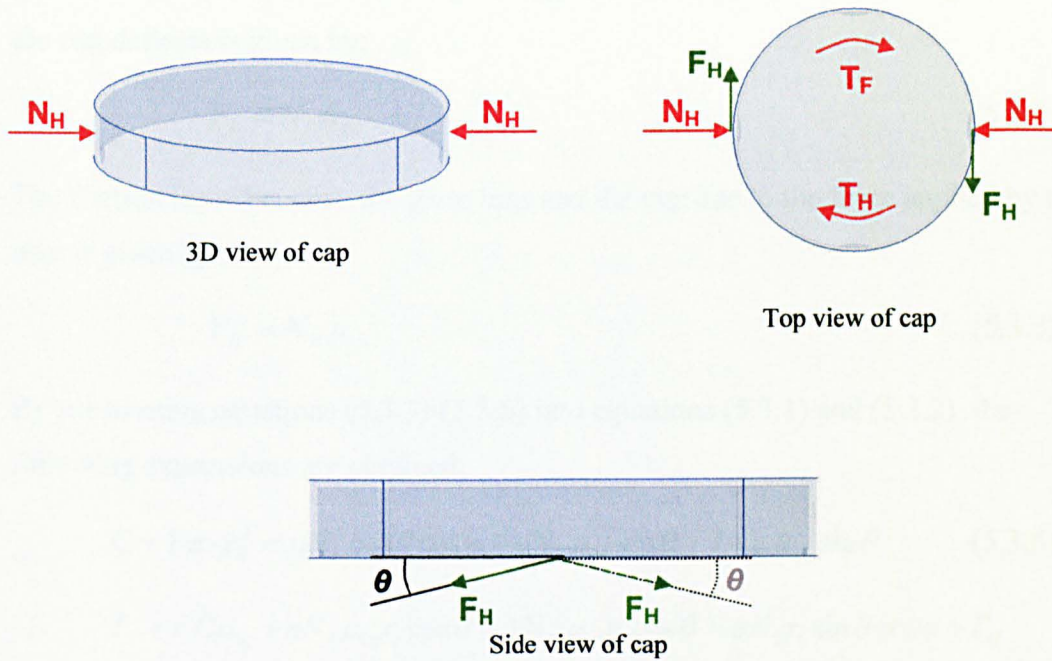

Figure 5.3 Cap diagrams showing the forces applied by the user during opening.

Resolving forces vertically, upwards positive.

$$C + P\pi \cdot r_s^2 = nN_L \cos \theta \cos \phi + nF_L \sin \theta + 2F_H \sin \theta \quad (5.3.1)$$

Taking moments about an axis down the centre of the jar and cap, clockwise positive.

$$T_S + T_F + nF_L r_t \cos \theta + 2F_H r_t \cos \theta = nN_L r_t \sin \theta \cos \phi + T_H \quad (5.3.2)$$

Note also that:

The torque due to friction with the liner is related to the normal contact force between the liner and the glass (C), the coefficient of friction and the radius of the contact point by:

$$T_F = r_s C \mu_{lg} \quad (5.3.3)$$

The friction force F_P between the glass lugs and the cap due to the force generated as the cap deflects is given by:

$$F_L = N_L \mu_{gc} \quad (5.3.4)$$

The friction force between the glass lugs and the cap due to the force applied by the user is given by:

$$F_H = N_H \mu_{gc} \quad (5.3.5)$$

By substituting equations (5.3.3)-(5.3.5) into equations (5.3.1) and (5.3.2), the following expressions are obtained:

$$C + P\pi \cdot r_s^2 = nN_L \cos \theta \cos \phi + nN_L \mu_{cg} \sin \theta + 2N_H \mu_{cg} \sin \theta \quad (5.3.6)$$

$$T_S + r_s C \mu_{lg} + nN_L \mu_{cg} r_i \cos \theta + 2N_H \mu_{cg} r_i \cos \theta = nN_L r_i \sin \theta \cos \phi + T_H \quad (5.3.7)$$

These last two equations can then be combined and rearranged to give equation (5.3.8).

$$T_H = T_S + nN_L \left[\mu_{gc} \cos \theta (r_s \cos \phi + r_s \mu_{gc} \tan \theta + r_i) - r_i \sin \theta \cos \phi \right] + 2N_H \mu_{gc} \cos \theta (r_i + \mu_{gc} r_s \tan \theta) - \mu_{gc} \pi P r_s^3 \quad (5.3.8)$$

Values for the known parameters can be substituted in for the variables in order to solve for unknowns.

Of note in this equation is the fact that T_H and N_H (the forces applied by the user) appear on opposite sides of the equation. This therefore means that as the grip applied by the user increases, the torque that must be applied by the user also increases (remember that the analysis is performed at the point at which the closure is starting to open). Therefore the force T_H is the force required to open the closure, and an

increase in N_H causes T_H to rise. N_H should therefore be kept to a minimum in order to lower the opening torque.

However, the torque applied by the user is given by the product of the grip force they apply, the friction coefficient between their hand and the cap and the outer radius of the cap. Hence equation (5.3.8):

$$T_H \leq N_H \mu_{ch} r_C \quad (5.3.8)$$

Therefore there must be a minimum value for N_H in order that the user can apply a high enough torque to the lid to allow opening. Depending on the nature of the contact between the cap and the hand and the cap and the glass, gripping too hard may make the closure impossible to open. If the friction between the cap and the glass builds up faster than that between the cap and the user's hand then the user will be unable to open the lid regardless of how hard they grip. They will always slip. Whether or not this occurs requires further testing and analysis to determine values for the remaining terms in the equation.

The relationship between the torque required to open the closure and many of the other terms in the equation is slightly more complex. However as a general rule increasing the vacuum of the jar (ie making the value of P more negative) will increase the required opening torque. Increases in the coefficient of friction between glass and cap will increase the required opening torque. A reduction in friction between the user's hand and the cap may increase the required opening torque as it will require higher grip forces during the opening process. Larger jars (with higher values for r_t and r_s) are likely to be harder to open than smaller jars. This is dependant on the relative values of the angles and the coefficients of friction.

5.4 Conclusions

As noted in Chapter 5.2, the force required to open a jar lid can be broken down into two parts – a grip force to hold the lid firmly, and a torque to twist off the lid. Minimum applicable levels must be reached for both forces in order to open the

closure. Although the user must still meet a minimum value for applicable torque, the grip force they can apply can also be used together with the friction data to calculate a theoretical limit for the torque that they can apply. As can be seen above, the grip term appears in both sides of the system equations governing opening. As this term appears in both sides of the equation an optimal value must exist for the grip force used. This should not be a surprise, as squeezing the lid will increase the contact pressure between the cap and glass, thus making the lid harder to remove. The optimal value of grip will give the lowest possible required opening force for the closure. Gripping with a force below this value will result in the user being unable to open the closure as their hand will slip before they can apply a high enough torque to the lid (assuming of course that they are strong enough to apply the required torque level). As the grip force is increased the maximum force that could be applied will also increase, until the optimal value for grip is reached. At this grip level the closure will open. Increasing the grip force above this value will not only increase the torque that the user can apply to the lid, but will also increase the torque required to open the closure. This is because the closure is deformable, and by applying higher and higher grip forces the user is pressing the lugs on the lid into the threads on the jar. This therefore increases the friction between the lug and the glass, and hence makes the closure harder to open. Note that providing the coefficient of friction is higher between the cap and the hand than it is between the cap and the glass the closure should still be openable at higher grip forces, it will just require a larger opening torque. If however this is not the case, the jar may become impossible to open when higher grip forces are applied.

6 Jar Opening Force Measurement

6.1 Introduction

In order to evaluate the performance of current products properly, the opening torque required to gain access to current products must first be measured. This gives an indication of the reduction in opening torque that will be required in order to consider the closure system to be inclusive.

To measure the opening torques for current jars, products were purchased 'off the shelf' from a supermarket, rather than obtaining the required samples direct from the manufacturers. In this way the measured torques are guaranteed to be identical to those experienced by consumers as they open the products they buy. By sourcing products in the same fashion as end users, this also ensures the measured values will not be affected by any time-dependent factors such as chemical interaction or relaxation of the closure materials.

By testing a range of sizes of jars, an indication of the force required for opening can be obtained. Similarly, an indication of the variation in opening torque can also be found for jars of the same size. This allows estimations of the numbers of people likely to be unable to open jars of various sizes. If the measured figures indicate that a certain percentage of people should have difficulty with a certain percentage of jars, and a similar percentage of people complain of openability problems this will indicate the results are likely to be correct. The accuracy of all the sections of the study can be checked in this manner.

6.2 Apparatus

The opening torques was measured using custom designed equipment. Due to financial considerations, it was first decided to build an analogue torque meter in-house. The proposed method involved using a torsion spring and sliding marker to indicate the applied force. Upon further investigation, however, it was seen that this indication method would not give a precise indication of the applied force at any instant in time, only the peak applied force. In order to more fully understand the force system required for opening, some quantification of the force-time curve was needed. Therefore, it was proposed to use an optical rotary encoder coupled to a digital counter. This approach would allow a force-time curve to be generated, and show the torque required to open the container at all stages of the opening process. A dual channel rotary encoder also allowed the direction of the applied torque to be shown. However, the cost of this optical encoder/torsion spring system was found to be comparable with that of a suitable commercial torque sensor. Using a torque sensor to directly read the torque resulted in an increase in accuracy and decrease in size and mass of the system. The deflections required to measure the torque using a sensor are also minimal, meaning that the sensor needs to deform very small distances to measure a range of torques. In contrast, a torsion spring must deflect a much larger amount to measure larger torques and still retain an element of accuracy. This would make performing the tests much more difficult. The sensor based method was therefore chosen as the best, both in terms of cost and accuracy and also ease of use.

In order to select a suitable sensor, estimations of the required torque were made using data from Adultdata³⁵. A sensor was chosen based upon the maximum values that people were able to apply, plus a generous factor added in to allow for the fact that jars may have higher opening torques than people can apply. A suitable sensor was selected that was capable of measuring torques across this range whilst being as compact, lightweight and cheap as possible. The base of the torque sensor was fixed to a large steel plate, which was then clamped to a solid tabletop. The other end of the torque sensor was attached to a clamp to hold the base of the jar being tested. The

clamp was designed to hold jars of varying sizes and shapes, hence independently movable arms were required. Additionally the clamp needed to be simple to machine to allow it to be made quickly and cheaply in-house. CAD software was used during the design process, and several potential designs were developed. The designs were ranked in terms of their ability to hold various jars, the cost to manufacture and their suitability to connect to the torque sensor. A CAD model of the chosen clamp design is shown in Figure 6.1 below.

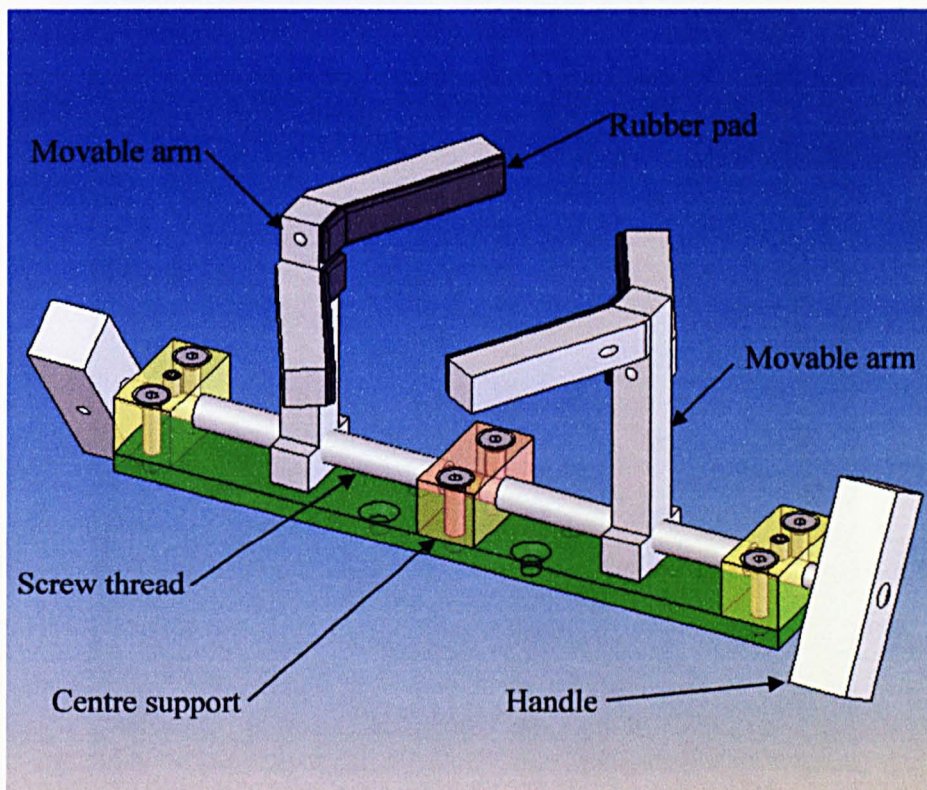

Figure 6.1 CAD view of jar clamp during the design process.

The clamping mechanism was designed such that the jar is held axially to avoid eccentric loading on the sensor as the torque is applied. The arms of the clamp were angled to allow a large range of jar sizes to be accommodated. Each of the arms can be independently adjusted by turning the handles. This turns the threaded bar that the movable arm is attached to, causing the arm to slide along the base rail. This allows oddly shaped or irregular jars to be held and subsequently tested. The sensor used

was designed to compensate for reasonable radial forces, and so these were not specifically controlled. The apparatus used for the testing is shown in Figure 6.2. The sensor used was a Futek T5160 100in-lb torque sensor, powered using a 12v supply. The output from the sensor was measured using a Pico USB TC-08 sampler connected to a computer. This sampler was chosen as it is low cost yet simple to use and provides excellent resolution at acceptable speeds with minimal extra required componets. The full apparatus as used for testing is shown in Figure 6.2.

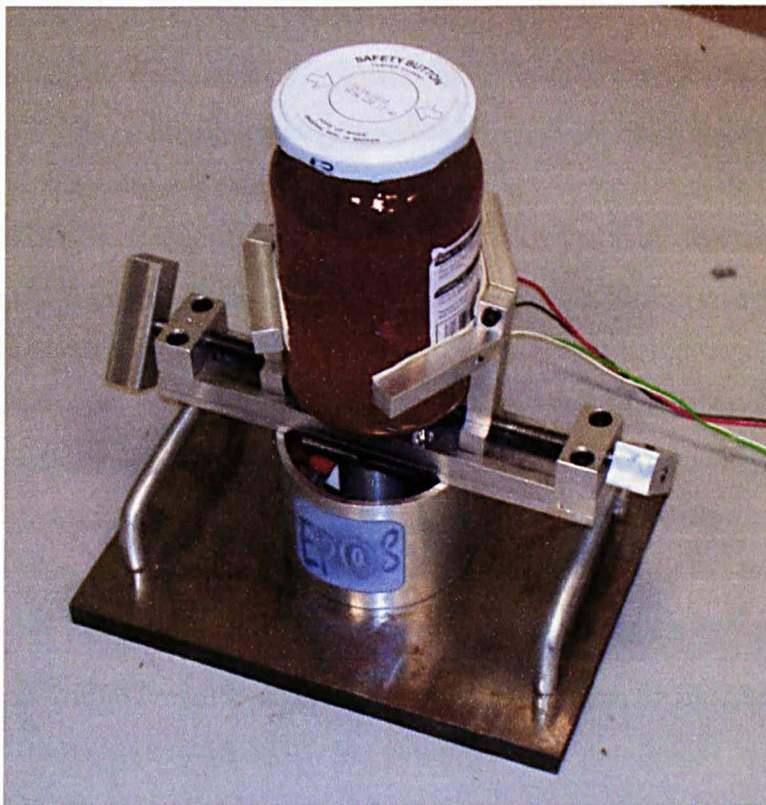

Figure 6.2 Photograph of the apparatus used to measure required opening torque.

6.3 Method

The apparatus was set up as shown in Figure 6.2. The base of the jar was centred on the jar holder. The arms of the jar holder were then tightened until the jar was

securely held in place. The axial alignment of the jar was then checked to ensure that the jar was perfectly aligned with the axis of the sensor, and adjustments were made if necessary. The alignment was initially checked visually, to check that the jar looked properly centred. The distance from the centre support to each arm was then measured, and adjustments made until both arms were equi-distant from the centre. The lower portion of the rig was rigidly clamped to a solid surface. The jar lid was then twisted until the closure opened. The torque required to keep the base of the jar fixed was monitored using the torque sensor and computer sampler.

To minimise as far as possible the effects of uncontrolled variables, all the jars were opened by a single operator, using the same hand and grip for each test. Before performing a test the operator washed and dried the relevant hand to ensure the start conditions were the same for each test. Care was taken to open the jars in a single movement, without stopping the opening motion during the test. The tests were performed in small batches to avoid any possible fatigue effects. To minimise environmental effects the jars were tested in 2 sessions, with half of the jars of each size tested during each session. The results from each session can then be compared to check that both sessions yield similar results. During each session, one jar of each diameter was tested in turn, and then the operator rested their arm briefly before conducting another round of tests. The order of the tests was shuffled to minimise further any possible fatigue effects.

For the test, jars with lid outside diameters of 55 mm, 65 mm, 75 mm and 85 mm were selected from a supermarket. As the purpose of test was merely to get an indication of the required opening torque only small sample sizes were used for each diameter, with ten jars of each size tested. Financial constraints also limited the number of samples.

After the testing process was completed, the peak opening torque for each jar was calculated and plotted on a graph of torque against diameter. A curve was then fitted to the data using MATLAB to allow comparisons to be made with calculated user applied torques.

If the best fit lines used for the grip and jar opening torque can be represented by an equation, then the applicable opening force and the required opening torque can be equated to calculate the minimum required friction coefficient for a user group to

open a jar. This will be the point at which a user will first be able to open a specific size jar. The size of jar will indicate the easiest to open jar for a given user group. As the coefficient of friction is increased from this value users will be able to open a larger variety of jar sizes.

6.4 Results

The output from the sensor gave a voltage-time trace as shown in Figure 6.3. The voltage output from the sensor is proportional to the torque applied to the sensor.

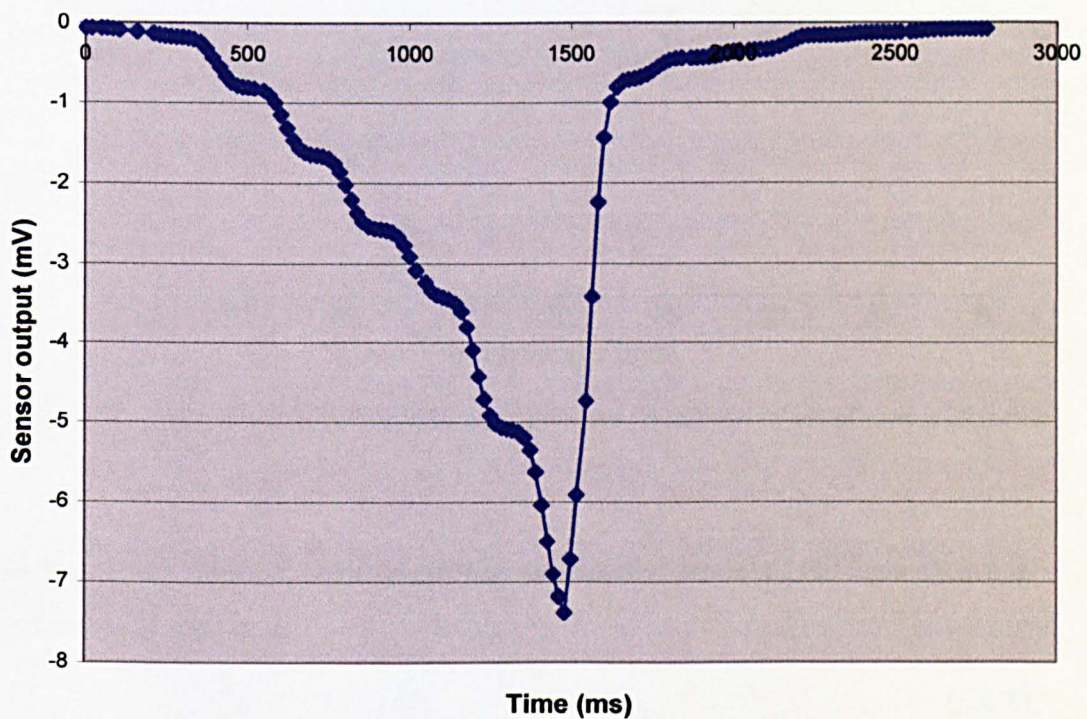

Figure 6.3 Graph showing sensor output whilst opening 75 mm jar.

As described above, the peak applied torque was calculated from the voltage-time trace for each opening test, and the required opening torques were plotted for each diameter jar lid on a graph of diameter against torque. A best fit curve was then fitted through this data to give an equation of opening torque against diameter for various

diameters of jar. Lines to indicate 95% confidence intervals were then added to give an indication of the opening torque for all available jars of different sizes.

The graph of diameter against torque is shown below, plotted together with the fitted curve.

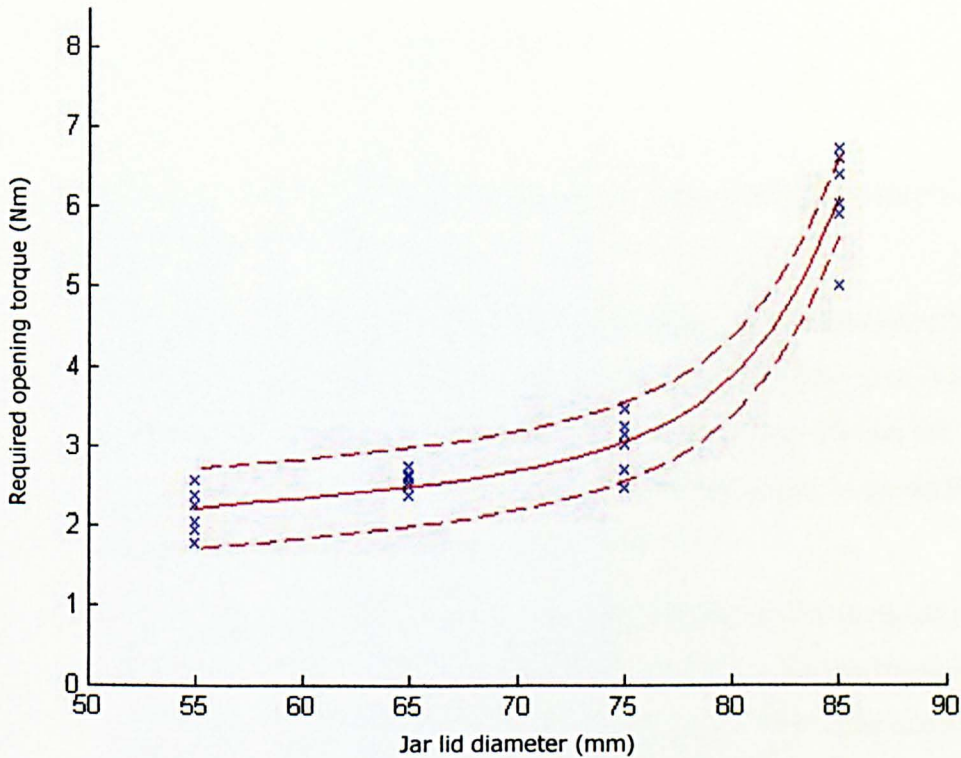

Figure 6.4 Graph showing the required opening torques for samples of jars of various diameters.

The curve fitted through the data used an exponential model of the form shown in equation 6.4.1 below.

$$y = a \cdot e^{b \cdot x} + c \cdot e^{d \cdot x} \quad (6.4.1)$$

where a,b,c,d are constants.

A curve of this type was fitted to the original measured data using all the available data points. This model was chosen as it best followed the observed trends of the points and resulted in a smooth curve.

These lines can then be plotted together with the torque that users can apply to a jar lid. This will give an indication of the sizes of jars that are likely to be able to be opened by consumers.

6.5 Discussion and Conclusions

As can be seen from Figure 6.4, the required opening torque increases rapidly as the diameter of the jar increases.

Due to financial constraints and limited product availability, jars of diameter larger than 85 mm could not be tested. However with reference to the above plot it is likely that the largest sizes of jar are harder to open still. Jars larger than 85 mm are uncommon for domestic use and so it was not considered necessary to spend further resources investigating the forces required to open them.

As can be seen in Figure 6.4, the torque required for opening increases rapidly as diameter increases. This may be for several reasons. Firstly, as shown by equation (5.2.1) in Chapter 5, the torque due to a force is dependent on the magnitude of the force and the distance it acts from the centre of rotation. Therefore if there are equal forces preventing the different sized closures from opening, this would result in higher torques being required to open the larger lids. This is because the forces will be acting a greater distance from the point about which the cap is being turned.

A further consequence of having a cap with a larger radius is that the cap also has a larger circumference, as the circumference of a circle is directly proportional to the radius. This means that the larger jars have correspondingly more liner material than smaller jars. Since this liner material is known to bond with the surface of the glass jar (as noted in Section 2.4.1.1), it is likely that having twice the contact area between the liner and the glass will result in there being twice as many bonds formed between the two materials. The forces required to break these bonds and hence open the closure will also therefore be proportional to the radius.

The overall effect of these two factors is that the force required to open the larger jars increases with the square of the radius, as the two proportional relationships compound each other. Although this does not fully explain the exponential relationship that the results seem to display, there may be further factors that also act concurrently that result in this relationship.

Another possible explanation concerns the way in which the closures are applied to the jars during the capping process. As the closures are applied by counter-rotating belts on the capping line, the resulting torque imparted to the lid will be affected by the size of the closure (for the same reasons outlined above – the belts apply a force to the outer edge of the closure, so a higher radius will result in a larger torque). If the same belt speeds and settings are used for all the sizes of jar, larger jar lids will be applied with far greater torques than smaller lids.

More work is required in the above areas to confirm or dispel these theories.

Comparisons with measured human strength data is given in Chapter 7.

7 Wrist-Twisting Strength Measurement

7.1 Introduction

As noted in the literature review (Section 2), all the previous work looking at human strength have used either geometries or materials that are not directly related to the opening of packaging. Also, as noted in Section 2.5.2, in order to truly design inclusively, the abilities of the user must be considered to guarantee they will be able to use the product. An accurate determination of the strength of consumers must therefore be performed before any recommendations can be made.

The most accurate method for determining the torque that a consumer can apply to an item of packaging is to measure the forces exerted as the user twists actual lids and jars. By using the same surface materials and geometries, any possible errors due to changes in the frictional properties or the position of the user's hands are avoided.

7.2 Aims and Objectives

The aim of this experimental work was to determine accurately the torque that users can apply to the lid of various sizes of vacuum lug closures. As shown in the literature survey (Section 2.2.2), all the previous studies on human wrist twisting strength were not directly relatable to jar opening, due to specific differences in the way the tests were carried out, differences in materials used for the tests or differences in the diameter or shape of the test pieces. The primary objective was therefore to design a system whereby the actual forces that users can apply to packaging are

measured. As noted in Chapter 2, the correct forces can only be measured by using the correct materials and geometry for any given situation. By designing tests based on this principle, the equipment can therefore be used to measure the actual opening strength users apply to various sizes of vacuum lug closure.

Much of the previous test data is based on results from equipment in which the jar is fixed to a tabletop. The user then applies a force to this fixed lid with one or both hands. This setup has also been mimicked in order to test the effect that this has on the torque that a user can apply.

7.3 Experimental Design

As detailed above, in order to properly measure human strength with regards to the jar opening process, new equipment needed to be designed and built. In addition, an experimental procedure needed to be developed to ensure that the way in which the opening situation was modelled was realistic.

7.3.1 Test Device Design

In order to ensure that the new device fulfilled all of the requirements for the new tests, a detailed checklist of necessary criteria was created. This checklist was derived from a brainstorm of the opening process and situation.

Device requirements:

- 'Jar hand' only in contact with identical materials to those in normal use.
- 'Jar hand' used with correct geometry.
- 'Lid hand' only in contact with identical materials to those in normal use.
- 'Lid hand' used with correct geometry.
- Device similar in mass to 'off the shelf' product.
- Device similar in appearance to 'off the shelf' product.
- Lid should remain fixed during the test (minimal relative movement between lid and base).
- Accurately measure applied torque.
- Indicate direction of torque applied.
- Range of sizes available, easy to change between.
- Device cost as low as possible.

The above requirement list was used to ensure that resultant designs addressed all of the problems that had been identified with previous investigations into human opening strength. By ensuring that the device is the same size, shape, and materials as original products it will ensure the user's hand interacts correctly with the tester. Similarly by controlling the appearance and weight of the device it will ensure that the user's unconscious reaction to the device will be as realistic as possible. If a subject thinks that they are opening a real jar, they will react as if they are opening a real jar, and hence allow the correct force to be recorded. Obviously, the primary function of the tester is to read the torque applied accurately. However, care must be used to ensure the torque is measured correctly. The values recorded during the test must not be affected by any other forces that the user may apply (such as vertical or radial forces). These forces would not aid the user to open a closure, and so must not influence the measured values. Similarly, the device must correctly record the direction of the force that the user applies, as a subject may be able to twist the lid harder in one direction than the other. Clearly applying the force in the wrong

direction will not open the closure, regardless of the level of force applied. In fact it may make the closure subsequently more difficult to open. The device must therefore be able to determine the direction of the torque, not merely its magnitude. The lid of the jar also should not markedly deflect relative to the base during the test. As can be seen in the typical force trace shown in Figure 6.3, the peak force required to open a closure only needs to be applied momentarily. As soon as the jar begins to open, the force required to open a jar rapidly decreases. Observing the closure during the opening process confirms that the lid barely deflects before it opens completely, and hence the maximum force occurs before any deflection takes place. The lid therefore should not move during the test, as any motion may indicate to the subject that the jar had opened and hence they need not put in any further effort. As the idea of the test is to measure maximum opening ability, the subjects must put in the maximum effort they can and not be dissuaded or confused by feedback from the test device that differs from that they will experience when opening actual packaging.

As with any product design there was a requirement to keep the costs down and produce equipment that was suitable for a variety of uses. The device therefore needed to be as simple to manufacture as possible. Any sensors or other potentially expensive components also needed to be removable so they could be used in other devices if necessary.

In order to keep the device costs as low as possible, it was originally decided to try to manufacture a purely mechanical system in-house to measure the torque applied by the user. However, after a detailed analysis of the system it was determined that a suitable torsion spring could not be manufactured at the required cost point, especially in low quantities. An accurate system of reading the applied torque from the mechanical torsion spring would further add to the required cost and complexity, whilst also pushing the device mass and dimensions over the required limits. The system design was therefore altered to contain an electronic sensor. The sensor chosen was a Futek T5160 100in-lb torque sensor. This is a lightweight, low cost, oem-type device with the required range and precision as noted in the literature search. This sensor allowed considerably higher precision than could have been possible with the mechanical system. The sensor is also the same model as that used in the jar opening torque measurements. This means the same sensor could be used

for both sets of tests, keeping the overall cost of the project down. Its low mass also allowed the design to remain within the allowable weight limits. A mounting system was developed with the use of Solidworks 2003 computer aided design (CAD) software to ensure that the components would fit together as intended. Simplicity was the main aim behind the design of the test apparatus. The simplest, and hence the cheapest and fastest design to manufacture was chosen. The fewest possible components were used in the design, and stock parts (such as nuts and bolts) used to reduce the number of machined parts. Wherever possible component dimensions were selected to match the dimension of the stock material the components would be made from. This greatly reduces the cost and time required for manufacture as less machining is required. Using aluminium for the bulk of the components in the system meant that little work was required to optimise the structure to reduce the weight of the design, which removed the need for time consuming numerical simulation work to check the integrity of the apparatus. CAD software was used to check that the final mass of the system would be within allowable limits. The volume and density of the resin was used to control the final mass of the jar to ensure the overall weight of the device was close enough to actual products of the same diameter. A CAD model of the 75 mm device during the design process is shown in Figure 7.1.

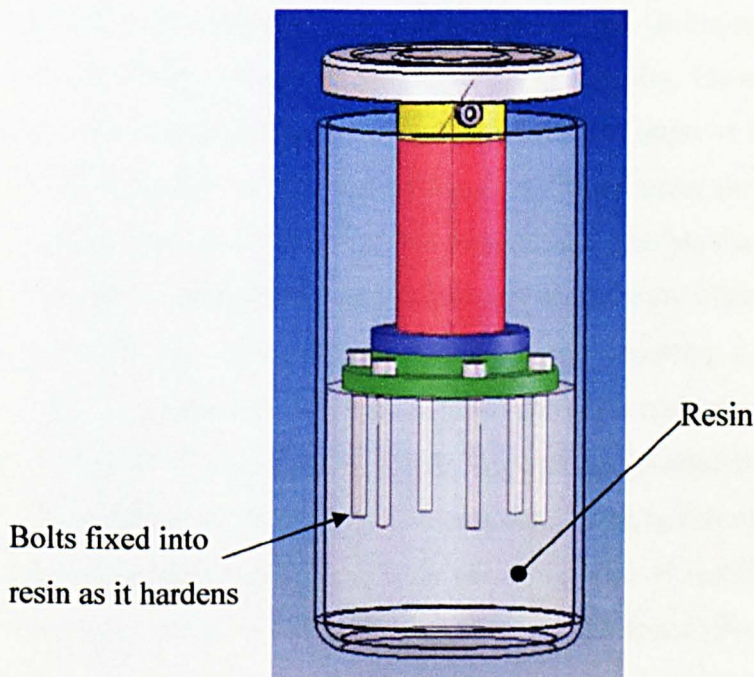

Figure 7.1 CAD model of the 75 mm torque device.

The final device consists of a glass jar that has had the screw threads removed from the top. The sensor is bolted to a plate, which is in turn fastened into a resin plug in the base of the jar. Protrusions are glued to the inside of the glass jar using a special epoxy able to bond to the glass surface. When the resin is poured into the jar it surrounds these protrusions, preventing the plug from spinning when a torque is applied to the structure. The remaining assembly was lowered into the resin before it set, allowing the resin to harden around the bolts. The outer surface of the glass jar was not altered. The jar lid was stuck to a plate using a two-part epoxy resin to ensure that the outer surface of the lid remained unchanged. The torque was transmitted to the sensor via a square drive socket, with the lid plate secured in place with a grub screw to prevent the lid coming loose during use. The height of the lid was set such that the gap between the lid and glass was kept to a minimum whilst allowing access to the lid removal screw. All the sizes of torque devices built used the same basic construction, however the dimensions of each component were adjusted to suit each size. All the dimensions and masses of the different testers were matched to actual products of various diameters. The sensor section in the middle of the device can simply be transplanted between sets of lids and bases to change the size of the tester.

The torque sensor used required a 10-15v supply voltage. Initially the sensor was connected to a variable voltage power supply set to 10 volts. However this was changed to make the equipment lighter and less bulky to improve its portability. The sensor was then supplied with 12 volts from an ATX computer power supply. This allowed a single computer to run both the sampler and provide the power for the sensors. The sensor calibrations were readjusted accordingly after the voltage change. The output from the sensor is in the form of a voltage, requiring a sampler capable of reading millivolts accurately. For ease of data collection and subsequent processing, a computer connected sampler was required. For cost and availability reasons a Pico USB TC-08 sampler was selected for this purpose. Although designed for reading temperatures from thermocouples, this sampler is capable of reading a millivolt scale with sufficient accuracy (20 bit on a $\pm 70\text{mV}$ scale) and speed give the required force-time trace.

7.3.2 Test Procedure Design

As above for the test device, a list of guidelines was also created for the design of the test. The following list of requirements was used to make sure that the test conditions were comparable to the way in which packaging is used by consumers.

Opening situation requirements:

- User-preferred postures used.
- Multiple attempts allowed during a test.
- Multiple grip types/changes allowed during a test.
- Subject encouraged during the test.
- Test stopped if any pain or discomfort felt.
- No standardised preparation for skin surface.

The opening process as performed by the user in the home needed to be closely mirrored by the test situation. A user opening a jar in the home would continue to adapt their grip or posture if they felt it would increase their applied opening torque. It was therefore considered unrealistic to enforce a standardised opening posture or grip on the subject. When opening a jar in the home a user would be spurred on by their desire to access the contents. Encouragement was used during the test to simulate this. However all subjects were told to stop if they felt any discomfort during the test. Packaging should not cause pain to the user, and therefore users should only be expected to apply forces that do not cause them pain. The test therefore was required to record the highest pain-free applicable torque.

A standardised skin preparation was avoided in this instance because it is important that the user's skin is in the same state that it would be when the user attempted to open the packaging in their home or other location. Whereas a standardised skin

preparation for testing would increase the repeatability of the test, it would decrease the accuracy of the results. The idea of the testing was to measure the forces a user can apply to packaging accurately. In order to do this the user, packaging and opening process must all represent reality as closely as possible. If the skin was prepared in a special manner this could affect the torque that a user can apply, and therefore reduce the accuracy of the results and hence the strength of the conclusions that could be drawn from them.

In order to properly measure the force that a person can apply to a vacuum lug closure in order to open it, the test apparatus should not deflect during the opening process. As shown Figure 6.3, the torque required to open a closure builds up to a maximum value then instantly drops as the closure begins to open. Therefore in order to properly replicate the opening process the closure should not move during the test in order to properly measure the maximum opening torque value that a user can apply.

7.3.3 Candidate Selection

In order to ensure that a true representation of the population was obtained, subjects from the full spectrum of society needed to be tested. The testing was therefore carried out on many different occasions and in several different locations. Testing locations included a public library, various university departments, a working men's club and an Age Concern day centre. This was to ensure that, as far as possible, people from all backgrounds were considered. Few details were gathered about the candidates unless they volunteered information regarding conditions that may affect their strength etc. This information was not collected as it was felt details of any conditions were not important – what mattered was the strength of the population, not the strength of certain groups of people with specific ailments. Some selection of candidates was used in that certain people were sometimes targeted over others, for example a person of specific age or gender may be specifically asked to perform the test if their demographic was poorly represented in the dataset. This was purely to maximise the effectiveness of each test session and to build up a useful and unbiased database as quickly as possible however. The database was continually assessed, and each group of candidates (for a specific jar size, age group and gender) was

monitored. Averages and deviations for each group were monitored to assess the number of required candidates in a group. Testing continued until each group of subjects contained enough data that adding further results did not significantly affect the averages for that group. The number of candidates required for this varied for each group, and candidates were not turned away from testing if they belonged to a group that was already well represented. There is therefore a variety in the numbers of candidates in each group. When time allowed, no person was declined if they wanted to take part in the testing, and certain groups may appear to be unfairly represented due to this fact. However it was felt that adding more test data was more valuable than having balanced numbers of subjects in each age and gender group. Having a group with more test results than another merely increases the accuracy of the average results for that group, it does not alter the accuracy of the averages for other groups. Hence whenever any subject was available they were tested, even if they were not specifically required, as this increases the accuracy of the dataset as a whole.

7.4 Method

7.4.1 Data Collection Apparatus

In order to measure the actual torque that people can apply to a jar lid, a torque sensor was embedded into a modified glass jar as described above. The threads were removed from the top of the jar to prevent them from interfering with the cap, however to ensure that the actual torque that can be applied was found, the jar lid and the outer surface of the glass jar were kept unchanged. A label similar to that found on consumer products was applied to the outside of the jar, again to mimic food products. An original cap was also attached to the embedded torque sensor, so that the operators hands only came into contact with the exact materials used in standard 'off the shelf' products. The cap was attached using an adhesive so that its outer surface was not affected. This was to keep both the appearance and surface finish of

the test piece as similar as possible to that of a real jar. The weight of the device was also considered – the weight of the tester was close to that of a full jar and visually it looked as similar as possible to the original product. This was to try to ensure that a subject’s behaviour in the test would be as similar as possible to their behaviour when opening a real product.

Table 7.1 Table showing mass of test devices compared to original products.

Jar Lid Diameter (mm)	Product Weight (g)	Tester Mass (g)	Percentage Change (%)
55 mm	499	513	2.7
75 mm	817	776	-5.3
85 mm	1031	954	-8.0

One of the torque devices developed is shown in Figure 7.2 (the 75 mm device is shown). The sensor used in each device was a Futek T5160 100 in-lb torque sensor, the top of which can be seen in the picture below. This sensor was designed to compensate for any lateral forces that the user might apply, so that only the actual torque applied was measured. The device was designed such that the sensors could be quickly and easily removed and replaced if necessary.

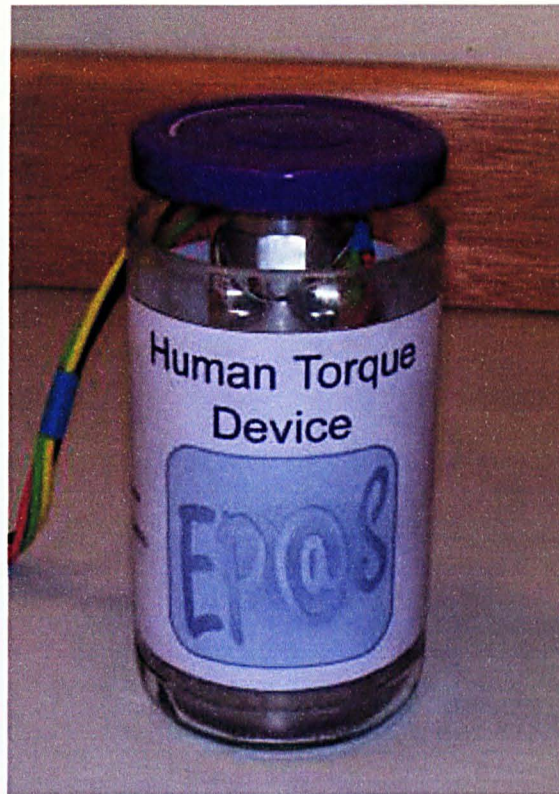

Figure 7.2 Photograph of the 75 mm torque device.

The torque sensors used were attached to a constant voltage power supply and a computer data logger. Initially the sensors were powered using a variable power supply set to 10 volts. This was changed for later tests however, to a 12-volt supply from a fixed voltage source. This was to reduce the size and weight of the equipment and hence improve portability. The collection of the data was handled by a computer, via a Pico USB TC-08. This sampler is primarily designed for use with thermocouples, but it provides 20-bit resolution on a $\pm 70\text{mV}$ range and so is ideally suited for use with the torque sensors. A photograph of the test setup is shown in Figure 7.3 and a diagram of the equipment is shown in Figure 7.4. The improved data collection and processing equipment used for later tests is shown in Figure 7.5.

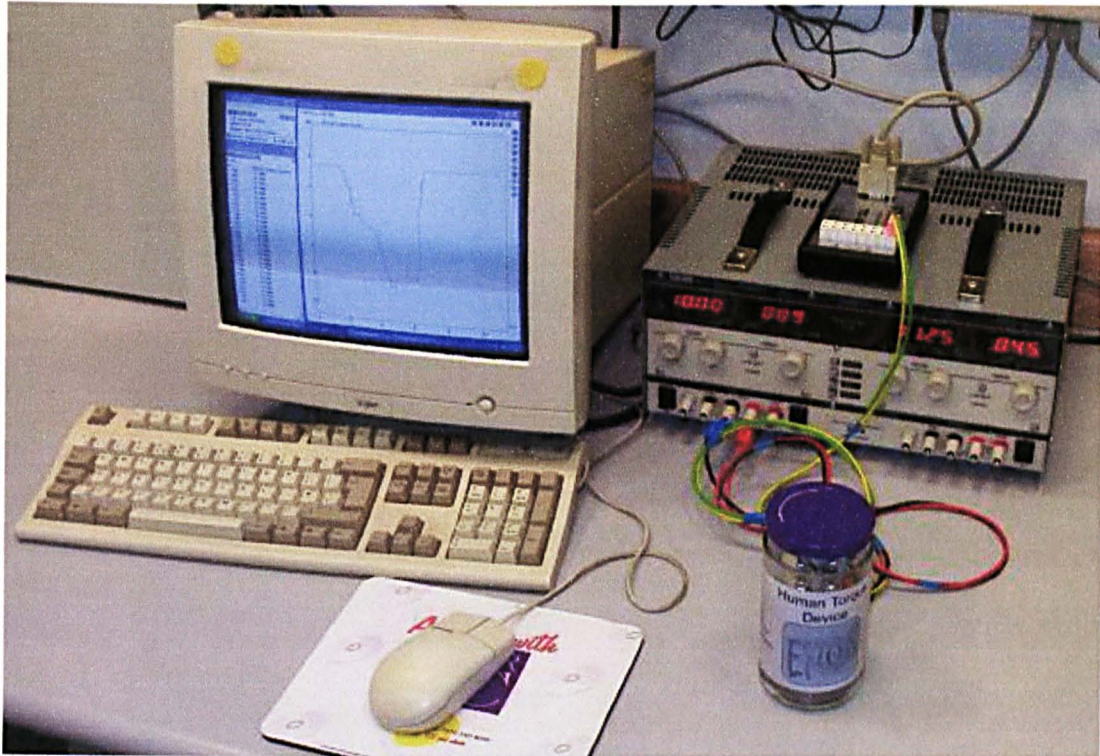

Figure 7.3 Photograph of the initial testing equipment.

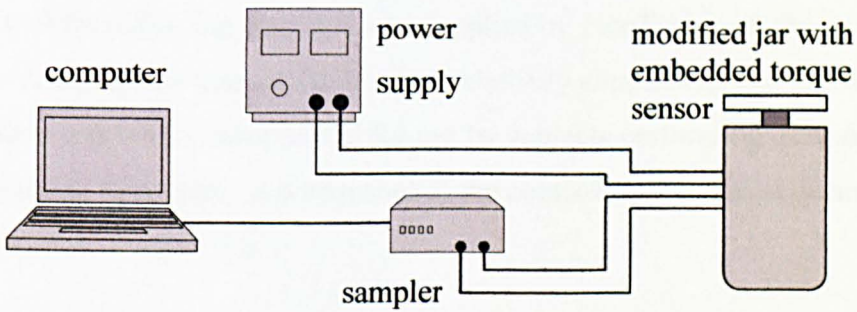

Figure 7.4 Diagram showing the connections between the tester device components.

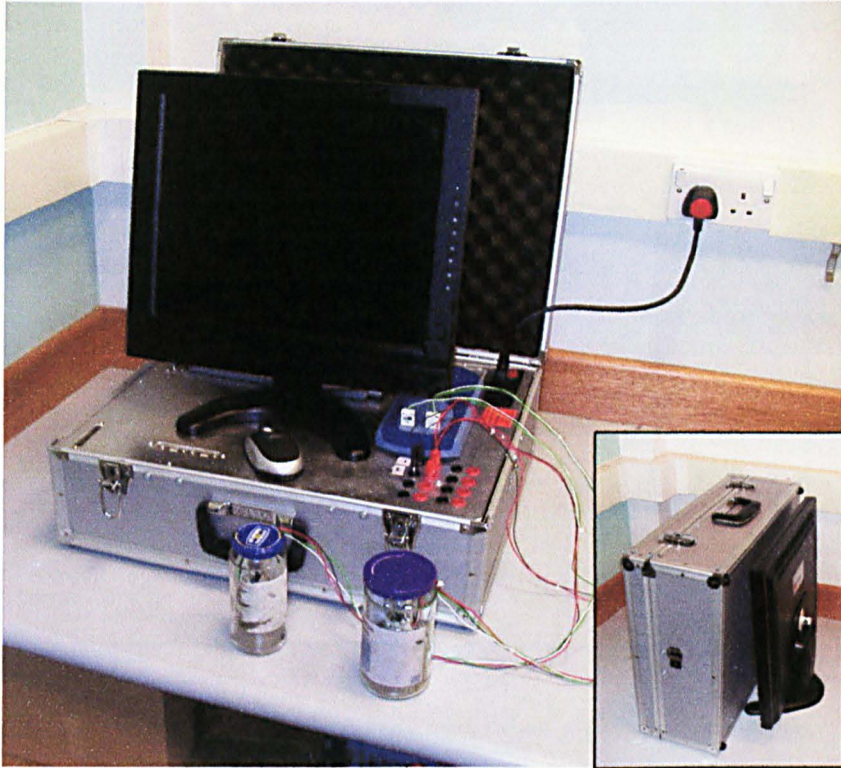

Figure 7.5 Photograph showing the improved testing equipment (inset shows equipment packed up for transport).

For the first phase of the testing, PicoLog software was used for data collection. This is a basic tool for collecting data, and was supplied by PicoTech with the sampler hardware. Although the data collection was relatively simple with this software, the user interface was overly complicated for use by subjects performing tests and required training to operate. A screenshot of the computer screen used during this testing is shown in Figure 7.6.

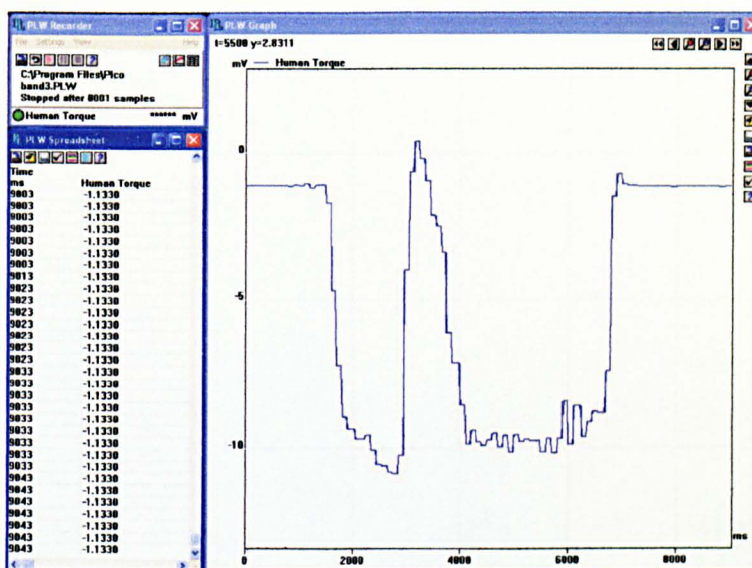

Figure 7.6. Screenshot of the PicoLog software used for data collection.

The software also could not analyse the data in any way, requiring all the analysis to be performed later. This proved to be very time consuming, because of the large numbers of tests that required analysis. For later tests, a graphical user interface (GUI) was written as a ‘front end’ for the PicoLog software using AutoIt v3. This is a scripting language primarily used to control Microsoft Windows and create user interfaces. The GUI provided a shield for the user from the complexity of the PicoLog user interface whilst still offering all the required functionality. The interface also only allowed the correct method for sampling data to be followed, ensuring no data could be lost or overwritten. It was also used to collect the required information about age and gender from the user, and recorded these along with the test data. By recording this information as the tests were performed it ensured that no data was lost or missed and it was easy to keep track of all the results. This software approach also allowed the data values to be stored in a format that simplified the subsequent analysis of the data, minimising the time taken for post processing. Screenshots of the GUI can be seen in Figure 7.7. Further code was written in MATLAB to process the data, reducing the time spent on post processing. This also

allowed graphs of user's strength against age or closure diameter to be shown in real time, acting as additional feedback to ensure the test has been performed correctly.

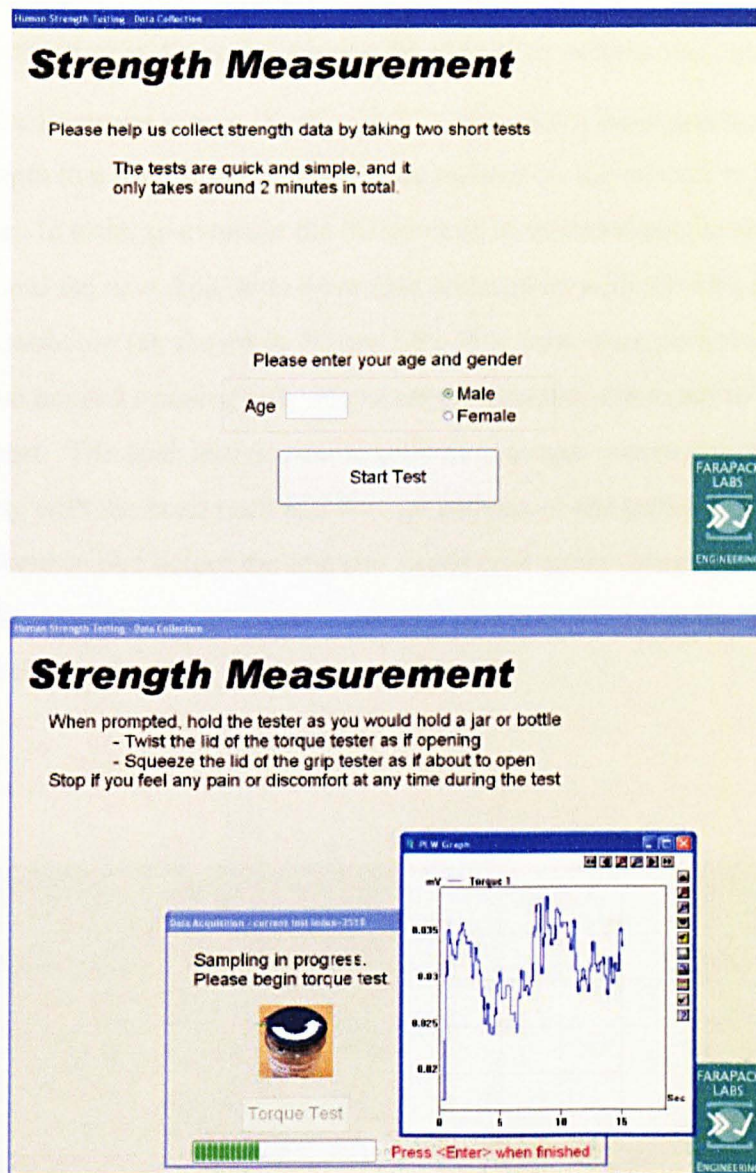

Figure 7.7 Screenshots from the improved sampling computer GUI.

Due to hardware limitations of the computers used for data collection, the above approach proved to be rather slow, as the computer needing several seconds to set up and finish each test, and even more time to perform the post processing. The method was not very efficient as the PicoLog software needed to be opened and closed for

each test to prepare the sampler properly for data collection. There exists the possibility to write code to interface directly with the sampler using libraries supplied with the hardware. This method would greatly improve the performance of the system, reducing any delays during the test. A new system to combine the data collection, processing and storage is being developed to address these problems.

As noted in the literature search (Section 2.2.2), there have been previous studies into opening strength that used fixed lids that were twisted by the subject to measure the opening force. In order to evaluate the differences in recorded torques between these prior studies and the new data, tests were also undertaken with the torque device clamped to a table top (as shown in Figure 7.8). The tests were performed in the same way as the two handed opening test. However participants were told to only use one hand for the test. The peak anticlockwise (opening) torque was measured and recorded along with the hand used and the age and sex of the participant. The subject was then allowed to rest before the test was performed again using their other hand. For this test the ages of the participants were restricted to a narrow band, so that age did not affect the results.

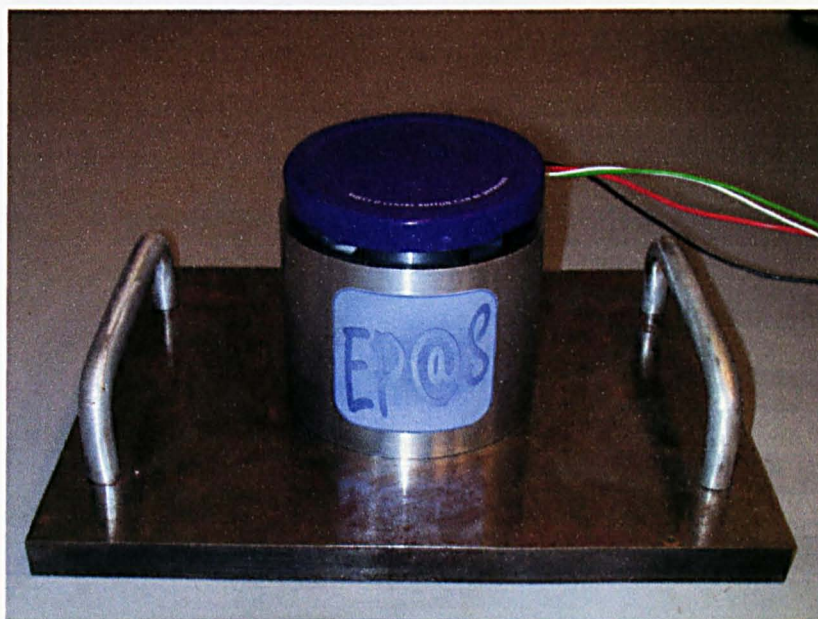

Figure 7.8 Photograph of the fixed lid torque measuring device.

7.4.2 Experimental Procedure

The tests were carried out on several different occasions. Each subject was tested individually, and asked to twist the lid of the tester in the same manner as they would normally open a jar (see Figure 7.9). They were not told that the jar lid would not open to ensure that they put in maximum effort. Subjects chose whether to stand or sit for the test, and could pick up the jar or leave it resting on the table. No type of grip was suggested, and multiple attempts using different postures or grips were allowed. Subjects were encouraged during the test to make sure that they applied the highest torque that they could, but were instructed to stop if they felt any pain or discomfort during the test. The encouragement was again to ensure that the subject put in maximum effort for the test, mimicking their desire to access the contents of the jar. After taking the test, the subject was shown the computer output. If they felt they had not used their maximum torque they were given the option of repeating the test. The peak torque applied by each subject was then calculated and recorded together with the age and sex of the participant.

The single-hand comparison tests were performed in the same manner as above, with the fixed lid device (shown in Figure 7.8) used in place of the two-handed test apparatus. The only difference with this test was that the subject was not allowed to pick the device up from the tabletop as they were with the two-handed opening test, as the base was fixed to the table.

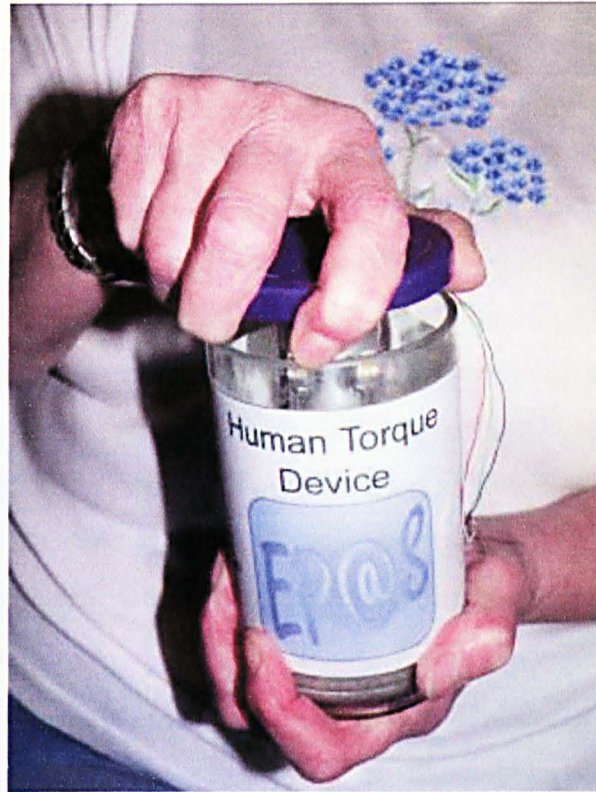

Figure 7.9. Opening torque measuring device in use.

7.4.3 Data Analysis Method

To analyse the result, the data was arranged into several groups in order to investigate several effects. This approach was needed to identify any trends due to age, gender and jar size. A separate comparison was also needed to quantify any differences between the 'fixed lid' tests, in which the jar lid was clamped rigidly to a tabletop, and the 'free jar' tests, in which the jar device was held in both hands.

To investigate changes due to age, the records were first split by gender and diameter. The resulting data was then divided by age, and the mean and standard deviation torque for each age decade were calculated. A graph of mean ± 1 standard deviation torque against age was then plotted for each diameter. Separate curves for males and females were plotted on the same curves to allow comparisons between the genders.

In order to show how changing the diameter affects the applied torque, the data was grouped by age. Restricting the age range ensures that age will have only minimal effect on the measured torques, allowing diameter effects to be seen. Upon inspection of the graphs of age versus applicable torque (Figure 7.10, Figure 7.11, Figure 7.12 and Figure 12.1), it was noted that the data exhibits a rough plateau across the middle of the age range. The forces that users can apply then begins to drop with increasing age. To minimise the effect of age it was therefore felt appropriate to split this plateau from the declining section of the results, and a cut-off of 60 years of age was select as the best compromise for this. Two age groups were chosen for each gender – 30-60 years old and 60+ years old. This split also resulted in two age groups covering approximately 30 years, as the oldest subjects tested were around 90 years old. The mean and standard deviation for the applied torque at each diameter by each age group were calculated. Graphs were plotted of torque against diameter for each of these age groups.

To fully determine the number of people able to open closures of various sizes, population distribution data for the UK was used. Assuming a normal distribution for the spread of people's strength at any given age, estimates for the strength of each individual in the entire population can be made. The number of people below the required jar opening force can then be determined for each size of jar. From this a percentage of the population that can open jars of different sizes can be calculated and hence the performance of the closure system can be rated.

By changing the values used for required opening torque in the calculations above, it is also possible to predict the numbers of people that will be able to open jars should the required torques be lowered. This can be therefore be used to determine opening limits for future designs.

7.5 Results and Discussion

In this study, 1142 people were tested (523 females and 619 males). The age of the subjects ranged from 8 to 95 for the women (8 to 93 for the men). There was an approximately even spread of subjects across the ages ranges. This is with the exception of the 30 mm closure however, for which only limited testing was performed (for more details see Appendix 1, Section 12.1). The numbers of candidates in each group is listed in Appendix 2. The peak applied torque in the anticlockwise direction was calculated for each test using a calibration curve for the test sensor. This was recorded with the age and gender of the participant in preparation for the various parts of the analysis.

Four different diameters were tested – three of which were vacuum lug closures and the fourth a ROPP closure as found on spirit bottles and carbonated water etc. The VLCs used had outer diameters of 85 mm, 75 mm and 55 mm. The 55 mm lid was the smallest standard VLC-type closure that could be found in local shops. Additional testing was also performed on a 30 mm ROPP closure to provide a comparison. The data from this testing is presented in Appendix 1 (Chapter 12). All the lids used were from standard ‘off-the-shelf’ products.

7.5.1 Torque against Age

For this section of the analysis, the torque results were taken for each diameter of jar lid and split by gender. The data was then divided into age groups, separated by decade. For each decade the mean average and the standard deviation was calculated. Graphs of mean torque against age could then be plotted for each jar lid diameter. These graphs can then be used to give an indication of the average strength of the population with relation to age for a specific jar lid size. Mean \pm 1 standard deviation curves were also plotted on the graphs to indicate the spread of strength values for each age group. On each graph in this chapter, the green lines represent the male data

and the blue lines represent the female data. The solid lines give the mean results, and the dotted lines show mean ± 1 standard deviations. The dotted red line shows the measured opening torque for a sample of the closure being tested.

7.5.1.1 55 mm Diameter Lid

Test results from 509 participants (285 males and 224 females) were used in this section of the analysis. The data was processed as described above, and plotted on age and torque axes. For comparison the mean opening torque for a sample of the type of jar used is also shown. The results can be seen in Figure 7.10 below.

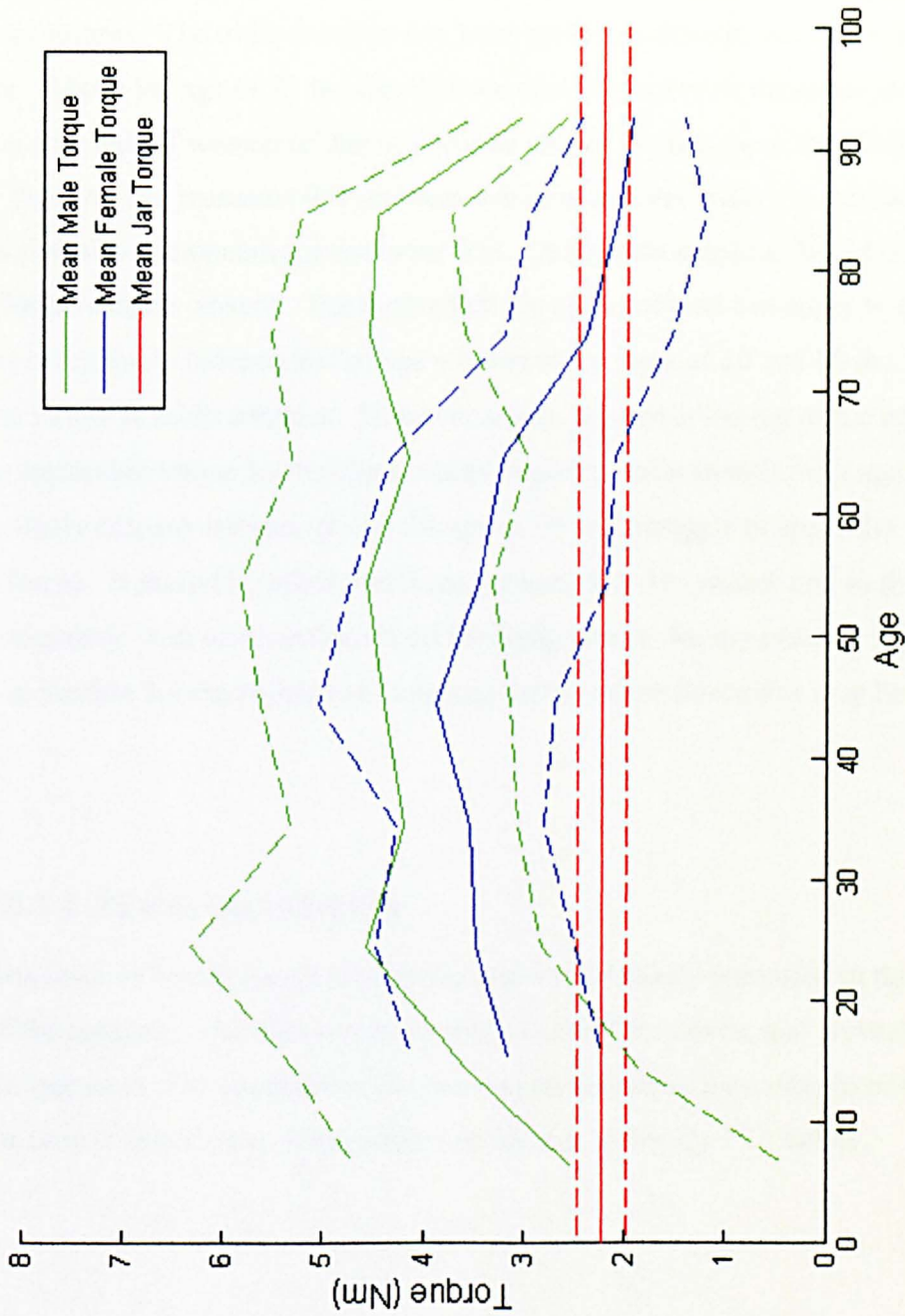

Figure 7.10. Graph of mean applicable torque against age for a 55 mm VLC.

From the above graph, it can be seen that few people have problems opening this size of closure. For most of the age range the mean and standard deviation lines are well

above the mean jar torque. Younger children may have problems with the closure, however this is not really a problem as there is little need for children of this age to open such closures. The older females also have problems though, and this is more of a concern. Above the age of 75 the female mean line drops below the mean jar line, indicating over half of women of this age will be unable to open more than half of the jars they buy. As age increases this problem worsens, and the mean + 1 standard deviation line also approaches the mean jar line. Older male subjects should not have any problems with the closure. The torque that the male subjects can apply to this size of jar is relatively independent of age – between the ages of 20 and 80 the applicable torque is fairly constant. However as can be seen at the top of the age range the applicable torque by the oldest males begins to drop sharply with age. It is therefore likely that any subjects above the age of 95 will struggle to apply the required forces. It should be noted that there are very few 95+ males, and so this is not a demographic with much influence on the design limits for the system. However as noted in Section 3.4 the population is ageing and so in the future this may become an issue.

7.5.1.2 75 mm Diameter Lid

Test results from 317 participants (161 males and 156 females) were used in this section of the analysis. The data was processed as described above, and plotted on age and torque axes. For comparison the mean opening torque for a sample of the type of jar used is also shown. The results can be seen in Figure 7.11 below.

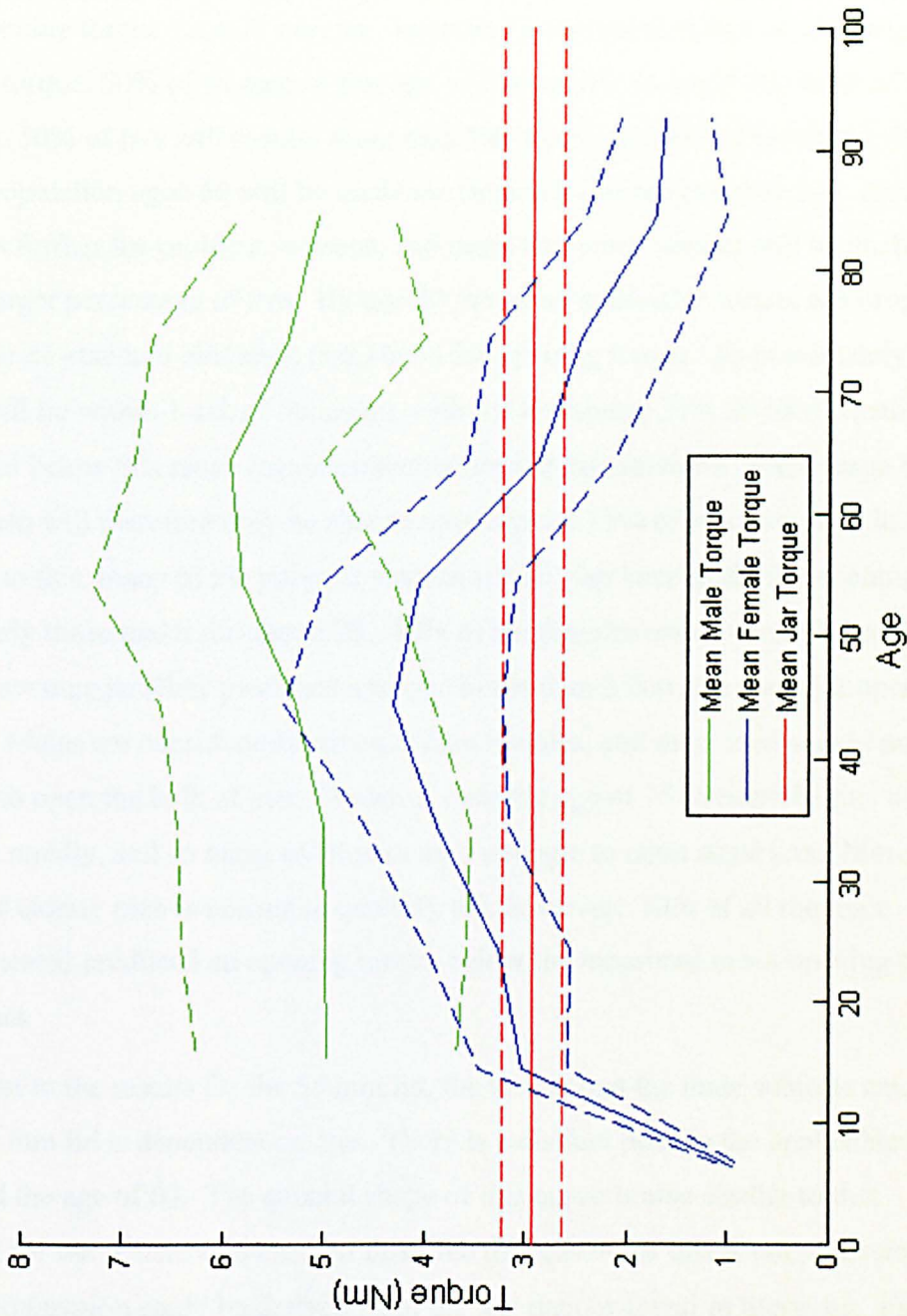

Figure 7.11 Graph of mean applicable torque against age for a 75 mm VLC.

Figure 7.11 shows the results obtained graphically, with mean applicable torque against age for a 75 mm vacuum lug closure.

As can be seen from this graph, much of the female population will struggle to open some jars. At age 65, the mean strength for females drops below 3 Nm, the measured mean opening torque for a 75 mm jar. Assuming a normal distribution of strength and opening torque, 50% of women of this age will be unable to apply this level of torque. Similarly 50% of jars will require more than this torque to open. Therefore half the female population aged 65 will be unable to open 50% of the jars they buy. As age increases further the problem worsens, and more and more women will be unable to open a larger percentage of jars. By age 80 the mean applicable torque has dropped below the ± 1 standard deviation (s.d.) band for opening torque. Approximately 69% of jars will lie within 1 s.d. of the mean, with the remaining 31% divided equally above and below this range (again assuming normal distribution). An average 80 year old woman will therefore only be able to open around 15% of jars (around 1 in 7). In addition to this, many of the younger women would also have difficulty opening jars, particularly those under the age of 25. 40% of the females tested would be unable to open an average jar (they produced a torque lower than 3 Nm, the mean jar opening torque). Males are considerably stronger than females, and most men should not struggle to open the bulk of jars. However over the age of 75 strength begins to decrease rapidly, and so many older men may struggle to open some jars. More testing of elderly men is needed to quantify this however. 10% of all the male subjects tested produced an opening torque below the measured mean opening torque for the jars.

In contrast to the results for the 55 mm lid, the torque that the male subjects can apply to the 75 mm lid is dependent on age. There is a distinct peak in the applicable torque at around the age of 60. The general shape of this curve is also similar to that observed for the female subjects. At this time the reason for this is not understood, and no explanation could be derived from the test data or found in literature. Further testing may provide an explanation.

7.5.1.3 85 mm Diameter Lid

Test results from 274 participants (150 males and 124 females) were used in this section of the analysis. The data was processed as described above, and plotted on

age and torque axes. For comparison the mean opening torque for a sample of the type of jar used is also shown. The results can be seen in Figure 7.12 below.

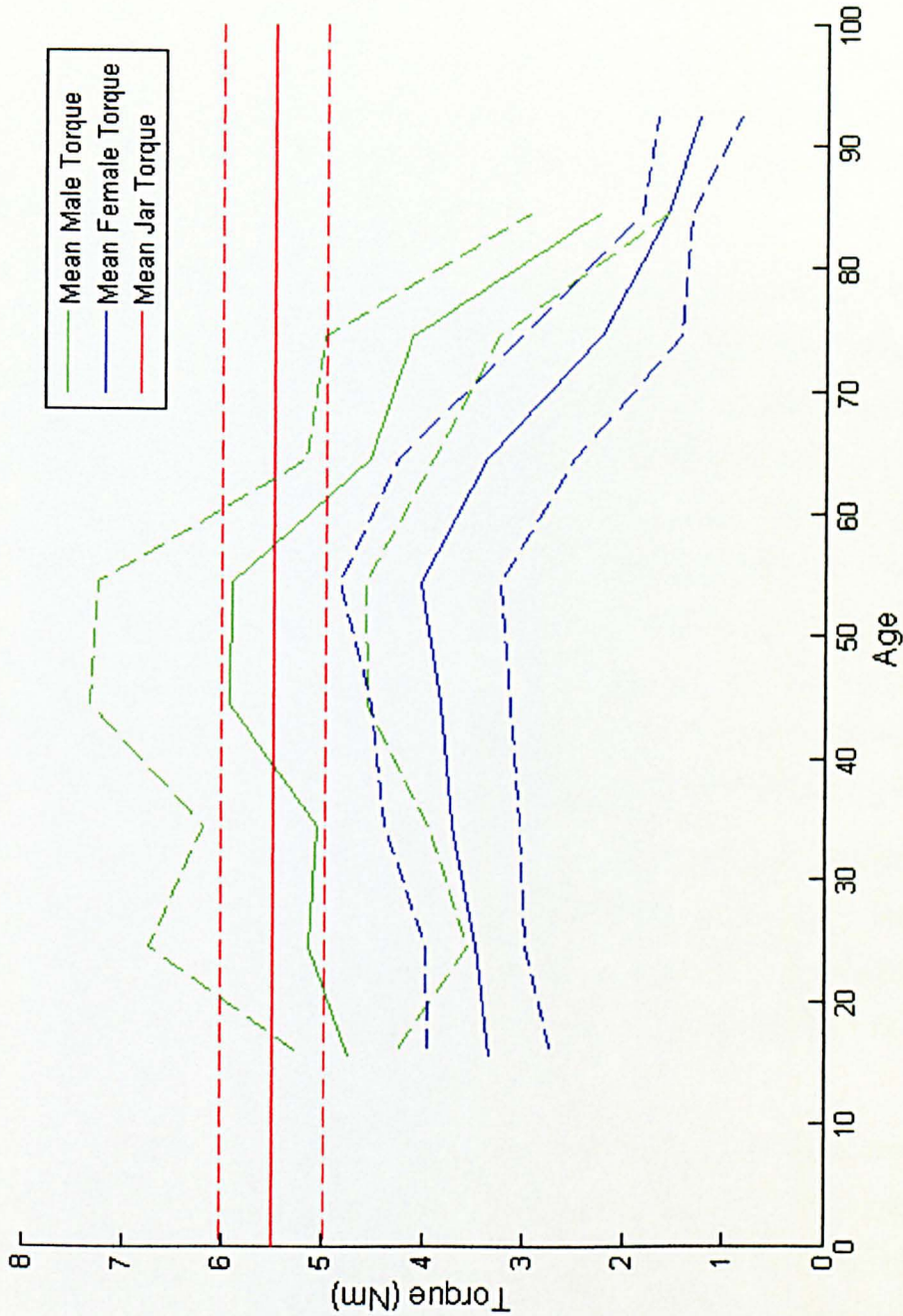

Figure 7.12. Graph of mean applicable torque against age for an 85 mm VLC.

As seen in Figure 7.12, the bulk of those tested will struggle to open most jars. Males between the age of 40 and 55 are the only group likely to be able to open more than half of the jars that they buy (as the mean applicable torque is higher than the mean required torque). Males either side of this band are, on average, weaker and therefore less likely to be able to open jars of this size, although until around the age of 60 the mean + 1 s.d. line is above the mean jar torque line, so that at least 15% of males should be able to open at least half the jars they buy. Above the age of 55 there is a sharp drop in the torque that males can apply, and so almost all men of this age and higher will be unable to open jars of this size.

For the female subjects, it is immediately apparent from the results that very few women of any age will be able to open this kind of packaging. For the entire age range the mean and standard deviation lines are well below the required torque lines, indicate simply that most women are not strong enough to apply the level of force required to open these large jars. It is interesting to note however, that although the female subjects are much weaker than their male counterparts for the bulk of the age range, as they get older the gap between the two sexes gets smaller and smaller as the male group loses strength faster with age than the female group. Further testing of elderly subjects, especially males, may even indicate that women become stronger than the men when opening larger jars as they approach the age of 90 and beyond.

These results were backed up by the comments recorded from subjects of both sexes during testing. Many people mentioned that they were often unable to open larger jars unaided, and had to resort to various tools to aid opening. The more elderly subjects often indicated that they would not buy products in such large jars as they knew that they would be unable to access the contents.

The results from this test exhibit the same approximate shape curves as for the smaller two sizes (with the exception of the male data for the 55 mm jar lid). However for this jar the drop in strength with increasing age is more marked than for the smaller jars, with rapid reductions in strength observed for both the male and female subjects. The reasons for this are not fully understood, however, but it highlights the greater problems that elderly users are likely to experience with larger jars. This confirms the need to test people of a wide range of ages on different sized closures in order to properly assess the openability of a design.

7.5.2 Torque against Diameter

For the investigation into the effects of diameter on the torque users can apply, data from 908 tests was collected. There was an approximately even spread of subjects between the various age and gender groups. For details of the numbers of subjects in each group see Appendix 2. To minimise the effects of aging on the results, the age groups were restricted for the test. Young and older groups were created for each gender. The younger group consisted of subjects aged 30-60 years old. The older group contained those volunteers aged over 60. Note that, although the same test data is used for this analysis, the numbers of subjects in this section of the investigation is lower than that for the Torque against Age investigation (Section 7.5.1) as the subjects below the age of 30 are excluded from this analysis. The age groups were chosen after examining the Torque-Age graphs presented above. Generally it was observed from the graphs that measured ability formed a plateau between 30 and 60, with lower recorded values either side of the band.

Data for the 30 mm ROPP closure is not presented on the graphs. As noted in the literature review, human strength data is very dependent on the geometry of the situation. Although ROPPs are straight walled closures and therefore similar to the VLCs used in the rest of the study, the wall height is considerably longer. This may impact on the applicable opening torque, and so the results from the two closures are not directly comparable. Graphs of opening torque against age for the 30 mm closure are presented in section 12.1 however.

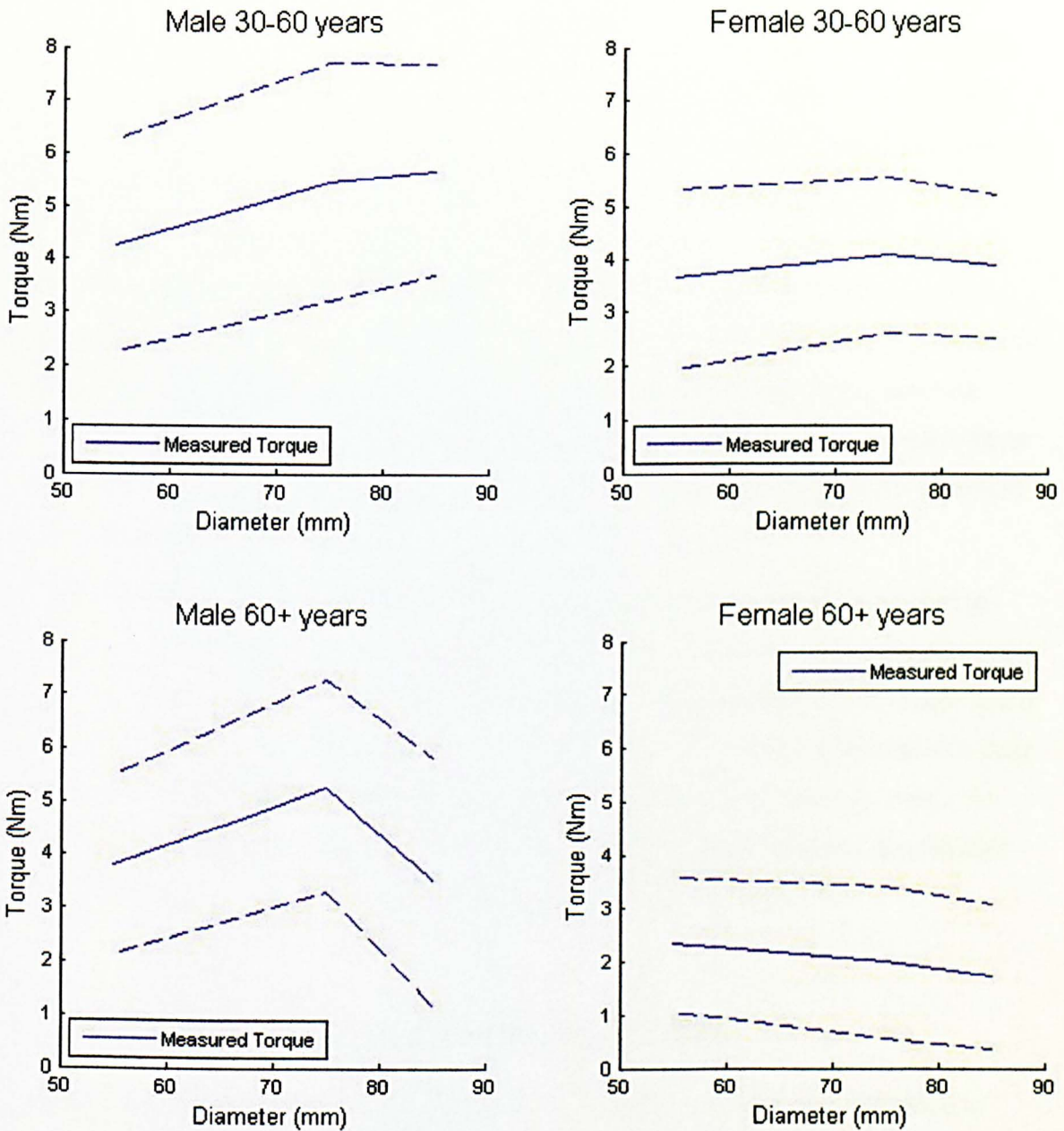

Figure 7.13. Graphs of applied torque against lid diameter for each age group.

As can be seen in Figure 7.13, diameter has a pronounced effect on applicable torque for male users. Younger males can continue to apply higher torques with increasing diameter (within the diameter limits tested). The older males are able to apply similar levels of torque to the smaller closures. In contrast to this, the older males can apply

far lower torques to the larger closures. This means that, although younger men may not struggle to open larger jars, as the subjects age they may begin to have problems. The reason why the older men can match the ability of the younger group for smaller closures yet are much more sensitive to the larger diameters is unknown at this time. The fact that the male subjects can apply differing levels of torque to the various sizes of jar may indicate that the torque the males can apply is limited by the amount of force they can transmit to the lids with their hands and wrist. The different sizes of lids may affect the grip a user can apply, and hence the torque that user can apply before slipping. The fact that the applicable torque is dependent on diameter therefore indicates that a male will slip before they can apply the maximum forces they can generate with their arms. This would need to be verified by a series of experiments to measure the forces that male users can apply with their arms if not potentially limited by slipping on the closure.

The younger females can apply higher torques than their older counterparts for the entire diameter range. However both young and older females are able to apply similar levels of torque to jars of all diameters. This might imply that the torque that a female can apply to a jar lid is dependant on the force that they can generate with their arm rather than the force they can transmit to the jar using their hand and wrist. As the maximum torque is largely independent of diameter, it may indicate that females are unable to generate enough torque to begin to slip on the closure.

7.5.3 Fixed Lid vs Free Device Comparison

For this investigation, 50 subjects (26 male, 24 female) were tested as described in Section 7.4 to determine the torque that they could apply to a 75 mm jar when the device was held freely in both hands. All the subjects were aged between 17 and 26 to minimise any possible age effects. The subject's gender and dominant hand was recorded together with the highest applicable torque they could generate with each hand. 30 of the above subjects were then re-tested according to the method outlined in Section 7.4.2 using the fixed jar lid apparatus (Figure 7.8). Each user was tested using each hand individually, and the highest anti-clockwise torque they applied was

recorded for each hand. The mean and standard deviations were then calculated for each test and comparisons made between the results.

No correlation was found between the relative force a user could apply with their dominant hand and their non-dominant hand. In fact, in almost all cases, users were stronger when using their left hand to turn the jar lid, regardless of their hand dominance. Hand dominance was therefore ignored in the resulting analysis, with the comparisons focusing on the difference between the forces applied with the left and right hands instead.

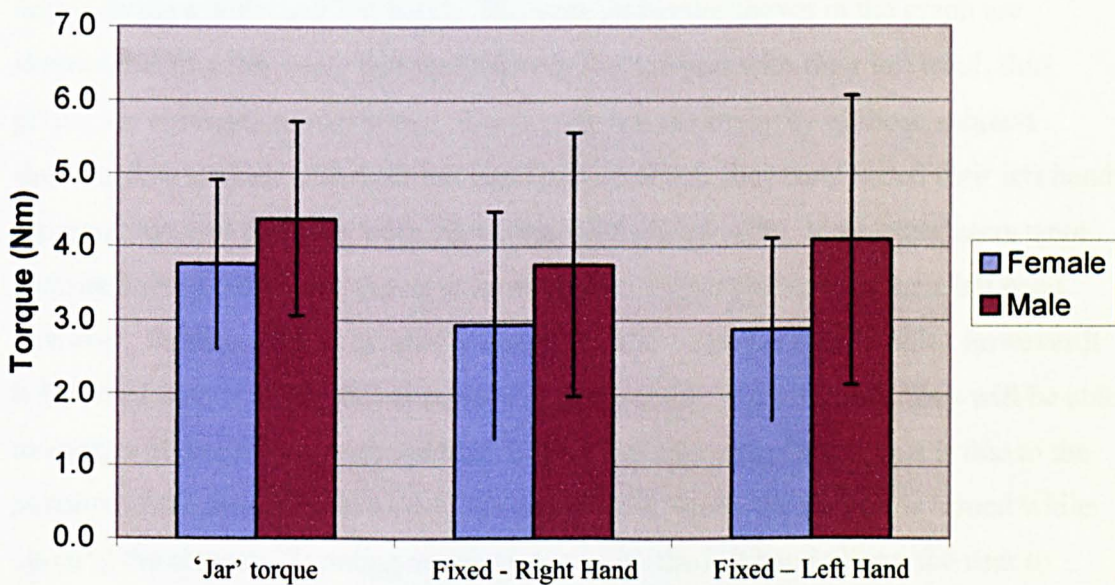

Figure 7.14 Graph showing the comparison between fixed lid and 'jar' measured torque.

The test using a fixed jar turned with 1 hand produced consistently lower results than that using the free jar and two hands (23% lower for women, 11% lower for men). This shows that tests done in this manner are likely to underestimate the forces that the user can apply to a jar in real use. This may seem like a test based on this previous method will be valid, therefore, as designs based upon its results will be easier to open than expected. However, underestimations of user strength have a serious drawback. If designs are based on limits derived from single hand type tests, the limits will be lower than required for adequate user openability. It is reasonable to expect that making products easier to open whilst retaining the structural integrity of

the package will increase costs, as resources must be spent on redesign, prototyping and evaluating the improved versions. Using these tests will therefore result in increased costs for the manufacturer as products will be over-engineered. These increased manufacturing costs will need to be recovered, thereby increasing the cost of the product. Making the product easier to open than necessary may also increase the likelihood of packaging failure due to the jar opening in transit etc, further increasing costs. Setting the correct design limits is therefore important for the manufacturer as well as the consumer.

The graph seems to suggest that users apply the same torque with either their left or right hand. However this was not noticed in practise. The bulk of users applied higher torques with their left hand. The average results shown in the graph are skewed due to a few users that applied very low torques with their left hand, thus giving the averages shown above. During the test the majority of those subjects showing low torques with their left hand indicated that they rarely used their left hand for anything, and that they were very weak on their left side. Most other users were surprised when they were shown to have applied higher forces with their left hand however. Further work is needed to determine the cause for these results, however it is believed that, if a subject has arms of approximately even strength, they will be able to apply a higher torque with their left hand. The reasoning behind this is due to the position of the thumb in relation to the direction in which the closure is turned while opening the closure. Twisting anticlockwise with the left hand allows the user to 'push' with the thumb, using it as a lever to increase the contact force and hence the friction between the hand and the cap. With the right hand this is not the case, as the thumb is dragged across the surface of the jar and the mechanical advantage is lost. For the same reason it is believed that a user will be able to apply a higher force clockwise to a closure with their right hand. However if a (usually right-handed) person has an especially weak left arm, this will mask the effect and they will be stronger with their dominant right hand. The effect of a very weak left hand may also be compounded by a lack of technique with the left hand if they are not used to opening packaging in that manner. Further work must be done to investigate these hypotheses however.

The observed fact that many people can apply higher torques with their left hand may suggest that people would be able to apply yet higher forces with their right hand if they were twisting the closure in the opposite direction (i.e. when closing the lid rather than opening it). This may cause further problems, as if a person opened a jar and re-closed it themselves, they may re-apply the lid in such a way as to be unable to re-open it themselves. This possibility suggests that an ideal first step towards solving the openability problem would therefore be to change the direction of the threads on the cap, so a clockwise rotation is required for opening. However it was felt that this was not a viable proposition, as it would cause far more problems and confusion than it would solve. People are used to lids (and many other twisting devices, such as taps etc) being opened in an anti-clockwise fashion, and therefore the idea was dismissed. Hence no further testing was performed.

7.6 Validation

There are two possible methods available for assessing the validity of the data obtained. The results can be compared to other similar studies to check that the findings follow the same trends as in other tests. Secondly, the interpretation of the results can also be used to assess the accuracy of the data qualitatively. By comparing the results of surveys etc with the measured results it is possible to gauge if the data is likely to be correct. For example, if 50% of the subjects stated they had problems with jars and 50% of those tested produced a torque lower than that required to open a jar, it is likely that the results are accurate.

7.6.1 Quantitative Assessment

The results obtained followed the same general trend as those found in other publications, such as ‘Strength Data for Design Safety’⁹ and the study by Voobij and Steenbekkers¹⁷. The data obtained in this study is shown superimposed on the results from the DTI test data in Figure 7.15. As seen in this figure, the values obtained in

the new study are considerably lower than those found in the prior work. This may be due to the different materials used by the DTI, as their test device was made from aluminium and brass, and therefore has different surface properties to actual packaging. The new data mirrors the rapid drop in strength with increasing age shown for the 85mm closure, although the smaller lids do not seem to be as affected by diameter as in the previous tests. The result is that older males can apply lower torques to the larger jars than they can to smaller closures. This is significant for designers, as it highlights the problems some users will face if a larger closure is used. The values found also follow the same general trend as those previously found by Rohles¹⁴, yet they are considerably lower across the entire range. The results therefore follow the trends found in one previous study across the entire age range, and give similar results to 2 further studies for over half of the ages tested. It is therefore likely that the new test is accurate and that the existing data overestimates the strength of the elderly population, especially when using larger diameters.

It should also be noted that the new data is based upon tests on far more subjects than the prior studies. For example the DTI data used to plot Figure 7.15 below is based on just 59 tests across the entire age spread, with 24 of these subjects being below the age of 16. As these subjects are unlikely to need to open packaging, their significance in the test is limited. In contrast, the new study is based on tests performed on around 200 subjects and is therefore likely to be far more representative of society as a whole.

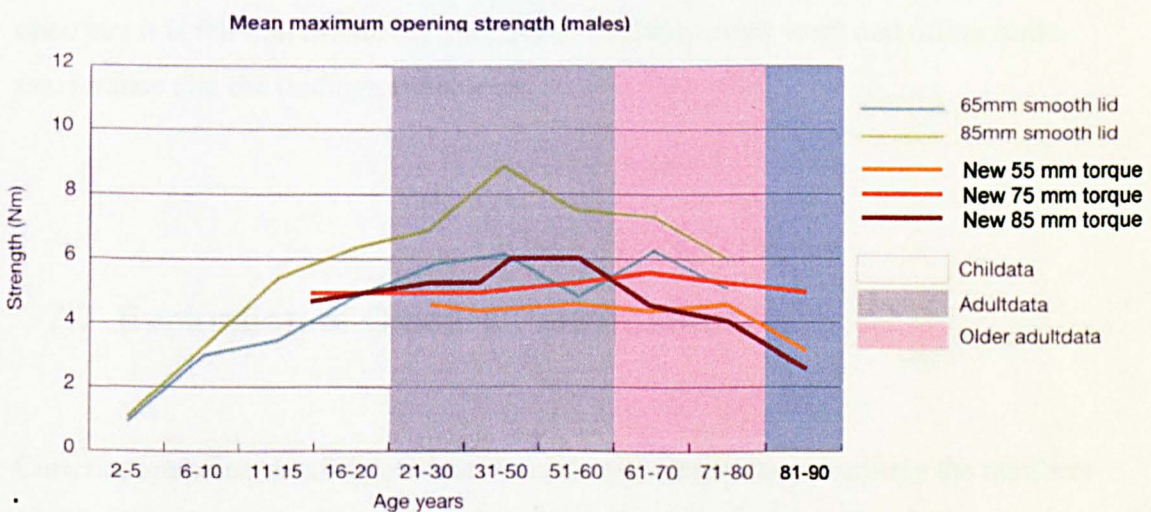

Figure 7.15 Graph showing comparison between DTI opening torque measurements and the values obtained in this study for male subjects.

7.6.2 Qualitative Assessment

The results can also be compared with the results of various surveys of the population. A packaging survey in 'Yours' magazine⁴, aimed at the retirement age group, stated that over 70% of the 2,000 candidates have had to abandon a product they were unable to open, and 91% needed to ask for assistance to open a package. Although these figures cover packaging of all types, jars were second on the 'worst thing to open' list. These statistics fit well with the values found in testing.

When talking to those taking part in the study, many of the elderly subjects also indicated that they had trouble with jars, with some even stating they would not buy jars as they could not open them. A number of female subjects across the entire age range also said they had problems with some jars, as the results suggest they would. Few male candidates under the age of 70 complained of difficulty with jars during the testing. Again this agrees well with the data, and suggests the results are accurate. However few men of any age complained that they were unable to open jars, yet this may be more due to social pressures rather than the subject's experience with packaging. As this survey of the subjects was performed on an informal basis, not all users were asked the same questions and not all responses were catalogued it cannot be statistically analysed and used to support the results of the study qualitatively. However as most of the complaints were made by those predicted to be unable to open jars it is felt that the survey supports the experimental work and offers some reassurance that the findings are correct.

7.7 Evaluation of Closure Performance

Current population distribution data is required to determine accurately the numbers of people that are currently able to open VLCs of various sizes. The Office of National Statistics' website²¹ contains demographic data for the current population of the UK (as of 2005). The site also contains predicted demographics for the UK

population. If it is assumed that there is a normal distribution of strength among all users of any given age, the proportion of users of that age able to apply a given force can be determined from the strength measurements. The demographic data gives the number of people of each age, and hence the numbers of people in each strength category can be calculated. An accurate map of the strength of each user can therefore be made, and hence the number of people able to apply the required opening force can be determined. By using the predicted data the effects of future population trends can be forecast. As noted in Section 2.2.3.1, the population in the UK is steadily ageing, and so this allows the possible effects of this ageing with regards to packaging to be quantified.

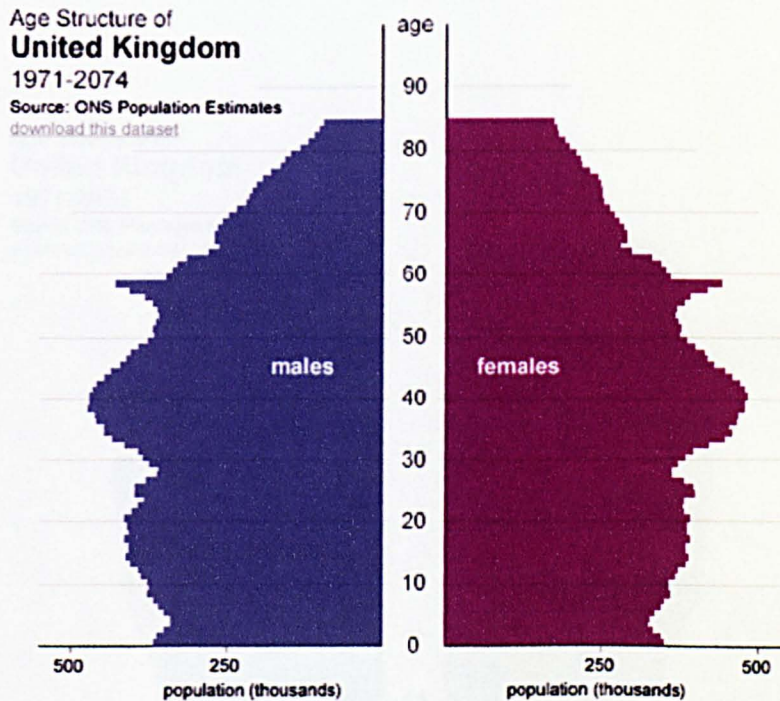

Figure 7.16 2005 UK Population demographics.

The current and predicted UK demographics are shown in Figure 7.16 above and Figure 7.17 below. The difference in the two distributions is marked, with a far larger percentage of older adults in the predicted demographics. As shown in the above analysis, strength begins to decrease with age, so this change in demographics will bring with it an associated loss of strength. The effect this has on openability is seen in Table 7.2, in which the percentage of people unable to open jars of each tested size

is given. The values used for required jar opening force are the average measured forces needed to open the jar samples found in Chapter 6. The strength-age distributions for the population for each size of jar were mapped onto the population-age distributions to give the number of people capable of generating levels of force to each size of closure. This was then compared to the mean torques required to open the jars to give an estimation of the overall numbers in the population that would be able to apply the required forces to open the jars, and hence the actual percentage of the population that would be able to open a specific jar.

This method allows the strength database to be adapted to give the numbers of people capable of opening jars as the population demographics changes.

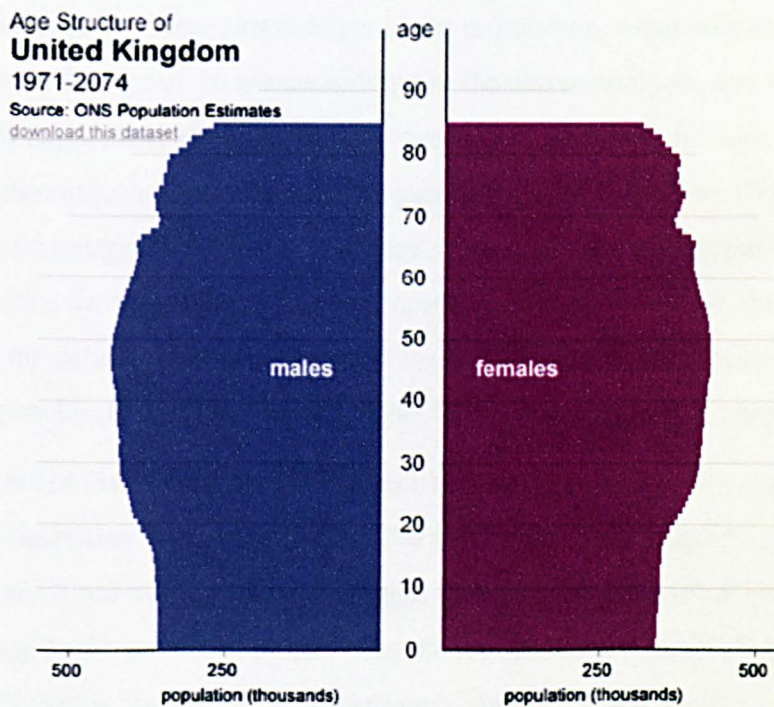

Figure 7.17 Predicted 2070 UK Population demographics.

Table 7.2 Table showing the percentage of males and females currently and predicted to be unable to open various sizes of jar.

		Male		Female	
Diameter \ Year	Year	2005	2070	2005	2070
	55 mm		9.0 %	7.6 %	19.6 %
75 mm		6.7 %	6.1 %	34.8 %	42.2 %
85 mm		68.8 %	72.4 %	96.0 %	95.8 %

As can be seen from the data in the table above, the currently required opening forces are simply too high for large percentages of the population, especially the females. Only those over the age of 10 are considered in the above analysis, and hence it is reasonable to expect that all might need to open a jar. However in many cases large numbers of the subjects will be unable to open many jars. Less than 10% of the male subjects should struggle with the smaller jars sizes. Also due to the predicted changes in demographics for the males, a higher proportion of men should be able to open these jars in the future. However over two thirds of males tested would be unable to open the largest jar, and this proportion is set to increase in years to come.

It should be noted that the number of males likely to be unable to open the smaller jars actually decreases in years to come. The forces that male subjects can apply to the smaller jars is not largely affected by age, stated in the discussion above.

Therefore despite the increase in older men, then population strength is not likely to be greatly affected in the future. However male strength when applied to the 85 mm jar is greatly affected by age. Hence the drop in numbers able to open the larger jar in the future.

For the female subjects the situation is far worse. Nearly 20% of women currently cannot open the smallest jars, and over a third will fail to open the 75 mm jar. Both of these figures are predicted to rise over the next 60 years, meaning one quarter of women will be unable to open the 55 mm jar, and 42% will not be able to open the 75

mm jar by 2070. The biggest problem however is the 85 mm jar. Almost all woman are unable to open the closure as it stands, and this is unlikely to change in the future unless improvements are made to the design. As the females are far more sensitive to age than the males for all the sizes tested, the increasing numbers of older subjects dramatically affects the percentage of the population able to open jars.

From the above it is clear that current designs are far from inclusive. In order to allow even 95% of the population to open the jars vast reductions in opening torque are required. The 55 mm maximum allowable torque would be around 1.4 Nm (down from the current value of 2.2 Nm), the 75 mm must drop from 3.0 Nm to 1.7 Nm, and the 85 mm must drop to around 30% of its current value (from 5.5 Nm to 1.6 Nm). All these figures rely on current demographic data however – if the population spread shifts as predicted by the ONS²¹ then the torque limits will drop still further.

In Chapter 2.5.2, it was stated that a goal for Inclusive Design would be allowing 98% of the population to use the closure. However this aim would be all but impossible to achieve as current data indicates that some users can effectively apply little or no force to jars during the opening process. However if the torque required to open jars could be reduced to 1 Nm across the board this would only exclude around 3% of the population from opening the 55 mm closure and 2% from the other two sizes. It may come as a surprise that this will allow greater numbers to open the largest jar than the smallest jar. This is because most people can apply higher torques to the larger jar (because the applicable torque is (in some part) proportional to the closure diameter). If the torque required to open the larger jar is therefore reduced to that required to open the smaller jar (as was proposed), the numbers likely to succeed in opening the closure will be higher for the bigger diameter.

7.8 Conclusions

The forces that a human can apply are dependent on many factors. The age and physical condition of the subject greatly influence the amount of force that can be generated. As age increases past 60, strength begins to reduce rapidly. In order to ensure that packaging can be opened by all, it must be designed with the weakest consumers in mind.

By developing a test using equipment based on actual packaging and measuring the strength of a wide cross section of the population, a useful database has been created showing the ability of the population. This data can be used together with demographic data and population predictions to produce limits and hence design closures that will be openable by the population and remain openable in the future.

The force that can be applied to a package is also very dependent on the packaging itself. Even seemingly small changes in materials or geometry can have a large impact on the forces a consumer is able to generate. Specific testing is therefore required to determine the forces that a consumer will be able to apply to a specific package. When the strength of the weakest consumer in the target group has been established, design limits based on the strength of that weakest user can be set. If these design limits are then adhered to, it will ensure that all consumers in the target group will be able to open the package. In the case of food packaging, the target group should encompass as much of the population as possible.

With the current opening torque requirements for user packaging many users are excluded, especially from the larger jars. The current packaging prevents over two thirds of the population from opening the larger jars, and is thus unacceptable.

From the test data and predicted population strengths, a reasonable attempt at inclusive design should be based upon a limit of 1 Nm torque to open any size of jar. This should allow 97-98% of the population access to products. For the larger sizes of closure this obviously represents more of a challenge. It is therefore reasonable to suggest packing foods normally contained in these larger jars either in smaller

quantities or in new designs of jar comprising smaller closures on equivalent volume jars.

7.9 Further work

In order to keep up to date with changes in the population it is necessary to continually update the strength measurement database. This is needed to ensure the data properly accounts for any shifts in employment type or changes in healthcare etc. The population strength predictions also need to be continually updated as predicted data is replaced by actual information.

Further work is also needed to clarify the reasons behind some of the trends observed, particularly regarding the fixed lid vs free jar torque measuring results. Due to the complex interactions between the fingers and the jar/lid it is likely that some form of computer simulation will be required to determine the effects of using different hands to open the closures. This method may also be able to shed some light on the forces applicable to closures of different sizes, possibly to create a link between hand size and preferred closure diameter.

8 Hand Grip Strength Measurement

8.1 Introduction

As noted in Section 2.2, strength measurements for a specific action must be made using a test rig that is dimensionally and materially identical to the actual situation. This obviously can be expensive and time consuming if specific testing is required for jars with every variation of diameter, shape and material. A system of generating accurate results from simple quick tests would therefore be invaluable. This was echoed by the results of a survey of designers, manufacturers and ergonomists by the DTI, in which a request for new strength data was made. It was stated that the 'data should describe generic functions, rather than be product-specific, so that it can be used in as many design applications as possible'.

In Section 5.2, the maximum grip force that a user can apply was shown to determine the limit of the torque that the user can apply. The grip and torque forces are related via the coefficient of friction between the user's hand and the lid of the packaging. Therefore if these two factors are known then it is possible to predict the opening torque that a user can apply. This approach allows the opening torque for a range of materials to be determined from a single set of simple grip measurements on a range of diameters, together with a series of finger friction tests on suitable materials. The results from these grip tests can therefore be combined with appropriate friction data and compared with the results from the measured torque tests (Chapter 7) to assess the validity of the method.

Further, the grip forces a user can apply can also be used to predict the required coefficient of friction that would be needed in order to allow that user to open a

particular jar or other item. This information is invaluable to packaging designers and manufacturers to ensure their products can be opened.

8.2 Theory

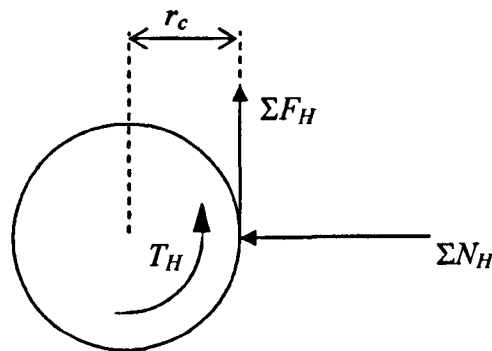

Figure 8.1 Diagram of force system applied to a closure.

Figure 8.1 shows a representation of the force system present when the user grips a closure prior to opening. The user applies a grip force to the outer surface of the closure. As the user then twists their wrist, a frictional force builds up resisting the closure slipping against the surface of the hand. The limiting value of this frictional force is given by the product of the maximum grip force applied to the closure by the hand and the maximum value of the coefficient of friction between the cap material and the skin of the hand. As this frictional force is applied around the edge of the closure (only round closures considered), the resultant force is a couple or moment acting to open the closure. The value of this moment is given by the product of the tangential force and the perpendicular distance from that force to the axis about which it is acting. In Figure 8.1, a single force, ΣN_H is shown to represent the sum of all radial forces applied by the user. Note that the forces that make up ΣN_H need not necessarily be balanced as the lid need not be in equilibrium, because only a small

timestep need be considered as the closure opens. It therefore is unimportant if the closure accelerates laterally as this will not affect the opening of the closure. If ΣN_H is considered to be the sum of all radially applied grip forces, then the resultant moment value is given by the product of the frictional force resulting from this overall grip force and the radius of the closure.

To summarise, the torque applied by the user is given by the formula:

$$T_H = \mu_{CH} \cdot \Sigma N_H \cdot r_C \quad (8.2.1)$$

Now consider the hypothesis that the maximum grip force that a user can apply, ΣN_H , is linearly dependent on the radius of the closure, r_c . That is to say a graph of max force against diameter would yield a best fit line of the form $y = mx + c$ where m is the gradient of the line and c is the intercept on the y axis. This straight-line model serves as an example of the type of model that may be used to link the grip force and diameter, and a different or more complicated model may be required in practise.

Using this model implies that equation (8.2.2) is true:

$$\Sigma N_H = m \cdot r_C + c \quad (8.2.2)$$

Now substitute equation (8.2.2) into equation (8.2.1) to eliminate ΣN_H to give equation (8.2.3) below:

$$T_H = \mu_{CH} \cdot r_C \cdot (m \cdot r_C + c) \quad (8.2.3)$$

A surface can then be generated using the above equation with ranges for the coefficient of friction μ_{CH} and radius r_c . The resulting surface shows the ability range for the user, indicating the maximum torque they can transfer to lids of varying sizes and surface materials. Note that this is not necessarily the maximum torque that a user can necessarily apply to a lid, it is the maximum torque that a user would be able to transmit to that lid. If the user is not capable of generating this level of torque then the applied value will be lower. However if they are capable of generating a higher torque than the calculated value they will be unable to transmit this force to the closure. The calculated value is therefore one limit to the torque, the other being the strength of the users arm, or their ability to generate a twisting force. A surface can still be generated regardless of the form of the best fit line of the grip data – it need not follow the linear model demonstrated above. The above method can also be

expanded for use with data from multiple subjects to give an ability ‘zone’, to indicate the spread of abilities within a population.

It should be noted that the above equation merely provides a limit to a user’s maximum possible applicable torque derived from their grip strength and finger friction. The actual torque they can apply to a closure may be limited by other factors, such as the strength of their wrist. The upper boundaries of the range of finger friction values used may also not be possible to achieve. The technique therefore may over predict user strength for certain diameters or materials. Other factors may also affect the accuracy of the prediction for different groups of users. The technique should also only be used to predict opening torques for diameters for which grip strength tests have been performed. Using the method to predict torques outside of these limits may result in incorrect values.

8.3 Experimental Design

In order to measure the grip force that a consumer can apply to packaging during the opening process, a custom device was needed to ensure the correct values were obtained. Human grip strength is normally measured using a hand dynamometer (Figure 8.2), which measures a whole hand grip strength between two parallel bars.

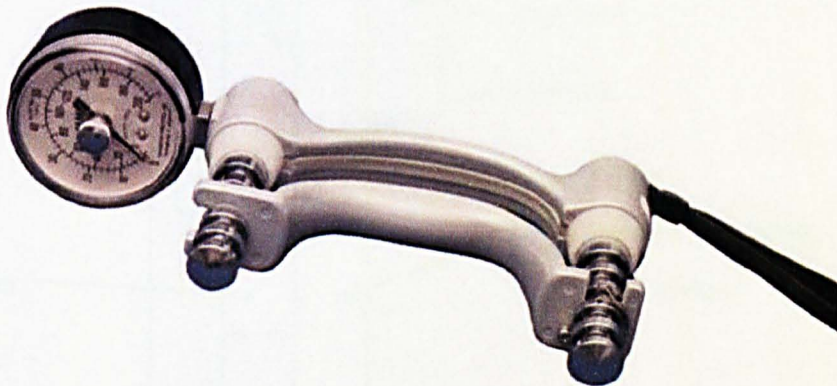

Figure 8.2 Jamar hand dynamometer
(photograph reproduced with permission from Lafayette Instrument Company).

As discussed in Section 2.2, to obtain data useful in predicting user strength when opening packaging, the strength measurements must be made under the same conditions as the actual opening action is performed. A device to measure the grip force as applied to a jar lid was therefore required. A realistic experimental procedure was also needed, again to ensure the data obtained is accurate.

8.3.1 Test Device Design

The proposed design utilised strain gauges on a pair of metal beams to measure the applied force. To concentrate the strain in the beams a cut-out was made in each to reduce the cross sectional area and hence increase the local stress. This increases the local deformation under load and hence allows a far more accurate reading of the applied force to be obtained. A diagram showing the initial design is shown in Figure 8.3 below. This design was decided upon after comparing the potential performance and cost of several other methods, such as using an embedded force sensor or building a more complex sensor arrangement.

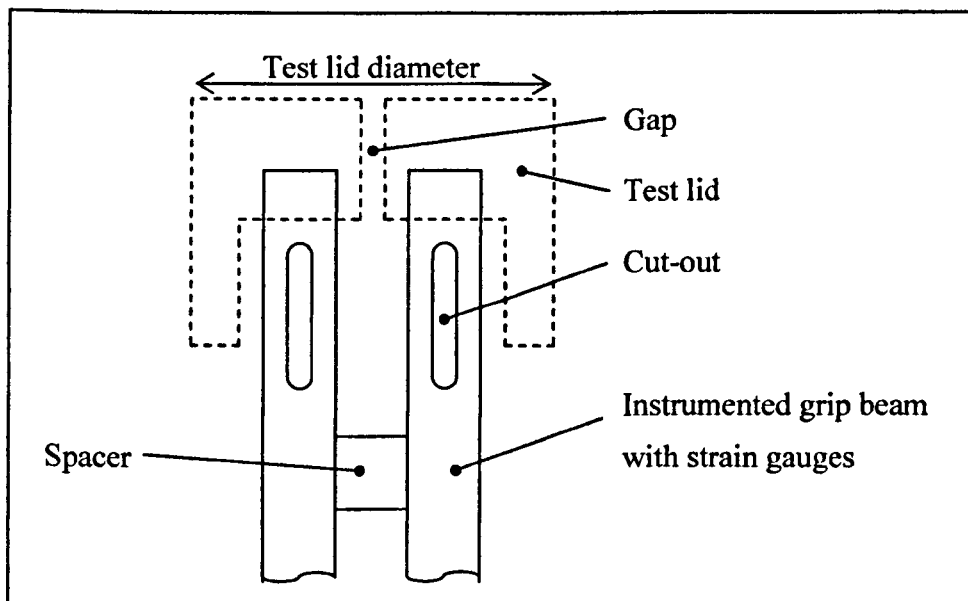

Figure 8.3. Diagram showing the initial design of the grip measuring equipment.

As shown in Figure 8.3, the device consisted of a pair of beams, separated by a spacer to create a gap. Discs of various diameters could then be split in half, and each piece attached to a beam. Forces applied diametrically to the disc are transmitted to the beam, causing deflections in the cut-out region. Strain gauges were used to measure the local strain in the beam, and hence calculate the applied force when compared to a suitable calibration. To ensure that the device performs linearly under increasing load (and is therefore easier to calibrate and post-process the results is made more simple) the beams must only deflect in the region of the cut-out. Using information from Adultdata³⁵, a maximum grip force of around 500 Newtons was found as the highest possible grip force an adult male would be likely to be able to apply to the beams. 10 mm square section aluminium beams were used as the base material for the beams as they would be lightweight and effectively rigid under this load.

To allow the device to be used for the full range of lid sizes, the width of both beams plus the gap between them must be controlled. Obviously, the device could not measure the grip applied to a 30 mm closure if the outer edges of the beams were more than this distance apart. To enable the device to represent a 30 mm ROPP closure properly, the overall diameter of the device, including the split lid, must equal 30 mm. Similarly to represent a 50 mm closure correctly the device must be 50 mm in diameter. As the two beams are 10 mm wide, and the outer edges must fit inside a 30 mm cap, an 8 mm spacer was used to give a total beam width of 28 mm. This allowed the device to be fitted inside a split 30 mm ROPP cap whilst keeping the overall outer dimension of the tester at 30 mm. Larger cap sizes can still be represented by using split caps of larger diameter.

In order to keep the device as accurate as possible, it is preferable that the beams should remain rigid with all the deformation occurring in the cutout region. This means the local strains at these points will be greatest and hence easier to measure accurately with strain gauges. Finite element analysis (FEA) was used to determine the required cutout length and wall thickness. Models of the beam were created in Solidworks before being meshed using Hypermesh and solved in Ansys. The 500 N maximum grip force determined earlier was used as an input to the FEA software, with a 500N force applied laterally to the tip of the beam whilst the base was fixed. The

dimensions of the cutout were chosen such that the deflection of the tip of the beam under this load was 3 mm. This would allow the strongest adult males to be tested using the device without the two halves of the device touching together and hence affecting the measured force. It also allowed for forces higher than this to be measured before the two lid parts touched, as the beams had 4 mm of space to flex into. A picture of the FEA model used is shown in Figure 8.4.

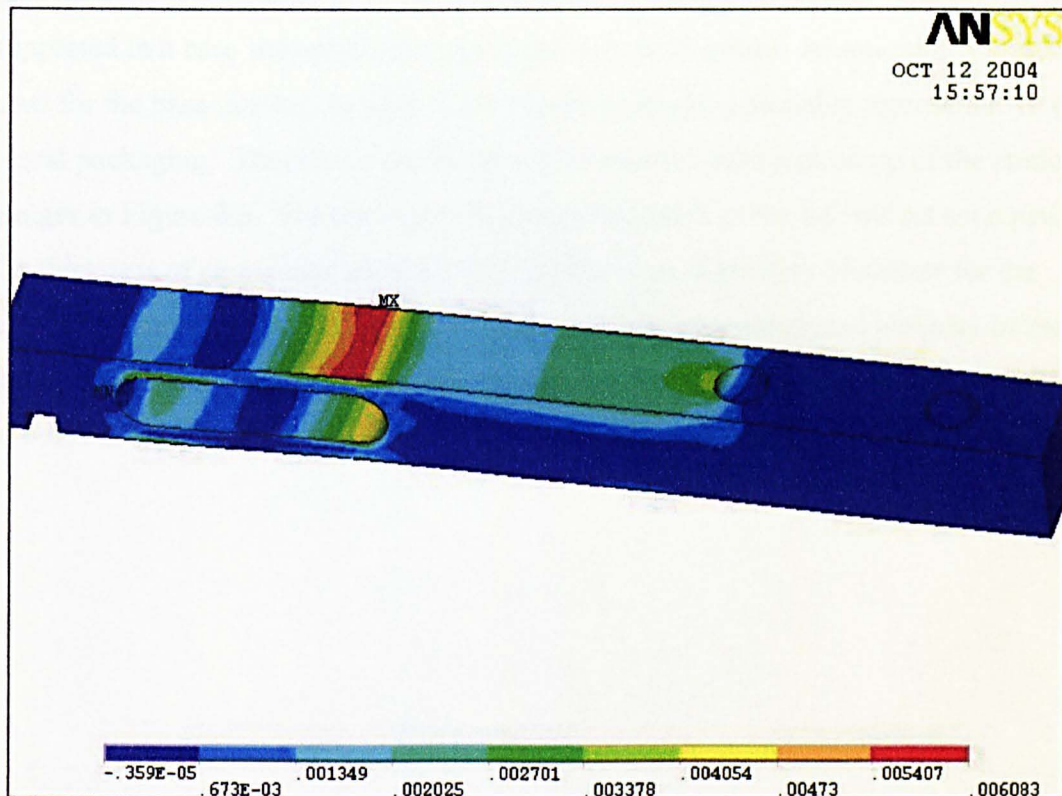

Figure 8.4. Finite Element Analysis of grip beams device.

The finite element model above was used to position the strain gauges in the optimal positions. To measure the strain in the beams properly, the gauges must be placed in the regions of highest strain. A pair of gauges were used on each beam, with the gauges located at the base of the cutout on opposite sides of the beam (one gauge covering the red region of highest strain, marked 'MX' in Figure 8.4, the second gauge located in the equivalent position on the opposite side of the beam). The four gauges on the pair of beams were connected up as a wheatstone bridge. The gauges

were connected in order to maximise the voltage change across the bridge with changes in applied load.

Discs to represent three sizes of lids (30 mm, 50 mm and 70 mm diameter) were manufactured. Aluminium was chosen as the material for the lids. Because the hands do not move relative to the surface of the disc during the grip test, it was not considered necessary to control the surface finish and material as was required for the torque tests. A smooth machined finish was considered sufficient. Each disc was then split into two halves and mounted onto the instrumented beams. The beams were supported in a base shaped to represent a generic jar or bottle. Aluminium was again used for the base material to keep the test device weight reasonably representative of actual packaging. The device can be seen in Figure 8.5 with a close up of the strain gauges in Figure 8.6. For the larger diameters the depth of the lid was set equal to the thickness of an average standard VLC of the same diameter. However for the smaller closures this was not possible whilst still retaining structural integrity of the lid. This was not thought to affect the results, however more testing may be required to confirm this hypothesis.



Figure 8.5. Photograph of the grip device.

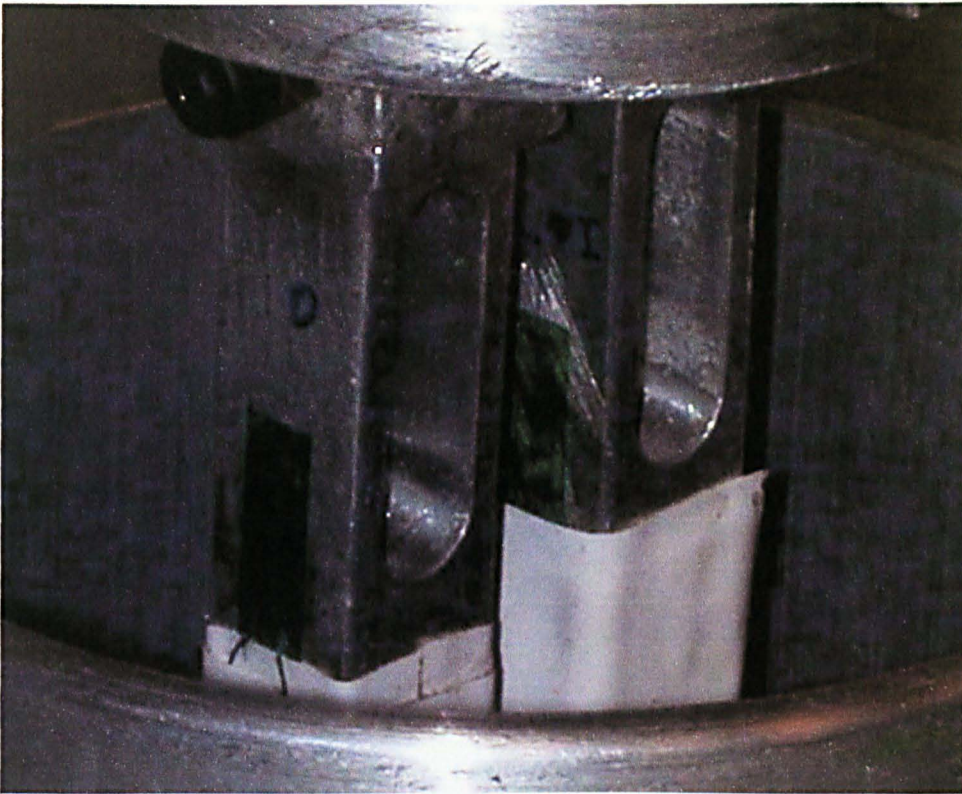

Figure 8.6. Close up view of strain gauges on grip device.

In order to calculate the actual loads applied to the beams a suitable calibration curve was required. The strain gauges were connected to a 5v regulated power supply and a computer (via a Pico TC-08 digital sampler) to measure the output. The input voltage was selected to give the most useful output from the strain gauges. The device was calibrated using various masses suspended from the beams. The output from the device was measured for each deadweight load applied, and a graph plotted of load against voltage output. This was repeated with the load applied to each beam. No difference was found between the two orientations for the calibration.

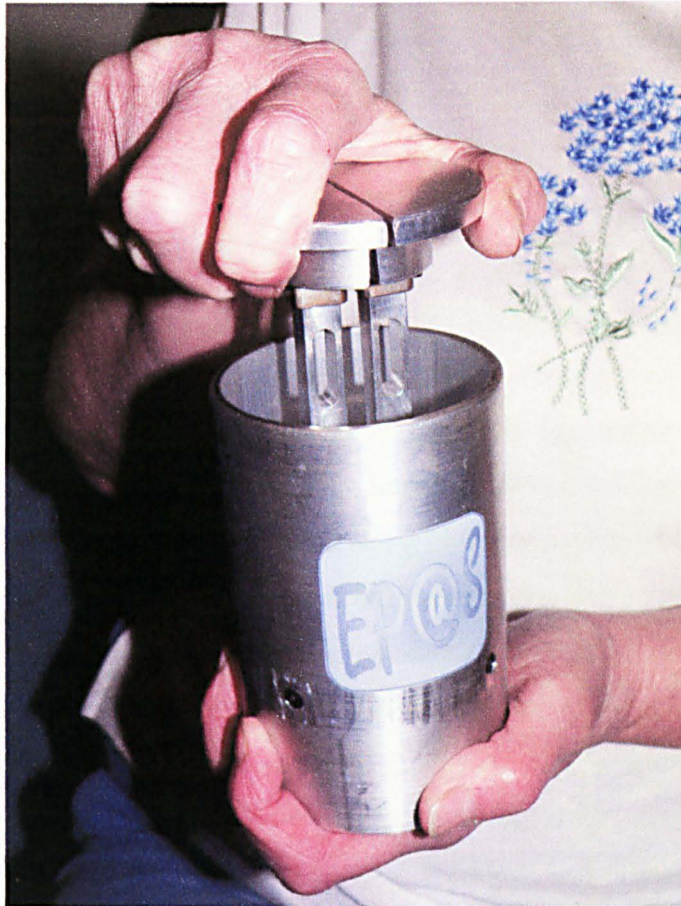

Figure 8.7. Grip device in use by an elderly female subject.

The device was designed so that a user would interact with it as similarly as possible to the way in which they would interact with a bottle or jar they were about to open. To this end it was freely movable and could be used in any position or orientation during the test. The equipment needed to be connected to the sampler with wires. However the wires were made as long, thin and flexible as possible to minimise any possible effect this may have.

The grip force that a user can apply is independent of the material being gripped, because no relative motion is taking place. The measured grip force can therefore be used to model different forms of packaging by altering the skin friction values used in the analysis detailed in the 'theory' section above. This means the same grip results can be used to predict the forces that can be applied to lids made of various materials. Because the material of the test device is irrelevant, the device is constructed from

machined aluminium to keep costs down. The use of lightweight materials also keeps the mass of the device comparable to jars of similar dimensions, preventing the possibility of device mass affecting the measured results.

8.3.2 Candidate Selection

As for the torque device investigation presented in Chapter 7, it is necessary to test subjects from the full spectrum of society to ensure that a true representation of the population is obtained. The testing was therefore carried out on many different occasions and in several different locations. Some of the test sessions coincided with the torque testing, and subjects were tested using both apparatus. The subject was allowed to rest between the tests to prevent fatigue affecting the results. Testing locations included a public library, various university departments, a working men's club and an Age Concern day centre. This was to ensure that, as far as possible, people from all backgrounds were considered. Few details were gathered about the candidates unless they volunteered information regarding conditions that may affect their strength etc. This information was not collected as it was felt details of conditions etc were not important – what mattered was the strength of the population, not the strength of certain groups of people with specific ailments. Some selection of candidates was used in that certain people were sometimes targeted over others, for example a person of specific age or gender may be specifically asked to perform the test if their demographic was poorly represented in the dataset. This was purely to maximise the effectiveness of each test session and to build up a useful and unbiased database as quickly as possible however. The database was continually assessed, and each group of candidates (for a specific jar size, age group and gender) was monitored. Averages and deviations for each group were monitored to assess the number of required candidates in a group. Testing continued until each group of subjects contained enough data that adding further results did not significantly affect the averages for that group. The number of candidates required for this varied for each group, and candidates were not turned away from testing if they belonged to a group that was already well represented. There is therefore a variety in the numbers of candidates in each group. When time allowed, no person was declined if they wanted to take part in the testing, and certain groups may appear to be unfairly

represented due to this fact. However it was felt that adding more test data was more valuable than having balanced numbers of subjects in each age and gender group. Having a group with more test results than another merely increases the accuracy of the average results for that group, it does not alter the accuracy of the averages for other groups. Hence whenever any subject was available they were tested, even if they were not specifically required, as this increases the accuracy of the dataset as a whole.

8.4 Method

The testing of grip strength was performed in several different sessions. Subjects were tested individually to prevent any possible embarrassment during the test. During the testing process, the tester also discussed packaging and related problems to keep the subject at ease and also to gain an insight into their experiences with packaging. To prevent fatigue, only a single diameter grip was tested during each session. The subject was given the tester and asked to hold it as they would hold a jar or bottle. They were allowed to stand or sit for the test, and were allowed to hold the device freely in both hands or rest it on a tabletop if preferred. They were then asked to squeeze the lid as if gripping it tightly to prepare to open it. They were told not to twist the lid of the device during the test, but merely apply a grip force in the same manner as they would if they were trying to open the closure. The subjects were asked to apply the highest force they could without causing discomfort, and were instructed to stop if they felt any pain or discomfort at any point during the test. This was to ensure that the highest comfortably applicable grip was measured for the specific packaging opening situation and geometry.

A computer was used to calculate the highest force that a subject applied during the test. This value was recorded along with the age and gender of the test subject, together with any other relevant information the subject offered (such as arthritis, previously broken bones etc). The data was then grouped by gender and then by age, and plotted on graphs of grip force against diameter for various age ranges.

For each gender and age group the data was then examined and plotted. Best fit lines were fitted to the data to encompass the range of data points across each diameter. Equations for these lines were then calculated using MATLAB, and used to generate surfaces in 3 dimensions to represent limit for user ability when opening a jar. More details about this process are given in the 'Theory' section above (Section 8.2).

8.5 Results and Discussion

A total of 380 people over the age of 30 were tested during the course of the study. Tests were performed on three different sized lids, and the data separated by gender. The data was also separated into 2 age groups. The age groups were selected as 30-60 years and over 60 years old in line with the groups chosen in the torque study. The age group limits were selected to minimise the effect of age within the group. The grip test data for each diameter lid were plotted for each age and gender group. The mean and standard deviation for each diameter and age group was calculated. A 'least squares' line of best fit was then added to the 3 sets of mean grip data for each age group, to give a model of the way in which grip force is affected by diameter. Two further best fit lines were added to each plot, to indicate the mean \pm 1 standard deviation for the subjects (Figure 8.8). The simple linear best fit line was chosen as a proof of concept model to develop the methods used in the analysis, however more complicated models may be required in the future to more accurately describe the data. For this initial study as there are only three diameters tested more accurate models cannot be fitted to the data, and so the linear model is the best choice.

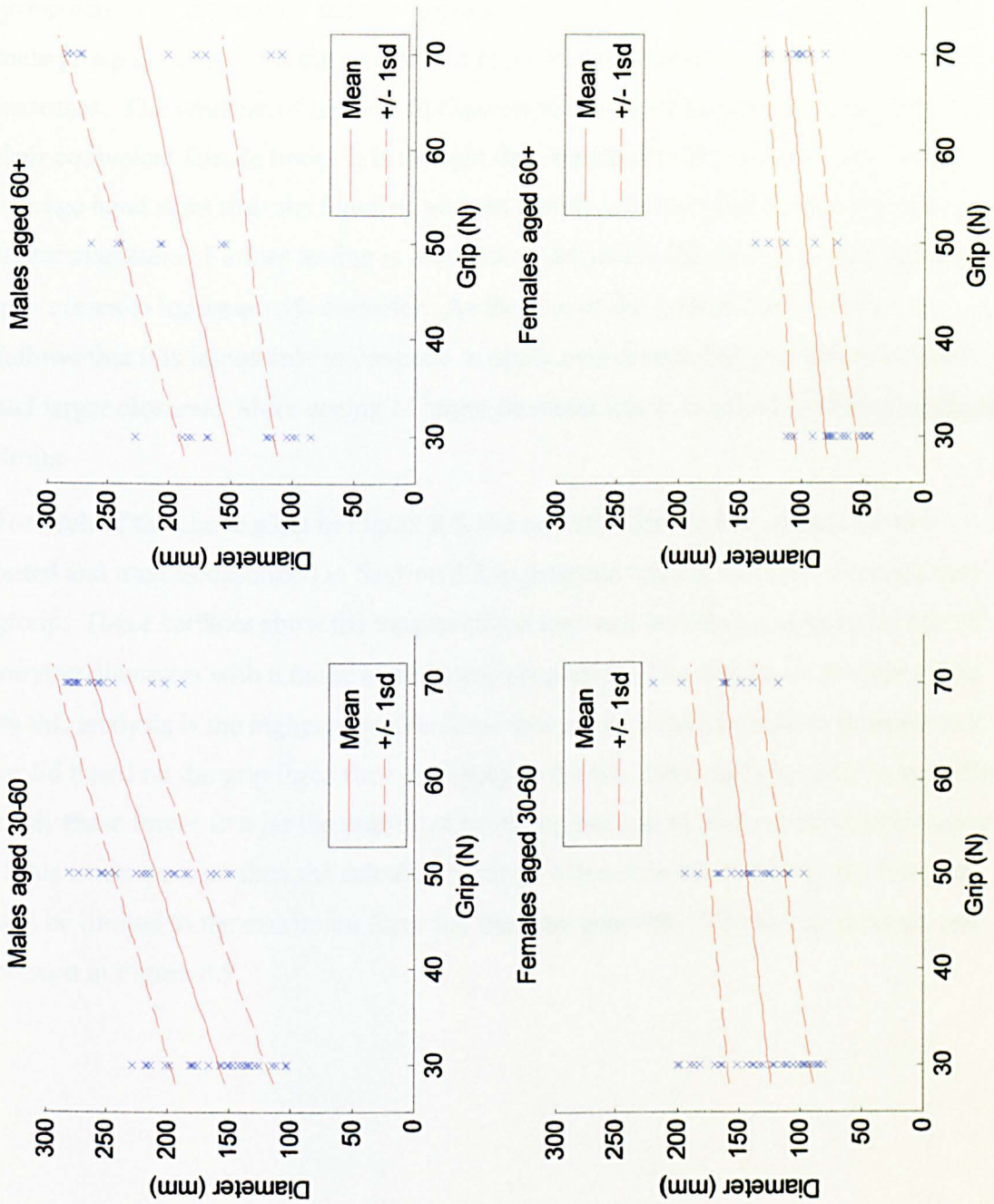

Figure 8.8. Plots of measured grip data and fitted curves for all age groups.

Dotted lines show ± 1 standard deviation.

As can be seen from the plots in Figure 8.8, the 30-60 year old males are the strongest group across all diameters of jar. The women aged over 60 group are the weakest group across all diameters, and can apply around half of the grip force that the young male group generate. All the groups can apply higher grip forces as the diameter increases. The gradient of the best fit lines on the two male graphs are steeper than their equivalent female lines. It is thought this is related to the males having larger average hand sizes than the females, and are therefore better able to cope with the larger diameters. Further testing is required to determine the limit at which applicable grip ceases to increase with diameter. As the size of the human hand is finite, it follows that it is impossible to continue to apply ever-increasing grip forces to larger and larger closures. More testing of larger diameter lids is required to determine these limits.

For each of the above plots in Figure 8.8, the equation for the line of best fit was noted and used as described in Section 8.2 to generate 'ability surfaces' for each user group. These surfaces show the torques that a user will be able to apply to jar lids of varying diameters with a range of frictional properties. The maximum torques given by this analysis is the highest possible force that a user would be able to transmit to a jar lid based on the grip force they can apply to the lid. Obviously in order to actually apply these forces to a jar the user must be strong enough to apply the required torque. If this is not the case then the calculated values will not be attainable by the user, and will be limited to the maximum force the user can generate. The ability surfaces can be seen in Figure 8.9.

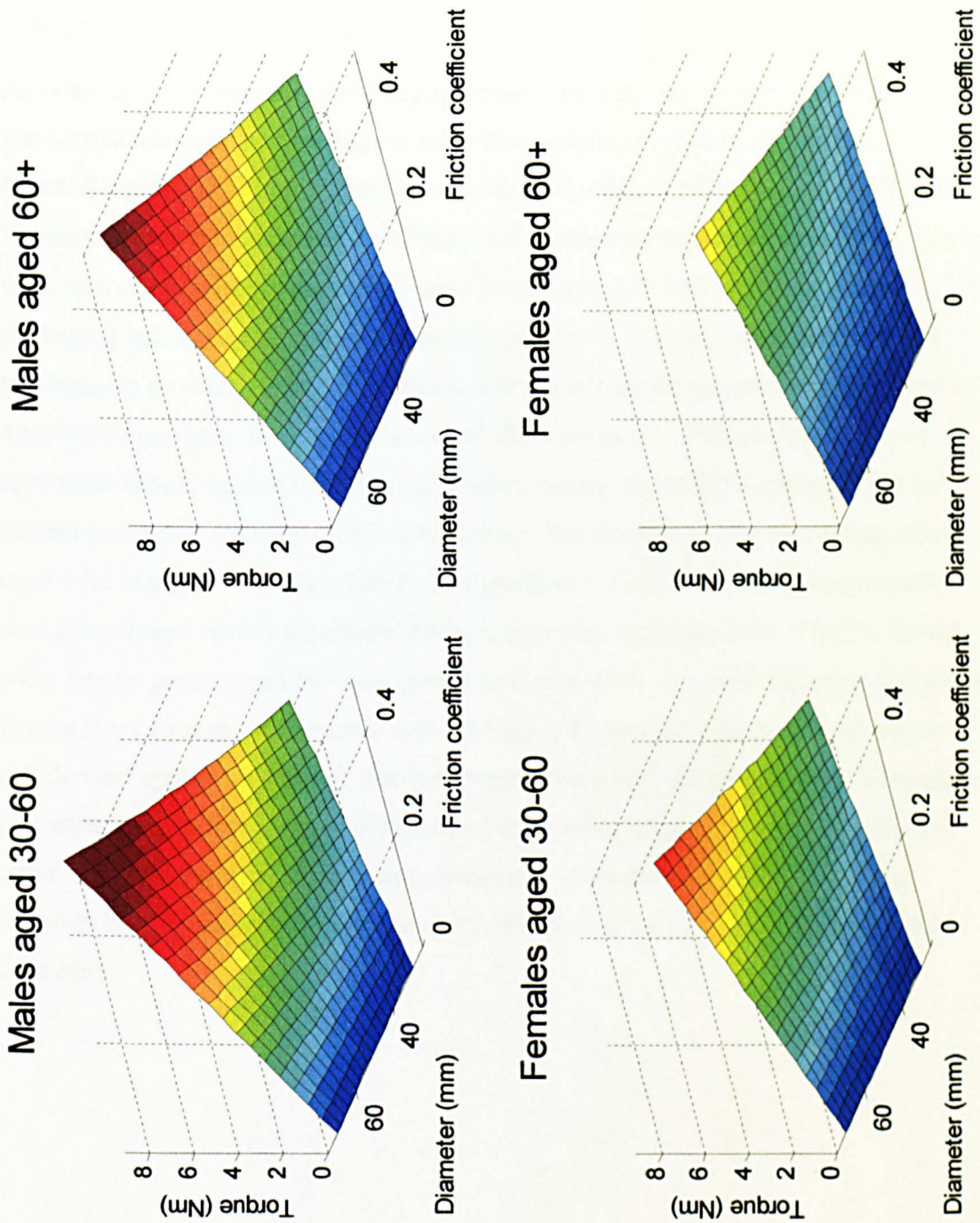

Figure 8.9. Ability surfaces for each age group.
In each plot the y-axis and colour scales are kept constant.

The fact that torque is directly proportional to diameter, coupled with the increase in grip the users exhibit at larger diameters means that the applicable torque increases for all groups as the diameter increases (Figure 8.9). Applicable torque also increases with increasing friction coefficient.

As noted in the literature review, approximate values for the friction coefficients between human skin and packaging materials have been determined (Section 2.3). Menardi used a very simple friction model to find values for the friction coefficients between human skin and samples of laquered aluminium and laquered tinfoil. These two types of material are commonly used to make jar lids and bottle caps in the packaging industry. Using these values for skin friction, a slice through the above surfaces can be taken to give an indication of the maximum torque users can apply to a variety of currently available products of different sizes. The resultant curve of applicable torque against diameter can then be compared with the opening data for current packaging (as measured in Chapter 6). The likelihood of a user being able to open a lid of a given size can therefore be predicted. Graphs for the younger male user group (aged 30-60) are shown for both materials in Figure 8.10. Graphs for the older female group (aged 60+) are shown in Figure 8.11. It should be noted that these graphs show a range of diameters from 55 mm to 85 mm for both measured torque and derived applicable torque. The jar opening force was measured across this range. However the grip force was only measured up to a diameter of 70 mm. The plotted curve therefore involves some extrapolated data. This data cannot be used with certainty but should provide a reasonable indication of the applicable force at these diameters.

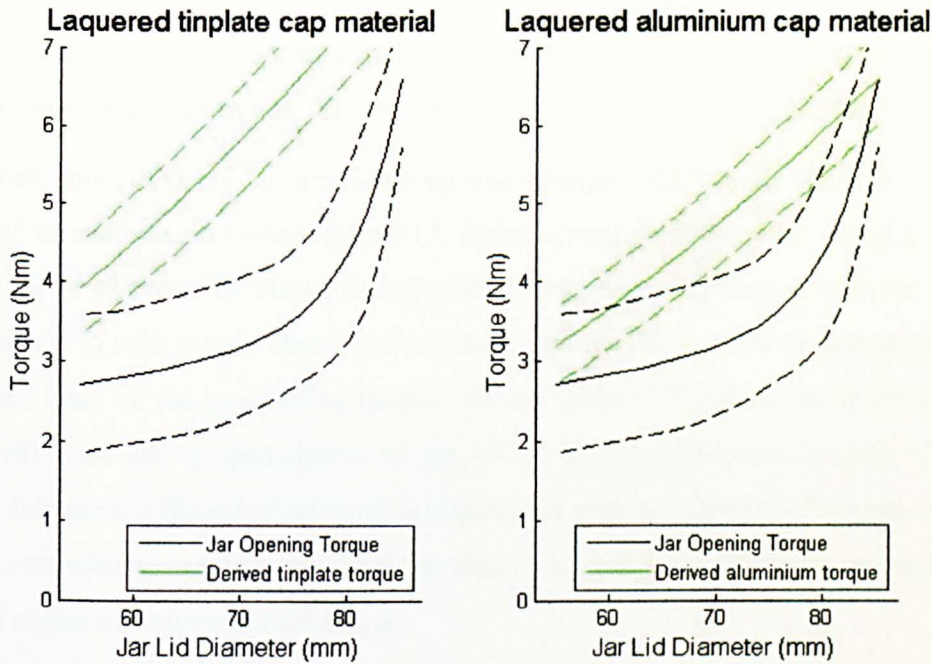

Figure 8.10 Plots showing the calculated torque limit a male aged 30-60 can apply to various sizes of jar lid compared to the required opening torque for various jars. Dotted lines show mean \pm 1 standard deviation for derived torque and 95% confidence bands for jar opening torque.

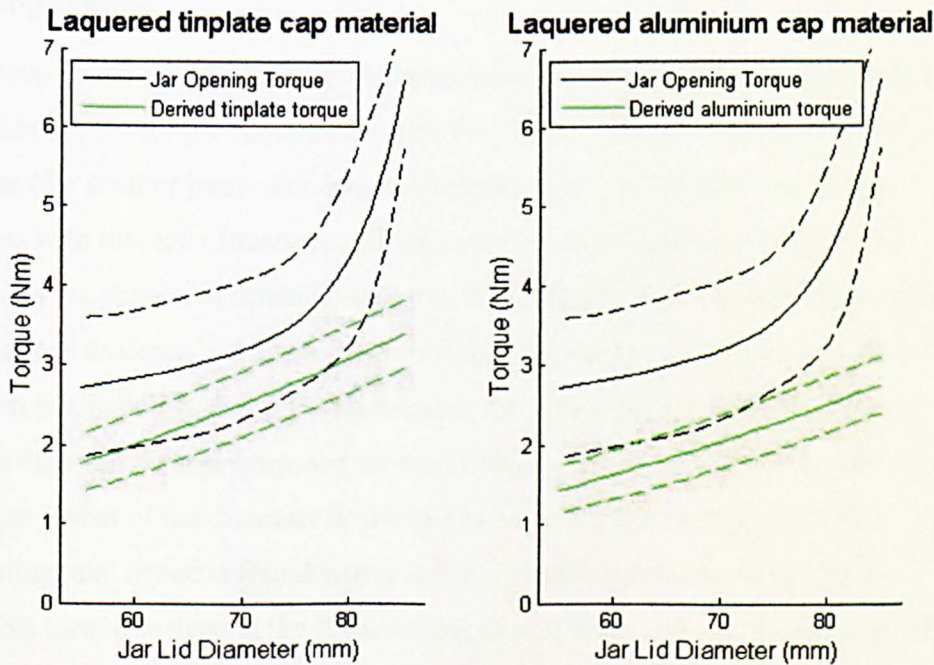

Figure 8.11. Plots showing the calculated torque limit a female aged 60+ can apply to various sizes of jar lid compared to the required opening torque for various jars. Dotted lines show mean \pm 1 standard deviation for derived torque and 95% confidence bands for jar opening torque.

By examining the plots in Figure 8.10, it can be seen that for common jar lid sizes, younger males should not have opening problems for lids made from either of the materials tested. Some larger and smaller jars may pose problems for some members of this group, more commonly if the lid is made from lacquered aluminium.

In contrast, most of the older female group will struggle with almost all of the jars they buy, as can be seen from Figure 8.11. Approximately 69% of the group's population lie between the dotted lines for the derived opening torque, with the remaining 31% split evenly above and below the dotted lines. 95% of jars lie between the dotted lines for the jar opening torque. Hence almost 85% of the older female group will be unable to open almost all jars, of any size, with aluminium lids. For tinfoil lids the likelihood of opening is higher, but still around half of women over 60 will be unable to open any jars and the entire group will have trouble opening any jar with above average required torque.

By changing the values of friction used in the analysis, other materials can be assessed without performing more tests on large numbers of subjects. Similarly, different packaging types can be assessed by altering the 'force required for opening' curve. In this manner the technique is broadly adaptable for a wide range of packaging systems.

The torque that users can apply to closures increases with diameter. However, as shown above, the torque required to open the closures initially increases slowly with diameter (for smaller jars). For larger diameters, the rate at which the torque increases with diameter increases. There is therefore an optimal diameter that maximises the chance of opening success. By using the skin friction coefficients in the equations as described above, together with the measured jar opening torque data as shown in Chapter 6, the optimal diameter for a jar can be predicted. The jar opening data can be superimposed on the ability surfaces in Figure 8.9. The optimal size of jar is that of the diameter at which the lowest coefficient of friction is required for opening, and hence is found where the jar opening torque curve meets the applicable torque surface at the lowest friction coefficient value. A slice through the applicable torque surface at this optimal value for elderly females is shown in Figure 8.12.

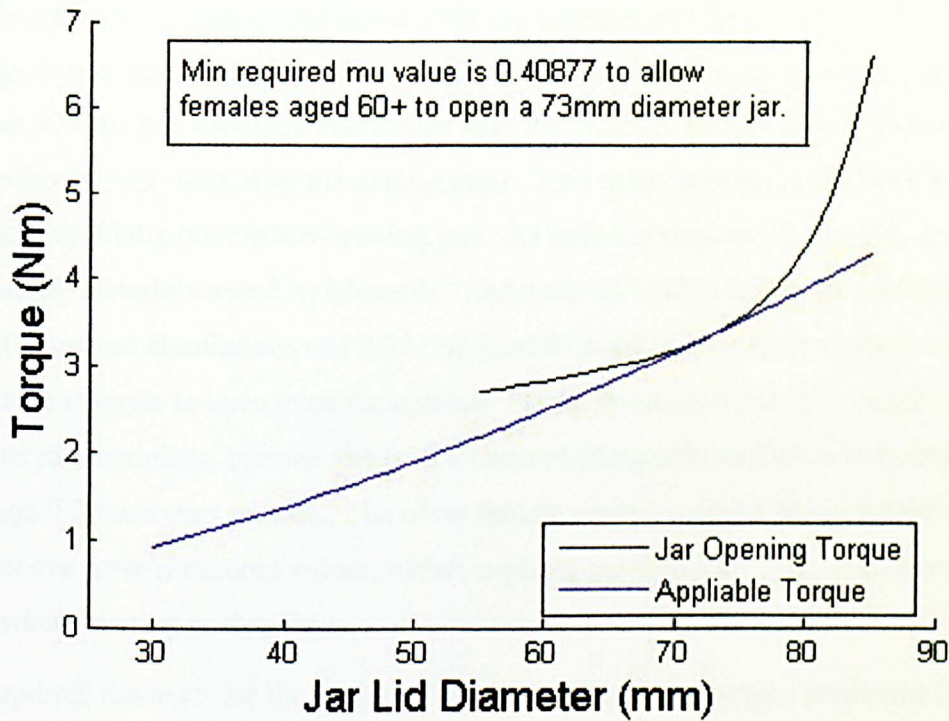

Figure 8.12. Graph showing the torque applicable by a female subject aged 60+ when skin friction is set the lowest value that will just allow a jar of optimal size to be opened.

The optimal size and corresponding minimum required coefficient of friction were calculated as above for each age group. The results are given in Table 8.1.

Table 8.1. Table showing optimal size and corresponding required minimum coefficient of friction to allow opening.

Age Group	Optimal Jar Diameter (mm)	Required Friction Coefficient
Males 30-60	73	0.17
Males 60+	73	0.20
Females 30-60	72	0.28
Females 60+	73	0.41

As shown in Table 8.1 above, the minimum required coefficient of friction for the male subjects does not change markedly with age. The older male group require only a 15% increase in friction coefficient over the younger male group (although this change is not statistically significant). However the older female group require almost 50% higher frictional coefficient than the younger female group, and over twice the friction needed by the male groups. This illustrates the problems the elderly women especially have when opening jars. As noted in section 2.3, the two common packaging materials tested by Menardi³⁰ had material to skin frictional coefficients of 0.26 (lacquered aluminium) and 0.32 (lacquered tinplate). Younger women will therefore struggle to open even the optimal 73 mm sized jar if the lid is made from lacquered aluminium, because the 0.26 measured frictional coefficient is below the average 0.28 that they require. The older female group require friction values that are way above these measured values, which explains the difficulty that older women face when opening packaging.

The optimal diameter for the jar for all ages was almost unchanged at around 73 mm, regardless of age or gender. The reasons for this is unknown, as it was predicted that the males, with their larger average hand sizes, would have a larger optimal diameter. However this was not shown by the results. Further testing and investigation will be required to determine the reasons for this.

8.6 Comparison with Measured Torque Data

Figure 8.13, Figure 8.14, Figure 8.15, and Figure 8.16 show the measured jar torque and grip-derived calculated torques on the same axes for each age group and gender.

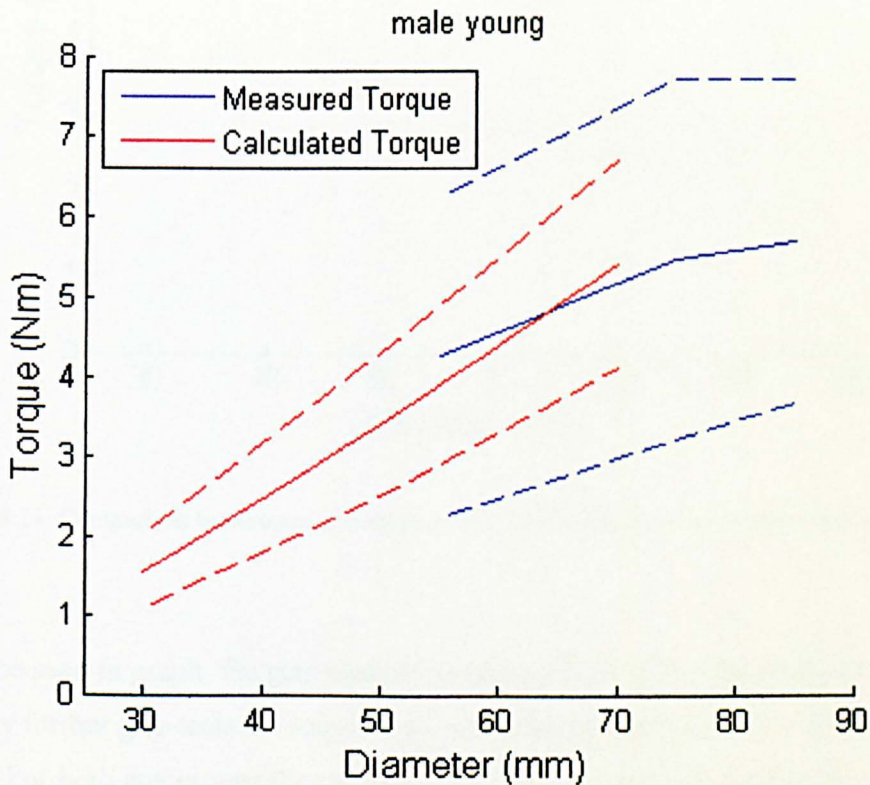

Figure 8.13 Comparison between measured and calculated torque against diameter for young males.

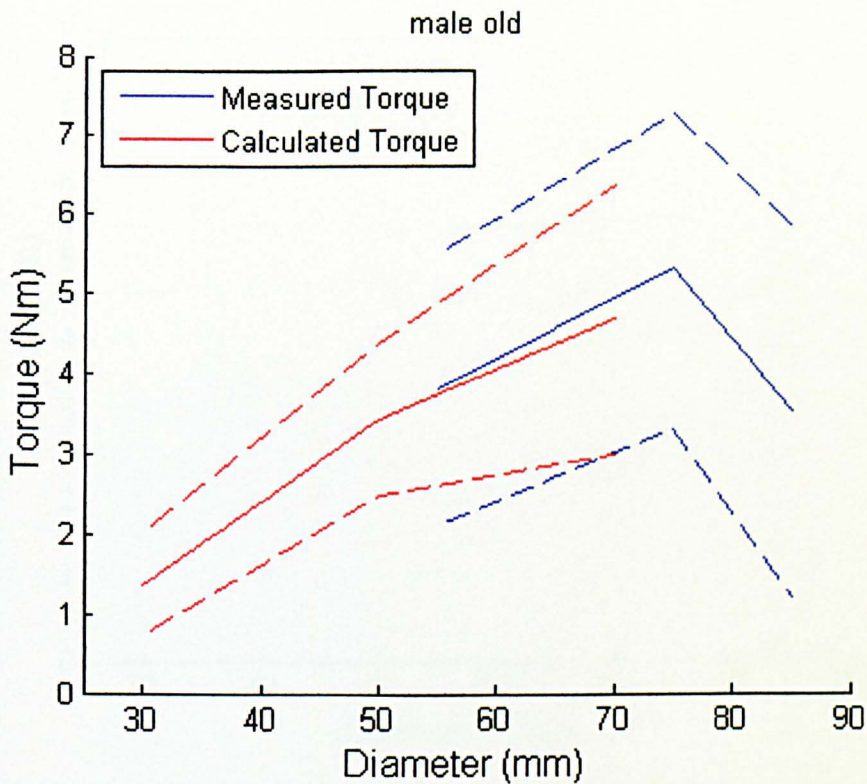

Figure 8.14 Comparison between measured and calculated torque against diameter for older males.

As can be seen in graph, the grip method results agree well for the male subjects. However further grip tests are required to extend the overlap between the sets of results. For both age groups the measured torque is slightly above the calculated torque limit. Although this should not be possible, the difference between the two values is small. Due to the likely variability in the measurements of grip strength, applicable torque and skin friction the differences in the values are believed to be insignificant and not an indication of a failing in the method.

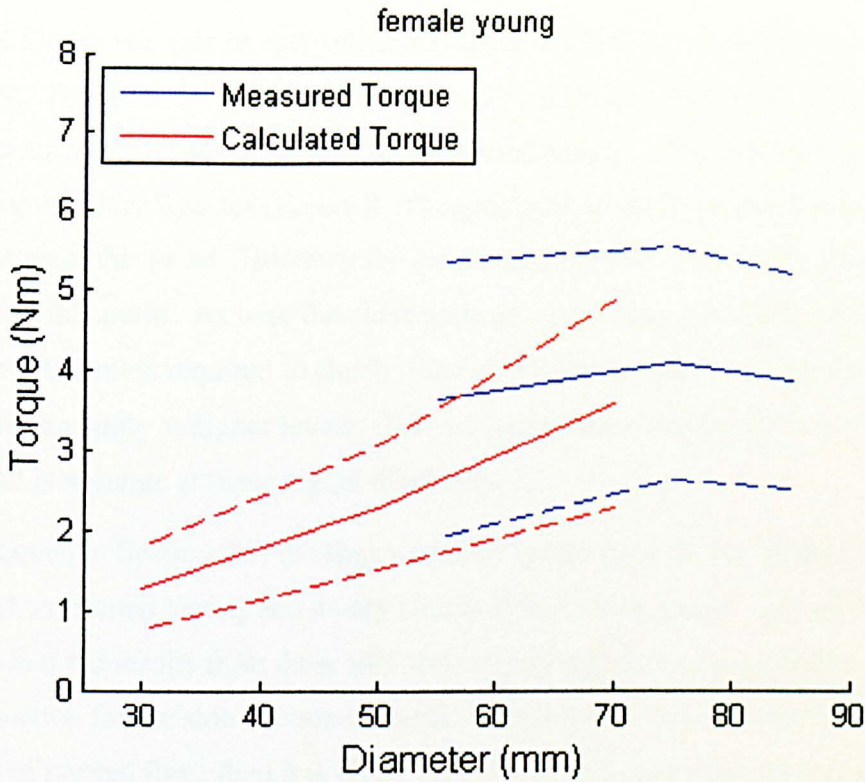

Figure 8.15 Comparison between measured and calculated torque against diameter for young females.

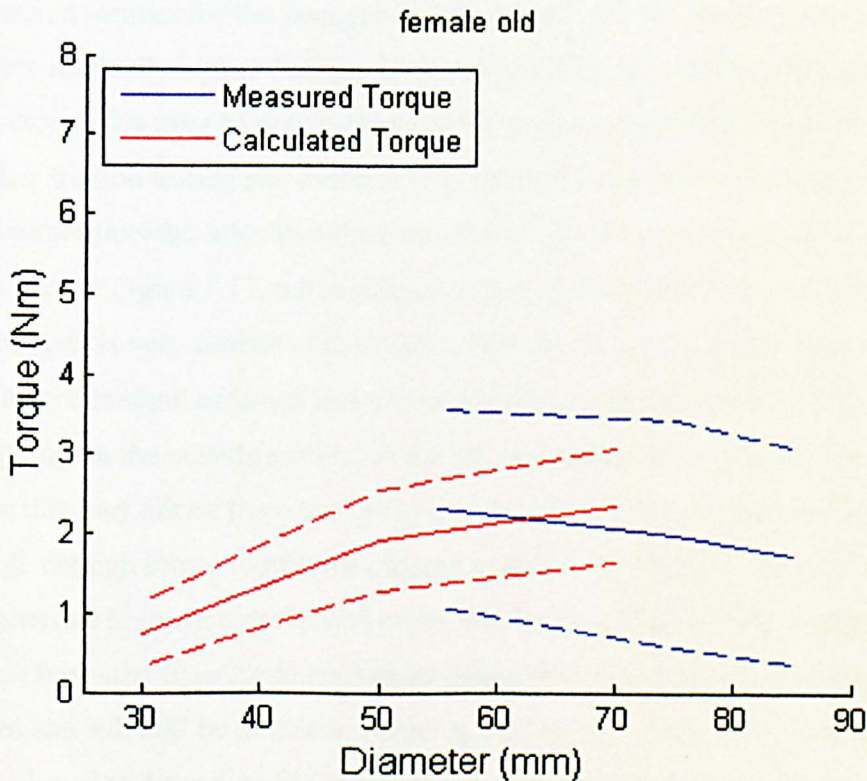

Figure 8.16 Comparison between measured and calculated torque against diameter for older females.

The data for the younger female subjects (Figure 8.15) does not agree as well as the male data. However the at 70 mm is reasonably close, and above this value the grip model looks likely to well represent the measured torque. Similarly the two sets of values for the older females (Figure 8.16) agree well at the 65 mm mark, as the two curves cross at this point. However the gradient of the two lines on the graph are very different at this point. As with the older male group, testing grip strength at a larger diameter (90 mm) is required to check if the grip test accurately predicts the forces that users can apply at higher levels. This will give more information as to whether the model is accurate at these higher diameters.

As mentioned in Section 2.3, the finger friction values used for the skin-pack interface are based on limited testing and a very simple skin friction model. Therefore it is possible that the results from these two sets of tests will give correct results if a better approximation for the skin friction is found. If skin-pack friction is found to be a function of normal force then it is likely the models will give a more accurate representation of the forces applicable at these larger diameters. Limitations in the current friction model may be the cause for the disagreement between the calculated and measured torques for the younger female group. For this group the measured torques are markedly higher than the limit predicted by the calculated torque investigation. This may be due to errors in the current simplified friction data used and further friction testing and analysis may solve this problem. The derived grip torque overpredicts the force that the older female users can apply to the larger jar lids. As seen in Figure 7.13, the measured torque that the older females can apply to the 85 mm jars is very similar to that which they can apply to 75 mm jars. The grip derived torque method assumes that the torque that a user can apply is limited by their hand slipping on the outside surface of the lid, and is therefore dependant on grip. However this may not be the case. As shown in Chapter 5.2, a user must be able to apply high enough forces to grip the closure and prevent slipping, but must also be able to generate high enough forces to turn the closure. If an elderly woman is unable to provide this wrist twisting force despite being able to grip the closure relatively hard, then she will still be unable to open her packaging. Some form of testing needs to be developed to determine the wrist twisting strength of packaging users, especially

elderly females, in order to see if this is indeed the limiting factor. The results of these wrist-twisting strength tests would need to be independent of the user's grip strength and of the materials used. Any limits found could then be used as a second rule together with the grip derived torque to determine the limits for applicable opening torque, and therefore allow the system to more fully predict the forces these users can apply. Limits on users' wrist-twisting strength would, like the grip measurements, be independent of the type of packaging used. They would therefore also be transferable, and hence reduce the amount of extra testing required to evaluate user ability for new packaging designs. A set of grip measurements for various diameters and a single set of wrist twisting strength data could then be used to determine the applicable opening forces for any type of package for which skin friction data was available.

Further testing is also required to increase the accuracy of the friction data. If a greater degree of accuracy for the friction data is obtainable then the above results can be properly compared with the measured torque values. Only then will it be possible to state with any degree of certainty if the method is accurate enough to be useful. In particular the effect of changing the normal forces need to be investigated as users can apply varying levels of force to closures of different sizes.

If the work involved in obtaining sufficiently accurate friction models proves to be excessive, it may be the case that direct torque measurements are more reliable and easier to obtain. However, any accurate friction models would have more widespread possible usage as the data could be used to model all manner of other packaging interactions. For example the data could be used to model the pinch-pull force that a user can apply to the tab on a film lid, but a jar torque test is only of use to predict the forces that can be applied to similar size and material jars. A further option would be to design tests to indicate the relative friction coefficients between different material types. In this way a single comprehensive skin-packaging material friction coefficient dataset can be produced, together with a series of smaller friction tests on different materials. These smaller friction datasets can then be used together with the main database to predict the performance of the wider range of materials using an analytical method similar to that derived for the grip-torque method described in Section 5.2.

8.7 Conclusions

From the results it can be seen that a population's ability to open a closure is dependent on both the diameter and the frictional properties of the material. The grip force a user can apply depends on the size of the closure. The relationship between grip and diameter is dependent on the user, and can be broadly classified by age.

The torque a user can apply to a jar lid increases with the diameter of the lid. However the force required to open jars also increases with diameter. The two forces can be equated and solved to find an optimal jar diameter for ease of opening. For all user groups this diameter is approximately 73 mm. Jars made with this outside diameter should be easiest for all users to open.

The opening torque that a user can apply is directly proportional to the friction coefficient between the user's hand and the cap material. Changing the coefficient of friction therefore has a very pronounced effect on the applied opening torque. Current packaging materials do not produce high enough frictional forces for many users to apply the required forces to open jars. For elderly women the highest value of measured packaging-skin friction coefficient was still 29% lower than that required to allow an average older woman to open an average optimally sized jar.

The results from these grip tests agree reasonably well with the measured data from Chapter 7 for the male subjects. However the agreement between the data sets for the female subjects is less conclusive. Further work is required into the friction between user's hands and packaging material in order to try and improve this. A second limiting factor, the user's wrist strength, must also be accounted for.

In order to improve openability for all users, jars should be made with an outside diameter as close as possible to 73 mm. The outside surface of the jar lids should also be chosen to create higher frictional forces between the cap and the user's hand. Obviously care must be used when selecting high friction surfaces for use in packaging to ensure that injury or discomfort does not result from their use.

The technique is easily, quickly and cheaply adapted to offer an insight into the likelihood that a user will be able to open any kind of package.

8.8 Further Work

As stated in Section 8.6, the main area of this grip-torque study that require more work is the frictional interaction between the skin and the packaging. Using the simple linear model for friction derived by Menardi³⁰ gives a reasonable first estimate as shown in Section 8.6, however it is clear the method is not perfect. A better skin friction model may improve this situation.

The second major area that needs improvement is the grip measurements that the method is based upon. Measurements were taken at 30, 50 and 70 mm diameters. However closures exist that are larger than these values. A further measurement at 90 mm would encompass all standard size jar lids with reasonable accuracy. The extra datapoint would also allow more complicated grip models to be fitted to the data (such as higher order polynomial expressions) to better represent the ability of the population. This change would allow more accurate ability surfaces to be generated and hence more accurate estimates of ability.

Finally, as is the case with all human measurements, it is necessary to keep performing tests so as to keep the database up to date and ensure that it reflects any changes in population demographics or lifestyle.

9 Conclusions and Recommendations

The forces that a human can apply when opening a jar are dependent on many factors. The age and physical condition of the subject greatly influence the amount of force that can be generated. In order to ensure that packaging can be opened by all, it must be designed with the weakest consumers in mind.

The forces that can be applied when opening a jar are also very dependent on the specific jar and closure involved. Even seemingly small changes in materials or geometry can have a large impact on the forces a consumer is able to generate. Specific testing is therefore required to determine the forces that a consumer will be able to apply to a specific package. Testing and analytical analysis reveals that the ideal size of jar lid for most consumers is 73 mm diameter. Food should therefore be packaged in jars of this size to promote openability.

When the strength of the weakest consumer in the target group has been established, design limits based on the strength of that weakest user can be set. If these design limits are then adhered to, it will ensure that all consumers in the target group will be able to open the package. In order to design jars that can be opened by 97-98% of the population, it is necessary to limit the required opening torques to 1 Nm.

In order to design inclusively, it is important to fully understand the ability of the target users and the forces required to open packaging. It is not enough to make a product easier to open and call it 'inclusive'. Specific tests must be done that relate the strength of the user to the population in question to make sure all the target market will be able to open a product.

This study originally set out to solve the problem of difficult to open vacuum lug closures. However it was soon found that this goal was unachievable in the timescale of a PhD. There were too many gaps in knowledge requiring extensive experimental and analytical work. It was therefore decided instead to fill in some of these gaps,

analysing the way in which closures work and developing a model equating opening forces with design parameters. Work was then undertaken to determine the forces required to open current closures of different sizes, and a graph of closure diameter versus opening torque was produced. Tests were then developed to quantify human strength accurately yet cost effectively. A database was subsequently created containing a large number of tests on male and female subjects of all ages. Further tests were then designed to assess whether similar data could be predicted using a combination of simpler tests and analytical work. Although there is still further work to be done, there is good agreement between the calculated and measured data. The data obtained during this study can therefore be used when creating new designs or adapting current designs to ensure that they do not suffer from the same openability problems as current VLCs. As detailed in Chapter 10 there are areas that required further investigation. However the results obtained to date are useful as a proof of concept, demonstrating that a combination of analytical and experimental work can be useful in assessing human ability and hence designing inclusive products.

In addition to developing a useful database of strength measurements, the study also discovered that making simple design changes, like choosing the correct size of jar, can affect the numbers of people likely to open a particular closure.

10 Further Research

10.1 Wrist-twisting Strength Measurement

In order to properly check the accuracy of the results presented in this study, a test measuring the actual level of openability success should be performed. A random group of people should be selected and presented with a number of jars of each size to open. By comparing the number of jars that each subject manages to open with the predicted numbers in this study, the accuracy of the current work can be verified. Due to time and cost restrictions this was not performed, however it would provide a valuable confirmation as to the usability and reliability of the data. Repeat tests would also be of value to check that the database of strength measurements properly reflects any demographics or other changes to the populations.

As with any study based upon human measurement, it is necessary to update the strength database continually. This ensures that it remains accurate and responds to any possible changes that may affect the data it contains (such as economic or social changes that affect the way people live or advances in medical science that may affect physical condition).

In the tests performed in this study, care was taken to ensure that the test rig was similar mass to a full food jar. Testing jars of different mass could be used to show whether this was necessary to obtain accurate results. Should it be demonstrated that the tester mass does not affect performance this may reduce the cost of future tests as the design of the equipment will be simpler if weight is of no concern. Testing jars of different mass could also be used to recommend limits for the mass of consumer products if it proves to be a factor. Heavy or bulky jars may adversely affect the

torque that a person can apply to a jar lid, and so if the mass is reduced it may allow higher opening forces to be required whilst still retaining openability.

In order to extend the test methodologies created here across other forms of packaging, it will be necessary to design and build devices based on different packaging types (glass/plastic bottles, plastic caps etc). Since the opening torque a user can apply is dependent on geometry, specific apparatus will be needed for different types of packaging. The data obtained could be used either to alter existing designs to be more inclusive, or invent new closures with optimal geometry for opening. However this approach may not be necessary if the derived force method can be expanded, as this will allow transferability without requiring such in-depth strength measurement.

10.2 Grip Strength Measurement

More testing of human grip strength, both in terms of number of subjects and also number of grip diameters are also needed to improve the accuracy of the results. A larger sample population will also allow more detailed error analysis and hence a greater understanding of the limitations of the results.

A more detailed system to model the effect of changing diameter on human grip for each of the age groups would also be possible if more diameters of tester were used and if more tests performed. This would allow a greater degree of accuracy to be obtained and hence improve the usability of the derived grip method to aid the design and evaluation of this and other types of packaging.

If possible, equipment should be developed to allow the effect of lid height to be investigated. The current equipment has different height lids, as smaller lids had a minimum depth in order to retain structural integrity. The larger diameter lids were matched to the height of VLC lids in order to keep the test device mass comparable to actual jars.

10.3 Skin Friction

More work is necessary in order to fully understand the frictional properties of human skin, and how the coefficient of friction changes under varying load and speed. This study assumes that skin friction follows Amonton's Law⁴⁵, however it has been shown to deviate from this in several other studies. Further work should therefore be done to investigate more thoroughly the frictional behaviour during the opening process. Testing of more different materials and geometries would also allow the adaptation of the tool for various other packaging systems. An accurate representation of the interaction between packaging materials and human skin is critical in creating more useful analytical models. This will further increase the usefulness of the derived torque methods described in Chapter 8, and allow its use for more types of packaging system.

10.4 Opening Force Measurement

There are several further areas that require investigation with regards to determining fully the factors that affect the forces required to open various jars. Firstly, more types of jars should be measured, in order to ensure that the range of opening torques is accurately determined. To further ensure the repeatability of the test, a clamp should be designed in order to ensure that the lid is gripped in exactly the same way each time a jar is opened. This could then be extended to investigate the effects of changing the grip force. If a force sensor were to be incorporated in such a grip, the applied force could be set to known values. By applying a range of grip forces accurately to the lids the hypothesis that changing grip affects opening torque can be tested, and hence the validity of the model developed in Chapter 5 verified.

Further work should also be done to investigate the possibility of improving opening torques by using alternative liner material to reduce friction and sticktion between the jar and the liner. If a suitable liner can be found that does not suffer from the above problems this may result in a much improved and easier to open closure.

The capping process used to apply the lids to the jars should also be investigated. If the variability in the capping can be lessened then it may be possible to apply current caps with lower forces and still ensure that all closures are sufficiently tight to protect ensure the jar remains sealed.

11 References

1. Euromonitor. *Food Packaging in Poland*. Available on www.euromonitor.com. 2006.
2. SPG Media. *Global Packaging Market Statistics*. Available on www.packaging-gateway.com. 2004.
3. Institute of Food Science & Technology. *Food Packaging – Frequently Asked Questions*. Available on www.ifst.org.
4. McConnell V (Editor). 'Yours' Magazine, 'Pack it in! – Just say no to impossible packaging'. Emap Esprit, 30th January-27th February 2004.
5. Silgan Plastics Corporation. *Glossary of Packaging Terms*. Available on clearplass.com.
6. Crown Holdings, Inc. *Metal Closures - Products & Services*. Available on www.crowncork.com.
7. EHCAN. *Closures for Glass Containers*. Available on www.ehcan.com.
8. Fowler, N. and Nicol, A.C. - Functional and biomechanical assessment of the normal and rheumatoid hand. *Clin Biomech* 16(8):660-6. October 2001.
9. Department of Trade and Industry. *Strength Data for Design Safety*. UK DTI. 2000.
10. Giampaoli S, Ferrucci L, Cecchi F, Lo Noce C, Poce A, Dima F, Santaquilani A, Vescio M F, Menotti A. *Hand-grip strength predicts incident disability in non-disabled older men*. *Age and Ageing*. 1999;28:283-288.
11. Mathiowetz V, Kashman N, Volland G, Weber K, Dowe M, Rogers S. *Grip and Pinch Strength: Normative Data for Adults*. *Arch Phys Med Rehabil* 1985;66:69-72.

12. Crawford J O, Wanibe E, Nayak, L. *The Interaction Between Lid Diameter, Height and Shape on Wrist Torque Exertion in Younger and Older Adults*. Ergonomics. 2002;45.10:922-933.
13. Imrhan, S. N. and Loo, C. H. *Modelling wrist-twisting strength of the elderly*, Ergonomics, vol 31, 1807-1819. 1988.
14. Rohles, F. H., Moldrup, K. L. and Laviana, J. E. *Opening jars: an anthropometric study of the wrist twisting strength in elderly*. Proceedings of the Human Factors Society, 27th Annual Meeting, 112-116. 1983.
15. Department of Trade and Industry. *Specific Anthropometric and Strength Data for People with Dexterity Disability*. UK DTI. 2002.
16. Crawford, J. O., Wanibe, E. and Nayak, L. *The Interaction Between Lid Diameter, Height and Shape on Wrist Torque Exertion in Younger and Older Adults*. Ergonomics, vol 45, no 10, 922-933. 2002.
17. Voorbij, A. I. M. & Steenbekkers. *The Twisting Force of Aged Consumers When Opening a Jar*. Applied Ergonomics, vol 33, no 1, 105-109. 2002.
18. Fowler, N. K. and Nicol, A. C. 1999. *Measurement of external threedimensional interphalangeal loads applied during activities of daily living*. Clinical Biomechanics, vol 14, 721-726 13. 1999.
19. Chadwick, E. K. J. and Nicol, A. C. *A Novel Force Transducer For The Measurement Of Grip Force*. Journal of Biomechanics, vol 34, 125- 128. 2001.
20. Carmeli E, Patish H, Coleman R. *The Ageing Hand*. Journal of Gerontology. 2003;58A,2:146-152.
21. BBC Online. *Will living longer threaten our lifestyle?* Available from news.bbc.co.uk. April 2004.
22. UK Government Actuary Population Projections, National Statistics Office. Available on www.ons.gov.uk.
23. Trades Union Congress. *The Future of Work*. Available from www.tuc.org.uk. March 2002.

-
24. Naylor, P. F. D. *The Skin Surface and Friction*. British Journal of Dermatology 1955;67:239-248.
 25. Koudine, A. A., Barquins, M., Anthoine, P. H., Auberst, L., Leveque, J. L. *Frictional Properties of Skin: Proposal of a New Approach*. International Journal of Cosmetic Science. 2000;22:11-20.
 26. Highly, D. R., Coomey, M., DenBeste, M., Wolfram, L. J. *Frictional Properties of the Skin*. Journal of Investigative Dermatology. 1973;69:303-335.
 27. Asserin, J., Zahouani, H., Humbert, P. H., Couturuard, V., Mougin, D. *Measurement of the Friction Coefficient of the Human Skin In Vivo. Quantification of the Cutaneous Smoothness*. Colloids Surf B: Biointerfaces. 2000;181:88-91.
 28. Sivamani R K, Goodman J, Gitis N V, Maibach H I. *Coefficient of Friction: Tribological Studies in Man, an Overview*. Skin Research and Technology. 2003;9.3:227-234.
 29. O'Meara, D.M. and Smith, R.M. *Static friction properties between human palmar skin and five grabrail materials*. Ergonomics, 2001;44.11:973-988.
 30. Menardi, C. *Measuring Finger Friction*. MEng Thesis, University of Sheffield, UK. May 2006.
 31. Comaish S, Bottoms E. *The Skin and the Friction: Deviations from Amonton's Laws and the Effects of Hydration and Lubrication*. British Journal of Dermatology. 1971;84:37-43.
 32. Sealy, D., J., A. *Investigation into the Openability of Vacuum Lug Caps*. Masters Thesis, University of Sheffield. May 2002.
 33. Langley, J. *Inclusive Design: A Design Approach for Consumer Packaging*. PhD Thesis, University of Sheffield. March 2004.
 34. Assembly Magazine. *Ergonomics Glossary*. Available from www.assemblymag.com. May 2002.
 35. Department of Trade and Industry. *Adultdata – The Handbook of Adult Anthropometric and Strength Measurements*. UK DTI. 1998.
-

36. Department of Trade and Industry. *Older Adultdata – The Handbook of Measurements and Capabilities of the Older Adult*. UK DTI. 2000.
37. Yoxall A, Langley J, Janson R, Wearn J, Manson G. *The Use of Uncertainty Analysis for the Design of Container Closures*. Packaging Technology and Science. 2006; 19:139-147. DOI: 10.1002/pts.716
38. BBC Online. *Shop local, campaign group urges*. Available on news.bbc.co.uk. April 2006.
39. Paine, F. A. *The Packaging User's Handbook*. Blackie Academic & Professional, London, UK. 1991.
40. BBC Online. *Older people strategy a wise move*. Available on news.bbc.co.uk. January 2007.
41. Chadwick, E. K. J. and Nicol, A. C. *A Novel Force Transducer For The Measurement Of Grip Force*. Journal of Biomechanics, vol 34, 125-128. 2001.
42. Crawford, J. O., Wanibe, E. and Nayak, L. *The Interaction Between Lid Diameter, Height and Shape on Wrist Torque Exertion in Younger and Older Adults*. Ergonomics, vol 45, no 10, 922-933. 2002.
43. Design Council. *An Introduction to Ergonomics*. Available from www.designcouncil.org.uk. Updated January 2007.
44. Yoxall, A., Janson, R., Taylor, J.C. and Wearn, J. *Help or Hinderance: The Use of Tools for Opening Packaging*. Applied Ergonomics, Under review 2006.
45. Amonton G. *De La Resistance Cause dans les Machines*. Histoire de l'Academie Royale des Science avec les Memories de Mathematiques et de Physique. 1699;12:106.

12 Appendix 1

12.1 Torque Results for 30 mm Diameter Lid

The 30 mm diameter lid used in testing is a ROPP type, and hence the results are not directly comparable with those from the VLC testing. Some limited testing was performed however to check the performance and scalability of the apparatus, and to provide limited comparisons.

Test results from 42 participants (23 males and 19 females) were used in this section of the analysis. The data was processed as described in Section 7.4, and plotted on age and torque axes. The results can be seen in Figure 12.1 below. Note that the graph has the same axes scales as all the graphs in Section 7.5.1 for ease of comparison. The required opening torques for a sample of ROPP bottles has been added as a guide for this data, however again note that due to the difference in closure type these results are not directly comparable to the VLC data.

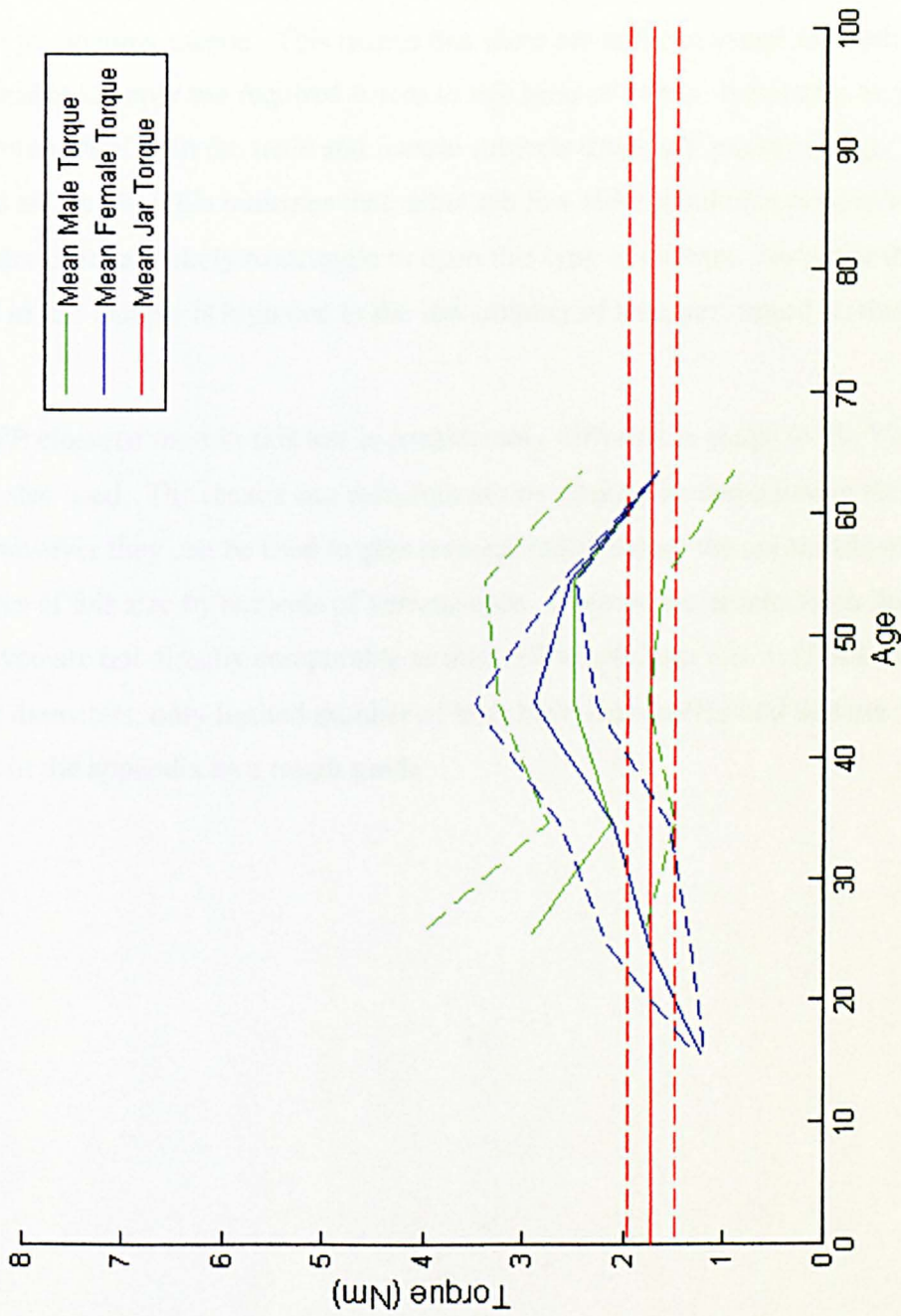

Figure 12.1. Graph of torque against age for a 30 mm ROPP closure.

As shown in Figure 12.1 (and in comparison with the graphs in Section 7.5.1), the torques that most users can apply to closures of this diameter are lower than the torques they can apply to larger diameter closures. For most of the tested age range

the bulk of users can apply forces higher than the mean opening torque for the jar. However the mean – 1 standard deviation lines for both males and females are around the mean jar opening torque. This means that there are still considerable numbers of people unable to apply the required forces to this kind of bottle. It can also be seen that the strength of both the male and female subjects drops off quickly as age increases above 60. This indicates that, although few elderly volunteers were tested, many older users are likely to struggle to open this type of closure. Note that the variance in this sample is high due to the low number of tests performed on this closure.

The ROPP closure used in this test is considerably different in shape to the VLC closures also used. The results can therefore not be directly compared to the VLC results, however they can be used to give a rough indication of the applicable torque to closures of this size by subjects of various ages. Because the results from this closure type are not directly comparable to those obtained from the VLC lids used for the other diameters, only *limited number of tests* have been performed that are merely included in the appendix as a rough guide.

13 Appendix 2

13.1 Subject Numbers Breakdown

13.1.1 Torque – Age Analysis

The numbers of subjects in each age and gender group for each size of closure is shown in Table 13.1. The total number of subjects tested as part of the analysis was 1142.

Table 13.1 Table showing the number of subjects in each age, gender and diameter group for torque-age analysis of the torque measurement investigation.

	Lid Diameter	Age Band									
		0-9	10-19	20-29	30-39	40-49	50-59	60-69	70-79	80-89	90+
Male	30 mm	0	0	6	6	4	4	3	0	0	0
	55 mm	4	104	88	18	19	21	7	10	5	9
	75 mm	0	11	29	22	25	22	12	20	19	1
	85 mm	0	6	87	18	11	10	7	5	4	2
	Total Male	4	121	210	64	59	57	29	35	28	12
Female	30 mm	0	1	7	7	2	1	1	0	0	0
	55 mm	0	24	36	12	17	25	15	20	52	23
	75 mm	1	15	27	16	12	13	12	24	32	4
	85 mm	0	3	22	16	26	14	2	16	13	12
	Total Female	1	43	92	51	57	53	30	60	97	39
Total	5	164	302	115	116	110	59	95	125	51	

13.1.2 Torque – Diameter Analysis

The numbers of subjects in each age and gender group for each size of closure is shown in Table 13.1. The total number of subjects tested as part of the analysis was 908.

Table 13.2 Table showing the number of subjects in each age, gender and diameter group for torque-diameter analysis of the torque measurement investigation.

	Lid Diameter	Age Group	
		30-60	60+
Male	55 mm	82	43
	75 mm	93	77
	85 mm	55	26
	Total Male	230	146
Female	55 mm	79	138
	75 mm	58	101
	85 mm	81	75
	Total Female	218	314
	Total	448	460

13.1.3 Grip – Diameter Analysis

The numbers of subjects in each age and gender group for each size of closure is shown in Table 13.3. The total number of subjects tested as part of the analysis was 380.

Table 13.3 Table showing the number of subjects in each age, gender and diameter group for the grip strength investigation.

Lid		Age Group	
		30-60	60+
Diameter			
Male	30 mm	61	23
	50 mm	35	15
	70 mm	40	17
Total Male		136	55
Female	30 mm	55	33
	50 mm	35	14
	70 mm	33	19
Total Female		123	66
Total		259	121