

**CONSERVATION OF BRITISH COLONIAL BUILDINGS
BUILT BETWEEN 1800 AND 1930 IN MALAYSIA**

BY

A. GHAFAR BIN AHMAD

**B.Sc. (Arch.) Univ. of Wisconsin-Milwaukee, USA
M.Arch. (Urban Design) Kent State Univ., Ohio, USA**

**Thesis Submitted to
the School of Architectural Studies,
University of Sheffield
for the Degree of Doctor of Philosophy**

October 1993

CONSERVATION OF BRITISH COLONIAL BUILDINGS BUILT BETWEEN 1800 AND 1930 IN MALAYSIA

PH.D. THESIS

A. GHAFAR BIN AHMAD
University of Sheffield

SUMMARY

The main intent of the thesis is to study the methods and techniques of building conservation in the United Kingdom and to develop possibilities of transferring them to the context of British colonial buildings in Malaysia. It is axiomatic, based on visits to and observations of a large number of buildings in Malaysia and the United Kingdom, that there are many similarities between the British colonial buildings built between 1800 and 1930 in Malaysia and those built in the same period of time in the United Kingdom; in terms of style, building materials, detailing, function and construction.

Like many other countries in which building conservation seems a fairly new practice, Malaysia faces problems in dealing with the issues of historic buildings. The present legislation for historic buildings is not sufficient nor suitable, to protect such buildings from being demolished and destroyed. There is also no suitable system for discovering and recording the British colonial buildings in the country. Another aspect is lack of technical knowledge in repairing and maintaining historic buildings. An introductory chapter explains further these problems besides describing the British colonial architecture and the present situation of building conservation in Malaysia.

The thesis is divided into five parts. Part One, deals with legislation, examines the scope of building conservation, reasons for conservation, terminology, recording and listing buildings; and also some case law in regard to building conservation in the United Kingdom. Part Two looks upon philosophical attitudes of some organizations dealing with building conservation in the United Kingdom and Malaysia. Part Three includes a study of methodology which covers saving historic buildings, systems for discovering and recording, data of British colonial buildings, the use of building materials and common defects; and methods and techniques of building maintenance. Part Four presents and analyses case studies of building conservation in the United Kingdom and Malaysia. Several buildings have been selected to compare their changes of use and methods of renovation. Part Five provides conclusions and recommendations for the improvement of the British colonial buildings in Malaysia.

ACKNOWLEDGEMENTS

First of all, I would like to express my sincere gratitude and deepest appreciation to my supervisor, Professor Kenneth H. Murta, for his valuable supervision, support and constructive criticism throughout the duration of this study. Many thanks to Mrs. Doreen Spurr, secretarial staff and librarian Mrs. Lois Burt in the School of Architectural Studies at the University of Sheffield for their great assistance.

I would also like to express my greatest appreciation and thanks to the Public Service Department, Malaysia and the Universiti Sains Malaysia for financially supporting my study in the United Kingdom. Special thanks to the Heritage of Malaysia Trust, National Museum of Malaysia, National Archive of Malaysia and Universiti Teknologi Malaysia for their valuable assistance, particularly in providing useful information and allowing me to use their facilities during my fieldwork study.

I am also grateful to my fellow students at the University of Sheffield and Sheffield Hallam University for their help, support and friendship. Last, but not least, to my dearest parents Mr. Haji Ahmad Md. Yatim and Mrs. Hajjah Asiah Sarwan; and family whose support, patience and understanding have always renewed my confidence.

CONTENTS

	Page
Summary	i
Acknowledgements	ii
Contents	iii
List of Figures	vi
CHAPTER 1	
INTRODUCTION	1
1.1 Background of Malaysia	1
1.2 Colonial Architecture	3
1.3 Situation of Building Conservation in Malaysia	11
1.4 Problems of Historic Buildings	17
1.5 Intent of Thesis	24
PART ONE : LEGISLATION	
CHAPTER 2	
TOWARDS AN UNDERSTANDING OF BUILDING CONSERVATION	26
2.1 Reasons For Conservation	27
2.2 Standard of Ethics	32
2.3 Scope of Building Conservation	34
2.4 Terminologies	37
CHAPTER 3	
LEGISLATION FOR RECORDING AND LISTING BUILDINGS	40
3.1 Recording Buildings	41
3.2 The Practice of Listing Buildings in the United Kingdom	42
3.3 No.1 Poultry Street: A Case Study	48
3.4 Complexity or Possibility	54
PART TWO : PHILOSOPHY OF CONSERVATION	
CHAPTER 4	
ORGANIZATIONS OF BUILDING CONSERVATION IN THE UNITED KINGDOM	59
4.1 The Importance of Building Conservation Organizations	59
4.2 Organizations in the United Kingdom	60
4.3 Official Organizations	61
4.4 Private Societies	63
4.5 Charitable Trust Societies	65
CHAPTER 5	
ORGANIZATIONS OF BUILDING CONSERVATION IN MALAYSIA	68
5.1 General Views	68
5.2 Official Conservation Committees	69
5.3 Private Society	71
5.4 Charitable Trust	72
5.5 Comparison and Recommendations	72

PART THREE : METHODOLOGY

CHAPTER 6	
SAVING HISTORIC BUILDINGS	78
6.1 The Principles of Repair	79
6.2 Modern Inventions and New Materials	82
6.3 Public Safety and Access	83
6.4 Protection From Traffic	84
6.5 Fire and Security	86
6.6 Preventive Maintenance	89
6.7 Presentation	89
6.8 Cost Estimation and Control	90
6.9 Rehabilitation of Historic Buildings	90
CHAPTER 7	
SYSTEMS FOR DISCOVERING AND RECORDING	93
7.1 Objectives of Discovering and Recording	93
7.2 Discovering the British Colonial Buildings	95
7.3 Principles and Levels of Recording	100
7.4 Format For a Record Card	103
7.5 Preserving Records	110
CHAPTER 8	
DATA OF BRITISH COLONIAL BUILDINGS	112
8.1 Classification of British Colonial Buildings	113
8.2 Format For a Building Data Matrix	134
8.3 Procedure For Recording Building Data Matrix	139
8.4 The Use of Computer Database	139
CHAPTER 9	
BUILDING MATERIALS AND COMMON DIAGNOSES	142
9.1 Building Materials	142
9.2 Timber	144
9.3 Common Diagnoses of Timber Defects	147
9.4 Stone	149
9.5 Repair and Maintenance of Stone	153
9.6 Brick	155
9.7 Plaster and Stucco	157
CHAPTER 10	
METHODS AND TECHNIQUES OF BUILDING MAINTENANCE	160
10.1 Importance and Nature of Recording and Building Maintenance	160
10.2 Climatic Conditions and Building Problems	162
10.3 Air-Conditioning Systems	163
10.4 Some Common Building Problems of Historic Buildings and Their Solution	170
10.5 Programme of Cyclical Maintenance	203

PART FOUR : CASE STUDIES

CHAPTER 11	
CASE STUDIES OF BUILDING CONSERVATION IN THE UNITED KINGDOM	206

11.1 Criteria For Building Selection	206
11.2 Methods of Case Studies	207
11.3 Case Study One: Sessions House, Kent County Hall, Maidstone	208
11.4 Case Study Two: Tate Gallery Albert Dock, Liverpool	217
11.5 Case Study Three: Christ Church, Stannington, Sheffield	225

CHAPTER 12 CASE STUDIES OF BUILDING CONSERVATION IN MALAYSIA

12.1 Criteria and Reasons For Building Selection	233
12.2 Method of Case Studies	234
12.3 Case Study One: JKR 92 Memorial Library and Museum, Kuala Lumpur	236
12.4 Case Study Two: Old District Council, Klang, Selangor	246
12.5 Case Study Three: PAM Centre, Kuala Lumpur	254
12.6 Case Study Four: Sultan Abdul Samad Building, Kuala Lumpur	265
12.7 Building Comparison and Recommendations	287

PART FIVE : CONCLUSIONS

CHAPTER 13 CONCLUSIONS

13.1 Principles and Attitudes	295
13.2 Recommendations	297

APPENDICES

1 Extraction of the Town and Country Planning Act 1976	302
2 Extraction of the Antiquities Act 1976	304
3 Extraction of the Johore Enactment No.7 of 1988	305
4 Extraction of the Malacca Enactment No.6 of 1988	306
5 Building Data Matrix Introduced By Heritage of Malaysia Trust	308
6 Building Data Matrix For British Colonial Buildings	314
7 Paint Types and Methods of Removal	324
8 Using Limewash	325

BIBLIOGRAPHY

326

LIST OF FIGURES

		Page
Fig.1	Malaysia and its location	2
Fig.2	Portuguese architecture in Malacca	4
Fig.3	Dutch architecture in Malacca	4
Fig.4	Moorish architecture designed by Arthur Charles Alfred Norman	7
Fig.5	Moorish architecture designed by A.B. Hubbock	8
Fig.6	Tudor architecture in Kuala Lumpur	9
Fig.7	Neo-Classical architecture	10
Fig.8	The Carcosa mansion built with a taste of Neo-Gothic style	12
Fig.9	Holy Rosary Church in Kuala Lumpur	12
Fig.10	The Central Market in Kuala Lumpur, a good example of adaptive re-use project	14
Fig.11	Three examples of adaptive re-use buildings on Ampang Road, Kuala Lumpur	15
Fig.12	Some mansions in Penang have been converted into office spaces	16
Fig.13	Some British colonial buildings have been vandalised, improperly maintained and left abandoned	16
Fig.14	Examples of the privately owned buildings	18
Fig.15	The residence of Chan Chin Mooi family	20
Fig.16	Penang Court in Georgetown	22
Fig.17	The Willis Faber and Dumas Headquarters in Ipswich	44
Fig.18	No.1 Poultry Street, London	49
Fig.19	Two proposal schemes (A & B) for No. 1 Poultry Street	52
Fig.20	Revised Scheme B	53
Fig.21	The destruction of Eastern Hotel in Kuala Lumpur	58
Fig.22	Structure of conservation management	74
Fig.23	The insertion of vertical curtains of Thixotropic grout to protect foundations from traffic vibration	85
Fig.24	Two examples of protections of historic building from traffic	87
Fig.25	Examples of the use of mechanical means to produce drawings	99

Fig.26	A record card used by Penang City Council	104
Fig.27	A record card used by Heritage of Malaysia Trust	105
Fig.28	Front page of a suggested format for a new record card	106
Fig.29	Back page of a suggested format for a new record card	109
Fig.30	One of questionnaire charts used for recording traditional domestic architecture in the United Kingdom	114
Fig.31	Forts / Military	116
Fig.32	Churches	118
Fig.33	Mosques	119
Fig.34	Palaces	121
Fig.35	Clock towers	122
Fig.36	Prisons	123
Fig.37	Government offices	125
Fig.38	Institutional and commercial	127
Fig.39	Residential	129
Fig.40	Schools	130
Fig.41	Railway stations	132
Fig.42	Hotels and guest houses	133
Fig.43	Miscellaneous Buildings / Monuments	135
Fig.44	Examples of common building decays in British colonial buildings	143
Fig.45	Timbers are stacked into layers in air seasoning methods	146
Fig.46	Examples of poor installation of air-conditioning units	165
Fig.47	Louvered windows, air-wells and verandahs can play a major role in encouraging natural ventilation	167
Fig.48	Placing air-conditioning units at outside is more preferable than on windows and walls	169
Fig.49	Various forms of underpinning	173
Fig.50	Causes to the problems of leaning wall	176
Fig.51	Basic repair of restraining an outward leaning wall	176
Fig.52	Method of raking shores for temporary support to a leaning wall	178

Fig.53	Major repairs for leaning brick walls	179
Fig.54	Old and new roof tiles	182
Fig.55	Problem of matching and finishing new mortar with the old	185
Fig.56	Peeling paint on areas exposed to excessive rain and dampness	187
Fig.57	Common problems associated with defective rainwater goods	192
Fig.58	The insertion of a damp-proof membrane in a stable wall	195
Fig.59	The method of electro-osmosis damp-proofing	195
Fig.60	Broken plaster caused by biological attack	196
Fig.61	Bolster is used to loosen up board	200
Fig.62	The use of batten and gentle pressure to ease nails slightly out of joists	200
Fig.63	Method of lifting subsequent boards by using a crowbar and block	200
Fig.64	Repairing a split board	202
Fig.65	Repairing a broken edge	202
Fig.66	Battens are screwed to joists for strengthening a weak board	202
Fig.67	Floor plans of Kent County Hall	210
Fig.68	Floor plans of Kent County Hall (con't)	211
Fig.69	External views of Kent County Hall	215
Fig.70	Internal views of Kent County Hall	216
Fig.71	Sections,elevations and floor plans of Tate Gallery,Liverpool	219
Fig.72	Main entrance and lobby of Tate Gallery,Liverpool	220
Fig.73	Perspective views of Tate Gallery,Liverpool	222
Fig.74	Floor plans of Christ Church,Stannington	226
Fig.75	External views of Christ Church,Stannington	227
Fig.76	Internal views of Christ Church,Stannington	229
Fig.77	Vestry,Christ Church, Stannington	230
Fig.78	Elevations,sections and floor plans of JKR 92 Memorial Library and Museum,Kuala Lumpur	237
Fig.79	Two views showing the building then and now	238

Fig.80	North and west elevations	240
Fig.81	Building details	243
Fig.82	Interior views of the building	244
Fig.83	Ground floor plan; and the building before and after renovation	248
Fig.84	Views of Old District Council Offices	249
Fig.85	Copies of the original drawings of the building	251
Fig.86	Floor plans and north-east elevation of PAM Centre	256
Fig.87	Main entrance and internal courtyard	257
Fig.88	PAM Centre before and after renovation	259
Fig.89	Front page of Historic Building Record Card	263
Fig.90	Back page of Historic Building Record Card	264
Fig.91	Location and front elevation of Sultan Abdul Samad Building	268
Fig.92	Floor plans of Sultan Abdul Samad Building	269
Fig.93	Elevations of Sultan Abdul Samad Building	270
Fig.94	Views showing pinnacles and iron grilled screens	272
Fig.95	Later constructions and additions	275
Fig.96 to 115	Building data matrix recorded for Sultan Abdul Samad Building	277
Fig.116	Building comparison	288
Fig.117	Design problems	293

CHAPTER 1

INTRODUCTION

1.1 BACKGROUND OF MALAYSIA

Malaysia, one of the fastest growing countries in Southeast Asia, was formed in 1963, six years after its independence from the British. It consists of fourteen states, twelve in Malay Peninsula and two, Sabah and Sarawak states, in East Malaysia which lies in the northern quarter of the island of Borneo. Geographically, the Malay Peninsula is bounded by Thailand, Burma, Kampuchea, Vietnam and Laos in the north, Singapore and Indonesia in the south; while the islands of Philippines are in the east (Fig.1). It has a population of 18.7 million(1992). Some of the country's major cities are Kuala Lumpur, the capital of the country, Georgetown, Johor Bahru, Ipoh, Kuching, Kota Kinabalu and Malacca.

This multiracial country comprises of Malays 51%, Chinese 35% with 10% of Indians. The remaining 4% are formed by other ethnic groups such as the Dayaks, Kadazans, Thais, Eurasians, Filipinos, Indonesians and Arabs. The government is a parliamentary democratic system with a Prime Minister as the Head of the Government with an elected *Yang Di Pertuan Agong* (King), whom is one of nine Sultans, serving five-year terms as the Supreme Head of State. Although Islam is the official religion of the country, freedom of worship is enjoyed by all ethnic communities.

Like many other countries in Asia, Malaysia has its own architectural heritage which is basically influenced by several architectural styles including Indian Kingdoms between 7th to 14th Century, Southern Chinese in the 15th



Fig.1 Malaysia and its location

Century to present, Portuguese between 1511 and 1641, Dutch between 1641 and 1795, Indonesian in 18th Century; and British from 1795 to 1957. The Malay vernacular from 15th Century onwards, commonly uses timber for building structure, floor, walls and stilts; and *Nipah*, *Rumbia* (Sago) or *Bertam* thatch for pitched roofs, can be found in most *kampung* (village) areas throughout the country. The Southern Chinese architecture, which mainly consists of verandah-walkway shophouses, clan mansions and Buddhist temples, can be seen in many urban places.

1.2 COLONIAL ARCHITECTURE

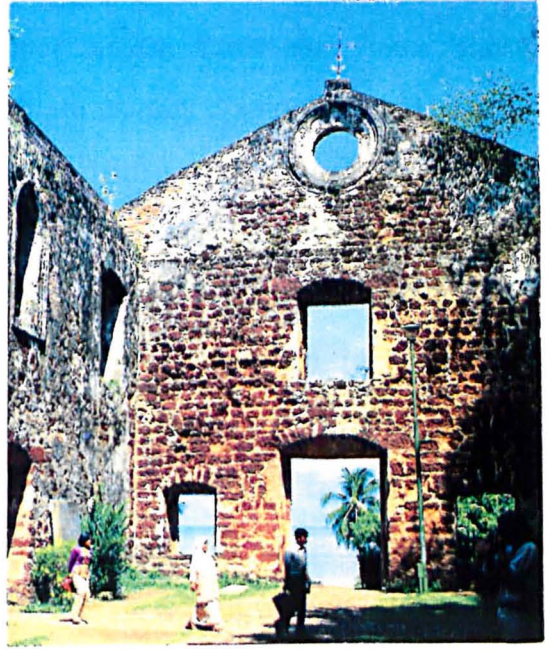
Even though Malaysia has long gained its independence, the remains of its colonial architecture, particularly from the Portuguese, Dutch and British occupations can still be found in some major cities. The Portuguese and Dutch architecture are mostly found in Malacca, a 15th-century port city which became the trade centre of spices demanded by the Europeans. For instance, the existing Portuguese Porta de Santiago Gate built in 1511 and St. Paul's Church built in 1590 (Fig.2). Unfortunately, both buildings were destroyed by the Dutch and left in ruins. The Dutch Stadthuys building, which was built between 1641-60 for the Dutch Governor, has undergone many restoration stages before it was finally converted into a museum (Fig.3). There are still traces of Dutch influence. Another example of Dutch building is Christ Church which was erected in 1753 and is the oldest Protestant church in Southeast Asia. Like the Studthuys, the church was well maintained and is currently used by the local Christians. Today, Dutch influence still remains in the materials and types of buildings found in Malacca.

1.2.1 British Colonial Architecture

During the British occupation of Malaysia, many colonial buildings were built mainly in the first British colonial settlement in Southeast Asia,



Porta de Santiago Gate (1511)



An interior view of the ruined St. Paul Church (1590)

Fig.2 Portuguese architecture in Malacca



Stadthuys (1641-60)



Christ Church (1753)

Fig.3 Dutch architecture in Malacca

Georgetown but also in Kuala Lumpur, Ipoh, Taiping, Seremban, Johor Bahru and Kuching. These colonial buildings, which are usually discernible and easy to identify, range from official residences for British Resident-Generals and Anglican churches to railway stations and functional erections such as public buildings. The buildings display particular design characteristics which are similar or probably identical to that of contemporary design in homeland England. This is due to those British architects or builders involved who felt that their buildings should reflect a sense of imperialist tradition, by creating the mansions and churches to portray the home country. Of course, there is a fundamental difference between the desire to re-create a "little corner of England in a foreign field", on the one hand, and the desire to produce fine buildings which challenged the British originals in style and opulence, on the other.¹

It is important to understand that the British colonial buildings not only possess an original identity in their own style but were generally constructed by trained contractors, bricklayers, soldiers, builders or even priests who had learned the rudiments of construction during their service in England, India and other parts of the British empire. They had also introduced some of the best building techniques during that period of time. In early 1900, for example, as a rule of the Civil Service Commission in London, non-cadet officials were trained in not only medicine and agriculture but architecture and some other specialised fields.² This accounts for the durability and relatively good condition of these buildings. Even though British colonial architecture represents a relatively small part of the Malaysian building heritage, its characters and styles have influenced more or less many other new buildings especially commercial buildings, offices and houses.

Aesthetically, the British colonial buildings built in Malaysia are essentially hybrids. Under Western influence, sometimes they look Classical, sometimes Gothic and sometimes more a taste of oriental forms. These were

¹Robert F. Heskeith, ed., *Architecture of the British Empire*, London: George Weidenfeld and Nicolson Ltd., 1986, p. 187.

²John G. Butcher, *The British in Malaya 1880-1941*, Kuala Lumpur: Oxford University Press, 1979, p. 46.

modified to a greater or lesser degree by the use of local building materials and architectural traditions. Generally, the buildings can be classified into several architectural styles including Moorish, Tudor, Neo-Classical and Neo-Gothic.

The Moorish influence can be seen many in buildings in the heart of Kuala Lumpur such as the Old General Post Office and the majestic Sultan Abdul Samad Secretariat Building (Fig.4). Both of which were built between 1894 and 1897. They were both designed by Arthur Charles Alfred Norman, a senior architect in the Public Works Department in Malaya (former name of the Malay Peninsula). Other buildings include the Railway Station built in 1911 and Railway Administration Headquarters built in 1917 (Fig.5). The later two buildings were designed by A.B. Hubbock, an acting chief architect of Malaya who had worked for a time in the Public Works Department in India.³ To give a new image to the Islamic faith of the Malays, the architect had borrowed the Moghul architecture of northern India for inspiration. With a handsome mixture of Islamic and Italianate breeding, these impressive colonnaded buildings are not only major landmarks, but form a sense of unity to the city of Kuala Lumpur. These buildings are good examples of the hybrid nature of such colonial architecture.

Tudor architecture, however, is a typical style of two social club buildings in Kuala Lumpur. They are the Royal Selangor Club building built around 1884; and the Selangor Chinese Club built in 1929 (Fig.6). The architectural style, which features large exposed wooden beams in half-timbered walls, was a typical model for some of the earliest social club buildings in the country.

Some examples of Neo-Classical buildings are the elegant Municipal Council building in Penang built in 1879, Town Council Offices (former Police Contingent building) in Klang built in 1910; and Seremban State Library built in 1912 which was formerly known as the State Secretariat building (Fig.7). The

³S. Vlatscas, *A History of Malaysian Architecture*, Singapore: Longman Singapore Publishers Pte. Ltd., 1990, p. 59.



Old General Post Office, Kuala Lumpur (1894)



Sultan Abdul Samad Building, Kuala Lumpur (1897)

Fig.4 Moorish architecture designed by Arthur Charles Alfred Norman



Railway Station, Kuala Lumpur (1911)



Railway Administration Headquarters, Kuala Lumpur (1917)

Fig.5 Moorish architecture designed by A.B. Hubbock



Selangor Club (1884)



Selangor Chinese Club (1929)

Fig.6 Tudor architecture in Kuala Lumpur



Municipal Council building, Penang (1879)



Town Council Offices (former Police Contingent building), Klang (1910)



State Library (former State Secretariat building), Seremban (1912)

Fig.7 Neo-Classical architecture

use of classical proportioned columns and pilasters using Doric, Ionian or Corinthian capitals became the means by which the architects sought to create these majestic structures.

However, there are relatively few colonial buildings built in the Neo-Gothic style. For instance, the Carcosa mansion, another good example of the hybrid nature of such colonial architecture which is located on a hill top in Kuala Lumpur (Fig.8), was originally built in 1897 as the official residence for Sir Frank Swettenham who was the British Resident-General of the Federated Malay States. The design of the building was largely influenced by Tudor and Neo-Gothic styles. After Swettenham, the building was occupied by other Resident-Generals and Chief Secretaries, Senior Army Officers during the Japanese occupation of Malaysia from 1941 to 1945 and was the residence of the British High Commissioner from 1946 to 1988. Today, the building has been renovated, with conservation attitudes as the basis, to become a luxury hotel.

As might be expected religious buildings are mainly Neo-Gothic. An example of this Neo-Gothic architecture is the Church of Holy Rosary in Kuala Lumpur built in 1903 (Fig.9). The building portrays many typical Gothic features of the churches of Europe. The Church was established earlier to serve the needs of the Chinese community in Kuala Lumpur.⁴

For decades, many British colonial buildings have survived. Under the Antiquities Act 1976; some of them have been gazetted by the Malaysian Government which then give some protection and encouragement to be preserved.

1.3 SITUATION OF BUILDING CONSERVATION IN MALAYSIA

Building conservation in Malaysia is a relatively new practice in the local architectural scene. Although a lot of initiatives had been made by the Government, through the channels of Museums Department, Ministry of Works;

⁴Pertubuhan Akitek Malaysia, *1890-1990: 100 Years Kuala Lumpur Architecture*, Kuala Lumpur: Pertubuhan Akitek Malaysia, 1990, p. 23.

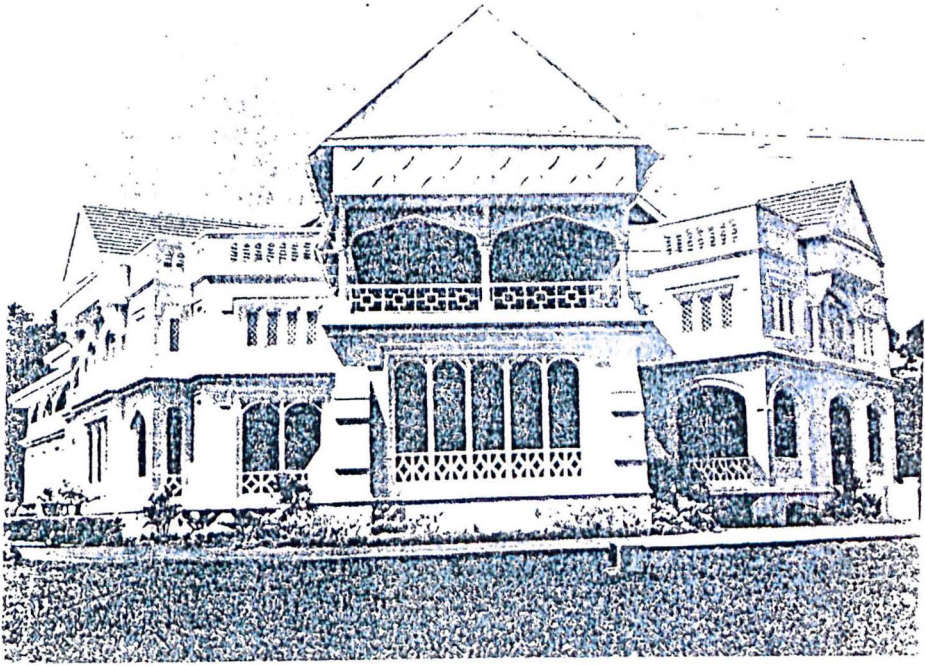


Fig.8 The Carcosa mansion built with a taste of Neo-Gothic style



Fig.9 Holy Rosary Church in Kuala Lumpur

and conservation bodies like Badan Warisan Malaysia (Heritage of Malaysia Trust) , in the past few years to preserve some historical buildings including those of the Portuguese, Dutch and British periods; the public awareness of the importance of preserving such buildings was then less encouraging. However, today the public attitude towards building conservation has changed gradually ever since the successful project of adaptive re-use of Central Market built in 1930s located in the heart of Kuala Lumpur (Fig.10). The Central Market, which used to be a wet market with all the noisy stalls and unpleasant odours, has been converted into a handicraft and cultural centre. People now shop for souvenirs in the building instead of fish , and stroll in comfort on clean tiled floors, sit on benches under shady trees and enjoy cultural shows at an open-air theatre near the Gombak River.⁵ The building has shown a great achievement through the conservation efforts. The experience of the Central Market re-development in Kuala Lumpur has ignited the realisation that adaptive re-use may be a possible, or even a better solution to re-develop a location.⁶

Besides the Central Market, there are few other buildings including the British colonial buildings which have been sold or leased to individuals or private sectors for conversion for either commercial, residential or office purpose. Along Ampang Road in Kuala Lumpur, for example, one can notice many old buildings built in the early 1900s which have been used for the residence of the foreign diplomats, restaurant and tourist information centre (Fig.11). In addition, some mansions in Penang have undergone physical transformations to adapt to climatic conditions as well as the local way of life. Two mansions have already been converted to become premises for a printing office and a bank (Fig.12).

However, unfortunately some British colonial buildings have been vandalised and destroyed by irresponsible people who seemingly did not appreciate historical values and architectural heritage. On the other hand, some existing buildings are improperly maintained by either the owner, architect,

⁵Ramlan Said, "Central to Cause of Conservation", *New Straits Times*, Dec. 5, 1990, sec. Times Two, p. 1.

⁶Ahmad Nizam Radzi, "College Creativity", *Majallah Akitek*, Jan.- April, 1988, p. 37.

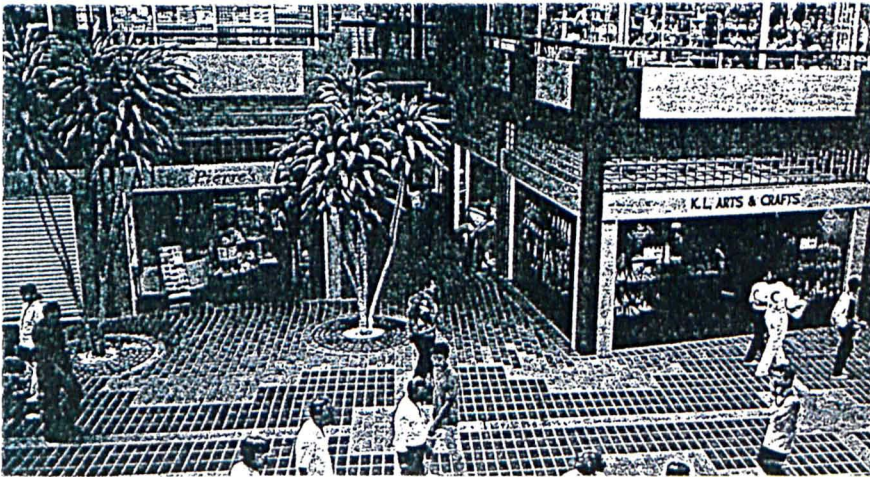


Fig.10 The Central Market in Kuala Lumpur, a good example of adaptive re-use project



Residence of foreign diplomat



Le Coq D'or Restaurant (1929)



Malaysian Tourist Information Centre (1935)

Fig.11 Three examples of adaptive re-use buildings on Ampang Road, Kuala Lumpur



Fig.12 Some mansions in Penang have been converted into office spaces



Fig.13 Some British colonial buildings have been vandalised, improperly maintained and left abandoned

building contractor or specialised engineer. As a result, many of these buildings have been left abandoned (Fig.13). This is either because of lack of technical knowledge in building maintenance or perhaps the buildings are left to the market forces of the normal building industry; site value and location often being factors in the situation.

Out of a possible list of over 360 historic buildings recommended by the National Museum and Heritage of Malaysia Trust in December 1989, only 51 of them have been gazetted by the Government under the Antiquities Act 1976. These gazetted buildings are mostly owned by the government and 22 of which are British colonial architecture. However, there is no single privately owned colonial building identified for conservation that has been gazetted under the Act even though there are a number of private bungalows, churches and commercial buildings of immense cultural, historical and architectural value found throughout Malaysia. Some examples of the private buildings identified for conservation are St. Mary's Church, PAM Centre, Wisma Loke in Kuala Lumpur; Wesley Church, Royal Ipoh Club, St. Michael's Institution Kindergarden in Ipoh; All Saints Church, Lady of the Sacred Heart Church in Taiping; and the Eastern and Oriental Hotel, The Standard and Chartered Bank and a few fine bungalows in Georgetown (Fig.14). Something needs to be done!

1.4 PROBLEMS OF HISTORIC BUILDINGS

Like many other countries in which building conservation seems a fairly new practice, Malaysia faces several problems in dealing with the issues of historic buildings. First, the present legislation on historic buildings is not sufficient and suitable for the protection of such buildings from being demolished and destroyed. There are four Acts and Enactments which show some aspects of building conservation in Malaysia even though it is felt that their application and formulation are restricted and not intended to address the question of heritage conservation extensively. The four Acts and Enactments are Town and Country



Fig.14 Examples of the privately owned buildings

Planning Act 1976, Antiquities Act 1976, Johore Enactment No.7 of 1988; and Malacca Enactment No.6 of 1988 (refer to Appendix 1-4 for further notes on the Acts and Enactments).

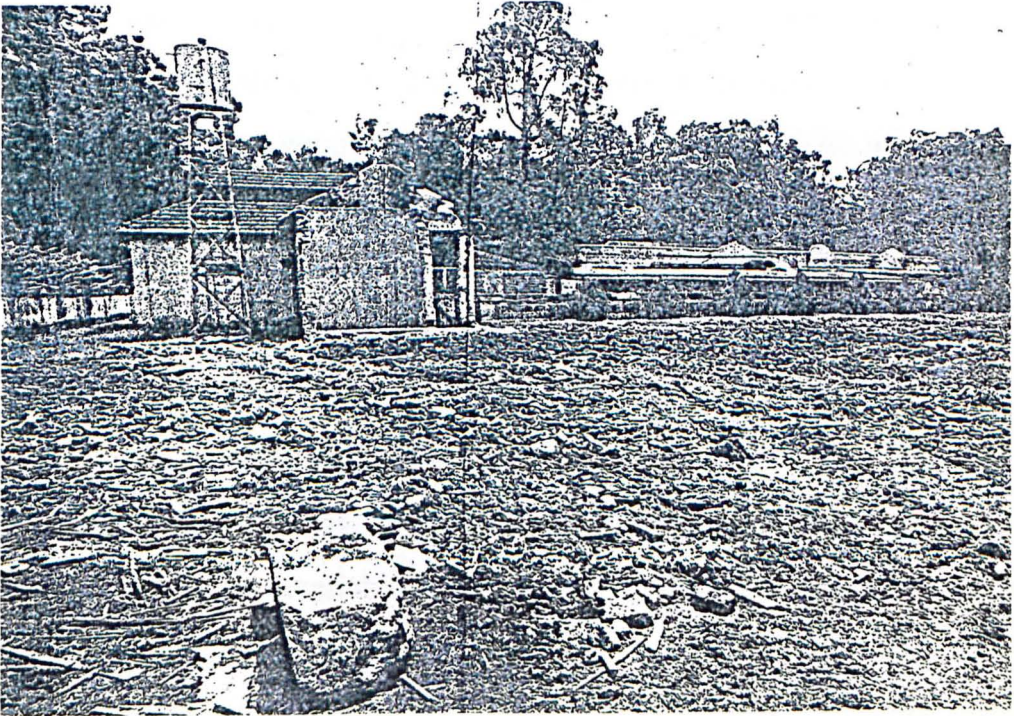
With the country's current rapid development in which the practice of demolishing old buildings has been the norm, none of these pieces of legislation is comprehensive enough. For example, there is currently no law that can prevent a developer from developing or demolishing an old building which has not been gazetted for preservation. This can be seen in the case of Chan Chin Mooi residence situated at Ampang Road, Kuala Lumpur. Built in 1909 with mixed styles of Western and Eastern architecture, the historic building was reduced to rubble in early May 1991 by the owners. The only remains on the site are the rear portion of the building and the staff quarters for the family's driver, gardener and servants (Fig.15). With regard to the destruction, a member of the family let it be known that the building could not be saved because of termite attack; and also all the necessary approvals to demolish the building had been obtained from the City Hall a month prior to the incident.⁷ It is not known what will be built on the site of the demolished bungalow. If the current situation of legislation continues to permit such demolition, nothing can be saved of the rest of the non-gazetted historic buildings; particularly those privately owned.

Only Section 19 of the Town and Country Planning Act 1976 prohibits the development or demolition of buildings without the authority's permission in which the contravention of the Act carries a maximum fine of MR50,000. Having realized the problems of present legislation and the need to generate more interest in building conservation, there have been few responses from the Government as well as the conservation bodies to amend current legislation. The Ministry of Works has formed a committee to prepare a white paper on the conservation of buildings in Malaysia to be presented to the Cabinet. Furthermore, the Heritage of Malaysia Trust has also submitted its recommendations on architectural

⁷Lee Ah Chai, "Historical Building Demolished", *New Straits Times*, sec. City Extra, May 24, 1991, p. 1.



Before



After

Fig.15 The residence of Chan Chin Mooi family

heritage conservation to the Government. The outcome from the Government has not been made known yet.

The second problem that faces the practice of building conservation in Malaysia is the lack of technical knowledge in repairing and maintaining old buildings. Ungku Suraya, an executive director of the Heritage of Malaysia Trust, has mentioned that at the present time there are practically no skilled labourers and technical experts in conservation methods and techniques. This is a major problem because almost all conservation jobs involve both repair and maintenance stages requiring an understanding of and analysis of building defect diagnoses. There is also the question of testing and treating building materials, choosing appropriate tools and specifications, introducing new technologies and so forth as well as meeting contemporary regulations and attitudes.

The condition of an old building may be put at greater risk if it is handled by unskilled persons. An example is the Penang Court building built in 1904 which has undergone major external and internal renovation work in 1990 (Fig.16). The two-storey building represents a combination of Georgian architecture with open verandahs or walkways and arches. The renovation work which was supervised by architects and engineers did not achieve high standards in maintaining its original values. Fungus and peeling paint are already commonly seen on the external columns and walls. It is felt that those responsible for its renovation did not seem to appreciate the original builder's sense of aesthetics and attention to detail.⁸

As far as building methods and techniques go, there is not enough technical information available which architects and contractors can use as references in their conservation projects. Most conservation work is treated improperly by using insuitable and inconsistent techniques which are harmful to the building materials and structures. Such areas of difficulty can be summarised as follows:

⁸Joceline Tan, "Penang's Imposing Hall of Justice", *New Straits Times*, sec. Times Two, Jan. 11, 1991, p. 2.



North elevation of Penang Court (1904)



East wing

Fig.16 Penang Court in Georgetown

- i. methods of cleaning buildings
- ii. preventing water penetration through roofs and walls
- iii. aesthetic aspects of modern use eg. signs floodlighting and surroundings
- iv. removal of damaged floors, roof tiles and walls
- v. upgrading the fire resistance of doors, timber floors; and cast-iron and steel beams and columns to modern requirements and regulations
- vi. upgrading the acoustic performance of party walls and floors
- vii. upgrading the building foundations to comply with new loading requirements.

In addition to these two problems of legislation and technical knowledge, there is no suitable system for discovering and recording the British colonial buildings in Malaysia. The system for discovering and recording the British colonial buildings is quite important in building conservation, particularly in:

- i. locating the building location, function and owner
- ii. assisting the authority and conservation bodies in keeping a record on the buildings for future research and funding
- iii. classifying the buildings into their functions (e.g. church, government office, railway station, school, institution, palace, military building)
- iv. measuring building defects and assessing remedial measures
- v. identifying and for historical purposes in the classification of British influenced architectural styles (e.g. Moorish, Tudor, Neo-Classical and Neo-Gothic) through the analysis of building characters, elements and shapes.

1.5 INTENT OF THESIS

The main intent of this thesis is to study the methods and techniques of building conservation in the United Kingdom and to develop possibilities of transferring them to the context of British colonial buildings in Malaysia. This, of course, requires that such buildings not already known can be discovered, suitably identified and categorized. It is axiomatic, based on visits to and observations of, a large number of buildings in Malaysia and the United Kingdom, that there are many similarities between the British colonial buildings built in the 18th and 19th Century in Malaysia and those built in the same period of time in the United Kingdom; in terms of style, building materials, detailing, function and construction. In the United Kingdom, building conservation has long been established. The methods and techniques of building maintenance used in the country have been improved from time to time. Therefore, it is of a great advantage to introduce these effective methods and techniques to the British colonial buildings in Malaysia.

Besides the methods and techniques of building maintenance, other topics will be discussed in this thesis such as the understanding of the scope and reasons for conservation; organizations involved in building conservation in the United Kingdom and Malaysia, in addition to building surveys and pathology including diagnostic techniques.

The thesis is divided into five parts. The first part deals with legislation in which two chapters: *Towards an Understanding of Building Conservation*; and *Legislation of Recording and Listing Buildings* covers the scope of building conservation, terminology, reasons for conservation, examples of legislation and some case law in regard to building conservation in the United Kingdom. The second part looks at philosophical attitudes of some organizations dealing with building conservation in the United Kingdom and Malaysia. Two chapters involve this, in which a comparative study is made and recommendations are considered. The third part includes methodology which covers five chapters:

Saving Old Buildings, Data of British Colonial Buildings, Systems for Discovering and Recording British Colonial Buildings, Building Materials and Common Diagnoses; and Methods and Techniques of Building Maintenance. This is an important part because it focuses the main intent of the thesis. The fourth part presents and analyses case studies of buildings in the United Kingdom and Malaysia. Several buildings have been selected to compare their changes of use and methods of renovation. The final part provides conclusions and recommendations for the improvement of British colonial buildings in Malaysia.

PART ONE
LEGISLATION

CHAPTER 2

TOWARDS AN UNDERSTANDING OF BUILDING CONSERVATION

In today's world, the term conservation has become familiar to almost everybody. From newspapers to television, from small meetings to international conferences, people often raise issues of conservation in regard to wildlife, rainforest or even historic buildings. However, what does conservation really mean?

Conservation by definition is a guardianship providing for maintenance, preservation or protection of what presently exists, from being destroyed or changed in an inappropriate manner. For wildlife conservation, it implies a protection of endangered animals and plants collectively from being harmed and killed either by people directly or by indirect human activity. In nature, there is the implication of maintaining an ecological balance in steady state. As for rainforest conservation, it means saving the trees of tropical jungles from being unnecessarily cut down for timber products or other reasons. However, conservation of building requires preservation and maintenance of buildings of the past, which have historical and architectural significance. If they are functionally obsolete, then they can be possibly adapted to new uses. It is a process which "leads to the prolongation of the life of cultural property and for its utilization now and in the future".¹

Building conservation has long been of concern, although its popular application is relatively recent in origin. The practice of building conservation

¹ Bernard M. Feilden, *Conservation of Historic Buildings*, London: Butterworth Scientific, 1982, p.v.

embraces the acts which keep older buildings intact. The term older buildings mean historic buildings that were built in all periods of the past. Like an artist's painting, an historic building has significant cultural values and should be considered as a precious structural monument. It may have architectural, aesthetic, historic, archaeological, economic, social; and spiritual values as well as narrative and documentary materials which make us curious about the people and culture that created it.

Before practising the conservation of building, one must have a broad understanding of the field itself. This is to ensure that any action taken during the conservation work is properly performed and is in accord not only with the building requirements but is within the scope of contemporary knowledge of the subject.

This chapter discusses the reasons for conservation, standards of ethics, and elaborates upon the scope of building conservation and clarification of terminologies.

2.1 REASONS FOR CONSERVATION

Since the last war and with the growth of modern building practice and other aspects of modern civilisation, demolition of old buildings has become a common pattern in urban centres. Buildings such as warehouses, churches and other community buildings have been demolished in order to make way for more profitable projects such as modern shopping complexes and multistory office buildings. In addition, many new housing estates have been developed in and around urban areas to accommodate the rapid growth of population. It is important to understand that if those responsible for urban centres continuously demolish old buildings, they may not only lose the historic buildings but are unable to show new generations their past history.

Regardless of their age, original function and aesthetic values; there is a case to be made for old buildings to be preserved and conserved through the

adaptation of contemporary technologies available to suit present day needs. The idea that old buildings are automatically less comfortable and less convenient than new ones is deceptive. It is "a falsehood that has been deliberately fostered as a superstitious article of belief by those with vested interests in redevelopment of many kinds".²

To institute a policy of building conservation by either legislation or planning policies, a set of decisions based upon a number of motives and criteria is made, invariably by Government Authority often with the assistance of conservation bodies. Both political and economic considerations are important if a conservation plan is to be successfully implemented. In making decisions, it is necessary to have a firm understanding of why buildings should be preserved or conserved. The following reasons are typically used in considering these decisions:

1. Sensitivity towards the past including historical and aesthetics
2. Emotional ties
3. Continuity and stability of physical surroundings
4. Absence of protection against economic pressure
5. Importance of tourism in Malaysian economy
6. Lower estimated cost of development and financial gain
in redevelopment

2.1.1 Sensitivity Towards the Past

Old buildings which were built in the past have certain building characters that are remarkable and unique in some ways. From building materials to window detailing, old buildings portray to the modern world their images as they were first built in historic times. Almost all of these buildings, of course, are deteriorating and need to be restored. One of the reasons for restoring buildings is to show a sense of sensitivity towards the past. It is important to have this

² John Harvey, *Conservation of Buildings*, London: John Baker Ltd., 1972, p.20.

concern because without it old buildings will never be preserved or conserved properly and sincerely. This will lead to further devastation especially by lack of building maintenance. Therefore, any activities of destruction, alteration or removal of old buildings should be tackled with a high degree of sensitivity. It is important to retain existing and possibly rare examples of buildings, architecture or craftsmanship which would otherwise disappear.

2.1.2 Emotional Ties

Another reason for keeping old buildings is to reflect emotional ties. This is due to the fact that old buildings symbolize cultural identity and heritage of a certain community at a particular time. From acknowledging the qualities of buildings, people can relate and learn not only about the life of their predecessors but building innovations made in the past. For example, through preservation and conservation of many groups of buildings on the historic streets of Bath, the local community, as well as tourists, are able to feel the life of the Romans and Saxons in the early days of the city. Also, notable buildings such as temples, the Roman-bath complex, the Abbey, churches as well as the Royal Crescent all have shown the triumph of engineering, building technology and style of the Romans and society of early, medieval and renaissance periods.

For Malaysia, the remains of the British colonial architecture should be preserved and conserved. This should be seen not so much as emotional ties relating to the life of the predecessors, but rather in terms of keeping the historical records and evidence of the development of the country. Also, retaining buildings that have been the place of important events or significant people in the country's history. The presence of such colonial architecture is also important in creating sentimental values which among other things brings back the sense of the British occupation in the country, particularly in regard to the period immediately before independence. It helps to create a sense of the relationship between those earlier events and the current events of a particular place.

Conservation should be seen as representing a particular aspect of Malaysia's history and development.

2.1.3 Continuity and Stability of Physical Surroundings

Old buildings or groups of building are preserved because they are needed to maintain continuity and stability of physical surroundings within a conservation area especially in scale and proportion. They also demonstrate aspects of past or continuing culture of a country. Even buildings with less quality in terms of architectural design are sometimes preserved, for they represent a special class or type of building as viewed from a broader perspective. It is important to have building control to maintain continuity and stability of the physical environment. A commonly used technique is to create what are called conservation areas in which the community takes on elements of protection for an area which may not have individual buildings of great merit but where the whole area is indicative of a style or cultural assembly. Very often domestic and vernacular architecture falls into this category. The shophouses of Georgetown in Penang are an example. This is to ensure that all buildings treated in the conservation area are protected collectively against any sort of demolition; and that any future alterations or additions are carried out sensitively.

Building control may include several aspects. First, a facade treatment which involves the control of display and advertisements, selection of colours and materials for building exteriors; and the form of any future additions and extensions. Any forms of advertisements such as neon signs, illuminated boards and painted panels should be prohibited or discouraged and limited to the smallest number and sizes with a high quality of graphics and lettering. This is to preserve as much of the original facade as possible. Selection of appropriate colours and materials for building facades is essential, particularly in respecting other buildings in the adjacent areas and in ensuring variety in the urban fabric. However, all future additions and extensions of the building facade such as fixing

window canopies, building entrance porches and balconies should be done only with notification to, approval of the local authority who may find it advantageous to give advice. This is because additions and extensions to a building means adding a layer of history of a country or region.

Another aspect of building control is allowable height. To ensure the continuity and stability of physical surroundings, all new developments near the conservation area should maintain about the same level or height of the existing old buildings. It is important to have the height control because without it old buildings may be hidden behind new development; and as a result they may be left beyond public awareness.

2.1.4 Absence of Protection Against Economic Pressure

Sometimes old buildings are preserved or conserved because of the absence of protection against economic pressure politically and economically. Buildings, mainly located in Central Business Districts, receive threats of demolition either from private or public sectors in order to give way to profitable projects on their sites. With a high cost offered, building owners may be unable to resist the temptation to sell their properties to these interested sectors. It is very important for the conservation bodies to pressure the Government Authority to keep the old buildings from being abused. Central government may have to institute a system of subsidy to ensure maintenance of reasonable economic use of existing buildings and sites. Alternatively a strict control system could be instituted with demolition only allowed after full consideration of the situation.

2.1.5 Importance of Tourism in Malaysian Economy

Nowadays, sometimes old buildings are preserved and conserved for the purposes of the tourism industry. This is because preservation and conservation of buildings may demonstrate aspects of past or continuing culture of a country or region. People or tourists in particular are often attracted to the

buildings which are either of historical value or architecturally outstanding, the last remaining examples of their stylistic types; or are examples of superlatives such as the "most", the "first", the "longest" or the "biggest"? Rehabilitation or careful adaptive re-use of old buildings into appropriate new uses such as shops, museums, restaurants and entertainment centres may help to promote tourism.

2.1.6 Lower Estimated Cost of Development and Financial Gain

Providing that old buildings are structurally in a reasonable physical state and do not require excessive structural alterations, the cost of preserving and conserving them is usually substantially lower than demolishing and constructing a new development. For example, the cost of rehabilitating an existing building will be only 50-80% of the cost of new construction (of equivalent floor area and volume), resulting in considerable financial savings.³

Some old buildings are preserved or conserved because of the potential income they will produce. The buildings can appreciate in value if properly cared and maintained. Therefore, they are often become a source of investment. Ghirardelli Square in San Francisco, for instance, is more profitable as a tourist attraction than it was as a chocolate factory.⁴

2.2 STANDARD OF ETHICS

Since building conservation requires many disciplines in the working phases, a standard of ethics must be paid attention to during the conservation work. Ethics of conservation may differ from one country to another depending on the emotional and cultural values; and the overall conservation needs of the community. Once an ethical stance regarding conservation has been adopted by a society, the moral force of the ethical position must be translated into principles

³ David Highfield, *Rehabilitation and Re-Use of Old Buildings*, London: E & F.N.Spon Ltd, 1987, p. vii.

⁴ Wayne O. Attoe, "Historic Preservation" in Anthony Catanese and James Snyder, ed., *Introduction to Urban Planning*, New York: Mc Graw Hill Co., 1979, p.314.

and policies for action. Based upon the above aspects, the ethical standard may include the following areas from which working policies can be derived:

Inspection

Whoever is responsible for the inspections of the building should not destroy, remove or misrepresent any historic evidence. This is to avoid any inaccuracy in the initial documentation which may later cause improper treatment in chemical tests or repair work.

Documentation

Documenting the building condition before any alterations are made including the origin and history of the building. Photographs and measured drawings may be necessary to prepare a full report. This should include the techniques and material used during the previous treatments. Such information is needed so that the development of the building throughout its life to the present time may be understood.

Intervention

Any intervention must be kept to a minimum degree. This is due to the fact that in conservation, as much of the original fabric ought to be preserved, protected, salvaged and re-used where possible. This should be governed by constant respect for the aesthetic, historical and physical integrity of cultural property.

Building's Stability

The building's stability should be reinforced during repair work. Buildings with excessive superimposed loads should have them carefully removed to avoid any further deterioration of structural members and ground

movement. An engineer who is experienced in historic structures should be consulted if dangerous movements are suspected in the building.

Public Safety

During the period of repair, public safety and secured access to the building are vital. All temporary structural supports such as scaffolding and timber or steel shores must be made safe for people using public rights of way and these on adjoining private land. Also, access ways to inaccessible parts of large buildings should be constructed and protected with secured temporary stairs or ladders.

Security

Assessing security of building's cultural artefacts and architectural elements must be established to protect it from intruders, vandals and thieves of these cultural artefacts and architectural elements. Supervision of the surroundings by either security guards or local authority such as policemen during day and night time is sometimes essential.

Future Demolition

All future alterations, demolition or extension of any listed buildings must obtain permission from the Local Planning Authority and give prior notification to conservation bodies. A severe penalty should be given to those who perform unauthorised alterations, demolition or extension of the building. This implies of course that appropriate legislation has been passed to make demolition an offence.

2.3 SCOPE OF BUILDING CONSERVATION

The scope of building conservation becomes important when there are threats of demolition and other forms of destruction of historic buildings. As

stated by Sir Bernard M. Feilden , "the basis of historic building conservation is established by legislation through listing and scheduling buildings and ruins, through regular inspections and documentation; and through town planning and conservative actions".⁵ This range of activities requires various professional involvement and expertise including town planners, urban designers, conservation architects, landscape architects, quantity surveyors, specialised engineering input as well as building contractors, archaeologists, art historians and antiquaries. There are also skilled craftsmen who all contribute their skills to achieve a balanced solution. They may be supported by other skills such as biologists, chemists, geologists and even seismologists. Obviously, when a great many disciplines are involved with building conservation, the need to understand its principles and objectives; and at the same time a high degree of cooperation and communication among workers are highly essential.

The work of listing and scheduling buildings is of prime importance in the scope of building conservation and is a continuous process. The difference between listing and scheduling buildings is that the former are mostly occupied dwellings or buildings in use; whereas the latter tend to be unoccupied structures or ruined monuments. Experience over the world has shown that listing buildings may have social and political repercussions as well as architectural significance. It is important for the availability of the whole system that procedures are seen to be fair and impersonal yet achieve control over areas and buildings considered important in this context. In the end listing and scheduling should have the same result.

Under the authorization of a high ranking person such as a Secretary of State, a team of investigators from Government Authority or other recognized organisations should be responsible for the job. It is important that the team has representation, from or be advised by, an expert committee consisting of experienced conservation architects, historians and antiquaries. In the United

⁵ Bernard M. Feilden, p.3.

Kingdom, the Secretary of State of the Department of Environment plays an important role in building conservation, particularly in compiling the lists and schedules of buildings of special architectural or historic interest, approving with or without modification, such as the lists compiled by persons or bodies of persons. He may also amend any list compiled or approved; and consider in any respect the way in which the building exterior and man-made objects or structures fixed to the building contribute to the architectural or historic interest.⁶

However, buildings that are to be selected for the list could come from historic areas, towns and cities; and places where there are existing old buildings. In selecting the buildings, special criteria should be considered:

1. Good examples of a particular architectural style
or good illustrations of social or economic history
(eg. railway stations, markets, schools, public
building and traditional architecture)
2. Innovation of technology (eg. cast-iron prefabrication)
3. Related to special characters and events
4. Group values which consist of groups of buildings
of little individual architectural interest but
which form a coherent and harmonious whole when
taken together (eg. terraces, squares and other groups)
5. Historical records and evidence of the country

Generally, the list does not have to be a long document but a series of lists divided in street alphabetical order. Each list refers to a particular local authority area. In the United Kingdom, the list is classified into two grades of building of which grade one relates to buildings of outstanding national interest which only the greatest necessity would justify their demolition; and grade two, of buildings of special architectural or historic interest which have a good claim

⁶ Matthew Saunders, *The Historic Home Owner's Companion*, London: B. T. Batsford Ltd., 1987, p.16.

to survival. Grading of buildings is necessary in the process of listing, for it might affect the grants available to the buildings. There is a further category of Grade II starred which indicates a higher level than normal in this class.

All information gathered in the listing and scheduling inspections should be documented together with measured drawings and photographs. It is necessary to note down the present condition of the buildings, particularly their materials and state of structural decay. General views of the property and close-ups of defects are usually all that is necessary for prompt recall of details observed during the inspection but such inspector must decide upon appropriate methodology. It may be that a full survey is necessary.

2.4 TERMINOLOGIES

In the process of building conservation, clarification of the terminologies related to the subject is necessary. This is because the field consists of various approaches some of which overlap, and that understanding of the terms would help those involved in grasping the meaning of its objectives; and to provide a set of criteria and methods for building conservation.

Conservation

The object of conservation is not only to recapture a sense of the past but to preserve, conserve and restore as much of the existing fabric of its original condition or situation to achieve this end. Conservation policy is used as a tool to keep the conserved fabric from being destroyed and at the same time keeping it attractive. However, the goal of conservation areas is mainly preservation of the physical fabric (architectural forms) of recognized town areas. Conservation may include a change of use inside and outside a building. The latter includes management of traffic and other planning aspects. This can often be justified by economic considerations relating to its preservation.

Preservation

Preservation normally deals with keeping cultural property from being harmed or decayed. Its goal is to maintain the property in its existing condition. Possible repairs may be carried out in order to prevent further decay. In the United States, the term historic preservation is usually applied to existing buildings and urban settings. However, in the United Kingdom, historic preservation particularly refers to older historical buildings and monuments.

Restoration

As restore means to renew or to give back, the term restoration refers to the revival of the original concept and fabric of the building. In other words, returning buildings to an earlier known state or form by repairs without the introduction of new materials. Major activities in restoration are replacing of the features that had been destroyed and removal of elements that had been added. Any replacement of decayed parts must be harmoniously integrated or amalgamated with the rest. It also means that the original state must be known or theoretically re-constructed. This often means detailed knowledge of the period and any require research at a high level.

Rehabilitation

The goal of rehabilitation is to make old buildings usable again. Sometimes buildings are no longer needed for the practical purposes for which they were built. Therefore, by treatments of interior space, the buildings can be adapted for other new uses. Temporary requirements for comfort, safety and utility should be complied with if adaptive alteration is necessary for the interior of the buildings. A particular problem is the requirement to install contemporary standards of safety, health and function into the old buildings. There may be implications for the exterior and immediate surroundings. These must be tackled with great care and high levels of design.

Replication and Relocation

Replication is the approach of imitating what previously existed. It is not widely used but is appropriate in some buildings which are symbolically important. For example, new construction imitating the old may be necessary in occupying the gaps between existing buildings or in renewing historical buildings important in the tourist industry.

Like replication, relocation is not widely used but sometimes necessary for economic reasons. This is because it is less expensive to purchase a used structure rather than to construct an entirely new building. Techniques exist for moving buildings, either in whole or parts to be reassembled on other sites.

Adaptive Re-Use

Some old buildings are no longer needed or are no longer practical for the purposes for which they were built. Therefore, they can be adapted to serve new uses while at the same time maintaining the original form and character. Such process is called adaptive re-use. It is considered a less rigorous type of conservation.

Maintenance

Maintenance is continuous care and protection of a cultural heritage as distinguished from repair which involves restoration or reconstruction. It can be considered as continuing preservation. It has been shown to be economic in most cases. Building maintenance needs to be organised and tackled by routines of daily, weekly, monthly, quarterly, semi-annual, annual and longer term inspections depending on the building's function and condition; and the resources available. A good example is the quinquennial inspection system used by the churches in England. This has legal connotations and could act as a model for other countries.

CHAPTER 3

LEGISLATION FOR RECORDING AND LISTING BUILDINGS

In the process of establishing a proper legislation for historic buildings, it is important to understand the concepts and procedures of recording and listing buildings. This is because the methods are useful not only for preparing systematic documentation of old buildings of historical and architectural value as well as in formulating conservation areas but also for the purposes of grading; and possibly providing a future framework for incentive grants available to the buildings. In the United Kingdom, it is the government, particularly the Department of the Environment under the supervision of the Secretary of State, which has the responsibility to record and compile lists of such buildings.

The work of listing buildings has been generally discussed as part of the scope of building conservation in Chapter 2. However, this chapter elaborates more on the subject and also looks upon the systems of recording and listing buildings in the United Kingdom. This follows an important example of a legal case in regards to listed buildings and a conservation area located on and around No. 1 Poultry Street, London which have been planned to be demolished for a new development. Later in the chapter, a discussion on complexity focuses on the possibilities of transferring the legislation for recording and listing buildings in the United Kingdom to the context of the British colonial buildings in Malaysia.

3.1 RECORDING BUILDINGS

Recording of old buildings before any alterations, demolition or maintenance decisions are made is vital. It is basically a process of examining a historic building with the basic aid of a record system (refer to Chapter 7). As suggested by a conservation body English Heritage, this could be achieved in two A4-size pages, divided into several sections stating some important information about the building. Such information may consist of:

- name of building and date built
- address
- building location in reference to scaled map
- names of owner, occupier and architects who have been concerned
- building uses if different by floors
- building conditions: structure and materials
- date of listing and listing reference number
- grading

In addition to the above information, it may be necessary to include drawings and photographs. Details of the origin and history of the building should be included so that the development of the building throughout its life may be understood; and in order to assess the relative importance of existing features.¹

When a building has been recorded initially and it has been found to have cracks and other structural deformations, a preliminary descriptive report may be prepared for further specific structural and analytical studies. This preliminary report is essential for briefing specialists, particularly the structural engineer.²

¹Eleanor Michell, *Emergency Repairs for Historic Buildings*, London: English Heritage, 1988, p. 17.

²Benard M. Feilden, *Conservation of Historic Buildings*, London: Butterworth & Co., 1982, p. 206.

3.2 THE PRACTICE OF LISTING BUILDINGS IN THE UNITED KINGDOM

The practice of listing buildings in the United Kingdom was originated by the Town and Country Planning Act of 1947. The Act required the then Minister of Town and Country Planning to compile lists of buildings in every borough, urban and rural district in the country, and a specialist team of investigators was formed for the purpose.³ It made a new start to the protection of buildings which were of historic or architectural importance. Earlier legislation had not proved effective. However, the Town and Country Planning Act of 1968 later introduced more severe protection by requiring listed building consent to be granted by local planning authority before any tampering with a listed building could take place. The provision of this Act has greatly helped to reduce the number of listed buildings demolished. For instance, in 1965, buildings which were under the statutory list were demolished at the rate of 400 or 500 each year.⁴

A listed building means "a building which is for the time being included in a list compiled or approved by the Secretary of State; and for the purposes of the provisions of the Act relating to listed buildings and building preservation notices, any object or structure fixed to a building, or forming part of the land, and comprised within the curtilage of a building, shall be treated as part of the building."⁵ However, this may not apply to plant, machinery or other equipment contained in the building.

In the United Kingdom, buildings which are considered to be selected for the lists are based upon four principles. The four principles of selection are:

1. All buildings built before 1700 which survive in anything like their original condition are listed.
2. Most buildings of 1700 to 1840 are listed, though

³Pamela Cunningham, *Care for Old Homes*, Dorset: Prism Alpha, 1984, p. 19.

⁴Donald W. Insall, *The Care of Old Buildings Today: A Practical Guide*, London: The Architectural Press, 1972, p. 13.

⁵Rogers W. Suddards, *Listed Buildings: The Law and Practice*, London: Sweet & Maxwell, 1982, p. 15.

selection is necessary.

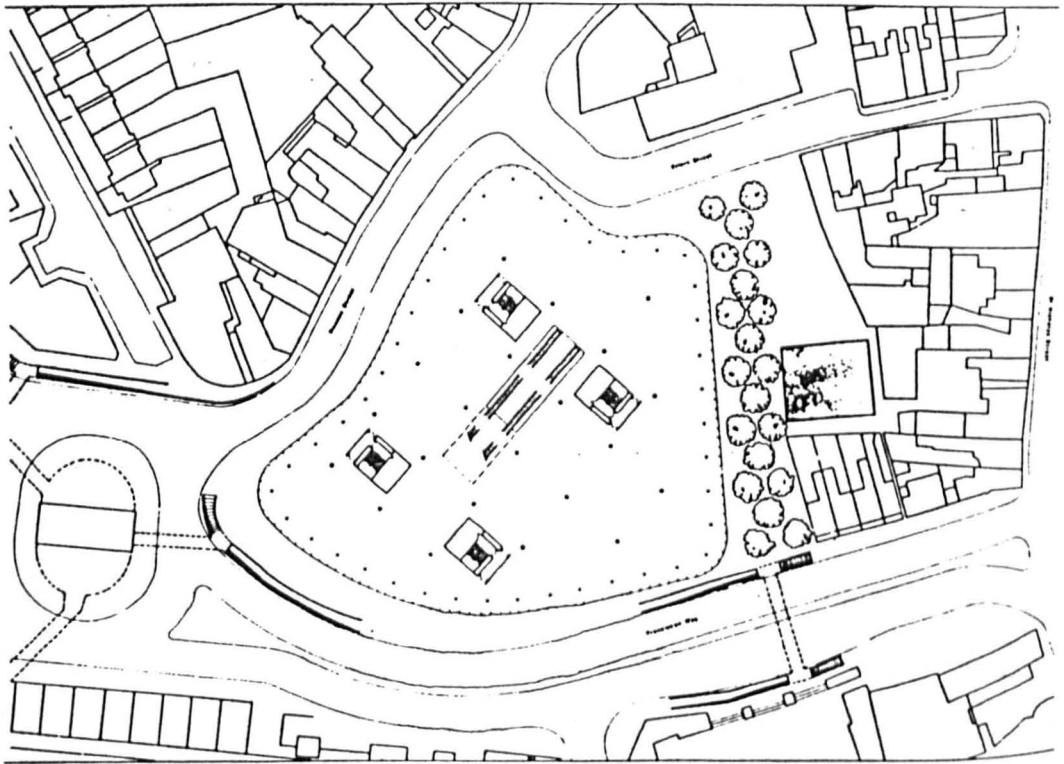
3. Between 1840 and 1914, only buildings of definite quality and character are listed, and the selection is designed to include the principal works of the principal architects.
4. Between 1914 and 1939, selected buildings of high quality are listed.

However, many buildings built after 1939 and are of outstanding values architecturally and historically have been included in the lists. There is no minimum age for listing but it is only exceptional circumstances that buildings under 30 years old are listed. By 1990, there are 23 post-war buildings which have been listed in England in which five are less than 30 years old. Among them is the Economist Building in London built in 1964 and was listed as Grade II in 1988.⁶ The Arts Tower and Main Library at University of Sheffield have recently been listed.

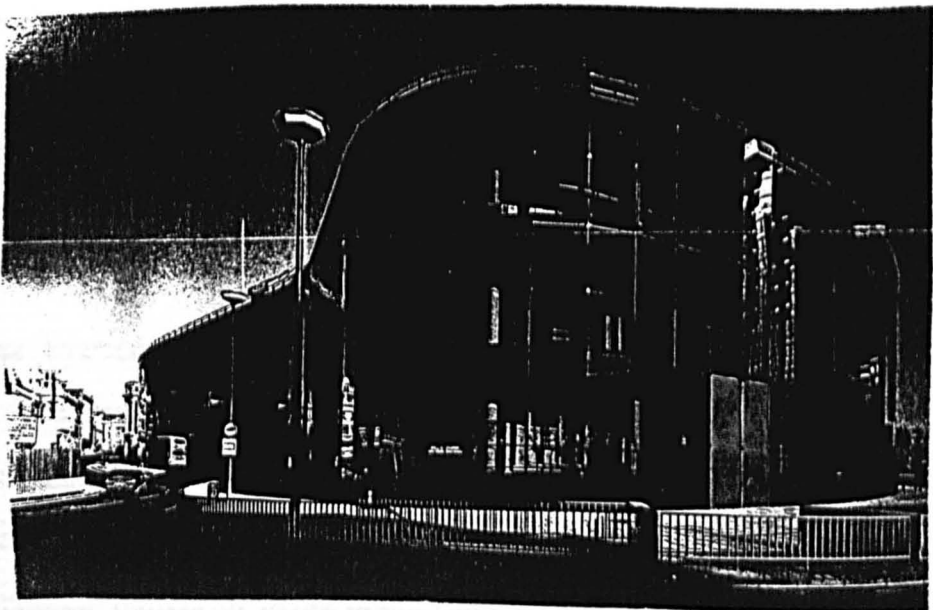
Some contemporary buildings although are not listed, can already be recognised as improving and adding interest to the urban environment. For example, the Willis Faber and Dumas Headquarters in Ipswich designed by architect Sir Norman Foster in 1970-71 and constructed from 1973-75. With its irregular shape of black glass wall, this four-storey office building was considered architecturally outstanding (Fig.17). The building was designed with the concept embraced a remarkable renaissance of social ideas (strong feelings of community in working conditions) in terms of corporate feeling and used advanced technologies, then entirely new to the building industry, to support this vision.⁷ Officially acclaimed as the finest work by a British designer anywhere in the world completed between 1965 and 1983, the Willis Faber and Dumas

⁶Department of the Environment, "The Heritage of England and Wales: Environment in Trust", 1990.

⁷Patrick Hodgkinson, "Foster Wins First Trustees' Medal", *RIBA Journal*, September 1990, p. 56.



Ground level



The irregular shape of black glass wall

Fig.17 The Willis Faber and Dumas Headquarters in Ipswich

Headquarters was awarded the 1990 Trustees' Medal by RIBA Architecture Awards Trust. It too has been recently listed.

At present, for the purpose of statutory protection the listed buildings in the United Kingdom are classified into two grades which are:

GRADE I Buildings of outstanding national interest which only the greatest necessity would justify their demolition.

GRADE II Buildings of special architectural or historic interest which have a good claim to survival.

Formerly there was a further category of Grade III which were buildings of importance to the streetscape and townscape for their group values. The grade has been abolished. Instead, the buildings were either moved up to Grade II* or informally notified to local planning authorities. Thus, in 1968, when the first listing was completed, there was a total of over 115,000 listed buildings in England and Wales. 4351 of which were listed as Grade I and 111,300 as Grade II.⁸ Since then, the number of listed buildings in the country has been increased; and more will be added to the lists as resurveys continue. In March 1990, for example, a total number of 447,724 listed buildings were recorded in England and Wales.⁹ 1.5% of all the listed buildings are classified Grade I.

3.2.1 The Procedures of Listing

The procedures of listing begin with the initiation of spot listing in which a specialist team of the Department of the Environment investigators visits an area to see which buildings may deserve listing. The buildings visited may be of in immediate danger of being demolished or at high risk to the future of their properties such as for sale by auction or private treaty. Private individuals may propose buildings for listing. It is usual for conservation groups to be active in this process.

⁸Donald W. Insall, p. 12.

⁹Department of the Environment, 1990.

To verify the consideration of requests to list buildings, it is important for the team during the listing to be accompanied by a location plan and up-to-date photographs of the main elevation of the buildings as well as any information about the buildings such as date when built, architect, historical associations and details of any interesting interior features. Buildings, which are considered to be listed, are then recorded by the team in a provisional report in a descending order of importance either Grade I or II.

The report of the investigation is later sent to Chief Investigating Officer before it is presented to the Department of the Environment administrative officer for further acceptance. The report is subject to a thorough check by members of the Departmental staff. All sorts of information related to the buildings are carefully considered at this stage. If the selection becomes unconditional, the decision of listing the buildings is made by a Higher Executive Officer. However, any provisional decision may just well be made by an Executive Officer.

Upon deciding the listed buildings, a list is prepared and presented through the Head of the Branch to be signed by an Assistant Secretary on behalf of the Secretary of State if that has statutory status. Once a signature and date are obtained, the list is considered operative. Local planning authorities are then informed by letter including a copy of the list indicating that the related buildings have been selected for listing. It is the responsibility of the local planning authorities to notify each owner or occupier that the buildings have been included in the list. At the same time, a copy of list is also made available at council offices for public inspection free of charge at reasonable times and in a convenient place. The list is then registered by the local planning authority.

3.2.2 The Effects of Listing

Once the date of the signing of the list has been obtained, the listing is then considered effective. If permitted development is being carried out and later

a notice of listing is received, the building owner or occupier must terminate the work immediately. It may require good judgement to consider whether the work he is carrying out would effect the special characters of the building's architectural or historic values.

Any works for the demolition, alteration or extension of a listed building (regardless of the grade of the building) must first obtain a Listed Building Consent from the local planning authority. This is to ensure that the proposed works are approved and satisfactory to the requirements of building conservation and preservation. In some circumstances, the consent is needed from the Department of the Environment in which the Secretary of State is being notified. Application for the Listed Building Consent should be accompanied by plans and drawings illustrating the proposed development. It is important to ensure a good quality of drawings and plans because an inadequate presentation may lose the application. Listed Building applications may require careful consideration and consultation. Time is required for this. The statutory period for a decision to be made is therefore increased to three months.

When a Listed Building Consent is granted for the demolition or alteration of a listed building, a notice of the proposed works is required by the local planning authority to be advertised outside the building for a minimum period of seven days. All reactions and comments should be forwarded to the local planning authority and the Department of the Environment for further considerations.

Where the local planning authority plans to grant Listed Building Consent to allow any demolition or alteration of a building, it must first notify the Secretary of State who may call in the application for his own decisions. Also, a prior notification should be given to the following six conservation bodies:

1. Ancient Monument Society
2. Council for British Archaeology

3. Georgian Group
4. Society for the Protection of Ancient Buildings
5. Victorian Society
6. Royal Commission on Historical Monuments (England)
or Royal Commission on Ancient Monuments in Wales
and Monmouthshire

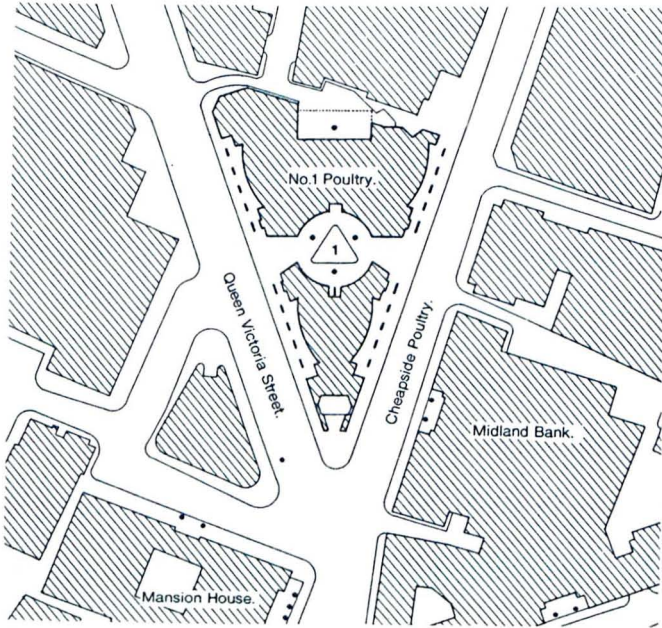
If anyone carries out works for demolition, alteration or extension in a way which would effect the character of the listed building without the prior approval from the local planning authority, he may be penalized on conviction imprisonment of up to 12 months or a fine; or both.

In a case where unoccupied listed buildings need repair works, the local planning authority has power to carry out the works and to recharge the owner.

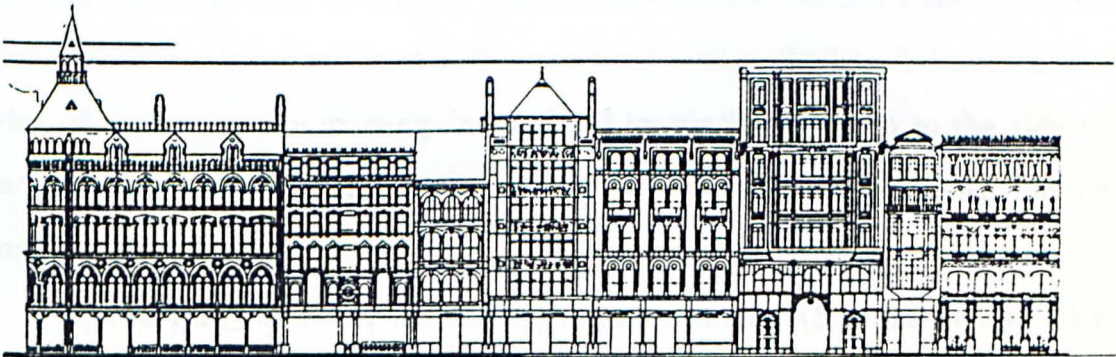
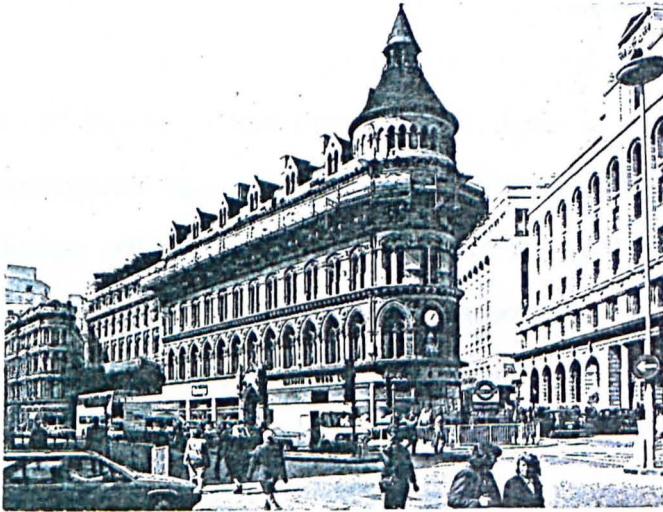
3.3 NO.1 POULTRY STREET : A CASE STUDY

In the United Kingdom, although there are decent laws which have been implemented for the protection of the listed buildings, there have been a few cases in which listed buildings were planned to be demolished in order to make way for more profitable projects. A good example is No.1 Poultry Street, a set of eight buildings located in London which have been planned for a new office and shop development.

The development which is well-known as "No.1 Poultry" is located in a triangular site of about 33,500 square feet bounded by Poultry Street to the north and Queen Victoria Street to the southeast (Fig.18). It has become a controversial issue since its present planning application in May 1986, following rejection of any earlier schemes described below. This is due to the fact that the development involves the demolition of a set of eight Grade II listed buildings. The best known of these buildings is the Victorian Gothic Mappin and Webb building of 1870 designed by John Belcher at the corner of the site.



Location map.



Eight Grade II listed buildings looking from Poultry Street

Fig.18 No.1 Poultry Street, London

Architect James Stirling was commissioned by client and developer Peter Palumbo to design a new scheme for the site. It took Stirling and Palumbo five years of battling in court over this controversial scheme before their proposals had been approved worthy of being built.

However, before Stirling was appointed for the scheme, Palumbo's previous dream for the site was an 18-storey steel and glass tower dominating a new plaza designed by Mies Van der Rohe in 1967 shortly before his death. After a public inquiry, the idea of Mies glass tower was vetoed in 1985 and later abandoned completely.¹⁰ The Secretary of State refused to grant Planning Permission but if there was an acceptable proposal for replacing existing buildings, he did not rule out the redevelopment of the site.¹¹

As far as the conservation of building is concerned, the existing eight listed buildings and their facades; and the street pattern within the site are not appropriate bases for a modern office facility, particularly in regard to Palumbo's design criteria of improving the office needs of the city with a floor to floor height of 15 feet, few columns as possible; and a minimum floor area of 10,000 square feet per level. The existing buildings have varied floor levels and that their small floor areas are incapable of transferring the floor loading and fire rating of a modern office building. Some parts of the building facades are decayed and structurally dangerous which may lead to great difficulties and make restoration impracticable when combined with new construction. Stirling believed that the idea of preserving the existing facades and incorporating them to the side of a larger building would make the old look derisory while making the new inappropriate.¹²

Stirling came out with two proposal schemes (Scheme A and B) for Planning Approval in which Scheme A retained and refurbished the Mappin and Webb building while Scheme B used the apex of the Mappin and Webb triangle

¹⁰Hugh Pearman, "Stirling's Rising Value", *The Sunday Times*, April 14, 1991, Sec. 5, p. 2.

¹¹"No. 1 Poultry", *Recent Work of James Stirling Michael Wilford and Associates*, Tokyo: A+U Publishing Co. Ltd., 1990, p. 136.

¹²"Office Building No.1 Poultry", *Architecture and Urbanism*, November, 1986, p. 145.

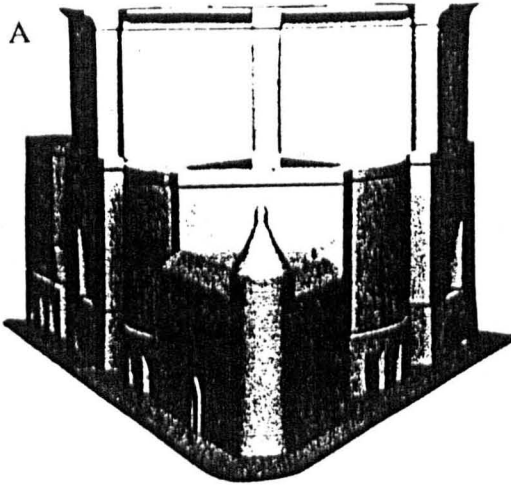
as an entrance to the building with portholed flank walls and large concave cornices above (Fig.19). The construction of these buildings included stone-clad reinforced concrete frames, raised floors, suspended ceilings and separate plant rooms on each floor. They are designed to be air-conditioned with the exception of the Mappin and Webb refurbishment in Scheme A. Both schemes were revised by the City of London Planning Committee in which after negotiations Scheme B was preferable for the site providing that few amendments and revisions had to be made to the building design, particularly its insufficient servicing, roofscape and building scale. The revised Scheme B has two large triangular archways in the centre of the main north and south facades which carry up to define the drum of a central circular courtyard for the two upper floors (Fig.20). At the corner of the building where the Mappin and Webb building is located, a circular element takes a form of a Rostal Column which represents the Roman celebration of a naval victory.¹³ The building covers approximately 134,300 square feet of floor areas with shops at basement and ground floor levels, offices at first to fifth levels and a roof garden and restaurant.

Despite remarkable support from the Royal Fine Art Commission and several leading architects including Sir Richard Rogers, Stirling's scheme has been running into criticism from conservation bodies like the English Heritage and SAVE Britain's Heritage. Stirling had been accused by the English Heritage for destroying the character of the area by replacing the eight listed buildings with a five-storey building.¹⁴ The criticism continued that if the site would have been redeveloped, Stirling's scheme would be inappropriate and dominating the area. Others commented on the loss of ground level shopping and destruction of street pattern.

¹³Collin St. John Wilson, "No. 1 Poultry, a Great Building for the 90's", *Recent Work of James Stirling Michael Wilford and Associates*, Tokyo: A+U Publishing Co. Ltd., 1990, p. 146.

¹⁴Russell Steadman, "Stirling Under Attack at Close of Poultry Inquiry", *Building*, June 24, 1988, p. 9.

Scheme A



Scheme B

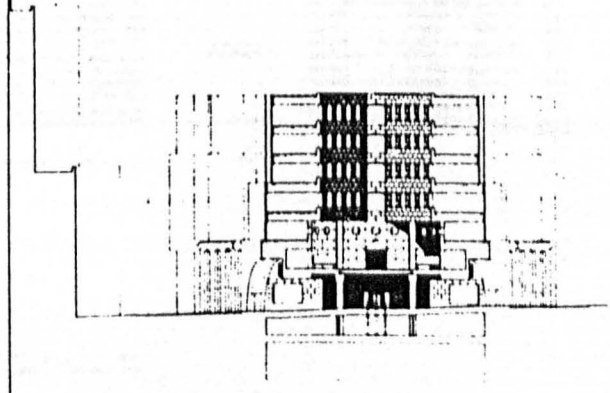
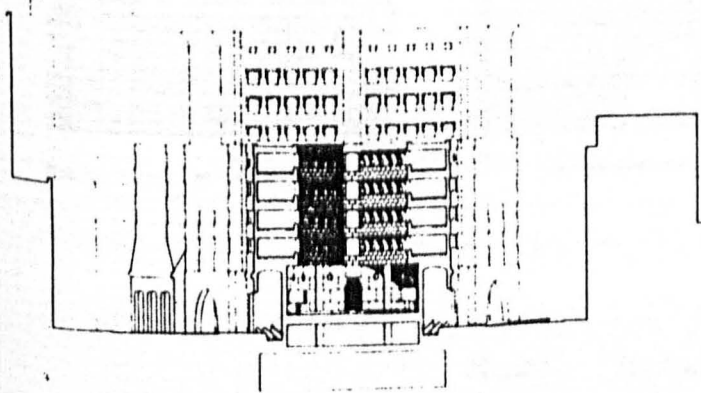
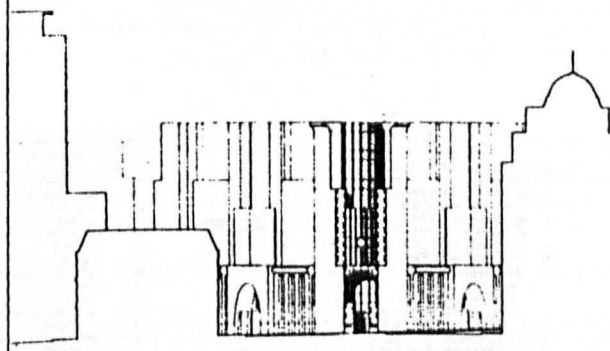
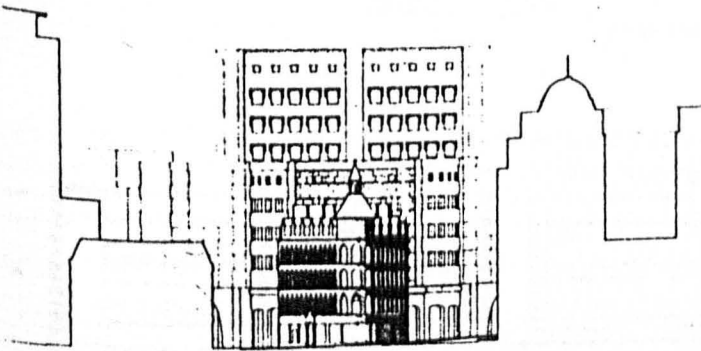
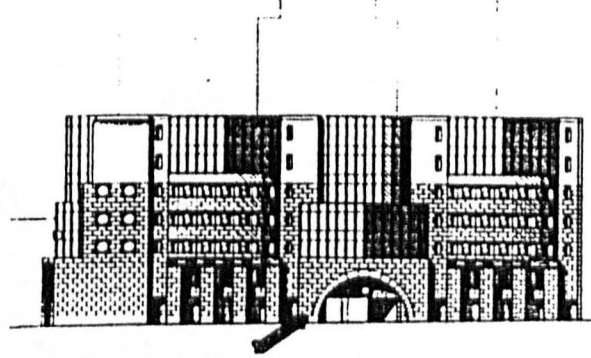
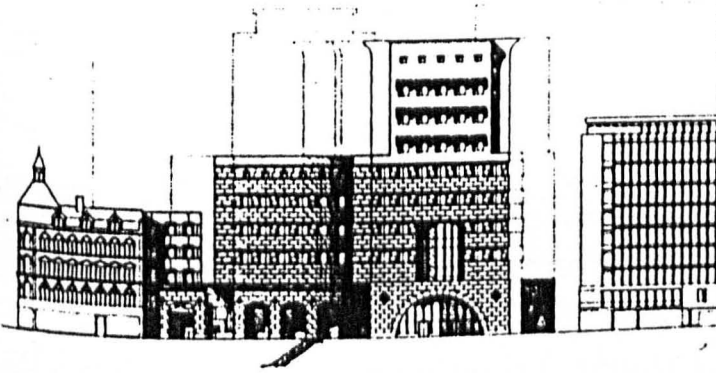
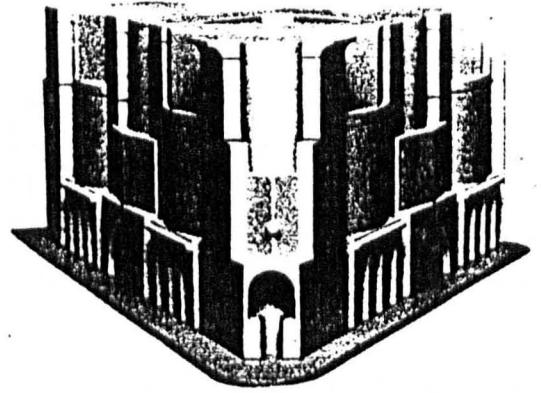
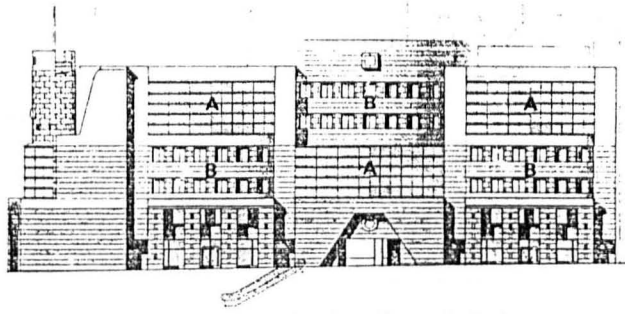
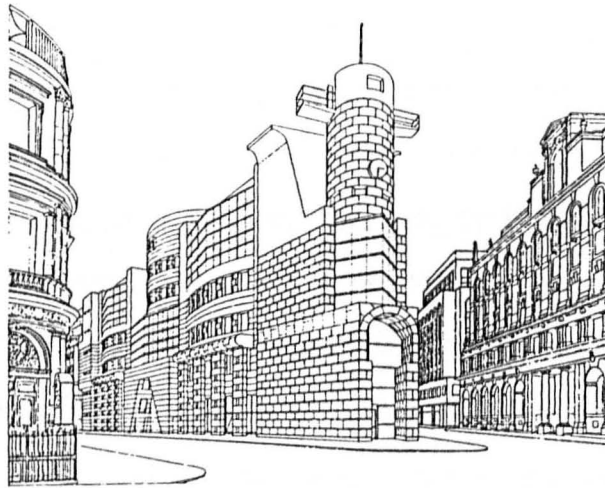


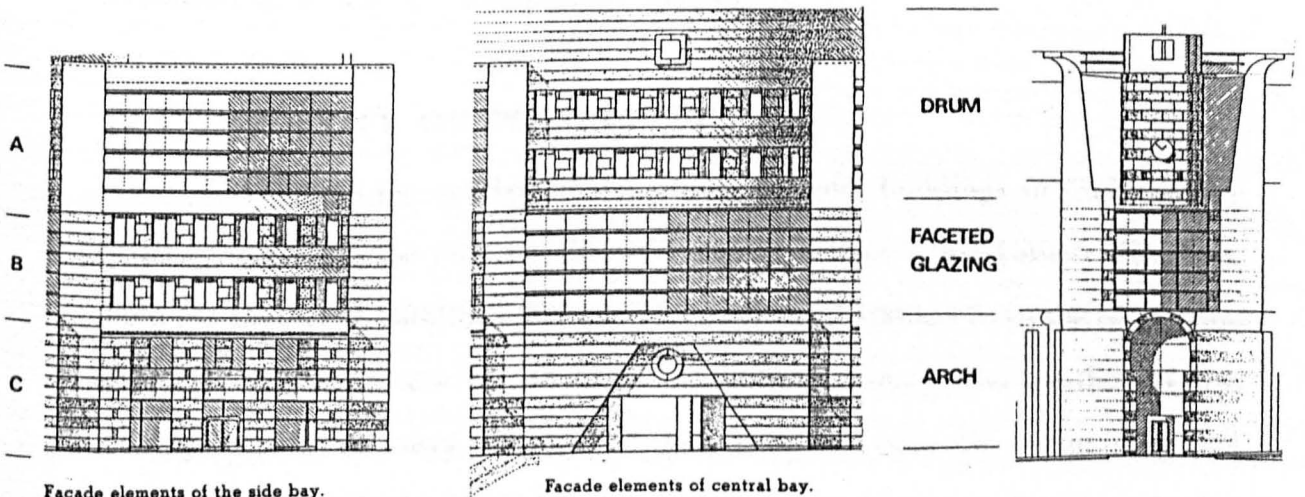
Fig.19 Two proposal schemes (A & B) for No. 1 Poultry Street



Facade to Cheapside Poultry.



Perspective view from Mansion House.



Facade elements of the side bay.

Facade elements of central bay.

Fig.20 Revised Scheme B

However, as stated by architect Prof. Colin St. John Wilson in the evidence in favour submitted at the Public Inquiry, the following five positive responses were outlined to support Stirling's scheme:

1. The scheme offers a new building of outstanding architectural merit and in doing so goes some way at least to redeem a record of abysmal contributions previously blessed by the City Fathers.
2. It is a building that in its rich variety of form fully replaces the element of variety presently on site.
3. It introduces a building whose seriousness and monumental overtones much more appropriately accord with such neighbouring buildings.
4. It enhances the quality of its neighbours by reinforcing their architectural presence without changing the scale of the area as a whole.
5. It enhances the general public amenity of the area by the disposition of shops, escalators, protected walkways, car park, restaurant, pub and roof garden.

The decision was to allow the Stirling scheme. It was said that there was the possibility of a modern masterpiece in the project.

3.4 COMPLEXITY OR POSSIBILITY

Although the number of the British colonial buildings in Malaysia are small compared to the total number of listed buildings in the United Kingdom, there are several possibilities that can be learned and applied from the discussion above. First, the system of recording old buildings suggested by the English Heritage could be very useful and practical not only for examining but resurveying the British colonial buildings throughout Malaysia. This implies the setting up of a team of specialists. Any legislative programme should include appropriate resource for the whole system to be maintained. With the basic aid of the record system, the colonial buildings may have a proper building document throughout their life. This may be helpful to the local planning authority to keep

track on the total number of buildings exist in the country and also to consider any grant available to them. All important information regarding the buildings including details of the origin and history may be obtained from several sources such as local planning authorities, museums, National Archive of Malaysia, Ministry of Works; and Heritage of Malaysia Trust. It is believed that through the system of recording the British colonial buildings, more historical evidence would be discovered and added to the development of the history of Malaysia.

The second possibility that can be applied to the British colonial buildings in Malaysia is the criteria of selecting and grading the buildings for the purpose of statutory lists. Unlike the historic buildings in the United Kingdom which have a long history of survival, the British colonial buildings in Malaysia have a relatively short history of national consciousness. Therefore, it is important to consider whether or not all British colonial buildings in the country should be selected for the lists. This is because the number of the buildings survived are relatively small and that their existence in the country in terms of architectural and historical values would be of value to the national interests. However, based upon the degree of importance, the British colonial buildings may be classified into three grades:

GRADE I Buildings of architectural excellence and historical importance. It is essential to the national interest that they be preserved.

(Such buildings include the Railway Station and Administrative Building, Selangor Club, Sultan Abdul Samad Secretariat Building in Kuala Lumpur; and St. George's Church in Georgetown)

GRADE II Buildings of architectural and historical interest and value to the state.

(For examples, the Johore Royal Museum in Johor Bahru and Penang Court Building in Georgetown)

GRADE III Buildings of special character architecturally or historically which may have a good claim to survival. Such buildings are of either religious, cultural, social interest or be examples of a particular culture and craftsmanship.

The third possibility is the procedures of listing buildings used in the United Kingdom in which similar procedures may be applied to the British colonial buildings in Malaysia. This may begin with the initiation of spot listing in every district and state in Malaysia done by a specialist team formed by the Museum Departments and assisted by representatives from various local planning authorities.

However, it would be helpful if the team is assisted by representatives from the local planning authority, for some of the buildings may need permission to enter them; and access is required for sight of building plans and details of their origin.

Another possibility is the effects of listing buildings, particularly where there is a threat of demolition, alteration or extension in such a way which would effect the character of the British colonial buildings. Since such buildings are considered of value to the heritage of Malaysia and should be automatically listed, it is important to have strong legal protection for the future sake of these buildings. For example, the idea of granting Listed Building Consent should be incorporated in order to ensure that any proposed demolition works are controlled and approved by a local planning authority. Anyone who carries out unauthorised works may be severely penalized on conviction, by imprisonment of up to 12 months or a fine to the amount of the current market value of the site; or both. If a Listed Building Consent is granted, the local planning authority should notify the Museum Departments and also conservation bodies including the Heritage of Malaysia Trust.

As far as the demolition of historic buildings is concerned, it is important to relate and learn a lesson from the destruction of Eastern Hotel in Kuala Lumpur which occurred in February, 1990. The Eastern Hotel, which was

built between 1910-1915, was one of the only five privately owned buildings to be listed by National Museum for gazetting but it was never gazetted.¹⁵ As a matter of fact, the two-storey neo-classical building was destroyed by the developers of the site for the new development of Capital Square complex (Fig.21). It is particularly sad to lose the building because it was the only building linked to Yap Ah Loy, one of Kuala Lumpur's famous Capitan Cinas; and was also a well-known landmark to the city. The Malaysian Government must put its powers to make new laws for the protection of the country's architectural heritage from any further destruction before consideration and consultation.

Lessons can be considered from No.1 Poultry. Strong support from private and government sectors should occur in Malaysia so that buildings with good features can be saved from any demolition. This is not to deny change absolutely but to ensure that careful, informed judgement is brought to bear by protective procedures which may prevent deterioration of buildings and eventual destruction possibly without enhancement of the visual environment. In fact, local planning authorities in Malaysia should take the case into account and learn that such demolition of historic buildings may cause a great loss to the country's heritage.

¹⁵V.F. Chen, "Demolition of Eastern Hotel: An Act of Vandallism", *Berita Warisan*, Vol. 5, May 1990, p. 3.



Eastern Hotel: Standing proud before the demolition



The rubble of what was once the Eastern Hotel

Fig.21 The destruction of Eastern Hotel in Kuala Lumpur

PART TWO
PHILOSOPHY OF CONSERVATION

CHAPTER 4

ORGANIZATIONS OF BUILDING CONSERVATION IN THE UNITED KINGDOM

4.1 THE IMPORTANCE OF BUILDING CONSERVATION ORGANIZATIONS

For some countries like Malaysia and the United Kingdom, organizations for the conservation of buildings can play a major role especially in saving historic buildings from being demolished and the vacant site used for new development. Generally, building conservation organizations consist of groups of people who are concerned about the effects of contemporary attitudes upon historic buildings and their context. Using their time, knowledge and skills, these people act as watchdogs reporting, advising or protesting to the government; making sure that the rules and laws enforced to the historic buildings are followed. They are usually prominent in commenting upon policies affecting buildings and often become involved in specific cases.

Apart from their main objective, some organizations contribute much good work. They can carry out building recordings and surveys when the local authority has not had time or the ability to organize such work. Sometimes, they can find out what local people feel about the council's plans and present their ideas and conclusions in a considered way. Often among their members are specialists as well as those with strong knowledge of local conditions who can perhaps force local planners to do their job and also give some advice to the local authority.

4.2 ORGANIZATIONS IN THE UNITED KINGDOM

In the United Kingdom, the care and conservation of the historic buildings are concerned by several public organizations. The Town and Country Planning Act 1968, through the channels of these organizations, has helped to protect all listed buildings from demolition and unsuitable alteration. The Act substantially amended and strengthens the statutory provision for protecting historic buildings and conservation areas, and imposes new restrictions on demolition and other work. The main way in which this is done is that applications for planning approval of listed buildings have to be circulated to these bodies for comment.

The organizations are defined into three categories which are official bodies, private societies and charitable trusts. The official organizations, whose act as advisory bodies, give advice on the technical problems involved in building conservation and repair work; and give a second opinion whenever it is needed. Like the official organizations, the private societies exist for the double purposes of giving technical advice and champion individual cases in which their aid may be sought. However, the charitable trusts more or less give advice to trustees on transactions in charity properties and maintaining central indexes of name, locality and objects for public inspection. Very often the trusts own, or operate as trustees, important buildings or estates. The charitable trusts also work closely with other bodies. This chapter looks upon the purposes and philosophy of such official, private and charitable organizations in the United Kingdom. It should be noted that even if local authorities give approval under the planning acts, the Secretary of State may 'call in' specific areas for decision at governmental level. This was the position of No. 1 Poultry described earlier.

4.3 OFFICIAL ORGANIZATIONS

The Building Research Station

The organization offers a wide range of advisory services on problems affecting old and new buildings. Advice is available through letter, telephone, consultation and site visit. Useful leaflets on technical problems are published by the organization.

The Forest Products Research Laboratory

The laboratory examines samples of infected timber and confirms any doubt in fungus diagnosis. It also publishes useful bulletins on technical problems affecting wood.

The Council for Small Industries in Rural Areas

The Council was founded in 1921 by the Government to help small firms by giving advices in rural areas of England and Wales. The types of advisory services include finance, business or technical advice and general problems such as the recruitment of labour. Some courses like furniture restoration, ironwork and thatching are run by the Council.

Institute of Geological Sciences and Geological Museum

The Institute advises on geological aspects of building and decorative stones. It also advises on matching of stones for repair.

The Royal Commission on Historical Monuments

Set up in 1908 under the chairmanship of Lord Burghclere, the Commission records significant monuments or structural works of man from earliest time to 1850. The recording consists of noting, planning and photographing. A number of monument inventories have been done and published for some cities in the country. In addition, the Royal Commission on

Historical Monuments for England, Wales and Scotland has been established. Each Royal Commission has to be consulted on applications to demolish any listed buildings in the national area.

The Council for Places of Worship

Formerly known as the Council for the Care of Churches, the Council for Places of Worship has been in existence since 1923. It is incharged of all matters relating to the construction, care and use of places of worship belonging to the Church of England.

English Heritage

English Heritage is an independent public body created by Government in 1984. Its main objective is to protect and preserve a great wealth of monuments, buildings and other architectural treasures throughout England. There are over 350 historic properties in England which are in the guardianship of English Heritage. These include prehistoric and Roman remains, medieval castles and abbeys, homes; and working industrial monuments. Although partly funded by Government grants, the continuing success of English Heritage work relies on subscriptions from its members. Apart from reporting and advising Government on which buildings warrant listing and what alterations should be permitted, it also offers grants for repair and maintenance of England's great cathedrals and some other major conservation projects.

Through its Survey Services Branch of Research and Professional Services, English Heritage provides professional support to Historic Properties Groups, advice on conservation and recording; and development of improved survey methods. It also offers short measured survey course to the public. English Heritage publishes books, bulletins, booklets and pamphlets.

4.4 PRIVATE SOCIETIES

The Society for the Protection of Ancient Buildings

Known as the SPAB, the Society was founded in 1877 by William Morris. It is the pioneer of all the private organizations and in giving technical advice. Its greatest concern is to ensure the continuance of informed technical knowledge in traditional methods of construction and repair. However, the following are services that the Society provides:

- i. advice on all problems affecting old buildings including their treatment and repair
- ii. investigates cases of buildings suffering from neglect or threatened by damaging treatment or with destruction
- iii. holds annual courses on the repair of ancient buildings for architects, surveyors and builders
- iv. administers scholarships, which enable students studied architecture to learn old buildings and their repairs
- v. arranges public lectures on specific subjects dealing with old building
- vi. organizes conferences to highlight current problems in the field of preservation
- vii. publishes information on the history and care of old buildings, their features and fittings.
- viii. maintains and circulates a list of properties for lease or sale dependant upon suitable conservation measures being accepted.

The Ancient Monument Society

Known as the '*Ruins*', the Society was founded in 1924 for the study and conservation of ancient monuments, historic buildings and fine old craftsmanship. In addition, it:

- i. examines all cases referred regardless of age and period of a building
- ii. appoints an architect or surveyor to check the examined buildings and to report back on its condition or merit
- iii. provides small financial grants to assist projects of special interests
- iv. publishes annual volume of Transactions.

Council for British Archaeology

Founded in 1944, the Council plays an active role in every field of endeavour relating to the archaeology of Britain. Its aims are to advance the study and practice of archaeology in the country, to promote public's education and interest in the understanding of British archaeology and to conduct and publish the results of the research. Some of the Council's major involvements include giving advice to the National Trust for the appointment of archaeology consultants, making recommendations to the Council for the Care of Churches when archaeological advisers are sought for Anglican dioceses and engages in a continuous dialogue with the Government at all levels. It also encourages cooperation between amateur and professional archaeologists. Through its conferences and publications, the Council promotes research on these subjects.

The Georgian Group

The Group was founded in 1937. Its aims are to deal with problems affecting Georgian buildings built since 1714, to give advice on preservation and

repair; and to protect Georgian buildings from any destruction and disfigurement. Like the SPAB, the Group provides publications on building maintenance and treatments.

The Victorian Society

The Society was founded in 1958, at a time when Victorian architecture was either actively disliked or ignored. Its primary tasks are to save the best examples of the such architecture when they are threatened with demolition, to learn about Victorian and to some extent Edwardian history and culture with special reference to architecture and the decorative arts; and to enjoy the surrounding wealth of architectural pleasures. It organizes activities such as study tours, lectures, conferences and exhibitions at either national or regional level. It also offers advice on architectural and design problems.

The Association for Studies in Conservation of Historic Buildings

The aims of the Association are to inform its members of current practice in the conservation of historic buildings and monuments, to give training methods in the technique and philosophy of building conservation and also to hold meetings and discussions.

4.5 CHARITABLE TRUST SOCIETIES

The National Trust

The Trust was founded in 1895 by Octavia Hill, Sir Robert Hunter and Canon Hardwicke Rawnsley; three imaginative people who had realized an increasing threat to the countryside and historic buildings of England, Wales and Northern Ireland (there is an independent National Trust for Scotland). As an independent charitable organization, it promotes permanent preservation from pictures, chattels, gardens, grand houses, mills, inns to bridges and castles of beauty or historic interest. Due to problems of looking after these properties, the

Trust must be highly selective. It can only accept property whose future financial is certain. It also preserves houses not as museums but as homes for families traditionally connected with them to live in. The Trust owns more than 300 historic buildings and 570,000 acres of land throughout the country. It is supported by the subscriptions of its members and its own earnings.

Pilgrim Trust

Founded in 1930 by Edward Harkens, the Trust has devoted a large part of its resources to the preservation of the national heritage of architecture and history such as monuments and churches; and to promote art. It may provide aid for the repair of elements of churches such as furniture, wall paintings, monuments clocks and glass.

Incorporated Church Building Society

The Society was founded in 1818 to administer charitable funds which are used for construction, repair of both ancient and modern Anglican Churches in England and Wales. It publishes useful booklets and pamphlets on the requirements of new and old churches.

The Civic Trust

The Trust is a recognised charity agency founded in 1957 by Lord Duncan Sandys. It is supported by public in the form of sponsorship, covenants, donations and individual membership. Its main concern is to improve and regenerate the standards of urban environmental quality and management throughout the country. This includes the improvement of shopping streets, promotion of new techniques for transplanting trees at places where people live and work; and also studies of major problems like damage and disruption caused by heavy lorries and urban wasteland. The Trust's achievements consist of the concept of conservation areas, laws to protect historic buildings and keep them in

repair, the designation of green belts around cities, regeneration of run down towns; and the annual Environment Week.

The SAVE Britain's Heritage

The Heritage was founded in 1975 by a group of journalists, historians, architects and planners who campaign publicly for endangered historic buildings and local landmarks. It emphasizes on the possibilities of alternative use for the historic buildings and also prepares its own schemes for re-use of threatened properties. Through the Heritage's publications, reports and exhibitions; it has championed the cause of decaying country houses, redundant churches and chapels, disused mills and warehouses, markets and cinemas as well. Supported and aided by a wide range of contacts, the SAVE Britain's Heritage is also very active on the broader matters of preservation policy.

By and large, any demolition and alteration of the listed buildings is subjected to prior notification of the following six organizations:

- i. Ancient Monuments Society
- ii. Council for British Archaeology
- iii. Georgian Group
- iv. Society for the Protection of Ancient Buildings
- v. Victorian Society
- vi. Royal Commission on Historical Monuments (England) or
Royal Commission on Ancient Monuments in Wales and
Monmouthshire

CHAPTER 5

ORGANIZATIONS OF BUILDING CONSERVATION IN MALAYSIA

5.1 GENERAL VIEWS

Unlike the United Kingdom in which the public interest in concerning the historic buildings is supported and maintained by many different organizations, the number of building conservation bodies in Malaysia is comparatively small and their efficacy restricted. Generally, the care and conservation of historic buildings in Malaysia are the concern of various groups. Most of the groups come from government sectors through the channel of special conservation committees formed by local authorities, and also state and national museums. These committees act as the official government groups which supervise all matters related to conservation and preservation of historic buildings. Besides these committees, there are a few other public organizations recently established by groups of architects, planners, journalists, artists and historians to support and maintain the national architectural heritage.

Despite the groups' efforts to create more public awareness of the importance of protecting buildings of historic and architectural significance, Malaysia indeed at this stage needs to have more building conservation organizations of various concerns and local architectural backgrounds. Since the government is more concerned on the preservation of old government buildings, such new organizations may concentrate on private buildings of different architectural character such as churches and mosques, Malay timber houses of traditional and vernacular models; and also colonial architecture. For example,

Malaysia should have similar specialised organizations such as the Society for the Protection of Ancient Buildings and Council for Places of Worship in the United Kingdom. Perhaps, there will be Society for the Protection of British Colonial Buildings, Council for Historic Mosques or Traditional Malay Timber House Society in the future. No matter what these organizations are interested in, their main objectives must be to preserve and prolong the life of the national architectural heritage and also to create pride for the heritage in future generations. This chapter looks upon building conservation organizations in Malaysia including the conservation committees, private society and charitable trust; and also analyses some aspects of comparison and makes recommendations for exchanges between such organizations and the ones in the United Kingdom.

5.2 OFFICIAL CONSERVATION COMMITTEES

Conservation and Urban Design Unit of Kuala Lumpur City Hall

Known as *Unit Pengekalan Dan Seni Bandar*, the Unit was founded by Kuala Lumpur City Hall in early 1988 for the purposes of carrying out research, providing guidelines and implementing regulations for its urban environment and conservation areas. The Unit is operated under the Department of Planning. Since its establishment, the Unit has expanded its work to matters related to urban conservation work. There is a recognition that individual building should not be treated in isolation and cannot be divorced from context and surroundings. This is due to the importance of protecting many old buildings built in the city. The Unit is considered as the pioneer among all the official conservation committees set up by other local authorities in the country. Its greatest concerns in building conservation include to the maintenance of design disciplines within, civic precincts, to ensure that new development is in harmony with, and does not change the unique character of those precincts, to encourage households and property owners to improve properties in ways which will not distract from their cultural significance; and to encourage recycling and adaptation of obsolescent

buildings of architectural, historical or social significance to new uses. The following are services that the Unit provides:

- i. prepares plans for any new development in the conservation areas
- ii. formulates planning principles and development guidelines for short and long terms
- iii. harmonizes all projects of urban design and development with other government departments and agencies
- iv. carries out programmes which encourage public awareness, understanding and appreciation of better urban environment
- v. evaluates planning applications and gives advice to property owners, developers and government agencies.

Malacca Preservation and Conservation Committee

The Committee was established in late 1988, following the issue of Malacca Enactment No. 6 of 1988. Its main purpose is to advise the State Authority on matters of policy, administration and management of cultural heritage and conservation areas. Among the members in the Committee are the Chief Minister of Malacca, State Secretary and one representative from the National Museum and State Public Works Department. The Committee not only formulates proposals and programmes for the preservation and conservation of cultural heritage and conservation area but makes suitable arrangements with the owner of historic building if there is a need of urgent repair to be carried out.

Penang Conservation Unit

The Unit was formed by Penang City Council in early 1991 for the purpose of preserving old buildings and streetscapes, retaining the unique character of Georgetown; and revitalising old areas without having to destroy the old fabric. Some of its conservation works include:

- i. identifying buildings and sites for conservation zoning
- ii. controlling and considering any new development planned in the conservation areas
- iii. formulating guidelines and development policies for the conservation areas
- iv. compiling building inventories which involve recording and collecting data of buildings of historical and architectural significance.

The Unit also provides some incentives to building owners in order to keep their properties well maintained. Such incentives include tax reduction, subsidy for decoration and financial aid for repairs.

5.3 PRIVATE SOCIETY

Penang Heritage Trust

Founded in 1987 by architect Dato Lim Cheong Keat, the Trust is a voluntary society which seeks to preserve and enhance Penang's heritage. It cooperates with the Penang Conservation Unit through good planning and activities to advance the goals of conservation. The Trust also organizes public seminars on building conservation and invites representatives from different local authorities, private agencies, museums, Public Works Department and official conservation committees of Kuala Lumpur and Malacca. It is prominent in publicity and intervenes in local and regional development proposals.

5.4 CHARITABLE TRUST

Heritage of Malaysia Trust

The Trust began officially in 1983 as a Charity Trust. It was set up by a group of volunteers who were keen to preserve Malaysia's heritage. It is headed by a Council who meet each month to discuss various projects and current issues. Each council member is responsible for a project of a particular issue. The objects of the Trust include:

- i. to promote the permanent preservation for the benefit and education of the people of Malaysia of all historic buildings
- ii. to preserve the setting of historic buildings and where appropriate their historic content
- iii. to preserve the character of groups of attractive buildings which enhance a street, a town or a village but which are not individually outstanding
- iv. to preserve sites of archaeological or pre-historic interest.

Membership of the Trust is via invitation. Donations to the Trust are tax-exempt and the funds are channelled into various restoration projects that the Trust is working on. Funds also go towards research into the background of each building considered to have architectural and historical significance.

5.5 COMPARISON AND RECOMMENDATION

5.5.1 Central Conservation Committee

Malaysia needs to have more building conservation organizations of various concerns and local backgrounds but there should be a closer relationship and joint action where appropriate among the official conservation committees, private societies and charitable trusts. The present situation of conservation is that there is a minimum interaction between the government and private sector agencies. Only old government buildings of architectural and historical

significance are well preserved and receive better improvement treatment in terms of the quality of the localities in which they are situated. Other important buildings including especially those privately owned, which are mainly the concern of the private and charitable organizations, are in fact getting less attention from the government. There is imbalance in distribution and commitment of the conservation work between the organizations. In addition, communication and cooperation between the building conservation organizations are essential. Particularly, when the historic buildings need immediate repairs and protection against any destruction.

However, it is considered that conservation of buildings in Malaysia can be improved by establishing an official central conservation committee. A suitable vehicle might be to use an existing authority by going through the channel of the National Museum (Fig.22). This committee should be responsible for all matters related to the interests of building conservation in the country from listing and scheduling historic buildings and ancient monuments to providing technical expertise and controlling building regulations. It is a great advantage to have the committee based in Kuala Lumpur because there are many facilities and sources available for the committee to refer to such as the National Archive, National Museum, government departments and major higher institutions. Members of the committee may consist of various groups of people from the government sectors like the Public Works Department, Ministries of Housing and Local Government; and Education who all share the same interest, knowledge and experience in the conservation of the national heritage.

Since each state in Malaysia has different types of historic buildings to be concerned about, it may be helpful to have regional representatives under the control of the central conservation committee. Such regional representatives can be divided into Northern region for the states of Penang, Kedah, Perak and Perlis and to be based in Georgetown; East Coast region for Terengganu, Kelantan and

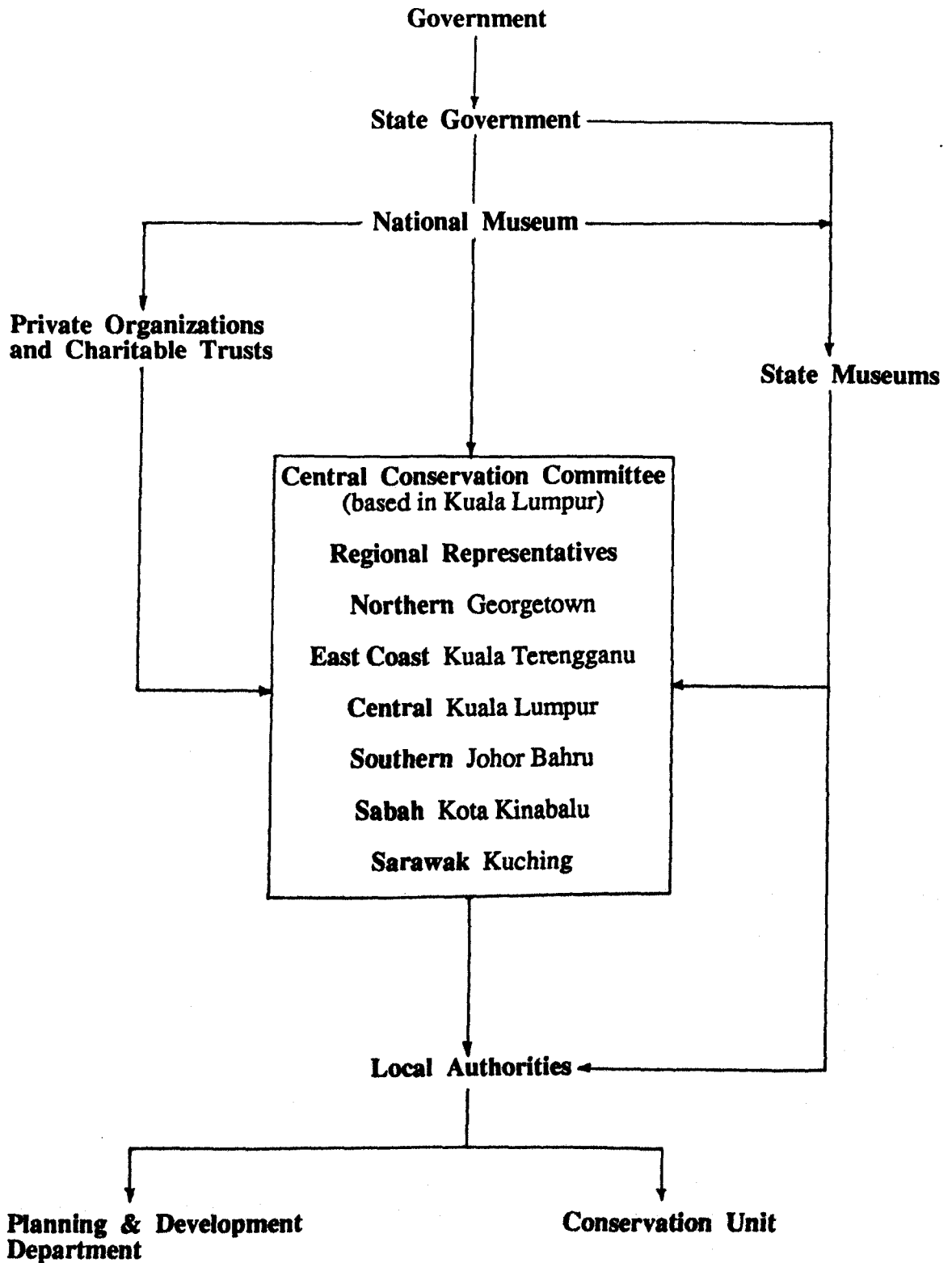


Fig.22 Structure of Conservation Management

Pahang states and to be based in Kuala Terengganu; Central region for Selangor and Negeri Sembilan states and to be based in Kuala Lumpur; and Southern region for the states of Johore and Malacca and to be based in Johor Bahru. There are regional representatives in Kota Kinabalu and Kuching for the states of Sabah and Sarawak in East Malaysia. It is important for these representatives to develop a good relationship with not only the state museums but State Government and local authorities as well. At the regional level, the representatives may assist the local authorities in various local activities including environmental and building improvements, heritage and tourism schemes; and spreading the conservation messages to local people as the Civic Trust in the United Kingdom has done.

5.5.2 Technical Advice

Providing technical advice on aspects of conservation work to developers, contractors or even architects may be a major task for the central conservation committee. Particularly, during the early stage of the committee's establishment. However, lessons can be considered from the Society for the Protection of Ancient Buildings (SPAB) in the United Kingdom which was the pioneer of the private organizations in giving the technical advice. Like SPAB, the committee should first form a technical panel consisting of a group of people who are knowledgeable or have experienced in treating old buildings. It is this technical panel to which all questions about conservation work initially be referred to. It should be consulted on technical problems. It is the concern of the technical panel that all traditional methods of construction and repair should be continuously assessed and reported upon to disseminate knowledge on the field.

Some of the SPAB services may also be applied by the committee. For examples, investigating cases of buildings which suffer from neglect or threatened by damaging treatment or with destruction; discussing all problems and giving advice on immediate treatment and repair. With the assistance of the

technical panel, the committee may also organize public lectures on specific subjects dealing with old buildings and hold national conferences to bring into problems in the field of preservation and conservation. All information on the technical aspects should be compiled and published in forms of leaflets, monthly journals or annual transactions.

5.5.3 Skilled Manpower

There is no doubt that skilled manpower plays a major role in building up the conservation practice. Without it, old buildings will be like gardens with no gardeners to look after. Even though Malaysia does have technical and vocational schools, none of these institutions offers courses on building conservation. Neither do the local universities have to offer a proper programme for such a subject. This has resulted in a lack of skilled manpower for restoration work.

However, there are a number of ways for Malaysia to overcome the problem. One of the ways is through the promotion of public's education and interest in the building conservation skills. This can be achieved by introducing a proper course of building conservation to the technical and vocational schools and also a complete diploma programme to the higher institutions. Perhaps, there will be programme of short courses designed primarily for architects, planners, surveyors and other related professional groups associated with historic buildings.

Another way is to set up a heritage workshop which acts as a centre for nurturing craftsmen who have developed traditional skills in the country. There are many good craftsmen who can make tiles or produce pottery and wood carving in a few places in Malacca, Penang and the East Coast. To ensure that there is a continuous traditional skill in the future, the craftsmen may teach young people on their related expertise by running the workshop on a full or part-time basis. The government is concerned about unemployment, there is a shortage of

craftsmen in the conservation area. An opportunity exists. It is suggested that government initiative is necessary to set up the educational system so that existing institutions may organize courses at appropriate level, or new educational/training centres set up.

The third way is through an organization for studies in building conservation which is similar to the Association for Studies in Conservation of Historic Buildings in the United Kingdom. Unlike the Penang Heritage Trust or Heritage of Malaysia Trust. The new organization may not only inform its members about current practice in the conservation of historic buildings and ancient monuments but provide training methods and techniques. The organization may cooperate with the technical panel of the central conservation committee, particularly in tackling any issues of building repairs and maintenance. SPAB is maintained by subscriptions and legacies. This has built up a suitable financial base. It is almost certain that a subsidy from government is required to establish an appropriate body in Malaysia.

5.5.4 Research Facilities

All historical facts and recordings of historic buildings in the country should be well documented and kept for future reference and research. Both the National Archive and National Museum may have to collate all building data including old photographs, original floor plans and drawings; and any related written articles. However, at the national level building inventories and surveys may have to be coordinated by several full-time researchers with the assistance of the public and local architectural students. It is important for the Archive and Museum to provide sufficient research facilities for the researchers including a computerised system for recording and listing buildings; and a complete set of technical tools for testing of building diagnoses. The good offices of the architectural professions will be required. The regional organizations of PAM may be of advantage in this respect.

PART THREE
METHODOLOGY

CHAPTER 6

SAVING HISTORIC BUILDINGS

Apart from a few particular cases, historic buildings are immovable cultural properties and saving them is an important task. As well as understanding the building materials and determining their common diagnoses, those who are responsible for the conservation work should be able to carry out several other important but occasionally tedious jobs. These include historical research, discovering and recording historic buildings, visual inspection of original drawings and reports on structural condition which may further lead to fundamental decisions about building repairs, preservation or demolition. This may involve the production of very detailed measured drawings. Others include an initial report on building diagnosis, structural analysis and non-destructive testing; so that a full report covering all the above stages, can be presented to a higher authority. The discovering, recording and visual inspections are thoroughly discussed in chapters 7 and 8.

In addition, there are several essential aspects which should be considered in the conservation of historic buildings. These are public safety and access, protection of historic buildings from traffic, fire and security, preventive maintenance, presentation, cost estimation and control; and rehabilitation of buildings. All of these are later discussed in this chapter. Besides, this chapter also elaborates upon the principles of repair and discusses the need to introduce modern inventions or new materials to historic buildings.

6.1 THE PRINCIPLES OF REPAIR

There is no standard specification for the repair of historic buildings nor should there be! However, the English Heritage has listed ten main principles of repair, restoration and maintenance of historic buildings; which can be a basic guidance for the conservation of British colonial buildings in Malaysia. The principles are broad and generally applicable to the whole of the built environment. It should be recognized that each individual case must be analysed so that the principles can be applied to generate specific solutions for particular problems.

6.1.1 The Purpose of Repair

Determining the primary purpose of repair is the most important principle. Its main objective is to prevent the process of decay of building materials and characters while maintaining building structures in good condition. It is also important not to alter any features that give the building its particular historical or architectural significance.

6.1.2 The Need for Repair

The main need for repair is to achieve a sufficiently sound structure, particularly to ensure structural safety and therefore its long-term survival and to meet certain requirements of any appropriate use. Therefore, any intervention during repair must be kept to the minimum in order to stabilise and conserve historic buildings.

6.1.3 Avoiding Unnecessary Damage

Any unnecessary replacement of historic fabric should be avoided even though the work is carefully carried out. This is to prevent any adverse effect on the appearance of a building which then significantly reduces its historical or architectural value or seriously diminishes its authenticity.

6.1.4 Analysing Historic Development

Before any repair is carried out, it is necessary to analyse thoroughly the historic development of a building. This is to ensure that any historical facts about the buildings are well documented for future work or research. Archaeological and architectural investigation, recording and interpretation of a particular structure, and its assessment in a wider historic context may be desirable. If appropriate, these processes may continue even during the course of repair.

6.1.5 Analysing the Causes of Defects

Any decayed fabric should be analyzed prior to carrying out the work of repair and replacement. This includes an analysis of causes of defects, condition and nature of existing building materials; and a survey of structural defects. The main purpose of carrying out such analyses is to avoid any repetition of building problems or to repeat previous design errors.

6.1.6 Adopting Proven Techniques

In order to preserve the appearance and historic integrity of a building and to ensure that repairs have an appropriate life, all repair work should match existing materials and methods of construction. Therefore, any new methods and techniques of repair should only be carried out where they have proved themselves over a long period and also where traditional alternatives cannot be identified. However, the degree of damage caused to the building's appearance, historic integrity and fabric should be considered when it is decided to adopt new methods and techniques.

6.1.7 Truth to Materials

In carrying out repairs for building materials, it is important to execute the work honestly. There should be sincerity to the materials and also the whole building as well. However, repairs should be dated discreetly where appropriate.

6.1.8 Removal of Damaging Previous Alterations

In some cases, additions or alterations are of importance for the part they play in the cumulative history of a building. In fact, there will often be a strong presumption in favour of their retention. However, if they are to be removed based on the grounds of having no intrinsic value in themselves or may seriously disrupt the overall architectural interest of the building, then the implications of doing so must be carefully considered in advance.

6.1.9 Restoration of Lost Features

Some elements of a historic building, for example balustrades, pinnacles, cornices, festoons or window tracery, may have been broken or lost in the past. If they are of structural significance, then they should be restored or replaced in the course of repair. However, to avoid inaccurate and unnecessary replacement, sufficient evidence should be provided to support both the existence and form of the lost features.

6.1.10 Safeguarding the Future

Like other historical objects, buildings of architectural and historical significance should be regularly monitored and maintained. Reviews should include public safety and access, protection of historic buildings from traffic, fire and security; and preventive maintenance. Choosing an appropriate and sympathetic use for a historic building is important to secure its future and also to minimise its repair requirements and the need for structural interventions.

6.2 MODERN INVENTIONS AND NEW MATERIALS

Introduction of modern inventions and new materials in historic buildings presents a great challenge to the main principle of conservation which is to preserve as much of the original character as possible. Exceptions however should be given to those mechanical, electrical and acoustical services required for health, safety or function. This is because the installation of such services in historic buildings is normally required by contemporary building regulations. However, there are several factors which should be considered during the installation of building services. Firstly, all installation works are to be carried out by professionals or experts in order to avoid or minimize any disturbance to existing structures and decay to other building materials. Secondly, depending on the size of rooms and strength of the existing structures; new services introduced such as sprinklers, ducts, electrical equipment, acoustical reflectors and air-conditioning systems should be either blended with or deliberately contrasted with the rest of the building structure. The main principles of intervention are harmony and quality. Being new materials, they should be treated as new things rather than the old ones. New materials such as glass, marble or tiles should be honestly expressed in historic buildings. This not only shows the values of sincerity and simplicity towards conservation but reflects one of the principles of repair which is truth to materials. Thirdly, any modern inventions or new services should, if possible, not occupy a lot of space or room. This is because occupying such spaces may mean giving up many existing building structures, resulting a low percentage of original character being preserved.

As far as the modern inventions and new materials are concerned, they should be under control and expressive. It should be recognized that only existing materials in extremely bad condition should be replaced. In addition, new materials should have qualities which are durable and consistent with the rest of the old building fabric.

6.3 PUBLIC SAFETY AND ACCESS

During the period of repair, the building should not only be made and safe for conservation architects and workers to inspect and work but for other people using public rights of way and also those on adjoining private land. There are a few things that need to be considered as far as the safety and access of the public are concerned. Firstly, it is important to have warning signs or notices in the area mainly in front of the building. The signs or notices should be visible, neat and permanent, reflecting the value of the building. Avoid posting signboards directly onto exterior walls, for this may affect the walling materials and devalue the building. Secondly, security; where there are broken windows or doors, putting up grilles or bars across the frames; or temporarily covering the accessible parts with boards is necessary to prevent unwanted intruders. Thirdly, conservation architects should inspect the interior of the building, ensuring that it should be free from unseen hazards such as rotten floorboards, unprotected staircases, broken stair treads, lightly constructed ceilings and missing handrails.

Exterior features including scaffolding which may fall on the members of the public should be fixed. In addition, any accessible paths should be well lit, particularly at night. Bad lighting and electrical equipment should be checked and changed regularly.

Apart from observing public safety before, during and after the repair work; it is desirable to maintain a healthy environment. For example, where the application of flammable materials or hazardous chemicals is required, the work should be fully supervised by a safety officer with special responsibilities to remind persons of dangers and see that any appropriate industrial regulations are met. In addition, protective fire escape routes should be notified in case of fire or other emergencies.

6.4 PROTECTION FROM TRAFFIC

It should be recognized that historic buildings cannot get away from man-made causes of decay including vibration from road vehicles and the possibility of direct impact from a heavy vehicle. Vibrations from the traffic may initiate cracks in materials which are already affected by the changes of temperature, humidity and settlement, which in due time, if it is not protected, may cause structural failures. Constant vibrations, for instance, can also cause loss of foundation strength by affecting the subsoil and loss of structural strength in the main structures. There are several ways to protect historic buildings from traffic vibration.

Most of the historic buildings were built long before the increase of the traffic vibration environment. In order to eliminate the source of vibration, it is important to detour the traffic going to the areas where there are important or large numbers of historic buildings. Local authority and town planners should play a major role in banning heavy vehicles and restricting vehicle speeds in such areas. Road surfaces near historic buildings should be carefully maintained also.

Another way of protecting historic buildings from traffic vibration is through the insertion of vertical curtains of thixotropic grout in trenches to insulate the foundations of buildings (Fig.23). The method, which was suggested by the Building Research Establishment, United Kingdom requires the trenches to be at least equal in depth to one-third of the wavelength of the vibration concerned. However, for low frequencies, depending on the velocity of the wave propagation in the soil, the depth can exceed 5m or 16 feet. It is important to carry out a site investigation using soil mechanics techniques prior to the insertion of the trenches.

For historic buildings located very close to the road, there is always a possibility of direct impact from a heavy vehicle. Where the traffic cannot be banned or restricted from the road, a traffic barrier should be fixed directly to a

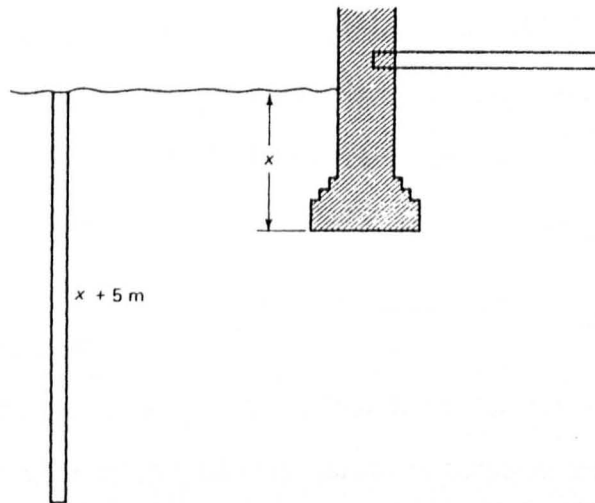


Fig.23 The insertion of vertical curtains of Thixotropic grout to protect foundations from traffic vibration

building in a form of a steel box beam with collapsible hexagon mounting brackets. Alternatively, free-standing barriers can be placed with a minimum clearance of 300mm between posts and the building with a set-back of 600mm from the kerb (Fig.24).

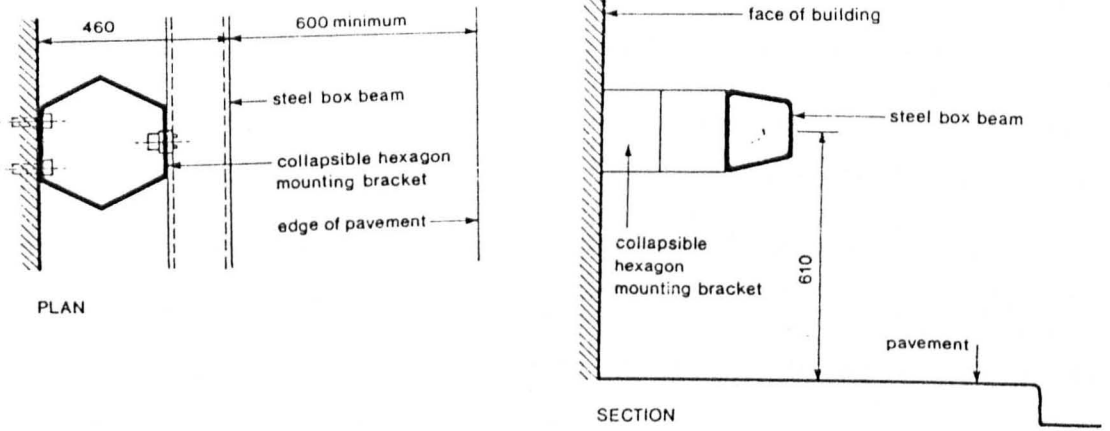
6.5 FIRE AND SECURITY

Both fire and security precautions should be considered in the conservation of historic buildings. This is because they may originally have never expected any fire and crime risks. In fact, the risks are even greater in an empty historic building rather than in an occupied and secured one.

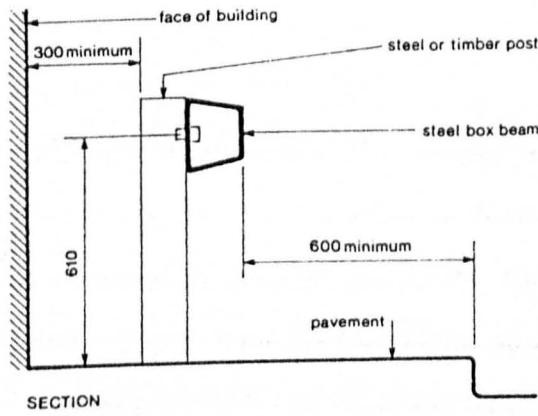
6.5.1 Fire Precautions

There are a number of ways that fires can be started accidentally in historic buildings. One of the most common is through the failure of electrical and gas equipment or supply. Therefore, it is important to have the equipment or supply lines checked and tested regularly. The advice of the electrical engineer should be sought. Fires can also be started by those who are cleaning, or using the buildings by smoking. Repair work especially that involves the use of blowlamps and welding torches near rubbish or any inflammable materials inside or outside the buildings. It is advisable that fires should never be lit inside an historic building, particularly in bedrooms, roof spaces, cupboards, attics and kitchen areas. Portable extinguishers should be located strategically. The case of the Hampton Court Fire which arose from smoking in bed is a good example.

The advice of fire prevention officers should also be sought for recommendations and appropriate fire fighting precautions. Building owners should be responsible for providing adequate fire protection. For example, automatic devices such as sprinklers and fire alarms or smoke detectors are usually required by law to be installed in historic buildings. In addition, fire extinguishers should be provided and placed visibly in main areas including



Example 1: A steel box beam fixed to building



Example 2: Free-standing traffic barrier

Fig.24 Two examples of protections of historic building from traffic

risk areas such as corridors and kitchens as well as work areas described above. It is essential to provide protective escape routes or means of fire-escaped staircases. However, the visual effect upon the character of historic buildings requires the most careful consideration. A high degree of architectural skill is necessary for such work. Besides, based upon standards of fire protection, historic buildings should respond to high fire resistance structural materials and consideration should be given to apply fire proofing of fabrics for extending the ignition time. For instance, there are a number of ways to upgrade existing timber doors for fire proofing ¹:

1. covering with intumescent coatings which swell up to form fire-resistant barriers.
2. sandwich panelling, a technique splitting the door and giving it a fire-resistant core.

6.5.2 Assistance and Advice on Security

Historic buildings, particularly the empty ones are vulnerable to intruders, vandals and thieves. To counter these problems, assistance and advice on the security can be obtained from either the police, local authority, neighbours and local amenity society. Supervision by the police on empty historic buildings should be consulted. The supervision can be made by delegating a full attention to the surroundings or discussing physical protection on the building site. Assistance from the local authority may include a nightly tour by a security guard or officer. Adjoining owners may also unofficially cooperate to check the historic buildings. Local amenity society may be informed about the historic buildings in the area, for some of its members may pass the buildings and help to give a report about any damages immediately.

In addition, it is important to fix a complete protection system for historic buildings such as electronic alarms at windows, fixed grilles and doors.

¹Andy Davey et. al., *The Care and Conservation of Georgian Houses*, London: The Architectural Press, 1986, p. 18.

The system can also be used to actuate a piercing noise in rooms and outside areas which will signal neighbours and police station. If such protection systems are used, it is important to consider and retain the aesthetic values of the buildings. These too require architectural skill to maintain character.

6.6 PREVENTIVE MAINTENANCE

Preventive maintenance of historic buildings is normally geared to its preservation for economic reasons. It is a process which a historic building is kept practicable for the benefit of its users. Such maintenance needs full support not only from the building owners and occupants but from the local authority which may lay down a maintenance policy to an acceptable standard or requirement. It also requires competent skilled craftsmen. Generally, all maintenance work need to be organized and tackled by regular routines of daily, weekly, monthly, quarterly, semi-annual and annual inspections. Cyclical maintenance should also include longer term routines such as quinquennial inspections followed by reports. Maintenance of historic buildings is further discussed in chapter 10.

6.7 PRESENTATION

Before a conservation project is started and its main objectives are defined, an appropriate presentation programme and policy should be established by those who are genuinely interested in values of cultural property. The presentation programme, which includes policy guidelines, governs the direction of historic buildings in terms of emotional, symbolic and cultural values. These go along with values of art, history, aesthetic, architecture, archaeology and site landscape and townscape. The main purpose of the presentation programme is to avoid any aesthetic confusion once the project is completed and also to present historic buildings in an intelligible way to the public. For example, if spiritual value is placed as the highest priority in the policy, then visitors to the building

may be limited in access at certain times and restricted to type and frequency of appropriate activities. Presentation should also consider crowd control, security, prevention of crime and vandalism. Many existing examples of good presentation can be seen in museums and art galleries. It is suggested that this concept should be extended to other building types with advantage.

6.8 COST ESTIMATION AND CONTROL

Cost estimation and control in any conservation project are desirable since unexpected expensive mistakes can be made due to insufficient initial inspections, wrong diagnosis, unskilful administrative, poor supervision, bureaucratic delays and lack of specific responsibility. Other reasons include the difficulty of estimating costs due to uncertain knowledge and usually, a long time scale. It is advisable to estimate preliminary cost after carrying out the initial inspection. Such estimation includes the costs of labour, craftsmen, materials, plant and overheads. A funding body should be established to govern and control the total cost of the conservation project which all lead to administrative measures. A programme of works should also be considered with the right size of team with the right balance of skills for each conservation operation. Such programming includes archaeological and art historical investigations together with the supply of scaffolding and the use of construction plant. The primary aim being to protect the building fabric.

6.9 REHABILITATION OF HISTORIC BUILDINGS

Finding an appropriate use for historic buildings can be one of the hardest problems in the practice of building conservation. This is often the case where historic buildings have to be used for other than their original functions, under the heading of building rehabilitation. Many historic buildings, nowadays, have adopted new uses in order to cope with high demands and rapid changes or patterns of life and scale of activities or indeed simply to enable the building to

survive. These include some of the British colonial buildings in Malaysia which have been converted into various uses such as, from palaces to museums, government offices to libraries; and residences to restaurants or hotels. It should be recognized that if historical values and structural conditions are neglected in the rehabilitation, some buildings may decay and suffer destruction, particularly when they cannot withstand with new superimposed loadings.

To ensure that the rehabilitation of British colonial buildings in Malaysia is appropriate and successful, with full consideration of their structures, costs, new uses, services as well as safeguarding historical and architectural values; there are three main aspects which should be established:

1. creating a rehabilitation policy.
2. providing rehabilitation guidelines (at project level).
3. setting up a rehabilitation team.

Creating a rehabilitation policy by the government may be necessary to point to the appropriate direction for the rehabilitation scheme. The policy should include aspects of building regulations for any proposed new use, structural calculations for the strength of floors and foundations, recommend suitable or alternative use for historic buildings, procedures for the maintenance of buildings, contract arrangements and owner's responsibilities. It is important when forming the policy to consider the principle of minimum intervention applied to conservation work.

It is necessary to set up a rehabilitation team to consider overall policy consisting of various professionals such as urban planners, engineers, quantity surveyors, conservation architects, historians, landscape architects, a traffic manager and a development economist. The main purpose of this multi-disciplinary team is to study and analyse the values of historic buildings, based upon several different surveys, including historic development, functions, services, conditions and structures. Also to receive feedback from the public

concerning building conservation. Such teams have been formed in many cities and amenity organizations in the United Kingdom where members of the team meet regularly to discuss their work and establish priorities. Detailed surveys are carried out and also owners, occupants and representatives of community organizations are consulted and discussed about the outcome of the surveys. In addition, after carrying out the studies, the rehabilitation team may recommend the most suitable use for each historic building. Basically, it is important to preserve the values in buildings, reduce total costs and introduce a closer new use to the original. It is possible that project teams may be formed from members of the overall team. Clearly only those appropriate to the project in hand would be used.

Like the rehabilitation policy, providing rehabilitation guidelines for building owners and local authorities is equally important. This may be helpful, particularly in deciding to change the function and physical elements of historic buildings. The guidelines must be simple, informative and with many examples from case studies and graphics possible. It is probable that initially central government initiative will be required as necessary skills are in short supply.

CHAPTER 7

SYSTEMS FOR DISCOVERING AND RECORDING

The purpose of this chapter is to study the main objectives and principles of discovering and recording historic buildings, with a view to applying them, particularly, to British colonial buildings in Malaysia. In addition, the study will consider the transfer of methods and systems of recording used by some conservation organizations in the United Kingdom. These include the Royal Commission on the Historical Monuments of England (RCHME), English Heritage, National Trust; and the International Council on Monuments and Sites (ICOMOS UK) to the context of the British colonial buildings in Malaysia.

7.1 OBJECTIVES OF DISCOVERING AND RECORDING

Since conservation of historic buildings is a relatively new phenomena in Malaysia, the need to have suitable systems for discovering and recording the buildings is very important. Besides the two major problems of insufficient legislation and lack of technical knowledge in maintaining historic buildings, there is also no suitable system for discovering and recording the British colonial buildings in the country. Historic buildings in the country are not well documented and researched. Even though there are a number of historic buildings inspected and recorded by the local authorities and museums, the information gathered about the buildings is usually not sufficient. It is part of this thesis not only to research existing recording systems but to suggest a suitable and systematic format for recording for the British colonial buildings in the country.

Such systems of discovering and recording historic buildings are essential for the purpose of obtaining reliable information and evidence about a building's history, location, function, architectural quality, condition and so forth. As well as providing the basis for action in conservation, these historical and architectural records can also present a great contribution to Malaysia's history and development. They can also be taken as a body of facts on the basis of which other groups of people including historians, administrators and planners can carry out their jobs to save the building. However, it should be recognized that the recording carried out is not only for historical and architectural purposes but also for builders who are engaged to repair the buildings, so that administrators can then maintain them or so that planners can take steps to preserve them.¹

If there is a system of financial subsidy, grant applications also require a full record of the significant facts about a building as supporting evidence. In addition, records of buildings are needed in planning maintenance programmes, particularly in monitoring the long-term effects of repair and remedial works, identifying any structural and constructional defects, deciding whether any specially careful treatments are needed for historical or structural aspects of the building; or in assessing whether any historic features of the building deserve to be shown to the public.²

For the work of discovering historic buildings, the job can be carried out by a surveyor or researcher. However, for the recording, the ideal person is someone who knows how to take any decisions about what is to be done to the buildings and the implications of action to be taken, or what alterations may be compatible with the historic buildings; and respects the integrity of building structures when repairs are necessary to be carried out. The recorders could be building owners, conservation architects, specially trained surveyors or those who have the skills and knowledge for such work.

¹Nicholas Cooper, in *Recording Historic Buildings: A Symposium*, London: RCHME, 1991, p.8.

²International Council on Monuments and Sites (ICOMOS), *Guide to Recording Historic Buildings*, London: Butterworth Architecture, 1990, p. 9.

For example, in the United Kingdom, under successive Town and Country Planning Acts; the Royal Commission on Historical Monuments (including England, Scotland and Wales) is the principal national body charged with the recording of historic buildings before they are in whole or in part to be demolished. A full record and report of the buildings are therefore, desirable before any decisions have been reached upon the buildings. In addition, there are groups of professional people in the country who are recording buildings although there is yet no central body through whom these professional recorders can be approached.³

7.2 DISCOVERING THE BRITISH COLONIAL BUILDINGS

Most of the British colonial buildings in Malaysia are scattered around the country. In addition, some of the building records are kept at government departments of various places. Therefore, in a process of discovering the British colonial buildings in the country, one must not only know how to get information about the buildings but to easily approach or identify them efficiently and economically. It is important to look for any documentary material which may throw light on the building's history, condition or development. Such material may include survey and architectural drawings, written descriptions either published or unpublished, old illustrations; and other documents such as diaries, letters or building accounts.

There is no central body for recording historic buildings in Malaysia. However, there are several ways of getting information about the British colonial buildings in the country. One route is through looking up and collating any possible records at various government agencies and local institutions such as museums, archives, local authorities, libraries and universities. Some historical information, particularly of various government buildings including photographs, original drawings and written articles may have been kept by the agencies or

³ICOMOS, p. 67.

institutions for recording purposes. In addition, local conservation organizations such as the Penang Heritage Trust and Heritage of Malaysia Trust may also provide assistance in getting more information about the historic buildings including those which they have worked on.

If the government agencies, institutions or the local conservation organizations provide insufficient sources or references on the British colonial buildings, another way of getting information about these buildings is by conducting a building survey. Particularly, at places which have been used during the colonization for the British settlements, military areas, railway stations; or some plantation areas in the country. These include the major cities such as Kuala Lumpur, Georgetown, Johor Bahru, Kuching, Kota Kinabalu, Malacca, Ipoh, Kuantan, and Seremban. Other areas include the Cameron Highlands, Taiping, Kuala Kangsar, Kuala Lipis, Batu Gajah and Kelang. One may spot various types of the British colonial buildings ranging from residences and churches to railway stations, public and government buildings.

A further way is by observing buildings and investigating the physical elements or features of an old building. Conducting verbal interviews with people who can be expected to know about any historic buildings located in or around their area may help a surveyor or researcher in getting more information about the British colonial buildings. In some cases, the information gathered may lead to further investigations or building surveys either in the area itself or at other places. Systems of identifying the building are discussed in *Data of British Colonial Buildings* in chapter 8. This is because most of the British colonial buildings have certain architectural styles or influences which are distinguished from other local architecture either of the Malay, Chinese or Indian. Most of the buildings built during the British period, particularly between 1800 and 1930 have the characteristics of either Moorish influence, Tudor, Neo-Classical or Neo-Gothic. These can be seen from the shapes and styles of the building

elements such as doors, windows, walls, ceilings, staircases or interior decoration.

Once the information about the existence of British colonial buildings have been discovered, the next step which a surveyor or researcher should do is to record all the information about the building's design, construction, development, history and use. The format used will obviously vary according to the scale of the building concerned. It may be possible to record all essential information onto a simple A4 card. A good example is illustrated later in this chapter. This has been developed by the Penang City Council with the Heritage of Malaysia Trust. On the other hand, a larger or more significant historical example may require a full report accompanied by measured drawings and photographic surveys. All descriptions and interpretations about the buildings should be recorded into different levels of recording under the three headings suggested by the RCHME: written account, drawings and photography.⁴

7.2.1 Written Account

A written account provides a range of building description and analysis but not the description of features clearly shown in drawings or photographs. This includes:

1. a precise location of the building (by number, street name, town, district and state).
2. date when the record was carried out and the name of the surveyor or recorder.
3. a short description of building's type, purpose and materials.
4. a summary statement of building's plan, form, use, age and development sequence. The names of architects and builders if known.

⁴Royal Commission on the Historical Monuments of England, *Recording Historic Buildings: A Descriptive Specification*, 2nd ed., London: RCHMB, 1991, p. 1.

5. an account of the building's past and present use and of the uses of its parts, with the evidence for these interpretations.
6. any evidence for the former existence of demolished structures associated with the building.
7. copies of other records of the building, or a note of the building's past and present relationship to its setting.
8. relevant information from other available sources and from other people such as owners, builders and architects.

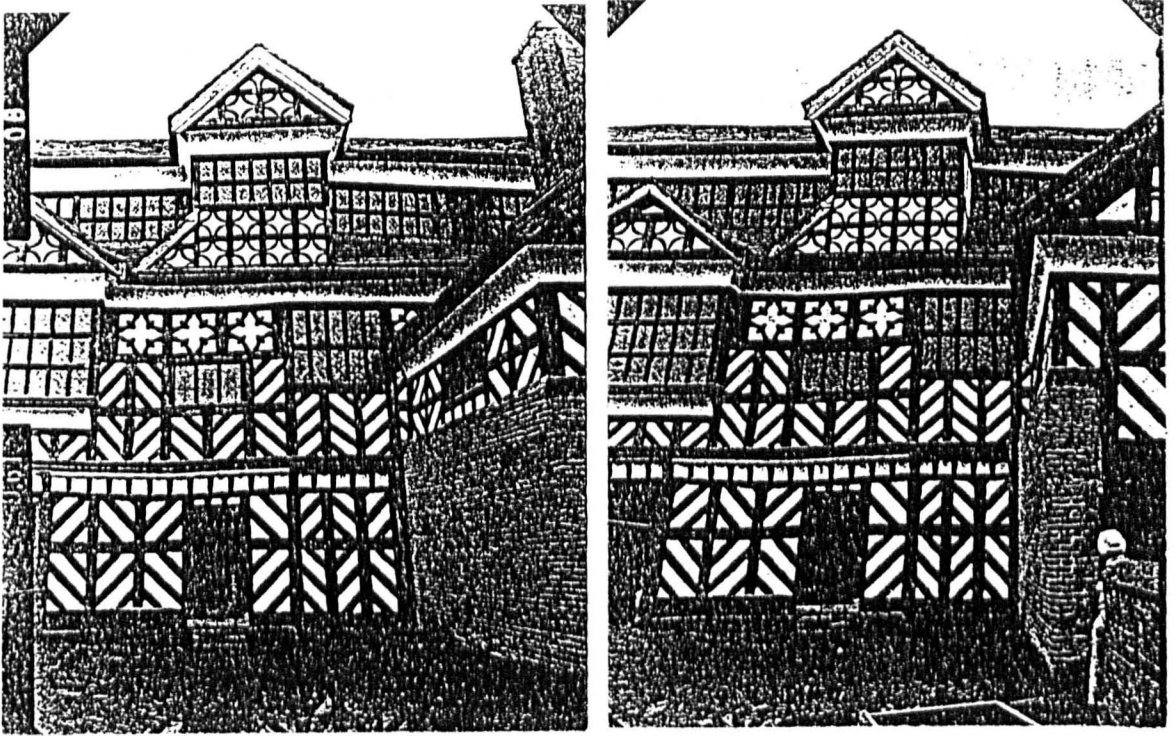
7.2.2 Drawings

Drawings play an important role in recording buildings, particularly in visualizing what have been described in the written account. They may be produced by either hand or mechanical means such as *photogrammetry*⁵ or *rectified photography*⁶ (Fig.25). With appropriate scale to the building, typically 1:100 or 1:50 for plans and 1:50 for sections, the drawings produced should remain legible with annotations if necessary. Drawings must include north points on all plans, clearly labelled with the name of the subject, the surveyor's name and the date of the survey. A set of drawings may be produced including:

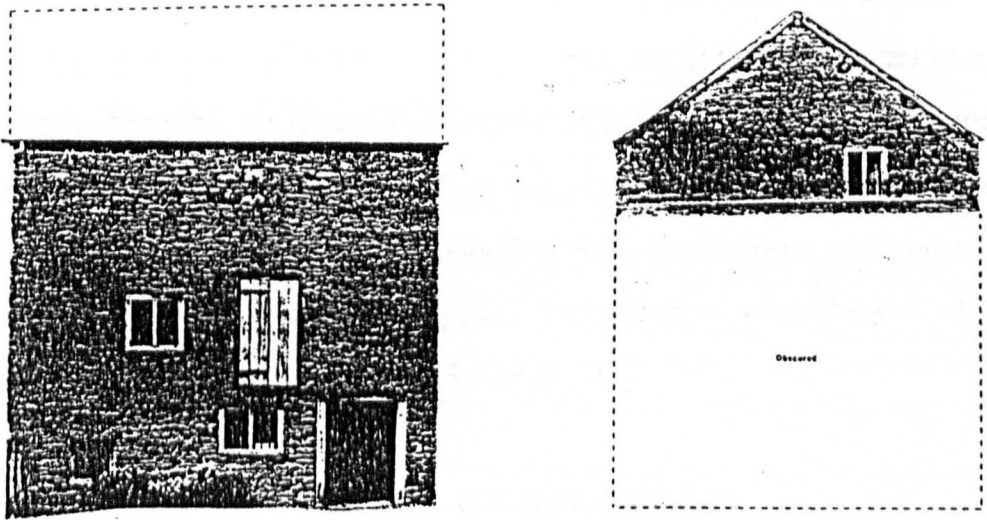
1. a sketch plan, roughly dimensioned and may not always include structural details.
2. plans of all floors as existing.
3. sections to show an overall form of the building.

⁵*Photogrammetry* is a means of producing drawings by measurement from photography. Essentially, a three-dimensional image is produced by stereoscopic photography from which accurate measurement can be made.

⁶*Rectified photography* involves making a true-to-scale photographic print of an object such as the facade of a building. Dimensions can then be scaled off the photograph with reasonable accuracy. Photographic prints are normally made onto transparent film so that dyeline copies may be taken.



A 3-dimensional image is produced by photogrammetric survey



Parts of the building's elevation have to be indicated in another manner, after the elevations are recorded by rectified photography

Fig.25 Examples of the use of mechanical means to produce drawings

4. elevations, if necessary, to illustrate the building's design, development and function.
5. a site plan relating the building to other structures or landscape features.
6. copies of earlier plans which give additional information on the building's history.

7.2.3 Photography

Photographs are required not only to show the building's appearance (external and internal) from a convenient viewpoint, but also to record any evidence on which the analysis of its historic development will be based upon. Sometimes photography may include the building's relationship to its setting, to other buildings or to a significant viewpoint; the overall appearance of circulation areas and principal rooms; and other building's design, development and use which do not show adequately on general photographs. For permanent and archival purposes, black and white photography is preferable to colour. This is because colour photographs tend to age and fade much faster than the black and white ones. However, to record the internal details and decorations, significant structural details or problems of building materials, colour photographs should be used. Each print should be clearly labelled with the subject, orientation, date taken and cross-referenced to its negative. In important areas the use of colour notation based upon standards should be used.

7.3 PRINCIPLES AND LEVELS OF RECORDING

There are two main principles involved in recording historic buildings. The first is to establish and illustrate the historical significance of the buildings and their details, so that those who are concerned about the buildings (owners, administrators, planners, architects, surveyors and historians) may be fully aware of the development of the buildings. Secondly, it is important to record whatever

work that is actually carried out. All recordings should be cumulative and updated whenever any conservation work is carried out to the buildings. This can be carried out in a combination of a written description and analysis of the buildings with a visual record made by drawings and photographs. As suggested by the RCHME⁷, there are four levels of recording, ranging from the simplest, with photographs and notes, to the most comprehensive with the fullest architectural and historical analysis, drawings and photography.

7.3.1 Visual Record

The first level, which is a visual record, is adopted when the main aim is to gather basic information about a large number of buildings for the purpose of either statistical information, a pilot project, urban planning; or whenever resources are limited and much ground has to be covered in a short time. The visual record normally includes a minimum information of the building's location, age and type (in written account), a sketch plan roughly dimensioned and a few photographs of the building's external appearance; and its circulation areas and principal rooms, if necessary.

7.3.2 Descriptive Record

The second level is a descriptive record which is carried out in similar circumstances to the visual record but when rather more information is required. It may also be made for a building whose importance does not call for any fuller record. It is necessary to describe and photograph the exterior and interior details of the building. Apart from stating the building's location, type, materials and so forth; written account should also include a description of building's plan, form, function, age, development sequence and names of architects or builders.

⁷RCHME, p. 1.

7.3.3 Analytical Record

The third level of recording is fully analytical including all visual records which are required to illustrate the building's appearance and structure, and to support an historical analysis. An introductory written description about the building's origin, development and use is also essential. Most of the information contained in the record have been attained through an examination of the building itself and other readily available sources such as published books and other people (owners, builders, architects) who may have known about the building.

In the forming of the analytical record, very much of the analyses are related to the changes of building's original form and fabric, particularly evidence of multiple usage periods or phases of the building. These include differences in building materials, wall alignment and thickness, structural techniques; breaks in masonry crack surveys and evidence of demolition of parts of building if there is no replacement by a later structure.

7.3.4 Level 4: Buildings of Special Importance

This level of recording is only employed by the Royal Commission in respect of buildings of special importance. Apart from building's history clarified in the analytical record, this type of recording draws on the full range of other sources of information about the building's craftsmen, ownership, occupancy, designer and also discusses its significance in terms of architectural, social, regional or economic history. Reconstruction drawings, even though are not part of a record, are sometimes helpful as supporting evidence. Additional photographs of the building's internal and external details, structures, decorative features; and its relationship to its setting and other buildings are also included in the record.

7.4 FORMAT FOR A RECORD CARD

One of the basic aids needed by a recorder or surveyor when carrying out the recording work is a record card. The card, which identifies the historic building with architectural, historical and updated information, is designed to allow extra information to be inserted about the building; particularly in the course of an emergency repair work. This A4-size card is not only ideal for the initial appraisal and survey but making the compilation and filing systems a lot more easier.


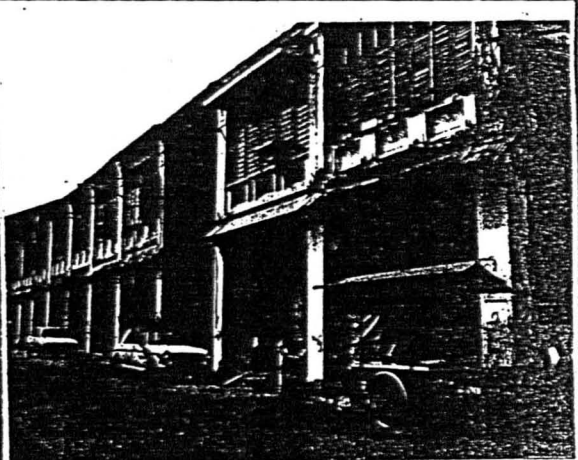
At present, the Penang City Council and Heritage of Malaysia Trust have made an initiative step to use a record card in obtaining information about historic buildings that they have worked on (Fig.26 & 27). However, the format of the record cards needs to be improved so that other relevant information about the buildings should be included. For the work of discovering and recording the British colonial buildings, a more suitable and systematic record card should be introduced. Based on the record card used by the English Heritage, the new suggested format for a record card for the British colonial buildings should basically consist of several sections stating some important particulars about the buildings; of which the architectural and historical information on one side of the card and the updated information on the other. However, if extra spaces are needed, for instance for additional updated information; then the format can continue on to a new card.

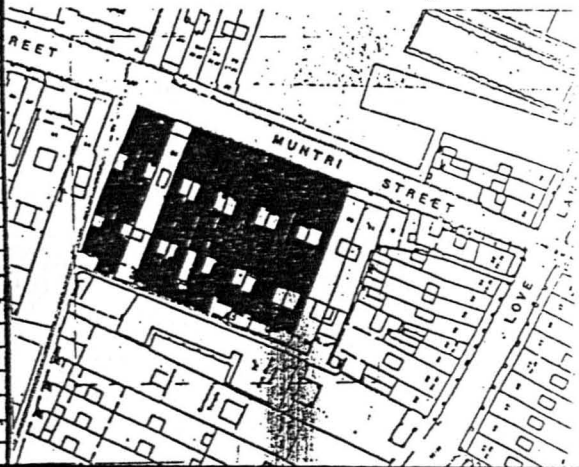
On the front page of the record card, the following information are needed to be filled in (Fig.28):

1. Name of building
2. Address of building
3. Building type (eg. railway station, church, government office, residence etc.)
4. Owner of building
5. Date the building built

Fig.26

A record card used by Penang City Council

GEORGE TOWN		street/No. LEBUH MUNTRI 15/17/19/21/23 25/27/29/33/35
PULAN PINANG		district/area 19
plot/No. 210, 209, 208, 207	compiler SM	
206, 205, 204, 203,	photographer	
film No. 16-CE, 30-CR, 31-CR neg. No.	literature	
owner		
type of building SHOP HOUSES		
1 building character, location in the city fitting in the surrounding	15/17/19/21/23/25/27/29/33/35 Lebuh Muntri (Lot 203, 204, 205, 206, 207, 208, 209, 210)	
2 historical consideration built in which year, period, architect, artist, owner	An ensemble of ten double storey terrace houses of similiar design in the straits eclectic style; built around 1900. The facade of the ground floor is decorated in the chinese style with central beautifully carved timber doors flanked by two windows with curvilinear air vents above. The upper floor is supported by columns and the buildings are separated by party walls. Below the full length timber louvred windows is a moulded spandrel divided into three rectangular bays.	
3 architectural considerations, description of the style pertaining to history of art	The terrace houses ensemble is important for its setting and of street scape value.	
4 interior fittings wallpainting, ceiling, furniture		
5 signification, classification: a artistic value b historic value c scientific value d important for the setting/ town planning		
6 condition of the building		



HERITAGE OF MALAYSIA'S BUILT HERITAGE

Recording..... Name of Recorder.....

Location of Building
.....
.....

Town/City..... State

Name of Building'.....

Owner's Name (if known)

Year of Construction

A. Building Type
Fill in code number

B. Wall Construction

Concrete Timber Brickwork

Steel Other

C. Roof Construction

Tile Attap Shingle

Sheet Roofing Composite

D. Condition

Good Fair Bad

Derelict

E. Alterations/Additions YES NO
Tick relevant box

F. Present Use
Fill in Code Number

G. Adjacent Buildings/Land
Fill in Code Number

H. Remarks/History
.....
.....
.....
.....
.....

REFERENCE CODE

1) Residential
a) traditional Malay houses
b) istanas
c) bungalows
d) villas
e) courtyard mansion
f) terrace/townhouse

2) Commercial
a) shophouse
b) market
c) financial office bldgs
d) godowns
e) hotels

3) Educational
a) schools/colleges
b) institutions
c) government buildings
d) hospitals
e) embassies

4) Religious Use
a) mosque
b) surau
c) wakaf
d) Chinese temple
e) Kongsi house
f) Hindu temple
g) Sikh temple
h) Church
i) Cemetery

5) Industrial Use

6) Recreational Use
a) clubhouse
b) theatre/cinema

7) Transport Use

8) Agricultural Use

9) Mixed Use

10) Others

Fig.27 A record card used by Heritage of Malaysia Trust

HISTORIC BUILDING RECORD CARD		
1 Name of Building:	5 Date Built:	11 City of:
2 Address:	6 Architect/Builder:	12 File Refs.:
	7 Cons. Area:	13 Map Refs.:
	8 Grade:	14 Listing Serial No.:
3 Building Type:	9 Date Listed:	15 Photographer:
4 Owner:	10 Recorder/Surveyor:	
16 Description:		
17 Map and Photographs:		
18 Scale of Map:	19 Date of Photograph:	20 Photographic Refs.:
21 Building Problems:		22 Is the Building at Risk?

Fig.28 Front page of a suggested format for a new record card

6. Name of architect or builder
7. Name of conservation area where the building is located
8. Grade of building (if appropriate)
9. Date the building is listed or gazetted
10. Name of recorder or surveyor who carries out the recording
11. Name of city where the building is located (this is to see under which local authority the building is authorized under)
12. File reference number of the record card
13. Map reference number from which the location map is referred to.
14. Listing serial number if given in the gazette
15. Name of photographer
16. General description of the building
17. A location map and appropriate photographs are needed as a reference
18. Scale of map should be indicated
19. Date of photographs taken
20. Photographic reference number (if the rest of the building photographs are stored at different place)
21. A summary description of building problems including the materials and structures
22. A question whether the building is at risk.

However, on the other page of the record card, the page format is basically divided into four main sections, one of which has its own space for dates of events. The main sections are Names, Uses, Condition and Diary. Each of these sections is given a space to insert any updated information about the building (Fig.29).

The Name section allows the recorder or surveyor to state names and addresses of those who have carried out any conservation work for the building. This may include the previous or present owners, occupiers, architects or whoever responsible for such work. The main purposes of this section are to keep track on the development of the building's conservation work and also to be able to contact those who are responsible with the work if further investigations are required.

Under the section on Uses, all building functions are recorded by every floor of the building. If the building has only one level, then all rooms' functions are recorded. This section is quite important because it shows the changes of activities occurred in the building throughout a certain period of time. It can also provide a good record, particularly for buildings which have undergone physical transformations or an adaptive re-use process. All rooms and floors should be indicated if they are empty or occupied.

On the other hand, the Condition section allows the recorder or surveyor to further explain and illustrate the building conditions or problems which have been highlighted on the front page of the record card (under section 21: Building Problems). The use of small diagrams is necessary to visualize the conditions or problems. Any proposals or suggestions to such conditions or problems may be helpful, particularly if the building is at risk and in need of an emergency repair.

Finally, the Diary section allows all events related to the building to be recorded. Such events include any meetings, applications and grants from either local authorities, architects, contractors or owners. The main objective is to

HISTORIC BUILDING RECORD CARD								
Dates	NAMES & Address	Owner	Occupier	Architect	Other *	Dates	DIARY Meetings, application, grant etc.	Initials
* Please Specify								
Dates	USES Floor by Floor if Different	Empty		Occupied				
Dates	CONDITION Diagrams and Proposals						Initials	
Tick for Continuation Sheet								

Fig.29 Back page of a suggested format for a new record card

record the progress of the events as well as the building's development. Due to future changes of recorders or surveyors, both the Diary and Condition sections require initial names of the people. It is recognized that a card filing system has some drawbacks. The possibility of using computer based Information-Technology techniques will be considered in section 8.4 of chapter 8.

7.5 PRESERVING RECORDS

Basically, there are two types of records which need to be preserved: those made as part of the initial appraisal and survey; and those which are generated as a result of any work carried out. The purpose of preserving the records is to make them available to anyone who may in the future have an interest or concern about the building or who may require further information about it. The records should be kept safely in a public archive, whose permanence and proper management system make it possible for the records to be maintained and preserved.

In the United Kingdom, the national body which concerns with the repository and preservation of such records is the National Monuments Record (NMR). Maintained by the Royal Commission on the Historical Monuments of England, the NMR's aim is to provide a comprehensive record of the English archaeology and architecture, it comprises a computerised database, photographs, measured drawings and written reports.⁸ Due to a wide range of records, the NMR is organized into three sections: the National Buildings Record, the National Archaeological Record and the National Library of Air Photographs; which are all open for public consultation and study. In addition, one may always refer to his appropriate local County Record Office or local authority which usually maintains a Sites and Monuments Record comprising of information about historic and environmental resources in the area.

⁸Collecting Policy, RCHME, March 1991.

In Malaysia, the appropriate national body which can maintain and preserve all records of historic buildings in the country including those of the British colonial buildings is the National Archive in Kuala Lumpur. With its archival and research facilities, the National Archive can be a central body for those who may have a legitimate concern about the nation's historic buildings. In addition, copies of the records should be given to other local authorities. These records are only limited to the historic buildings located in the respected local area. However, there are other public repositories for the deposit and preservation of the building records. They include the building owner, architect and a body or individual (recorder) commissioning to carry out the recording work.

One of the reasons why the building owner should be given a copy of the record of his historic building is so that it can always be available especially when the building is required for any alteration, extensions or for major repairs. Later, when the building is passed on to a new successor; the record can also act as a document which informs all the development stages that the building has gone through in the past.

Legislation is required so that if an architect is commissioned to carry out any conservation work for the historic building, he should also be given a copy of the record prior to the commencement of the work. This is to ensure that the architect is aware of his responsibilities when monitoring the work, particularly in the course of any specialist treatment. It is also his responsibility to make sure that the record is preserved together with any other relevant contract papers. If he no longer needs the record or when the work is completed, he should hand in the record either to the building's present owner, the National Archives or local authorities.

If the initial building survey has been carried out by someone or a body other than the architect, then the person will also keep a copy of the record until the work is finished. Like the architect, the person is also required to hand in the copy once the work is completed. Again, legislation will be necessary.

CHAPTER 8

DATA OF BRITISH COLONIAL BUILDINGS

In addition to the record card, a historic building needs to have a building data matrix, a graphic system which identifies various elements of a building. The main purposes are to develop an understanding of the stylistic origins and periods of the building through the process of identifying its physical features and ornaments, to act as a guidance for future repair and maintenance; and later to be easily adopted for computer analyses, particularly with the application of computer databases. The building data matrix can be carried out during the process of recording buildings, when undertaking a pilot study of buildings under threat or for a national building survey. Apart from the architectural aspects, the difference between the building data matrix and the record card is that the latter includes historical information and it is designed to allow all updated information about the building while the former only concentrates on the physical features and styles of the building and it is necessary to carry out at one time.

In the United Kingdom, the building data matrix was used by Dr. R.W. Brunskill for recording the four main types of traditional domestic architecture: Great Houses which includes principal castles, palaces and great country houses; Large Houses consisting of manor houses which display vernacular qualities; Small Houses comprising dwellings of general run of farmers; and Cottage which includes dwellings of the landless labourers.¹ In his article published by the Ancient Monuments Society, *A Systematic Procedure For Recording English*

¹R.W. Brunskill, abridged edition, *A Systematic Procedure For Recording English Vernacular Architecture*, London: The Ancient Monuments Society, 1976, p. 1 & 2.

Vernacular Architecture; he has introduced a set of questionnaire charts consisting of sketches of general arrangement and architectural characteristics from walling materials and organization of roofs to disposition of chimneys and information on dormer windows. The sketches are grouped and divided into numbered boxes in which a coding system is applied to varify the multiple-choice graphics (Fig.30). The idea of questionnaire charts seems interesting and can be a good reference for generating a building data matrix for the British colonial buildings in Malaysia.

In Malaysia, although the building data matrix has been introduced by the Heritage of Malaysia Trust, it is only appropriate to certain building types such as shophouses, terrace houses and traditional Chinese mansions (Appendix 5). It is found that with its limited choices of architectural graphics, the matrix is insufficient enough to record and define all categories of the British colonial buildings. Therefore, the main purpose of this chapter is to develop a building data matrix which concentrates particularly on the British colonial buildings in the country. Basically, this building data matrix is based upon the one developed by the Trust with reference to photographs taken during the inspections of the British colonial buildings; and other relevant literature including *Architecture and Ornament: A Visual Guide*, *The Elements of Style*, *An Illustrated History of Architectural Styles*, and *A Systematic Procedure For Recording English Vernacular Architecture*.

8.1 CLASSIFICATION OF BRITISH COLONIAL BUILDINGS

Before discussing on the building data matrix, it is important to classify the various types of the British colonial buildings in Malaysia, particularly those which were built between 1800 and 1930. This is because the classification not only identifies the similarities of the physical elements between buildings of the same functions and styles but it shows how the British architecture integrates

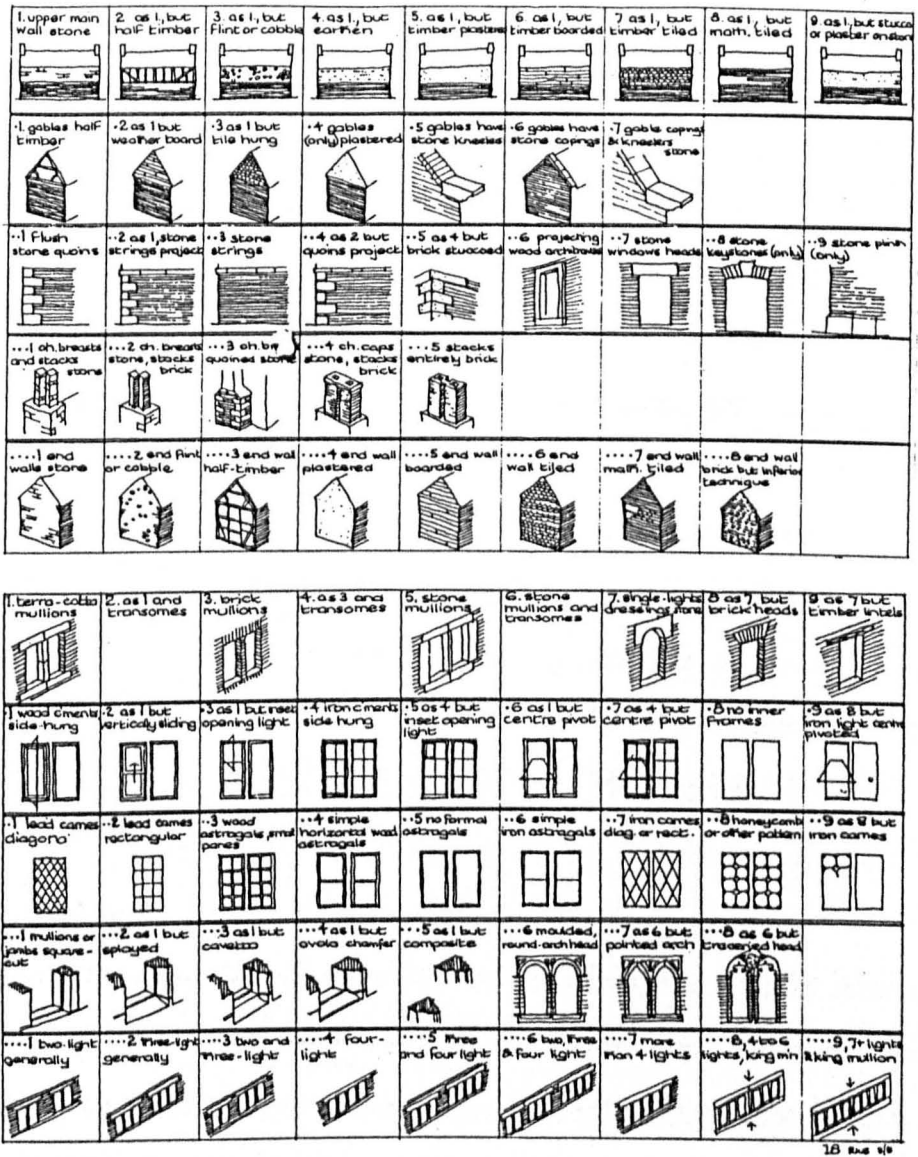


Fig.30 One of questionnaire charts used for recording traditional domestic architecture in the United Kingdom

Source: R.W.Brunskill, abridged ed., *A Systematic Procedure For Recording English Vernacular Architecture*, London: The Ancient Monuments Society, 1976.

with the local architectural scene and also have survived throughout the development of the country's national heritage. This may perhaps develop a greater understanding and sensitivity towards the buildings, especially for those who concern to preserve and conserve the British architecture in Malaysia.

The British colonial buildings can be classified into the following types:

- | | |
|-----------------------|--|
| 1. Forts / Military | 7. Institutional and |
| 2. Churches / Mosques | Commercial |
| 3. Palaces | 8. Residential |
| 4. Clock Towers | 9. Schools |
| 5. Prisons | 10. Railway Stations |
| 6. Government Offices | 11. Hotels and Guest
Houses |
| | 12. Miscellaneous Buildings /
Monuments |

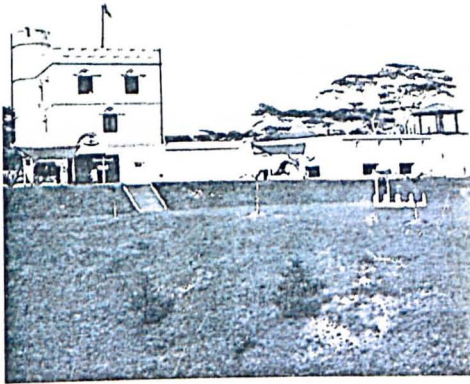
8.1.1 Forts / Military

There are a number of historic forts in Malaysia, mainly built either during the Malay Sultanate or the periods of the Portuguese, Dutch and British. Even though these forts mainly remain as ruins nowadays, many have been gazetted by the Museums Department for protection and preservation. Some of the existing forts built during the British colonization include Fort Cornwallis (1808) in Georgetown, Fort Bukit Puteri (1830) in Kuala Terengganu, Fort Lily (1855) in Betong, Fort Alice (1864) in Sri Aman, Fort Margherita (1879) in Kuching; and Fort Sylvia (1880) in Kapit, Sarawak (Fig.31). Most of them were made of solid masonry and can be found on high land either near rivers or seas.

Besides forts, there are a few other colonial buildings built for the purposes of military and defence. These include many of the police and army headquarters and barracks. However, some of these buildings have been



Fort Cornwallis,
Penang (1808)



Fort Margherita,
Kuching (1879)



Museum and Gallery,
Univerisiti Sains Malaysia, Penang

Fig.31 Forts / Military

converted into a museum and classrooms. A good example is the Universiti Sains Malaysia in Penang.

8.1.2 Churches / Mosques

There are a number of churches and mosques built during the period, most of which were influenced by the western styles such as the Gothic and Classical characters. Some of them, mosques in particular, have adopted the Moorish influence to give the Islamic image to the buildings. Among the historic churches are St. George's Church (1817) in Georgetown, St. Francis Xavier's Church (1849) in Malacca, Cathedral of the Assumption (1860) in Georgetown, Lady of the Sacred Heart Church (1883) in Taiping, Church of Immaculate Conception (1883) in Johor Bahru; and All Saints Church (1886) in Taiping (Fig.32). These churches were made of local timber, brick or stone with plastered walls and clay roof tiles. Some have stained glass windows while others use wooden panels.

Most of the mosques built during the period have a main dome, minarets with pointed arches and classical columns. Among them are Kapitan Kling Mosque (1801) in Georgetown, Sultan Abu Bakar Mosque (1892) in Johor Bahru, Jamek Mosque (1909) in Kuala Lumpur; and Jamek Mosque (1925) in Muar (Fig.33). They were made of similar building materials used for the churches. Some have added marble for floor surfaces and steps. They can be regarded as British colonial buildings as they were built to accommodate those populations which were imported for colonial purposes that is skilled labour forces. They were designed by British architects.

8.1.3 Palaces

During the British period, many rulers of the various Malay states were provided with grandiose new palaces by the British State Residents. These



St. George's Church,
Georgetown (1817)



Church of Immaculate
Conception, Johor Bahru (1883)



Lady of the Sacred Heart
Church, Taiping (1883)

Fig.32 Churches



Sultan Abu Bakar Mosque,
Johor Bahru (1892)



Jamek Mosque,
Kuala Lumpur (1909)



Jamek Mosque,
Muar (1925)

Fig.33 Mosques

replaced the traditional timber palaces.² With the influence of western characters and styles, these royal palaces or *istanas* (Malay word for palace) look monumental, solid and graceful compared to the old ones. Thus, they portray the images of wealth, power and status of the Malay rulers. Examples of the western royal palaces are Istana Sultan Abu Bakar (1866) in Johor Bahru which has now turned into a royal museum, Istana (1870) in Kuching, Istana Maziah (1898) in Kuala Terengganu; and Istana Hulu (1898) in Kuala Kangsar (Fig.34).

8.1.4 Clock Towers

Clock towers have become another interesting type of architecture left by the British. They were built purposely to commemorate an event, a fallen Imperial paladin or to pay tribute to the British Residents. These memorials are many seen in the states of Perak, Kedah, Penang, Sabah and Sarawak. They are either located in roundabouts, main streets, in front of major buildings or in open spaces. Example of the historic clock towers in Malaysia are Clock Tower (1870) in Taiping, Round Tower (1886) in Kuching, Victoria Tower (1897) in Georgetown, Atkinson Clock Tower (1905) in Kota Kinabalu; and JWW Birch Clock Tower (1909) in Ipoh (Fig.35).

8.1.5 Prisons

It is important to classify this type of building because not only it explains the history and social life of the region but architecturally it shows rather different characters and styles from other types of British colonial buildings. Compared to other types of British architecture, the number of prisons built during the period is small. Despite their age and conditions, most of the prisons are structurally sound and still occupied by prisoners. Two of the earliest prisons built by the British are Taiping Prison (1883) and Pudu Prison (1895) in Kuala Lumpur (Fig.36).

²S. Vlatceas, *A History of Malaysian Architecture*, Singapore: Longman Singapore Publishers Pte. Ltd., 1990, p. 75.



Istana Sultan Abu Bakar,
Johor Bahru (1866)



Istana, Kuching (1870)



Istana Maziah,
Kuala Terengganu (1898)

Fig.34 Palaces



Clock Tower,
Taiping (1870)



Victoria Tower,
Georgetown (1897)

JWW Birch Tower,
Ipoh (1909)



Fig.35 Clock towers



Taiping Prison (1883)



Pudu Prison, Kuala Lumpur (1895)

Fig.36 Prisons

8.1.6 Government Offices

In the 19th Century, a lot of new government offices were built in the country to house the additional arrivals of colonial administrators. Vast office buildings for all sorts of administrations filled business districts in the main towns and cities. Different architectural styles were introduced by the British architects and designers but most of the government buildings were very much influenced by the Moorish style and also Neo-Classical elements with some adaptations to the local climate. This is because many British architects had experienced designing such buildings in many parts of British empire and introduced the styles to the country. It also reflected the eclectic nature of design found in Britain at the end of the 19th Century. Of course with the majority of the population, which is muslim Malay, the Moorish influence borrowed from northern India seemed appropriate for many government buildings. It is very interesting to record the physical elements and parts of these buildings, particularly their different styles and shapes of windows, doors, columns, arches, pediments and building forms.

There are many kinds of government offices ranging from court houses and district offices to secretariat buildings and state religious departments. Most of the government offices have been gazetted, due to their architectural heritage and historical values, for protection and preservation. Some of them have undergone physical transformations, with conservation as a basis, to accommodate the higher demand of office spaces. Among the historic government offices are Court House (1874) in Kuching, District Offices (1879) in Taiping, Old Town Hall (1879) and State Religious Department (1884) in Georgetown, Court House (1892) in Batu Gajah; and Sultan Abdul Samad Building (1894) in Kuala Lumpur (Fig.37).



Court House,
Kuching (1874)



District Offices,
Taiping (1879)



State Religious Department,
Georgetown (1884)

Fig.37 Government offices

8.1.7 Institutional and Commercial

Buildings fall under this category have played an important role in the development of Malaysia. This is because during the period, a lot of such buildings were built mainly for commercial and social activities, banking, trading and public health. The number has increased when many new tin mines were opened especially in the states of Perak and Selangor. These include banks, hospitals, social clubs and museums. Some of the buildings are Perak Museum (1883) in Taiping, Algemene Bank (1889) in Georgetown; and Tanglin Hospital (1890), Old Standard Chartered Bank Building (1909) and Selangor Club (1910) in Kuala Lumpur (Fig.38).

8.1.8 Residential

During the British period, there was a tremendous influx of not only British officials but doctors, engineers, educators as well as merchants and planters. As a result, a lot of residences (eg. bungalows and villas) were built to house all these people, and they are found in towns, cities and on plantation estates. Some of these buildings have borrowed the western traditions, particularly in the styles and methods of construction with of course, adaptations to the local climate. This can be seen from the introduction of verandah, ventilation grilles and high ceilings. Built of brick, timber or stone, the buildings are architecturally sound, with a few exceptions of some buildings which were left abandoned or attacked by termites and insects.

However, many of these buildings have been conserved and converted to other uses such as a restaurant, an office for diplomats, luxury hotel and social club. It is important to record these residences before further demolitions are taking place. Some of the existing residences are Wisma Loke Yew (1890) in Kuala Lumpur which is now used as an art gallery and music conservatory, Seri Mutiara (1890) in Georgetown, Dato Jaafar's Residence (1893) in Johor Bahru,



Perak Museum,
Taiping (1883)



Algemene Bank,
Georgetown (1889).



Old Standard Chartered
Bank Building,
Kuala Lumpur (1909)

Fig.38 Institutional and commercial

Carcosa Seri Negara (1897) in Kuala Lumpur which has been converted into a luxury hotel; and Homestead (1910) in Georgetown (Fig.39).

8.1.9 Schools

It is under the British period that education systems flourished in Malaysia. Many schools and colleges were built throughout the country, most of which at least have two or three storeys with western characters and styles appeared on the building facades. Vast pairs of Ionian columns, arches or windows, and series of balusters along the corridors are some of the common features shared by the early schools. Most of the schools were made of brick and timber with clay roof tiles. Among the historic schools in the country are King Edward VII's (1905) and St. George's School (1915) in Taiping, Malay College (1905) in Kuala Kangsar, St. John's Institution (1907) in Kuala Lumpur, St. Michael's School (1912) in Ipoh; and High School (1915) in Muar (Fig.40).

8.1.10 Railway Stations

With the introduction of train in Malaysia and the needs of better and faster communications in the 19th Century, the British had to build railway stations in major towns and cities in the country. In the early days, the railway stations were small and built of timber and thatch. However, as the demands of railway traffic increased many stations had to enlarge or replace with bigger structures using brick, stone, timber and concrete. Like most of the early government buildings and mosques, some of the early major railway stations were influenced by the Moorish style. Domed turrets, domes, pointed arches, archways, classical columns, pilasters and high ceilings are common architectural features in the buildings, creating them majestic public buildings. At present, many of the railway stations have incorporated other uses including a restaurant, a hotel or a tourist information centre into the buildings. Examples of the railway



Wisma Loke Yew,
Kuala Lumpur (1890)



Dato Jaafar's Residence,
Johor Bahru (1893)



Lim Mah Chye's Mansion,
Georgetown (1911)

Fig.39 Residential



St.Michael's School,
Ipoh (1912)



St.George's School,
Taiping (1915)



High School,
Muar (1915)

Fig.40 Schools

stations can be found in Taiping (1873), Kuala Lumpur (1911), Ipoh (1917) and Johor Bahru (Fig.41).

8.1.11 Hotels and Guest Houses

Unlike today's modern hotels which are of high-rise buildings, most hotels built during the British period are three or four-storey high. Many of the early hotels and guest houses portray a western look with classical columns, arches and plenty of windows as their common features. Later in the period, a number of private bungalows, villas or mansions were converted into a hotel in order to cope with higher demands. However, at present only a few hotel and guest houses have remained their original function while others have been adapted to other uses including an office, a restaurant or an art gallery. Examples of the early hotels and guest houses are the E & O Hotel (1885), Metropole Hotel (1900) in Georgetown; and Rest House (1894) in Taiping (Fig.42).

8.1.12 Miscellaneous Buildings / Monuments

There are a number of street furniture, fountains, gate posts, statues and monuments built either as part of a building or to commemorate someone or something during the British occupation in Malaysia. For example, the historic Horse Fountain (1897), located at the corner of Merdeka Square, Kuala Lumpur, which was constructed by Riley, Hargreaves and Co. The Fountain, a memorial tribute to a popular Selangor Police Inspector name Steve Harper, was designed to include the heads and necks of horses reaching upwards to a spacious bowl in which water from fountain fell and supplied the horses' needs. Another example is the monument situated in front of St. George's Church (1817) in Georgetown. This classical monument is believed to be built as a shelter for gardeners, drivers and even visitors to the Church. Other examples classified into this category are the gate posts at the entrance of Sultan Abu Bakar Mosque (1892) in Johor Bahru, statues of Sir Frank Swettenham, Kuala Lumpur and Captain Francis



Kuala Lumpur (1911)



Ipoh (1917)



Johor Bahru

Fig.41 Railway stations



E & O Hotel,
Georgetown (1884)



Rest House,
Taiping (1894)



Metropole Hotel,
Georgetown (1900)

Fig.42 Hotels and guest houses

Light, Georgetown; the English phone booth in Cameron Highlands; and the Pavilion Polo Iskandar (1920) in Kuala Kangsar, Perak (Fig. 43). It is important that these monuments should be gazetted for further preservation and protection.

It should be recognized that all of these building types have been designed to modern building regulations and requirements. It is a threat to the building structures if the work of preservation or conservation are carried out by unskilled people. This includes improper methods and techniques of building maintenance.

8.2 FORMAT FOR A BUILDING DATA MATRIX

As far as the building data matrix is concerned, it can be divided into six main sections which are, File References, Building title, Structures, Interior, Ornament and Architectural Features; and Comments. Each of these sections has its own sub-titles consisting of selected sketches or graphics in a form of multiple choices. To assist the recorder in selecting the appropriate choices, all graphics are named and labelled. A coding system is applied by numbering each choice for quick and easy references.

The six main sections, sub-titles and selected multiple choices are explained as follows (please refer to Appendix 6 for a complete building data matrix and graphical information):

SECTION 1 : FILE REFERENCES

1.1 Name of Building.

1.2 Address of Building.

1.3 File Reference Number.

1.4 Name of Recorder.

1.5 Date of Recording.

SECTION 2 : BUILDING

2.1 Stylistic Influence.

(Moorish Influence, Tudor, Neo-Classical, Neo-Gothic and Other)



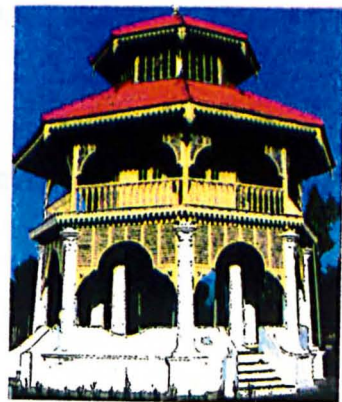
Monument of St. George's Church, Georgetown (1817)



Gatepost of Sultan Abu Bakar Mosque, Johor Bahru (1892)



Horse Fountain, Kuala Lumpur (1897)



Pavilion Polo Iskandar, Kuala Kangsar (1920)

Fig.43 Miscellaneous Buildings / Monuments

2.2 Elevation.

(Symmetrical, Asymmetrical, Linked, Tower, Minaret and Other)

2.3 Height / Level.

(One, 1 1/2, Two, 2 1/2, Three, 3 1/2, Four and Other)

2.4 Plan.

(Square, Rectangular, L-shaped, T-shaped, Irregular and Other)

2.5 Dimensions.

(Building Length and Facade Width)

SECTION 3 : STRUCTURES**3.1 Foundations Type.**

(On Stilts, Slab On Grade, Basement Half, Basement Full and Other)

3.2 Foundations Material.

(Concrete, Stone, Brick, Wood Planks, Wood Stilts, Columns and Other)

3.3 Wall Material.

(Concrete, Stone, Brick, Plaster On Brick, Wood, Metal and Other)

3.4 Brickwork.

(Running Bond, Stack Bond, English Bond, Flemish Bond, Flemish Spiral, Flemish Cross, Rat-Trap, English Cross and Other)

3.5 Stonework.

(Rubblework, Rag-Work, Ashlar, Polygonal, Random, Random Coursed, Broken Coursed, Irregular Coursed and Other)

3.6 Wood Wall.

(Clapper Board, Board on Board, Board and Batten, Tongue and Groove; and Other)

3.7 Wall Ornamentation.

(Timber Framing, Festoon and Other)

3.8 Window Type.

(Leaded, Mull, Sash, Sliding, Casement, French, Pivoting, Folding, Louvred, Awning, Rounded and Other)

3.9 Protuding Window.

(Box, Bay, Bay Curved and Other)

3.10 Window Trim.

(Plain, Moulded, Decorated Pediment, Shaped Transom, Fanlight, Arch-headed, Keystoned Lintel and Other)

3.11 Door Type.

(Panel, Glass, Ledge and Brace, Louvred, French, Swing, Double Swing, Sliding, Double Sliding and Other)

3.12 Door Trim.

(Plain, Moulded, Decorated Pediment, Shaped Transom, Fanlight, Arch-headed, Keystoned Lintel and Other)

3.13 Roof Type.

(Flat, Gable, Hipped Gable, Pyramidal, Hipped, Vaulted, Domed and Other)

3.14 Roofing Material.

(Thatch or *Atap*, Plain Tile, Pantile, Spanish Tile, Corrugated, Interlocked, Bitumen Felt and Other)

3.15 Roof Supports.

(Base Cruck, Raised Cruck, Tie Beam, King Post, Queen Post, Crown Post, Hammerbeam, Arch Brace, Pitched, Scissors, Clerestory and Other)

3.16 Roof Trim.

(Plain Fascia, Decorated Fascia, Plain Soffit, Plain Frieze, Decorated Frieze, Modillions, Bargeboard and Other)

3.17 Parapet.

(Plain, Crenellated, Gable, Shaped Gable, Balustrade and Other)

3.18 Dome Type.

(Cupola, Sail Dome, Drum-dome, Pendentive, Domical, Umbrella and Other)

3.19 Turret Type.

(Rotunda, Domed, Imperial, Conical Broach, Spired, Chatri and Other)

3.20 Arch Type.

(Semi Circular, Segmental, Three Centred, Parabolic, Round Trefoil, Venetian, Stilted, Pointed Saracenic, Equilateral, Pointed Segmental, Pointed Trefoil, Cinquefoil, Ogee and Other)

3.21 Column Type.

(Doric, Ionic, Corinthian, Tuscan, Composite, Engaged Column, Pilaster and Other)

3.22 Column Parts.

(Frieze, Plinth, Pedestal, Entablature, Dentils and Other)

3.23 Columniation.

(Distyle, Tristyle, Tetrastyle, Penanstyle, Hexastyle, Other)

SECTION 4 : INTERIOR**4.1 Floor Material.**

(Plain Tile, Decorated Tile, Timber Floorboard, Concrete, Stone, Marble and Other)

4.2 Wall Material.

(Wood, Concrete, Stone, Brick, Plaster on Brick, Metal and Other)

4.3 Staircase Type.

(Circular, Quarter Turn, Quarter Winding, Spiral, Straight Flight, Dogleg, Geometrical, Double Return and Other)

4.4 Staircase Style.

(Tudor/Jacobean, Federal/Empire, Gothic/Victorian and Other)

4.5 Ceiling Type.

(Flat Plastered, Plastered Moulded Cornice, Exposed Beams, Decorated Plastered, Central Rose, Suspended and Other)

4.6 Other Features.

(Fireplace, Decorated Wall Panels, Skirting, Decorated Internal Door and Other)

SECTION 5 : ORNAMENT / ARCHITECTURAL FEATURES**5.1 Moulding Type.**

(Cone, Round, Cyma Reversa, Fascia, Cock Bead, Ogee, Nebuly and Other)

5.2 Tracery Type.

(Geometrical, Intersecting, Panel, Reticulated and Curvilinear)

5.3 Exterior Parts.

(Chimney, Roof Cresting, Roof Finial, Fencing, Window Shading Device, Wall Cloak and Other)

5.4 Open Outdoor Areas.

(Verandah, Five-Foot Colonnade, Arcade, Balcony, Courtyard, Porch and Other)

5.5 Ventilation.

(Louvred Panel, Air Well, Grille, Decorated Screen and Other)

SECTION 6 : COMMENTS

8.3 PROCEDURE FOR RECORDING BUILDING DATA MATRIX

The first thing that a recorder should do before carrying on with the building data matrix is to check whether the building, which is going to be recorded in the matrix, has a record card. This is to ensure that by going through the card he will get a better understanding and view about the building. However, if the building does not have a record card, then he should consider of carrying out both jobs together. If necessary, assistants may be needed during the operations.

When carrying out the recording for the building data matrix, the first step is to fill up the file references of Section 1. This includes the name and address of the building, its file reference number, name of recorder and date of the recording as well. The main purpose of this section is to have a cross-reference with the record card while keeping an information on the person responsible for the job.

The next step is to record the building's characteristics by identifying any appropriate sketches or graphics given in the multiple-choice questionnaire charts. Any relevant particulars should be indicated by circling or ticking the number written in each box. One may also indicate more than one graphic if he finds it appropriate; or explain any different shapes in the given empty boxes written 'Other' if necessary. Any comments about the building including building defects or problems can be highlighted in a Comment space provided at the end of the matrix. It is important to refer to architects or building conservationists if any doubts or confusions occur during the operation of the procedure.

8.4 THE USE OF COMPUTER DATABASE

At present, the use of computer technology has become very convenient and popular in almost every field. For example, in the architectural field, computer aided design (CAD) has long been introduced for producing more accurate drawings while saving time and working spaces. In the field of building conservation, computer database can be applied to produce a heritage information

system through the applications of digital imaging technology and electronic publishing. All information about a historic building are stored on the computer database which enables pictorial records such as photographs of building, interiors, stained glass and architectural details, along with historic sketches and paintings, to be displayed on screen with great clarity.

There are several advantages of using the computer database in storing the building information. Firstly, it saves a lot of filing space, particularly for archival purposes. This is because all building information can be stored in computer diskettes which only require a minimum area of space. Secondly, it allows users or researchers to decide upon which records are most valuable to their research and this can avoid excessive handling of fragile materials. Thirdly, the users can always have access to one place where they can scan the archive on screen rather than having to visit a number of various offices and government departments. This can save a lot of time.

In the United Kingdom, the use of computer database has been introduced by the Royal Commission on the Historical Monuments of England with a collaboration from Attica Cybernetics, an Oxford-based consultancy whose staff worked with the Commission to produce a state-of-the-art heritage information system.³ A prototype imaging system, which was developed to revolutionize access to heritage information, allows users to point to a map on the computer screen and retrieve textual information and images of buildings and archaeological monuments in a particular location. The system also incorporates all entries on each building from the Commission's existing computerised indexes. The data allows for retrieval under a various headings including street address, map co-ordinates, building type, period, architects and level of statutory protection. No computer knowledge is required to use this inexpensive system. It only needs a 386 PC for operation; and all data, descriptions and images can be stored either on the computer's own hard disk or on a CD-ROM drive.

³ RCHME, "Heritage Information at the Touch of a Button", *Newsletter*, No. 6, Spring 1992.

The use of computer database system seems to be a good idea for storing not only the British colonial buildings but other historic buildings in Malaysia. The government, conservation organizations, local authorities and those who concern to preserve and conserve the national heritage should start thinking of computerising all building data. The storage of data would be greatly helped and produced if a centralised system was designed. Duplication would be necessary to obviate loss but it would ensure protection against the perils implicit in a paper system of fine, fading, incorrect entries and error.

CHAPTER 9

BUILDING MATERIALS AND COMMON DIAGNOSES

9.1 BUILDING MATERIALS

The relationship in design and construction between contemporary buildings in the United Kingdom and its colonies has been noted. Building materials such as timber, stone, brick and plaster are widely seen in historic buildings in the United Kingdom as well as being used in the British colonial buildings in Malaysia. These materials are extremely durable if they are properly maintained. Sources are still available. Even though a number of the British colonial buildings in Malaysia, particularly government buildings, churches, schools, high courts and railway stations may appear superficially in a good physical condition, some elements and materials are in need of immediate structural repair or treatment. One may spot symptoms such as cracks, peeling paint, broken plaster, rotten timber, harmful vegetation or mould and fungal stains on the building facades (Fig.44). The latter indicate penetration by water or presence of dampness as a result of the prevailing humidity.

In the care and conservation of historic buildings, understanding of building materials and accurate diagnosis of defects is most important. This is because historic buildings are, like older people, vulnerable to all sorts of diseases. Therefore, in order to tackle the diseases, conservation architects, contractors, specialised engineers and those involved in building conservation should first become familiar with the building materials in common use before going into deeper into techniques of preservation. This chapter explores the use



Fig.44 Examples of common building decays in British colonial buildings

of common building materials such as timber, stone, brick and plaster; and analyses causes of decay in each of the materials.

9.2 TIMBER

Timber has long been used by man especially in building construction. It is the most useful material available for wall, floor, roof and other structural framing. However, all commercial timbers can be classified into softwoods and hardwoods, depending on the characteristics of their grains, weight and moisture content.

The softwoods normally have soft tiny cells that are packed closely together parallel to the length of the tree or log. The softness nature of the softwood tissues affects the rigidity and strength of the timber itself. The softwoods have 15 per cent of the moisture content and about 350 to 700 kg/m³ of weight. It is important to use well dried timber which only contains 12 per cent. In building construction, softwoods are used for cladding, window and door frames; and flooring joists. Examples of the commercial softwoods are Cedar, Pine, Fir, Cypress, Larch and Damar Minyak which is used in Malaysia.

The hardwoods, on the other hand, have larger cells compared to the softwoods. The cells form a continuous ring, as the timber grows older, to mark the boundary of the growth ring. In Malaysia, hardwood timbers are classified into heavy, medium and light depending on their natural durability and general characteristics. The timbers are invariably resilient and well adapted to resist suddenly applied loads. Generally, the hardwoods have 12 per cent of the moisture content and about 200 to 1200 kg/m³ of weight. In building construction, hardwoods are used for flooring, walls, roofing; and window and door frames. Such hardwoods include Ash, Elm, Oak, Chestnut, Kapur, Meranti; and Chengal which is the most popular and well-known timber in Malaysia.

9.2.1 Seasoning of Timber

Before timber is being used for building construction, it is important for the material to be seasoned. In many situations, it is safer not to rely upon natural durability of the timber. This is because the moisture content of the wood, if it exceeds above 20 per cent, may cause decay such as fungal rots and beetle infestation.¹ It is realized that dryness is a significant factor in the superiority of seasoned timber.

Seasoning of timber is a process of maintaining a balance between the evaporation of water from the surface of timber and the movement of water from the interior of the wood to the surface. The primary aim in seasoning is to render timber as stable as possible, for the timber increases its strength properties as it dries. There are two common methods of timber seasoning: air and kiln seasoning.

Air seasoning is a method which makes the best use of winds and sun, while protecting the timber from rain. By circulating the air, the wind prevents the timber from absorbing moisture indeed it reduces moisture content by evaporation. In addition, by raising the temperature of the air and allowing a greater percentage of mixture to be absorbed, the sun initially helps in the drying process. Timber is usually seasoned under cover with walls being louvred to allow air circulation or is piled on a good concrete floor in a permanent building. In warm and tropical countries such as Malaysia, it is necessary to keep the timbers in stacks by separating them into layers (Fig.45).

Kiln seasoning is a process of drying the timber in a closed chamber or kiln, allowing maximum control of air circulation, humidity and temperature. The kiln, which consists of an air-tight vessel, is fitted with heating devices and steam sprays. Timbers are stacked inside the kiln under controlled temperatures and air circulation. Although the method is expensive compared to air seasoning, the

¹Jack Bowyer, *Vernacular Building Conservation*, London: Architectural Press Ltd., 1980, p. 52.

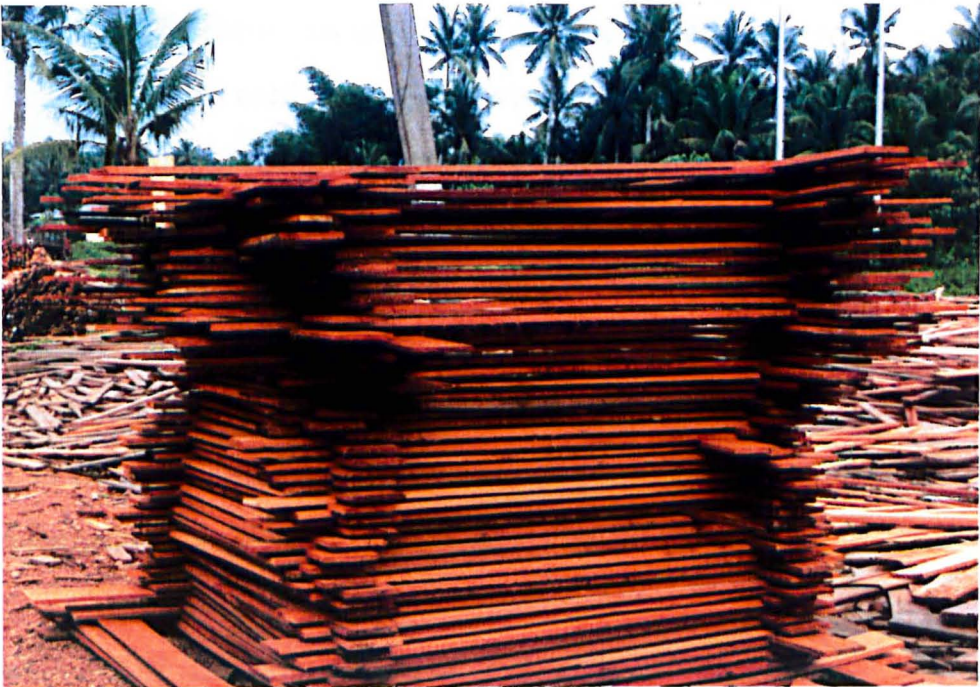


Fig.45 Timbers are stacked into layers in air seasoning methods

results are superior in many respects. In general kiln drying is controllable and swift. Natural seasoning takes much longer.

9.2.2 Preservation of Timber

Besides the seasoning method, timbers can be preserved by chemical processes either before manufacture or after. The chemical process is basically done by applying solutions using brush or spray on timber surfaces. There are several types of timber preservation and among them are:

- i. Creosote
- ii. Water-borne solutions of copper, chromium and arsenic chemicals
- iii. Organic solvent solutions, mixtures of fungicides and insecticides
- iv. The chemicals used in the organic solvents can be also used in a water-based emulsion form
- v. Appropriate chemicals for flame-proof protection and water-repellancy to timber.

These applications are not only cheap and easy to obtain and use, but are safe, free from smell or staining and effective against all pests. Care must be taken to avoid environmental pollution and to use preventive materials in a controlled and appropriate way.

9.3 COMMON DIAGNOSES OF TIMBER DEFECTS

Timber has been used comprehensively in the building industry. Timber can deteriorate easily if it is exposed to water penetration, high moisture content and loading beyond its capacity. In Malaysia, there are two common dangers to timber: fungal and insect attacks, in addition to the range of disorders found in temperate areas.

Fungal Attack

Fungi are plants that cannot produce their own food. Instead, they feed on other plants and animals; and are found growing as either parasites or saprophytes.² They produce a number of tiny spores; and can live if there is oxygen, a reasonable temperature and a moisture level of at least 20 per cent or over. Their reproduction spores float in the air and can easily land anywhere. The two most common are classified as dry rot (*Merulius Lacrymans*) and wet rot (*Coniophora Cerebella*).

Dry rot attacks timber when a moisture content is not less than 20 per cent. It will grow actively in temperatures ranging between 0 to 26 Celsius. It forms mycelium, which is a white fluffy mass apparently similar to cotton wool, during the early stages when conditions are damp and humid. Later on, it becomes *merulius lacrymans* which is a brown cubical rot. This is a dangerous stage because the rot digests the cellulose content of the wood leaving deep cracks and splits. Therefore, load bearing capacity is greatly reduced. It can also penetrate thick mortar in order to reach for timber. Dry rot is more common in wet and warm areas than drier areas.

Wet rot normally attacks timber when there is at least 25 per cent of moisture content. Like dry rot, the wet rot causes concavity of the sides and ends of the affected timber with longitudinal cracking with damp masonry. As a result, the timber suffers loss of strength and weight which can lead to structural failure.

Insect Attack

Keeping timber from fungal attack is not enough, for there is always insect attack. All insects including beetles and termites share the same life cycle which is from an egg laid on the surface or in a crack, then it hatches to produce a larva that bores into timber. Later, the larva converts into an adult which bites a hole before mating and producing more eggs. Insect attack usually happens in a

²K.St.G. Cartwright and W.P.K. Findlay, *Decay of Timber and Its Preservation*, London: Her Majesty's Stationery Office, 1958, p. 9.

damp and therefore more digestible timber is found in elements such as wall-plates, the feet of rafters and bearing ends of beams and trusses; and in all timbers which are placed against or built into damp walling.³ It is dangerous to leave the timber with many insect holes because they may soften the timber and form further cracks. Eventually the timber loses its load bearing capacity and fails.

9.3.1 Treatments of Affected Timber

Dry rot can be treated by eliminating and preventing recurrence of dampness and ensuring that the rooms in the building are well ventilated. All timbers that are suffering from the symptoms should be cut away and changed to a new well-seasoned timber. Timbers that ends are cut should be brushed with chemical preservative in order to avoid further fungal attack.

Like dry rot, the wet rot can be treated by removing the decayed timber and replacing with preservative-treated timber. Rotted timber can also be treated by applying fungicidal preservative. This would prevent from further deterioration.

For the beetle and termite attacks, affected timber can be treated by pressure-spraying with insecticide or fumigant insecticidal processes. Powerful insecticides may be also applied in a timber preservative. All infected timbers should be taken out and burnt immediately. There are implications for use in Malaysia due to high humidity and high rainfall; prevention by ventilation is to be preferred to the use of chemical preservatives.

9.4 STONE

Like timber, stone has been used in building construction for thousands of years. Due to its natural durability and strength, stone is used for structural columns, exterior walls, staircases, window framing as well as roofing material.

³Donald W. Insall, *The Care of Old Buildings Today*, London: Architectural Press Ltd., 1975, p. 120.

However, stone comes in different types and properties ranging from the hard impervious such as granite, slate, marble to the softer and pervious sandstones and limestones.

Among sedimentary rocks, granite has been of much importance to builders. It can withstand the most severe weather conditions and is also impenetrable to water when it is kept dry. Granite has three essential components which are markedly crystalline : quartz, which is intensely hard; felspar, which is slightly less so; and mica, which is comparatively soft and chemically inactive. Such characteristics give a tremendous strength, mottled appearance and structural uniform to the granite. Granite is virtually insoluble under normal conditions as well as being practically impervious to moisture. All granites can be polished by the use of abrasives with water.

Slate is another type of stone in which for many years has been the most popular of roofing materials. It is classified as metamorphic. Slate is also suitable for steps, paving floors, window sills, lintels, external cladding material and decorative internal work. With a high content of natural silicates of alumina and iron, slates are tough, almost completely impenetrable but may be brittle. Some of the best slates are those known as the mica slates.

Like granite and slate, sandstone has been popular as a building material for decades. Predominantly composed of grains of quartzes or silica and a high percentage of feldspar or mica particles, sandstone has a combination of strength and durability. With a wide range of colours, from dull crimson and pink to cream and blue-grey; sandstones fall within three classifications: red sandstone, millstone grit and coal measure sandstone. Each of these classifications has different grain finest and crushing strength which enable it to very great weathering capability. Sandstone has been used for floor paving, steps and external walls.

Another type of stone used in building is limestone. Principally, it contains carbonates of lime and numberless fossils and shells, laid down in

prehistoric sea-beds. Limestone comes in different names and properties. Among the common ones are Portland, Bath, Ketton, Clipsham, Doultling and Beer. When it contains a high percentage of density material it has a low percentage of absorption. Limestone is generally excellent in severe weathering. However, its direct enemy is polluted atmosphere, particularly sulphurous smoke. This is because whenever sulphurous smoke comes into contact with especially if it passed through rain it turns into dilute sulphuric acid, a highly corrosive agent. This will affect the strength, percentage of absorption and natural colour of the limestone. Indeed it describes the outer layer giving the well known black and white affect seen on Portland Stone buildings. The black being the deepest of dirt in protected areas under sills, cornices and string courses. While the exposed surfaces are cleansed by dissolution.

Marble, on the other hand, has been attracted to both architects and sculptors ever since the days of Classical Greece. Due to its fine-grained and compact structure, and relatively soft when freshly quarried; marble is relatively easy to carve and polish. Such qualities in the marble make it the best material for statues, memorials and architectural details.

9.4.1 Types of Masonry Used in Building

Depending on a surface pattern, joint mortar and level of courses, stones used in a building, particularly for masonry walls can be identified into rubblestone, ashlar and rock facing.

Rubblestone is the commonest type of masonry for old stone building. Bedded in wide mortar joints, the rubblestone has rough surfaces and is coursed either in random or squared rubble. To give a horizontal bed, often a small stone is fitted or levelled in between the rubbles. This occurs in internal skin of the masonry wall and around window or door openings.

Ashlar masonry is quite different compared to rubblestone. Normally, ashlar has been carefully cut, dressed and squared before being employed as a

facing stone or external of the masonry wall. It is laid in finely jointed level course. There are two types of ashlar: polished and rusticated V-jointed. Ashlared blocks are smooth on the face and at the sides. However, at the back, which is bonded into brick or concrete wall, the surface is left rough.

Rock facing is visually rough compared to ashlar. The stone is hard and needed a special pitching hammer or a hydraulic splitting machine. Rock-faced stone is sometimes used for exterior wall. Together with ashlar, rock facing can look most impressive.

9.4.2 Causes of Stone Decay

Although stones will last for many hundred years, its tendency of decay in any kind of weather is possible. Granite, slate, sandstone and limestone do weather. Such weathering occurs in three situations:

- i. the attacks from soluble salt especially when it comes up from the ground where there is no damp course, in locations near the sea or from a heavily polluted atmosphere
- ii. trouble arising from the slow build-up of soot deposits and dust, leading to possible onset of decay due to small vegetation organisms
- iii. the straight forward erosion by wind and rain. Stone will become saturated when it is exposed excessively to driving rain. As a result, its surfaces become marked and rough.
- iv. saturation and drying out will cause salts to migrate towards the surface, crystallising just behind the outer skin and causing lamination.

Besides weathering, stone may also decay through faulty materials and workmanship. Stonework may suffer from defects either in the stone itself or the method of its use. For example, the alternation of hard and thin soft layers in the quarries merely produces a slight surface roughening. Any deeper beds of soft stone will bring serious faults and failures. However, the commonest error found in masonry work is of failure in juxtapositioning sandstone with limestone. This will lead to water action and salt migration which may attack the limestone. The life of stonework may also be affected when there are varying temperature movements of its mineral constituents, and differences in thermal and moisture movements between exposed and protected stone.

9.5 REPAIR AND MAINTENANCE OF STONE

In building conservation, the repair and maintenance of stone is amongst the most important activities. This is because the life of a stone structure may be greatly extended if the repairs are properly and competently carried out. However, before any repair is done, architects and whoever responsible for the repair should recognize and diagnose problems, know where to obtain the right replacement materials and find the appropriate skills to carry out the work.

There are two stages in repairing decayed stonework providing that there is no structural or constructive reason which would lead to repetition. Clearly any fault should be remedied. The first stage is the removal of harmful elements such as soot and deleterious salts by careful cleaning. Secondly, the replacement of decayed stonework through the process of new stone matching, positioning and grouting. Nevertheless, stone cleaning can be done by:

9.5.1 Low Pressure Washing

Water spray, at low pressure, is used to soften deposits of surface dirt. Then, bristle brushes are applied to remove the dirt. The method is quiet and is not danger to public. However, water may penetrate through open joints in the

masonry wall which may cause decay in other materials such as timber and iron fixing. In addition, the water may soak into the ground which later upsets the foundation stability. The existence of thin mud strata in harder stones has serious implications for cleaning. Water expands the mud stone and causes lamination. The best known failure in this connection is that of the 'Leaves of Southwell' which have deteriorated after cleaning with water.

9.5.2 Abrasive Blasting (Dry or Wet)

Dry blasting is a fast cleaning method using compressed air jet. The method leaves no water staining on stone and no water penetration. However, there is a risk of damage to the stone surfaces. The speeding air with abrasive powder, coming out from the jet can destroy gradually the stone grains or textures. To the public health, the dust that come off from siliceous material such as sandstone can cause lung damage. In addition, the method creates noise disturbance. It can damage fine curving or mouldings.

Wet blasting, on the other hand, uses a mixture of water and abrasive material under pressure. Like the dry blasting the method damages the stone surfaces and also creates health risk to the public. It also allows water penetration in the stonework.

9.5.3 Mechanical Cleaning

The method requires various tools with interchangeable heads such as cone-shaped carborundum heads of different sizes, grinding discs and soft wire brushes. All are attached to power tools. No water is applied in the method. Therefore, no water staining and water penetration. However, the method causes scars, depressions and abrasions on the stone surfaces.

9.5.4 Chemical Cleaning

In chemical cleaning, products containing caustic soda should not be used because they contain soluble salts which likely can cause serious damage to sandstone. Instead, a chemical cleaner such as hydrofluoric acid is recommended, for it leaves no soluble salts in masonry. Although the method creates no dust or noise and no risk of mechanical damage, it requires skilled operatives and also can cause severe skin burns.⁴ Buildings need to be washed down with clean water.

Besides proper methods of cleaning, stonework needs sensible maintenance. Routine maintenance can sometimes reduce the necessity for repair and replacement. Some examples of the routine maintenance are keeping gutters, downpipes, roof coverings in good working order to avoid any overflow of water which later may lead to water penetration; excessive vegetation removed or controlled, joint properly pointed and painting of ferrous metal. In all these methods the importance of joint between stones cannot be over emphasized. Painting should take place after cleaning, as cleaning often reveals weaknesses in jointing materials.

9.6 BRICK

Another type of material used in building masonry is brick or burnt clay block. Brickwork has been used in many old buildings built during the British colonization of Malaysia. Some of the colonial buildings have exposed brick walls and others are plastered and painted. It is important to realize that old bricks in some aspects are slightly different than modern bricks. The texture of the modern brick looks closer and smoother, and the edges are straighter and sharper compared to the old material. In addition, the colour and size of the modern brick are much reddish and thicker in a standard size than of the old

⁴Andy Davey and Bob Heath; *The Care and Conservation of Georgian Houses*, London: Architectural Press Ltd., 1986, p. 69.

brick. These characters yield a greater challenge in the process of matching and harmonizing the new with the old brickwork being repaired.

In masonry, bricks are bonded and stacked together by mortar joint which is a mixture of sand, water, cement; and lime prepared from chalk or limestone burnt in a kiln and then hydrated or slaked with water. The use of lime in a mortar gives the mixture a soft texture which admits the buildings to breathe freely.⁵

9.6.1 Causes of Brick Decay

Like stone, brick may decay through weathering processes including sulphurous smoke caused by polluted atmosphere, water penetration through small holes and openings of the brick as well as mortar joints; and dampness in wall caused by no damp course in locations near the sea or river. In addition, brick may deteriorate due to harmful vegetation such as creeping and ivy plants; and also mould or fungal growth that accumulate on the brick surfaces. The latter has become a common sight on many old historic buildings in Malaysia, mainly because the mould or fungal growth can easily flourish in environmental conditions of high humidity and lack of ventilation.

Brick can also decay due to cracks caused by structural movements. Such structural movements may come from building foundations when subsoil is compressed through the decades or centuries followed by wall deflections due to the foundation weakness or an uneven loading distribution from above wall structures. It is important to analyse the cause of cracks.

9.6.2 Treatments of Brick Decay

Treatments of brick decay are similar to those of stone. However, removal of harmful elements including soot, dust or fungal stains can be done through careful cleaning methods either washing, mechanical or chemical.

⁵Michael Wingate, *An Introduction to Building Limes: Information Sheet 9*, London: Society for the Protection of Ancient Buildings, 1987, p. 1.

During the cleaning, it is necessary to avoid any damage to the brick surfaces as well as mortar joints. Harmful vegetation should be removed from the brick surface as quickly as possible, for roots can go deep into the existing holes causing further cracks and water penetration. Removal of harmful vegetation such as creeping and ivy plants can be done by cutting the thick roots at ground level and applying an ammonium sulphamate paste on the root, which gradually wither and kill the plants.⁶

9.7 PLASTER AND STUCCO

Plaster is an English phenomenon whereas stucco is something similar but belonging to continental Europe. The differences between plaster and stucco are their basic chemical composition and techniques of strengthening. Plaster contains lime, sand and water; and sometimes chopped animal hairs to give tensile strength. However, stucco contains marble dust. Both plaster and stucco are used widely in decorative panels, ceiling renderings, cornices; and internal walls. Sometimes, stucco is used for external walls. The finest of the finishes depends on the choice of sand used in either the plaster or stucco. For example, for the internal renderings, soft sand is appropriate. Whereas coarse sharp sand is applied for the external renderings.

Like many other building materials, plaster and stucco tend to deteriorate over a period of time. Causes of deterioration include direct expose to driving rain, condensation, evaporation, air pollution, aerosols, capillarity, thermal stresses, vegetal causes, insect attacks, animals and human activities. However, plaster and stucco may become cracked due to either shrinkage or movement in the substrate. Shrinkage usually occurs early in the life of the building but substrata movement is often the reason for failure in historic situations.

⁶Andy Davey and Bob Heath; p. 73.

Plaster or stucco repairing is a laborious job. It needs patience and conscientious attention. Before doing any repair work, every trace of dust on the renderings should be removed. After that, all cracks should be filled before redecoration takes place. For plaster ceiling repair, it is highly advised to bond the existing plaster with plaster of Paris. In order to bond together the whole of the ceiling structure into a complete unity, a combination of resin mixed with a highly reactive organic chemical may be used. If the ceiling is too bad to repair, then it is generally renewed with either plaster lath or plaster board with one or two coats of patent gypsum plaster. This may prevent the ceiling structure from shrinkage cracks. For the reattachment of loose plaster, injection of consolidant by pre-wetting and drilling either through ceiling lath or plaster itself is appropriate.

To maintain the plaster and stucco from decay, several things should be considered including:

- i. lime-based paints which are the best for the maintenance of lime plaster
- ii. moulds and lichens should be destroyed with fungicides then surfaces must be washed with clean water
- iii. plaster should be removed from a half-timbered building when it is harming the structure by allowing moisture penetration.

It should be recognised that timber, stone, brick and plaster used in most of the British colonial buildings in Malaysia are locally produced. Sandstones, limestones, granites and marble, for example are locally quarried and have been used in many British colonial buildings in the country. Therefore, repair and maintenance of stone discussed earlier is applicable to such buildings.

Unlike stone or brick, timber used in building construction, flooring, joinery, staircases and doors in the British colonial buildings in Malaysia comes from different local tree species, varying in durability or resistance to decay.

Even though fungal and insect attacks are two common dangers to timber, there are certain types of timber used in the buildings that are termite resistance. For example, the very resistant wood of Belian, Chengal and Balau, the moderately resistant of Keranji, Resak and Meranti; and the susceptible of Kapur, Meranti and White Seraya. Identifying of these types of timber is important before any treatment and maintenance including cleaning and polishing are carried out.

A good example is the PAM Centre built in 1907 in Kuala Lumpur which has undergone renovation and preservation (see section 12.5). During a structural survey carried out before renovation and preservation, it was found that the main roof was in a dangerous state of collapse developing from extensive termite attack and rot. However, its Chengal staircases and floors were found structurally in good condition. This has shown that the very resistant Chengal products have survived either fungal or insect attack. It is important that a greater treatment and care of termite-resistant timber should be continuously considered in the maintenance and repair of the British colonial buildings in Malaysia. This also includes an analysis and inspection of cracks and decayed floorboards.

CHAPTER 10

METHODS AND TECHNIQUES OF BUILDING MAINTENANCE

10.1 IMPORTANCE AND NATURE OF RECORDING BUILDING MAINTENANCE

In the practice of building conservation, historic buildings are not only recorded for historical and structural purposes but for the programming and future work of building maintenance. Important factors are materials used in the fabric, methods of construction, function and environmental conditions. All elements of historic buildings tend to deteriorate but at a greater or lesser rate depending upon function and location. Buildings will rapidly decay and degrade when building maintenance has been neglected. This can perhaps lead to other harmful effects and threaten safety of both occupants and building finishes. Therefore, it is very important for property owners to provide and programme appropriate maintenance work for their historic buildings.

Building maintenance is actually a process by which a building is kept useable at a pre-determined standard for the use and benefit of its occupants or users.¹ The standard may vary according to the function of the building. Its prime aim is to preserve a building in its initial state, as far as practicable while retaining, where appropriate, its investment values, and presenting a good appearance; so that it effectively serves its purpose. It is impossible to produce buildings which are maintenance-free, but maintenance work can be minimized by good design and proper workmanship carried by skilled experts or competent craftsmen using suitable codes of installation, requisite building materials and

¹Bernard M. Feilden, *Conservation of Historic Buildings*, London: Butterworth Scientific, 1982, p. 430

methods. Building maintenance has become a major part of the work in the building industry. In the United Kingdom, for instance, building maintenance is quite important due to the fact that it absorbs one-third of the country's building industry output.² This not only requires improved methods of maintenance, being reviewed and upgraded from time to time but demands effective maintenance management embracing many skills and objectives. In developing countries, the need for building maintenance for both old and new buildings is often overlooked. Therefore, a fundamental aspect of the thesis is to show that conservation of historically valuable building cannot be left to the market forces of the normal building industry. The importance of maintenance is such that it requires a properly educated and trained workforce involving good management as well as suitably trained craftsmen.

As stated in British Standard 3811, there are two types of maintenance work: planned and unplanned. The former includes planned preventive maintenance which is work directed to the prevention of failure of a facility, carried out within the expected life of the facility to ensure its continued operation. For example, traffic vibration and air pollution may be reduced through the application of suitable town planning techniques where possible. Unplanned maintenance includes any emergency work resulting from unforeseen breakdowns or damage due to external causes.

Generally, building maintenance comprises of three working stages: servicing, rectification and replacement.³ Servicing is essentially a regular cleaning operation undertaken at intervals of varying frequency as well as planned replacement of short-term demands such as changing lamps and filters. Rectification is work done due to inherent faults in building design such as unsuitable use of materials and incorrect assembly of building elements which can result in the failure of physical breakdown of the building fabrics or elements. Replacement is any work done because of service conditions which

²Bernard M. Feilden, p. 218.

³Ivor H. Seeley, *Building Maintenance*, London: MacMillan Press, Ltd., 1976, p. 8.

cause building materials to decay at different rates. All of these working stages can be well organized through a programme of cyclical maintenance which will later discuss in this chapter.

This chapter discusses the methods and techniques of building maintenance used in the United Kingdom, and investigates possibilities of transferring them to the context of British colonial buildings in Malaysia.

10.2 CLIMATIC CONDITIONS AND BUILDING PROBLEMS

Before discussing the appropriate methods and techniques of building maintenance, it is important to consider the climatic conditions of Malaysia and the effect on maintenance work. This is because buildings in the country tend to weather rapidly, particularly in respect of external building materials which are exposed to external causes such as rain, wind, solar radiation including ultra-violet light; and atmospheric pollution. For a tropical country such as Malaysia where heavy rainfall and warm sunshine occur all year round, proper building maintenance has become a major factor in the conservation of the historic buildings. Buildings which are located near the sea or even rivers require in particular full maintenance work and treatment; for the water coming from the ground causes dampness and structural instability. For example, damp-proof courses had to be installed in the Sultan Abdul Samad Building in Kuala Lumpur, during its conservation work, in order to prevent rising water coming from the nearby Gombak River.⁴ Furthermore, soluble salt which comes from the sea and together with the presence of a polluted atmosphere can cause damage to the exterior surfaces of the buildings. This can be noticed in many old buildings in Penang, particularly those which are located near or facing the sea. These factors are quite essential especially in determining the amount of maintenance work to be done.

⁴ Author's personal interview with architect Zahani Tan Sri Ahmad of BEP who is responsible for the conservation work of the building. July 10, 1991, Kuala Lumpur.

From building inspections carried out on more than 70 British colonial buildings built between 1800 and 1930 throughout Malaysia, it was found that most of the buildings shared the following common problems: fungal stain, harmful growth, insect or termite attack, erosion of mortar joint and peeling paint. Except the last two, repairs and treatments of these problems have been discussed in chapter 9. However, in other cases, symptoms lead to apparent common causes including unstable foundations, ageing and failure of roof tiles, leaning walls, defective rainwater goods, dampness penetration, broken plastered rendering, and decayed timber especially floorboards.

10.3 AIR-CONDITIONING SYSTEMS

Another problem found in the British colonial buildings arises from the installation of air-conditioning systems. It is obvious that during the early part of British colonisation, all buildings built were without air-conditioning systems. In order to cool off the occupants inside the buildings, ceiling fans and louvered windows or high openings were adapted for cross-ventilation and air movement.

Where buildings in Malaysia have to contend with high humidity and warm temperatures, the need to install air-conditioning systems to meet modern building requirements seems necessary. Air-conditioning systems are now in common use throughout the country. Some advantages include a healthier atmosphere, alert users or staff, reduced cleaning and less external noise. Less wind disturbance, dust and pollution from external sources. Artificial ventilation has been introduced to many of old buildings including those of the British colonial period. This includes buildings such as churches, courts, offices and schools. Window units and openings are closed and sealed to maintain cool air inside the buildings. There is no doubt that it is one of the ways to provide comfortable conditions for occupants and users.

As far as the effects on fabric is concerned, there are four main aspects which need to be considered when air-conditioning systems are decided to be

installed in any old buildings. Firstly, the cooler and drier air produced by air-conditioning systems may possibly cause shrinkage of building fabric. Secondly, there will be a possibility of condensation either on the surfaces or within the structure of the fabric. This allows the build-up of mould, algae or fungal stains. Thirdly, there may be problems of installation which include difficulties in installing either air-conditioning units or central systems. Finally, from the aesthetic point of view the installations of the air-conditioning systems in some old buildings were unfortunately carried out in a poor manner by simply placing units on windows, walls or at front facade. This affects the appearance of the buildings (Fig.46). Cooling towers for centralised systems can be unsightly and unsympathetic aesthetically.

10.3.1 NATURAL OR ARTIFICIAL VENTILATION

As far as the conservation of old buildings is concerned, any introduction of modern equipments including air-conditioning systems should have good and practical reasons to do so. Before the installation of air-conditioning systems is carried out, several aspects should be considered such as the amount of energy, running costs and maintenance needed, possibilities of causing structural disturbances to existing walls and ceilings, and the appearance of the buildings, particularly if the units are placed on front facades. Instead, depending on their functions, locations and vernacular designs; those responsible should first consider to use natural ventilation rather than artificial. In a warm and humid climate, vernacular designs such as louvered windows, air-wells and verandahs can play a major role in encouraging natural ventilation; giving buildings and occupants a cooling effect. Buildings located near the sea, for example, may have an advantage because a great amount of winds received is good for either stack-ventilation or cross-movement of air. It is important to consider the functions of old buildings and the period of time spent by the occupants. Certain buildings such as churches and schools may not necessarily

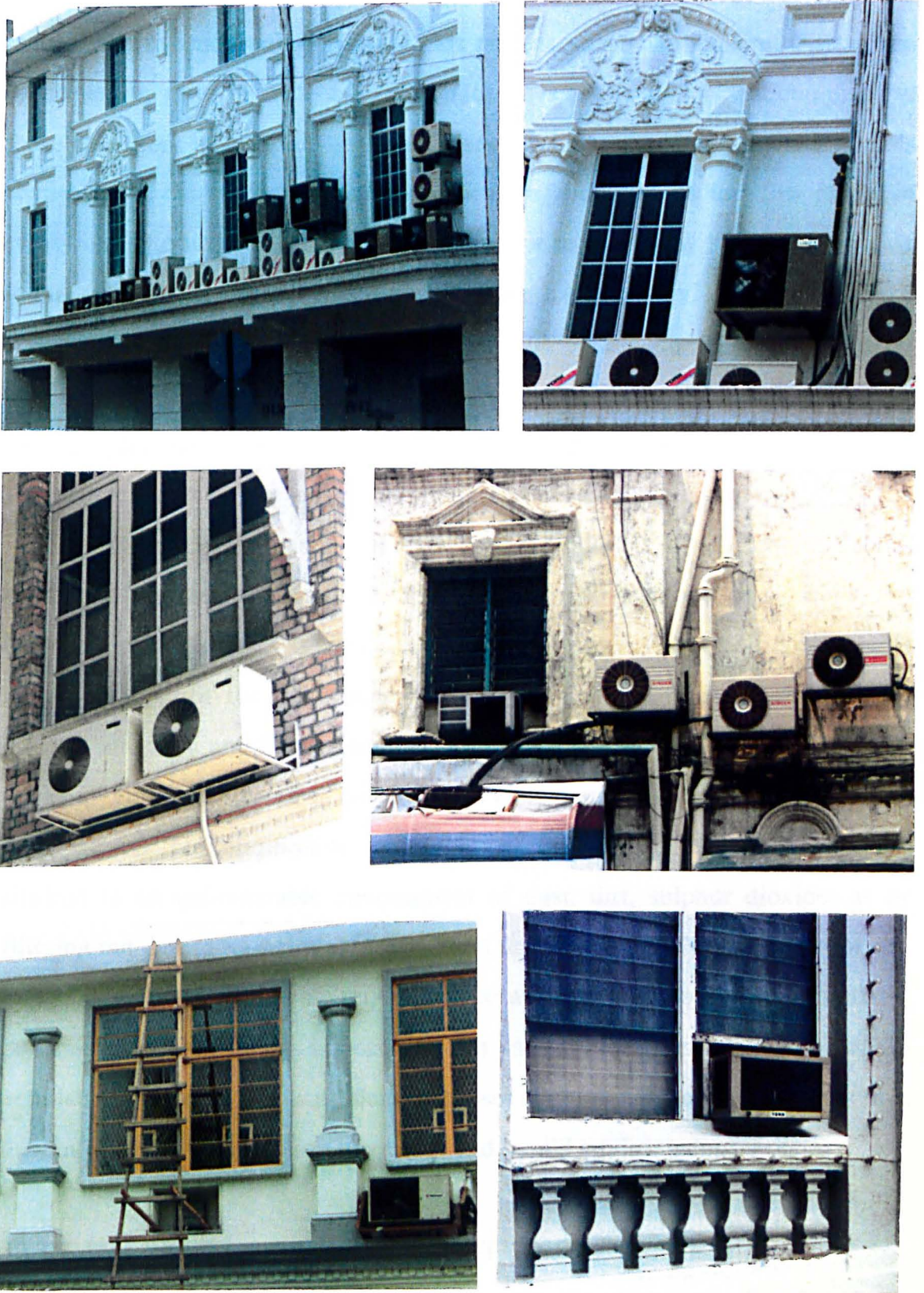


Fig.46 Examples of poor installation of air-conditioning units

require an air-conditioning system. This is because of two reasons. Firstly, the time spent by users or students in the buildings is not as long as that compared to those who work in an office or a bank. Secondly, many old churches and schools have adapted the vernacular designs which are good enough to allow plenty of cross-ventilation of air inside the buildings. For example, big louvered windows found in both St. John's Institution, Kuala Lumpur; and Cathedral of the Assumption, Penang can be opened, when appropriate, to allow plenty of air passing through the buildings (Fig.47). A number of louvered panels adapted in the Cathedral towers and verandah walkways at ground level of the Institution are sufficient enough for such stack-ventilation or cross-movement of air.

On the other hand, there are certain buildings which require an air-conditioning system even though they have louvered windows or air-wells. For example, museums and libraries either old or new need to have air-conditioning system to control the environment within the buildings. By controlling the internal humidity and temperatures, certain objects such as paintings, artifacts, books and other contents can be prevented from condensation, cracking or other damages. An air-conditioning system may also be beneficial for old buildings situated in an unfavourable environment of dust, dirt, sulphur dioxide; as by filtering out damaging pollutants, it reduces damages to furnishings and contents. Where users or occupants are required to be working long hours either in offices or banks, air-conditioning is necessary. In such a case, dependence on natural ventilation alone is not sufficient because the users or occupants may feel uncomfortable when working in a warm and humid environment.

10.3.2 PLACEMENT OF AIR-CONDITIONING SYSTEM

Like many other modern equipments, the design of air-conditioning system has gone through many changes and improvements which not only supply an adequate quantity of air and silent operation but permits longer periods between maintenance visits. For the British colonial buildings in Malaysia, two types of



St. John's Institution, Kuala Lumpur (1904)



Cathedral of the Assumption, Penang (1860)

Fig.47 Louvered windows, air-wells and verandahs can play a major role in encouraging natural ventilation

air-conditioning systems are widely used which are a domestic-scale packaged system and a split system. The former, commonly placed on window units or walls, has all components: compressor, condenser, evaporator and fan in one unit. It normally serves one room, without any ducts. The latter, however, has the compressor and condenser placed outside while the evaporator and its fan are inside the building (Fig.48).

When it is decided to install an air-conditioning system into an old building, several aspects of building conservation should be considered. The main objectives of this approach are that the introduction of air-conditioning units should not destroy or degrade building materials, affect the appearance of the building; and should be as unobtrusive as possible. Careful placement of the unit plays a major role in achieving these objectives. Where a split system is installed, for instance, it is important to place the compressor and condenser units on ground level at the back of a building or other suitable location. If the units are placed on the ground level and not to be visible, it is of a good idea to put screening devices such as short plants, shrubs or fences around the units. Any ducts should not run in full view but placed above a suspended ceiling. However, if the suspended ceiling reduces the room height and also causes other problems to the building structures and fabric, then it is advisable to leave the ducts visible. For the ducts on upper floor, they can be concealed conveniently in a roof space. A new chiller plant room, if necessary, may be constructed outside the building to protect the compressor and condenser units. For the domestic-scale packaged system, the placement can be in a corridor, balcony or verandah, in the conditioned space itself but not on window units or fixed onto walls. To match and blend with the existing colour of a building, the air-conditioning units and electrical wirings may be painted.



Fig.48 Placing air-conditioning units at outside is more preferable than on windows and walls

10.3.3 MAINTENANCE OF AIR-CONDITIONING SYSTEM

Since most air-conditioning systems consist of a fan, filter and cooling coil, a regularly check-up or maintenance is desirable. Most of the maintenance work depend on both the types of filter used in the system and the extent of pollution in the environment. As a rough guide, if the system uses filter cells, then they may have to be changed or cleaned once a month in heavily polluted locations, once every two months in city centres and once every three months in rural or suburban areas.⁵ However, for a cleanable filter the need to change or clean the part is about one to two years. Other maintenance works include a check-up of blocked filters resulting in reduced air flow and breakdown of fan bearing causing downflow of cold air with consequent occupancy discomfort, cleaning out ducts and overhaul of the air-conditioning plant at least once a year. A check list should be prepared and accompanied during maintenance visits. It is also important in old buildings to provide easy access for building maintenance and inspection.

10.4 SOME COMMON BUILDING PROBLEMS OF HISTORIC BUILDINGS AND THEIR SOLUTION

Maintenance of historic buildings involves not only the methods and techniques of building repairs but requires a great understanding of building structures, particularly their main functions and common problems. Building foundations, wall and roof, for example, are very important in maintaining the life of a building. Any problems observed in the structure require thorough inspection and maintenance which should be carried out by a competent and skilled person. Even though many of the British colonial buildings surveyed share apparent common problems such as fungal stain, harmful growth, erosion of mor-tar joint, peeling paint and so forth; the need to understand common problems of foundations, wall and roof are essential.

⁵Ivor H. Seeley, *Building Maintenance*, London: MacMillan Press, Ltd., 1976, p. 125.

All recommendations on the method of repair are based on the principles and objectives of repairs suggested by various sources including the English Heritage, Building Research Establishment (BRE), Society for the Protection of Ancient Buildings (SPAB); and other architectural references.

10.4.1 UNSTABLE FOUNDATIONS

Foundations are a part of a building which distributes loads from roofs, walls and floors on to the earth below. They are structurally important to the permanence of a building and if this is lacking there is no point of spending large sums of money on other superficial restoration work. Most of the common problems occurred in the foundations depend on the geology of the ground upon which a building stands and is surrounded by, structural failures; and presence and height of the water table. Besides, inherent failures may also happen in a building in which it has to cope and carry any unsettled problems of the foundations. The Leaning Tower of Pisa in Italy is a classic example of which inherent failures caused by corrections made during construction combined with traffic vibrations, deep construction and abstraction of water from deeper layers of soil have led to its present leaning position. To avoid any common problems and inherent failures of the foundations, it is advisable to conduct a scientific study of ground carrying the foundations. Any structural movements should be monitored as well as measuring alterations in the level of water table.

It is important to understand that all of the common problems of the foundations may lead to instability of the building structures, causing unsafety to users or occupants. Unstable foundations may occur because of several reasons including shrinking clay soil, resulting when the sub-soil is drying and water table is low, which is no longer holding the structure above; penetration of dampness and water that may decay walls and foundations; presence of large trees near the building; and the undertaking of extensive excavations or mining nearby. Other causes include landslides caused by heavy rain, heavy construction

near an old building and lowering of water tables, usually by hard landscaping and road areas.

However, building foundations may also be affected by several changes of building conditions. One of the major conditions is the increased loads, particularly the floor loading which may have come from the changing of building function or any alterations and extensions carried out within the building. Others include traffic vibrations and deterioration of building materials, especially when timber structures become rotten. All work of upgrading the foundations should be carried out by professionals and competent builders, for they involve soil testing, calculation of loads and other investigation.

The most traditional method of repair to unstable foundations is underpinning. It may be used to form deeper or wider foundations but it relies on adjacent excavations which need to be shored and extensive enough to allow access for concreting.⁶ In other words, short lengths of walling are cut out and propped up while the larger foundations are inserted. Underpinning comes in different forms including:

1. Continuous underpinning.
2. Closely spaced piers with foundation arching.
3. Continuous beam and piers.
4. Headed lintel and pier.
5. Bored mini-pile through footing.
6. Bored micropile with caps.
7. Bored pile with cantilever cap.
8. Bored pile with cased steel needles (Fig.49).

It is important to carefully arrange the phasing of underpinning, for such work involves shifting load from one part of the structure to another. In addition, the success of underpinning depends on the strength of the masonry

⁶Construction Industry Research and Information Association (CIRIA), *Structural Renovation of Traditional Buildings*, London: CIRIA, 1986, Report III, p. 70.

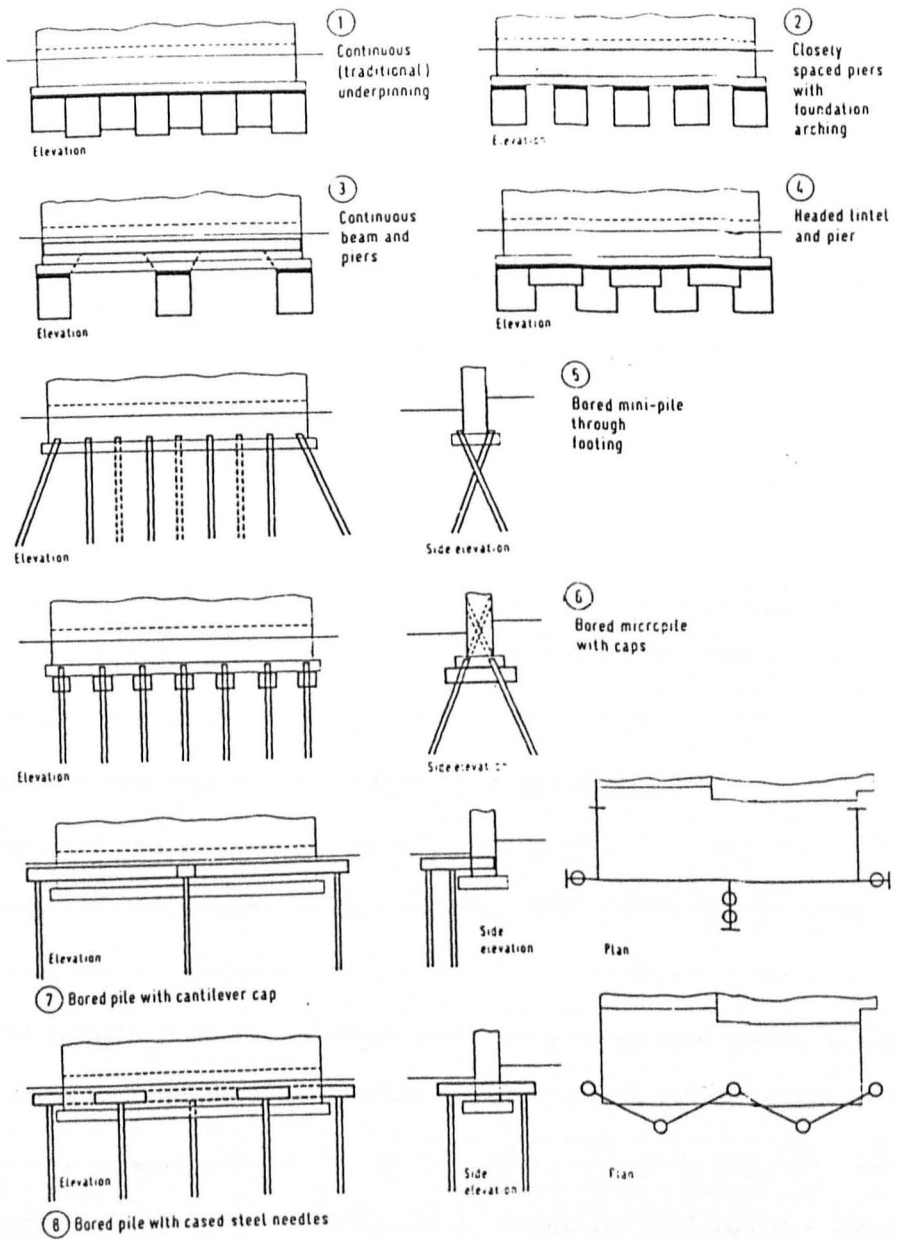


Fig.49 Various forms of underpinning

above and if this is unsound, further difficulties may occur. It is an opportunity to insert a damp-proof course when underpinning the foundations.

10.4.2 EXTERNAL WALLS

Apart from distributing loads from roofs and floors to foundations, external walls may be harmful to a building if they are structurally unsound. As far as the maintenance routine is concerned, an investigation of wall defects should be carried at least every 10 to 15 years. Cracks in wall, either vertical or diagonal, are common symptoms of structural instability. Such defects should be investigated and the cause diagnosed in the foundations, weak materials and joints; or any shrinkage or thermal movements such as timber window frames. However, if the cracks are fine and confined to mortar joints, then it will be sufficient to rake out the front portion of the mortar joint and repoint. The use of too strong mortar and rich in cement should be avoided.

For diagonal cracks which often being widest at the foundations and may terminate at the corner of a building, they often occur when shallow foundations are laid on shrinkable sub-soil that is drier than normal or when there is a physical uplifting action of main roots of a large tree close to the walls. Unless the walls have become structurally unsafe, it may not be worth of clearing off the tree and repairing the walls. If the walls need to be repaired, allowance must be made for any further growth in the roots by bridging the foundations across them.

Besides cracks, walls may have another defect which is leaning walls. Leaning walls may not be a common sight in the British colonial buildings in Malaysia but their occurrences are sufficient enough to indicate that there is a serious structural movement in the buildings. There are a few causes to the problem of leaning walls including:

1. Spreading roof which forces the weight of a roof down towards the walls.

2. Hogging and sagging due to soil movement.
3. Weak foundation due to presence of dampness, shrinkable clay soil or decayed building materials.
4. Disturbance of nearby mature trees in which their roots gradually expand the local settlement (Fig.50).

Symptoms of these causes are when the walls tend to fall either outward or downward; and predominantly diagonal cracks which are wider at top and become narrower as they pass downward to ground level. It is important that such cracks should not be confused with other cracking resulting from shrinkage of wall surfaces.

If the causes of leaning walls are in doubt and full repairs are uncertain, then professional advice should be sought. However, SPAB has introduced some advice to building owners on ways of undertaking simple repairs to buildings which they can either carry out themselves or with unskilled labour.⁷ Although the repairs are appropriate for traditional farm buildings, their fundamental principles can be adopted and practised in some of the British colonial churches and other timber-framed buildings in Malaysia. One of the advantages of the repairs is such that they will often be worth an hour or two of a professional's time in ensuring that the causes of the leaning walls are correctly diagnosed.

The basic repair is by restraining an outward leaning wall which is outward thrust. This can be done by using a wire hawser or small diameter rod stretched across the width of the building, attached at each end to the wall plate, the ends of main rafters or the tops of vertical timber posts in a timber-framed building (Fig.51). The hawser is best attached to a bolt in the side of a sound

⁷John Sell, *First Aid Repairs to Traditional Farm Buildings*, London: SPAB, 1989, Information Sheet 7.



Fig.50 Causes to the problems of leaning wall

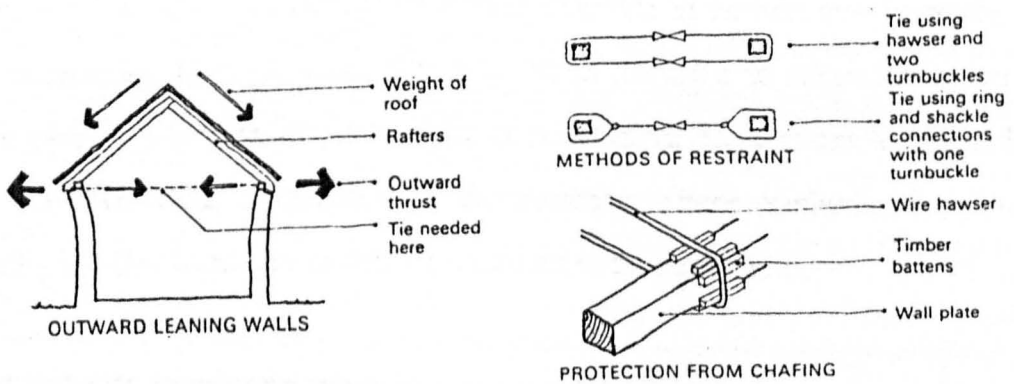


Fig.51 Basic repair of restraining an outward leaning wall

rafter which properly joints to the wall plate. Once attached, the hawser should be tightened by using a turnbuckle. However, it is important not to pull back the timber structure to its original position because it can cause damage to timber joints and other undesirable structural movements. To protect the wall plate from chafing, timber battens are placed around it.

Alternatively, raking shores may be used to provide temporary support to a leaning wall. Depending on the height of a building, the shores either made from timber or steel are placed against scaffold boards connected into the outward wall with timber needles. Cross bracing and steel stakes or hardwood wedges are needed to give a greater support to the shores (Fig.52). With tall buildings, the number of shores or rakers depends on the number of floor joists. Angled at between 45 and 75 degrees, the centre line of each shores intersects the ends of the floor joists and centre lines of wall plate to give maximum support at critical points of concentrated loads. To avoid any structural collapse due to the absence of adequate shoring, building engineers and builders should be consulted for detailed advice.

Other major repairs for the leaning walls, particularly of brickwork include methods of providing a restraint to walls which are strapping a connection into wall, providing reinforced concrete at corner; and inserting a tie plate connection through walls (Fig.53). When deciding to adopt the method of the tie plate connection through walls, it is essential to consider how much the plate may affect the appearance of the building. These methods of repair are normally applied to bigger buildings and tend to be permanent.

10.4.3 ROOF STRUCTURES

Unlike foundations and external walls, roofs are a part a building which is severely exposed to rain, wind and sun. In Malaysia, most of the British colonial buildings have pitched roof with timber structures and use clay tiles. Some have a combination of pitched and flat roofs. Even though, the structural

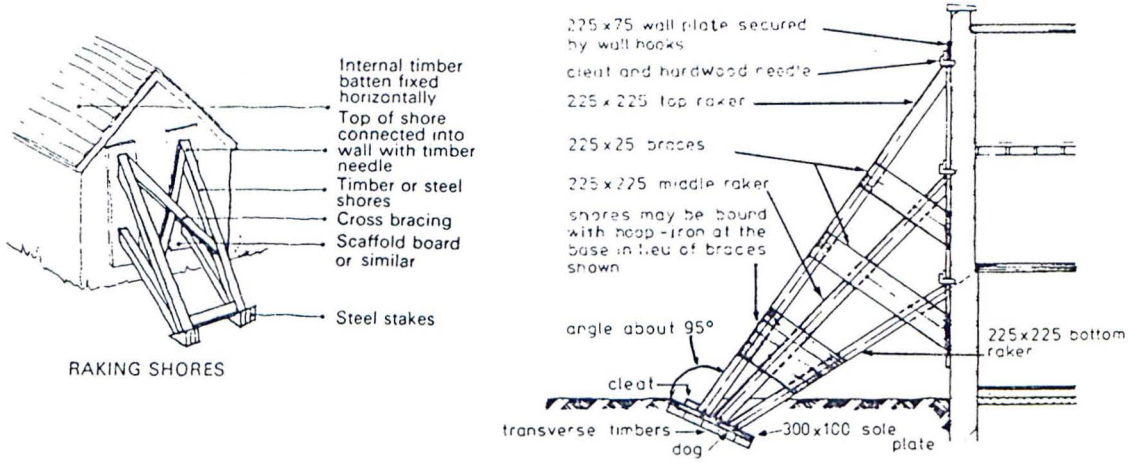
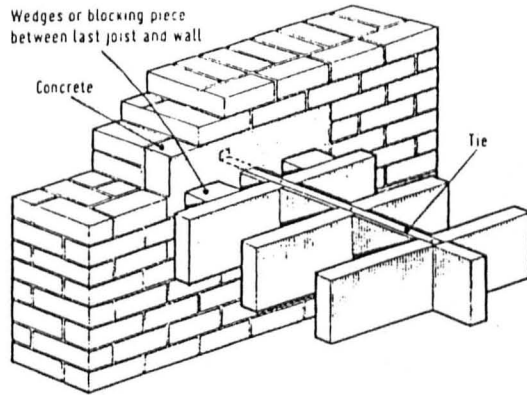
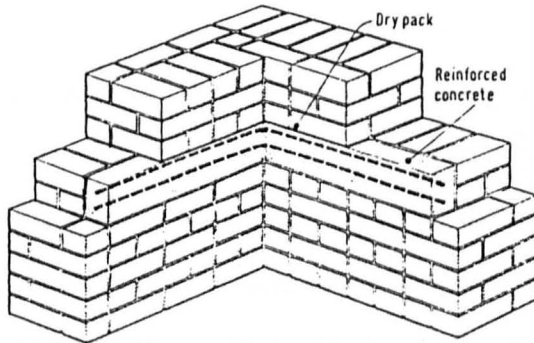


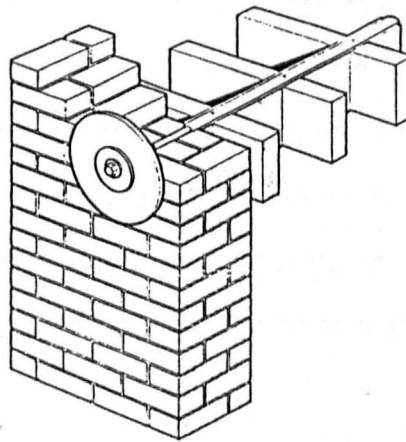
Fig.52 Method of raking shores for temporary support to a leaning wall



(a) Strap the connection into wall



(b) Reinforced concrete elbow tie



(c) Tie plate connection through wall

Fig.53 Major repairs for leaning brick walls

stability of the roofs is generally satisfactory, it is important to understand common roof problems, particularly when carrying out regular building inspections and determining the method of repairs.

Sagging of roof and roof spread are two examples of common roof problems. The former is caused by deterioration of structural timber ends which allow the roof to bow in the course of time or by the heavier weight of new roof coverings which exceeds the design loading of the roof timbers. There is a need for remedial and repair work if the roof is approaching structural instability, leaking and where the structural timbers have been weakened by fungal or termite attack. It may be necessary in some cases to fix struts in suitable positions to support the roof and prevent further sagging. However, if the roofs are badly defected, it is necessary to replace with new structure which does not exceed the design loading of the original. For the roof spread, the symptom is normally the development of horizontal cracks in external walls of a building near eaves level, with an outward movement of a portion of the wall above. This happens when there has been over-loading of structural roof members due to either being under-designed, or a heavier roof covering has been replaced for the original, corrosion of fixing nails; or fungal or termite attack of structural timbers. Methods of repair vary from providing additional or replacement connections to the use of threaded iron or steel rods passed through plates on the outside of walls back towards their original position.⁸ The trusses themselves may be brought back to their original form by tensioning the feet.

10.4.4 ROOF CONSTRUCTION AND FINISHES

Besides being one of the main structures in a building, roof may act as a weather shield, giving protection to users or occupants from rain and sun. Therefore, it is also important to treat any ageing roof tiles. In Malaysia, clay tiles have been widely used in the British colonial buildings. They appear in different

⁸H.J. Eldridge, *Common Defects in Buildings*, London: Her Majesty's Stationary Office, 1976, p. 343.

sizes and colour usually reddish, depending on the manufacturer that produced them. Some of the old buildings still have the original tiles even though their condition need to be considered. Others have changed to a more modern type of roof coverings including corrugated sheet metal or weather proof tiles (Fig.54).

In examining the conditions of the roof tiles, it is important to check the following:

1. The fixings holding the roof tiles to the roof structure
2. The joints in the roof tiles
3. Inaccessible and unattended points, particularly internal valleys and gutters
4. Points of maximum exposure such as at the foot of a rainwater pipe
5. Abutments against other structures such as chimney, jack roof or finial

Common defects of the roof tiles include the corrosion of nails fixing the tiles to battens and rafters, the decay of battens; and cracking of tiles which may cause by harmful growth or walk upon. The harmful growth is quite dangerous to the tiles because it may lift the tiles and create leaks. Excess of moss or mould stains on tiles should be removed by cleaning them with wire brush and water to avoid further damages to the tiles. These considerations are essential in generating the general maintenance for the roof tiles. Another aspect to be considered in the common defects is the mortar applied for ridge tiles which tends to decay or flake off over the years. It is believed that the mortar pointing in the ridge tiles requires complete renewal at intervals of about 40 to 50 years.⁹ This does not preclude inspection and maintenance which may require areas to be renewed at lesser intervals.

⁹Bernard M. Fielden, p. 293.



Fig.54 Old and new roof tiles

It is advisable to take photographs of the roof tiles prior to any recovering, repair or stripping. This is to ensure that the original tiles are properly copied or followed, as be a reference to the new or second-hand tiles.

When stripping, it should be carried out carefully so that all sound existing tiles remain undamaged. They may be sorted according to type, size and thickness and stored ready for reuse. Replacement of decayed battens should preferably be of good quality softwood pre-tested against fungal attack. This is because the durability of the battens is important in the life of the whole roof. As galvanised steel has shorter life, the use of stainless steel nails is preferable for fixing the tiles to the rafters, although they may be difficult to remove when repairs are necessary. When tiles get displaced, they should be re-nailed if possible.

Retiling should be carried out by using tiles salvaged from the roof or sound second-hand tiles that match the existing ones in type, size, thickness, colour and texture. Mixing the tiles judiciously is quite important to maintain or get back the original composition of colour and texture of the entire roofs. It may be necessary to have purpose-made tiles made to match existing ones.

10.4.5 EROSION OF MORTAR JOINTS

Basically, the main function of a mortar joint is to even out irregularities of individual blocks, whether they be of stones or bricks. At the same time it provides some adhesion between the blocks. In old buildings, lime-based mortar is often used for the bedding. However, due to its nature of weak and slow hardening, the mortar has been widely superseded by cement:lime mortar that is workable and sufficiently strong without causing drying shrinkage.

As long as there is a presence of salt crystalization, scouring action of winds, disintegrating effects of plant growing on a wall or water penetration leading to the concentrations of moisture and dampness; the tendency of erosion of mortar joints is always possible. Where mortar has weathered out or become

soft and crumbly, repointing should be undertaken which is an operation of raking out decayed mortar from the joints of masonry or brickwork to a depth of between 25mm and 40mm (or at least to twice the height of the joint); and refilling the joint with suitable mortar. It is important to point out that repointing should be carried out using a lime-sand mortar and not a cement-sand mortar. This is to avoid any damage not only to the appearance and character but the structure of a building as well. For example, a rich cement mix shrinks on setting, producing cracks in the pointing through which water can penetrate while at the same time preventing evaporation. Sound old pointing should be left undisturbed.

There are few important things needed to be taken during the repointing of a building. Decayed mortar can be removed forcibly by the use of a mechanical disc or carefully raked out by using a knife or spike manually. For a hard mortar, the removal should be carried out with a great care by using a sharp quirk and a small lump hammer, cutting out only the defective area. Other unsuitable methods should be avoided to prevent any increases to the width of mortar joints.

For the mixing of a new mortar, it is advisable to match it in mix and finish with the original mortar (Fig.55). If the original mortar is impossible to copy or the facilities for analysis are unavailable, the new mix should be compatible with the strength of stone or brick wall. The general principle is that mortar should be slightly weaker than the stone or brick.¹⁰ This is to allow moisture to evaporate out through the joints not the stones or bricks, reducing the rate of decay.

Mixes vary considerably depending on original mixes, types of stones or bricks but a general guide is a proportion of 1:3 of binding agent (lime) to aggregate (a sharp sand, well washed and graded). To obtain the correct colour of the mix, aggregate can be adjusted but the use of additives and pigments should

¹⁰Christopher Breerton, *The Repair of Historic Buildings: Advice on Principles and Methods*, London: English Heritage, 1991, p. 45.

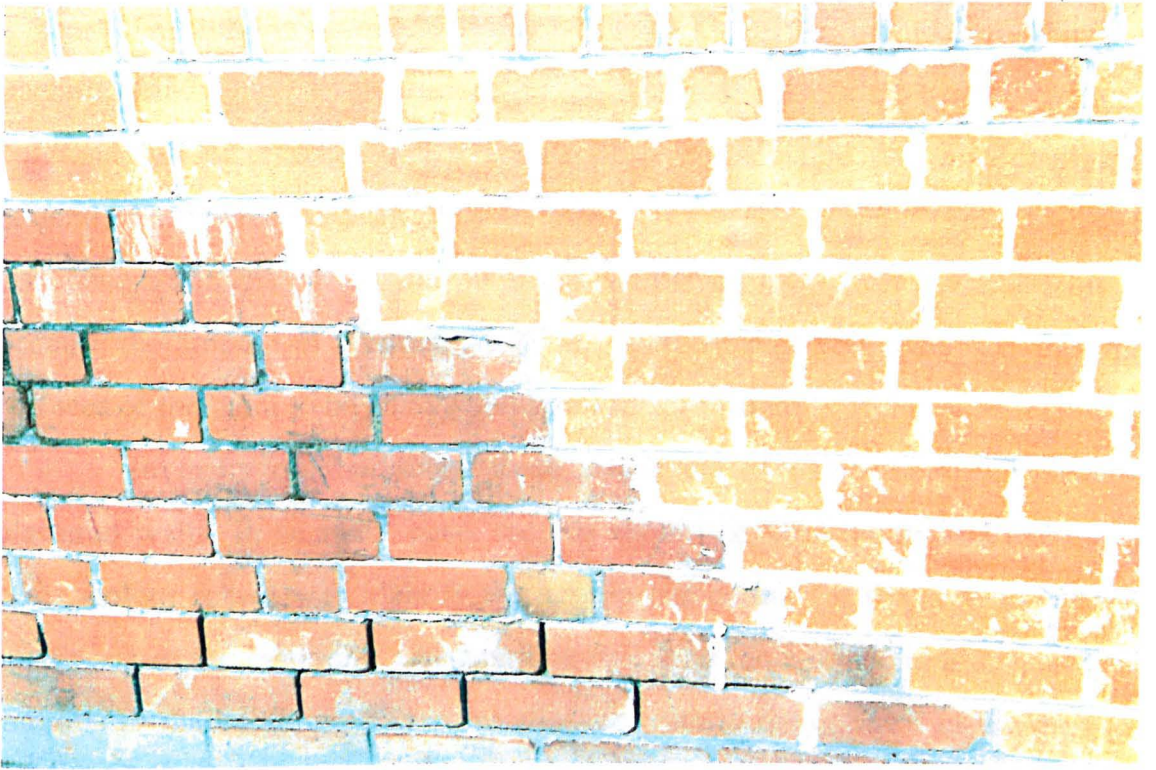


Fig.55 Problem of matching and finishing new mortar with the old

be avoided. Before the new mortar is packed firmly into the joint by using a pointing iron, it is important to wash out all loose materials and joint wetted to avoid suction.

10.4.6 PEELING PAINT

One of the common problems found in British colonial buildings is peeling paint which likely occurs on the facades, mainly on plastered walls, columns and other areas which are exposed to excessive rain and dampness (Fig.56). However, some buildings located near the sea may face a much greater risk once the signs of peeling paint are visible on the exterior walls. This is because the amount of constant wind, rain and sun received can easily turn the surfaces of the paint to be chalky and wrinkled or blistered.

In many old buildings, there are layers of paints being applied on plastered walls. In such the case, records should be kept on the existing paint types, colour schemes to identify the appropriate colour for the new paintwork, conditions of the materials; and anything that is to the architectural or historical interests of the buildings. These are all done prior to the removal of the damage paint. For example, in the restoration of 1907 Loke Chow Kit mansion or known as PAM Centre in Kuala Lumpur, a building committee has decided to retain the original colour scheme of the building by painting it with lime wash. This makes the building an architectural delight which remains as close as possible to the original scheme.

In general, before choosing any appropriate method of paint removal for the British colonial buildings in Malaysia, it is important to analyse the surface of damaged paints and possible side effects to other building materials. Reference to local authority and a consultation with various paint manufacturers are essential and helpful.

There are many different types of paint including emulsion, limeys, oil-based, tar, bituminous, oil-bound water paint and cement. All of these require



Fig.56 Peeling paint on areas exposed to excessive rain and dampness

different methods of removing. Therefore, it is helpful to be able to identify the type of paint that has been applied before deciding the means to remove the paint. Improper removal method applied can make the eventual removal of the paint more difficult.

SPAB has listed six main methods of removing paint, all of which are depending on the nature and conditions of the paints.¹¹

Water Washing

Water washing can be helpful in removing paints, particularly those which are of water-thinned. This is because adhesion in the coatings is likely to be loosened when thoroughly wetted. When appropriate, the use of warm or hot water is necessary for softening limes, whitening and soft distemper or copolymer emulsion paints before sponging, scrubbing or scrapping off the resultant form.

Avoid the use of soda, soft soap or other highly alkaline soap in the washing, for it may leave harmful residues which later attack new paintwork. Instead, mild liquid detergents are more suitable. In applying this method, it is important to prevent water from being absorbed and penetrated into other underlying layers. This is because the trapped water may cause moisture which then spreads behind the new paintwork and generates blistering.

Steam Stripping

The method is a process in which steam at low pressure is applied to the paint through a hose capped with a perforated metal concentrator. The appliance used is similar to that of stripping wallpaper. It is useful for removing water-thinned paints including the emulsions because the combination of heat and moisture from the steam can soften the paint which then is removed with a sponge and water.

¹¹ Adela Wright, *Removing Paint From Old Building*, London: SPAB, 1989, Information Sheet 5.

Compared with the water washing, steam stripping is more effective and can be faster over large areas. However, steam stripping can be slow and laborious in removing multiple layers of old encrusted paint and may damage other areas or elements.

Chemical Paint Removers

There are two main types of chemical paint removers: solvent (non caustic) and alkaline (caustic). Both of which contain toxic ingredients which are flammable and health risk; and that the method should be handled by a competent and experienced person. Application of the removers should be with a brush and when appropriate, should be used in well ventilated rooms.

The solvent remover, usually based on methylene chloride, are very effective in removing only oil-based paints. The alkaline remover is also effective on not only the oil-based paint but other tough paints that cannot be removed by other means.

Once applied, these chemical paint removers can break down the oil or resins that bind the paint and then soften the layer. The use of a hard brush and water is helpful in scraping or scrubbing off the softened paint. However, these removers are not suitable for plywood, veneers or hardwood. They may raise the grain of timber and darken some woods as well. Furthermore, they can be harmful to brickwork, stonework, metal and most types of plaster or putty.

Abrasive Methods

Paints can be removed by hand scraping and sanding, and by mechanical methods. The former uses a wetted medium-coarse glass paper wrapped round a wood block. It is suitable for removing a thin layer of paint. The latter, however, uses hand powered tools applied with standing attachment such as a disc, flap wheel or rotary stripper. It is practically suitable for flat surfaces. It can also be used to remove multiple layers of old paintwork that do not respond

to other forms of paint removal. Blast cleaning by using controlled pressure of air or water is helpful in the abrasive methods, but the work should be in the hands of an experienced contractor with careful supervision from a conservationist. It is laborious but often effective.

Hot Air Paint Stripper

Hot air paint stripper, an electrical tool with heat adjustable, is basically designed to soften and blister oil-based paints and varnishes on wood surfaces before the paints are scrapped away with a stripping knife or scraper. It is not suitable for the removal of water-based paints or any type of paint on metal or plaster. The method is fast and effective, but extra caution is needed, particularly in adjusting the temperature for the hot air, in applying on areas near glass windows or flammable materials; and in risking other sound old plaster.

Burning Off Method

Like hot air paint stripper, the burning off method is effective on oil-based paints but not on water-based coatings. Instead of hot air, blowlamps or blowtorches are used to soften the paint prior to any scraping. Therefore, the work should be handled by an expert who is accustomed to the devices.

Even though the method is quicker than other forms of removal, there are few risks when involving with the method. For example, there is a danger not only that the paint itself may catch fire but rotted timber below the paint film may ignite without noticeable.

In cases which removing paint is needed for brick or stone walls, the method of solvent (non caustic) stripper can be successful. Other methods such as alkaline (caustic) strippers and air abrasive should be avoided. On the other hand, for the removal of paint from plastered wall, the solvent stripper can be successful. Avoid using alkaline removers, for the built-up harmful residues can

be absorbed by plaster. For repainting old plaster, it is an advantage to use lime, whitening or soft distemper. Further summary of paint types and some methods of removal can be referred in Appendix 7.

10.4.7 DEFECTIVE RAINWATER GOODS

Lead downpipes are rarely used in the British colonial buildings in Malaysia even though they are very durable compared to other materials. Instead, cast and galvanised iron; and PVC are widely used.

Common problems associated with the defective rainwater goods of the British colonial buildings include sagging or missing eaves gutters, corroded or broken galvanised iron downpipes; or leaking rainwater heads (Fig.57). Others may include undersized gutters or downpipes which cause overflow of water, particularly in heavy rain; and an improper disposal of water at ground level. Rainwater goods play a major role in old buildings and that they should be repaired immediately when any defect is spotted. This is because they can lead to further problems to the buildings such as water penetration into walls, harmful growth and also bad appearance for the buildings.

There are few possible causes to the defective of rainwater goods. Due to inadequate painting, for example, iron rainwater good can become rusted and fractured. Lack of proper fixings of the wall, particularly by means of projecting lead ears or lugs can cause instability to the downpipes. Where the routines of building inspections and maintenance have been neglected, the rainwater goods can be easily exposed to all sorts of defects.

In renewing or repairing the defective rainwater goods, it is important to maintain a proper system of disposal water from eaves gutters to open channels or drains at ground level. It is also essential to consider the future maintenance of the goods.

In regard to the iron downpipes, it is important to fix them on spacers two or more inches clear of the wall. This is to ensure that any leaking will tend



Fig.57 Common problems associated with defective rainwater goods

to run down the pipe rather than the wall. As a result, water penetration into wall can be prevented. When the downpipes are fixed in this way, rainwater heads should be painted to inhibit the development of rust. However, this is not so with the lead downpipes, nor lead rainwater heads and gutters. Any splits found in these goods should be fixed by lead welding, not soldering. For undersized gutters or downpipes which unable to cope with the heavy rain, then it is advisable to fit larger components of the same design; and not so much larger that they affect the appearance of the building. All rainwater goods should be clear from any blockage. Weekly inspections on the gutters and downpipes are essential.

10.4.8 DAMPNES PENETRATION

One of the most common faults in the British colonial buildings is dampness penetration. It can be a serious matter, particularly to the buildings which are located close to water sources. It can also cause not only deterioration to the building structures but damages to furnishings and contents as well. The main cause of dampness is water which may enter a building by a number of different routes.

Water penetration occurs commonly through walls exposed to prevailing wet wind or rain. With the existence of gravity, water is likely to penetrate through capillaries or cracks between mortar joints and bricks or blocks before building up trap moisture behind hard renders and also driving further up the wall to emerge at a higher level. Dampness may also occur in walls because of other factors such as leaking gutters or downpipes, defective drains, burst plumbing and condensation due to inadequate ventilation.

Dampness may enter a building from the ground though it should have been prevented from doing so by properly constructed damp-proof courses and membranes. Moisture present in the ground may penetrate through cracks or

mortar joints in the wall. Lack of and failure of the damp-proof courses can also cause dampness to rise up walls.

Providing that there is no damp-proof course in a building, there are several ways that can be introduced to prevent dampness from penetrating walls. The first method is the insertion of a damp-proof membrane in a stable wall of not more than 450mm thick. This can be done by sawing a slot in a mortar bed joint, normally just above the floor slab and at least 150mm above outside ground level; and then inserting the membrane in the slot in 600mm lengths (Fig.58).¹²

Alternatively, the damp-proof courses can be inserted by the method of electro-osmosis damp-proofing. The installation consists of 25mm holes drilled from the outside with strip electrodes of high conductivity copper mortared into drillings and looped into copper strip set into bed joints at damp-course level along the wall face (Fig.59). The purpose is to provide a bridge between the wall at the damp-course level and the soil, thus destroying the surface tension and also preventing rising moisture.

Another process of preventing the rising damp is by injecting a silicate solution in water or a silicate-latex mixture into the lowest accessible mortar bed joint through drill holes 10mm in diameter at 50mm intervals. The silicate, which becomes a water-repellent bond after injection, acts as a stabiliser within the wall allowing the area to harden off. The method is useful especially for thick or unstable walls where damp-proof course insertion may not prove possible.

10.4.9 DEFECTIVE PLASTERED RENDERING

Identifying the causes of defective rendering is important before any conservation work can be adopted. In the British colonial buildings, broken plastered rendering occurs mostly on external walls, columns and ceiling (Fig.60). In a humid tropical climate, the defects of rendering are normally

¹²Ivor H. Seeley, p. 56.

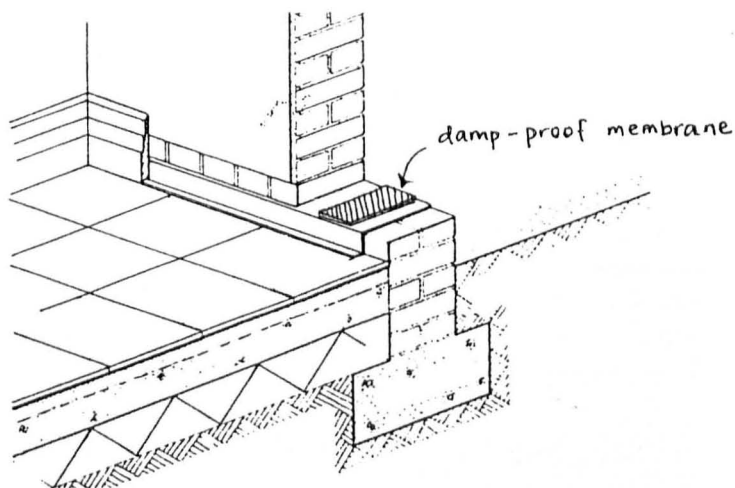


Fig.58 The insertion of a damp-proof membrane in a stable wall

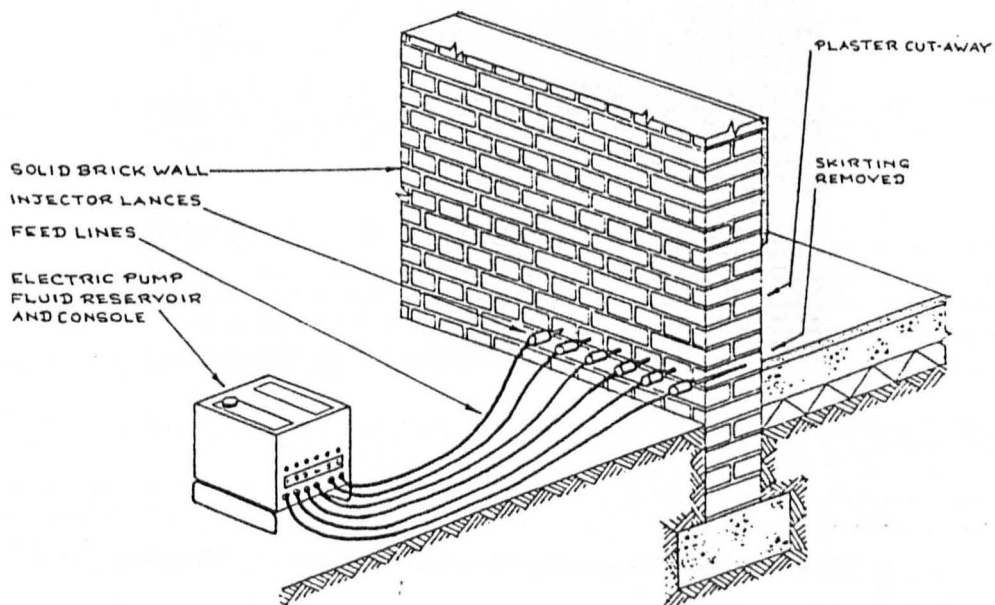


Fig.59 The method of electro-osmosis damp-proofing



Fig.60 Broken plaster caused by biological attack

caused by biological attacks arising out of penetrating rain, evaporation, condensation, air pollution, dehydration and thermal stress. Other causes may come from mould or harmful growth, insects, animals and traffic vibration. Prior to being decomposed and broken apart, plastered rendering may become cracked due to either shrinkage or movement in the substrate itself.

Before any repair is done, it is necessary to analyse the broken plaster, particularly its original colour, texture and its major ingredients including, if any, the presence of calcium carbonate (lime) with gypsum, marble dust, ground brick or sand as fillers; and animal hairs or vegetable fibres. This is to ensure that the old plaster can be copied and matched. Thickness of the plaster should be checked to avoid any uneven finish coats. Thoroughly cleaning is essential and every trace of dust should be removed.

For the repair of the broken plaster, the main principle is such that the new plaster must be no stronger than the material to which it is applied. This is to allow sufficiently flexible to accommodate any movement of substrate and also to allow moisture to evaporate freely from it. Wetting the existing coats before the application of the new plaster is important to reduce the development of suction. Careful stripping and cutting the broken plaster should be done without affecting the existing sound plaster.

Depending on the texture of the plaster wall, column or ceiling, a new mixture of one part of lime to two of sand can be applied in one coat of about 6mm-10mm thick. The choice of sand, however, relies upon the purpose texture of either the external or internal work. For example, coarse sharp sands are generally preferred for external work while soft sands for internal work.

For the plaster ceiling, if it is loosened; a technique of reattachment can be applied. The process, which requires the drilling of 5mm holes through the ceiling lath at 300mm centres, uses consolidant injected into the holes. In a case where floorboards cannot be lifted, holes may have to be drilled through the plaster itself. Both the lath and plaster need to be wetted with a mixture of 3:3:2

parts of water, denatured ethyl alcohol and acrylic emulsion by using a foaming spray. The acrylic emulsion acts as a bonding agent in the mixture.

For the restoration of a decorative plasterwork, a specialist firm with a knowledge of making moulds of cornices and ceiling using silastomer silicone rubber should be consulted.

If fine hair cracks happen on the finished plaster caused by either excess lime in the final coat or the use of loamy sand; filling of the cracks can be extremely difficult. However, it is often better to apply modern fillers with adhesive qualities.

10.4.10 DECAYED FLOORBOARDS

Timber floorboards are widely used in the British colonial churches, schools, residential and railway station in Malaysia. This is because the material was available, durable and easy to construct. In some buildings, old floorboards are cleaned and regularly polished to enhance the richness of a room. Unfortunately, some are often badly abused with serious damages on the surface of floorboards; undulating floors and gaps between the boards.

Proper maintenance and repair of the floorboards are very important. Otherwise, deterioration of the floorboards may occur; leading to further structural problems and unsafety of occupants. The main causes to the deterioration are termite and beetle attacks, others include careless lifting of weakened boards by occupants, electricians or plumbers; lack of natural seasoning and preservatives, and corroded nails.

Decayed floorboards can be repaired or patched by a number of ways depending on the nature of the decays and whether or not they may disturb the building structures. The main principle in repairing or patching a decayed floorboard is that although a board may be suffering from the decay, its strength may not have been reduced significantly. Therefore, only the affected area should be repaired or patched and not necessarily the whole floorboard. Following are

some of the methods and techniques of repairing or patching old floorboards adopted from SPAB¹³:

Lifting Floorboards

In the process of lifting decayed floorboards; ingenuity, preparation, care and patience are the keys to success. The necessary tools needed include a 6 inch bolster, wooden blocks of various thickness, a flat hardened steel plate, a hammer, a 1/2 inch batten about 8 inches longer than the width of the board, nail punches, a hacksaw; and a crowbar.

There are two stages in the process of lifting the floorboards. The first stage, which is easing up the first board, requires gaps big enough for the bolster to fit between boards. Using a block of wood or flat hardened steel plate placed at the edge of the adjoining board, the bolster fits the gaps, works on one side of the decayed floorboard; and levers from side to side to loosen it (Fig.61). Repeat the same procedure on the other side of the board until the board has raised by up to one third of its thickness. Then, move towards the middle and back towards the end until one end of the board comes free. If the floor is very decayed, a nail punch should be used to drive nails down. Once the one end has been freed, a 1/2 inch batten should be placed under the spanning of two adjacent boards and gradually move towards the next set of nails (Fig.62). Allow a gentle pressure on the free part of the board in order to ease the nails slightly out of the joists. Remove the batten and let the board drop to its original position to give access to the nail heads. Pull out the nails by using hammer or crowbar.

The second stage is the method of lifting subsequent boards by using a block placed across the joist; and a crowbar inserted between the board and joist, levering upwards (Fig.63). Where the board is very weak, placing a block underside of board or clamping in position is essential.

¹³Philip Hughes, *Patching Old Floorboards*, London: SPAB, 1988, Information Sheet 10.

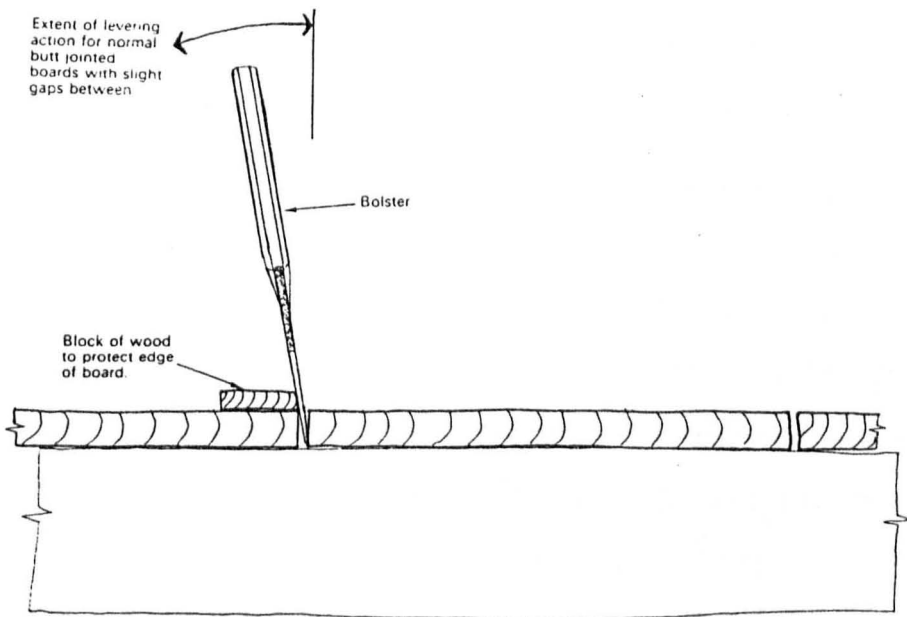


Fig.61 Bolster is used to loosen up board

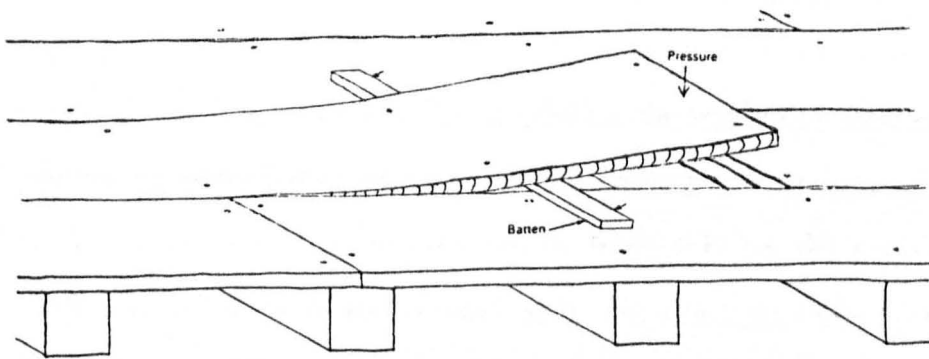


Fig.62 The use of batten and gentle pressure to ease nails slightly out of joists

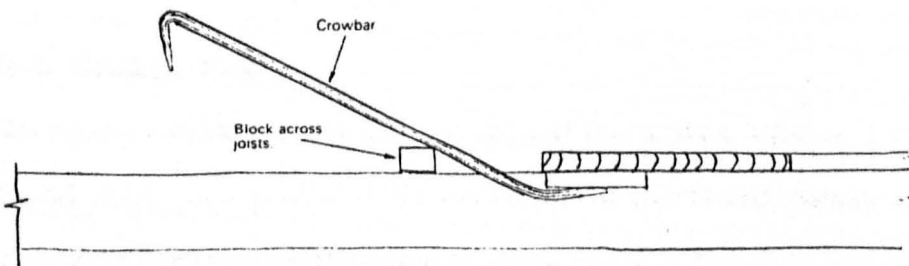


Fig.63 Method of lifting subsequent boards by using a crowbar and block

Reducing Unevenness in a Warped or Twisted Board

Sometimes a floorboard may warp or twist due to uneven shrinkage or expansion. It is impossible to make a warped or twisted board perfectly straight but the condition can be reduced to an acceptable level. Lift the warped or twisted using the method above, and immerse and soak it in water. Then, lay the board out to dry on battens and apply weights to overcome twisting. If the board tends to revert to its original twist when weights are removed, this should be compensated for by over weighting. Leave the board under pressure for at least one week and allow it to dry slowly. If it is held flat while drying then the warping is likely to be reduced. Before relaying the board, it is necessary to treat the underside of board against termite or beetle attack.

Repairing a Split Board

A split board with a crack in the middle can be treated by first lifting it and then, placing on two clamps using small blocks to protect edges of board. Prior to this, the board should be marked on the underside for the positions of joists, crack should be cleaned; and if necessary, any warp or twist should be removed. A small block of same board with grain running in same direction is needed, placed on top of the split and screwed to underside (Fig.64). Then, relay the board.

Repairing a Broken Edge

To repair a broken edge, cut out around the broken edge of a lifted old floorboard and mark joist positions on underside of the board. Select seasoned timber of the same variety with the grain running in same direction and form new section to fit the old. Glue together and cramp in position. If the broken edge occurs between joists, the new section can be supported by block screwed to underside of board (Fig.65). Relay the board after work is finished.

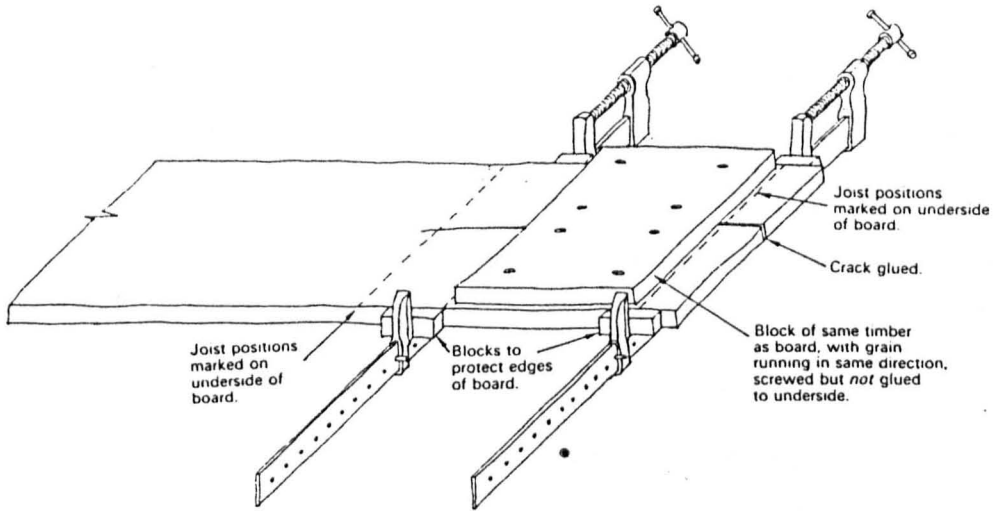


Fig.64 Repairing a split board

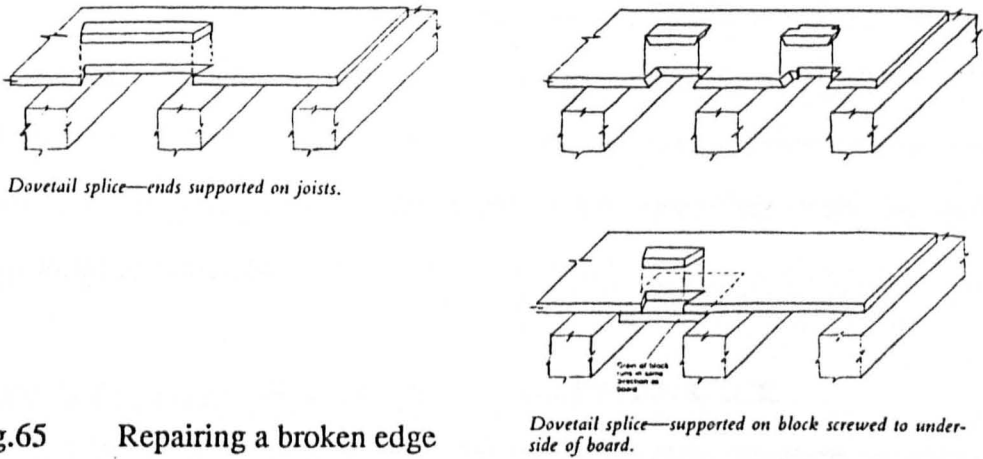


Fig.65 Repairing a broken edge

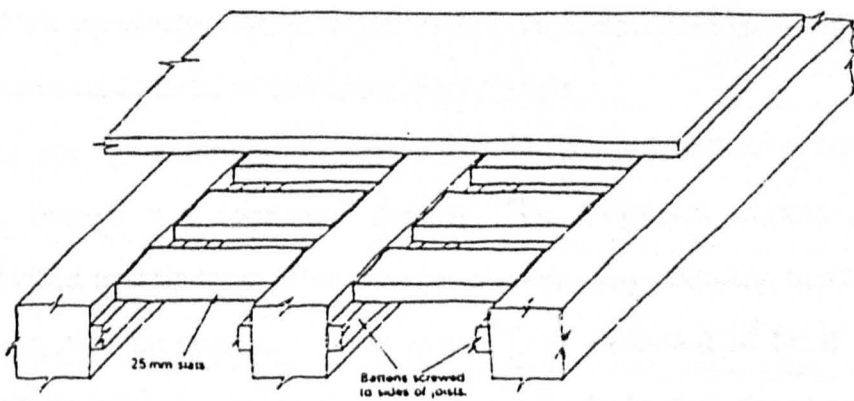


Fig.66 Battens are screwed to joists for strengthening a weak board

Strengthening a Weak Board

A weak board can be strengthened by screwing battens to sides of joists and then laying 25mm thick slats on battens under the weakened board (Fig.66). Before relaying the board to its position, treatment of board and batten against termite or beetle attack is essential.

In relaying old boards, lightly greased brass screws (iron screws will eventually rust and extremely difficult to remove) should be used for nailing the floorboards down. This is important, particularly to avoid any disturbance over a decorative plaster ceiling underneath; and also where frequently lifting and relaying of the board will be necessary. It is also important not to sand the old board, for it will remove the smooth surface of the board. If removal of a paint, stain or varnish is necessary, reference to an appropriate method may be derived from Appendix 7. Polishing boards is acceptable but applications of modern varnishes and finishes should be avoided because they tend to give an unsympathetic appearance.

10.5 PROGRAMME OF CYCLICAL MAINTENANCE

Building maintenance should be organized through a rigorous programme of cyclical maintenance starting with daily routines and working upwards which involves periodic programmes of daily, weekly, monthly, semi-annual, annual inspections; or quinquennial routines

For the quinquennial routines, it is the responsibility of architect or surveyor to inspect any structural defects. The long-term maintenance plan should be revised and updated after each inspection. Any attention to the building defects should also be studied for the next report presented to local authority. Some of the tasks that the architect or surveyor should look in the inspection are cleaning out all voids and spaces, changing tap washers, checking lighting conductors, inspecting and testing electric installation, checking any signs of abnormal deterioration; and cleaning out gutters of leaves, branches or plants.

However, some inspections are carried out at least every thirty years, especially for major monuments. In such a case, a report containing information of updated maintenance and repair work, photographs, key drawings and recommendations should be prepared by a qualified professional. This is to ensure that the report will be a valuable source of reference for those responsible for a building now and in the future.

Depending on the nature work of maintenance and repairs, the programme of cyclical maintenance may be divided into two main categories: day-to-day maintenance and maintenance involving builder's works. As stated by English Heritage, the day-to-day maintenance include work which can be dealt by building owner without the need to employ outside labour.¹⁴ This consists of cleaning leaves from gutters, downpipes and drainage channels; removing plant growth from masonry, looking for insect and fungal attack in timber, checking ventilation; and removing bird droppings. In addition, Sir Bernard M. Feilden has suggested that fire-detection systems should also be checked as well as windows, doors, lavatories and electrical system. It is advisable to ask cleaners to report any defects they note such as broken windows, leaks in roof, falling pieces of masonry and lime dust from spalling plaster or insect droppings. The second category, which is maintenance involving builder's works, is best carried out on an annual basis by a builder who has knowledge of and sympathy towards the construction of historic buildings. Such works include refixing and replacing loose or broken roof tiles, eaves, gutters, downpipes; and rodding and inspection of soil drainage systems. Besides, testing all fire extinguishers and refilling if necessary, cleaning out ducts and air-conditioning units, servicing elevators; and decorating and cleaning sections of the interior of building are all needed in the building maintenance.

However, to secure the general structural stability and life of a building, it is important to regularly inspect not only the main structural elements including

¹⁴Christopher Brereton, p. 12.

foundations, walls and roofs; but other common building problems. Proper methods and techniques of building repairs; and good maintenance programmes are equally important. It is a duty of owners, conservationists, architects, trustees, local authorities and the public to see that a historic building is handed on to the next generation in good condition.

PART FOUR
CASE STUDIES

CHAPTER 11

CASE STUDIES OF BUILDING CONSERVATION IN THE UNITED KINGDOM

11.1 CRITERIA FOR BUILDING SELECTION

Three historic buildings in the United Kingdom are selected for the case studies. The buildings are Sessions House, Maidstone built in 1824-26, Tate Gallery Albert Dock, Liverpool built in 1841-45; and Christ Church, Stannington, Sheffield built in 1828. The Sessions House was used for courts before converting to an office complex for Kent County Hall. The Tate Gallery, which was used to be a warehouse, has been transformed into an art gallery, a maritime museum, a coffee shop and classrooms. Whereas Christ Church retains its original function but greatly modified to meet contemporary requirements in both worship and pastoral care.

The criteria on which these buildings are selected is based on that of the date on which they were built. The relevant dates are between 1800 and 1930; architecturally, the buildings demonstrate a good example of conservation and rehabilitation work. This may give a good comparison on how building problems were tackled. Another aspect is that the buildings have some similarities and characters with some of the British colonial buildings in Malaysia, particularly the ones selected for the case studies. These include building uses, materials or constructions.

11.2 METHODS OF CASE STUDIES

In each of the case studies, the building is analysed by the characteristics of historical background, architectural significance, building condition and defects together with construction problems, building conservation; and building requirements. Building research and inspections were carried out on each of the selected buildings. These include historical research, structural survey, building condition and defects, photographic studies, site investigation; and correspondence and interviews with architects responsible for the restoration and renovation works.

11.3 CASE STUDY ONE :

SESSIONS HOUSE, KENT COUNTY HALL, MAIDSTONE.

Historical Background

The Sessions House, dates to 1824-26, was designed by Sir Robert Smirke, an architect who was also responsible for the British Museum and the Royal Mint. It is located at the corner of Lower Boxley and County Road. This four-storey Neo-Classical building was quite important, for it used to house two principal courtrooms and a council chamber for Maidstone. In 1914, a semi-circular block was built and adjoined on two sides of the Sessions House. This has turned it into a big building. The building is adjacent to the outer wall of Maidstone Prison at the rear. The Sessions House has been used for courts for quite a number of decades until it was handed over to Kent County Hall for council uses.

In 1987, the building was refurbished into a thoroughly modern office environment while its appearance has been carefully restored to that envisaged by its designer. Closely involved with the English Heritage, architects Jack Daniels and Bob Ratcliffe of Kent County Council's department of building design were given a job to do the refurbishment and conservation work. With a total cost of around £8m, the work has become one of the largest local government refurbishment schemes of recent years.¹

Architectural Significance

Architecturally the building portrays many interesting features including solid stone walls at ground level, ionic columns, pilasters, decorative plastered ceilings, corner quoins; and a well defined main entrance with an arch topped with a decorative pediment. The building is not only rich in architectural details and vocabulary but many of its features are reflected in a number of

¹Peter Weatherhead, "No Stone Unturned: Refurbishment Maidstone County Hall", *Building*, June 21, 1991, p. 42.

British colonial buildings in Malaysia. The Sessions House was planned symmetrically with four levels in the original building and six levels in additional blocks (including a basement). There is exposed stonework at the base of the building. There are courtrooms, member's lounge, a seminar room, a lecture theatre, an exhibition hall and an assembly area. Most of these areas or rooms have high ceilings, a typical room design for many government buildings of the time. There is also a grand staircase leading from members' entrance and lobby to the upper level. Oak panelling can be seen in many areas including along staircases, lobby, council chamber and courtrooms. There are existing light wells in the slated roof to allow natural light into the interior spaces. However, many parts of the building were well restored during the refurbishment. Major work involved dividing the courtrooms into a staff restaurant, seminar room, meeting rooms and kitchen.

Building Condition and Problem

Like many other historic buildings, the Sessions House faced some building problems despite its structural stability. Decorative plastered ceilings were in the state of disrepair while the roof needed to be reslated. Externally, all the stonework were required to be cleaned and the facades redecorated. Interior walls were stripped back to brick and replastered.

Building Conservation

As far as building conservation is concerned, the architects' main philosophy was to retain the old design and building materials as much as possible. A three-year work programme had been planned which covered a spectrum of building refurbishment from historical authenticity to office computerisation. The work was carried out in three main phases:

Phase One:
Renovation of council chamber

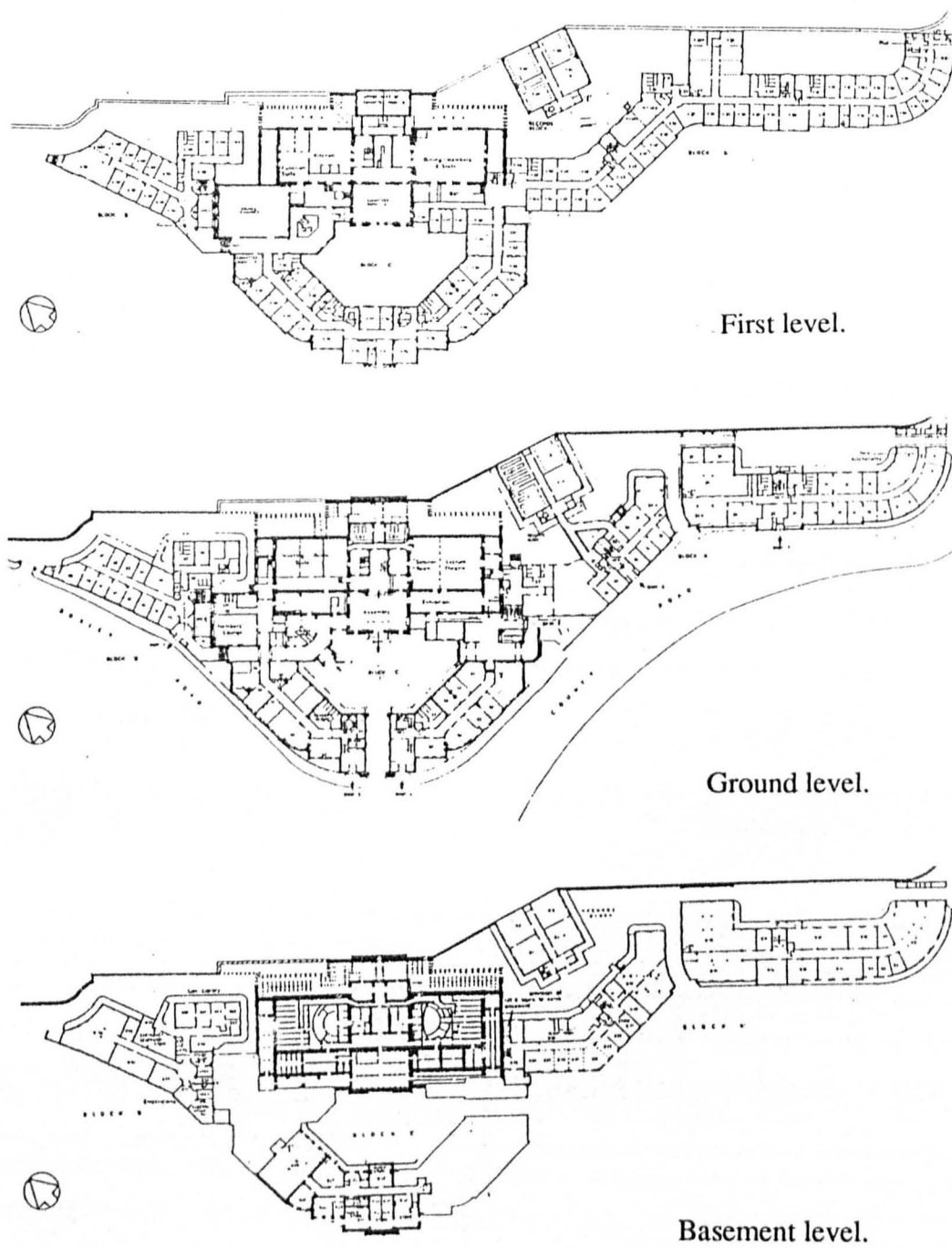


Fig.67 Floor plans of Kent County Hall

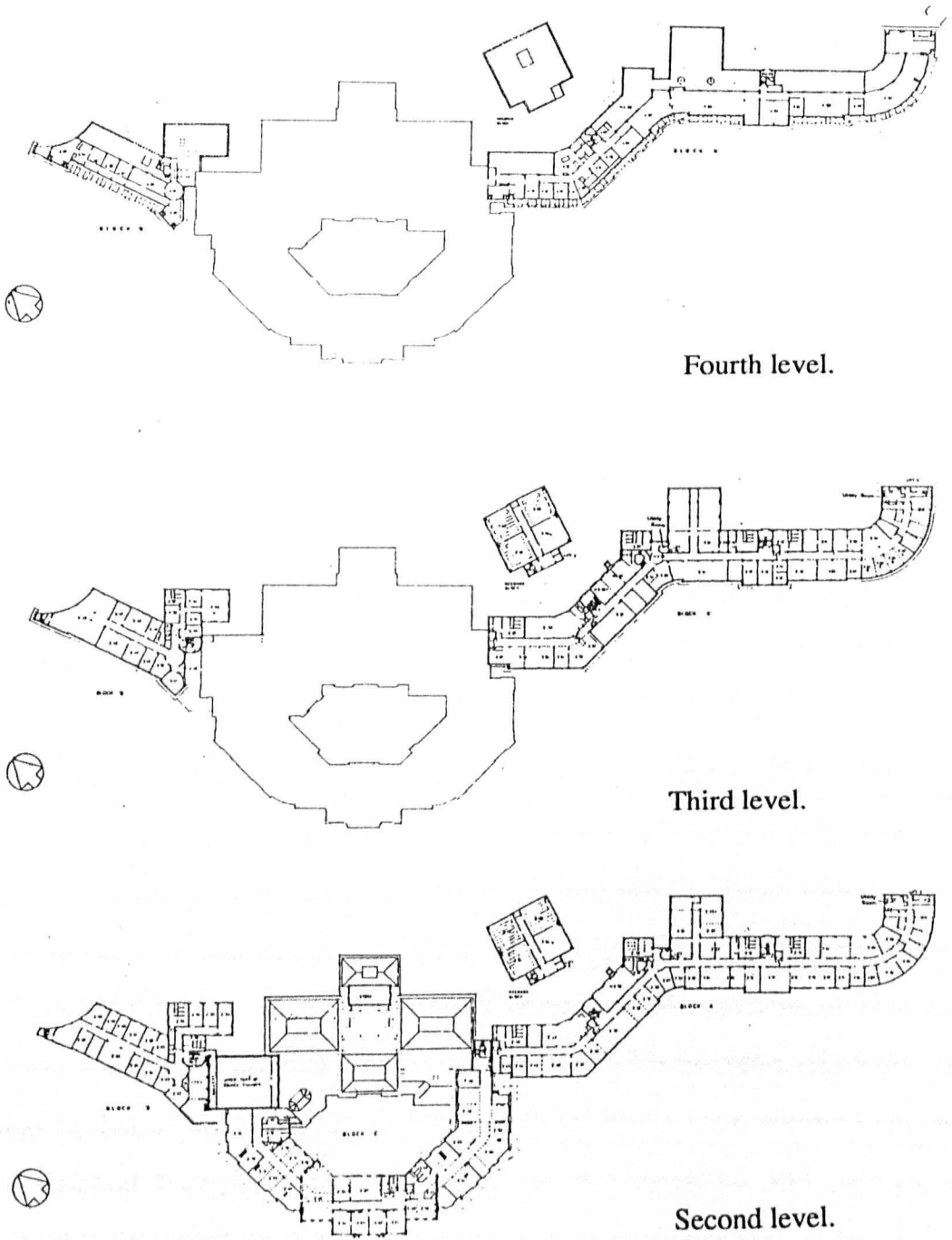


Fig.68 Floor plans of Kent County Hall (con't)

Phase Two:

Recasting of the historic courts into meeting rooms, a seminar room, staff restaurant and kitchen. Realigning a section of the outer wall of the Maidstone Prison at the rear

Phase Three:

Refurbishment of adjoining council office accommodation. This includes the improvement and redecoration of the semi-circular blocks; and the cleaning of its stone facades.

Several consultations have been sought during the phases including structural engineers, services and historic building colour consultants, quantity surveyors, interior designers, acoustic consultants and English Heritage. This was to ensure that the building was carefully converted to a modern office environment without affecting its appearance and characters.

Phase One

Renovation of the council chamber involved several works. One of the major works includes the repositioning of the chamber's layout through 90°. In other words, a timber screen and chairman's desk were repositioned from the short wall to the long one facing entrance doors. According to the architects, the idea was not only to provide a more flexible space but to create an environment similar to that of the European parliament. Floor levels were adjusted and walls were stripped back to brick before they were replastered and painted with emulsion paint. Much of fibrous plasterwork was also reinstated. A new balcony was inserted into a flank wall opposite a public gallery. The structure had to comply with the Building Regulations. While existing ceiling grilles were used for air extraction, a new grill was installed at each corner for air-conditioning systems. The roof above has been reslated and its laylight and lantern were replaced by a new light box housed in the roof void. Other restoration works include removing and replacing any poor oak panels, restoring decorative plaster

with reformed mouldings, restoring balustraded marble stair; and installing digital electronic voting systems with display panels and sound amplification.

Phase Two

Phase two involved two major works: recasting of courtrooms into meeting and seminar rooms, staff restaurant and kitchen; and realigning a section of the outer wall of the Maidstone Prison. The former work included the insertion of new floors in the high-ceiling courtrooms, utilising their volume. This has divided the courtrooms into a staff restaurant and kitchen with a boiler room at first level; and seminar and meeting rooms at ground level. Much of the original ceiling renderings were replastered and retained to their original designs. The new seminar room, which can hold 120 people, has suspended ceiling equipped with lightings, air-conditioning ducting and other services.

A rear circulation space was needed for building services. This also involved a provision of a new stair connecting the kitchen with a back service yard. However, after a lengthy negotiation with the prison authorities a section of prison perimeter wall has been demolished and realigned. With the consent of English Heritage, external brick fins were also removed to create a necessary space behind the building.

Other works included the filling in of existing light wells to provide an exhibition space outside a lecture theatre and a new lift shaft within a small assembly area beside the council chamber. Another work was the addition of spacious entrance and reception areas to the building. The areas were created partly from an arched vehicular tunnel to the courts and also partly by taking a space from adjacent rooms. The architects have sought to achieve a bold and inviting entrance to the building. However, the stone arch at each end of the tunnel has been retained but provided with glazed doors. To access disabled people, the floor level has been raised at one side. At the reception desk, all access points to the building have been monitored for security.

Phase Three

The major work involved in the phase three was the refurbishment of adjoining council office accommodation. This included the redecoration and improvements of the semi-circular front block that hides the Sessions House from the road. Internal walls were replastered where necessary and external stone facades were cleaned by using low pressure washing method. Long terrazzo-floored corridors, which previously sound had echoed along them with virtually every footstep, were carpeted. Some areas in the building have been transformed to an open office plan with rest areas by removing partition walls. Double glazing windows were also installed on the main road elevations and lavatories upgraded. To allow core trunking to reach all office areas, suspended corridor ceilings were installed to carry electric, computer and telephone cables. Finally, colour coding has been used to identify different areas in the building and new recessed corridor lighted.

Building Requirements

A part from providing a thoroughly modern office environment for the Maidstone County Hall, it is required that the new uses should not affect the pristine clarity and decorative aspects of Sir Robert Smirke's design. For example, one may see Smirke's original designs such as doors, staircases and stone flooring in the assembly area which was used to be a session hall. Any structural changes should meet safety and building regulations. To meet the fire regulations, building materials were upgraded. This includes the application of fire-retardant coatings on timber panels. Fire-extinguishers are also strategically placed in the building. Since it is a public building, better links between the council chamber and adjacent buildings; and improve access for the disabled are necessary.



Sessions House.



Semi-circular block.



Main entrance with disabled access.



Internal courtyard.

Fig.69 External views of Kent County Hall



Restaurant.



Seminar room.



Reception Area.



New additions.



Council Chamber room.

Fig.70 Internal views of Kent County Hall

11.4 CASE STUDY TWO:

TATE GALLERY ALBERT DOCK, LIVERPOOL.

Historical Background

Designed by dock engineer Jesse Hartley in 1841-45, the Tate Gallery Albert Dock in Liverpool is a part of the finest group of warehouses in Britain. Its design was very much influenced by Philip Hardwick and Thomas Telford's St. Katherine Dock, London, of 1827-29. At the Albert Dock, semi-elliptical arches are introduced into the colonnade as bays for hydraulic cranes which were all powered from the central pumphouse. Once the bustling hub of the boom port in the 19th Century, the Albert Dock warehouses have been converted into a spectrum of commercial uses from fashionable residences and eating places to a maritime museum and art galleries. With its rugged industrial classicism, the Dock has been listed as Grade I building.

The Tate Gallery, which occupies the north-west corner of the Albert Dock, was chosen in early 80's to house a large quantities of London Tate Gallery's modern paintings. The Albert Dock was not only chosen for the excellence of the building but the cultural ambience of Liverpool. As a branch of the Tate Gallery, it is always referred to as 'The Tate of the North'.

Following his Tate Gallery's expansion plans in London, architect James Stirling of Stirling Wilford and Associates was recommissioned in 1985 to design the conversion of the new Tate Gallery in the Albert Dock. The three-year conversion saw the transformation of the warehouse to various uses including art galleries, artist studios, classrooms, bookshop, restaurant, offices and performance space.

Architectural Significance

The Albert Dock is outstanding not only as architecture but as a good example of metal and masonry structure. It is also one of the earliest

development in this form of construction and pioneered in open fire-proof interior.² This seven-storey warehouse includes a basement and mezzanine floor; and in plan was divided into various area by brick spine and cross-walls. Its massive exposed external brick walls and brick-vaulted floors are supported by a series of cast iron columns and arched beams. The existing stair shaft at the south end was the means of access between floors and its location influenced the arrangement of galleries. The floors are of either stone or timber.

At ground floor, a double-height entrance hall or foyer with two bow-fronted balconies above greet any visitors to the Gallery. A reception counter and reading room are located in the foyer. Loading and unloading services are in the service yard at the rear of the building. There are three double-height galleries. Two of which face the dockside while the other, located in between classroom and handling area, along the back overlooking River Mersey. These galleries were formed by removal of the existing very low first floor which now serves as a mezzanine. A new central staircase and lifts were provided to the mezzanine and first and second floor galleries. This main stair, which directly opposite the entrance, is entered past a delightful double circular column of revolving doors. At the mezzanine floor, there are a restaurant, book shop, offices and staff facilities.

While the first and second floors are given over to galleries and workshop areas, the third and fourth floors are given over to plant, services, artist studios and performance space. Air-handling units are placed on the third floor using existing window openings for intake and exhaust. Transit storage facilities and handling also occupy part of the third floor and are related to the goods lift. The service core passes through the roof to form a cooling tower, tank room and lift pulley room. In addition to the third floor, the basement is used for plant along with services, packing cases, cloak room and storage. The building was arranged in section to have wet services in areas where there was no risk of water

²"Tate on the Mersey", *Architectural Review*, July 1988, p.21

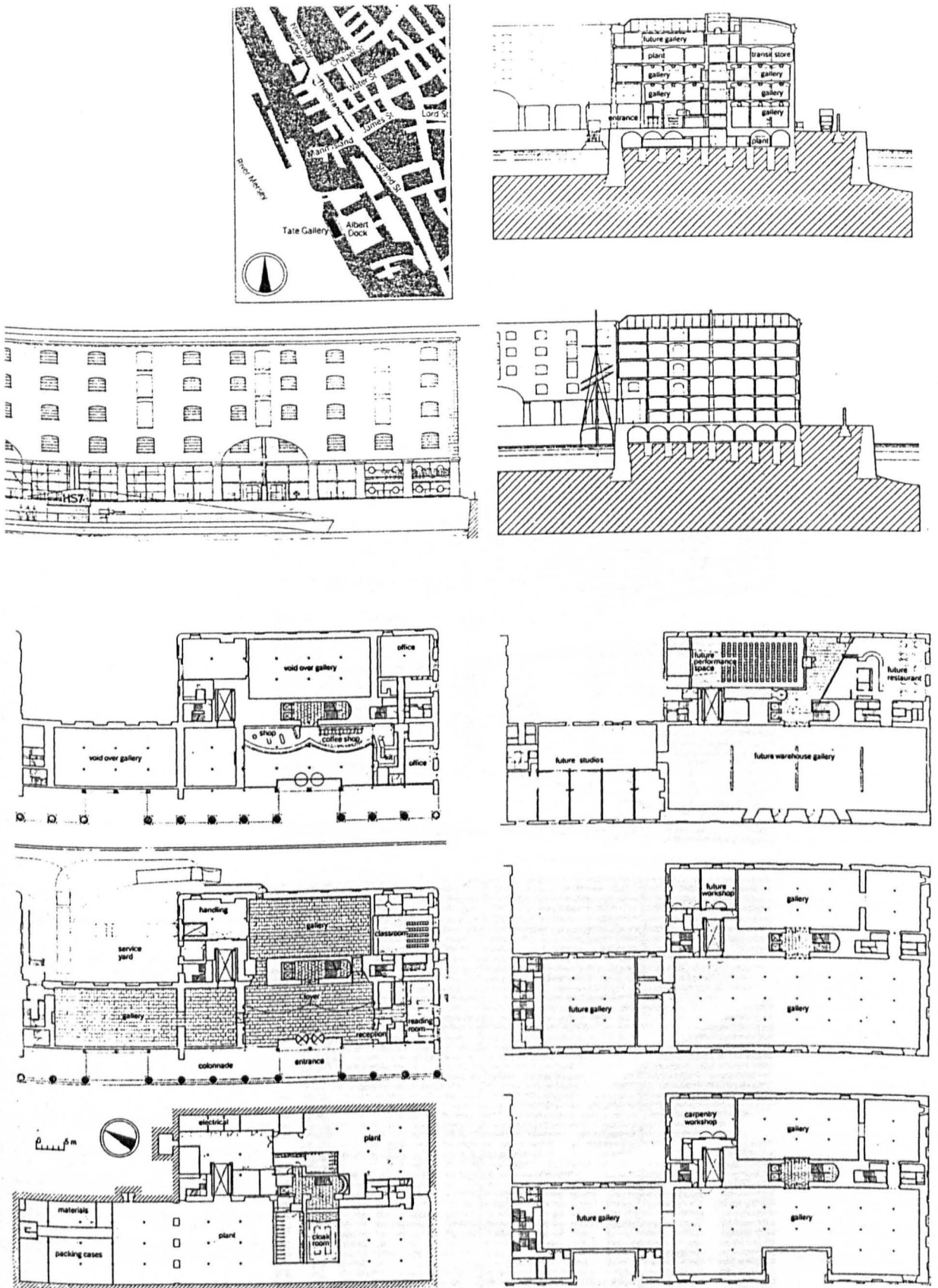


Fig.71 Sections, elevations and floor plans of Tate Gallery, Liverpool

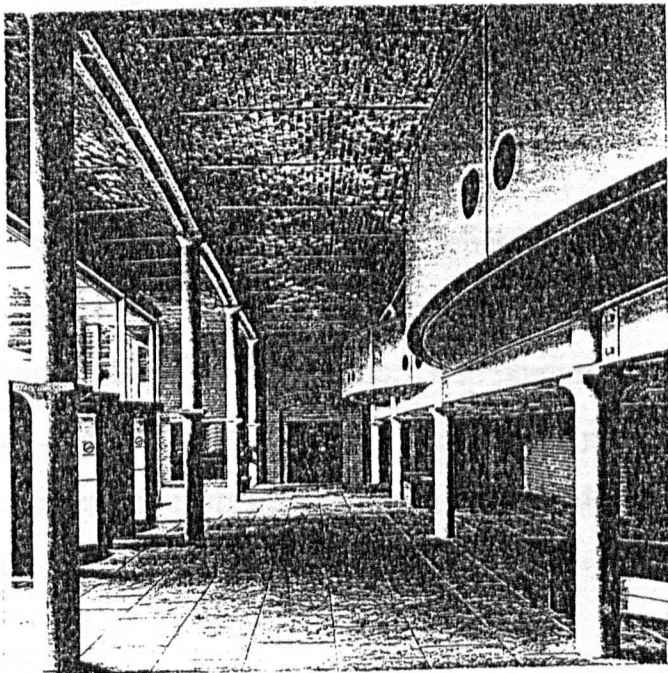
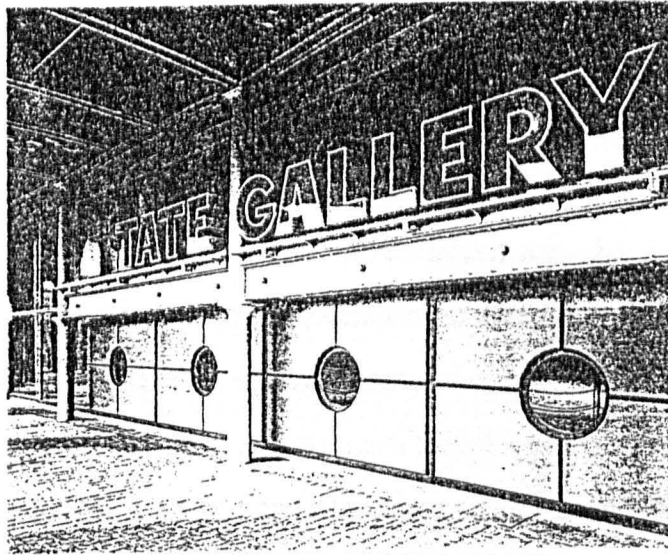
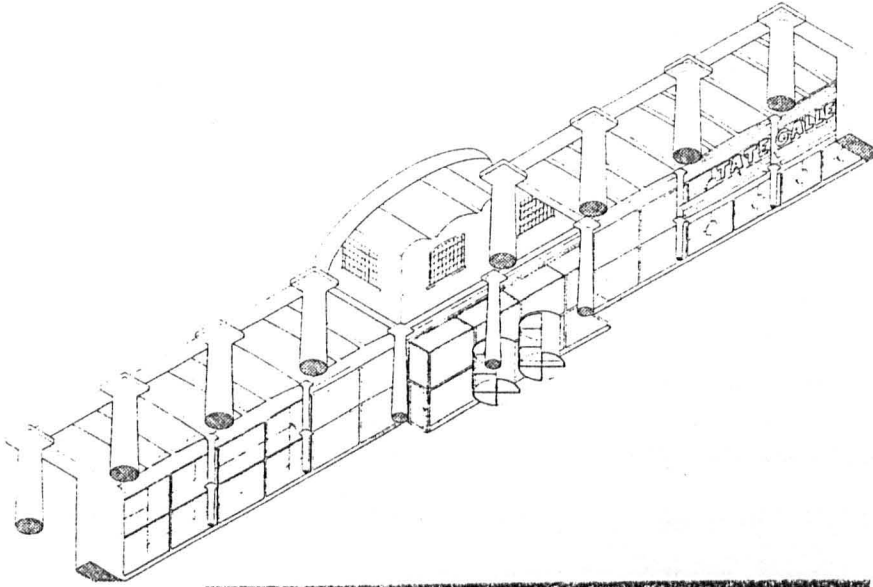


Fig.72. Main entrance and lobby of Tate Gallery, Liverpool

getting into the galleries. Therefore, wet plant and incoming services are restricted to the basement.

Building Condition and Problem

Even though the building appears ideal for conversion to an art gallery, there were several conditions to be considered. One of them is the constraints of the existing fabric. For example, on the upper floors, ceilings are lower than ideal. This has created a problem for the duct system that looms large in diagonal views, disrupting the ebb and flow of the vault. In addition, joining the new and old fabric needs considerable demands on craftsmanship, particularly between floors, walls and ceilings.

On the ground floor where the galleries are generously high and enclosed, providing sufficient lighting is quite important. In some rooms, windows have been retained to provide welcome visual release, drawing upon the gallery's marvellous location. Due to the presence of corrosive sea air, another condition considered was to achieve proper temperature and humidity control over large gallery floor areas. This is very important in the maintenance of any paintings and artifacts in the building. A challenge task here was to incorporate services necessary to create a climatic controlled and yet uniformly lit.

Building Conservation

Basically, the conservation of the Tate Gallery is divided into two phases. Phase I, which includes structural refurbishment, started in 1985 with a total cost of £7.5m. However, phase II is still subjected to funding at a budget cost of £3m. This will cover the provision of a warehouse gallery, resident artists studios, a performance space and restaurant at upper floors. Additional galleries and educational facilities will occupy the undeveloped southern end of the first and second floors.

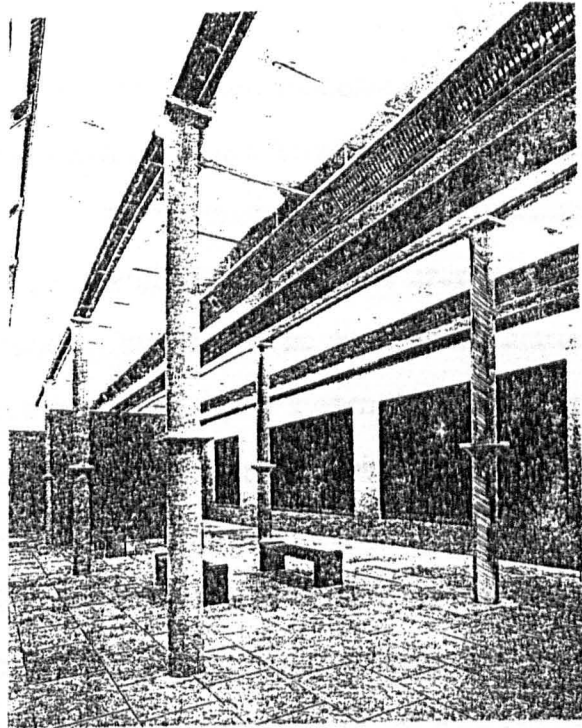
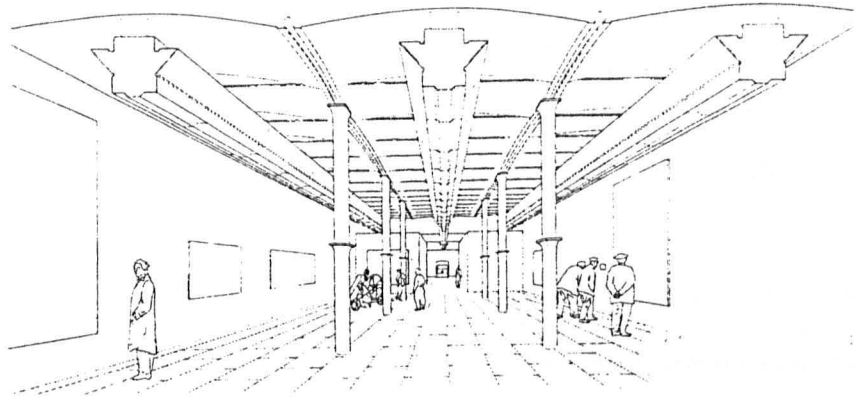


Fig.73 Perspective views of Tate Gallery,Liverpool

All conversions and alterations were carried out in two categories. Firstly, to make a sequence of galleries for displaying art and an entrance hall that is a public meeting place. Secondly, to achieve the environmental standards necessary for exhibiting art from any collection on the international gallery circuit.

The existing mezzanine at the ground floor was removed from all areas except the north end where the minimum floor to ceiling height was adapted for administrative and curatorial offices, a reading room and educational facilities. A permanent windowless wall was built to enclose the gallery facing the dockside colonnade to allow maximum hanging surface. Whereas transparent wall encloses the entrance hall and at the northern end it has small porthole windows for offices, reception and reading rooms. The double bow fronted balcony at the mezzanine floor overlooking the hall accommodates a bookshop and restaurant.

The low floor to ceiling height and the absence of floor voids are a characteristic of the existing building. The horizontal distribution of air and power is, therefore accommodated by a system of inner wall linings behind which is space to organise services. For example, in the offices, classroom and reading room these wall linings are developed as built-in furniture, in the galleries they become the surface on which to hang the art.

To achieve proper temperature and humidity control over large gallery floor areas, it was necessary to introduce air into the galleries from the centre of the space. The central fire wall has been enlarged by one column bay to form a bigger space containing vertical ducts (that link the basement plant room and air handling equipment on the third floor), main and escape stairs, lifts and WCs. Continuous vent ducts were suspended from the ceilings. These ducts contain uplighting, linear air-conditioning systems, public address loudspeakers, smoke detectors, fire alarms, sprinklers, data logging cabling; and infra red lighting control. However, in the galleries the ducts run above the centre of each column bay and are fed from both ends to reduce bulk. They are hung from suspension

brackets to compromise the brick vaults as little as possible. All vaults in the galleries were painted white to reduce the red component in reflected uplight which may affect the paintings displayed. The cast iron columns were also painted in light grey to look as neutral as possible. Architect James Stirling had chosen to exhibit the Tate Gallery's presence by putting a blaze of orange-framed blue infill panels and a chunky illuminated sign in front of the gallery.

Building Requirements

Apart from providing various rooms and spaces for the art gallery, it is important to achieve proper temperature and humidity control over large gallery floor areas. Maintaining the existing external facades is equally important as to harmonise with the rest of the warehouses in the Albert Dock. In such a big building, fire safety and fire-escape stairs should be considered in the conversion.

11.5 CASE STUDY THREE :

CHRIST CHURCH, STANNINGTON, SHEFFIELD

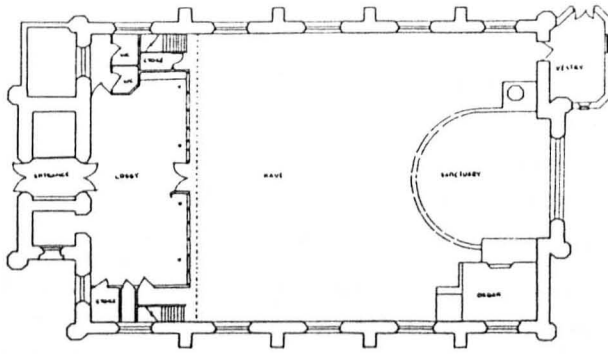
Historical Background

Christ Church, located at the corner of School Lane and Church Street in Stannington, Sheffield, is a good example of stone buildings built in 1828. It is one of the churches built under the 1817 and succeeding acts and is known as a "commissioners church". Surrounded by a grave yard, the building has been a centre for religious and social gatherings of the local community. It is historically important also as it is one of the oldest buildings in the area. It is a grade II listed building.

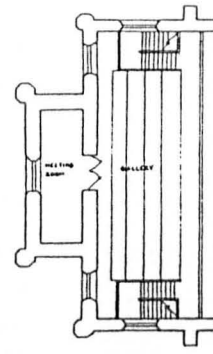
In 1992, alteration, extension and repair works were carried out to save the church. Architects Prof. K.H. Murta and Prof. Peter Fawcett were commissioned by the Church Committee to handle the job. The interior of the church was carefully considered while its appearance and building function have been retained albeit to meet modern liturgical requirements and to allow the pastoral role of the parish to be enhanced.

Architectural Significance

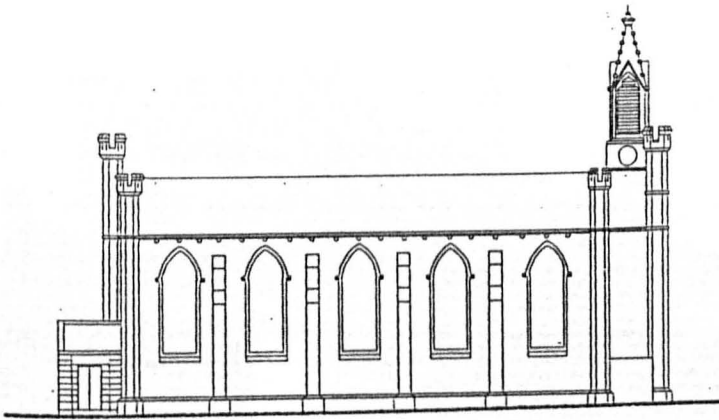
The Church, like many other churches in the country, portrays many features including stone walls, stained glass tracery windows, high ceiling and a clock tower. Other interesting features are small towers located at the building corners and a defined timber lychgate facing the road with stone paving leading to the main entrance. The Church is rectangular and planned symmetrically: a foyer, nave and sanctuary area. The application of building regulations has meant that access to the balcony and escape from it requires two new staircases. A new partition was built separating the foyer and nave. In addition, the building has been provided with new storage areas, toilets and a vestry located at the external northeast corner.



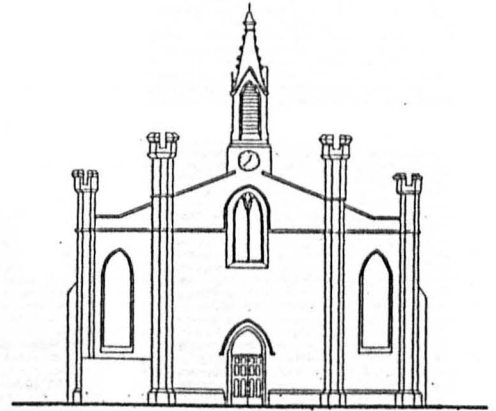
Ground level



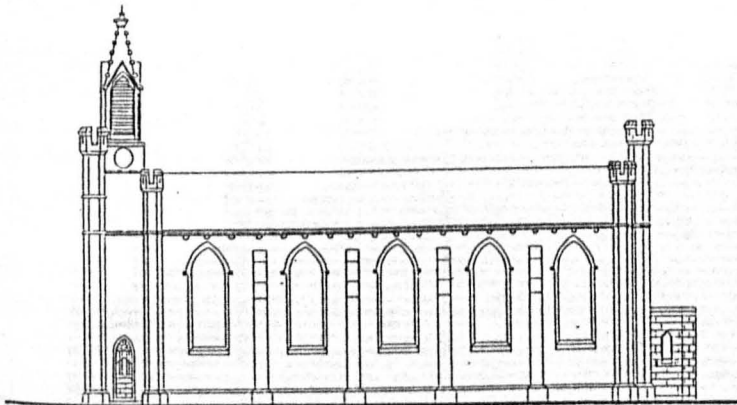
Gallery/Balcony (upper level)



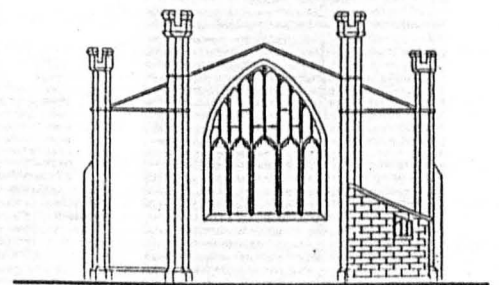
North elevation



West elevation



South elevation



East elevation

Fig.74 Floor plans of Christ Church,Stannington

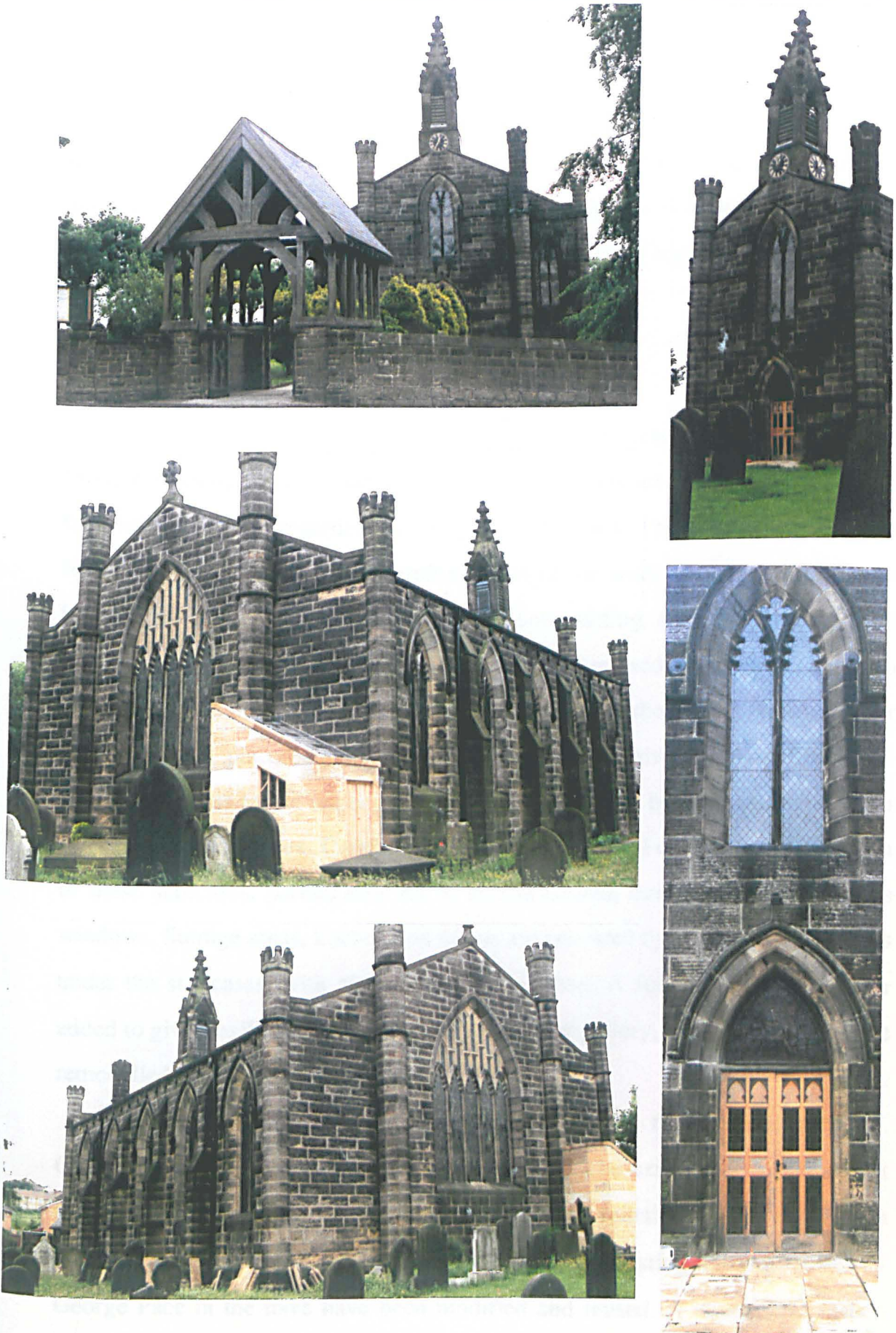


Fig.75 External views of Christ Church, Stannington

Building Condition and Problem

Due to its structural stability, there was little work to be carried out to the main building structures. However, the most challenging tasks came from the alteration and repair of the interior. The existing timber floor was damaged and rotted, and had to be replaced. The effect of the building regulations especially in regard to fire precautions and escape was far reaching.

Building Conservation

This is a case which poses the problems of updating building function. Modern worship requires participation between celebrant and people. A face to face relationship is regarded as being advantageous. The table should be the focus with people around it. Therefore much of the work was carried out in the interior of the building. This includes constructing a new partition wall underneath the existing gallery. Timber and glass are used to screen the space so created yet give a sense of integration with the body of the church. A new timber door has been placed in the middle of the wall to give access to the nave. However, access to the upper gallery, from the nave, is by staircases situated at both ends of the narthex. Careful work has been observed during the construction of these staircases, particularly not to let the landing damage the stained glass windows. Storage areas, kitchen and toilets are provided by placing them in areas under the staircases, with access from the narthex. A folding screen was later added to give flexibility to the space. On the upper gallery, the existing tiers were remodelled to give space new seating.

The whole floor including the sanctuary was renewed and carpeted. Old timber benches were replaced by new chairs. The existing organ located at the south corner of the altar has been inspected and remained in position. Much of the lighting were replaced by new ones. However, existing lighting fittings by George Pace in the nave have been modified and reused. A new sound system has been installed. Interior walls and columns were repainted.

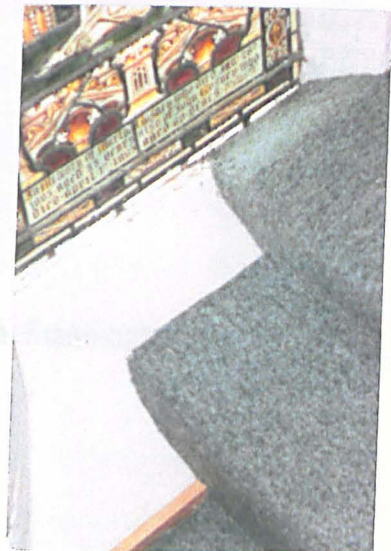


Fig.76 Internal views of Christ Church, Stannington

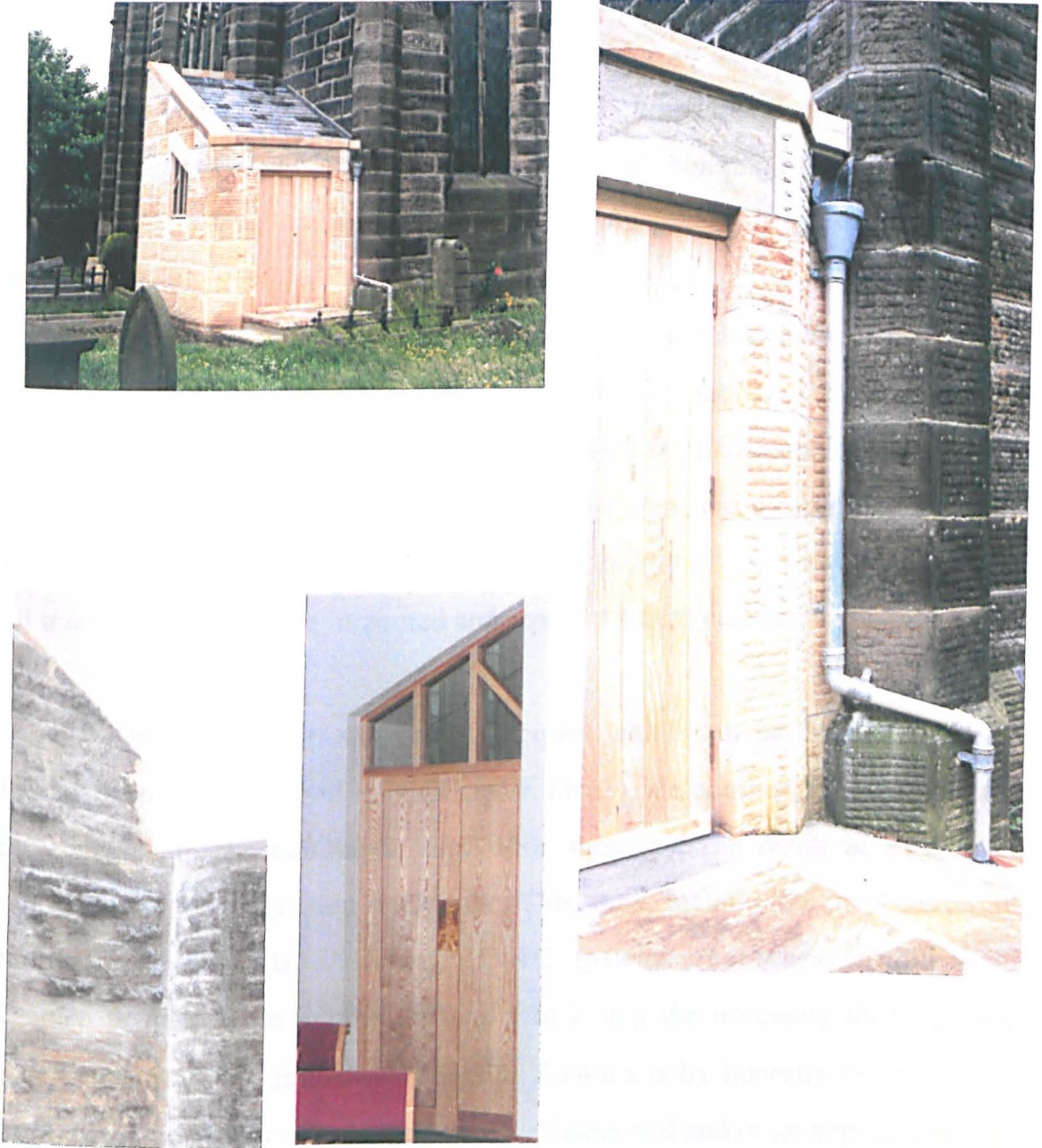


Fig.77 Vestry, Christ Church, Stannington

Another later addition to Christ Church is the vestry room located at the north corner of the rear elevation. The new vestry room was constructed in concrete floor slab and stone walls. An exit door has been provided for alternative escape from the interior. Once again the demand of regulations and standards has had to be accommodated in an historic building.

Building Requirements

Apart from alteration and repair works to the interior, fire requirements have been emphasized in new building materials. This includes the new partition walls, for which timber has been used. As required by fire regulations, the timber wall has had fire retardant coating applied. Exit signs are clearly visible. Stone flags at main entrance were reset to form ramp to door giving wheel chair access. All tracery windows were inspected and repaired where necessary.

Generally, there are some principles which can be derived from the three case studies discussed in this chapter. Firstly, the contrast between new and old elements in the buildings. Very often these are the result of mandatory requirements for upgrading buildings. This may include the application of building services, lifts, staircases, HVAC systems and access facilities for disabled people. There is often difficulty in hiding the necessary ducts, grilles, instruments etc. It is argued that the way forward is by honestly exposing new elements, provided always, that they are well designed and of an appropriate high quality and are skilfully related to the original fabric. The element of contrast has long been a tool in the hands of conservation architects and can be used positively.

Secondly, there is general agreement that harmonization of materials is a key factor in conservation. Modern techniques often mean that different forms may be used. The extension to the Church at Stannington shows how modern stone cutting techniques can lead to reconstruction of elements such as windows,

openings etc. in a satisfactory manner which by adding a further layer of history to the building while having reference to be original is a modern of design. Even though the renovation of each building was carried out in a different way, new materials applied are well blended with the rest of the fabric.

The third principle is that new materials are similar in quality to the original. This is quite important to ensure structural safety and high quality of constructional standards which are needed for long-term survival. It has been shown that durability must be a factor to be aimed for. The use of innovative materials should be approached with caution but their use may be necessary. New materials should have either the life expectation of traditional materials or positive measures should be used to ensure easy inspection and replacement without detriment to the fabric.

CHAPTER 12

CASE STUDIES

OF BUILDING CONSERVATION IN MALAYSIA

12.1 CRITERIA AND REASONS FOR BUILDING SELECTION

Four British colonial buildings in Malaysia are selected for case studies. The buildings include Sultan Abdul Samad Building (1894), Pertubuhan Akitik Malaysia or PAM Centre (1907), JKR 92 Memorial Library and Museum (1909) in Kuala Lumpur; and Old District Council (1910) in Klang, Selangor. Except the PAM Centre, all of the buildings are owned by the government.

The criteria on which these buildings are selected is based on that of the date on which they were built. The relevant dates for this study are between 1800 and 1930. Other criteria are architectural and historical values. A further aspect is that they all demonstrate conservation and rehabilitation work and that there is sufficient building information and documentation available. In addition, there are several reasons for selecting the buildings. Firstly, they are of different architectural styles such as the Moorish influence, Neo-Classical and also with a taste of Neo-Victorian. These diverse architectural influences not only portray significant and historical values of the buildings but somehow or rather affect the methods and techniques of building conservation. Secondly, each building has undergone both conservation and rehabilitation stages under the supervision of four different architects. This may perhaps give a good comparison on how each architect tackled building problems and new uses. Finally, although they are buildings mainly in the public sector, they have very different uses. Three of them are owned by the central or council government. The other example being

used as offices for PAM. Therefore, these are all good examples for analysing the financial supports received for the buildings, particularly their total conservation cost and funds for building maintenance.

12.2 METHODS OF CASE STUDIES

Between June and September 1991, a building research and inspections were carried out by the author on each of the selected buildings. These include the following:

1. historical research from the National Archive, PAM Resource Centre, National Museum, Kuala Lumpur City Hall and libraries,
2. building inspections covering structural survey, building condition and defects; and air-conditioning systems,
3. photographic study,
4. site investigations, particularly landscaping and neighbouring buildings,
5. interviews with architects responsible for the restoration and renovation works.

All building data including floor plans, elevations, photographs, building documentations and any relevant articles about the buildings were studied and analysed for the case studies. In each of the case study, the building is analysed by the characteristics of historical background, architectural significance, building condition and defects together with construction problems, building conservation; and building requirements. The buildings are also recorded at four different levels of recording which include a Visual record for the JKR 92 Memorial Library and Museum, the Descriptive record for the Old District Council, an Analytical record for the PAM Centre and Building of

Special Importance for the Sultan Abdul Samad Building. Generally, the Visual record includes basic information about the building's location, external appearance and circulation areas. The Descriptive record, however includes a description of building's plan, form, function, age, development sequence and names of architects or builders. The Analytical record requires analyses of building's history, appearance, structure and any changes in building's original form and fabric. The fourth level of recording which is Buildings of Special Importance includes a wide range of information such as a building's craftsmen, ownership and occupancy. It further discusses the building's significance in terms of architectural, social, regional and economic history. All of these will demonstrate examples of a differing approach in recording buildings as discussed in chapter 7.

In addition, the Old District Council and Sultan Abdul Samad Building are given as an example to illustrate the applications of the record card and building data matrix previously discussed in chapters 7 and 8. Floor plans, elevations, sections and photographs of each building are included in the case studies. Later in this chapter, a comparison of the buildings and recommendations to particular problems will be discussed.

12.3 CASE STUDY ONE :

JKR 92 MEMORIAL LIBRARY AND MUSEUM, KUALA LUMPUR.

Visual Record

Built in 1909 by British architect Arthur Charles Alfred Norman, the building is located on Raja Road facing the Merdeka Square in Kuala Lumpur, an area of historical, cultural and architectural significance. This two-storey building, formerly the Government Printing Office, was recently converted into a Memorial Library and Museum of Kuala Lumpur. It is a good example of the British architecture which blends Neo-Victorian features with the adaptation for the local climatic conditions. The building, which looks square from its floor plans, has an exposed brick exterior except for plastered pilasters, stonedressings, windows and other finishes. Entrance to the building is from the west side. A reception area is located near the entrance. There is an office space with six prefabricated iron columns at ground and upper levels. Access to the upper level is by an L-shaped staircase situated behind the reception area. A chiller plant room is located outside at the corner of the east elevation to provide air-conditioning systems for the building. This is a good example of placing the air-conditioning systems, for they do not affect the building fabric and appearance.

Historical Background

The building is historically important because it was designed by architect Arthur Charles Alfred Norman who was also responsible for the design of many historic buildings in Kuala Lumpur including the nearby St. Mary's Church and Sultan Abdul Samad Building. It is also located close to the Merdeka Square which was used to be the social and recreational ground for the European community during the British period. Apart from being used to house the Government Printing Office, the building was over years used by the Post and

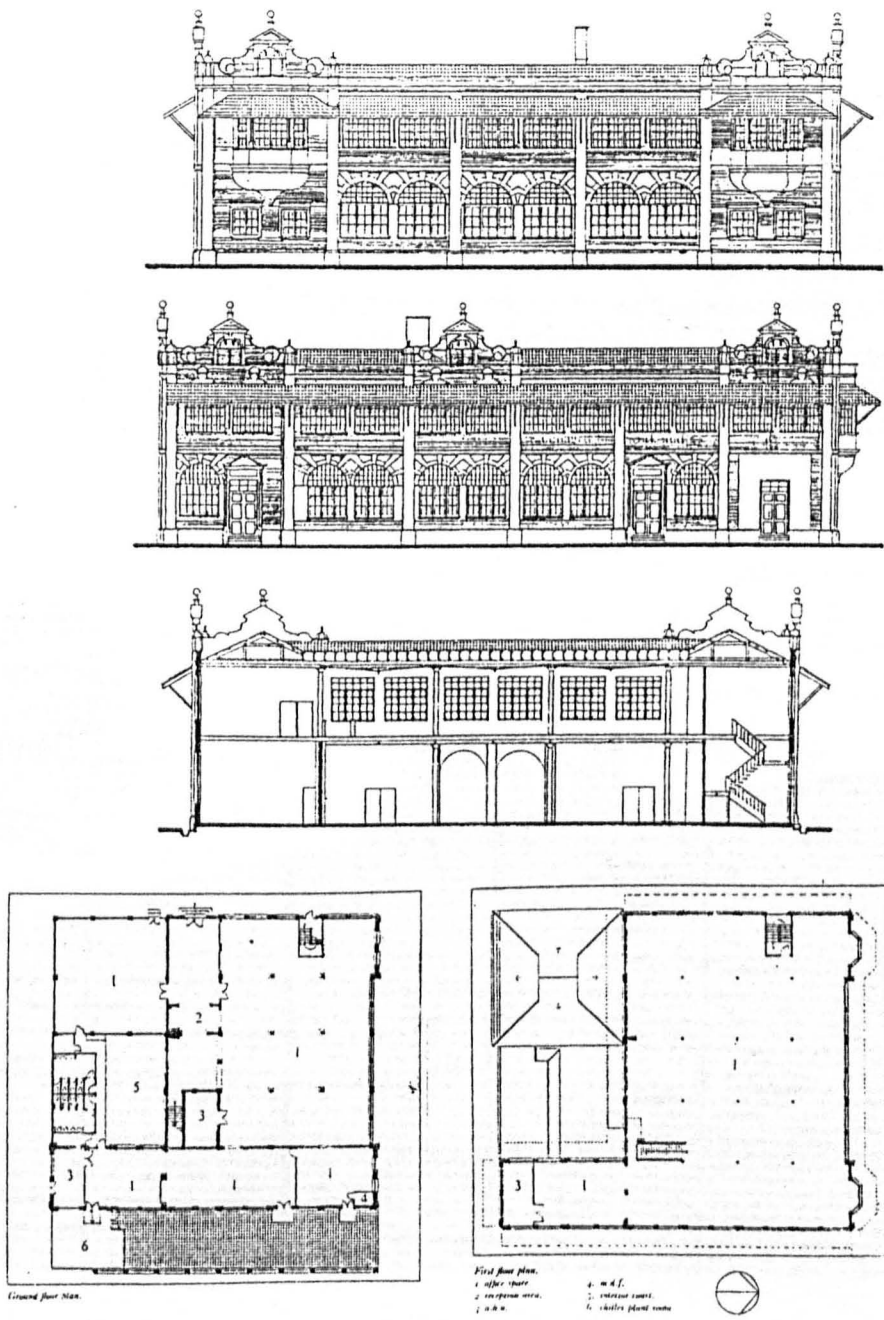


Fig.78 Elevations,sections and floor plans of JKR 92 Memorial Library and Museum,Kuala Lumpur

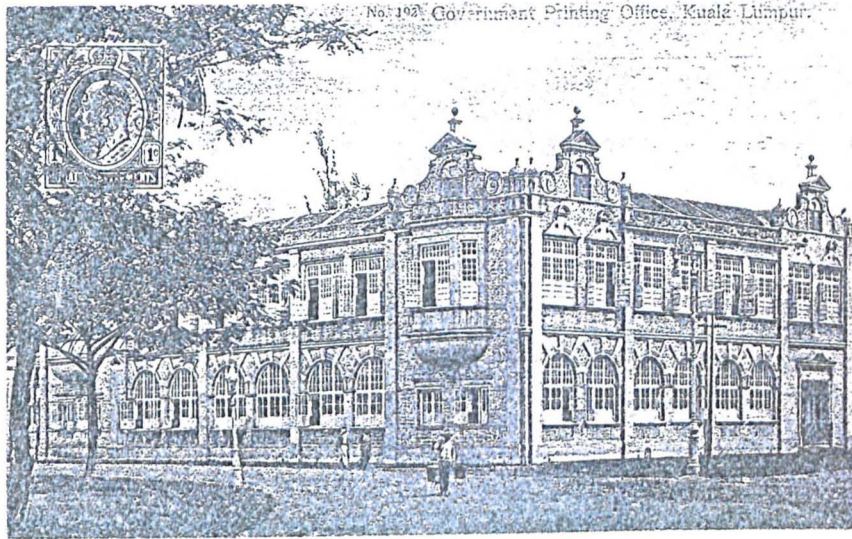


Fig.79 Two views showing the building then (above) and now (below).

Telegraph Offices, and the Ministry of Labour.¹ It is considered one of many early office buildings constructed to meet the administrative needs of Kuala Lumpur, the newly formed capital at that time.

Architectural Significance

Architecturally, the building portrays many interesting features including oriel windows at upper level, shaped gables at every corner which follow a Flemish design with triangular pediments crowning on top; and half-circular windows with keystones at ground level. Another feature is the shading devices overhanging above the upper level windows. The original design did not include these awnings. They were added some time after completion of the building for protection against the harsh tropical sun and rain which later become a part of the building design. There is no pronounced entrance or front porch in the building but a simple door at the west side. Although exposed brickwork is widely used, rendered painted plaster is the finish for pilasters and spandrels of the oriel windows.

The building is a good example of a type of local construction during the British period. This can be seen at the cast iron columns which exemplify the kind of prefabricated structural system used in many historic buildings of the time in England. Structurally, the building is of load bearing perimeter brickwork with an internal grid of columns and timber beams. At upper level, steel ties spanning between columns were used to give a greater structural strength. It was considered the most practical way of construction at that time, allowing a break away from normal traditional shophouse dimensions which were between 16 feet to 20 feet to 26 feet (5m to 6m to 8m).

Another features of the building are internal downpipes which were connected to the ground-level columns. However, during the restoration work the internal downpipes were redirected to the outside. This is because they had

¹Yeo Pang Boon, "Restoration of JKR 92", *Majalah Akitek*, March and April, 1986, p. 17.



Fig.80 North (above) and west (below) elevations.

caused leaks which damaged the floor structural members. A good example of preventative conservation.

The building was gazetted by the government under the Antiquities Act. A local architectural firm, Hajeeder Associates, was commissioned to carry the restoration and renovation works in 1985 and 1986. The total cost of restoration and renovation works was MR1.62 million.

Building Condition and Problem

Prior to the restoration and renovation works, the building was in a state of disrepair and poor condition. For example, some of the brickwork were deteriorating because of plants growing on its facade. Plaster and paint were peeling off both internally and externally. Many members of the roof and floor structures were decayed due to leakages in the roof and from the internal downpipes.

Throughout the years, the building has gone many alterations in order to accommodate with various changes in building uses. For example, entrances were created in existing window openings. Internal partitions were put up to provide office compartments and to house printing machines. Others include pipework running obtrusively on outside walls to supply the need of additional sanitary facilities; and air-conditioning units which were dealt by simply placing them on window units.

Building Conservation

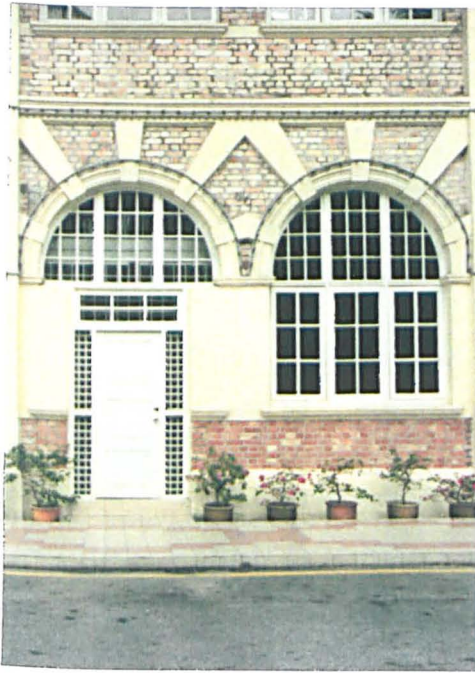
Prior to the restoration work, the architect made a study of structural conditions which includes roof, beams, columns and floors. This is of primary importance not only to restore the existing structures but to secure the safety of the building if it is to be used again. In an effort to restore the building, the architect has dealt with several areas. Firstly, to restore the building facade. This includes the reinstating of existing doors as windows and vice-versa which

required the reorganisation of the internal spaces. Existing ad hoc entrances were, as a result, relocated to the sides. Pipework running on outside walls was removed and relocated to a common area outside the building which also accommodates other sanitary facilities.

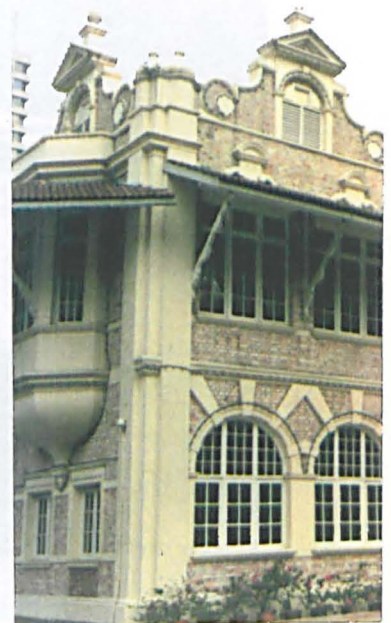
Secondly, the treatment of outside walls. The brickwork was cleaned, scrubbed and washed down with pressurized water in order to remove dust, paint and loose particles. Any damaged or chipped bricks were either replaced or touched up. Unfortunately, the final result is inappropriate. This is because in some affected areas, the new brickwork does not match or blend with the rest of the old bricks in terms of colour and texture. The colour of the new brick looks much reddish and its texture is much smoother. Getting the right colour and texture which match the old bricks is an important task. Apart from using similar bricks salvaged from other historic buildings, there is one way of achieving the task. This involves the process of grinding salvaged chipped bricks to form into new bricks which are in accordance to the existing shape and colour. Furthermore, during the restoration works any remnants clinging to the existing bricks were scrapped off. Fungal growth found on the brickwork was removed by applying hydrofluoride acid. New bricks were also given a water repellent coating. For the protection of painted and plastered surfaces, a special paint system containing unwoven fibre glass was applied to act not only as a glue but as reinforcement to both paint film and plaster. Then, a new coat of water-based emulsion paint was applied onto the surfaces.

Another aspect that was considered by the architect was the retention of the first floor awnings. The main reason for retaining the awnings is that these elements are not only typical of tropical construction but of both historical and architectural significance to the building. However, timber supports of the awnings had to be upgraded structurally in order to hold the new tile covering.

Air-conditioning was dealt by constructing a new chiller plant to centralise the air-conditioning for the building. As a result, air-conditioning units



(Above) Entrance door.
(Left) New brickwork seems does not match with the rest.

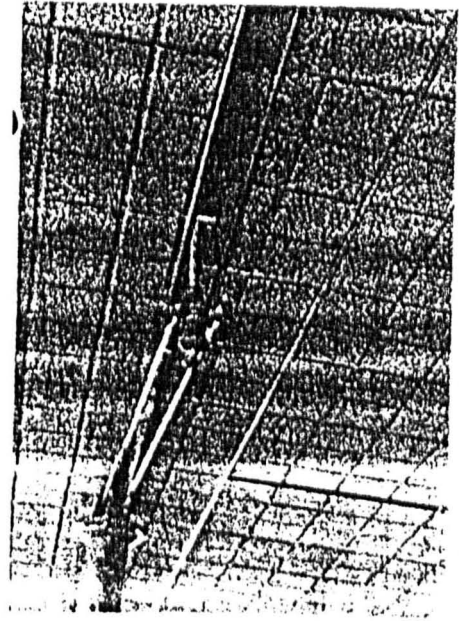


Close-up of the first floor awnings.

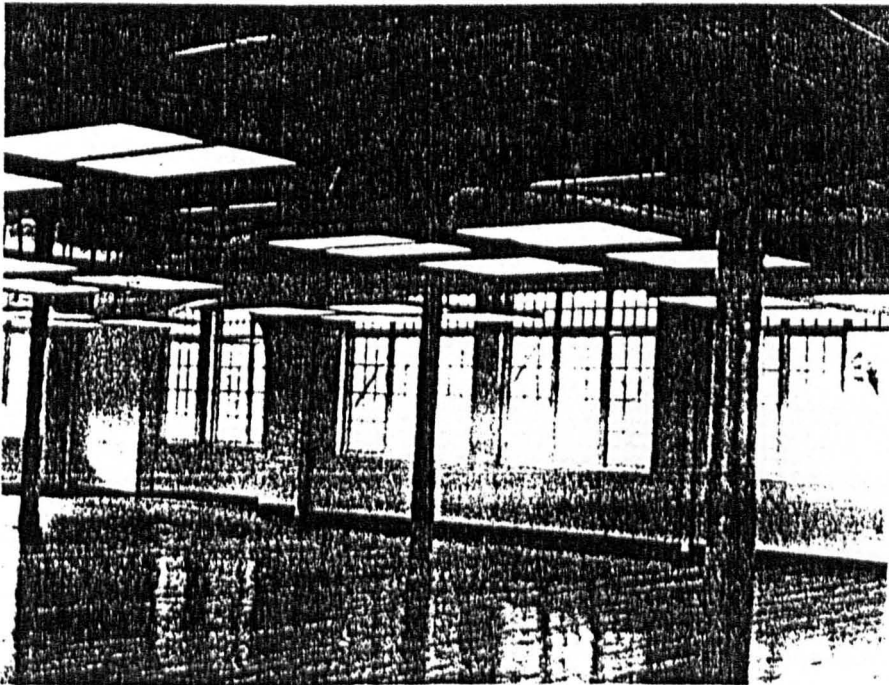
Fig.81 Building details



Prefabricated iron column and internal downpipe which was redirected to outside.



Steel ties spanning between columns to give a greater structural strength.



Interior view of upper level.

Fig.82 Interior views of the building

placed in window units were removed. Ducts running through at the ground level are in full view between main beams instead of being concealed above a suspended ceiling. For the ducts at the upper level, they are concealed conveniently in the roof space, giving prominence to structural framework. Another consideration is that the existing low height of the upper level would not allow a suspended ceiling. With the introduction of air-conditioning, the existing jack roofs were removed during the restoration work as the architect considered minimisation of the heat storage capacity of the roof space.

Building Requirements

Apart from upgrading the building structures and safety features, one of the building requirements was to improve fire protection. This includes the placement of cement boards underneath the floor joists. Fire exit doors and protective fire-escaped staircase were also improved. On the whole, the building did not undergo a major structural renovation because the new functions which are to house a library and museum are rather appropriate for the internal spaces. Therefore, no new partitions were introduced.

12.4 CASE STUDY TWO:

Old District Council, Klang, Selangor.

Descriptive Record

Built in 1910, the building was designed by British designer Harbeck assisted by W.S. Huxley.² It is located within an area of historical significance along Stesen Road where buildings of various western architectural styles have been built. Originally, the building was used for the Klang District Office. However, it was turned into the Klang Police Contingent Building from 1973 to 1985. In 1985, when the Police moved to their new headquarters in Shah Alam, the building was left unoccupied for two years. Then in early 1987, the building was restored and conserved to its original state for adaptive reuse as part of the Klang District Office.

This two-storey H-shaped building is symmetrical on its east-west axis. It consists of North and South wings and a West wing enclosing a courtyard on three sides with a centrally located staircase in the West wing. The North, South and West facades are emphasized by a series of collanades that form an enclosing verandah, a typical tropical construction for many old administrative buildings in the country. This predominantly portrays a western quality of the building. The front facade, which faces the Stesen Road, is featured by three porticos; of which the main portico situated in the centre. Later additions to the building include a new canteen located in the rear courtyard, centralised air-conditioning systems, shading devices for courtyard windows, new paving materials surrounding the building; and new landscaping at front elevation.

Its major building materials include concrete, brick, timber and plaster. Marseilles tiles are also used for the roof. When the building was taken over by the Police, it was painted white and blue, a colour combination which decorates every police station in the country. However, the external paint was stripped and

²"Police Contingent Building", *Majalah Arkitek*, Nov. and Dec. 1991, Vol.3, No. 6, p. 95.

repainted white during the restoration work.

Historical Background

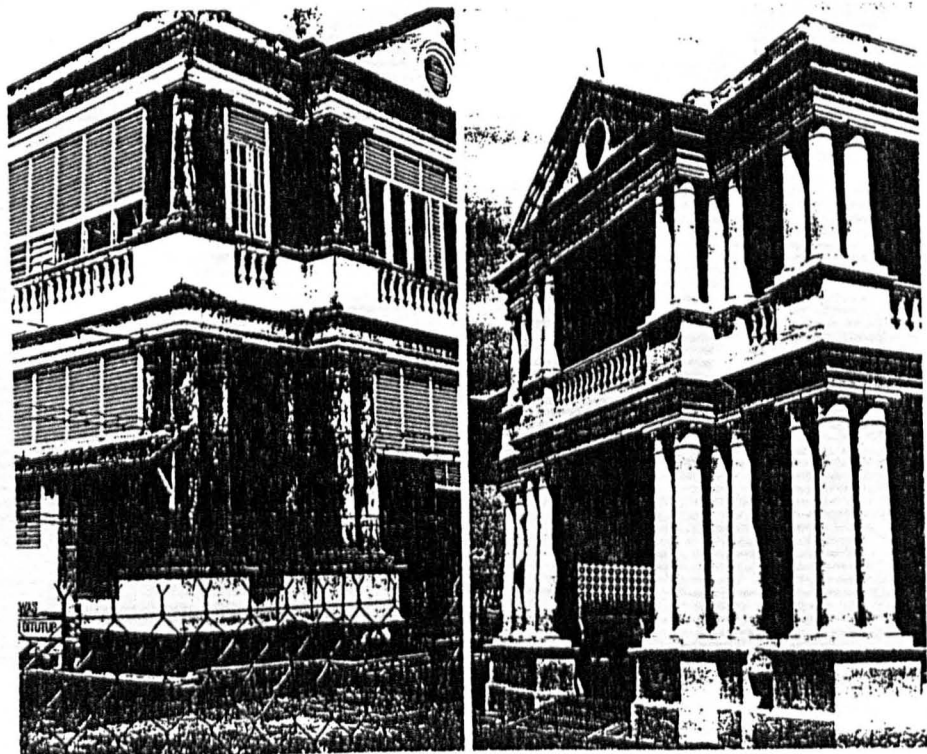
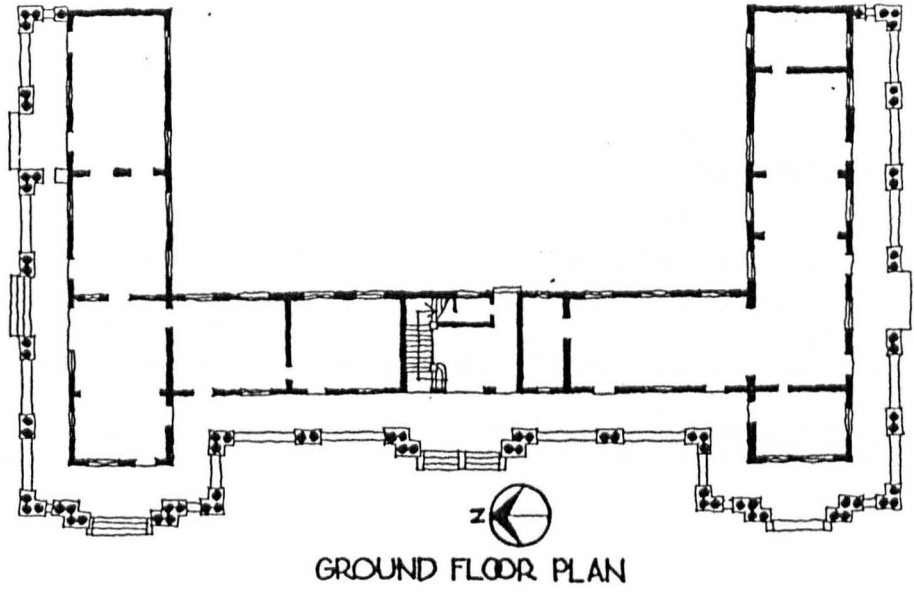
It was recorded by the National Archive in Kuala Lumpur that the date of approval of construction for the District Council was on February 25, 1908. The building was historically important because not only it was designed by a British designer but it is situated close to buildings of various architectural influences, making its area of historical significance. Under the Antiquities Act, the building was gazetted and given protection for preservation and maintenance. In June 1987, CSL Associates was commissioned as the architects responsible to carry out essential repair works as well as to restore and conserve the building to its original state for adaptive reuse.

Architectural Significance

Architecturally, the building portrays some common features which can be spotted in many government offices and schools built during the British period. These include a series of colonnades, porticos, verandah and balustrade at upper level. Like the JKR 92 Memorial Library and Museum, the building is architecturally important because it is an early example of adaptation for tropical design including louvred windows located on each pediment of the porticos, window awnings and sun louvres in the verandah. Another interesting thing about the building is that the use of locally-made rendered columns, concrete balusters and cornices in the pediments. All of these have made the building structurally sound and solid.

Building Condition and Problem

Since the building was left unoccupied for two years prior to the restoration works, its condition was dilapidated. For example, external paints were peeling off. Mould or fungal stains were found on exterior surfaces. Some



Before

After

Fig.83 Ground floor plan; and the building before and after renovation



Front elevation.



Fig.84 Views of Old District Council Offices

of the roof tiles were found missing and unwanted plants were spotted on the roof. Many windows and doors were broken and needed to be repaired. Timber floor boardings were left disrepaired.

A survey of the existing building was carried out by the architects to document the conditions including its existing interior finishes, essential repairs required and suitable replacement for missing items.³ This included a photographic survey, producing measured drawings, proposing rectification and repair works on any defects; and preparing schedules for building conditions and demolition of recent additions.

Building Conservation

To ensure that the restoration and conservation works confined with the original state of the building, the architects had to refer to the original working drawings kept at the National Archive. Most of the works include the restoration of the building fabric itself. For example, the existing blue and white external paint was stripped and the building was repainted white to match with the original base coat. However, prior to the painting work, mould or fungal stains were dealt with. Plastered mouldings around openings were restored and highlighted. The sun louvres in the verandah were repaired and painted black to differentiate between solid and void of the building.

The interior timber finishes and floor boardings were restored and rejuvenated. To highlight the beauty of the original wood, the boardings were carefully stripped and polished. Any defective windows and doors were restored to their original appearance. Other building parts which were restored and enhanced are the arches to internal openings and entrance arches leading to the main staircase.

As far as the roof structures are concerned, they were repaired with minimum interference to the original fabric. Only defective parts were cut and

³"Colonial Legacy", *Majalah Aritek*, Jan. and Feb. 1989, p. 46.

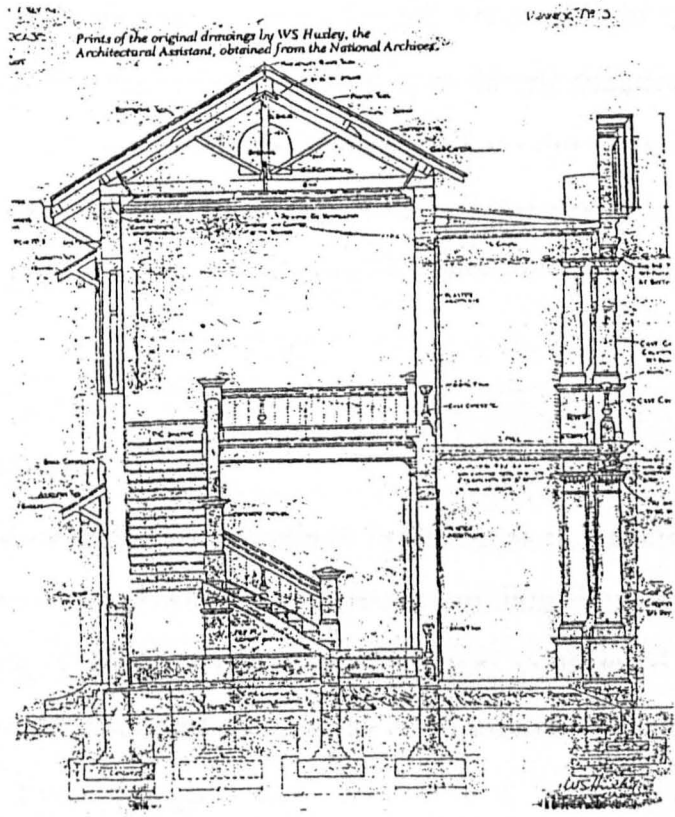
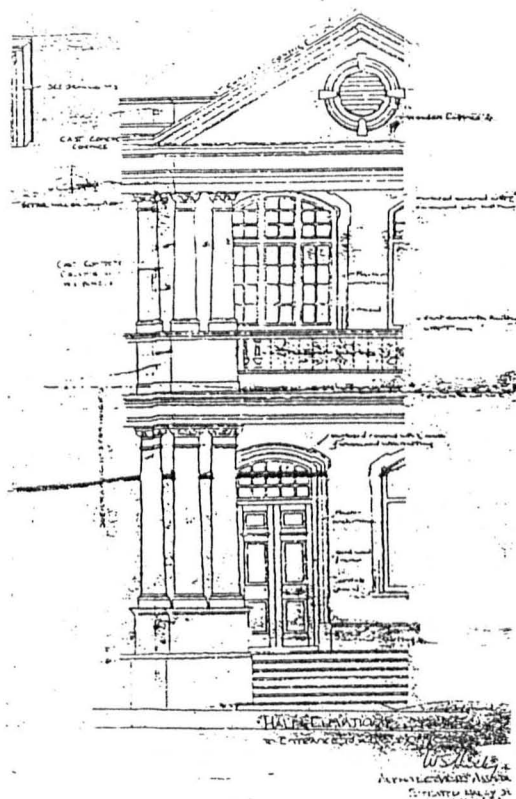


Fig.85 Copies of the original drawings of the building

replaced by a similar material available. For instance, the original Marseilles tiles were replaced from those in buildings of the same period which have been demolished.

Air-conditioning systems were dealt by centralising the air-conditioning units and locating them at one place outside the building, in the enclosed courtyard. This is a good example of handling the units, for they do not affect the building appearance and disturb the exterior walls as well. The architects had placed planting at one side of the units. Even though it is considered a good idea for screening purposes, it is felt that more short plants should be planted around the units. In addition, the units should be covered or protected against rain and sun.

Later additions to the building including wall partitions, awnings at ground level and toilets situated at the ends of the colonnades to each wing were removed. This is important as to maintain the originality of the building. To beautify the surrounding area of the building, new paving materials were laid and trees were planted at front facade to incorporate into the overall scheme. Even though this affects the originality of the building premises, it is considered that the paving and planting may aesthetically enhance the importance of the building.

Building Requirements

A part from restoring the whole building, it is required that the new function should be confined within the existing building floor plans. In fact, the architects' approach of an open office-planning was considered to be the most suitable as this would not alter the spatial configuration and ambience of the existing building. Even though a new canteen was built separated from the building, there is no major construction added or attached to the building. However, as required by building regulations the architects have also considered the fire and safety requirements. These include exit signs, fire extinguishers and

security guards.

12.5 CASE STUDY THREE:

Pertubuhan Akitek Malaysia (PAM) Centre, Kuala Lumpur.

Analytical Record

Pertubuhan Akitek Malaysia or PAM Centre is located at No. 4 & 6 Tangsi Road in Kuala Lumpur, an area close to historic buildings such as the Selangor Club, Sultan Abdul Samad Building and St. Mary's Church. This two-storey Centre consists of two separate buildings of which are presently used to house the Secretariat of Malaysian Institute of Architects, conference and committee rooms, a building materials display centre, a library and classes for Architectural Technician Training Course. Also, an office space for the Heritage of Malaysia Trust and Eastern Asian Region Organisation on Planning and Housing.

The Centre, which was referred as Loke Hall, was originally built in 1907 as a mansion for Loke Chow Kit, a prominent businessman and municipal councillor. Loke's design of his house was influenced to some extent by what he saw during his European tour with his friend Loke Yew in 1903.⁴ Built by Loke Chow Kit himself, the building has pediments, hooded moulds, fanlights, porch, loggia, blind arcade, corner quoins, regency verandahs or balconies which all contribute to its architectural delight. It also housed a suite of offices for Loke's mining ventures.

Before the building was occupied by the Malaysian Institute of Architects in June 1973, it has undergone several stages of adaptive reuse. From 1907 to 1909, the building was occupied as a residence for Loke Chow Kit and his family. In 1909, the building was taken over by a European group who turned it into a hotel called the Empire Hotel. However, in 1916 the building was sold to Loke Yew's son, Alan Loke who later renovated it to become a new hotel named

⁴"Back to Its Past Glory", *Malay Mail*, Aug. 17, 1990.

the Peninsular Hotel. It is believed that the building became a meeting place for many planters and members of the trading houses around Kuala Lumpur. Due to strong competition from other existing hotels in the city such as the Station Hotel, Eastern Hotel and Majestic Hotel; the Peninsular Hotel had to close down. The building was then left unoccupied for a number of years before the Loke Trust was set up to take charge of the property.

When the Malaysian Institute of Architects moved its Secretariat to the Loke Hall in 1973, the building was in a serious and dilapidated condition. Roof leaks, sagging rafters, rotting timber and earth movement are some of the examples. There was a proposal to demolish the building and the adjoining properties for a high-rise building project. This has drawn much public concern including conservationists and members of the Institute. However, in late 1989, it was suggested that the Institute should continue to keep the premises in a good state of repair and maintain a record of cost expended for future considerations of the Kuala Lumpur City Hall. Architect John Koh of Akitek Majubina was commissioned in 1989 by the Institute to carry out a restoration and refurbishment programme for the building.

Historical Background

Built in the early 1900, the PAM Centre is an example of a high degree of local artisans' craftsmanship during that period. Historically, the building is often associated with the early development of Kuala Lumpur. This is because it is located in an area where many administrative, commercial and religious buildings have been built. Owned by one of Kuala Lumpur's leading businessmen, the building has reflected the growth of commerce, particularly the tin mining, and wealth of the local people in those days.

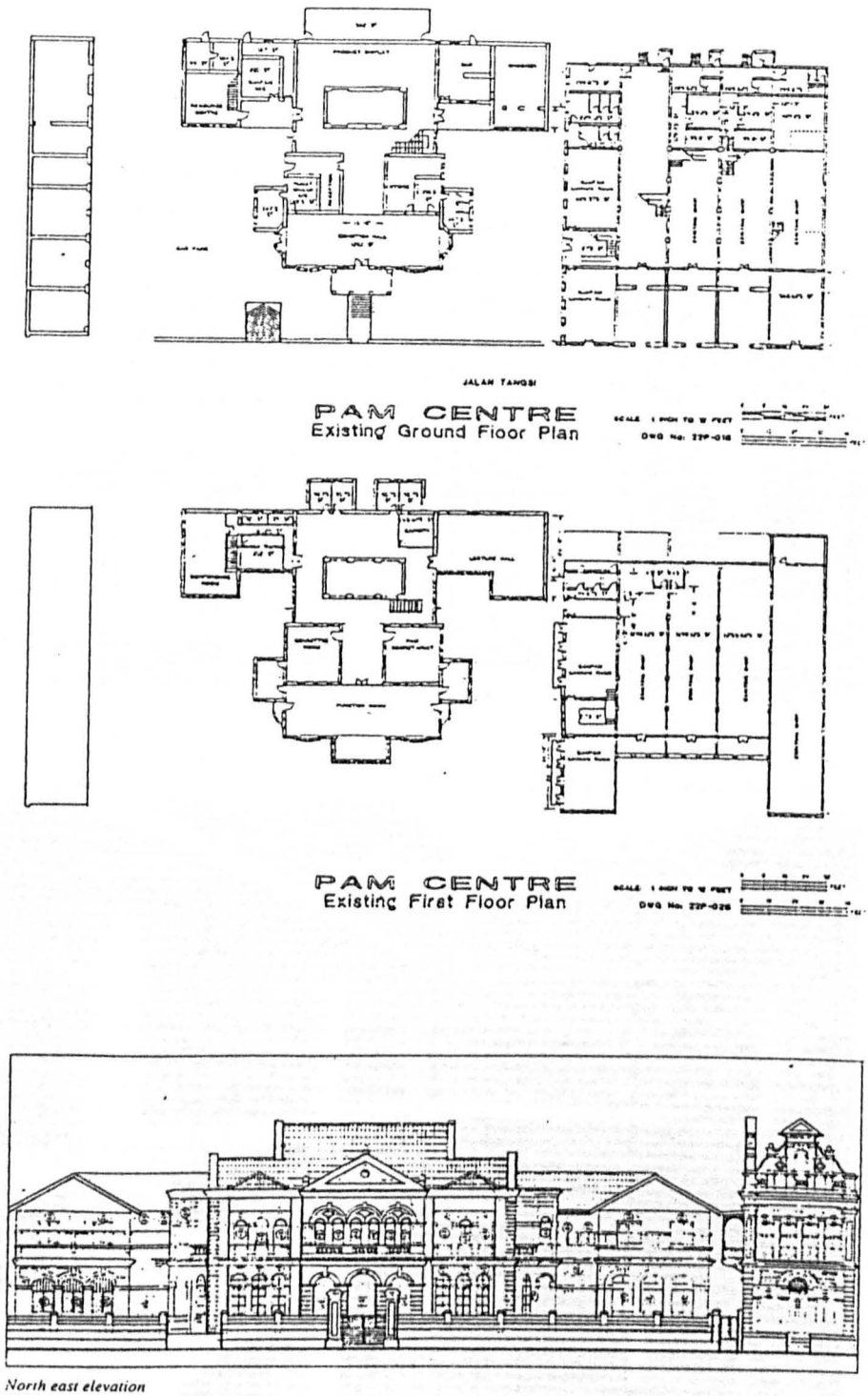


Fig.86 Floor plans and north-east elevation of PAM Centre



Fig.87 Main entrance (above) and internal courtyard (below).

Architectural Significance

The PAM Centre was built complete with stables and carriage house enclosing a yard on the south and an office annexe on the north. Architecturally, the building is more than Neo-Classical in style with the adaptations to the local climate. This tropicalised classical building is rich in architectural details and vocabulary. These include decorative pediments, hooded moulds, louvred and French windows, regency balconies, loggia, corner quoins, fanlights and an internal courtyard. Both buildings of the PAM Centre including the main residential building and its annexed office block are built of load bearing walls of masonry construction. Building materials include Chengal timber, brick and plaster. The external walls were originally painted with lime wash but later in the years were painted over by modern paints. However, during the restoration work the building committee decided to repaint the walls with lime wash, to return it to what it was originally painted, and to retain the original colour scheme of white and cream yellow.

The PAM Centre was planned symmetrically along a central East-West axis with its space equally balanced on both sides. The central three pairs of arched windows on the upper level, echoing the triple-arched portico at below, are topped by a Palladian pediment. The roof does not overhang the facades but stopped by a shallow cornice. To allow ventilation into the building, fanlights are filled with timber louvres. In addition, the internal two-storey colonnaded courtyard allows more light and ventilates the back half of the building internally.

Building Condition and Problem

Before the PAM Centre was restored, its building condition was in the state of disrepair. Roof leaks and rotting timber were the main problems. A structural survey in late 1983 indicated that the main roof was in dangerous state of collapse developing from extensive termite attack and rot. Also the problem of earth movement at the back of the building. The external walls had to be

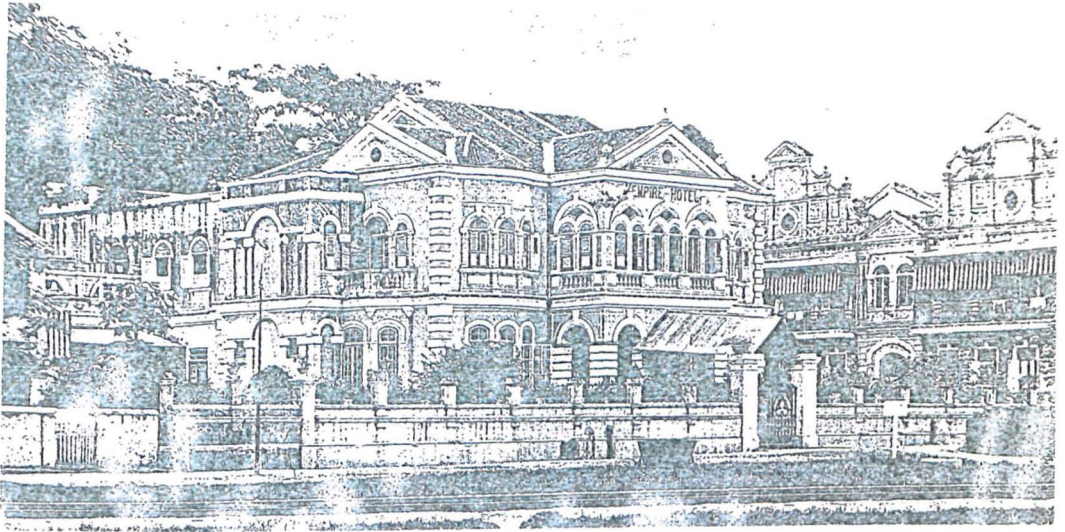


Fig.88 PAM Centre before (above) and after (below) renovation.

repainted as surfaces started to peel off and develop mould or fungal stains. Some of the windows and doors needed to be replaced.

Another problem facing the restoration and refurbishment of the building is insufficient financial support. This is because the building is privately owned and that all the expenses for the works of renovation, restoration and continual maintenance are at the Institute's own costs. Unlike other historic government buildings, the PAM Centre received most of its funds from donation or loan from members of the Institute, income from the products display centre and the Architectural Technician Training Course classes.

Building Conservation

As far as building conservation is concerned, a programme of restoration and refurbishment was planned and carried out in two phases. Phase One included the exterior skin of the building, ground floor, foyer area, toilets and offices, upgrading of building services, pest control works and the construction of retaining walls to the rear landslip. On the other hand, Phase Two covered the redecoration of the first floor of the main building, sewerage, landscaping, renovation of library, products display area, members lounge; and relocation of the Secretariat and Council's meeting room. The works were carried out within two years starting from 1989.

Prior to the implementation of the phases, several studies, surveys and proposals were carried out. These include the following:

1. background research,
2. photographic study and measured drawings,
3. termite damage survey and pest control works,
4. structural survey,
5. slope improvement studies,
6. building utilisation study and space planning,
7. landscaping proposals,

8. cost estimation,
9. tender and contract documentation.

Termite attack at the roof was controlled by drilling the slab at intervals and injecting with chemical. Roof leaks and rafter sagging were meant by re-roofing the affected sections. Some of the broken roof tiles were replaced by similar tiles salvaged from other historic buildings. Retaining masonry walls were constructed and some vegetation at the back of the building was cut down to prevent further earth movement. Timber floors were repaired, cleaned and polished. Broken windows and doors, most of which made of timber, were repaired and maintained their finishes including brass hooks for casement windows.

One of the interesting works during the restoration and refurbishment of the exterior walls is the use of lime wash. It was decided by the building committee that the building should retain its original lime wash paint and colour scheme which was cream yellow. Before the new lime paint was applied, old paints were scraped off. Any tough dirt or fungal stains on the wall surfaces were cleaned using wire brush and water. This followed by the application of one layer of anti-fungus limer paint. Consultation with chemists of a paint company was sought for better treatment of the new finishes.

Like many other historic buildings, the PAM Centre was improved by the air-conditioning systems which were dealt with by a split system. However, only certain rooms were air-conditioned. Others such as lecture rooms, exhibition hall and products display area around the internal courtyard depend on natural ventilation. Plenty of windows around the building also allow cross-movement of air. The total cost of the restoration and refurbishment of the building was around MR2 million.

Building Requirements

Besides the restoration and refurbishment of the building fabric, the building had to repair some of its major structures for safety and fire protections. All rooms and spaces were carefully conserved to accommodate new uses. Landscaping within the building premises is also included. In addition, all changes should remain as close as possible to the original scheme of 1907.

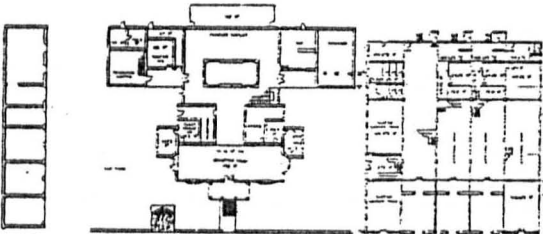

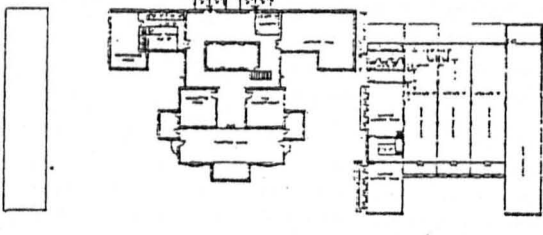
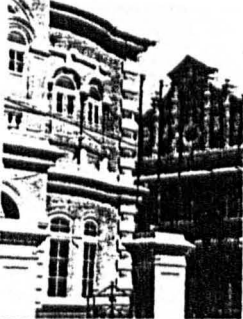
HISTORIC BUILDING RECORD CARD		
1 Name of Building: PAM CENTRE (LOKE HALL)	5 Date Built: 1907	11 City of: KUALA LUMPUR
2 Address: NO 4 & 6 TANGSI ROAD KUALA LUMPUR	6 Architect/Builder: LOKE CHOW KIT	12 File Refs.:
	7 Cons. Area:	13 Map Refs.:
	8 Grade: -	14 Listing Serial No.: -
3 Building Type: RESIDENCE	9 Date Listed: -	15 Photographer: A.G.A
4 Owner: LOKE TRUST	10 Recorder/Surveyor: Mr. A. Ghafar Ahmad	
16 Description: This two-storey building is more than Neo-Classical in style with the adaptations to local climate. The Centre has a main building with stables and carriage house enclosing a yard on the south and an annexed block on the north. It has decorative pediments, hooded moulds, louvered windows, balconies, loggia, corner quoins, fanlights and internal courtyard. Building materials include timber, brick and plaster.		
17 Map and Photographs:		
 <p style="text-align: center;">PAM CENTRE Existing Ground Floor Plan</p>		
 <p style="text-align: center;">PAM CENTRE Existing First Floor Plan</p>		
18 Scale of Map: NOT ON SCALE	19 Date of Photograph: 12-8-91	20 Photographic Refs.: PC 1002
21 Building Problems: NO		22 Is the Building at Risk? NO

Fig.89 Front page of Historic Building Record Card

HISTORIC BUILDING RECORD CARD						
Dates	NAMES & Address	Owner	Occupier	Architect	Other	Initials
Dates	USES Floor by Floor if Different	Empty	Occupied			
1907-09	Loke Chow Kit No. 4 & 6, Tangsi Road Kuala Lumpur	<input checked="" type="checkbox"/>				
1909-16	A European Group (Empire Hotel)	<input checked="" type="checkbox"/>				
1916-	Alan Loke (Peninsula Hotel) & Loke Trust	<input checked="" type="checkbox"/>				
1973-	Malaysian Institute of Architect		<input checked="" type="checkbox"/>			
1989-90	Architect John Koh of Arkitek MAJUBINA 11A JLN. 52 21/50 & DAMANSARA UTAMA, PJ. <small>* Please Specify</small>		<input checked="" type="checkbox"/>			
1907-09	Residential		<input checked="" type="checkbox"/>			
1909-16	Hotel		<input checked="" type="checkbox"/>			
1916-	Hotel		<input checked="" type="checkbox"/>			
1970	Hotel		<input checked="" type="checkbox"/>			
1973-92	PAM Centre		<input checked="" type="checkbox"/>			
Dates	CONDITION Diagrams and Proposals					Initials
1973	Roof Leaks and Rotting Timber					
1983	Main roof in a dangerous state of collapse arising from extensive termite attack and rot.					
Tick for Continuation Sheet						

Fig.90 Back page of Historic Building Record Card

12.6 CASE STUDY FOUR:

Sultan Abdul Samad Building, Kuala Lumpur.

Level 4: Building of Special Importance

Formerly known as the Secretariat Building, Sultan Abdul Samad Building (named after the then Sultan of Selangor state) is considered as one of the most important historic buildings in Malaysia. Its unique and dramatic style; and grandeur of scale have made it the first architectural landmark in Malaysia. It has come to symbolise the city of Kuala Lumpur. Designed by British architect A.C. Norman assisted by engineer C.E. Spooner, the building was built in 1894 and completed in 1897 with a total cost of MR152,000. The building was designed with a mixture of Moorish influence inspired from northern India and European styles. It is of historically and architecturally significant, particularly to the early development and history of Kuala Lumpur.

The Sultan Abdul Samad Building, stretching 121.91 metre or 400 feet along the east of Raja Road, is situated in an area facing the Merdeka Square and backing Belanda Road and both Gombak and Klang Rivers. It is surrounded by many historic buildings including Jamek Mosque, St. Mary's Church, Selangor Club, Old Standard Chartered Bank Building, JKR 92 Memorial Library and Museum, Infokraft Malaysia, Old General Post Office and High Court all of which form the most memorable combination of the British colonial architecture in the country. It was originally constructed to house the Secretariat offices of the Colonial State of Selangor. It served this function until 1978 when, the Federal Territory having been established, the Selangor Government moved to Shah Alam, Selangor's new capital. During these 81 years, the building has modified and undergone many changes and additions in response to high demands for office spaces.⁵ It was then handed over to the Justice Department to be used as both the Federal and High Courts. However, due to difficulties in reconciling its

⁵Martin Dickie, "Bangunan Sultan Abdul Samad, Jalan Raja", *Majalah Arkitek*, March and April, 1986, p. 33.

plan of small cellular office spaces with the large rooms required for the Courts, the building's initial schemes for the conversion did not meet with the official approval. Later in 1979, an architectural firm BEP Akitek was commissioned to undertake the works of restoration and conservation to fit with the new required spaces. Under the Antiquities Act, the building was gazetted by the government on October 13, 1983 for preservation and maintenance.

This two-storey building, with a mezzanine floor of 5.48 metre or 18 feet high in between, was planned asymmetrically with an F-shaped plan form. Constructed of exposed red brick with imitation stone dressing made of plastered brick and a tiled roof; the building has adopted a two-metre wide verandahway around both floors. The verandahs that surround the building are arcaded and emphasised by various forms of arches including pointed, ogee, horse-shoe, multifoil and four-centred arches. There is an elevated internal courtyard with car park below. The building has a symmetrically front facade with three onion-shaped domed towers: a 41 meter high tower which is square in plan in the centre and two shorter circulation towers with outer stairways which climb the towers in a spiral fashion.

Historical Background

It is believed that the building's first elevations were drawn up by R.A.J. Bidwell in Classical Renaissance style under supervision of Arthur Charles Alfred Norman, the state architect. The general layout of plans and elevations drawn up by Bidwell and Norman were approved by the State Engineer and Director of the Public Works Department, C.E. Spooner. However, Spooner suggested that an Oriental style would be more appropriate in keeping with the tropical and cultural environment, and later Norman changed the external elevations.⁶ Eventually, Moorish influence was chosen for the exterior of the building which was emphasised by various pointed arches, columns,

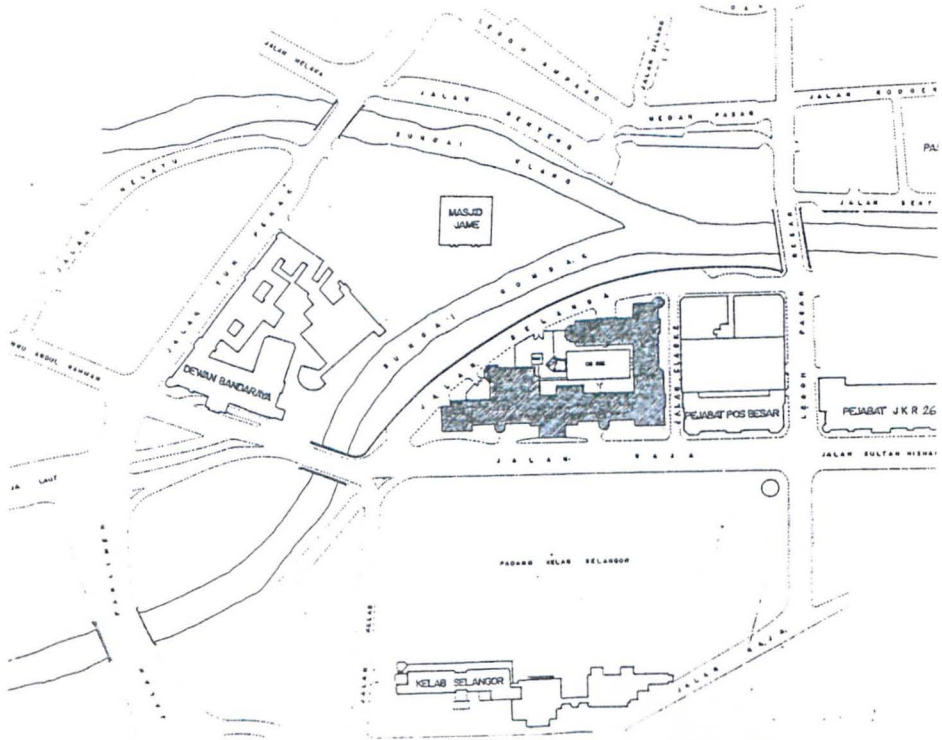
⁶Ken Yeang, *The Architecture of Malaysia*, Amsterdam: The Pepin Press, 1992, p. 77.

pinnacles and onion-shaped domes. These features were mixed with the European forms and building functions. A marble plaque in the entry stated, "This stone was laid by HE The Governor on the 6th day of October 1894. AC Norman Architect, CE Spooner, BE State Engineer". Upon completion in 1897, it was the largest building to be built at that time. The building was originally designed for the Selangor State Secretariat. It was previously occupied by the Selangor State Government Treasury, the Accountant-General's Office and the Marriage Registry. At present, the building houses the High Court and Supreme Court.

Architectural Significance

Apart from its historical importance, the building has architectural values which has led to some of its features being adopted for other government buildings built during the British period. For example, some buildings around the area have used pointed arches, verandahs, domes, pinnacles, decorative pediments and exposed red brick with imitation stone dressing made of plaster. All of these became common features of the British colonial architecture built under the Moorish influence. Another important aspect about the building is that it was designed by British architect Arthur Charles Alfred Norman who was also responsible for designing many renowned buildings in Kuala Lumpur including the St. Mary's Church, High Court, Carcosa, Old Chartered Bank Building, Municipality Hall, Selangor Club Building and the Infokraft Malaysia (former Public Works Department).

A statue of Sir Frank Swettenham, the then British Resident of Selangor, was erected at the end of the building near the Gombak Bridge. In 1921, an impressive ceremony attended by the British High Commissioner Sir Lawrence Guillemard and Rulers of the four Federated Malay States was held to honour Sir Frank Swettenham. It was under Swettenham's direction as the British Resident in the 1880's that the first steps were taken to modernise Kuala



Location map.



West elevation (front facade) facing Raja Road.

Fig.91 Location and front elevation of Sultan Abdul Samad Building

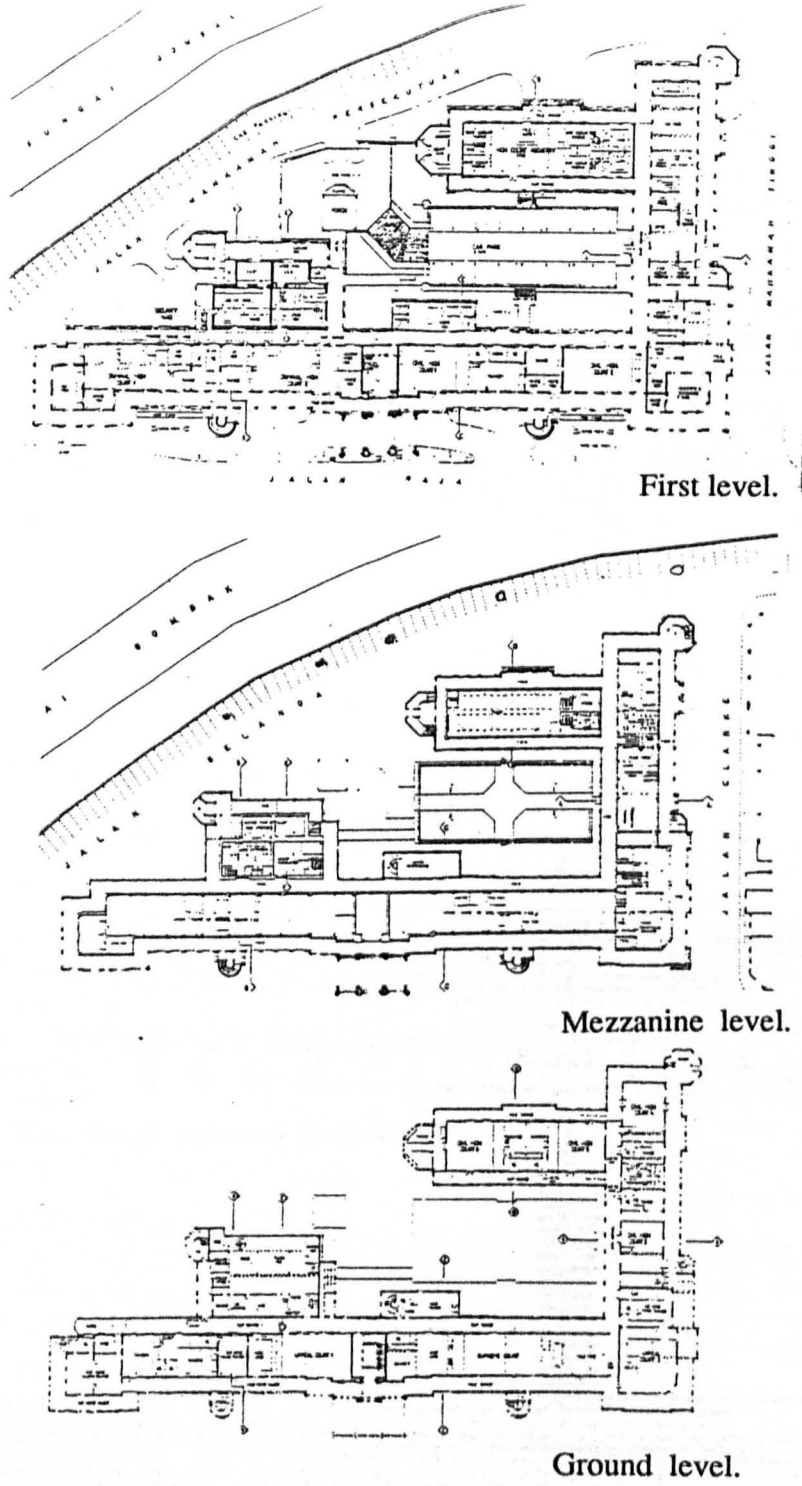
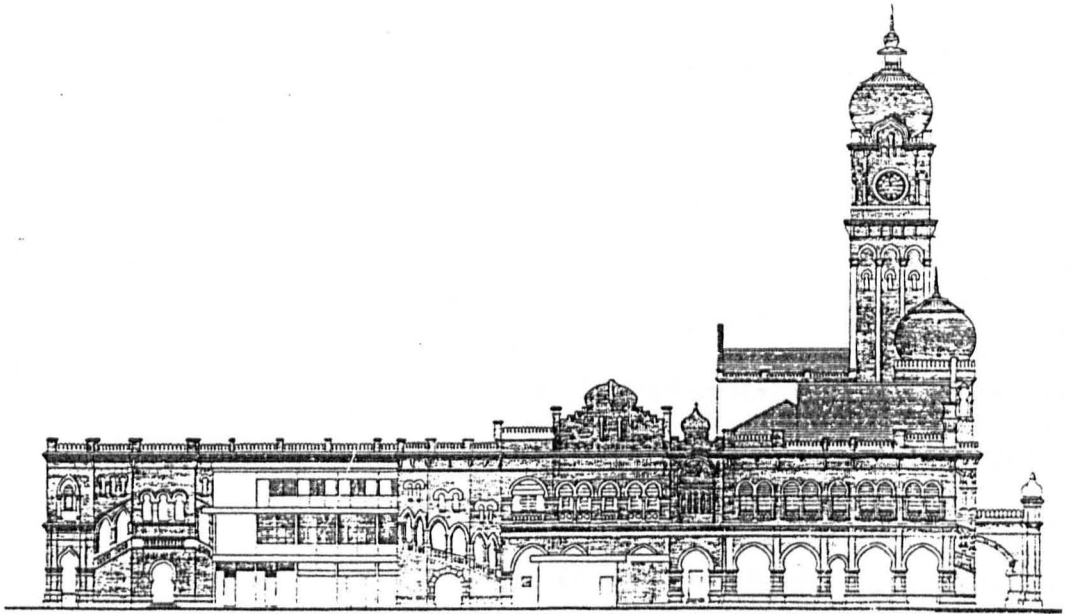
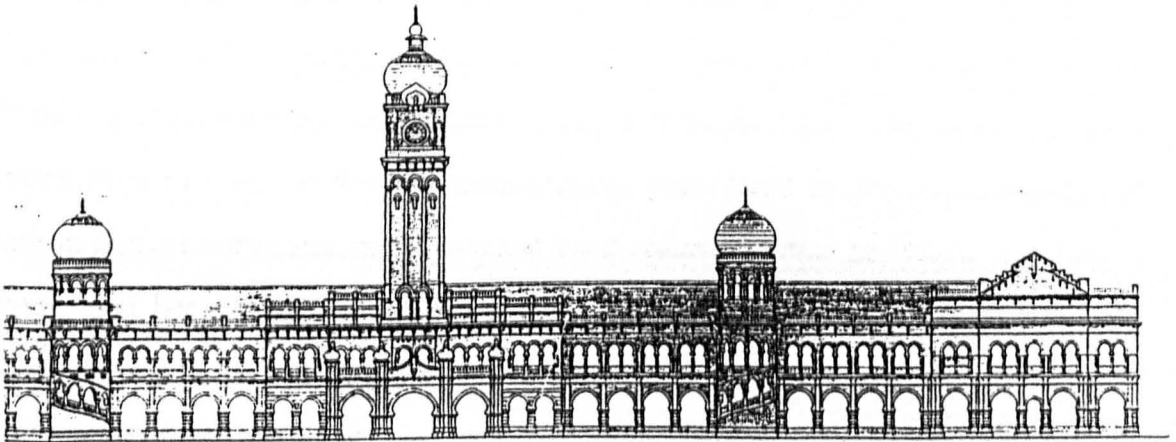


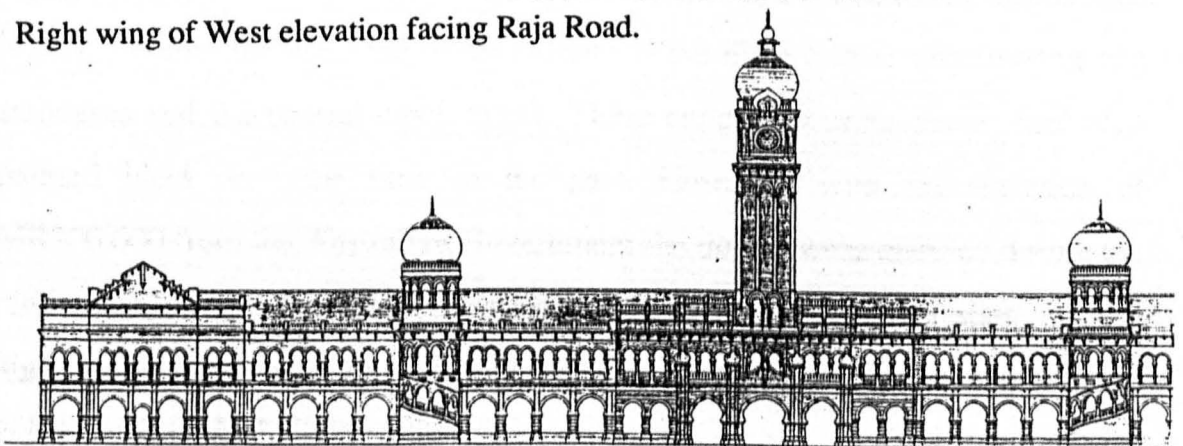
Fig.92 Floor plans of Sultan Abdul Samad Building



North elevation.



Right wing of West elevation facing Raja Road.



Left wing of West elevation.

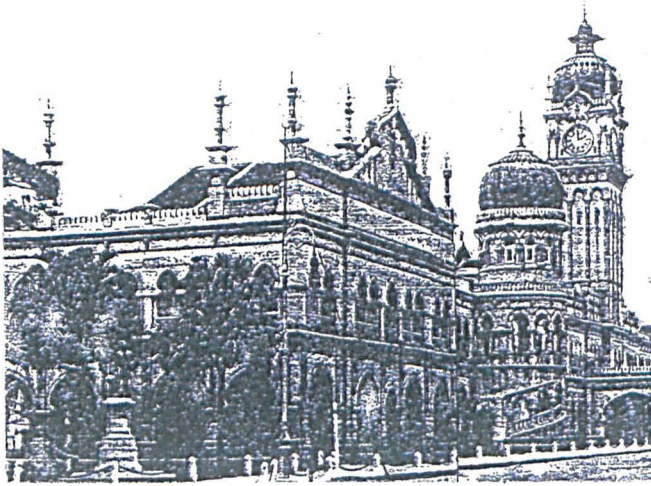
Fig.93 Elevations of Sultan Abdul Samad Building

Lumpur.⁷ However, after Independence in 1957, the statue was removed to its present site outside the National Museum in Kuala Lumpur.

Building Condition and Problem

There had been many additions and modifications carried out to the building over the years before the works of renovation and restoration. For example, many places in the verandah ways were blocked up and taken over as offices. The open internal courtyard was occupied to house offices, canteen, toilets and air-conditioning plant, much of which spoilt the original feature of the plan. For security purposes, grilled screens were fixed in between columns with an arched curve motif at lower level. Pinnacles placed on the pediments and on top corners of the central tower were taken down before the war, in fear of bombing attacks which could cause a danger to pedestrians. The architects were much happy to restore the pinnacles and put them back to the original state but due to budget constraint they have not been restored. Over the years, mezzanine floors had been added in several places, bearing on the old walls. In addition, some of its main building problems include broken roof tiles, rotting timber trusses, decayed woodwork, water penetration through foundations; and broken bricks. Another modification of the exterior is the three domes surmounting two staircases and the central clock tower. These copper-covering domes had been painted black at some time in the past. However, with the donation of MR200,000 from the Australian Government the domes were restored during the renovation work. Copper has been used to restore to its original state. A very high grade lacquer was applied to burnish the domes. This gives a magnificent golden look to the building.

⁷Muzaffar D.J. Tate, *Kuala Lumpur in Postcards 1900-1930: From the Collections of Major David Ng and Steven Tan*, Petaling Jaya, Malaysia: Penerbit Fajar Bakti Sdn. Bhd., p. 9.



Old picture (left) showing pinnacles on pediments. Before the war the pinnacles were taken down (middle) in fear of bombing attacks which could cause a danger to pedestrians.



Iron grilled screens were fixed for security reason.

Fig.94

Views showing pinnacles and iron grilled screens

Building Conservation

Apart from renovating and restoring the building fabric and shell, the architects had to consider the client's main spatial requirement which was to fit the required spaces into the building. Such required spaces include two Criminal High Courts, six Civil High Courts, two Appeal Courts, a Supreme Court and other supporting spaces such as chambers, witness and counsel rooms, library, registry and lockups. Due to the number and size of the spaces required, the architects had to analyse and criticise the building structures. A complete set of measured drawings had to be prepared since there were no original drawings of the building.

A mezzanine structure was designed to accommodate the extra spaces. A totally new building of reinforced concrete was constructed within the old shell so that no new loads were imposed on the old brick walls and strip footings. This new structure stands on bored micropiles. The interior floors were totally gutted leaving only the self-supporting shell consisting of the inner and other corridor walls; and corridor floors. The courts, chambers, registries and administrative office were planned within the shell. In certain areas the height of the shell was sufficient to provide two courtrooms to be located above each other at the old corridor floor levels. In other areas, mezzanines with lower ceiling heights were inserted in the shell. As a result the structure varies from two to four storeys in height.

One important aspect which was considered during the building conservation was the circulation of court staff, judges, officials, prisoners and the public to the inner courts. Access for the staff, judges and official is through corridors around the inner court while the public enter from the outer corridors. Access for the prisoners from the lock-up room to the Criminal High Courts is by means of an underground passage with three to four feet thick walls.

Later additions such as a canteen and annexes which were not in keeping with the architectural significance of the building were demolished. This

is to maintain not only the original forms but the old layout of the building. All decayed bricks and roof tiles were replaced. New bricks which were locally made and similar to the old ones were used where necessary. Some of the old bricks were cleaned and restored to the original state. Any rotting trusses eaten up by termites were replaced. New roof tiles have replaced the old Marseille tiles and relaid in the same pattern. Some of the old tiles have been salvaged and used for other historic buildings including the PAM Centre. Arched motifs and mouldings were replastered where necessary and painted cream white.

To minimise the noise coming from the road, particularly into the Criminal High Courts, double glazing windows were installed. Another common problem in re-using buildings. Like many historic buildings in the country, air-conditioning was dealt by placing a plant on an external roof above the inner courtyard with a parapet wall extended up to conceal it. However, the ducts were contained below decorative ceilings. This has in some cases meant that the mezzanine floors have only 7 feet 6 inches of clear height. For the water penetration coming from the adjacent rivers through the foundations, the problem had been solved by inserting a damp-proof course in the foundation walls.

Of later constructions is the semi-sunken car park located in the courtyard. The car park, which can accommodate 32 cars, is covered by a concrete slab with planting on top. This solution deals with parking, often a visual problem for historic buildings. Another addition is the overhead bridge connecting the Sultan Abdul Samad Building and the nearby Old General Post Office building. This gives an easy access for staff, judges and officials to get into these buildings from the first level. An interesting thing about this bridge is that it maintains some of the characteristics of the existing buildings. These can be seen from its exposed bricks, pointed arches and plastered mouldings. The total cost of renovating and restoring the building was MR17.2 million.



Semi-sunken car park in the courtyard.



Verandah way was blocked and taken over as waiting area.

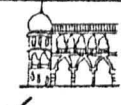



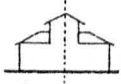
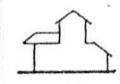
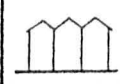
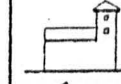
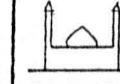
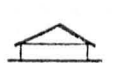





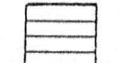

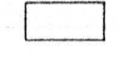
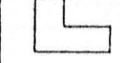
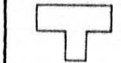
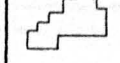
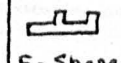






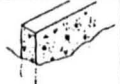
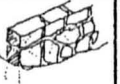
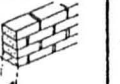
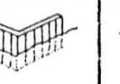
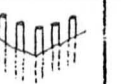
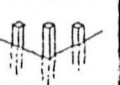


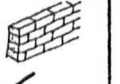



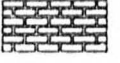

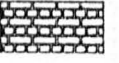


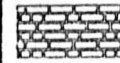
Overhead bridge connecting the building and the Old General Post Office (Right).

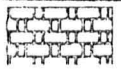
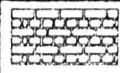
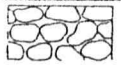
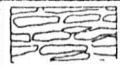

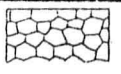
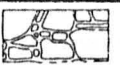
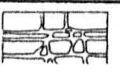
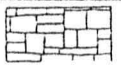
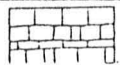
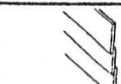


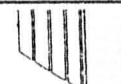
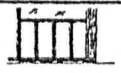

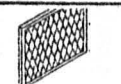

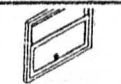

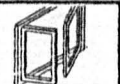

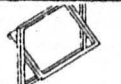

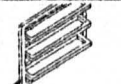
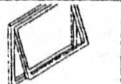
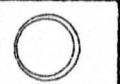
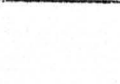
Fig.95 Later constructions and additions



















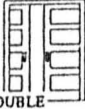

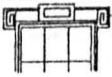





Building Requirements


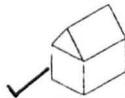






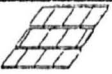




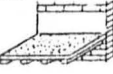









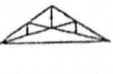
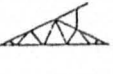






Basically, there were three main requirements for the building. Firstly, the spatial requirements in which the architects had to include several courts and other supporting spaces. This led to further structural analyses and reorganising the building circulation. Secondly, the building services and security which include air-conditioning, an electrical sub-station, an underground passage and grilled screens fixed between columns. Thirdly, external treatment, which covered cleaning or replacing bricks, replastering and painting mouldings and ceilings, stripping and lacquaring domes, roofing and relaying new roof tiles, putting up double glazing windows facing Raja Road; and repaving sidewalks. In addition, providing sprinklers, fire extinguishers and protective fire-escape staircases is quite important, particularly in this such large building.

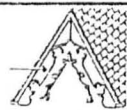

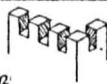


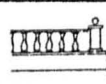
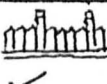



















BUILDING DATA MATRIX					
SECTION 1 : FILE REFERENCES					
1.1 Name of Building: Sultan Abdul Samad Building			1.3 File Reference: KL 102664		
1.2 Address of Building: Raja Road, Kuala Lumpur			1.4 Name of Recorder: A.G. AHMAD		
			1.5 Date of Recording: AUG. 13 '91		
SECTION 2 : BUILDING					
2.1 Stylistic Influence					
 <input checked="" type="checkbox"/> 01 MOORISH	 02 TUDOR	 03 NEO-CLASSICAL	 04 NEO-GOTHIC	<input type="checkbox"/> 05 OTHER	
2.2 Elevation					
 <input checked="" type="checkbox"/> 01 SYMMETRICAL	 02 ASYMMETRICAL	 03 LINKED	 <input checked="" type="checkbox"/> 04 TOWER	 05 MINARET	<input type="checkbox"/> 06 OTHER
2.3 Height / Level					
 01 ONE	 02 1 1/2	 03 TWO	 <input checked="" type="checkbox"/> 04 2 1/2	 05 THREE	 06 3 1/2
 07 FOUR	<input type="checkbox"/> 08 OTHER				
2.4 Plan					
 01 SQUARE	 02 RECTANGULAR	 03 L-SHAPED	 04 T-SHAPED	 05 IRREGULAR	 F-Shaped <input checked="" type="checkbox"/> 06 OTHER































2.5 Dimensions (ft & m)					
Building Length: 400 Ft			Facade Width:		
SECTION 3 : STRUCTURES					
3.1 Foundations Type					
 01 ON STILTS	 02 SLAB ON GRADE	 03 BASEMENT HALF	 04 BASEMENT FULL	05 OTHER	
3.2 Foundations Material					
 01 CONCRETE	 02 STONE	 03 BRICK	 04 WOOD PLANKS	 05 WOOD STILTS	 06 COLUMNS
07 OTHER					
3.3 Wall Material					
 01 CONCRETE	 02 STONE	 03 BRICK	 04 PLASTER ON BRICK	 05 WOOD	 06 METAL
07 OTHER					
3.4 Brickwork					
 01 RUNNING BOND	 02 STACK BOND	 03 ENGLISH BOND	 04 FLEMISH BOND	 05 FLEMISH SPIRAL	 06 FLEMISH CROSS









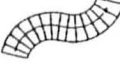












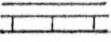
3.4 Brickwork (cont')					
					
07 RAT-TRAP	08 ENGLISH CROSS	09 OTHER			
3.5 Stonework					
					
01 RUBBLEWORK	02 RAG-WORK	03 AŞILAR	04 POLYGONAL	05 RANDOM	06 RANDOM COURSED
					
07 BROKEN COURSED	08 IRREGULAR COURSED	09 OTHER:			
3.6 Wood Wall					
					
01 CLAPPER BOARD	02 BOARD ON BOARD	03 BOARD & BATTEN	04 TONGUE & GROOVE	05 OTHER	
3.7 Wall Ornamentation					
					
01 TIMBER FRAMING	02 FESTOON	03 OTHER			
3.8 Window Type					
					
01 LEADED	02 MULL	03 SASH	04 SLIDING	05 CASEMENT	06 FRENCH
					
07 PIVOTING	08 FOLDING	09 LOUVRED	10 AWNING	11 ROUNDED	12 OTHER

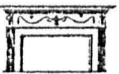



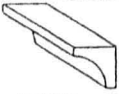
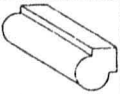
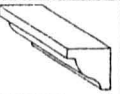
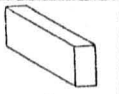
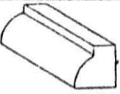
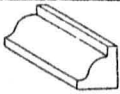












3.9 Protuding Window					
 01 BOX	 02 BAY	 03 BAY CURVED	04 OTHER		
3.10 Window Trim					
 01 PLAIN	 02 MOULDED	 03 DECORATED PEDIMENT	<input checked="" type="checkbox"/>  04 SHAPED TRANSOM	 05 FANLIGHT	 06 ARCH-HEADED
 07 KEYSTONED LINTEL	08 OTHER				
3.11 Door Type					
<input checked="" type="checkbox"/>  01 PANEL	 02 GLASS	 03 LEDGE & BRACE	 04 LOUVRED	 05 FRENCH	 06 SWING
 07 DOUBLE SWING	 08 SLIDING	 09 DOUBLE SLIDING	10 OTHER		
3.12 Door Trim					
<input checked="" type="checkbox"/>  01 PLAIN	 02 MOULDED	 03 DECORATED PEDIMENT	 04 SHAPED TRANSOM	 05 FANLIGHT	 06 ARCH-HEADED
 07 KEYSTONED LINTEL	08 OTHER				





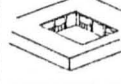




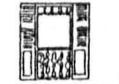
3.13 Roof Type					
 01 FLAT	<input checked="" type="checkbox"/>  02 GABLE	 03 HIPPED GABLE	 04 PYRAMIDAL	 05 HIPPED	 06 VAULTED
 07 DOMED	08 OTHER				
3.14 Roofing Material					
 01 THATCH OR ATAP	 02 PLAIN TILE	 03 PANTILE	<input checked="" type="checkbox"/>  04 SPANISH TILE	 05 CORRUGATED	 06 INTERLOCKED
 07 BITUMEN FELT	08 OTHER				
3.15 Roof Supports					
 01 BASE CRUCK	 02 RAISED CRUCK	 03 TIE BEAM	 04 KING POST	 05 QUEEN POST	 06 CROWN POST
 07 HAMMERBEAM	 08 ARCH BRACE	<input checked="" type="checkbox"/>  09 PITCHED	 10 SCISSORS	 11 CLERESTORY	12 OTHER
3.16 Roof Trim					
 01 PLAIN FASCIA	 02 DECORATED FASCIA	 03 PLAIN SOFFIT	 04 PLAIN FRIEZE	 05 DECORATED FRIEZE	 06 MODILLONS

3.16 Roof Trim (cont')					
					
07 BARGEBOARD	08 OTHER				
3.17 Parapet					
					
01 PLAIN	02 CRENELLATED	03 GABLE	04 SHAPED GABLE	05 BALUSTRADE	06 OTHER ✓
3.18 Dome Type					
					
01 CUPOLA	02 SAIL DOME	03 DRUM-DOME	04 PENDENTIVE	05 DOMICAL	06 UMBRELLA
					
07 OTHER ✓					
3.19 Turret Type					
					
01 ROTUNDA	02 DOMED	03 IMPERIAL ✓	04 CONICAL BROACH	05 SPIRED	06 CHATRI
07 OTHER					
3.20 Arch Type					
					
01 SEMI CIRCULAR	02 SEGMENTAL	03 THREE CENTRED	04 PARABOLIC	05 ROUND TREFOIL	06 VENETIAN

3.20 Arch Type (cont')					
 07 STILTED	 08 POINTED SARACENIC	 09 EQUILATERAL	 10 POINTED SEGMENTAL	 11 POINTED TREFOIL	 12 CINQUEFOIL
 13 OGEE	14 OTHER.				
3.21 Column Type					
 01 DORIC	 02 IONIC	 03 CORINTHIAN	 04 TUSCAN	 05 COMPOSITE	 06 ENGAGED COLUMN
 07 PILASTER	08 OTHER				
3.22 Column Parts					
 01 FRIEZE	 02 PLINTH	 03 PEDESTAL	 04 ENTABLATURE	 05 DENTILS	06 OTHER
3.23 Columniation					
 01 DISTYLE	 02 TRISTYLE	 03 TETRASTYLE	 04 PENASTYLE	 05 HEXASTYLE	06 OTHER
SECTION 4 : INTERIOR					
4.1 Floor Material					
 01 PLAIN TILE	 02 DECORATED TILE	 03 TIMBER FLOORBOARD	 04 CONCRETE	 05 STONE	 06 MARBLE

4.1 Floor Material (cont')					
07 OTHER					
4.2 Wall Material					
 01 WOOD	 02 CONCRETE	 03 STONE	 04 BRICK	 05 PLASTER ON BRICK	 06 METAL
07 OTHER					
4.3 Staircase Type					
 01 CIRCULAR	 02 QUARTER TURN	 03 QUARTER WINDING	 04 SPIRAL	<input checked="" type="checkbox"/> 05 STRAIGHT FLIGHT	 06 DOGLEG
 07 GEOMETRICAL	 08 DOUBLE RETURN	<input checked="" type="checkbox"/> 09 OTHER			
4.4 Staircase Style					
 01 TUDOR / JACOBAN	 02 FEDERAL / EMPRE	 03 GOTHIC / VICTORIAN	04 OTHER		
4.5 Ceiling Type					
 01 FLAT PLASTERED	 02 PLASTERED MOULDED CORNICE	 03 EXPOSED BEAMS	 04 DECORATED PLASTERED	 05 CENTRAL ROSE	 06 SUSPENDED

4.5 Ceiling Type (cont')					
07 OTHER					
4.6 Other Features					
 01 FIREPLACE	 02 DECORATED WALL PANELS	 03 SKIRTING	 04 DECORATED INTERNAL DOOR	05 OTHER	
SECTION 5 : ORNAMENT / ARCHITECTURAL FEATURES					
5.1 Moulding Type					
 01 CONE	 02 ROUND	 03 CYMA REVERSA	 04 FAŚCIA	 05 COCK BEAD	 06 OGEE
 07 NEBULY	08 OTHER				
5.2 Tracery Type					
 01 GEOMETRICAL	 02 INTERSECTING	 03 PANEL	 04 RETICULATED	 05 CURVILINEAR	
5.3 Exterior Part					
 01 CHIMNEY	 02 ROOF CRESTING	 03 ROOF FINIAL	 04 FENCING	 05 WINDOW SHADING DEVICE	 06 WALL CLOCK
07 OTHER					

5.4 Open Outdoor Areas					
 01 VERANDAH	 02 FIVE-FOOT COLONNADE	 03 ARCADE	 04 BALCONY	 05 COURTYARD	 06 PORCH
07 OTHER					
5.5 Ventilation					
 01 LOUVRED PANEL	 02 AIR WELL	 03 GRILLE	 04 DECORATED SCREEN	05 OTHER	
SECTION 6 : COMMENTS					

12.7 BUILDING COMPARISON AND RECOMMENDATIONS

Based on each case study, it is my view, that each building was well restored and renovated. All the architects had made a good attempt at saving the buildings. A comparison table is provided to summarise the case studies (Fig.116). However, there are several aspects in which the operations can be further analysed and compared. These include the following:

1. planning policies,
2. methods and techniques of building conservation used,
3. the use of new building materials and incorporation
in the existing fabric,
4. client's requirements and the role of architect,
5. appropriate new uses and compliance with contemporary
building legislation,
6. building maintenance,
7. costs and financial support,

12.7.1 Planning Policies

Local authorities should play a major role in maintaining the good conditions for historic buildings. It is suggested that the Kuala Lumpur City Hall should detour the traffic coming to the Merdeka Square or limit the types of vehicles using the Raja Road. This is to avoid traffic vibrations which may affect the foundations of the Sultan Abdul Samad Building. Furthermore, free-standing traffic barriers should be placed near the buildings to avoid any unexpected impact from heavy vehicles. Any new development near the buildings should be restricted or controlled. The ethos of planning policies for areas such as that around Merdeka Square and that adjoining the river and Central Market should be removed. The question of traffic management is vital if these areas are to realize their full value following the treatment of individual buildings.

	JKR 92 Library & Museum	Old District Council	PAM Centre	Sultan A. Samad
Date Built	1909	1910	1907	1894
Architect/ Builder	A.C. Norman	Harbeck	Loke Chow Kit	A.C. Norman
Location	Kuala Lumpur	Klang	Kuala Lumpur	Kuala Lumpur
Listed Building	Yes	Yes	No	Yes
Owner	Government	Council	Private	Government
Past Uses	1.Printing Office	1.District Office 2.Klang Police	1.Residence, 2.Empire Hotel 3.Peninsula Hotel	1.State Secretariat 2.Accountant Office 3.Marriage Registry
Present Use	Memorial Library and Museum	District Council	Malaysian Institute of Architects	High and Supreme Courts
Date of Repair	1985-86	June 1987	1989	1979
Architects for Repair	Hajeedar Associates	CSL Associates	Akitek Majubina	BEP Akitek
Cost of Repair	MR1.62m	n/a	MR2m	MR17.2m

Fig.116 Building Comparison

12.7.2 Methods and Techniques of Building Conservation Used

Choosing appropriate methods and techniques of building conservation is very important, particularly in respecting the original building fabric. For example, each case study has illustrated how outside walls were treated. In such a case, proper treatment of fungal growth is essential as this problem is common to historic buildings in Malaysia. Scraping off with wire brushes and washing down with pressured water may not be the right solution to the problem. Instead, the fungal growth can be removed by fungicidal washes including the application of hypochloride acid and then with a special clear protective coating on affected surfaces. The method was also applied to outside walls of the JKR 92 Memorial Library and Museum. If decorative finishes are badly affected, they are best removed first. Fungicidal paints may help to control fungal growth but consultation with chemists of a paint company should be sought. It is important to wash down the walls after treatment with clean water before redecoration. The drainage of fungicidal mixtures should also be considered.

Another good example of maintaining the original paint and colour scheme for the exterior walls is that found in the PAM Centre. The architect recommended to the building committee, the use of lime washing to match with the original scheme. This not only maintains the character of the surfaces but allows the outer skin to breathe, particularly in increasing the amount of moisture able to evaporate. The Society for the Protection of Ancient Buildings, United Kingdom has listed several important aspects which should be considered when applying lime wash.⁸ These include preparation, damping down, applying the lime wash first coat; and subsequent coats (see Appendix 8). This was the basis of the application to the PAM Centre.

In situations where new structures are designed to accommodate extra spaces and where new loads may be imposed on the old walls and strip footings, strengthening the foundations by inserting bored micropiles is acceptable. This

⁸Jane Schofield, reprint ed., *Basic Limewash*, Information Sheet No. 1, London: SPAB, 1991, p. 4.

was carried out in the Sultan Abdul Samad Building. However, it should be recognised that the structures must be first analysed by structural engineers and also consultation with experienced conservationist architects is necessary. The whole question of permissible floor loading in historic buildings is being reconsidered. The use of the PAM Centre as offices would indicate a higher loading than found in its previous uses. However, in practice the loading is probably less here than it was originally.

12.7.3 The Use of New Building Materials and in the Existing Fabric

As the main objective of any conservation work is to preserve as much of the original building materials, the use of new materials should be controlled. Only building materials which are seriously decayed or expected to cause any danger to occupants should be replaced; by similar materials if possible. Other common reasons for using new materials in historic buildings include those necessary for security to prevent ingress where grilled screens are fixed to doors, windows and in between columns. Also fire regulations, especially for changed use in which upgrading the party walls, floors and doors; and providing sprinklers are desirable. In the case studies, both the Sultan Abdul Samad Building and PAM Centre give an example of the use of new bricks and roof tiles. Where decayed bricks of the Sultan Abdul Samad Building needed to be replaced, the architects had to find bricks similar to the original locally made by a brick company in Kuala Lumpur. On the other hand, the PAM Centre uses new roof tiles salvaged from that of the Sultan Abdul Samad Building which was retiled.

Another aspect which should be considered when using new materials is that they should not affect the appearance of the building, particularly in forms of textures and colours. New materials should blend with the existing fabric. This develops the continuity and harmony of the building materials. SPAB and other

authorities have produced notes on the techniques for enabling new materials to blend with old. For example by application of organic materials. There is a school of thought which argues that new materials should read as being new and simply weather and age with the building.

12.7.4 Client's Requirements and the Role of Architects

One of the important aspects that an architect should observe is the client's requirements, particularly when more space is required in the building. Both clients and architects should be sensitive to the building's historic values and less determined to cram all functions and spaces into the old shell. Historic buildings were built to only hold certain loads and sometimes may not withstand additional new loads. Structural deformation may occur when such happens. Therefore, it is important for architects to discuss and inform clients about any possible spatial requirements and increasing loading which may not only disturb building structures but lose some of its original decoration and ceiling heights.

12.7.5 Appropriate New Uses and With Contemporary Building

Legislation

Finding appropriate new uses is important in building conservation. Many historic buildings have been lost because they were functionally obsolete and no appropriate use could be found. There is no standard conversion for historic buildings in terms of their new uses. However, two main factors which should be considered are the new uses should not usually require additional structures to be built or greatly changed construction; and there should not be any structural disturbance to the historic building's fabric. A principle elucidated in ecclesiastical work is that any alteration should be reversible. This inhibits major structural intervention and can act as a positive design factor when considering the future of historic buildings. Except PAM Centre, all buildings in the case studies maintain their original functions as offices. However, among them only

the Sultan Abdul Samad Building has a mezzanine floor inserted above ground level.

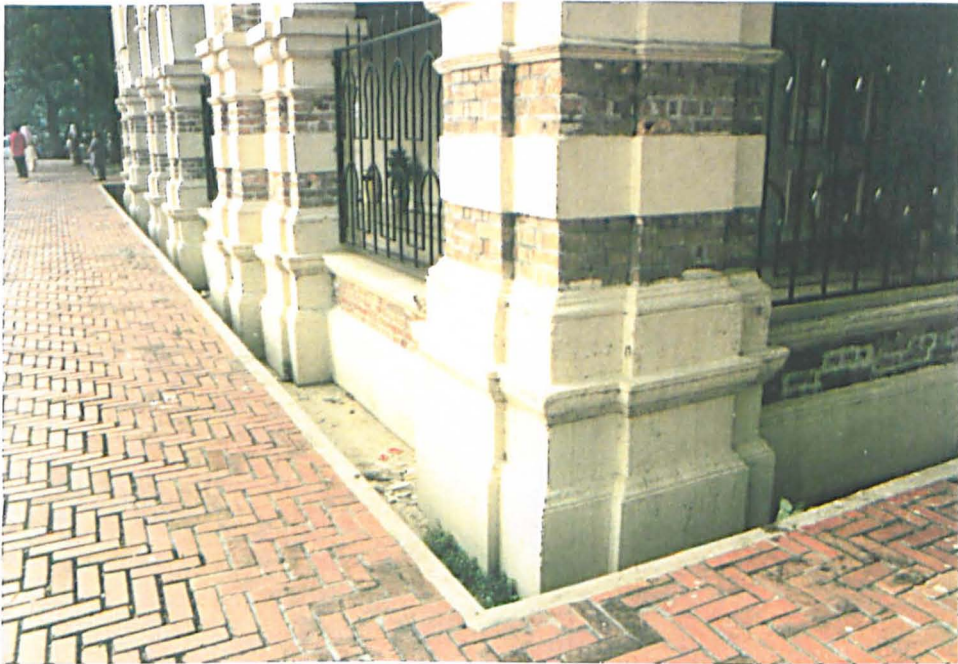
Apart from selecting appropriate new uses for historic buildings, there should also be building controls, particularly in building elevations, colours and surrounding elements. A good example is the new awnings placed in the front elevation of the JKR 92 Memorial Library and Museum. The problem with the awnings is that they were placed at a different level and created badly designed junctions especially at the corners of the building. In the Old District Council building, air-conditioning units were placed outside in the inner courtyard. This is good strategy but could have been improved with suitable planting to screen the units or alternatively to have them protected in a chiller plant. A further indication of the need to consider detail is also evident. All the buildings' sidewalks were well paved. However, at certain areas of the Sultan Abdul Samad Building, the pavement is level higher than the plinth and does not follow the building lines. This creates a gap between the pavement and the plinth trapping all sorts of rubbish, plants and water which are not only unsightly and a health hazard but devalue the aesthetic qualities that were the aim of the renovation process.

12.7.6 Building Maintenance

Historic buildings should have building maintenance carried out at regular basis. There should also be maintenance routines either quarterly, semi-annual, annual or quinquennial (refer to section 10.5 for further explanation of cyclical maintenance). Most of the buildings in the case studies were renovated and restored more than five years ago. Therefore, it is time for these buildings to be subjected to routine inspections followed by reports of building conditions and structural problems for action.



The problem with the awnings is that they were placed at different level and created a bad design especially at building corners.



Pavement which does not follow the building contour, creating a gap that traps rubbish, plants and water.

Fig.117 Design problems

12.7.7 Financial Support

Since three of the buildings are owned by the central or council government, there seemed no problem in getting financial support for the conservation work. Being privately owned, the PAM Centre faced difficulties in raising enough funds to save the building. It is suggested that the government should give financial support to not only public but also private buildings of high architectural and historical values.

PART FIVE
CONCLUSIONS

CHAPTER 13

CONCLUSIONS

Early investigation has shown that Malaysia faces three main problems in dealing with the issues of historic buildings. These are insufficient legislation, lack of technical knowledge in building repairs and maintenance; and that no suitable systems exist for discovering and recording British colonial buildings. As the thesis focuses mainly on the study of methods and techniques of building conservation in the United Kingdom and to develop possibilities of transferring them to the context of British colonial buildings in Malaysia, some principles and attitudes toward conservation of such buildings have been recognised. Besides, throughout the research several recommendations are made for the improvement of British colonial buildings in Malaysia.

13.1 PRINCIPLES AND ATTITUDES

It is important to state that British colonial buildings in Malaysia should retain their original character as much as possible. Only necessary work should be carried out by well-experienced people in a sincere and honest manner. If any work is carried out to preserve and conserve such buildings, principles and attitudes should be observed.

Firstly, any alterations or additions to the architectural designs should be contextual in the sense of taking references from the existing buildings. This is to ensure that there is continuity and harmony in building fabric. Introducing new materials to the old ones means adding a new layer to the history of the buildings.

Therefore, if this is necessary any work involving alterations or additions should be ensure that the original is photographed and well documented.

Secondly, introduction of other modern inventions including mechanical, electrical and acoustical services in the historic buildings should be either blended with or deliberately contrasted with the rest of the building structures. There are good examples of both techniques in conservation. Where possible they should be non-intrusive. Apart from harmony, the main principle of intervention in building is quality. This is because high quality of new building materials guarantees the extension of the life span of the buildings. To comply with modern building requirements, British colonial buildings remaining in use should meet fire and safety regulations appropriate to their function. These include the provision of fire alarms, sprinklers, fire extinguishers, fire-escape staircases; and also upgrading building materials for fire resistance. Exit signs must be clearly visible and located above main doors and entrances. Like many other countries where providing disable access is mandatory in public buildings, British colonial buildings in Malaysia should also be equipped with ramps, lifts and other facilities for the disabled people. Modern legislation indeed includes and places stress on these matters. The design of these elements and integration in buildings requires design skills of high quality.

Thirdly, there should be flexibility in choosing appropriate new uses for British colonial buildings. As long as the building structures and architectural details are kept intact, economical and that the new uses provide comfort to the occupants. It is important that the new uses should be confined whenever possible within the existing building floor plans. Climatic conditions of Malaysia and their effects on maintenance work should also be considered in any design decisions.

13.2 RECOMMENDATIONS

Throughout the research and as part of the main intent of the thesis, several recommendations have been made for the improvements of British colonial buildings in Malaysia. These recommendations can be categorised into various aspects, which have given some answers to the issues of historic buildings in Malaysia.

13.2.1 Legislation

Current legislation which protects historic buildings in Malaysia should be revised and strengthened as soon as possible. New legislation should not only address the question of heritage conservation extensively but be suitable enough to protect and prevent such buildings from being demolished and destroyed. It should also provide for protection and insist upon cyclical maintenance of historic buildings including the ones which have not yet been listed for preservation. This is quite important, particularly to ensure that any of the buildings may not be abused by developers for future projects. Tougher penalties including maximum fines should be enforced to those who demolish any historic buildings without local authority's permission.

Building inspections and surveys carried out in the research have shown that the British colonial buildings in the country are of immense cultural, historical and architectural values. Therefore, the Government should expand its building listing not only concentrating on public buildings but other private British colonial buildings such as bungalows, hotels, churches and the like.

As in the United Kingdom, the idea of granting Listed Building Consent should be incorporated in the new legislation. This is to ensure that any proposed demolition works carried out to such buildings are controlled and approved by local planning authority. Any Listed Building Consent granted by the local planning authority should notify the Museum Departments and conservation bodies.

Through the channels of the Antiquities Act 1976 and Museum Departments, the Government should require local planning authorities to list any British colonial buildings in every district or state in Malaysia. Based upon the degree of architectural and historical importance, it should be recognised that all British colonial buildings in Malaysia are given protection and mandatory cyclical maintenance regardless of their present status of preservation. British colonial buildings may be classified into three main grades. Criteria of selecting and grading the buildings for the purpose of statutory lists are discussed in section 3.4. A specialist team formed by the Museum Departments and assisted by representatives from various local planning authorities may begin the procedures of listing buildings, particularly the initiation of spot listing. The latter would provide immediate protection for those buildings identified but not yet listed.

13.2.2 Conservation Management

Apart from establishing a specialist team to select and list the British colonial buildings, there should be an official central conservation committee consisting of a group of people who are knowledgeable or experienced in treating old buildings. Like SPAB, the committee, through its technical panel, offers various services including providing technical advice on aspects of conservation, investigating cases of historic buildings which suffer from neglect or threatened by damaging treatments and discussing on all problems affecting such buildings. It is suggested that the committee is centralised in Kuala Lumpur since there are many facilities and sources available for the committee to refer to such as the National Archive, National Museum, government departments and major higher institutions. In addition, building inventories and measuring may have to be coordinated by the committee with the assistance of the public. For future reference, all building data including photographs, floor plans and drawings should be kept at the National Archive and National Museum in Kuala Lumpur.

This would augment and duplicate for protection these archives which are kept at regional or local centres.

13.2.3 Technical

A great deal of information on material technology and good practice exists. The task lies in transferring this knowledge to Malaysian conditions. It is recommended that a small technical section as part of or reporting to the central conservation committee mentioned in section 13.2.2 above, should be changed with this work. It is important for those involved in any conservation work to retain building materials as much as possible. Before going into further actions of conservation, all causes of decay thought to be due to local conditions in each of the materials should be analysed. All methods of repair and maintenance of common building problems discussed in the thesis should be tackled in respect of existing building materials. Any new materials should have quality which are durable and consistent with the rest of the building fabrics. It is suggested that old building materials including bricks, stone, roof tiles and windows which become available should be salvaged for future preservation. This would be a local or regional responsibility. Records should be kept on the use of materials in terms of their origin, age, original qualities and location in the building.

Any introduction of air-conditioning systems should only be for good and practical reasons. In certain types of British colonial buildings, natural ventilation may be incorporated with artificial methods. Placement and screening of the air-conditioning elements and/or units are quite important. The main objective suggested is that the units should not destroy building materials, affect the appearance of the building; and should be as unobtrusive as possible. Depending on the types of pollution in the environment, the air-conditioning systems installed in British colonial buildings should be regularly checked and maintained. Any effects on the building fabric should be monitored.

13.2.4 Systems for Discovering and Recording

The principle of having a system for discovering and recording British colonial buildings is to obtain reliable information and evidence about a building's history, location, function, architectural quality and condition. Such a system is quite important not only for those who carry out their jobs to save the buildings but for builders and planners. Another aspect is that all historical and architectural facts about the buildings can also present a contribution to Malaysia's history and development. Several ways of discovering information about British colonial buildings in Malaysia are discussed in section 7.2. A format of an A4-size card with drawings, photographs and building descriptions should be considered in the system. Different levels of recording under three headings suggested by the RCHME are also included in the descriptions.

In addition to the record card, a building data matrix introduced in the thesis is recommended to identify various elements of a British colonial building. The main purposes are to develop an understanding of the stylistic origins and periods of the building through the process of identifying its physical features and ornaments; and to act as a guidance for future repair and maintenance work. It can also be adopted for a computer database. The latter would enable several databases to be maintained to assist in security of information.

Classification of British colonial buildings into twelve categories helps to identify various types of such buildings, particularly those which built between 1800 and 1930. As far as preserving all records of British colonial buildings are concerned, it is suggested that the National Archive should act as a central body which concerns with the repository and preservation of such records. However, copies of the building records should be retained locally or regionally and be given to building owners for future preservation and conservation work.

It is concluded that the present systems for conservation of historic buildings in Malaysia can be improved. The thesis has shown that British

colonial buildings, in particular, can be saved and maintained with the adaptation of proper methods and techniques; and good maintenance programmes similar to those developed in the United Kingdom. It is equally important that such historic buildings should not be left to the market forces of the normal building industry. There should be continuous research, seminars, technical exhibitions about British colonial buildings; and conservation courses at higher institutions in order to create greater public awareness and understanding toward the importance of such an architectural heritage. Even though the number of British colonial buildings in Malaysia is relatively small as compared to other indigenous architecture, it is the duty of building owners, conservationists, architects, trustees, local authorities and the public to see that British colonial buildings are handed on to the next generation in good condition.

APPENDIX 1

Extraction of the Town and Country Planning Act 1976

Purpose and Interpretations

The Act provides for the proper control and regulation of town and country planning in local authority areas. It empowers local authorities to prepare Local and Action Area Plans and the Designation of Conservation Districts following the completion of Structure Plan and Urban Areas in the country. Rules and procedures have to be submitted to the National Museum.

A "building" may include any house, hut, shed or roofed enclosure, whether or not used as a human habitation; and any wall, fence, platform, jetty or bridge; and any structure or foundation connected to any of these structures.

"Building operation" means the demolition, erection, re-erection or extension of a building or part thereof; and includes increasing height or floor area, roofing or re-roofing, any addition to or alteration that materially affects or is likely to materially affect the building in any manner.

"Development" means the carrying out of any building, engineering, mining, industrial or other similar building operation.

Functions of Local Planning Authority

The functions of a local planning authority shall be:

- i. to regulate, control and plan the development; and use of all lands and buildings within its area.
- ii. to institute a survey of its area which is examining the matters that may be expected to affect the development of that area.
- iii. to decline any planning permission if the development in respect of which the permission is applied for would contravene any provision of the development plans.
- iv. to discontinue the development carrying out by developer, within a period specified in a notice, if the authority is not satisfied with the planning applied for.

Planning Permission and Penalties

No person other than a local authority shall carry out any development unless planning permission in respect of the development has been granted to this

However, no planning permission shall be necessary for carrying out work for the maintenance, improvement or other alteration affecting only the interior of the building (provided the work does not materially affect the external appearance or involve any increase in height or floor area of the building).

Any person who carries out development without the approval of the planning permission commits an offence and is liable, on conviction, to a maximum fine of MR50,000.

Any person who continues to carry out any development after being required to discontinue it by a notice served on him commits an offence. Upon conviction, he may be fined of up to MR20,000 which may extend to MR500 for each day development is carried out after the first conviction for the offence. If fails to comply with requirements of notice, he may be fined not exceeding MR10,000.

Provision for Conservation of Building

For the purpose of conservation, the State Authority may make rules for the protection of ancient monuments, lands and buildings of historic or architectural interest.

APPENDIX 2

Extraction of the Antiquities Act 1976

Ancient Monument and Historical Sites

The Act provides for the control and preservation of, and research into ancient and historical monuments.

An "ancient monument" is defined as any monument which is or is reasonably believed to be at least one hundred years old or which is declared as one. Such monument may be a house, temple, church, building, cave, grave or a standing stone which has historical, religious or cultural significance.

A "historical site" means a site declared as such by a Minister who is responsible for the museums.

The Director-General of Museums may publish in the Gazette a schedule of ancient monuments and historical sites together with the limits thereof. With regard to the ancient monuments and historical sites, permission in writing from the Director-General is required for the following actions:

- i. digging, excavation, building works, tree planting, quarrying, irrigation, burning of lime or depositing of earth or refuse on or in the immediate.
- ii. demolition, disturbance, obstruction, modification, marking, pulling down or removal of any such monuments or part thereof.
- iii. alterations, additions or repairs.
- iv. erect buildings or walls abutting upon an ancient monument.

Care of Private Properties

The Director-General may take the following actions with regard to the ancient monuments and historical sites under private ownership:

- i. make contributions towards the cost of carrying out any works of repair or conservation.
- ii. purchase or lease the site by private treaty or compulsory acquisition.
- iii. remove the whole or part of an ancient monument with payment of compensation (fixed by agreement or submitted to the Minister for decision in case of disputes).

Penalties for Demolishing and Damaging

Any person who demolishes or damages any ancient monument without permission commits an offence and is liable to imprisonment not exceeding three months or to a fine not exceeding MR500 or both.

APPENDIX 3

Extraction of the Johore Enactment No. 7 of 1988

Purpose and Interpretations

An Enactment to establish a body corporate by the name of Yayasan Warisan Negeri (YWN) for the preservation of the cultural and historical heritage of the Johore state; and to provide for matters connected therewith.

An "ancient monument" means any monument in the State which is or is reasonably believed to be at least one hundred years old or which is declared by the State Authority to be one.

A "monument" includes any building, structure, erection or other work whether above or below the surface of the land, any memorial, place of interment and any part of a monument that is considered to be worthy of preservation historically, traditionally, archaeologically or architecturally.

A "historical site" means a site which has been declared by the State Authority to be preserved.

A "curator" is the Chief Executive Officer appointed by the YWN to be responsible for carrying out any decisions and directions made by the body and exercising general control over its officers and servants.

Establishment and Functions of the YWN

As an established body corporate, the YWN may involve in suing and be sued in its name, in entering into contracts; and in acquiring, purchasing, taking, holding movable or immovable property incidental or appertaining to the body. Members of the YWN include a Chairman who is the Chief Minister of State, Deputy Chairman, Treasurer, Secretary and a representative from the National Museum and National Art Gallery.

The YWN has the authority to do research and inspection on monuments, advise and control on any alterations, repairs and renovations of any kind to ensure the better preservation. In addition, it can receive donations, grants from any source and contribute the grant or loan towards any repair and maintenance of monuments or articles of historic values.

The functions of the YWN shall be:

- i. to stimulate public interest and support in the preservation and dissemination of knowledge of the cultural and historical heritage of the State.
- ii. to preserve monuments and articles of historic, traditional, archaeological or architectural interest.
- iii. to protect the amenities relating to the monuments.
- iv. to take appropriate measures to preserve all records, documents and data relating to those monuments and articles.
- v. to provide for libraries as reference and research work.
- vi. to manage and administer the fund.

Penalty

Any person who wilfully defaces, damages or interferes with any monument shall be guilty of an offence and shall be liable upon conviction to a maximum fine of MR10,000 or to a term of two years imprisonment or both.

APPENDIX 4

Summary of the Malacca Enactment No. 6 of 1988

Purpose and Interpretations

An Enactment to make provisions for the preservation, conservation and enhancement of cultural heritage and matters incidental thereto. It may be also called as the Preservation and Conservation of Cultural Heritage Enactment 1988.

A committee, known as the Preservation and Conservation Committee, shall be established by the State Authority in order to advise on matters of policy, administration and management of cultural heritage and conservation areas. This Committee is chaired by the Chief Minister of State.

The Enactment requires clarification of common terminologies used in preservation and conservation of cultural heritage.

"Adaptation" means a process of modifying a cultural heritage or a conservation area to suit a proposed compatible use.

"Conservation" defines a process of looking after a cultural heritage or a conservation area so as to retain its significance; and this includes maintenance, preservation, restoration, reconstruction, adaptation or a combination of two or more of these.

"Cultural heritage" includes any antiquity, historical object, historical site, fabric, building, structure, work of art, manuscript, coin, vehicle, ship or tree which has a significant and special architectural, aesthetic, historical, cultural, scientific, economic interest or value.

"Maintenance" means a continuous protection and care of a cultural heritage or a conservation area as distinguished from repair which may involve restoration or construction.

"Preservation" is a process of maintaining a cultural heritage or a conservation area in its existing state or form.

"Reconstruction" means a process of returning a cultural heritage or a conservation area as nearly as possible to an earlier known state by the introduction of old or new materials.

"Restoration" means a process of returning the existing cultural heritage or a conservation area to an earlier known state by removing accretion or by reassembling the existing repairs without the introduction of new materials.

Declaration of Cultural Heritage

The State Authority may on the recommendation of the Local Authority and advise of the Committee declare any cultural heritage which is desirable to be preserved or conserved, and also may designate an area within such heritage is located as a conservation area.

Any person who owns any cultural heritage which has not been declared may apply in a prescribed form to the Local Authority within which the heritage is located for such declaration. Upon processing the application, the Local Authority, however, shall notify the owner that his heritage or area is subject to preservation or conservation.

Any cultural heritage which has been declared to be preserved or conserved shall be inspected at all reasonable times by an officer authorised by the Local Authority.

Restriction of Planning Permission

Planning permission shall be obtained from the Local Authority prior to any demolition, alteration, reconstruction, renovation, modification and repair of any cultural heritage. In the case of conservation area, such planning permission is also required for erecting any building or structure, destroying any trees, digging, quarrying, irrigating or disturbing the landscaping in such area.

The Local Authority may impose conditions with respect to the reconstruction of a building or any part of it with the use of original material so far as practicable. Any alteration to the interior of the building may also be specified in the permission.

Repair of Historic Building

Whenever a building is declared to be preserved or conserved and is in need of urgent repair, the Local Authority may make arrangement with the owner or occupier for the repair to be executed and also for making contribution towards the cost. This also implies to any building of which has not been declared but is located in a conservation area (so as to maintain the harmonious character or appearance of the area).

A fund known as Preservation and Conservation Fund shall be established by the State Authority to maintain, preserve, conserve, acquire any cultural heritage or conservation area. The Fund shall also be expended for carrying out activities including publication, exhibition and campaign for the protection of the cultural heritage.

Financial Incentives and Tax Relief



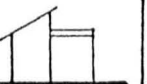
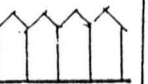

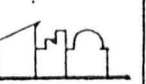





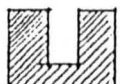



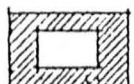
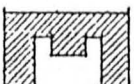

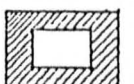


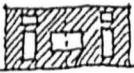
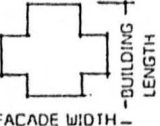

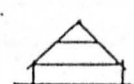
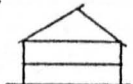
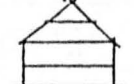

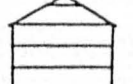
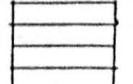
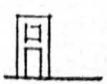
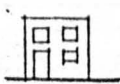
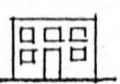
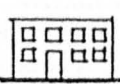
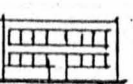
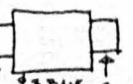
Any person who owns a cultural heritage or conservation area declared for preservation or conservation may apply to the State Authority for financial assistance which include grant, aid, loan, reduction of rates and rent; and also a tax relief in respect to the revenue earned.

Penalty

Any person who contravenes any provision of this Enactment shall be guilty and be liable on conviction to a maximum fine of MR10,000 or five years imprisonment or both.

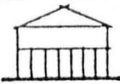
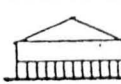
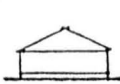
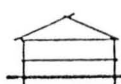
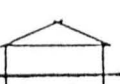
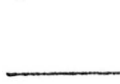
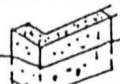
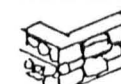
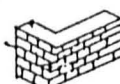
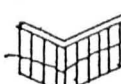

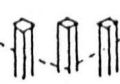



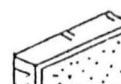


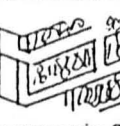
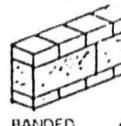
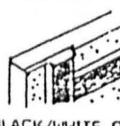

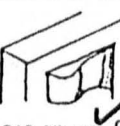
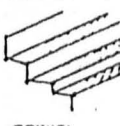

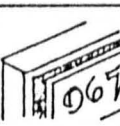
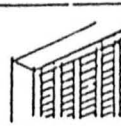

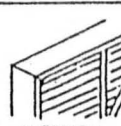
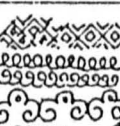
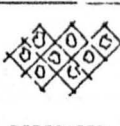
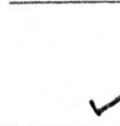
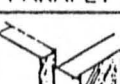


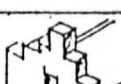






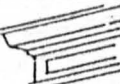
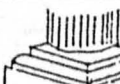

APPENDIX 5

Building Data Matrix Introduced by Heritage of Malaysia Trust

1. BUILDING CONTEXT						
						
DETACHED SINGLE 01	SEMI-DETACHED RELATED 02	SEMI-DETACHED NON-RELATED 03	LINK RELATED 04	LINK NON-RELATED 05	ATTACHED IRREGULAR ✓ 06	LINK PART OF COMPOSITION 07
OTHER 08	OTHER 09	COMMENTS LARGE MANSION WITH SEVERAL SELF-CONTAINED APARTMENTS.  COURTYARD				
2. PLAN						
						
SQUARE 01	RECTANGULAR 02	L-SHAPED 03	U-SHAPED 04	T-SHAPED 05	H-SHAPED 06	POLYGONAL 07
						OTHER 14
ATRIUM ✓ 08	PAVILION 09	CRUCIFORM 10	VERANDAH 11	IRREGULAR 12	RECTANGULAR W/ AIRWELL(S) 13	OTHER 14
OTHER 15	OTHER 16	COMMENTS FIVE COURTYARDS.  PLAN SYMMETRICAL ON EITHER SIDE.				
3. BUILDING DIMENSIONS						
		FACADE WIDTH METRES <input type="text" value="70"/> FEET <input type="text" value="200"/>	BUILDING LENGTH METRES <input type="text" value="70"/> FEET <input type="text" value="200"/>			
4. BUILDING HEIGHT (LEVELS)						
						
ONE 01	1 1/2 02	TWO ✓ 03	2 1/2 04	THREE 05	3 1/2 06	FOUR 07
5. BUILDING MODULES (BAYS)						
						OTHER 07
ONE BAY 01	TWO BAYS 02	THREE BAYS 03	FOUR BAYS 04	OVER 4 BAYS ✓ 05	OTHER 06	OTHER 07

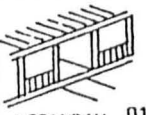
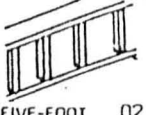

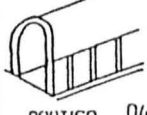


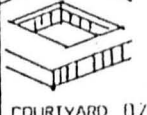
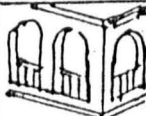
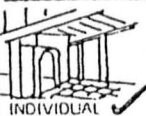
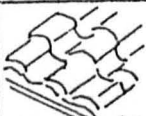
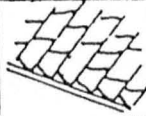
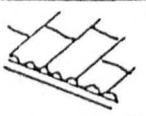
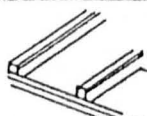

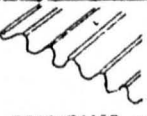
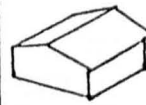
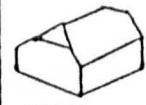
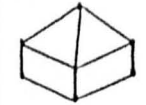
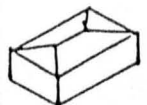
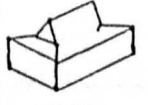
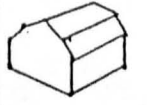
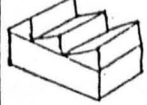
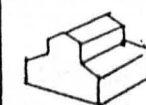
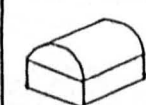
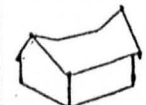

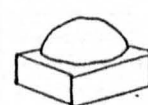
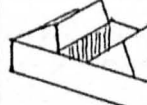
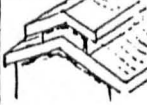
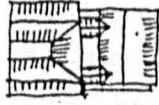
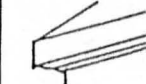






APPENDIX 5

Building Data Matrix Introduced by Heritage of Malaysia Trust

6. FOUNDATION							COMMENTS
 ON STILTS FULL LEVEL 01	 ON STILTS SEMI-LEVEL 02	 SLAB ON GRADE <input checked="" type="checkbox"/> 03	 BASEMENT HALF 04	 BASEMENT FULL 05	 OTHER 06	07	
7. FOUNDATION WALL MATERIAL							COMMENTS
 CONCRETE <input checked="" type="checkbox"/> 01	 STONE 02	 BRICK 03	 WOOD PLANKS 04	 WOOD STILTS 05	 COLUMNS 06	OTHER 07	
8. WALL MATERIAL							COMMENTS
 CONCRETE 01	 STONE 02	 BRICK 03	 PLASTER ON BRICK <input checked="" type="checkbox"/>	 WOOD 05	 METAL 06	OTHER 07	
9. WALL ORNAMENTATION (MULTIPLE CHOICE)							COMMENTS (DESCRIBE UNIQUE DETAILS) BAS RELIEF OF SCROLLS & CHARACTERS OVER ARCHWAYS OF UPPER FLOORS. DECORATED PLASTER WORK UNDER GABLED ROOF. COLOURWORK BLUE. BAS RELIEF - VARIOUS CERAMIC COLOURS. RED, YELLOW, GREEN.
 RUSTICATION 01	 BANDED BRICK 02	 BLACK/WHITE TUDOR 03	 DECORATED PANEL 04	 BAS-RELIEF <input checked="" type="checkbox"/> 05	 CORNICE 06	 CARVING <input checked="" type="checkbox"/> 07	
 INSCRIPTION 08	 FRETWORK 09	 FLUTING 10	 LATTICED SCREEN 11	 DIAPER PATTERN <input checked="" type="checkbox"/> 12	 DECORATED TILES 13	 COLOURWORK 14 <input checked="" type="checkbox"/>	
OTHER 15	NONE 16						
10. PARAPET							COMMENTS
 PLAIN 01	 CRENELLATED 02	 GABLED 03	 STEPPED 04	 DECORATED 05	 BALUSTRADE 06	OTHER 07	
11. COLUMN (MULTIPLE CHOICE)							COMMENTS
 ENGAGED COLUMN 01	 DORIC 02	 IONIC 03	 CORINTHIAN 04	 ENTABLATURE <input checked="" type="checkbox"/> 05	 PLINTH <input checked="" type="checkbox"/> 06	 PILASTER <input checked="" type="checkbox"/> 07	

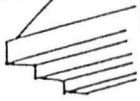
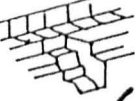
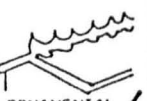
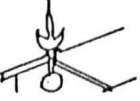

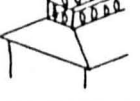

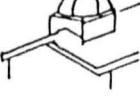
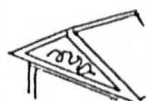


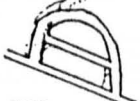
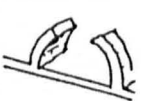
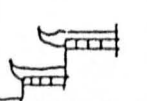








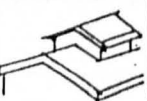


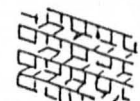
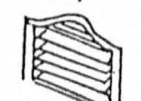


APPENDIX 5

Building Data Matrix Introduced by Heritage of Malaysia Trust

					COMMENTS	
OTHER 08	OTHER 09	OTHER 10	OTHER 11			
12. OPEN OUTDOOR AREAS (MULTIPLE CHOICE)						
 VERANDAH 01	 FIVE-FOOT WAY/COLONNADE 02	 ARCADE 03	 PORTICO 04	 BALCONY 05	 AIRWELL 06	 COURTYARD 07
 LOGGIA 08	 INDIVIDUAL PORCHES w/ ARCHWAY 09	OTHER 10	OTHER 11	COMMENTS DECORATED CORBEL BRACKETS SUPPORT ROOF OVER PORCH.		
13. ROOF MATERIAL						
 TILES TRADITIONAL 01	 TILES MODERN 02	 ASBESTOS SHEETS 03	 ZINC SHEETS 04	 ATAP 05	 CORRUGATED METAL 06	COMMENTS GLAZED SEGMENTAL TILE ROOFING BROUGHT FROM CHINA. 07
14. ROOF TYPE						
 GABLE 01	 HIPPED GABLE 02	 PYRAMIDAL 03	 HIPPED 04	 GABLED HIP 05	 MANSARD 06	 SAWTOOTH 07
 MONITOR 08	 VAULTED/ARCHED 09	 MINANGKABAU 10	 MERU 3-TIERED 11	 DOMED 12	 GABLE w/ AIRWELL(S) 13	 GABLE w/ JACK ROOF 14
OTHER 15	OTHER 16	OTHER 17	OTHER 18	COMMENTS  ROOF SYSTEM		
15. ROOF TRIM (MULTIPLE CHOICE)						
 PLAIN FASCIA 01	 DECORATED FASCIA 02	 PLAIN SOFFIT 03	 DECORATED SOFFIT 04	 PLAIN FRIEZE 05	 DECORATED FRIEZE 06	 BRACKETS 07

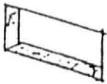




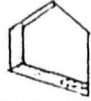

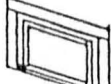
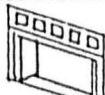

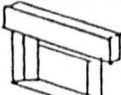


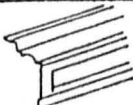
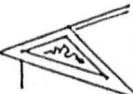


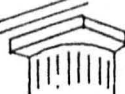










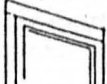





APPENDIX 5

Building Data Matrix Introduced by Heritage of Malaysia Trust

 <p>CORBELLED CORNICE 08</p>	 <p>CORBEL BRACKET 09 <input checked="" type="checkbox"/></p>	<p>NO FASCIA 10</p>	<p>OTHER 11</p>	<p>COMMENTS CORBEL BRACKET SUPPORT ROOF OVER PORCH & MAIN ROOF. CERAMIC SCULPTURE DECORATION OF FLOWERS FOR FASCIA & SOFFIT.</p>		
<p>16. ROOF ORNAMENTATION (MULTIPLE CHOICE)</p>						
 <p>ORNAMENTAL RIDGE 01 <input checked="" type="checkbox"/></p>	 <p>FINIAL 02</p>	 <p>BARGE BOARD 03</p>	 <p>BALUSTRADE 04</p>	 <p>SPIRE 05</p>	 <p>CUPOLA 06</p>	<p>DRAW</p> <p>SCULPTURED FIGURES 07</p>
<p>OTHER 08</p>	<p>NONE 09</p>	<p>COMMENTS (DESCRIBE UNIQUE DETAILS) CERAMIC SCULPTURE DECORATION OF FLOWERS FOR ROOF RIDGE.</p>				
<p>17. PEDIMENT</p>						
 <p>CLASSICAL 01</p>	 <p>BAROQUE 02</p>	 <p>SEGMENTAL 03</p>	 <p>SEMI-CIRCULAR 04</p>	 <p>OPEN 05</p>	<p>NONE</p> <p>OTHER 06</p>	<p>COMMENTS</p>
<p>18. GABLE GALL</p>						
 <p>STEPPED 01</p>	 <p>BOW-SHAPED 02</p>	 <p>STRAIGHT 03</p>	 <p>FIVE PEAKS ADORING HEAVEN 04</p>	 <p>CAT CRAWLING 05</p>	 <p>PARTIAL CAT CRAWLING 06 <input checked="" type="checkbox"/></p>	 <p>FORM OF THE WAVES 07</p>
 <p>EAR OF THE COOKING PAN 08</p>	 <p>INVERTED V 09</p>	<p>OTHER 10</p>	<p>N/A 11</p>	<p>COMMENTS DECORATED WITH CERAMIC SCULPTURE OF FLOWERS.</p>		
<p>19. VENTILATION (MULTIPLE CHOICE)</p>						
 <p>JACK ROOF 01</p>	 <p>TRIANGLE IN GABLE 02</p>	 <p>VENTILATOR 03 <input checked="" type="checkbox"/></p>	 <p>LATTICED SCREEN 04</p>	 <p>JALOUSIE 05</p>	 <p>AIR WELL 06 <input checked="" type="checkbox"/></p>	<p>OTHER 07</p>
<p>OTHER 08</p>	<p>N/A 09</p>	<p>COMMENTS FIVE COURTYARDS. VENTILATORS OVER WINDOWS & DOORS. (SEMI-CIRCULAR.)</p> 				

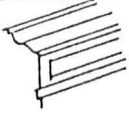
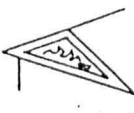









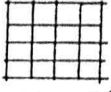
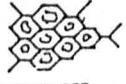



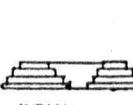


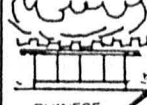






APPENDIX 5

Building Data Matrix Introduced by Heritage of Malaysia Trust

20. WINDOW FORM (TYPICAL)						
						
FLAT 01	SEGMENTAL 02	SEMI-CIRCULAR <input checked="" type="checkbox"/> 03	OGEE 04	POINTED 05	TRIANGULAR 06	OTHER 07
OTHER 08	OTHER 09	COMMENTS				
21. WINDOW TRIM (TYPICAL) (MULTIPLE CHOICE)						
						
PLAIN 01	MOULDED 02	DECORATED 03	SHAPED TRANSOM <input checked="" type="checkbox"/> 04	LINTEL 05	VOUSSOIRS 06	KEYSTONE 07
						
ENTABLATURE 08	PEDIMENT 09	ENGAGED COLUMN 10	PILASTER 11	DORIC CAPITAL 12	IONIC CAPITAL 13	CORINTHIAN CAPITAL 14
	OTHER 16	OTHER 17	COMMENTS (DESCRIBE UNIQUE DETAILS) WOODEN CARVINGS ON CURVED PORTION OF WINDOWS. (VENTILATORS.)			
VENETIAN <input checked="" type="checkbox"/> 15						
22. DOOR FORM (MAIN ENTRANCE)						
						
FLAT 01	SEGMENTAL 02	SEMI-CIRCULAR <input checked="" type="checkbox"/> 03	OGEE 04	POINTED 05	TRIANGULAR 06	OTHER 07
OTHER 08	N/A 09	COMMENTS				
23. DOOR TRIM (MAIN ENTRANCE) (MULTIPLE CHOICE)						
						
PLAIN 01	MOULDED 02	DECORATED 03	SHAPED TRANSOM <input checked="" type="checkbox"/> 04	LINTEL 05	VOUSSOIRS 06	KEYSTONE 07

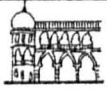



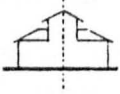
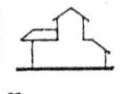
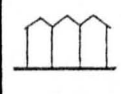
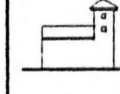
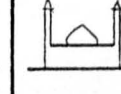



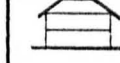
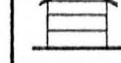
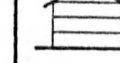
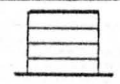
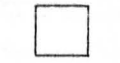
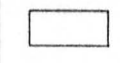
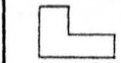
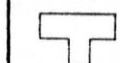
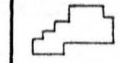
APPENDIX 5

Building Data Matrix Introduced by Heritage of Malaysia Trust

						
ENTABLATURE 08	PEDIMENT 09	ENGAGED COLUMN 10	PILASTER 11	DORIC CAPITAL 12	IONIC CAPITAL 13	CORINTHIAN CAPITAL 14
			COMMENTS (DESCRIBE UNIQUE DETAILS) WOODEN CARVED VENTILATORS OVER DOORS.			
VENETIAN 15	OTHER 16	N/A 17				
24 SPECIAL DOORS (MULTIPLE CHOICE)						
				COMMENTS		
PINTU BESAR <input checked="" type="checkbox"/> 01	PINTU PAGAR 02	SHUTTER 03	OTHER 04			
25 FLOOR MATERIAL						
					INTERIOR	COMMENTS EXTERIOR- TILE SHAPE
PLAIN TILE <input checked="" type="checkbox"/> 01	DECORATED TILE 02	WOOD 03	CONCRETE 04	STONE 05	MARBLE <input checked="" type="checkbox"/> 06	
26 STYLISTIC INFLUENCES						
						
INDIAN KINGDOMS 01	MALAY VERNACULAR 02	STRAITS ECLECTIC 03	CHINESE BAROQUE <input checked="" type="checkbox"/> 04	CHITYA INDIAN VERNACULAR 05	COLONIAL 06	MODERN 07
	COMMENTS CHINESE COURTYARD STYLE.					
OTHER 08						
27 OTHER ELEMENTS/ORNAMENTATION						
INTERIOR 	INTERIOR: 	INTERIOR: 	WOODEN CARVINGS ON DOORS & SCREENS PAINTED GOLD			
COMMENTS/DESCRIPTION/SYMBOLIC SIGNIFICANCE EXTENSIVE WOODEN CARVINGS & DETAILS IN INTERIOR HIGHLY DECORATIVE BUT IN BAD REPAIR.						


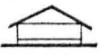


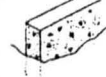
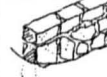
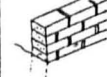
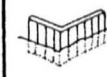


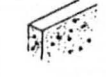

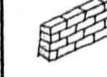
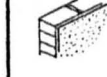


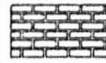
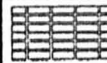
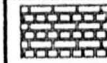
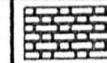
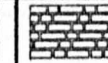
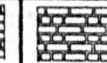
APPENDIX 6

Building Data Matrix for British Colonial Buildings

BUILDING DATA MATRIX					
SECTION 1 : FILE REFERENCES					
1.1 Name of Building:			1.3 File Reference:		
1.2 Address of Building:			1.4 Name of Recorder:		
			1.5 Date of Recording:		
SECTION 2 : BUILDING					
2.1 Stylistic Influence					
 01 MOORISH	 02 TUDOR	 03 NEO-CLASSICAL	 04 NEO-GOTHIC	05 OTHER	
2.2 Elevation					
 01 SYMMETRICAL	 02 ASYMMETRICAL	 03 LINKED	 04 TOWER	 05 MINARET	06 OTHER
2.3 Height / Level					
 01 ONE	 02 1 1/2	 03 TWO	 04 2 1/2	 05 THREE	 06 3 1/2
 07 FOUR.	08 OTHER				
2.4 Plan					
 01 SQUARE	 02 RECTANGULAR	 03 L-SHAPED	 04 T-SHAPED	 05 IRREGULAR	06 OTHER

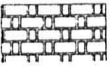
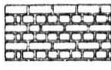

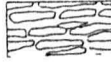
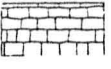
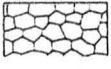
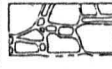
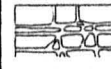
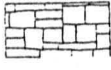
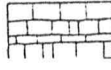



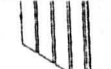


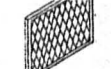

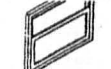



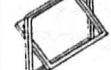
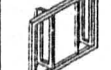

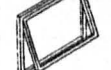


APPENDIX 6

Building Data Matrix for British Colonial Buildings

2.5 Dimensions (ft & m)					
Building Length:			Facade Width:		
SECTION 3 : STRUCTURES					
3.1 Foundations Type					
					
01 ON STILTS	02 SLAB ON GRADE	03 BASEMENT HALF	04 BASEMENT FULL	05 OTHER	
3.2 Foundations Material					
					
01 CONCRETE	02 STONE	03 BRICK	04 WOOD PLANKS	05 WOOD STILTS	06 COLUMNS
07 OTHER					
3.3 Wall Material					
					
01 CONCRETE	02 STONE	03 BRICK	04 PLASTER ON BRICK	05 WOOD	06 METAL
07 OTHER					
3.4 Brickwork					
					
01 RUNNING BOND	02 STACK BOND	03 ENGLISH BOND	04 FLEMISH BOND	05 FLEMISH SPIRAL	06 FLEMISH CROSS


















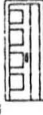
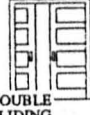







APPENDIX 6

Building Data Matrix for British Colonial Buildings

3.4 Brickwork (cont')					
					
07 RAT-TRAP	08 ENGLISH CROSS	09 OTHER			
3.5 Stonework					
					
01 RUBBLEWORK	02 RAG-WORK	03 AŞHLAR	04 POLYGONAL	05 RANDOM	06 RANDOM-COURSED
					
07 BROKEN COURSED	08 IRREGULAR COURSED	09 OTHER			
3.6 Wood Wall					
					
01 CLAPPER BOARD	02 BOARD ON BOARD	03 BOARD & BATTEN	04 TONGUE & GROOVE	05 OTHER	
3.7 Wall Ornamentation					
					
01 TIMBER FRAMING	02 FESTOON	03 OTHER			
3.8 Window Type					
					
01 LEADED	02 MULL	03 SASH	04 SLIDING	05 CASEMENT	06 FRENCH
					
07 PIVOTING	08 FOLDING	09 LOUVRED	10 AWNING	11 ROUNDED	12 OTHER









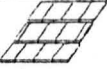

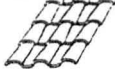

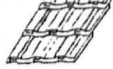
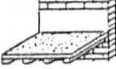








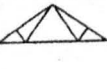
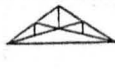
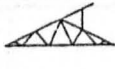






APPENDIX 6

Building Data Matrix for British Colonial Buildings

3.9 Protuding Window					
 01 BOX	 02 BAY	 03 BAY CURVED	04 OTHER		
3.10 Window Trim					
 01 PLAIN	 02 MOULDED	 03 DECORATED PEDIMENT	 04 SHAPED TRANSOM	 05 FANLIGHT	 06 ARCH-HEADED
 07 KEYSTONED LINTEL	08 OTHER				
3.11 Door Type					
 01 PANEL	 02 GLASS	 03 LEDGE & BRACE	 04 LOUVRED	 05 FRENCH	 06 SWING
 07 DOUBLE SWING	 08 SLIDING	 09 DOUBLE SLIDING	10 OTHER		
3.12 Door Trim					
 01 PLAIN	 02 MOULDED	 03 DECORATED PEDIMENT	 04 SHAPED TRANSOM	 05 FANLIGHT	 06 ARCH-HEADED
 07 KEYSTONED LINTEL	08 OTHER				

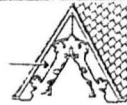

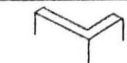

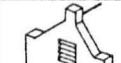

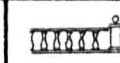

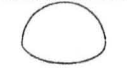

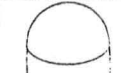



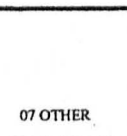


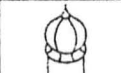



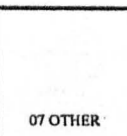
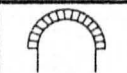
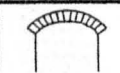
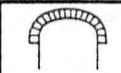
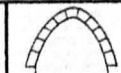
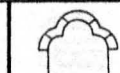

APPENDIX 6

Building Data Matrix for British Colonial Buildings

3.13 Roof Type					
 01 FLAT	 02 GABLE	 03 HIPPED GABLE	 04 PYRAMIDAL	 05 HIPPED	 06 VAULTED
 07 DOMED	08 OTHER				
3.14 Roofing Material					
 01 THATCH OR ATAP	 02 PLAIN TILE	 03 PANTILE	 04 SPANISH TILE	 05 CORRUGATED	 06 INTERLOCKED
 07 BITUMEN FELT	08 OTHER				
3.15 Roof Supports					
 01 BASE CRUCK	 02 RAISED CRUCK	 03 TIE BEAM	 04 KING POST	 05 QUEEN POST	 06 CROWN POST
 07 HAMMERBEAM	 08 ARCH BRACE	 09 PITCHED	 10 SCISSORS	 11 CLERESTORY	12 OTHER
3.16 Roof Trim					
 01 PLAIN FASCIA	 02 DECORATED FASCIA	 03 PLAIN SOFFT	 04 PLAIN FRIEZE	 05 DECORATED FRIEZE	 06 MODILLONS























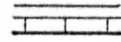
APPENDIX 6

Building Data Matrix for British Colonial Buildings

3.16 Roof Trim (cont')					
 07 BARGEBOARD	 08 OTHER				
3.17 Parapet					
 01 PLAIN	 02 CRENELLATED	 03 GABLE	 04 SHAPED GABLE	 05 BALUSTRADE.	 06 OTHER
3.18 Dome Type					
 01 CUPOLA	 02 SAIL DOME	 03 DRUM-DOME	 04 PENDENTIVE	 05 DOMICAL	 06 UMBRELLA
 07 OTHER					
3.19 Turret Type					
 01 ROTUNDA	 02 DOMED	 03 IMPERIAL	 04 CONICAL BROACH	 05 SPIRED	 06 CHATRI
 07 OTHER					
3.20 Arch Type					
 01 SEMI CIRCULAR	 02 SEGMENTAL	 03 THREE CENTRED	 04 PARABOLIC	 05 ROUND TREFOIL	 06 VENETIAN















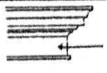


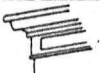
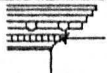










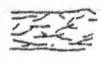
APPENDIX 6

Building Data Matrix for British Colonial Buildings

4.1 Floor Material (cont')					
07 OTHER					
4.2 Wall Material					
 01 WOOD	 02 CONCRETE	 03 STONE	 04 BRICK	 05 PLASTER ON BRICK	 06 METAL
07 OTHER					
4.3 Staircase Type					
 01 CIRCULAR	 02 QUARTER TURN	 03 QUARTER WINDING	 04 SPIRAL	 05 STRAIGHT FLIGHT	 06 DOGLEG
 07 GEOMETRICAL	 08 DOUBLE RETURN	09 OTHER			
4.4 Staircase Style					
 01 TUDOR / JACOBEBAN	 02 FEDERAL / EMPIRE	 03 GOTHIC / VICTORIAN	04 OTHER		
4.5 Ceiling Type					
 01 FLAT PLASTERED	 02 PLASTERED MOULDED CORNICE	 03 EXPOSED BEAMS	 04 DECORATED PLASTERED	 05 CENTRAL ROSE	 06 SUSPENDED

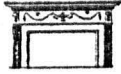



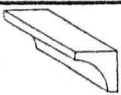
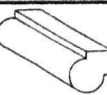
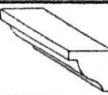

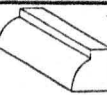
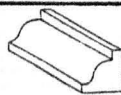







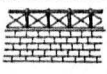




APPENDIX 6

Building Data Matrix for British Colonial Buildings

3.20 Arch Type (cont')					
 07 STILTED	 08 POINTED SARACENIC	 09 EQUILATERAL	 10 POINTED SEGMENTAL	 11 POINTED TREFOIL	 12 CINQUEFOIL
 13 OGEE	14 OTHER				
3.21 Column Type					
 01 DORIC	 02 IONIC	 03 CORINTHIAN	 04 TUSCAN	 05 COMPOSITE	 06 ENGAGED COLUMN
 07 PILASTER	08 OTHER				
3.22 Column Parts					
 01 FRIEZE	 02 PLINTH	 03 PEDESTAL	 04 ENTABLATURE	 05 DENTILS	06 OTHER
3.23 Columniation					
 01 DISTYLE	 02 TRISTYLE	 03 TETRASTYLE	 04 PENANSTYLE	 05 HEXASTYLE	06 OTHER
SECTION 4 : INTERIOR					
4.1 Floor Material					
 01 PLAIN TILE	 02 DECORATED TILE	 03 TIMBER FLOORBOARD	 04 CONCRETE	 05 STONE	 06 MARBLE





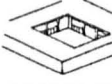





APPENDIX 6

Building Data Matrix for British Colonial Buildings

4.5 Ceiling Type (cont')					
07 OTHER					
4.6 Other Features					
 01 FIREPLACE	 02 DECORATED WALL PANELS	 03 SKIRTING	 04 DECORATED INTERNAL DOOR	05 OTHER	
SECTION 5 : ORNAMENT / ARCHITECTURAL FEATURES					
5.1 Moulding Type					
 01 CONE	 02 ROUND	 03 CYMA REVERSA	 04 FASCIA	 05 COCK BEAD	 06 OGEE
 07 NEBULY	08 OTHER				
5.2 Tracery Type					
 01 GEOMETRICAL	 02 INTERSECTING	 03 PANEL	 04 RETICULATED	 05 CURVILINEAR	
5.3 Exterior Part					
 01 CHIMNEY	 02 ROOF CRESTING	 03 ROOF FINIAL	 04 FENCING	 05 WINDOW SHADING DEVICE	 06 WALL CLOCK
07 OTHER					

APPENDIX 6

Building Data Matrix for British Colonial Buildings

5.4 Open Outdoor Areas					
 01 VERANDAH	 02 FIVE-FOOT COLONNADE	 03 ARCADE	 04 BALCONY	 05 COURTYARD	 06 PORCH
07 OTHER					
5.5 Ventilation					
 01 LOUVRED PANEL	 02 AIR WELL	 03 GRILLE	 04 DECORATED SCREEN	05 OTHER	
SECTION 6 : COMMENTS					

APPENDIX 7

Paint Types and Methods of Removal

(Source: *Removing Paint From Old Buildings*, SPAB, Information Sheet 5, 1989)

Limewash

Brush down all loose material with a bristle brush. Washing and scrubbing is usually sufficient. Old sulphated limewash in multiple applications may need to be softened with a wet poultice over a long period or as a last resort, removed mechanically.

Oil paints (eg. alkyd, gloss and enamel paints)

Solvent removers, hot air strippers and abrasive methods.

Emulsion paints (mainly for internal use)

Removal depends upon the type of emulsion and the number of coats. Some can be softened with hot water and scrubbed or scraped off. Some respond to a solvent stripper. Steam stripping is effective on one or two coats.

Steam stripping in conjunction with methylated spirits may be necessary for removing multiple layers of old paint, including polyvinyl emulsion that has resisted other forms of treatment. A solvent stripper combined with a poultice is sometimes successful. Preliminary hand rubbing will reduce encrustation.

Bituminous paints

There is no entirely satisfactory method. Steam cleaning may be helpful. Some types will respond to naphtha. Mechanical methods may be necessary. Bituminous stains can be removed by scrapping followed by scrubbing using water containing liquid detergent; when dry a poultice with white spirit is applied.

Cement paint

Difficult to remove. Some will respond to dilute hydrochloric acid; thorough washing is needed after application as the acid can cause damage to substrate, particularly limestone. Low pressure wet abrasive methods will probably be necessary.

Creosote

Difficult to remove. Solvent strippers can be effective if penetration of the coating is shallow. It is usually best to allow creosote to weather and fade naturally. "Bleeding" can occur if painted over with other paints.

Distemper, oil-bound (washable distemper) water paint

Can be difficult to remove. Steam stripping followed by stripping with a knife is usually the most successful method. Hot water washing and scrubbing can loosen adhesion of some types of paint.

Distemper, size-bound (soft distemper)

These distempers are generally removed by washing down thoroughly with warm water. Do not add alkaline soaps or detergents as harmful residues can be absorbed by porous surfaces. Steam stripping is also successful.

Tar

On a non absorbent surface tar can sometimes be removed by washing and scrubbing with water and detergent. A solvent stripper used alone or combined with a poultice should aid removal. Mechanical methods may be necessary. A blow torch can be successful on cob.

APPENDIX 8

Using Limewash

(Source: Jane Schofield, *Basic Limewash*, SPAB, Information Sheet 1, reprint ed., 1991)

Using the limewash:

Generally, limewash should be applied thinly and be allowed to dry out slowly. A very fine surface can be achieved using putty lime or quicklime provided sieving is careful and thorough and there are several thin applications. This good quality limewash will develop a strong finish and will not brush off on clothes etc.

Preparation

The surface to be limewashed should be brushed or washed free of any loose particles, dust, dirt, lichen etc. If there is much mould growth, the surface may be treated with a fungicide. Any deep holes should be pointed in advance with a lime mortar.

Damping down

This is very important for a good finish. Taking an area of about 4 sq. yards at a time, spray the wall surface with water so that the water in the limewash will not be sucked out immediately it is applied. Old limewash, cob, lime plaster etc. will need more damping down than hard stones.

Applying the limewash first coat

Brush the limewash onto the dampened area, working it well into any cracks and joints but not allowing it to build up too thickly at any point or it will craze on drying out. The limewash will be transparent on application, so care is needed for even coverage. Move to the next area, damping as you go.

Subsequent coats

Allow the previous coat to dry out completely, preferably overnight. Lightly dampdown the previous coat before applying the next. Three coats at least should be applied in all; more on new external surfaces. After the initial drying out, limewash will continue to harden and strengthen for several weeks.

BIBLIOGRAPHY

BOOKS:

- Addleson, L., 2nd. ed., (1989), *Building Failures: A Guide to Diagnosis, Remedy and Prevention*, London: Butterworth Architecture.
- Ashurst, J. and Ashurst, N., (1988), *Practical Building Conservation: Mortars, Plasters and Renders*, Hants: Gower Technical Press Ltd. Vol. 3.
- (1988), *Practical Building Conservation: Stone Masonry*, Hants: Gower Technical Press. Vol. 1.
- Bailey, B., (1984), *Ruin*, London: George Weidenfeld and Nicolson Ltd.
- Barrett, H. and Phillips, J., (1987), *Surburban Style: The British Home 1840-1960*, London: Macdonald & Co. Ltd.
- Bath City Council, (1978), *Saving Bath: A Programme for Conservation*, Bath: Bath City Council.
- Beard, G., (1983), *Stucco and Decorative Plasterwork in Europe*, Wisbech: Thames and Hudson.
- Binney, M. and Watson S.M., (1990), *Bright Future: The Re-Use of Industrial Buildings*, London: SAVE Britain's Heritage.
- Bowyer, J., (1980), *Vernacular Building Conservation*, London: Architectural Press.
- Brereton, C., (1991), *The Repair of Historic Buildings: Advice on Principles and Methods*, London: English Heritage.
- Brunskill, R. W., abridged ed., (1976), *A Systematic Procedure for Recording English Vernacular Architecture*, London: The Ancient Monuments Society.
- (1985), *Timber Building in Britain*, London: Victor Gollancz Ltd.
- Building Research Establishment (BRE), (1990), *Surveyor's Checklist for Rehabilitation of Traditional Housing*, Watford: BRE.
- Butcher, J. G., (1979), *The British in Malaya 1880-1941*, Kuala Lumpur: Oxford University Press.
- Calloway, S., ed., (1991), *The Elements of Style*, London: Mitchell Beazley.
- Cantacuzino, S., (1975), *New Uses for Old Buildings*, London: Architectural Press.
- Cantacuzino, S. and Brandt, S., (1980), *Saving Old Buildings*, London: Architectural Press.
- Cartwright, K.S.G. and Findlay, W.P.K., (1958), *Decay of Timber and Its Preservation*, London: Her Majesty's Stationary Office.
- Catanese, A. and Snyder, J., eds., (1979), *Introduction to Urban Planning*,

New York: McGraw Hill Co.

- Construction Industry Research and Information Association (CIRIA), (1986), *Structural Renovation of Traditional Buildings*, London: CIRIA.
- Cooper, N., (1991), in *Recording Historic Buildings: A Symposium*, London: Royal Commission on the Historical Monuments of England (RCHME).
- Cowan, H.J., ed., (1991), *Handbook of Architectural Technology*, New York: Van Nostrand Reinhold.
- Cruickshank, D., (1986), *Georgian Buildings*, New York: Rizzoli International Publication Inc.
- Cunnington, P., (1984), *Care for Old Houses*, Dorset: Prism Alpha.
- Davey, A. and Heath, B., (1986), *The Care and Conservation of Georgian Houses*, London: Architectural Press.
- Davies, P., (1987), *Splendours of the Raj: British Architecture in India 1660-1947*, Middlesex: Penguin Books Ltd.
- Desch, H.E., (1981), *Timber*, London: Macmillan Press Ltd.
- Draft Structure Plan*, (1987), Penang: Municipal Council of Penang Island.
- Eldridge, H.J., (1976), *Common Defects in Buildings*, London: Her Majesty's Stationary office.
- Fawcett, J., ed., (1976), *The Future of the Past*, London: Thames and Hudson.
- Feilden, B.M., (1982), *Conservation of Historic Buildings*, London: Butterworth Scientific.
- Fleming, J., Honour, H. and Pevsner, N., 3rd. ed., (1980), *Dictionary of Architecture*, London: Penguin Group.
- Forest Research Institute, (1981), *Properties and Uses of Commercial Timbers of Peninsular Malaysia*, Kepong: Malaysian Timber Industry Board.
- Girouard, M., (1979), *The Victorian Country House*, London: Yale University Press Ltd.
- Grewal, G.S., (1988), *Kiln-Drying Characteristics of Some Malaysian Timbers*, Kepong: Malaysian Timber Industry Board.
- Halim, N.A., (1981), *Tempat-Tempat Bersejarah Perak (Trans. Historical Places in Perak)*, Kuala Lumpur: Jabatan Muzium.
- Harvey, J., (1972), *Conservation of Buildings*, London: John Baker Ltd.
- Hersey, G.L., (1972), *High Victorian Gothic*, London: The Johns Hopkins University Press.
- Hesketh, R.F., (1986), ed., *Architecture of the British Empire*, London: George Weidenfeld and Nicolson Ltd.
- Highfield, D., (1987), *Rehabilitation and Re-Use of Old Buildings*, London: E & F.N. Spon Ltd.

- Insall, D.W., (1975), *The Care of Old Buildings Today*, London: Architectural Press Ltd.
- Institution of Civil Engineers, (1985), *Design Life of Buildings*, London: Thomas Telford Ltd.
- International Council on Monuments and Sites (ICOMOS), (1990), *Guide to Recording Historic Buildings*, London: Butterworth Architecture.
- Kajian Pengekalan Pusat Bandar* (Trans. *Analysis on Conservation of City Centre*), (1991), Kuala Lumpur: Dewan Bandaraya Kuala Lumpur.
- Kendall, E., (1977), *Recycling Buildings: Renovations, Remodellings, Restorations and Reuses*, New York: McGraw Hill Book Company.
- Kennedy, J., (1962), *A History of Malaya A.D. 1400-1959*, London: MacMillan and Co. Ltd.
- Kennet, W., (1972), *Preservation*, London: Maurice Temple Smith Ltd.
- Khoo, K.K., (1981), *Taiping: Ibukota Perak*, Kuala Lumpur: Persatuan Muzium Malaysia.
- King, A.D., (1984), *The Bungalow: The Production of a Global Culture*, London: Routledge and Kegan Paul Plc.
- Kuala Lumpur Structure Plan*, (1984), Kuala Lumpur: Dewan Bandaraya Kuala Lumpur.
- Legal Research Board, comp., *Uniform Building By-Laws 1985*, Kuala Lumpur: International Law Book Services.
- Lim, S.C., (1984), *Malaysian Timbers for Flooring*, Kepong: Malaysian Timber Industry Board.
- Lion, E., (1982), *Building Renovation and Recycling*, New York: John Wiley and Sons.
- Marsh, P., (1983), *The Refurbishment of Commercial and Industrial Buildings*, London: Construction Press.
- Michell, E., (1988), *Emergency Repairs for Historic Buildings*, London: English Heritage.
- Mills, E.D., (1980), *Building Maintenance and Preservation: A Guide for Design and Management*, London: Butterworth & Co.
- Moore, W., ed., (1990), *Petronas Heritage Mapbook of Peninsular Malaysia*, Petaling Jaya: Falcon Press Sdn. Bhd.
- Nakamura, T., ed., (1990), *Recent Work of James Stirling Michael Wilford and Associates*, Tokyo: A + U Publishing Co. Ltd.
- National Building Agency, comp., (1983), *Common Building Defects: Diagnosis and Remedy*, Essex: Construction Press.
- Ng, D., comp., (1983), *Malaya 1900-1930: A Retrospect of the Country Through Postcards*, Petaling Jaya: Star Publications (M) Bhd.

- Oliver, A., (1988), *Dampness in Building*, Oxford: Blackwell Scientific Publications (BSP) Professional Books.
- O'Neil, H., (1965), *Stone for Building*, London: William Heinemann Ltd.
- Parnell, A.C., (1987), *Building Legislation and Historic Buildings*, London: The Architectural Press.
- Patterson, D., (1988), *Commercial Timbers of the World*, Hants: Gower Technical Press.
- Pengekalan Bangunan Di Kuala Lumpur* (Trans. *Building Conservation in Kuala Lumpur*), Kuala Lumpur: Dewan Bandaraya Kuala Lumpur, Dec. 1990.
- Pertubuhan Akitik Malaysia (PAM), (1990), *1890-1990: 100 Years Kuala Lumpur Architecture*, Kuala Lumpur: PAM.
- Powys, A.R., (1981), *Repair of Ancient Buildings*, London: Society for the Protection of Ancient Buildings (SPAB).
- Proceeding of Conservation of Penang's Architectural Heritage*, compiled by, Seminar, Penang State Government, March 4, 1991.
- Proceeding of the Heritage Conservation Now*, comp., Seminar and Workshop, Heritage of Malaysia Trust, Oct. 25-27, 1990.
- Reiner, L.R., (1979), *How to Recycle Buildings*, New York: McGraw Hill Inc.
- Richardson, B.A., (1980), *Remedial Treatment of Buildings*, Lancaster: The Construction Press Ltd.
- Royal Commission on the Historical Monuments of England, (1991), *Recording Historic Buildings*, London: RCHME.
- (1991), 2nd. ed., *Recording Historic Buildings: A Descriptive Specification*, London: RCHME.
- Ryan, N.J., (1967), *The Making of Modern Malaysia*, Kuala Lumpur: Oxford University Press.
- Saud, R.M., comp., (1981), *Kota-Kota Bersejarah di Semenanjung Malaysia* (Trans. *Historical Forts in Peninsular Malaysia*), Kuala Lumpur: Jabatan Muzium.
- Smith, R.T., ed., (1987), *An Illustrated History of Architectural Styles*, London: Omega Books Ltd.
- Society for the Protection of Ancient Buildings et. al., (1976), *Save the City: A Conservation Study of the City of London*, London: SPAB.
- Stamp, G. and Goulancourt, A., (1986), *The English House 1860-1914*, London: Faber and Faber Ltd.
- Suddards, R.W., (1982), *Listed Buildings: The Law and Practice*, London: Sweet and Maxwell.
- (1988), 2nd. ed., *The Law And Practice of Historic Buildings, Ancient Monuments And Conservation Areas*, London: Sweet and

Maxwell.

Saunders, M., (1987), *The Historic Home Owner's Companion*, London: B.T. Batsford Ltd.

Seeley, I.H., (1976), *Building Maintenance*, London: MacMillan Press Ltd.

Strategy for National Conservation, comp., Conference, Heritage of Malaysia Trust, Aug. 1986.

Tate, M.D.J., (1987), *Kuala Lumpur in Postcards 1900-1930: From the Collections of Major David Ng and Steven Tan*, Petaling Jaya: Penerbit Fajar Bakti Sdn. Bhd.

Taylor, A.C. and Ireson, A.S., (1983), *English Stone Building*, London: Victor Gollancz Ltd.

Thompson, M.W., (1981), *Ruins: Their Preservation and Display*, London: British Museum Publications Ltd.

Timmons, S., ed., (1976), *Preservation and Conservation: Principles and Practices*, Washington D.C.: Preservation Press.

Vlatseas, S., (1990), *A History of Malaysian Architecture*, Singapore: Longman Singapore Publishers Pte. Ltd.

White, A. and Robertson, B., (1990), *Architecture and Ornament: A Visual Guide*, London: Studio Vista.

Winstedt, R., (1966), *Malaya and Its History*, London: Hutchinson and Co. Ltd.

Wright, J.H.G., (1983), *Building Control by Legislation: The UK Experience*, Chichester: John Wiley and Sons.

Yeang, K., (1992), *The Architecture of Malaysia*, Amsterdam: The Pepin Press.

Zetter, R., ed., (1982), *Conservation of Buildings in Developing Countries*, Oxford: Dept. of Town Planning, Oxford Polytechnic.

PERIODICALS:

Ashurst, J., reprint ed., *Cleaning Stone and Brick*, Technical Pamphlet No. 4, London: SPAB, 1985.

"Back to Its Past Glory", *Malay Mail*, Aug. 17, 1990.

Balasegaram, M., "Conserving Old Beauties", *Sunday Star*, Sept. 30, 1990.

Bravery, A.F., "Mould and Its Control", *Information Paper*, Watford: Building Research Establishment, June 1985.

"Building Mortar", *Building Research Establishment Digest*, June 1991, No. 362.

Chen, V.F., "The Conservation of Traditional Values in Urban Development Part I", *Majalah Akitek*, Jan. and Feb. 1991.

- "Demolition of Eastern Hotel: An Act of Vandalism"*, *Berita Warisan*, May 1990, Vol. 5.
- "Colonial Legacy: Renovation of the Former Police Contingent Building Klang"*, *Majalah Akitek*, Jan. and Feb. 1989.
- Department of the Environment, *The Heritage of England and Wales: Environment in Trust*, Pamphlet, 1990.
- "Design of Timber Floors to Prevent Decay"*, *Building Research Establishment Digest*, Aug. 1991, No. 364.
- "Dialogue With the Minister of Works"*, *Berita Akitek*, Dec. 1990.
- Dickie, M., *"Conservation in Malaysia: A Polemic"* and *"Bangunan Sultan Abdul Samad, Jalan Raja"*, *Majalah Akitek*, March and April 1986.
- "Conservation in Practice"*, *Majalah Akitek*, Feb. 1986.
- "Double-Barrelled Stirling"*, *Architects' Journal*, May 4, 1988.
- "Focus on Pahang"*, *Berita Warisan*, Aug. 1991, Vol. 7.
- Hashim, D.M., *"Typology and the Evolution of the Malaysian Mosque"*, *Majalah Akitek*, Nov. and Dec. 1990.
- "Heritage Information at the Touch of a Button"*, *Newsletter, RCHME*, Spring 1992, No. 6.
- Hodgkinson, P., *"Foster Wins First Trustees' Medal"*, *Royal Institute of British Architects Journal*, Sept. 1990.
- "How Not to Do Conservation"*, *Majalah Akitek*, July and Aug. 1989, Vol. 1, No. 4.
- Hughes, P., *The Need for Old Buildings to Breathe*, Information Sheet No. 4, London: SPAB, Spring 1986.
- Koh, J.S.S., *"PAM Centre: Loke Hall Circa 1907"*, unpublished, Aug. 1990.
- Konig, A., *"Some Observations and Thoughts for Urban Conservation in Malaysia"*, *Majalah Akitek*, Jan. 1985.
- Kulterman, U., *"Architecture in South-East Asia: Malaysia"*, *Mimar*, Dec. 1987, No. 26.
- Latham, I., *"Liverpool Echo"*, *Building Design*, May 27, 1988.
- Lee, A.C., *"Fear of Losing More Historical Buildings"*, *New Straits Times*, May 27, 1991, sec. City Beat.
- "Historical Building Demolished"*, *New Straits Times*, May 24, 1991, sec. City Extra.
- "Legal Aspects of Conservation: The Present Situation and Recommendations"*, *Majalah Akitek*, March and April, 1986.
- Lim, J.C.S., *"Conservation: A Rising Consciousness"*, *Majalah Akitek*, March 1983.

- "The Three S's of Conservation"*, *Berita Warisan*, Dec. 1989, Vol. 4.
- Locke, P., 2nd. ed., *Timber Treatment*, Information Sheet No. 2, London: SPAB, 1991.
- Majid, H.A., *"Towards a Conservation Movement in Malaysia"*, *Majalah Akitek*, Sept. 1976, Vol. 3.
- "Malaysia Embarks on Restoration of Monuments"*, *Building and Construction News*, July 31-Aug. 6, 1991.
- Mallet, L., *"Poultry Tower Proves Fly in Ointment for RFAC"*, *Building Design*, May 13, 1988.
- "Office Building No. 1 Poultry"*, *Architecture and Urbanism*, Nov. 1986.
- Pearman, H., *"Stirling's Rising Value"*, *The Sunday Times*, April 14, 1991, sec. 5.
- "Police Contingent Building"*, *Majalah Akitek*, Nov.-Dec. 1991, Vol. 3, No. 6.
- "Preserving Malaysia's Heritage"*, *Berita Warisan*, Dec. 1988-Feb. 1989, Vol. 1.
- Radzi, A.N., *"College Creativity"*, *Majalah Akitek*, Jan.- April 1988.
- Rajadurai, C., *"PAM Building"*, *Majalah Akitek*, Feb. 1982.
- Ranee, A., *"Heritage to Take Stock of Our Past"*, *New Straits Times*, April 9, 1991, sec. Lifestyle.
- Said, R., *"Central to Cause of Conservation"*, *New Straits Times*, Dec. 5, 1990, sec. Times Two.
- Sell, J., reprint ed., *First Aid Repair to Traditional Farm Buildings*, Information Sheet No. 5, London: SPAB, Dec. 1989.
- Schofield, J., reprint ed., *Basic Limewash*, Information Sheet No. 1, London: SPAB, 1991.
- Steadman, R., *"Stirling Under Attack at Close of Poultry Inquiry"*, *Building*, June 24, 1988.
- "Stirling in Context"*, *Architects' Journal*, May 4, 1988.
- "Stirling in the Dock"*, *RIBA Journal*, May 27, 1988.
- Stocker, P., *"Kuala Lumpur Railway Station"*, *Majalah Akitek*, March and April 1986.
- "The Early Clubs"*, *Majalah Akitek*, Jan 1987, No. 1.
- Tack, C.H., *"Preservation of Timber for Tropical Building"*, *Overseas Building Notes*, Watford: BRE, Nov. 1979, No. 183.
- Tan, J., *"Penang's Imposing Hall of Justice"*, *New Straits Times*, Jan. 11, 1991, sec. Times Two.
- "Tate on the Mersey"*, *Architectural Review*, July 1988.

- "Termites and Tropical Building"*, *Overseas Building Notes*, Watford: BRE, Oct. 1976, No. 170.
- "Timber in Tropical Building"*, *Overseas Building Notes*, Watford: BRE, Oct. 1972, No. 146.
- Too, A., "Churches", *Majalah Akitek*, Nov. and Dec. 1990.
- Wan, B.W.A., "Malaysian Architecture: Some Questions in the Making of Its History", *Majalah Akitek*, Jan. 1985.
- Weatherhead, P., "No Stone Unturned: Refurbishment Maidstone County Hall", *Building*, June 21, 1991.
- Weston, R., "Stirling Statement", *Architects' Journal*, July 6, 1988.
- "Why Do Buildings Crack?", *BRE Digest*, May 1991, No. 361.
- Williams, G.B.A., reprint ed., *Pointing Stone and Brick Walling*, Technical Pamphlet No. 5, London: SPAB, 1986.
- Wong, C., "Old School Buildings", *Majalah Akitek*, Jan.-Feb. 1992.
- "Working for Better Legislation", *New Straits Times*, Dec. 5, 1990, sec. Times Two.
- Wright, A., reprint ed., *Removing Paint From Old Buildings*, Information Sheet No. 5, London: SPAB, Dec. 1989.
- Yeo, P.B., "Restoration of JKR 92", *Majalah Akitek*, March and April 1986.