

**Creation and Validation of an *In-vitro* Model of an Edentulous Mandibular Ridge for Testing Mandibular Complete Denture Retention**



The  
University  
Of  
Sheffield

University of Sheffield  
School of Clinical Dentistry

**PhD thesis submitted by Neda AL-Kaisy  
August 2011**

## **ACKNOWLEDGMENT**

I dedicate this thesis to the memory of my father who instilled in me the importance of working hard to make dreams come true. He witnessed the start of the study, but unfortunately, he didn't witness the end of it.

I would like to express my sincere gratitude to my supervisors: Dr. Tony Johnson, Dr. Nicolas Martin and Dr. Cheryl A. Miller for their guidance, support, motivation and assistance during the research and writing of this thesis.

Furthermore, I thank the staff of Academic Unit of Restorative Dentistry and The prosthetic clinic of Charles Clifford Dental Hospital. Special thanks also to the patients who agreed to participate in this study.

I would like to extend my gratitude to Dr. Frank Johnson, a Consultant Anaplastologist at Northern General Hospital for his instructions regarding maxillofacial materials.

Thanks to every one of my colleagues for their help and support. Particularly, Haitham AL-Mansour for his help to solve many computer and software problems. A special mention should go to: Hawa Fathi, Shirin ShahrbaF, Faraedon Zardawi and Salam AL-Zahawi for unforgettable happy times during the last four years.

I am very thankful as well, to the Ministry of Education/ Government of Iraq for granting me a scholarship to pursue this study.

I would like to thank my family: my dear husband for his unfailing support and understanding which enabled me to complete this thesis, my beloved mother and brothers for their encouragement and spiritual support.

## **ABSTRACT**

The missing teeth of edentulous adults are most commonly replaced with complete upper and lower dentures. The most prevalent problem regarding complete dentures is the retention of the mandibular one.

The testing of most denture retention systems has usually employed *in-vivo* testing with no prior *in-vitro* tests being carried out. In addition, *in-vitro* tests that have been carried out did not replicate the natural real situation of the oral cavity.

The aim of this study was to design and develop an artificial edentulous mandibular jaw model, with the associated soft-tissue structure (artificial mucosa and reflected tissue) based on real patient parameters, to facilitate testing the retention of mandibular complete dentures. This would enable us to optimise the design and manufacture of novel systems prior to testing on real patients in a clinical trial.

The objectives for this study were to firstly conduct a clinical evaluation of patients' satisfaction with complete denture and to correlate the effect of loose mandibular denture with patient satisfaction.

The second objective was to evaluate and identify the most appropriate synthetic materials that would replicate the soft tissue properties. Twelve elastic materials were assessed. These are representative of the following categories of materials: Addition and condensation-reaction silicone, polysulphide, polyether, alginate, maxillofacial impression material, soft lining material and non dental materials-chair side artist materials.

Suitable substitute materials to the oral mucosa were used to construct the model. Testing of the model was conducted using a series of protocols to

measure and compare the retention of mandibular dentures of varying designs (well-fitting, over- and under-extended) with and without denture adhesives (PoliGrip®, GlaxoSmithKline; Fixodent®, Procter & Gamble; Super Wernets®, GlaxoSmithKline).

In conclusion, an *in-vitro* model of a mandibular ridge can be created to approximate the biophysical characteristics of the covering mucosa, and can be used to assess differences in the retention of various denture designs and different denture adhesives.

# Table of Contents

<b>1. INTRODUCTION .....</b>	<b>2</b>
1.1 Outcome of previous studies to test the retention of complete dentures .....	5
<b>2. LITERATURE REVIEW .....</b>	<b>16</b>
<b>2.1 Edentulism as a problem - Epidemiology .....</b>	<b>17</b>
2.1.1 Patient satisfaction/expectation and retention of the denture .....	17
2.1.2 Mandibular denture retention as a greater problem .....	18
2.1.3 Effect of anatomical parameters and ridge resorption .....	20
2.1.4 Classification of edentulous ridge resorption .....	21
<b>2.2 Denture retention .....</b>	<b>24</b>
2.2.1 Factors that affect retention of mandibular dentures .....	24
2.2.2 Dynamic and static factors .....	25
2.2.3 Improvement of mandibular denture retention .....	34
<b>2.3 Testing the retention of mandibular dentures .....</b>	<b>43</b>
2.3.1 Clinical testing methods .....	43
2.3.2 Laboratory testing methods .....	44
2.3.3 Rationale for an <i>in-vitro</i> analogue model of an edentulous mandibular ridge .....	46
<b>3. DESIGN CONSIDERATIONS IN THE CONSTRUCTION OF AN <i>IN-VITRO</i> MODEL .....</b>	<b>49</b>
<b>3.1 Assessment of ridge resorption .....</b>	<b>49</b>
<b>3.2 Assessment of properties of oral soft tissue .....</b>	<b>51</b>
3.2.1 Thickness and elasticity of the oral mucosa .....	51
3.2.2 Wettability of oral mucosa .....	54
<b>3.3 Oral mucosa analogue materials .....</b>	<b>55</b>
3.3.1 Elastic dental impression materials .....	55
3.3.2 The modulus of elasticity of elastic materials .....	66
3.3.3 Dimensional stability of elastic materials .....	67
3.3.4 The wettability of elastic materials .....	68
<b>3.4 Summary .....</b>	<b>73</b>
<b>4. HYPOTHESIS, AIMS AND OBJECTIVES.....</b>	<b>76</b>
<b>5. PATIENT SATISFACTION WITH COMPLETE DENTURES – A CLINICAL EVALUATION.....</b>	<b>78</b>
5.1 Introduction .....	78
5.2 Methodology .....	81
5.3 Results .....	83
5.4 Discussion .....	89
5.5 Conclusions.....	92

<b>6. IDENTIFICATION OF A SYNTHETIC SOFT TISSUE ANALOGUE MATERIAL .....</b>	<b>94</b>
<b>6.1 Introduction .....</b>	<b>94</b>
<b>6.2 The retention test .....</b>	<b>96</b>
6.2.1 Materials and methods.....	97
6.2.2 Results of the retention test .....	105
6.2.3 Discussion.....	114
6.2.4 Conclusions .....	119
<b>6.3 The elastic recovery test .....</b>	<b>120</b>
6.3.1 Materials and methods.....	123
6.3.2 Results.....	126
6.3.3 Discussion.....	130
6.3.4 Conclusions .....	133
<b>6.4 The dimensional stability test .....</b>	<b>134</b>
6.4.1 Materials and methods.....	134
6.4.2 Results.....	136
6.4.3 Discussion.....	139
6.4.4 Conclusions .....	141
<b>6.5 The wettability test.....</b>	<b>142</b>
6.5.1 Materials and methods.....	142
6.5.2 Results.....	144
6.5.3 Discussion.....	147
6.5.4 Conclusions .....	149
<b>6.6 General Discussion and Conclusions .....</b>	<b>150</b>
<b>7. CREATION OF A MODEL OF A MODERATELY RESORBED MANDIBULAR RIDGE FROM AN EDENTULOUS INDIVIDUAL .....</b>	<b>161</b>
<b>7.1 Application for NHS Ethics Approval to replicate a human edentulous mandible .....</b>	<b>161</b>
7.1.1 The participants: .....	162
<b>7.2 Construction of the ridge analogue.....</b>	<b>162</b>
7.2.1 The Impression .....	162
7.2.2 Obtaining a negative to the original cast: .....	163
7.2.3 Ridge reduction to allow for a soft tissue overlay .....	165
7.2.4 Construction of soft tissue overlay for the extra oral model.....	167
<b>7.3 Construction of a complete denture for model validation.....</b>	<b>168</b>
<b>8. TESTING THE RETENTION OF DIFFERENT DENTURE DESIGNS WITH AND WITHOUT DENTURE ADHESIVES ON THE <i>IN-VITRO</i> MODEL .....</b>	<b>171</b>
<b>8.1 Design of a denture retention test with a well fitting denture experiment .....</b>	<b>172</b>
8.1.1 Materials and methods.....	173
8.1.2 Results.....	176
8.1.3 Discussion.....	179
<b>8.2 Assessment of retention of well and ill-fitting mandibular denture designs on the <i>in-vitro</i> model. ....</b>	<b>183</b>

8.2.1	Materials and methods.....	183
8.2.2	Results.....	185
8.2.3	Discussion.....	187
8.2.4	Conclusions .....	188
<b>8.3</b>	<b>The effect of denture adhesives on the retention of the different fitting dentures.....</b>	<b>189</b>
8.3.1	Denture adhesive mechanism of action .....	189
8.3.2	Materials and methods.....	191
8.3.3	Results.....	196
8.3.4	Discussion.....	212
8.3.5	Conclusions .....	220
<b>8.4</b>	<b>The effect of denture adhesives on the retention of each denture type.....</b>	<b>221</b>
8.4.1	Method.....	221
8.4.2	Results.....	221
8.4.3	Discussion.....	227
8.4.4	Conclusions .....	229
<b>9.</b>	<b>GENERAL DISCUSSION AND CONCLUSIONS .....</b>	<b>231</b>
9.1	Creation of an <i>in-vitro</i> model.....	231
9.2	Testing the retention of different denture designs with and without denture adhesives .....	235
<b>10.</b>	<b>FUTURE WORK .....</b>	<b>239</b>
<b>11.</b>	<b>REFERENCES.....</b>	<b>241</b>
<b>12.</b>	<b>APPENDICES.....</b>	<b>256</b>
12.1	Appendix 1: Data Collection forms.....	256
12.2	Appendix 2: Patient Information Sheet .....	259
12.3	Appendix 3: Participant Consent Form .....	263
12.4	Appendix 4: The retentive forces (gf) of well-fitting denture with the use of different amount of saliva at 50 mm/min tensile speed in two series of experiment. ....	264
12.5	Appendix 5: The retentive forces (gf) of well-fitting denture with the use of 0.9 ml saliva at different tensile speed in four series of experiment. ....	265

## List of Figures

Figure 1-1: Types of mandibular ridge resorption, (A): Slight ridge resorption. (B): Moderate ridge resorption, (C): Sever ridge resorption (Lee <i>et al.</i> , 2009). .....	3
Figure 1-2: The spring scale device is placed at the margin of the mandibular denture to measure the retention strength in grams (Manes <i>et al.</i> , 2011). .....	8
Figure 1-3: Disposable gnathometer measuring maximum incisal force of the maxillary denture while the patient is applying pressure to the frontal teeth (Baat <i>et al.</i> , 2007). .....	8
Figure 1-4: Four-element Voigt model. $E_0$ : instant elasticity; $E_1$ : retardation elasticity; $\eta_1$ : retardation viscosity; $\eta_N$ : permanent viscosity; $\sigma_0$ : static stress. Adapted from Shibata <i>et al.</i> , (2008). .....	13
Figure 2-1: Cawood and Howell classification of mandibular ridge resorption. From Cawood and Howell, (1988). .....	23
Figure 2-2: Upward dislodging force in direction opposite to denture insertion. Adapted from Darvell and Clark (2000). .....	24
Figure 2-3: Schematic diagram representing the intermolecular forces between the fitting surface of the denture, mucosa surface and saliva molecules that contribute to denture retention. Adapted from Basker and Davenport, (2002d). .....	30
Figure 2-4: Schematic diagram representing the positive and negative meniscus formed at the edge of salivary film. Adapted from Darvell and Clark, (2000). .....	31
Figure 2-5: The means of improvement complete denture retention. A: applying denture adhesive to the fitting surface of the denture, B: implant-retained lower denture, C: applying denture lining material to the fitting surface of the denture. ....	34
Figure 3-1: Schematic diagram representing the elastic and viscoelastic recovery. Adapted from Van Noort, (2007). .....	66
Figure 3-2: Schematic diagram representing the measurement of Static Sessile Drop (Mondon, 2004). .....	69
Figure 3-3: Schematic diagram representing the Tilting wafer method .....	70
Figure 3-4: Schematic diagram representing the captive drop method .....	71
Figure 3-5: Measurement of contact angle by Wihelmy plate method (Ghosh, 2009). .....	72
Figure 5-1: Patients' satisfaction with the existing dentures (n=121) .....	86
Figure 5-2: Patients' satisfaction with the new dentures (n=110). .....	86
Figure 5-3: Patients' reasons for complaints with the old dentures. ....	86
Figure 6-1: A test jig with 1.5 mm thickness of tested elastomeric material. ....	98
Figure 6-2: The testing jig with its die stone mould. ....	98
Figure 6-3: An alginate impression taken to the testing jig with its tested material. ....	98
Figure 6-4: Waxing the cast with 1.5 mm thickness wax sheet and prepared for flasking. ....	99



Figure 6-5: Testing the resistance to vertical displacement of an acrylic resin disc resting on a synthetic soft tissue analogue. ....	100
Figure 6-6: The retention force required to separate the acrylic disc from different underlying synthetic mucosa at 5 mm/min tensile speed with the use of 0.3 and 0.5 ml of saliva. * Represents a statistical difference between 0.3 and 0.5 ml of saliva. ....	107
Figure 6-7: The retention force required to separate the acrylic disc from different underlying synthetic mucosa at 10 mm/min tensile speed with the use of 0.3 and 0.5 ml of saliva. * Represents a statistical difference between 0.3 and 0.5 ml of saliva. ....	107
Figure 6-8: The retention force required to separate the acrylic disc from different underlying synthetic mucosa at 15 mm/min ....	107
Figure 6-9: The retention force required to separate the acrylic disc from different underlying synthetic mucosa at 20 mm/min tensile speed with the use of 0.3 and 0.5 ml of saliva. Represents a statistical difference between 0.3 and 0.5 ml of saliva. ....	108
Figure 6-10: The retention force required to separate the acrylic disc from different underlying synthetic mucosa at 25 mm/min tensile speed with the use of 0.3 and 0.5 ml of saliva. * Represents a statistical difference between 0.3 and 0.5 ml of saliva. ....	108
Figure 6-11: The retention force required to separate the acrylic disc from different underlying synthetic mucosa at 30 mm/min tensile speed with the use of 0.3 and 0.5 ml of saliva. * Represents a statistical difference between 0.3 and 0.5 ml of saliva. ....	108
Figure 6-12: The retention force required to separate the acrylic disc from different underlying synthetic mucosa at 35 mm/min tensile speed with the use of 0.3 and 0.5 ml of saliva. * Represents a statistical difference between 0.3 and 0.5 ml of saliva. ....	109
Figure 6-13: The retention force required to separate the acrylic disc from different underlying synthetic mucosa at 40 mm/min tensile speed with the use of 0.3 and 0.5 ml of saliva. * Represents a statistical difference between 0.3 and 0.5 ml of saliva. ....	109
Figure 6-14: The retention force required to separate the acrylic disc from different underlying synthetic mucosa at 45 mm/min tensile speed with the use of 0.3 and 0.5 ml of saliva. * Represents a statistical difference between 0.3 and 0.5 ml of saliva. ....	109
Figure 6-15: The retention force required to separate the acrylic disc from different underlying synthetic mucosa at 50 mm/min tensile speed with the use of 0.3 and 0.5 ml of saliva. * Represents a statistical difference between 0.3 and 0.5 ml of saliva. ....	110
Figure 6-16: The retention force required to separate the acrylic disc from different underlying synthetic mucosa at 55 mm/min tensile speed with the use of 0.3 and 0.5 ml of saliva. * Represents a statistical difference between 0.3 and 0.5 ml of saliva. ....	110
Figure 6-17: The retention force required to separate the acrylic disc from different underlying synthetic mucosa at 60 mm/min tensile speed with the use of 0.3 and 0.5 ml of saliva. * Represents a statistical difference between 0.3 and 0.5 ml of saliva. ....	110

Figure 6-18: The retention force of acrylic disc with synthetic mucosa with 0.3 and 0.5 ml of saliva at 5 mm/min speed. The letters represent a statistical analysis, same letters indicate statistically no different.....	113
Figure 6-19: The retention force of acrylic disc with synthetic mucosa with 0.3 and 0.5 ml of saliva at 60 mm/min speed. The letters represent a statistical analysis, same letters indicate statistically no different.....	113
Figure 6-20: Schematic diagram representing the typical behaviour of oral tissue under constant pressure loading. This showed the amount of instantaneous elastic compression of the mucosa immediately after load application, and the delayed elastic compression which takes place up to the end of the loading pressure. The amount of instantaneous elastic recovery after load removal and the delayed elastic recovery over time (which was measured for the tested materials in our experiment) (Kydd and Daly, 1982). ....	122
Figure 6-21: A material specimen for the elastic recovery test with the metal mould.....	123
Figure 6-22: The material specimen being subjected to 840 gf of compressive load on a tensile testing machine. ....	124
Figure 6-23: Measuring the length of the specimen before and after load application. ....	125
Figure 6-24: The percentage elastic recovery of tested materials after the application of 840 gf compressive ....	129
Figure 6-25: The ISO 4823:2000 recommended mould used to construct the material samples for dimensional stability test. ....	135
Figure 6-26: The 3 samples for each tested material, which kept dry during storage under the laboratory environmental condition. ....	135
Figure 6-27: Material sample to measure the dimensional stability.....	136
Figure 6-28: Dimensional change of the tested materials over a 14-week period. ....	138
Figure 6-29: Contact angle measurement of an acrylic resin sample using a contact angle Goniometer. ....	144
Figure 6-30: The mean of the contact angle of a drop of distilled water and a drop of artificial saliva of all tested materials with acrylic samples (n=3). The 1 <sup>st</sup> column represents the contact angle with a drop of distilled water, while the 2 <sup>nd</sup> with a drop of saliva. The letters represent the statistical differences between the contact angle of water and saliva (different letters indicate significant differences). Acrylic P= Polished acrylic samples, Acrylic NP= unpolished acrylic samples.....	146
Figure 6-31: The contact angle of a drop of artificial saliva of all tested materials. The letters represent the statistical differences between the contact angle of water and saliva (different letters indicate significant differences). ....	146
Figure 6-32: The analogue scale of the elastic recovery test data for 840 (gf) of load for 30 seconds. The numbe ....	152
Figure 6-33: The analogue scale of the elastic recovery test data for 840 (gf) of load for 10 minutes. The numbers represent the grade of each material according to the approximation to the oral mucosa recovery after load removal. ....	152

Figure 6-34: The analogue scale of the dimensional stability test data over the period of 14 weeks. The numbers represent the grade of each material according to its dimensional stability. ....	153
Figure 7-1: The special design custom tray fit the preliminary cast.....	163
Figure 7-2: The final impression of the mandibular edentulous ridge with reflected tissue. ....	163
Figure 7-3: The stone cast poured from the final impression. ....	164
Figure 7-4: Taking an impression to the original cast.....	164
Figure 7-5: Encircling the resultant silicone cast with wax sheet and pouring a negative to the silicone cast using Dublisil silicone material and a negative stone cast poured on the Dublisil silicone negative. ....	165
Figure 7-6: The resultant stone negative for the original cast. ....	165
Figure 7-7: A layer of wax with varying thickness was laid on the ridge area.....	166
Figure 7-8: Pouring a negative stone cast for the mucosa wax pattern. ....	166
Figure 7-9: The resultant two parts of the model. Left: mucosa wax pattern negative cast, right: original negative cast. ....	166
Figure 7-10: The use of nylon mesh to aid the retention of soft tissue analogue on the mucosa negative cast. A thin layer of ProGel outer skin applied on the surface of the 2 <sup>nd</sup> model halve (original negative cast). ....	167
Figure 7-11: The 2 halves of the model with the soft tissue analogue closed together and left to set. ....	168
Figure 7-12: The resultant extra oral model with its covering and reflecting tissues.....	168
Figure 7-13: Taking an alginate impression to the model ridge and pouring a stone cast.....	169
Figure 7-14: lower teeth arrangement (Left) and the resultant model with the finished mandibular complete denture in place on the model and the denture with hooks ready for the verification tests (right). ....	169
Figure 8-1: The well-fitting denture on the model connected to a tensile testing machine.....	174
Figure 8-2: Adjusting the occlusal surface of the denture to make it parallel to the base of the tensile machine.....	174
Figure 8-3: The effect of saliva amount on the retention of mandibular complete denture on the model with 50 mm/min tensile speed. The 1 <sup>st</sup> and 2 <sup>nd</sup> experiments (Series 1 and series 2) conducted with n=10 at each amount of saliva * Represent a statistical difference between the two experiments with the use of the same amount of saliva. The oval shape encircles the most optimum amount of saliva. ....	177
Figure 8-4: The effect of tensile speed on the retention force of mandibular complete denture with the use of 0.9 ml of saliva in four sets of experiments. In each experiment the retention of the denture was tested 10 times at each tensile speed. The letters represent statistical differences between the 4 sets of experiments at each tensile speed (different letters indicate significant differences). The oval shape encircles the chosen tensile speed. ....	178

Figure 8-5: The mean retention force of a fitted mandibular complete denture at different tensile speeds (n=40). The letters represent the statistical differences between different tensile speeds.....	178
Figure 8-6: The special flask for copying the well-fitted denture using DUBLISIL silicone material.....	184
Figure 8-7: The wax has been poured into the denture space.....	185
Figure 8-8: The resultant wax denture, which was carefully removed and processed in heat cured resin.....	185
Figure 8-9: From left to right: under extended denture, well-fitting denture and overextended denture.....	185
Figure 8-10: The retention forces of well and ill-fitting dentures at 3 different days when using 0.9 ml of artificial saliva at a 50 mm/min tensile speed (n=10). The letters represent the statistical differences of the retention forces of the same denture at different days (different letters indicate significant differences (P<0.05)).....	186
Figure 8-11: The mean retention forces (gf) of the three types of denture with artificial saliva at full separation of the denture from underlying artificial mucosa. The letters represent the statistical differences of the 3 types of dentures (different letters indicate significant differences (P<0.05)).....	186
Figure 8-12: The separation distance of the denture from underlying tissue at which the retention force of denture adhesives was measured.....	192
Figure 8-13: Five strips of past adhesive applied on the tissue surface of mandibular denture, 8 mm length measured using dividers.....	194
Figure 8-14: 0.2 ml of powder adhesive applied on the moistened tissue surface of mandibular denture.....	194
Figure 8-15: The retention forces of the well-fitting denture without adhesive at different days. The letters represent the statistical analysis of the retention forces of the denture (different letters indicate significant differences). ....	197
Figure 8-16: The retention forces of the overextended denture with no adhesive at different days. The letters represent the statistical analysis of the retention forces of the denture (different letters indicate significant differences). ....	197
Figure 8-17: The retention forces of the under extended denture with no adhesive at different days. The letters represent the statistical analysis of the retention forces of the denture (different letters indicate significant differences). ....	197
Figure 8-18: The mean retention forces (gf) of the three types of dentures with no adhesives used at 2.8 - 3.8 mm separation distance of the denture away from the underlying artificial mucosa. The letters represent the statistical analysis of the 3 types of dentures (different letters indicate significant differences). ....	198
Figure 8-19: The retention force of 3 types of dentures with PoliGrip® adhesive over a period of 5 hours (series 1 & series 2 experiments). The small letters represent the statistical analysis of the 3 types of dentures at the same time interval; while the capital letters are for the same denture at each time interval (different letters indicate significant differences). ....	201

Figure 8-20: The retention force of 3 types of dentures with Fixodent® adhesive over a period of 5 hours (series 1 & series 2 experiments). The small letters represent the statistical analysis of the 3 types of dentures at the same time interval; while the capital letters are for the same denture at each time interval (different letters indicate significant differences). .....202

Figure 8-21: The retention force of 3 types of dentures with Wernets® adhesive over a period of 5 hours (series 1 & series 2 experiments). The small letters represent the statistical analysis of the 3 types of dentures at the same time interval; while the capital letters are for the same denture at each time interval (different letters indicate significant differences). .....202

Figure 8-22: The mean of each 10 pulls of the 40 pulls of the retention force of 3 types of dentures with the use of PoliGrip® adhesive when left for 5 hours then 40 pulls conducted. The small letters represent statistical differences of the 3 types of dentures within each group, while the capital letters indicate statistical differences of the same denture at different groups (different letters indicate significant differences). The oval shape encircles the mean of all 40 pulls. ....205

Figure 8-23: The mean of each 10 pulls of the 40 pulls of the retention force of 3 types of dentures with the use of Fixodent® adhesive when left for 5 hours then 40 pulls conducted. The small letters represent statistical differences of the 3 types of dentures within each group, while the capital letters indicate statistical differences of the same denture at different groups (different letters indicate significant differences). The oval shape encircles the mean of all 40 pulls. ....205

Figure 8-24: The mean of each 10 pulls of the 40 pulls of the retention force of 3 types of dentures with the use of Wernets® adhesive when left for 5 hours then 40 pulls conducted. The small letters represent statistical differences of the 3 types of dentures within each group, while the capital letters indicate statistical differences of the same denture at different groups (different letters indicate significant differences). The oval shape encircles the mean of all 40 pulls. ....206

Figure 8-25: Comparing the 1st and last 10 pulls (intervals and full 5 hours tests) of 3 types of dentures with the use of PoliGrip® adhesive. The small letters represent the statistical differences of the 3 types of dentures at the 1st 10 pulls of both test series, while the capitals are for last 10 pulls of both test series (different letters indicate significant differences). The numbers represent the statistical differences between the 1st and last 10 pulls of each series (different numbers indicate significant differences between the results). .....208

Figure 8-26: Comparing the 1<sup>st</sup> and last 10 pulls (intervals and full 5 hours tests) of 3 types of dentures with the use of Fixodent® adhesive. The small letters represent the statistical differences of the 3 types of dentures at the 1<sup>st</sup> 10 pulls of both test series, while the capitals are for last 10 pulls of both test series (different letters indicate significant differences). The numbers represent the statistical differences between the 1<sup>st</sup> and last 10 pulls of each series (different numbers indicate significant differences between the results). .....208

Figure 8-27: Comparing the 1 <sup>st</sup> and last 10 pulls (intervals and full 5 hours tests) of 3 types of dentures with the use of Wernets® adhesive. The small letters represent the statistical differences of the 3 types of dentures at the 1 <sup>st</sup> 10 pulls of both test series, while the capitals are for last 10 pulls of both test series (different letters indicate significant differences). The numbers represent the statistical differences between the 1 <sup>st</sup> and last 10 pulls of each series (different numbers indicate significant differences between the results). .....	209
Figure 8-28: The retention forces for the well-fitting denture with the use of different tested adhesives over a period of 5 hours (series 1 & series 2 experiments). The small letters represent statistical differences of the 3 types of denture adhesive at each time interval, while the capital indicate statistical differences of the same denture adhesive at different time intervals (different letters indicate significant differences). .....	223
Figure 8-29: The retention forces for the overextended denture with the use of different tested adhesives over a period of 5 hours (series 1 & series 2 experiments). The small letters represent statistical differences of the 3 types of denture adhesive at each time interval, while the capital indicate statistical differences of the same denture adhesive at different time intervals (different letters indicate significant differences). .....	223
Figure 8-30: The retention forces for the under extended denture with the use of different tested adhesives over a period of 5 hours (series 1 & series 2 experiments). The small letters represent statistical differences of the 3 types of denture adhesive at each time interval, while the capital indicate statistical differences of the same denture adhesive at different time intervals (different letters indicate significant differences). .....	224
Figure 8-31: Comparing the 1st and last 10 pulls (intervals and full 5 hours tests) of the well-fitting denture with the use of three types of denture adhesive. The small letters represent the statistical differences of the 3 types of denture adhesives at the 1st 10 pulls of both test series, while the capitals are for last 10 pulls of both test series (different letters indicate significant differences). The numbers represent the statistical differences between the 1st and last 10 pulls of each series (different numbers indicate significant differences between the results). .....	225
Figure 8-32: Comparing the 1st and last 10 pulls (intervals and full 5 hours tests) of the overextended denture with the use of three types of denture adhesive. The small letters represent the statistical differences of the 3 types of denture adhesives at the 1st 10 pulls of both test series, while the capitals are for last 10 pulls of both test series (different letters indicate significant differences). The numbers represent the statistical differences between the 1st and last 10 pulls of each series (different numbers indicate significant differences between the results). .....	226
Figure 8-33: Comparing the 1st and last 10 pulls (intervals and full 5 hours tests) of the under extended denture with the use of three types of	

denture adhesive. The small letters represent the statistical differences of the 3 types of denture adhesives at the 1st 10 pulls of both test series, while the capitals are for last 10 pulls of both test series (different letters indicate significant differences). The numbers represent the statistical differences between the 1st and last 10 pulls of each series (different numbers indicate significant differences between the results).....226

## List of Tables

Table 1-1: Modified Kapur Index Scale for retention and stability of maxillary and mandibular complete dentures (Olshan <i>et al.</i> , 1992).....	8
Table 5-1: The number of previous complete denture sets among the patients .....	84
Table 5-2: The duration of complete denture experience among the patients (N/A: patients without data, who could not remember the age of their dentures or patients who do not wear their dentures after construction).....	84
Table 5-3: Clinician evaluation of original dentures.....	87
Table 5-4: Clinician evaluation of new dentures.....	87
Table 5-5: The patients' overall satisfaction with their complete denture service at the CCDH (n=110). .....	88
Table 6-1: The composition of the artificial saliva used.....	100
Table 6-2: Soft tissue analogue materials tested. ....	102
Table 6-3: The mean and standard deviation (SD) of the retention force of tested materials at different tensile speed.* Significant difference between 0.3 and 0.5 ml of saliva at same speed. ....	111
Table 6-4: The analogue scale of the retention test data at speed 60 mm/min. The letters represent the statistical differences between the tested materials.....	151
Table 6-5: The analogue scale of the wettability test data with saliva. The letters represent the statistical differences between the tested materials.....	154
Table 6-6: The properties grades table of tested materials from the retention, elastic recovery, dimensional stability and wettability tests. Grad 5 represents the best results, while 1 represent the worst. L.B = light body, H.B = heavy body, M.B = medium body. the performance position of tested materials from best to worst in representing oral mucosa on the <i>in-vitro</i> model according to the overall results grading....	155
Table 8-1: The types of denture adhesives tested. ....	190
Table 8-2: The 1 <sup>st</sup> and the mean of 10 pulls of the intervals 5 hours experiment with the 1 <sup>st</sup> pull and the mean of 10-40 pulls of the full 5 hours experiment with their standard deviation. ....	211



# 1

---

# Introduction

## 1. Introduction

Edentulism can be a debilitating handicap that affects psychological well-being and masticatory function with a detrimental effect on general health and body mass Index. In 2009, the proportion of edentate adults in the UK stands at 6 % (Adult Dental Health Survey 2009).

Most edentulous people require maxillary and mandibular complete denture prostheses. Of the two prostheses, it is the mandibular complete denture, which generally has the bigger problem with regard to retention (Broz, 1989). This is especially true for those with severely resorbed ridges which fail to provide adequate support, retention, stability and bracing because of the functional movements of adjacent structures such as the tongue and masticatory musculature which undermine the peripheral seal, which is necessary for denture retention, in addition to reduced support area (Hickey and Zarb, 1980) (Figure 1-1).

The major problem for lower complete denture wearers with severely resorbed ridges is lack of retention. Such loss occurs later in life when the individual's ability to develop or maintain the neuromuscular skills necessary to wear dentures is reduced. The degree of retention is dependent on the design of the complete denture prosthesis and the biological and physiological properties of the underlying and surrounding denture-bearing anatomical tissues.

Poor retention is often related to loss of bone support. The resorption pattern of the residual ridge presents a serious challenge in prosthetic restoration for

edentulous patients. Reasons for residual ridge resorption are multiple and may vary among edentulous patients without diagnosis of the exact etiological factors (Nishimura and Garrett, 2004).

There is strong evidence that denture retention is of great importance to the individual's quality of life and overall psychological well-being (Jacobson and Krol, 1983).



(A)



(B)



(C)

Figure 1-1: Types of mandibular ridge resorption, (A): Slight ridge resorption. (B): Moderate ridge resorption, (C): Severe ridge resorption (Lee *et al.*, 2009).

Previous literature mainly tested the *in-vivo* retention of the maxillary denture rather than the retentive quality of the mandibular dentures because it is problematic, as it tends to be intimately associated with stability (muscle control). These investigations are mainly clinically based and lack background laboratory testing data and the results are largely inconclusive for the following reasons:

- The experiments are limited to the intra-oral conditions of the study participants
- There is great variation in the types and magnitude of chewing loads amongst individuals.
- Clinical tests lead to physical and mental fatigue of the participants. This limits the duration of individual experimental sessions and affects the quality of data that is obtained (Fernandes *et al.*, 2003).
- Clinical *in-vivo* studies require ethical approval and are limited by the constraints of such studies (funding, sample size, participant human variables, etc.)

In order to maximise the data from such clinical trials, it is essential to undertake effective pre-clinical laboratory characterisation of the appliance to be tested. Such laboratory studies give better understanding of the mechanical factors that affect the retention of denture prosthetic appliances.

It is important to test the retention as a component of a whole denture seating on synthetic tissue system matching the oral condition and not to concentrate on testing the retention individually as in case of testing the retention of implants without including the over-denture and oral mucosa.

## 1.1 Outcome of previous studies to test the retention of complete dentures

The following topics are discussed:

- *In-vivo* testing studies
- *In-vitro* testing studies
- Oral mucosa investigation studies

### I. *In-vivo* testing studies

Most previous studies were restricted to the static or physical definition of denture retention “resistance of a denture towards removal in a direction opposite to the insertion” which mainly depend on the basis of a close adaptation of the denture base to the supporting mucosa.

The *in-vivo* testing of complete denture retention took various experimental designs. Skinner *et al.*, (1953) compared the retention of well and ill-fitting maxillary dentures by measuring the dislodging force applied at right angles to the plane of the denture being tested using a *dynamometer* loading device attached to differently placed “eyes” constructed in the outer surface of the denture base by means of hooks. They found that the relief areas under the denture decrease the retention, while the post-dam and the peripheral seal increase the retention.

Others applied vertical dislodging forces to maxillary palatal plates of dentate persons using a hydraulic and electrical system with an extra oral transducer to test the effect of denture adhesives (Ow and Bearn, 1983). The dislodging force applied by the operator engaged a periodontal probe with a hook connected to a hydraulic measuring device fixed on the outer surface of the plate.

*Chani et al.*, 1991 tested the retention of well and ill-fitting palatal plates of dentate participants with and without denture fixatives. They used a *retenometer*, which allowed a dislodging force in a vertical dimension. The force with a rate of 5 N/second was applied till the dislodgment occurred where its value displayed on the machine. Their study showed that the retention of well-fitting plates with saliva was significantly higher than ill-fitting ones and the denture fixatives improved retention for well and ill-fitting plates immediately and for 3 and 6-hour intervals.

With the same principle of testing the retention, *Mirza et al.*, (1983) and (1984) tested the retention of mandibular dentures with and without the use of denture adhesives. A specially designed mechanical gadget was used to allow a vertical pulling action to the mandibular denture through the connection of the instrument hook with an eye fixed to the outer surface of the denture. They found that denture adhesives significantly increase the retention of mandibular dentures.

A spring scale was found to be an easy way to measure the static retention of mandibular complete dentures with and without denture fixatives (*Manes et al.*, 2010) (Figure 1-2).

Others tested the retention of complete dentures by scoring the retention and stability according to the Kapur scale to test the effect of denture adhesives (*Olshan et al.*, 1992, Kapur, 1967) (Table 1-2). They concluded that their results were compatible with other laboratory results using more complicated methods, which could be unpractical for clinical tests.

Other than the static condition, researchers tried to assess denture retention and stability during function. *Floystrand and Orstavik*, (1984) used a miniature

bite force recorder and sensor to measure the resistance of maxillary complete dentures to a unilateral force. An occlusal load applied on one side of the denture and the resistant of dislodgment was measured on the other side. They found that the average load of 70 N was tolerated before the dentures were dislodged.

Well and ill-fitting maxillary denture dislodgment during chewing activity was tested by Chew *et al.*, (1985) and Grasso *et al.*, (1994) using a *kinesiograph*<sup>1</sup>. Chewing was performed with and without denture adhesives. They found that well-fitting dentures showed significantly less dislodgment than ill-fitting denture and the adhesives improved retention of both the well and ill-fitting dentures. Chew *et al.* (1985), found that the effect of adhesives were significantly greater with ill-fitting dentures, while Grasso *et al.*, (1994) found the retention improvement was the same in both well and ill-fitting dentures.

Others believed that measuring the incisal bite force gave an indication of complete denture retention. Baat *et al.*, (2007) used a disposable *gnathometer* with a decimal scale for measuring the maximum incisal biting force of complete maxillary dentures, with and without denture adhesives (Figure 1-3).

---

<sup>1</sup> A method used to graphically record the denture movements. The device has a sensor array fixed on the face of the patient and a small magnet-tracking device connected to the denture.



Figure 1-2: The spring scale device is placed at the margin of the mandibular denture to measure the retention strength in grams (Manes *et al.*, 2011).

Score	Retention	Stability
0 (No)	Denture displace itself	Demonstrate extreme rocking on its supportive structures under pressure
1 (Poor)	Slight resistant to vertical pull and little or no resistance to lateral force	Demonstrate moderate rocking on its supportive structures under pressure
2 (Fair)	Moderate resistant to vertical pull and little or no resistance to lateral force	Demonstrate slight rocking on its supportive structures under pressure
3 (Good)	Moderate resistant to vertical pull and lateral force	Demonstrate very slight rocking on its supportive structures under pressure
4 (Very good)	Very good resistant to vertical pull and lateral force	Demonstrate no rocking on its supportive structures under pressure
5 (Excellent)	Excellent resistant to vertical pull and lateral force	Demonstrate no rocking on its supportive structures under pressure

Table 1-1: Modified Kapur Index Scale for retention and stability of maxillary and mandibular complete dentures (Olshan *et al.*, 1992).

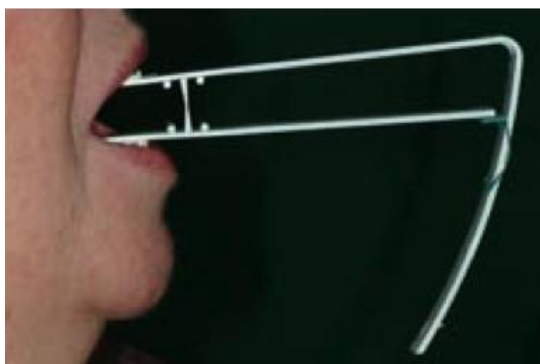

Figure 1-3: Disposable gnathometer measuring maximum incisal force of the maxillary denture while the patient is applying pressure to the frontal teeth (Baat *et al.*, 2007).



## **II. *In-vitro* testing studies**

Many authors tried to conduct retentive tests *in-vitro* and compared their results with the *in-vivo* findings.

Skinner and Chung (1951) measured the retention of well and ill-fitting complete maxillary plates. These plates were seated on an aluminium maxillary model covered with synthetic elastomeric resin (Dicor-D) to simulate the soft tissue of the mouth. Distilled water was used as a medium between the elastomeric resin layer and the denture base. A seating force was applied in a magnitude of 3000 g for 5 seconds. A pulling action applied through chains connected with 3 loops attached to the outer surface of the plates, one in the middle anterior region and one in either ridge posterior area. They found that the retention was less with ill-fitting plates.

*In-vitro* testing allows the construction of more complicated devices to act for investigation of denture retention. Norman *et al.*, (1987) constructed a device with three pressure transducers connected to a chart recorder. This device recorded the changes in vertical dimension and distributed the applied force when denture adhesives were used. They used a metal maxillary edentulous model with a water flow system with the use of different types of denture adhesives. An increase of vertical dimension was noticed with the use of the adhesives and uneven distribution of seating force produced uneven adhesive distribution.

On the other hand, some more simple laboratory methods were used, for example in the study of retention effect of denture adhesives conducted by Chew, (1990) they used a clear acrylic disc (diameter 32 mm and thickness 2 mm) to represent the denture and a skin of a rat was selected as a substitute for

the oral mucosa. The rat skin was mounted on a cylindrical block and held taut with a ring clamp, the acrylic disc with the denture adhesive laid on it was then subjected to a tensile dislodging force at 1, 3, 5 hour after adhesive application. The results showed that there was a reduction in the effectiveness of the adhesives, and that there was an increase in adhesive loss with time.

Koppang *et al.*, (1995), also used a simple method to test the retentive effect of paste and powder types of adhesive. They applied a tensile force using a tensile testing machine at 1 mm/min speed to separate an acrylic resin plate from an acrylic resin bottom surface of a dry acrylic resin vessel. An isotonic solution at 35° C was added to the vessel and kept at this temperature for the remainder of experiment. The results indicate that paste adhesive maintains its effect for a longer time than the powder type. They also found that testing denture adhesives with low crosshead speed or forces, best reflected the clinical situation.

The same principles were used to compare the retentive ability of powder and paste denture adhesives by measuring the force needed to separate a glass surface and acrylic resin samples when the adhesive materials were applied between them (Chowdhry *et al.*, 2010).

Panagiotouni *et al.*, (1995) also used a glass surface and an acrylic disc surface to test the retention of various commercially available denture adhesives. Artificial saliva was used between the glass surface and the acrylic disc. A dislodging force at 20 mm/min was used to separate the two surfaces. They concluded that denture adhesives increased the retention ability of saliva and the adhesive pastes exhibited greater retentive values than that of adhesive powders.

A comparison of retentive activity of a new denture adhesive constructed by Zhao *et al.*, (2004) was conducted using a universal testing machine. Bonding load was performed between two methacrylate cylinders (25 mm in diameter and 55 mm in height). The test was performed by applying 0.3 g of adhesive to the dry polished surface of the resin cylinders. Then a 2 kg weight was applied to the top of cylinder for 15 seconds. The force required to separate the cylinders was recorded as the retention force of the tested adhesives. They found that their new adhesive (Comfort-DA) was significantly stronger than the existing product tested (Fittydent).

### **III. Oral mucosa investigation studies**

Most studies concerning edentulous ridge mucosa concentrated on studying the *in-vivo* biomechanical characteristic of oral mucosa, displaceability and thickness. The degree of deformation of the mucous membrane under pressure and the quality of the mucus film lying on it are assumed to be the most characteristic features describing the mucous membrane (Chowdhry *et al.*, 2010).

A useful mean to determine many physical properties of any tissue is by testing the modulus of elasticity, which is applicable to the biophysics of oral mucosa. Pain is a limiting factor to the compressive modulus *in-vivo*, thus a compressive modulus would be the one of clinical concern (Kydd and Mandley, 1967).

An ultrasonic transducer was first introduced in dentistry by Daly and Wheeler, (1971) to measure the thickness of oral mucosa. The maximum thickness, which could be measured at that time, was 3.75 mm. Further development of

this testing device enabled it to investigate the viscoelasticity of oral soft tissue by adding a load cell.

An initial elastic compression took place instantly on the application of a load (45-55% reduction), which was followed by a delayed elastic deformation. On removal of the load, an instantaneous elastic decompression was observed followed by a continuing delayed elastic recovery.

By using B- Mode ultrasonic diagnostic equipment, researchers could measure the amount of compressibility of palatal edentulous mucosa due to impression pressure. They found that 100 gm/cm<sup>2</sup> impression pressure causes 0.32 - 0.61 mm compression in denture foundation mucosa. By measuring this effect, dentists can select an appropriate impression procedure (Odagiri, 1992).

The mode of oral mucosa distortion under physiologic load was demonstrated by Compagnoni *et al.*, (2003) with the aid of a *kinesiograph*. The results showed that under load, oral mucosa distortion has two phases: a fast initial displacement as load is applied and a slower and incomplete recovery when load is removed. Progressive chewing reduces the amount of the denture displacement and the recovery of the mucosa is slow and incomplete.

The relationship between the thickness and elasticity of oral mucosa was also investigated using an ultrasonic thickness gage (Hosono *et al.*, 2007). They found that there was no relation between the Young's modulus and the thickness of oral mucosa, and it varied widely where the mucosa is thin.

To the authors knowledge, no studies have been carried out which simulating the characteristics of oral mucosa using other synthetic materials, except a study conducted by Hayakawa *et al.*, (1994), which compared the elastic behaviour of oral mucosa (especially after load release) with a newly developed

light cure soft lining material, as this material could act as a cushion to compensate for the lost thickness and function of oral mucosa under the complete denture. The physical behaviour of oral mucosa was monitored by special design creep measuring apparatus using the Voigt's four-element model (Figure 1-4). The results indicated that by controlling the amount of cross-linking agent and inorganic filler, the lining material properties might approximate those of mucosa.

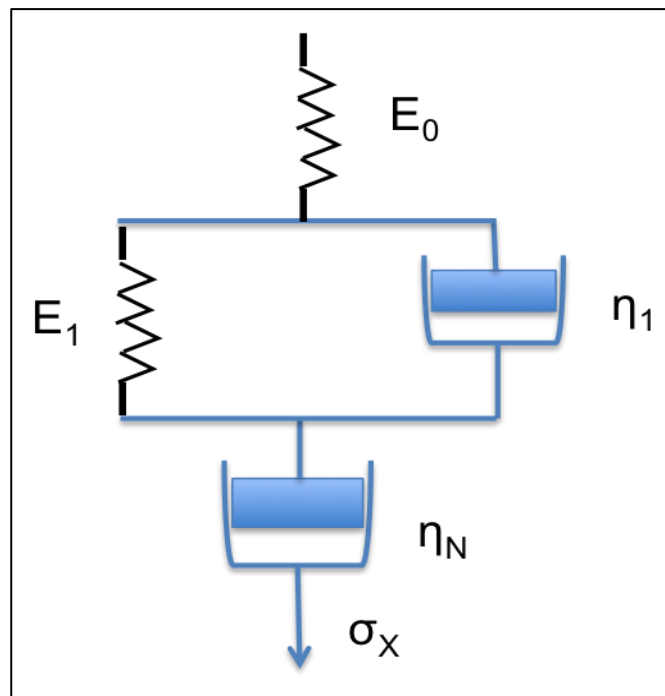

Figure 1-4: Four-element Voigt model.  $E_0$  : instant elasticity;  $E_1$  : retardation elasticity;  $\eta_1$  : retardation viscosity;  $\eta_N$  : permanent viscosity;  $\sigma_0$  : static stress. Adapted from Shibata *et al.*, (2008).

In many other *in-vitro* studies related to substitute oral tissue on an *in-vitro* model, a substitution was made by one of the elastic materials without further investigations to compare the physical characteristics of these materials with those of oral mucosa.

To the authors knowledge there are no reported denture-retention studies performed on a custom-designed and validated *in-vitro* oral model of the human edentulous mandibular ridge. Some studies did use an edentulous model, but these were rather crude as they are simply based on a cast, which are fabricated either from acrylic resin or dental stone with an overlying uniform layer of silicone material. The design of the model and overlying mucosa in these studies is not based on real patient parameters, but on arbitrary data (Ohguri *et al.*, 1999, Taguchi *et al.*, 2001, Dong *et al.*, 2006).

The purpose of this study is to design and develop an artificial edentulous mandibular ridge model, with associated tissue structure (overlying mucosa and muscles attachments) that closely resembles in function a human natural edentulous mandible. This will enable the evaluation of the retention of mandibular dentures using a variety of different retentive mechanisms on the mandibular model simulation. In this investigation an edentulous mandibular ridge and associated soft tissue model has been designed and constructed in a dedicated prosthetic laboratory employing conventional materials and techniques used for the construction of oral and maxillofacial prostheses. This model has been tested as an effective way of assessing the retention of mandibular complete dentures.

# 2

---

## Literature Review

## 2. Literature Review

The following literature review examines some of the factors discussed above in greater detail. The following topics are reviewed and discussed in the context of the proposed project:

- 1) Edentulism as a problem – Epidemiology
  - I. Patient satisfaction/expectations and retention of dentures
  - II. Mandibular retention as a greater problem
  - III. Effect of anatomical parameters and ridge resorption
  - IV. Classification of
  - V. ridge resorption
- 2) Denture retention
  - I. Factors that affect retention of mandibular dentures
  - II. Dynamic and static factors
- 3) Testing of denture retention
  - I. Clinical testing
  - II. Laboratory testing
  - III. Rationale for the construction a mandibular analogue model



## **2.1 Edentulism as a problem - Epidemiology**

The condition of individual oral status provides information about the overall general health. Edentulism affect the patients' ability to chew, impaired taste, phonetics and aesthetics, which result in limited social activities and adversely affect the quality of life. These factors determine the need for the replacement of missing natural teeth (Shimazaki *et al.*, 2001).

The proportion of adults in England who are edentate (no natural teeth) has fallen by 22 % from 28 % in 1978 to 6 % in 2009 (Adult Dental Health Survey 2009). By 2028, there is thought to be a projected decrease in edentulism to only 4%. However, a general increase in life expectancy of the aging population could potentially increase the need for complete dentures (Burke, 2000, Steele *et al.*, 2000, Office for National Statistics, 1999).

The causes of edentulism are many, including genetic or microbial disease that has strong individual and behavioral influences. Total tooth loss can result in local anatomical, physiological, and psychosocial changes that include alveolar bone loss and a reduction in masticatory function altered facial esthetics associated with changes in vertical dimension and muscular function, and deterioration in social functions (Cooper, 2009).

### **2.1.1 Patient satisfaction/expectation and retention of the denture**

The great majority of complete denture patients are satisfied with their dentures. However, even if the dentures are constructed to all accepted criteria, some patients will still be dissatisfied with their new dentures (Burns *et al.*, 1995). Denture satisfaction depends on many factors, including quality of the dentures

(function, fit, and appearance) and the denture wearing experience, in addition to patient perception of affective and economic status (Celebić *et al.*, 2003).

In epidemiological studies, the proportion of unsatisfied patients of varying age and denture qualities range between 20% and 35% (Berg, 1993). Younger patients wearing a good quality maxillary and mandibular dentures for the first time, with short period of being edentulous were more satisfied with the retention of maxillary than the retention and comfort of mandibular dentures (Celebić *et al.*, 2003).

Patient satisfaction with mandibular complete dentures mainly depends on the quality of mandibular residual alveolar ridges, retention and stability of mandibular denture, accuracy of reproduction of retruded jaw relationships and patient adaptability (Fenlon and Sherriff, 2008).

In self-reported satisfaction regarding complete denture use, patients have described instability and discomfort as reasons for dissatisfaction, suggested that the stability of the prosthesis might be a key feature of denture acceptance (Fenlon *et al.*, 2002).

### **2.1.2 Mandibular denture retention as a greater problem**

Edentulous people often require maxillary and mandibular complete denture prostheses.

Of the two prostheses, it is the mandibular complete denture which generally has a major problem with regard to retention (Broz, 1989), and it is considered a major oral disease entity and characterized by individual variability in volume and rate (Atwood, 1971).

Tooth extraction in the mandible will result in more dramatic reduction in alveolar bone volume than in the maxilla (Tallgren, 1972). The continued resorption of the mandibular alveolar bone is associated with greater difficulty with mandibular denture construction, use, and satisfaction.

Treatment of the severely resorbed mandibular ridge has been a problem in dentistry for many years and the patient often loses hope of normal function. This type of anatomy lacks the characteristics of an ideal ridge: adequate bone support, covered by adequate soft tissue, without interfering undercut, no sharp ridges, adequate buccal and lingual sulci, and no muscle attachment interfere with the periphery of the prosthesis. Thus it is difficult to make an adequate prosthesis, because of decreased support and the approximation of surrounding mobile tissue onto the denture border, thereby reducing the stability and retention of the denture (Golds, 1985).

The management of the edentulous patient by well-trained clinicians is necessary and should involve the continued monitoring of residual alveolar ridge resorption and related issues of denture function.

Many techniques have been developed to deal with the problem of the compromised ridge. Some researchers used a metal base for snugness of fit of mandibular denture or implanting platinum-cobalt magnets to increase stability, or extend the flanges to provide greater denture bearing area, but no one of these technique was applicable (Jennings, 1989). Levin *et al.*, (1970) stated that the experience of denture wearer was more important than the technique used to stabilize the denture.

### **2.1.3 Effect of anatomical parameters and ridge resorption**

The oral anatomical parameters which are considered important factors in denture support, stability and retention are: quality of the denture bearing area, facial musculature and neuromuscular control. Compromised ridges with weak muscular control and retruded tongue position adversely affect denture retention (Beresin and Schiesser, 2006).

For the oral and facial musculature to be most effective in providing retention and stability for complete denture, the following points should be considered:

- The denture bases must be properly extended to cover the maximum area possible without interfering with the health and function of the structure that surrounds the denture.
- The occlusal plane must be at the correct level.
- The arch form of the teeth must be in the neutral zone between the tongue and cheeks.
- The polished surface of the dentures must be properly shaped.

(Shay, 1997).

The typical pattern of residual ridge resorption results in the medial-lateral and anterior-posterior narrowing of the maxillary denture foundation and widening of the mandibular denture foundation (Davis, 1997b). Tallgren, (1972) found that the reduction of the mandibular anterior ridge height was four times that of the maxillary ridge.

Reasons for residual ridge resorption are many and may vary among edentulous patients without diagnosis of the exact aetiological factors (Nishimura and Garrett, 2004). It could be considered to be an inevitable

consequence of the loss of natural teeth, tissue remodelling, occlusal disharmony, and prolonged denture wear (Wyatt, 1998).

Alveolar bone loss subsequent to long-term edentulism may be severe and the process may progress throughout life (Kalk and de Baat, 1989, Bairam and Miller, 1994). Any detrimental external moulding force might adversely impact the residual bony ridges as overlying oral soft tissues atrophied with time (Lammie, 1960). Schlosser, (1950) suggested that local factors such as ill-fitting dentures and associated trauma to oral tissues, faulty impressions, excessive occlusal vertical dimension, inaccurate centric jaw relationships, and occlusal disharmony, were primarily responsible for rapid destruction of the denture bearing structures (Schlosser, 1950).

### **2.1.4 Classification of edentulous ridge resorption**

A classification system of edentulous ridge resorption is important to facilitate patient identification and to provide insight into the difficulty of denture treatment. It guides prosthodontists, general dentists and dental educators in providing the appropriate treatment for each patient (McGarry *et al.*, 1999).

Atwood, (1971) performed micro-radiographic studies to evaluate midsagittal sections of mandibles. This classification with two dimensional (2-D) criteria, in which the residual ridge classifications are as follow:

Class I: pre-extraction, class II: post-extraction, class III: high and well rounded ridge, class IV: knife edge ridge, class V: low and well rounded ridge, class VI: depressed ridge.

Others reported a classification of resorbed mandibular ridge based on cephalometric images and correlated the resorption with vertical facial

morphology (Mercier and Lafontant, 1979). Cawood and Howell, (1988) developed a classification of edentulous jaws based on cross section study of a sample of dried skulls. They found that the changes are highly significant in both the vertical and horizontal axis, while the basilar process remain relatively stable regardless of the degree of atrophy of alveolar process. They included linear and cross-section criteria and expanded the classification into the posterior alveolar segment. It is currently the most comprehensive way of classifying edentulous jaws and it is suggest to be use as a research tool (Fenlon *et al.*, 1999). The determination of the stage of resorption is simply and quickly accomplished by manual and visual inspection. While other classifications are mostly based on radiographical evaluation (Eufinger *et al.*, 1997).

The Cawood and Howell classification classes are as follows:

Class I: dentate, class II: immediately post extraction, class III: well-round ridge form, adequate in height and width, class IV: knife-edge ridge form adequate in height and inadequate in width, class V: flat ridge form, inadequate in height and width, and class VI: depressed ridge form, with some basilar loss evident (Figure 2-1).

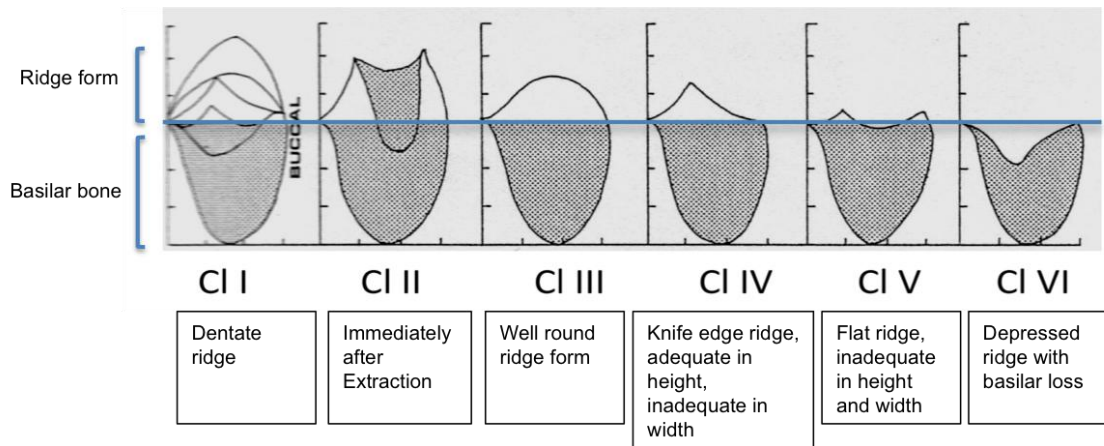

Figure 2-1: Cawood and Howell classification of mandibular ridge resorption. From Cawood and Howell, (1988).

Such classifications assist:

- Communication between clinicians.
- Selection of appropriate surgical prosthodontic treatment.
- Evaluation and comparison of different treatment methods.
- In deciding which interceptive technique to preserve alveolar process.

(Cawood and Howell, 1988).

## 2.2 Denture retention

### 2.2.1 Factors that affect retention of mandibular dentures

Denture retention is the resistance of the denture to dislodging forces exerted in directions opposite to that of its insertion (Wright, 1969) (Figure 2-2). It could be defined as the properties of a denture that retain it in contact with the tissues (Prosthodontic Terms, 2005). It is basic to oral and systemic health in our ageing population. It resists the adhesiveness of food, the force of gravity and the force associated with the opening of the jaw.

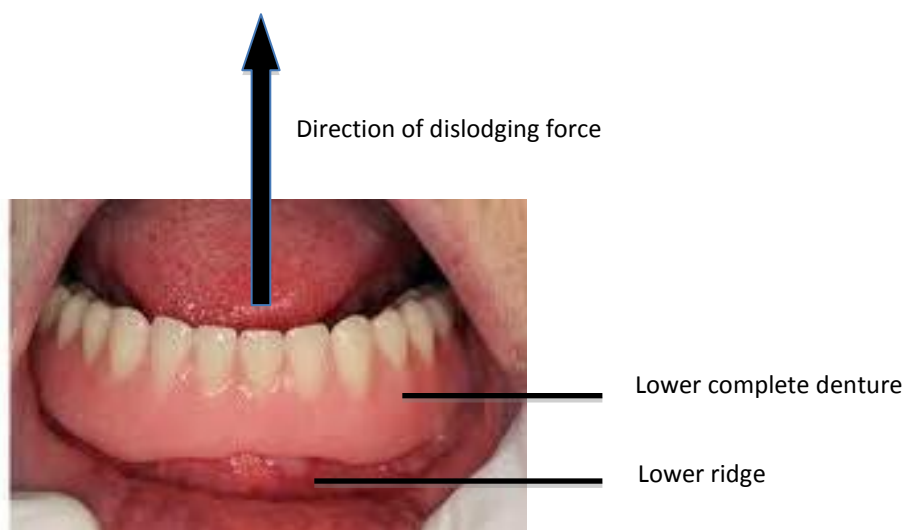

Figure 2-2: Upward dislodging force in direction opposite to denture insertion. Adapted from Darvell and Clark (2000).

The degree of retention is largely dependent on biological and physiological properties of a complete denture and the denture bearing and surrounding tissues. Thus it mainly depends on the accuracy of the impression and the peripheral extension of the denture. Other factors such as the correct vertical



dimension, the shape of the polished surface, tooth position in relation to the ridge, the balanced occlusion and free cuspal interferences may relate more to the stability of the denture rather than the retention (Tuckfield, 1953).

Denture retention cannot be explained merely in terms of simple physical equations, as human elements are heavily involved in the process also. Physical factors like adhesion, cohesion, surface tension, wettability, atmospheric pressure and gravity hold the denture in a static condition, but during mastication these factors are frequently lost, as this dynamic action breaks the border seal upon which physical retention depend. Other factors are important to influence retention during function, these include: physiological, psychological, mechanical and surgical factors (Murray and Darvell, 1993).

Despite great research efforts devoted to this controversial topic, disagreements regarding the relative importance of the various contributing factors exists (Jacobson and Krol, 1983). It would seem that retention is more likely a complex, and personal phenomenon that is controlled by great number of factors (Lindstrom *et al.*, 1979).

### **2.2.2 Dynamic and static factors**

The retentive factors do not act all at the same time, some act in static conditions and others may be effective when the denture is in function and a more severe dislodging force is being applied.

Factors that affect denture retention during function include:

#### **2.2.2.1 The oral and facial musculature**

These could supply supplementary retentive forces. They could be considered more important than other factors responsible for denture retention in cases

with severe mandibular ridge resorption (Brill *et al.*, 1959). Poorly designed prostheses that fail to accommodate muscular function, result in compromised denture stability and reduced retention (Beresin and Schiesser, 2006).

For the oral and facial musculature to be most effective in providing retention for complete dentures, the denture bases must cover the maximum denture bearing area with correct occlusal plane and arch form position (Shay, 1997).

### **2.2.2.2 Denture occlusion**

Most denture wearers perform random contacts throughout the day. These contacts may result from functional activity like swallowing, or parafunctional activity like clenching or bruxism. With an adequate balanced denture occlusion, the undesirable outcomes of functional and parafunctional loading can be reduced.

### **2.2.2.3 Flow of saliva**

A layer of mucous saliva is essential for the retention of complete dentures due to its viscosity and surface tension and the maintenance of a good peripheral seal, these factors are basic to the oral health of an aging group of denture wearers (Kawazoe and Hamada, 1978). The contents of proteins, glycoproteins and electrolytes are influenced by these factors in saliva (Dawes, 2004).

Saliva must adhere to the mucosa and the surface of the denture. The layer of saliva between the denture and the mucosa should be highly cohesive and, thus, difficult to break. The outer layer of saliva, which joins the outer surface of the denture and mucosa, should be difficult to break because of surface tension (Figure 2-3).

The retention of mandibular complete dentures is adversely influenced by the secretion rate of the salivary glands, but increasing the flow rate of parotid saliva does not significantly affect retention of maxillary and mandibular dentures (Niedermeier and Krämer, 1992).

### **2.2.2.4 Patient skills**

The successful manipulation of dentures depends upon effective muscular activity, which in turn dependent on adequate sensory feedback which involve a learning process that, initially a conscious effort then replaced by a subconscious behaviour pattern through continuous practicing (Basker and Davenport, 2002a).

The patients' ability to acquire the necessary skills to control their dentures, with high level of muscular control could compensate the overall reduction in retention. The clinical challenge now is that the complete tooth loss is occurring later in life when the patients ability to develop the neuromuscular skills necessary to wear dentures successfully is reduced (Miller *et al.*, 1998).

The static factors that assist well-adapted denture retention are mainly physical factors, these are:

- Adhesion and cohesion.
- Surface tension and capillary attraction.
- Wettability.
- Atmospheric pressure.
- Gravity.

### **2.2.2.5 Adhesion and cohesion**

Adhesion means chemical interaction across the interface of two contacting surfaces, through covalent bonds or chelation. The adhesion between a drop of water and a solid glass will prevent the movement of the drop away from the glass (Jacobson and Krol, 1983). There is no direct adhesion between the denture and tissue, but there is between denture-saliva-tissue, through ionic forces between charged salivary glycoprotein and surface epithelium or acrylic resin (Jacobson and Krol, 1983, Stanitz, 1948) (Figure 2-3). The direct adhesion which occurs between oral mucosa and the denture base in xerostomia patients is not effective and will lead to ulceration and discomfort because of a lack of lubrication effect of saliva (Shay, 1997).

Quality of denture adhesion depends on close adaptation of the denture to the underlying tissue, size of the denture bearing area and the type of saliva. The most adhesive saliva is thin serous with some mucus components. Thick andropy saliva is very adhesive, but tends to build up so that it is too thick that interfere with denture adaptation. Mandibular denture cover less surface area than maxillary denture and therefore subject to a lower magnitude of adhesive retentive forces. Similarly patients with small jaws or very flat alveolar ridges cannot expect retention to be as great as patients with large jaw, or prominent alveolar ridges (Davis, 1997a, Shay, 1997).

Murray and Darvell, believed that adhesion plays little or no role in denture retention. They exclude this factor from enhancing retention when they explained the separation of the two horizontal plates with a drop of water placed between them occurs not as a result of failure of adhesion, but on the shear within the liquid. In particular, if the liquid boundaries move across the solid

surface, the strength of concern is shear at the contact line. As a result, adhesive failure does not normally participate in loss of retention (Murray and Darvell, 1989).

Cohesion is the attraction of like molecules for each other. It occurs within the layer of fluid (like saliva) that present between the denture base and mucosa (Figure 2-3). Forces of cohesion are responsible for maintaining the continuity of a water droplet when placed in contact with another material. It is generalized to mean the hydrostatic tensile strength of a fluid. Typically the tensile strength of saliva is very high, but the formation of bubbles and the ease of their flow would cause loss of retention, so normal saliva is considered not very cohesive. For this reason, some authors discounted it as one of the physical factors of retention (Murray and Darvell, 1989, Stanitz, 1948, Darvell and Clark, 2000).

Cohesion is considered to be a weaker force than adhesion (Blahova and Neuman, 1971).

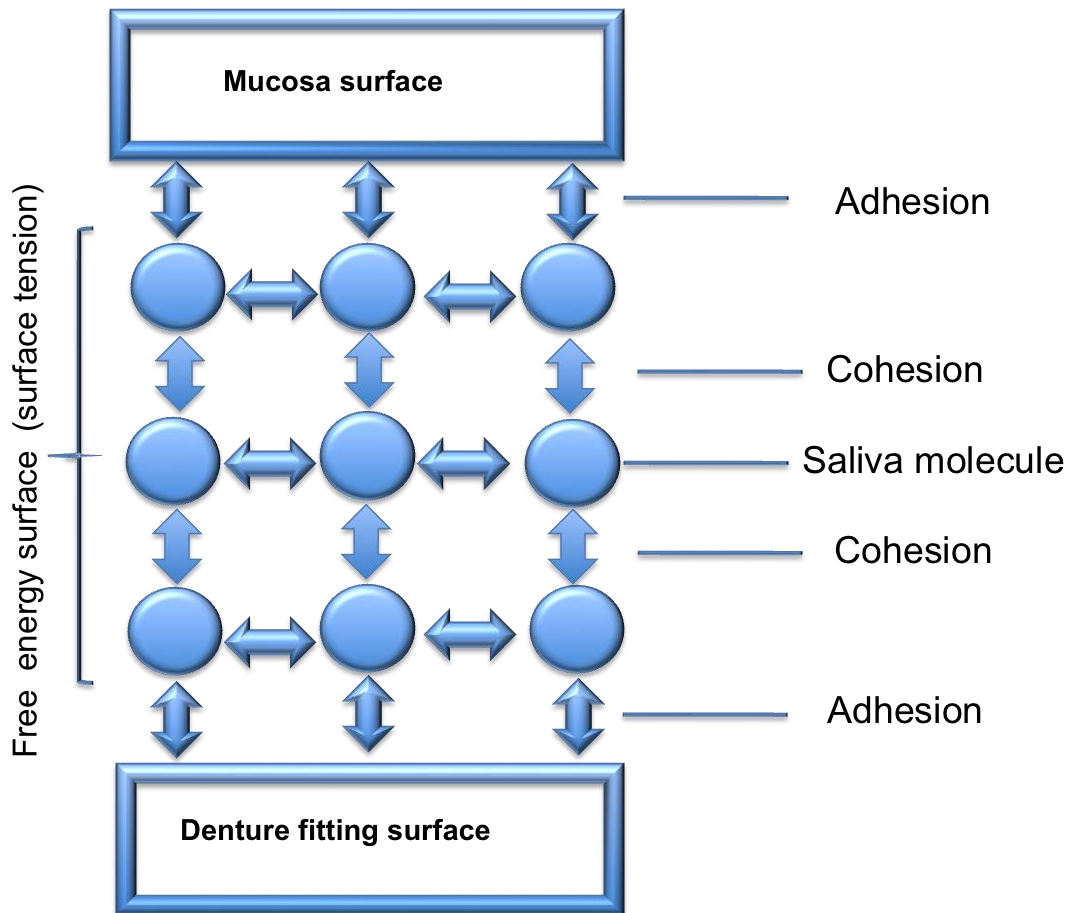

Figure 2-3: Schematic diagram representing the intermolecular forces between the fitting surface of the denture, mucosa surface and saliva molecules that contribute to denture retention. Adapted from Basker and Davenport, (2002d).

### 2.2.2.6 Surface tension and capillary attraction

The surface tension is the resistance to separation of two parallel surfaces that is imparted by a film of liquid between them. It can also be explained as the force that maintains the surface continuity of a fluid that results from an imbalance in cohesive forces between molecules present at the surface. Within the fluid the cohesive attraction between molecules is balanced in equilibrium, while at the surface the absence of neighbouring molecules creates the one-sided attraction and imbalance that causes a free potential energy called surface tension (Figure 2-3). It is relatively small force when considered alone,

but by interacting with other physical factors it becomes an important determinant (Jacobson and Krol, 1983).

This force could be responsible for maintaining the attraction of two opposed plates against a straight pull (not sliding action). It is dependent on the ability of the fluid to wet the rigid surrounding material. Before applying the force a positive menisci (curvature outside) were found at the periphery, when they tried to separate them, the edge become a negative curvature and a negative pressure formed which in turn develop a retentive force (Bohannon, 1954) (Figure 2-4).

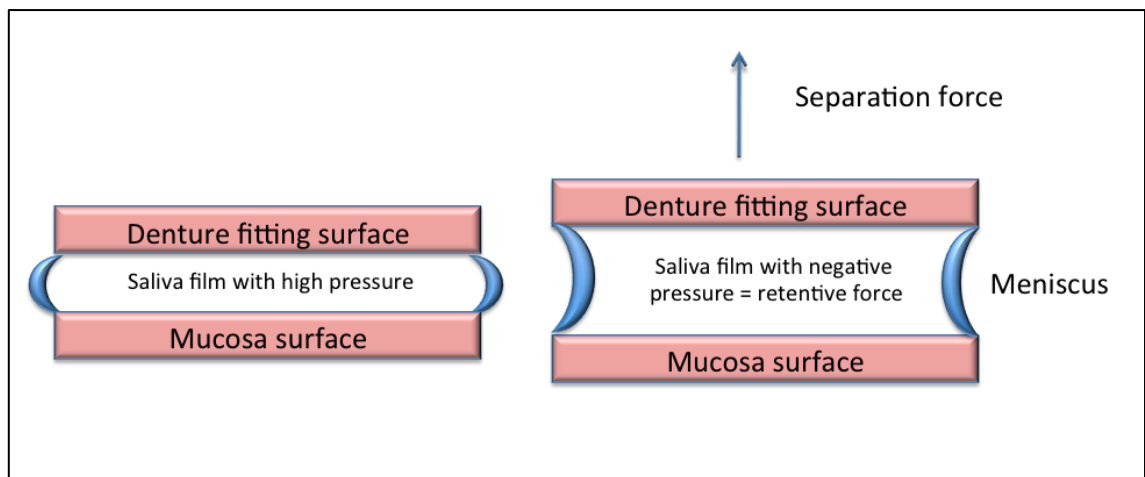

Figure 2-4: Schematic diagram representing the positive and negative meniscus formed at the edge of salivary film. Adapted from Darvell and Clark, (2000).

The role of surface tension can act through capillary attraction, which is the tendency to advance a liquid into narrow spaces, maximizing the wetted area over the surface. It does not act on the surface of the liquid only, but it works in the whole column of the liquid and attracts the two capillaries walls (which represent here the inner surface of the denture and the mucosal surface) to each other. The more narrower the space, the greater the attraction will be (Darvell and Clark, 2000).

Surface tension is important in denture retention only in a thin liquid film, when excess liquid exists between the plates the retention force is lost by losing the existence of meniscus which forms the seal (Tyson, 1967).

### **2.2.2.7 Wettability**

The ability of a liquid to contact a substrate depends on the wettability of the liquid on that particular substrate. Good wetting is the ability to cover the substrate completely (Van Noort, 2007a). When a liquid wets a solid surface it lowers the energy of a system. If there is no wetting there would be no force needed to be applied to separate the denture from saliva and there would be no retention.

Buccal epithelium in the oral cavity was found to be hydrophobic (Van der Mei *et al.*, 2004), but it was expected to be more wettable with saliva because the proteins and mucopolysaccharide contents adsorb rapidly and strongly to the soft tissue, therefore forming a surface which is more wettable. Although, some literature stated that oral mucosa has low surface tension and thus it is considered a hydrophilic, but this fact was mentioned without actual measuring data (Massad and Cagna, 2002, Shay, 1997).

The conventional denture base materials have a higher surface tension than oral mucosa, but once coated by salivary pellicle, the surface tension is reduced and display reasonable wetting characteristics. Therefore, a thin film of saliva between the supporting soft tissues and well-adapted denture base yields retention as the saliva maximizes contact with both approximating surfaces. If the material has high surface tension, fluid will minimize its contact with the



material, resulting in formation of beads on the material surface (Massad and Cagna, 2002, Shay, 1997).

#### **2.2.2.8 Atmospheric pressure**

The effect of atmospheric pressure on denture retention remains undetermined and many authors doubt its significance. Murray and Darvell, (1989) described its insignificance when of a drop of water was placed between horizontally suspended plates, and an additional weight was attached to the lower one, the plates showed similar tendency to separate under either ordinary or reduced atmospheric pressure.

Under normal denture condition there is no pressure differences and the atmospheric pressure has no bearing of retention. It operates only when a pulling force affects the denture and lead to an increase in the space between the fitting surface of the denture and underlying mucosa, thus reducing the inner pressure and a vacuum beneath the denture developed to retain the denture. This can be operated only in the presence of a perfect peripheral seal (Darvell and Clark, 2000).

#### **2.2.2.9 Gravity**

This is a trivial force and insignificant in comparison to other forces. It may be beneficial only in cases where the denture that is resting on the mucosa under its own weight where other retentive forces and factors are marginal (Ostlund, 1947).

Gravity obviously needs to be overcome to raise the mandibular denture, but equally it contributes to the lack of retention of the maxillary denture, since gravity would be of no benefit there. The mass of a mandibular acrylic denture

is typically only a few grams, and increasing this to enhance the gravity effect appreciably can only be at the expense of fatigue for the jaw carrying the load (Darvell and Clark, 2000).

### 2.2.3 Improvement of mandibular denture retention

Complete denture retention could be improved by using:

- Denture adhesives
- Implant over dentures
- Denture linings

As demonstrated in Figure 2-5.

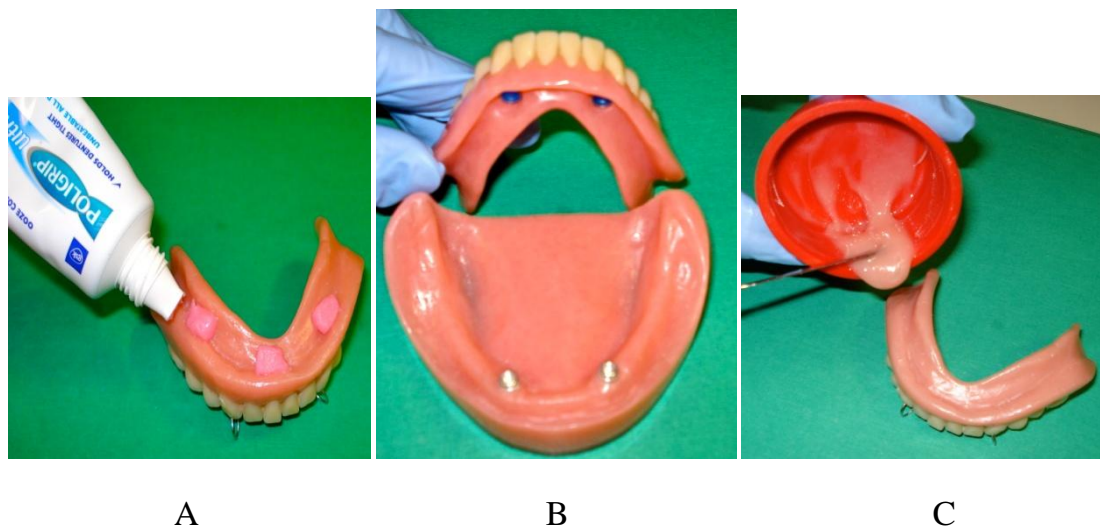

Figure 2-5: The means of improvement complete denture retention. A: applying denture adhesive to the fitting surface of the denture, B: implant-retained lower denture, C: applying denture lining material to the fitting surface of the denture.

### **2.2.3.1 Denture adhesives**

Denture adhesives could be defined as materials used to adhere a denture to the oral mucosa (ProsthodonticTerms, 2005). They bond a denture and the underlying oral tissues via physical and chemical actions. Major elements of adhesive products are ingredients which swell by absorbing water and become viscous and sticky (Shay, 1991).

Denture adhesives were first used in the late 18th century and their use has continued to increase, however, the dental literature does not discuss these products in detail. Dental professionals have also tended to focus little attention on and maintained a negative attitude toward denture adhesives. Many dentists have even viewed adhesive usage as a poor reflection of their own clinical skills and prosthetic expertise. However, it is reported that 75% of dentists recommended the use of denture adhesives (Shay, 1991, Grasso, 1996).

Responses of denture wearers to questions regarding satisfaction, retention, eating and masticatory performance of complete dentures demonstrated a subjective improvement when using a denture adhesive. The improvement in satisfaction and retention was more pronounced in the maxillary than in the mandibular denture (Baat *et al.*, 2007).

#### **◆ Use of denture adhesives**

The need for denture adhesives is not necessarily an indication of suboptimal therapy, or admission of failure by either the dentist or patient. A number of uses have been proposed for denture adhesives (Stafford, 1970, Karlsson and Swartz, 1990, Rendell *et al.*, 2000, Coates, 1995, Slaughter *et al.*, 1999, Shay, 1997):

- The main purpose for the use of denture adhesives is to improve stability, retention and comfort of dentures. This leads to improved incisal force, masticatory ability, and psychological confidence.
- They also have specific uses during the fabrication of dentures, to stabilize trial bases during the clinical stages of construction.
- They are appropriate for use at the post insertion phase for conventional dentures, in patients with inadequate oral anatomy or in denture wearers after insertion of immediate dentures.
- They aid in the retention of large prostheses such as cleft palate obturators and maxillofacial prostheses.
- They can be used as a vehicle for applying drugs to the oral mucosa.
- They aid the retention and comfort in patients with dry mouths. The use of a well-hydrated denture adhesive provides a cushioning or lubricating effect, reducing frictional irritation of the supporting soft tissue and preventing further tissue dehydration.
- They can be used with partially or wholly paralysed oral musculature patients due to neurological or cerebrovascular diseases.

(Thus they should be an important part of patient and dentist education).

### ◆ **Negative influence of adhesives**

Denture adhesives can mask underlying denture problems, avoiding necessary dental visits and offering an alternative to good clinical practices.

It has been suggested that they can contribute to the development of certain oral conditions (denture stomatitis, candidiasis and alveolar bone resorption) (Slaughter *et al.*, 1999). In contrast, Grasso (1994), and Rendell *et al.*, (2000)

found that tissue trauma might be reduced, not increased, with the use of adhesive because of significant improvements in all dimensions of movement.

The improvement in masticatory ability with the increase in biting force may provide larger stress on residual ridges during mastication (Grasso *et al.*, 2000).

An increase in occlusal vertical dimension was shown to occur by Benson *et al.*, (1972) mainly because they were usually made from natural gums, but present day adhesives are made from synthetic materials, they have better flow and are quite safe to use. Thus dental professionals advised that neither dentists nor patients should use denture adhesives as a substitute for either good clinical practice or proper denture maintenance regimes (Slaughter *et al.*, 1999).

Despite the restraining attitude of dentists towards denture adhesives, it has been shown that a substantial proportion of denture wearers (33%) had tried denture adhesives in the past, but only (7%) were regular users (Coates, 2000).

### ◆ ***In-vivo* tests of denture adhesives**

The *in-vivo* objective effects of denture adhesives on retention and stability of complete maxillary and mandibular denture cases have been demonstrated by many studies. In addition to previously mentioned *in-vivo* studies to test the affectiveness of denture adhesives on the retention of complete dentures in section 1.1 page 5, other studies used a cineradiography technique<sup>2</sup> to assess denture mobility during function with and without denture adhesives (Karlsson and Swartz, 1981, Karlsson and Swartz, 1990). They found that denture

---

<sup>2</sup> Cine-radiography is a method for obtaining a moving x-ray image on a screen. The use of this technique in odontology has been investigated with special reference to observation of bolus-position, the mandibular movement pattern, chewing velocity and the stability of full dentures.

adhesive had no effect to reduce denture mobility, but they could limit the number of vertical loosening of the denture when the seal was broken.

With a system of multi-channel alternating magnetic field magnetometer tracking<sup>3</sup> it was demonstrated that a denture adhesive significantly reduced movement of complete maxillary dentures and complete mandibular implant-retained over-dentures during mastication (Grasso *et al.*, 2000).

It has been agreed that objective measurement can provide a more reliable position on the role of denture adhesive, nevertheless, subjective responses and satisfaction of denture wearers with regard to the effectiveness of denture adhesive can provide a broader base for evaluation by questionnaire (Kulak *et al.*, 2005).

### ◆ ***In-vitro* tests on denture adhesives:**

In previous *in-vitro* tests, authors measured the bond strength of adhesives either between two acrylic discs (Floystrand *et al.*, 1991, Zhao *et al.*, 2004), glass and resin specimens (Panagiotouni *et al.*, 1995), skin of a rat and acrylic discs (Chew, 1990), or metal edentulous mouth model, without including the effect of soft tissue attached to the model (Norman *et al.*, 1987) (as discussed previously in section 1.1 page 9)

The argument against the laboratory studies of denture adhesives is that they do not represent the intraoral condition as the surfaces used for *in-vitro* bond strength studies do not adequately represent the oral mucosa side of the bonding equation. Denture adhesives do not perform in the same manner when bonded to keratinized mucosa as they do when bonded to acrylic resin.

---

<sup>3</sup> magnetometer tracking is a detection method of denture movements signals using an alternating magnetic field that determines the position of magnetic receiver coils relative to a transmitter coil positioned over the head.

Additionally, they do not accurately match intraoral temperature and pH fluctuation combined with muscle movements, which undoubtedly have some effect on denture adhesive bond strength (DeVengencie *et al.*, 1997, Zhao *et al.*, 2004, Panagiotouni *et al.*, 1995).

However, the result of such *in-vitro* evaluation tests may correlate with *in-vivo* data when an *in-vitro* model is created to match as far as possible the intraoral anatomy and conditions.

### **2.2.3.2 Implant over-dentures**

One of the most important reasons to use implants is to improve the retention of complete mandibular dentures, which are often associated with problems in jaws with advanced ridge resorption (Zarb and Schmitt, 1990, Branemark *et al.*, 1977).

Implant prosthodontics have become a routine part of dental treatment for many patients, especially for completely edentulous individuals (Adell *et al.*, 1981).

According to Tallgren, (1972) the annual alveolar ridge height reduction was shown to be approximately 0.4 mm in the edentulous anterior mandible, while long-term bone resorption under an implant retained over-denture may remain constant at 0.1 mm annually.

It has been established that the survival rate for implants is high in the anterior region of the mandible and that the surgical complications are low and the consequence residual ridge resorption will be greatly minimized (Feine *et al.*, 2002).

**◆ Conventional dentures versus implant over-dentures**

It is not clear whether the implant-prosthesis offers better advantages over the conventional complete denture for managing the edentulous jaw. There are functional and psychosocial advantages and disadvantages to both the conventional denture and the implant prosthesis, which indicates that neither method is distinctly superior (MacEntee and Walton, 1998).

Although implant-retained dentures offer a solution to many persistent prosthetic problems, they cannot be regarded as a routine treatment for edentulous patients because of the immediate and long-term cost. High quality conventional dentures continue to offer high level of success (Basker and Davenport, 2002b), and still implant-supported dentures offer limited improvements for a limited set of individuals (Cooper, 2009).

A number of studies indicate that functional improvement and satisfaction with implant denture therapy may be limited (Roumanas *et al.*, 2002). While others were able to report a significant higher patient satisfaction with two implant over-dentures than with conventional dentures in many aspects: ability to speak and chew, comfort, aesthetic and stability (Rashid *et al.*, 2011), in addition the cost difference between mandibular two implant over-dentures and conventional dentures is not as large as one might expect and for this reason two implant over-dentures should become the first choice of treatment for the edentulous mandible (Feine *et al.*, 2002).

It was proposed in the McGill consensus statement (Feine *et al.*, 2002) and in the York consensus statement (Thomason *et al.*, 2009) that an over-denture on 2-implants should be the first treatment option for complete edentulous mandible. This form of treatment is predominant in some countries like



Netherlands as the Dutch National Health Service, as well as most private insurance companies, reimburses most costs of implant over-dentures in edentulous people with resorbed residual ridge, whereas there is no reimbursement for fixed restorations (Carlsson *et al.*, 2004). While in the UK the implant treatment is concentrated with the private sector or limited to the secondary care environment (Basker *et al.*, 2011).

### **2.2.3.3 Denture linings**

Denture linings are used to modify the impression surface of dentures to overcome some of problems associated with the wearing of dentures.

The materials used are either applied by the dentist at the chair-side or in laboratory.

They are classified into:

- Rigid materials.
- Short-term soft lining materials.
- Long-term soft lining materials.

#### **◆ The rigid materials**

The rigid materials are described as chair-side reline materials, and contain poly (ethylmethacrylate) with liquid monomer. These materials have great benefits for chair-side relines and permit the patient to refit their denture in one clinical visit. Especially for those with consequence bone resorption after immediate denture insertion at the initial healing period. It has a working life of about one year, after which the material will deteriorate and should be replaced by a permanent rebase or a replacement denture. It provides immediate improvement of fit and comfort (Basker and Davenport, 2002b).

◆ **Short-term soft lining materials**

The composition of these is as follows: powder: poly(ethylmethacrylate), or copolymers/ methacrylate, liquid: aromatic esters like dibutyl phthalate and ethyl alcohol.

They are used as tissue conditioner in traumatised, inflamed mucosa, as they act as a cushion absorbing and distribute the occlusal load. Because they lose their softness in a short period of time, they are used for temporary improvement of the fit of the denture or as a diagnostic aid to check the reaction of the patient to an improvement in the fit of the denture or they could be used as a functional impression (Basker and Davenport, 2002b).

◆ **Long-term soft lining materials**

Long-term soft lining materials are made either of autopolymerising or heat curing silicone rubbers or cold or heat curing acrylic.

These materials can distribute occlusal stress more evenly under the denture. They have a cushioning effect and absorb impact that can arise from masticatory function. Adding these materials to a complete mandibular denture improves the ability to bite and chew and provide general improvement in comfort and masticatory ability.

They are used mainly when the patient complains of persistent pain due to poor quality mucosa, in gross resorption of mandible with sharp bony ridge and spicules and in case of superficial mental foramen and mental nerve (Basker and Davenport, 2002b).

## 2.3 Testing the retention of mandibular dentures

### 2.3.1 Clinical testing methods

Previous literature mainly tested the *in-vivo* retention of the maxillary denture rather than the retentive quality of the mandibular denture because this is problematic, as it tends to be intimately associated with oral muscles control.

The retentive qualities of a complete mandibular denture may be gauged by assessing the resistance to vertical displacement. This may be evaluated clinically by asking the patient to relax with the tongue at rest, place a probe between the lower incisor teeth, and assess the resistance of the denture to upward pressure of the probe. The presence of a peripheral seal should resist upward movement of the denture (McCord and Grant, 2000).

For research purposes, the basic methods for clinically testing the retention of different denture designs that can be carried out are:

The subjective method: The subjective feelings of patients in the functional state can be gained simultaneously through a questionnaire (Zhang and Xu, 2003).

Methods with more or less clinical objective criteria use clinical testing: Mainly used for epidemiological research, they were considered not reliable because the methods with clinical criteria are very pragmatic (de Baat, 2004).

Objective methods: The static retention can be measured as a resistance to dislodgement loads applied vertically to the incisive edge of the central incisors of maxillary and mandibular dentures, using a *miniature bite force recorder* (Orstavik and Floystrand, 1984).

From the *in-vivo* studies of denture retention previously mentioned in section 1.1 page 5 only a tensile apparatus, *gnathodynamometer (Retentiometer)*

proved reliable when investigating denture retention *in-vivo* (Ghani and Picton, 1994, Ghani, 2002, de Baat, 2004, Zhang and Xu, 2003, Du *et al.*, 2003). This device mainly tested the retention of maxillary complete dentures and is designed to apply vertical tensile forces with a metal hook secured with autopolymerising acrylic resin at the centre of the palate (Sipahi *et al.*, 2007).

Retention testing conducted in those clinically based investigations are largely inconclusive because it associated with many limitation and problems related to ethical, economical, and technical issues.

Hence the importance of supplementing the clinical findings with laboratory testing procedures to achieve optimum benefits.

### **2.3.2 Laboratory testing methods**

It is important to conduct *in-vitro* studies of mechanical properties of prosthetic appliances mainly because of ethical, economical, and technical problems that are associated with *in-vivo* studies. If a laboratory study could be created to be relevant to clinical studies, they would benefit the attempt to understand and control better the factors influencing dental treatments with prosthetic appliances.

In most cases laboratory testing of the retention of conventional and implant supported complete dentures, was carried out through the use of tensile testing by applying tensile forces at different loads and speeds. The maximum retentive force for the prostheses can be measured depending on the dislodgment forces. These tensile forces could be applied axially and may also be tested in a paraxial direction to evaluate the resistance to rotational dislodgment forces.

Previous studies have concentrated on measuring the maximum retentive force of over-denture attachments during linear vertical dislodgement (Setz *et al.*, 1998, Williams *et al.*, 2001). As a restoration in the mouth is subjected to a range of displacing forces in differing directions, it is important to understand retentive and stabilizing properties of attachments during various dislodging patterns. Some researchers applied tensile loads in axial and paraxial directions anteriorly, posteriorly and laterally to simulate a twisting (torque) type action to measure the maximum retention force of mandibular over-dentures retained by different implant attachments (Rutkunas and Mizutani, 2004, Rutkunas *et al.*, 2007).

However, Teraoka *et al.*, (2004) in their *in-vitro* experiment to compare the retentive forces of full palate and palate less coverage maxillary complete dentures showed no significant differences regarding the direction of applied forces.

In such an extra oral model, the characters of covering synthetic mucosa should approximate to the oral tissue as much as possible as its elasticity, thickness and wettability will affect physical denture retention.

Many researchers who carried out laboratory testing procedures tried to cover their edentulous casts with a uniformly thick layer of silicone material to mimic the elasticity of oral mucosa. They are not usually dependent on a real measurement of the thickness and elasticity of oral mucosa.

Ohguri *et al.*, (1999) covered the mandibular edentulous model with a 1.5 mm thick artificial tissue to study the influence of the occlusal scheme on the pressure distribution under a complete denture.

Taguchi *et al.*, (2001) and Dong *et al.*, (2006) covered a dental stone model with a 2 mm thickness of polysulfide rubber impression material (Surflex) to simulate oral mucosa to study the effect of viscoelastic properties of resilient denture liners. While Rutkunas and Mizutani (2004) and Rutkunas *et al.*, (2007) covered the mandibular cast with a 3 mm thickness of white silicone material (Fit checker, GC.Co., Japan) to simulate the resilient mucous membrane.

To simulate muscles of mastication, Demann and Haug, (2002) used polyethylene straps to simulate the suprahyoid muscles and polysulfide to simulate periosteum and mucosa in their investigation to provide an *in-vitro* evaluation of the effects of soft tissue and position on vector during distraction.

Other than elastic impression materials, elastic maxillofacial materials may be suitable for mimicking the reflected sulcus and attached muscles.

To the authors knowledge no experimentation has been carried out to determine oral tissue elasticity and find a comparable substitute.

### **2.3.3 Rationale for an *in-vitro* analogue model of an edentulous mandibular ridge**

An effective *in-vitro* testing of denture retention systems is a logical and essential step prior to undertaking costly clinical trial investigations. Moreover, *in-vitro* testing would complement results obtained from subsequent clinical studies.

It is essential to undertake an effective pre-clinical laboratory characterisation of the appliances. Such laboratory studies give better understanding of the mechanical factors that affect the retention of denture prostheses. In addition,

they could investigate denture retention with forces of different loads and speeds and could easily control the environmental conditions.

Compared with the maxillary denture, mandibular denture retention for patients with resorbed ridges is the most annoying problem for both the patient as well as the clinician; therefore there is a real need to improve mandibular denture retention. To make these investigations more effective and to reduce the time, effort and cost for clinical trials, it is essential to investigate new materials or ideas to improve mandibular denture retention extra orally first, so that only successful materials and ideas go forward for clinical investigation.

# 3

---

## **Design considerations in the construction of an *in-vitro* model**



### **3. Design considerations in the construction of an *in-vitro* model**

The following topics are discussed:

- I. Assessment of ridge resorption
- II. Assessment of properties of the oral soft tissues
- III. Oral mucosa analogue materials

#### **3.1 Assessment of ridge resorption**

Advanced reduction of residual ridges presents a significant restorative challenge because of inability to provide adequate support, retention and stability for the following reasons:

- The functional movements of anatomic structures such as the tongue, floor of the mouth, and facial and masticatory musculature, which cause difficulty in establishing the lingual border seal.
- Reduced support area associated with bone atrophy and motion of the mandible (Hickey and Zarb, 1980).

Treatment of the severely resorbed lower ridges has been a problem for the patient as well as for the dentist, because the retention problem always accompanied by this type of ridge.

Edentulous patients with severe residual ridge resorption frequently complain about poorly fitting, loose dentures, even when these were manufactured to a good standard. This problem is caused by flat or only slightly raised alveolar

ridges, which allow undesirable shifting of the denture even when only minor forces are applied (Slagter *et al.*, 1992).

Edentulous ridge resorption is a continuous procedure throughout the lifetime, so the majority of denture wearer patients will inevitably have a high degree of resorption with time (Kalk and de Baat, 1989).

According to Cawood and Howell's classification in 1988, class IV (knife-edge ridge form adequate in height and inadequate in width) and class V (flat ridge form, inadequate in height and width) represent moderately resorbed ridges and they can be easily assessed clinically without x-ray, hence they were considered as the basic ridge type for this present study.

The current set of the study experiment permits testing the static denture retention, which mainly depends on the accuracy of the impression and border seal.

To record the shape of mucosa overlying the ridge with functional depth and width of the sulci as accurately as possible, a high accurate impression is needed.

To ensure the accuracy of the final impression, special trays must be made of a material that is dimensionally stable and rigid. Cold or light curing acrylic resins are satisfactory. Spaced trays are used for alginate material while for light body elastomers or zinc oxide eugenol paste a close fit tray will be satisfactory. (Basker and Davenport, 2002c).

### **3.2 Assessment of properties of oral soft tissue**

Most studies concerning edentulous ridge mucosa concentrated on studying the biomechanical characteristic of oral mucosa, displaceability and thickness. Chowdhry *et al.*, (2010) considered the degree of deformation of the mucous membrane under pressure and the quality of the mucus film lying on it to be the most important characteristic features describing the mucous membrane. While Kydd and Mandley, (1967) found that the main characteristic features of a material that determined force dissipating capabilities were the thickness and modulus of elasticity.

To substitute the oral mucosa on an *in-vitro* model to test complete denture retention, it is important to investigate the wettability of the substitute materials and compare it with that of oral mucosa to approximate the natural real situation.

#### **3.2.1 Thickness and elasticity of the oral mucosa**

To construct a denture for an edentulous patient, one must carefully examine and diagnose the denture bearing area. Irritation under dentures usually occurs where the underlying soft tissue is thin or where occlusal forces are being concentrated in a small area. The primary stress-bearing area, consisting of fibrous connective tissue and cortical bone, should take most of the occlusal force, whereas the areas covered with thin mucosa should not be loaded excessively. Determination of these areas usually depends on the clinician's level of experience (palpation and use of pressure-indicating paste) or on the patients' reaction after the denture is inserted (sore spots and complaints of

discomfort). Therefore, information on the denture bearing area is needed (Uchida *et al.*, 1989).

To establish a comprehensive assessment of the biomechanical characteristics of denture supporting tissue, both elasticity and thickness should be evaluated simultaneously.

The early determination of the thickness of the oral mucosa, were carried out using cephalometric x-ray (Lytle, 1957). Penetration methods using an injection needle (Ostlund, 1958) or a periodontal probe (Turck, 1965) were also used. All these methods have disadvantages, as they are invasive, traumatic, and the patient is exposed to unnecessary radiation or harmful experiences.

Other studies have been undertaken to demonstrate elasticity changes in soft tissue contours as a result of mechanical stress, by observing the blanching of mucosa under a transparent acrylic resin base plate farthest from the applied pressure (Kydd *et al.*, 1971a), while others used a dental comparator or dentograph to compare casts of edentulous and partially edentulous tissues immediately following the removal of the prosthesis (Lytle, 1962).

A non-invasive technique which could measure both the thickness and elasticity of the oral mucosa was discussed by Kydd *et al.*, (1971a) who measured the thickness of oral mucoperiosteum in the mandible of edentulous mouths, using an ultrasonic echo ranging technique, the thickness was  $1.9 \pm 0.61$  mm (anteriorly),  $2.1 \pm 0.31$  mm (left premolar area) and  $2.5 \pm 0.53$  mm (right premolar area).

They also used the ultrasonic echo ranging technique, to show the delay recovery of mucosa as a result of compressive load. It was found that when a stress was applied to soft tissue an instantaneous initial elastic compression of

soft tissues occurs, and then a slow delay elastic recovery takes place and continues to diminish in rate as the duration of the load is extended. The soft tissue returned to between 70-90 % of their original thickness 20 minutes after the release of pressure. The residual deformation was equal to 10-30 % and a complete recovery occurred after 3 hours as demonstrated in Figure 5-20.

It was demonstrated that the recovery after pressure releasing showed that the initial recovery amount of mucosa was lower and the final recovery time was longer in older subjects, and the tendency was exaggerated when the displacement was increased (Yoshida *et al.*, 1999). That is why dentists usually ask elderly patients to leave any previous prostheses in the mouth for at least 4 hours and use low viscosity materials for the impression.

This delay in the recovery of the mucosa could be regarded as creep, the mucosa under the denture took a longer time to return to the original position during occlusal force unloading (Hada *et al.*, 1990) and the oral tissue is more responsive to the duration than the magnitude of the load (Kydd and Daly, 1982).

Valuable measurements of the thickness of edentulous oral mucosa have been conducted by Uchida, *et al.*, (1989) who examined 100 edentulous patients using a B-mode ultrasonic measurement. They found that the thickness of the mucosa of lower edentulous ridges on the height of the contour, to be 1.44 - 1.60 mm (in severely resorbed ridges), 1.34 - 1.62 mm (in moderate resorbed ridges) and 1.41 - 1.70 mm (in minimum resorbed ridges).

They found that a decrease in mucosal thickness with age was not related. Furthermore, the degree of ridge reduction did not contribute to mucosal reduction, unlike Hayakawa *et al.*, (1994) who concluded that age is responsible

for changes in the oral structures and longer denture wearing time resulting in greater resorption of residual ridge while the overlying mucosa simultaneously decreased in thickness.

Studying the thickness and elasticity of the mucosa using an ultrasound method give a good base to correlate the elastic properties of other impression and soft lining materials that can act simultaneously for better prosthodontic prognosis, and consider the most effective impression method.

#### **3.2.2 Wettability of oral mucosa**

Wettability of soft tissue surfaces in the human body, including the human oral cavity, could play an important role in many biological processes, like adhesion of infectious microorganisms, elasticity and functionality of tissue membranes. Generally, tissues with adsorptive and exchange functions or in need of lubrication like intestinal, corneal and peritoneal surfaces tend to be more hydrophilic, while tissues requiring protection against pathogenic microorganisms or acids like human skin, corneal, visceral peritoneum covering the kidneys tend to be hydrophobic (Holly, 1992).

There has been little work to evaluate the wettability of soft tissues in the human oral cavity. It was found that the buccal epithelium in the human oral cavity is the most hydrophobic soft tissue in the human body and has a protective function against infection (Van der Mei *et al.*, 2004). The contact angle of a drop of water on the attached gingiva of the front maxillary incisors was measured by a sessile drop technique using a photo camera, which found to be 72 - 82°. Another study by Ranca *et al.*, (2006) found the tongue surface has a hydrophobic tendency and is weakly polar, but when coated with saliva, the

surface of the tongue become significantly more hydrophilic. The saliva helps to increase the tongue surface free energy and reduce the dynamic coefficient of friction. In the same manner the wettability of mucous membrane is suspected to be more hydrophilic with saliva to ease the spreading of a thin layer of saliva to help the physical retention of the denture to take place.

### **3.3 Oral mucosa analogue materials**

Many previous studies used elastic dental impression materials as an analogue to the oral mucosa as discussed previously in section 2.3.2 pages 44, 45 and 46.

The current study tested denture lining materials, maxillofacial prosthetic materials and special effect materials (film industry) in addition to different types of elastic impression materials to select the suitable material to mimic the characteristic features of oral mucosa.

#### **3.3.1 Elastic dental impression materials**

There are no other materials that can mimic the character of the soft tissue of the oral cavity and associated structure in its viscoelasticity and aesthetic appearance better than elastic impression materials. Many authors used elastic impression materials like silicone and polysulfide for producing artificial mucosa (Skinner and Chung, 1951, Ohguri *et al.*, 1999, Taguchi *et al.*, 2001, Dong *et al.*, 2006, Rutkunas *et al.*, 2007).

In addition to the oral mucosa, facial muscles were simulated by using polyethylene straps (Demann and Haug, 2002) to provide an *in-vitro* evaluation of the effects of soft tissue and position on vector during distraction.

Elastic impression materials are those that remain elastic after they have been removed from the mouth, and are used mainly for all types of impressions when tooth and tissue undercuts are present.

The elastic impression materials are divided into two main categories: Hydrocolloid and elastomeric materials.

Hydrocolloid: agar (reversible), alginate (irreversible)

In colloid suspension there are no solid particles that can be detected nor does the mixture behave as a simple solution. The molecules remain dispersed because they carry small electrical charges and repel one another within the dispersing medium. When the fluid medium of the colloid is water it is referred to as hydrocolloid (McCabe and Walls, 2009b).

Elastomeric: polysulfide, polyether, silicones (condensation and addition cured).

These materials are also known as non aqueous elastic impression materials. Their polymers are used at a temperature above their glass transition temperature ( $T_g$ ); where they become more and more fluid. The transition from fluid to solid of elastomeric materials depends on the process of cross linking (binding the long chains together to form a three dimensional network) (Van Noort, 2007b).

#### ◆ Agar

Mainly consist of galactose sulphate, which forms a colloid with water. It liquefies when heated in a water bath between 71°C and 100°C for 8 - 12



minutes, and when cooled to 30°C - 50°C, it turns again to a gel. Thus it can be used repeatedly, but not more than four times, because the reheating causes some breakdown of the polymer structure and the agar becomes noticeably stiffer.

It has hydrophilic nature, thus it provides very accurate reproduction of the surface detail. The model should be poured immediately or within an hour when kept in a relative humidity, because of syneresis and imbibition characteristics. It is now relatively infrequently used because it tears very easily; is dimensionally unstable and does not bond to the specially designed stock tray which causes discomfort to the patient, it also needs special equipment which cost time and money in addition it can not be recycled for patient use due to cross infection concerns (Van Noort, 2007b).

#### ◆ Alginate

It is supplied as a powder and sets by chemical reaction that cross links the polymer chain when mixed with water. These chains cannot be broken once formed, so it is an irreversible reaction and the material can only be used once. It is mainly composed of sodium alginate, a small amount of calcium sulphate, which causes the reaction; silica fillers, which provide body and rigidity, sodium phosphate as a retarder and potassium sulphate (Ferracane, 2001, Paulin and Pendleton 2000, Wassell *et al.*, 2002a). The surface reproduction is not as good as that with agar or elastomers, and thus they are not recommended for crown and bridgework, but they are very popular for full and partial dentures. Also they suffer from syneresis and imbibition giving poor dimensional stability. The model should be poured within one hour and kept moist. A snap removal technique is

needed to ensure that the time for which the material is under compression is as short as possible to prevent permanent deformation. They are weak materials and have low tear resistance (lower than agar) (Van Noort, 2007b).

#### ◆ **Polysulfide (mercaptan, Thiokol)**

Polysulfide was introduced into general use in the early 1960s. It is available in a range of viscosities namely; light bodied (low viscosity); medium or regular bodied and heavy bodied (high viscosity). They are supplied as two pastes, the base paste which is often white in colour, consists of 80% polysulphide and 20% inert filler such as titanium dioxide and a plasticizer, and the activator paste, which is often brown in colour, consists of 78% lead dioxide (which gives the material its brown colour), while the remainder is sulphur and dibutyl phthalate (Smith *et al.*, 1986).

The polymer is terminated with a mercaptan group (-SH). They are also known as Thiokol rubbers as they are derived from thiols, which is the sulphur analogue of alcohol. During mixing the accelerator oxidises the mercaptan group and leads to cross linking and lengthening of the chain and conversion of the paste to rubber with water as a by-product and the reaction is exothermic (Van Noort, 2007b).

They have high tear strength, are hydrophobic, flow well, and are easily removed from the mouth and model because of their flexibility. They are relatively unpopular because of their long working and setting time, they are also messy to handle and have poor patient acceptance due to an unpleasant sulphide odour. They show slight contraction during polymerization, the shrinkage occurs as a result of a continued setting reaction after the apparent

initial setting time, and due to evaporation of water produced as a by-product of the setting reaction. The recommended maximum storage time of the set impression is about 48 hours. Their dimensional properties are not ideal and some of this strain of deformation may not be fully recovered (Smith *et al.*, 1986, Wassell *et al.*, 2002b).

#### ◆ Polyether

The first polyether impression material introduced in the 1960s was Impregum™ (3M ESPE, Seefeld, Germany), which was available only in a regular viscosity. More recently heavy and light bodied systems have been introduced (Permadyne, 3M ESPE, Seefeld, Germany); a light body, polyether tray impression material that offers high precision impressions for use in the one-step/two-viscosity technique.

The polymer is cured by a reaction with imine end groups ( $\text{NH}=\text{CH}_2-\text{CH}_2$ ). The base paste consists of polyether, a plasticiser like glycoether or phthalate and colloidal silica as an inert filler. The activator paste consist of an aromatic sulphonate ester, a plasticiser and an inert filler (Van Noort, 2007b).

It has good dimensional accuracy, but it swells in a moist environment with low tear strength.

They are hydrophilic, have excellent dimensional stability as no by-product is produced during cross-linkage, they provide good accuracy and surface detail as well as low shrinkage upon setting, with a short setting time. On the negative side, they have low tear strength, low flexibility and high stiffness, so tend to break the teeth when being removing from the model. The set material may swell and distort because of the absorption of water on storage in conditions of

high humidity. Impressions should therefore be stored dry. Ideally the impression should be poured within 48 hours after setting (Eames *et al.*, 1979, Wassell *et al.*, 2002b).

A new polyether material (Impregum Penta soft, 3M ESPE, Seefeld, Germany) has been produced to be more flexible with a higher strain in compression than other new addition cured silicone. The flexible materials would be expected to have less cross-linking, less fillers, and more plasticizer, so they would be expected to be weaker than the earlier stiffer materials and more easily torn (Lu *et al.*, 2004).

#### ◆ **Condensation reaction silicone (polysilixone) (Type I)**

These were the first type of viable silicones to be introduced in the early 1960s and still available in a range of viscosities: putty, heavy, medium and light bodies. The base paste containing silicone fluid and filler and the activator paste contain tetra-ethyl silicate (cross linking agent). They consist of polydimethyl siloxane polymers with a hydroxyl terminal group. The cross linking is achieved by the use of a tetraethyl silicate (TES), and produces volatile ethanol which compromise the dimensional stability. This shrinkage related to the amount of silicone present and thus the heavily filled putty shrinks far less than the wash material, which is why the impressions must be poured immediately. The condensation and addition cured silicones have the best elastic properties of any impression material, their recovery of strain being said to be almost instantaneous (Wassell *et al.*, 2002).

The uncompleted mixing procedures and contamination with moisture could lengthen the setting time. In addition they are hydrophobic, shrink on storage and have low tear strength (Smith *et al.*, 1995) (Noort, 2007).

#### ◆ **Addition reaction silicone (poly vinylsiloxanes) (Type II)**

These are the most recent addition to the range of elastomeric materials. The base paste containing polyvinyl silicone, silanol and filler, the activator paste containing polyvinyl siloxane, platinum, filler and polydimethyl siloxane polymers with a vinyl terminal group (-CH=CH<sub>2</sub>). The setting reaction is via a platinum crystal and a silanol.

These can be used in a wide variety of impression techniques because they are available in varying forms: putty, heavy, medium and light bodies. The mixing of low viscosity materials with a gun delivery system prevents the incomplete mixing and reduces the chance of air bubbles.

There is an inhibition of the setting of addition-cured silicone putties when the mixer is wearing latex gloves (Van Noort, 2007b). They have good storage stability, but are hydrophobic and have low tear strength.

These materials have the least shrinkage on setting because no by-product is produced during the setting reaction, resulting in an extremely stable and accurate impression material, with excellent dimensional accuracy and long term dimensional stability so that accurate dies can be poured for up to a week after the impression has been removed from the mouth.

They have a short setting time and high stiffness making them difficult to remove from the mouth. They are hydrophobic (non polar molecules, forming a high contact angle with water), poor wettability and are expensive (McCabe and

Wilson, 1978). Research has been conducted to produce hydrophilic silicone rubbers like some commercial addition cured products (Wassell *et al.*, 2002).

The elastic and viscoelastic properties of addition reaction silicones as a function of composition were reported by (Williams and Craig, 1988), they stated that by increasing the hydride polymer (cross linker) and the filler, the percentage of permanent set, percentage of strain and creep were decreased, but the elastic modulus was increased.

#### ◆ **Permanent denture soft lining and ridge conditioning materials**

Soft lining materials are commonly used for replacement of the fitting surface of the acrylic dentures in order to improve the fit of the denture, or in order to act as a cushion to enable traumatized tissue to recover before recording an impression for a new denture, or used in patients who cannot tolerate a hard base, especially those with irregular alveolar ridge covered by thin mucosa thus enhancing patient comfort.

Permanent soft lining materials are expected to function over a long period of time. They can be achieved either by laboratory or chair-side procedures. A laboratory-processed denture lining material exhibits more complete polymerization than chair-side materials, thus they gain better physical and mechanical properties, while chair-side procedures are simple and practical.

There are two types of permanent lining materials:

- Acrylic permanent lining materials
- Silicone permanent lining materials

#### **Acrylic permanent lining materials**

These are cold and hot curing types, supplied as powder and liquid. Their softness depends on the combination of methacrylate and a plasticizer. They have viscoelastic behaviour, both deformation and recovery processes are slow rather than instantaneous, the recovery is complete with permanent deformation. They lose elasticity within a few weeks through rapid loss of alcohol and slow leaching of plasticizer so they require regular replacement (Jin *et al.*, 2009, McCabe and Walls, 2009a). The conventional heat-cured PMMA denture lining materials are more wettable than other materials, thus it provides a condition in which saliva will spread over the surfaces with ease reducing the frictional problems and patient discomfort (Monsenego *et al.*, 1989).

#### **Silicone permanent lining materials**

These are analogous to the two types of silicone elastic impression materials, addition and condensation types. The condensation types are generally supplied as a paste and liquid, on mixing a condensation cross-linking reaction takes place and releases alcohol as a by-product. The addition types are two pastes mixed using a cartridge/gun system; the addition cure reaction takes place without any by-product.

Silicone materials demonstrate greater resistance to change in physical properties when exposed to solid or liquid chemical components and are more elastic. They have a high resistance to flow and are more elastic than acrylic. A perfectly elastic material may offer a better cushioning effect and they remain permanently soft.

A drawback of silicone lining materials is their bond failure with the acrylic denture base material, which creates a potential surface for bacterial growth, and plaque accumulation (Kawano *et al.*, 1992). Another limitation of silicone materials is hydrophobicity, which may cause frictional damage to the oral mucosa especially if saliva flow is reduced (McCabe and Walls, 2009b, Jin *et al.*, 2009).

◆ **Maxillofacial prosthetic materials: Coform impression materials (M515-original blue, M517-soft orange, M518-hard green):**

These are designed as an external impression material for use in maxillofacial prostheses. The materials are thixotropic (the property of becoming less viscous when subjected to an applied stress, shown for example by some gels that become temporarily fluid when shaken or stirred) so they do not run or slump when injected on a vertical surface.

The material is a two-part 1:1 room temperature platinum addition cure system. They are composed of silica particles in platinum catalyzed (vinyl terminated) silicone fluid.

They are supplied as Coform soft and hard (Technovent Principality, Wales, UK) dual cartridge dispensing system for use with mixing nozzles and a dispensing gun (Coform technical data sheet).

◆ **Special “make-up” materials**

These materials are used in making the facial prosthetics that are used to change or adapt the outward appearance of a persons face or head in the film industry. They are made from a wide range of materials including latex, foam



latex, silicone, and cold foam Silicone is commonly used for creating prosthetic appliances, but only as it applies to mould making silicone. Appliances made of silicone look and feel remarkably like real skin.

Mould making silicones are available mainly as addition (platinum) cure and to a lesser degree as condensation (tin) cure. Condensation cure systems are usually softer and work better with a wide variety of materials. Addition cure systems usually cure faster, are more rigid and exhibit minimal shrinkage. Many platinum silicones are for application directly to the skin but they are more expensive.

Other make up materials like gelatin, foamlatex, and even bondo appliances still have their place in the world of creative makeup effects (Debereceni, 2009).

#### **ProGel silicone neutral skin (S 518a) and ProGel silicone outer skin (S 518e)**

They are intended for makeup artists who need to create chair-side realistic smaller prosthetic pieces without the need for a workshop facility.

They are platinum, vinyl addition cure systems, and are room temperature cure and are supplied in dual cartridges for easy use. This method of delivery means that no air is trapped in the material during mixing.

Care must be taken not to use this material with a mould which have been previously used for tin-curing silicones or latex based materials or with the presence of sulphur as these materials could affect its setting time.

ProGel neutral material sets to a slightly sticky material, so it must be covered by ProGel Silicone Outer skin to form a smooth outer surface (ProGel technical data sheet).

### 3.3.2 The modulus of elasticity of elastic materials

The elastic materials are those materials, which undergo full elastic recovery immediately after removal of an applied load. If the recovery takes place slowly, or if a degree of permanent deformation remains, the material is said to be viscoelastic. The extent of deformation under load is characterised by the modulus of elasticity (Figure 2-6).

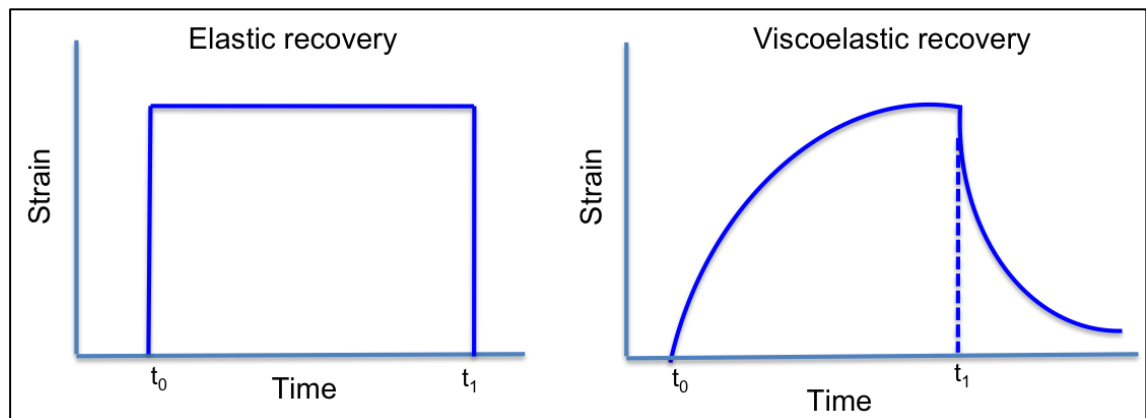

Figure 3-1: Schematic diagram representing the elastic and viscoelastic recovery. Adapted from Van Noort, (2007).

Many viscoelastic materials used in dentistry show an instantaneous increase in strain followed by a gradual increase in strain when subjected to a load. On removal of the load an instantaneous recovery occurs followed by gradual recovery. Some permanent distortion remains and this deformation is dependent on the applied load and time of application and strain rate. If the material is strained for only a short time a near elastic response will be obtained. While if it is strained for a longer time it will flow and not all of the strain may be relieved (McCabe and Walls, 2009c).

Elastic recovery and strain in compression are important in determining the clinical accuracy of an impression material in recording the undercut areas.

Practical impression materials require greater than 96.5% recovery when removed from the mouth (Lu *et al.*, 2004).

Polysulphide impression materials are the most flexible, followed by condensation silicone, while the polyether materials have lower elastic recovery than addition silicone impression materials. They demonstrate time independent deformation, with no viscous flow and nearly complete recovery after load removal. However, the different viscosity of the same material differs in stiffness, for example, the putties exhibit higher stiffness than other viscosities of similar material (Van Noort, 2007b, Goldberg, 1974).

As the oral soft tissue has a viscoelastic property, many authors have attempted to measure the elastic modulus of oral soft tissue and compared it with elastomeric impression materials. Inoue, *et al.* (1985) tried to measure the elasticity of edentulous maxillary and mandibular oral mucosa using their own apparatus. They found that the elastic modulus (E) of oral mucosa ranges from 0.66 – 4.36 MPa, which was slightly higher, when compared with polysulfide and condensation reaction silicone impression materials.

#### **3.3.3 Dimensional stability of elastic materials**

The degree to which the dimensions of a material alter after setting is said to be a measure of its dimensional stability. Dimensional stability is a necessary physical property of dental impression materials, it gives dentists information about whether they could delay pouring impressions without loss of accuracy or whether it is better to pour it immediately.

Dimensional changes occurred mainly due to polymerisation reaction which cause a contraction, this contraction will continue to occur in materials long after

the apparent setting due to continued slow setting or release of stresses set up during setting, or may be due to water absorption or loss of constituents from the material (Clancy *et al.*, 1983).

The elastomeric impression materials demonstrate slight setting shrinkage. Polyether and addition-cured silicones have the lowest setting shrinkage, followed by polysulfide. While the condensation-cured silicones have the highest degree of setting contraction.

On storage, the polysulfide continues to contract, especially if they are kept in a low humidity environment (as the by-product of the setting is water). In contrast, polyethers are very stable in a dry environment, but in high humidity they will absorb water and expand.

The condensation-cured silicones show considerable contraction with time (as the by-product of the setting is alcohol).

Addition-cured silicones are extremely stable and show no dimensional changes on storage (Luebke *et al.*, 1979, Van Noort, 2007b).

#### **3.3.4 The wettability of elastic materials**

Studying the wettability properties of impression materials is important, because they give an indication to the accuracy of dental impression materials in making the impressions. While for lining materials and maxillofacial materials, wettability gives an indication of the ease that saliva is likely to spread over their surfaces, thus forming a lubricant layer for patient comfort and it can also give an indication of denture retention (McCabe and Walls, 2009c, Yayi Wei and Brainard, 2009).

There are two basic ways to measure a material's wettability:

- Static method (sessile drop)
- Dynamic methods (Tilting wafer method, Captive drop method and Wilhemy plate method)

#### 3.3.4.1 Static method (sessile drop):

It is an optical method that involves the measurement of contact angles formed by a drop of liquid on the material to be investigated (Figure 2-7). It is generally used to estimate wetting properties of a localized region on a solid surface. The difficulty in determining the exact point of contact between the material surface and the edge of the liquid cause some variations in readings (Rupp *et al.*, 2005).

The procedure requires measuring more than one droplet for statistical purposes, as there is apparently incomparability of results from different laboratories (Muller and Oehr, 2011).

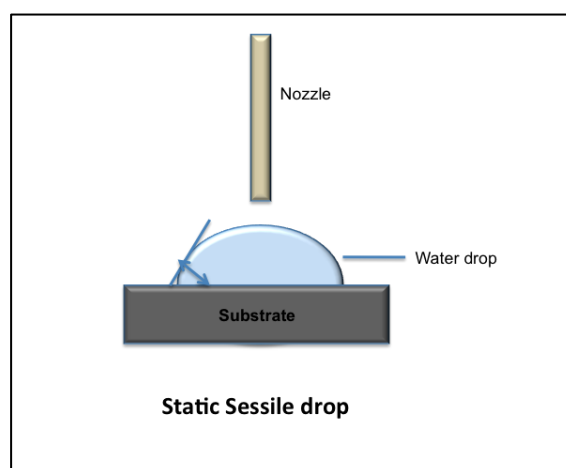

Figure 3-2: Schematic diagram representing the measurement of Static Sessile Drop (Mondon, 2004).

### 3.3.4.2 Dynamic methods

The dynamic methods include:

#### ◆ Tilting wafer method

This is where a drop of water is dispensed over a wafer, then tilted slowly, immediately prior to the sliding of the droplet, the contact angle at the front and rear of the drop are measured. The wafer-tilting angle is called the sliding angle (Figure2-8).

This method is sensitive to the environmental humidity, the volume of droplet, and the tilting speed of the wafer.

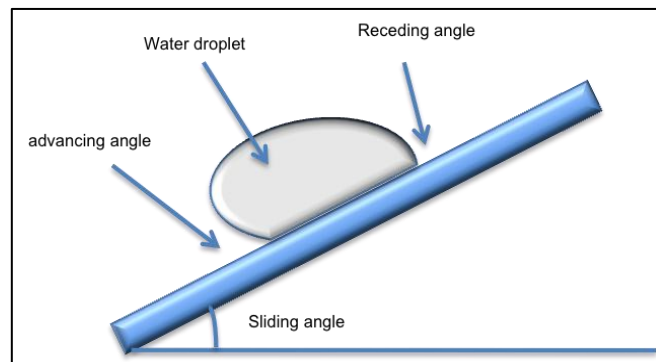

Figure 3-3: Schematic diagram representing the Tilting wafer method for measuring dynamic contact angles (Yayi Wei and Brainard, 2009)

#### ◆ Captive drop method

The advancing and receding contact angles are measured by this method. It is performed by using a small nozzle with a diameter of 0.3 mm held 0.5 mm above the substrate surface. Water is slowly injected onto the substrate, forming a droplet. The surface of the water droplet expands outward and the

advancing contact angle is measured. Then the receding contact angle is measured by pulling the water back into the nozzle as the size of the droplet contracts, the surface of the droplet moves inward and the receding contact angle is measured (Figure 2-9).

It is less sensitive to experiment details than the tilting method (Yayi Wei and Brainard, 2009).

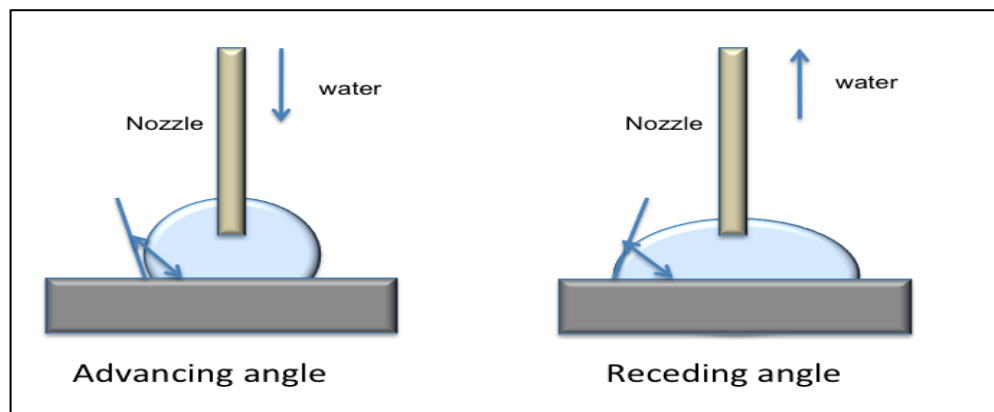

Figure 3-4: Schematic diagram representing the captive drop method for measuring dynamic contact angles (Yayi Wei and Brainard, 2009)

#### ◆ Wilhemy plate method

In this method a substrate is held vertically and immersed in water. The substrate is held stationary to measure the static contact angle. The substrate is pushed into the water to measure the advancing contact angle and when pulled slowly out the water, the receding contact angle is measured (Yayi Wei and Brainard, 2009) (Figure 2-10).

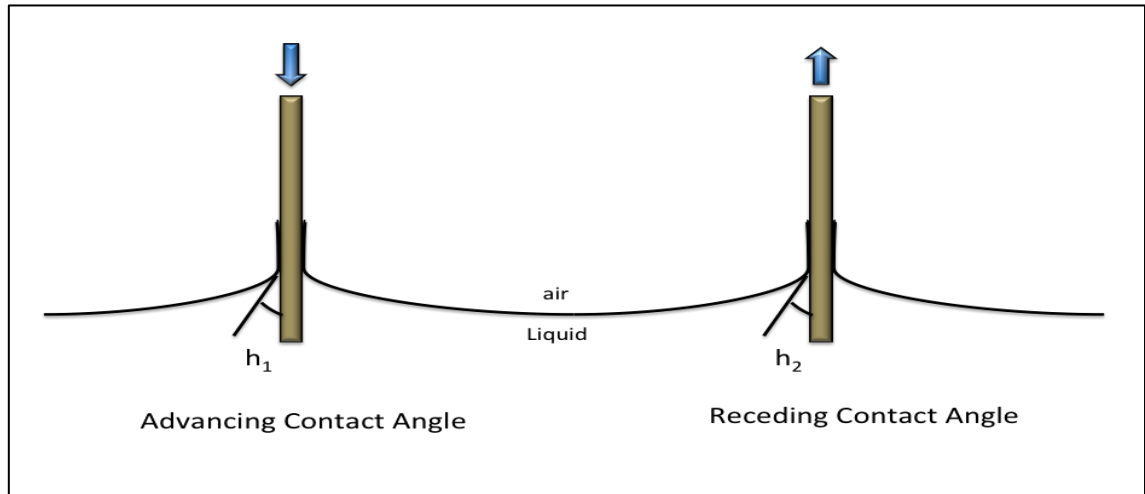

Figure 3-5: Measurement of contact angle by Wilhelmy plate method (Ghosh, 2009).

It is necessary to use at least two or three different liquids to formulate an impression about dispersive and polar contributions to the surface free energy (Waters *et al.*, 1995).

In general the contact angle measurements depend on: The surface tension of the materials involved, homogeneities in chemical composition, structure at the contact line (roughness), purity of the liquid and the electrostatic charge at the surface (Muller and Oehr, 2011).

The main disadvantage of elastomeric impression materials is the lack of wettability, and if the surface of the tooth or soft tissue has become contaminated with saliva, the impression material is unable to wet it and this can give rise to the formation of air bubbles and loss of surface details. A surfactant has been added to some addition cured materials to reduce the hydrophobicity of the surface and so reduce the contact angle to be closer to that of polyether impression materials which are considered the most hydrophilic impression materials (Van Noort, 2007b).



The hydrophobicity of vinyl polysiloxane (VPS) impression materials derives from their chemical structure, as does the hydrophilicity of polyethers. VPS impression materials contain hydrophobic, aliphatic hydrocarbon groups surrounding the siloxane bond. While, Polyethers, in contrast, contain functional groups, such as carbonyl and ether groups, enabling water molecules to interact through hydrogen bonding (Rupp *et al.*, 2005).

#### **3.4 Summary**

The improvement of complete denture retention for highly resorbed ridges is still the aim of many clinical and laboratory studies. Clinically based investigations of mandibular denture retention are largely limited and inconclusive. In order to maximize the data from such clinical trials, it is essential to undertake an effective pre-clinical laboratory characterisation of the appliance or material to be tested.

A laboratory-based model of the human edentulous mandible and associated anatomical structures will enable effective testing of the retention of mandibular complete denture prosthesis prior to clinical trials.

Any new materials that could aid denture retention could be tested and compared effectively using the *in-vitro* model; the percentage of different components of these materials could be compared for better performance. The amount used, concentration and frequency could also be evaluated. The effect of different environmental conditions on the activity of the materials could be investigated. Further concepts to improve the retention of conventional or

implant supported over-denture design could be investigated prior to a clinical trial.

For the *in-vitro* testing of denture retention, to be more reliable, the effect of mucous membrane should be considered. In normal situations when a denture is pressed to place on the mucous membrane, the mucous membrane elastically deforms to the outline of the denture and a thin layer of saliva remains under the denture, in turn the action of physical attraction comes into action to hold the denture in a static condition.

Thus retention is enhanced by the elasticity of the mucous membrane of the basal seat area and by good border seal.

An artificial working model covered by substitute mucosa constructed from appropriate materials with properties that closely match the oral tissues in their physical characterisation such as: thickness, viscoelasticity, wettability, and dimensional stability will match as much as possible the clinical ridge condition, and thus give basic guide lines for complete denture testing procedures. To date, an extra-oral model based on realistic highly resorbed ridge measurements and properties has not been constructed to test the retention of mandibular complete denture.

# 4

---

## **Hypothesis, Aims and Objectives**

## 4. Hypothesis, Aims and Objectives

### The Hypothesis

An *in-vitro* model of a human edentulous mandibular ridge and the reflected tissues provides an effective model to test the retention of mandibular complete dentures in an objective manner.

### The Aims

- 1- To create an *in-vitro* model of an edentulous human, moderately to severe atrophic mandible ridge and the reflected tissues to test the retention of complete dentures.
- 2- To verify the effectiveness of this model by testing a range of complete denture designs with and without retention aids (denture fixatives).

### The Objectives

- Assessment of the problem (Service Evaluation project).
- Creation of soft tissue analogue.
- Creation of a mandibular ridge analogue.
- Verification of the effectiveness of the *in-vitro* edentulous mandibular model.

# 5

---

## **Patient Satisfaction with Complete Dentures – A Clinical Evaluation**

**Presented at**

- **BSODR Annual Conference, Sheffield, 2011:  
Patient satisfaction with complete dentures  
provided by undergraduate dental students  
(Mohramzadeh K. *et al.*, 2011).**

## **5. Patient Satisfaction with Complete Dentures – A Clinical Evaluation**

### **5.1 Introduction**

For assessment of the quality of complete denture treatment, a clinical evaluation of the prostheses should be established. The poor correlation between the perceptions and treatment expectation of the patient with those of the dentist is responsible for many prosthetic failures (Albino *et al.*, 1984). Many assessment methods for measuring and evaluation of patient satisfaction with their complete dentures have been discussed (Sato *et al.*, 1998). These are mainly subjective evaluation for complete denture performance and not reliable for predicting patients' satisfaction of new dentures (Carlsson, 1997).

There is poor correlation between patient satisfaction and clinical variables. 55% of patients were satisfied with dentures clinically considered unfit and needed replacement (Garrett *et al.*, 1996) and vice versa (Berg 1993, Carlsson 1967). Patients showed higher expectations about the outcome of denture therapy including aesthetics and function than the dentist and dental technician perceived (Marachlioglou *et al.*, 2010), mainly because the clinicians do not take into account the need and attitudes of individual patients.

The principle goal in therapies for edentulism is improvement rather than cure, and therefore it is patient-based outcomes that are most important (Silverman, 1993). Many studies related to edentulous subjects strongly support the concept that patient-based measures are more sensitive than functional measures for

detecting differences between treatments (Feine *et al.*, 1994, Awad *et al.*, 2003).

Previous studies found that the proportion of complete denture patients who are dissatisfied with new and well made prostheses range between 10% and 15% (Carlsson *et al.*, 1967, Berg, 1984), while other epidemiological studies reported that patients dissatisfied with their dentures range between 20% and 30% (Berg, 1993).

Many factors could have contributed to this dissatisfaction: quality of dentures, oral condition, patient-dentist relationship, attitude towards dentures, patient's personality and socioeconomic factors, anatomical conditions and denture-wearing experience particularly with mandibular complete dentures. In addition the quality of mandibular residual alveolar ridges and the accuracy of jaw relations, which in turn affect mandibular denture security (Celebić A *et al.*, 2003, Fenlon and Sherriff, 2008).

Dissatisfaction with mandibular dentures has a multifactorial basis. Patients have described instability and discomfort as reasons for dissatisfaction. Stability and comfort are the features that distinguish maxillary denture acceptance from more generalized mandibular denture dissatisfaction (Fenlon *et al.*, 2002).

The extent of effect of each factor on patient satisfaction is a controversy. For instance, patient personality was considered an unimportant factor, but Fenlon *et al.*, (2007) found the neurotic personalities were significantly less satisfied with their complete dentures. Similarly the quality of dentures was considered a weak factor by Narhi *et al.*, (1997), but considered a significant factor by Celebic *et al.*, (2003).

Level of patient expectation has been shown to increase where the provision of complete dentures has been undertaken in a dental hospital setting as opposed to a general practice setting (Smith and McCord, 2004).

It is clear that there is a multitude of interrelated factors, which contribute to patient satisfaction with complete dentures, and there are no established standards or criteria to evaluate this satisfaction.

A clinical evaluation of patients' satisfaction with complete dentures was conducted at the Charles Clifford Dental Hospital (CCDH) to evaluate the quality of the service the hospital provides as a function of patient satisfaction in order to implement improvements in the overall quality of patient care that they provide.

The PhD investigator of this thesis has participated in this clinical evaluation of patients' satisfaction with complete dentures. The rationale for participation in this service evaluation was to find if there is a correlation between patient satisfaction and the loss of denture retention. A further aim was to assess if the loss of retention of the mandibular complete denture is a main reason for dissatisfaction with denture wearing.

This is a trust approved clinical evaluation of service provision undertaken at Charles Clifford Dental Hospital (CCDH) within the STH NHS Trust between February and June 2010 (CEU registration number: 3274).



## 5.2 Methodology

121 complete denture patients treated by undergraduate students were evaluated in this study. The students provided this item of treatment in small, close-support clinical groups under the guidance of a clinical tutor with recognised expertise in the provision of complete dentures. The patients' data included the source of referral, period of tooth loss, period of wearing present dentures, the number of previous complete dentures, and the principle presenting complaint.

The clinical evaluation consisted of three components:

1- Patients' evaluation survey on the satisfaction of their existing (old) and new dentures. The patients were asked to complete a questionnaire at the start and at the end of the treatment to record their views and overall satisfaction regarding their existing (old) and new dentures. The assessment criteria regarding the outcome of the treatment included the fit of the maxillary and mandibular dentures, speech and the appearance of the dentures which are frequently related to patient expectation and overall satisfaction (Sato *et al.*, 2000). In addition to the ability to chew, which was considered a determining factor for acceptance of the complete dentures (de Souza e Silva *et al.*, 2009).

The subjective evaluation of the patients were based on a 4- points scale according to (Idowu *et al.*, 1987), from very satisfied, satisfied to dissatisfied and very dissatisfied. The range of response options for selected denture factors (appearance, comfort, fit, ability to chew and speech and overall satisfaction) was also used by Davis *et al.*, (1986).

This questionnaire sought to identify:

- Patients' opinion about their complete dentures.
- Patient satisfaction with each denture factor (fit, ability to chew, speak and aesthetic consideration), to determine the most variables that positively or negatively affect patient acceptance to the complete denture.

Accordingly this will provide a view of the aspects of good practice, and to identify areas of patient care that require improvement (clinically and laboratory).

**2-** A clinical evaluation of the overall quality of dentures to identify the clinical and technical errors in the old and new complete dentures. With the help of the clinical tutor, assessment of any errors in the polished surfaces, occlusion, appearance, in addition to any anatomical constraints and procedural difficulties, was carried out. At the end of the questionnaire sheets, there was a section filled by the clinical tutor about the type of adjustment needed at the fit and review stage.

**3-** Patient opinion about the care provided at CCDH during the treatment process: professionalism, the schedule of appointments, receiving adequate instruction about the care of mouth and dentures, was also obtained.

The full data collection forms are shown in Appendix (12.1).

### 5.3 Results

121 complete denture patients were evaluated: 52 were males and 69 were females. Patient ages ranged from 37 – 91 years with a mean of 69.4, median 71 and standard deviation of 11.7 years.

10 Patients had been edentulous for less than one year, 26 patients had been edentulous 1-10 years, 30 Patients had been edentulous 20-30 years, and 51 patients had been edentulous for over 30 years. The other 4 patients did not provide any edentulous period data.

Table 5-1 showed the number of sets of previous dentures constructed for the patients. The full set number was considered, for patients who could not give the exact number, and gave a range, the lowest number was considered.

The satisfaction of patients for old and new dentures (Figure 5-1 and Figure 5-2) indicates a very high rate of patient satisfaction with the quality of service provided on the complete denture clinic and shows a great response shift compared to the patients satisfaction with the old dentures (Figure 5-2).

Number of complete	Number of patients
1 set	27
2 sets	23
3 sets	20
4 sets	11
5 sets	7
6 sets	3
7 sets	1
8 sets	1
9 sets	2
10 sets	1
No data	25

Table 5-1: The number of previous complete denture sets among the patients

Years of experience with complete denture	Number of patients
Less than 1 year	10
1 - under 2 years	13
2 - under 5 years	24
5 - under 10 years	9
10 - under 20 years	25
20 - under 40 years	18
40 and more years	9
N/A	13

Table 5-2: The duration of complete denture experience among the patients (N/A: patients without data, who could not remember the age of their dentures or patients who do not wear their dentures after construction)

According to patients' satisfaction regarding the old denture, the principle presenting complaint showed that the most dissatisfaction was regarding the fit of the mandibular dentures (Figure 5-1). 58% of the patients were dissatisfied or very dissatisfied with their old lower dentures due to loose dentures compared to 28% dissatisfaction with the fit of maxillary denture.

For ability to chew, the dissatisfaction was scored at 54% compared to 38% who were satisfied and very satisfied with their chewing performance. Regarding other denture criteria, the scores were assigned to satisfied and very satisfied for speak and appearance (68 and 65% respectively).

The main patients' principal presenting complaints with their old denture was loose denture 49% followed by inability to eat 10% (Figure 5-3).

Table 5-3 and Table 5-4 showed the clinicians evaluation of old and new dentures for specific criteria. The evaluation scores were much better for the new dentures than the old ones.

The highest percentage in the error of old dentures polished surfaces were under extension 17%, neutral zone errors 15% and over extension 13%. Although polished surface errors in new dentures were very low compared to the old ones, over extension was the most detected error 9%, followed by fraenum attachment errors 4% and restricted tongue space 3%.

Vertical dimension was the most detectable occlusal error in the old dentures (26%) compared to only 1% in new dentures, followed by errors in centric relation 9% in old dentures compared to only 3% in the new dentures.

Lip support and horizontal incisal plane were the most errors seen regarding the appearance in old dentures (14% and 10% respectively) compared to only 1% in new dentures.

## 5. Patient satisfaction – A clinical evaluation

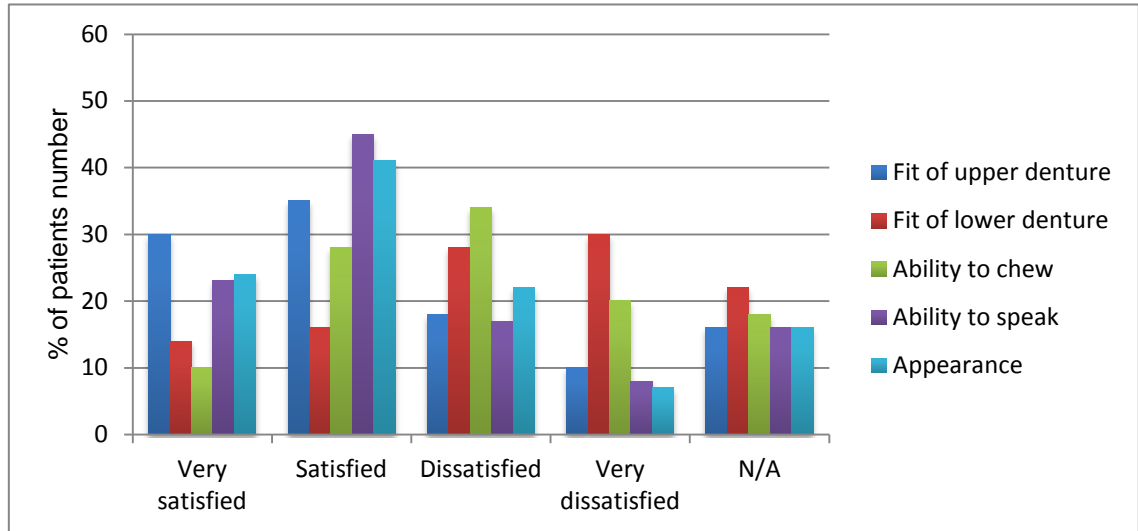

Figure 5-1: Patients' satisfaction with the existing dentures (n=121).

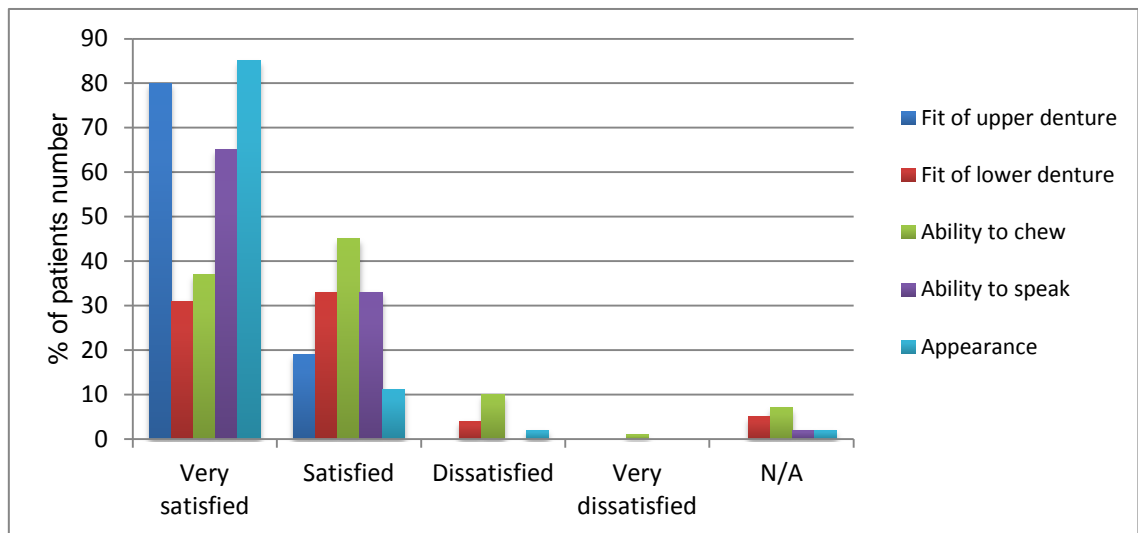

Figure 5-2: Patients' satisfaction with the new dentures (n=110).

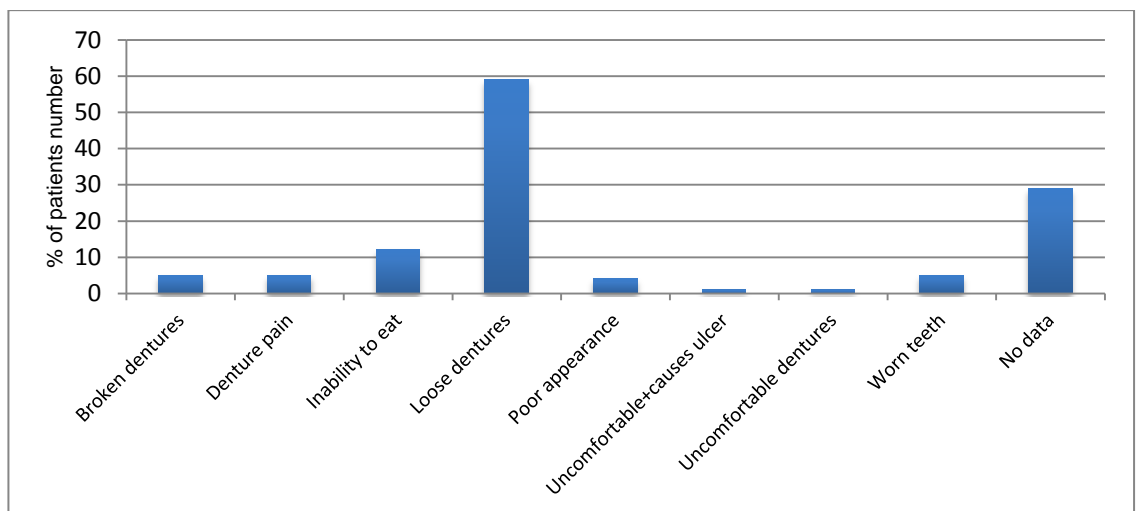

Figure 5-3: Patients' reasons for complaints with the old dentures.

## 5. Patient satisfaction – A clinical evaluation

Errors in polished surfaces		Occlusion errors		Appearance		Anatomical constraints	
Over extension	13%	Vertical dimension	26%	Shad	4%	Intra oral access	1%
Under extension	17%	Even in CR	9%	Mould	5%	Alveolar ridge size & morphology	30%
Fraenae attachments	0	Even articulation	5%	Horizontal incisal plane	10%	Muscle attachments	5%
Neutral zone	15%	Teeth not on the ridge	5%	Lip support	14%	Fibrous flabby ridge	5%
Tongue space	5%			Position of the teeth	7%	Superficial mental nerve	0
						Unusual anatomy	5%
<b>Total</b>	<b>50%</b>		<b>45%</b>		<b>40%</b>		<b>46%</b>

Table 5-3: Clinician evaluation of original dentures.

Errors in polished surfaces		Occlusion errors		Appearance		Anatomical constraints		Procedural difficulties	
Over extension	9%	Vertical dimension	1%	Shad	0	Intra oral access	1%	Gag reflex	2%
Under extension	1%	Even in CR	3%	Mould	1%	Alveolar ridge size & morphology	4%	Habituated mandibular position	1%
Fraenae attachments	4%	Even articulation	0	Horizontal incisal plane	1%	Muscle attachments	0	Difficulty achieving CR	2%
Neutral zone	1%	Teeth not on the ridge	0	Lip support	1%	Fibrous flabby ridge	1%	Dry mouth	1%
Tongue space	3%			Position of the teeth	0	Superficial mental nerve	0		
						Unusual anatomy	2%		
<b>Total</b>	<b>18%</b>		<b>4%</b>		<b>3%</b>		<b>8%</b>		<b>6%</b>

Table 5-4: Clinician evaluation of new dentures

The overall satisfaction of patients about complete denture treatment service at CCDH is demonstrated in Table 5-5.

88% were very satisfied, 10% satisfied, while only 2% were very dissatisfied.

	<b>Yes</b>	<b>No</b>	<b>Not answered</b>	
<b>Meet patient expectation</b>	95%	2%	3%	
<b>Come again</b>	98%	0	2%	
<b>Recommend the service to a friend</b>	97%	0	3%	
<b>Which set of dentures the patient intended to wear</b>	<b>New set</b> 93%	<b>Previous set</b> 2%	5%	
<b>Overall satisfaction</b>	<b>Very satisfied</b> 88%	<b>Satisfied</b> 10%	<b>Dissatisfied</b> 0	<b>Very dissatisfied</b> 2%

Table 5-5: The patients' overall satisfaction with their complete denture service at the CCDH (n=110).

The evaluation of the complete denture construction process as a whole was as follows:

- 99% of patients felt that they had been treated professionally.
- 98% of patients felt that all of their questions were adequately answered.
- 98% of patients felt they had received adequate information on how to care for their dentures
- 94% of patients felt they had received adequate information on how to care for their mouth.
- 95% of patients felt that overall quality of care provided met their expectations



## 5.4 Discussion

In this survey, although the patients had attended the clinic for replacement of their old denture, it is anticipated that there would be significant dissatisfaction with these dentures. Parameters related to maxillary complete dentures (fit of the maxillary denture, ability to speak and appearance) were rated in the best categories (very satisfied and satisfied), while the highest dissatisfaction was with the retention of mandibular dentures and chewing ability, this relationship between denture dissatisfaction and mandibular denture was also confirmed by Berg, (1984).

There was prominent dissatisfaction regarding mandibular denture retention, 58% of patients were dissatisfied or very dissatisfied, compared to 30% satisfied or very satisfied and this agreed with findings published by Fenlon *et al.*, (2002). The dissatisfaction with the ability to chew (which mainly related to the retention and stability of dentures) was 59% dissatisfied or very dissatisfied, compared to 38% satisfied or very satisfied.

The most prevalent problem regarding the old dentures was the retention of the mandibular denture, which showed the highest dissatisfaction, accordingly the patient acceptance of their complete denture could be adversely affected. The problem of retention was the main complaint of 49% of patients and this agreed with a previous study which mentioned that 35% of their patients group seeking new dentures was because of loose present dentures (Davis *et al.*, 1986). Special attention should be paid to minimise the effect of this problem in the construction of complete dentures.

The satisfaction results concerning the new dentures should be considered with caution, since they reflect the patients' immediate response with the new dentures, because the service forms were completed on the final review appointment prior to discharge.

A high rate of overall satisfaction was noted, the majority of the patients rated the newly inserted denture for all denture variables (fit of maxillary denture, ability to speak and the appearance) in satisfaction categories (Figure 5-2) confirming the finding of Berg, (1988) found that the patients' satisfaction with their new dentures were significantly superior to the old ones. This could be due to the short time given to evaluate denture satisfaction (1-2 weeks after insertion), and also some patients might have found it difficult to express their dissatisfaction directly to the person who made the denture (Berg, 1988).

All the patients in this sample had previous denture experience. They can quickly adapt to the new one and develop the neuromuscular control required to stabilize the new denture and they are more realistic regarding aesthetics (Weinstein *et al.*, 1988).

Among the most prominent errors in old dentures, which were detected by clinicians, under extension in the polished surface agreed with Brunello and Mandikos, (1998), While the vertical dimension was the prominent error followed by uneven centric relation unlike the finding of Brunello and Mandikos, (1998).

Under extension in the old dentures was much more prominent than in the new dentures, this could be due to excessive border adjustment of the old denture by the dentist without diagnosis of the real problem.

The survey does not have data on patients' long-term satisfaction with their new dentures; this will be the focus of a follow-up study.

## **5.5 Conclusions**

- The chief complaint for complete denture patients was the looseness of mandibular denture and chewing ability.
- Patients were more satisfied with the fit of their maxillary dentures than the mandibular.
- This study indicates a very high rate of patient satisfaction with the quality of service provided by the complete denture clinic and shows a great response shift compared to the patients satisfaction with the old dentures.

# 6

---

## Identification of a Synthetic Soft Tissue Analogue Material

**Presented at:**

- **BSODR Annual Conference, Glasgow, 2009: Evaluation of synthetic tissue analogue in a laboratory edentulous mandible (AL-KAISY N. *et al.*, 2009).**
- **IADR/AADR/CADR General Session, Barcelona, 2010: Evaluation of Synthetic Materials for An *in-vitro* Mandibular Edentulous Model (AL-KAISY N. *et al.*, 2010).**

## 6. Identification of a Synthetic Soft Tissue Analogue Material

### 6.1 Introduction

To develop a mandibular model based on real patient's parameters that closely match the ridge and reflected tissues, the mucosa and reflected tissue analogues should have physical properties that match those of the real tissues as closely as possible.

The resiliency and viscoelasticity of edentulous ridges oral mucosa exerts the greatest influence on denture sustaining conditions (Chowdhry *et al.*, 2010). Under load, the oral mucosa will undergo viscoelastic deformation, as result potential space beneath the denture permit a uniform thin layer of saliva, thus adhesion / physical attraction will take place to retain the denture.

Many researchers have sought an appropriate oral mucosa substitute using a resilient material on their laboratory oral model for various testing procedures. They concentrated on replacing the oral mucosa with an average thickness of resilient material without further investigation to match the materials' characteristics with those of the oral mucosa. In some studies, 2 mm thickness silicone light body impression material (Reprosil) was used to simulate the resiliency of the oral mucosa on a laboratory model to test the retention of implant over-dentures (Fanuscu and Caputo, 2004, Kenney and Richards, 1998). Taguchi *et al.*, (2001) covered their dental stone model with a 2 mm thickness of polysulfide rubber impression material (Surflex) to study the effect of viscoelastic properties of resilient

denture liners. While Rutkunas and Mizutani, (2004) and Rutkunas *et al.*, (2007) covered the mandibular cast with a 3 mm thickness of white silicone material (Fit checker) to simulate the resilient mucous membrane to test the retentive force of over-dentures.

A wide variety of elastomeric materials should be investigated to find the most suitable materials, which approximate the characteristics of oral mucosa. It is appropriate to start the investigation of general behaviour of these materials as a representative of oral mucosa in order to exclude the inappropriate ones from further investigation.

Another important feature, which needs further investigation, is the resiliency and viscoelasticity of materials that could match those of oral mucosa. Also because these are synthetic materials, which could deteriorate with time, it is essential to analyse their dimensional stability with time.

In addition, the wettability of tested materials should be investigated. Efficient wettability will give an indication of the ease with which saliva will spread over their surfaces, and thus affect the retention of the denture overlying these materials.

In order to find the most appropriate soft tissue analogue from the range of selected elastomeric materials, four tests were rated as being important, these were:

- Retention Test.
- Elastic Recovery Test.
- Wettability Test.
- Dimensional Stability Test.

## 6.2 The retention test

This test investigates the dislodgement forces between the denture and the tissue covering the mandibular ridge when subjected to pulling force in an axial direction apposite to the direction of denture insertion when the denture is held in a static condition. It could be evaluated in the laboratory by applying a tensile dislodging force to separate two contacting surfaces, and hence the physical factors of retention could be investigated (Craig *et al.*, 1960).

In the same manner many previous *in-vitro* studies were conducted to test the retention of denture adhesives between two acrylic discs (Floystrand *et al.*, 1991, Zhao *et al.*, 2004), glass and resin specimens (Panagiotouni *et al.*, 1995), or skin of a rat and acrylic discs (Chew, 1990).

A tensile tester was used to investigate the *in-vitro* retention force of complete palate and palate-less coverage dentures seated on a polyurethane model using artificial saliva, by applying a load vertically and in a 45° directions to the occlusal plane (Teraoka *et al.*, 2004).

Before designing a retention test of mandibular complete denture on the *in-vitro* model, it was essential to design a preliminary simple test to check the retention phenomenon of different elastic materials that could replace oral mucosa on the extra-oral model with an acrylic disc which represents the complete denture on the model with the use of artificial saliva.



The laboratory experiment that was conducted in this retention test was designed to determine:

- The optimum tensile speed to give the best retention results.
- The optimum amount of artificial saliva and its action to represent all physical properties of retention.
- The durability of the tested material to act as artificial mucosa.
- The tear resistance to withstand the repeatability of retentive testing.
- The adherence of these materials to the testing base model through out the retention test.

### 6.2.1 Materials and methods

A specially designed test jig (50 mm diameter, 20 mm depth) was designed and constructed.

A cold cure acrylic disc (50 mm diameter, 10 mm depth) was constructed to fit into its base, which represented the cast in the extra oral model, covered by a layer of elastomeric material with 1.5 mm thickness which represent the average thickness of mucosa in a highly resorbed ridge (Uchida *et al.*, 1989) (Figure 6-1).

The uniform thickness of the selected artificial silicone materials was accomplished by using a die and counter die stone moulds constructed for this purpose (Figure 6-2).

An alginate impression was taken of the testing jig with its artificial mucosa material (Figure 6-3). The impression was then poured to obtain a stone counter die model.

## 6. Identification of a synthetic soft tissue analogue material

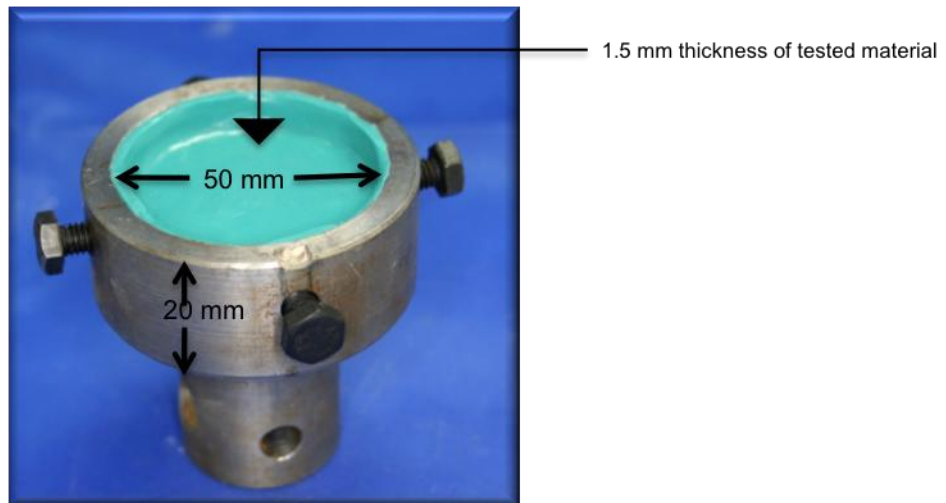

Figure 6-1: A test jig with 1.5 mm thickness of tested elastomeric material.

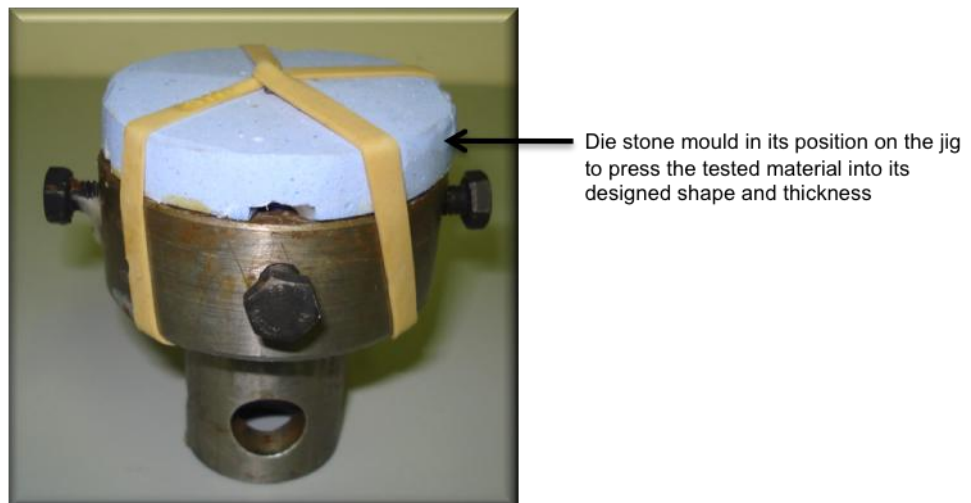

Figure 6-2: The testing jig with its die stone mould.

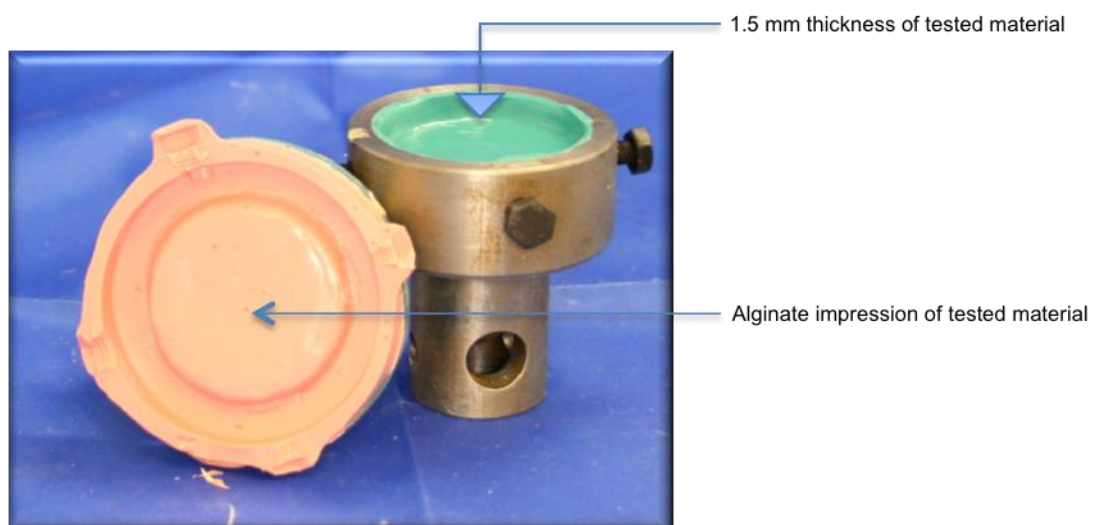

Figure 6-3: An alginate impression taken to the testing jig with its tested material.

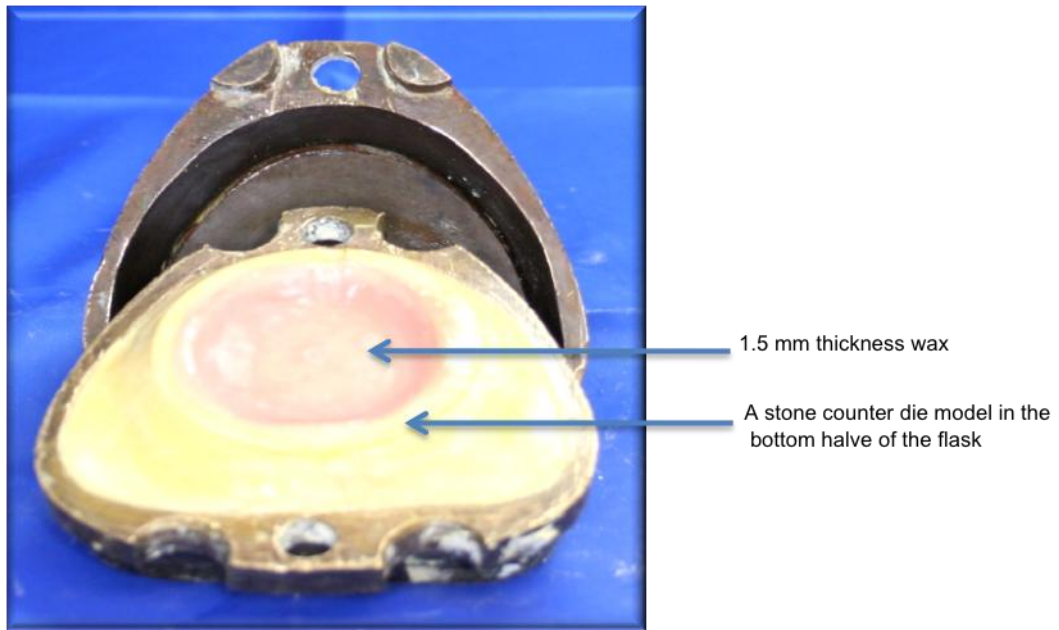

Figure 6-4: Waxing the cast with 1.5 mm thickness wax sheet and prepared for flasking.

On this stone cast, a clear heat cure acrylic resin disc was constructed to be 1.5 mm thickness and 50 mm diameter, which took the role of a mandibular complete denture (Figure 6-4). A clear heat cure acrylic disc (Fast cure denture base: Type 1 class 1, WHW Plastic. Therm Rd, Hull, UK) was processed in a water bath using the same curing cycle, which was used to construct the project complete dentures (5 hours at 70°C and 2 hours at 95°C).

The clear acrylic disc permitted view of the distribution of the saliva layer beneath the acrylic disc and enabled observation what was happening during the testing procedure.

The clear acrylic disc fitted precisely to cover the synthetic mucosa layer of the model. A hook was fixed to the centre of the external surface. The disc was seated in the mould and linked to a tensile testing machine (LLOYD Instruments – LRX. UK) via a chain (Figure 6-5). The jig was then subjected to tensile forces at different

## 6. Identification of a synthetic soft tissue analogue material

tensile speeds with the use of artificial saliva (As saliva Orthana. As pharma, Hampshire, UK). The composition of artificial saliva used is shown in Table 6-1.

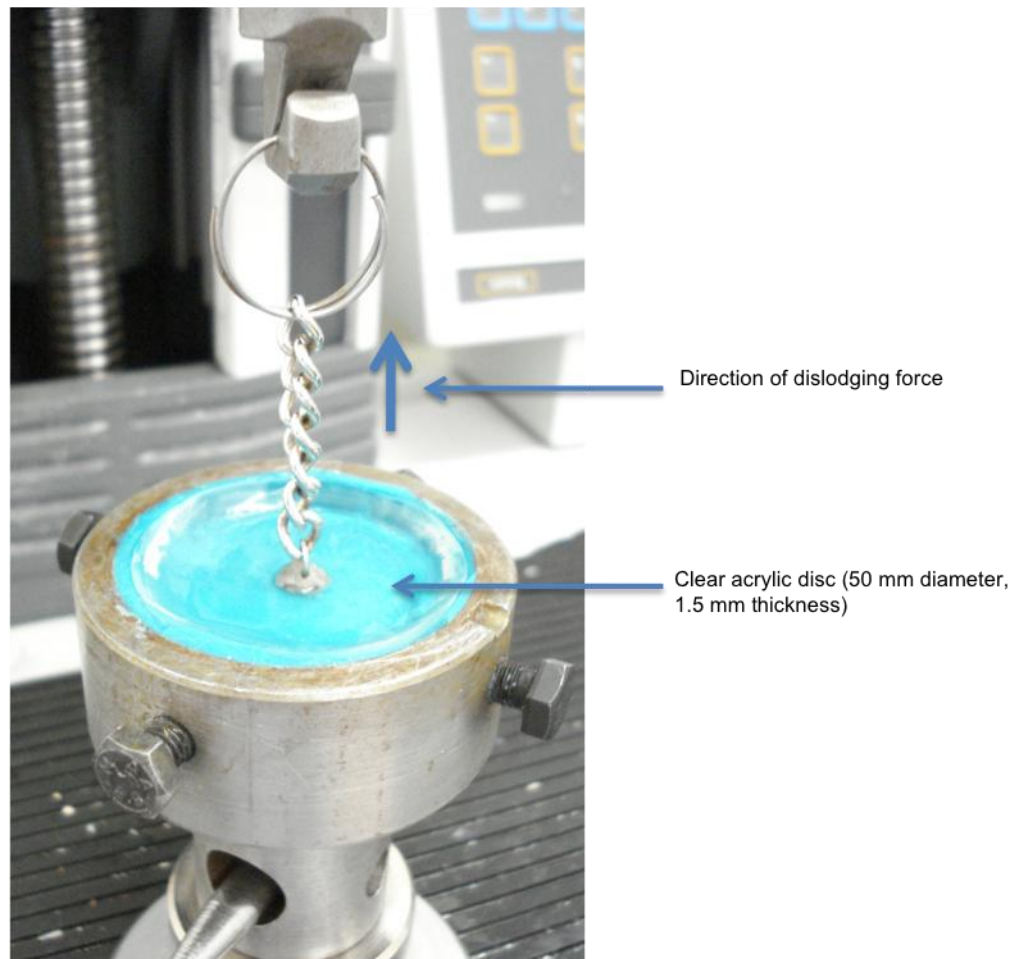

Figure 6-5: Testing the resistance to vertical displacement of an acrylic resin disc resting on a synthetic soft tissue analogue.

Composition	Each 50 ml contain
Mucin Gastric	1.75g
Xylitol	1.0g
Menthae Piperitae aetheroleum	2.5mg
Spearmint Oil Methylis	2.5mg
Parahydroxybenzoas	50mg
Benzalkoni Chloridum	1mg
E.D.T.A.-Disodium	25mg
Sodium Fluoride	0.21mg
PH	Neutral

Table 6-1: The composition of the artificial saliva used.

Twelve elastomeric materials were tested (Table 6-2). Most of the materials tested were in a single layer system, except for numbers 11 and 12, where the materials were constructed as a multilayer system (in two layers in case of material no.11 and in three layers in case of material no.12). The materials were mixed according to manufacturers directions, using a gun delivery system. The materials Xantopren® light body and Permlastic® light body were mixed by hand as these materials were supplied as base and accelerator pastes; the alginate powder was mixed with water using a rubber bowl and the Impregum™ medium body was mixed using the Pentamix automatic mixing unit.

Table 6-2 also includes special-effects make-up materials [ProGel outer skin (S 518e), ProGel neutral skin (S 518a)], which are used in the film and theatre industry and are not used in dentistry; also they have not previously been reported in the literature for this application.

Each type of material was mixed according to the manufacturer's direction and was inserted on the acrylic base of the inner surface of the jig. The die stone mould pressed the material into its designed shape and thickness, and was left in its position until the material had fully set.

The tested material on the jig was left undisturbed for 24 hours to permit full elastic recovery of the material to take place, with the exception of alginate where the retention experiments were conducted immediately after the materials had been set because the alginate would have lost all its properties after a short period of time.

## 6. Identification of a synthetic soft tissue analogue material

Sample number	Trade name	Manufacturer	Type
1	Provil® novo light body	Heraeus Kulzer GmbH, Hanau, Germany	Addition-cured silicone impression material.
2	Aquasil™ ultra light body	Dentsply, Milford, USA	
3	Extrude Extra® heavy body	Kerr, Romulus, USA	
4	Xantopren® L blue light body	Heraeus Kulzer GmbH, Hanau, Germany	Condensation-cured silicone impression material.
5	Permlastic® light body	Kerr, Salerno, Italy	Polysulfide impression material.
6	Impregum™ medium body	3M ESPE, Seefeld, Germany	Polyether impression material.
7	Codent® Alginate	Codent, Headley Down, Bordon, UK	Irreversible hydrocolloid impression material.
8	(M517) Coform soft	Principality, Newport, UK	Maxillofacial soft impression material.
9	ProGel outer skin (S 518e)	Principality, Newport, UK	Chair-side makeup artists' material.
10	Elite® soft lining	Zermack, Rovigo, Italy	Soft addition silicone lining material.
11	Multilayer: ProGel neutral skin(S 518Aa)+ ProGel outer skin(S 518e)	Principality, Newport, UK	Chair-side makeup artists materials
12	Multilayer: ProGel neutral skin(S 518Aa)+Elite soft lining+ ProGel outer skin(S 518e)	As mentioned above for each material.	As mentioned above for each material.

Table 6-2: Soft tissue analogue materials tested.

The jig with its covering tested material and acrylic disc was connected to the tensile testing machine and adjusted to measure the tensile load (pull to break) in gram force (gf)  $\approx 1/102$  N (it was rapidly determined that only small amounts of force were needed to produce dislodgement and it was decided to calculate the dislodgement forces in grams/force (gf) instead of Newton's).

Two variables needed to be determined prior to undertaking this test: The crosshead speed to break the seal and the volume of saliva to be used.

### **Determination of the effect of the tensile speed:**

The retentive loads were 1<sup>st</sup> measured at 5 mm/min tensile speed. As the tested acrylic disc is small in size and weight, the expected amount of force needed to break the seal would be small, and thus the retentive force was measured at a very slow crosshead speed of 5 mm/min. The speed was then increased to investigate if there was a positive effect on the resultant retentive force.

Teraoka *et al.*, (2004) measured the retentive force of complete palate and palateless dentures *in-vitro* at 1, 2, 5 and 10 mm/min, accordingly and because the measurement at 1 to 5 mm/min was hardly detectable, it was decided to start the experiment at 5 mm/min then continue to more than 50 mm/min to match Chung *et al.*, (2004), Rutkunas and Mizutani, (2004) and Rutkunas *et al.*, (2007) who all measured the retentive forces of denture's attachments at 50 mm/min. This cross head speed has been reported to approximate to clinically relevant movements of the denture away from edentulous ridge (Sarnat, 1983).

### **Determination of the effect of the amount of the artificial saliva:**

The use of 0.5 ml of artificial saliva gave enough spread to cover the whole surface between the tested mucosa material and the acrylic disc, with an excess of saliva appearing to rest on the outer surface of the acrylic disc. The use of 0.3 ml saliva was enough to spread on the whole surface between the tested material and acrylic disc without any excess of saliva coming out to rest on the outer surface of the acrylic disc. The decision was made to conduct the experiment at these two levels and determine the effect of the amount of saliva on the retention force.

### **Experiment**

The clear heat cured acrylic disc was inserted in its precise position on the tested material on the jig and connected to the tensile machine arm by a chain, in order to ensure a uni-directional pull with no torque forces (Figure 6-5).

The retention test for each material was divided into two parts: the 1<sup>st</sup> part was conducted with 0.3 ml of artificial saliva and the 2<sup>nd</sup> was with 0.5 ml of artificial saliva. The experiments were conducted three times for each tested material for ten pulls each time (n=30).

When using 0.3 ml artificial saliva between the acrylic disc and the tested mucosa material, the tensile force was measured at 5 mm/min speed, this measurement was repeated 10 times. Then the tensile force was measured at 10, 15, 20, 25, 30, 35, 40, 45, 50, 55, 60 mm/min. Fresh saliva was used with each test. The 2<sup>nd</sup> part of the experiment was identically conducted in exactly the same manner with the use of 0.5 ml of artificial saliva.

The two parts of the experiment (with 0.3 and 0.5 ml of saliva) were conducted using the same tested impression material sample, except for alginate where each



part was conducted on a new set of alginate material. This experiment was repeated three times at different days, and the means of 30 pulls for both 0.3 and 0.5 ml of saliva were calculated and analysed.

### 6.2.2 Results of the retention test

The retention forces needed to separate the acrylic disc from the underlying synthetic mucosa increased steadily with the increase of tensile speed (Figure 6-6 to Figure 6-17).

The maximum retention force was with alginate with 0.3 ml of saliva (from 105 gf at 5 mm/min speed, 123 gf at 10 mm/min speed, 129 gf at 15 mm/min speed, 174 gf at 20 mm/min speed, 194 gf at 25 mm/min speed, 182 gf at 30 mm/min speed, 174 gf at 35 mm/min speed, 226 gf at 40 mm/min speed, 241 gf at 45 mm/min speed, 266 gf at 50 mm/min speed, 279 gf at 55 mm/min speed to 272 gf at 60 mm/min speed) (Table 6-3). While with the use of 0.5 ml of saliva, Pro+Pro (multilayer system: basement layer: ProGel neutral skin and the superficial layer: ProGel outer skin) showed the highest values (from 87 gf at 5 mm/min speed – 213 gf at 55 mm/min speed), except at speed 20 mm/min where Aquasil™ putty showed the highest value (119 gf) and at speed 30 and 60 mm/min where Coform get the highest retention force (159 gf, 195 gf respectively) (Figures 6-9, 6-11 and 6-17).

In contrast, the minimum retention force was seen with Extrude Extra® heavy body at almost all tensile speeds with both 0.3 and 0.5 ml of saliva (its minimum retention force was 34 gf at 5 mm/min speed with 0.3 ml of saliva and the maximum retention force was 116 gf at 45 and 55 mm/min speed with 0.5 ml of saliva) (Table 6-3).

More constant results with high retention force were observed with Provil® Novo light body, Aquasil™ putty, Xantoprin® light body , Permlastic® light body , Pro+Pro

and Pro+Pro+Elite at speed 30-60 mm/min. While Coform showed fluctuating results (Figure 6-11 to Figure 6-17).

As regards to the amount of saliva used, there were no statistical differences between the retention force with 0.3 or 0.5 ml of saliva at each tensile speed for the majority of the tested materials. The only exception was with alginate which showed statistically greater retention force with the use of 0.3 ml of saliva at all speeds, unlike Impregum™ medium body where no significant differences between the use of 0.3 and 0.5 ml of saliva was observed at all speed (Table 6-3).

Other statistical differences present were more with 0.3 ml than with 0.5 ml of saliva. However, Coform showed statistically greater retention with 0.5 ml of saliva at speeds of 30, 45, 50 and 60 mm/min.

## 6. Identification of a synthetic soft tissue analogue material

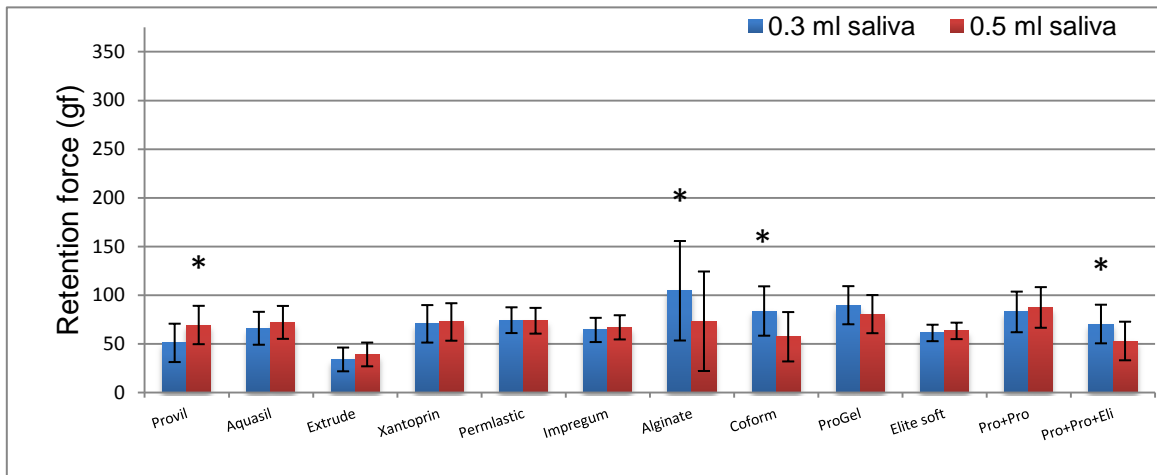

Figure 6-6: The retention force required to separate the acrylic disc from different underlying synthetic mucosa at 5 mm/min tensile speed with the use of 0.3 and 0.5 ml of saliva. \* Represents a statistical difference between 0.3 and 0.5 ml of saliva.

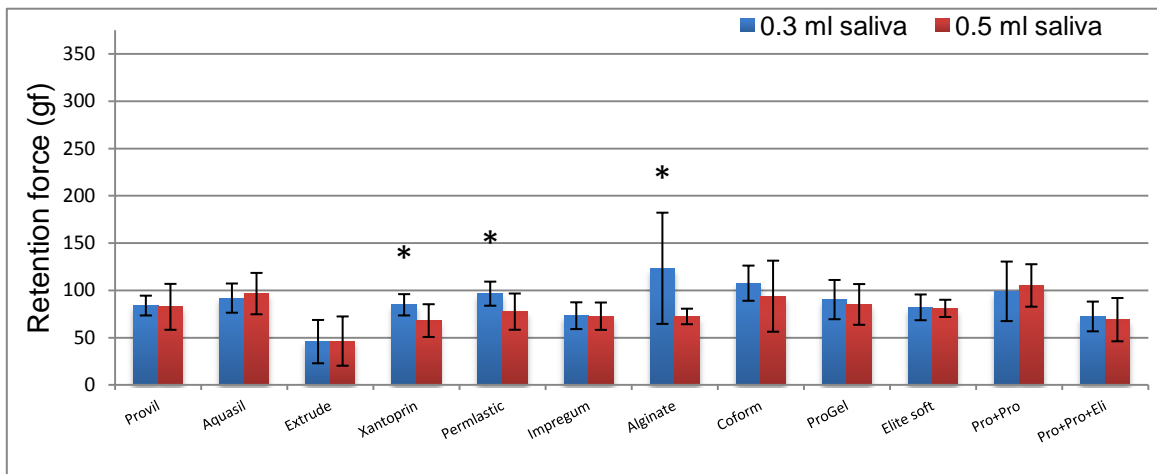

Figure 6-7: The retention force required to separate the acrylic disc from different underlying synthetic mucosa at 10 mm/min tensile speed with the use of 0.3 and 0.5 ml of saliva. \* Represents a statistical difference between 0.3 and 0.5 ml of saliva.

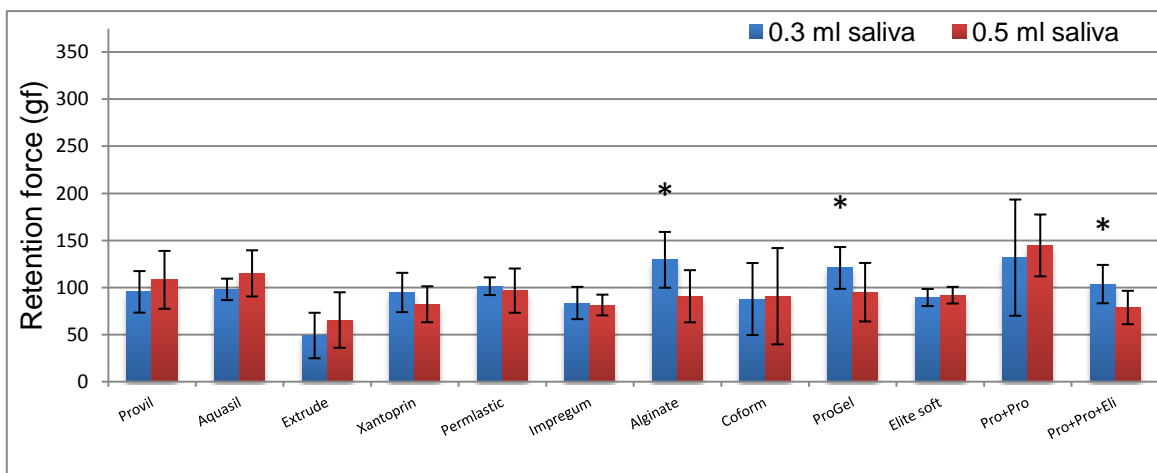

Figure 6-8: The retention force required to separate the acrylic disc from different underlying synthetic mucosa at 15 mm/min tensile speed with the use of 0.3 and 0.5 ml saliva. \* Represents a statistical difference between 0.3 and 0.5 ml of saliva.

## 6. Identification of a synthetic soft tissue analogue material

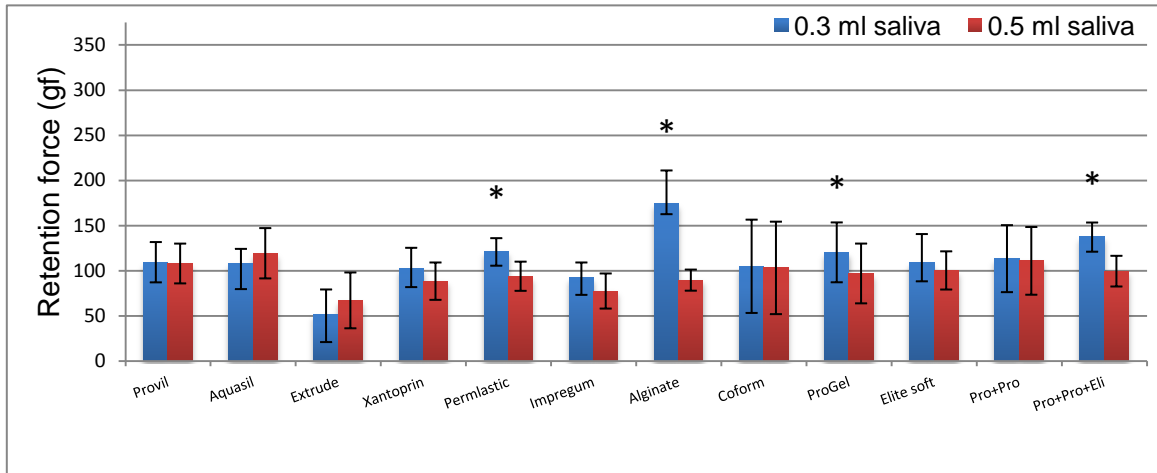

Figure 6-9: The retention force required to separate the acrylic disc from different underlying synthetic mucosa at 20 mm/min tensile speed with the use of 0.3 and 0.5 ml of saliva. Represents a statistical difference between 0.3 and 0.5 ml of saliva.

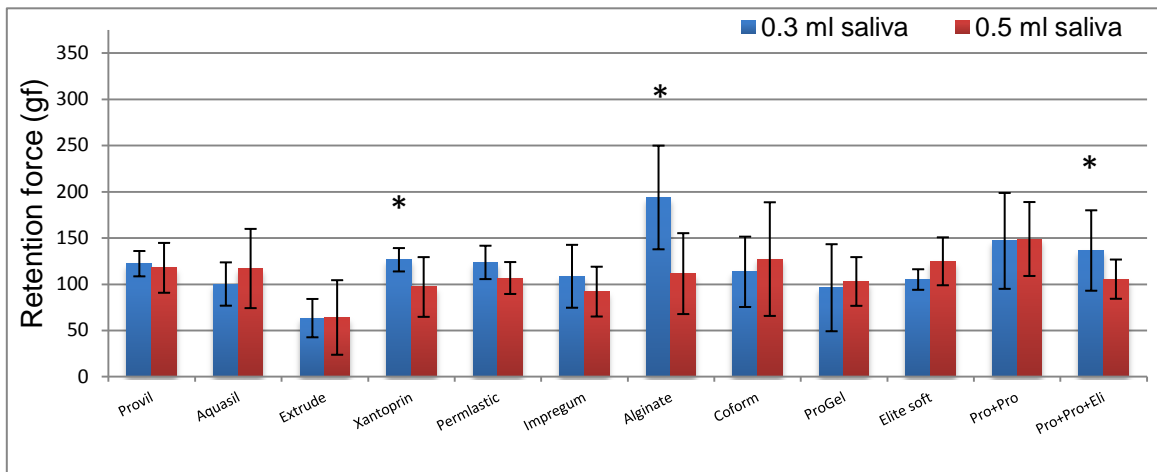

Figure 6-10: The retention force required to separate the acrylic disc from different underlying synthetic mucosa at 25 mm/min tensile speed with the use of 0.3 and 0.5 ml of saliva. \* Represents a statistical difference between 0.3 and 0.5 ml of saliva.

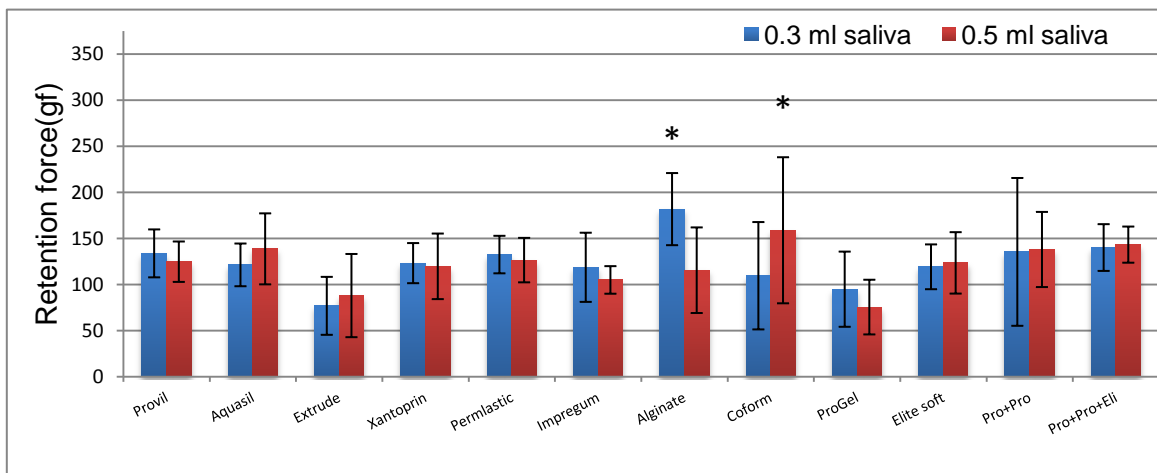

Figure 6-11: The retention force required to separate the acrylic disc from different underlying synthetic mucosa at 30 mm/min tensile speed with the use of 0.3 and 0.5 ml of saliva. \* Represents a statistical difference between 0.3 and 0.5 ml of saliva.

## 6. Identification of a synthetic soft tissue analogue material

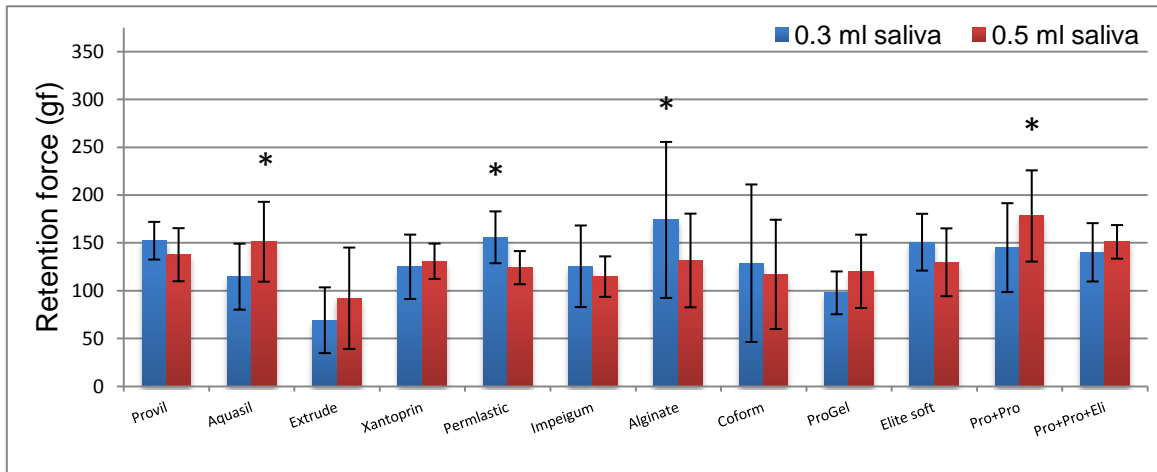

Figure 6-12: The retention force required to separate the acrylic disc from different underlying synthetic mucosa at 35 mm/min tensile speed with the use of 0.3 and 0.5 ml of saliva. \* Represents a statistical difference between 0.3 and 0.5 ml of saliva.

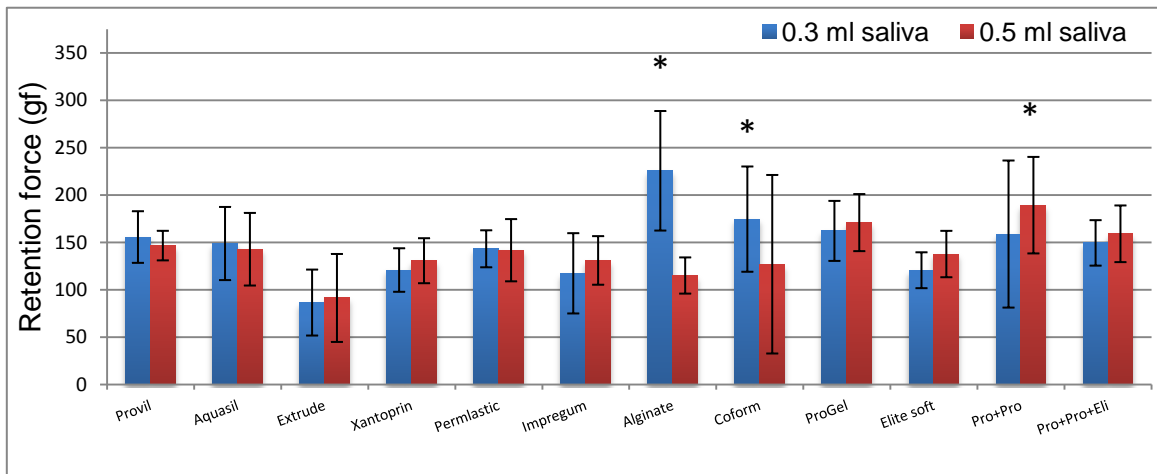

Figure 6-13: The retention force required to separate the acrylic disc from different underlying synthetic mucosa at 40 mm/min tensile speed with the use of 0.3 and 0.5 ml of saliva. \* Represents a statistical difference between 0.3 and 0.5 ml of saliva.

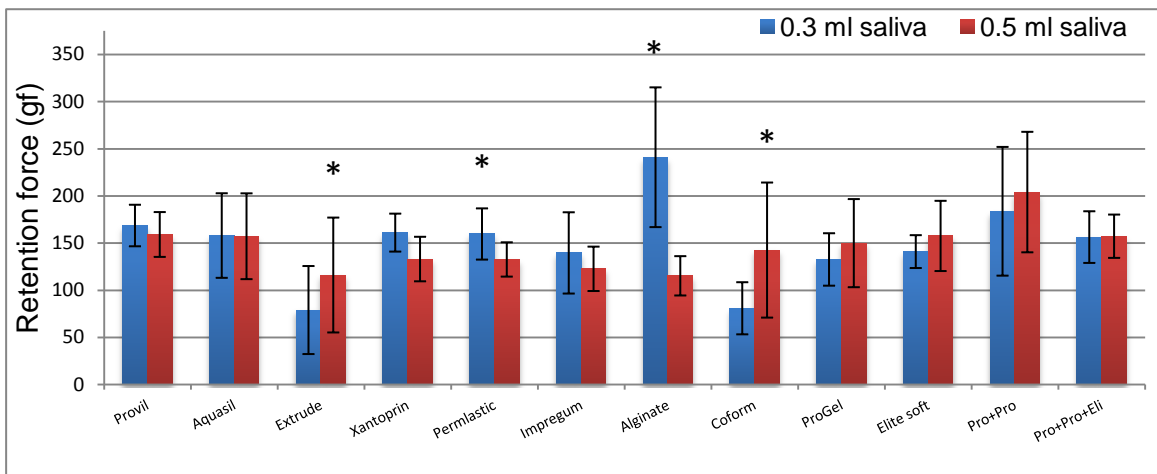

Figure 6-14: The retention force required to separate the acrylic disc from different underlying synthetic mucosa at 45 mm/min tensile speed with the use of 0.3 and 0.5 ml of saliva. \* Represents a statistical difference between 0.3 and 0.5 ml of saliva.

## 6. Identification of a synthetic soft tissue analogue material

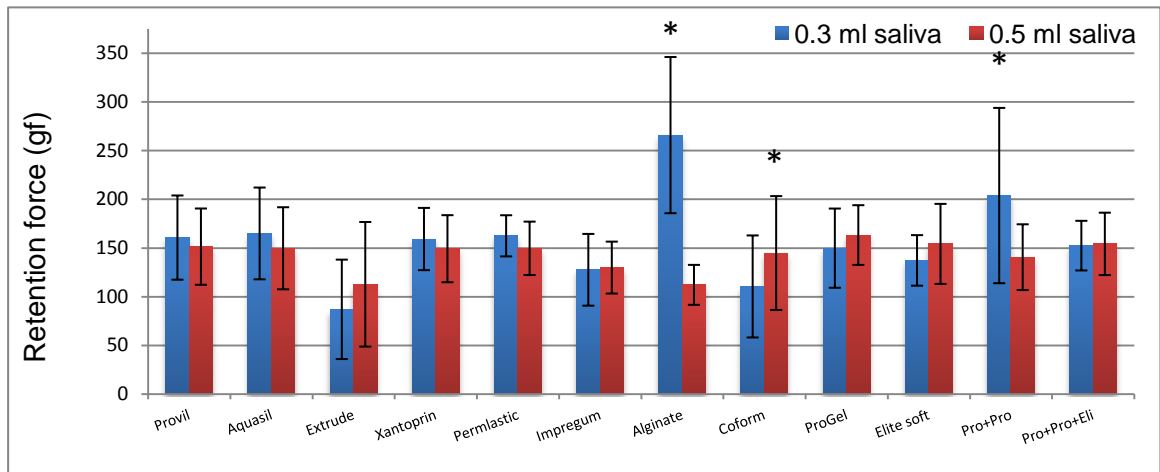

Figure 6-15: The retention force required to separate the acrylic disc from different underlying synthetic mucosa at 50 mm/min tensile speed with the use of 0.3 and 0.5 ml of saliva. \* Represents a statistical difference between 0.3 and 0.5 ml of saliva.

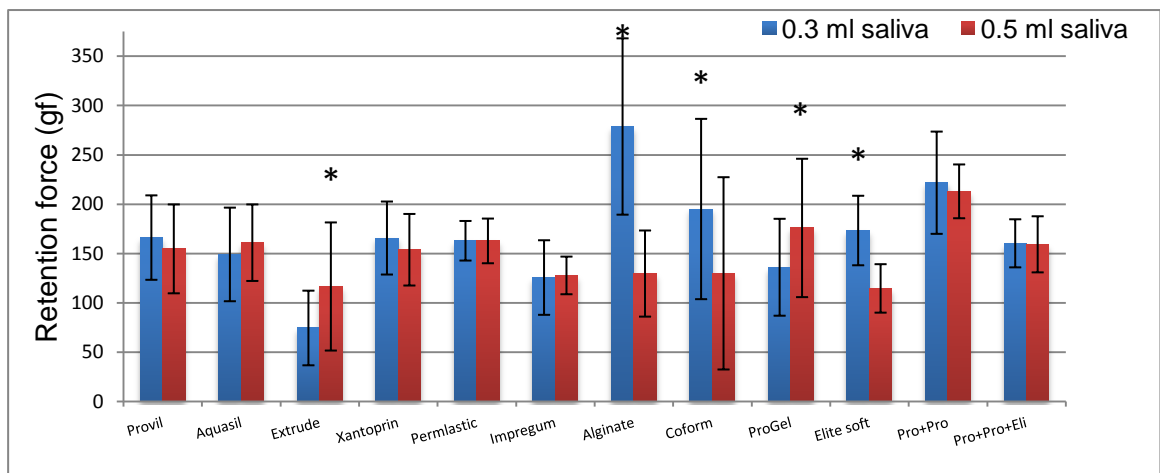

Figure 6-16: The retention force required to separate the acrylic disc from different underlying synthetic mucosa at 55 mm/min tensile speed with the use of 0.3 and 0.5 ml of saliva. \* Represents a statistical difference between 0.3 and 0.5 ml of saliva.

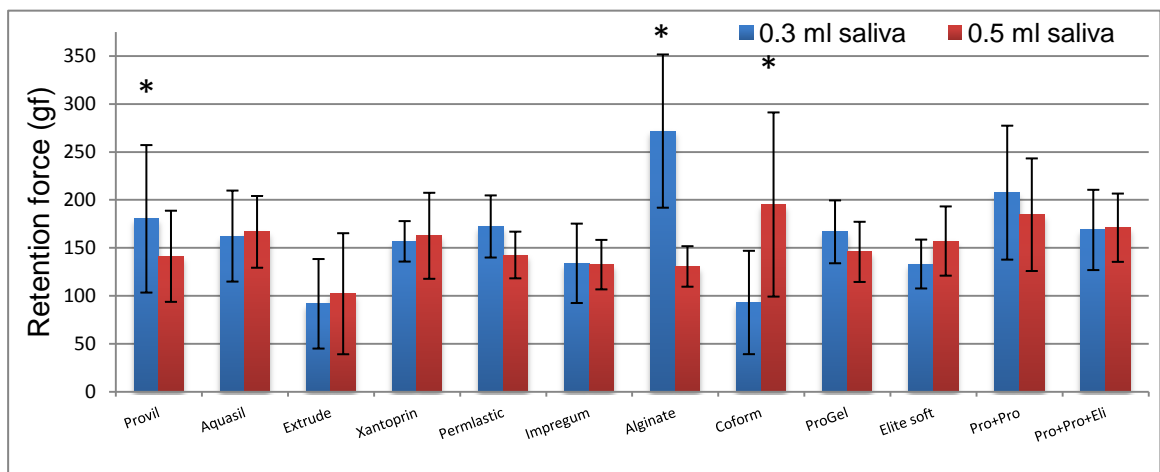

Figure 6-17: The retention force required to separate the acrylic disc from different underlying synthetic mucosa at 60 mm/min tensile speed with the use of 0.3 and 0.5 ml of saliva. \* Represents a statistical difference between 0.3 and 0.5 ml of saliva.

## 6. Identification of a synthetic soft tissue analogue material

Table		Tensile Speed mm/min											
		5	10	15	20	25	30	35	40	45	50	55	60
Provil	0.3 ml saliva	51 ±20	84 ±10	95 ±22	109 ±23	122 ±14	134 ±26	152 ±20	156 ±27	168 ±22	161 ±43	166 ±43	*180 ±80
	0.5 ml saliva	69 ±19	83 ±24	108 ±31	108 ±22	118 ±27	125 ±22	138 ±28	147 ±16	158 ±23	151 ±39	155 ±45	141 ±47
Aquasil	0.3 ml saliva	66 ±17	92 ±15	98 ±11	108 ±17	100 ±23	121 ±23	115 ±35	149 ±39	158 ±45	165 ±47	149 ±47	162 ±47
	0.5 ml saliva	72 ±17	97 ±22	115 ±25	119 ±28	117 ±43	139 ±39	*151 ±42	143 ±38	157 ±45	150 ±42	161 ±39	167 ±37
Extrude	0.3 ml saliva	34 ±12	46 ±23	49 ±24	52 ±27	63 ±21	77 ±31	69 ±34	87 ±35	79 ±47	86 ±51	75 ±38	92 ±47
	0.5 ml saliva	39 ±12	46 ±26	65 ±29	67 ±31	64 ±40	88 ±45	92 ±53	91 ±46	*116 ±61	113 ±64	*116 ±65	102 ±63
Xantoprin	0.3 ml saliva	71 ±19	*88 ±11	95 ±21	103 ±23	*126 ±13	123 ±22	125 ±34	121 ±23	161 ±20	159 ±32	166 ±37	157 ±21
	0.5 ml saliva	73 ±19	68 ±17	82 ±19	88 ±21	97 ±32	120 ±36	131 ±18	131 ±24	133 ±24	149 ±34	154 ±36	163 ±45
Permlastic	0.3 ml saliva	74 ±13	*96 ±13	101 ±9	*122 ±14	123 ±18	133 ±20	*156 ±27	143 ±20	*159 ±27	162 ±21	163 ±20	172 ±32
	0.5 ml saliva	74 ±13	78 ±19	97 ±24	94 ±16	107 ±17	127 ±24	124 ±17	142 ±33	132 ±18	150 ±27	163 ±23	142 ±24
Impregum	0.3 ml saliva	64 ±12	73 ±14	83 ±17	93 ±16	108 ±34	119 ±38	126 ±43	117 ±42	139 ±43	128 ±37	126 ±38	134 ±41
	0.5 ml saliva	67 ±12	73 ±14	81 ±11	78 ±19	92 ±27	105 ±15	115 ±21	113 ±26	123 ±24	130 ±27	128 ±19	133 ±26
Alginate	0.3 ml saliva	*105 ±51	*123 ±59	*129 ±30	*174 ±37	*194 ±56	*182 ±39	*174 ±82	*226 ±63	*241 ±74	*266 ±80	*279 ±89	*272 ±80
	0.5 ml saliva	73 ±51	72 ±8	91 ±28	90 ±12	111 ±44	116 ±46	132 ±49	115 ±19	115 ±21	112 ±21	130 ±44	131 ±21
Coform	0.3 ml saliva	*84 ±25	108 ±19	88 ±38	104 ±52	113 ±38	110 ±58	129 ±82	*175 ±56	81 ±28	110 ±52	*195 ±91	93 ±53
	0.5 ml saliva	57 ±25	94 ±38	91 ±51	103 ±51	127 ±61	*159 ±79	117 ±57	127 ±94	*142 ±72	*145 ±58	130 ±97	*195 ±96
ProGel	0.3 ml saliva	90 ±20	90 ±21	*121 ±22	*120 ±33	96 ±47	95 ±41	98 ±22	162 ±32	132 ±28	150 ±41	136 ±49	167 ±33
	0.5 ml saliva	81 ±20	85 ±22	95 ±31	97 ±33	103 ±26	76 ±30	120 ±38	171 ±30	150 ±47	163 ±31	*176 ±70	146 ±31
Elite soft	0.3 ml saliva	61 ±8	82 ±14	89 ±9	109 ±31	105 ±11	119 ±24	151 ±30	121 ±19	141 ±17	137 ±26	*173 ±35	133 ±25
	0.5 ml saliva	63 ±8	81 ±9	92 ±9	100 ±21	125 ±26	124 ±33	130 ±35	138 ±24	157 ±37	154 ±41	115 ±25	157 ±36
Pro+Pro	0.3 ml saliva	83 ±21	99 ±31	132 ±62	114 ±37	147 ±52	135 ±80	145 ±46	159 ±78	184 ±68	*203 ±90	222 ±52	208 ±70
	0.5 ml saliva	87 ±21	105 ±22	145 ±33	111 ±37	149 ±40	138 ±41	*178 ±48	*189 ±51	204 ±64	141 ±34	213 ±27	185 ±59
Pro+Pro+Ei	0.3 ml saliva	*70 ±20	72 ±16	*104 ±20	*138 ±15	*136 ±43	140 ±25	140 ±31	150 ±24	156 ±27	152 ±25	160 ±24	169 ±42
	0.5 ml saliva	53 ±20	69 ±23	79 ±18	100 ±17	105 ±21	143 ±20	151 ±18	159 ±30	157 ±23	154 ±32	159 ±28	171 ±36

Table 6-3: The mean and standard deviation (SD) of the retention force of tested materials at different tensile speed.

\* Significant difference between 0.3 and 0.5 ml of saliva at same speed.

The retention forces for the tested materials increased steadily with increasing tensile speed. However, there were exceptions and in some cases a clear reduction was observed from the preceding speed as in the case of Coform where the retention forces decreased from 175 gf at speed 40 mm/min to 81 gf at a speed of 45 mm/min and from 195 gf at speed 55 mm/min to 93 gf at a speed of 60 mm/min (Table 6-3).

The statistical differences in retention force of the tested materials with 0.3 and 0.5 ml of saliva at the minimum speed (5 mm/min) and the maximum speed (60 mm/min) were demonstrated in Figure 6-18 and Figure 6-19. By comparing the two graphs, a prominent increase in the retention force with an increase of tensile speed was observed. At 5 mm/min speed with 0.3 ml of saliva alginate showed the significantly highest retention force ( $P<0.05$ ), followed equally by ProGel (outer skin), Coform and Pro+Pro. While with 0.5 ml of saliva, Pro+Pro and ProGel (outer skin) obtained the significantly highest retention force ( $P<0.05$ ). In contrast, Extrude Extra® heavy body showed the significantly lowest retention force with both 0.3 and 0.5 ml of saliva ( $P<0.05$ ).

At 60 mm/min speed with 0.3 ml of saliva, Codent® alginate had significantly higher retention force than the others, followed by Pro+Pro and Provil® light body, while Extrude Extra® heavy body and Coform showed the significantly lowest retention force ( $P<0.05$ ). With 0.5 ml of saliva the highest force shared between Coform, Pro+Pro, Pro+Pro+Eli and Aquasil™ putty. In contrast, the lowest values were in addition to Extrude Extra® heavy body, the Impregum™ medium body and alginate, which showed no statistical differences ( $P>0.05$ ).



## 6. Identification of a synthetic soft tissue analogue material

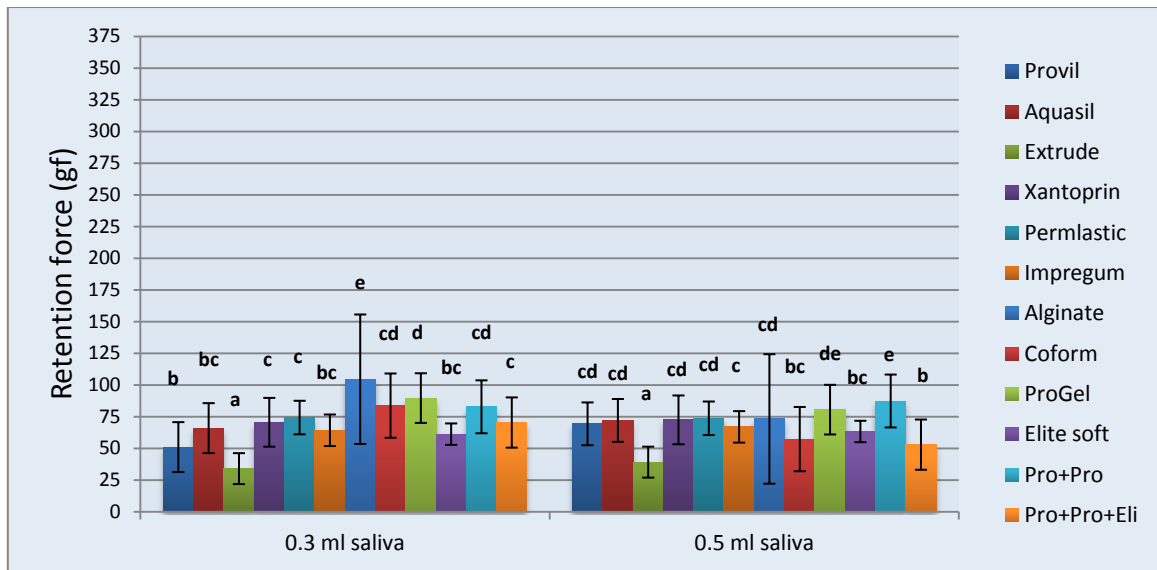

Figure 6-18: The retention force of acrylic disc with synthetic mucosa with 0.3 and 0.5 ml of saliva at 5 mm/min speed. The letters represent a statistical analysis, same letters indicate statistically no different.

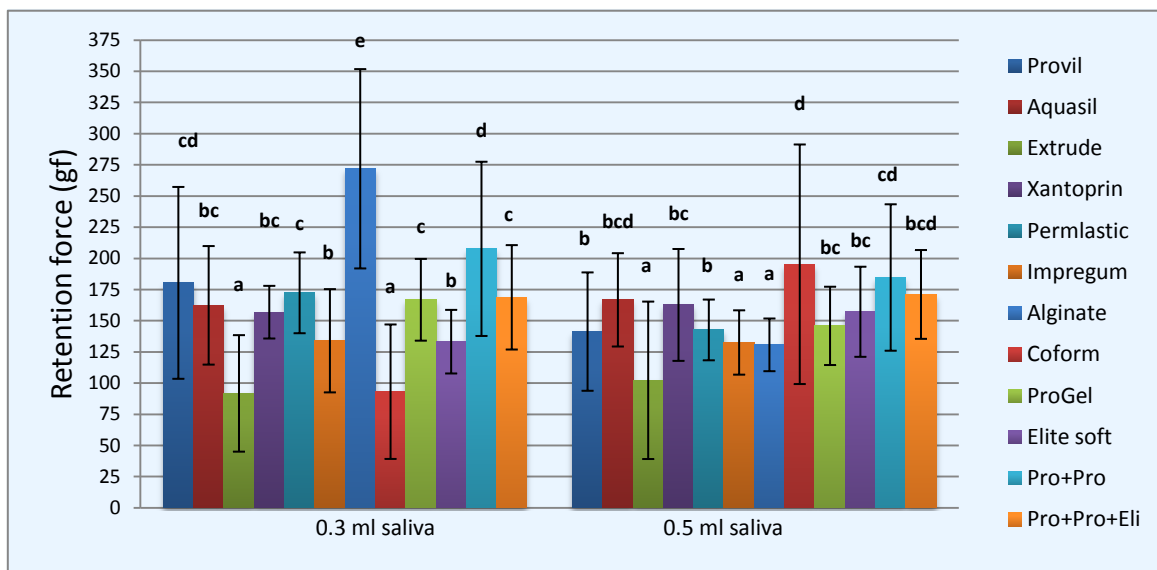

Figure 6-19: The retention force of acrylic disc with synthetic mucosa with 0.3 and 0.5 ml of saliva at 60 mm/min speed. The letters represent a statistical analysis, same letters indicate statistically no different.

### 6.2.3 Discussion

The retention experiments depended on the physical principle of retention, which states that a retention force is developed between two contacting surfaces in the presence of liquid when subjected to a load trying to separate them (Craig *et al.*, 1960).

The amount of saliva, cross head speed and the type of elastomeric material were the variables of this retention experiment.

#### 6.2.3.1 The effect of cross head speed

The increase in retention force with the increase of tensile speed could be explained theoretically, according to Stefan's law that described the viscous tension. It states that the magnitude of the separating force of two parallel circular plates of radius (r) that are separated by liquid of viscosity ( $\eta$ ) and thickness (h) is positively proportional with velocity (V) of the applied force (F):

$$F = \left( \frac{3}{2} \pi \eta r^4 \right) / h^3 \cdot V \quad (\text{Shay, 1997}).$$

Practically, in denture retention, a sudden pulling effect led to an increase in the volume between the denture base and the tissue, a lower pressure will be maintained in the presence of peripheral seal resisting this pulling force. When the pulling force exceeded this resistance, a displacement took place and a gap will be opened along the border seal, consequently reducing the resistance to vertical movement and subsequently lifting of the denture (Lindstrom *et al.*, 1979).

Many previous reports in the literature performed their retention tests at a crosshead speed of 50 mm/min (Rutkunas and Mizutani, 2004, Chung *et al.*, 2004, Rutkunas *et al.*, 2007). This crosshead speed has been reported by Sarnat, (1983)

to approximate clinically relevant movement of the denture away from the edentulous ridge.

In the retention test, the highest retention values were seen at speeds from 50 - 60 mm/min for all tested materials (Table 6-3). As the test model (acrylic disc) was a small size (50 mm diameter, 1.5 mm thickness), speeds over 50 mm/min appeared to be too high to observe the separation of denture from the oral mucosa.

### **6.2.3.2 The effect of the amount of saliva**

With 0.3 ml of saliva, alginate showed the highest retention values for all tensile speeds, while a reduction in retention force was observed when an increased amount of saliva (0.5 ml) was used. This agreed with Blahova and Neuman, (1971) who stated that when saliva accumulated around the denture, the physical retention factor (capillary attraction) reduces and little resistance is needed to pull them apart. Since the acrylic disc with 0.5 ml of saliva was wetted more than in 0.3 ml, other principles of retention like surface tension, viscosity and film thickness may not play a role in disc retention with alginate. In addition, the imbibition ability of alginate with the use of saliva could affect their properties.

The other tested materials showed no statistically significant retention differences between 0.3 or 0.5 ml of saliva, mainly because of the low wettability of these materials, which interfere with the formation of a uniform thin continuous layer of saliva that can act to aid the discs retention in both 0.3 and 0.5 ml of saliva.

This variability in statistical differences between different materials at different speeds, reflect the lack of correlation between cross head speed and the amount of saliva used.

### **6.2.3.3 The effect of the type and viscosity of tested materials**

In spite of alginate having obtained the highest retention force, it was the only material excluded at this stage as a substitute to the oral mucosa from further tests because of its low tear resistance, and weak adherence to the underlying disc. In addition, alginate impression materials are subjected to drying after a short period of setting thus makes it difficult to use in other related tests.

However, Extrude Extra® heavy, showed the lowest retention force at all tensile speeds. These negative results may be attributed to its high hydrophobicity and rigidity (McCabe and Wilson, 1978). It was the only heavy body used in this study and its stiffness makes the adaptation of the acrylic disc difficult compared to the other silicone materials. Despite its negative results, it was not excluded at this stage as further investigations may reflect other positive characters.

There were no obvious differences according to the types of the material (addition cured silicone, condensation cured silicone, polysulfide, polyether, soft lining, maxillofacial and special effect materials) in the retention results. No single type of materials showed superiority over the others in getting high retention results.

There is no published data regarding Coform (M517) for this application. In its retention test results, a fluctuation in retention force values appeared throughout the successive cross head speeds. The chemical property of the material as they become less viscous when subjected to an applied stress may play a role in these results.

The viscosity of the tested materials (light body, heavy body and putty) showed an effect. The heavy body material (Extrude Extra®) showed the lowest retention forces compared to the light body and medium body materials.

The medium body (Impregum™) showed average retention results and was statistically less retention than some light body materials (Provil® novo and Permlastic®) with 0.3 ml of saliva, and other light body materials (Auasil™ ultra and Xantopren®) with 0.5 ml of saliva at a speed 60 mm/min ( $P < 0.05$ ). The average retention results could be due to the absorption ability of the material to saliva, which could affect the material's properties (Eames *et al.*, 1979, Wassell *et al.*, 2002b). While the hydrophilicity of Impregum™ showed no positive effect on the material in this test. In addition, their low tear strength had no negative effect throughout the experiment.

Further use of different viscosity materials may be needed to investigate this outcome.

Other types of materials which are considered more resilient than the others: film makeup materials (ProGel neutral skin and ProGel outer skin), ProGel single layer, Permlastic® light body and Elite® soft lining material, did not show a statistical significance. But generally, they gave good results when the tensile speed increased.

### **6.2.3.4 The effect of other characteristics**

The mixing and handling procedures of the majority of tested materials were performed; the use of an auto-mixing gun gave better control especially in constructing the multilayered tested materials.

The tear resistance appeared good for all the tested materials and they could stand the repeated testing without change, except for alginate, which showed slight tears on the borders.

The adherence of alginate to the underlying disc was also poor, and movement of the material occurred after the 2<sup>nd</sup> or 3<sup>rd</sup> trial.

## 6. Identification of a synthetic soft tissue analogue material

The tested materials showed good durability throughout the experimental period. They showed no change in their properties, but in the case of alginate when left on the jig during testing, dryness and crack formation resulted.

The retention test results could not confirm a selection of a suitable substitute to oral mucosa. In order to get better approximation to the characters of oral mucosa, a combination of factors needed to be investigated: wettability, viscoelasticity, durability and stability throughout the test period.

#### 6.2.4 Conclusions

- The retention force of the acrylic disc seated onto the tested materials increased with an increase in pulling force.
- There was no significant difference in the retention force when using 0.3 and 0.5 ml of saliva in the majority of cases. The small difference in the amount of artificial saliva used did not significantly affect the results (but this will not necessarily be the situation when using the complete denture on the extra oral model and thus further investigation is needed when the model used with a fully contoured denture).
- The type of material used has no effect on the retention force (but type of materials viscosity could have an effect on the retention results).
- Thirty five – sixty mm/min tensile speeds were determined to be the optimum range of cross head speeds to determine retention force.
- The least suitable material to represent oral mucosa in the retention test was alginate. In spite of giving the highest retention results with 0.3 ml of saliva, it is not dimensionally stable and would need to be replaced often, in addition it can tear easily, and does not adhere strongly to the acrylic base like the other elastic impression materials tested.
- The retention test alone is not enough to base selection of a suitable soft tissue analogue. Other material property tests could help to determine a suitable material that could mimic oral soft tissue.

### 6.3 The elastic recovery test

The aim of the elastic recovery test was to ascertain whether the viscoelasticity of the mucosa could be emulated using a suitable artificial soft material for the *in-vitro* model. The materials previously described and used in the retention test, were used for this experiment to investigate their elastic recovery following the application of a compressive load.

Kydd and Daly, (1982) described the ideal viscoelastic behaviour of oral mucosa after load application (Figure 6-20). They found that an instantaneous initial elastic compression of the soft tissue occurred immediately after the application of the load reach to 30% - 40% of initial thickness and take about 0.1 second at 10 gm/mm<sup>2</sup> load, followed by slow delay elastic compression goes to about 50% - 60% over the next 10 minutes. Then an instantaneous recovery occurred immediately after load removal, which continued to diminish in rate until the material reached its original thickness. The soft tissue returned to 70% - 90 % of its original thickness 20 minutes after load removal and a complete recovery occurred after about 3 hours.

The same distortion of oral mucosa under physiologic load was demonstrated by Compagnoni *et al.*, (2003) with the aid of *kinesiographic* instrument. They found that under load, oral mucosa distortion has two phases: a fast initial displacement as load is applied and a slower and incomplete recovery when load is removed.

The physical behaviour of oral mucosa was monitored by Hayakawa *et al.*, (1994) using a special design creep measuring apparatus and compared with that of a new developed light cure soft lining material. The results indicated that



the lining material properties might approximate those of mucosa by adjusting the amount of cross-linking agent and inorganic filler.

In the current elastic recovery experiment, only the delayed elastic recovery of tested materials was recorded, neither the amount of instantaneous elastic response nor the instantaneous and delayed elastic compression that takes place within the material during load application were recorded (Figure 6-20). In addition it was difficult to measure the amount of compression for each material when subjected to a compressive load, mainly because the project measuring procedure and device were different than other studies. Previous studies conducted to investigate the viscoelastic behaviour of different elastic materials, either used instruments similar to the one mentioned according to ISO 4823 (Lu *et al.*, 2004), or according to American Dental Association Specification number 19 (Goldberg, 1974) or used their own designed measuring apparatus (Demot *et al.*, 1984, Jorgensen, 1976), while others used an ultrasonic device (Hayakawa *et al.*, 1994, Takeuchi *et al.*, 2009).

This limitation in measuring the complete viscoelastic behaviour of tested materials restrict the data related to the amount of immediate and delayed displaceability and resiliency of tested material, thus limit the comparison with biophysical properties of oral mucosa.

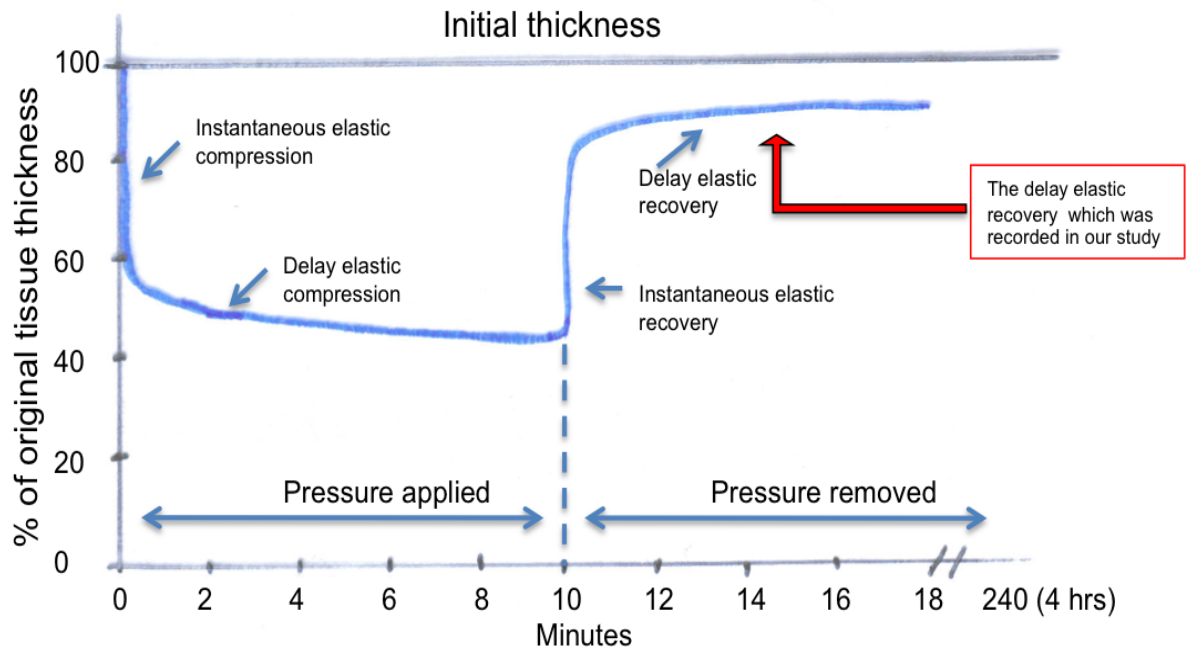

Figure 6-20: Schematic diagram representing the typical behaviour of oral tissue under constant pressure loading. This showed the amount of instantaneous elastic compression of the mucosa immediately after load application, and the delayed elastic compression which takes place up to the end of the loading pressure. The amount of instantaneous elastic recovery after load removal and the delayed elastic recovery over time (which was measured for the tested materials in our experiment) (Kydd and Daly, 1982).

In this test, a load was applied to a sample of constant cross section and then removed after a period of time; the strain was measured as a function of time. This test was selected as a method for this investigation because it enabled a comparison with data already in the literature (Goldberg, 1974, Demot *et al.*, 1984, Jorgensen, 1976).

Many previous studies conducted by Inoue *et al.*, (1985), Hayakawa *et al.*, (1994) and Takeuchi *et al.*, (2009) correlated the mucosal elastic recovery and mucosal thickness with other impression and lining materials using an ultrasound method, the use an ultrasonic device to enable the measurement of both thickness and elasticity of very thin material samples resembling the thickness of oral mucosa was considered. As an alternative, an industrial ultrasonic measurement device had been tried, according to Hosono *et al.*,

(2007) and Takeuchi *et al.*, (2009), but the device didn't prove very predictable nor give reliable measurements as its transducer gave variable results for measuring sample with thickness more than 0.5 mm.

### 6.3.1 Materials and methods

The material specimens were prepared according to BS EN ISO 4823. The materials were mixed according to the manufacture's instructions and formed in a cylindrical metal mould 20 mm high and 12.5 mm in diameter. Glass plates were pressed against the ends of the mould to extrude excess material and ensure flat ends. The materials were left for the recommended time of setting from the start of mixing. The specimens were removed from the mould and left until the next day to start the elastic recovery test to allow sufficient time for the material to recover to its original length after being subjected to pressure through the removal of the specimen from the mould. Six specimens were prepared for each material (Figure 6-21).

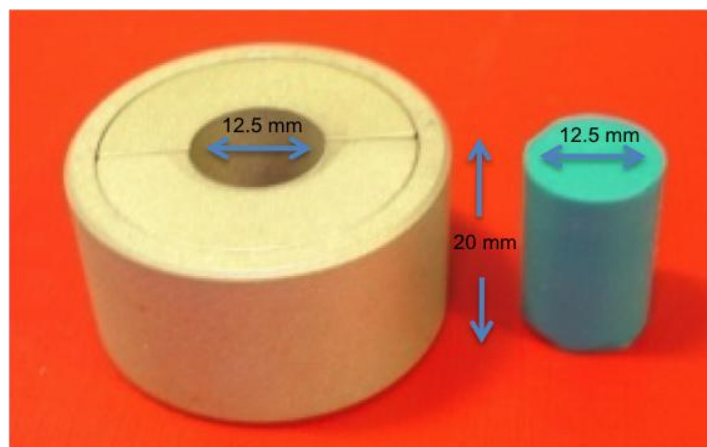

Figure 6-21: A material specimen for the elastic recovery test with the metal mould

## 6. Identification of a synthetic soft tissue analogue material

The original length of the specimen was measured using a travel stage microscope (Mitutoyo TM, Japan). The specimen was then placed in a tensile testing machine and subjected to 480 (gf) load at two different times: the 1<sup>st</sup> three specimens for 30 seconds and the 2<sup>nd</sup> three for 10 minutes (Figure 6-22). The use of 840 gf load was selected in accordance to Shi *et al.*, (1998) who found that the mean value of the maximum pressure born by the mandibular edentulous region was  $0.84 \text{ kg/cm}^2$  (= 840 gf).

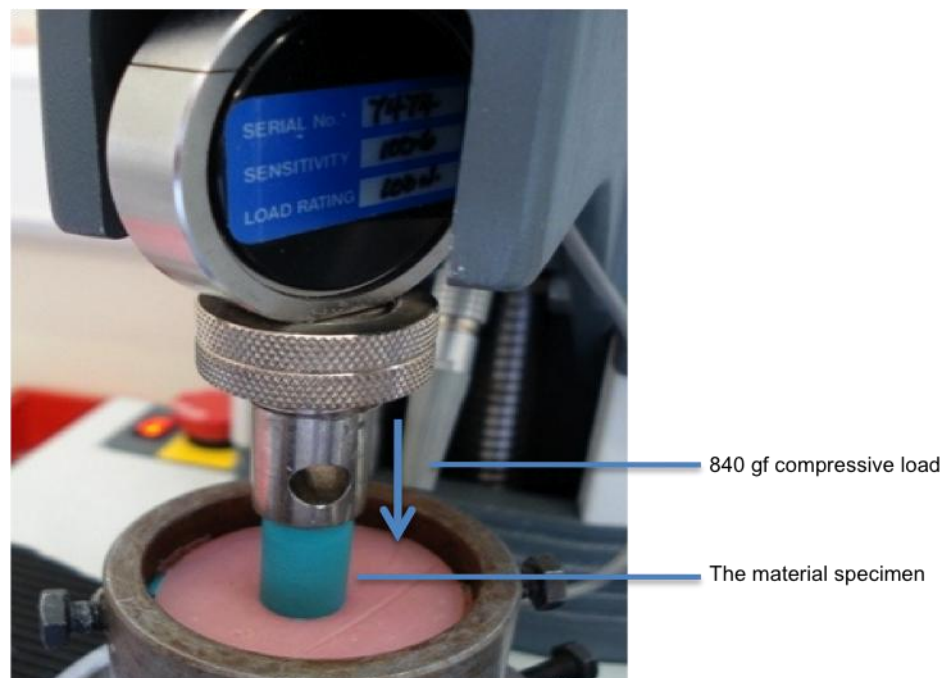

Figure 6-22: The material specimen being subjected to 840 gf of compressive load on a tensile testing machine.

On releasing the load, the specimen was directly transferred to the travelling microscope, positioned on to a specially made base to facilitate the measurement of the specimen length (Figure 6-23).

The time taken to transport the specimen from the tensile machine, after load removal, to the travelling microscopy for measurement took approximately one

## 6. Identification of a synthetic soft tissue analogue material

minute. The first reading was recorded at 1 minute, then a further eleven measurement times were taken for each specimen at 1, 2, 3, 4, 5, 10, 20, 30 minutes, and 1, 3, 4, 24 hours after load removal, three times for each material. During the whole experiment the specimens were stored dry in the same laboratory temperature.

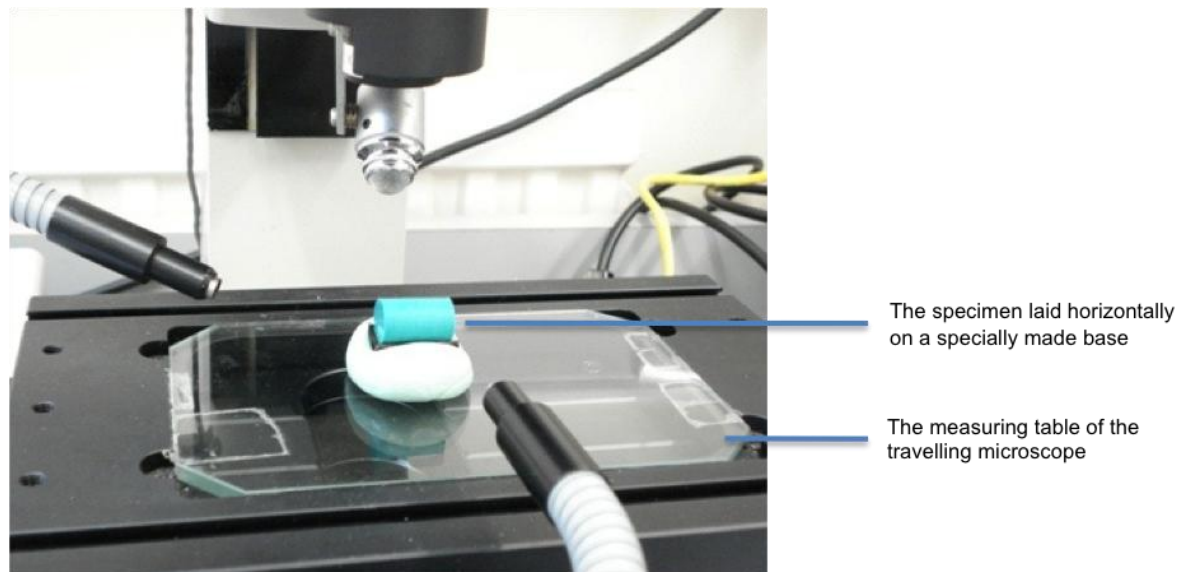

Figure 6-23: Measuring the length of the specimen before and after load application.

The percentage of recovery at each time interval was calculated according to the equation number 1:

$$\% \text{ of elastic recovery} = (\text{new measurement} / \text{original length}) \times 100$$

### **Determination of load time:**

The use of load times of 30 seconds and 10 minutes were selected according to previous studies. The minimum loading time of 30 second was used by Hayakawa *et al.*, (1994) to compare the elastic recovery of soft lining material with that of oral mucosa. While a maximum loading time of 10 minutes was used by other authors (McCarthy and Moser, 1978, Demot *et al.*, 1984,

Rantanen and Lindholm, 1973, Kydd and Daly, 1982); who investigated the elastic recovery of tissue conditioners and elastic impression materials. In addition Kydd and Daly, (1982) used a 10 minutes load time when they investigated the *in-vivo* elastic recovery of oral mucosa. They found that the oral tissue is more responsive to the duration than the magnitude of the load and for this reason two different times (30 seconds and 10 minutes) were used in this test, with one load to investigate the differences in elastic response.

### 6.3.2 Results

Figure 6-24 compares the percentage of elastic recovery (according to the equation number 1) for all the tested materials after 30 seconds and 10 minutes load at time intervals up to 24 hours.

It can be clearly seen that samples under 10 minutes load developed more strain than those under 30 seconds load, and they started their recovery at a lower level than those under 30 seconds of load.

The majority of the materials subjected to 30 seconds load started their recovery between 99.7% - 99.9% of their original length and continued more or less within the same level for all the time periods except the multilayer Pro+Pro+Elite which showed a more continuous recovery until it reached 100% of the original length after 3 hours of load removal (a recovery of 0.3% in three hours). After 3 hours relaxation, the Pro+Pro+Elite showed slight expansion beyond its original length reaching to +0.1%.

Permlastic® light body (polysulfide impression material) started its recovery at a lower percentage (98.3%) and also continued to recover more gradually to 99% three hours after load removal (a recovery of 0.7% in three hours).

Generally, no gradual upward trend was noticed for the majority of tested materials, the range of recovery under 30 seconds load was very small to allow such gradual recovery (in range of 0.3%). In addition, a shrinkage was detected rather than relaxation through the successive time period which was most prominent in case of Xantopren® light body (condensation cured silicone). It shrank from 99.6% after 1 minute of load removal till 98.6% after 24 hours of load removal (1% shrinkage in 24 hours).

The majority of the materials subjected to a 10 minute load, started their recovery at 99.2% – 99.8% of their original length and continued to recover within that range. Among them, Pro+Pro multilayer recovered slowly from about 99% at the 3 minutes after load removal until 99.7% at a 3 hours time period (a recovery of 0.7% in three hours) and Pro+Pro+Elite multilayer recovered by 0.4% in four hours after load removal. While Permlastic® light body and Xantopren® light body (condensation cured silicone) started to recover from 98.2%. Permlastic® continued to recover slowly for the 30 seconds load, while Xantopren® showed slight prolonged shrinkage instead of recovery but it was less prominent than the shrinkage observed after the removal at the 10 minutes load (0.2% shrinkage under 10 min load versus 1% shrinkage under 30 seconds load in 24 hours) (Figure 6-24).

Under 10 minutes load a more gradual upward trend was noticed than for a 30 second load for the majority of tested materials (in range of 0.8% under a 10 minutes load versus 0.3% under a 30 second load).

The slight permanent deformation continued within the material even after 24 hours relaxing time. All the tested materials failed to retain their original length after 24 hours, except the multilayer Pro+Pro+Elite with 30 seconds load, which

## 6. Identification of a synthetic soft tissue analogue material

exceeded the original length by 0.1% after 24 hours and the ProGel material, which returned approximately to its original length after this period.



## 6. Identification of a synthetic soft tissue analogue material

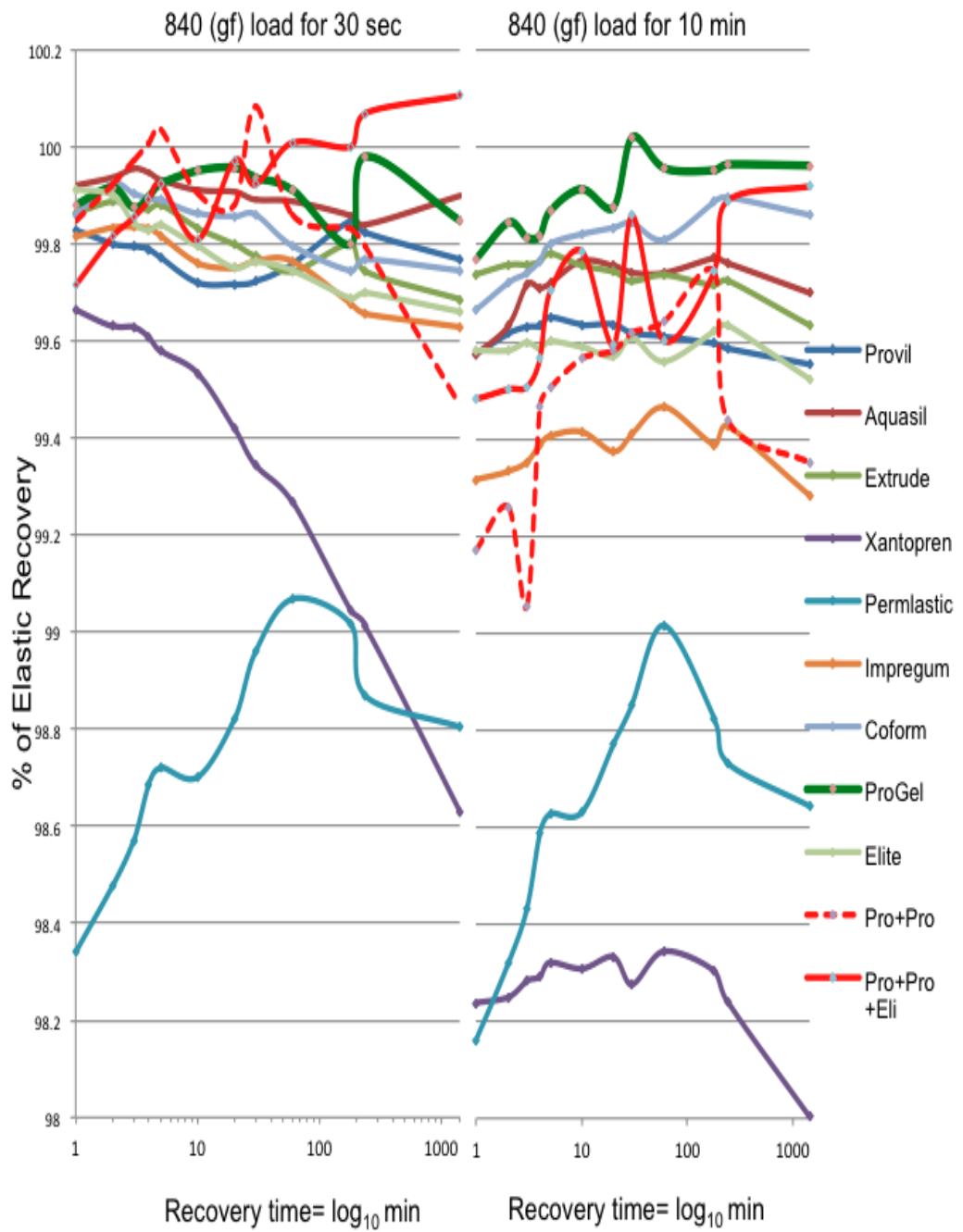

Figure 6-24: The percentage elastic recovery of tested materials after the application of 840 gf compressive load at two different times: 30 seconds and 10 minutes.

### 6.3.3 Discussion

The oral mucosa is considered a viscoelastic material that demonstrates distinct time-dependent properties. Kydd and Daly, (1982) found that the mucosa recovery varies with magnitude and duration of applied force and they stated that at the removal of a moderate load from mucosa, an elastic recovery occurs until 3 hours after load removal, when the oral mucosa then returns to original thickness.

Although the elastic recovery of tested materials cannot be directly compared with mucosa, because of the differences in thickness and structure, this current experiment compares the elastic and viscoelastic behaviour of a range of materials.

There was no ideal slow upward trend for elastic recovery of the majority of tested materials in both experiments (30 seconds load and 10 minutes load); as what occurred to the oral mucosa after load removal. An instantaneous recovery of oral mucosa noticed immediately after load removal, which continued to diminish in rate until the material reached its original thickness. The soft tissue returned to 70% - 90 % of its original thickness 20 minutes after load removal and a complete recovery occurred after about 3 hours. The only slow viscoelastic recovery was demonstrated by Permlastic® in both experiments (30 seconds load and 10 minutes load), Pro+Pro+Elite with 30 seconds load and Pro+Pro multilayer with 10 minutes load.

Delay recovery has been investigated in oral mucosa which is subjected to pressure from a denture, it took time to return to the original position after removal of occlusal load (Hada *et al.*, 1990) and the oral tissue is more

responsive to the length of loading than to the magnitude of the load according to Kydd and Daly, (1982) the soft tissues returned to between 70-90 % of their original thickness 20 minutes after the release of pressure and a residual deformation equal to 10-30 % could still remain after 3 hours depending on the age of the patient, older patients showed less immediate recovery and take longer time to for complete recovery. Compared with oral mucosa, the tested materials recovered to 98-99 % of their original length, 1 minute after load removal.

The tested materials generally retain a very slight permanent deformation after load removal, as the majority of materials did not return 100% to their original length. This deformation was more prominent under 10 minutes load compared to the 30 seconds load. This agreed with the finding of McCabe and Walls, (2009c) who stated that; If the material is strained for only a short time a near complete elastic response will be obtained, while if it is strained for longer it will flow and not all of the strain may be relieved.

Permlastic® light body (polysulfide) and Xantopren® light body (condensation reaction silicone) showed more permanent deformation under both 30 seconds and 10 minutes loads. This agreed with Goldberg, (1974) who stated that polysulfide exhibited more retarded elastic deformation than the silicone materials. In addition, polysulfide (Permlastic® light body) impression material is considered to be a highly flexible material and to exhibit time dependent recovery, followed by condensation silicone (Xantopren®). The polyether (Impregum™ medium body) had lower elastic recovery than addition silicone impression materials (Provil® novo light body, Aquasil™ light body and Extrud® Extra heavy body) (Van Noort, 2007b, Goldberg, 1974) and this was confirmed

in these experiments, particularly with 10 minutes load as demonstrated in Figure 6-24.

The aim of this test was to find a material, which recovered slowly after load removal from its compressed length till it reached approximately 100% of its original thickness within 3-4 hours as in the case of oral mucosa.

From the results the majority of the tested materials behaved as elastic rather than viscoelastic. After 1 minute of load removal, the majority of the tested materials recovered spontaneously rather than slowly from their compressed length to about 99.2 % - 99.9 % of their original length.

### 6.3.4 Conclusions

Measuring the delay elastic recovery without immediate and delay elastic compression and immediate elastic recovery limits the comparison with biophysical properties of oral mucosa. In addition the measuring procedure using a microscope to determine the length of the sample during recovery intervals might be difficult to determine the beginning and end points of the sample length. With respect to above mentioned limitation, the following conclusions were derived:

- The recovery of tested materials after removing the stress is not truly viscoelastic in nature (time dependent recovery). The majority of tested materials behave as elastic materials rather than viscoelastic.
- Permlastic® light body could be considered a viscoelastic material. It showed slow continuous recovery to 99% of its original length after 1-3 hours of load removal. As to a lesser degree did Pro+Pro multilayer with 10 minutes load and Pro+Pro+Elite with 30 seconds load.
- More strain developed within the material samples when the loading time increased.
- For better selection of a suitable substitute for oral mucosa, a material sample with the same thickness of oral mucosa should be constructed and a non-invasive technique (ultrasonic echo ranging technique) could be used, which could measure the viscoelasticity (compression and recovery) of the samples.

## **6.4 The dimensional stability test**

Dimensional stability of the materials used in the model is crucial to enable repeatable and reproducible experiments to be carried out over a period of time. Thus the dimensional stability test was important to evaluate the most suitable materials that could remain stable over a reasonably long period.

Most dimensional stability studies focus on a short-term investigation. In current study, there is a need to investigate the longer-term stability of the model.

The linear change over time of all tested materials was measured.

### **6.4.1 Materials and methods**

The materials used in this study are listed in Table 6-2 (except alginate which was excluded directly after the retention test).

The samples were made using the recommended test apparatus described in BS EN ISO 4823:2000+A1: 2007 for elastomeric impression materials, (30 mm x 3 mm) dimension, scored with three horizontal lines of various width (25, 50 and 75  $\mu\text{m}$ ), intersected by two vertical lines at each side and 18 mm apart from the inner vertical lines (Figure 6-25). The dimension at zero time represents the dimension of the horizontal line of the mould.

Each material was mixed according to manufacturer's instructions for use and placed into the ring mould, a rigid, flat, glass plate was placed on the top of the mould with weight to contain the material and to ensure a consistent thickness of 3 mm. Three samples were made for each tested material (Figure 6-26).

Prior to impression making, the die was wiped with alcohol to remove any residue and then allowed to air dry. Care was taken to avoid contamination of

## 6. Identification of a synthetic soft tissue analogue material

the surface of the die prior of making the sample impression. Latex gloves were not worn during material application because of their potential inhibitory effect on the polymerization of poly vinyl silicone materials (Kahn *et al.*, 1989).

The dimensional accuracy was evaluated 24 hours after making each impression. The length of the horizontal 3 lines was measured between inner cross-points for each impression using a travelling stage reflecting microscopy to the nearest 0.001 mm (Mitutoyo TM, Japan), and the three measurements were averaged (Figure 6-27). Then the dimension was followed for several time intervals: 24 hours, 1, 2, 3, 4, 5, 6, 7, 8, 10, 12, and 14 weeks.

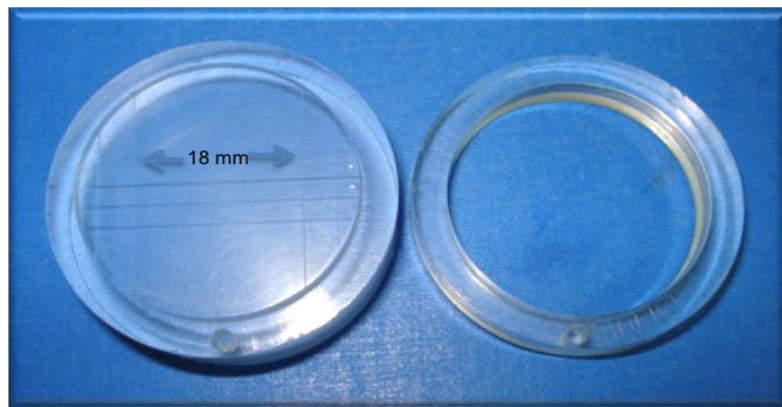

Figure 6-25: The ISO 4823:2000 recommended mould used to construct the material samples for dimensional stability test.



Figure 6-26: The 3 samples for each tested material, which kept dry during storage under the laboratory environmental condition.

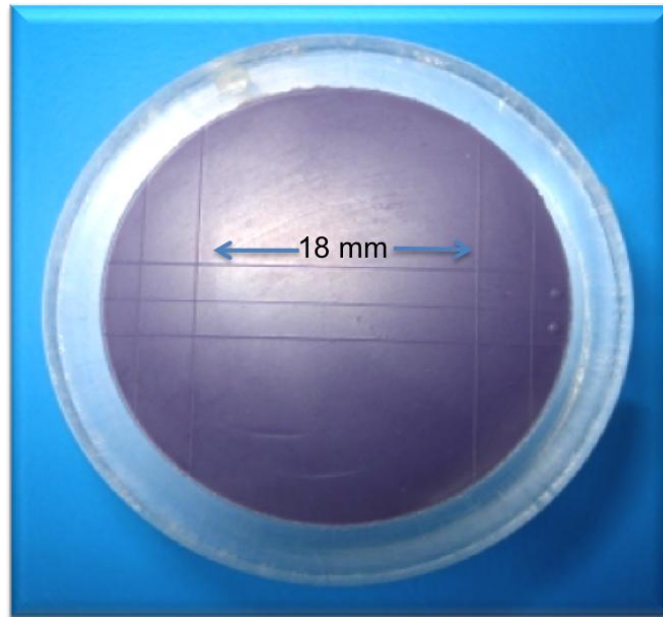

Figure 6-27: Material sample to measure the dimensional stability

### 6.4.2 Results

Figure 6-28 shows the average dimension measurements for all tested materials at the various time periods. All tested materials showed a slight shrinkage after 24 hours of setting (0.1 - 0.2 mm). Aquasil™ soft putty (addition cured silicone) showed the least shrinkage, compared to the other materials (less than 0.1 mm) and the multilayer Pro+Pro material showed the highest shrinkage of 0.4 mm less than the original dimension. In contrast, the multilayer Pro+Pro+Elite showed a 0.2 mm expansion.

After the slight shrinkage which was observed after 24 hours of setting, the single layer materials began to expand slightly from the 1<sup>st</sup> week after setting, except Xantopren® and Impregum™ which showed slight continuous shrinkage till the end of the 14<sup>th</sup> week of setting.

In general, the single layer of addition reaction silicone (Provil® novo light body, Aquasil™ soft Putty, Extrude Extra® heavy body), polysulfide (Permlastic® light



body), maxillofacial impression material (Coform, M517), ProGel outer skin as a single layer, soft lining material (Elite® soft) showed slight dimensional changes about 0.1 mm from the original dimension. These changes remained virtually constant during the testing period. The condensation reaction silicone (Xantopren® light body) was the most dimensionally unstable material, followed by polyether (Impregum™ medium body).

Multilayer configurations showed different dimension behaviour from other single layers. Although the Pro+Pro multilayer sample showed 0.4 mm shrinkage after 24 hours of setting, it recovered to join the other addition silicone impression materials from the 1<sup>st</sup> to the 4<sup>th</sup> week of setting, then it expanded slightly to reach the original length at the 5<sup>th</sup> week, it then slightly exceeded this limit in the successive weeks.

The other multilayer sample Pro+Pro+Elite, behaved in an opposite manner. It showed an expansion rather than shrinkage at all time intervals. This expansion was more prominent in the 1<sup>st</sup> 24 hours of setting and reach 0.7 mm over the test block length at the end of the 14<sup>th</sup> week of setting.

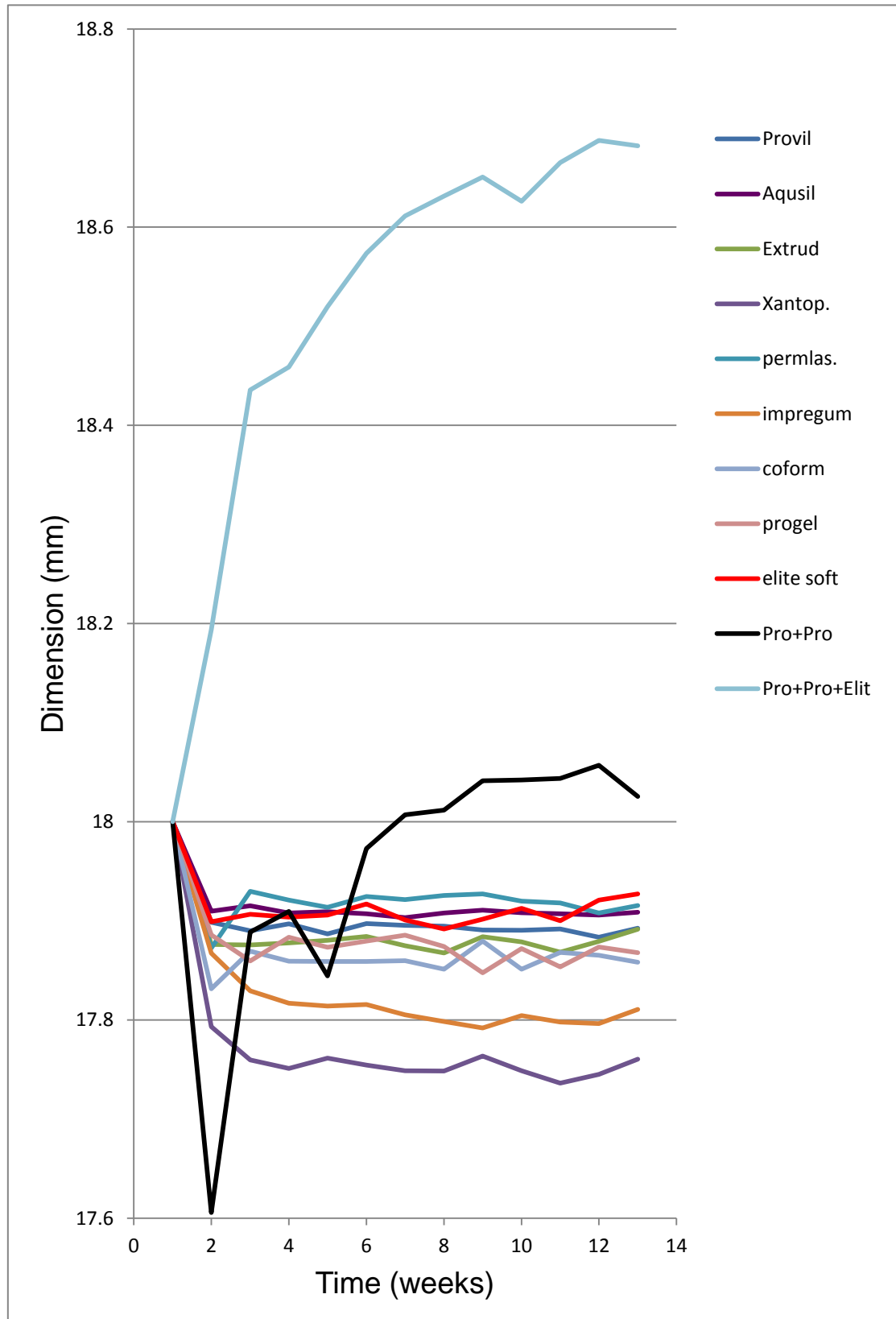

Figure 6-28: Dimensional change of the tested materials over a 14-week period.

### 6.4.3 Discussion

Most of the tested materials shrank slightly after 24 hours of setting. Silicone, polyether and polysiloxane shrank immediately after separation from the test block due to thermal contraction and this small change in dimension continued for weeks after setting when compared to the test block (Vermilyea *et al.*, 1975, Clancy *et al.*, 1983), and this was confirmed by this current study.

The results showed that the addition-cured silicone (Provil®, Aquasil™ and Extrude®) and polysulphide (Permlastic®) demonstrated slight setting shrinkage (mainly because of their polymerization reaction with no bi-product), while condensation-cured silicone (Xantopren®) was found to be dimensionally less stable and had the highest setting shrinkage as the bi-product of the setting reaction is alcohol. This agreed with Luebke *et al.*, (1979) and Van Noort, (2007). While polyether (Impregum™ medium body) demonstrated more shrinkage than addition-cured silicone which agrees with the authors mentioned above.

ProGel outer skin (S 518e) is a single layer material, and dimensionally it behaves similarly to other silicone addition cure systems. But when layered with ProGel neutral skin (S 518a), to form the multilayer Pro+Pro, a change in dimension behaviour was observed. It showed higher shrinkage after 24 hours then expanded to reach the original length at the 5<sup>th</sup> week after setting. This is probably mainly due to changes in the chemical composition and the reaction of the composition of the constituents materials as the layers are squeezed directly from their cartilage over each other and left to set. Some inter-mixing of unset materials with each other was inevitable and as a result a change of

chemical composition could have occurred, subsequently affecting the dimensional behaviour of the resultant material.

The same observation was noticed in the case of the multilayer Pro+Pro+Elite, both ProGel outer skin (S 518e) and Elite soft lining material as single layers behave like other addition cure silicone materials, but when layered together an expansion in dimension was observed mainly due to the same explanation discussed previously for the Pro+Pro material.

As an impression material, it is true that distortion over 0.4% could be considered negative as it might cause poorly fitting restorations (Craig *et al.*, 1975), but a dimensional change more than this figure could be considered acceptable when the purpose is the construction of synthetic mucosa, since this will not adversely affect denture fit on the *in-vitro* model.

#### **6.4.4 Conclusions**

- A single layer of addition reaction silicone, polysulfide, maxillofacial impression material, ProGel, and soft lining materials were dimensionally stable and behaved similarly over time.
- When the materials were used in a multilayer configuration, the resultant material behaved as a new material with different dimensional characteristics.
- Single and Multilayer materials could be considered dimensionally stable for a 14 weeks period for the purpose of creating a substitute for oral mucosa.
- In general all the materials with slight dimensional changes could be considered acceptable for creating the synthetic mucosa covering for an extra oral model.

## **6.5 The wettability test**

Wettability is considered an important factor in complete denture retention. The more hydrophilic the material that acts as a substitute to the oral mucosa, the easier will be to spread saliva over the entire surface to ensure wetting and improve denture retention.

Van der Mei *et al.*, (2004) found that the buccal epithelium in the human oral cavity is hydrophobic with a 72-82° contact angle with a drop of water. Another study conducted by Ranca *et al.*, (2006) found that when a hydrophobic tongue was surface coated with saliva, the surface of the tongue become significantly more hydrophilic. The saliva proteins and mucopolysaccharide contents adsorb rapidly and strongly to the soft tissue and the inner surface of the denture to increase the total surface free energy and formed a surface, which is more wettable to aid the physical retention of the denture to take place.

In this experiment the aim was to investigate the ability of the test materials to be satisfactorily wetted with the surface of the denture to form a thin uniform layer of artificial saliva that would aid denture retention. The contact angle of a drop of distilled water or a drop of artificial saliva on the outer surface of the test materials can be used as an indicator of a material's wettability, the smaller the contact angle, the greater the wettability.

### **6.5.1 Materials and methods**

The static sessile drop technique using of drop measuring Goniometer (Ramehart contact angle Goniometer, model 100-00, 220, USA) was used to compare the wettability of the tested materials (Figure 3-2 page 69).

The materials tested are listed in Table 6-1 except alginate, which was excluded after the retention test. Heat cure acrylic samples polished and unpolished (polished samples were representing the outer polished surface of the denture, while unpolished were represent the fitting surface of the denture); were added to the test using the same resin used for the fabrication of the complete dentures to be tested on the model (Aesthetic Basis material heat cure/ Candulor Zahne/ Wangen/ ZH /Switzerland). Three samples for each tested material were prepared.

The tested materials were prepared using the same mould as for the dimensional stability test to achieve a uniform flat surface. The tested materials were mixed and packed as discussed previously for the dimensional stability test. The samples were left dry under the same laboratory environmental conditions and the contact angles measured after 24 hours of setting.

The acrylic samples were prepared as following: one sheet of denture wax cut into strips of 20 mm x 10 mm x 1.5 mm height. The wax samples were then invested using dental plaster in a denture flask. The subsequent processing was identical to that was used to cure the project dentures (5 hours at 70°C and 2 hours at 95°C). Three of these acrylic samples were finished and polished to represent the outer polished surface of the denture, while the other three were kept unpolished to represent the fitting surface of the denture. The acrylic samples were stored in water room temperature till the contact angle was measured.

The samples were cleaned with surgical spirit to remove any residues, left to dry then the contact angle of a drop of a size equal to 5 µl of distilled water, and another drop of artificial saliva (As Saliva Orthana. As pharma, Walworth

Industrial Estate, Andover, Hampshire UK) measured at least 2 minutes after droplet application as demonstrated in Figure 6-29.

One-way ANOVA was carried out to test for significant differences between the results at the 95% confidence level ( $P < 0.05$ ). A Student's T-test was also carried out to identify individual significances.

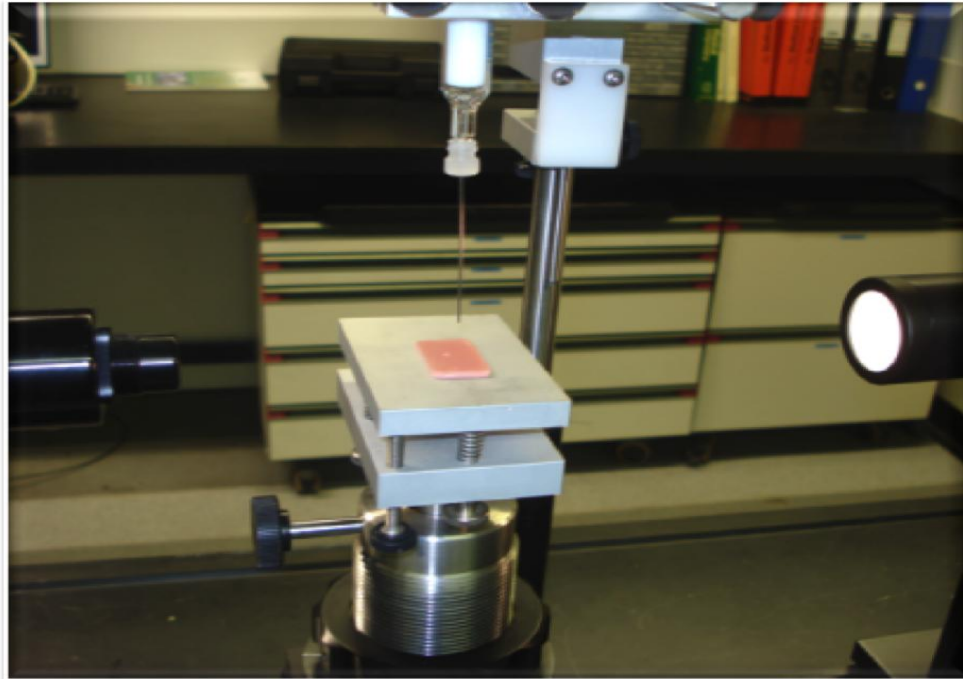

Figure 6-29: Contact angle measurement of an acrylic resin sample using a contact angle Goniometer.

### 6.5.2 Results

The mean and standard deviation of the contact angle of a drop of distilled water and a drop of artificial saliva placed onto the soft tissue analogue and acrylic resin materials being assessed can be seen in Figure 6-30.

Saliva proved to have better wettability than water for Provil® novo light body, Aquasil™ soft putty, Elite® soft lining, Pro+Pro multilayer and the acrylic samples both polished and unpolished. The other materials: Extrude Extra®



heavy body, Xantopren® light body, Permlastic® light body, Impregum™ medium body, Coform soft (M517), ProGel outer skin, and Pro+Pro+Elite multilayer showed no statistical difference between water and saliva.

With water, the most hydrophilic material was Impregum™ medium body (35° contact angle), followed by Extrude Extra® heavy body (48° contact angle), and Provil® novo light body (50° contact angle). While the most hydrophobic materials were Xantopren® light body, Aquasil™ soft putty and Elite soft lining (81°, 80°, 78° contact angles respectively). The contact angles of other materials had a range between 67°-75° (Figure 6-30).

The mean and statistical differences of tested materials when using saliva are shown in Figure 6-31. The most wettable material was Provil® novo light body (30° contact angle) followed by Impregum™ medium body and Extrude Extra® heavy body (44°, 46° contact angles respectively). In contrast, the most hydrophobic materials were Xantopren® light body, ProGel and Coform with 76°, 74° and 73° contact angles respectively. The wettability of the other materials tested showed no statistical differences and their values ranged between 55°-67° contact angles.

## 6. Identification of a synthetic soft tissue analogue material

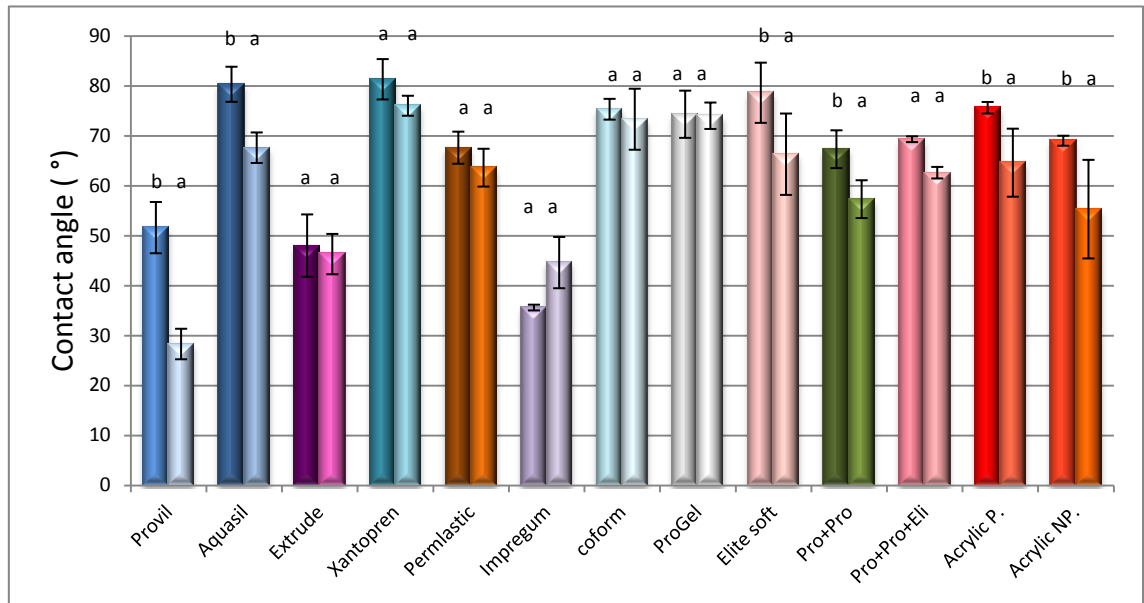

Figure 6-30: The mean of the contact angle of a drop of distilled water and a drop of artificial saliva of all tested materials with acrylic samples (n=3). The 1<sup>st</sup> column represents the contact angle with a drop of distilled water, while the 2<sup>nd</sup> with a drop of saliva. The letters represent the statistical differences between the contact angle of water and saliva (different letters indicate significant differences). Acrylic P= Polished acrylic samples, Acrylic NP= unpolished acrylic samples.

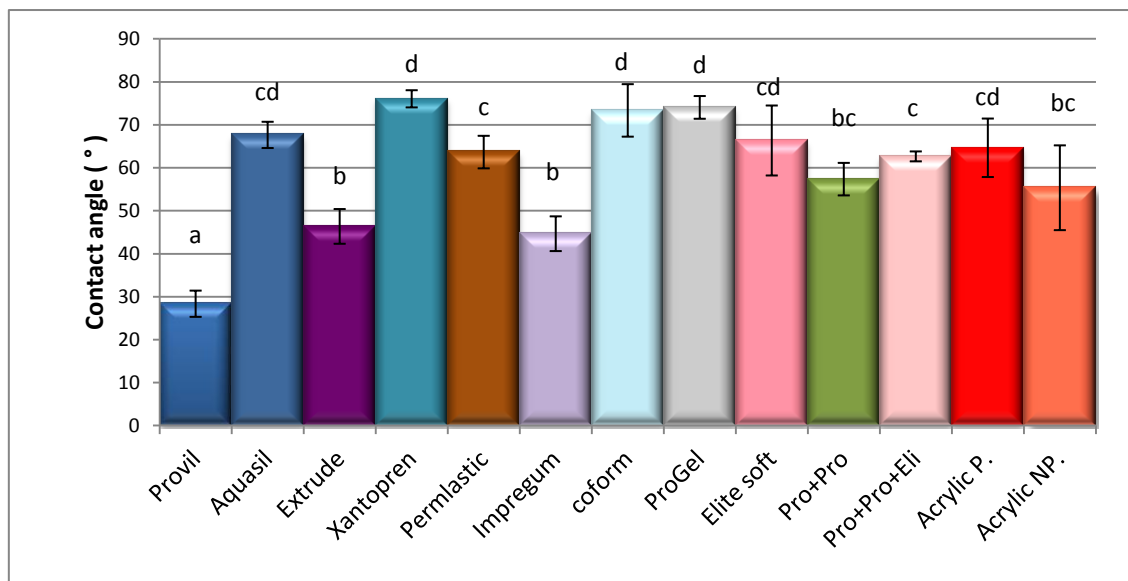

Figure 6-31: The contact angle of a drop of artificial saliva of all tested materials. The letters represent the statistical differences between the contact angle of water and saliva (different letters indicate significant differences).

### 6.5.3 Discussion

The surface wettability of mucosa substitute materials for the extra oral model is important for denture retention. It was necessary to find the most wettable materials among the tested group.

Many previous studies measuring contact angle measurements (CAM) used a drop of water (Grundkea *et al.*, 2008, Zgura *et al.*, 2010). The importance of comparing the CAM of water with saliva was emphasised by Sharma and Chitre, (2008), Massad and Cagna, (2002) and Muller and Oehr, (2011) to formulate an impression about the surface free energy of the solid materials. In addition, artificial saliva was used as an interpose fluid between the synthetic mucosa and the mandibular complete denture constantly to fit onto the *in-vitro* model.

The results of this study agreed with those of Sharma and Chitre, (2008) Massad and Cagna, (2002) that a large number of the tested materials showed statistically better wettability with saliva than with water, because proteins and muco polysaccharids increase the adsorption of saliva into the test silicone materials and acrylic resin. While some of the materials showed no significant difference between water and saliva (Figure 6-30).

According to Murakami *et al.*, (1990), the hydrophilicity of addition-type silicone impression materials had a  $51.4 \pm 1.3^\circ$  contact angle, and other impression materials which are considered hydrophobic varied from  $84.6 \pm 6.1^\circ$  to  $97.7 \pm 4.4^\circ$ . While others stated that the advancing contact angles of a hydrophilic group, which included polyether was equal to  $45.8^\circ \pm 7.6^\circ$  (McCormick *et al.*, 1989). A hydrophobic group consisting of a polysulfide was  $62.6^\circ \pm 10.1^\circ$ , a

poly vinyl siloxane was  $71.1^{\circ} \pm 12.3^{\circ}$ , and a condensation-reaction silicone  $74.1^{\circ} \pm 11.0^{\circ}$ .

Within the limitations of this experiment, and with comparison to the above mentioned studies, Provil®<sup>®</sup>, Impregum™, Extrude Extra® and Pro+Pro should be considered as hydrophilic materials and the others as hydrophobic. But materials like Pro+Pro+Elite, permlastic®, Elite® soft and Aquasil™ were not statistically different to the Pro+Pro, which was considered hydrophilic, as shown in Figure 6-31.

The most hydrophobic materials were Xantopren®, ProGel and Coform. Whilst the other materials were considered hydrophilic.

Provil® novo and Extrude Extra® (addition cured silicone materials) are considered hydrophobic as they contain hydrophobic aliphatic hydrocarbon groups while Impregum™ (polyether) is considered a hydrophilic material because it contains the functional groups [carbonyl (C=O) and ether (C–O–C)] that attract and interact with water molecules (Hamalian *et al.*, 2011). Current results confirmed this and showed that, of the tested materials, they were the most hydrophilic materials.

According to the results in Figure 6-31, acrylic could also be considered within the least hydrophilic materials as compared with the other elastic materials. But the unpolished samples were not statistically different from the polished, disagreeing with Muller and Oehr, (2011), who stated that contact angle measurement could be influenced by the surface structure like roughness. This could explain that the resultant roughness in the acrylic resin samples was not so prominent as to cause statistical differences.

#### 6.5.4 Conclusions

- Different materials exhibited different contact angles.
- Provil® Novo light body, Impregum™ medium body and Extrude Extra® heavy body were considered to be the most hydrophilic materials.
- Xantopren® light body, ProGel and Coform, Aquasil™ ultra light body, and Elite® soft lining material were considered the least hydrophilic materials.
- The wettability of other materials: Permlastic® light body, multilayers Pro+Pro and Pro+Pro+Elite showed varying degrees of hydrophilicity.

## 6.6 General Discussion and Conclusions

The results of the aforementioned investigations (the Retention test, the Elastic Recovery test, the Dimensional Stability test, and the Wettability test) did not confirm the superiority of one of the tested materials over another as an ideal analogue material to represent the human mandibular-ridge soft tissue.

The data expressed above is complex and difficult to analyse when establishing a preferable material for the model. In order to aid with the comparison of physical characteristics, a comprehensive table of the results of each property rational has been created (Table 6-6) using an analogue result scale from 1 - 5, in which the value 5 represents the best results, while 1 represents the worst.

The scale for each property is used as follows:

- ***The Retention test data:***

The grades for the retention test depend on the statistical differences in the retention of tested materials. The highest speed results [60 mm/min with the use of 0.3 and 0.5 ml of saliva (Figure 6-19)] were used as representative to retention results in the property grade table. This particular speed was decided upon as the maximum retention force was seen under these conditions.

In the property grade Table 6-6, the retention ability grades were:

Grade 5= maximum retention force.

Grade 1= minimum retention force.

As shown in Table 6-4.

Retention Test			
0.3 ml saliva		0.6 ml saliva	
Grade	Statistical differences	Grade	Statistical differences
1	a	1	a
2	b	2	ab
2	bc	3	bc
3	c	4	c
3	cd	4	cd
4	d	5	d
5	e		

Table 6-4: The analogue scale of the retention test data at speed 60 mm/min. The letters represent the statistical differences between the tested materials.

- ***The elastic recovery test data***

The best results are seen in those materials that demonstrate a complete gradual recovery after 3 hours of load removal.

The elastic recovery grades were based on the approximation of test materials to the viscoelastic behaviour of oral mucosa after load removal, in normal conditions gradual elastic recovery occurs until 3 hours after load removal, when the oral mucosa then returns to normal thickness.

In the property grade Table 6-6, the viscoelasticity grades were:

Grade 5= gradual complete recovery.

Grade 1= immediate recovery.

As shown in Figure 6-32 and Figure 6-33.

## 6. Identification of a synthetic soft tissue analogue material

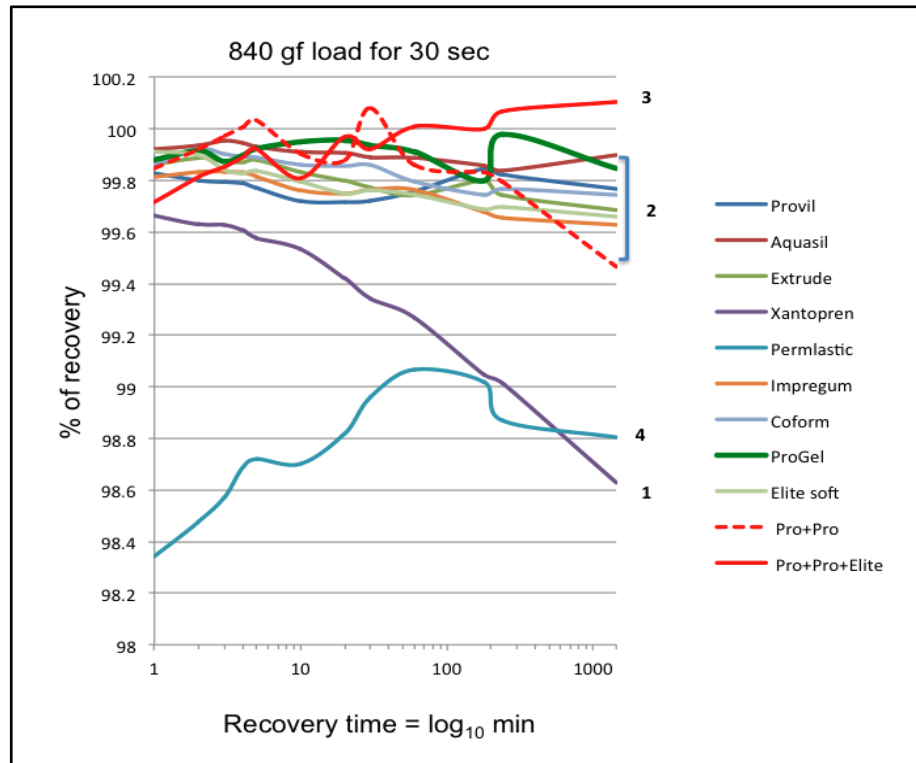

Figure 6-32: The analogue scale of the elastic recovery test data for 840 (gf) of load for 30 seconds. The numbers represent the grade of each material according to the approximation to the oral mucosa recovery after load removal.

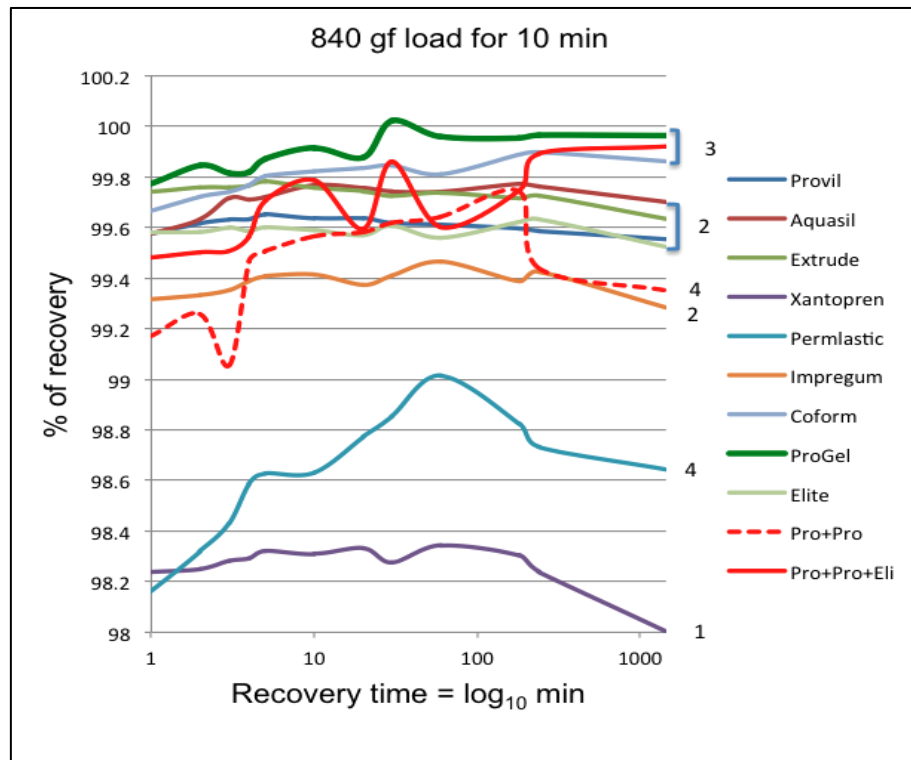

Figure 6-33: The analogue scale of the elastic recovery test data for 840 (gf) of load for 10 minutes. The numbers represent the grade of each material according to the approximation to the oral mucosa recovery after load removal.



- **The dimensional stability test data**

The best results are seen in those materials that demonstrate no dimensional changes over the 14-week test period.

In the dimensional stability test, the grades are based on the amount of shrinkage or expansion that occurred after setting and the dimensional stability over the whole 14-week period.

In the property grade Table 6-6, the dimensional stability grades were:

Grade 5= no dimensional changes, no shrinkage or elongation after setting.

Grade 1= showed dimensional changes, high shrinkage and elongation after setting.

As shown in Figure 6-34.

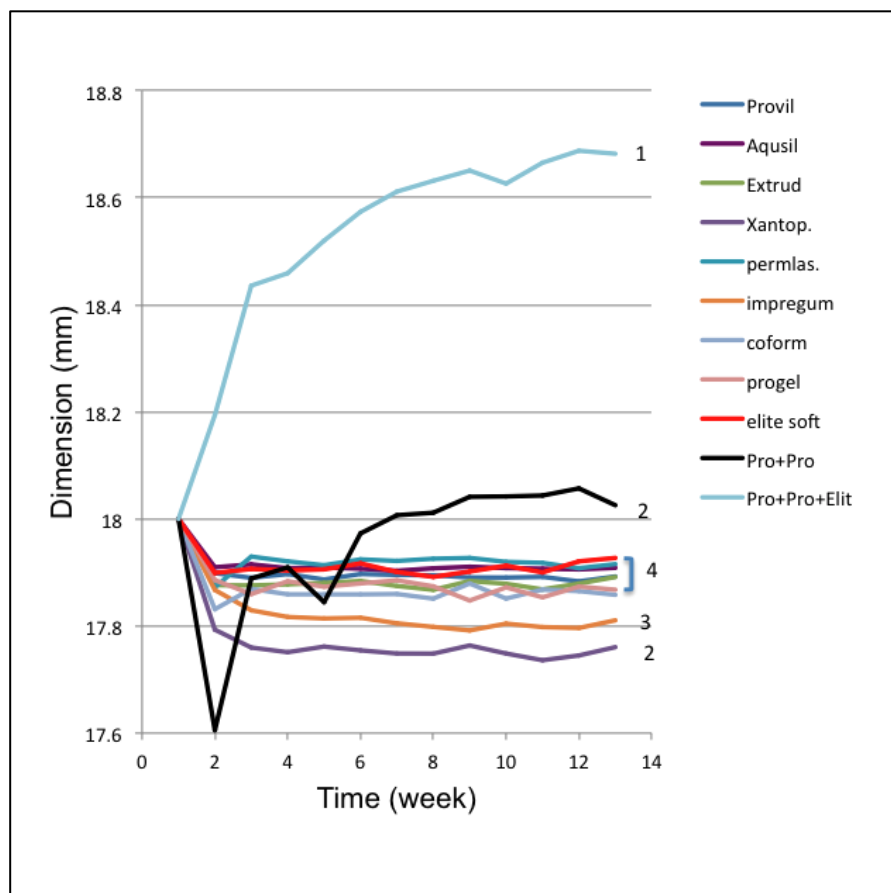

Figure 6-34: The analogue scale of the dimensional stability test data over the period of 14 weeks. The numbers represent the grade of each material according to its dimensional stability.

- **The wettability test data**

The ranking of wettability test based on the statistical differences in the wettability of tested materials as given in Figure 6-31.

In the property grade Table 6-6, the wettability grades were:

Grade 5= the most wettable material with low contact angle.

Grade 1= the least wettable material with high contact angle.

As shown in Table 6-5.

<b>Wettability Test</b>	
Grade	Statistical differences
5	a
4	b
3	bc
2	c
2	cd
1	d

Table 6-5: The analogue scale of the wettability test data with saliva. The letters represent the statistical differences between the tested materials.

Each material tested is shown in Table 6-6 and shown its respective ranking in each of the tests carried out, and the performance position of tested materials is shown in Table 6-7.

According to Table 6-6, the least suitable material to represent oral mucosa in the retention test was alginate. In spite of giving the highest retention results

## 6. Identification of a synthetic soft tissue analogue material

with 0.3 ml of saliva, it was dimensionally unstable because of imbibition and syneresis and would need to be replaced often, in addition it can tear easily, and does not adhere strongly to the acrylic base like the other elastic materials tested and has an unpractical mixing procedure for the construction of the mucosal layer of the *in-vitro* model. For these reasons it was excluded from other tests.

Materials	Retention Test		Elastic Recovery Test		Dimensional Stability Test	Wettability Test	Overall Grade	Resiliency Characters
	0.3ml saliva	0.5ml saliva	30 sec load	10 min load				
	Permlastic® L. B	3	3	4				
Multilayer: Pro+Pro	4	4	2	4	2	3	19	High resiliency
Provil® novo L. B	3	3	2	2	4	5	19	Very low resiliency
Multilayer: Pro+Pro+Elite	3	4	3	3	1	3	17	High resiliency
Aquasil™ soft Putty	2	4	2	2	4	2	16	Low resiliency
(M517) Coform soft	1	5	2	3	4	1	16	Medium resiliency
ProGel outer skin (S518e)	3	3	2	3	4	1	16	Medium resiliency
Impregum™ M.B	2	2	2	2	3	4	15	Medium resiliency
Elite® soft relining	2	3	2	2	4	2	15	Low resiliency
Extrude Extra® H. B	1	1	2	2	4	4	14	Very low resiliency
Xantopren® L. B	2	4	1	1	2	1	11	Very low resiliency

Table 6-6: The properties grades table of tested materials from the retention, elastic recovery, dimensional stability and wettability tests. Grad 5 represents the best results, while 1 represent the worst. L.B = light body, H.B = heavy body, M.B = medium body. the performance position of tested materials from best to worst in representing oral mucosa on the *in-vitro* model according to the overall results grading.

Xantopren® L blue light body (condensation cured silicone) had good retention results with the use of 0.5 ml of saliva, but it was the least representative to the elasticity of oral mucosa and the least wettable material. In addition it shrank more than other materials in the dimensional stability test, and it set to a rubbery hard material after setting making the adaptation of the acrylic disc on the material in the retention test difficult. As a result it was excluded as an analogue to oral mucosa for the model.

Minimum retention forces were seen with Extrude Extra® heavy body (addition cured silicone) at all tensile speeds, although it showed good hydrophilic characteristics in the wettability test and it is suspected that this feature could improve disc retention. It is apparent that there are additional factors that affect retention other than wettability, such as the resiliency and compressibility of the material. The mucous membrane deforms elastically to the outline of the denture and a thin layer of saliva remains under the denture, in turn capillary attraction comes into action to hold the denture in position. We hypothesise that this is the reason why Extrude Extra®, which set to a rubbery rather than a compressible material failed to get good retention although it showed good wettability with saliva.

The results of both ProGel outer skin and Elite® soft lining materials showed average values of retention and elastic recovery tests, but good dimensional stability. In contrast, they were the most hydrophobic materials.

Impregum™ medium body was hydrophilic with acceptable dimensional stability, but its recovery was elastic rather than viscoelastic, and also had poor retention values.

Coform and Aquasil™ soft putty showed good retention values with 0.5 ml saliva and good dimensional stability. In contrast they showed low wettability characters and they were recovered elastically rather than viscoelastically.

The only viscoelastic behaviour was observed with Permlastic® light body, Pro+Pro multilayer and to a lesser degree Pro+Pro+Elite. They showed slow continuous recovery after load removal, but they varied in the approximation to the full thickness after 3 hours of load removal, Pemlastic® recovered more gradually to only 98.8 - 99% while Pro+Pro and Pro+Pro+Elite to about 99.8%.

The retention values of these materials also showed good results in the retention test. Permlastic®, however, was observed to release some oily exudates after storage for several days in the dimensional stability test and this might adversely interfere with any future extra oral retention test. In addition it is not easy to manipulate and mixed, resulting in a material of unpredictable constitution.

Provil® Novo light body showed good overall results, but the resultant material set to a rubbery hard material that interfered with the easy adaptation to the acrylic disc in the retention test. In addition it recovered elastically rather than viscoelastically after load removal like the majority of silicone impression materials.

Pro+Pro multilayer and Pro+Pro+Elite showed good retention and elastic recovery results, an average wettability, but with slight dimensional instability which was more prominent with Pro+Pro+Elite multilayer. It showed an expansion of 0.6 mm in the 1<sup>st</sup> 30 days reaching 0.7 mm 98 days following setting, however, it was considered acceptable in resembling oral mucosa.

From the discussion above, the conclusion that the factors tested above (elastic recovery, dimensional stability and wettability) had not been a sole indicator of retention effectiveness. As a conclusion, based on the experiments undertaken and represented in Table 6-6, it has become clear though, that other physicals properties, that are intrinsic to the particular materials and to the 'denture-saliva-tissue' system are at play and should be investigated further. Other such properties would include:

1. The resiliency and compressibility of the setting material and the ability to maintain these characters after setting for sufficient time.
2. Ease of manipulate and mixing.
3. High tear resistance to withstand the testing procedure.
4. Match the oral mucosa appearance and consistency.

From the above discussion based on the overall properties grades table of tested materials (Table 6-6),it was decided to choose the following materials to create the oral mucosa and reflected tissue analogue:

- Pro+Pro multilayer to replace the reflected tissue on the model: composed of 2 layers: ProGel neutral skin (S 518a) as the base layer and ProGel outer skin (S 518e) for the superficial layer. This material combination has high resiliency and compressibility.
- Pro+Pro+Elite to replace the oral mucosa that covers the residual ridge. Made up from three layers: ProGel neutral skin (S 518a) as the base layer, Elite soft lining material as the intermediate layer and ProGel outer skin (S 518e) for the surface layer. The advantage of using the Elite soft material in between to substitute ridge mucosa is to minimize the compressibility of Pro+Pro material to approximate the mucosa in its

resiliency and colour as Elite soft showed good results in previous experiments and set to a less rubbery material unlike other tested materials.

These multi-layers have the following advantages over other materials tested to substitute oral mucosa.

- They showed generally good results in the tests conducted to evaluate the test materials (Table 6-6).
- They are easy to manipulate and mix, have enough mixing and working time.
- Their resiliency and compressibility resemble real oral tissue, and maintain these characters after setting for a sufficiently long time.

# 7

---

## **Creation of a Model of a Moderately Resorbed Mandibular Ridge from an Edentulous Individual**



## **7. Creation of a Model of a Moderately Resorbed Mandibular Ridge from an Edentulous Individual**

The purpose of this study is to design and develop an artificial edentulous mandibular ridge model, with associated tissue structure (the overlying mucosa and muscles attachments) so that it closely resembles in function a human natural edentulous mandible. This will enable us to test the retention of mandibular dentures using a variety of different retention mechanism on the mandibular model simulation.

To construct an accurate analogue replica model it was necessarily to obtain an impression from a patient with a moderately resorbed ridge (class IV and V Cawood and Howell classification) (Cawood and Howell, 1988).

### **7.1 Application for NHS Ethics Approval to replicate a human edentulous mandible**

Ethical approval was applied for and approved by the South Yorkshire research Ethics Committee to enable impressions to be taken of mandibular edentulous ridges from patients attending the CCDH for routine prosthodontic treatment (REC reference number: 08/H1310/110 on 13 January 2009)

The clinical component required the use of the restorative clinics of the Charles Clifford Dental Hospital (CCDH). The impressions were taken in a manner analogous to that used for the provision of a complete mandibular denture, with a modified special-tray technique that recorded the reflected tissues.

### **7.1.1 The participants:**

Two participants were selected from those patients attending the restorative department of the CCDH, University of Sheffield, for the provision of complete dentures. The participant selection criterion was the shape of the edentulous mandibular ridge. This information was obtained at the first clinical stage based upon a simple intra-oral examination. Participants were selected that had an average sized mandible, with a Class IV or Class V ridge shape (Cawood and Howell, 1988) and typical soft tissue covering the ridge which was covered by healthy mucosa.

Patients that agreed to participate in this study were supplied with an information sheet (Appendix 12.2) and asked to sign a consent form (Appendix 12.3).

## **7.2 Construction of the ridge analogue**

### **7.2.1 The Impression**

A modified final impression was taken to fully record the sulcus and adjacent reflected tissues. Appropriate custom trays were made from the preliminary models for the purpose of recording the necessary details of the mandibular edentulous ridge and reflected tissue (Figure 7-1).

A modified final impression using low fusing – green stick impression compound (Kerr, Orang, USA) to adjust the custom tray borders with the oral reflected tissue was employed. Then the final impression was taken using Aquasil™ Ultra

## 7. Creation of a model of a moderately resorbed mandibular ridge

monophase and Aquasil™ Ultra LV Wash (Regular Set, Densply, Milford, USA) (Figure 7-2).

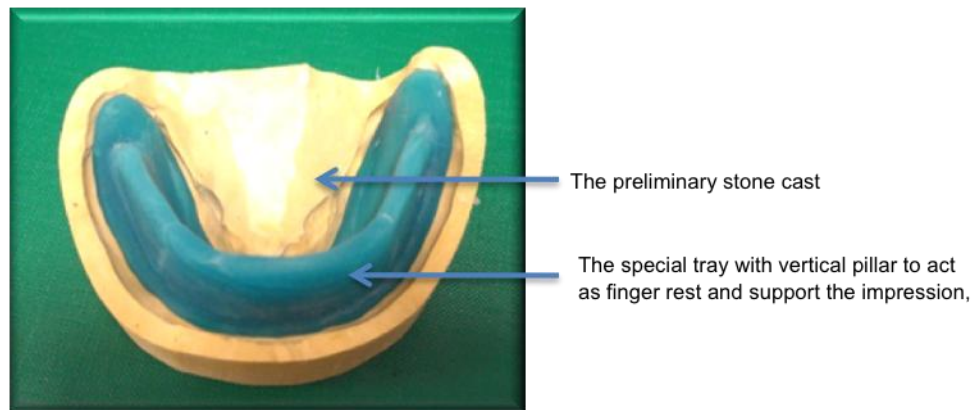

Figure 7-1: The special design custom tray fit the preliminary cast.



Figure 7-2: The final impression of the mandibular edentulous ridge with reflected tissue.

### 7.2.2 Obtaining a negative to the original cast:

The final cast was obtained by pouring the final impression with stone as shown in Figure 7-3.

The second laboratory step was to construct a stone negative of the original cast using a die and counter die technique.

An impression was taken of the original cast using Aquasil™ putty impression material as a base and Aquasil™ light body as a superficial layer (Figure 7-4).

## 7. Creation of a model of a moderately resorbed mandibular ridge



Figure 7-3: The stone cast poured from the final impression.

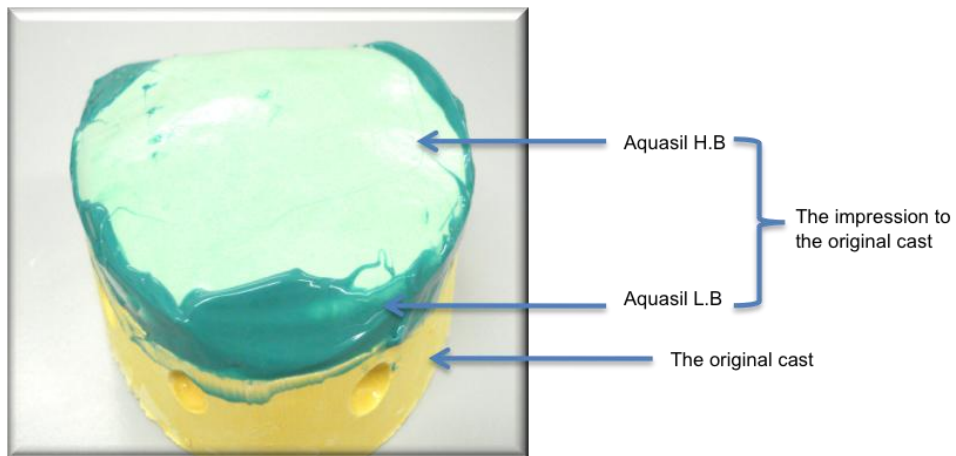

Figure 7-4: Taking an impression to the original cast.

A negative to the resultant Aquasil™ impression was poured using a special duplicating silicone material (Dublisil, addition-vulcanising vinyl-polysiloxane, Dreve Dentamid GmbH, Unna/Germany) (Figure 7-5).

The resultant negative stone cast of the original was obtained by pouring the Dublisil silicone negative with die stone (Figure 7-6).

## 7. Creation of a model of a moderately resorbed mandibular ridge

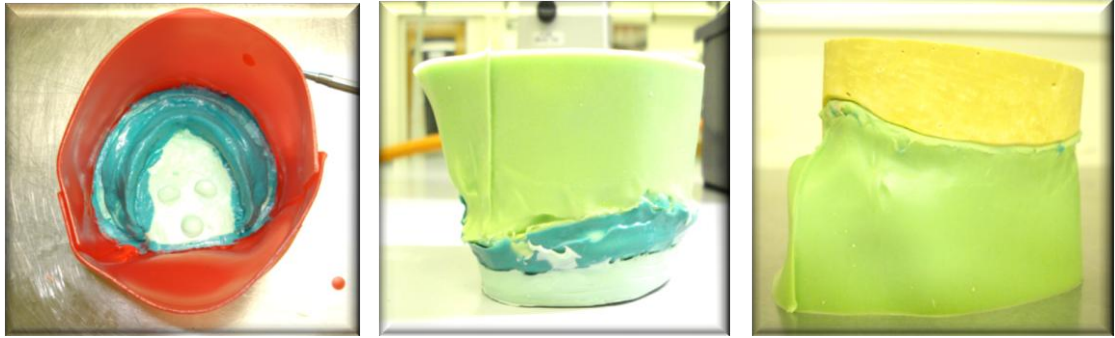

Figure 7-5: Encircling the resultant silicone cast with wax sheet and pouring a negative to the silicone cast using Dublislil silicone material and a negative stone cast poured on the Dublislil silicone negative.

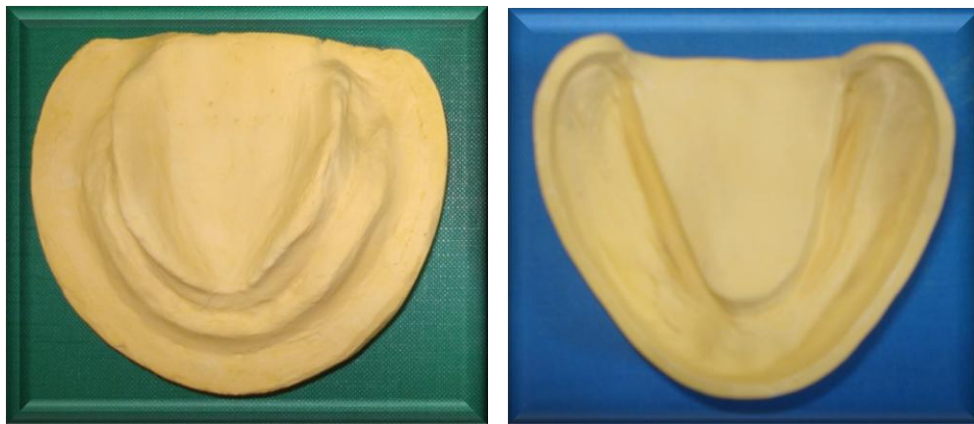

Figure 7-6: The resultant stone negative for the original cast.

### 7.2.3 Ridge reduction to allow for a soft tissue overlay

A layer of wax with varying thicknesses approximating to the thickness of ridge oral mucosa according to Uchida, *et al.*, (1989) was applied on the resultant stone negative cast and was measured using a special thickness measuring device (Bracon Ltd, East Sussex, UK). Wax was also laid to produce the reflected and adjacent tissue (Figure 7-7).

## 7. Creation of a model of a moderately resorbed mandibular ridge



Figure 7-7: A layer of wax with varying thickness was laid on the ridge area.

A negative for this wax pattern was then poured with die stone (Figure 7-8) and the resultant cast formed the base of the model (Figure 7-9).



Figure 7-8: Pouring a negative stone cast for the mucosa wax pattern.

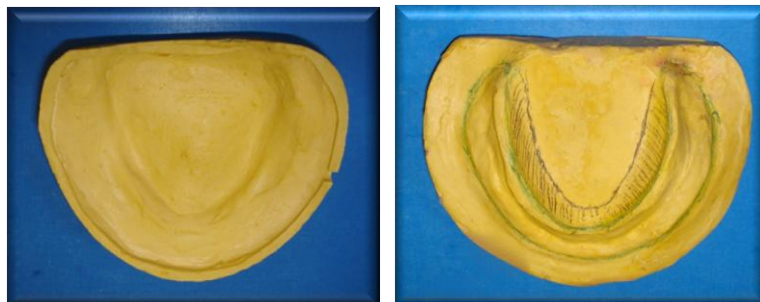

Figure 7-9: The resultant two parts of the model. Left: mucosa wax pattern negative cast, right: original negative cast.

#### 7.2.4 Construction of soft tissue overlay for the extra oral model

A special polyester mesh (PE 710 HD, Lockertex, Warrington, Cheshire, England) was fixed on the periphery and tongue space of the (mucosa wax pattern) negative cast to aid the retention of the soft tissue analogue materials (ProGel neutral skin-the basement layer, Elite soft lining-the intermediate layer, and ProGel outer skin-the superficial layer) (Figure 7-10).

A thin layer of transparent ProGel outer skin was applied to the surface of the (original) negative cast (Figure 7-10). Another thin layer of Elite soft lining material was then laid on the ProGel outer skin layer on the ridge area. Then an adequate amount of ProGel neutral skin filled the tongue and ridge area of the (mucosa wax pattern) negative cast, then the two halves were closed together and fixed tightly with elastic bands and left for about 2-3 hours to completely set (Figure 7-11).

The resultant *in-vitro* model, the stone cast with its synthetic tissue covering is as near as possible to the dimensions of the patient's ridge parameters and was with appropriate compressibility (Figure 7-12).

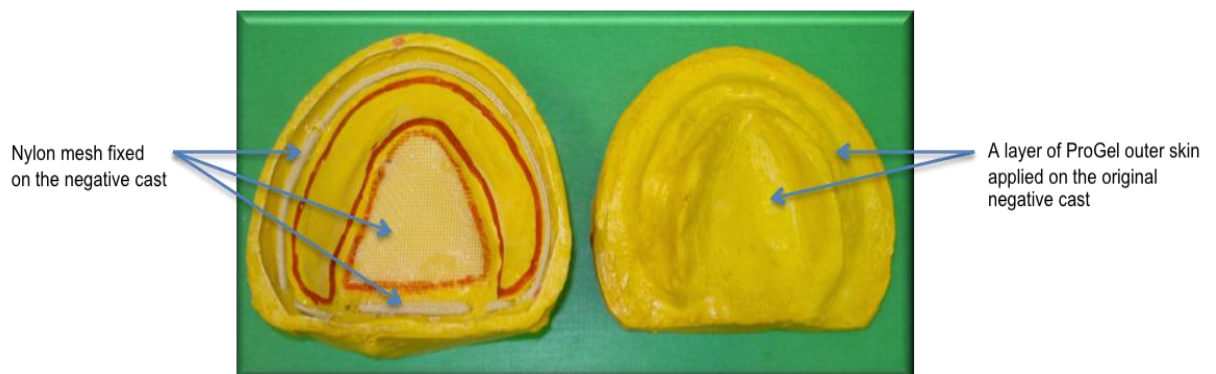

Figure 7-10: The use of nylon mesh to aid the retention of soft tissue analogue on the mucosa negative cast. A thin layer of ProGel outer skin applied on the surface of the 2<sup>nd</sup> model halve (original negative cast).

## 7. Creation of a model of a moderately resorbed mandibular ridge



Figure 7-11: The 2 halves of the model with the soft tissue analogue closed together and left to set.

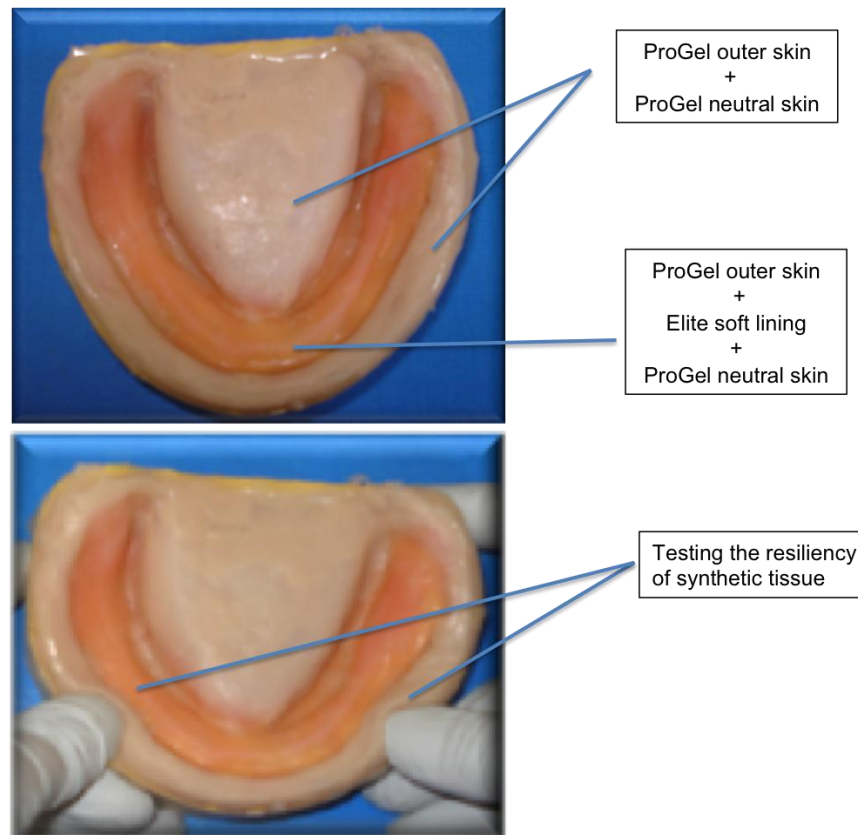

Figure 7-12: The resultant extra oral model with its covering and reflecting tissues.

### 7.3 Construction of a complete denture for model validation

After the construction of the extra-oral model, a testing protocol was conducted to validate the model and test its effectiveness to be able to conduct different testing protocols. For this, a complete denture was made to fit the model. Using



## 7. Creation of a model of a moderately resorbed mandibular ridge

a special tray, an alginate impression was taken of the model ridge, which was poured to form the final cast (Figure 7-13). Denture base construction, teeth arrangement on the middle of the ridge using a Candulor Static-Laser (Wangen/ZH, Punten, Switzerland), flasking, packing and curing using Aesthetic Basismaterial heat cure acrylic resin (Candulor Zahn/ Punten 4, Postfach 89 CH-8602 Wangen/ZH/Switzerland) at curing cycle (5 hours at 70°C and 2 hours at 95°C), then finished using conventional techniques (Figure 7-14).



Figure 7-13: Taking an alginate impression to the model ridge and pouring a stone cast.

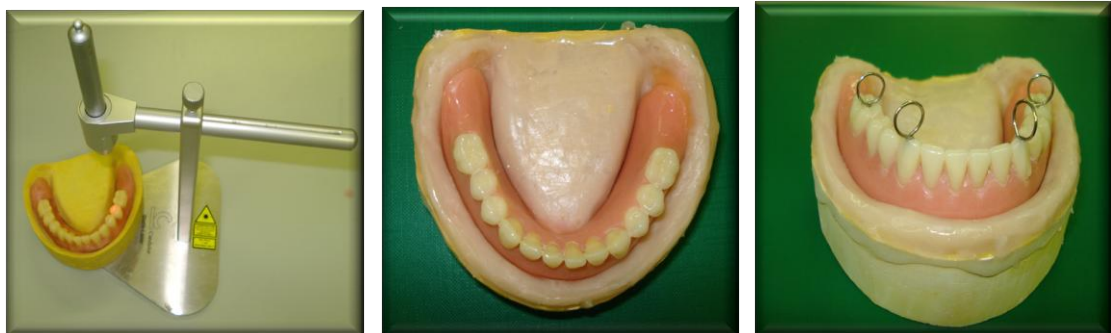

Figure 7-14: lower teeth arrangement (Left) and the resultant model with the finished mandibular complete denture in place on the model and the denture with hooks ready for the verification tests (right).

A tensile test of the denture on the model with a vertical pull direction was undertaken on a universal tensile testing machine. Four stainless steel hooks were fixed on the occlusal surface of the teeth (2 in canine areas and 2 in the 1<sup>st</sup> molar area) (Figure 7-14).

---

# 8

---

## **Testing the retention of different denture designs with and without denture adhesives on the *in-vitro* model**

**Presented at**

- **BSODR Annual Conference, Sheffield, 2011: *In-vitro* model for testing the retention of complete dentures (Al-Kaisy N. *et al.*, 2011).**

## **8. Testing the retention of different denture designs with and without denture adhesives on the *in-vitro* model**

After the construction of the *in-vitro* model with its fitted mandibular complete denture, the verification of this model was carried out.

### **Aim**

To verify the effectiveness of the model as an accurate replica of a human edentulous mandible for the purpose of testing denture retention.

### **Objectives**

To undertake the following validation tests on the model:

- 1-** Design and validation of retention test with a well-fitting mandibular denture (8.1)
- 2-** Measure and compare the retention of different mandibular denture designs (8.2)
- 3-** Measure and compare the retention of different mandibular denture designs with the use of different denture adhesives (8.3).
- 4-** Measure and compare the retention of each mandibular denture design with the use of different denture adhesives (8.4).

### **8.1 Design of a denture retention test with a well fitting denture experiment**

The principle of the test for retention depends on the use of dislodgment forces between the denture and the tissue covering the mandibular ridge with an intervening film of saliva. The principle dislodgment force is a pulling force in the direction opposite to the direction of denture insertion when the denture is held in a static condition.

In the mouth, the compressible mucosa is of vital importance to the retention of the denture. Tyson, (1967) stated that any attempt to remove the denture by a pulling action would be strongly resisted by the impaction of the mobile mucosa against the denture base because this produces an extremely thin film of saliva in this area, which slows the flow of fluid from the periphery.

In this experiment, the dislodgment force was an axial pull in an opposite direction to that of denture insertion. The variables, which need to be controlled, are the amount of saliva between the denture and mucosa and the speed of dislodgment. The variability of viscosity of the saliva is a further variable that is considered too complex to factor into the experiment. Thus a single viscosity artificial saliva replacement was used, that has been manufactured as a close and validated substitute for human saliva (As saliva orthana, As pharma, Hampshire, UK). Teraoka *et al.*, (2004) used 1 ml of artificial saliva when testing the retention of complete palate coverage and palate less dentures *in-vitro* using a tensile tester. Others used artificial saliva to investigate the *in-vitro* retentive ability of denture adhesives when interposed between an acrylic disk specimen and a clean glass surface, where they found highly significant

differences between the retentive ability of different types of denture adhesives with the use of artificial saliva (Chowdhry *et al.*, 2010).

### **8.1.1 Materials and methods**

The model with the well-fitting denture in place was connected to a universal tensile testing machine (LLOYD Instruments – LRX. UK) with the aid of 4 holding points attached to the denture's occlusal surface and connected to the machine by an adjustable wiring system connected to the holding points by S-shape hooks (Figure 8-1). The wires were adjusted so that they all produced an equal axial pull in a simultaneous manner.

The occlusal surface of the denture teeth was made parallel with the base of the tensile tester by holding the model on a surveyor table to allow adjustment to ensure parallelism to the base of the machine (Figure 8-2).

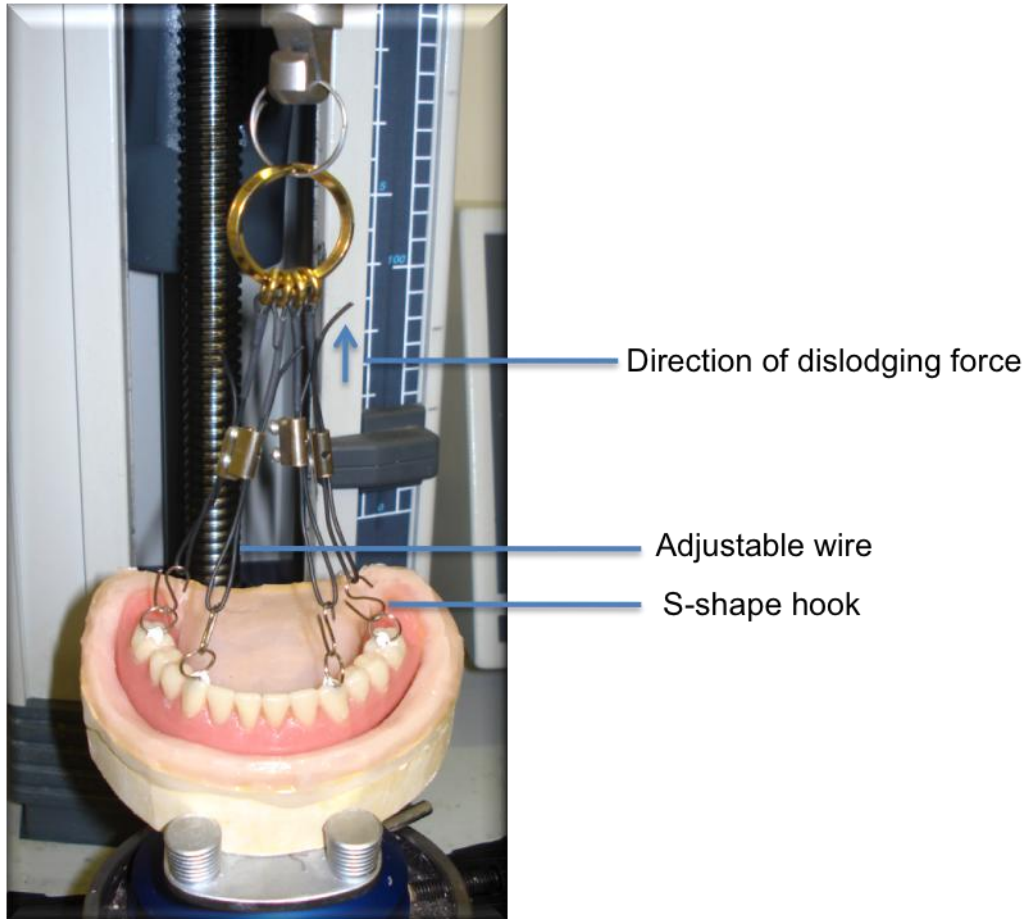

Figure 8-1: The well-fitting denture on the model connected to a tensile testing machine.

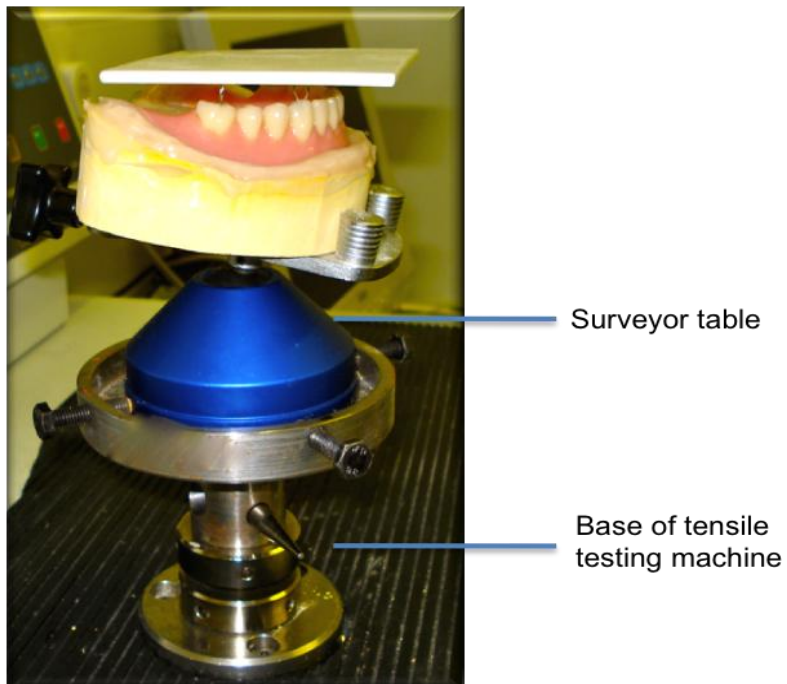

Figure 8-2: Adjusting the occlusal surface of the denture to make it parallel to the base of the tensile machine.

The retention force of the mandibular denture was tested on the tensile testing machine, by applying an axial upward pulling force. This measuring technique with the 4 holding points attached to the denture's occlusal surface was assumed to apply central dislodging force that detached the denture completely from underlying cast in one pull. But what actually happened that the anterior part of the denture detached while the posterior remain in contact with the cast. This could be due to the lack of centralization of dislodging force or due to anatomy of residual ridge which is not a flat surface to permit uniform dislodging action.

The aim of this experiment was to determine the optimum amount of artificial saliva and the ideal tensile speed to be used for subsequent, reproducible experiments. A series of retention experiments were conducted with different amounts of artificial saliva at different tensile speeds with the well-fitting denture.

To specify the optimum amount of saliva, two series of experiments were conducted with different amounts of saliva (0, 0.3, 0.5, 0.7, 0.9, 1.1 and 1.5 ml) at speed 50 mm/min, as this speed was suggested in previous literature (Rutkunas and Mizutani, 2004, Chung *et al.*, 2004, Rutkunas *et al.*, 2007) (the data illustrated in appendix 12.4).

To determine the ideal tensile speed, four series of experiments were conducted using the optimum amount of saliva (0.9 ml) at different speed of dislodgment (30, 50, 70 mm/min) (the data illustrated in appendix 12.5).

For each experiment, ten full separation tests were measured and the means are presented in the results. 'Loss of retention' in this experiment was taken as complete separation of the denture from the underlying supporting tissues.

## 8.1.2 Results

### 8.1.2.1 Determination of the optimum volume of saliva

With no saliva, retention of the mandibular denture was less than with the use of saliva with a force of 50 gf (Figure 8-3).

Retention increased significantly with the use of saliva, and increased subsequently with an increase in the amount of saliva till it peaked with 0.9 ml of saliva for both experiments (70, 65 gf).

The maximum retention force showed a reduction as the amount of saliva increased beyond 0.9 ml.

In the 1<sup>st</sup> experimental series, no significant differences were found with the use of 0.5, 0.7, and 0.9 ml of saliva; while in the second experiment there were no significant differences with the use of 0.3, 0.7 and 0.9 ml of saliva ( $P>0.05$ ).

Some statistical differences in the retention of the denture were observed with the use of the same amount of saliva in both experiment series as with the use of 0.3, 0.5, 0.7, 1.1 and 1.5 ml of saliva.



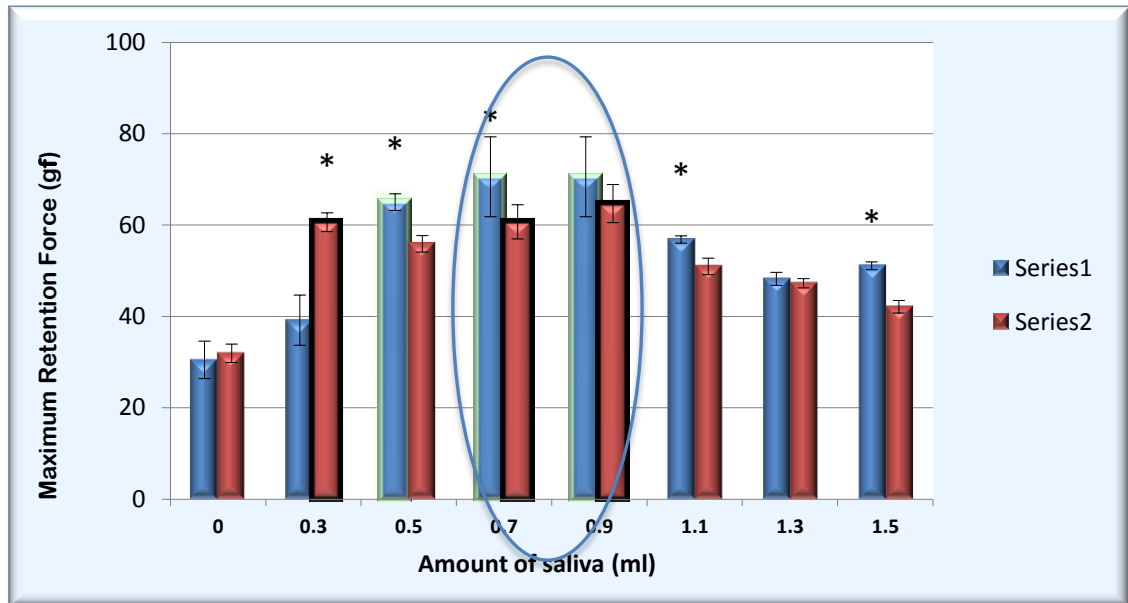

Figure 8-3: The effect of saliva amount on the retention of mandibular complete denture on the model with 50 mm/min tensile speed. The 1<sup>st</sup> and 2<sup>nd</sup> experiments (Series 1 and series 2) conducted with n=10 at each amount of saliva \* Represent a statistical difference between the two experiments with the use of the same amount of saliva. The oval shape encircles the most optimum amount of saliva.

### 8.1.2.2 Determination of the optimum tensile speed

The retention forces of the well-fitting complete denture at different dislodging speeds are shown in Figure 8-4. The maximum retention force was seen with a speed of 70 mm/min with a range from 60 – 74 gf in the four series of experiments, while with a speed of 50 mm/min the range was 52 - 71 gf. The minimum retention forces were seen at a speed of 30 mm/min with a range from 52 – 62 gf.

Some significant differences were observed between the retention forces of the four experiments conducted at different times with the same tensile speed.

The mean retention force of the well-fitting mandibular complete denture at each speed for the four experiments was shown in Figure 8-5. It can be clearly seen that the retention force increased significantly with an increase in dislodgment speed.

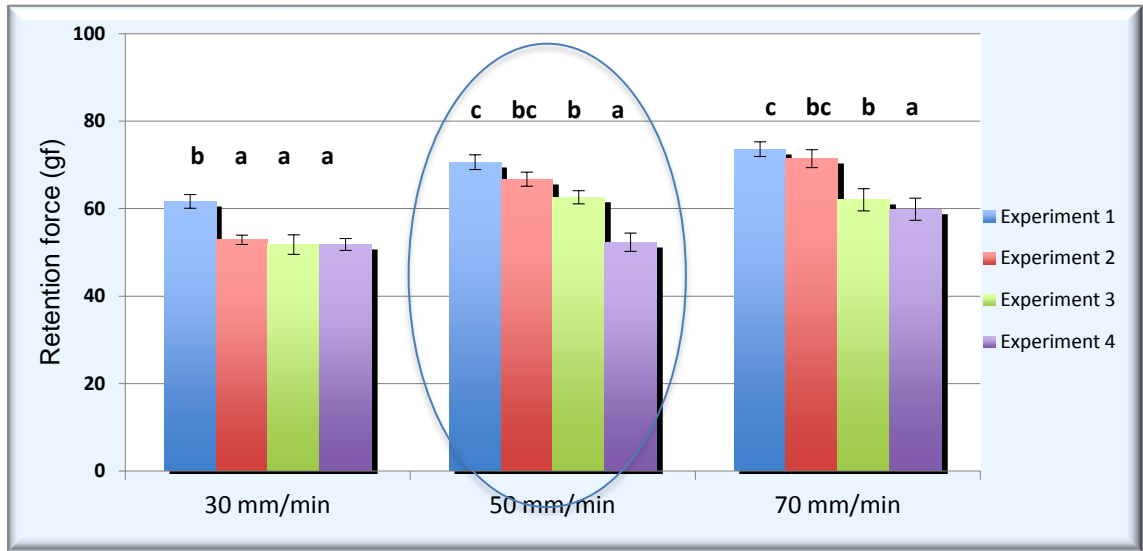

Figure 8-4: The effect of tensile speed on the retention force of mandibular complete denture with the use of 0.9 ml of saliva in four sets of experiments. In each experiment the retention of the denture was tested 10 times at each tensile speed. The letters represent statistical differences between the 4 sets of experiments at each tensile speed (different letters indicate significant differences). The oval shape encircles the chosen tensile speed.

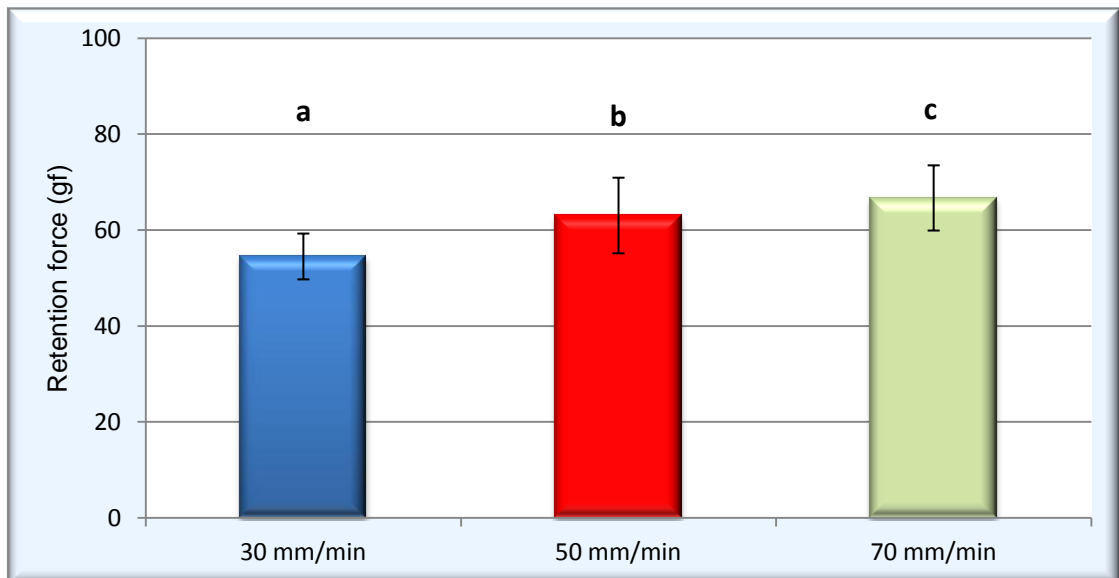

Figure 8-5: The mean retention force of a fitted mandibular complete denture at different tensile speeds (n=40). The letters represent the statistical differences between different tensile speeds.

### 8.1.3 Discussion

The amount of saliva plays an important role in the retention of the denture. With no saliva present, the minimum retention was observed (Figure 8-3). It has been suggested that the retention of dentures *in-vivo* is mainly related to the presence of saliva produced by salivary glands (Niedermeier and Krämer, 1992, Ostlund, 1960). This disagrees with earlier observations of other researchers who stated that retention was greater when the surfaces of the denture and mucosa were dried than when there was saliva between them (Skinner *et al.*, 1953, Stamoulis, 1962). However, current understanding of adhesion and cohesion between substrates would support the concept for an intervening film of saliva aids denture retention. Also, too much saliva can be detrimental; i.e. when the layer of saliva is increased in thickness, a reduction or even a loss of retention could happen as was confirmed by this current work.

The retention increased with the increased amount of saliva between the fitting surface of the denture and artificial mucosa layer until it formed a continuous thin layer of saliva, this was between 0.7 and 0.9 ml. When this amount was exceeded, the retention began to reduce. This agreed with Blahova and Neuman, (1971) who stated that as saliva accumulated around the denture, the physical retention factor (capillary attraction) reduces and little resistance is needed to pull them apart.

0.9 ml of saliva was chosen as the optimum volume as this provided the maximum retention force for the denture. It was chosen rather than 0.7 ml, which was not significantly different to 0.9 ml, as having slightly more saliva would compensate for any evaporation during testing.

As with the increased amount of saliva, an increase in tensile speed used to dislodge the denture away from the ridge, positively affects the retention and this is clearly demonstrated in Figure 8-5. The increase in retention force with the increase of tensile speed was explained according to Stefan's law. He stated that the magnitude of separating force of two parallel circular plates that are separated by liquid is positively proportional with the velocity of the applied force (Shay, 1997).

It was shown from the dislodgement speed results that the maximum retention of the denture was at a tensile speed of 70 mm/min, but the decision was made to consider a speed of 50 mm/min as being the optimum dislodgment speed for the denture retention tests on the *in-vitro* model. This was mainly because many previous reports in the literature were performing at a cross head speed of 50 mm/min (Rutkunas and Mizutani, 2004, Chung *et al.*, 2004, Rutkunas *et al.*, 2007), this cross head speed has also been reported by (Sarnat, 1983) to approximate clinically to the movement of the denture away from the edentulous ridge. Using this same speed would enable us to compare results with other studies, as the majority of them have used similar testing conditions. In addition, a speed 70 mm/min seemed very high compared to the *in-vivo* dislodgment of the denture when performing occlusal activity other than heavy mastication.

For both the saliva and tensile speed experiments, statistical differences were observed within the same sets of experiments, which were conducted at different days (Figure 8-3 and Figure 8-4). This finding confirmed Floystrand and Orstavik's observation in 1984 when they tested the retention ability of a complete denture against a unilateral occlusal load. They found that the

resistance against dislodgment varied considerably when tested on different days (Floystrand and Orstavik, 1984).

This variability could be due to the timing variation in the volume and resiliency of the supporting soft tissue, which is affected directly by uncontrollable finger pressure magnitude and direction when trying to seat the denture each time during the experiment. In addition changes in the surrounding environments such as laboratory temperature and humidity may have had an effect. The research laboratory used was not 100% controllable in this respect.

The differences could not be due to fluctuation in saliva qualities and quantities, which were tightly controlled, during the experiments. But any change in temperature may have affected the results. In order to reduce the effect of this variable, the experiment was repeated on different occasions (days).

### 8.1.3.1 Conclusions

- The optimum amount of saliva that gave the maximum retention force for the well-fitting mandibular complete denture on the model was 0.9 ml of saliva.
- The optimum tensile speed chosen to dislodge the well-fitting mandibular complete denture during retention tests on the *in-vitro* model was 50 mm/min.
- There is a good correlation between the denture retention *in-vitro* results obtained and the reported *in-vivo* data in the literature.

## **8.2 Assessment of retention of well and ill-fitting mandibular denture designs on the *in-vitro* model.**

After optimising the amount of saliva (0.9 ml) and tensile speed (50 mm/min) and determining the experiment procedures and measurements for a well-fitting mandibular complete denture, verification of the model was performed by comparing the retention forces of the well-fitting denture with ill-fitting dentures designs.

To test the model effectively to reflect differences in retention of different denture designs, two types of ill-fitting dentures (under and overextended) were fabricated.

### **8.2.1 Materials and methods**

In addition to the well-fitting denture, two types of mandibular complete denture design were used, over and under extended dentures.

The ill-fitting dentures were constructed by duplicating the well-fitting one using a die and counter die technique. A mould of the well-fitting denture was produced using a special duplicating silicone material (Dublisil, addition-vulcanising vinyl-polysiloxane, Dreve Dentamid GmbH, Unna/Germany) in a denture duplicating flask (Figure 8-6). After setting the silicone halves were separated and the denture was removed.

The flask was then reassembled and held together with elastic bands. Molten wax was then poured into one of the sprue holes cut into the silicone, until the mould was full (Figure 8-7). After cooling, the duplicate wax denture was carefully removed from the flask (Figure 8-8), and subsequently invested and

processed using heat cured resin (Aesthetic Basismaterial heat cure/ Candulor Zahne/ Pünten 4, Postfach 89 CH-8602, Wangen/ZH/Switzerland) with the same curing cycle used to cure the well-fitting denture (5 hours at 70°C and 2 hours at 95°C).

This procedure was repeated to obtain a second copy denture. The 1<sup>st</sup> one was trimmed to 2 mm from the border and 5 mm from the retro molar pad area to replicate an under extended denture. While the other duplicated denture was made to fit the model loosely by removing about 2 mm from the fitting surface of the denture and considered as an overextended denture (Figure 8-9).

Using the same retention experiment principles of the *in-vitro* model, the retention tests for the three types of denture were conducted on three different days with the use of 0.9 ml of saliva and at a 50 mm/min tensile speed to full denture separation from underlying tissues. 10 pulling actions were performed at each test for each denture (n=10).



Figure 8-6: The special flask for copying the well-fitted denture using Dublisisil silicone material.



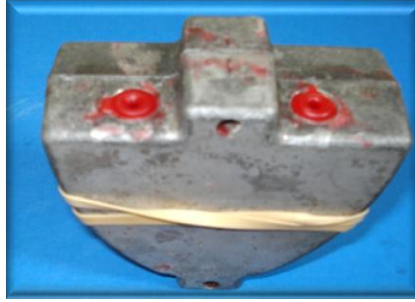

Figure 8-7: The wax has been poured into the denture space.



Figure 8-8: The resultant wax denture, which was carefully removed and processed in heat cured resin.



Figure 8-9: From left to right: under extended denture, well-fitting denture and overextended denture.

### 8.2.2 Results

Figure 8-10 shows the retention forces of the three different designs of denture at three different occasions using of 0.9 ml of saliva at a 50 mm/min tensile speed. The retention forces did not vary greatly during the test series of 10 pulling actions within the same occasion, but statistical differences were seen between the retention denture forces at different occasions for the same denture in the case of the well-fitting and overextended dentures.

The retention forces of the well-fitting denture were significantly higher than the retention seen for the ill-fitting denture (70 gf for well-fitting denture versus approximately 20 gf for ill-fitting dentures). The overextended denture showed significantly higher values than the under extended denture ( $P < 0.05$ ) (Figure 8-11).

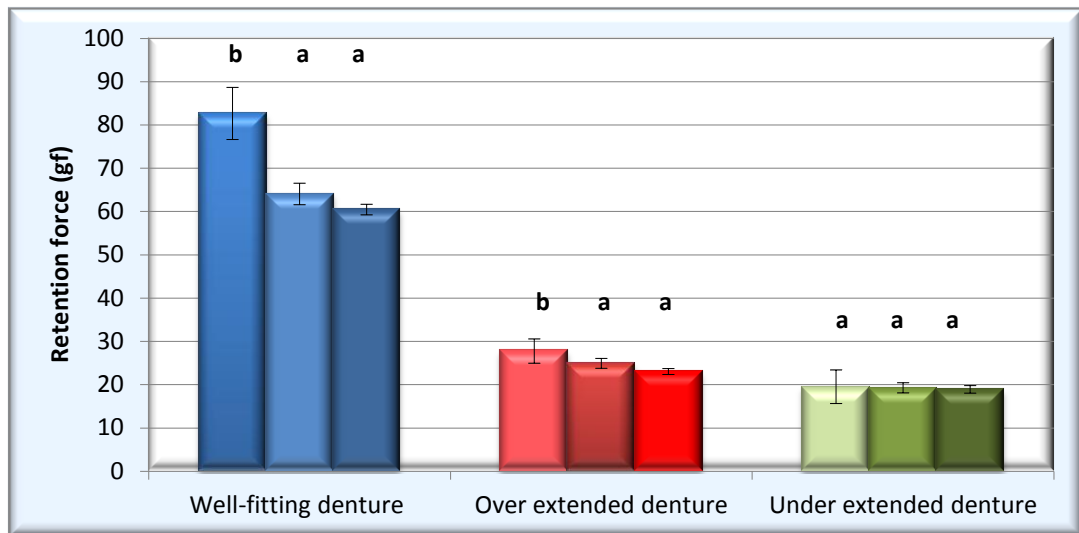

Figure 8-10: The retention forces of well and ill-fitting dentures at 3 different days when using 0.9 ml of artificial saliva at a 50 mm/min tensile speed ( $n=10$ ). The letters represent the statistical differences of the retention forces of the same denture at different days (different letters indicate significant differences ( $P < 0.05$ )).

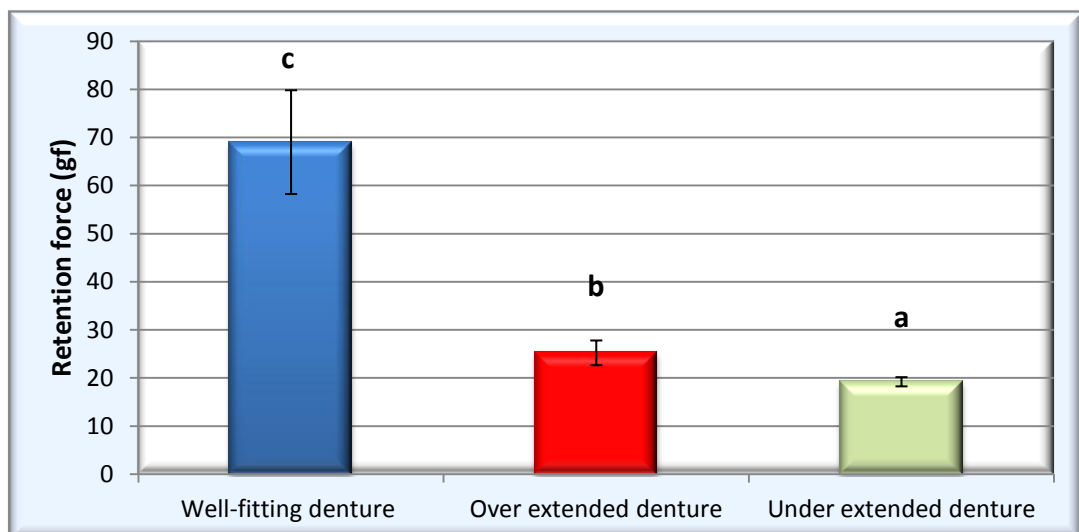

Figure 8-11: The mean retention forces (gf) of the three types of denture with artificial saliva at full separation of the denture from underlying artificial mucosa. The letters represent the statistical differences of the 3 types of dentures (different letters indicate significant differences ( $P < 0.05$ )).

### 8.2.3 Discussion

The results indicate that dislodgment loads remained relatively stable and did not vary greatly during a test series of 10 pulls within the same occasion, but statistical differences were seen between different experiment periods for the same denture agreeing with work by Floystrand and Orstavik, (1984) who demonstrated that complete maxillary dentures they tested *in-vivo* showed different retention rates on different days. This indicates that model factors governing retention did not vary greatly within a limited period, but day-to-day differences show that the retention factors cannot be expected to act equally on different days.

The retention forces of a well-fitting denture were much higher than the forces for ill-fitting dentures, and this underlines the importance of the maximum extension and good fit of the denture to its supporting tissues for optimum retention. This agreed with Ghani *et al.*, (1991) who found that the *in-vivo* retention force of well-fitted palatal plates were significantly higher compared to the values for ill-fitting plates.

The maximum coverage importance for retention even if it does not precisely fit the underlying ridge tissue, is also illustrated by the significantly better retention of the overextended denture compared to the under extension denture (Figure 8-11).

#### 8.2.4 Conclusions

- The *in-vitro* model effectively reflects differences in retention for dentures with differing degrees of ridge adaptation and compares well to the *in-vivo* findings.
- The retention for the well-fitting denture is much higher than for the ill-fitting dentures.
- The overextended denture provided better retention than the under extended denture.

### **8.3 The effect of denture adhesives on the retention of the different fitting dentures**

For further verification of the *in-vitro* model, the comparative retention of well and ill-fitting dentures, using different types of denture adhesives was conducted using a tensile testing machine.

Three types of mandibular complete denture designs were used as previously mentioned (Figure 8-9): A well-fitting denture, an overextended and an under extended denture.

Three types of popular, commercially used, denture fixatives were also used in this study (Table 8-1). They were used in accordance with the manufacturer's instructions.

#### **8.3.1 Denture adhesive mechanism of action**

Denture adhesive properties depend on both physical and chemical actions.

##### **Physical action**

The physical forces are based on a principle derived by Stefan law (Shay, 1997), which states that the force required to pull two plates apart is directly proportional to the viscosity of the liquid between them. Saliva increases the viscosity of the adhesives, and thus provides strong bio-adhesive and cohesive forces, thereby increasing the force required to separate the prosthesis from the oral surface.

Adhesive name	consistency	Composition	Company
PoliGrip® Ultra	Paste	<ul style="list-style-type: none"> <li>• Poly (methylvinylether/ maleic acid)</li> <li>• Sodium- magnesium-zinc mixed partial salt.</li> <li>• Petrolatum cellulose gum,</li> <li>• Paraffinum liquidum,</li> <li>• Silica,</li> <li>• Aroma,</li> <li>• CI 45430.</li> </ul>	GlaxoSmithKline, Stafford Miller Ltd, Dungarvan Co. Waterford, Ireland).
Fixodent® Neutral Taste	Paste	<ul style="list-style-type: none"> <li>• Calcium/Zinc PVM/MA Copolymer,</li> <li>• Paraffinum liquidum.</li> <li>• Cellulose gum.</li> <li>• Petrolatum.</li> <li>• Silica.</li> </ul>	Procter & Gamble, Technical Centres Ltd., Egham, Surrey, UK).
Super Wernets®	Powder	<ul style="list-style-type: none"> <li>• Cellulose Gum,</li> <li>• Dicalcium phosphate.</li> <li>• PEG-90M.</li> <li>• Sodium phosphate.</li> <li>• Aroma.</li> </ul>	GlaxoSmithKline, Stafford Miller Ltd, Dungarvan Co. Waterford, Ireland).

Table 8-1: The types of denture adhesives tested.

### Chemical action

Most adhesives contain ingredients that provide bio adhesion via carboxyl groups (-C(=O)OH). As the adhesive hydrates, free carboxyl groups form electrovalent bonds that produce the stickiness. Polymethyl vinyl ether-maleic anhydride (PVM-MA) copolymer is a synthetic compound widely used in denture adhesives because of its high level of carboxyl groups. While sodium carboxymethyl cellulose (CMC), is a naturally derived adhesive ingredient, and commonly used because of its carboxyl groups. CMC has the advantage of being more soluble in water than PVM-MA salts (Smita *et al.*, 2010).

Many manufacturers combine divalent salts of PVM-MA, with CMC to provide quick, up-front hold through the action of CMC and a hold of longer duration through the use of the PVM-MA divalent salt.

The divalent salt not only increases product performance by reducing the rate of dissolution, but it also increases the cohesive strength of the overall material by developing a highly cross-linked matrix between the CMC, PVM-MA copolymer and divalent calcium cation.

Recently, manufacturers have introduced products that combined PVM-MA zinc and calcium salts with CMC. These materials provide even greater cohesive strength for longer durations because of the stronger covalent bond that develops via the divalent zinc cation (Grasso, 1996).

The relative span of effectiveness of fixatives has not been fully studied, the influence of chemical and physical composition or the anatomy of the supporting tissue and denture base surface characteristic upon the performance of these materials, is also far from clear.

### **8.3.2 Materials and methods**

It was proposed that the *in-vitro* model would give a true assessment of a denture adhesives quality in static conditions with-out any contribution from surrounding tissues such as the lips, tongue, and cheeks.

In the model verification experiments undertaken with denture fixatives, retention has been expressed in term of the force required to dislodge the mandibular denture to a separation distance of 2.8 - 3.8 mm from the underlying ridge tissue using a tensile testing machine. This separation distance was determined by following the distance curve produced on the tensile tester and

the machine then stopped by pressing the stop button when the separation distance exceeded 2.5 mm (Figure 8-12).

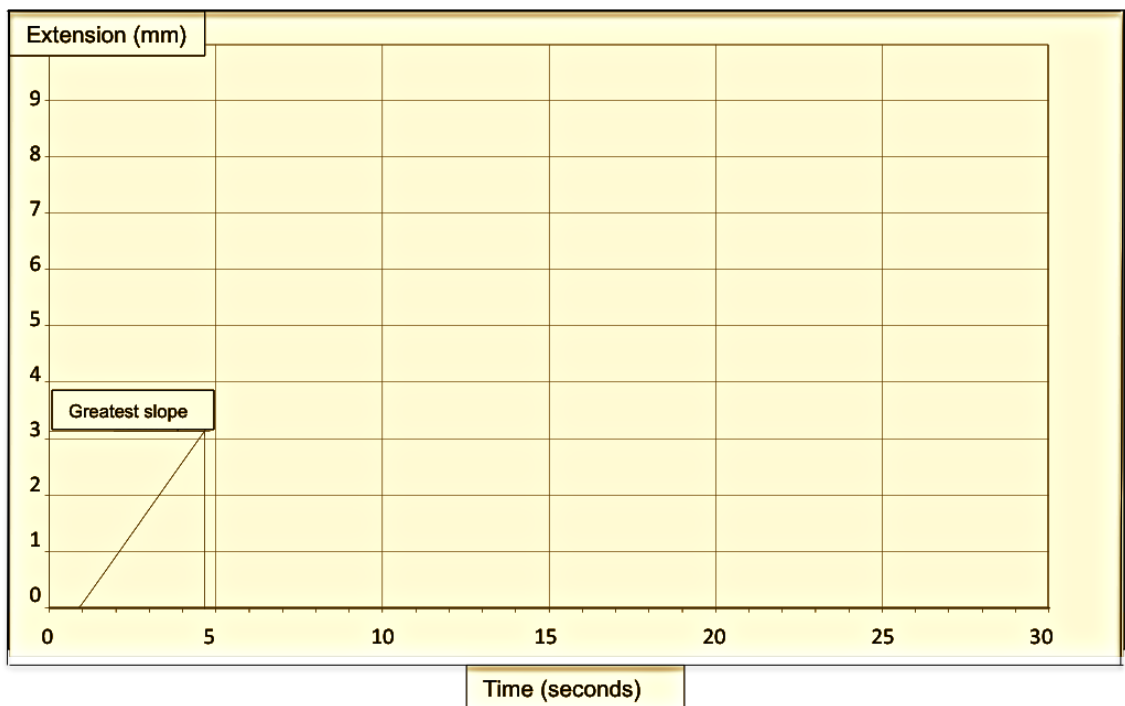
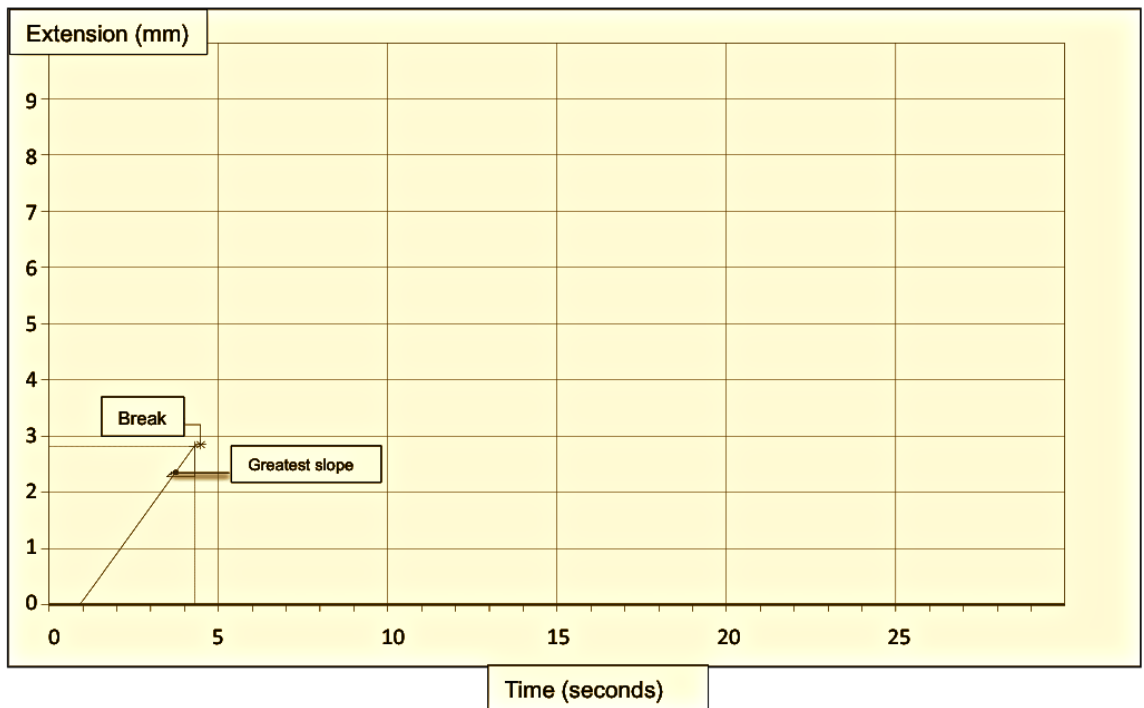

Figure 8-12: The separation distance of the denture from underlying tissue at which the retention force of denture adhesives was measured.



As a fair representation of the *in-vivo* situation as small lateral displacements or rocking and tipping are very difficult to measure accurately or reproducibly, the decision was made to consider this minimum separation (2.8 - 3.8 mm) as the basic separation distance that would occur in the patient mouth before full detachment would occur, this displacement will usually be transitory and may not reach a point of complete detachment.

The retention force for one well-fitting denture, one overextended, and one under extended denture for each of the denture fixative type tested was carried out.

The retention of each denture was measured first without the application of denture adhesives, using 0.9 ml of artificial saliva as the interface medium (n=10).

A tensile speed of 50 mm/min at a separation distance of (2.8 - 3.8 mm) was used. Then the denture was removed, thoroughly cleaned with water and liquid soap then thoroughly dried. Adhesive was applied onto the fitting surfaces of the mandibular dentures, the paste type applied in five strips of 8 mm at the frontal, right and left canine and 2nd molar areas as recommended by the manufacturer. Strips were measured with dividers (DB Orthodontics Ltd, Silsden, Keighley, UK) and excess removed with a wax knife (Figure 8-13).

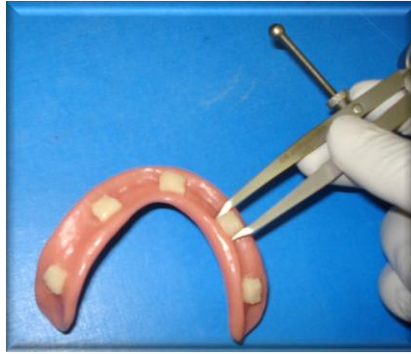

Figure 8-13: Five strips of past adhesive applied on the tissue surface of mandibular denture, 8 mm length measured using dividers.



Figure 8-14: 0.2 ml of powder adhesive applied on the moistened tissue surface of mandibular denture.

While the powder adhesive type was applied onto the moist fitting surfaces of the mandibular denture, 0.2 ml was found sufficient to make a uniform layer on the fitting surfaces of the mandibular dentures as recommended by manufacturers (Figure 8-14).

The dentures were then placed on the model after applying a new sample of artificial saliva (0.9 ml) on the ridge mucosa for each test and then pressed into position using moderate finger pressure for 2-3 seconds; the seating force could not be measured, but was carried out by the same operator each time. However, a study by (Norman *et al.*, 1987), found that the seating force of a thumb to the plate of a maxillary dentures was equal to 17.1 Newton.

The retention forces of the three types of dentures used with the adhesives were measured in two different series:

**Series one:** the retention was measured at different intervals up to a 5 hour period, the intervals were: 5 minutes, 1 hour, 3 hour and 5 hour intervals. These intervals were chosen according to Chew *et al.*, (1990) and Chew, (1985) who used this timing to test the *in-vitro* and *in-vivo* retention forces of adhesives. This period is considered as the maximum period that the denture wearer could leave a denture with adhesive attached in the mouth. 10 pulls were measured at each time interval, and the mean of these 10 pulls presented in the results.

A five minute break was given to the denture with adhesive before starting the test to allow moistening of the adhesive by the saliva (Manes *et al.*, 2011).

**Series two:** To provide ample time for the adhesive to exert whatever effect it might have on denture retention, an uninterrupted period of 5 hours was allowed to elapse between the application of the adhesive and the measurement of retention. The denture was not removed from the model after the application of the adhesive and before the retention measurement after 5 hours. Forty vertical pulls were conducted at the end of this period.

In both series of experiment, an addition of 0.1 ml of artificial saliva was added around the periphery of the denture after one hour of denture adhesive application and 0.2 ml at the 3 and 5 hours testing period to compensate for any evaporation from the original amount of saliva during this period.

The previous literature measured the retention effect of denture adhesives based on only one pull / interval, while in current experiments a mean of 10 - 40 pulls at different time intervals were considered for measuring the activity of

fixatives, to investigate if the 1<sup>st</sup> pull could give a true indication for the retention ability of the denture adhesives.

The data from well-fitting, under and overextended dentures with and without the use of the three types of adhesives in both experiment series were analyzed by one-way ANOVA at the 95% confidence intervals ( $P \leq 0.05$ ).

### **8.3.3 Results**

#### **8.3.3.1 Denture retention without adhesive**

In order to see if there are any substantial variations in retention of the same denture at different test occasions and on different days, a number of repeated tests were made (6 tests at different days which represent the 1<sup>st</sup> 10 pulls without adhesives at various time intervals and after 5 hours). These showed substantial variation between the dentures used in the study (Figure 8-15 to Figure 8-17).

Statistical differences were seen in the retention of the same denture on different days ( $P \leq 0.05$ ). The mean retention forces with no adhesives for the 3 types of dentures at various test occasions are presented in Figure 8-18.

The retention forces were significantly higher for the well-fitting denture compared to the values for the ill-fitting dentures. The values being more than doubled that of the ill-fitting dentures (50 gf for well-fitting denture compared to approximately 20 gf for ill-fitting dentures) ( $P < 0.05$ ).

The overextended denture showed significantly higher values than the under extended denture (22 gf versus 20 gf) ( $P < 0.05$ ).

## 8. Testing the retention on the *in-vitro* model

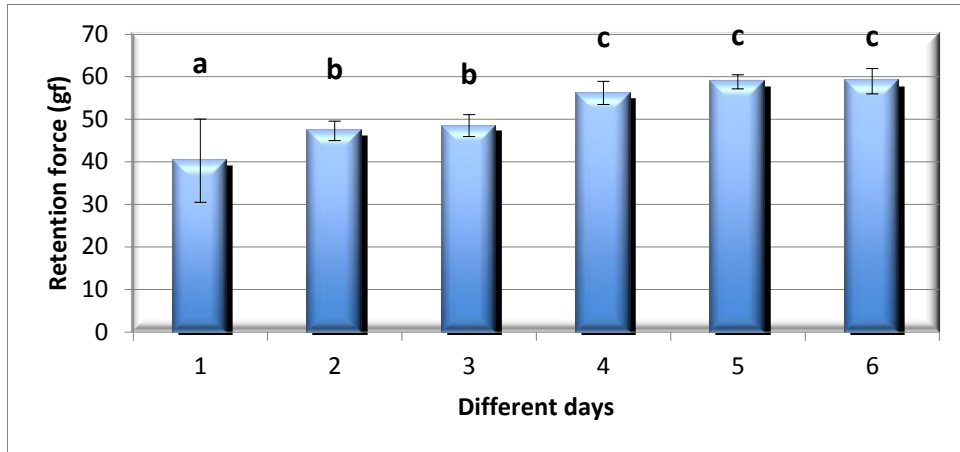

Figure 8-15: The retention forces of the well-fitting denture without adhesive at different days. The letters represent the statistical analysis of the retention forces of the denture (different letters indicate significant differences).

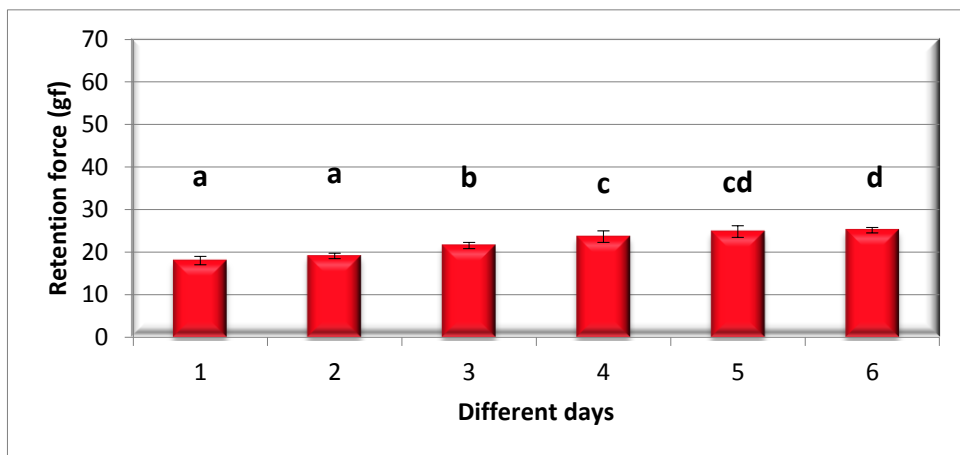

Figure 8-16: The retention forces of the overextended denture with no adhesive at different days. The letters represent the statistical analysis of the retention forces of the denture (different letters indicate significant differences).

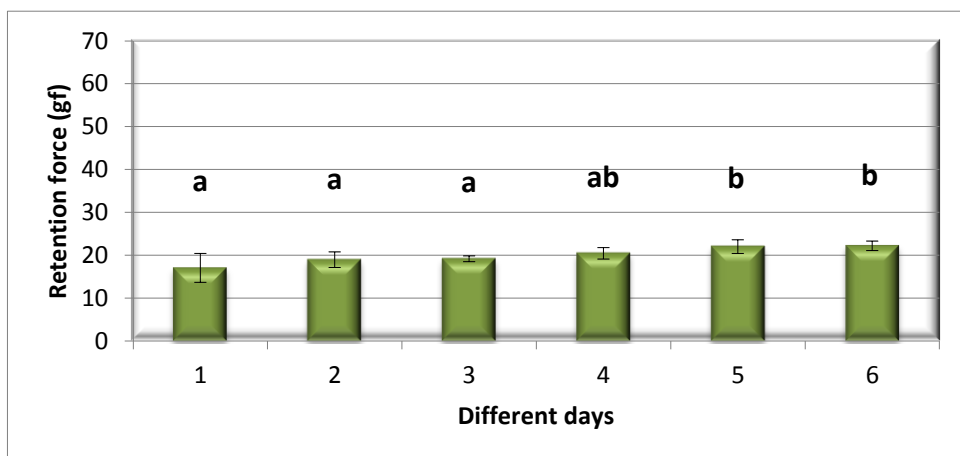

Figure 8-17: The retention forces of the under extended denture with no adhesive at different days. The letters represent the statistical analysis of the retention forces of the denture (different letters indicate significant differences).

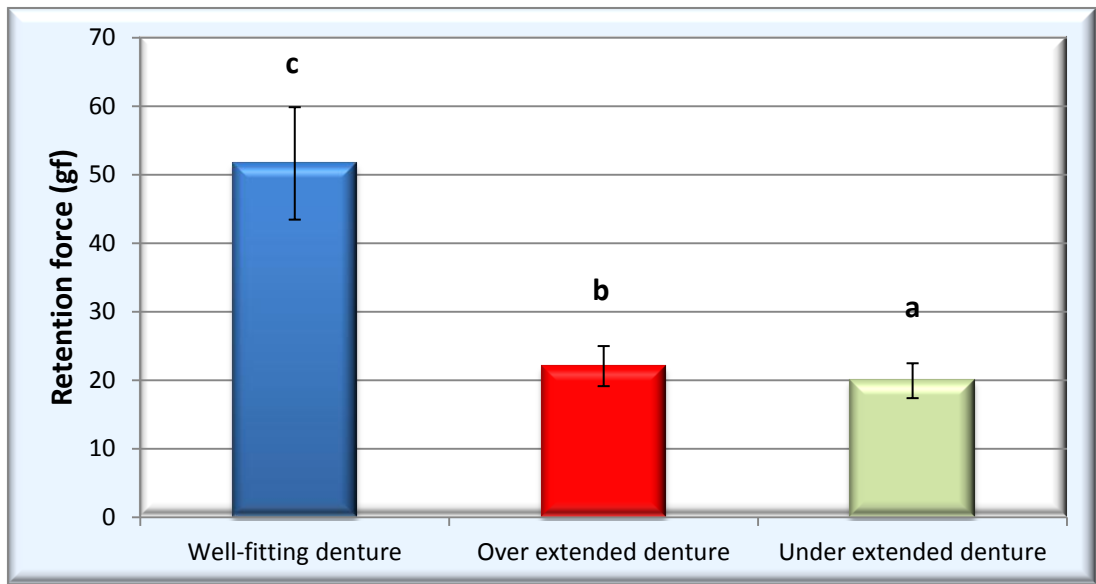

Figure 8-18: The mean retention forces (gf) of the three types of dentures with no adhesives used at 2.8 - 3.8 mm separation distance of the denture away from the underlying artificial mucosa. The letters represent the statistical analysis of the 3 types of dentures (different letters indicate significant differences).

### 8.3.3.2 Denture retention with adhesive

#### ◆ 1<sup>st</sup> series of experiments: time intervals from 5 minutes to 5 hours.

Data for retention forces of different denture designs at various time intervals up to 5 hours when using PoliGrip® adhesive are presented in Figure 7-19, Fixodent® adhesive in Figure 8-20 and with Wernets® in Figure 8-21.

It can be clearly seen that the denture adhesive improves the retention of all 3 types of dentures, when compared to the results with no adhesive one.

There was much more variation in the retention force of the well-fitting denture with all types of adhesives. This variance is indicated by the large standard deviation. Because the adhesives behaved differently with the well-fitting denture than with the ill-fitting dentures, and in order to clearly illustrate the effect of adhesives on denture retention, a comparison of adhesives used with each denture at different time intervals will be presented in addition to a comparison of different types of dentures at the same time interval.

The well-fitting denture tested with the three adhesives showed significantly higher retention forces at all time intervals ( $P \leq 0.05$ ), except at the end of the period 3 - 5 hours with PoliGrip® (Figure 8-19), and at the beginning of the period 5 minutes interval with Wernets® (Figure 8-21), where it was not significantly different from the retention forces of other types of dentures ( $P > 0.05$ ). With Fixodent® the well-fitting denture showed significantly higher retention force at all time intervals ( $P \leq 0.05$ ) (Figure 8-20).

While the retention of both ill-fitting dentures was not statistically different with all the tested adhesives at any of the time periods ( $P > 0.05$ ) (Figures 8-19 to 8-

21), except with the Wernets® adhesive at the end of the 5 hours. After 5 hours, Wernets® was significantly more effective in the overextended than in the underextended denture ( $P \leq 0.05$ ) (Figure 8-21).

The maximum retention force for the well-fitting denture was with PoliGrip® at the 5 minute interval (799 gf); for the overextended denture the maximum retention force was with Wernets® at the 5 hour interval (322 gf); and for the under extended denture it was with PoliGrip® at the 5 minute interval.

The minimum retention force with the well-fitting denture was with Wernets® at the 5 minute interval (174 gf), and for both ill-fitting dentures it was with Fixodent® at the 5 hour interval (113 gf for overextended denture, and 64 gf for the under extended denture).

The ill-fitting dentures with PoliGrip®, achieved their maximum retention at the beginning of the experiment (5 minute interval), and kept this maximum retention fairly constantly through the 5 hour intervals (Figure 8-19). While with Fixodent® adhesive, the ill-fitting dentures showed the highest level of retention at the 5 minute and 1 hour Intervals, then the retention began to drop off with a minimum retention seen at the 5 hour interval (Figure 8-20). In contrast, the retention with Wernets®, steadily rose to peak at the middle of the experimental period (1-3 hours) and then dropped off after this with the under extended denture, but kept its highest level of retention with the overextended denture at the end of 5 hour (Figure 8-21).

The maximum retention ability of PoliGrip® and Fixodent® with the well-fitted denture was from the 5 minute until the 3 hour intervals, but this activity statistically reduced at the 5 hour period (Figure 8-19 and Figure 8-20). While with Wernets®, the retention started at the 5 minute interval with a minimum



level (as with the case of ill-fitting dentures), peaked at the 3 hour period and ended at the 5 hour interval with the same retention level as at the 1 hour interval (Figure 8-21).

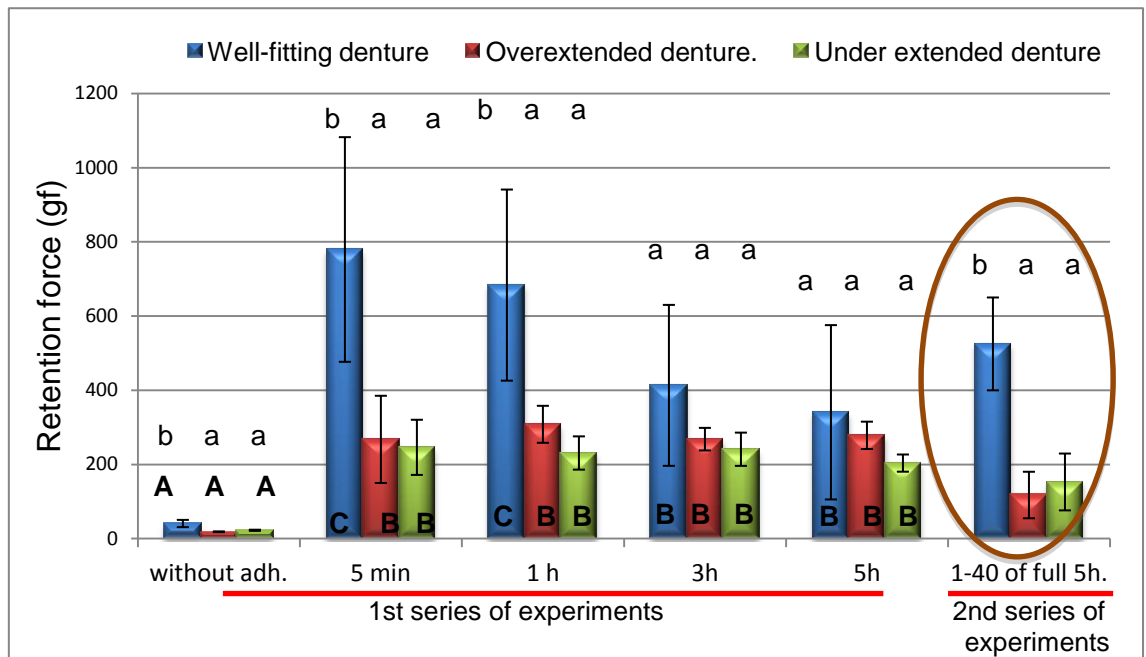

Figure 8-19: The retention force of 3 types of dentures with PoliGrip® adhesive over a period of 5 hours (series 1 & series 2 experiments). The small letters represent the statistical analysis of the 3 types of dentures at the same time interval; while the capital letters are for the same denture at each time interval (different letters indicate significant differences).

8. Testing the retention on the *in-vitro* model

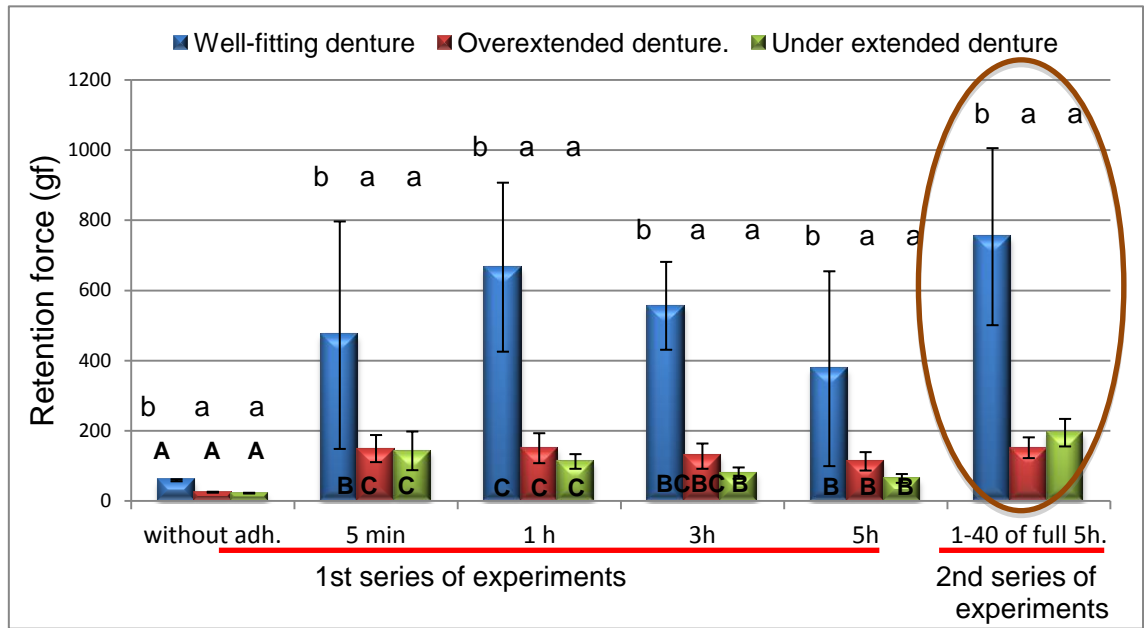

Figure 8-20: The retention force of 3 types of dentures with Fixodent® adhesive over a period of 5 hours (series 1 & series 2 experiments). The small letters represent the statistical analysis of the 3 types of dentures at the same time interval; while the capital letters are for the same denture at each time interval (different letters indicate significant differences).

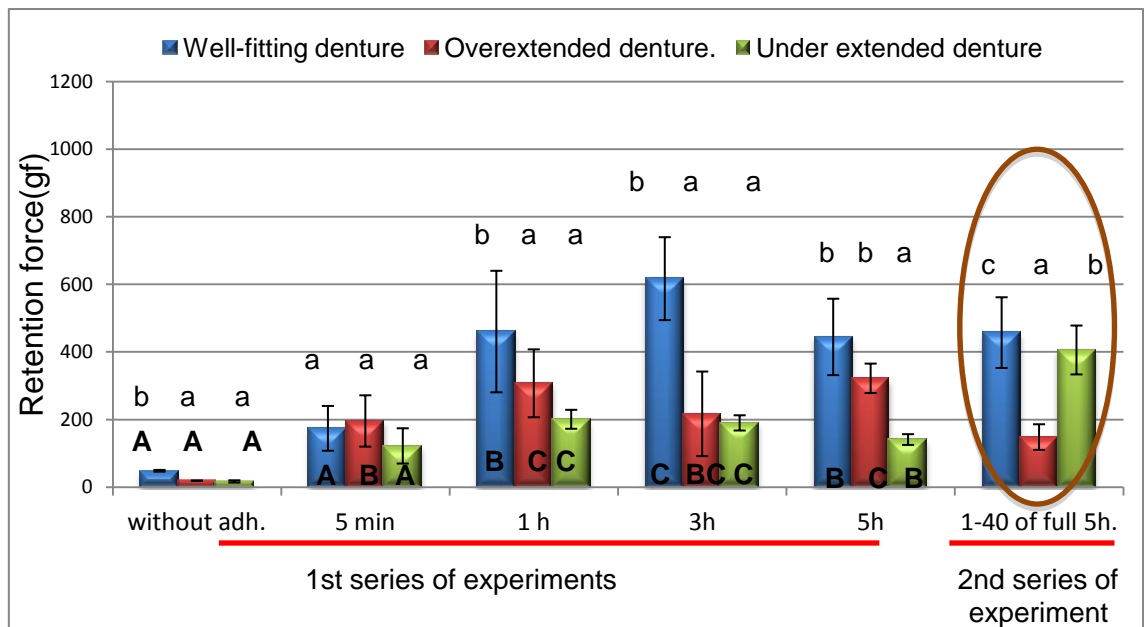

Figure 8-21: The retention force of 3 types of dentures with Wernets® adhesive over a period of 5 hours (series 1 & series 2 experiments). The small letters represent the statistical analysis of the 3 types of dentures at the same time interval; while the capital letters are for the same denture at each time interval (different letters indicate significant differences).

◆ **2<sup>nd</sup> series of experiments: adhesive left undisturbed on the model for 5 hours before testing (n=40).**

The retention forces of the 3 types of dentures after the application of adhesives for 5 hours showed an increase compared with the retention seen with no adhesives present. As with the 1<sup>st</sup> series of experiments, the retention force of the well-fitting denture showed the greatest retention values with all denture adhesives and was significantly better than the other two dentures ( $P \leq 0.05$ ) (The oval shape presented in Figures 8-19, 8-20 and 8-21).

There was no significant difference between the two ill-fitting dentures when adhesives were used in the case of PoliGrip® (Figure 8-19) and Fixodent® (Figure 8-20) ( $P > 0.05$ ), but with Wernets®, the under extended denture showed significantly higher retention than the over extension denture. This was the exact opposite of what was observed in case of Wernets® at the 1<sup>st</sup> series of experiments (Figure 8-21).

To follow the behaviour of denture adhesives during the sequence of each successive 10 pulls of the total 40 pulls after 5 hours of fixative application, the following trends were observed:

- The retention force of the well-fitting denture was statistically higher than that seen for the ill-fitting dentures in all successive 10 pulls with PoliGrip® (Figure 8-22) and Fixodent® (Figure 8-23) ( $P \leq 0.05$ ). But with Wernets®, it showed insignificant differences in the retention force with the under extended denture at the 1<sup>st</sup> and the 4<sup>th</sup> set of 10 pulls of the successive 40 pulls ( $P > 0.05$ ) (Figure 8-24).

- The retention force of PoliGrip® showed a steady downward trend for both well-fitting and under extended dentures (from 700 to 400 gf in the case of the well-fitting denture and from 200 to 100 gf in the case of the under extended denture). While retention of the overextended denture with PoliGrip®, stabilized at approximately 100 gf in the last 30 pulls of the 40 pull cycle which was significantly less than was seen for the 1<sup>st</sup> 10 pulls (200 gf) (Figure 8-22).
- The last 10 pulls with Fixodent® showed significantly higher retention force for the well-fitting denture at 900 gf ( $P \leq 0.05$ ), compared to the values in the preceding 30 pulls, which were not significantly different (from 600-800 gf). In contrast, the under extended denture showed significantly lower retention force during the last 10 pulls (100 gf) than for the preceding 30 pulls. The results for the overextended denture showed that the highest retention was in the 1<sup>st</sup> 10 pulls, which was 200 gf ( $P \leq 0.05$ ) (Figure 8-23).
- The retention ability of Wernets® used with the well-fitting denture was in direct contrast to Fixodent®, the last 10 pulls had significantly lower retention values than the preceding 30 pulls ( $P \leq 0.05$ ). With the overextended denture, the behaviour of Wernets® was directly opposite to PoliGrip® and Fixodent®, low retention values were seen from the 1<sup>st</sup> 10 pulls to the 3<sup>rd</sup> 10 pulls, but then showed significantly higher values at the 4<sup>th</sup> 10 pulls. While the retention for the under extended denture with Wernets® was significantly better than with the overextended denture ( $P < 0.05$ ) (Figure 8-24).

## 8. Testing the retention on the *in-vitro* model

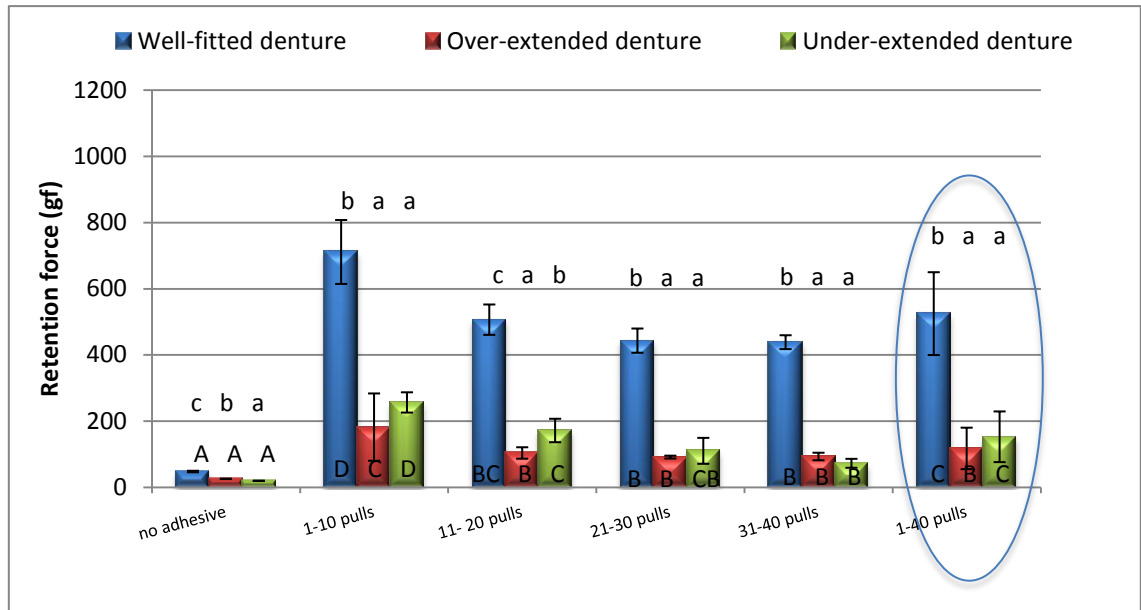

Figure 8-22: The mean of each 10 pulls of the 40 pulls of the retention force of 3 types of dentures with the use of PoliGrip® adhesive when left for 5 hours then 40 pulls conducted. The small letters represent statistical differences of the 3 types of dentures within each group, while the capital letters indicate statistical differences of the same denture at different groups (different letters indicate significant differences). The oval shape encircles the mean of all 40 pulls.

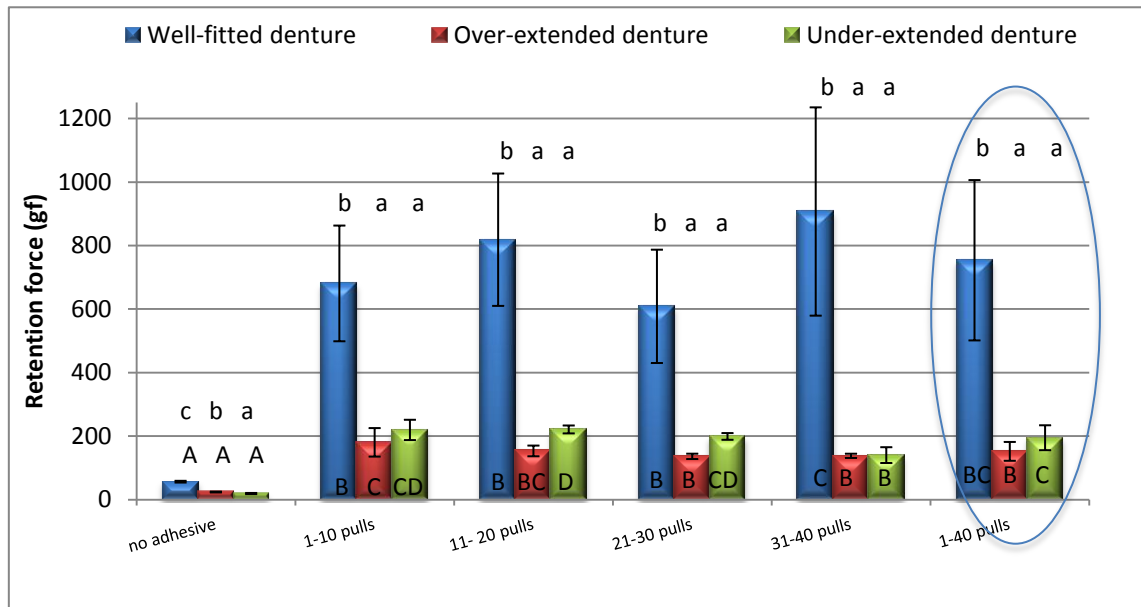

Figure 8-23: The mean of each 10 pulls of the 40 pulls of the retention force of 3 types of dentures with the use of Fixodent® adhesive when left for 5 hours then 40 pulls conducted. The small letters represent statistical differences of the 3 types of dentures within each group, while the capital letters indicate statistical differences of the same denture at different groups (different letters indicate significant differences). The oval shape encircles the mean of all 40 pulls.

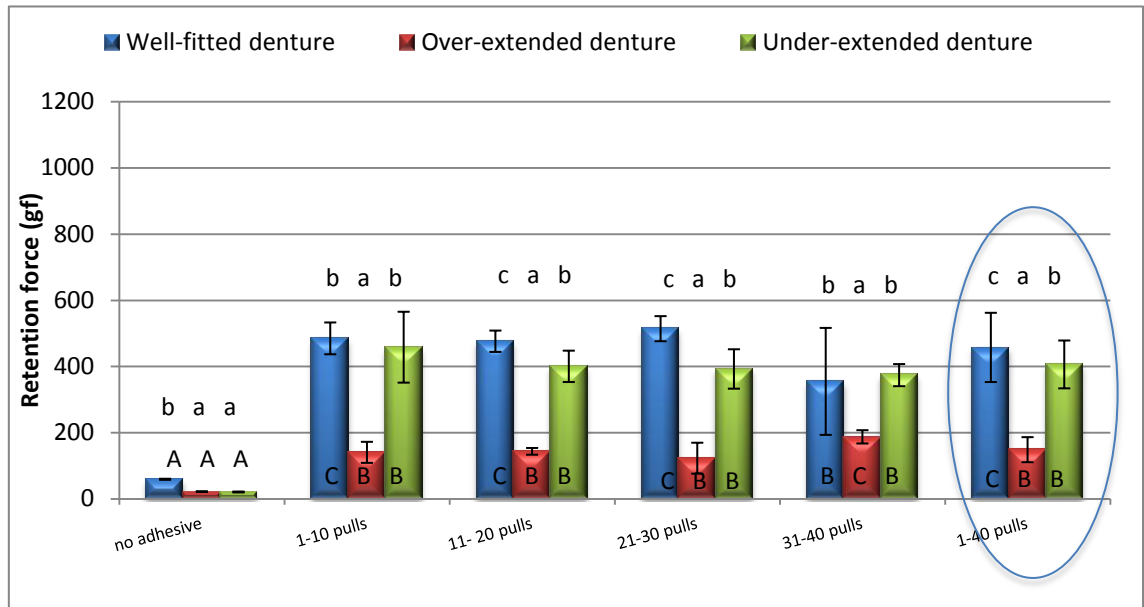

Figure 8-24: The mean of each 10 pulls of the 40 pulls of the retention force of 3 types of dentures with the use of Vernets® adhesive when left for 5 hours then 40 pulls conducted. The small letters represent statistical differences of the 3 types of dentures within each group, while the capital letters indicate statistical differences of the same denture at different groups (different letters indicate significant differences). The oval shape encircles the mean of all 40 pulls.

#### ◆ 1<sup>st</sup> series versus the 2<sup>nd</sup> series

To compare the retention of well and ill-fitting dentures at the beginning and the end of the 5 hours of fixatives application, and to illustrate the difference in the action of tested adhesives according to the time left after adhesive insertion and the start of tests, the 1<sup>st</sup> set of 10 pulls and the last 10 pulls of both experiment series were compared.

The comparisons of the adhesive activity with the 3 types of dentures are demonstrated in Figure 8-25 to Figure 8-27. This comparison was conducted to find the best testing procedure to reflect the true onset and duration of activity of the denture adhesives, and to investigate if the deterioration of adhesive retention is because of natural degradation of the contents or due to repeated denture dislodgment.

Generally, it is clear that the retention increased significantly when using adhesives, no matter what time was left before or during the testing procedure after the fixatives were applied.

The retention forces of the 1<sup>st</sup> 10 pulls of the ill-fitting denture with PoliGrip®, registered statistically the same values no matter what time was left after the adhesive was applied. While the retention at the end of the 1<sup>st</sup> experimental series (5 hour interval) was significantly higher compared to the last 10 pulls of the 2<sup>nd</sup> experiment series (full 5 hours) (Figure 8-25).

The ill-fitting dentures used with Fixodent® demonstrated the same retention values at the beginning and the end of both test series (Figure 8-26).

Figure 8-27 showed that the mean retention forces at the 1<sup>st</sup> and last 10 pulls for the under extended denture with Wernets®, in the 2<sup>nd</sup> experiment series was significantly higher than those seen in the 1<sup>st</sup> series of experiments, while the retention of the overextended denture was the same at the beginning for both experiment series, but significantly less at the end of series two ( $P < 0.05$ ).

In summary, the well-fitting dentures using PoliGrip® demonstrated the same retention values at the beginning and the end of both experiment's series (Figure 8-25), while with Fixodent® the retention was better at the beginning and end of the second series (Figure 8-26). Wernets® acted differently with the well-fitted denture, the retention in the 1<sup>st</sup> 10 pulls in the 2<sup>nd</sup> series was greater than in the 1<sup>st</sup> series with this condition reversed in the last 10 pulls (Figure 8-27).

## 8. Testing the retention on the *in-vitro* model

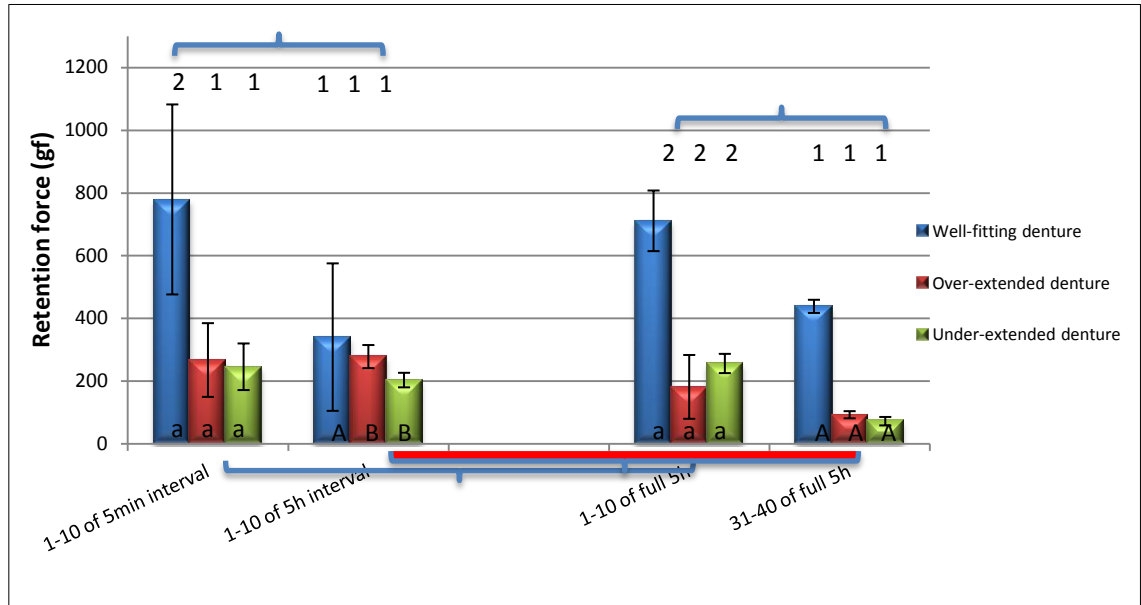

Figure 8-25: Comparing the 1<sup>st</sup> and last 10 pulls (intervals and full 5 hours tests) of 3 types of dentures with the use of PoliGrip® adhesive. The small letters represent the statistical differences of the 3 types of dentures at the 1<sup>st</sup> 10 pulls of both test series, while the capitals are for last 10 pulls of both test series (different letters indicate significant differences). The numbers represent the statistical differences between the 1<sup>st</sup> and last 10 pulls of each series (different numbers indicate significant differences between the results).

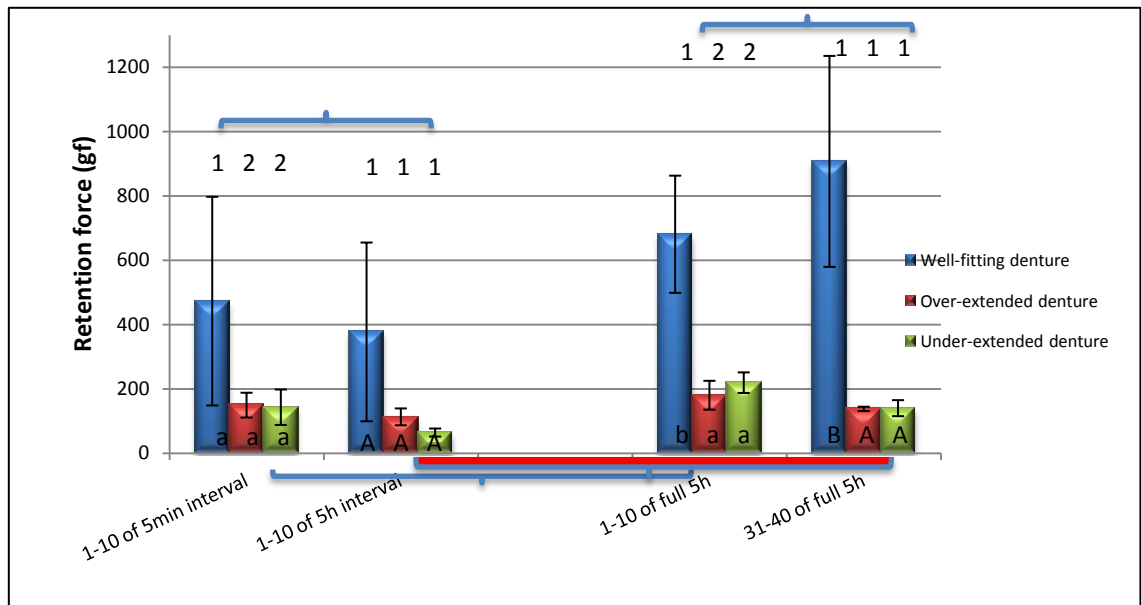

Figure 8-26: Comparing the 1<sup>st</sup> and last 10 pulls (intervals and full 5 hours tests) of 3 types of dentures with the use of Fixodent® adhesive. The small letters represent the statistical differences of the 3 types of dentures at the 1<sup>st</sup> 10 pulls of both test series, while the capitals are for last 10 pulls of both test series (different letters indicate significant differences). The numbers represent the statistical differences between the 1<sup>st</sup> and last 10 pulls of each series (different numbers indicate significant differences between the results).



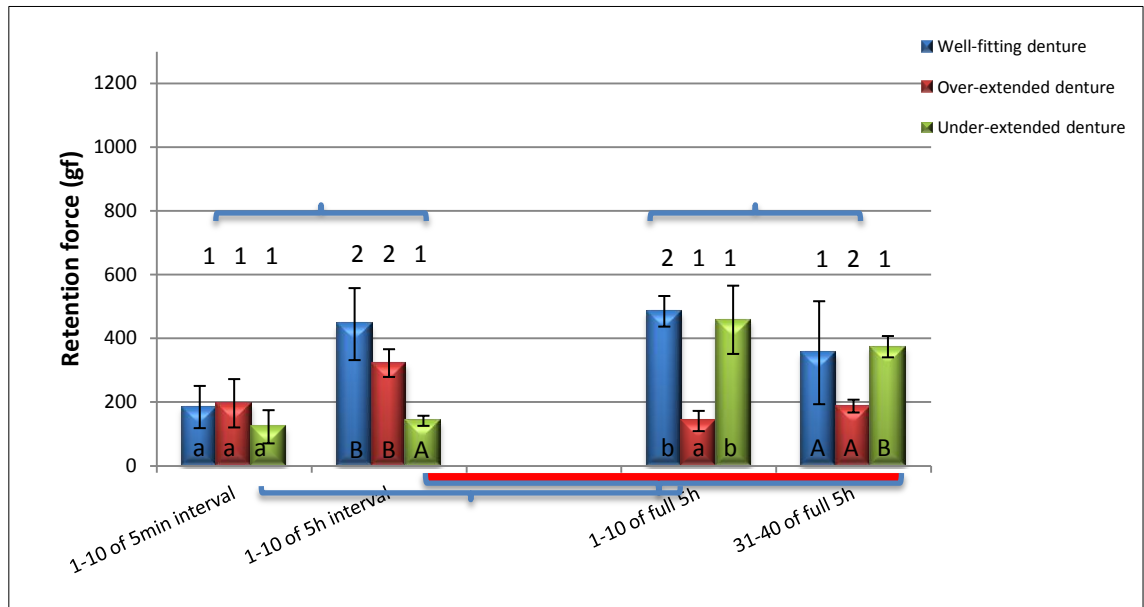

Figure 8-27: Comparing the 1<sup>st</sup> and last 10 pulls (intervals and full 5 hours tests) of 3 types of dentures with the use of Wernets® adhesive. The small letters represent the statistical differences of the 3 types of dentures at the 1<sup>st</sup> 10 pulls of both test series, while the capitals are for last 10 pulls of both test series (different letters indicate significant differences). The numbers represent the statistical differences between the 1<sup>st</sup> and last 10 pulls of each series (different numbers indicate significant differences between the results).

#### ◆ 1<sup>st</sup> pull versus the mean of its 10-40 pulls

Table 8-2 shows the data for each type of denture with the 3 types of test adhesive, including the 1<sup>st</sup> pull and the mean with standard deviation for each time intervals for the 1<sup>st</sup> and 2<sup>nd</sup> series of experiments.

It is interesting to observe that the 1<sup>st</sup> pull in each sequence approximates to the mean of 10 pulls when measuring the retention without adhesives. In addition the standard deviation of their means was low.

When using of adhesives the retention values increased dramatically, and the 1<sup>st</sup> pulls were mainly higher than the mean of the 10 pulls. However, this was not the case for all data, some data showed that the 1<sup>st</sup> pulls were lower than the mean of the 10 pulls. In addition the standard deviation was high when using adhesives, especially in the case of the well-fitting denture.

It is also interesting to notice that the 1<sup>st</sup> pulls after 5 hours of continuous adhesives application (series 2) showed higher retention than the 1<sup>st</sup> pulls after 5 minutes of adhesives insertion (series 1), except in the case of the overextended denture with PoliGrip® where the value was higher after 5 minutes of application.

8. Testing the retention on the *in-vitro* model

		<i>Intervals 5h</i>										<i>Full 5h.</i>								
		n=1	n=10	n=1	n=10	n=1	n=10	n=1	n=10	n=1	n=10	n=1	n=10	n=1	n=10	n=10	n=10	n=10	n=10	n=40
		1st pull (no adh.)	1-10 (no adh.)	1st pull (5min)	1-10 (5min)	1st pull (1h)	1-10 (1h)	1st pull (3h)	1-10 (3h)	1st pull (5h)	1-10 (5h)	1st pull (no adh.)	1-10 (no adh.)	1st pull (5h)	1-10 (5h)	11-20 (5h)	21-30 (5h)	31-40 (5h)	1-40 (5h)	
<b>Well-fitted</b>	<b>PoliGrip</b>	48	47 ± 6	179★	799 ± 303	960	683 ± 258	252★	412 ± 217	170★	371 ± 225	49	47 ± 2	956	711 ± 97	506 ± 46	443 ± 37	438 ± 21	525 ± 125	
	<b>Fixodent</b>	63	59 ± 3	588	473 ± 324	477★	666 ± 241	646★	556 ± 125	812	377 ± 278	54	56 ± 3	768	680 ± 182	818 ± 182	608 ± 182	907 ± 328	753 ± 252	
	<b>Wernets</b>	50	49 ± 3	218	174 ± 66	827	460 ± 180	407★	617 ± 123	635	445 ± 113	61	59 ± 2	560	485 ± 48	476 ± 32	514 ± 38	355 ± 162	457 ± 105	
<b>Over extended</b>	<b>PoliGrip</b>	18	18 ± 1	564	267 ± 118	436	308 ± 50	320	268 ± 30	374	278 ± 37	25	25 ± 1	397	181 ± 102	103 ± 17	91 ± 4	93 ± 11	117 ± 63	
	<b>Fixodent</b>	23	25 ± 1	233	149 ± 39	262	150 ± 43	220	128 ± 36	180	113 ± 26	23	24 ± 1	279	180 ± 45	153 ± 17	136 ± 8	138 ± 7	152 ± 30	
	<b>Wernets</b>	20	19 ± 1	120★	196 ± 76	199★	307 ± 100	157★	217 ± 125	427	322 ± 44	22	22 ± 1	218	140 ± 32	143 ± 10	122 ± 47	187 ± 20	148 ± 38	
<b>Under extended</b>	<b>PoliGrip</b>	25	22 ± 2	83★	246 ± 74	339	230 ± 45	335	240 ± 45	244	203 ± 23	19	19 ± 1	263	256 ± 31	171 ± 35	110 ± 39	72 ± 13	152 ± 77	
	<b>Fixodent</b>	24	22 ± 1	135★	143 ± 55	138★	112 ± 21	121	79 ± 16	98	64 ± 13	24	19 ± 2	268	219 ± 32	221 ± 12	199 ± 11	140 ± 25	195 ± 39	
	<b>Wernets</b>	21	17 ± 3	35★	122 ± 52	269	201 ± 28	251	190 ± 23	182	141 ± 16	22	20 ± 1	429★	480 ± 85	400 ± 47	392 ± 60	374 ± 33	406 ± 72	

Table 8-2: The 1<sup>st</sup> and the mean of 10 pulls of the intervals 5 hours experiment with the 1<sup>st</sup> pull and the mean of 10-40 pulls of the full 5 hours experiment with their standard deviation.

★ when the 1<sup>st</sup> pull was lower than the mean of 10 pulls.

### 8.3.4 Discussion

The model was able to provide good comparative data regarding the effectiveness of various denture adhesives.

In this type of test, the aim was to concentrate on the verification of the model to undertake comparative retention tests of different denture designs with and without the use of fixatives.

Certain points regarding the criteria of our experiments should be kept in mind: The sample size to measure the retention of dentures with adhesives was small (only one denture of each denture design), so any conclusion regarding the activity of adhesives should be considered with caution.

In addition the retention results were based on a mean of 1-10 pulls for each time interval and 1- 40 pulls in 2<sup>nd</sup> series of experiment, rather than only one pull for each time interval as used in most previous studies into adhesive retention.

The same amount of fixative was used for all denture types. However, it may be that the amount required for the well-fitting denture is not the same as that required for ill-fitting dentures.

Also, the seating force of the denture during the experiments was not measurable; finger pressure was therefore a potential variable.

Lastly the environmental condition (lab. temperature and humidity) was not 100% controllable, and variation in these variables may have taken place between experiments.

#### 8.3.4.1 Without Adhesives:

The results indicate that dislodgment loads remained relatively stable and did not vary greatly during a test series of 10 pulling actions within the same occasion. Statistical differences appeared between different experiment data for the same denture (Figure 8-15) and this agrees with other authors, who demonstrated that most of the complete maxillary dentures they tested *in-vivo* showed different retention values on different days (Floystrand and Orstavik, 1984). This indicated that model factors governing retention did not vary greatly within a limited period, but day-to-day differences show that the retention factors cannot necessarily be expected to be the same on different days.

Using finger pressure, as a method of seating the denture was not well controlled and does not favour good reproducibility in magnitude and duration (although it was conducted by the same researcher). This seating force was regarded significant with regard to the value for retention, which could influence the resistance to load. This load could also affect the distribution of saliva under the denture as well as the response of the viscoelastic synthetic tissue. In addition, the change in the surrounding environment (laboratory temperature and humidity) at different days may affect the results (Ow and Bearn, 1983).

Many previous literature pay attention to this variable, Skinner and Chung, (1951) seated the maxillary denture plates on their *in-vivo* aluminium model by applying 3000 g force for 5 seconds then applied pulling action using a weight of water to separate the plates from the model. While Norman *et al.*, (1987) used seating pressure of 17 N before measuring the effect of denture adhesives on the vertical dimension on an *in-vitro* metal maxillary model to ensure even adhesive distribution. Others applied 2 kg weight for 15 sec to seat their acrylic

resin samples with to test the compare the retentive activity of different denture adhesives (Koppang *et al.*, 1995, Zhao *et al.*, 2004). Lighter finger pressure of 200 g for 10 sec applied to seat maxillary plates of dentate participants measured by special hydraulic measuring device fixed on the outer surface of the plates to measure the effect of two different powder adhesives (Ow and Bearn, 1983). Ghani *et al.*, (1991) exerted seating force using retenometer of 10 N for 10 second to seat maxillary plates of dentate participant to test the force required to dislodge the well and ill-fitting palatal plates with and without denture adhesives.

The mean retention forces for all types of dentures when using saliva without adhesives were demonstrated in Figure 8-18. The retention forces of the well-fitted denture were substantially higher than the forces for the ill-fitting dentures, and this underlines the importance of maximum extension and the good fit of dentures to their supporting tissues, for optimum retention. This agreed with Ghani *et al.*, (1991) who found that the *in-vivo* retention force of well-fitting palatal plates were significantly higher compared to the values for ill-fitting plates.

The importance of maximum coverage for retention, even if it does not precisely fit the underlying ridge tissue, was also illustrated in the significantly better retention of the overextended denture compared to the under extended denture (Figure 8-18).

When comparing the retention using saliva at 2.8 - 3.8 mm of separation distance (Figure 8-18) and at full separation (Figure 8-11) showed approximately the same levels. The data, for the well-fitted denture at full separation, however, appeared slightly higher. This may be due to the smaller

sample size, which represented a mean of 30 pulls in the case of full separation and a mean of 60 pulls in the case of 2.8 - 3.8 mm of separation.

#### **8.3.4.2 With Adhesives**

This new approach into denture adhesive materials, with the limitation of pulling distance to only 2.8 - 3.8 mm distance away from the underlying tissue instead of full separation of the denture away from its base and using a mean of 10-40 pulls instead of considering only one pull, which have been used in almost all previous adhesive investigations, could add valuable information about the effect of repeated pulling action on the effectiveness of denture adhesives and would compare very well to what happens in reality when patients apply adhesive to their dentures.

The test method described for denture adhesives (considering the mean of 10 pulls at different time intervals) seems useful to assess the effectiveness of denture adhesives.

The results indicate that the 1<sup>st</sup> pull test did not necessarily give the highest retention value or an indication as to the effectiveness of the adhesive. There were differences between the 1<sup>st</sup> pull at different time intervals and their mean (Table 8-2).

#### **◆ 1<sup>st</sup> series of experiment: time intervals from 5 minutes to 5 hours**

The fixatives used in this study produced an instantaneous improvement in retention, which was statistically significant compared to the force shown with saliva only. At the end of the 5 hours period, retention was still greater than without adhesives (Figure 8-19 to Figure 8-21). However, the fixatives tested did not completely fulfil the criteria to provide an instantaneous improvement in

the retention after its application and thereafter be able to maintain a high level of retention over a period of 5 hours for all denture types. Generally, PoliGrip® fulfilled this criteria with ill-fitted dentures, but not with the well-fitting denture. Fixodent® adhesive had a rapid effect of retention which lessened toward the end of the 5 hours, whereas Wernets® showed the minimum retention force immediately after insertion and showed an increase in retention force over successive periods this disagreeing with Ghani *et al.*, (1991) who found that the maximum retention with powder was achieved immediately.

Results indicated that the adhesives improved retention of both well-fitting and ill-fitting dentures but exerted their greatest effect with the well-fitting denture, and thereby underline the importance of the good fit of the denture base to its supporting tissues. This disagrees with Chew *et al.*, (1985) who found that fixatives exert the greatest effect on ill-fitting dentures when measuring the denture dislodgment of maxillary complete dentures during function using kinesiograph<sup>4</sup>. But agreed with This agreed with Ghani *et al.*, (1991) who found that the retention of well-fitting palatal plates of dentate subjects with saliva was significantly higher than ill-fitting ones and the different type of denture adhesives (PoliGrip paste, Dentu hold liquid and Wernets powder) improved the retention of well and ill-fitting palatal plates immediately and for all time intervals (0, 3 and 6 hours). The results also agreed with other *in-vivo* studies conducted on the affectivity of denture adhesives on the retention of mandibular dentures conducted by Mirza *et al.*, (1983) and (1984) who tested the affectiveness of denture adhesives using a specially designed mechanical gadget to allow a

---

<sup>4</sup> A method used to graphically record the denture movements. The device has a sensor array fixed on the face of the patient and a small magnet-tracking device connected to the denture that records the spatial three-dimensional position during functional movement. The analysis would appear on a computerized system (Rodrigues *et al.*, 2003).



vertical pull action to the mandibular denture through the connection of a hook with an eye fixed to the outer surface of the denture. They found that denture adhesives significantly increase the retention of mandibular dentures immediately after insertion and the affectiveness become less 3 hours after insertion, then wears off after 24 hours. Manes *et al.*, (2011) also found a significant increase of mandibular denture with the use of denture adhesives using a simple measuring device (spring scale).

Substantial variation was seen in the retention force for the same denture at the same measurement occasion especially for the well-fitting denture. Part of this variation could be attributed to the uncontrolled finger loading force and loading pattern. This agreed with Chew *et al.*, (1985) when they measured maxillary denture dislodgment during chewing action using a kinesiograph at 1,3 and 5 hours after adhesive application (PoliGrip and Fixodent pastes and Secure powder). Their study found that there were no significant differences between adhesive affectiveness at different time intervals and there was no constant trend with regard to increase or decrease in effectiveness with time. The project results could not directly correlated with these results as they reflect the measurement of the adhesive affectivity during denture function.

Among other factors that could influence these variations is the amount of adhesive applied. The adhesive layer applied to the fitting surface of a well-fitting denture, which could be very thick depending on the minimum space between the inner surface of a well-fitting denture and the underlying tissue. Consequently there will be unequal pressure applied on the viscoelastic synthetic tissue that covers the extra-oral model. Thus it is necessary to investigate the effect of applying different amounts of adhesive on the retention

of well and ill-fitting dentures, in addition finding a way to seat the denture with a constant load magnitude and speed may lead to more predictable results, without being as variable as the denture retention. The irregularities in adhesive application, distribution and hydration or dryness of the fixative may also have contributed to some of the variation seen.

Although many other factors may also influence the behaviour of a denture fixative, its physical and chemical formulation (Table 8-1) seems to play an important role in its overall efficiency.

From the results of comparing both series of experiment (Figure 8-25 to Figure 8-27), it was difficult to decide if the denture adhesive deterioration is due to repeated periodic denture dislodgment from 5 minutes of adhesive application up to 5 hours, or due to the destruction of the gel matrix of the material itself when left for 5 hours before doing the test. To determine if this was a factor the 2<sup>nd</sup> series of experiments were conducted.

◆ **2<sup>nd</sup> series of experiments: adhesive left undisturbed on the model for 5 hours before testing (n=40).**

The behaviour of PoliGrip® and Fixodent® in the 2<sup>nd</sup> series of experiments matched the 1<sup>st</sup> series; the well-fitting denture had significantly more retention than the ill-fitting dentures which showed the same retention forces. It seemed that the repeated denture dislodgment (series 1) and the natural adhesives degradation (series 2) had the same effect on PoliGrip® and Fixodent®. While in the case of Wernets® , the uninterrupted 5 hours improved its retention ability with the under extension denture rather than the overextended denture, it appeared that the oily free powder type of adhesives when left uninterrupted dissolve more by the action of saliva which leave the overextended denture

without sufficient amount of fixative, in contrast the remaining amount of Wernets® would be an ideal amount for the under extended denture.

The highest values for the 1<sup>st</sup> pulls after seating the denture with adhesive for an uninterrupted 5 hours in the 2<sup>nd</sup> series of experiment, compared to the 1<sup>st</sup> pull after 5 minutes of application in the 1<sup>st</sup> series of experiment (Table 8-2) indicate that the adhesive could act better if the patient applied the adhesive for a longer time prior to performing masticatory loading.

From the description above, it was difficult to be precise as to the specific trend of behaviour of adhesives in both experiment series. The cause of the variable results observed could be due to the small sample size equal to only one denture type per tested denture adhesives.

### 8.3.5 Conclusions

- The results obtained from previous experiments for different denture designs indicate the suitability of the *in-vitro* model for testing denture retention, both with and without denture adhesives.
- Denture adhesives increased denture retention for all three types of dentures immediately after application. At the end of 5 hours period of application, the retention of dentures with fixative was still better than without adhesive.
- Denture adhesives significantly improve denture retention when a complete denture is covering the maximum ridge area with close adaptation to the underlying tissues. Ill-fitting dentures will benefit from adhesive but to a lesser degree especially with PoliGrip® and Wernets®.
- When using denture adhesives, a large scatter was obtained from tests performed on different days and for various time intervals.
- Due to the small size of the sample population and many other interrelated factors influence denture retention, the findings should be used with caution for any denture adhesive retention conclusions.
- *In-vitro* comparative testing of different denture designs and different denture adhesives can be made prior to carrying out *in-vivo* testing, using the model presented.

## **8.4 The effect of denture adhesives on the retention of each denture type**

In this section, the results obtained to show the effect of denture adhesives on the retention of each type of dentures (well-fitting, overextended and under extended). The experiment was conducted in two different modes, according to the time intervals between the tests:

**Series 1:** Testing at different time intervals up to 5 hours: 5 minutes, 1 hour, 3 hours and 5 hours. 10 pulls were performed at each time interval.

**Series 2:** The 'denture adhesive' system was left uninterrupted for 5 hours before conducting a retention test of 40 continuous pulls.

### **8.4.1 Method**

The data displayed in this section is the data of section 8.3, but displayed differently to illustrate the effectiveness of the three adhesives (PoliGrip®, Fixodent® and Wernets®) for each type of denture.

### **8.4.2 Results**

#### **8.4.2.1 Series 1 Results**

With the well-fitting denture, PoliGrip® was significantly more effective than Wernets® 5 minutes after application ( $P < 0.05$ ). In contrast, it was significantly less effective than Wernets® at the 3 hour interval. The three fixatives behaved similarly to each other at the 1h and 5 hour test point ( $P > 0.05$ ) (Figure 8-28).

With the overextended denture, PoliGrip® and Wernets® showed similar retention activity at all time intervals ( $P > 0.05$ ). Fixodent® was significantly less

effective than the PoliGrip® at all time intervals, and less than Wernets® at the 1 hour and 5 hour intervals ( $P < 0.05$ ) (Figure 8-29).

PoliGrip® with the under extended denture showed significantly higher retention activity at all time intervals ( $P < 0.05$ ), except at the 1 hour period where it was similar to Wernets® ( $P > 0.05$ ). Wernets® was significantly more retention than Fixodent® at 1, 3 and 5 hour intervals (Figure 8-30).

#### **8.4.2.2 Series 2 Results**

With the well-fitting denture, Fixodent® was more effective than the other two denture tested in the 2<sup>nd</sup> series of experiment as shown in Figure 8-28. It is clear that Fixodent® retention effect with well fitting denture at the end of 5 hours, was doubled in the second series of experiment compared to the first series (Figure 8-28), in contrast, however, Wernets® retention effect was approximately the same and PoliGrip® was slightly higher than that observed in the 1<sup>st</sup> series of experiment.

With the overextended denture, Wernets® showed good retention, similar to Fixodent® when left for 5 hours before the pulling actions were performed. While PoliGrip® was significantly less adhesive than either of these two adhesives ( $P < 0.05$ ). However, the Wernets® and PoliGrip® retention values in this case were generally less than those seen in the 1<sup>st</sup> series of experiments (Figure 8-29).

With the under extended denture, Wernets® showed significantly better retention than the others (Figure 8-30). With continuous 40 pulls in the second series of tests, PoliGrip® with the under extended denture, deteriorated more, Fixodent® showed slightly better retention, While Wernets® showed

approximately double the retention values compared to the 1<sup>st</sup> series of tests (Figure 8-30).

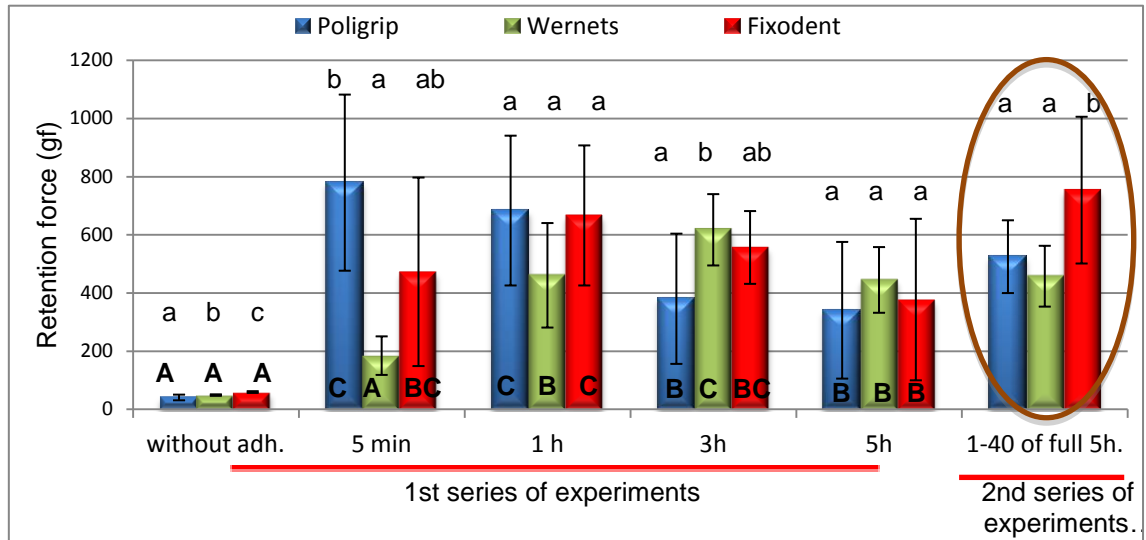

Figure 8-28: The retention forces for the well-fitting denture with the use of different tested adhesives over a period of 5 hours (series 1 & series 2 experiments). The small letters represent statistical differences of the 3 types of denture adhesive at each time interval, while the capital indicate statistical differences of the same denture adhesive at different time intervals (different letters indicate significant differences).

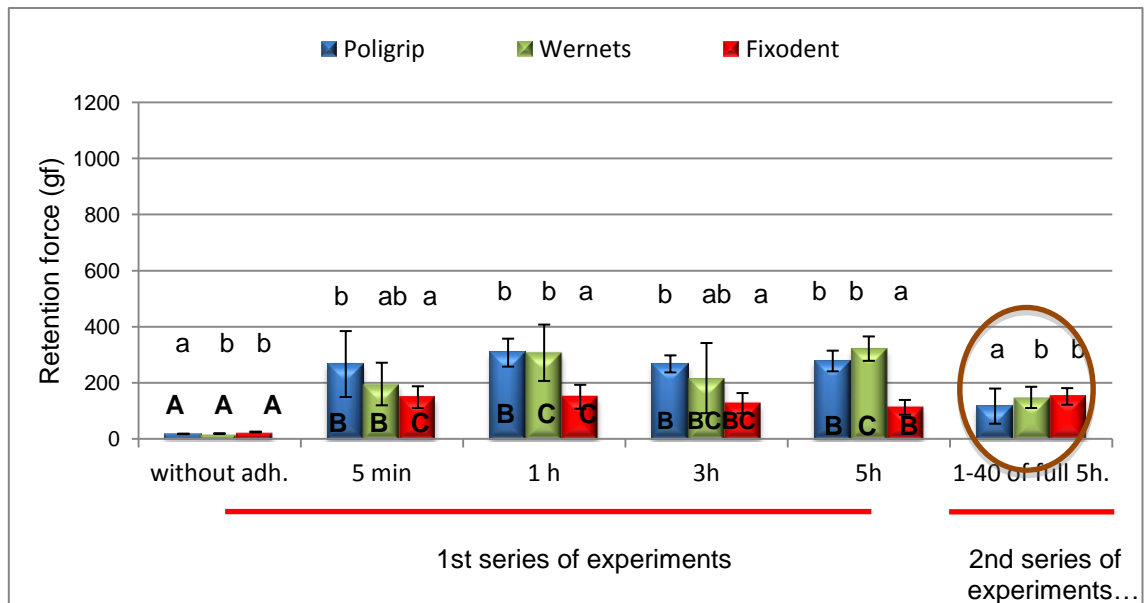

Figure 8-29: The retention forces for the overextended denture with the use of different tested adhesives over a period of 5 hours (series 1 & series 2 experiments). The small letters represent statistical differences of the 3 types of denture adhesive at each time interval, while the capital indicate statistical differences of the same denture adhesive at different time intervals (different letters indicate significant differences).

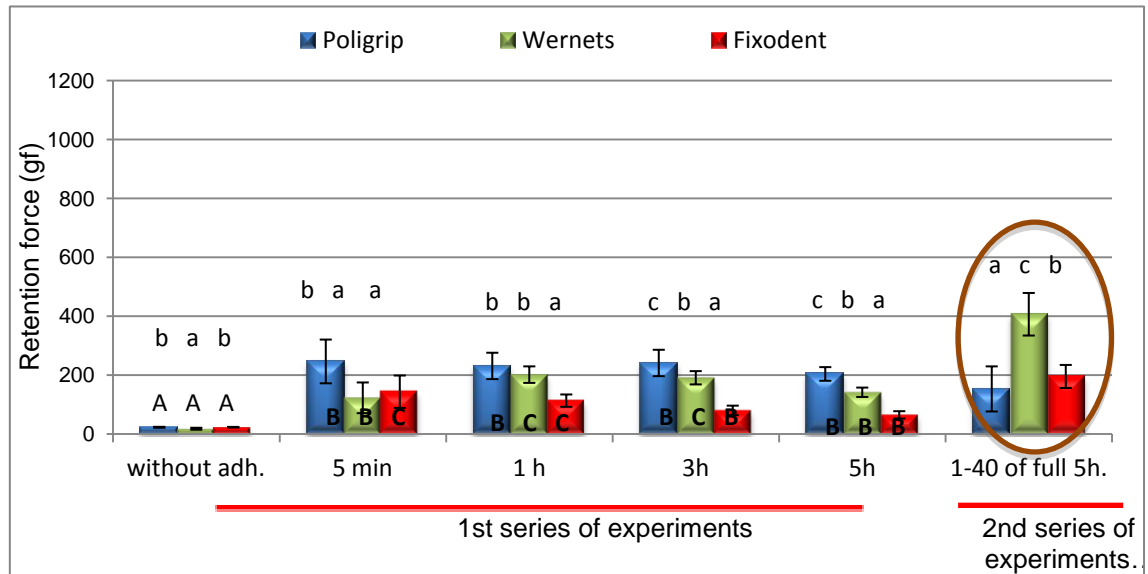

Figure 8-30: The retention forces for the under extended denture with the use of different tested adhesives over a period of 5 hours (series 1 & series 2 experiments). The small letters represent statistical differences of the 3 types of denture adhesive at each time interval, while the capital indicate statistical differences of the same denture adhesive at different time intervals (different letters indicate significant differences).

#### 8.4.2.3 Series 1 versus Series 2 Results

The retention of adhesives with the well-fitting denture at the 1<sup>st</sup> 10 pulls and the last 10 pulls of both test series is demonstrated in Figure 8-31. PoliGrip®, showed significantly same retention at the beginning and the end of both series. Wernets® effectivity at the 1<sup>st</sup> 10 pulls of the series 1 was statistically less than in series 2, but showed the same retention value at the last 10 pulls of both series. Fixodent®, showed more retention at the beginning and the end of series 2 than in series 1 experiments.

With overextended denture, PoliGrip® and Wernets® were found to be equally effective at the 1<sup>st</sup> 10 pulls of both series ( $P < 0.05$ ), but their effectivity were statistically less at the last 10 pulls of series 2 than the end of series 1 (Figure 8-32). Fixodent® showed same effectivity at the beginning and the end of both series.



Generally, the retention values of PoliGrip® and Wernets® were adversely affected by the repeated pulling action.

With an under extended denture, PoliGrip® was with same effectivity at the beginning of both series, but deteriorated more at the last 10 pulls of the series 2 experiment, Fixodent® and Wernets® showed better retention at the beginning and the end of series 2 experiment than at series 1 (Figure 8-33).

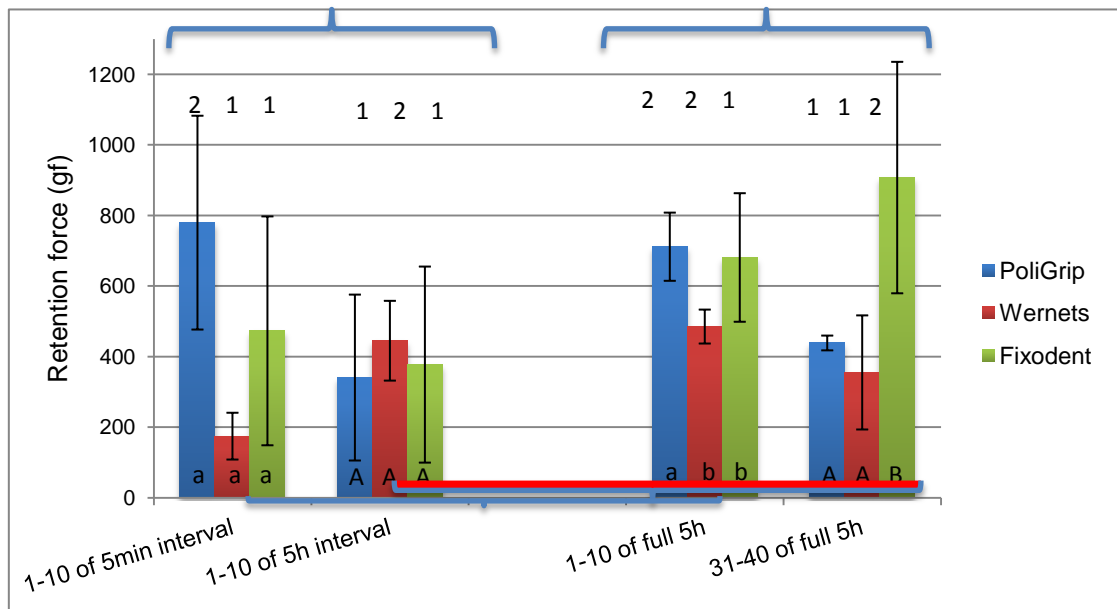

Figure 8-31: Comparing the 1st and last 10 pulls (intervals and full 5 hours tests) of the well-fitting denture with the use of three types of denture adhesive. The small letters represent the statistical differences of the 3 types of denture adhesives at the 1st 10 pulls of both test series, while the capitals are for last 10 pulls of both test series (different letters indicate significant differences). The numbers represent the statistical differences between the 1st and last 10 pulls of each series (different numbers indicate significant differences between the results).

8. Testing the retention on the *in-vitro* model

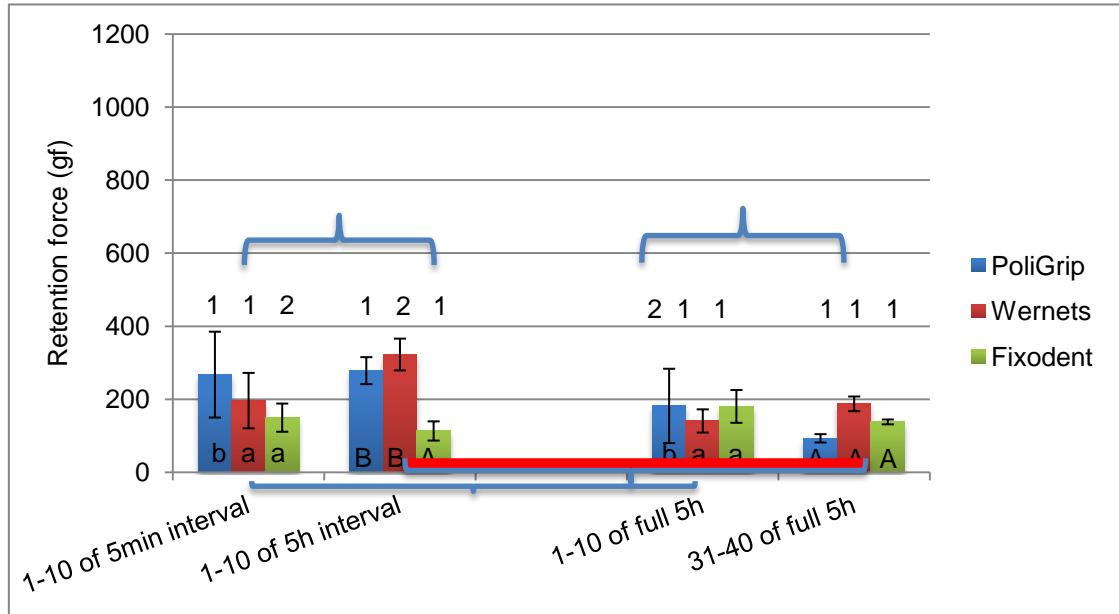

Figure 8-32: Comparing the 1st and last 10 pulls (intervals and full 5 hours tests) of the overextended denture with the use of three types of denture adhesive. The small letters represent the statistical differences of the 3 types of denture adhesives at the 1st 10 pulls of both test series, while the capitals are for last 10 pulls of both test series (different letters indicate significant differences). The numbers represent the statistical differences between the 1st and last 10 pulls of each series (different numbers indicate significant differences between the results).

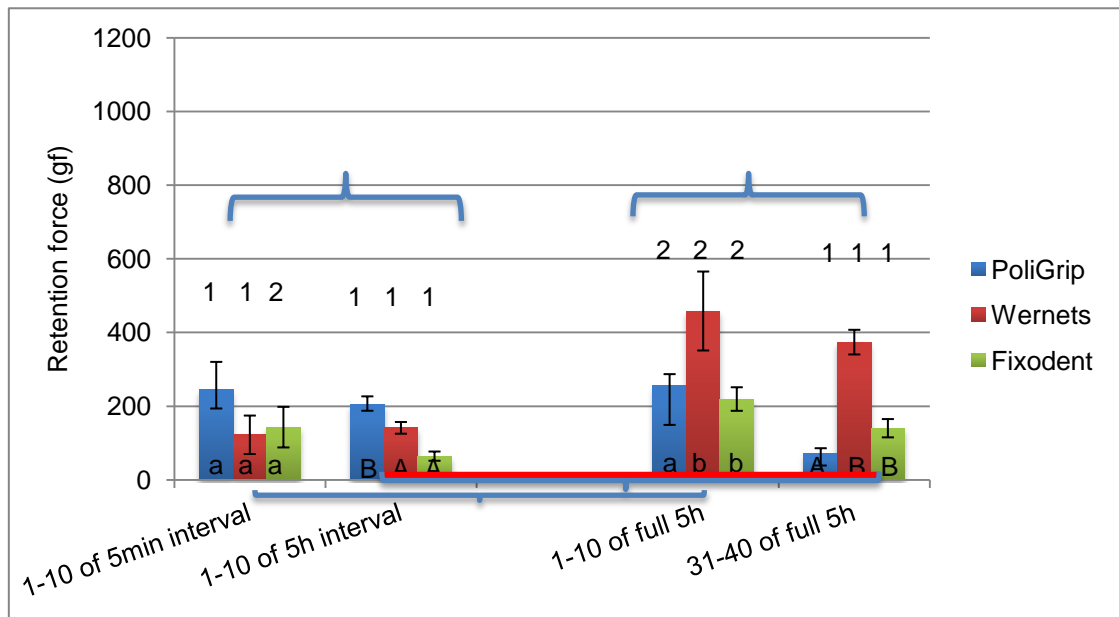

Figure 8-33: Comparing the 1st and last 10 pulls (intervals and full 5 hours tests) of the under extended denture with the use of three types of denture adhesive. The small letters represent the statistical differences of the 3 types of denture adhesives at the 1st 10 pulls of both test series, while the capitals are for last 10 pulls of both test series (different letters indicate significant differences). The numbers represent the statistical differences between the 1st and last 10 pulls of each series (different numbers indicate significant differences between the results).

### 8.4.3 Discussion

The results showed that there were variations in denture adhesives performance with different types of dentures in both series of experiment (series 1 and series 2).

For the purpose of reproducibility and effective comparison between systems, the same amount of adhesive with differently fitting dentures was undertaken, which could explain the variation in results between well and ill-fitting dentures.

It is suggested that denture retention may be affected if the volume of adhesive increases to such an extent that the distance between the fitting surface of the base plate and the mucosa increases (Ow and Bearn, 1983).

#### 8.4.3.1 Adhesives effectiveness in different types of dentures

The well-fitting denture got the highest retention forces with the tested adhesives compared with the ill-fitting dentures, agreeing with Ghani *et al.*, (1991).

Depending to some extent upon the patient's usage of the product, Fixodent® could be suitable for patients with a well-fitting denture and who want high retention immediately after application and for up to a 5 hours period. The most effective period was 3 hours after application. The same adhesive showed better retention than the others with well-fitting denture in the series 2 tests (Figure 8-28).

Patients with overextended dentures could use PoliGrip® and Wernets® adhesive to get improved denture retention immediately after denture adhesive application and then for up to 5 hours (Figure 8-29). When looking to get the

highest retention benefit in series 2, Wernets® and Fixodent® appear to be a good choice (Figure 8-29). Wernets® could be used successfully in both series of experiments with the overextended denture.

In the case of the under extended denture, it would be better to use PoliGrip® to get improved retention with the same activity level for the interval periods in series 1. However, Wernets® could be used instead when performing occlusal activity after uninterrupted period of 5 hours (series 2) (Figure 8-30).

#### **8.4.3.2 Effectiveness of adhesives with time**

The 5 hours post insertion stage did not necessarily indicate a decline in the level of forces recorded at 5 minutes. However, these results clearly demonstrate that retention with the use of denture adhesives is still higher than the salivary forces, agreeing with Ghani *et al.*, (1991) and Grasso *et al.*, (1994). Maximum denture retention was achieved between 5 minutes to 3 hours after denture adhesive insertion, which could be either maintained or reduced for the remainder of the test period. Previous studies done by Ghani *et al.*, (1991), Ghani and Picton, (1994) and Floystrand *et al.*, (1991) indicated a reduction in adhesive activity with time. They found that a 6 hours *in-vivo* post insertion stage indicated a decline from the level of forces recorded at the 3 hours stage. Even some *in-vitro* studies confirm these results (Chew, 1990). This to some extent disagreed with the results of this work, which showed that a gradual degradation was not the case in the test adhesives with different types of denture or with different modes of timed pulling actions. Few cases showed an increase in retention values even after 3 hours, like Wernets® in the overextended denture agreeing with Mirza *et al.*, (1983 and 1984) who

demonstrated an *in-vivo* increase in retention of mandibular dentures in some cases even after 24 hours of adhesive application.

#### **8.4.4 Conclusions**

- The use of denture adhesive produced a significant improvement in the retention of mandibular dentures up to 5 hours after application.
- This improvement occurred with well-fitting dentures more than with ill-fitting dentures.
- Although the tested adhesives did not follow a specific trend in all types of denture at all time intervals, Fixodent® was the most effective adhesive in the case of well-fitting dentures, but the least effective for ill-fitting dentures. PoliGrip® could be used successfully with ill-fitting dentures. Wernets® could be used in under extended dentures when carrying out masticatory activity 5 hours after adhesive application.

# 9

---

## **General Discussion and Conclusions**

## 9. General Discussion and Conclusions

### 9.1 Creation of an *in-vitro* model

Complete dentures have been available to the edentulous person for centuries; and in the last 60 years, they have not undergone significant changes in design or manufacturing methods. The rehabilitation of the many edentate person using dentures is less than satisfactory as current technology couldn't always provide solutions for problems of retention and stability (Cooper, 2009).

Treatment of the severely resorbed mandibular ridge has been a problem in dentistry for many years and the patient often loses hope of normal function. This problem could affect patients' general satisfaction with their complete dentures.

The service evaluation survey conducted by the University of Sheffield/CCDH for complete denture patients revealed that 64% of patients were dissatisfied with the fit of their mandibular complete denture. This high incidence of problems with the mandibular complete denture warrants an attempt to improve the effectiveness of this prosthesis. Such investigations would benefit from being performed in an *in-vitro* environment, analogous to the oral environment prior to clinical trials. This might make such clinical investigations less cost-effective and useful.

To obtain the optimum benefits from such *in-vitro* tests, they should be conducted in a manner resembling the real situation. The primary

requirement for such simulation is the simulation of the anatomy of the ridge and the physiology of the covering mucosa and reflecting tissues.

As a result, any new materials that could aid denture retention could be tested and compared effectively using this laboratory model. A range of variables thought to be associated with the provision of denture retention could be tested; e.g.: The amount of new denture adhesives used, concentration and frequency of application, the effect of different environmental condition on these materials and could also investigate effect of implant retention on complete dentures.

This study simulated the residual anatomy by tacking impressions for moderately resorbed ridges class IV (Cawood and Howell, 1988), while the thickness and elasticity of oral mucosa covering the residual ridge was obtained from previous literature:

- ♦ The thickness: as demonstrated in Figure 7-7 page 166, according to Uchida *et al.*, (1989).
- ♦ The viscoelasticity: when a stress was applied to the oral soft tissue, a fast initial displacement occurs, and a slower and incomplete recovery takes place when load is removed (Kydd *et al.*, 1971b).

The tested materials were elastic materials mainly used in dental clinics. In addition to the elastic impression and maxillofacial materials, the study reported in this thesis other special effect materials used in the film industry as these materials are used to mimic skin and facial tissues in movies. The tested materials had been used as a single and multilayered configuration.

Four tests were conducted to choose the most suitable material that could approximate the oral mucosa and reflected tissue properties.



### **1- Retention test**

This test was carried out to assess the retentive ability of various materials, in a simple way, prior to their usage on the model as a substitute to oral mucosa. With the use of an acrylic disc and artificial saliva, the retentive test was conducted using dislodging force with the aid of a tensile testing machine.

The test also investigated the effect of two important variables: the amount of saliva and dislodgment speed. There were no significant differences in the retention of acrylic disc with the use of 0.3 and 0.5 ml artificial saliva and the cross head speed 35 – 60 mm/min was determined to be the optimum range of speed to determine the retention force. In addition other properties of tested materials like tears resistance and ability to adhere to the underlying cast were also investigated, all tested materials showed high tear resistant and good adherence to the underling cast except alginate.

### **2- Elastic recovery test**

The aim of the elastic recovery test was to ascertain whether the viscoelasticity of the mucosa could be emulated using a suitable artificial soft material for the *in-vitro* model. The elastic recovery following the application of a compressive load was recorded and compared.

No material showed the classical visoelastic recovery of oral mucosa as mentioned previously according to Kydd *et al.*, (1971).

### **3- Dimensional stability**

As the model was designed to perform continuous repeated retentive tests over reasonably long period, it was necessary to evaluate the dimensional changes of tested materials over the projected model shelf life.

Almost all materials were dimensionally stable over a 14-week period. Single layer materials showed less dimensional changes than a multilayer configuration.

### **4- Wettability**

The aim was to compare the wettability of the tested materials and find the suitable material that approximates the wettability of oral mucosa.

Oral mucosa has been found to be hydrophobic when in contact with water to form 72°-79° using the sessile drop technique with a photo-camera (Van der Mei *et al.*, 2004). In current study the majority of tested materials approximate the water contact angle of mucosa from 67.3° – 80.4°.

From the results of previous tests, none of the materials tested could fully mimic the mucosa requirement: viscoelasticity, wettability and dimensional stability which in turn affected the retention.

From the results of the tests carried out, the following multilayers materials were chosen:

- ProGel outer skin (S 518e) + ProGel neutral skin (S 518a) multilayer to replace the reflected tissue on the model: this material combination has high resiliency and compressibility.
- ProGel outer skin (S 518e) + Elite® soft lining + ProGel neutral skin (S 518a) multilayer to replace the oral mucosa that covers the residual ridge.

## **9.2 Testing the retention of different denture designs with and without denture adhesives**

To test the effectiveness of the model as an analogue of the natural *in-vivo* situation, retentive tests were performed with accurately fitting and well-designed mandibular complete denture. As a result of this test the optimum amount of artificial saliva (0.9 ml) and dislodgment speed (50 mm/min) were determined.

Using the same test principles, the retention of differently designed complete dentures: under and overextended dentures in addition to a well-fitting denture were measured and compared. The model showed a significant difference in retention values between these three designs and the retention forces of a well-fitting denture were much higher than the forces for ill-fitting dentures, and this agreed with Ghani *et al.*, (1991).

The *in-vitro* model effectively reflects differences in retention for dentures with differing degrees of ridge adaptation and compares well to the *in-vivo* findings.

Further retentive tests were conducted to determine if the model could be used successfully to test denture adhesive affectivity on denture retention and compare the results with previously reported clinical studies.

In this study three different types of commercially popular denture adhesives (PoliGrip®, Fixodent® and Wernets®) were used to test the retention of different denture designs (well-fitting, over and under extended dentures).

The retention of different mandibular complete denture designs was investigated in two series configurations (as discussed previously on page 195).

The fixatives used in this study produced an instantaneous improvement in retention, which was statistically significant compared to the force shown with saliva only. At the end of the 5 hour period, retention was still greater than without the use of any adhesives. The retention with well-fitting denture was statistically higher than with ill-fitting dentures. This agreed with previous studies conducted by Ghani *et al.*, (1991), Mirza *et al.*, (1983) and (1984) and Manes *et al.*, (2011) as discussed previously on page 214.

The retentive activity of denture adhesives in this current study did not follow a constant trend at various time intervals with different types of denture and this agreed with Chew *et al.*, (1985) as discussed previously on pages 217 and 218.

These fluctuations in denture adhesive retention ability could be due to certain limitations that need to be acknowledged regarding the present study:

### **1- Washout action of saliva**

In the current model there was a fixed amount of saliva used in the retention experiments, which make the model environment different from the situation in the mouth, where there is a continuous secretion and washout action of saliva upon the denture adhesives.

### **2- Lab temperature**

To mimic the situation of the mouth, the experiment temperature should approximate to mouth temperature. Different temperatures make the comparison of saliva and denture adhesive affectiveness on retention, compared to the real condition, unpractical.

### **3- Seating force**

The seating force of the denture during the experiments was not measurable; the finger pressure used was therefore a potential variable. This load could affect the distribution of saliva and denture adhesive under the denture as well as the response of the elastic recovery of the substitute mucosa on the *in-vitro* model (as discussed previously in section 8.3.4.1 pages 213, 214 and 215).

### **4- Centralization of dislodgment force**

The method of connecting mandibular complete dentures to the universal testing machine (4 holding points attached to the denture's occlusal surface and connected to the machine by an adjustable wiring system) did not produce a uniform pulling action, the detachment of the denture occurred anteriorly first.

### **5- Sample size**

The sample size to measure the retention of dentures with adhesives was small (only one denture of each denture design), so any conclusion regarding the activity of adhesives should be considered with caution.

**In conclusion, the *in-vitro* model of a mandibular ridge was created to approximate the biophysical characteristics of the real ridge covering and reflected tissue to test the retention of lower complete denture and can be used to test the differences in retention of different designs of lower complete dentures with and without denture adhesives.**

# 10

---

## Future Work

## 10. Future Work

There are two main areas that could be developed in the future:

### ▪ **Model design**

- To better replicate the real situation of a patient's mandibular ridge configuration, a trial to design and build a mechanical model of a mandible with functioning muscles, which can replicate the muscles effects on a denture. With the assistance of mechanical engineers, the model could be supplied with devices to be able to measure pressure points created on the soft tissues and muscles areas when the denture is loaded (sensors inside the silicone and bone elements of the model).
- To precisely simulate the oral mucosa, the correlation of thickness and elasticity of synthetic mucosa materials could be measured using ultrasonic thickness gauge with a strain gauge to enable the measurement effect of load and thickness simultaneously and compare it with oral mucosa as in a previous study (Takeuchi *et al.*, 2009).

### ▪ **Testing new ideas to aid mandibular denture retention**

- Challenge current wisdom relating to complete mandibular denture design.
- Measure denture retention forces using different retention methods like new adhesives.
- Evaluate the effectiveness of novel implant abutments on denture retention.

# 11

---

## References



---

## 11. References

- ADELL, R., LEKHOLM, U., ROCKLER, B. & BRANEMARK, P. I. 1981. A 15-year study of osseointegrated implants in the treatment of the edentulous jaw. *Int J Oral Surg*, 10, 387-416.
- AL-KAISY N., MARTIN N., MILLER C. & A., J. 2011. *In-vitro* model for testing the retention of complete dentures. *J Dent Res*, 130.
- AL-KAISY N., MARTIN N. , MILLER C. A. & JOHNSON A. 2009. Evaluation of synthetic tissue analogue in a laboratory edentulous mandible. *J Dent Res* 88, 0162.
- AL-KAISY N., MARTIN N. , MILLER C. A. & JOHNSON A. 2010. Evaluation of Synthetic Materials for An *in-vitro* Mandibular Edentulous Model. *J Dent Res* 89, 138712.
- ALBINO, J. E., TEDESCO, L. A. & CONNY, D. J. 1984. Patient perceptions of dental-facial esthetics: shared concerns in orthodontics and prosthodontics. *J Prosthet Dent*, 52, 9-13.
- ATWOOD, D. A. 1971. Reduction of residual ridges: a major oral disease entity. *J Prosthet Dent*, 26, 266-79.
- AWAD, M. A., LUND, J. P., SHAPIRO, S. H., LOCKER, D., KLEMETTI, E., CHEHADE, A., SAVARD, A. & FEINE, J. S. 2003. Oral health status and treatment satisfaction with mandibular implant overdentures and conventional dentures: a randomized clinical trial in a senior population. *Int J Prosthodont*, 16, 390-6.
- BAAT, C. D., HOF, M. V. T., ZEGHBROECK, L. V., OZCAN, M. & KALK, W. 2007. An international multicenter on the effectiveness of a denture adhesive in maxillary dentures using disposable gnathometer. *Clinical Oral Invest.*, 11, 237-243.
- BAIRAM, L. R. & MILLER, W. A. 1994. Mandible bone resorption as determined from panoramic radiographs in edentulous male individuals ages 25-80 years. *Gerodontology*, 11, 80-5.
- BASKER, R. M. & DAVENPORT, J. C. 2002a. Factors influencing the outcome of prosthetic treatment. In: EDITION, T. (ed.) *Prosthetic Treatment of the Edentulous Patient*. Munksgaard: Blackwell.
- BASKER, R. M. & DAVENPORT, J. C. 2002b. Implant-retained prosthesis. In: EDITION, T. (ed.) *Prosthetic Treatment of the Edentulous Patient*. Munksgaard: Blackwell.
- BASKER, R. M. & DAVENPORT, J. C. 2002c. Impressions. In: EDITION, T. (ed.) *Prosthetic Treatment of the Edentulous Patient*. Munksgaard: Blackwell.

- 
- BASKER, R. M. & DAVENPORT, J. C. 2002d. Stability of the dentures. *Prosthetic Treatment of the Edentulous Patient. 4th ed.*, Oxford, Blackwell: 56-70.
- BASKER, R. M., DAVENPORT, J. C. & THOMASON, J. M. 2011. *Prosthetic Treatment of the Edentulous Patient - fifth edition*, Oxford, Wiley - Blackwell.
- BENSON, D., ROTHMAN, R. S. & SIMS, T. N. 1972. The effect of a denture adhesive on the oral mucosa and vertical dimension of complete denture patients. *J South Calif Dent Assoc*, 40, 468-73.
- BERESIN, V. E. & SCHIESSER, F. J. 2006. The neutral zone in complete dentures. 1976. *J Prosthet Dent*, 95, 93-100; discussion 100-1.
- BERG, E. 1984. Influence of some anamnestic, demographic and clinical variables on patient acceptance of full dentures. *Acta Odontol Scand.*, 4, 119-127.
- BERG, E. 1988. A 2-year follow-up study of patient satisfaction with new complete dentures. *J Dent*, 16, 160-5.
- BERG, E. 1993. Acceptance of full dentures. *Int Dent J*, 43, 299-306.
- BLAHOVA, Z. & NEUMAN, M. 1971. Physical factors in retention of complete dentures. *J Prosthet Dent*, 25, 230-5.
- BOHANNAN, H. M. 1954. A critical analysis of the mucostatic principle. *J Prosthet Dent*, 4.
- BRANEMARK, P. I., HANSSON, B. O., ADELL, R., BREINE, U., LINDSTROM, J., HALLEN, O. & OHMAN, A. 1977. Osseointegrated implants in the treatment of the edentulous jaw. Experience from a 10-year period. *Scand J Plast Reconstr Surg Suppl*, 16, 1-132.
- BRILL, N., TRYDE, G. & SCHUBELER, S. 1959. The role of exteroceptors in denture retention. *Journal of Prosthetic Dentistry*, 9, 761-768.
- BROZ, M. 1989. [Analysis of the most common causes of failure in complete dentures]. *Vojnosanit Pregl*, 46, 32-5.
- BRUNELLO, D. & MANDIKOS, M. 1998. Construction faults, age, gender, and relative medical health: factors associated with complaints in complete denture patients. *J Prosthet Dent*, 79, 545-554.
- BURKE, F. J. 2000. A synopsis of the adult dental health survey: oral health in the United Kingdom 1998. *Dent Update*, 27, 184-6.
- BURNS, D. R., UNGER, J. W., ELSWICK, R. K., JR. & GIGLIO, J. A. 1995. Prospective clinical evaluation of mandibular implant overdentures: Part II--Patient satisfaction and preference. *J Prosthet Dent*, 73, 364-9.
- CARLSSON, G. E. 1997. Clinical morbidity and sequelae of treatment with complete dentures. *Journal of Prosthetic Dentistry*, 79, 17-23.
- CARLSSON, G. E., KRONSTROM, M., DE BAAT, C., CUNE, M., DAVIS, D., GAREFIS, P., HEO, S. J., JOKSTAD, A., MATSUURA, M., NARHI, T., OW, R., PISSIOTIS, A., SATO, H. & ZARB, G. A. 2004. A survey of the use of mandibular implant overdentures in 10 countries. *Int J Prosthodont*, 17, 211-7.
-

- 
- CARLSSON, G. E., OTTERLAND, A., WENNSTROM, A. & ODONT, D. 1967. Patient factors in appreciation of complete dentures. *J Prosthet Dent*, 17, 322-8.
- CAWOOD, J. I. & HOWELL, R. A. 1988. A classification of the edentulous jaws. *Int J Oral Maxillofac Surg*, 17, 232-6.
- CELEBIĆ A, KNEZOVIĆ-ZLATARIĆ D, PAPIĆ M, CAREK V, BAUCIĆ I & J., S. 2003. Factors related to patient satisfaction with complete denture therapy. *J Gerontol A Biol Sci Med Sci.* , 58, M948-53.
- CELEBIĆ, A., KNEZOVIĆ-ZLATARIĆ D, PAPIĆ M, CAREK V, BAUCIĆ I & J., S. 2003. Factors related to patient satisfaction with complete denture therapy. *J Gerontol A Biol Sci Med Sci.* , 58, M948-53.
- CHEW, C. L. 1990. Retention of denture adhesives--an in vitro study. *J Oral Rehabil*, 17, 425-34.
- CHEW, C. L., BOONE, M. E., SWARTZ, M. L. & PHILLIPS, R. W. 1985. Denture adhesives: their effects on denture retention and stability. *J Dent*, 13, 152-9.
- CHOWDHRY, P., PHUKELA, S. S., PATIL, R. & YADAV, H. 2010. A Study to Evaluate the Retentive Ability of Different Denture Adhesive Materials: An In Vitro Study. *J Indian Prosthodont Soc*, 10, 176-181.
- CHUNG, K. H., CHUNG, C. Y., CAGNA, D. R. & CRONIN, R. J., JR. 2004. Retention characteristics of attachment systems for implant overdentures. *J Prosthodont*, 13, 221-6.
- CLANCY, J. M., SCANDRETT, F. R. & ETTINGER, R. L. 1983. Long-term dimensional stability of three current elastomers. *J Oral Rehabil*, 10, 325-33.
- COATES, A. J. 1995. Denture adhesives: a review. *Aust Prosthodont J*, 9, 27-31.
- COATES, A. J. 2000. Usage of denture adhesives. *J Dent*, 28, 137-40.
- COMPAGNONI, M. A., DE SOUZA, R. F. & LELES, C. R. 2003. Kinesiographic study of complete denture movement related to mucosa displacement in edentulous patients. *Pesqui Odontol Bras*, 17, 356-61.
- COOPER, L. F. 2009. The current and future treatment of edentulism. *J Prosthodont*, 18, 116-22.
- CRAIG, R. G., BERRY, G. C. & PEYTON, F. A. 1960. Physical factors related to denture retention. *Journal of Prosthetic Dentistry*, 10, 459-467.
- CRAIG, R. G., OBRIEN, W. & POWERS, J. M. 1975. *Dental Materials, Properties and Manipulation*, C. V. Mosby Company, St. Louis.
- DALY, C. H. & WHEELER, J. B. 1971. The use of ultra-sonic thickness measurement in the clinical evaluation of the oral soft tissues. *Int Dent J*, 21, 418-29.
- DARVELL, B. W. & CLARK, R. K. 2000. The physical mechanisms of complete denture retention. *Br Dent J*, 189, 248-52.
- DAVIS, D. M. 1997a. Developing an analogue/substitute for mandibular denture-bearing area. . In: G. A. ZARB, C. L. BOLENDER, G. E. CARLSSON & LOUIS, S. (eds.) *Boucher's Prosthodontic Treatment for*
-

- 
- Edentulous Patients*. 11th Edition. Pages 162-181 ed. Missouri USA: Mosby.
- DAVIS, D. M. 1997b. Developing an analogue/substitute for mandibular denture-bearing area. . In: ZARB G. A., BOLENDER C. L., CARLSSON G. E. & BOUCHER, C. O. (eds.) *Boucher's Prosthodontic Treatment for Edentulous Patients*. 11th ed., USA, Mosby: 162-181.
- DAVIS, E. L., ALBINO, J. E., TEDESCO, L. A., PORTENOY, B. S. & ORTMAN, L. F. 1986. Expectations and satisfaction of denture patients in a university clinic. *J Prosthet Dent*, 55, 59-63.
- DAWES, C. 2004. *Factors influencing salivary flow rate and composition*. In: Edgar M, Dawes C, O'Mullane D, eds. *Saliva and Oral Health*, London: British Dental Association.
- DE BAAT, C. 2004. [Research methods in dentistry 1. Methods to quantify retention of complete dentures]. *Ned Tijdschr Tandheelkd*, 111, 206-12.
- DE SOUZA E SILVA, M. E., DE MAGALHAES, C. S. & FERREIRA E FERREIRA, E. 2009. Complete removable prostheses: from expectation to (dis)satisfaction. *Gerodontology*, 26, 143-9.
- DEBERECENI, T. 2009. *Special make-up effects for stage & screen: making and applying prosthetics* Elsevier Inc.
- DEMANN, E. T. & HAUG, R. H. 2002. Do position and soft tissue affect distraction vector? An in vitro investigation. *J Oral Maxillofac Surg*, 60, 149-55; discussion 155-6.
- DEMOT, B., DECLERCQ, M. & ROUSSEEUW, P. 1984. Visco-elastic properties of four currently used tissue conditioners. *Journal of Oral Rehabilitation*, 11, 419-427.
- DEVENGENCIE, J., NG, M. C., FORD, P. & IACOPINO, A. M. 1997. In vitro evaluation of denture adhesives: possible efficacy of complex carbohydrates. *Int J Prosthodont*, 10, 61-72.
- DONG, J., IKEBE, K., GONDA, T. & NOKUBI, T. 2006. Influence of abutment height on strain in a mandibular overdenture. *J Oral Rehabil*, 33, 594-9.
- DU, L., XU, C. & CHAO, Y. 2003. [The measurement of retentive forces in mandibular complete overdenture with Magfit magnetic attachments]. *Hua Xi Kou Qiang Yi Xue Za Zhi*, 21, 366-8.
- EAMES, W. B., WALLACE, S. W., SUWAY, N. B. & ROGERS, L. B. 1979. Accuracy and dimensional stability of elastomeric impression materials. *J Prosthet Dent*, 42, 159-62.
- EUFINGER, H., GELLRICH, N. C., SANDMANN, D. & DIECKMANN, J. 1997. Descriptive and metric classification of jaw atrophy. An evaluation of 104 mandibles and 96 maxillae of dried skulls. *Int J Oral Maxillofac Surg*, 26, 23-8.
- FANUSCU, M. I. & CAPUTO, A. A. 2004. Influence of attachment systems on load transfer of an implant-assisted maxillary overdenture. *J Prosthodont*, 13, 214-20.
- FEINE, J. S., DE GRANDMONT, P., BOUDRIAS, P., BRIEN, N., LAMARCHE, C., TACHE, R. & LUND, J. P. 1994. Within-subject
-

- 
- comparisons of implant-supported mandibular prostheses: choice of prosthesis. *J Dent Res*, 73, 1105-11.
- FENLON, M. R. & SHERRIFF, M. 2008. An investigation of factors influencing patients' satisfaction with new complete dentures using structural equation modelling. *J Dent*, 36, 427-34.
- FENLON, M. R., SHERRIFF, M. & NEWTON, J. T. 2007. The influence of personality on patients' satisfaction with existing and new complete dentures. *J Dent*, 35, 744-8.
- FENLON, M. R., SHERRIFF, M. & WALTER, J. D. 1999. Operator agreement in the use of a descriptive index of edentulous alveolar ridge form. *Int J Oral Maxillofac Surg*, 28, 38-40.
- FENLON, M. R., SHERRIFF, M. & WALTER, J. D. 2002. Agreement between clinical measures of quality and patients' rating of fit of existing and new complete dentures. *J Dent*, 30, 135-9.
- FERNANDES, C. P., GLANTZ, P. O. & NILNER, K. 2003. On the accuracy of some in vitro models for mechanical studies of maxillary removable partial dentures. *Dent Mater*, 19, 127-36.
- FERRACANE, J. L. 2001. *materials in dentistry: principles and applications. 2nd edition; published by lippincott williams & wilkins.*
- FLOYSTRAND, F., KOPPANG, R., WILLIAMS, V. D. & ORSTAVIK, J. 1991. A method for testing denture adhesives. *J Prosthet Dent*, 66, 501-4.
- FLOYSTRAND, F. & ORSTAVIK, J. S. 1984. Retention of complete maxillary dentures measured as resistance against unilateral occlusal loading. *Acta Odontol Scand*, 42, 29-36.
- GHANI, F. 2002. Investigations into some factors affecting denture base retention in vivo. *J Coll Physicians Surg Pak*, 12, 513-7.
- GHANI, F. & PICTON, D. C. 1994. Some clinical investigations on retention forces of maxillary complete dentures with the use of denture fixatives. *J Oral Rehabil*, 21, 631-40.
- GHOSH, P. 2009. surface and interfacial tension. *Colloid And Interface Science.* Asoke K.Ghosh, PHI Learning Privit Limited, New Delhi.
- GOLDBERG, A. J. 1974. Viscoelastic properties of silicone, polysulfide, and polyether impression materials. *J Dent Res*, 53, 1033-9.
- GOLDS, L. 1985. The prosthetic treatment in the presence of gross resorption of the mandibular alveolar ridge. *J Dent*, 13, 91-101.
- GRASSO, J., GAY, T., RENDELL, J., BAKER, R., KNIPPENBERG, S., FINKELDEY, J., ZHOU, X. & WINSTON, J. L. 2000. Effect of denture adhesive on retention of the mandibular and maxillary dentures during function. *J Clin Dent*, 11, 98-103.
- GRASSO, J. E. 1996. Denture adhesives: changing attitudes. *J Am Dent Assoc*, 127, 90-6.
- GRASSO, J. E., RENDELL, J. & GAY, T. 1994. Effect of denture adhesive on the retention and stability of maxillary dentures. *J Prosthet Dent*, 72, 399-405.
-

- 
- GRUNDKEA, K., MICHELA, S., KNISPELB G. & GRUNDLERB, A. 2008. Wettability of silicone and polyether impression materials: Characterization by surface tension and contact angle measurements. *Colloids and Surfaces A: Physicochemical and Engineering Aspects*, 317, 598-609.
- HADA, M., IMAI, M., OOISHI, A. & MATSUMOTO, N. 1990. [On the viscoelastic properties of the palatal mucosa analyzed for the displacement of maxillary complete denture]. *Nihon Hotetsu Shika Gakkai Zasshi*, 34, 408-14.
- HAMALIAN, T. A., NASR, E. & CHIDIAC, J. J. 2011. Impression materials in fixed prosthodontics: influence of choice on clinical procedure. *J Prosthodont*, 20, 153-60.
- HAYAKAWA, I., HIRANO, S., KOBAYASHI, S., NAGAO, M. & MASUHARA, E. 1994. The creep behavior of denture-supporting tissues and soft lining materials. *Int J Prosthodont*, 7, 339-47.
- HICKEY, J. & ZARB, G. 1980. *Bouchers Prosthodontic Treatment for Edentulous patients. 8th ed.*, 170-230.
- HOLLY, F. 1992. Wettability and bioadhesion in ophthalmology. In: SCHRADER ME & GI, L. (eds.) *Modern approach to wettability: Theory and applications*. New York: Plenum Press.
- HOSONO, Y., SATO, Y., AHIMODAIRA, O. & HARA, S. 2007. Assessment of biomechanical characteristic of denture supporting tissue using an ultrasonic thickness gage and tactile sensor. *Nihon Hotetsu Shika Gakkai Zasshi*, 51, 291-9.
- IDOWU, A. T., HANDELMAN, S. L. & GRASER, G. N. 1987. Effect of denture stability, retention, and tooth form on masticatory function in the elderly. *Gerodontics*, 3, 161-4.
- INOUE, K., ARIKAWA, H., FUJII, K., SHINOHARA, N. & KAWAHATA, N. 1985. Viscoelastic properties of oral soft tissue. 1. A method of determining elastic modulus of oral soft tissue. *Dent Mater J*, 4, 47-53.
- JACOBSON, T. E. & KROL, A. J. 1983. A contemporary review of the factors involved in complete denture retention, stability, and support. Part I: retention. *J Prosthet Dent*, 49, 5-15.
- JENNINGS, D. E. 1989. Treatment of the mandibular compromised ridge: a literature review. *J Prosthet Dent*, 61, 575-9.
- JIN, N. Y., LEE, H. R., LEE, H. & PAE, A. 2009. Wettability of denture relining materials under water storage over time. *J Adv Prosthodont*, 1, 1-5.
- JORGENSEN, K. D. 1976. A new method of recording the elastic recovery of dental impression materials. *Scand J Dent Res*, 84, 175-82.
- KAHN, R. L., DONOVAN, T. E. & CHEE, W. W. 1989. Interaction of gloves and rubber dam with a poly(vinyl siloxane) impression material: a screening test. *Int J Prosthodont*, 2, 342-6.
- KALK, W. & DE BAAT, C. 1989. Some factors connected with alveolar bone resorption. *J Dent*, 17, 162-5.
-

- 
- KAPUR, K. K. 1967. A clinical evaluation of denture adhesives. *J Prosthet Dent*, 18, 550-8.
- KARLSSON, S. & SWARTZ, B. 1981. Denture adhesives - their effect on the mobility of full upper dentures during chewing. A cineradiographic study. *Swed Dent J*, 5, 207-11.
- KARLSSON, S. & SWARTZ, B. 1990. Effect of a denture adhesive on mandibular denture dislodgment. *Quintessence Int*, 21, 625-7.
- KAWANO, F., DOOTZ, E. R., KORAN, A., 3RD & CRAIG, R. G. 1992. Comparison of bond strength of six soft denture liners to denture base resin. *J Prosthet Dent*, 68, 368-71.
- KAWAZOE, Y. & HAMADA, T. 1978. The role of saliva in retention of maxillary complete dentures. *J Prosthet Dent*, 40, 131-6.
- KENNEY, R. & RICHARDS, M. W. 1998. Photoelastic stress patterns produced by implant-retained overdentures. *J Prosthet Dent*, 80, 559-64.
- KOPPANG, R., BERG, E., DAHM, S., REAL, C. & FLOYSTRAND, F. 1995. A method for testing denture adhesives. *J Prosthet Dent*, 73, 486-91.
- KULAK, Y., OZCAN, M. & ARIKAN, A. 2005. Subjective assessment by patients of the efficiency of two denture adhesive pastes. *J Prosthodont*, 14, 248-52.
- KYDD, W. L. & DALY, C. H. 1982. The biologic and mechanical effects of stress on oral mucosa. *J Prosthet Dent*, 47, 317-29.
- KYDD, W. L., DALY, C. H. & WHEELER, J. B., 3RD 1971a. The thickness measurement of masticatory mucosa in vivo. *Int Dent J*, 21, 430-41.
- Arstand, T. (1959): 'The resiliency of the edentulous alveolar ridge.' *Odont. Tidsk.*, 67, 506.
- KYDD, W. L., DALY, C. H. & WHEELER, J. B., 3RD 1971b. The thickness measurement of masticatory mucosa in vivo. *Int Dent J*, 21, 430-41.
- KYDD, W. L. & MANDLEY, J. 1967. The stiffness of palatal mucoperiosteum. *J Prosthet Dent*, 18, 116-21.
- LAMMIE, G. 1960. The reduction of the edentulous ridge. *J Prosthet Dent*, 10, 605-611.
- LEE, J. H., CHEN, J. H., LEE, H. E., CHANG, H. P., CHEN, H. S., YANG, Y. H. & CHOU, T. M. 2009. Improved denture retention in patients with retracted tongues. *J Am Dent Assoc*, 140, 987-91.
- LEVIN, B., GAMER, S. & FRANCIS, E. D. 1970. Patient preference for a mandibular complete denture with a broad or minimal base: a preliminary report. *J Prosthet Dent*, 23, 525-8.
- LINDSTROM, R. E., PAWELCHAK, J., HEYD, A. & TARBET, W. J. 1979. Physical-chemical aspects of denture retention and stability: a review of the literature. *J Prosthet Dent*, 42, 371-5.
- LU, H., NGUYEN, B. & POWERS, J. M. 2004. Mechanical properties of 3 hydrophilic addition silicone and polyether elastomeric impression materials. *J Prosthet Dent*, 92, 151-4.
-

- 
- LUEBKE, R. J., SCANDRETT, F. R. & KERBER, P. E. 1979. The effect of delayed and second pours on elastomeric impression material accuracy. *J Prosthet Dent*, 41, 517-21.
- LYTLE, R. B. 1957. The management of abused oral tissues in complete denture construction. *Journal of Prosthetic Dentistry*, 7, 27-42.
- LYTLE, R. B. 1962. Soft tissue displacement beneath removable partial and complete dentures. *Journal of Prosthetic Dentistry*, 12, 34-43.
- MACENTEE, M. I. & WALTON, J. N. 1998. The economics of complete dentures and implant-related services: a framework for analysis and preliminary outcomes. *J Prosthet Dent*, 79, 24-30.
- MANES, J. F., SELVA, E. J., DE-BARUTELL, A. & BOUAZZA, K. 2010. Comparison of the retention strengths of three complete denture adhesives: An in vivo study. *Med Oral Patol Oral Cir Bucal*.
- MANES, J. F., SELVA, E. J., DE-BARUTELL, A. & BOUAZZA, K. 2011. Comparison of the retention strengths of three complete denture adhesives: An in vivo study. *Med Oral Patol Oral Cir Bucal*, 16, e 132-6.
- MARACHLIOGLOU, C. R., DOS SANTOS, J. F., CUNHA, V. P. & MARCHINI, L. 2010. Expectations and final evaluation of complete dentures by patients, dentist and dental technician. *J Oral Rehabil*, 37, 518-24.
- MASSAD, J. J. & CAGNA, D. R. 2002. Removable prosthodontic therapy and xerostomia. Treatment considerations. *Dentistry Today*, 21, 80-2, 84, 86-7.
- MCCABE, J. F. & WALLS, A. W. G. 2009a. Denture lining materials. *Applied Dental Materials*. 4th ed. Wiley: 124-132.
- MCCABE, J. F. & WALLS, A. W. G. 2009b. Impression materials: Hydrocolloid. *Applied Dental Materials: 9th ed.* Wiley: 154-162.
- MCCABE, J. F. & WALLS, A. W. G. 2009c. Properties used to Characterise Materials. *Applied Dental Materials*. 9th ed. Wiley: 14-31.
- MCCABE, J. F. & WILSON, H. J. 1978. Addition curing silicone rubber impression materials. An appraisal of their physical properties. *Br Dent J*, 145, 17-20.
- MCCARTHY, J. A. & MOSER, J. B. 1978. Tissue conditioners as functional impression materials. *J Oral Rehabil*, 5, 357-64.
- MCCORD, J. F. & GRANT, A. A. 2000. Clinical assessment. *Br Dent J*, 188, 375-80.
- MCCORMICK, J. T., ANTONY, S. J., DIAL, M. L., DUNCANSON, M. G., JR. & SHILLINGBURG, H. T., JR. 1989. Wettability of elastomeric impression materials: effect of selected surfactants. *Int J Prosthodont*, 2, 413-20.
- MCGARRY, T. J., NIMMO, A., SKIBA, J. F., AHLSTROM, R. H., SMITH, C. R. & KOUMJIAN, J. H. 1999. Classification system for complete edentulism. The American College of Prosthodontics. *J Prosthodont*, 8, 27-39.
-



- 
- MERCIER, P. & LAFONTANT, R. 1979. Residual alveolar ridge atrophy: classification and influence of facial morphology. *J Prosthet Dent*, 41, 90-100.
- MILLER, W. P., MONTEITH, B. & HEATH, M. R. 1998. The effect of variation of the lingual shape of mandibular complete dentures on lingual resistance to lifting forces. *Gerodontology*, 15, 113-9.
- MIRZA, F. D., DIKSHIT, J. V. & MURDIA, N. S. 1984. Comparative study of effectiveness of denture adhesives at different time intervals. *J Indian Dent Assoc*, 56, 335-7.
- MOHRAMZADEH K., AL-KAISY N., BISHOP M. & N., M. 2011. Patient satisfaction with complete dentures provided by undergraduate dental students. *J Dent Res*, 42, 130.
- MONDON, M. 2004. Changes in water contact angles during the first phase of setting of dental impression materials. *Int J Prosthodont*, 16, 49-53.
- MONSENEGO, P., BASZKIN, A., COSTA, M. L. & LEJOYEUX, J. 1989. Complete denture retention. Part II: Wettability studies on various acrylic resin denture base materials. *J Prosthet Dent*, 62, 308-12.
- MULLER, M. & OEHR, C. 2011. Comments on an essay on contact angle measurement by strobel and Lyons. *Plasma processes and polymers*, 8, 19-24.
- MURAKAMI, H., TAKEHANA, S., TAKENAKA, M. & ABE, T. 1990. [The physical properties of silicone impression materials with hydrophilicity and hydrophobicity. Wetting, water absorption, surface structure of dental stone and dimensional change on stone dies]. *Aichi Gakuin Daigaku Shigakkai Shi*, 28, 1105-14.
- MURRAY, M. D. & DARVELL, B. W. 1989. Reappraisal of the physics of denture retention. *Int J Prosthodont*, 2, 234-42.
- MURRAY, M. D. & DARVELL, B. W. 1993. The evolution of the complete denture base. Theories of complete denture retention--a review. Part 2. *Aust Dent J*, 38, 299-305.
- NARHI, T. O., ETTINGER, R. L. & LAM, E. W. 1997. Radiographic findings, ridge resorption, and subjective complaints of complete denture patients. *Int J Prosthodont*, 10, 183-9.
- NIEDERMEIER, W. & KRÄMER, R. 1992. Salivary secretion and denture retention. *J Prosthet Dent*, 67, 211-6.
- NISHIMURA, I. & GARRETT, N. 2004. Impact of Human Genome Project on treatment of frail and edentulous patients. *Gerodontology*, 21, 3-9.
- NOORT, R. V. 2007. *Introduction to dental materials, Elastic Impression materials*, 191-207, 3rd edition. Edinburgh : Mosby.
- NORMAN, R. D., STEWART, G. P., MAROSO, D. J., GEPHART, J. S. & KOHUT, B. E. 1987. In vitro measurement of vertical denture displacement by denture adhesives. *Dent Mater*, 3, 342-6.
- ODAGIRI, K. 1992. Local compressibility of denture foundation--evaluation of denture foundation in relation to impression pressure. *Kokubyo Gakkai Zasshi*, 59, 88-104.
-

- 
- OFFICE FOR NATIONAL STATISTICS 1999. Adult dental health survey - Oral Health in the United Kingdom 1998. *Office national statistics*, 99.
- OHGURI, T., KAWANO, F., ICHIKAWA, T. & MATSUMOTO, N. 1999. Influence of occlusal scheme on the pressure distribution under a complete denture. *Int J Prosthodont*, 12, 353-8.
- OLSHAN, A. M., ROSS, N. M., MANKODI, S. & MELITA, S. 1992. A modified Kapur scale for evaluating denture retention and stability: methodology study. *Am J Dent*, 5, 88-90.
- ORSTAVIK, J. S. & FLOYSTRAND, F. 1984. Retention of complete maxillary dentures related to soft tissue function. *Acta Odontol Scand*, 42, 313-20.
- OSTLUND 1947. Some physical principles in the retention of dentures. *Northwestern University bulletin*, 12, 125-133.
- OSTLUND, S. G. 1958. The effect of complete dentures on the gum tissues : A histological investigation. *Acta odontologica scandinavica*, 16, 1-36.
- OSTLUND, S. G. 1960. Saliva and denture retention. *Journal of Prosthetic Dentistry*, 10, 658-663.
- OW, R. K. & BEARN, E. M. 1983. A method of studying the effect of adhesives on denture retention. *J Prosthet Dent*, 50, 332-7.
- PANAGIOTOUNI, E., PISSIOTIS, A., KAPARI, D. & KALOYANNIDES, A. 1995. Retentive ability of various denture adhesive materials: an in vitro study. *J Prosthet Dent*, 73, 578-85.
- PAULIN, C., A & PENDLETON, A. E. 2000. The Dental Assistant. 349-354.
- PROSTHODONTIC TERMS 2005. The glossary of prosthodontic terms. *J Prosthet Dent*, 94, 10-92.
- PROSTHODONTICTERMS 2005. The glossary of prosthodontic terms. *J Prosthet Dent*, 94, 10-92.
- RANTANEN, T. & LINDHOLM, K. 1973. Two new tissue conditioners and their ability to reproduce undercuts. *Proc Finn Dent Soc*, 69, 105-9.
- RASHID, F., AWAD, M. A., THOMASON, J. M., PIOVANO, A., SPIELBERG, G. P., SCILINGO, E., MOJON, P., MULLER, F., SPIELBERG, M., HEYDECKE, G., STOKER, G., WISMEIJER, D., ALLEN, F. & FEINE, J. S. 2011. The effectiveness of 2-implant overdentures - a pragmatic international multicentre study. *J Oral Rehabil*, 38, 176-84.
- RENDELL, J. K., GAY, T., GRASSO, J. E., BAKER, R. A. & WINSTON, J. L. 2000. The effect of denture adhesive on mandibular movement during chewing. *J Am Dent Assoc*, 131, 981-6.
- RODRIGUES, C., ANTONIO, M., FREITAS, R. & BARROS, D. 2003. Kinesiographic study of mandibular movements during functional adaptation to complete dentures. *J Appl Oral Sci*, 11, 311- 8.
- ROUMANAS, E. D., GARRETT, N. R., HAMADA, M. O., DIENER, R. M. & KAPUR, K. K. 2002. A randomized clinical trial comparing the efficacy of mandibular implant-supported overdentures and conventional dentures in diabetic patients. Part V: food preference comparisons. *J Prosthet Dent*, 87, 62-73.
-

- 
- RUPP, F., AXMANN, D., JACOBI, A., GROTEN, M. & GEIS-GERSTORFER, J. 2005. Hydrophilicity of elastomeric non-aqueous impression materials during setting. *Dent Mater*, 21, 94-102.
- RUTKUNAS, V. & MIZUTANI, H. 2004. Retentive and stabilizing properties of stud and magnetic attachments retaining mandibular overdenture. An in vitro Study. *Stomatologija Baltic Dental and Maxillofacial Journal*, 6, 85-9.
- RUTKUNAS, V., MIZUTANI, H. & TAKAHASHI, H. 2007. Influence of attachment wear on retention of mandibular overdenture. *J Oral Rehabil*, 34, 41-51.
- SARNAT, A. E. 1983. The efficiency of cobalt samarium (Co5Sm) magnets as retention units for overdentures. *J Dent*, 11, 324-33.
- SATO, Y., HAMADA, S., AKAGAWA, Y. & TSUGA, K. 2000. A method for quantifying overall satisfaction of complete denture patients. *J Oral Rehabil*, 27, 952-7.
- SATO, Y., TSUGA, K., AKAGAWA, Y. & TENMA, H. 1998. A method for quantifying complete denture quality. *J Prosthet Dent*, 80, 52-7.
- SCHLOSSER, R. O. 1950. Basic factors retarding resorptive changes of residual ridges under complete denture prosthesis. *J Am Dent Assoc*, 40, 12-9.
- SETZ, I., LEE, S. H. & ENGEL, E. 1998. Retention of prefabricated attachments for implant stabilized overdentures in the edentulous mandible: an in vitro study. *J Prosthet Dent*, 80, 323-9.
- SHARMA, N. & CHITRE, V. 2008. An *in-vitro* comparative study of wettability of four commercially available saliva substitutes and distilled water on heat polymerized acrylic resin. *The Journal of Indian Prosthodontic Society*, 8, 30-35.
- SHAY, K. 1991. Denture adhesives. Choosing the right powders and pastes. *The Journal of the American Dental Association*, 122, 70-6.
- SHAY, K. 1997. The retention of complete dentures. In: G. A. ZARB, C. L. BOLENDER, G. E. CARLSSON & LOUIS, S. (eds.) *Boucher's Prosthodontic Treatment of Edentulous Patients*. 11th edition. pages 400-411 ed. Missouri USA: Mosby.
- SHIBATA, M., ARAKI, T. & SAGARA, Y. 2008. Development of Specified Protocols and Methodology in the Application of Food Kansei Model for the Optimal Design of Danish Pastry. *Food Sci. Technol. Res*, 14, 367-376.
- SHIMAZAKI, Y., SOH, I., SAITO, T., YAMASHITA, Y., KOGA, T., MIYAZAKI, H. & TAKEHARA, T. 2001. Influence of dentition status on physical disability, mental impairment, and mortality in institutionalized elderly people. *J Dent Res*, 80, 340-5.
- SILVERMAN, W. A. 1993. Doing more good than harm. *Ann N Y Acad Sci*, 703, 5-11.
- SIPAHI, C., BEYZADEOGLU, M., DEMIRTAS, S. & OZEN, J. 2007. Effect of different mucosal and acrylic resin surface treatments in a denture
-

- 
- retention model for patients with radiotherapy-induced xerostomia. *Int J Prosthodont*, 20, 405-8.
- SKINNER, E. W., CAMPBELL, R. L. & CHUNG, P. 1953. A clinical study of the forces required to dislodge maxillary denture bases of various designs. *J Am Dent Assoc*, 47, 671-80.
- SKINNER, E. W. & CHUNG, P. 1951. The effect of surface contact in the retention of a denture. *J Prosthet Dent*, 1, 229-35.
- SLAGTER, A. P., OLTHOFF, L. W., BOSMAN, F. & STEEN, W. H. 1992. Masticatory ability, denture quality, and oral conditions in edentulous subjects. *J Prosthet Dent*, 68, 299-307.
- SLAUGHTER, A., KATZ, R. V. & GRASSO, J. E. 1999. Professional attitudes toward denture adhesives: A Delphi technique survey of academic prosthodontists. *J Prosthet Dent*, 82, 80-9.
- SMITA, M., RAMANDEEP DUGAL & KOTHAVADE, M. 2010. A review of denture adhesives used in the dental profession. *Annals and Essences of Dentistry* 11, 129-133.
- SMITH, B., WRIGHT, P. & BROWN, D. 1986. *The Clinical Handling of Dental Materials*. 66.
- SMITH, B. G. N., WRIGHT, P. S. & BROWN, D. 1995. *The Clinical Handling of Dental Materials*, Wright.
- SMITH, P. W. & MCCORD, J. F. 2004. What do patients expect from complete dentures? *J Dent*, 32, 3-7.
- STAFFORD, G. D. 1970. Denture adhesives--a review of their uses and compositions. *Dent Pract Dent Rec*, 21, 17-9.
- STAMOULIS, S. 1962. Physical factors affecting the retention of complete dentures. *Journal of Prosthetic Dentistry*, 12.
- STANITZ, J. 1948. An analysis of the part played by the fluid film in the denture retention. *J Am Dent Assoc*, 37, 168.
- STEELE, J. G., TREASURE, E., PITTS, N. B., MORRIS, J. & BRADNOCK, G. 2000. Total tooth loss in the United Kingdom in 1998 and implications for the future. *Br Dent J*, 189, 598-603.
- SWARTZ, M. L., NORMAN, R. D. & PHILLIPS, R. W. 1967. A method for measuring retention of denture adherents: an in vivo study. *J Prosthet Dent*, 17, 456-63.
- TAGUCHI, N., MURATA, H., HAMADA, T. & HONG, G. 2001. Effect of viscoelastic properties of resilient denture liners on pressures under dentures. *J Oral Rehabil*, 28, 1003-8.
- TAKEUCHI, S., SATO Y., KITAGAWA N., SHIMODAIRA O. & S., H. 2009. A Study on Measurement of Viscoelasticity of Oral Mucosa. *IADR, MIAMI, FLORIDA*, Paper no.417.
- TALLGREN, A. 1972. The continuing reduction of the residual alveolar ridges in complete denture wearers: a mixed-longitudinal study covering 25 years. *J Prosthet Dent*, 27, 120-32.
-

- 
- TERAOKA, F., NAKAGAWA, M. & TAKAHASHI, J. 2004. Retention force of complete palate coverage and palate-less dentures in vitro. *Dent Mater J*, 23, 19-23.
- THOMASON, J. M., FEINE, J., EXLEY, C., MOYNIHAN, P., MULLER, F., NAERT, I., ELLIS, J. S., BARCLAY, C., BUTTERWORTH, C., SCOTT, B., LYNCH, C., STEWARDSON, D., SMITH, P., WELFARE, R., HYDE, P., MCANDREW, R., FENLON, M., BARCLAY, S. & BARKER, D. 2009. Mandibular two implant-supported overdentures as the first choice standard of care for edentulous patients--the York Consensus Statement. *Br Dent J*, 207, 185-6.
- TUCKFIELD, W. J. 1953. the problem of the mandibular denture. *Journal of Prosthetic Dentistry*, 3, 8-28.
- TURCK, D. 1965. A Histologic Comparison of the Edentulous Denture and Non-Denture Bearing Tissues. *J Prosthet Dent*, 15, 419-34.
- TYSON, K. W. 1967. Physical factors in retention of complete upper dentures. *J Prosthet Dent*, 18.
- UCHIDA, H., KOBAYASHI, K. & NAGAO, M. 1989. Measurement in vivo of masticatory mucosal thickness with 20 MHz B-mode ultrasonic diagnostic equipment. *J Dent Res*, 68, 95-100.
- VAN DER MEI, H. C., WHITE, D. J. & BUSSCHER, H. J. 2004. On the wettability of soft tissues in the human oral cavity. *Arch Oral Biol*, 49, 671-3.
- VAN NOORT, R. 2007a. *Introduction to Dental Materials, 3rd edition, p.71*, Mosby.
- VAN NOORT, R. 2007b. *Introduction to dental materials, Elastic Impression materials,191-207*, Mosby.
- VERMILYEA, S. G., POWERS, J. M. & CRAIG, R. G. 1975. Polyether, polysulfide and silicone rubber impression materials. 2: accuracy of silverplated dies. *J Mich Dent Assoc*, 57, 405-10.
- WASSELL, R. W., BARKER, D. & WALLS, A. W. 2002a. Crowns and other extra-coronal restorations: impression materials and technique. *Br Dent J*, 192, 679-84.
- WASSELL, R. W., BARKER, D. & WALLS, A. W. 2002b. Crowns and other extra-coronal restorations: impression materials and technique. *Br Dent J*, 192, 679-84, 687-90.
- WATERS, M. G., JAGGER, R. G., JEROLIMOV, V. & WILLIAMS, K. R. 1995. Wettability of denture soft-lining materials. *J Prosthet Dent*, 74, 644-6.
- WEINSTEIN, M., SCHUCHMAN, J., LIEBERMAN, J. & ROSEN, P. 1988. Age and denture experience as determinants in patient denture satisfaction. *J Prosthet Dent*, 59, 327-9.
- WILLIAMS, J. R. & CRAIG, R. G. 1988. Physical properties of addition silicones as a function of composition. *J Oral Rehabil*, 15, 639-50.
- WRIGHT, C. R. 1969. Evaluation of the factors necessary to develop stability in mandibular denture. *Journal of Prosthetic Dentistry*, 16, 414.
-

- 
- WYATT, C. C. 1998. The effect of prosthodontic treatment on alveolar bone loss: a review of the literature. *J Prosthet Dent*, 80, 362-6.
- YAYI WEI & BRAINARD, R. L. 2009. *Advanced processes for 193-nm immersion lithography* SPIE, Bellingham, Washington.
- YOSHIDA, M., OMATSU, M., PIQUERO, K. & SAKURAI, K. 1999. Relationship between aging and recovery of the underlying mucosa immediately after removal of pressure: the first molar region in the mandible. *Bull Tokyo Dent Coll*, 40, 61-9.
- ZARB, G. A. & SCHMITT, A. 1990. The longitudinal clinical effectiveness of osseointegrated dental implants: the Toronto study. Part I: Surgical results. *J Prosthet Dent*, 63, 451-7.
- ZGURA, I., BEICA, T., MITROFAN, I. L., MATEIAS, C. G., PIRVU, D. & PATRASCU, I. 2010. Assessment of the impression materials by investigation of the hydrophilicity. *Digest Journal of Nanomaterials and Biostructures*, 5, 749-755.
- ZHANG, P. & XU, J. 2003. [Study on retention and stability of linear occlusal complete dentures]. *Zhonghua Kou Qiang Yi Xue Za Zhi*, 38, 46-8.
- ZHAO, K., CHENG, X. R., CHAO, Y. L., LI, Z. A. & HAN, G. L. 2004. Laboratory evaluation of a new denture adhesive. *Dent Mater*, 20, 419-24.

# 12

---

## Appendices

## 12. Appendices

### 12.1 Appendix 1: Data Collection forms

Evaluation Number	Sheffield Teaching Hospitals  NHS Foundation Trust
<b>Charles Clifford Dental Hospital – SERVICE EVALUATION</b> <b>Patient Satisfaction with Complete Dentures provided</b> <b>on the Student Clinical Taught Courses (Year 3)</b>	
<p>Our students provide a complete denture service as part of their required training to become dentists. We are very keen to improve this service and would very much welcome your views.</p> <p>We would like to record your views at the beginning and end of the treatment period. We would be grateful if you could complete this simple questionnaire at these two stages. Your comments will help us to provide a better service.</p>	
<b>START of TREATMENT FORM (OLD DENTURE ASSESSMENT)</b>	
<b>Patient Data</b>	
Source of Referral	GDP GMP CDS CONS other.....
How long has the patient been edentulous?	
How many sets of previous dentures?	
How old are the current dentures?	
Principle presenting complaint	Loose dentures, inability to eat, poor appearance, worn teeth, broken dentures, gag reflex, denture pain
<b>Concerns with your Old Dentures (Completed by patient)</b>	
How satisfied are you with the fit of your <i>upper</i> denture?	Very satisfied – Satisfied – Dissatisfied – Very dissatisfied
How satisfied are you with the fit of your <i>lower</i> denture?	Very satisfied – Satisfied – Dissatisfied – Very dissatisfied
How satisfied are you with your ability to chew with your dentures?	Very satisfied – Satisfied – Dissatisfied – Very dissatisfied
How satisfied are you with your ability to speak with your dentures?	Very satisfied – Satisfied – Dissatisfied – Very dissatisfied
How satisfied are you with the appearance of your dentures?	Very satisfied – Satisfied – Dissatisfied – Very dissatisfied
<b>Clinician's Evaluation of Old Dentures</b>	
Record obvious clinical/technical errors in the completed denture (e.g. under/over-extended dentures, neutral zone probs.) <b>Please circle as appropriate</b>	
Obvious errors in Polished Surfaces	Over-Extension                      Under-Extension                      Fraenae attachments
	Neutral zone space                      Tongue space.
Obvious Occlusion errors	Vertical dimension    Even in CR    Even articulation    Teeth not over the ridge
Appearance	Shade    Mould    Horizontal incisal plane    Lip support    Position of teeth
Anatomical Constraints	Intra-oral access    Alveolar ridge size and morphology    Muscle attachments
	Fibrous/flabby ridge    Superficial mental nerve    Unusual anatomy
Procedural Difficulties	Gag reflex    Habituated mandibular posturing    Difficulty achieving CR    Dry mouth
1	



**Charles Clifford Dental Hospital – SERVICE EVALUATION**  
**Patient Satisfaction with Complete Dentures provided**  
**on the Student Clinical Taught Courses (Year 3)**

**END of TREATMENT FORM (NEW DENTURE ASSESSMENT)**

**Process**

Do you feel that you have been treated professionally?	YES	NO
Were all your questions answered adequately?	YES	NO
Were attempts made to organise your appointments to suit your convenience?	YES	NO
Did you receive adequate information on how to care for your <i>dentures</i> ?	YES	NO
Did you receive adequate information on how to care for your <i>mouth</i> ?	YES	NO
Did the overall quality of care provided meet your expectations? If not, please explain....	YES	NO

**Outcome**

How satisfied are you with the fit of your <i>upper</i> denture?	Very satisfied – Satisfied – Dissatisfied – Very dissatisfied
How satisfied are you with the fit of your <i>lower</i> denture?	Very satisfied – Satisfied – Dissatisfied – Very dissatisfied
How satisfied are you with your ability to chew with your dentures?	Very satisfied – Satisfied – Dissatisfied – Very dissatisfied
How satisfied are you with your ability to speak with your dentures?	Very satisfied – Satisfied – Dissatisfied – Very dissatisfied
How satisfied are you with the appearance of your dentures?	Very satisfied – Satisfied – Dissatisfied – Very dissatisfied

**Overall Satisfaction**

Do the dentures provided meet your expectations?	YES	NO
Would you come again?	YES	NO
Would you recommend this service to your friends?	YES	NO
Which set of dentures do you intend to wear from now on?	Previous set	New set
What is your overall level of satisfaction? Please comment...	Very satisfied – Satisfied – Dissatisfied – Very dissatisfied	

Evaluation Number

**Charles Clifford Dental Hospital – SERVICE EVALUATION**  
**Patient Satisfaction with Complete Dentures provided**  
**on the Student Clinical Taught Courses (Year 3)**

**If the patient is “Dissatisfied” or “Very dissatisfied” with the New Dentures:**

- Record obvious clinical/technical errors in the completed denture (e.g. under/over-extended dentures, neutral zone probs.)
- Did any problems arise during the making of the dentures (e.g. gagging, difficulty in obtaining RCP)?

**Please circle as appropriate**

Obvious errors in Polished Surfaces	Over-Extension	Under-Extension	Fraenae attachments		
	Neutral zone space		Tongue space.		
Obvious Occlusion errors	Vertical dimension	Even in CR	Even articulation	Teeth not over the ridge	
Appearance	Shade	Mould	Horizontal incisal plane	Lip support	Position of teeth
Anatomical Constraints	Intra-oral access		Alveolar ridge size and morphology		Muscle attachments
	Fibrous/flabby ridge		Superficial mental nerve		Unusual anatomy
Procedural Difficulties	Gag reflex	Habituated mandibular posturing	Difficulty achieving CR	Dry mouth	

**What adjustments were made to the denture at fit or review stage?**

Upper Denture	Occlusal	Fit surface	Flanges	Polished surface	Posterior extension
Lower Denture	Occlusal	Fit surface	Flanges	Polished surface	Posterior extension
Comments					

Date:

Completed by:

## 12.2 Appendix 2: Patient Information Sheet

### Participant Information Sheet

#### 1. Research Project Title

The official title of this project is:

The design and validation of an *in-vitro* model of a human mandibular edentulous ridge to test the retention of mandibular complete dentures.

**We are trying to design a simple model in the laboratory of the human lower jaw without any teeth so that we can improve the fit and retention of complete dentures.**

#### 2. Invitation Paragraph

You are being invited to take part in a research project. Before you decide whether or not you wish to participate, it is important for you to understand why the research is being done and what it will involve. Please take the time to carefully read the following information and discuss it with others if you wish. Feel free to ask us if anything is not clear or if you would like more information on any aspect of this project. Thank you for your time.

#### 3. What is the purpose of the project?

**The main purpose of this study is to develop a realistic model of a lower jaw without teeth and the surrounding soft tissues. This will enable us to design better ways of improving the security of lower dentures. The development of this model will mean that new dentures can be tested without the need to test on patients.**

In order to make this model, we need to duplicate the shape of the lower jaw, by taking impressions similar to the procedure that we use for making dentures. The impressions will be slightly extended from either side to record the cheeks side and tongue side of the denture-bearing tissues.

#### 4. Why have I been chosen?

You have been invited to participate in this research study because you have no natural teeth in your lower jaw and you are attending our clinics for the provision of new complete dentures.

#### 5. Do I have to take part?

**No, you are not obligated to take part in this study at all. This is entirely your decision and the project is run on a completely voluntary basis.** Refusal to take part will not disadvantage you or the treatment that you are receiving at the Charles Clifford Dental Hospital in any way. If you do decide to take part you will be given this information sheet to keep for reference and you will be asked to sign a consent form. If you decide to take part you are still free to withdraw at any time without giving a reason and again withdrawal will not disadvantage you in any way.

**6. What will I have to do if I choose to take part?**

Should you decide to take part, we will need to see you on 2-3 occasions to coincide with your regular denture appointments. After you have been seen by the students for your denture appointment, we will see you to record the shape of your bottom jaw with impressions. Each session will take no longer than 15 minutes.

We will need to take 1-2 impressions of your lower jaw, in a similar way to the technique used to make dentures.

**7. How will my appointments be scheduled?**

We will let you know when and how your appointments will be scheduled. These appointments will take place to coincide with your denture appointments, so that on some days, you will have a slightly extended appointment: You will see the dental student for your denture appointment and us for a further 15 mins. We will inform you when these extended appointments will take place.

**8. What are the possible disadvantages and risks of taking part?**

In the case of this project, there will be no disadvantages and risks in taking part.

The impressions taken will be similar to those taken to record the shape of the jaws for denture provision. Every effort will be made to minimise any possible discomfort associated with this. In any event, the impressions taken for the purpose of this research project should not be any more uncomfortable than recording conventional impressions for the provision of dentures.

**9. What are the possible benefits of taking part?**

The data that we will obtain from the impressions will help us in the construction of a better complete denture service in the future. There are no immediate benefits for those people participating in the project, other than our gratitude and the satisfaction that your support has been crucial to the development of better ways of retaining bottom dentures.

**10. What if something goes wrong?**

The risks of something going wrong are extremely small. You may experience momentary discomfort as a result of recording the impressions, but we do not anticipate that this should be any worse than any discomfort experienced during normal impression taking for denture provision, which is minimal.

If you have any cause to complain about any aspect of the way in which you have been approached or treated during the course of this study, the normal University complaints mechanisms are available to you and are not compromised in any way because you have taken part in a research study.

If you have any complaints or concerns please contact either the clinical project supervisor:

Dr. Nicolas Martin, Department of Adult Dental Care, School of Clinical Dentistry, University of Sheffield

Or

**Contact the Patient Advice and Liaison Service (PALS) Officer:**

Sheffield Teaching Hospitals NHS Foundation Trust  
Patient Partnership Department  
B Floor, Royal Hallamshire Hospital  
Glossop Road  
Sheffield  
S10 2JF

Tel: 0114 2712450

Email: [pals@sth.nhs.uk](mailto:pals@sth.nhs.uk)

The University's Registrar and Secretary who is the designated official person at the University responsible for receiving complaints brought against the University.

**11. Who can I talk to for more information?**

You are free to discuss this project with anybody that may be able to give you appropriate advice. You may also contact Professor Andrew Rawlinson at the address below in order to obtain independent scientific advice. Professor Rawlinson is not associated with this study in any way.

Professor Andrew Rawlinson, Professor of Restorative Dentistry, Department of Adult Dental Care  
School of Clinical Dentistry, University of Sheffield

**12. Will my taking part in this project be kept confidential?**

All information that is collected about you during the course of the research project will be kept strictly confidential. Any information about you that is presented will have your name and address removed so that it will be impossible to recognise you from it. The only details that will be recorded are: Age, gender, the number of years since your teeth were extracted and the shape of your bottom jaw.

**13. What will happen to the results of the research project?**

The results will be used to design new methods of improving the retention of lower complete dentures in a laboratory setting. These results will be evaluated and presented throughout the dental profession by means of publications in professional journals and research conferences.

**14. Who is organising and funding the research?**

The University of Sheffield.

**15. Who has reviewed this project?**

The project had been reviewed and approved by:

- South Yorkshire Research Ethics Committee.
- Research department of Sheffield Teaching Hospitals NHS Foundation Trust
- The University of Sheffield.

**16. Contact for further information:**

PhD research student: Dr. Neda AL-Kaisy, Department of Adult Dental Care, School of Clinical Dentistry

Email: [n.al-kaisy@sheffield.ac.uk](mailto:n.al-kaisy@sheffield.ac.uk)

Thank you for taking part in this study

Should you agree to become a participant, you will be given a copy of this *Participant Information Sheet* and a copy of your signed *Participant Consent Form* to keep.

## 12.3 Appendix 3: Participant Consent Form

### Participant Consent Form

**Title of Project:**

The design and validation of an in-vitro model of a human mandibular edentulous ridge to test the retention of mandibular complete dentures.

**Name of Researcher:**

N. AL-Kaisy, Dept. Adult Dental Care, the University of Sheffield

**Participant Identification Number for this project:** \_\_\_\_\_

1. I confirm that I have read and understood the information sheet dated \_\_\_\_/\_\_\_\_/\_\_\_\_ for the above project and that I have had the opportunity to ask questions.
2. I understand that my participation is voluntary and I am free to withdraw at any time without giving any reason.   
Withdrawal from this study will not disadvantage you or the treatment that you are receiving at the CCDH in any way.
3. I understand that my responses will be anonymised before analysis. I give permission for members of the research team to have access to my anonymised responses.
4. **I understand that data collected during the study may be looked at by individuals from the NHS Trust where it is relevant to my taking part in this research. I give permission for these individuals to have access to my data.**
5. I agree to take part in the above project.

-----  
Name of participant                      Date                                      Signature

-----  
Name of person taking                      Date                                      Signature  
the consent

**Copies:**

One copy for the Participant and one copy for the Principal Investigator.

**12.4 Appendix 4: The retentive forces (gf) of well-fitting denture with the use of different amount of saliva at 50 mm/min tensile speed in two series of experiment.**

<b>Series one experiment</b>									
	<b>0 ml</b>	<b>0.3 ml</b>	<b>0.5 ml</b>	<b>0.7 ml</b>	<b>0.9 ml</b>	<b>1.1 ml</b>	<b>1.3 ml</b>	<b>1.5 ml</b>	
	23.970	46.230	69.232	80.160	80.160	57.274	48.542	50.272	
	31.505	39.178	65.605	75.347	75.347	55.688	46.942	49.885	
	36.588	46.877	62.984	68.028	68.028	55.525	47.131	50.826	
	34.135	40.692	63.619	54.559	54.559	57.115	48.724	50.570	
	30.334	36.496	65.373	55.473	55.473	57.702	47.921	51.546	
	34.475	37.092	64.166	77.306	77.306	56.772	46.656	52.274	
	31.062	32.425	65.266	73.067	73.067	56.043	48.547	51.917	
	26.326	42.793	63.745	73.858	73.858	57.714	50.870	51.983	
	25.556	40.026	63.618	73.375	73.375	56.871	49.957	50.165	
	30.607	29.719	66.185	74.107	74.107	57.316	46.682	50.968	
<b>Average</b>	<b>30.456</b>	<b>39.153</b>	<b>64.979</b>	<b>70.528</b>	<b>70.528</b>	<b>56.802</b>	<b>48.197</b>	<b>51.041</b>	
<b>SD</b>	<b>4.109</b>	<b>5.494</b>	<b>1.827</b>	<b>8.745</b>	<b>8.745</b>	<b>0.794</b>	<b>1.423</b>	<b>0.843</b>	
<b>Series two experiment</b>									
	<b>0 ml</b>	<b>0.3 ml</b>	<b>0.5 ml</b>	<b>0.7 ml</b>	<b>0.9 ml</b>	<b>1.1 ml</b>	<b>1.3 ml</b>	<b>1.5 ml</b>	
	36.626	64.228	55.444	70.771	74.039	46.384	48.429	40.346	
	32.903	61.022	54.020	61.428	66.656	50.200	45.863	41.207	
	31.242	60.159	54.175	59.306	66.150	51.358	45.718	43.306	
	31.545	61.255	55.927	56.942	65.769	50.750	46.784	40.725	
	31.864	57.738	53.882	60.291	59.987	50.277	46.116	43.367	
	31.881	61.798	54.570	60.226	61.549	51.415	47.967	44.443	
	30.758	60.748	58.567	58.922	62.045	51.457	47.748	42.905	
	29.077	62.274	58.473	59.371	59.972	52.763	47.743	42.153	
	30.235	58.947	57.582	60.440	65.058	51.820	47.517	40.762	
	32.832	57.633	55.971	58.968	65.494	52.684	48.282	41.658	
<b>Average</b>	<b>31.896</b>	<b>60.580</b>	<b>55.861</b>	<b>60.667</b>	<b>64.672</b>	<b>50.911</b>	<b>47.217</b>	<b>42.087</b>	
<b>SD</b>	<b>2.023</b>	<b>2.053</b>	<b>1.799</b>	<b>3.747</b>	<b>4.171</b>	<b>1.813</b>	<b>1.016</b>	<b>1.372</b>	



**12.5 Appendix 5: The retentive forces (gf) of well-fitting denture with the use of 0.9 ml saliva at different tensile speed in four series of experiment.**

	Series one experiment			Series two experiment			Series three experiment			Series four experiment		
	30 mm/min	50 mm/min	70 mm/min	30 mm/min	50 mm/min	70 mm/min	30 mm/min	50 mm/min	70 mm/min	30 mm/min	50 mm/min	70 mm/min
	49.163	67.219	61.532	53.745	64.284	67.241	53.157	56.230	74.959	64.057	72.220	73.818
	47.967	68.301	54.051	53.185	63.898	63.947	50.780	55.021	73.016	62.875	69.432	73.773
	51.931	68.510	61.357	53.252	64.067	62.104	52.189	49.563	74.302	60.819	67.865	71.194
	52.394	67.537	57.380	51.151	60.538	63.498	50.637	52.224	71.833	61.307	69.359	71.522
	55.075	66.920	59.638	52.226	61.757	61.515	49.942	53.489	74.247	60.470	69.637	71.419
	50.899	65.041	61.544	51.857	61.243	60.288	50.411	51.842	74.787	59.653	70.138	69.476
	53.269	68.651	62.060	52.372	62.654	58.538	51.474	51.615	73.913	61.090	70.804	67.164
	54.572	65.597	58.953	52.083	60.735	62.471	53.949	51.957	75.701	63.274	73.426	71.952
	51.552	64.187	59.946	54.349	64.397	61.234	53.272	50.033	72.922	62.987	70.549	70.370
	50.666	65.150	61.983	54.246	62.097	59.051	51.987	50.974	70.048	59.726	72.447	73.246
<b>Average</b>	<b>51.749</b>	<b>66.711</b>	<b>59.844</b>	<b>52.846</b>	<b>62.567</b>	<b>61.989</b>	<b>51.780</b>	<b>52.295</b>	<b>73.573</b>	<b>61.626</b>	<b>70.588</b>	<b>71.393</b>
<b>SD</b>	<b>2.229</b>	<b>1.611</b>	<b>2.538</b>	<b>1.072</b>	<b>1.507</b>	<b>2.542</b>	<b>1.362</b>	<b>2.094</b>	<b>1.674</b>	<b>1.561</b>	<b>1.686</b>	<b>2.054</b>

