

# Qualitative Spatial Change : Space-Time Histories and Continuity

**Shyamanta M. Hazarika**

Submitted in accordance with the requirements  
for the degree of Doctor of Philosophy.



**The University of Leeds  
School of Computing**

**January 2005**

The candidate confirms that the work submitted is his own and that appropriate credit has been given where reference has been made to the work of others. This copy has been supplied on the understanding that it is copyright material and that no quotation from the thesis may be published without proper acknowledgement.



*To my mother and the memory of my father*



## Abstract

Spatial configurations tend to change. Dealing with spatial representations often means dealing with changing representations. Change in state for qualitative spatial representation languages has been analyzed through transition graphs in which relations form *conceptual neighbourhoods* via potential motion. Continuity has remained an implicitly assumed notion for any such understanding of motion. The work described in this thesis is concerned with formalizing an *intuitive* notion of spatio-temporal *continuity* for a qualitative theory of spatial change.

Taking over a theory for spatial regions, I extend it for space-time. A mereotopological spatio-temporal theory based on space-time histories is developed. I formalize the intuitive notion of spatio-temporal continuity and christen it *strong firm* continuity. Continuous transitions in mereotopology for space-time *histories* are investigated.

For *strong firm* continuity, transition rules for spatio-temporal histories are formulated. The conceptual neighbourhood for the spatial representation language RCC-8 specifies which transitions are continuous, and in its original presentation was simply posited without any proof of correctness. Formal proofs for the non-existence of transitions i.e., transitions absent from the RCC-8 conceptual neighbourhood are presented here.



## Acknowledgements

I am indebted to my supervisor Prof. Anthony G Cohn for his unique insight and warm guidance. He has always been encouraging and enthusiastic and it has been a genuine pleasure working with him. Prof. Cohn made great time and effort to help turn this work into a dissertation. Thank you Sir.

I would like to acknowledge the financial support through the Commonwealth Scholarship received from the Commonwealth Scholarship Commission, 36 Gordon Square, London. Without it I could never afford to be in the United Kingdom!

The Qualitative Spatial Reasoning Group at Leeds is a great place to work and learn. I am obliged to Brandon Bennett for the numerous discussions with him during the course of this work. I would like to thank John Stell, Anthony Roy, Paolo Torrini and Ah Lian Kor for several fruitful QSR meetings. Thanks to Javier Fontanura, Mary Cryan and Karim Djemmame for making the Level - 9 lab a great place to work in.

David Randell took a particular interest in this work. I am grateful to him for the various interactions about the intricacies of getting automated proofs. I earnestly appreciate his meticulous working through my axiom set and critical suggestions.

My stay in the United Kingdom would not have been this pleasant without my cousin and her family. 'Ashirbad' has been my home for the last couple of years. Thank you Madhan'ba', Neal and Boon.

Thanks to my brother Rupu and sisters Nita'ba' and Rita'ba' for their constant support and encouragement in my endeavour to educate myself. My deepest gratitude goes to my parents. Thank you 'Maa' for all the trouble you have taken to ensure we get the best out of life. I fondly remember 'Deuta' for his unwavering perseverance to do truth, from which I draw my drive and strength. I offer my sincere tributes to him.





# Contents

<b>1</b>	<b>Introduction</b>	<b>1</b>
1.1	Motivation . . . . .	2
1.1.1	Qualitative Continuity . . . . .	2
1.1.2	Continuity and Transition . . . . .	2
1.2	Organisation of the thesis . . . . .	2
<b>2</b>	<b>Qualitative Spatial Representation and Reasoning</b>	<b>5</b>
2.1	What is Qualitative Spatial Reasoning? . . . . .	5
2.2	Ontological Commitments . . . . .	8
2.3	Different Approaches to QSR . . . . .	10
2.3.1	Topology . . . . .	10
2.3.2	Mereotopology . . . . .	11
2.3.3	Orientation . . . . .	12
2.3.4	Distance and Size . . . . .	13
2.3.5	Shape . . . . .	13
2.4	Region-Based Theories of Space . . . . .	14
2.4.1	Early Theories . . . . .	14
2.4.2	Clarke’s Calculus of Individuals . . . . .	15
2.4.3	Region Connection Calculus . . . . .	17
2.4.4	Asher and Vieu’s Theory . . . . .	22
2.4.4.1	Muller’s Extension . . . . .	23
2.4.5	Other Region-Based Theories . . . . .	24
2.5	Qualitative Spatio-Temporal Reasoning . . . . .	25
2.5.1	Qualitative Spatial Change . . . . .	26
2.5.1.1	Qualitative Motion . . . . .	26
2.5.1.2	Transitions between Spatial Relations . . . . .	27
2.5.2	Incorporating Time into Space . . . . .	28
2.5.3	Qualitative Simulation . . . . .	29

2.5.4	Other approaches to QSTR based on space-time . . . . .	30
2.6	Qualitative Continuity . . . . .	30
2.7	Continuity and Conceptual Neighbourhoods . . . . .	31
2.7.1	Defining Metrics on Regions . . . . .	32
2.7.2	Spatial Transitions over Histories . . . . .	32
<b>3</b>	<b>Mereotopological Theory of Space-Time</b>	<b>35</b>
3.1	Underlying Logic and Domain of Interpretation . . . . .	35
3.2	Mereotopological Framework . . . . .	37
3.2.1	Primitive Relations . . . . .	37
3.2.2	Mereotopological Relations . . . . .	39
3.2.2.1	Boolean Functions . . . . .	41
3.2.3	Firm Connection . . . . .	43
3.3	Temporal Relations . . . . .	44
3.3.1	Temporal Order . . . . .	44
3.3.2	Interval Relations . . . . .	45
3.4	Spatio-Temporal Interactions . . . . .	48
3.4.1	Temporal Slice . . . . .	49
3.4.1.1	Existence of Temporal Slices . . . . .	50
3.5	Underlying Temporal Structure . . . . .	51
<b>4</b>	<b>Continuous Transitions in Mereotopology</b>	<b>55</b>
4.1	Spatio-Temporal Continuity of a s-t history . . . . .	57
4.1.1	Strong Continuity . . . . .	57
4.1.2	Continuity: Ruling out Sideways Leaps . . . . .	58
4.1.2.1	Firm Continuity: Non-Pinched Histories . . . . .	58
4.1.3	Strong Firm Continuity . . . . .	59
4.2	Hierarchy of CNDs . . . . .	60
4.3	Characterizing Transitions . . . . .	61
4.3.1	Continuity and Space-Time Histories . . . . .	61
4.3.2	Durative Relations $R_{sp}^=$ . . . . .	65
4.3.2.1	Transitions between $R_{sp}^=$ Relations . . . . .	68
4.4	A Model for Instantaneous Relations . . . . .	69
4.4.1	Instantaneous Transition Matrix . . . . .	70
4.4.2	Constraints for Non-Existing Relations . . . . .	70
4.4.3	Existing Instantaneous Transition Matrices . . . . .	72
4.4.4	Shared Boundary at Instantaneous Transition . . . . .	74

4.5	Elementary Transitions . . . . .	77
4.5.1	Transition Operators . . . . .	77
4.5.1.1	Trans . . . . .	78
4.5.1.2	InsRel . . . . .	78
4.5.2	Transitions and Continuity . . . . .	78
4.5.2.1	EleTran . . . . .	78
4.6	Conceptual Neighbourhood Diagram under StrFCONT . . . . .	79
4.6.1	DirTran . . . . .	79
4.6.2	Why is NECP adequate? . . . . .	79
4.6.2.1	Temporal Slices as NECPs . . . . .	80
4.6.2.2	NECPs and Trans . . . . .	81
4.6.3	Instantaneous Transitions and StrFCONT . . . . .	82
4.6.3.1	Non-Instantaneous Relations and InsRel3 . . . . .	82
4.6.3.2	Instantaneous Transition Matrix $\mathbb{M}_r$ and InsRel3 . . . . .	83
4.6.4	Non-Existence of Transitions . . . . .	84
4.6.5	Recovering the CND . . . . .	86
<b>5</b>	<b>Further Work and Conclusion</b>	<b>87</b>
5.1	Potential Application: Abducing Qualitative Histories . . . . .	87
5.1.1	Abductive Framework . . . . .	87
5.1.1.1	Spatio-Temporal Theory $\Sigma_{ST}$ . . . . .	89
5.1.1.2	Spatio-Temporal Patterns $\Delta_P$ . . . . .	89
5.1.2	Generalized Transitions . . . . .	91
5.1.3	Specifying the Local Survey $\Phi$ . . . . .	92
5.1.4	Selection Heuristics . . . . .	93
5.1.4.1	Global Persistence . . . . .	93
5.1.4.2	Additional Heuristics . . . . .	97
5.1.5	What is achieved? . . . . .	100
5.2	Summary of Work . . . . .	101
5.2.1	Contributions . . . . .	101
5.2.1.1	Taking <i>histories</i> further . . . . .	101
5.2.1.2	Intuitive Spatio-Temporal Continuity . . . . .	102
5.2.1.3	Transition between Histories . . . . .	102
5.2.2	Critical Evaluation . . . . .	103
5.2.2.1	Continuity: What did we not attempt? . . . . .	103
5.2.2.2	Recovering the Transition Graph: What is left out? . . . . .	104

5.3	Further Work . . . . .	105
5.3.1	Proof of Consistency . . . . .	105
5.3.2	Experiments with Theorem Proving . . . . .	106
5.3.3	Extending the Abductive Formalism . . . . .	106
<b>A</b>	<b>Reference of Formulae</b>	<b>109</b>
<b>B</b>	<b>Space-Time Theorems</b>	<b>111</b>
<b>C</b>	<b>Transition Theorems I</b>	<b>135</b>
<b>D</b>	<b>IM and NECP Theorems</b>	<b>153</b>
<b>E</b>	<b>Transition Theorems II</b>	<b>185</b>
	<b>Bibliography</b>	<b>226</b>
	<b>Index</b>	<b>247</b>

# List of Symbols

$C_\alpha$	Connection Primitive, A1-A3 . . . . .	38
$P_\alpha$	Parthood Relation, D1 . . . . .	39
$O_\alpha$	Overlap Relation, D2 . . . . .	39
$PP_\alpha$	Proper-part Relation, D3 . . . . .	39
$DR_\alpha$	Discrete Relation, D4 . . . . .	39
$DC_\alpha$	Disconnected Relation D5 . . . . .	39
$EC_\alpha$	Externally connected Relation D6 . . . . .	39
$PO_\alpha$	Partial overlap Relation D7 . . . . .	39
$EQ_\alpha$	Equal Relation D8 . . . . .	39
$TPP_\alpha$	Tangential proper-part Relation D9 . . . . .	39
$NTPP_\alpha$	Non-tangential proper-part D10 . . . . .	39
$TPPi_\alpha$	Tangential proper-part inverse . . . . .	39
$NTPPi_\alpha$	Non-tangential proper-part inverse . . . . .	39
$\mathfrak{U}$	Constant symbol to denote the universe D15 . . . . .	42
$CON_\alpha$	One-pieceness D16 . . . . .	43
$INCON$	Interior connectedness D17 . . . . .	43
$FCON$	Firm-connection D18 . . . . .	44
$\bowtie$	Temporal connection . . . . .	44
$\subseteq_t$	Temporal inclusion D19 . . . . .	44
$\sigma_t$	Temporal overlap D20 . . . . .	44
$<_t$	Temporal order A9-A12 . . . . .	44
$NECP$	Non-externally connected part D22 . . . . .	46
$\bowtie_t$	Temporally meets D23 . . . . .	46
$\sqsupseteq_t$	Interval relation: ends-with D24 . . . . .	47
$\sqsubset_t$	Interval relation: starts-with D25 . . . . .	47
$\parallel_t$	Interval relation: between D26 . . . . .	47
$IP$	Initial part D27 . . . . .	48
$FP$	Final part D28 . . . . .	48

TS	Temporal Slice D29 . . . . .	49
ORD	Temporally Ordered D31 . . . . .	52
EMB	Embeds D32 . . . . .	52
$\text{Comp}_{\text{st}}$	Binary component relation D33 . . . . .	57
$\text{StrCONT}_{\text{st}}$	Strong continuity D34 . . . . .	57
CONT	Continuity D35 . . . . .	58
ECTS	Adjacent temporal slices of a history D36 . . . . .	59
NP	Non-pinched history D37 . . . . .	59
FCONT	Firm continuity D38 . . . . .	59
StrFCONT	Strong firm continuity D39 . . . . .	59
$\mathcal{CS}\text{-}0$	Doctrine of strong firm continuity StrFCONT. . . . .	59
$\mathcal{CS}\text{-}1$	Weaken $\mathcal{CS}\text{-}0$ with temporal pinching of one history. . . . .	59
$\mathcal{CS}\text{-}2$	Weaken $\mathcal{CS}\text{-}0$ with temporal pinching of both histories. . . . .	59
$R_{\text{sp}}^{\equiv}$	Durative relation . . . . .	65
$P_{\text{sp}}^{\equiv}$	Durative part D40 . . . . .	65
$\text{DC}_{\text{sp}}^{\equiv}$	Durative disconnection D41 . . . . .	65
EQTS	Contemporaneous temporal slice pair D42 . . . . .	66
$\text{EC}_{\text{sp}}^{\equiv}$	Durative external connection D43 . . . . .	66
$P_{\text{sp}}^{\equiv*}$	Strong version of durative part D44 . . . . .	66
$\text{PO}_{\text{sp}}^{\equiv}$	Durative partial overlap D45 . . . . .	67
$\text{EQ}_{\text{sp}}^{\equiv}$	Durative equal D46 . . . . .	67
$\text{TPP}_{\text{sp}}^{\equiv}$	Durative tangential proper-part D47 . . . . .	67
$\text{NTPP}_{\text{sp}}^{\equiv}$	Durative non-tangential proper-part D48 . . . . .	67
$\text{rcc}_{\alpha}$	Reified RCC-8 relation D49 . . . . .	69
$\mathbb{M}_r$	Instantaneous transition matrix D50 . . . . .	70
IM	Predicate to denote RCC-8 relation holding between StrFCONT histories A22 . . . . .	73
SBE	Shared boundary element D51 . . . . .	75
Trans	Durative transition operator D52 . . . . .	78
InsRel	Instantaneous transition operator D53 . . . . .	78
InsRel3	Predicate relating three relations for an instantaneous tran- sition D54. . . . .	78
EleTran	Elementary transition D55 . . . . .	79
DirTran	Direct transition D56 . . . . .	79
$\Sigma_{\text{ST}}$	Spatio-temporal theory. . . . .	88

$\Delta_P$	Logical description of spatio-temporal patterns. . . . .	88
$\Delta_H$	Space-time histories : a mereotopological world model. . .	88
$\Phi$	Local survey: a set of spatio-temporal relationships. . . .	88
$\wp$	Spatio-temporal pattern . . . . .	90
IMB	Spatio-temporal pattern: Immobility D57 . . . . .	90
NPT	Spatio-temporal pattern: Non-repeating D58 . . . . .	90
RPT	Spatio-temporal pattern: Repeating D59 . . . . .	90
pat	Spatio-temporal pattern relation D60 . . . . .	91
PatTran	Pattern transition D61 . . . . .	91
GTrans	Generalized transition D62 . . . . .	91
Dom	Dominance relation . . . . .	91
Obs	Observation interval . . . . .	92
$\Omega$	Observed s-t knowledge . . . . .	92
$\Gamma$	Set of named objects . . . . .	92
Episode	Episode D63 . . . . .	94
EB	Episodic boundary Definition 3 . . . . .	94
IntP	Interior part D64 . . . . .	99
COL	Binary behaviour pattern: Coalescence D65 . . . . .	99
SEP	Binary behaviour pattern: Separation D66 . . . . .	99
CLN	Binary behaviour pattern: Collision D67 . . . . .	99
DIS	Binary behaviour pattern: Disjointness D68 . . . . .	99
ATT	Binary behaviour pattern: Attachment D69 . . . . .	99





# List of Figures

2.1	A counter-example to projecting regions to dimensions separately. . . . .	9
2.2	Lattice defining the subsumption hierarchy of dyadic relations. . . . .	18
2.3	Different shapes distinguishable using $C$ alone. . . . .	20
2.4	Different types of CON region. . . . .	21
2.5	Varieties of multiple connection. . . . .	21
2.6	Pictorial representation of the envisioning axioms . . . . .	27
2.7	Transition graph for the Hausdorff metric. . . . .	33
3.1	A space-time history for 2-D space. . . . .	36
3.2	Connection Primitives: (a) spatial (b) temporal and (c) spatio-temporal. . .	38
3.3	JEPD set of RCC-8 relations under (a) $C_{st}$ and (b) $C_{sp}$ . . . . .	40
3.4	Firm and Non-Firm connection. . . . .	43
3.5	NECP of $x$ with respect to $y$ . . . . .	46
3.6	Interval relation of <b>a.</b> $\bowtie_t$ and <b>b.</b> $\neg \bowtie_t$ for multi-piece intervals. . . . .	46
3.7	Temporal Relations over spatio-temporal regions. . . . .	47
3.8	$C_{sp}$ and $C_t$ connected may not be $C_{st}$ connected. . . . .	48
3.9	Temporal Slice of a history. . . . .	49
3.10	Existence of temporal slices for histories connected spatio-temporally. . . .	51
3.11	Multipiece intervals embedding one another. . . . .	52
4.1	Transition between spatio-temporal histories. . . . .	56
4.2	Muller's definition of discontinuity of a history. . . . .	58
4.3	Firmly-continuous history and non-firm history with temporal pinching. . .	59
4.4	Possible transitions under temporal pinching. . . . .	60
4.5	Transition graph for strong space-time continuity. . . . .	60
4.6	Discontinuity characterized through change of $C_{sp}$ relation . . . . .	61
4.7	Discontinuity involving a temporal gap . . . . .	62
4.8	Disconnected external entity and continuous history. . . . .	63
4.9	Transition from $\neg C_{st}$ to $PP_{st}$ implies discontinuity. . . . .	63

4.10	$EC_{st}$ to $PP_{st}$ transition. . . . .	64
4.11	An $EC_{st}$ to $PP_{st}$ transition with sporadic spatio-temporal relation. . . . .	65
4.12	$NTPP_{sp}^-(x, y)$ is different from the standard RCC definitions . . . . .	66
4.13	Relation between $R_{sp}^-$ and temporal slice of a history. . . . .	67
4.14	Instantaneous relations possible between $StrFCONT$ histories. . . . .	74
4.15	Shared boundary at an instantaneous transition. . . . .	75
4.16	$PO_{sp}^-$ to $NTPP_{sp}^-$ transition . . . . .	76
4.17	Durative transition operator $Trans$ . . . . .	77
4.18	RCC-8 relation resulting from how $NECPs$ are connected. . . . .	79
5.1	Schematic diagram of the Abductive Framework . . . . .	88
5.2	Transition Graph for RCC-8 relations for rigid objects. . . . .	89
5.3	A selection of spatio-temporal patterns for a single entity. . . . .	90
5.4	Example scenario with two observation intervals. . . . .	96
5.5	Example scenario with three observation intervals. . . . .	97
5.6	Example scenario with five observation intervals. . . . .	98
5.7	A selection of binary spatio-temporal patterns. . . . .	100

# List of Tables

2.1	Defined relations in Clarke's theory. . . . .	16
4.1	Transitions under StrFCNT . . . . .	85



# Chapter 1

## Introduction

---

Moving around the environment is one of the primary tasks which human beings and animals accomplish equally well. In the animal kingdom as a whole, reasoning about space is probably the most common and basic form of intelligence [Davis, 1990]. For human beings, *spatial reasoning*, the representation and reasoning about space is a particularly powerful and accessible mode of cognition [Piaget and Inhelder, 1967; Davis, 1990]. In our every day interaction with the physical world, spatial reasoning appears to be driven by *qualitative abstractions* rather than complete quantitative knowledge a priori [Escrig and Toledo, 1998b]. Therefore, Qualitative Reasoning holds promise for developing theories<sup>1</sup> for reasoning about space: indeed, the desire to reason about space more akin to the cognitive process led to the birth of *Qualitative Spatial Reasoning* within Artificial Intelligence.

Space and time are inextricably linked. Spatial configurations frequently change over time. An obvious way to incorporate the notion of time into spatial representations is to consider *space-time* histories traced by spatial objects over time as primitive entities [Hayes, 1985a; 1985b]. Combined space-time representations for spatio-temporal reasoning is an emerging area [Galton, 1993; 1997b; Claramunt and Thériault, 1996; El-Geresy *et al.*, 2000; Agouris *et al.*, 2000; Muller, 1998b; 2002; Bittner, 2002b; 2002a]. This has inspired the work described in this thesis.

---

<sup>1</sup>The word theory is used in its logical/mathematical context i.e., a set of formal axioms which specify the properties and relations of a collection of entities, not in the natural scientist's sense of an empirically testable explanation of observed regularities.

## 1.1 Motivation

Motion can be seen as a form of spatio-temporal change. Such a notion is key to our understanding of spatial relations and changes thereof. Relations form *conceptual neighbourhoods* [Freksa, 1992] through potential motion. However *continuity* remains an implicitly assumed notion. Consequently what constitute *continuous transitions* is typically posited rather than recovered from the theory.

### 1.1.1 Qualitative Continuity

Until recently, space-time continuity has remained an implicitly assumed notion within qualitative spatial reasoning. Galton was the first to address what continuity implies for a qualitative theory of motion [Galton, 1993]. He characterised continuity at the semantic level [Galton, 2000a]. Muller [1998b; 1998c] had an explicit characterization of continuity for a single component history. However Muller’s notion of continuity is inadequate (see Section 2.6, Chapter 2). A goal of this thesis is to make explicit the *intuitive* notion of spatio-temporal continuity.

### 1.1.2 Continuity and Transition

With a combined space-time representation, *allowable* transitions between spatial relations for spatial representation languages need no longer be posited. Transition rules can be stated which can be proved correct within the theory. Muller presented transition rules [Muller, 1998b; 1998a] that claimed to recover parts of the conceptual neighbourhood for the *Region Connection Calculus* (RCC). However, Muller’s transition rules were shown to be inadequate by Davis [2001]. Davis provided an alternative characterisation in Muller’s language for space-time histories [Davis, 2000], but was not strictly mereotopological (see Section 2.7.2, Chapter 2). My goal here is to formulate transition rules for space-time histories so as to recover the conceptual neighbourhood for RCC within pure mereotopology.

## 1.2 Organisation of the thesis

The principal focus of this thesis is (a) to develop a mereotopological theory of space-time and (b) under the intuitive notion of spatio-temporal continuity, recover the conceptual neighbourhood for RCC. The thesis is organised into the following chapters:

## Chapter 2: Qualitative Spatial Representation and Reasoning

In the next chapter I shall review related work in the area of Qualitative Spatial Reasoning. The different approaches to qualitative spatial representation are mentioned for completeness. The emphasis is on *Region-Based Theories of Space*: theories based on regions as the primitive entity. The earliest of the region-based theories of space are those of Leśniewski and of Whitehead. The mereotopological theory of space-time in this thesis is based on the spatial representation language Region Connection Calculus [Randell *et al.*, 1992b] which is a development of Clarke's theory. I shall therefore describe in some detail the theories of Clarke [1981] and Randell *et al.* [1992b]. I am interested in change in spatial relations over time. Any such change is spatio-temporal. I shall therefore review the related area of qualitative spatio-temporal reasoning including qualitative continuity and continuous transitions.

## Chapter 3: Mereotopological Theory of Space-Time

A mereotopological theory of space-time is developed here. The mereotopological theory of space-time is based on RCC and closely follows the one by Muller [1998c]. I introduce three distinct dyadic primitives, one each for spatial, temporal and spatio-temporal connection. In order to introduce spatio-temporal interaction, I retain the classical notion of temporal order [Muller, 1998c] and define temporal relations similar to those of Allen for multi-piece intervals [Allen and Hayes, 1985]. I have a simpler formulation and arrive at linearity (as in Kamp's Logic [1979] with overlap replaced by temporal connection) for the underlying temporal structure.

The mereotopological theory forms the basis on which in Chapter 4 formal proofs for non-existence of transitions i.e., transitions absent from the RCC conceptual neighbourhood are presented.

## Chapter 4: Continuous Transitions in Mereotopology

I formalize the most common implicitly assumed intuitive notion of spatio-temporal continuity, for which I strengthen Muller's notion of continuity and christen it *strong firm continuity*.

I formulate transition rules for space-time histories. The notion of *strong firm continuity* defined above is reinforced through additional axioms. For the RCC relations I define *durative* relations and formulate transition operators. I present an analysis from first principles of which relations can hold instantaneously under strong firm continuity and under what conditions. Formal proofs for the non-existence of transitions i.e., transitions absent

from the RCC-8 conceptual neighbourhood under *strong firm* continuity are presented.

## **Chapter 5: Further Work and Conclusion**

I conclude by enumerating the contributions of this work. A framework based on the mereotopological spatio-temporal theory for constructing qualitative space-time histories from partial information is described. I shall present a critical evaluation and pointers towards future work.



## Chapter 2

# Qualitative Spatial Representation and Reasoning

---

This chapter is a brief overview of the field of qualitative spatial representation and reasoning. In recent years much research has been done in this area. An exhaustive and complete overview here is neither feasible nor intended. Here I shall give a general understanding of the field and particular insight into the lines of research, which originated and inspired the work undertaken in this thesis. More complete overviews are [Cohn, 1997; 1999] and [Vieu, 1997]. A recent survey is [Cohn and Hazarika, 2001b].

I will retrace the emergence of qualitative spatial reasoning. The guiding principles of qualitative spatial reasoning and the different approaches to qualitative spatial representation are highlighted. I shall discuss the closely related area of qualitative spatio-temporal reasoning. I shall review the work done so far in formalization of qualitative spatio-temporal continuity and continuous transitions.

### 2.1 What is Qualitative Spatial Reasoning?

Artificial Intelligence (AI) has as one of its central topics the ability to represent and reason with *common-sense* knowledge [McCarthy, 1959]. Of our commonsensical abilities, those involving space and spatial attributes are perhaps the most basic ones. The physical world in which we live has a spatial extent and all physical objects are located in space. Space is an important part of common-sense reasoning.

Early forays into common-sense reasoning about the physical world involved solving textbook problems on physics and mathematics. The earliest systems like STUDENT [Bobrow, 1968], CARPS [Charniak, 1968], ISSAC [Novak, 1976] and MECHO [Bundy *et al.*, 1979] could solve a variety of problems. However, these were not adequate for reasoning about most commonplace physical scenarios. This gave rise to the urge for something different from the traditional approach solely relying on mathematical equations. A system suggested by De Kleer [1975] involving both quantitative knowledge and qualitative information concerning the physical situation marked the starting point for *qualitative physics* [Forbus, 1989; Weld and De Kleer, 1990].

Hayes' *Naive Physics Manifesto* [1979; 1985a; 1985b] paved the way for establishing qualitative physics (meantime re-christened *qualitative reasoning*) as an important topic of research within AI. The Naive Physics Manifesto proposed to represent space-time with four-dimensional *histories*. Based on Hayes' histories, Forbus [1980; 1983] presented a system, which reasoned about motion through free space by using both qualitative and quantitative information.

Qualitative Reasoning (QR) is an approach for dealing with common-sense knowledge without recourse to complete quantitative knowledge. Representation of knowledge is through a limited repository of qualitative abstractions. The essence is to represent continuous properties of the world by a discrete system of symbols. The resulting set of qualitative values is termed a *quantity space*. The most frequently used quantity space is the abstraction  $\{+, -, 0\}$ . This was successful in *qualitative dynamics* – the sub-field of qualitative physics describing forces that causes systems to change over time. The bulk of work dealt with reasoning about scalar quantities, whether they denote the level of liquid in a tank, the height of a bouncing ball [Weld and De Kleer, 1990] or a complex socio-economic allocation problem [Brajnik and Lines, 1988]. This success was largely due to the possibility of exploiting the underlying partial or total order of the quantity space using *transitivity*.

On the contrary, it was conjectured that this cannot be the case for *qualitative kinematics* – the sub-field of qualitative physics concerned with spatial reasoning required by common-sense physics. Forbus, Neilson and Faltings in their seminal paper on qualitative kinematics [Forbus *et al.*, 1987] put forward the *poverty conjecture*. According to the poverty conjecture there is no purely qualitative general-purpose kinematics. The neglect of spatial reasoning in QR can be partially attributed to the poverty conjecture. But qualitative spatial reasoning is more than just kinematics. To understand why the poverty conjecture contributed to the delayed progress of spatial reasoning within QR, it is worth recalling their third (and most strongest) argument:

No Total Order: quantity spaces don't work in more than one dimension, leaving little hope for concluding much about combining weak information about spatial properties.

Forbus, Neilson and Faltings [1987]

They doubt if transitivity of values (a key feature of qualitative quantity spaces) can be exploited much in higher dimensions. Forbus et al. conclude that the space of representations in higher dimensions is sparse and for spatial reasoning nothing weaker than numbers will do [Forbus *et al.*, 1987].

Despite early forays such as the Naive Physics Manifesto [Hayes, 1979; 1985a; 1985b], the multi-dimensional nature of space has been ill addressed. However, it is exciting to note that there has been an increasing amount of research over the last few years, which tends to refute, or at least weaken the poverty conjecture. Qualitative spatial representations addressing many different aspects of space including topology, orientation, shape, size and distance have been put forward. There is a rich diversity of these representations and they exploit transitivity as demonstrated by the *transitivity tables*<sup>1</sup>, which have been built for these representations.

In spite of all these developments, in most current computerized applications, spatial information is based almost entirely on *numerical* co-ordinates and parameters. In contrast, everyday spatial interactions are driven by *qualitative abstractions*. Research on *mental models* suggests that qualitative representations are an essential component of common-sense reasoning about the physical world [Davis, 1990; Knauff *et al.*, 1998]. For computer systems to be *intelligent*, with many other facets of *common-sense knowledge* such as visual recognition, natural language processing and speech understanding, it would need more than ad hoc understanding of space and spatial interactions. Therefore there is increasing interest in the study of spatial concepts from a cognitive point of view. Qualitative Spatial Representation and Reasoning is concerned with providing calculi which allow a machine to represent and reason with spatial entities without resort to traditional quantitative techniques prevalent within for example, computer graphics or computer vision.

Qualitative spatial representation and qualitative spatial reasoning can be regarded as two separate sub-fields. Representation is concerned with different forms of spatial knowledge and how it can be formalized within a computational framework. Reason-

---

<sup>1</sup>Originating in Allen's analysis of temporal relations and called the transitivity table [Allen and Koomen, 1983], is now more appropriately renamed composition table since more than one relation is involved and it is the composition of the relations that is being represented rather than the transitivity of individual relations.

ing is concerned with methods and techniques for decision-making using spatial knowledge and developing efficient algorithms for doing so. The term Qualitative Spatial Reasoning (QSR) usually subsumes both the sub-fields of representation and reasoning.

## 2.2 Ontological Commitments

Conventional mathematical theories of space consider points as primitive spatial entities. Extended spatial entities such as regions are defined, if necessary, as sets of points. However, many regard considering points as primitive spatial entities a philosophical error:

No one has ever perceived a point, or ever will do so, whereas people have perceived individuals of finite extent. So the natural philosophical approach is to treat points and other boundaries as in some sense ideal abstractions or limits arrived at by approximating from individuals alike in kind with those, which are experienced.

Simons [1987, page 42]

While it may be easier to deal with points rather than with regions in a computational framework, within QSR there is a strong tendency to take regions of space as the primitive spatial entity [Vieu, 1997]. This ontological shift means building new theories for most spatial and geometrical concepts. However there are strong reasons for taking regions as the ontological primitive: (a) the spatial extension of any physical object is region-like rather than a lower dimension entity, such as a line or a point and therefore a region-based spatial theory would provide a more direct method for reasoning about physical objects and (b) one can always define points, if required, in terms of regions [Biacino and Gerla, 1991; Pratt and Schoop, 1998].

However, it needs to be admitted that at times it is advantageous to view a 3D physical entity as a 2D or even a 1D entity. Once entities of various dimensions are admitted, a pertinent question would be whether mixed dimension entities are allowed [Cohn *et al.*, 1997b; 1997a; Gotts *et al.*, 1996; Pratt and Lemon, 1997]. A related question is how to model the multi-dimensionality of space? One approach is to model space by considering each dimension separately, projecting each region to each of the dimensions and reasoning along each dimension separately. However, this approach is grossly inadequate. As shown in Figure 2.1 below, two objects overlap when projected on to both the  $x$  and  $y$  axes individually, when in fact they may not overlap at all. Though note that for certain domains such an approach could be used (cf. [Walischewski, 1999]).

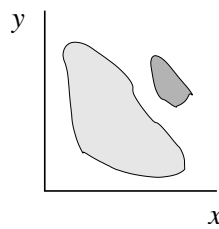

Figure 2.1: Projecting regions to each dimensions and reasoning separately may give misleading information, e.g. about disjointness of these two regions.

The nature of the embedding space, i.e. the universal spatial entity, is another important ontological commitment. Conventionally, one might take this to be  $R^n$  for some  $n$ , but one can imagine applications where discrete (e.g. [Egenhofer and Sharma, 1993]), finite (e.g. [Gotts, 1996d]), or non convex (e.g. non connected) universes might be useful. Continuous space models are favoured by high-level approaches to handling spatial information, whereas discrete, digital representations are used at the lower level. An attempt to bridge this gap by developing a high-level qualitative spatial theory based on a discrete model of space is [Galton, 1999]. Recently Roy and Stell [2002] show how one particular spatial representation language for continuous space can be modified so as to permit discrete spaces. For an investigation into discrete vs continuous space, see [Masolo and Vieu, 1999].

Apart from the above ontological questions there are further issues, the one with far reaching consequences being: what primitive *computations* should be allowed? In a logical theory, this amounts to deciding what primitive *non-logical* symbols one will admit without definition, only being constrained by some set of axioms. One could argue that this set of primitives should be small, not only for mathematical elegance and to make it easier to assess the consistency of the theory, but also because this will simplify the interface of the symbolic system to a perceptual component because fewer primitives have to be implemented. The converse argument might be that the resulting symbolic inferences may be more complicated or that it is more natural to have a large and rich set of concepts which are given meaning by many axioms which connect them in many different ways.

First we need to formalize the naive world view, using whatever concepts seem best suited to that purpose - thousands or tens of thousands of them if necessary. Afterwards we can try to impose some a priori ontological scheme upon it. But until we have the basic theory articulated, we do not know what our subject matter is. Now, this is not to say that we should not exercise some care in avoiding unnecessary proliferation of axioms, or some aesthetic sensibility in designing axioms to give clean proofs and to interact as elegantly as possible.

But these are matters of general scientific style, not ends in themselves.

Hayes [1985b, page 5]

## 2.3 Different Approaches to QSR

There are many different aspects to space and therefore to its representation. Qualitative spatial representations addressing different aspects of space including topology, orientation, shape, size and distance have been put forward. There is a rich diversity of these representations.

### 2.3.1 Topology

Topology is perhaps the most elemental aspect of space. Topology must form a fundamental aspect of qualitative spatial reasoning since it certainly can only make qualitative distinctions. Topology has been studied extensively within the mathematical literature. However much of it is too abstract to be of relevance to those attempting to formalize common-sense spatial reasoning. Although various qualitative spatial theories have been influenced by mathematical topology, there are number of reasons why such a wholesale importation seems undesirable in general [Gotts *et al.*, 1996].

Moreover, we are interested in qualitative spatial reasoning and not just representation, and this has been paid little attention in mathematics.

Neither point-set nor algebraic topology is particularly well-adapted to reasoning of the forms such as: Given that a region  $a$  is in relation  $R_1$  to region  $b$ , and region  $b$  is in relation  $R_2$  to region  $c$ ; what relations may or must hold between  $a$  and  $c$ ?

Cohn [1999]

Of course, it might be possible to adapt the conventional mathematical formalisms, and indeed this strategy has been adopted [Egenhofer and Franzosa, 1991; 1995; Worboys and Bofakos, 1993]. One existing approach to topology which has been espoused by QSR is the work to be found in philosophical logic [Whitehead, 1929; De Laguna, 1922; Woodger, 1937; Clarke, 1981; 1985; Biacino and Gerla, 1991]. This work has built axiomatic theories of space which are predominantly topological in nature, and which take regions rather than points as primitive.

In particular the work of Clarke [Clarke, 1981; 1985] has led to the development of the so called *Region Connection Calculus* [Randell and Cohn, 1989; Randell *et al.*, 1992b;

1992a; Randell and Cohn, 1992; Cui *et al.*, 1992; Cohn *et al.*, 1994; Bennett, 1994; Gotts, 1994b; Cohn, 1995; Gotts *et al.*, 1996; Cohn *et al.*, 1997b; 1997a]. Clarke's theory has also been a basis for theory of common-sense geometry [Vieu, 1991; Asher and Vieu, 1995]. I shall discuss these further in section 2.4.

### 2.3.2 Mereotopology

Mereology is the theory of parts and whole due to Leśniewski [1927 1931]. More on mereology will be said in section 2.4.1. Mereotopology is the combination of the disciplines of mereology and topology.

Varzi [1994; 1996] presents a systematic account of the subtle relations between mereology and topology. He notes that whilst mereology is not sufficient by itself, there are theories in the literature which have proposed integrating topology and mereology. The notion of *connection*, which is the key topological notion for the qualitative description of space, cannot be defined in terms of the mereological *part-whole* relation alone. Therefore topological notions have to be added to mereology to provide an adequate qualitative theory of space. There are three main strategies of integration: (a) generalize mereology by adding a topological primitive, (b) topology is primal and mereology is a sub-theory and (c) topology as a specialised domain-specific sub-theory of mereology.

Borgo *et al.* [1996] generalize mereology and add the topological primitive  $SC(x)$ :  $x$  is a *self-connected* (one-piece) spatial entity, to the mereological part relation. Alternatively a single primitive can be used as in [Varzi, 1994]:  $x$  and  $y$  are *connected parts* of  $z$ . The main advantage of separate theories of mereology and topology is that it allows *collocation* without sharing of parts. This is not possible in the remaining two approaches.

Following Clarke [1981], the theories of Randell *et al.* [1992b] and Asher and Vieu [1995] are based on a single topological primitive  $C(x, y)$ :  $x$  and  $y$  are connected. One defines the parthood relation  $P(x, y)$  from  $C(x, y)$ . This has the elegance of being a single unified theory, but collocation implies sharing of parts. These theories are normally boundary-less (i.e. without lower dimensional spatial entities) but this is not absolutely necessary (cf. [Randell and Cohn, 1989; Gotts, 1996b]).

Eschenbach and Heydrich introduce topology as a specialised domain-specific sub-theory of mereology [Eschenbach and Heydrich, 1995]. Restricted quantification is used by introducing a sortal predicate  $Region(x)$ .  $C(x, y)$  can then be defined as:

$$C(x, y) \equiv_{def} Region(x) \wedge Region(y) \wedge O(x, y)$$

where  $O(x, y)$  is true iff regions  $x$  and  $y$  share a part.

The mereotopological theory discussed in this thesis is closely based on the theory of Randell et. al [1992b]. Thus for me, topology is primal and mereology is a sub-theory.

### 2.3.3 Orientation

Orientation relations describe where objects are placed relative to one another. Orientation can be defined in terms of three basic concepts: the primary object, the reference object and the frame of reference. Of the qualitative orientation calculi to be found in the literature, certain calculi have an explicit triadic relation while others presuppose an extrinsic frame of reference [Frank, 1992; Hernández, 1994].

Most approaches to dealing with orientation qualitatively are based on points as basic spatial entities. Frank [1992] suggested different methods of describing cardinal direction of a point with respect to a reference point in a geographic space i.e., directions are in form of ‘north’, ‘east’, ‘south’ and ‘west’. Freksa defined the direction of a located point to a reference point with respect to a perspective point [Freksa, 1992]. Within this approach, three axes are used, one is specified by the perspective point and the reference point, the other two axes are orthogonal to the first one and are specified by the reference point and the perspective point respectively. These axes define 15 different ternary base relations.

Of those with explicit triadic relations it is especially worth mentioning the work of Schlieder [1993], following earlier work by Goodman and Pollack [1993], who develops a calculus based on a function which maps triples of points to one of three qualitative values,  $+$ ,  $0$  or  $-$ , denoting anticlockwise, co-linear and clockwise orientations respectively. Schlieder also developed a calculus for reasoning about the relative orientation of pairs of line segments [Schlieder, 1995].

A triadic orientation calculus, based on a relation  $CYCORD(x, y, z)$  which is true (in 2D) when  $x, y, z$  are in a clockwise orientation, shows how a number of qualitative calculi can be translated into the  $CYCORD$  system [Röhrig, 1994], whose reasoning system (implemented as a constraint logic program) can then be exploited. A refinement of the theory, leading to an algebra of ternary relations for cyclic ordering of 2D orientations contains 24 atomic relations, hence  $2^{24}$  relations, of which  $CYCORD$  relation is one [Isli and Cohn, 1998; 2000]. Whilst orientation is clearly very important for many modes of spatial reasoning, further consideration of this aspect of spatial information is beyond the scope of this thesis.



### 2.3.4 Distance and Size

Distance is one of the most important aspects of space. Qualitative representation of distance is based on either some *absolute* scale or some kind of *relative* measurement. ‘A is close to B’ is a statement of the first category, whereas a statement such as ‘A is closer to B than to C’ is from the second category.

Of interest in this context are the order of magnitude calculi [Raiman, 1986; Mavrovouniotis and Stephanopoulos, 1988] developed within QR which are of the *absolute* kind of representations. Among *relative* representations, perhaps the earliest is De Laguna’s *Geometry of Solids* [De Laguna, 1922]. In section 2.4.1 I say more on De Laguna’s formalization. Another method of determining the relative size of two objects relies on being able to translate regions (assumed to be shape and size invariant) and then exploit topological relationships. If a translation is possible so that one region becomes a proper part of another, then it must be smaller [Mukerjee and Joe, 1990].

Distance is closely related to the notion of orientation: e.g. distances cannot usually be summed unless they are in the same direction. Therefore it is perhaps not surprising that there have been a number of calculi which are based on *positional information*: a primitive which combines distance and orientation information [Frank, 1992; Zimmermann and Freksa, 1993; Zimmermann, 1993]. The framework for representing distance [Hernández *et al.*, 1995] has been extended to include orientation [Clementini *et al.*, 1997] combining qualitative orientation and absolute distance knowledge. [Isli and Moratz, 1999] combines qualitative orientation [Isli and Cohn, 1998] and relative distance information. Another combined distance and position calculus is [Escrig and Toledo, 1998a]. Worth mentioning here is Liu’s *qualitative trigonometry* which explicitly defines the semantics of qualitative distance and qualitative orientation angles and formulates a representation for trigonometry [Liu, 1998].

### 2.3.5 Shape

Shape is an important characteristic of an object, and particularly difficult to describe qualitatively. Qualitative formalisms for describing shape can either be *constructive representations* or certain *constraining approaches*.

Within the constructive representation of qualitative shape, complex shapes are described by structured combinations of primitive entities. One needs to go beyond topology, introducing some kind of *shape primitives* whilst still retaining a qualitative representation. Approaches which work by describing the boundary of an object include those that classify the sequence of different types of boundary segments [Richards and Hoffman, 1985]

or by describing the sequence of different types of curvature extrema [Leyton, 1988] along its contour. Alternatively one might construct a complex shaped region out of simpler ones along the lines of constructive solid geometry, but starting from a more qualitative set of primitives [Requicha and Boelcke, 1992]. A general curvature-based theory of qualitative outlines in 2D is presented in [Galton and Meathrel, 1999; Meathrel and Galton, 2000; Meathrel, 2001]. This theory subsumes the system of Hoffman and Richards [1985] and Leyton [1988].

In a purely topological theory, very limited statements can be made about the shape of a region: whether it has holes or interior voids or whether it is one-piece or not. The *shape abstraction* primitives such as the bounding box or the *convex hull* have been considered briefly within the 9-intersection model [Clementini and Di Felice, 1997] whilst the latter technique has been investigated extensively within the RCC calculus [Cohn, 1995; Davis *et al.*, 1999]. In section 2.4.3 I shall further discuss shape description using RCC.

## 2.4 Region-Based Theories of Space

Formal region based theories of space date back to the early part of the 20th century. Whitehead, in his book *The Concept of Nature* proposed the construction of a geometry in which spatial regions rather than points would be basic entities [Whitehead, 1920]. In *Process and Reality* he suggested that a general theory of objects, events and processes could be developed based on the primitive relation of connectedness [Whitehead, 1929]. Since the only well-developed physical theories are formulated in terms of points in space, Whitehead proposes the method of *extensive abstraction* as a method of constructing points from regions of space. The idea is to define a point in terms of certain infinitely nested sets of regions.

### 2.4.1 Early Theories

Nicod's doctoral dissertation *Geometry in the Sensible World* [Nicod, 1924] developed Whitehead's approach. He proposed a number of highly path-breaking approaches to constructing geometrical systems. The ones worth noting are: (a) characterization of geometry from the point of view of being equipped with a *kinaesthetic sense* of one's own movement in space and (b) taking into account the viewpoint and perspective of an observer in describing geometrical entities. It is interesting to note that Nicod's thesis contains a discussion of temporal relationships between intervals and proposes a classification which is essentially the same as that adopted much later by Allen [1981].

De Laguna's *Geometry of Solids* was also influenced by Whitehead [De Laguna, 1922].

The theory is based on a triadic primitive  $\text{CanConnect}(x, y, z)$ :  $x$  can connect  $y$  and  $z$ .  $\text{CanConnect}(x, y, z)$  is true if a body  $x$  can connect  $y$  and  $z$  by simple translation i.e., without scaling, rotation or shape change. The primitive is extremely expressive and it is easy to define notions such as *connectedness* and *relative distance* measures.

Contemporary with Whitehead, the Polish logician and philosopher Leśniewski presented mereology – a formal theory of the part-whole relation [Leśniewski, 1927 1931]. Leśniewski presented mereology in his own logical calculus, which he called ontology – a calculus based on principles which are rather different from those of standard predicate calculus. A full description of Leśniewski’s ontology is beyond the scope of this thesis (see [Simons, 1987] for a detailed account).

However, mereology is not bound to the form in which it was originally presented. Mereology as understood today is a formulation due to Tarski [1929] and is built on the single primitive relation  $P(x, y)$ :  $x$  is a part of  $y$ . Building on Leśniewski’s mereology by introducing a new sphere primitive, Tarski gave a theory of the *Geometry of Solids* [Tarski, 1929], which is embedded by means of definition into an axiomatisation of elementary Euclidean geometry (as given in [Tarski, 1959]). In *The Axiomatic Method in Biology*, Woodger [1937] presents proofs of a number of theorems derivable from the axioms of mereology (as presented by Tarski). A shortcoming of the theory of mereology, based as it is on the part relation, is that no distinction can be made between the relations of connectedness and overlapping: if two regions do not overlap they are simply discrete! Leonard and Goodman [1940] devised a formalism which they called *Calculus of Individuals*, based upon a predicate that holds when two individuals are discrete.

### 2.4.2 Clarke’s Calculus of Individuals

A theory more expressive than that of Leonard and Goodman [1940] and simpler than that of Tarski, is Clarke’s formalism based on connectedness [Clarke, 1981; 1985]. Clarke’s intended interpretation was spatio-temporal. Clarke took as his primitive  $C(x, y)$ : the notion of two regions  $x$  and  $y$  being connected. Apart from axioms to ensure  $C$  is reflexive and symmetric, Clarke had an axiom of *extensionality*. The axiom of extensionality states that if two regions are connected to exactly the same other regions then they must be the same. From the  $C$  relation, Clarke defines the relation of *part to whole* (or which we call *parthood*) and several other useful spatial relations as enumerated in Table 2.1 below.

Clarke defines a *fusion* operator analogously with Leśniewski’s sum [Leśniewski, 1927 1931]. The fusion of a set of regions  $X$  is that region which is connected to all and only those regions that are connected to at least one region in the set. The fusion operator  $f$

Relation	Interpretation	Definition
$DC(x, y)$	$x$ is disconnected from $y$	$\neg Cxy$
$P(x, y)$	$x$ is a part of $y$	$\forall z[C(z, x) \rightarrow C(z, y)]$
$PP(x, y)$	$x$ is a proper part of $y$	$[P(x, y) \wedge \neg P(y, x)]$
$O(x, y)$	$x$ overlaps $y$	$\exists z[P(z, x) \wedge P(z, y)]$
$DR(x, y)$	$x$ is discrete from $y$	$\neg O(x, y)$
$EC(x, y)$	$x$ is externally connected to $y$	$[C(x, y) \wedge \neg O(x, y)]$
$TP(x, y)$	$x$ is a tangential part of $y$	$[P(x, y) \wedge \exists z[EC(z, x) \wedge EC(z, y)]]$
$NTP(x, y)$	$x$ is a nontangential part of $y$	$[P(x, y) \wedge \neg \exists z[EC(z, x) \wedge EC(z, y)]]$

Table 2.1: Defined relations in Clarke's theory.

is defined as follows:

$$x = f(X) \equiv_{def} \forall y[C(y, x) \leftrightarrow \exists z[z \in X \wedge C(y, z)]]$$

The theory also contains an axiom ensuring that for every non-empty set of regions a fusion region exists. Thus the fusion operator can be seen to be only *partial*. In a standard first-order theory all functions are assumed to be total. Clarke introduces a slight modification into the logical interpretation of quantification in his theory. The rule of universal quantification is revised so that one can only replace the variable either by an individual constant or a complex term  $\tau$  for which it is provable that  $\exists x[x = \tau]$ . This restriction may be regarded as a rudimentary sort theory: quantifiers range over a sort *region* and all individual constants refer to this sort [Bennett, 1997]. However functions (such as  $f$ ) may have as their value either a region or an entity  $\emptyset$  whose sort is disjoint from region.

Clarke defines functions similar to the Boolean operators using  $f$ . The lack of a null region means the functions do not form a Boolean algebra and therefore the functions are termed quasi-Boolean. The quasi-Boolean functions are  $\text{sum}(x, y)$ : the sum of  $x$  and  $y$ ;  $\text{prod}(x, y)$ : the intersection (product) of  $x$  and  $y$  and  $\text{compl}(x)$ : the complement of  $x$ .

$$\text{sum}(x, y) \equiv_{def} f(\{z | (P(z, x) \vee P(z, y))\})$$

$$\text{prod}(x, y) \equiv_{def} f(\{z | (P(z, x) \wedge P(z, y))\})$$

$$\text{compl}(x) \equiv_{def} f(\{y | \neg C(y, x)\})$$

Clarke defines a set of topological operators viz. *interior*, *closure* and *exterior* as functions from regions to regions. In Clarke's system it is possible to distinguish regions having the properties of being (topologically) closed or open<sup>2</sup>. An additional axiom con-

<sup>2</sup>A closed region is one that contains all its boundary points (more correctly all its limit points), whereas an object is open if it does not contain any of its own boundary points.

cerning these topological functions is given. The axiom asserts: (a) every region has a non-tangential part and thus an interior (remembering that in Clarke's theory a topological interpretation is assumed) and (b) the product of two open regions is itself open. Clarke's system has the odd result (from a commonsense view point) that if a body maps to a closed region of space, then its complement is open and the two are disconnected and not touching!

Clarke subsequently extended his original theory of spatial regions by the introduction of *points* through extensive abstraction. Points are not basic entities of the system but are identified with certain sets of region. Clarke axiomatised a set of conditions for a set of regions to be points. Biacino and Gerla [1991] noted that Clarke's treatment of points leads to a collapse of connection  $C$  to  $O$  as under the given axiomatisation every pair of connected regions must overlap!

### 2.4.3 Region Connection Calculus

The Region Connection Calculus (RCC) is a modification and development of Clarke's original theory. The basic part of the formal theory assumes a dyadic relation:  $C(x, y)$  to mean that region  $x$  is connected to region  $y$ .  $C$  can be given a topological interpretation in terms of points incident in regions<sup>3</sup>. In this interpretation,  $C(x, y)$  holds when the topological *closures* of regions  $x$  and  $y$  share at least one point. Clarke's topological interpretation of  $C(x, y)$  is different in that regions  $x$  and  $y$  themselves share a point. Actually, given the disdain of the RCC theory as presented in [Randell *et al.*, 1992b] for points, a better interpretation, given some suitable distance metric, would be that  $C(x, y)$  means that the distance between  $x$  and  $y$  is zero (c.f. [Stell and Worboys, 1997]). This has the effect of collapsing the distinction between a region, its closure and its interior, which it is argued has no relevance for the kinds of domain with which QSR is concerned.

Unlike Clarke, RCC does not introduce the topological distinctions between the types of regions assumed by the theory. According to Randell *et al.* [1992b] it seems odd to have open, semi-open and closed regions as a model for regions. Such a topological distinction also reflects a general concern that a remoteness exists between the facts of actual observation and the descriptive languages used. To bridge this gap, there has been strong interest within Philosophy in developing languages with a clear primitive observation or phenomenal content [Hamblin, 1971]. From the standpoint of our naive understanding of the world a topological structure distinguishing between open, semi-open and closed regions is arguably too rich for our purpose. I base my mereotopological theory on RCC.

---

<sup>3</sup>If one wants to think of regions as consisting of sets of points.

$C(x, y)$  is surprisingly powerful. It is possible to define many predicates and functions which capture interesting and useful topological distinctions. Following Clarke the mereological relation of *parthood*  $P(x, y)$  is defined as:

$$P(x, y) \equiv_{def} \forall z[C(z, x) \rightarrow C(z, y)]$$

The definition of parthood requires space not to be discrete. According to RCC any region connected to an atomic region is connected to the complement of that region. If space is discrete, the above definition for  $P$  would make an atomic region part of its complement!<sup>4</sup> RCC is based on the presumption that space is not discrete.

The parthood relation is used to define *proper-part* (PP), *overlap* (O) and *disjoint* (DR). Further, DC, EC, PO, EQ, TPP and NTPP i.e., *disconnected*, *externally connected*, *partial overlap*, *equal*, *tangential proper-part* and *non-tangential proper-part* respectively are defined. These relations, along with the inverses for the last two viz. TPPi and NTPPi, constitute a *Jointly Exhaustive* and *Pairwise Disjoint* (JEPD) set of base relations referred to as RCC-8.

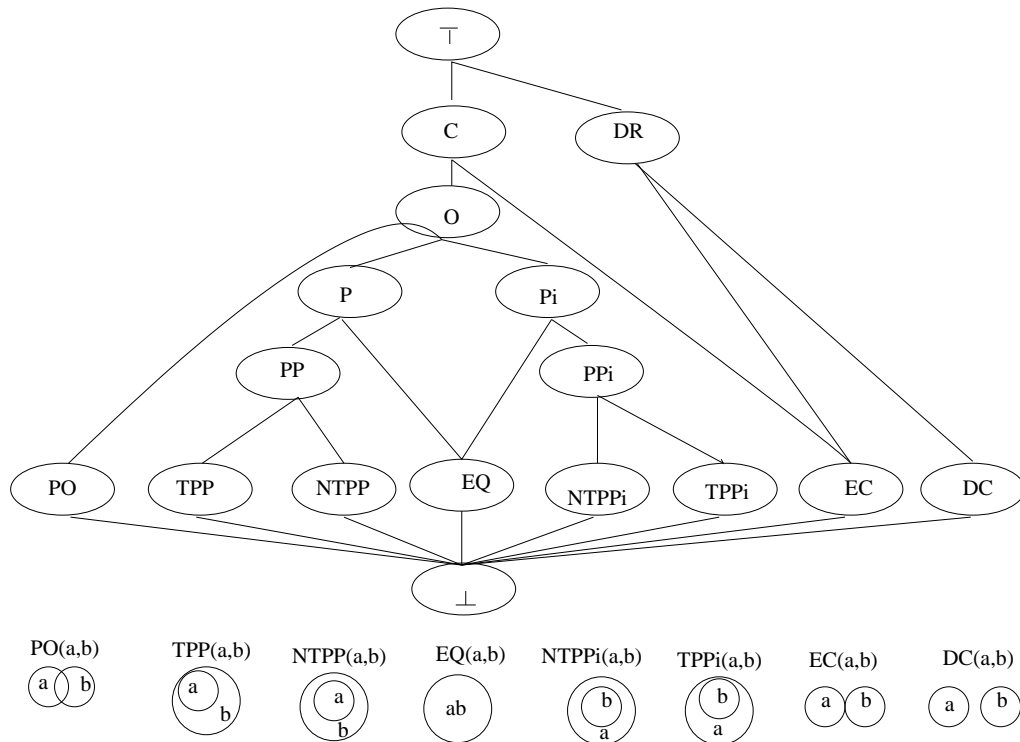

Figure 2.2: Lattice defining the subsumption hierarchy of dyadic relations defined in terms of  $C$ . The pictorial representation of eight base relations is included below the lattice. From [Randell *et al.*, 1992b].

<sup>4</sup>Note that in the original formulation of Clarke and that of Asher and Vieu, since the topological interior function is defined, this notion of part does not force a non-atomic interpretation.

All the relations defined in terms of  $\mathbf{C}$  can be embedded in a relational lattice with the top element interpreted as tautology and the bottom element as contradiction. The relational lattice along with the pictorial representations of the eight base relations is shown in Figure 2.2. Note the distinction between  $\mathbf{C}(x, y)$  and  $\mathbf{O}(x, y)$ . In the latter case, but not necessarily in the former, there is a region that is a part of both  $x$  and  $y$ . The lattice is used, in conjunction with many sorted logic LLAMA [Cohn, 1983; 1987] to implement a resolution-based automated reasoning system for the theory [Randell and Cohn, 1992].

A formal semantics for RCC has been given by [Gotts, 1996a; Dornheim, 1995; Stell and Worboys, 1997]. Furthermore, a canonical model for arbitrary ground Boolean wffs over RCC-8 atoms has been proposed [Renz and Nebel, 1998] which is then utilised in a procedure to generate an actual 2D or 3D interpretation. He used the canonical model to transform the modal encoding to propositional logic, and since some relations transform to a tractable fragment of propositional logic, he thus identifies a tractable fragment of RCC-8.

All regions in a particular model of the axioms are of the same dimensionality as the universal region,  $\mathbf{u}$ , assuming  $\mathbf{u}$  itself to be of uniform dimensionality. This follows from the fact that RCC includes an axiom that all regions have a NTPP [Bennett, 1997; Cohn *et al.*, 1997a; Gotts, 1996a]. One source of the difficulties arising is the fact that within RCC there is no way to refer directly to the boundary of a region or to the dimensionality of the shared boundary of two EC regions, or to any relations between entities of different dimensionalities. There has been a tendency in much of the work involving qualitative spatial reasoning to assume, if only implicitly, that the spatial entities considered in any one theory should have the same dimension. In cases where reasoning about dimensionality becomes important, RCC and related systems based on  $\mathbf{C}$  are not very powerful<sup>5</sup>. The INCH calculus [Gotts, 1996b] treats points and spatially extended entities as specializations of the more general notion of a *spatial extent*. It aims to improve on the expressiveness of connection-based calculi such as RCC, while avoiding the counter-intuitive consequences of a point-set approach.

Another proposal addressing the problem of representing and reasoning about regions of different dimensionality (though still not of mixed dimensionality) is [Galton, 1996]. Galton adopted an axiomatic approach, building on a variant of Classical Extensional Mereology (as recounted in [Simons, 1987]), through use of the mereological part relation  $\mathbf{P}(x, y)$  and a topological boundary primitive  $\mathbf{B}(x, y)$ :  $x$  bounds  $y$ . [Galton, 1996]

---

<sup>5</sup>One way of reasoning about regions of different dimensionality would be to impose a sort structure (one sort for each dimension) and essentially taking a copy of the theory for each dimension-sort.

leads towards the desired intuitive picture of a strictly linear hierarchy of dimensions, but stopped short of constructing the desired hierarchical structure of dimensions. Other theories which introduce the notion of boundaries of regions explicitly include [Varzi, 1994; Smith, 1997] and [Randell and Cohn, 1989].

Taxonomies of topological properties and relations can be defined using the single predicate  $C(x, y)$ . Apart from the simple RCC-8 relations, the primitive  $C(x, y)$  can be used to define many more predicates. For example one could define predicates which count the number of times two regions touch. In a series of papers, [Gotts, 1994a; 1994b; Gotts *et al.*, 1996; Gotts, 1996c], Gotts sets himself the task of distinguishing a ‘doughnut’ (a solid one piece region with a single hole). It is shown how under a restrictive set of assumptions about the topological properties of the regions in general, and the target region in particular, all shapes depicted in Figure 2.3 can be distinguished.

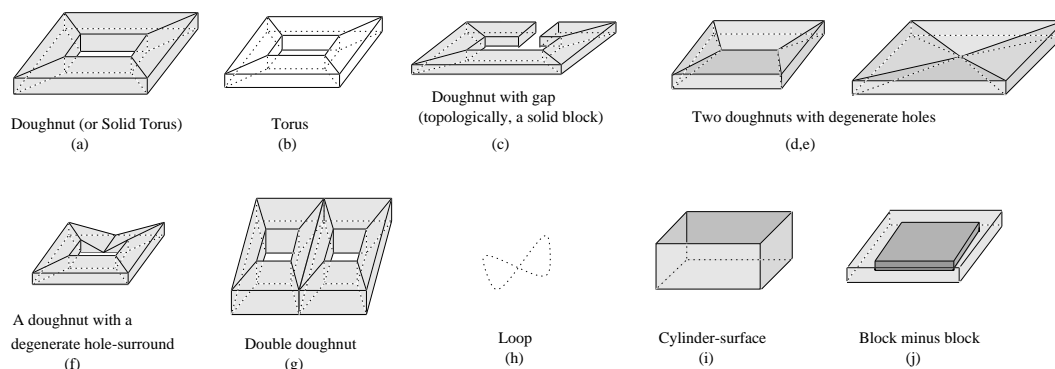

Figure 2.3: It is possible to distinguish all the above shapes using  $C$  alone. From [Gotts, 1994b]

Another range of topological distinctions between one-piece (CON) regions can be made (under certain assumptions) using  $C$ . As shown in Figure 2.4, a region, if it is connected, may or may not be interior connected (INCON); meaning that the interior of the region is all of one piece. It is relatively easy to express this property (or its converse) in terms of  $C$ . However INCON does not rule out all regions with anomalous boundaries, and in particular does not exclude the regions (d,e,f) of Figure 2.3, which do have one-piece interiors, but which nevertheless have boundaries which are not (respectively) simple curves or surfaces, having *anomalies* in the form of points which do not have line-like (or disc-like) neighbourhoods within the boundary (i.e. which are locally Euclidean). It appears possible using  $C(x, y)$  to define a predicate WCON that will rule out the anomalous cases of Figure 2.3, but it is by no means straightforward and it is not demonstrated conclusively in [Gotts, 1994b] that the definitions do what is intended, as is pointed out in [Cohn *et al.*, 1997b].



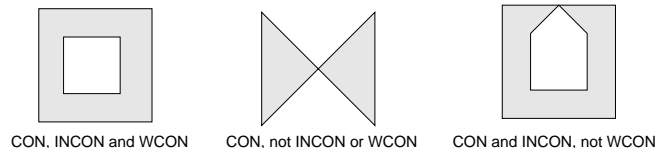

Figure 2.4: Different types of CON region. From [Gotts, 1994b]

It is worthwhile to point here that [Cohn and Varzi, 1998] studied three distinct families of theories, corresponding to the different ways of interpreting the connection relation vis-a-vis the options made available by the open-closed distinction. The classification of varieties of topological connection is extended further in [Cohn and Varzi, 2003] by considering a second, orthogonal dimension: the strength of the connection based on *conduits*. Four cases of strong connection are identified (corresponding to  $a, b, c, d$  in Figure 2.5). Considering the notion of multi-piece regions leads to the idea that the degree of connection between the various components of a multi-piece region is a third dimension of variation of connection relation. Four variations of connection between  $x$  and  $y$  are based on whether *some* or *all* components of  $x$  are connected to *some* or *all* components of  $y$  (corresponding to  $\alpha, \beta, \gamma, \delta$  in Figure 2.5).

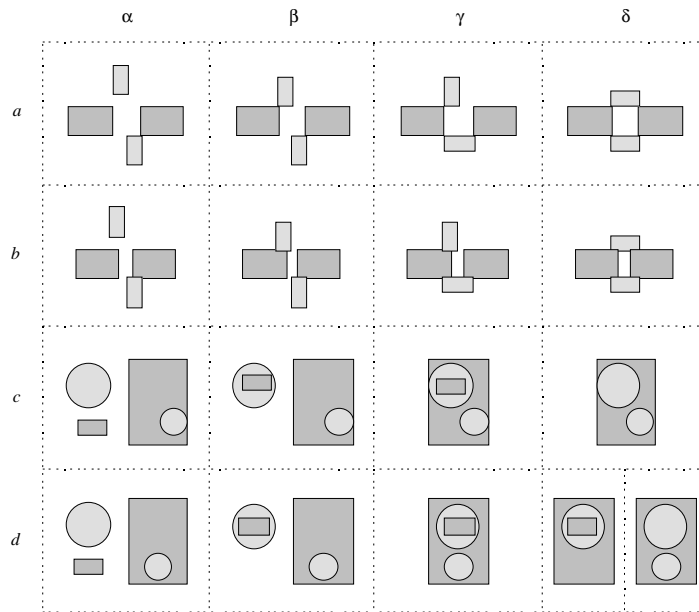

Figure 2.5: Varieties of multiple connection, based on whether *some* or *all* components of one is connected to *some* or *all* components of the other. The different rows correspond to the type of strong connection. From [Cohn and Varzi, 2003].

RCC theory has shown that many interesting predicates can be defined once one takes the notion of a convex hull of a region (or equivalently, a predicate to test convexity) and combines it with a topological representation. The theory axiomatizes an additional

primitive function  $\text{conv}(x)$ : the convex hull of  $x$ . The above tasks of distinguishing cases of surrounding and containment becomes almost trivial once the  $\text{conv}(x)$  primitive is introduced. The additional relations defined using  $\text{conv}$  allow one to specify whether one region is inside, partially inside or outside another. By computing the topological relationships between the shape itself and the different components of the difference between the convex hull and the shape, one can distinguish many different kinds of concave shapes [Cohn, 1995]. A refinement to this technique exploits the idea of recursive shape description [Sklansky, 1972] to describe any non convex components of the difference between the convex hull and the shape. The convex hull is clearly a powerful primitive and in fact it has recently been shown [Davis *et al.*, 1999] that this system essentially is equivalent to an affine geometry: any two compact planar shapes not related by an affine transformation can be distinguished by a constraint language of EC, PP and the  $\text{conv}$  primitive.

#### 2.4.4 Asher and Vieu's Theory

Asher and Vieu [1995] with an aim to develop the foundations of a common-sense geometry also give a mereotopological system based on Clarke's *Calculus of Individuals*. The original interpretation of  $C(x, y)$  is retained, though the fusion operator is discarded, it is made first order and several errors are corrected. A significant feature of Asher and Vieu's theory is the notion of *weak contact* and *strong contact*. They qualify the standard interpretation of connection and make distinction between connection such as 'relation between a glass and the table on which it is standing' with that from 'relation between the stem of the glass and the cup of the glass' [Asher and Vieu, 1995]. The former is an example of weak contact whilst the latter is of strong contact. Contrary to the RCC interpretation, [Asher and Vieu, 1995] argue that differentiating between an individual, its closure and its interior is cognitively important.

On our point of view, it is on the contrary cognitively important to be able to view material objects as closed individuals and their complements as open ones, so that their interpretations do not share any point. Indeed, we do not want the the air around the glass to have a 'glass boundary' belonging to it, that is why in  $RT_0$ , the glass and the air are in weak contact.

Asher and Vieu [1995]

The distinction is captured through incorporation of notions of open and closed sets from point-set topology into their mereotopology. For any region there is a *minimal* open region containing it. This is the smallest *neighbourhood* of the region. Thus, in contrast

to RCC, space is not allowed to be dense. However, based on the connection predicate  $C(x, y)$ , Asher and Vieu define parthood  $P(x, y)$  as done in RCC. Use of the same parthood definition (which gives rise to the requirement in RCC that space be dense) explains the major distinction between the two theories – for Asher and Vieu a region is not connected to its complement, whereas for RCC it is.

#### 2.4.4.1 Muller’s Extension

Muller has taken over the theory of Asher and Vieu [1995] and extends it to *space-time* [Muller, 1998b; 1998c; 1998a]. Taking up the idea of spatio-temporal histories [Hayes, 1985a; 1985b], Muller presents a mereotopological model in which the primitive entities are spatio-temporal regions, on which spatio-temporal and temporal relations are defined. The expressive power of the theory allows for definition of complex motion classes such as those expressed by motion verbs in natural language.

Of Asher and Vieu’s theory, Muller retains the part dealing with notions of mereology and classical topology, leaving aside the definition for notion of natural contact between two objects. The spatio-temporal relations are an extension of spatial relations of [Asher and Vieu, 1995] to space-time. Additional temporal relations are introduced to add further structural specification. As the primitive objects are extended both in time and space, the appropriate logics for temporal relations are close to *event logics* [Kamp, 1979] where *contemporaneous* entities need not be equal. Besides a classical *temporal precedence* relation  $<_t$ , a primitive *temporal connection*  $\approx$  (a connection with almost the same behaviour as  $C(x, y)$  but only on a temporal level) is introduced. With these it is possible to distinguish a temporal overlap from a simple temporal contact.

The notion of a *temporal slice*  $TS(x, y)$ :  $x$  is a temporal slice of  $y$  (i.e., the maximal component part corresponding to a certain time extent) introduced by Muller is significant for spatio-temporal interactions particularly to define relations changing through time and recover some concepts of relative spatial localisation. However it is not clear using Muller’s extension how to express statements such as ‘John is at the *same place* where Mary was’, which is of considerable importance for any theory for spatio-temporal reasoning. In the thesis I extend the mereotopological theory to include a *purely* spatial connection relation (cf. Section 3.2.1, Chapter 3).

Perhaps the most important contribution of Muller’s mereotopological theory of space-time was an explicit qualitative definition of *continuity*. More will be said about that in section 2.5.

### 2.4.5 Other Region-Based Theories

#### Egenhofer's n-intersection Model

An alternative approach to representing and reasoning about topological relations has been promulgated via a series of papers [Egenhofer, 1989; Egenhofer and Franzosa, 1991; Egenhofer, 1994; Clementini *et al.*, 1994; Egenhofer and Herring, 1994; Egenhofer and Franzosa, 1995]. Three sets of points are associated with every region - its interior, boundary and complement. The relationship between any two regions can be characterized by a 3x3 matrix called the 9-intersection<sup>6</sup>. Taking into account the physical reality of 2D space and some specific assumptions about the nature of regions, there are exactly 8 matrices, corresponding to the RCC-8 relations.

Different calculi with more JEPD relations can be derived by changing the underlying assumptions. For example, one can reason about regions which have holes by classifying the relationship not only between each pair of regions, but also the relationship between each hole of each region and the other region and each of its holes [Egenhofer *et al.*, 1994]. Alternatively, one can extend the representation in each matrix cell by the dimension of the intersection [Clementini and Di Felice, 1995], which allows one to enumerate all the relations between areas, lines and points. Though I use a matrix representation of instantaneous relations in Chapter 4, Section 4.14, loosely inspired by 9-and 4-intersection models, this approach to spatial representation is not relevant to the work in this thesis, and nothing more need be said about it here.

#### Region Based Geometry

*Region Based Geometry* (RBG) is an axiomatic theory of qualitative configurations of regions [Bennett *et al.*, 2000c; 2000b; Bennett, 2001a] based on *Geometry of Solids* [Tarski, 1929]. The formulation of RBG is influenced by [Borgo *et al.*, 1996] but is more elegant. [Bennett *et al.*, 2000b] assume only *parthood* and the morphological notion of a *sphere* whereas [Borgo *et al.*, 1996] employ an additional topological primitive *simple region* and relations *congruence* and *strong connection*.

Tarski showed how to give a categorical axiomatisation of the geometry of regions by adding a sphere primitive to Leśniewski's Mereology [Tarski, 1929] where the combination of mereological and geometrical axioms involves set theory. In RBG, the interface is achieved by purely 1st-order axioms. Note that geometry and mereotopology still retains

---

<sup>6</sup>A simpler 2x2 matrix [Egenhofer and Franzosa, 1991] known as the 4-intersection featuring just the interior and the boundary is sufficient to describe the eight RCC relations. The 3x3 matrix allows more expressive sets of relations to be defined since it takes into account the relationship between the regions and its embedding space.

the second order axioms. The elementary *sub-language* of RBG is extremely expressive. In [Cristani *et al.*, 2000] a precursor to RBG was used for describing spatial locations. Subsequent developments appeared in [Bennett *et al.*, 2000a] and [Bennett *et al.*, 2000b]. A concise but definitive version of the theory together with a detailed proof of its categoricity is given in [Bennett, 2001a].

## 2.5 Qualitative Spatio-Temporal Reasoning

The connection between time and space has been a recurring topic, initially in geography (cf. Hagerstand's Time Geography [1967]), and more recently in computer science. Spatial *configurations* tend to change. Reasoning about space often involves reasoning about change in spatial configurations. Spatial change is spatio-temporal.

Spatio-temporal reasoning is so common in our daily life that we rarely notice it as a particular concept of spatial analysis. When applied to computer information systems, spatio-temporal reasoning attempts to solve problems that deal with objects that occupy space and change over time.

Egenhofer and Golledge [1998]

Taking time into account is a central issue for GIS [Egenhofer and Golledge, 1998] and spatial databases [Peuquet, 1999]. A lot of effort is devoted to providing useful and well-grounded models to be used as high level qualitative description of spatio-temporal change [Egenhofer and Al-Taha, 1992; Claramunt and Thériault, 1996; Hornsby and Egenhofer, 2000]. Driven by *cognitive* approaches that characterize the processing of spatial information in QSR, there has been work in other areas within AI such as computer vision, robotics etc. on qualitative representation and reasoning about spatial change [Escrig and Toledo, 1998b; Musto *et al.*, 1999; Galton, 2000a] and spatial interactions [Pinhanez and Bobick, 1996; Fernyhough *et al.*, 2000; Galata *et al.*, 2002]. Qualitative Spatio-Temporal Reasoning (QSTR) encompasses all such techniques.

There are two basic approaches to reasoning with qualitative spatial data over time: (a) take a *snapshot* viewpoint and describe dynamic behaviour as a set of temporal states or (b) view the world as spatio-temporal histories [Hayes, 1985a]. The first approach has been extensively investigated [Wolter and Zakharyashev, 2000; Bennett *et al.*, 2002] and complexity results are discussed. Bittner and Smith [2003] propose an ontological theory that is powerful enough to describe both complex spatio-temporal processes and enduring entities. The theory comprehends two major categories of sub-theories: SNAP and SPAN;

SNAP is the snapshot view and SPAN is the 4D view. The present thesis embraces the second approach of extending a purely spatial representation language to qualitative spatio-temporal language with relations which hold between space-time histories. My main concern is qualitative continuity and spatial change (in particular change of state for RCC-8 relations). I therefore review work encompassing qualitative continuity and continuous transitions. In section 2.5.4 I shall briefly mention other approaches to QSTR based on space-time.

## 2.5.1 Qualitative Spatial Change

Topological changes in ‘single’ spatial entity include: change in dimension (this is usually ‘caused’ by an abstraction or granularity shift rather than an ‘actual’ spatial change<sup>7</sup>); change in number of topological components (for example. breaking a cup, fusing blobs of mercury); change in the number of tunnels (e.g. drilling through a block of wood); change in the number of interior cavities (e.g. putting a lid on a container). Galton identifies varieties of spatial change [Galton, 2000a] based on a survey of spatial attributes.

### 2.5.1.1 Qualitative Motion

Change in spatial configurations over time is spatio-temporal and is the basis of motion. Motion can be seen as a kind of spatial change.

Motion is the prototype of all spatial change (indeed of all change, change in respect of property  $p$  being metaphorically represented as motion in  $p$ -space).

Galton [2000a, page 281]

In spite of a large amount of work in mereotopological theories as a basis for common-sense reasoning, very little work has been done on motion in a qualitative framework. Galton [1993; 1997b] and more recently [Muller, 1998b] have looked at motion in the more cognitive kind of approach characterized by processing spatial information. Even though qualitative, representation of motion as in [Hays, 1989; Rajagopalan and Kuipers, 1994] is in a *Cartesian* framework while [Forbus, 1983; Davis, 1990] insist more on the concept of dynamic processes.

Investigation of qualitative motion by Galton [1993; 1997b] is in a combined region-based space and interval/point-based time. Muller [1998b] enriches Asher and Vieu’s theory intended for spatial entities to achieve a formal theory for reasoning about motion.

---

<sup>7</sup>For example, we may view a road as being a 1D line on a map, a 2D entity when we consider whether it is wide enough for an outside load, and a 3D entity as we consider the range of mountains it passes over, or the potholes and a particularly delicate cargo.

An alternative approach is [Bennett *et al.*, 2000a] which explores the expressive power of RBG [Bennett *et al.*, 2000b] to the problem of representing and reasoning about the motion of rigid bodies within a confining environment. Motivated by the desire to exploit decidable modal logics for spatio-temporal qualitative reasoning, a series of rather expressive such calculi have been proposed [Wolter and Zakharyashev, 2000; Bennett *et al.*, 2002] in which it is possible easily to represent restrictions on continuous motion.

### 2.5.1.2 Transitions between Spatial Relations

In many domains we assume that change is continuous. Thus there is a requirement to build into the spatial calculus which changes in value will respect the underlying continuous nature of change. It is important to know which qualitative values or relations are *conceptual neighbours*: two relations drawn from a JEPD set of relations are conceptual neighbours if one can be transformed into the other by a process of gradual *continuous change* without passage through a third relation. Networks defining such neighbours are often called *conceptual neighbourhoods* in the literature following the use of the term by [Freksa, 1992] to describe the structure of Allen's 13 JEPD relations [Allen, 1983] according to their conceptual closeness<sup>8</sup>.

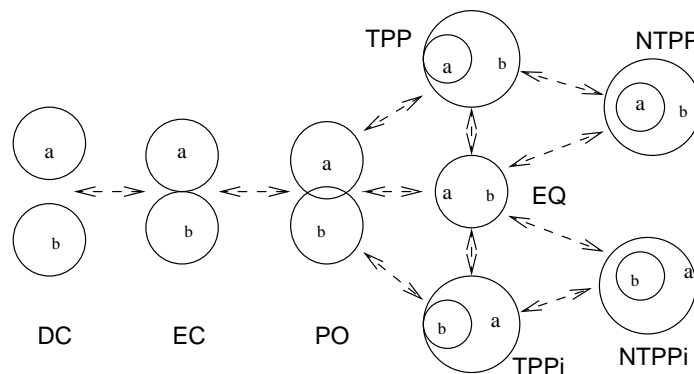

Figure 2.6: Pictorial representation of the envisioning axioms: *conceptual neighbourhood* for RCC-8. From [Cohn *et al.*, 1998].

For characterizing the change of state in RCC-8 (relations), the formal theory was augmented with a set of *envisioning axioms*. These axioms specify which direct transitions can be made in the topological relations between pairs of regions. Figure 2.6 is a pictorial representation of the envisioning axioms for RCC-8. The envisioning axioms can be regarded as an instance of the conceptual neighbourhood for RCC-8. However the notion

<sup>8</sup>Note that one can lift this notion of closeness from individual relations to entire scenes via the set of relations between the common objects and thus gain some measure of their conceptual similarity as suggested by [Bruns and Egenhofer, 1996].

of what constitutes continuous change is left uncharacterized. It is implicitly assumed but never made explicit. I shall return to that in section 2.6.

## 2.5.2 Incorporating Time into Space

### Ontological Primitive of Space-Time

In order to add time to space, an obvious and straightforward choice is to interpret entities in space-time rather than in space alone.

Events happen in time, but also in space – they have a where as well as a when. They are four-dimensional spatio-temporal entities. So are objects, which have a position and shape and composition at a given time or period, which may differ at other times, and have temporal as well as spatial boundaries. All of which suggests that a basic ontological primitive should be a piece of space-time with natural boundaries, both temporal and spatial. I will call these things *histories*.

Hayes [1985b]

In fact, Clarke's intended interpretation of his region-based calculus was spatio-temporal [Clarke, 1981; 1985]. Clarke's spatio-temporal interpretation followed Whitehead [Whitehead, 1929]. Starting with [Russell, 1914], there are a few authors [Quine, 1960; Carnap, 1958] and more recently [Hayes, 1985b; Vieu, 1991; Muller, 1998c] who consider whole space-time histories.

Spatio-temporal ontological questions have only begun to be addressed, and consequently, little work has been done on qualitative representations of space-time. Carnap had defined languages in which primitive entities were spatio-temporal [Carnap, 1958], but he stopped short of any characterisation of their properties. Hayes' theory of space-time [Hayes, 1985a] is the closest attempt to a spatio-temporal theory. To the best of our knowledge [Muller, 1998c] is the first attempt at a full mereotopological theory based on space-time as a primitive.

### Other Approaches

The notion of time can be also incorporated into space by some combination of spatial and temporal logics. There exists a wide spectrum of temporal languages [Allen, 1983; Gabbay *et al.*, 1994; van Benthem, 1996] and a variety of spatial formalisms [Clarke, 1981; Randell *et al.*, 1992b; Clementini *et al.*, 1994; Lemon and Pratt, 1998]. Effective reasoning procedures have been developed and implemented for temporal [Plaisted, 1986;



Kesten *et al.*, 1993] as well as spatial formalisms [Bennett, 1994; Haarslev *et al.*, 1999; Renz and Nebel, 1999]. For incorporation of time into space, the next logical step would be to have a combination of these two streams of reasoning. In fact, there have been attempts to have spatio-temporal hybrids [Guesgen and Hertzberg, 1992; Bennett and Cohn, 1999]. The most recent attempt at a spatio-temporal representation and reasoning based on RCC-8 is [Wolter and Zakharyashev, 2000]. Taking a temporal logic T and a spatial logic S, they integrate the intended models of T and S into a multi-dimensional spatio-temporal structure driven by semantic considerations. Next they combine T and S into a *super-language* which is capable of speaking about these structures, and a variety of ways to combine the languages. Thus they are able to create a family of expressive but decidable spatio-temporal formalisms.

Galton [1993; 1995] brought together a formal (mixed interval/point-based) model of time, comprising a fundamental set of temporal entities endowed with a temporal ordering relation, with a formal model of space based on regions. Galton identifies transitions as durative or instantaneous depending on whether the initial and final states are separated by an interval or an instant and defines eight different transition operators [Galton, 2000b]. This raises the question as to whether representing continuous motion on spatial regions requires a mixed temporal ontology of instants and intervals. In the thesis I explore the possibility of expressing transitions without introducing temporal points.

In yet another approach to incorporate time into spatial reasoning, the RCC formalism [Randell *et al.*, 1992b] contained a function  $\text{space}(x, t)$ , representing the space occupied by object  $x$  at a moment of time  $t$ . Alternatively, the connection relation  $C(x, y)$  could be made ternary  $C(x, y, t)$  to mean region  $x$  is connected to region  $y$  during time  $t$ . I do not explore these approaches any further.

### 2.5.3 Qualitative Simulation

Using conceptual neighbourhood diagrams, it is easy to build a qualitative spatial simulator [Cui *et al.*, 1992]. Such a simulator takes a set of ground atomic statements describing an initial state and constructs a tree of future possible states. Continuity alone does not provide sufficient constraints to restrict the generation of next possible states to a reasonable set in general. Domain specific constraints are required in addition. The construction of an envisioner [Weld and De Kleer, 1990] akin to the transition calculus approach of [Gooday and Cohn, 1996] would also be possible. It is an event-based approach to qualitative simulation where the behaviour of a system with time is measured in terms of *landmark* events i.e., events that result in interesting changes in the system being modelled rather than a sequence of qualitative states.

*Qualitative Physical Fields* [Lundell, 1996] extends *Qualitative Process Theory* [Forbus, 1984] to include qualitative spatio-temporal processes for e.g., modelling heat flow between topologically connected sunny and shaded regions and inferring the evolution of warm and cold regions. Perhaps *Process Grammars* [Leyton, 1988] is the most widely cited *change-based* qualitative formalization. Given two shapes, one can infer sequences of processes which could cause one to change into the other. Another work on ascertaining the causal history of shapes and of more relevance to region-based theories of space is an analysis by [Egenhofer and Al-Taha, 1992]. It identifies which traversals of a topological conceptual neighbourhood correspond to processes such as expansion of a region, rotation of a region etc. Whilst qualitative simulation is clearly an important mode of QSTR, any further discussion is beyond the scope of this thesis.

#### 2.5.4 Other approaches to QSTR based on space-time

Qualitative representation and reasoning over *episodes* in space [El-Geresy *et al.*, 2000] is the closest to the spatio-temporal entities of our mereotopological theory of space-time. The episode of an object is the consistent behaviour of a spatial object within a duration of time when this behaviour can be described as being consistent (i.e., described by a single function). The approach is limiting as only *well-behaved* approximations of representation of spatio-temporal relations are possible.

Elsewhere, there is research on reasoning about qualitative spatio-temporal relations at multiple levels of granularity [Bittner, 2002a; 2002b]. Even though the reasoning tasks at a given level of granularity seems similar to what I expect for my mereotopological theory, the underlying ontology is markedly different. Bittner distinguishes the domain of objects, and the domain of regions. Further, the domain of regions is constituted by regions of different dimensionality: four-dimensional spatio-temporal regions, three-dimensional spatial regions and one-dimensional temporal regions. This contrasts with our mereotopological theory where all regions in a particular model of the axioms are of the same dimension, as it has RCC as its basis (cf. Section 2.4.3).

## 2.6 Qualitative Continuity

Continuity of change is the perception of being *seamless* and is dependent on the granularity. What seems as continuous at some level of granularity may be discontinuous at a finer level. Nevertheless, continuity may be thought of as the intuitive idea of a gradual variation with no abrupt jumps or gaps. A formal characterization of such an intuitive notion of continuity for a qualitative theory of motion is what I refer to as qualitative

continuity.

Continuity has remained an implicitly assumed notion for construction of a conceptual neighbourhood for any qualitative spatial calculus. For example, the change of state in RCC has been analyzed through transition graphs in which the relations form conceptual-neighbourhoods via potential motion. Continuity remains an implicitly assumed notion.

A possible counter-example that has been much discussed by the *Region Connection Calculus* group is when a two-part scattered region  $x$  has one part inside  $y$ , and the other part outside  $y$ . If the inside part dwindles continuously to a point and then disappears, we have PO transformed into DC with no intervening instance of EC. The question is whether this kind of spatial change in which a component of a region disappears, is to count as continuous.

Galton [2000a, Page 78]

Only recently, Galton [1993; 1995; 1997b] has begun to address what continuity implies for a common-sense theory of motion. However, it characterizes continuity as a set of logical constraints on the transitions in a temporal framework but falls short of an explicit, generic characterization of spatio-temporal continuity.

Muller [1998b] has proposed an intuitive notion of space-time continuity that is perhaps nearest to a qualitative understanding of motion. Any spatio-temporal region  $w$  is qualitatively continuous just in case it is temporally self-connected and it does not make any spatial leaps (cf. Figure 4.2, Chapter 4).

$$\text{CONTINU}w \equiv_{def} [\text{CON}_t w \wedge \forall xu[[\text{TS}xw \wedge x \bowtie u \wedge \text{P}uw] \rightarrow \text{C}xu]]$$

Here  $\text{CON}_t w$  means that temporal projection of  $w$  is a connected time interval. Other predicates are as stated in section 2.4.4. However, for reasons discussed below, this definition of continuity is not adequate.

## 2.7 Continuity and Conceptual Neighbourhoods

The conceptual neighbourhood is usually built manually for each new calculus – potentially an arduous and error prone operation if there are many relations. Techniques to arrive at these automatically would be very useful. An analysis of the structure of conceptual neighbourhoods reported by [Ligozat, 1994] goes some way toward this goal. Ligozat showed how the topology of temporal and spatial relations, of which the notion of con-

ceptual neighbourhood is an important aspect, can be represented by spatial structures in Euclidean space.

A more fundamental approach which exploits the continuity of the underlying semantic spaces [Galton, 1997b] not only allows the construction of a conceptual neighbourhood for a class of relations from a semantics, but also infers which relations dominate other relations:  $R_1$  dominates  $R_2$  if  $R_2$  can hold over an interval followed/preceded by  $R_1$  instantaneously. E.g. in RCC-8 TPP dominates NTPP and PO, while EQ dominates all its neighbouring relations. Dominance is analogous to the equality change law to be found in traditional QR [Weld and De Kleer, 1990] and allows a stricter temporal order to be imposed on events occurring in a qualitative simulation [Galton, 2001]. Galton extends the conceptual neighbourhood diagram by adding the concept of dominance between qualitative states and formulates the dominance diagrams. The diagrams can be fundamental insights into the structure of the domain they represent.

### 2.7.1 Defining Metrics on Regions

Galton [1997a; 2000a] defines a metric over space of regions and then uses the standard epsilon-delta definition of continuity. Having a semantic grounding for continuity, it allows one to prove the correctness of the transition graph for RCC-8 rather than just positing it. Davis [2001] continues Galton's approach developing a more extensive analysis of the qualitative properties of continuous shape change where continuous is defined relative to a metric over regions.

The different metrics considered yield different concepts of continuous shape transformation. Out of the continuous transformations, the transition graph for the binary topological relations of RCC-8 under the Hausdorff distance (see Figure 2.7) is of interest to us here.

### 2.7.2 Spatial Transitions over Histories

An approach to automatically inferring continuity networks has been proposed by Muller [1998b; 1998a]. Davis [2001] has shown that the history based definition of continuity proposed by Muller is equivalent to continuity with respect to Hausdorff distance. Muller claims to show that it follows from his definition that the only transitions possible for the RCC-8 relations are the rules developed in [Cohn *et al.*, 1998] (see Figure 2.6). Davis on the contrary has shown in [Davis, 2001] that functions continuous in Hausdorff distance can execute any of the transitions as in Figure 2.7.

Davis argues that Muller's analysis of state transitions is not adequate [Davis, 2001;

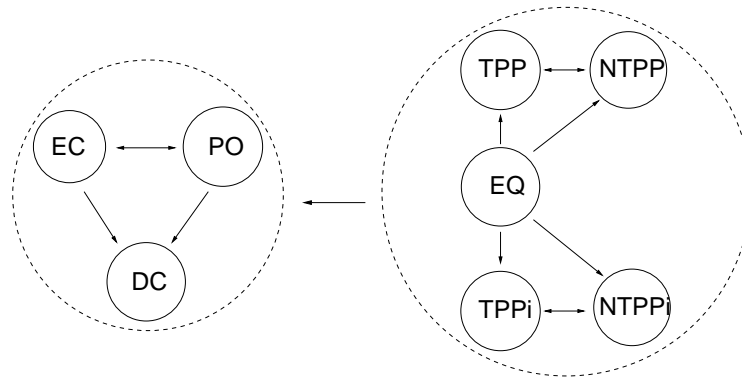

Figure 2.7: Transition graph for the Hausdorff metric. The significance of the arrow from the dashed circle on the left is that *every* relation on the right can undergo a transition to *any* relation on the left. From [Davis, 2001].

2000]. Davis provides an alternative characterisation of transitions in Muller’s first order language over histories. It is by no means straightforward and it is not demonstrated conclusively in [Davis, 2000] that the definitions do what is intended. Further, Davis’ characterization of transitions violate the spirit of mereotopology, as it achieves its end by using the expressive power of first-order logic over histories to, in effect, define time instants and spatial points. Thus it remains a challenge to find a more natural mereotopological (purely region based) expression for transition rules that would allow the correctness of the RCC-8 conceptual neighbourhood diagram to be proved in a pure mereotopological theory. I take up this challenge.

Moreover, I believe it is not only the case that Muller’s transition theorems are flawed but his definition of continuity (in Section 2.6) is not sufficient. I argue that for characterising the non-transition between  $EC_{st}$  and  $PP_{st}$  (cf. Figure 4.4, Chapter 4), the notion of continuity proposed in Muller [1998b] is too weak for this allows *temporal pinching*: a history is allowed to disappear and re-appear instantaneously. To avoid temporal pinching, I introduce a notion of *firm continuity*. Independently, Muller had also revised his definitions of continuity [Muller, 2002].

Muller’s revised definitions are not sufficient for characterizing continuity when involving transitions between pairs of histories. The following observation by Galton [2000a] with regard to intuitive notion of continuity and continuity in the Hausdorff distance is significant:

To find an example of a change that is in some intuitive sense continuous but is not H-continuous<sup>9</sup>, we must look for a case where the spatial change in an object arises not from the continuous motion of parts of the object but from

<sup>9</sup>H-continuous refers to continuity in the Hausdorff distance.

the continuous motion of things outside the object.

Galton[2000a, page 324]

This shows that the notion of continuity in a topological theory of space-time given by Muller needs to be reinforced through additional axioms. Bennett [2001b] gave an explicit definition of continuity in a not so dissimilar setting. Conjuncts in his definition have terms that relate to parts of the history and also regions outside the history<sup>10</sup>. To completely characterise the intuitive notion of continuity we need to have account of parts within and outside the history. This will form the focus of Chapter 4, Section 4.3.1.

---

<sup>10</sup>[Bennett, 2001b] do not have *histories* explicitly, only regions and time, but regions at a particular time can be referred to (through modal operators) both in the past and the future.

## Chapter 3

# Mereotopological Theory of Space-Time

---

This chapter describes a mereotopological theory of space-time. This is closely based on the theory proposed by Muller [1998a]. Asher and Vieu's [1995] topological theory serves as a basis for Muller's theory of spatio-temporal entities. The theory described here has the *Region Connection Calculus* of Randell et. al [1992b] as its basis. Consequently my language is simpler as it does not distinguish the interiors and closures of regions.

### 3.1 Underlying Logic and Domain of Interpretation

In common with existing formally given models of RCC [Bennett, 1997; Gotts, 1996a], I assume that the regions denoted are regular regions. The basic entities of my theory are *non-empty regular regions* of space-time. Following Hayes [1985a], space-time regions traced by objects over time are termed *histories*. Figure 3.1 shows the space-time history for a 2-D object. Note that assuming regions are regular implies all regions, including the universal region, are of uniform dimensionality.

For n-D space, the space-time (henceforth s-t) history is a n+1 dimensional volume. The object at any time is a *temporal slice* of its s-t history. One important question about such s-t histories is whether it is possible to have a zero extent along the temporal dimension, i.e., is it possible to have instantaneous spatial objects? This is analogous to

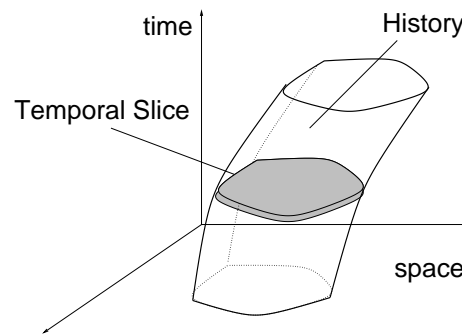

Figure 3.1: A space-time history is a  $n+1$  dimensional volume for  $n$ -D space.

asking if the surface of a cube is a spatial object in standard 3-D ontology [Heller, 1990, page 6]. The more pertinent question is the spatial analog of the above: what does it mean for a  $n+1$  dimensional s-t history to toggle instantaneously into a lower dimensional spatial extent? i.e., for histories to disappear and reappear again instantaneously at the same spatial location. This is termed *temporal pinching* and I shall discuss its implication for continuity in Chapter 4. It is worthwhile to point out that even though I commit to an ontology where objects are occurrent, I do not attempt a formal characterization of the identity criteria, which is difficult [Wiggins, 1980] and beyond the scope of this thesis. There are number of possibilities in the literature to cope with this (c.f. [Thomson, 1983]); some involve considering four dimensional space-time [Heller, 1990] while others focus on a revised theory of parts [Simons, 1987]

Following previous work within the Leeds QSR Group [Randell *et al.*, 1992b; Gotts *et al.*, 1996; Cohn *et al.*, 1997b], I do not wish to admit lower dimensional entities. For example, in their work on spatial mereotopology all regions were of the same dimension and Cohn *et al.* did not consider boundaries as spatial entities [Randell *et al.*, 1992b; Cohn and Varzi, 1998]. Here too, I do not admit lower dimensional entities such as temporal points into my ontology [Randell *et al.*, 1992b; Gotts *et al.*, 1996; Cohn *et al.*, 1997b]. Thus s-t histories may pinch to a *spatial point* at a *temporal point*, but I do not allow explicit reference to either of these points. In Chapter 4, I shall introduce descriptive apparatus to allow us to describe instantaneous transitions and histories which pinch to a spatial point instantaneously.

The spatio-temporal theory presented here is a first-order theory with equality. I use the symbol  $=$  for equality. The logical symbols of *and*, *or*, *negation* and *implication* are denoted  $\wedge$ ,  $\vee$ ,  $\neg$  and  $\rightarrow$  respectively. A definition is introduced by  $\equiv_{def}$  and will be referred to as **Di**, for some  $i$ . Similarly, axioms will be named **Ai** and theorems **Thi**. Formulae for which there are plausible informal reasons to believe that they should be provable, although no proof has been found are labelled as conjectures and named **Ci**.



Proofs of the theorems can be found in Appendix B through Appendix E. **Fi** refers to formulae from cited sources and other formulae we want to discuss. For reasons discussed in section 3.2.2.1, I employ the sorted logic LLAMA [Cohn, 1983; 1987]. Unless stated otherwise, the arguments of all relations within our mereotopological theory of space-time are of sort **Region**. For simplicity throughout the thesis, universal quantifiers scoping over whole formulae are omitted.

As pointed out by [Cohn, 2001; Hayes, 1985b, Page 32], when presenting an axiomatisation the question arises as to whether it captures the intended interpretation and intuitions. Ideally we would create a categorical theory and prove it so, as in RBG [Bennett, 2001a]. This is beyond my aim, here, so I will follow the approach (propounded in [Cohn, 2001]) of proving a variety of theorems to show that intended consequences of the theory do indeed hold. Ultimately, the theorems concerning the RCC-8 conceptual neighbourhood will be among these, but I will prove many other theorems on the way which go some distance to showing the consequences of the axiomatisation.

The theory is presented as a sequence of axioms, definitions and conjectures; each conjecture is expected to follow from the previous axioms, definitions and conjectures, and I use a theorem prover to attempt to prove them. If the conjecture is proved, it is regarded as a theorem and can help to prove subsequent conjectures. Failure to prove a conjecture suggests one of two possibilities: (a) the theorem prover is unable to arrive at the proof; or (b) axioms are too weak. Where there are plausible reasons to believe that the conjecture should be provable (and no counter-example is available), I add the conjecture to the theory, with the status of an axiom in that it can be used for subsequent proofs. For b above, I formally strengthen the axiom set by additional axiom(s).

In the absence of a categorical theory, I still naturally wish to have a consistent one. Showing consistency requires demonstrating a model of all the axioms. More will be said about the consistency of the theory in Section 5.3.1, Chapter 5.

## 3.2 Mereotopological Framework

The *Region Connection Calculus* is the basis for the mereotopological framework. The topological relation of connection is primal and the mereological relation of parthood is defined.

### 3.2.1 Primitive Relations

As discussed in Section 2.4.3, the Region Connection Calculus (RCC) is based on a single connection primitive. Here I have three versions of connection relation: spatial, temporal

and spatio-temporal. As shown in Figure 3.2, the spatial, temporal and spatio-temporal connection relations are interpreted in pure space, time and space-time respectively. Space is shown as 1D in Figure 3.2 and subsequent illustrations, but this is simply for ease of drawing. The defined concepts are applicable to 2D and other higher dimensional space.

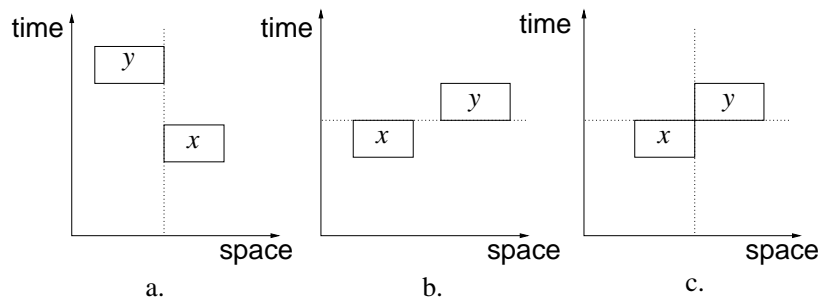

Figure 3.2: Connection Primitives: **a.** Spatial **b.** Temporal and **c.** Spatio-Temporal. Note that these diagrams show external connection which (as detailed in section 3.2.2) is a special (limit) case of connection.

Intuitively, spatial connection for s-t entities is the connection of their spatial projection. As shown in Figure 3.2(a), connection under spatial projection is interpreted along the temporal axis i.e., connection on projection to an infinitesimally thin ‘temporal slice’ at right angles to the temporal axis. Spatial connection is written as  $C_{\text{sp}}(x, y)$  :  $x$  is spatially connected to  $y$ . Here,  $x$  and  $y$  are s-t regions whose closures have a spatial point in common, though not necessarily simultaneously. Temporal connection is written as  $C_{\text{t}}(x, y)$  :  $x$  is temporally connected to  $y$ . Here,  $x$  and  $y$  are s-t regions whose closures have a temporal point in common, though not necessarily at the same place. Figure 3.2(b) illustrates temporal connection. The spatio-temporal connection primitive,  $C_{\text{st}}(x, y)$  :  $x$  is spatio-temporally connected to  $y$  (as shown in Figure 3.2(c)) is true just in case the closures of  $x$  and  $y$  at least share a s-t point.

The axiomatisation of these connection relations are identical and closely follows the axiomatisation of  $C$  in Cohn et al. [1997b]. The relation  $C_{\alpha}(x, y)$  is reflexive and symmetric. We have the following axioms:

$$\mathbf{A1.} \quad C_{\alpha}(x, x)$$

$$\mathbf{A2.} \quad C_{\alpha}(x, y) \rightarrow C_{\alpha}(y, x)$$

where  $\alpha \in \{\text{sp}, \text{t}, \text{st}\}$ .

### 3.2.2 Mereotopological Relations

The mereological relation of parthood,  $P_\alpha(x, y)$ :  $x$  is a part of  $y$ , is defined from the topological connection relation  $C_\alpha(x, y)$ . Based on  $C_\alpha$ , I have three distinct parthood relations: spatial, temporal or spatio-temporal part.

$$\mathbf{D1.} \quad P_\alpha(x, y) \equiv_{def} \forall z [C_\alpha(z, x) \rightarrow C_\alpha(z, y)]$$

Parthood is reflexive (Th1) and transitive (Th2).

$$\mathbf{Th1.} \quad P_\alpha(x, x)$$

$$\mathbf{Th2.} \quad [P_\alpha(x, y) \wedge P_\alpha(y, z)] \rightarrow P_\alpha(x, z)$$

The parthood relation is used to define proper-part ( $PP_\alpha$ ), overlap ( $O_\alpha$ ) and discreteness ( $DR_\alpha$ ). Further  $DC_\alpha, EC_\alpha, PO_\alpha, EQ_\alpha, TPP_\alpha$  and  $NTPP_\alpha$  i.e., disconnected, externally connected, partial overlap, equal, tangential proper-part and non-tangential proper-part respectively can be defined. These relations, along with the inverses for the last two viz.  $TPPi_\alpha$  and  $NTPPi_\alpha$  constitute the Jointly Exhaustive and Pairwise Disjoint (JEPD) relations of RCC-8.

I list the definitions for these relations (adapted from [Cohn *et al.*, 1997b]) using  $C_\alpha$ .

$$\mathbf{D2.} \quad O_\alpha(x, y) \equiv_{def} \exists z [P_\alpha(z, x) \wedge P_\alpha(z, y)]$$

$$\mathbf{D3.} \quad PP_\alpha(x, y) \equiv_{def} [P_\alpha(x, y) \wedge \neg P_\alpha(y, x)]$$

$$\mathbf{D4.} \quad DR_\alpha(x, y) \equiv_{def} \neg O_\alpha(x, y)$$

$$\mathbf{D5.} \quad DC_\alpha(x, y) \equiv_{def} \neg C_\alpha(x, y)$$

$$\mathbf{D6.} \quad EC_\alpha(x, y) \equiv_{def} [C_\alpha(x, y) \wedge \neg O_\alpha(x, y)]$$

$$\mathbf{D7.} \quad PO_\alpha(x, y) \equiv_{def} [O_\alpha(x, y) \wedge \neg P_\alpha(x, y) \wedge \neg P_\alpha(y, x)]$$

$$\mathbf{D8.} \quad EQ_\alpha(x, y) \equiv_{def} [P_\alpha(x, y) \wedge P_\alpha(y, x)]$$

$$\mathbf{D9.} \quad TPP_\alpha(x, y) \equiv_{def} [PP_\alpha(x, y) \wedge \exists z [EC_\alpha(z, x) \wedge EC_\alpha(z, y)]]$$

$$\mathbf{D10.} \quad NTPP_\alpha(x, y) \equiv_{def} [PP_\alpha(x, y) \wedge \neg \exists z [EC_\alpha(z, x) \wedge EC_\alpha(z, y)]]$$

In the present context, the above relations can be interpreted in either space, time or space-time (depending on the subscript  $\alpha$ ). The *classical* interpretation of RCC-8 relations is not fundamentally different from the RCC-8 relations under spatio-temporal interpretation in this thesis. However the RCC-8 relations under spatial connection have a different bearing. For example  $EQ_{sp}(x, y)$  may be true even though  $x$  and  $y$  occupy two distinct regions of space-time. To bring home this distinction, I present both the interpretations next to each other. Figure 3.3(a) shows the JEPD set of RCC-8 relations in space-time, whereas Figure 3.3(b) is the equivalent relations under spatial connection.

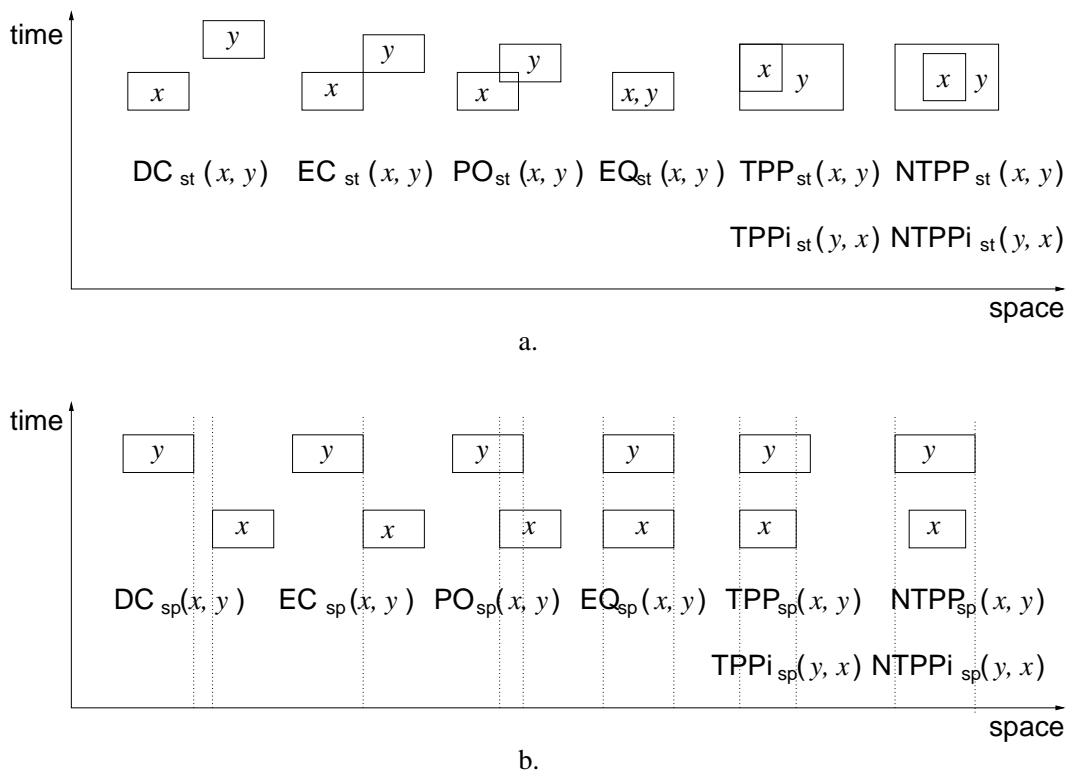

Figure 3.3: JEPD set of RCC-8 relations **a.** under  $C_{st}$  connection and **b.** under  $C_{sp}$  connection.

I have  $EQ_\alpha$ , where  $\alpha \in \{st, sp, t\}$  as the main equivalence relation. In addition, I have the notation  $=_\alpha$  as syntactic sugar for  $EQ_\alpha$  to mean spatio-temporal equivalence, spatial equivalence and temporal equivalence for  $\alpha = st$ ,  $\alpha = sp$  and  $\alpha = t$  respectively<sup>1</sup>.

Even though RCC is based on Clarke's Theory, in its original manifestation it did not include an *axiom of extensionality*. This is an axiom that is intended to assert that the identity of any two objects follow from their indiscernibility with respect to some property. Bennett [1997] was first to suggest the axiom of extensionality for RCC, based on the connection primitive  $C$ , and he called it  $C$ -extensionality. In its present manifestation, an axiom for  $C$ -extensionality would mean spatio-temporal equivalence under  $C_{st}$ . For  $C_{sp}$  and  $C_t$  it would imply spatial equivalence and temporal equivalence respectively. I include the axiom of extensionality (A3) in my axiomatisation of  $C_\alpha$ .

$$\mathbf{A3.} \quad \forall z[C_\alpha(z, x) \leftrightarrow C_\alpha(z, y)] \rightarrow [x =_\alpha y]$$

In line with  $C$ -extensionality, I shall term indiscernibility with respect to parthood relation  $P_\alpha$  as  $P$ -extensionality. Given the above definitions, this is derivable and we have theorem Th3.

<sup>1</sup>The subscripted equality  $=_\alpha$ , where  $\alpha \in \{st, sp, t\}$  applies to s-t histories; if one wanted to identify it with logical equality, one would have an axiom  $\forall x, y[(x = y) \leftrightarrow (x =_{st} y)]$ .

$$\mathbf{Th3.} \quad \forall z[\mathbf{P}_\alpha(z, x) \leftrightarrow \mathbf{P}_\alpha(z, y)] \rightarrow [x =_\alpha y]$$

### 3.2.2.1 Boolean Functions

In addition, I add the following existential axioms. In A4 the individual  $z$  is denoted  $x \cup y$  and represents the sum, whereas in A5 it is denoted  $x - y$  and represents the difference. A6 is the axiom for existence of an individual  $z$  which represents the intersection of  $x$  and  $y$  and is denoted  $x \cap y$ . In A7  $z$  represents the complement of an individual  $x$  and is denoted  $\bar{x}$ . We only need the spatio-temporal version of the axioms (A4 to A6) since the spatial and the temporal versions are implied by axiom A15 (introduced in Section 3.4, Page 48).

$$\mathbf{A4.} \quad \exists z \forall u[\mathbf{C}_{\text{st}}(u, z) \leftrightarrow (\mathbf{C}_{\text{st}}(u, x) \vee \mathbf{C}_{\text{st}}(u, y))]$$

$$\mathbf{A5.} \quad \neg \mathbf{P}_{\text{st}}(x, y) \rightarrow \exists z \forall w[(\mathbf{P}_{\text{st}}(w, x) \wedge \mathbf{DR}_{\text{st}}(w, y)) \leftrightarrow \mathbf{P}_{\text{st}}(w, z)]$$

$$\mathbf{A6.} \quad \mathbf{O}_{\text{st}}(x, y) \rightarrow \exists z \forall u[\mathbf{C}_{\text{st}}(u, z) \leftrightarrow \exists v(\mathbf{P}_{\text{st}}(v, x) \wedge \mathbf{P}_{\text{st}}(v, y) \wedge \mathbf{C}_{\text{st}}(v, u))]$$

$$\mathbf{A7.} \quad \forall x[\exists y[\neg \mathbf{C}_{\text{st}}(x, y) \rightarrow \exists z[\forall w(\mathbf{C}_{\text{st}}(w, z) \leftrightarrow \neg \mathbf{NTPP}_{\text{st}}(w, x)) \wedge \forall w(\mathbf{O}_{\text{st}}(w, z) \leftrightarrow \neg \mathbf{P}_{\text{st}}(w, x))]]]$$

Even though the above axioms (A4 to A7) characterize the Boolean functions, it is worth noting that each of the above formulae is not purely definitional. Since all functions must have a value, the use of the above functions carry existential commitment. A formula that introduces a new functional symbol into a theory cannot be regarded as a definition unless entities with appropriate properties to be values of the function are already guaranteed to exist as a consequence of the axioms of the theory [Bennett, 1997]. Therefore when using the functional extension of the basic theory for automated reasoning I replace A4 to A7 with the following explicit definitions:

$$\mathbf{D11.} \quad [z =_{\text{st}} (x \cup y)] \equiv_{\text{def}} \forall w[\mathbf{C}_{\text{st}}(w, z) \leftrightarrow (\mathbf{C}_{\text{st}}(w, x) \vee \mathbf{C}_{\text{st}}(w, y))]$$

$$\mathbf{D12.} \quad [z =_{\text{st}} (x - y)] \equiv_{\text{def}} \forall w[\mathbf{C}_{\text{st}}(w, z) \leftrightarrow \mathbf{C}_{\text{st}}(w, (x \cap \bar{y}))]$$

$$\mathbf{D13.} \quad [z =_{\text{st}} (x \cap y)] \equiv_{\text{def}} \forall u[\mathbf{C}_{\text{st}}(u, z) \leftrightarrow \exists v(\mathbf{P}_{\text{st}}(v, x) \wedge \mathbf{P}_{\text{st}}(v, y) \wedge \mathbf{C}_{\text{st}}(u, v))]$$

$$\mathbf{D14.} \quad [z =_{\text{st}} \bar{x}] \equiv_{\text{def}} \forall w[(\mathbf{C}_{\text{st}}(w, z) \leftrightarrow \neg \mathbf{NTPP}_{\text{st}}(w, x)) \wedge (\mathbf{O}_{\text{st}}(w, z) \leftrightarrow \neg \mathbf{P}_{\text{st}}(w, x))]$$

The above functions except for sum ( $x \cup y$ ) are *partial* with respect to the domain of regions. Following Randell et al. [1992b] I will employ the sorted logic LLAMA [Cohn, 1983; 1987] to make them *total* functions. In considering the spatio-temporal aspects of RCC theory, I assume that there are two disjoint (and non-empty) base sorts: Region and Null. The sort Null is added to allow arbitrary Boolean combinations of regions to be

expressed as functions viz. when two regions do not overlap and have no region as the intersection. Unless otherwise noted, we declare that the arguments of all relations in the RCC theory are of sort **Region**. The quasi-Boolean functions are made total by letting the result sort of the partial functions be  $\mathbf{Region} \cup \mathbf{Null}$ . The functions can be regarded as genuine Boolean operators over the domain  $\mathbf{Region} \cup \mathbf{Null}$ .

I also introduce a constant symbol ‘ $\mathfrak{U}$ ’ to denote the universe. Every region is connected to the universe. We have the following definition:

$$\mathbf{D15.} \quad (\mathfrak{U} =_{\text{st}} x) \equiv_{\text{def}} \forall y C_{\text{st}}(y, x)$$

Next I have axioms to relate the Boolean algebra to the relational part of the theory. Axiom A8 linking the sort literal **Null** and D13 implies that intersecting regions must overlap and regions that do not overlap have a null product. This is taken from [Cohn *et al.*, 1997a].

$$\mathbf{A8.} \quad \text{DR}_{\text{st}}(x, y) \leftrightarrow \text{Null}(x \cap y)$$

A number of theorems for RCC-8 have been reported in [Randell *et al.*, 1992b; Bennett, 1997]. I present here a representative set that will be used for our subsequent tasks. I have the following theorems.

$$\mathbf{Th4.} \quad [\text{NTPP}_{\alpha}(x, y) \wedge C_{\alpha}(z, x)] \rightarrow \text{O}_{\alpha}(z, y)$$

$$\mathbf{Th5.} \quad \text{P}_{\text{st}}(x, y) \rightarrow C_{\text{st}}(y, \bar{x})$$

$$\mathbf{Th6.} \quad \text{EC}_{\text{st}}(x, \bar{x})^2.$$

$$\mathbf{Th7.} \quad \neg \text{EC}_{\text{st}}(x, y) \leftrightarrow [C_{\text{st}}(x, y) \leftrightarrow \text{O}_{\text{st}}(x, y)]$$

I need to ensure that every region has a non-tangential proper part and thus avoid the problems associated with the definition of parthood discussed in Section 2.4.3, Chapter 2. The NTPP axiom (F1) was included by [Randell *et al.*, 1992b] to rule out the possibility of atomic models of the theory.

$$\mathbf{F1.} \quad \forall y \exists x \text{NTPP}_{\text{st}}(x, y).$$

It has been argued by Bennett [1997] to be a theorem since he presents a line of arguments to demonstrate that RCC would be inconsistent in the presence of atomic regions<sup>3</sup>. In a different setting, using an axiomatisation which is very close to the axiomatisation here, [Düntsch *et al.*, 2001] prove that the NTPP axiom is in fact a theorem. However, since I do not have a machine proof using the formulation presented here, I present it here

<sup>2</sup>Here variable  $x$  ranges over sort **Region** but does not include the universal region  $\mathfrak{U}$ . The sort **Region** have two subsorts: **UniversalRegion** and **RegionNotUniversalRegion**. Variable  $x$  in Th6 ranges over the sort **RegionNotUniversalRegion**.

<sup>3</sup>Bennett argue that the NTPP axiom (F1) is derivable from other axioms of the theory including axiom for C-extensionality A3 and axiom for complement of an individual A7.

as a conjecture C1. We only need the *st* version since C1 implies the *sp* and *t* versions using A15.

$$\mathbf{C1.} \quad \forall y \exists x \text{NTPP}_{\text{st}}(x, y).$$

### 3.2.3 Firm Connection

In order to identify instantaneous relations between histories (cf. Section 4.4, Chapter 4) and to distinguish between pinched and non-pinched histories in a pointless mereotopology (Section 4.1.3, Chapter 4), the categorisation of relations between certain parts of histories is essential. This requires a stronger notion of connection than straightforward spatio-temporal connection.

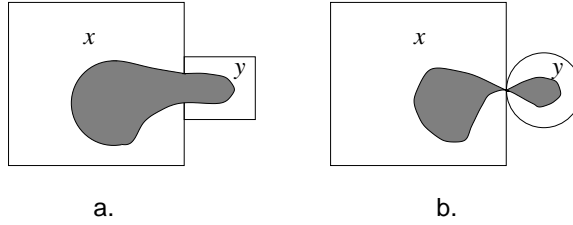

Figure 3.4: **a.** Firm and **b.** Non-Firm connection between two entities  $x$  and  $y$ .

I introduce the notion of *firm* connection corresponding to the *perfect* connection amongst *conduit-based* connections of [Cohn and Varzi, 2003]. Figure 3.4 illustrates *firm* connection and *non-firm* connection. A firm-connection in  $n$ -D space is defined as a connection wherein an  $n$ -D worm can pass through the connection without becoming visible to the exterior. In other words, for two regions to be firmly-connected, a direct *conduit* exists between the two [Cohn and Varzi, 2003].

To define firm-connection here, I first define one-pieceness (i.e., *s-t* connectedness). A *s-t* region  $x$  is spatio-temporally one-piece,  $\text{CON}_{\text{st}}x$ , just in case however it is split into parts whose union is that region, the parts are  $\text{C}_{\text{st}}$  connected to each other. Similarly we can define temporal connectedness: a *s-t* region  $x$  is temporally one-piece just in case all parts of  $x$  are temporally connected. We can also define spatial connectedness: a *s-t* region  $x$  is spatially one-piece just in case all parts of  $x$  are  $\text{C}_{\text{sp}}$  connected. D17 defines an interior connected region (corresponding to the notion of *simple* region in [Borgo *et al.*, 1996]). A region is interior connected  $\text{INCON}x$ , just in case for any  $y$  which is a  $\text{NTPP}_{\text{st}}$  of  $x$ , there exists a one-piece region which has  $y$  as a part and is itself  $\text{NTPP}_{\text{st}}$  of  $x$ .

$$\mathbf{D16.} \quad \text{CON}_{\alpha}x \equiv_{\text{def}} \forall y, z [x =_{\text{st}} (y \cup z) \rightarrow \text{C}_{\alpha}(y, z)]$$

$$\mathbf{D17.} \quad \text{INCON}x \equiv_{\text{def}} \forall y [\text{NTPP}_{\text{st}}(y, x) \rightarrow \exists z (\text{P}_{\text{st}}(y, z) \wedge \text{NTPP}_{\text{st}}(z, x) \wedge \text{CON}_{\text{st}}z)]$$

Finally D18 states that a connection between two entities  $x$  and  $y$  is a *firm-connection* just in case some  $u$  (which is a part of  $x$ ), and some  $v$  (which is a part of  $y$ ), is interior connected ( $\text{INCON}(u \cup v)$ ). We have the following definition:

$$\mathbf{D18.} \quad \text{FCON}(x, y) \equiv_{\text{def}} \exists u, v [\text{P}_{\text{st}}(u, x) \wedge \text{P}_{\text{st}}(v, y) \wedge \text{INCON}(u \cup v)]$$

FCON is reflexive and symmetric. We have the following theorems.

$$\mathbf{Th8.} \quad \text{FCON}(x, x)$$

$$\mathbf{Th9.} \quad \text{FCON}(x, y) \leftrightarrow \text{FCON}(y, x)$$

### 3.3 Temporal Relations

The temporal connection relation  $\text{C}_t$  makes it possible to have a temporal version of all the RCC definitions. The most commonly used temporal notions are *temporal inclusion*, *temporal overlap* and *temporal equivalence* corresponding to  $\text{P}_t(x, y)$ ,  $\text{O}_t(x, y)$  and  $\text{EQ}_t(x, y)$  respectively. For clarity I will at times write the temporal relations as infix operators. Following Muller [1998a], temporal connection  $\text{C}_t(x, y)$  is also written as  $x \approx_t y$ . Definitions D19 to D21 introduce temporal inclusion, temporal overlap and temporal equivalence as infix operators. I will write  $\text{P}_t(x, y)$ ,  $\text{O}_t(x, y)$  and  $\text{EQ}_t(x, y)$  as  $x \subseteq_t y$ ,  $x \sigma_t y$  and  $x =_t y$  respectively.

$$\mathbf{D19.} \quad x \subseteq_t y \equiv_{\text{def}} \text{P}_t(x, y)$$

$$\mathbf{D20.} \quad x \sigma_t y \equiv_{\text{def}} \text{O}_t(x, y)$$

$$\mathbf{D21.} \quad x =_t y \equiv_{\text{def}} \text{EQ}_t(x, y)$$

#### 3.3.1 Temporal Order

In order to introduce a s-t interpretation we must capture a notion of temporal order. For temporal order I retain the primitive,  $x <_t y$ : the closure of  $x$  strictly precedes the closure of  $y$  in time [Kamp, 1979; van Benthem, 1983; Muller, 1998c]. Axiom A9 postulates that temporal connection and temporal order are incompatible. Also temporal order is asymmetric (A10). Axiom A11 postulates the composition of temporal connection and temporal order. Finally axiom A12 postulates the monotonicity of temporal inclusion with regards to temporal order.

$$\mathbf{A9.} \quad x \approx_t y \rightarrow \neg(x <_t y)$$

$$\mathbf{A10.} \quad x <_t y \rightarrow \neg(y <_t x)$$

$$\mathbf{A11.} \quad [x <_t y \wedge y \approx_t z \wedge z <_t w] \rightarrow (x <_t w)$$



$$\mathbf{A12.} \quad x <_t y \rightarrow \forall z[(z \subseteq_t x \rightarrow z <_t y) \wedge (z \subseteq_t y \rightarrow x <_t z)]$$

From the above we have theorems Th10 and Th11 establishing the irreflexivity and transitivity of  $<_t$ . The relation is a strict (partial) order.

$$\mathbf{Th10.} \quad \neg(x <_t x)$$

$$\mathbf{Th11.} \quad [x <_t y \wedge y <_t z] \rightarrow (x <_t z)$$

We have the following theorems for the composition of  $<_t$  and temporal relations of  $=_t$ ,  $\sigma_t$  and  $\subseteq_t$ . Th17 establishes the reflexivity of temporal equivalence.

$$\mathbf{Th12.} \quad [x <_t y \wedge y =_t z] \rightarrow (x <_t z)$$

$$\mathbf{Th13.} \quad [x <_t y \wedge y \sigma_t z \wedge z <_t t] \rightarrow (x <_t t)$$

$$\mathbf{Th14.} \quad [x <_t y \wedge y \subseteq_t z \wedge z <_t t] \rightarrow (x <_t t)$$

$$\mathbf{Th15.} \quad x \subseteq_t y \rightarrow \forall z[(z <_t y \rightarrow z <_t x) \wedge (y <_t z \rightarrow x <_t z)]$$

$$\mathbf{Th16.} \quad [x =_t y \wedge x \subseteq_t z] \rightarrow (y \subseteq_t z)$$

$$\mathbf{Th17.} \quad x =_t x$$

In order to capture the properties of the Boolean sum operator and the temporal relations of connection and ordering, we need to introduce two more axioms. Axiom A13 states that if a region composed of the sum of two other regions is temporally before a third region, then both of its parts must also be before (and vice versa). The second axiom (A14) states that if a region composed of the sum of two other regions is temporally connected to a third region, then one of its parts must be connected to the third region (and vice versa).

$$\mathbf{A13.} \quad [x <_t y \wedge z <_t y] \leftrightarrow (x \cup z) <_t y$$

$$\mathbf{A14.} \quad (x \cup y) \bowtie z \leftrightarrow [x \bowtie z \vee y \bowtie z]$$

If the sum of  $x$  and  $y$  is temporally included in  $z$ ,  $x$  and  $y$  individually are temporally included in  $z$ . We have the following theorem:

$$\mathbf{Th18.} \quad (x \cup y) \subseteq_t z \rightarrow [x \subseteq_t z \wedge y \subseteq_t z]$$

### 3.3.2 Interval Relations

I shall use the term interval to refer to a spatio-temporal region, when the spatio-temporal region is to be used in a context where only its temporal extent is of interest. An interval  $z$  is the temporal extent of  $z$ , where  $z$  can be any history.

Allen [1984] and even before him Nicod [1924] pointed out that if time is totally ordered then there are 13 JEPD relations (which can be defined in terms of *meets* [Allen and Hayes,

1985]) in which one one-piece interval can stand to another. I will list here the ones that will be required for our subsequent discussion.

In order to define interval relations I introduce the notion of a non-EC<sub>t</sub> part for a pair of regions. For regions  $x$  and  $y$  temporally externally connected, NECP( $u, x, y$ ) states  $u$  to be a non-EC<sub>t</sub> part of  $x$  with respect to  $y$ . Figure 3.5 illustrates the NECP of  $x$  with respect to  $y$ .

$$\mathbf{D22.} \quad \text{NECP}(u, x, y) \equiv_{def} \text{EC}_t(x, y) \wedge \text{P}_{st}(u, x) \wedge \neg \text{EC}_t(u, y)$$

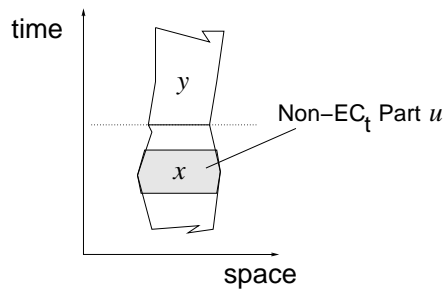

Figure 3.5: For regions  $x$  and  $y$  temporally externally connected,  $u$  is the NECP of  $x$  with respect to  $y$ .

Given a pair of temporally externally connected regions there exists for each a non-EC<sub>t</sub> part with respect to the other. Theorem Th19 establishes the existence of a NECP for a pair of EC<sub>t</sub> regions<sup>4</sup>.

$$\mathbf{Th19.} \quad \text{EC}_t(x, y) \rightarrow \exists z \text{NECP}(z, x, y)$$

Next I define *meets*. Note that unlike Allen we need our definitions to work for multi-piece intervals. This is achieved through the second conjunct of D23. The universal quantification for NECP makes it invariant of connectedness. D23 is the definition for *meets* which is a specialisation of EC<sub>t</sub>. Figure 3.6(a) shows the temporal relation of *meets*. Note that when multi-piece intervals EC<sub>t</sub> as in Figure 3.6(b) they don't *meet*.

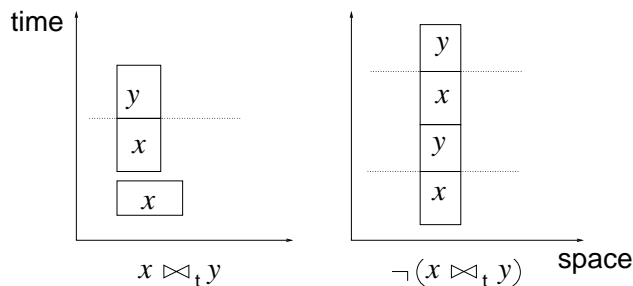

Figure 3.6: Interval relation of **a.**  $\bowtie_t$  and **b.**  $\neg \bowtie_t$  for multi-piece intervals.

<sup>4</sup>Note that theorems using D22 and Th19 (i.e., Th27, Th30 and Th31) require axioms for mereotopological correspondence between time and space-time. Proof of these theorems use axiom A15 and conjecture C2 from section 3.4.

$$\mathbf{D23.} \quad x \bowtie_t y \equiv_{def} \mathbf{EC}_t(x, y) \wedge \forall z[\mathbf{NECP}(z, x, y) \rightarrow z <_t y] \wedge \\ \forall z[\mathbf{NECP}(z, y, x) \rightarrow x <_t z]$$

Figure 3.7 shows the different temporal relations. D24 is the definition for a temporal interval  $x$  ending with another interval  $y$ . D25 is for a temporal interval  $x$  starting with another interval  $y$ . D26 defines interval  $x$  to be between two distinct intervals  $y$  and  $z$ . Note that this three place relation is not an ‘Allen’ relation.

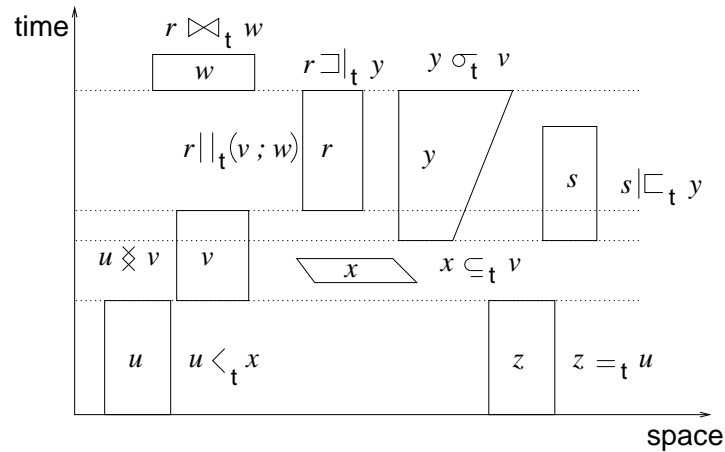

Figure 3.7: Temporal Relations over spatio-temporal regions.

$$\mathbf{D24.} \quad x \sqsupseteq_t y \equiv_{def} \forall u[x \bowtie_t u \leftrightarrow y \bowtie_t u]$$

$$\mathbf{D25.} \quad x | \sqsubset_t y \equiv_{def} \forall u[u \bowtie_t x \leftrightarrow u \bowtie_t y]$$

$$\mathbf{D26.} \quad x ||_t (y; z) \equiv_{def} [y \bowtie_t x \wedge x \bowtie_t z]$$

We have the following properties.  $\bowtie_t$  is irreflexive and asymmetric, whereas  $| \sqsubset_t$  and  $\sqsupseteq_t$  are reflexive and symmetric.

$$\mathbf{Th20.} \quad \neg(x \bowtie_t x)$$

$$\mathbf{Th21.} \quad x \bowtie_t y \rightarrow \neg(y \bowtie_t x)$$

$$\mathbf{Th22.} \quad x | \sqsubset_t x$$

$$\mathbf{Th23.} \quad x \sqsupseteq_t x$$

$$\mathbf{Th24.} \quad x | \sqsubset_t y \rightarrow y | \sqsubset_t x$$

$$\mathbf{Th25.} \quad x \sqsupseteq_t y \rightarrow y \sqsupseteq_t x$$

The following theorems establish the relation between interval relations and temporal order as well as other temporal relations.

$$\mathbf{Th26.} \quad [x \bowtie_t y \wedge y \bowtie_t z] \rightarrow x <_t z$$

$$\mathbf{Th27.} \quad [x \bowtie_t y \wedge y <_t z] \rightarrow x <_t z$$

$$\mathbf{Th28.} \quad [x \sqsubset_{\mathbf{t}} y \wedge y \sqsubset_{\mathbf{t}} z] \rightarrow x \sqsubset_{\mathbf{t}} z$$

$$\mathbf{Th29.} \quad [x \sqsupset_{\mathbf{t}} y \wedge y \sqsupset_{\mathbf{t}} z] \rightarrow x \sqsupset_{\mathbf{t}} z$$

$$\mathbf{Th30.} \quad [x \sqsubseteq_{\mathbf{t}} y \wedge y \bowtie_{\mathbf{t}} z \wedge z <_{\mathbf{t}} w] \rightarrow x <_{\mathbf{t}} w$$

$$\mathbf{Th31.} \quad x \bowtie_{\mathbf{t}} y \rightarrow \forall z[(z <_{\mathbf{t}} x \rightarrow z <_{\mathbf{t}} y) \wedge (y <_{\mathbf{t}} z \rightarrow x <_{\mathbf{t}} z)]$$

$$\mathbf{Th32.} \quad x \parallel_{\mathbf{t}} (y; z) \rightarrow \forall w[(w \sqsubseteq_{\mathbf{t}} y \rightarrow w <_{\mathbf{t}} z) \wedge (w \sqsubseteq_{\mathbf{t}} z \rightarrow y <_{\mathbf{t}} w)]$$

I introduce predicates to refer to the initial and final parts of a history. D27 states that a part of a history  $y$  can be termed an initial part just in case it starts with  $y$  and ends before it. Conversely,  $x$  is a final part of a history  $y$  (D28) just in case  $x$  starts after  $y$  and ends with it.

$$\mathbf{D27.} \quad \mathbf{IP}(x, y) \equiv_{\text{def}} \mathbf{P}_{\text{st}}(x, y) \wedge x \sqsubset_{\mathbf{t}} y \wedge \exists z[z \sqsupset_{\mathbf{t}} y \wedge x \bowtie_{\mathbf{t}} z \wedge x \cup z =_{\text{st}} y]$$

$$\mathbf{D28.} \quad \mathbf{FP}(x, y) \equiv_{\text{def}} \mathbf{P}_{\text{st}}(x, y) \wedge x \sqsupset_{\mathbf{t}} y \wedge \exists z[z \sqsubset_{\mathbf{t}} y \wedge z \bowtie_{\mathbf{t}} x \wedge x \cup z =_{\text{st}} y]$$

### 3.4 Spatio-Temporal Interactions

A s-t connection implies a spatial as well as a temporal connection, though note that the converse is not necessarily true. Figure 3.8 shows spatio-temporal regions  $x$  and  $y$  are spatially and temporally connected but not spatio-temporally. I add the following axiom:

$$\mathbf{A15.} \quad \mathbf{C}_{\text{st}}(x, y) \rightarrow [\mathbf{C}_{\mathbf{t}}(x, y) \wedge \mathbf{C}_{\text{sp}}(x, y)]$$

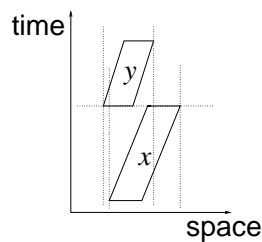

Figure 3.8: Space-time regions  $x$  and  $y$  are  $\mathbf{C}_{\text{sp}}$  and  $\mathbf{C}_{\mathbf{t}}$  connected but not  $\mathbf{C}_{\text{st}}$  connected.

In addition to axiom A15 above, I need to have F2.

$$\mathbf{F2.} \quad \mathbf{P}_{\text{st}}(x, y) \rightarrow [\mathbf{P}_{\text{sp}}(x, y) \wedge \mathbf{P}_{\mathbf{t}}(x, y)].$$

The above formula accounts for the mereological correspondence between space-time, space and time. The proof should be derivable from the definition of  $\mathbf{P}_{\text{st}}$  (D1) and axiom A15 and indeed I have sketched a proof manually. However, I could not arrive at a machine proof using SPASS and therefore have it as a conjecture here<sup>5</sup>:

<sup>5</sup>Muller[2002; 1998a] also includes an axiom to postulate the mereological correspondence between space-time and time, apart from having an axiom analogous to A15 to postulate that spatio-temporal connection implies temporal connection.

$$\mathbf{C2.} \quad P_{st}(x, y) \rightarrow [P_{sp}(x, y) \wedge P_t(x, y)].$$

Note that spatio-temporal overlap should imply spatial and temporal overlap simultaneously. We have the following theorem:

$$\mathbf{Th33.} \quad O_{st}(x, y) \rightarrow [(x \sigma_t y) \wedge O_{sp}(x, y)]$$

Models must not be spatio-temporal alone, so spatio-temporal connection  $C_{st}$  needs to be different from spatial as well as temporal connection [Muller, 2002; 1998a]. I introduce the following axioms.

$$\mathbf{A16.} \quad \exists x \exists y [C_t(x, y) \wedge \neg C_{st}(x, y)]$$

$$\mathbf{A17.} \quad \exists x \exists y [C_{sp}(x, y) \wedge \neg C_{st}(x, y)]$$

### 3.4.1 Temporal Slice

As already noted, I do not allow lower dimensional entities such as temporal points into my ontology. In order to refer to regions within a given time or to define relations between s-t regions that may vary through time, I introduce the notion of a *temporal slice*, i.e., the maximal component part corresponding to a certain time extent [Muller, 1998b].

This is different from the temporal slice of many mereological theories, such as the zero duration slice of [Simons, 1987, Page 32]. Following Muller [2002; 1998b] I stay completely within a pointless mereotopological theory. For a s-t history  $y$ , a temporal slice  $x$  is a part of  $y$  such that any part of  $y$  that is temporally included in  $x$  is a part of  $x$ . Temporal slice is written as  $TS(x, y)$ :  $x$  is a temporal slice of  $y$ .

$$\mathbf{D29.} \quad TS(x, y) \equiv_{def} P_{st}(x, y) \wedge \forall z [(P_{st}(z, y) \wedge z \subseteq_t x) \rightarrow P_{st}(z, x)]$$

Figure 3.9 shows (a) what it means for  $x$  to be a temporal slice of  $y$  during  $w$  and (b) when  $x$  is not a temporal slice of  $y$ , because the ‘missing’ chunk though part of history  $y$  and temporally included in  $w$  is not a part of  $x$ .

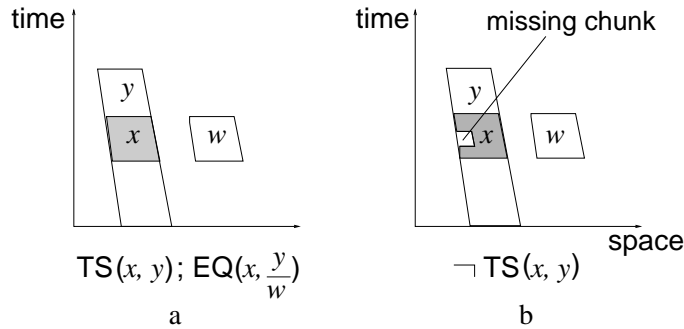

Figure 3.9: Temporal Slice of a history  $y$ : **a.** when  $x$  is a temporal slice of  $y$  during  $w$  and **b.** when  $x$  is not a temporal slice of  $y$ .

The definition for TS implies reflexivity, antisymmetry and transitivity. We have the following theorems:

**Th34.**  $\text{TS}(x, x)$ .

**Th35.**  $[\text{TS}(x, y) \wedge \text{TS}(y, x)] \rightarrow x =_{\text{st}} y$ .

**Th36.**  $[\text{TS}(x, y) \wedge \text{TS}(y, z)] \rightarrow \text{TS}(x, z)$ .

Any history  $y$  should have a temporal slice  $x$  corresponding to the temporal extent of a contemporaneous entity  $w$ . Analogous to A26 in [Muller, 2002] I have the following axiom to ensure the existence of temporal slice:

**A18.**  $w \subseteq_{\text{t}} y \rightarrow \exists x[\text{TS}(x, y) \wedge x =_{\text{t}} w]$

I have theorem Th37, which shows that this slice is unique.

**Th37.**  $[\text{TS}(x, y) \wedge \text{TS}(z, y) \wedge x =_{\text{t}} z] \rightarrow x =_{\text{st}} z$

I introduce a function  $\text{ts}(y, w)$  to return this corresponding slice whenever it exists (i.e., when  $w \subseteq_{\text{t}} y$ ). D30 is the definition of  $\text{ts}(y, w)$ .

**D30.**  $\text{ts}(y, w) \equiv_{\text{def}} \begin{cases} \iota x(\text{TS}(x, y) \wedge x =_{\text{t}} w) & \text{if } w \subseteq_{\text{t}} y \\ \text{Null} & \text{otherwise} \end{cases}$

For  $w \subseteq_{\text{t}} y$ , D30 returns the temporal slice of  $y$  corresponding to the temporal extent of  $w$ . Muller refers to the above temporal slice by the notation  $\frac{y}{w}$  [Muller, 2002; 1998a]. The notation  $\frac{y}{w}$  and the function  $\text{ts}$  are equivalent. I will regard  $\frac{y}{w}$  as syntactic sugar for the function  $\text{ts}(y, w)$ .

We have the following theorems involving the  $\text{ts}$  function.  $\text{ts}(x, x)$  is equal to  $x$  and therefore theorem Th38 and Th39.

**Th38.**  $\text{ts}(x, x) =_{\text{st}} x$

**Th39.**  $\text{TS}(\text{ts}(x, x), x)$ .

### 3.4.1.1 Existence of Temporal Slices

Two histories s-t connect if and only if one has a slice s-t connected to the other, as shown in Th40. Moreover, as shown in Figure 3.10(a) for temporal slice of a history  $y$  spatially disconnected from an entity  $z$  connected to  $y$ , there exists a temporal slice distinct from the first and s-t connected to  $z$ ; this is demonstrated by Th41.

**Th40.**  $\text{C}_{\text{st}}(x, y) \leftrightarrow \exists z[\text{TS}(z, y) \wedge \text{C}_{\text{st}}(x, z)]$

**Th41.**  $[\text{TS}(y_1, y) \wedge \neg \text{C}_{\text{sp}}(y_1, z) \wedge \text{C}_{\text{st}}(z, y)] \rightarrow \exists y_2[\text{TS}(y_2, y) \wedge \text{C}_{\text{st}}(y_1, y_2) \wedge \text{C}_{\text{st}}(z, y_2) \wedge \neg(y_1 =_{\text{st}} y_2)]$

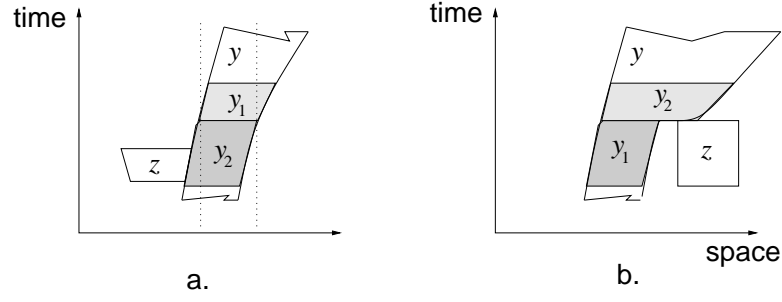

Figure 3.10: Existence of temporal slices for histories connected spatio-temporally.

Note that the final conjunct  $\neg(y_1 =_{st} y_2)$  adds nothing logically since it follows immediately from  $\neg C_{st}(y_1, z)$  and  $C_{st}(z, y_2)$ . Removing the last conjunct would leave the consequent reduced to  $\exists y_2[TS(y_2, y) \wedge C_{st}(y_1, y_2) \wedge C_{st}(z, y_2)]$ . However this is provable without the  $\neg C_{sp}(y, z)$  conjunct (in the antecedent), from a simpler antecedent  $[TS(y_1, y) \wedge C_{st}(z, y)]$ . I therefore choose to state this theorem in this ‘stronger’ form.

Related to Th41 is the following theorem, where the spatially disjoint entity is equitemporal. In such a case as shown in Figure 3.10(b), the temporal slice is externally s-t connected.

$$\text{Th42. } [TS(y_1, y) \wedge \neg C_{sp}(y_1, z) \wedge C_{st}(z, y) \wedge (y_1 =_t z)] \rightarrow \exists y_2[TS(y_2, y) \wedge C_{st}(y_1, y_2) \wedge EC_{st}(z, y_2) \wedge \neg(y_1 =_{st} y_2)]$$

The existence of a temporal slice for any contemporaneous entity is given by the following theorems. Given axiom A18 and the definition of  $ts$ , we have Th43. Furthermore we have the following theorems closely related to A18. If  $y$  is a spatio-temporal part of  $x$ , there exists a temporal slice of  $x$  temporally equivalent to  $y$  (Th44). And Th45 states that if  $x$  temporally overlaps  $y$ , there exists a temporal slice of  $x$  that is temporally included in  $y$ .

$$\text{Th43. } x \subseteq_t y \rightarrow TS(ts(y, x), y).$$

$$\text{Th44. } P_{st}(x, y) \rightarrow \exists u[TS(u, y) \wedge u =_t x]$$

$$\text{Th45. } x \sigma_t y \rightarrow \exists u[TS(u, y) \wedge u \subseteq_t x]$$

### 3.5 Underlying Temporal Structure

I will assume a linear underlying temporal order. The intuition is to have a temporal ordering between self-connected entities as in Kamp’s logics [Kamp, 1979], but where overlap is replaced by my temporal connection.

$$\text{F3. } CON_t x \wedge CON_t y \rightarrow [x <_t y \vee x \bowtie y \vee y <_t x]$$

For a theory allowing multipiece entities, I need something stronger than the above as the underlying temporal order. And I would like to have F3 as a theorem. Muller proceeds similarly. However, Muller uses a concept of maximal connected temporal part and defines a relation of betweenness for non self-connected entities. I present below a simpler formulation than Muller's. This is possible since I have interval relations (in particular *meets*) defined in my formalism. D31 states that  $x$  and  $y$  are ordered when  $x$  is temporally before or meets  $y$ .

$$\mathbf{D31.} \quad \text{ORD}(x, y) \equiv_{def} x <_t y \vee x \bowtie_t y$$

Apart from being temporally ordered,  $<_t$ , and meeting,  $\bowtie_t$ , non self-connected temporal entities can *embed* one another. Ladkin calls such non self-connected temporal entities *union-of-convex* intervals [Ladkin, 1987, Chapter 6, Page 65]. Logical definitions of a subset of all possible relations between non-convex intervals are provided in [Ladkin, 1987]. There are infinitely many relations definable in an algebra generated by such union-of-convex intervals [Ladkin and Maddux, 1988]. I prefer to group all these cases together here and term it *embed*.

I introduce the predicate  $\text{EMB}(x, y)$  to mean  $x$  embeds  $y$ .

$$\mathbf{D32.} \quad \text{EMB}(x, y) \equiv_{def} [\neg \text{CON}_t x \vee \neg \text{CON}_t y] \wedge \neg \text{ORD}(x, y) \wedge \neg \text{ORD}(y, x) \wedge \text{DR}_t(x, y)$$

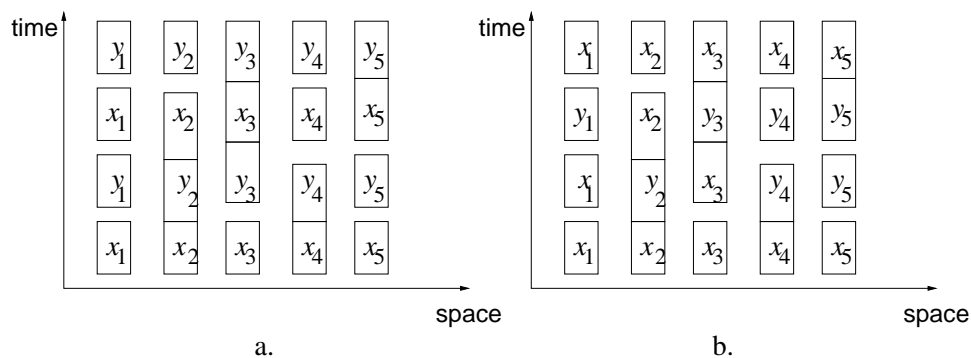

Figure 3.11: Multipiece intervals embedding one another. For two multipiece intervals,  $\text{EMB}(x, y)$  and  $\text{EMB}(y, x)$  could hold simultaneously. **a.**  $\exists x_i y_i [\text{EMB}(x_i, y_i) \wedge \text{EMB}(y_i, x_i)]$  and **b.**  $\exists x_i y_i [\text{EMB}(x_i, y_i) \wedge \neg \text{EMB}(y_i, x_i)]$ .

Figure 3.11 illustrates embedding of one multi-piece component within another. It is worth noting that for two multipiece intervals,  $\text{EMB}(x, y)$  and  $\text{EMB}(y, x)$  could hold simultaneously. Figure 3.11(a) shows five different ways in which two multipiece intervals  $x_i$  and  $y_i$  embed one another. There could also be situations in which one multipiece interval  $x_i$  embeds another multipiece interval  $y_i$  without  $y_i$  embedding  $x_i$ . Some different ways this is possible are shown in Figure 3.11(b).



EMB is irreflexive: we have theorem Th46.

**Th46.**  $\neg\text{EMB}(x, x)$

I am now in a position to state what I need for the underlying temporal structure. Temporally, a pair of entities can embed or be in an ordering relation or overlap each other. Therefore for a linear order as underlying temporal structure, I add the following axiom<sup>6</sup>:

**A19.**  $[\text{EMB}(x, y) \vee \text{ORD}(x, y) \vee \text{ORD}(y, x) \vee \text{O}_t(x, y)]$

This gives me the linearity condition I had set out to have. I have F3 as a theorem:

**Th47.**  $\text{CON}_t x \wedge \text{CON}_t y \rightarrow [x <_t y \vee x \approx y \vee y <_t x]$

---

<sup>6</sup>Even though pairwise disjoint, in absence of an underlying linear order, embeds, ordered and temporal overlap are not jointly exhaustive. A19 would be a theorem after addition of some other axiom for linear order.



## Chapter 4

# Continuous Transitions in Mereotopology

---

As noted in Chapter 2, change in qualitative spatial representation languages such as RCC-8 has been analyzed through transition graphs. Relations form a conceptual neighbourhood via potential motion. Continuity has generally remained an implicitly assumed notion. In this introductory part to Chapter 4, I outline my approach to making continuity *explicit*.

Transitions in RCC-8 conceptual neighbourhood diagrams in the literature (and the ones that are subject of the thesis) are transitions between *purely spatial* relations for *purely spatial* regions. However, I am working in a framework where I can only talk about st regions and their sp, t or st relations. Therefore there needs to be some mechanism to characterize what is happening to spatial relations (between spatial regions) just by looking at spatio-temporal regions.

To illustrate this, consider Figure 4.1. Spatio-temporal histories  $x$  and  $y$  in Figure 4.1(a) have a  $DC_{st}$  to  $PO_{st}$  transition with  $EC_{st}$  holding instantaneously at the end of  $z_1$ . Figure 4.1(b) shows a  $DC_{st}$  to  $EC_{st}$  transition with  $EC_{st}$  holding throughout  $z_2$ , including at the boundary between  $z_1$  and  $z_2$ .

In Figure 4.1(a), the *purely spatial* relationship between the temporal interior<sup>1</sup> (before the instant of transition at the end of interval  $z_1$ ) of  $\frac{x}{z_1}$  and  $\frac{y}{z_1}$  is *disconnection*. Note that if the *purely spatial* relationship between *purely spatial* regions is constant over an interval,

---

<sup>1</sup>The notion of a temporal interior will be handled via the NECP concept introduced in Section 3.3.2.

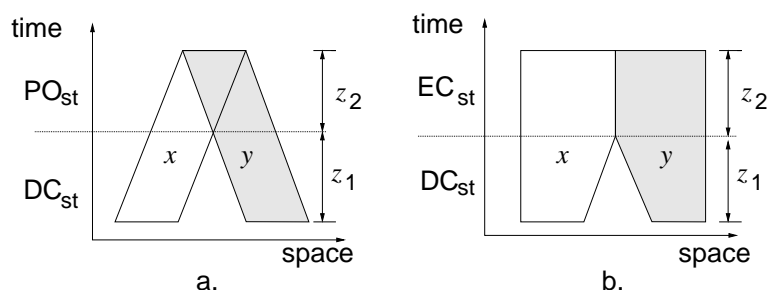

Figure 4.1: **a.**  $DC_{st}$  to  $PO_{st}$  transition with  $EC_{st}$  holding instantaneously at the end of  $z_1$  and **b.**  $DC_{st}$  to  $EC_{st}$  transition with  $EC_{st}$  holding throughout  $z_2$  (including at the boundary between  $z_1$  and  $z_2$ ).

and is say  $R_{sp}$ , the slices of the spatio-temporal regions over that interval normally have relation  $R_{st}$ <sup>2</sup>. The converse of this is not true i.e., spatio-temporal relation  $R_{st}$  over an interval does not necessarily mean that the *purely spatial* relationship remains constant (i.e., is  $R_{sp}$ ) over the interval. This is illustrated in Figure 4.11 (Section 4.3.2, Page 65), where even though the spatio-temporal relationship over the complete interval is  $EC_{st}$ , the *purely spatial* relationship for contemporaneous slices is sporadic, varying between *external connection* and *disconnection*. Similar temporal variation can occur between other relations. For characterizing transitions, I am interested in spatial relations that hold continuously over a given interval since it is only in this case that I can truly claim that a transition between the two relations in question has occurred. I therefore introduce *durative relations* in Section 4.3.2. Transitions characterising the RCC-8 conceptual neighbourhood will be defined in terms of these durative relations which ensure that the spatial relation holds between two histories throughout the intervals involved in the transition.

In order to characterise *direct* transitions between two histories (i.e., where a certain relation holds duratively during a given interval and a different relation holds duratively in an adjacent interval, without a third relation holding instantaneously in between), as in Figure 4.1(b), I introduce a *non-instantaneous transition* operator  $Trans$  in Section 4.5.1. On the other hand, transitions involving an instantaneous relation holding at the temporal boundary of two intervals, as in Figure 4.1(a), are characterized through  $InsRel$  that uses the *instantaneous transition matrix* introduced in Section 4.4.1. Through the instantaneous transition matrix  $M_r$ , I identify from first principles, conditions holding between two st histories which correspond to a unique instantaneous transition relation. Using  $M_r$ , I arrive at a formal definition of instantaneous transitions within the mereotopological framework.

<sup>2</sup>The only exception to this rule is for  $NTPP_{sp}$  when it is possible that the st relation is  $TPP_{st}$  rather than  $NTPP_{st}$ : if two regions  $x, y$  are such that  $NTPP_{sp}(x, y)$  at every time during an interval  $z$ , then  $TPP_{st}(\frac{x}{z}, \frac{y}{z})$  rather than  $NTPP_{st}(\frac{x}{z}, \frac{y}{z})$  would hold.

The main purpose of the rest of this chapter is to formally characterise the notion of continuous transitions between spatial relations discussed above in order to recover the CND for RCC-8. The basis of this characterisation is to restrict attention to *continuous histories*, i.e. the continuity of relations *between* histories depends crucially on the fact that the constituent histories themselves are continuous in a strong sense. In the next section, 4.1, I define an appropriate notion of continuity for a single s-t history, which I term *Strong Firm Continuity*. In section 4.2, I briefly discuss how weaker notions of continuity for s-t histories would lead to weaker CNDs. In section 4.3.1, I introduce further axioms which strengthen the notion of continuity of a s-t history. In section 4.3.2, I formally define the notion of a durative relation and present some introductory theorems characterising transitions between durative relations over continuous s-t histories. In section 4.4, I axiomatise instantaneous transitions via the *instantaneous transition matrix*. In section 4.5, I formally define the notion of transition of durative spatial relations between continuous s-t histories which will be used in section 4.6 to recover the CND.

## 4.1 Spatio-Temporal Continuity of a s-t history

In order to define the notion of spatio-temporal continuity, I introduce a binary component relation, where a component is a maximal one-piece part of a history. D33 gives the definition of a component.

$$\mathbf{D33.} \quad \text{Comp}_{\text{st}}(x, y) \equiv_{\text{def}} \text{CON}_{\text{st}}x \wedge \text{P}_{\text{st}}(x, y) \wedge \forall w[[\text{CON}_{\text{st}}w \wedge \text{P}_{\text{st}}(w, y) \wedge \text{P}_{\text{st}}(x, w)] \rightarrow w = x]$$

### 4.1.1 Strong Continuity

A spatio-temporal history is spatio-temporally continuous if there are no ‘spatial’ or ‘temporal’ gaps. For this to be the case, there can only be a single, unique, s-t component which can be characterised in the following definition of *Strong s-t continuity*<sup>3</sup>.

$$\mathbf{D34.} \quad \text{StrCONT}_{\text{st}}y \equiv_{\text{def}} \forall w_1, w_2[[\text{Comp}_{\text{st}}(w_1, y) \wedge \text{Comp}_{\text{st}}(w_2, y) \wedge w_1 =_{\text{t}} w_2 \wedge w_1 =_{\text{sp}} w_2] \rightarrow w_1 =_{\text{st}} w_2]$$

Strong s-t continuity is both ‘spatial’ and ‘temporal’ continuity<sup>4</sup>. Even though this is an appealing notion of spatio-temporal continuity, it does not rule out spatial leaps.

<sup>3</sup>Just before finalizing the thesis I realized that in fact  $\text{StrCONT}_{\text{st}}y$  appears to be equivalent to  $\text{CON}_{\text{st}}y$  ! Historically, components had been important to the definition of strong continuity [Hazarika and Cohn, 2001] and the present definition naturally followed from the earlier presentation. Time did not allow a reformulation using this simpler definition since many proofs would have had to have been recomputed.

<sup>4</sup>A spatio-temporal history is spatially (resp. temporally) continuous if there are no spatial (resp. temporal) gaps in the history.

See Figure 4.2: history  $w$  with spatio-temporal components  $x$  and  $(v + u)$  is spatially and temporally continuous (according to D34) but makes a *sideways spatial leap*. Thus the above notion needs to be refined further.

### 4.1.2 Continuity: Ruling out Sideways Leaps

Muller’s definition of continuity [Muller, 2002; 1998b] is: any s-t region is defined as qualitatively continuous just in case it is temporally self-connected and it doesn’t make any spatial leaps<sup>5</sup> (corresponding to a sudden gain or loss of parts, or a sudden translation). Muller’s definition captures part of what one might take to be an intuitive notion of spatio-temporal continuity. Figure 4.2 is an illustration of discontinuity under definition D35 below

$$\mathbf{D35.} \quad \text{CONT}_t w \equiv_{def} \text{CON}_t w \wedge \forall x \forall u [[\text{TS}(x, w) \wedge x \approx u \wedge \text{P}_{st}(u, w)] \rightarrow \text{C}_{st}(x, u)]$$

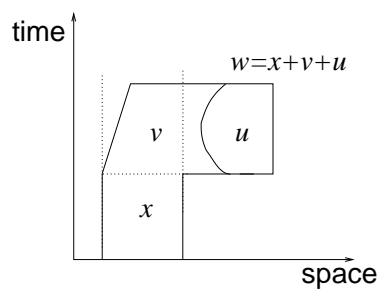

Figure 4.2: Muller’s definition of discontinuity of history  $w$ . The region  $w$  is discontinuous under Muller’s definition of continuity because it makes a *sideways spatial leap*.

#### 4.1.2.1 Firm Continuity: Non-Pinched Histories

The above definition of continuity (D35) is unable to stop histories from *temporal pinching*, i.e., exclude histories that disappear and reappear again instantaneously at the same spatial location. With temporal pinching, we have *weird* transitions possible: for example transitions that do not adhere to the conceptual neighbourhood diagrams for binary topological relations such as RCC-8. More about this will be said in Section 4.2.

In order to enforce a stronger notion of s-t continuity for histories, I disallow temporal pinching and introduce the notion of *firm-continuity*. A *non-pinched* continuous s-t history is *firmly continuous*.

<sup>5</sup>Note that Muller uses a slightly different definition of one-piece/connectedness using closures.  $\text{CON}_t w \equiv_{def} \neg \exists x_1, x_2 (w = x_1 + x_2 \wedge \neg (cx_1 \approx cx_2))$  where  $cx$  is defined as the closure of  $x$ . His mereotopological theory follows [Clarke, 1981] in having topological functions and  $Cxy$  interpreted as  $x$  and  $y$  share a point.

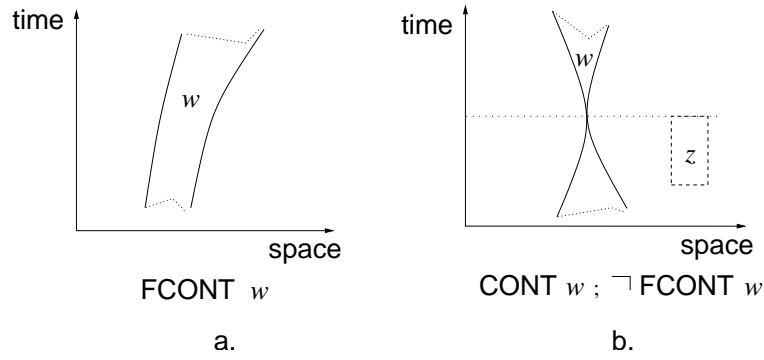

Figure 4.3: **a.** *Firmly-continuous* history and **b.** A *non-firm* history with ‘temporal pinching’ at the end of  $z$ .

Figure 4.3(a) shows a firmly-connected history  $w$ , while Figure 4.3(b) is for a history with temporal pinching. I first make definition D36 to denote *adjacent* temporal slices of a history. For a history  $z$ ,  $\text{ECTS}(x, y, z)$  states  $x$  and  $y$  to be temporally externally connected temporal slices of  $z$ . D37 is the definition of a non-pinched history  $w$  and D38 defines firm-continuity.

$$\text{D36. } \text{ECTS}(x, y, z) \equiv_{\text{def}} [\text{TS}(x, z) \wedge \text{TS}(y, z) \wedge \text{EC}_t(x, y)]$$

$$\text{D37. } \text{NP}w \equiv_{\text{def}} \forall xy[\text{ECTS}(x, y, w) \rightarrow \text{FCON}(x, y)]$$

$$\text{D38. } \text{FCONT}w \equiv_{\text{def}} \text{CONT}w \wedge \text{NP}w$$

### 4.1.3 Strong Firm Continuity

The notion of strong continuity (defined in Section 4.1.1) can now be further refined to exclude temporal pinching and also spatial leaps within a component. The strongest notion of space-time continuity will be  $\text{StrFCONT}$  as given by D39. I term this as *strong firm continuity*.

$$\text{D39. } \text{StrFCONT}y \equiv_{\text{def}} \text{StrCONT}_{\text{st}}y \wedge \text{FCONT}y$$

When considering the spatial relationship over time between pairs of s-t histories, for convenience of reference, the doctrine of strong firm continuity  $\text{StrFCONT}$  will be labelled  $\mathfrak{CS}\text{-0}$ . Allowing temporal pinching weakens  $\mathfrak{CS}\text{-0}$  to  $\mathfrak{CS}\text{-1}$  and  $\mathfrak{CS}\text{-2}$  depending on whether temporal pinching of one or both histories is allowed respectively.

I shall now consider how the above cases of continuity affect the notion of a conceptual neighbourhood diagram (CND). In Section 4.6 I shall examine the case for  $\mathfrak{CS}\text{-0}$  and present a formal proof for the non-existence of transitions i.e., transitions absent from the RCC-8 CND. But first I will take an informal approach and simply present, without proof, the CNDs for these three cases of continuity:  $\mathfrak{CS}\text{-0}$ ,  $\mathfrak{CS}\text{-1}$ ,  $\mathfrak{CS}\text{-2}$ .

## 4.2 Hierarchy of CNDs

With  $\mathcal{CS}$ -0, the intuitive transitions between histories hold. The RCC-8 conceptual neighbourhood is one such transition network. Under space-time interpretations and with temporal pinching, we can have a number of *weird* transitions.

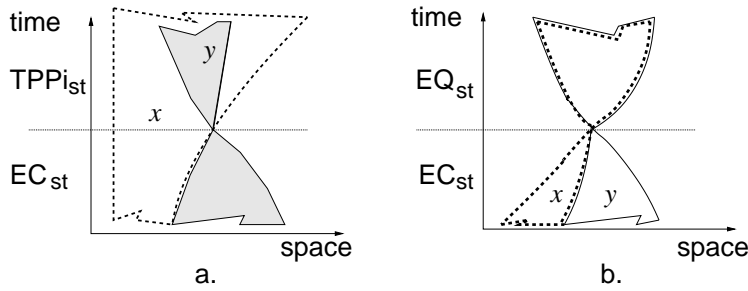

Figure 4.4: Transition under temporal pinching: **a.**  $EC_{st}$  to  $TPPi_{st}$  for temporal pinching of a single history. **b.**  $EC_{st}$  to  $EQ_{st}$  for temporal pinching of both histories.

Figure 4.4(a) shows the transition from  $EC_{st}$  to  $TPP_{st}$  between space-time histories  $x$  and  $y$ , for temporal pinching of  $y$ . In Figure 4.4(b), both histories  $x$  and  $y$  undergo temporal pinching and consequently we have a  $EC_{st}$  to  $EQ_{st}$  transition. These are not valid transitions of the standard RCC-8 conceptual neighbourhood [Cohn *et al.*, 1998] posited under the notion of continuity implicitly assumed there.

The RCC-8 transition networks for  $\mathcal{CS}$ -0,  $\mathcal{CS}$ -1 and  $\mathcal{CS}$ -2 are shown in Figure 4.5. Allowing pinching of a single history means a direct transition between  $EC_{st}$  and  $TPP_{st}$  or  $TPPi_{st}$  is possible. If pinching of both histories is allowed we have a direct transition between  $EC_{st}$  and  $EQ_{st}$ . Note that the diagram for  $\mathcal{CS}$ -2 differs slightly from the conceptual neighbourhood given in Figure 10 of [Davis, 2000] (see Figure 2.7, Chapter 2), for example: his figure has a direct link from DC to TPP. This depends on the interpretation of the spatial relationship holding when regions pinch to a spatio-temporal point. Davis considers the normalised (regularised) spatial cross section and isolated points will thus disappear, leading to the introduction of yet further links. I could have also taken this approach, in which case his Figure 10 and my diagram for  $\mathcal{CS}$ -2 would be identical.

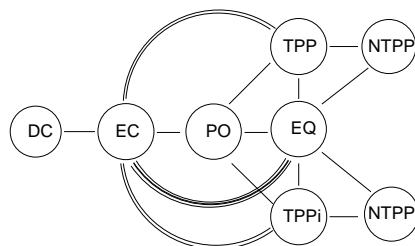

Figure 4.5: Transition graph for  $\mathcal{CS}$ -0,  $\mathcal{CS}$ -1 and  $\mathcal{CS}$ -2. Transitions for  $\mathcal{CS}$ -0 are shown as single arcs; additional links for  $\mathcal{CS}$ -1 are double arcs and for  $\mathcal{CS}$ -2 are triple arcs.



### 4.3 Characterizing Transitions

Before I introduce definitions to characterize transitions of RCC relations in a mereotopological theory of space-time, we need to look at why we need yet another set of definitions!

#### 4.3.1 Continuity and Space-Time Histories

For a single history  $w$  with a spatial leap, proving discontinuity is not difficult. For a continuous history, all temporally connected parts of adjacent temporal slices  $u$  and  $v$  should be spatio-temporally connected (cf. Figure 4.2, Page 58). I have theorem Th48.

$$\text{Th48. } \text{CONT}w \rightarrow \forall u, v[\text{ECTS}(u, v, w) \rightarrow \neg \exists x[\text{P}_{\text{st}}(x, v) \wedge \text{C}_t(x, u) \wedge \neg \text{C}_{\text{st}}(x, u)]]$$

Any history  $w$  having a sideways spatial leap (characterized through change of relation from  $\neg \text{C}_{\text{sp}}$  to  $\text{PP}_{\text{sp}}$  as shown in Figure 4.6) is discontinuous. Proving  $\neg \text{CONT}w$  for such a transition from axioms and definitions above is straightforward (Th49).

$$\text{Th49. } [\text{ECTS}(u, v, w) \wedge \neg \text{C}_{\text{sp}}(u, z) \wedge \text{PP}_{\text{sp}}(v, z)] \rightarrow \neg \text{CONT}w$$

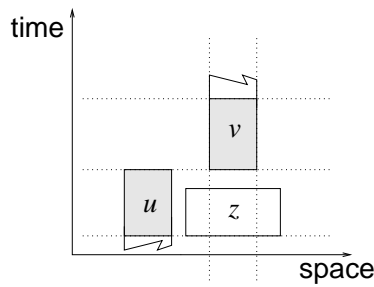

Figure 4.6: A discontinuous history  $w$ . Discontinuity is because of sideways spatial leap, characterised through change of pure spatial relationship.

Note that the second and the third conjuncts in the antecedent of Th49 can be replaced by  $\neg \text{C}_{\text{sp}}(u, v)$  whilst maintaining the truth of the theorem (In fact this weaker form can be easily proved from the theorem as stated.) Through Th49 I want to highlight the fact that proving discontinuity for a single history with a spatial leap *characterised through change in spatial relation with another history  $z$*  is straightforward. As we shall see in subsequent discussion, this is in contrast to proving discontinuity involving a sideways spatial leap for a pair of histories (c.f. Th51 below).  $\neg \text{C}_{\text{sp}}(u, v)$  would only relate adjacent temporal slices of the history  $w$ . Therefore in Th49 I introduce the second history  $z$  and have the second and the third conjuncts in the antecedent of Th49 stated explicitly.

The discontinuity of a history is not necessarily because of a sideways spatial leap. We may have discontinuity involving a temporal gap (which may not involve sideways spatial leap), characterised through a change in spatio-temporal relation as shown in Figure 4.7.

We have the following theorem:

$$\text{Th50. } [\text{ECTS}(x, y, z) \wedge \text{EQ}_t(u, x) \wedge \text{NTPP}_{\text{st}}(v, y)] \rightarrow [\neg\text{CONT}(u+v) \vee \neg\text{CONT}z]$$

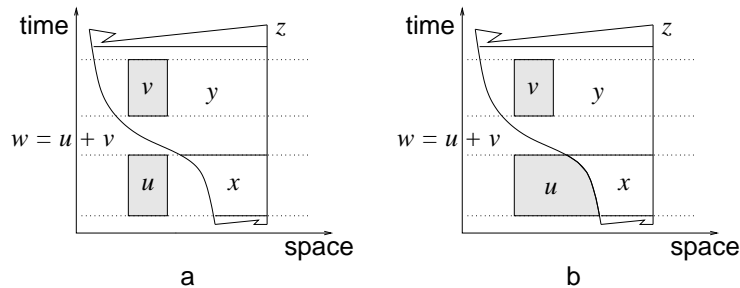

Figure 4.7: A discontinuous history  $w$ . Discontinuity arises because of temporal gap, characterised through change in spatio-temporal relationship. Note that it is immaterial whether **a.**  $u$  and  $x$  remain spatially disconnected,  $\text{DC}_{\text{sp}}$  and **b.**  $u$  and  $x$  are spatially connected,  $\text{C}_{\text{sp}}$ .

In spite of putting in a considerable amount of effort (using OTTER [McCune, 1994] and SPASS [Weidenbach, 2001]), I was not successful in proving discontinuity involving a sideways spatial leap for a pair of histories, nor could a hand proof be obtained. I make the following observations:

- a. continuity  $\text{CONT}w$  as defined by D35 relates only parts of the single history  $w$
- b. entities not part of  $w$  also influence the intuitive notion of continuity (see Section 2.7.2, Chapter 2).

This is particularly true when we are characterizing transitions between two distinct histories. D35 does not allow one to infer that for a temporal slice  $x$  equi-temporal to an external entity  $z$ ,  $\neg\text{C}_{\text{st}}(x, z)$  for a continuous histories  $w$  implies  $\neg\text{C}_{\text{st}}(z, w)$ . This is shown in Figure 4.8(a).

Note that a sideways spatial leap would make it possible for  $w$  to connect to  $z$ . But in that case it would be  $\neg\text{CONT}w$ . Contrast this with Th48 (based on D35) where a relation between temporal and spatial connection is established only for parts of (adjacent temporal slices of) a continuous history. I therefore add the following axiom (cf. Figure 4.8(b)):

$$\text{A20. } [\text{TS}(x, w) \wedge \text{EQ}_t(x, z) \wedge \neg\text{C}_{\text{st}}(x, z) \wedge \text{C}_{\text{st}}(z, w)] \rightarrow \neg\text{CONT}w.$$

For adjacent temporal slices  $y_1$  and  $y_2$  of history  $y$  and adjacent temporal slices  $z_1$  and  $z_2$  of history  $z$ , a transition from  $\neg\text{C}_{\text{st}}(y_1, z_1)$  to  $\text{PP}_{\text{st}}(y_2, z_2)$  involves discontinuity as shown in Figure 4.9. Having added axiom A20, a transition involving spatial leap between co-temporal adjacent slices of a pair of histories  $y$  and  $z$ , is proved discontinuous. I have the following theorem:

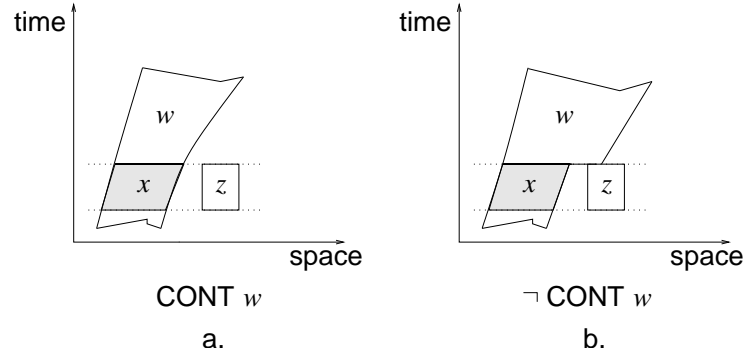

Figure 4.8: Disconnected external entity  $z$ , equi-temporal to a temporal slice  $x$  of space-time history  $w$ : **a.** remains st-disconnected from  $w$  for  $\text{CONT}w$  and **b.** can st-connect to  $w$  only when  $\neg\text{CONT}w$

$$\text{Th51. } [\text{ECTS}(y_1, y_2, y) \wedge \text{ECTS}(z_1, z_2, z) \wedge \text{EQ}_t(y_1, z_1) \wedge \neg\text{C}_{\text{st}}(y_1, z_1) \wedge \text{PP}_{\text{st}}(y_2, z_2)] \rightarrow [\neg\text{CONT}y \vee \neg\text{CONT}z]$$

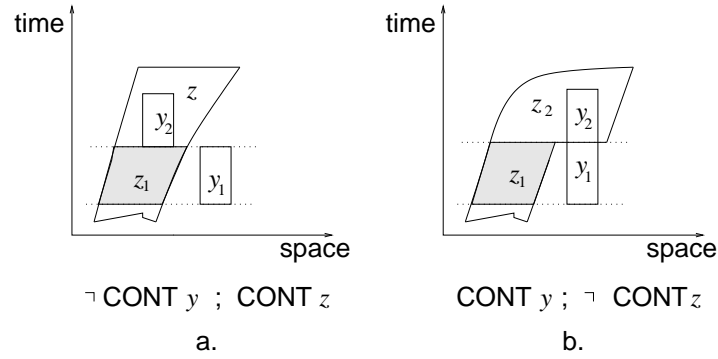

Figure 4.9: Transition between co-temporal adjacent temporal slices of a pair of histories  $y$  and  $z$ , from  $\neg\text{C}_{\text{st}}$  to  $\text{PP}_{\text{st}}$  implies discontinuity. If one is continuous then the other has to be discontinuous. Note that both can be discontinuous and satisfy the transition.

Similarly to theorem Th51, we would expect to have non-transition from  $\text{EC}_{\text{st}}(y_1, z_1)$  to  $\text{PP}_{\text{st}}(y_2, z_2)$  i.e., such a transition would imply discontinuity for one of the histories or both (F4). Such a theorem would not only show that spatial leaps are impossible in this situation, but also that temporal pinching does not occur.

$$\text{F4. } [\text{ECTS}(y_1, y_2, y) \wedge \text{ECTS}(z_1, z_2, z) \wedge \text{EQ}_t(y_1, z_1) \wedge \text{EC}_{\text{st}}(y_1, z_1) \wedge \text{PP}_{\text{st}}(y_2, z_2)] \rightarrow [\neg\text{FCONT}y \vee \neg\text{FCONT}z]$$

The definition of continuity D35, reinforced through additional axiom A20, along with notion of firm-continuity D38, can not yield the desired result. Consider F4. There is a disjunction on the right hand side. It is natural to phrase the required condition in this way. But to simplify our reasoning here, assume that the literal  $\neg\text{FCONT}y$  is moved across to the antecedent (so it becomes  $\text{FCONT}y$ ). If F4 is to be satisfied non trivially (i.e. if the antecedent is not false), then all the conditions in the antecedent must be true.

To illustrate this consider Figure 4.10. First we draw an  $\text{FCONT}_y$  such that  $\text{ECTS}(y_1, y_2, y)$  (case a). Next we make sure that  $\text{PP}_{\text{st}}(y_2, z_2)$  – see case b; note that  $z_2$  does not start earlier than  $y_2$  since  $z_1$  will have to be  $\text{EQ}_t$  with  $y_1$  and  $\text{ECTS}(z_1, z_2, z)$ . We also draw  $z_2$  so that on one side it extends laterally (spatially) beyond  $y_2$  whilst on the other (right hand) side  $y_2$  and  $z_2$  terminate at the same spatial point. This allows us to consider two separate cases below. We now need to draw  $z_1$ .  $z_1$  has to be  $\text{EQ}_t$  with  $y_1$  and  $\text{EC}_{\text{st}}(y_1, z_1)$ . In order for  $\text{EC}_{\text{st}}(y_1, z_1)$  to be true,  $y_1$  and  $z_1$  only need to touch once somewhere along their duration, but I just illustrate the situation where they  $\text{EC}_{\text{st}}$  continuously (analogous figures can be drawn for the other cases). However we try to draw  $z_1, z$  must fail to be  $\text{FCONT}$ , since it will have a sideways leap (case c), or it is temporally pinched to a point (case d). This motivates the introduction of A21 which is satisfied by Figure 4.10(c) and Figure 4.10(d).

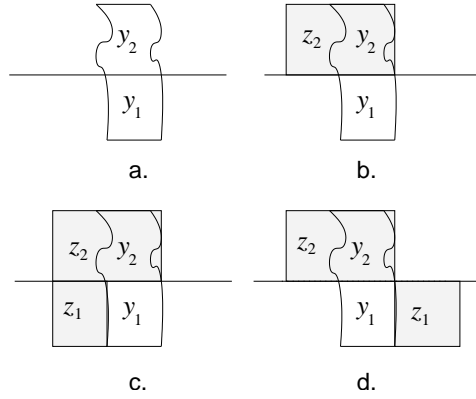

Figure 4.10: Between co-temporal adjacent temporal slices of a pair of histories  $y$  and  $z$ , an  $\text{EC}_{\text{st}}$  to  $\text{PP}_{\text{st}}$  transition involves spatial leap with or without temporal pinching.

$$\mathbf{A21.} \quad [\text{ECTS}(z_1, z_2, z) \wedge \text{EQ}_t(y_1, z_1) \wedge \text{EC}_{\text{st}}(y_1, z_1) \wedge \text{FCON}(y_1, z_2)] \rightarrow \neg \text{CONT}z$$

Continuity definition D35, reinforced with axioms A20 and A21, and the notion of firm continuity, D38, characterize the intuitive notion of spatio-temporal continuity, disallowing spatial leap and temporal pinching. F4 now becomes a theorem:

$$\mathbf{Th52.} \quad [\text{ECTS}(y_1, y_2, y) \wedge \text{ECTS}(z_1, z_2, z) \wedge \text{EQ}_t(y_1, z_1) \wedge \text{EC}_{\text{st}}(y_1, z_1) \wedge \text{PP}_{\text{st}}(y_2, z_2)] \rightarrow [\neg \text{FCONT}y \vee \neg \text{FCONT}z]$$

From D35 and axioms A20 and A21, we have the related theorems of non-transition from  $\text{DC}_{\text{st}}$  to  $\text{EQ}_{\text{st}}$  and  $\text{EC}_{\text{st}}$  to  $\text{EQ}_{\text{st}}$ .

$$\mathbf{Th53.} \quad [\text{ECTS}(y_1, y_2, y) \wedge \text{ECTS}(z_1, z_2, z) \wedge \text{EQ}_t(y_1, z_1) \wedge \text{DC}_{\text{st}}(y_1, z_1) \wedge \text{EQ}_{\text{st}}(y_2, z_2)] \rightarrow [\neg \text{CONT}y \vee \neg \text{CONT}z]$$

$$\mathbf{Th54.} \quad [\text{ECTS}(y_1, y_2, y) \wedge \text{ECTS}(z_1, z_2, z) \wedge \text{EQ}_t(y_1, z_1) \wedge$$

$$EC_{st}(y_1, z_1) \wedge EQ_{st}(y_2, z_2) \rightarrow [\neg FCONT y \vee \neg FCONT z]$$

### 4.3.2 Durative Relations $R_{sp}^=$

Figure 4.11 is representative of when a spatio-temporal relation in an interval (between temporal slices  $y_1$  and  $z_1$ ) is sporadic: here it changes between  $EC_{st}$  and  $DC_{st}$ . However, note that over the complete interval  $z_1$  it remains  $EC_{st}$  and Figure 4.11 illustrates an  $EC_{st}$  to  $PP_{st}$  transition from  $z_1$  to  $z_2$ .

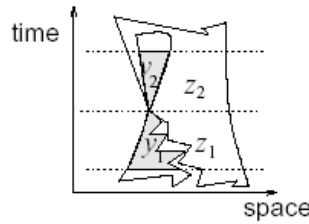

Figure 4.11: Illustration of an  $EC_{st}$  to  $PP_{st}$  transition with sporadic spatio-temporal relation during interval  $z_1$ : here it changes between  $EC_{st}$  and  $DC_{st}$ . However, note that over the complete interval  $z_1$  it remains  $EC_{st}$ .

This is not what we intuitively refer to as change from a given RCC relation to another. I need to have a set of *durative base relations*<sup>6</sup>: spatial relations that hold *continuously* during a given interval. For the conceptual neighbourhood diagram when I refer to change in RCC relation I will then mean change of such a pair of relations.

Even though not a base relation, I will define *durative part*, for in terms of this the base relations will be defined. Defining *durative part* (D40) and *durative disconnection* (D41) is straightforward. A spatio-temporal entity  $x$  is a durative part of  $y$  if they are temporally equivalent and  $x$  is a spatio-temporal part of  $y$  (D40). Similarly, a pair of entities are duratively disconnected if they are temporally equivalent and spatio-temporally disconnected (D41).

$$\mathbf{D40.} \quad P_{sp}^=(x, y) \equiv_{def} EQ_t(x, y) \wedge P_{st}(x, y)$$

$$\mathbf{D41.} \quad DC_{sp}^=(x, y) \equiv_{def} EQ_t(x, y) \wedge DC_{st}(x, y)$$

Next, I define *durative external connection*, in terms of which the remaining durative RCC base relations can be defined. As discussed above w.r.t Figure 4.11, note that the idea of a durative external connection  $EC_{sp}^=(x, y)$  is stronger than being merely equi-temporal and  $EC_{st}(x, y)$ . I define durative external connection (D43) using the notion of *contemporaneous temporal slice pair*: a pair of temporally equivalent temporal slices. I want the RCC relation to be true for all such contemporaneous temporal slice pairs during the

<sup>6</sup>For RCC-8, the transition graph is specified over the set of *base* relations (see Section 2.5.1.2, Page 27).

interval in question. I first define contemporaneous temporal slice pairs  $\text{EQTS}(u, v, x, y)$  (D42).

$$\text{D42. } \text{EQTS}(u, v, x, y) \equiv_{\text{def}} [\text{TS}(u, x) \wedge \text{TS}(v, y) \wedge \text{EQ}_t(u, v)]$$

$$\text{D43. } \text{EC}_{\text{sp}}^{\bar{=}}(x, y) \equiv_{\text{def}} \text{EQ}_t(x, y) \wedge \forall u, v [\text{EQTS}(u, v, x, y) \rightarrow \text{EC}_{\text{st}}(u, v)]$$

It will be useful to define a strong version  $\text{P}_{\text{sp}}^{\bar{=}*}$  of the durative part relation  $\text{P}_{\text{sp}}^{\bar{=}}$ <sup>7</sup>. D57 introduces  $\text{P}_{\text{sp}}^{\bar{=}*}$ .

$$\text{D44. } \text{P}_{\text{sp}}^{\bar{=}*}(x, y) \equiv_{\text{def}} [\text{P}_{\text{sp}}^{\bar{=}}(x, y) \wedge \neg \text{P}_{\text{sp}}^{\bar{=}}(y, x)]$$

In order to define the base relation  $\text{PO}_{\text{sp}}^{\bar{=}}$ , I check that for all subintervals  $z$  during the extent of  $x$  (or equivalently I could check for during the extent of  $y$ )  $\text{PO}_{\text{st}}(\frac{x}{z}, \frac{y}{z})$  holds.

$$\text{D45. } \text{PO}_{\text{sp}}^{\bar{=}}(x, y) \equiv_{\text{def}} \text{EQ}_t(x, y) \wedge \forall z [\text{P}_t(z, x) \rightarrow \text{PO}_{\text{st}}(\frac{x}{z}, \frac{y}{z})]$$

The definitions for  $\text{EQ}_{\text{sp}}^{\bar{=}}$  follow the standard RCC definitions based on  $\text{P}_{\text{sp}}^{\bar{=}}$ . For  $\text{TPP}_{\text{sp}}^{\bar{=}}(x, y)$  I have the standard RCC definition with  $\text{PP}_{\text{st}}$  and  $\text{EC}_{\text{st}}$  replaced with  $\text{P}_{\text{sp}}^{\bar{=}*}$  and  $\text{EC}_{\text{sp}}^{\bar{=}}$  respectively. The definition of  $\text{NTPP}_{\text{sp}}^{\bar{=}}(x, y)$  is different (D48). It is not sufficient to say that  $x$  is a  $\text{P}_{\text{sp}}^{\bar{=}*}$  of  $y$  and there does not exist any entity  $z$ ,  $\text{EC}_{\text{sp}}^{\bar{=}}$  connected to both  $x$  and  $y$ .

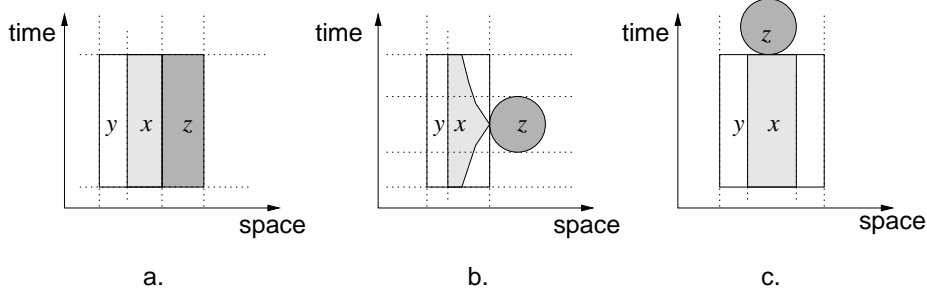

Figure 4.12:  $\text{NTPP}_{\text{sp}}^{\bar{=}}(x, y)$  is different from the standard RCC definitions. **a.**  $\text{TPP}_{\text{sp}}^{\bar{=}}(x, y)$  follows the standard RCC definition with  $\text{PP}_{\text{st}}$  and  $\text{EC}_{\text{st}}$  replaced with  $\text{P}_{\text{sp}}^{\bar{=}*}$  and  $\text{EC}_{\text{sp}}^{\bar{=}}$  respectively. **b.** Existence of any entity  $z$  within the temporal inclusion of  $x$ ,  $\text{EC}_{\text{st}}$  connected to both  $x$  and  $y$  means that not only does  $\text{NTPP}_{\text{sp}}^{\bar{=}}(x, y)$ , not hold, but nor does any other durative relation. **c.** In this case  $\text{NTPP}_{\text{sp}}^{\bar{=}}(x, y)$  does hold: there is no  $z$  within temporal inclusion of  $x$ ,  $\text{EC}_{\text{st}}$  connected to both  $x$  and  $y$  – the existence of a  $z$   $\text{EC}_{\text{st}}$  connected to both  $x$  and  $y$  outside the temporal extent of  $z$  (depicted) does not stop  $\text{NTPP}_{\text{sp}}^{\bar{=}}(x, y)$  from holding.

As shown in Figure 4.12(b), existence of *any* entity (within the temporal inclusion of  $x$ ) spatio-temporally externally connected to both  $x$  and  $y$  would make  $x$  a tangential proper-part of  $y$ . Therefore we replace  $\text{EC}_{\text{sp}}^{\bar{=}}$  with  $\text{EC}_{\text{st}}$ . Note that outside the temporal inclusion of  $x$ , there can exist an entity  $z$  that is externally connected to both  $x$  and  $y$

<sup>7</sup>Note that this predicate is weaker than a definition of  $\text{PP}_{\text{sp}}^{\bar{=}}$  would be, were I to introduce such a relation.

(Figure 4.12(c)).  $P_{sp}^{\bar{=}\ast}$ ,  $TPP_{sp}^{\bar{=}}$  and  $NTPP_{sp}^{\bar{=}}$  represent the inverses for  $P_{sp}^{\bar{=}\ast}$ ,  $TPP_{sp}^{\bar{=}}$  and  $NTPP_{sp}^{\bar{=}}$  respectively.

$$\mathbf{D46.} \quad EQ_{sp}^{\bar{=}}(x, y) \equiv_{def} [P_{sp}^{\bar{=}}(x, y) \wedge P_{sp}^{\bar{=}}(y, x)]$$

$$\mathbf{D47.} \quad TPP_{sp}^{\bar{=}}(x, y) \equiv_{def} [P_{sp}^{\bar{=}\ast}(x, y) \wedge \exists z[EC_{sp}^{\bar{=}}(z, x) \wedge EC_{sp}^{\bar{=}}(z, y)]]$$

$$\mathbf{D48.} \quad NTPP_{sp}^{\bar{=}}(x, y) \equiv_{def} [P_{sp}^{\bar{=}\ast}(x, y) \wedge \neg \exists z[z \subseteq_t x \wedge EC_{st}(z, x) \wedge EC_{st}(z, y)]]$$

As shown in Figure 4.13(a), any entity  $z$ ,  $EC_{sp}^{\bar{=}}$  with a temporal slice  $x$  of a history  $w$ , must be  $EC_{st}$  connected to the history (Th55). In Figure 4.13(b), an entity  $z$  is  $P_{sp}^{\bar{=}\ast}$  with a temporal slice  $x$  of history  $w$ . This implies  $PP_{st}(z, w)$ . We have Th56.

$$\mathbf{Th55.} \quad [EC_{sp}^{\bar{=}}(z, x) \wedge TS(x, w)] \rightarrow EC_{st}(z, w)$$

$$\mathbf{Th56.} \quad [P_{sp}^{\bar{=}\ast}(z, x) \wedge TS(x, w)] \rightarrow PP_{st}(z, w)$$

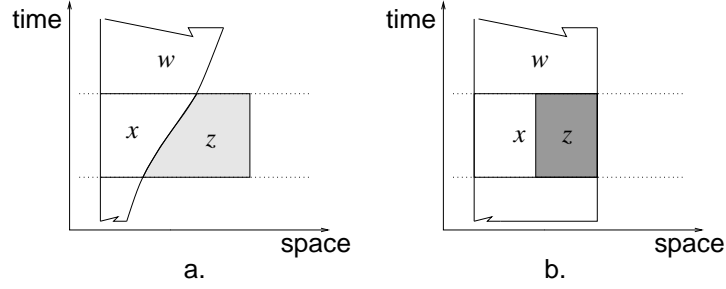

Figure 4.13: For any entity  $z$  **a.**  $EC_{sp}^{\bar{=}}$  connected with temporal slice  $x$  of a history  $w$ , implies  $EC_{st}(z, w)$  and **b.**  $P_{sp}^{\bar{=}\ast}$  of temporal slice  $x$  of a history  $w$ , implies  $PP_{st}(z, w)$ .

Proceeding similarly, one may expect  $DC_{sp}^{\bar{=}}$  to imply  $DC_{st}$ . However, note that F5 is not a theorem (cf. Figure 4.8(b)).

$$\mathbf{F5.} \quad [DC_{sp}^{\bar{=}}(z, x) \wedge TS(x, w)] \rightarrow DC_{st}(z, w)$$

Nevertheless, if history  $w$  is continuous (cf. Figure 4.8(a)) and  $x$  is a temporal slice of  $w$ , any external entity  $z$ ,  $DC_{sp}^{\bar{=}}$  with  $x$ , implies  $DC_{st}(z, w)$ <sup>8</sup>. We have the following theorem:

$$\mathbf{Th57.} \quad [DC_{sp}^{\bar{=}}(z, x) \wedge TS(x, w) \wedge CONTw] \rightarrow DC_{st}(z, w)$$

Note that  $TPP_{sp}^{\bar{=}}$  implies  $TPP_{st}$ , whereas  $NTPP_{sp}^{\bar{=}}$  implies only  $PP_{st}$ . If  $z$  is  $EQ_{sp}^{\bar{=}}$  with temporal slice  $x$ ,  $z$  is a temporal slice of  $w$  (Th60). We have the following theorems:

$$\mathbf{Th58.} \quad [TPP_{sp}^{\bar{=}}(z, x) \wedge TS(x, w)] \rightarrow TPP_{st}(z, w)$$

$$\mathbf{Th59.} \quad [NTPP_{sp}^{\bar{=}}(z, x) \wedge TS(x, w)] \rightarrow PP_{st}(z, w)$$

$$\mathbf{Th60.} \quad [EQ_{sp}^{\bar{=}}(z, x) \wedge TS(x, w)] \rightarrow TS(z, w)$$

<sup>8</sup>Proof for this is possible only with additional axiom A20 to strengthen CONT definition D35.

### 4.3.2.1 Transitions between $R_{sp}^=$ Relations

The transitions characterised by Th61 through Th64 are representative of transitions between durative relations. Th61 establishes the non-existence of a transition from  $DC_{sp}^=$  to  $P_{sp}^=*$  for continuous histories. Th62 is the corresponding theorem for non-existence of transition from  $EC_{sp}^=$  to  $P_{sp}^=*$  for firmly-continuous histories.

$$\text{Th61. } [ECTS(y_1, y_2, y) \wedge ECTS(z_1, z_2, z) \wedge \\ DC_{sp}^=(y_1, z_1) \wedge P_{sp}^*=(y_2, z_2)] \rightarrow [\neg CONT y \vee \neg CONT z]$$

$$\text{Th62. } [ECTS(y_1, y_2, y) \wedge ECTS(z_1, z_2, z) \wedge \\ EC_{sp}^=(y_1, z_1) \wedge P_{sp}^*=(y_2, z_2)] \rightarrow [\neg FCONT y \vee \neg FCONT z]$$

We have theorems for non-transitions from  $DC_{sp}^=$  or  $EC_{sp}^=$  to  $EQ_{sp}^=$ . Th63 establishes the non-existence of a transition from  $DC_{sp}^=$  to  $EQ_{sp}^=$  for continuous histories. Th64 is the corresponding theorem for non-existence of transition from  $EC_{sp}^=$  to  $EQ_{sp}^=$  for firmly-continuous histories.

$$\text{Th63. } [ECTS(y_1, y_2, y) \wedge ECTS(z_1, z_2, z) \wedge \\ DC_{sp}^=(y_1, z_1) \wedge EQ_{sp}^=(y_2, z_2)] \rightarrow [\neg CONT y \vee \neg CONT z]$$

$$\text{Th64. } [ECTS(y_1, y_2, y) \wedge ECTS(z_1, z_2, z) \wedge \\ EC_{sp}^=(y_1, z_1) \wedge EQ_{sp}^=(y_2, z_2)] \rightarrow [\neg FCONT y \vee \neg FCONT z]$$

Muller [1998b] set out theorems with similar interpretations based on notion of space-time continuity captured through D35. As pointed out in Section 2.7.2, Chapter 2, Davis [2001] has shown Muller's statement of the transition rules to be inadequate. It is not only that the transition rules are inadequate, D35 and D38 alone are not sufficient to capture intuitive strong firm continuity. For us, this is demonstrated from the fact that proof of Th61 through Th64 required A20 and A21.

I failed to arrive at proofs (whether machine generated or by hand) for Th61 and Th62 with D35 alone characterizing intuitive s-t continuity. Later, Muller did correct his definitions to forbid temporal pinching [Muller, 1998a; 2002]<sup>9</sup>. Muller terms the ruling out of temporal pinching as *temporal strong connectedness*, and envisaged that such a notion of continuity would eliminate an  $EC_{st}$  to  $PP_{st}$  transition. However, he failed to see the necessity to incorporate a relationship with external entities into the intuitive notion of continuity. Muller [1998a; 1998b; 2002] envisaged his definitions would eliminate the non-transitions, but (in absence of proofs) it is not clear if the definitions achieve that.

<sup>9</sup>Personal communication with Muller, brought to light his correction in [Muller, 2002]. Earlier partial correction to his definition of continuity [Muller, 1998b] was in French [Muller, 1998a].



Davis [2000] provided alternate characterization of transition rules. This is accomplished through defining time instants and spatio-temporal points. Spatial RCC-8 relations are then defined to hold instantaneously at these time points. Continuous transitions are stated in terms of these relations holding at all points in an interval.

It can reasonably be objected to this analysis that, though it observes the letter of the mereotopological enterprise, it violates the spirit, as it achieves its ends by using the very great expressive power of first-order logic over histories to, in effect, define time instants and spatio-temporal points.

[Davis, 2000].

Here I shall state the transition rules i.e., non-existence of transitions for continuous histories between durative base relations - spatial relations that hold continuously over an interval. Arguably, this is a more intuitive mereotopological expression of transition. Axiom A21 covers within pure region-based mereotopology, situations that require defining RCC-8 relations holding at an instantaneous cross-section (for characterizing of transitions) in [Davis, 2000].

However, the above characterization of transition is unable to capture instantaneous relations holding at the temporal boundary of two intervals. Therefore it cannot recover the complete conceptual neighbourhood for RCC-8. We need some mechanism to categorise instantaneous relations within mereotopology. This is the focus of section 4.4.

When defining the transitions between RCC-8 relations and specifying conditions for instantaneous relations, it will be helpful to treat RCC symbols as constant symbols rather than predicates. Thus I define predicates  $rcc_\alpha(\phi, x, y)$ : meaning  $\Phi_\alpha$  holds between s-t regions  $x$  and  $y$  where  $\phi$  is the lowercase translation of the RCC-8 relation  $\Phi$ .

$$\mathbf{D49.} \quad rcc_\alpha(\phi, x, y) \equiv_{def} \Phi_\alpha(x, y)$$

where  $\alpha$  is **st**, **sp**, **t** or  $\overline{\text{sp}}$  corresponding to spatio-temporal, spatial, temporal or durative RCC-8 relation. D49 is a (finite) axiom schema.

## 4.4 A Model for Instantaneous Relations

In this subsection I will analyse and thus axiomatise from first principles which relations can hold instantaneously. This in no way excludes any of the RCC-8 relations from holding over an interval. The analysis only identifies which of the relations can be instantaneous under  $\mathcal{CS}\text{-}0$  and under what mereotopological conditions. The underlying hypothesis for my analysis is that it is sufficient to consider the Boolean combinations of two regions and their FCON relationship over the instantaneous transition: this hypothesis is confirmed

below since it is shown that situations in which relations can be instantaneous is precisely characterised. FCON is chosen as a suitable predicate because the two parts of a pinched history will not FCON.

#### 4.4.1 Instantaneous Transition Matrix

I will determine the existence of an instantaneous topological relation between two histories  $x$  and  $y$  (occurring when two intervals  $z_1$  and  $z_2$  meet), based upon the comparison of  $(x \cup y)$ ,  $(x \cap y)$ ,  $(x - y)$  and  $(y - x)$ , restricted to the intervals  $z_1$  and  $z_2$  respectively. These can be combined such that they form 16 fundamental descriptions:

$$\begin{bmatrix} \psi_{11}(\frac{x \cup y}{z_1}, \frac{x \cup y}{z_2}) & \psi_{12}(\frac{x \cup y}{z_1}, \frac{x \cap y}{z_2}) & \psi_{13}(\frac{x \cup y}{z_1}, \frac{x - y}{z_2}) & \psi_{14}(\frac{x \cup y}{z_1}, \frac{y - x}{z_2}) \\ \psi_{21}(\frac{x \cap y}{z_1}, \frac{x \cup y}{z_2}) & \psi_{22}(\frac{x \cap y}{z_1}, \frac{x \cap y}{z_2}) & \psi_{23}(\frac{x \cap y}{z_1}, \frac{x - y}{z_2}) & \psi_{24}(\frac{x \cap y}{z_1}, \frac{y - x}{z_2}) \\ \psi_{31}(\frac{x - y}{z_1}, \frac{x \cup y}{z_2}) & \psi_{32}(\frac{x - y}{z_1}, \frac{x \cap y}{z_2}) & \psi_{33}(\frac{x - y}{z_1}, \frac{x - y}{z_2}) & \psi_{34}(\frac{x - y}{z_1}, \frac{y - x}{z_2}) \\ \psi_{41}(\frac{y - x}{z_1}, \frac{x \cup y}{z_2}) & \psi_{42}(\frac{y - x}{z_1}, \frac{x \cap y}{z_2}) & \psi_{43}(\frac{y - x}{z_1}, \frac{x - y}{z_2}) & \psi_{44}(\frac{y - x}{z_1}, \frac{y - x}{z_2}) \end{bmatrix}$$

where  $\psi_{ij} \in \{\text{FCON}, \neg\text{FCON}\}$ .

The notion of firm connection between the 16 individual pairs was identified as a simple test that enables the identification of whether an instantaneous relationship occurs. In case of parts of a pair not existing for one of the intervals, the connection is assumed to be  $\neg\text{FCON}$  without any loss in generality of the analysis.

I will call the instantaneous transition matrix  $\mathbb{M}_r(x, y, z_1, z_2)$ , where  $x$  and  $y$  are StrFCONT histories and  $z_1$  and  $z_2$  are adjacent intervals, temporally included in the histories. The subscript,  $r$ , is used to identify the relation holding instantaneously between  $x$  and  $y$  at the boundary of  $z_1$  and  $z_2$ . The entire matrix,  $\mathbb{M}_r$ , is to be regarded as a conjunction of its elements:

$$\text{D50. } \mathbb{M}_r(x, y, z_1, z_2) \equiv_{\text{def}} \bigwedge_{i=1}^4 [\bigwedge_{j=1}^4 \psi_{ij}(\delta_1, \delta_2)]$$

where  $\delta_1$  and  $\delta_2$  is one of  $(x \cup y)$ ,  $(x \cap y)$ ,  $(x - y)$  or  $(y - x)$  restricted to the intervals  $z_1$  and  $z_2$  respectively.

#### 4.4.2 Constraints for Non-Existing Relations

Based on the FCON or  $\neg\text{FCON}$  outcome of each pair,  $2^{16}$  possibilities exist for the instantaneous transition matrix; however only a small number of them are possible. The aim of this section is to make *explicit* the possibilities that are not realizable, thus arriving at the ones that characterize the class of instantaneous relations between two given histories.

For spatio-temporal histories  $x$  and  $y$  with a transition at the boundary between intervals  $z_1$  and  $z_2$ , if  $\frac{x-y}{z_1}$  is FCON to  $\frac{y-x}{z_2}$  (or  $\frac{y-x}{z_1}$  is FCON to  $\frac{x-y}{z_2}$ ), then both  $x$  and  $y$  must

have a sideways spatial leap and hence cannot be StrFCONT. Similarly, if  $\frac{x \cap y}{z_1}$  is FCON to either  $\frac{x-y}{z_2}$  or  $\frac{y-x}{z_2}$  then both  $x$  and  $y$  must have a sideways spatial leap and cannot be StrFCONT<sup>10</sup>. I have Conditions 1 and 2.

**Condition 1** *For StrFCONT histories  $x$  and  $y$ ,  $x - y$  restricted to the interval before a transition can never be FCON to  $y - x$  restricted to the interval after the transition (or vice versa).*

**Condition 2** *For StrFCONT histories  $x$  and  $y$ ,  $x \cap y$  restricted to the interval before a transition can never be FCON to either  $x - y$  or  $y - x$  restricted to the interval after the transition (or vice versa) .*

We have  $x \cup y = (x \cap y) \cup (x - y) \cup (y - x)$ . The following condition is based on this property.

**Condition 3**  *$x \cup y$  restricted to the interval before a transition is FCON to one of  $x \cap y$ ,  $x - y$  or  $y - x$  restricted to the interval after the transition (or vice versa) iff at least (a pair involving) one of  $x \cap y$ ,  $x - y$  and  $y - x$  is FCON.*

Since  $x$  and  $y$  are individually StrFCONT, we have Condition 4 (since otherwise  $x$  and  $y$  would be pinched histories).

**Condition 4** *For StrFCONT histories  $x$  and  $y$ ,  $x \cup y$  restricted to the interval before a transition is FCON to  $x \cup y$  restricted to the interval after the transition.*

If all of  $x \cap y$ ,  $x - y$  and  $y - x$  before the transition are FCON to themselves after the transition, then there is no instantaneous transition at the boundary between  $z_1$  and  $z_2$ . Therefore, for instantaneous transitions, I have Condition 5.

**Condition 5** *For StrFCONT histories  $x$  and  $y$  with an instantaneous transition, at least one of  $x \cap y$ ,  $x - y$  and  $y - x$  restricted to the interval before the transition must be  $\neg$ FCON to themselves restricted to the interval after the transition.*

For StrFCONT histories  $x$  and  $y$  undergoing an instantaneous transition with the intersection disappearing instantaneously,  $x - y$  and  $y - x$  restricted to the interval before the transition must be simultaneously FCON to themselves restricted to the interval after the transition. For these pairs to be  $\neg$ FCON, the histories must pinch to a point at the boundary between the intervals  $z_1$  and  $z_2$  and cannot be StrFCONT. I have Condition 6.

<sup>10</sup>Equally if either  $\frac{x-y}{z_1}$  or  $\frac{y-x}{z_1}$  is FCON to  $\frac{x \cap y}{z_2}$  then both  $x$  and  $y$  must have a sideways spatial leap and cannot be StrFCONT.

**Condition 6** For StrFCONT histories  $x$  and  $y$  with  $x \cap y$  restricted to the interval before the transition being  $\neg$ FCON to  $x \cap y$  restricted to the interval after the transition, both  $x - y$  and  $y - x$  restricted to the interval before the transition need to be simultaneously FCON to themselves restricted to the interval after the transition.

### 4.4.3 Existing Instantaneous Transition Matrices

The valid instantaneous transition matrices can be determined by successively applying the above conditions and cancelling the corresponding non-existing matrices<sup>11</sup>.

Condition 1 and Condition 2 together imply that any matrix must have the form

$$\begin{bmatrix} ? & ? & ? & ? \\ ? & ? & \neg\text{FCON} & \neg\text{FCON} \\ ? & \neg\text{FCON} & ? & \neg\text{FCON} \\ ? & \neg\text{FCON} & \neg\text{FCON} & ? \end{bmatrix}$$

Condition 3 implies that the first row (resp. column) is the Boolean sum of the remaining rows (resp. columns). We can ignore the first row and the column as being determined by the rest of the matrix. Therefore, there are three positions<sup>12</sup> which remain undetermined after Conditions 1 through 4. Each of these can be FCON or  $\neg$ FCON. There are  $2^3$  possible combinations i.e., 8 matrices.

Condition 3 together with Condition 4 eliminates the case where all of the three relations  $\psi_{22}, \psi_{33}$  and  $\psi_{44}$  are simultaneously  $\neg$ FCON. Condition 5 eliminates the case where all of the three  $\psi_{22}, \psi_{33}$  and  $\psi_{44}$  are simultaneously FCON. Condition 6 eliminates two cases: for  $\psi_{22}$  being  $\neg$ FCON one of either  $\psi_{33}$  or  $\psi_{44}$  is FCON but not both.

Four matrices remain for two StrFCONT histories in transition through an instantaneous relationship. Each matrix corresponds to a unique instantaneous relation. The geometric interpretation displayed in Figure 4.14 demonstrates this visually.

**Proposition 1** *The only possible transition matrices for relations which hold instantaneously between two StrFCONT histories correspond to  $\text{EQ}_{\text{st}}, \text{EC}_{\text{st}}, \text{TPP}_{\text{st}}$  and  $\text{TPPi}_{\text{st}}$ <sup>13</sup>.*

<sup>11</sup>Relations that can take either of the two values will be marked by a *wild card* (?).

<sup>12</sup>Corresponding to the elements (except  $\psi_{11}$ ) of the leading diagonal.

<sup>13</sup>Galton's *theory of dominance* [Galton, 1995] exploits the continuity of the underlying semantic space and allows one to infer which relations dominate other relations:  $R_1$  dominates  $R_2$  if  $R_2$  can hold over an interval followed or preceded by  $R_1$  holding instantaneously. From the theory of dominance, the above four relations are the only relations that hold instantaneously in RCC-8 (c.f. Section 5.1.2, Page 92).

The corresponding possible values for  $\mathbb{M}_r(x, y, z_1, z_2)$  are:

$$\begin{aligned} \mathbb{M}_{\text{eq}}(x, y, z_1, z_2) &= \begin{bmatrix} \text{FCON} & \text{FCON} & - & - \\ \text{FCON} & \text{FCON} & - & - \\ - & - & - & - \\ - & - & - & - \end{bmatrix} \\ \mathbb{M}_{\text{ec}}(x, y, z_1, z_2) &= \begin{bmatrix} \text{FCON} & - & \text{FCON} & \text{FCON} \\ - & - & - & - \\ \text{FCON} & - & \text{FCON} & - \\ \text{FCON} & - & - & \text{FCON} \end{bmatrix} \\ \mathbb{M}_{\text{tpp}}(x, y, z_1, z_2) &= \begin{bmatrix} \text{FCON} & \text{FCON} & - & \text{FCON} \\ \text{FCON} & \text{FCON} & - & - \\ - & - & - & - \\ \text{FCON} & - & - & \text{FCON} \end{bmatrix} \\ \mathbb{M}_{\text{tppi}}(x, y, z_1, z_2) &= \begin{bmatrix} \text{FCON} & \text{FCON} & \text{FCON} & - \\ \text{FCON} & \text{FCON} & - & - \\ \text{FCON} & - & \text{FCON} & - \\ - & - & - & - \end{bmatrix} \end{aligned}$$

where  $- = \neg\text{FCON}$

Figure 4.14 shows the relations that can hold instantaneously between two histories  $x$  and  $y$  corresponding to the four sub-cases of Proposition 1.

I introduce a predicate  $\text{IM}(r, x, y, z_1, z_2)$ , to denote spatio-temporal RCC-8 relation  $r$  holding between **StrFCONT** histories  $\frac{x}{(z_1 \cup z_2)}$  and  $\frac{y}{(z_1 \cup z_2)}$ . In conjunction with Proposition 1, I add axiom A22 to characterize  $\text{IM}(r, x, y, z_1, z_2)$  which effectively amounts to a definition of  $\text{IM}(r, x, y, z_1, z_2)$  under the condition that the histories are **StrFCONT**.

$$\begin{aligned} \mathbf{A22.} \quad & [\text{StrFCONT}(\frac{x}{(z_1 \cup z_2)}) \wedge \text{StrFCONT}(\frac{y}{(z_1 \cup z_2)})] \rightarrow \\ \text{IM}(r, x, y, z_1, z_2) & \leftrightarrow \begin{bmatrix} [ (r = \text{eq}) \quad \wedge \quad \mathbb{M}_{\text{eq}}(x, y, z_1, z_2) ] \quad \vee \\ [ (r = \text{ec}) \quad \wedge \quad \mathbb{M}_{\text{ec}}(x, y, z_1, z_2) ] \quad \vee \\ [ (r = \text{tpp}) \quad \wedge \quad \mathbb{M}_{\text{tpp}}(x, y, z_1, z_2) ] \quad \vee \\ [ (r = \text{tppi}) \quad \wedge \quad \mathbb{M}_{\text{tppi}}(x, y, z_1, z_2) ] \end{bmatrix} \end{aligned}$$

where  $\mathbb{M}_r(x, y, z_1, z_2)$  with  $r \in \{\text{eq}, \text{ec}, \text{tpp}, \text{tppi}\}$  is as per D50 with corresponding values as per Proposition 1.

It might be wondered why it takes a matrix involving 16 conditions over eight parts of  $x$  and  $y$  to identify the instantaneous relations and the conditions under which they can hold. It might turn out that it is in fact possible to characterise the conditions using a smaller set of conditions (and indeed Condition 3 tells us that it is certainly

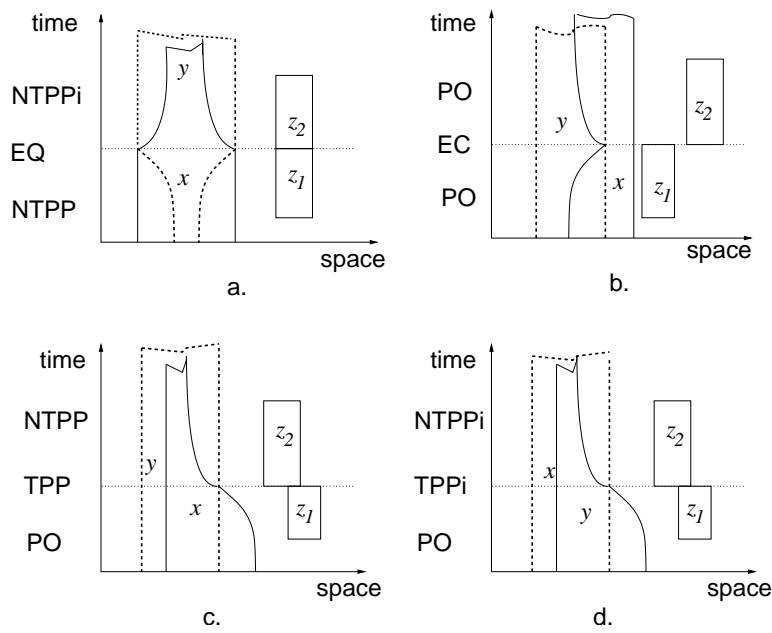

Figure 4.14: Instantaneous relations possible between StrFCONT histories  $x$  and  $y$ . In each case,  $x$  is bounded by a dotted line, and  $y$  by a solid line.

possible to ignore the conditions in the first row and column). However my intention was not to prejudge the final outcome, but rather to exhaustively analyse the relationships between the various parts of  $x$  and  $y$  without any preconception as to which relations could in fact be instantaneous and ‘discover’ the set analytically from the complete space of possible matrices. By conducting the analysis in this way we can have confidence that we have not missed a condition (an ad hoc style of analysis might easily identify a sufficient condition but might not identify all necessary conditions). This analysis is rather in the style of the 4- and 9-intersection model of Egenhofer [Egenhofer and Franzosa, 1991; Egenhofer and Herring, 1994; Egenhofer and Franzosa, 1995] (see Section 2.4.5, Chapter 2) where from a  $2 \times 2$  and  $3 \times 3$  matrix which determine whether various topological parts of two regions share points or not, then by imposing a variety of conditions (such as regularity or one pieceness), the  $2^4$  or  $2^9$  possibilities are whittled down to just eight possibilities (corresponding to the RCC-8 relations).

#### 4.4.4 Shared Boundary at Instantaneous Transition

In order to facilitate categorisation of the type of relation holding instantaneously at the temporal boundary, I introduce the notion of a shared boundary element for entities on the same side of the temporal boundary (about which an instantaneous transition occurs). A shared boundary element is denoted as  $SBE(w, x, y)$ :  $w$  is a shared boundary element of  $x$  and  $y$ . As in Figure 4.15(a), two regions  $x_1$  and  $y_1$  have a shared boundary element  $w$

iff  $w$  is equal to the intersection of  $x_1$  and  $y_1$  and there exists a one-piece region  $z$ , which is  $EC_t$  and firmly connected to  $w$ . I have the following definition:

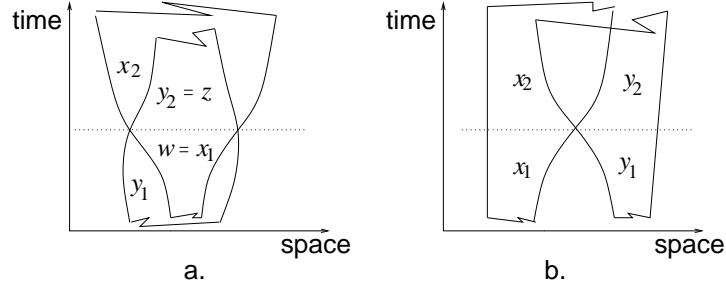

Figure 4.15: Shared boundary at an instantaneous transition. **a.**  $SBE(w, x_1, y_1)$  i.e.,  $w$  is the part of  $x_1$  and  $y_1$  with the shared boundary. For  $FCONT$  histories this forces  $\exists z SBE(z, x_2, y_2)$ . **b.** Note that for instantaneous transition there may not be a shared boundary element at all. For  $EC_{st}$  holding instantaneously we have  $\neg \exists w SBE(w, x_1, y_1)$ .

$$\mathbf{D51.} \quad SBE(w, x, y) \equiv_{def} \exists z [(w = x \cap y) \wedge EC_t(x, z) \wedge EC_t(y, z) \wedge EC_t(w, z) \wedge CONz \wedge FCON(w, z)]$$

A shared boundary element is symmetric about  $x$  and  $y$ . Further,  $(x - y)$  and also  $(y - x)$  cannot be a SBE of  $x$  and  $y$ . We have the following theorems:

$$\mathbf{Th65.} \quad SBE(z, x, y) \leftrightarrow SBE(z, y, x)$$

$$\mathbf{Th66.} \quad \neg SBE(x - y, x, y)$$

$$\mathbf{Th67.} \quad \neg SBE(y - x, x, y)$$

Figure 4.15(a) illustrates a transition with  $EQ_{st}$  holding instantaneously. Firm continuous histories involved in an instantaneous transition that have a shared boundary element  $w$  on one side in fact have shared boundary elements on both sides of the instantaneous boundary (as illustrated by Th68 and Th69) (also see Figure 4.16).

$$\mathbf{Th68.} \quad [[FCONTx \wedge FCONTy \wedge ECTS(x_1, x_2, x) \wedge ECTS(y_1, y_2, y) \wedge P_{sp}^{\equiv *}(x_1, y_1) \wedge P_{sp}^{\equiv *}(y_2, x_2)] \rightarrow [SBE(x_1, x_1, y_1) \wedge SBE(y_2, x_2, y_2)]]$$

$$\mathbf{Th69.} \quad [[FCONTx \wedge FCONTy \wedge ECTS(x_1, x_2, x) \wedge ECTS(y_1, y_2, y) \wedge PO_{sp}^{\equiv}(x_1, y_1) \wedge P_{sp}^{\equiv *}(x_2, y_2)] \rightarrow [SBE(x_1 \cap y_1, x_1, y_1) \wedge SBE(x_2, x_2, y_2)]]$$

As shown in Figure 4.15(b), an instantaneous transition without an SBE for the  $FCONT$  histories is possible. For instantaneous  $EC_{st}$ , no SBE exist on both sides of the instantaneous boundary. We have theorem Th70.

$$\mathbf{Th70.} \quad [[FCONTx \wedge FCONTy \wedge ECTS(x_1, x_2, x) \wedge ECTS(y_1, y_2, y) \wedge DR_{st}(x_1, y_1) \wedge PO_{sp}^{\equiv}(x_2, y_2)] \rightarrow \neg \exists z_1, z_2 [SBE(z_1, x_1, y_1) \wedge SBE(z_2, x_2, y_2) \wedge FCON(z_2, x_1)]]$$

The above theorems and the following properties for SBE and FCONT histories will be used in subsequent proofs for identification of instantaneous transitions. For FCONT histories in transition, shared boundary elements on either side of the transition boundary are firmly connected. We have theorem Th71. Parts of histories that do not comprise a shared boundary element are not firmly connected to a shared boundary element on the other side of the transition boundary (Th72).

$$\text{Th71. } [[\text{FCONT}x \wedge \text{FCONT}y \wedge \text{ECTS}(x_1, x_2, x) \wedge \text{ECTS}(y_1, y_2, y) \wedge \\ \text{EC}_t(w, x_2) \wedge \text{FCON}(w, x_2) \wedge \text{EC}_t(z, x_1) \wedge \text{FCON}(z, x_1) \wedge \\ \text{SBE}(w, x_1, y_1) \wedge \text{SBE}(z, x_2, y_2)] \rightarrow \text{FCON}(z, w)]$$

$$\text{Th72. } [[\text{FCONT}x \wedge \text{FCONT}y \wedge \text{ECTS}(x_1, x_2, x) \wedge \text{ECTS}(y_1, y_2, y) \wedge \\ \text{EC}_t(w, x_2) \wedge \text{FCON}(w, x_2) \wedge \text{EC}_t(z, x_1) \wedge \\ \text{SBE}(w, x_1, y_1) \wedge \neg \text{SBE}(z, x_2, y_2)] \rightarrow \neg \text{FCON}(z, w)]$$

A transition from  $\text{DR}_{\text{st}}$  to  $\text{PO}_{\text{sp}}^=$  for FCONT histories would satisfy the instantaneous matrix  $\mathbb{M}_{\text{ec}}$  (Th73). Theorem Th74 is for a transition from  $\text{P}_{\text{sp}}^=*$  to  $\text{Pi}_{\text{sp}}^=*$  for FCONT histories in which case it satisfies the  $\mathbb{M}_{\text{eq}}$  matrix.

$$\text{Th73. } [[\text{DR}_{\text{st}}(\frac{x}{z_1}, \frac{y}{z_1}) \wedge \text{PO}_{\text{sp}}^=(\frac{x}{z_2}, \frac{y}{z_2}) \wedge \text{ECTS}(\frac{x}{z_1}, \frac{x}{z_2}, \frac{x}{z_1 \cup z_2}) \wedge \\ \text{ECTS}(\frac{y}{z_1}, \frac{y}{z_2}, \frac{y}{z_1 \cup z_2}) \wedge \text{FCONT}(\frac{x}{z_1 \cup z_2}) \wedge \text{FCONT}(\frac{y}{z_1 \cup z_2})] \rightarrow \mathbb{M}_{\text{ec}}(x, y, z_1, z_2)]$$

$$\text{Th74. } [[\text{P}_{\text{sp}}^=(\frac{x}{z_1}, \frac{y}{z_1}) \wedge \text{P}_{\text{sp}}^=(\frac{y}{z_2}, \frac{x}{z_2}) \wedge \text{ECTS}(\frac{x}{z_1}, \frac{x}{z_2}, \frac{x}{z_1 \cup z_2}) \wedge \\ \text{ECTS}(\frac{y}{z_1}, \frac{y}{z_2}, \frac{y}{z_1 \cup z_2}) \wedge \text{FCONT}(\frac{x}{z_1 \cup z_2}) \wedge \text{FCONT}(\frac{y}{z_1 \cup z_2})] \rightarrow \mathbb{M}_{\text{eq}}(x, y, z_1, z_2)]$$

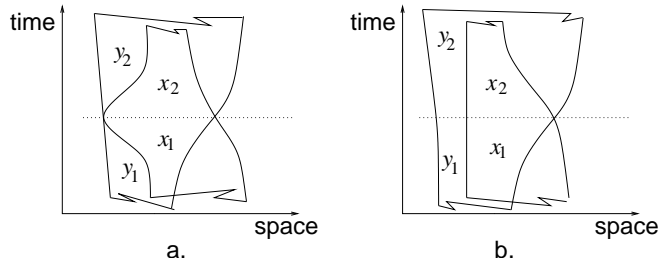

Figure 4.16:  $\text{PO}_{\text{sp}}^=$  to  $\text{NTPP}_{\text{sp}}^=$  transition for FCONT histories have the possibility of either of two distinct instantaneous relations holding. **a.**  $\text{PO}_{\text{sp}}^=$  to  $\text{NTPP}_{\text{sp}}^=$  with  $\text{EQ}_{\text{st}}$  holding instantaneously. **b.**  $\text{PO}_{\text{sp}}^=$  to  $\text{NTPP}_{\text{sp}}^=$  with  $\text{TPP}_{\text{st}}$  holding instantaneously.

A transition from  $\text{PO}_{\text{sp}}^=$  to  $\text{NTPP}_{\text{sp}}^=$  or  $\text{PO}_{\text{sp}}^=$  to  $\text{NTPPi}_{\text{sp}}^=$  is different in that either of a pair of instantaneous matrices is true. For  $\text{PO}_{\text{sp}}^=$  to  $\text{NTPP}_{\text{sp}}^=$ , either of the matrices  $\mathbb{M}_{\text{eq}}$  or  $\mathbb{M}_{\text{tpp}}$  is satisfied for FCONT histories.

For  $\text{PO}_{\text{sp}}^=$  to  $\text{NTPP}_{\text{sp}}^=$  transition with either  $\text{EQ}_{\text{st}}$  or  $\text{TPP}_{\text{st}}$  holding instantaneously, we have theorem Th75. Similarly for  $\text{PO}_{\text{sp}}^=$  to  $\text{NTPPi}_{\text{sp}}^=$ , either of  $\mathbb{M}_{\text{eq}}$  or  $\mathbb{M}_{\text{tppi}}$  holds (Th76).

$$\text{Th75. } [[\text{PO}_{\text{sp}}^=(\frac{x}{z_1}, \frac{y}{z_1}) \wedge \text{NTPP}_{\text{sp}}^=(\frac{x}{z_2}, \frac{y}{z_2}) \wedge \text{ECTS}(\frac{x}{z_1}, \frac{x}{z_2}, \frac{x}{z_1 \cup z_2}) \wedge$$



$$\begin{aligned}
 & \text{ECTS}\left(\frac{y}{z_1}, \frac{y}{z_2}, \frac{y}{z_1 \cup z_2}\right) \wedge \text{FCONT}\left(\frac{x}{z_1 \cup z_2}\right) \wedge \\
 & \text{FCONT}\left(\frac{y}{z_1 \cup z_2}\right) \rightarrow [\mathbb{M}_{\text{eq}}(x, y, z_1, z_2) \vee \mathbb{M}_{\text{tpp}}(x, y, z_1, z_2)] \\
 \text{Th76. } & [[\text{PO}_{\text{sp}}^{\overline{=}}\left(\frac{x}{z_1}, \frac{y}{z_1}\right) \wedge \text{NTPPi}_{\text{sp}}^{\overline{=}}\left(\frac{y}{z_2}, \frac{x}{z_2}\right) \wedge \text{ECTS}\left(\frac{x}{z_1}, \frac{x}{z_2}, \frac{x}{z_1 \cup z_2}\right) \wedge \\
 & \text{ECTS}\left(\frac{y}{z_1}, \frac{y}{z_2}, \frac{y}{z_1 \cup z_2}\right) \wedge \text{FCONT}\left(\frac{x}{z_1 \cup z_2}\right) \wedge \\
 & \text{FCONT}\left(\frac{y}{z_1 \cup z_2}\right)] \rightarrow [\mathbb{M}_{\text{eq}}(x, y, z_1, z_2) \vee \mathbb{M}_{\text{tppi}}(y, x, z_1, z_2)]
 \end{aligned}$$

## 4.5 Elementary Transitions

### 4.5.1 Transition Operators

I define two operators to capture the notion of elementary transition. Three distinct transition operators – two durative and one instantaneous, were defined in [Cohn and Hazarika, 2001a]. The durative operators, called *TransTo* and *TransFrom*, assumed that the initial and/or the final relations hold over intervals and differ as to which of the two relations hold at the dividing instant. The direction of change was established by incorporating  $\bowtie_t$  into the definition. RCC-8 transitions need not be directed in time, as for any transition forward in time, there is a dual one going backward. Therefore here the temporal relation  $\bowtie_t$  is replaced by temporal external connection,  $\text{EC}_t$ .

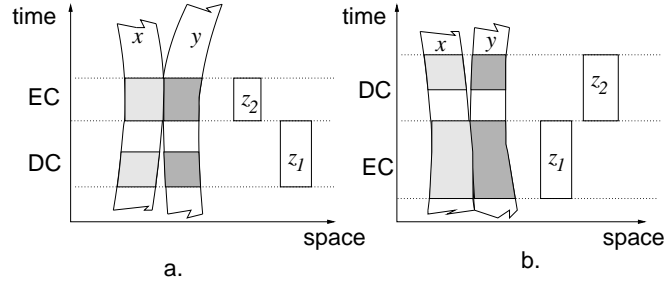

Figure 4.17: Durative transition operators **a.** *TransTo* and **b.** *TransFrom*. The pair collapses to a single operator *Trans* for histories  $x$  and  $y$  on  $x_1 \bowtie_t x_2$  being replaced by  $\text{EC}_t(z_1, z_2)$ .

Figure 4.17 shows *TransTo* and *TransFrom* at the end of interval  $z_1$ . The operators collapse to a single one with replacement of  $z_1 \bowtie_t z_2$  by  $\text{EC}_t(z_1, z_2)$ . I call this durative undirected transition operator, *Trans*. The other operator, *InsRel*, is for histories undergoing a transition involving an instantaneous relation. The instantaneous relation holds at the temporal boundary between  $z_1$  and  $z_2$  characterised through the instantaneous transition matrix.

I will first define the durative transition operator *Trans* and thereafter the instantaneous operator *InsRel*. Note that in the definitions below, the final two arguments to the durative relation  $\text{rcc}_{\text{sp}}^{\overline{=}}$ , amount to just testing the spatial topology without sporadic changes at the

specified time.

#### 4.5.1.1 Trans

A transition for two histories  $x$  and  $y$  from relation  $r_1$  to relation  $r_2$  occurs just in case  $z_1$  and  $z_2$  are externally temporally connected and  $r_1$  holds over contemporaneous temporal slices of every NECP part of the histories restricted to  $z_1$  with respect to  $z_2$ . Relation  $r_2$  holds over contemporaneous temporal slices of every NECP part of the histories restricted to  $z_2$  with respect to  $z_1$ .

$$\begin{aligned} \mathbf{D52.} \quad \text{Trans}(r_1, r_2, x, y, z_1, z_2) \equiv_{def} & [\text{EC}_t(z_1, z_2) \wedge (z_1 \cup z_2) \subseteq_t x \wedge (z_1 \cup z_2) \subseteq_t y \wedge \\ & \forall u, v [ [\text{NECP}(u, \frac{x}{z_1}, z_2) \wedge \text{NECP}(v, \frac{y}{z_1}, z_2) \wedge \text{EQTS}(u, v, \frac{x}{z_1}, \frac{y}{z_1}) ] \rightarrow \text{rcc}_{\text{sp}}^{\overline{=}}(r_1, u, v) ] \wedge \\ & \forall u, v [ [\text{NECP}(u, \frac{x}{z_2}, z_1) \wedge \text{NECP}(v, \frac{y}{z_2}, z_1) \wedge \text{EQTS}(u, v, \frac{x}{z_2}, \frac{y}{z_2}) ] \rightarrow \text{rcc}_{\text{sp}}^{\overline{=}}(r_2, u, v) ] \wedge \\ & \neg(r_1 = r_2) ] \end{aligned}$$

Note that in a standard topological interpretation of mereotopology such as [Asher and Vieu, 1995], this would amount to  $r_1$  and  $r_2$  holding over the interior of  $z_1$  and  $z_2$  respectively.

#### 4.5.1.2 InsRel

Any transition for two histories  $x$  and  $y$  with an instantaneous relation  $r$  holding in between  $z_1$  and  $z_2$  is related by  $\text{IM}(r, x, y, z_1, z_2)$ .

$$\begin{aligned} \mathbf{D53.} \quad \text{InsRel}(r, x, y, z_1, z_2) \equiv_{def} & [\text{EC}_t(z_1, z_2) \wedge (z_1 \cup z_2) \subseteq_t x \wedge \\ & (z_1 \cup z_2) \subseteq_t y \wedge \text{IM}(r, x, y, z_1, z_2) ] \end{aligned}$$

For each instantaneous relation holding between  $z_1$  and  $z_2$ , distinct RCC-8 relations hold before and after it. I introduce the predicate  $\text{InsRel3}$  relating the three relations:

$$\begin{aligned} \mathbf{D54.} \quad \text{InsRel3}(r_1, r_2, r_3, x, y, z_1, z_2) \equiv_{def} & [\text{InsRel}(r_2, x, y, z_1, z_2) \wedge \\ & \forall u, v [ [\text{NECP}(u, \frac{x}{z_1}, z_2) \wedge \text{NECP}(v, \frac{y}{z_1}, z_2) \wedge \text{EQTS}(u, v, \frac{x}{z_1}, \frac{y}{z_1}) ] \rightarrow \text{rcc}_{\text{sp}}^{\overline{=}}(r_1, u, v) ] \wedge \\ & \forall u, v [ [\text{NECP}(u, \frac{x}{z_2}, z_1) \wedge \text{NECP}(v, \frac{y}{z_2}, z_1) \wedge \text{EQTS}(u, v, \frac{x}{z_2}, \frac{y}{z_2}) ] \rightarrow \text{rcc}_{\text{sp}}^{\overline{=}}(r_3, u, v) ] \wedge \\ & \neg(r_1 = r_2) \wedge \neg(r_3 = r_2) ] \end{aligned}$$

### 4.5.2 Transitions and Continuity

#### 4.5.2.1 EleTran

I can now define an *elementary transition*. An elementary transition from an interval  $z_1$  to an adjacent interval  $z_2$  is defined as being a  $\text{Trans}$  or an  $\text{InsRel3}$ ;  $r_1$  is the relation that holds at the start of the transition,  $r_3$  is the relation that holds at the end of the transition,

and  $r_2$  is the relation that either holds instantaneously between  $z_1$  and  $z_2$  or which may be the same as either  $r_1$  or  $r_3$ :

$$\mathbf{D55.} \quad \text{EleTran}(r_1, r_2, r_3, x, y, z_1, z_2) \equiv_{def} [[\text{Trans}(r_1, r_3, x, y, z_1, z_2) \wedge (r_2 = r_3)] \vee [\text{Trans}(r_1, r_3, x, y, z_1, z_2) \wedge (r_2 = r_1)] \vee \text{InsRel3}(r_1, r_2, r_3, x, y, z_1, z_2)]$$

Transitions need to be continuous; therefore I add axiom A23 which states that for any Trans to be followed by another Trans, the intermediate state must be identical.

$$\mathbf{A23.} \quad [\text{Trans}(r_1, r_2, x, y, z_1, z_2) \wedge \text{Trans}(r_3, r_4, x, y, z_2, z_3)] \rightarrow [r_2 = r_3]$$

## 4.6 Conceptual Neighbourhood Diagram under StrFCONT

### 4.6.1 DirTran

I use the above formulation to recover the RCC-8 conceptual neighbourhood diagram under strong firm continuity (i.e., for StrFCONT histories). Here I want to show that the links not in the conceptual neighbourhood diagram (Figure 2.6, Chapter 2) represent inconsistent transitions by showing such transitions result in one or both of the histories being  $\neg$ StrFCONT. For this I define a direct transition DirTran as follows:

$$\mathbf{D56.} \quad \text{DirTran}(r_1, r_2, x, y, z_1, z_2) \equiv_{def} [\exists r[\text{EleTran}(r_1, r_2, r, x, y, z_1, z_2) \vee \text{EleTran}(r, r_1, r_2, x, y, z_1, z_2)] \wedge \neg \exists r[\text{EleTran}(r_1, r, r_2, x, y, z_1, z_2) \wedge \neg(r = r_1) \wedge \neg(r = r_2)]]$$

### 4.6.2 Why is NECP adequate?

The transition operators are defined in terms of contemporaneous temporal slices which are NECPs, whereas as seen in Section 4.3.1 discontinuity is based on transition between adjacent temporal slices of a pair of histories. Why is it that NECP is adequate? This is made clear in the following discussion.

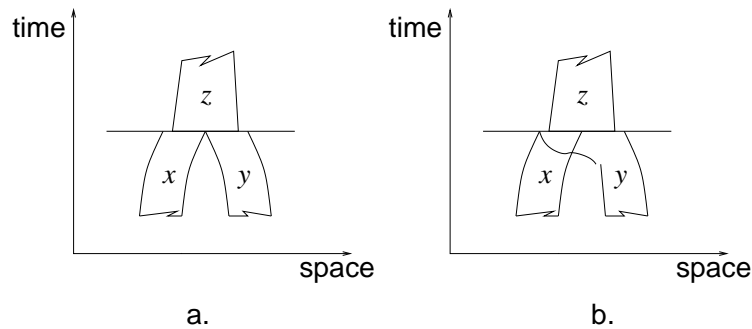

Figure 4.18: RCC-8 relation resulting from how NECPs are connected. **a.** Disconnected over all NECPs implies histories  $x$  and  $y$  are disjoint. **b.** Existence of NECPs that overlap implies histories  $x$  and  $y$  overlap.

As shown in Figure 4.18(a), when disconnected over all NECPs, two histories are disjoint<sup>14</sup>. We have theorem Th77. Note that from mereotopology, two histories  $x$  and  $y$  that have no parts that overlap (here these parts are stated to be not NECPs), do not overlap (Th78). For histories that overlap as shown in Figure 4.18(b), there exists an NECP that is part of the overlapping parts: we have theorem Th79.

$$\text{Th77. } [\text{EC}_t(x, z) \wedge \text{EC}_t(y, z) \wedge \forall u, v[[\text{NECP}(u, x, z) \wedge \text{NECP}(v, y, z)] \rightarrow \neg \text{C}_{\text{st}}(u, v)]] \rightarrow [\neg \text{C}_{\text{st}}(x, y) \vee \text{EC}_{\text{st}}(x, y)]$$

$$\text{Th78. } [\text{EC}_t(x, z) \wedge \text{EC}_t(y, z) \wedge \forall u, v[[\text{P}_{\text{st}}(u, x) \wedge \neg \text{NECP}(u, x, z) \wedge \text{P}_{\text{st}}(v, y) \wedge \neg \text{NECP}(v, y, z)] \rightarrow \neg \text{O}_{\text{st}}(u, v)]] \rightarrow \neg \text{O}_{\text{st}}(x, y)$$

$$\text{Th79. } [\text{EC}_t(x, z) \wedge \text{EC}_t(y, z) \wedge [\text{P}_{\text{st}}(u, x) \wedge \text{P}_{\text{st}}(u, y) \wedge \text{EC}_t(u, z)]] \rightarrow \exists w[\text{P}_{\text{st}}(w, u) \wedge \text{NECP}(w, x, z) \wedge \text{NECP}(w, y, z)]$$

If for two histories  $x$  and  $y$ , externally temporally connected to a third history  $z$ , all NECPs do not overlap,  $x$  and  $y$  do not overlap. We have the following theorem:

$$\text{Th80. } [[\text{EC}_t(x, z) \wedge \text{EC}_t(y, z) \wedge \forall u, v[[\text{NECP}(u, x, z) \wedge \text{NECP}(v, y, z)] \rightarrow \neg \text{O}_{\text{st}}(u, v)]] \rightarrow \neg \text{O}_{\text{st}}(x, y)]$$

Transitions for the RCC-8 conceptual neighbourhood are stated using DirTran which is defined in terms of EleTran. An EleTran is either a Trans or an InsRel3 and thus involves durative RCC-8 relations. Durative relations between two space-time histories involve a relationship between temporally equivalent temporal slices from each history. In Section 4.6.2.1, I look at what relation holds over histories for where a durative base relation holds over all NECPs which are EQTS. In Section 4.6.2.2, I shall ascertain how histories  $x$  and  $y$  restricted to temporal interval  $z_1$  are related during a given transition  $\text{Trans}(r_1, r_2, x, y, z_1, z_2)$ ; recall that as per the definition of Trans,  $r_1$  holds over EQTS which are NECPs of  $\frac{x}{z_1}$  and  $\frac{y}{z_1}$  (with respect to  $z_2$ ). This illustrates why NECPs are adequate to characterize continuous transitions, when discontinuity is characterized over adjacent temporal slices.

#### 4.6.2.1 Temporal Slices as NECPs

Suppose we know that a durative base relation holds over the NECPs (which are EQTS) of  $x$  and  $y$  with respect to an interval  $z$ . What can we say about the relation holding between the whole of  $x$  and  $y$ ? We have the following theorems for when a durative base relation holds for the NECPs. For  $\text{DC}_{\text{sp}}^-$  holding over all NECPs which are EQTS of two

<sup>14</sup>Note that this is true irrespective of whether or not the NECPs are temporal slices. For similar relationships involving existence of connection or overlap over NECPs we need to look at NECPs which are temporal slices. This is the focus of Section 4.6.2.1 and Section 4.6.2.2

histories  $x$  and  $y$ , with respect to a third history  $z$ ,  $DR_{st}$  holds between  $x$  and  $y$ . We have theorem Th81. Similarly  $EC_{st}$  holds over  $x$  and  $y$  for  $EC_{sp}^=$  holding over NECPs which are EQTS of  $x$  and  $y$  with respect to  $z$ : we have theorem Th82.

$$\text{Th81. } [[EC_t(x, z) \wedge EC_t(y, z) \wedge \forall u, v[[NECP(u, x, z) \wedge \\ NECP(v, y, z) \wedge EQTS(u, v, x, y)] \rightarrow DC_{sp}^=(u, v)]] \rightarrow DR_{st}(x, y)]$$

$$\text{Th82. } [[EC_t(x, z) \wedge EC_t(y, z) \wedge EQ_t(x, y) \wedge \forall u, v[[NECP(u, x, z) \wedge \\ NECP(v, y, z) \wedge EQTS(u, v, x, y)] \rightarrow EC_{sp}^=(u, v)]] \rightarrow EC_{st}(x, y)]$$

We have  $PO_{sp}^=$ ,  $EQ_{st}$  and  $TPP_{st}$  holding over complete histories  $x$  and  $y$ , for  $PO_{sp}^=$ ,  $EQ_{sp}^=$  and  $TPP_{sp}^=$  respectively holding over temporally equivalent temporal slices from  $x$  and  $y$ , which are NECPs with respect to  $z$  (Th83 through Th85).

$$\text{Th83. } [[EC_t(x, z) \wedge EC_t(y, z) \wedge EQ_t(x, y) \wedge \forall u, v[[NECP(u, x, z) \wedge \\ NECP(v, y, z) \wedge EQTS(u, v, x, y)] \rightarrow PO_{sp}^=(u, v)]] \rightarrow PO_{sp}^=(x, y)]$$

$$\text{Th84. } [[EC_t(x, z) \wedge EC_t(y, z) \wedge EQ_t(x, y) \wedge \forall u, v[[NECP(u, x, z) \wedge \\ NECP(v, y, z) \wedge EQTS(u, v, x, y)] \rightarrow EQ_{sp}^=(u, v)]] \rightarrow EQ_{st}(x, y)]$$

$$\text{Th85. } [[EC_t(x, z) \wedge EC_t(y, z) \wedge EQ_t(x, y) \wedge \forall u, v[[NECP(u, x, z) \wedge \\ NECP(v, y, z) \wedge EQTS(u, v, x, y)] \rightarrow TPP_{sp}^=(u, v)]] \rightarrow TPP_{st}(x, y)]$$

For the durative base relation  $NTPP_{sp}^=$  holding over NECPs which are EQTS, we have theorem Th86 establishing  $PP_{st}$  holding over complete histories.

$$\text{Th86. } [[EC_t(x, z) \wedge EC_t(y, z) \wedge EQ_t(x, y) \wedge \forall u, v[[NECP(u, x, z) \wedge \\ NECP(v, y, z) \wedge EQTS(u, v, x, y)] \rightarrow NTPP_{sp}^=(u, v)]] \rightarrow PP_{st}(x, y)]$$

#### 4.6.2.2 NECPs and Trans

For histories undergoing a Trans from  $DC_{sp}^=$  over NECPs of  $z_1$  to any other relation  $R_{sp}^=$  (where  $R_{sp}^=$  refers to a relation from the set of durative base relations in Section 4.3.2), the histories are disjoint over the interval  $z_1$ . We have theorem Th87. For the case of Trans from  $EC_{sp}^=$  to any other relation  $R_{sp}^=$ , histories restricted to interval  $z_1$  are spatio-temporally externally connected  $EC_{st}$  (Th88). Related to the above, we have theorem Th89 and Th90 corresponding to  $PO_{sp}^=$  and  $TPP_{sp}^=$  holding over all NECPs.

$$\text{Th87. } \text{Trans}(dc, r, x, y, z_1, z_2) \rightarrow DR_{st}\left(\frac{x}{z_1}, \frac{y}{z_1}\right)$$

$$\text{Th88. } \text{Trans}(ec, r, x, y, z_1, z_2) \rightarrow EC_{st}\left(\frac{x}{z_1}, \frac{y}{z_1}\right)$$

$$\text{Th89. } \text{Trans}(po, r, x, y, z_1, z_2) \rightarrow PO_{sp}^=\left(\frac{x}{z_1}, \frac{y}{z_1}\right)$$

$$\text{Th90. } \text{Trans}(tpp, r, x, y, z_1, z_2) \rightarrow TPP_{st}\left(\frac{x}{z_1}, \frac{y}{z_1}\right)$$

Theorem Th91 is for histories undergoing a Trans from  $\text{NTPP}_{\text{sp}}^{\overline{=}}$ , the histories restricted to interval  $z_1$  are  $\text{PP}_{\text{st}}$ . Corresponding to Th90 we have a theorem (Th92) for  $\text{TPPi}_{\text{sp}}^{\overline{=}}$  holding over the NECPs.

$$\text{Th91. } \text{Trans}(\text{ntpp}, r, x, y, z_1, z_2) \rightarrow \text{PP}_{\text{st}}\left(\frac{x}{z_1}, \frac{y}{z_1}\right)$$

$$\text{Th92. } \text{Trans}(\text{tppi}, r, x, y, z_1, z_2) \rightarrow \text{TPP}_{\text{st}}\left(\frac{y}{z_1}, \frac{x}{z_1}\right)$$

Further note that Trans being defined in terms of NECPs over  $z_1$  and  $z_2$ , we have the following theorems specifying the relation holding over histories restricted to  $z_2$  for a given relation over all NECPs during  $z_2$  with respect to  $z_1$ :

$$\text{Th93. } \text{Trans}(r, \text{eq}, x, y, z_1, z_2) \rightarrow \text{EQ}_{\text{st}}\left(\frac{x}{z_2}, \frac{y}{z_2}\right)$$

$$\text{Th94. } \text{Trans}(r, \text{po}, x, y, z_1, z_2) \rightarrow \text{PO}_{\text{sp}}^{\overline{=}}\left(\frac{x}{z_2}, \frac{y}{z_2}\right)$$

$$\text{Th95. } \text{Trans}(r, \text{tpp}, x, y, z_1, z_2) \rightarrow \text{TPP}_{\text{st}}\left(\frac{x}{z_2}, \frac{y}{z_2}\right)$$

$$\text{Th96. } \text{Trans}(r, \text{ntpp}, x, y, z_1, z_2) \rightarrow \text{PP}_{\text{st}}\left(\frac{x}{z_2}, \frac{y}{z_2}\right)$$

Related to Th95 and Th96 we have theorems Th97 and Th98 for  $\text{TPPi}_{\text{sp}}^{\overline{=}}$  and  $\text{NTPPi}_{\text{sp}}^{\overline{=}}$  holding over the NECPs during  $z_2$ .

$$\text{Th97. } \text{Trans}(r, \text{tppi}, x, y, z_1, z_2) \rightarrow \text{TPP}_{\text{st}}\left(\frac{y}{z_2}, \frac{x}{z_2}\right)$$

$$\text{Th98. } \text{Trans}(r, \text{ntppi}, x, y, z_1, z_2) \rightarrow \text{PP}_{\text{st}}\left(\frac{y}{z_2}, \frac{x}{z_2}\right)$$

Even though Trans is stated in terms of NECPs over  $z_1$ , these theorems remove the ambiguity as to which relations hold for histories over interval  $z_1$ . However, note that in certain cases (cf. Th87 and Th91), a relation that subsumes the expected spatio-temporal relation from the lattice of subsumption hierarchy (see Figure 2.2, Chapter 2) is all that can be inferred<sup>15</sup>.

### 4.6.3 Instantaneous Transitions and StrFCONT

#### 4.6.3.1 Non-Instantaneous Relations and InsRel3

An instantaneous transition given by InsRel3 involves a RCC-8 relation holding instantaneously. A22 eliminates the possibility of  $\text{DC}_{\text{st}}$ ,  $\text{PO}_{\text{st}}$ ,  $\text{NTPP}_{\text{st}}$  and  $\text{NTPPi}_{\text{st}}$  holding instantaneously for StrFCONT histories. Thus there is no InsRel3 for StrFCONT histories during time interval  $z_1$  to  $z_2$ , involving any of the above relations holding at the boundary of  $z_1$  and  $z_2$ . We have the following theorems:

<sup>15</sup>A number of other theorems based on the  $\text{R}_{\text{sp}}^{\overline{=}}$  relation being specified over NECPs during  $z_1$  or  $z_2$  can be proved along similar lines. I present here only the above theorems (Th87 to Th98) as only these are needed for subsequent proofs in Section 4.6.4. Note that I do not commit to the relation  $\text{R}_{\text{sp}}^{\overline{=}}$  holding over the NECPs at the other end; the relation at the other end (for a given relation at one end) determines whether a particular transition is consistent for StrFCONT histories (see Appendix D).

- Th99.**  $[\text{StrFCONT}(\frac{x}{z_1 \cup z_2}) \wedge \text{StrFCONT}(\frac{y}{z_1 \cup z_2})] \rightarrow \neg \text{InsRel3}(r_1, \text{dc}, r_2, x, y, z_1, z_2)$
- Th100.**  $[\text{StrFCONT}(\frac{x}{z_1 \cup z_2}) \wedge \text{StrFCONT}(\frac{y}{z_1 \cup z_2})] \rightarrow \neg \text{InsRel3}(r_1, \text{po}, r_2, x, y, z_1, z_2)$
- Th101.**  $[\text{StrFCONT}(\frac{x}{z_1 \cup z_2}) \wedge \text{StrFCONT}(\frac{y}{z_1 \cup z_2})] \rightarrow \neg \text{InsRel3}(r_1, \text{ntpp}, r_2, x, y, z_1, z_2)$
- Th102.**  $[\text{StrFCONT}(\frac{x}{z_1 \cup z_2}) \wedge \text{StrFCONT}(\frac{y}{z_1 \cup z_2})] \rightarrow \neg \text{InsRel3}(r_1, \text{ntppi}, r_2, x, y, z_1, z_2)$

#### 4.6.3.2 Instantaneous Transition Matrix $\mathbb{M}_r$ and $\text{InsRel3}$

Non-transitions involving  $\text{InsRel3}$  for  $\text{StrFCONT}$  histories based on the instantaneous relations,  $\text{EQ}_{\text{st}}$ ,  $\text{EC}_{\text{st}}$ ,  $\text{TPP}_{\text{st}}$  and  $\text{TPPi}_{\text{st}}$  are more subtle. Use of A22 leads to identification of the instantaneous transition matrix  $\mathbb{M}_r$  for a particular relation  $r$  holding instantaneously. Identifying non-transition requires checking  $\text{FCONnectivity}$  between parts of pair of histories, thus arriving at a contradiction through the particular  $\mathbb{M}_r$ . I present here a representative set of theorems involving  $\text{InsRel3}$  that will be used for subsequent tasks.

For  $\text{StrFCONT}$  histories,  $\text{EQ}_{\text{st}}$  holding instantaneously does not allow  $\text{InsRel3}$  involving either  $\text{DC}_{\text{sp}}^=$  or  $\text{EC}_{\text{sp}}^=$  over  $\text{EQTS}$  which are  $\text{NECPs}$  of  $x$  and  $y$  (restricted to  $z_1$ ) with respect to  $z_2$ . We have theorems Th103 and Th104.

- Th103.**  $\text{InsRel3}(\text{dc}, \text{eq}, r, x, y, z_1, z_2) \rightarrow [\neg \text{StrFCONT}(\frac{x}{z_1 \cup z_2}) \vee \neg \text{StrFCONT}(\frac{y}{z_1 \cup z_2})]$
- Th104.**  $\text{InsRel3}(\text{ec}, \text{eq}, r, x, y, z_1, z_2) \rightarrow [\neg \text{StrFCONT}(\frac{x}{z_1 \cup z_2}) \vee \neg \text{StrFCONT}(\frac{y}{z_1 \cup z_2})]$

We cannot have an  $\text{InsRel3}$  with  $\text{EC}_{\text{st}}$  holding instantaneously and either  $\text{EQ}_{\text{sp}}^=$ ,  $\text{TPP}_{\text{sp}}^=$ ,  $\text{NTPP}_{\text{sp}}^=$  or their inverses  $\text{TPPi}_{\text{sp}}^=$  and  $\text{NTPPi}_{\text{sp}}^=$  holding over  $\text{EQTS}$  which are  $\text{NECPs}$  of  $\frac{x}{z_2}$  and  $\frac{y}{z_2}$  (with respect to  $z_1$ ). We have the following theorems.

- Th105.**  $\text{InsRel3}(r, \text{ec}, \text{eq}, x, y, z_1, z_2) \rightarrow [\neg \text{StrFCONT}(\frac{x}{z_1 \cup z_2}) \vee \neg \text{StrFCONT}(\frac{y}{z_1 \cup z_2})]$
- Th106.**  $\text{InsRel3}(r, \text{ec}, \text{tpp}, x, y, z_1, z_2) \rightarrow [\neg \text{StrFCONT}(\frac{x}{z_1 \cup z_2}) \vee \neg \text{StrFCONT}(\frac{y}{z_1 \cup z_2})]$
- Th107.**  $\text{InsRel3}(r, \text{ec}, \text{ntpp}, x, y, z_1, z_2) \rightarrow [\neg \text{StrFCONT}(\frac{x}{z_1 \cup z_2}) \vee \neg \text{StrFCONT}(\frac{y}{z_1 \cup z_2})]$
- Th108.**  $\text{InsRel3}(r, \text{ec}, \text{tppi}, x, y, z_1, z_2) \rightarrow [\neg \text{StrFCONT}(\frac{x}{z_1 \cup z_2}) \vee \neg \text{StrFCONT}(\frac{y}{z_1 \cup z_2})]$
- Th109.**  $\text{InsRel3}(r, \text{ec}, \text{ntppi}, x, y, z_1, z_2) \rightarrow [\neg \text{StrFCONT}(\frac{x}{z_1 \cup z_2}) \vee \neg \text{StrFCONT}(\frac{y}{z_1 \cup z_2})]$

For  $\text{InsRel3}$  involving  $\text{TPP}_{\text{st}}$  as the instantaneous relation, we enumerate the following theorems. Th110 and Th111 refers to the impossibility of having  $\text{DC}_{\text{sp}}^=$  and  $\text{EC}_{\text{sp}}^=$  respectively holding over  $\text{EQTS}$  which are  $\text{NECPs}$  of  $\frac{x}{z_1}$  and  $\frac{y}{z_1}$  (with respect to  $z_2$ ).

- Th110.**  $\text{InsRel3}(\text{dc}, \text{tpp}, r, x, y, z_1, z_2) \rightarrow [\neg \text{StrFCONT}(\frac{x}{z_1 \cup z_2}) \vee \neg \text{StrFCONT}(\frac{y}{z_1 \cup z_2})]$
- Th111.**  $\text{InsRel3}(\text{ec}, \text{tpp}, r, x, y, z_1, z_2) \rightarrow [\neg \text{StrFCONT}(\frac{x}{z_1 \cup z_2}) \vee \neg \text{StrFCONT}(\frac{y}{z_1 \cup z_2})]$

Similarly we have theorems Th112 and Th113 that refer to the impossibility of having  $\text{TPPi}_{\text{sp}}^=$  and  $\text{NTPPi}_{\text{sp}}^=$  respectively holding over  $\text{EQTS}$  which are  $\text{NECPs}$  of  $\frac{x}{z_2}$  and  $\frac{y}{z_2}$  (with

respect to  $z_1$ ) with  $\text{TPP}_{\text{st}}$  holding instantaneously at the boundary of  $z_1$  and  $z_2$ .

$$\text{Th112. } \text{InsRel3}(r, \text{tpp}, \text{tppi}, x, y, z_1, z_2) \rightarrow [\neg \text{StrFCONT}(\frac{x}{z_1 \cup z_2}) \vee \neg \text{StrFCONT}(\frac{y}{z_1 \cup z_2})]$$

$$\text{Th113. } \text{InsRel3}(r, \text{tpp}, \text{ntppi}, x, y, z_1, z_2) \rightarrow [\neg \text{StrFCONT}(\frac{x}{z_1 \cup z_2}) \vee \neg \text{StrFCONT}(\frac{y}{z_1 \cup z_2})]$$

For  $\text{InsRel3}$  with  $\text{TPPi}_{\text{st}}$  as the instantaneous relation, theorems Th114 through Th116 refer to the impossibility of having  $\text{DC}_{\text{sp}}^=$ ,  $\text{EC}_{\text{sp}}^=$  or  $\text{TPP}_{\text{sp}}^=$  respectively holding over EQTS which are NECPs of  $\frac{x}{z_1}$  and  $\frac{y}{z_1}$  (with respect to  $z_2$ ).

$$\text{Th114. } \text{InsRel3}(\text{dc}, \text{tppi}, r, x, y, z_1, z_2) \rightarrow [\neg \text{StrFCONT}(\frac{x}{z_1 \cup z_2}) \vee \neg \text{StrFCONT}(\frac{y}{z_1 \cup z_2})]$$

$$\text{Th115. } \text{InsRel3}(\text{ec}, \text{tppi}, r, x, y, z_1, z_2) \rightarrow [\neg \text{StrFCONT}(\frac{x}{z_1 \cup z_2}) \vee \neg \text{StrFCONT}(\frac{y}{z_1 \cup z_2})]$$

$$\text{Th116. } \text{InsRel3}(\text{tpp}, \text{tppi}, r, x, y, z_1, z_2) \rightarrow [\neg \text{StrFCONT}(\frac{x}{z_1 \cup z_2}) \vee \neg \text{StrFCONT}(\frac{y}{z_1 \cup z_2})]$$

Finally, for  $\text{StrFCONT}$  histories, Th117 refers to the impossibility of having  $\text{NTPP}_{\text{sp}}^=$  holding over EQTS which are NECPs of  $\frac{x}{z_2}$  and  $\frac{y}{z_2}$  (with respect to  $z_1$ ) with  $\text{TPPi}_{\text{st}}$  holding instantaneously at the boundary of  $z_1$  and  $z_2$ .

$$\text{Th117. } \text{InsRel3}(r, \text{tppi}, \text{ntpp}, x, y, z_1, z_2) \rightarrow [\neg \text{StrFCONT}(\frac{x}{z_1 \cup z_2}) \vee \neg \text{StrFCONT}(\frac{y}{z_1 \cup z_2})]$$

#### 4.6.4 Non-Existence of Transitions

A link between relations  $r_1$  and  $r_2$  in the CND exists iff  $\text{DirTran}(r_1, r_2, x, y, z_1, z_2)$  is consistent. Absence of any link between  $r_1$  and  $r_2$  should entail  $\neg \text{DirTran}(r_1, r_2, x, y, z_1, z_2)$ . For example, since there is no direct link between  $\text{DC}_{\text{sp}}^=$  and  $\text{EQ}_{\text{sp}}^=$ , the following is a theorem expressing the non-existence of transition in the RCC-8 CND for  $\text{StrFCONT}$  histories.

$$\text{Th118. } [\text{StrFCONT} \frac{x}{z_1 \cup z_2} \wedge \text{StrFCONT} \frac{y}{z_1 \cup z_2}] \rightarrow \neg \text{DirTran}(\text{dc}, \text{eq}, x, y, z_1, z_2)$$

In Table 4.1 I have the relations  $r_1$  and  $r_2$  listed in the rows and columns respectively. The entries of the table can be understood as transition between the corresponding relations under  $\text{StrFCONT}$ . The table is symmetric about the diagonal. Transitions corresponding to the links present in the CND are marked ██████. I am concerned here with transitions that are absent from the CND of RCC-8. There are 17 such non-transitions. These are marked with the corresponding theorem that establishes the non-existence.

There is no transition from  $\text{EC}_{\text{sp}}^=$  and  $\text{EQ}_{\text{sp}}^=$  in the standard RCC-8 conceptual neighbourhood. The following theorem establishes this non-transition for  $\text{StrFCONT}$  histories.

$$\text{Th119. } [\text{StrFCONT} \frac{x}{z_1 \cup z_2} \wedge \text{StrFCONT} \frac{y}{z_1 \cup z_2}] \rightarrow \neg \text{DirTran}(\text{ec}, \text{eq}, x, y, z_1, z_2)$$

A *direct* transition from  $\text{DC}_{\text{sp}}^=$  and  $\text{PO}_{\text{sp}}^=$  is absent from the RCC-8 conceptual neighbourhood. However, a transition with  $\text{EC}_{\text{st}}$  holding instantaneously is possible, i.e.,  $\exists x, y, z_1, z_2 [\text{StrFCONT} \frac{x}{z_1 \cup z_2} \wedge \text{StrFCONT} \frac{y}{z_1 \cup z_2} \wedge \text{InsRel3}(\text{dc}, \text{ec}, \text{po}, x, y, z_1, z_2)]$  would be



	$DC_{sp}^=$	$EC_{sp}^=$	$PO_{sp}^=$	$EQ_{sp}^=$	$TPP_{sp}^=$	$TPPi_{sp}^=$	$NTPP_{sp}^=$	$NTPPi_{sp}^=$
$DC_{sp}^=$	■	■	Th120	Th118	Th121	Th125	Th123	Th127
$EC_{sp}^=$	■	■	■	Th119	Th122	Th126	Th124	Th128
$PO_{sp}^=$		■	■	■	■	■	Th129	Th130
$EQ_{sp}^=$			■	■	■	■	■	■
$TPP_{sp}^=$			■	■	■	Th131	■	Th133
$TPPi_{sp}^=$			■	■		■	Th134	■
$NTPP_{sp}^=$				■	■		■	Th132
$NTPPi_{sp}^=$				■		■		■

Table 4.1: Transitions under StrFCONT. Non-transitions are marked with the corresponding theorem that establishes their non-existence.

consistent. Any transition from  $DC_{sp}^=$  to  $PO_{sp}^=$  without an intervening instantaneous relation should not be possible for StrFCONT histories. We have the following theorem:

$$\text{Th120. } [\text{StrFCONT}_{z_1 \cup z_2}^x \wedge \text{StrFCONT}_{z_1 \cup z_2}^y] \rightarrow \neg \text{DirTran}(\text{dc}, \text{po}, x, y, z_1, z_2)$$

For any transition from being disconnected or externally connected to proper-part involves spatial leap and/or temporal pinching as seen in Section 4.3. Thus under strong firm continuity, there exists no direct link between  $DC_{sp}^=$  or  $EC_{sp}^=$  to  $TPP_{sp}^=$  and  $NTPP_{sp}^=$ . We have theorems Th121 through Th124 establishing this non-existence for StrFCONT histories.

$$\text{Th121. } [\text{StrFCONT}_{z_1 \cup z_2}^x \wedge \text{StrFCONT}_{z_1 \cup z_2}^y] \rightarrow \neg \text{DirTran}(\text{dc}, \text{tpp}, x, y, z_1, z_2)$$

$$\text{Th122. } [\text{StrFCONT}_{z_1 \cup z_2}^x \wedge \text{StrFCONT}_{z_1 \cup z_2}^y] \rightarrow \neg \text{DirTran}(\text{ec}, \text{tpp}, x, y, z_1, z_2)$$

$$\text{Th123. } [\text{StrFCONT}_{z_1 \cup z_2}^x \wedge \text{StrFCONT}_{z_1 \cup z_2}^y] \rightarrow \neg \text{DirTran}(\text{dc}, \text{ntpp}, x, y, z_1, z_2)$$

$$\text{Th124. } [\text{StrFCONT}_{z_1 \cup z_2}^x \wedge \text{StrFCONT}_{z_1 \cup z_2}^y] \rightarrow \neg \text{DirTran}(\text{ec}, \text{ntpp}, x, y, z_1, z_2)$$

Similarly no direct link exists between  $DC_{sp}^=$  or  $EC_{sp}^=$  to  $TPPi_{sp}^=$  and  $NTPPi_{sp}^=$  for StrFCONT histories. We have theorems Th125 through Th128.

$$\text{Th125. } [\text{StrFCONT}_{z_1 \cup z_2}^x \wedge \text{StrFCONT}_{z_1 \cup z_2}^y] \rightarrow \neg \text{DirTran}(\text{dc}, \text{tppi}, x, y, z_1, z_2)$$

$$\text{Th126. } [\text{StrFCONT}_{z_1 \cup z_2}^x \wedge \text{StrFCONT}_{z_1 \cup z_2}^y] \rightarrow \neg \text{DirTran}(\text{ec}, \text{tppi}, x, y, z_1, z_2)$$

$$\text{Th127. } [\text{StrFCONT}_{z_1 \cup z_2}^x \wedge \text{StrFCONT}_{z_1 \cup z_2}^y] \rightarrow \neg \text{DirTran}(\text{dc}, \text{ntppi}, x, y, z_1, z_2)$$

$$\text{Th128. } [\text{StrFCONT}_{z_1 \cup z_2}^x \wedge \text{StrFCONT}_{z_1 \cup z_2}^y] \rightarrow \neg \text{DirTran}(\text{ec}, \text{ntppi}, x, y, z_1, z_2)$$

Both  $\exists x, y, z_1, z_2[\text{StrFCONT}_{z_1 \cup z_2} \frac{x}{x} \wedge \text{StrFCONT}_{z_1 \cup z_2} \frac{y}{y} \wedge \text{InsRel3}(\text{po}, \text{eq}, \text{ntpp}, x, y, z_1, z_2)]$  as well as  $\exists x, y, z_1, z_2[\text{StrFCONT}_{z_1 \cup z_2} \frac{x}{x} \wedge \text{StrFCONT}_{z_1 \cup z_2} \frac{y}{y} \wedge \text{InsRel3}(\text{po}, \text{tpp}, \text{ntpp}, x, y, z_1, z_2)]$  would be consistent. Under strong firm continuity, a transition from  $\text{PO}_{\text{sp}}^=$  to  $\text{NTPP}_{\text{sp}}^=$  with  $\text{EQ}_{\text{st}}$  or  $\text{TPP}_{\text{st}}$  holding instantaneously is possible. Similarly for  $\text{PO}_{\text{sp}}^=$  to  $\text{NTPPi}_{\text{sp}}^=$  with  $\text{TPP}_{\text{st}}$  replaced by  $\text{TPPi}_{\text{st}}$  holding instantaneously. No direct transition from  $\text{PO}_{\text{st}}$  to  $\text{NTPP}_{\text{st}}$  or  $\text{NTPPi}_{\text{st}}$  exists and we have theorems Th129 and Th130.

$$\text{Th129. } [\text{StrFCONT}_{z_1 \cup z_2} \frac{x}{x} \wedge \text{StrFCONT}_{z_1 \cup z_2} \frac{y}{y}] \rightarrow \neg \text{DirTran}(\text{po}, \text{ntpp}, x, y, z_1, z_2)$$

$$\text{Th130. } [\text{StrFCONT}_{z_1 \cup z_2} \frac{x}{x} \wedge \text{StrFCONT}_{z_1 \cup z_2} \frac{y}{y}] \rightarrow \neg \text{DirTran}(\text{po}, \text{ntppi}, x, y, z_1, z_2)$$

No direct transition between  $\text{R}_{\text{sp}}^=$  to  $\text{Ri}_{\text{sp}}^=$  is possible. For StrFCONT histories, only transition possible between  $\text{R}_{\text{sp}}^=$  to  $\text{Ri}_{\text{sp}}^=$  is with  $\text{EQ}_{\text{st}}$  holding instantaneously. Therefore  $\exists x, y, z_1, z_2[\text{StrFCONT}_{z_1 \cup z_2} \frac{x}{x} \wedge \text{StrFCONT}_{z_1 \cup z_2} \frac{y}{y} \wedge \text{InsRel3}(\text{tpp}, \text{eq}, \text{tppi}, x, y, z_1, z_2)]$  would be consistent. Similar is the case for a  $\text{NTPP}_{\text{sp}}^=$  to  $\text{NTPPi}_{\text{sp}}^=$  transition under strong firm continuity. We have theorems Th131 and Th132.

$$\text{Th131. } [\text{StrFCONT}_{z_1 \cup z_2} \frac{x}{x} \wedge \text{StrFCONT}_{z_1 \cup z_2} \frac{y}{y}] \rightarrow \neg \text{DirTran}(\text{tpp}, \text{tppi}, x, y, z_1, z_2)$$

$$\text{Th132. } [\text{StrFCONT}_{z_1 \cup z_2} \frac{x}{x} \wedge \text{StrFCONT}_{z_1 \cup z_2} \frac{y}{y}] \rightarrow \neg \text{DirTran}(\text{ntpp}, \text{ntppi}, x, y, z_1, z_2)$$

A transition from  $\text{TPP}_{\text{sp}}^=$  to  $\text{NTPPi}_{\text{sp}}^=$  for StrFCONT involves  $\text{EQ}_{\text{st}}$  holding instantaneously and similarly for  $\text{TPPi}_{\text{sp}}^=$  to  $\text{NTPP}_{\text{sp}}^=$ . We have the following theorems:

$$\text{Th133. } [\text{StrFCONT}_{z_1 \cup z_2} \frac{x}{x} \wedge \text{StrFCONT}_{z_1 \cup z_2} \frac{y}{y}] \rightarrow \neg \text{DirTran}(\text{tpp}, \text{ntppi}, x, y, z_1, z_2)$$

$$\text{Th134. } [\text{StrFCONT}_{z_1 \cup z_2} \frac{x}{x} \wedge \text{StrFCONT}_{z_1 \cup z_2} \frac{y}{y}] \rightarrow \neg \text{DirTran}(\text{tppi}, \text{ntpp}, x, y, z_1, z_2)$$

#### 4.6.5 Recovering the CND

The missing links of the RCC-8 CND have been shown to be non-transitions under strong firm continuity. From Table 4.1 the remaining transitions possible between the RCC-8 relations are the ones envisioned originally as in Figure 2.6, Chapter 2. I have recovered the conceptual neighbourhood within my mereotopological theory of space-time.

However, in absence of formal proofs for the existence of transitions (corresponding to the links present in the CND), the recovery is only partial. More will be said about it in Section 5.2.2, Chapter 5.

## Chapter 5

# Further Work and Conclusion

---

In this chapter I shall summarise the main results of the thesis and point to areas for further work. First, I shall discuss a potential application based on the mereotopological framework developed in the thesis. I will present an approach to the problem of acquiring a qualitative world description from partial qualitative spatio-temporal information such as might be acquired by a mobile agent exploring some region in space [Hazarika and Cohn, 2002]. This is achieved by exploiting qualitative motion and a library of possible spatio-temporal patterns.

### 5.1 Potential Application: Abducing Qualitative Histories

Shanahan was the first to propose map-building for robotic navigation as a formal abduction task [Shanahan, 1998]. He proposed a logic-based framework using abduction for sensory data assimilation. However the system does not use a purely qualitative approach to spatial representation [Randell *et al.*, 1992b] and space is represented as a real-valued coordinate system. In line with Shanahan's suggestion [Shanahan, 1998, page 34-45], grounded at the sensory level, I explore the use of the mereotopological theory of space-time developed in this thesis, for building a world model from sensory information.

#### 5.1.1 Abductive Framework

A map emphasises the illusion of seeing a spatial scene from *above* at an instant of time (a snapshot) which I refer to as *global snapshot*: the complete knowledge of the world at

a particular time. In contrast, the knowledge of the world an autonomous agent garners as it continuously *explores* is only partial and I will refer to it as *local survey* knowledge: partial spatial knowledge of the world at all times during its exploration. I shall consider an *inhabited* dynamic system. My interpretation of a dynamical system is as in [Sandewall, 1994]. A dynamical system is one whose state changes over time and where effects flow forwards in time. It is *inhabited* iff it contains one or more *agents* which can influence the system's state at later times by performing *actions*.

With space-time primitives in an inhabited dynamic system, the key idea is to generate complete space-time *histories* by abduction: given a record of *local surveys*, the abductive task is to hypothesise the space-time *histories*, which, given the *spatio-temporal patterns* of objects in the domain, would explain the *local surveys*. In logical terms, if a *local survey* is represented as the conjunction  $\Phi$  of a set of spatio-temporal relationships, the task is to find an explanation of  $\Phi$  in the form of a logical description (a mereotopological world model)  $\Delta_H$  involving space-time *histories*, such that

$$\Sigma_{ST} \wedge \Delta_P \wedge \Delta_H \models \Phi, \text{ where}$$

1.  $\Sigma_{ST}$  is a spatio-temporal theory for space, time, change and continuity.
2.  $\Delta_P$  is a logical description of spatio-temporal *patterns* for objects in the domain.

Figure 5.1 below illustrates the abductive framework. The abductive reasoning engine is driven by selection heuristics. The process is a multi-tier procedure wherein explanations are abduced and then heuristics are used to choose preferred explanations. I shall present here a primary heuristic for spatial abduction and discuss a range of possibilities for refining the set of abduced explanations.

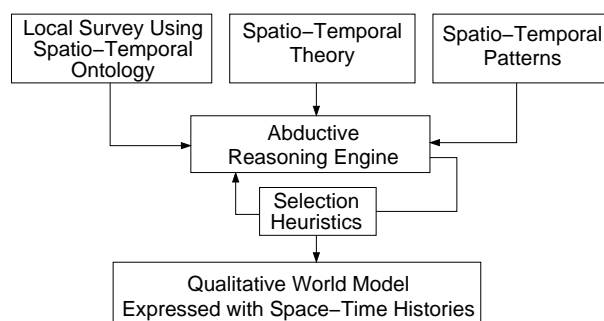

Figure 5.1: Abductive approach to generating an integrated spatio-temporal representation. The world model is constructed from local surveys based on a library of possible spatio-temporal patterns.

### 5.1.1.1 Spatio-Temporal Theory $\Sigma_{ST}$

The spatio-temporal theory  $\Sigma_{ST}$  is the mereotopological theory developed in the thesis including continuity expressed in a purely mereotopological framework. Any transition between RCC-8 relations to be consistent with the background theory  $\Sigma_{ST}$  must follow a path in the conceptual neighbourhood diagram (cf. Figure 2.6, Chapter 2). This imposes constraints on the abduction as discussed in Section 5.1.2.

The conceptual neighbourhood of Figure 2.6, Chapter 2 is under the assumption that histories are StrFCNT (cf. Section 4.6, Chapter 4). There isn't any restriction on the rigidity of the objects. Thus a transition involving spatio-temporal expansion of one of the histories is possible, for example,  $EQ_{st}(x, y)$  to  $NTPP_{st}(x, y)$  with uniform growth of history  $y$ . If we assume all objects are rigid<sup>1</sup>, we can add axiom A24 which further constrains the possible continuous transitions<sup>2</sup> in Figure 5.2.

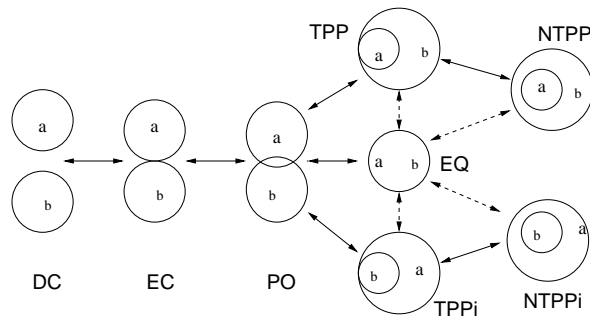

Figure 5.2: Transition Graph for RCC-8 relations under the assumption that all objects are rigid. Illegal transitions are shown with dashed lines.

$$\mathbf{A24.} \quad PP_{st} \frac{x}{z_1} \frac{y}{z_1} \rightarrow \neg EQ_{st} \frac{x}{z_2} \frac{y}{z_2}$$

The illegal transitions are shown with dashed lines in Figure 5.2. This axiom will also disallow the sequence  $TPP_{st} \rightarrow PO_{st} \rightarrow TPPi_{st}$  which would otherwise be possible given the purely local constraints imposed by the restricted form of Figure 5.2.

### 5.1.1.2 Spatio-Temporal Patterns $\Delta_P$

The range of phenomena that can be described in a s-t theory of space is potentially infinite. Identifying useful s-t patterns  $\Delta_P$  involving one or more spatial entities is a complex task and one far beyond the scope of the present work; here I am simply concerned

<sup>1</sup>More realistically some objects are rigid and some are not. To constrain the number of alternative abductive explanations, I assume only rigid objects in the domain.

<sup>2</sup>When Freksa gave the conceptual neighbourhood for Allen's Calculus, he also gave three specialised versions based on ways in which an interval can be deformed. The transition graph obtained for intervals of fixed size was called B-conceptual neighbourhood [Freksa, 1992]. The spatial equivalent is the movement of a region in space with area and shape unchanged [Cohn *et al.*, 1994].

with validating our abductive framework. Therefore here I will enumerate only a small possible representative group of s-t patterns for rigid (shape invariant) objects which will be sufficient to illustrate the ideas. The following qualitative s-t patterns are identifiable with a single spatial entity:

1. Immobility,  $IMBx$ : Immobility is the phenomenon of occupying the *same space* at *all times*.
2. Non-repeating,  $NPTx$ : Non-repeating is defined as the phenomenon of *never* being in the *same place twice*<sup>3</sup>.
3. Repeating,  $RPTx$ : Repeating is the phenomenon of being in the *same place at two different times, at being elsewhere inbetween*<sup>4</sup>.

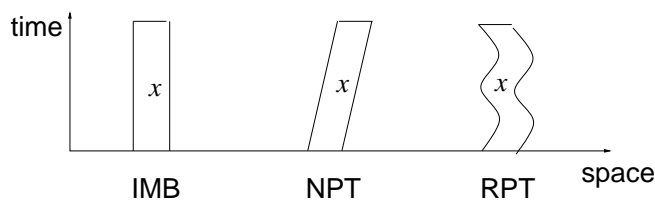

Figure 5.3: A selection of spatio-temporal patterns for a single entity.

Figure 5.3 shows the different s-t patterns identified above. D57 to D59 provide the object level definitions<sup>5</sup> for the above three different patterns. I cannot distinguish rotation from repeating mobility. Topologically, they both have the property that objects are in the same place twice. However, with an additional morphological primitive of *congruence* [Bennett *et al.*, 2000b] I could make the distinction. Further note that a sphere rotating occupies the same place at all times, so immobility as defined above does not necessarily mean being at rest. Also note that with congruence, I could make explicit at the object level the assumption that objects are rigid. Even without this I am able to axiomatise some of the effects of rigidity (see A24).

$$\mathbf{D57.} \quad IMBx \equiv_{def} \forall t [t \subseteq_t x \rightarrow EQ_{sp} x \frac{x}{t}]$$

$$\mathbf{D58.} \quad NPTx \equiv_{def} \forall u, v [(u \subseteq_t x \wedge v \subseteq_t x \wedge \neg(u =_t v)) \rightarrow \neg EQ_{sp} \frac{x}{u} \frac{x}{v}]$$

$$\mathbf{D59.} \quad RPTx \equiv_{def} \exists u, v, w [(u \subseteq_t x \wedge v \subseteq_t x \wedge w \subseteq_t x \wedge v \parallel_t (u; w)) \wedge EQ_{sp} \frac{x}{u} \frac{x}{w} \wedge \neg EQ_{sp} \frac{x}{u} \frac{x}{v}]$$

<sup>3</sup>Note that this definition implies that the object is never stationary. Objects that are in non-repeating motion and at rest intermittently would display a combination of IMB and NPT over time. This could be expressed as a (macro) pattern explicitly if desired.

<sup>4</sup>There are weaker and stronger versions of these predicates possible. For example, of never taking an overlapping path or of taking an overlapping path more than once (which might then yield the kind of semantic region descriptions computed in [Ferryhough *et al.*, 2000]).

<sup>5</sup>These definitions consider the spatial positions during different intervals, since in section 5.1.3 I will define a local survey to be knowledge that holds during a set of observation intervals. It is in fact possible, for example, for an entity  $x$  to be in the same position twice *instantaneously* and still satisfy  $NPTx$ .

### 5.1.2 Generalized Transitions

Any change occurring (excluding change in spatio-temporal pattern involving a single entity) involves an *EleTran*. For defining transitions between s-t patterns I treat pattern relations as constant symbols rather than as predicates. Thus I define a predicate  $\text{pat}(\mathbf{p}, x)$ : meaning pattern  $\mathfrak{P}$  holds for  $x$ ; where  $\mathbf{p}$  is the lowercase translation of the pattern relation  $\mathfrak{P}$ . I introduce the following definition schema:

$$\mathbf{D60.} \quad \text{pat}(\mathbf{p}, x) \equiv_{def} \mathfrak{P}(x)$$

I now define *pattern transitions* for monadic s-t patterns. A pattern transition for a monadic pattern relation is specified by  $\text{PatTran}(x, p_1, p_2, z_1, z_2)$  where history  $x$  undergoes a transition of pattern from  $p_1$  to  $p_2$ .

$$\mathbf{D61.} \quad \text{PatTran}(x, p_1, p_2, z_1, z_2) \equiv_{def} [\text{pat}(p_1, \frac{x}{z_1}) \wedge \text{pat}(p_2, \frac{x}{z_2}) \wedge \text{EC}_t(z_1, z_2) \wedge \neg(p_1 = p_2)]$$

I define a *generalized transition* from an interval  $z_1$  to an adjacent interval  $z_2$  as being an elementary transition or a pattern transition.

$$\mathbf{D62.} \quad \text{GTrans}(z_1, z_2) \equiv_{def} \exists x, y, r_1, r_2, r, p_1, p_2 [\text{PatTran}(x, p_1, p_2, z_1, z_2) \vee \text{EleTran}(r_1, r, r_2, x, y, z_1, z_2)]$$

It is important to capture the relationship between mobility and change. I shall present two axioms (A25 and A26) which capture such properties. If an object occupies distinct regions of space at different times then it must be  $\neg\text{IMB}$  somewhere in between. I add axiom A25 to capture this constraint.

$$\mathbf{A25.} \quad \neg\text{EQ}_{\text{sp}} \frac{x}{z_1} \frac{x}{z_2} \rightarrow \exists z_3 [z_3 \parallel_t (z_1; z_2) \wedge \neg\text{IMB} \frac{x}{z_3}]$$

Galton [1995] has introduced the concept of ‘dominance’: to say that  $q$  dominates  $p$  is to say that it is possible for  $q$  to hold at an instant which limits (at one or the other end) an open interval over which  $p$  holds. I use the predicate  $\text{Dom}(q, p)$  to express this<sup>6</sup>. In the case of  $\text{R}_{\text{sp}}^=$  relations we can obtain each of the following facts as a theorem:  $\text{Dom}(\text{ec}, \text{dc})$ ,  $\text{Dom}(\text{ec}, \text{po})$ ,  $\text{Dom}(\text{tpp}, \text{po})$ ,  $\text{Dom}(\text{tppi}, \text{po})$ ,  $\text{Dom}(\text{tpp}, \text{ntpp})$ ,  $\text{Dom}(\text{tppi}, \text{ntppi})$ ,  $\text{Dom}(\text{eq}, \text{po})$ ,  $\text{Dom}(\text{eq}, \text{tpp})$ ,  $\text{Dom}(\text{eq}, \text{tppi})$ ,  $\text{Dom}(\text{eq}, \text{ntpp})$ ,  $\text{Dom}(\text{eq}, \text{ntppi})$ . Galton [1995] has analyzed what he terms as *states of motion* and *states of position*. The *states of motion* are dominated by the *states of position*. For  $\text{Dom}(r_1, r_2)$  to be true,  $r_2$  needs to be a state of motion. Therefore at least one of the histories,  $\frac{x}{z_2}$  or  $\frac{y}{z_2}$  must not be immobile (for  $r_2$  holds between  $\frac{x}{z_2}$  and  $\frac{y}{z_2}$ ). I therefore add the following axiom to capture this relationship between dominance and motion.

<sup>6</sup>This is definable within the mereotopological theory from the Instantaneous Transition Matrix analysis.  $\text{Dom}(q, p) \equiv_{def} \exists r, x, y, z_1, z_2 [\text{StrFCONT} \frac{x}{z_1 \cup z_2} \wedge \text{StrFCONT} \frac{y}{z_1 \cup z_2} \wedge \text{InsRel3}(r, q, p, x, y, z_1, z_2)]$ .

$$\mathbf{A26.} \quad [\text{rcc}_{\text{sp}}^{\overline{=}}(r_1, \frac{x}{z_1}, \frac{y}{z_1}) \wedge \text{rcc}_{\text{sp}}^{\overline{=}}(r_2, \frac{x}{z_2}, \frac{y}{z_2}) \wedge \text{Dom}(r_1, r_2) \wedge \\ (z_1 \bowtie_t z_2 \vee z_2 \bowtie_t z_1)] \rightarrow [\neg \text{IMB}_{z_2}^x \vee \neg \text{IMB}_{z_2}^y]$$

### 5.1.3 Specifying the Local Survey $\Phi$

Now I shall specify the format of the observation  $\Phi$  that I am assuming. I will confine myself to considering the observations of a single agent, which records, at a sequence of intervals  $\tau_1, \tau_2, \dots, \tau_n$  the  $\text{R}_{\text{sp}}^{\overline{=}}$  relationships between pairs of objects that it observes and any patterns it notices. Thus  $\Phi$  consists of a conjunction of atoms each of the form  $\text{rcc}_{\text{sp}}^{\overline{=}}(r, \frac{x}{\tau_j}, \frac{y}{\tau_i})$  or  $\text{pat}(p_1, \frac{x}{\tau_j})$ .

I conjoin to  $\Phi$  also the  $n-1$  facts  $\tau_j \bowtie_t \tau_{j+1}$  where  $1 \leq j \leq n-1$ . This has the effect of uniqueness of names assumption for the named interval constants. We may also add statements asserting the agent's belief of the continuity of the histories; for example, that a history  $x$  is strong firm continuous i.e.  $\text{StrFCONT}x$ . We also need to add axioms to express the uniqueness of names for the named objects in the observations. It is also helpful to assume that if the agent observes an object at a particular time interval, then it is able to observe everything about it (i.e. its pattern of behaviour during  $z_1$  and the spatial relationships between it and all the objects it observes during  $z_1$ ). I introduce a predicate  $\text{Obs}(t)$  to mean  $t$  is an observation interval. I will also add the assumption that all objects have the same lifetime. Thus  $\Phi$  consists of:

1. A conjunction  $\text{Obs}(\tau_1) \wedge \dots \wedge \text{Obs}(\tau_n) \wedge \tau_1 \bowtie_t \tau_2 \wedge \dots \wedge \tau_{n-1} \bowtie_t \tau_n$  where  $\tau_1, \dots, \tau_n$  are constant symbols denoting the observation intervals of the agent. Note that unless  $n \geq 2$  then no change can be observed; so I assume  $n \geq 2$ .
2. A conjunction of atomic facts  $\Omega$  expressing observed s-t knowledge at the  $\tau_i$ , for example,  $\text{DC}_{\text{sp}}^{\overline{=}} \frac{\mathbf{b}}{\tau_2} \frac{\mathbf{c}}{\tau_2}$ ,  $\text{EQ}_{\text{sp}}^{\overline{=}} \frac{\mathbf{a}}{\tau_1} \frac{\mathbf{a}}{\tau_4}$ ,  $\text{IMB}_{\tau_2}^a$
3. A conjunction  $\bigwedge^{x_i \in \Gamma} \text{StrFCONT}x_i$  stating that each of the objects in  $\Gamma$  is strongly continuous, where  $\Gamma$  is the set of named objects in  $\Omega$ .
4. An axiom expressing the uniqueness of names of the objects in  $\Gamma$ .
5. The assumption that all objects have the same lifetime:  $\bigwedge^{\alpha, \beta \in \Gamma} \alpha =_t \beta$
6. I assume that during every observation interval  $z_i$  each history follows one of the behaviour patterns. This can be expressed by the following axiom schema, just for the objects in  $\Gamma$ .

$$\mathbf{A27.} \quad \text{Obs}(z_i) \rightarrow \exists p \forall x \in \Gamma [\text{pat}(p, \frac{x}{z_i})]$$

We could also express the global constraint  $\exists p \forall x \in \Gamma [\text{pat}(p, x)]$



### 5.1.4 Selection Heuristics

In general, abduction may yield more than one possible answer. Often abductive reasoning is accompanied by some preference criteria [Sandewall, 1989]. We can express these criteria using heuristics<sup>7</sup>.

My primary heuristic is to choose those explanations that minimize the number of changes of state i.e. exploit some form of ‘global’ persistence or *spatio-temporal inertia*.

#### 5.1.4.1 Global Persistence

Most non-monotonic approaches to reasoning about time and change assume that *fluents* tend to persist if nothing tells us the contrary. In other words, unnecessary change is minimized. I would like to import this *inertia* assumption explicitly into my s-t theory. Prior to this, I need to make a few more definitions and state certain assumptions.

I wish to characterize change in an abstract and qualitative way. I will only consider qualitative change between named histories. Thus purely metric changes which do not result in a qualitative change do not affect the explanations generated, nor do changes involving histories not corresponding to a named object of interest.

Within my s-t theory, a formula  $f_{st}$  (involving spatial relations between one or more space-time histories) whose value evolves over different temporal slices is a *spatio-temporal fluent*. My logical language for describing s-t fluents is  $\Sigma_{ST} \cup \Delta_P$ . Spatio-temporal inertia is expressed by the following reasoning step:

Given that a s-t fluent  $f_{st}$  holds during a given slice  $z_1$ , can we conclude that it holds during the subsequent slice  $z_2$  (where  $z_1 \bowtie_t z_2$ )? For example, if  $IMB_{z_1}^x$  then is  $IMB_{z_2}^x$  true?

There are two different categories of answers to this problem. Provided the s-t fluent  $f_{st}$  is known to be monotonic a priori, abductive inferences under *local survey* do not cause particular problem<sup>8</sup>. It is for abductive inference using non-monotonic s-t fluents that the inertia assumption needs to be exploited.

**Definition 1** *Spatio-temporal change: Given a collection of named s-t histories, a s-t change occurs if  $z_1$  and  $z_2$  are named slices through these histories (with  $z_1 \bowtie_t z_2$ ) and  $GTrans(z_1, z_2)$  is true.*

<sup>7</sup>In order to avoid trivial explanations, a set of predicates is distinguished such that every acceptable explanation must contain only these predicates. Further, given a theory  $\Sigma_{ST}$  and a formula  $\Phi$  to be explained, I add conditions  $\Sigma_{ST} \not\models \Phi$  and  $\Sigma_{ST} \not\models \neg\Phi$  guaranteeing that the set of all explanations is non-empty and non-trivial [Shanahan, 1997].

<sup>8</sup>Monotonicity is convenient because it means we can reason about what an agent believes on the basis of partial knowledge about its beliefs [Konolige, 1988].

**Definition 2** *Episode*: Given a collection of named s-t histories, an episode is the maximal slice through all these histories during which no s-t change occurs. I introduce the predicate  $\text{Episode}(e_i)$  to denote this notion (D63).

$$\begin{aligned} \text{D63. } \text{Episode}(e_i) \equiv_{\text{def}} & \neg \exists z_1, z_2 [\text{IP}(z_1, e_i) \wedge \text{Obs}(z_1) \wedge \text{Obs}(z_2) \wedge (z_1 \bowtie_t z_2) \wedge \\ & \text{GTrans}(z_1, z_2)] \wedge [\text{IP}(\tau_1, e_i) \vee [\exists w_1 (w_1 \bowtie_t e_i) \wedge \text{GTrans}(w_1, e_i)]] \wedge \\ & [\text{FP}(\tau_n, e_i) \vee [\exists w_2 (e_i \bowtie_t w_2) \wedge \text{GTrans}(e_i, w_2)]] \end{aligned}$$

where  $\tau_1$  and  $\tau_n$  are the initial and final observation intervals defined in Section 5.1.3.

**Definition 3** *Episodic Boundary*: Given two episodes  $e_i$  and  $e_j$  such that  $e_i \bowtie_t e_j$ , the episodic boundary is the pair  $(e_i, e_j)$ . I introduce the predicate  $\text{EB}(e_i, e_j)$  to denote this notion.

Note that although an object may be moving during some interval this does not necessarily imply there is any s-t change in our framework. For example, we can have  $\text{NPT}^{\frac{a}{z}}$  but no episode boundaries need occur during  $z$  unless there is some change of binary pattern or an  $\text{R}_{\text{sp}}^{\bar{a}}$  relation involving  $\mathbf{a}$  changes.

### Circumscriptive Theory $\mathcal{C}\mathfrak{I}$

*Circumscription* is a form of nonmonotonic reasoning initially introduced by McCarthy [McCarthy, 1980] and further developed by Lifschitz [Lifschitz, 1994] for reasoning under incomplete information. The basic idea of circumscription is to limit the set of objects of which a predicate is true, a process which is known as *minimising* the predicate.

Let  $\rho_1$  and  $\rho_2$  be predicates with arity  $n$ . Let  $\bar{x}$  be a tuple of  $n$  distinct variables. We have the following notation.

$$\rho_1 = \rho_2 \text{ means } \forall \bar{x} [\rho_1(\bar{x}) \leftrightarrow \rho_2(\bar{x})]$$

$$\rho_1 \leq \rho_2 \text{ means } \forall \bar{x} [\rho_1(\bar{x}) \rightarrow \rho_2(\bar{x})]$$

$$\rho_1 < \rho_2 \text{ means } [\rho_1 \leq \rho_2] \wedge \neg[\rho_1 = \rho_2]$$

Let  $A(\text{Ab}, Z_1, \dots, Z_m)$  be a sentence containing a predicate constant  $\text{Ab}$  and object, function, and/or predicate constants  $Z_1, \dots, Z_m$  (and possibly other object, function and predicate constants). The *circumscription* of  $\text{Ab}$  in  $A$  with *varied*  $Z_1, \dots, Z_m$  is the sentence

$$A(\text{Ab}, Z_1, \dots, Z_m) \wedge \neg \exists ab, z_1, \dots, z_m [A(ab, z_1, \dots, z_m) \wedge ab < \text{Ab}]$$

Here  $ab$  is a predicate variable of the same arity as  $\text{Ab}$ ; if  $Z_i$  is an object constant, then  $z_i$  is an object variable and if  $Z_i$  is a function/predicate constant, then  $z_i$  is a function/predicate

variable of the same arity. The equality symbol is not allowed to appear in the list  $Z_1, \dots, Z_m$ . If  $Z$  denotes the tuple  $Z_1, \dots, Z_m$  and  $z$  denotes the tuple  $z_1, \dots, z_m$ ; then the above formula can be written as

$$A(\text{Ab}, Z) \wedge \neg \exists ab, z [A(ab, z) \wedge ab < \text{Ab}]$$

The subformula  $\neg \exists ab, z [A(ab, z) \wedge ab < \text{Ab}]$  says that the extent of **Ab** is minimal. Minimality is understood as the impossibility of making the extent of the circumscribed predicate smaller even when some of the object, function, or predicate constants occurring in  $A$  are allowed to vary along with **Ab** in the process of minimizing its extent. The above formula is denoted as  $\text{CIRC}[A; \text{Ab}; Z]$ .

### Minimizing Spatio-Temporal Change

Some changes are forced by the observations, for example, if  $\{\text{DC}_{\text{sp}}^=(\frac{x}{z_1}, \frac{y}{z_1}), \text{EC}_{\text{sp}}^=(\frac{x}{z_2}, \frac{y}{z_2}), z_1 \bowtie_t z_2\} \subseteq \Phi$  then  $\text{GTrans}(z_1, z_2)$  is forced. However, if  $\{\text{IMB}_{z_1}^x, \text{IMB}_{z_3}^x, (z_2 \parallel_t (z_1; z_3))\} \subseteq \Phi$  and nothing else is known about  $x$  in  $\Phi$  then I want to assume that there is no change of pattern for  $x$  in  $z_2$ . This is akin to the commonsense law of inertia.

Spatio-temporal inertia is achieved by minimizing  $\text{GTrans}$  and thus the number of episodes. This is done by posing the problem as a *circumscriptive theory* under minimization of generalized transition  $\text{GTrans}$ <sup>9</sup>.

**A1.**  $\Sigma_{\text{ST}}$

**A2.**  $\Delta_{\text{P}}$

**A3.**  $\Phi$

**P1.** **circ**  $\text{GTrans}$  **var**  $\Lambda$

where  $\Lambda$  is the set of predicates that may occur in s-t fluents.

#### Example 1

Let us assume the scenarios as shown in Figure 5.4 for an autonomous agent, **a**, with on-board vision in an inhabited environment<sup>10</sup>.

There are two qualitatively different temporal parts: initially (during  $\tau_1$ ) **a** sees only **c**, then (during  $\tau_2$ ) it sees **b** as well. Thus during  $\tau_1$  we have

$$\{\text{DC}_{\text{sp}}^=\frac{\mathbf{a}}{\tau_1} \frac{\mathbf{c}}{\tau_1}, \text{IMB}_{\tau_1}^{\mathbf{c}}, \text{NPT}_{\tau_1}^{\mathbf{a}}\} \subseteq \Phi$$

<sup>9</sup>The circumscriptive theory here is defined using the notation in [Lifschitz, 1994, pages 307-308]. Instead of  $\text{CIRC}[A; \text{Ab}; Z]$ , the theory axioms  $A$  (A1 to A3) are listed, followed by the circumscription policy **circ**  $\text{Ab}$  **var**  $Z$  (P1).

<sup>10</sup>I am not concerned here with issues of lower level vision such as segmentation and recognition of objects. I assume that such lower level vision algorithms are available. I also assume an ability to anchor specific regions in the robot's visual image field to named objects.

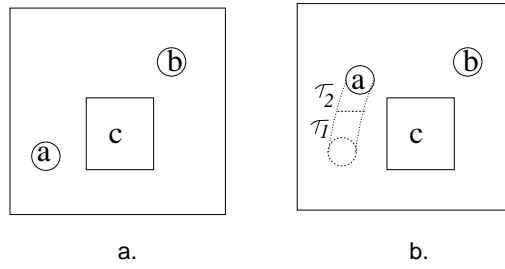

Figure 5.4: Scenarios of an inhabited dynamic environment: **a.** initial state, **b.** final state showing path with dotted lines. Two observation intervals  $\tau_1$  and  $\tau_2$  are represented.

and during  $\tau_2$  we have

$$\{DC_{sp}^{\frac{a}{\tau_2} \frac{c}{\tau_2}}, DC_{sp}^{\frac{a}{\tau_2} \frac{b}{\tau_2}}, DC_{sp}^{\frac{b}{\tau_2} \frac{c}{\tau_2}}, IMB_{\tau_2}^{\frac{c}{\tau_2}}, IMB_{\tau_2}^{\frac{b}{\tau_2}}, NPT_{\tau_2}^{\frac{a}{\tau_2}}\} \subseteq \Phi$$

It can also record the *pure* spatial relationships between  $\tau_1$  and  $\tau_2$ , i.e.,

$$\{EQ_{sp}^{\frac{c}{\tau_1} \frac{c}{\tau_2}}, PO_{sp}^{\frac{a}{\tau_1} \frac{a}{\tau_2}}\} \subseteq \Phi$$

Since  $\Sigma_{ST} \cup \Delta_P \cup \Phi$  does not imply any change of pattern or change of  $R_{sp}^{\equiv}$  relationship between  $\tau_1$  and  $\tau_2$ , minimizing GTrans will in fact result in an empty extension for GTrans. Thus there are no episodic boundaries and the only explanation possible is<sup>11</sup>:

$$\Delta_H = [IMB_{\tau_1}^{\frac{b}{\tau_1}} \wedge DC_{sp}^{\frac{b}{\tau_1} \frac{c}{\tau_1}} \wedge DC_{sp}^{\frac{a}{\tau_1} \frac{b}{\tau_1}} \wedge \neg GTrans(\tau_1, \tau_2)]$$

The first conjunct is of particular interest in this example.  $IMB_{\tau_1}^{\frac{b}{\tau_1}}$  is abduced from the observation  $IMB_{\tau_2}^{\frac{b}{\tau_2}}$  based on an empty extension for GTrans. Of course if I did not make the assumption, in Section 5.1.3, that all objects have the same lifetime, then other explanations might be possible (provided I extended the notion of GTrans to incorporate changes owing to objects coming into existence and ceasing to exist). Also note that if **a** was involved in some change from  $\tau_1$  to  $\tau_2$  (for example,  $DC_{sp}^{\frac{a}{\tau_1} \frac{c}{\tau_1}}$  to  $EC_{sp}^{\frac{a}{\tau_2} \frac{c}{\tau_2}}$ ) then an episodic boundary would be forced, and changes involving **b** could occur ‘for free’, thus resulting in multiple explanations (for example, where **b** starts moving during  $\tau_2$ ). Later, in section 5.1.4.2, I discuss how these might be avoided.

### Example 2

Consider another scenario for the autonomous agent **a** as shown in Figure 5.5.

There are three qualitatively different observation intervals : initially (during  $\tau_1$ ) **a** sees **b** and **c**. Thus we have

<sup>11</sup>Note that for those observations which do not change during  $\Phi$  (for example, the  $R_{sp}^{\equiv}$  relation between **a** and **c**), no explanation is produced. A solution is to add an initial observation interval  $\tau_0$ , without any observations. The abduction procedure would then abduce that the values must also hold in  $\tau_0$ . Thus the  $\tau_0$  values would also appear in the abduced formulae  $\Delta_H$ . The explanation of any observation which does not change during  $\Phi$ , for example,  $DC_{sp}^{\frac{a}{\tau_1} \frac{c}{\tau_1}}$  would thus be that **a** and **c** were  $DC_{sp}^{\equiv}$  just before  $\tau_1$  and  $\neg EB(\tau_0, \tau_1)$ .

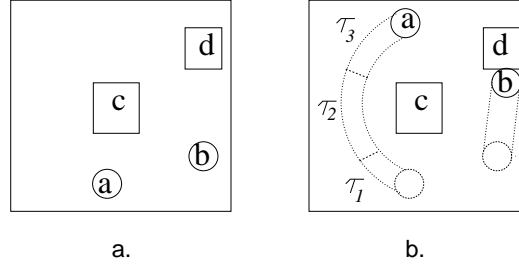

Figure 5.5: Set of scenarios for autonomous agent **a** in an inhabited dynamic environment. **a.** initial state, **b.** final state showing path with dotted lines. Three observation intervals  $\tau_1, \tau_2$  and  $\tau_3$  are represented.

$$\left\{ \text{DC}_{\tau_1}^{\mathbf{a} \mathbf{b}}, \text{DC}_{\tau_1}^{\mathbf{a} \mathbf{c}}, \text{DC}_{\tau_1}^{\mathbf{c} \mathbf{b}}, \text{IMB}_{\tau_1}^{\mathbf{c}}, \text{NPT}_{\tau_1}^{\mathbf{b}}, \text{NPT}_{\tau_1}^{\mathbf{a}} \right\} \subseteq \Phi$$

Then (during  $\tau_2$ ) it sees only **c** i.e.,

$$\left\{ \text{DC}_{\tau_2}^{\mathbf{a} \mathbf{c}}, \text{IMB}_{\tau_2}^{\mathbf{c}}, \text{NPT}_{\tau_2}^{\mathbf{a}} \right\} \subseteq \Phi$$

and finally (during  $\tau_3$ ) it sees **b** again and also **d** for the first time:

$$\left\{ \text{DC}_{\tau_3}^{\mathbf{a} \mathbf{b}}, \text{DC}_{\tau_3}^{\mathbf{a} \mathbf{c}}, \text{DC}_{\tau_3}^{\mathbf{a} \mathbf{d}}, \text{DC}_{\tau_3}^{\mathbf{b} \mathbf{c}}, \text{EC}_{\tau_3}^{\mathbf{b} \mathbf{d}}, \text{DC}_{\tau_3}^{\mathbf{c} \mathbf{d}}, \text{IMB}_{\tau_3}^{\mathbf{b}}, \text{IMB}_{\tau_3}^{\mathbf{c}}, \text{IMB}_{\tau_3}^{\mathbf{d}}, \text{NPT}_{\tau_3}^{\mathbf{a}} \right\} \subseteq \Phi$$

It can also record the *pure* spatial relationships. Thus we also have the following:

$$\left\{ \text{EQ}_{\tau_1}^{\mathbf{c} \mathbf{c}}, \text{EQ}_{\tau_2}^{\mathbf{c} \mathbf{c}}, \text{PO}_{\tau_1}^{\mathbf{a} \mathbf{a}}, \text{PO}_{\tau_2}^{\mathbf{a} \mathbf{a}}, \text{DC}_{\tau_1}^{\mathbf{b} \mathbf{b}} \right\} \subseteq \Phi$$

With these observations, based on the s-t patterns and minimization of GTrans, we have a single episodic boundary (i.e. 2 episodes) though it may occur either after  $\tau_1$  or after  $\tau_2$ . The following formula is one possible explanation of the *local survey* made by **a**:

$$\Delta_H = \left[ \text{IMB}_{\tau_2}^{\mathbf{b}} \wedge \text{IMB}_{\tau_2}^{\mathbf{d}} \wedge \text{DC}_{\tau_2}^{\mathbf{a} \mathbf{b}} \wedge \text{DC}_{\tau_2}^{\mathbf{c} \mathbf{d}} \wedge \text{EC}_{\tau_2}^{\mathbf{b} \mathbf{d}} \wedge \text{GTrans}(\tau_1, \tau_2) \right]$$

Alternatively the episode boundary may occur after  $\tau_2$  rather than after  $\tau_1$ :

$$\Delta_H = \left[ \text{NPT}_{\tau_2}^{\mathbf{b}} \wedge \text{DC}_{\tau_2}^{\mathbf{a} \mathbf{b}} \wedge \text{DC}_{\tau_2}^{\mathbf{c} \mathbf{d}} \wedge \text{GTrans}(\tau_2, \tau_3) \right]$$

Note that in neither of these explanations can we infer knowledge about **d** before the episode boundary.

#### 5.1.4.2 Additional Heuristics

In the preceding section I have shown how circumscribing GTrans addresses the issue of ‘global’ s-t inertia. As we have seen, in some very simple cases this may be sufficient to generate a unique explanation. However, in general, multiple explanations will still be possible. [Hazarika and Cohn, 2002] explore some further heuristics which might be used to prefer one explanation to another. Here are some such possible heuristics:

1. Prefer explanations where change happens as late as possible (i.e., the initial state extends for as long as possible)
2. Prefer explanations where change happens as early as possible (i.e., the final state extends as far back in time as possible)
3. Prefer explanations where the total ‘number of changes’ is minimal (i.e., if we count the number of changes at each episode boundary, and sum these, then this sum is minimal). There are variants of this, for example, where one minimizes the number of changes at the last or the first episodic boundary.
4. Assume some a priori knowledge on the kinds of change which might occur (for example, certain patterns are more likely and/or certain objects more likely to be immobile).

### Example 3

Let us consider another scenario as illustrated in Figure 5.6 below.

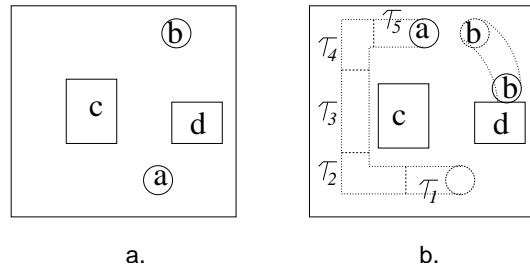

Figure 5.6: Scenarios for autonomous agent **a** in an inhabited dynamic environment. **a.** initial state, **b.** final state showing path with dotted lines. Five observation intervals  $\tau_1, \tau_2, \tau_3, \tau_4$  and  $\tau_5$  are represented.

There are five qualitatively different observation intervals as shown in Figure 5.6(b). Initially (during  $\tau_1$ ) **a** sees **c**, **d** and **b**. Thus we have

$$\{DC_{\tau_1 \tau_1}^{\mathbf{a} \mathbf{b}}, DC_{\tau_1 \tau_1}^{\mathbf{a} \mathbf{c}}, DC_{\tau_1 \tau_1}^{\mathbf{a} \mathbf{d}}, DC_{\tau_1 \tau_1}^{\mathbf{b} \mathbf{c}}, DC_{\tau_1 \tau_1}^{\mathbf{b} \mathbf{d}}, DC_{\tau_1 \tau_1}^{\mathbf{c} \mathbf{d}}, IMB_{\tau_1}^{\mathbf{b}}, IMB_{\tau_1}^{\mathbf{c}}, IMB_{\tau_1}^{\mathbf{d}}, NPT_{\tau_1}^{\mathbf{a}}\} \subseteq \Phi$$

Then, (during  $\tau_2$ ) it sees **c** and **d** but not **b** i.e,

$$\{DC_{\tau_2 \tau_2}^{\mathbf{a} \mathbf{c}}, DC_{\tau_2 \tau_2}^{\mathbf{a} \mathbf{d}}, DC_{\tau_2 \tau_2}^{\mathbf{c} \mathbf{d}}, IMB_{\tau_2}^{\mathbf{c}}, IMB_{\tau_2}^{\mathbf{d}}, NPT_{\tau_2}^{\mathbf{a}}\} \subseteq \Phi$$

Thereafter during  $\tau_3$ , it does not see anything other than **c**. Thus we have

$$\{DC_{\tau_3 \tau_3}^{\mathbf{a} \mathbf{c}}, IMB_{\tau_3}^{\mathbf{c}}, NPT_{\tau_3}^{\mathbf{a}}\} \subseteq \Phi$$

After that, during  $\tau_4$ , it sees **b** as well as **c**:

$$\{DC_{\tau_4 \tau_4}^{\mathbf{a} \mathbf{b}}, DC_{\tau_4 \tau_4}^{\mathbf{a} \mathbf{c}}, DC_{\tau_4 \tau_4}^{\mathbf{b} \mathbf{c}}, IMB_{\tau_4}^{\mathbf{c}}, NPT_{\tau_4}^{\mathbf{b}}, NPT_{\tau_4}^{\mathbf{a}}\} \subseteq \Phi$$

Finally during  $\tau_5$ , it sees **d** again

$$\{DC \frac{\mathbf{a}}{\tau_5} \frac{\mathbf{b}}{\tau_5}, DC \frac{\mathbf{a}}{\tau_5} \frac{\mathbf{c}}{\tau_5}, DC \frac{\mathbf{a}}{\tau_5} \frac{\mathbf{d}}{\tau_5}, DC \frac{\mathbf{b}}{\tau_5} \frac{\mathbf{c}}{\tau_5}, EC \frac{\mathbf{b}}{\tau_5} \frac{\mathbf{d}}{\tau_5}, DC \frac{\mathbf{c}}{\tau_5} \frac{\mathbf{d}}{\tau_5}, IMB \frac{\mathbf{c}}{\tau_5}, IMB \frac{\mathbf{d}}{\tau_5}, NPT \frac{\mathbf{b}}{\tau_5}, NPT \frac{\mathbf{a}}{\tau_5}\} \subseteq \Phi$$

It can also record the *pure* spatial relationships. Thus we also have the following

$$\{EQ \frac{\mathbf{c}}{\tau_1} \frac{\mathbf{c}}{\tau_2}, EQ \frac{\mathbf{c}}{\tau_2} \frac{\mathbf{c}}{\tau_3}, EQ \frac{\mathbf{c}}{\tau_3} \frac{\mathbf{c}}{\tau_4}, EQ \frac{\mathbf{c}}{\tau_4} \frac{\mathbf{c}}{\tau_5}, EQ \frac{\mathbf{d}}{\tau_1} \frac{\mathbf{d}}{\tau_2}, PO \frac{\mathbf{a}}{\tau_1} \frac{\mathbf{a}}{\tau_2}, PO \frac{\mathbf{a}}{\tau_2} \frac{\mathbf{a}}{\tau_3}, PO \frac{\mathbf{a}}{\tau_3} \frac{\mathbf{a}}{\tau_4}, PO \frac{\mathbf{a}}{\tau_4} \frac{\mathbf{a}}{\tau_5}, PO \frac{\mathbf{b}}{\tau_3} \frac{\mathbf{b}}{\tau_4}, PO \frac{\mathbf{b}}{\tau_4} \frac{\mathbf{b}}{\tau_5}, DC \frac{\mathbf{b}}{\tau_1} \frac{\mathbf{b}}{\tau_4}, DC \frac{\mathbf{b}}{\tau_1} \frac{\mathbf{b}}{\tau_5}\} \subseteq \Phi$$

Although there are four potential locations for episodic boundaries, circumscribing GTrans results in only two episodes, with alternative locations for the episodic boundary as shown in the two explanations below:

$$\begin{aligned} \Delta_H &= [NPT \frac{\mathbf{b}}{\tau_2} \wedge NPT \frac{\mathbf{b}}{\tau_3} \wedge IMB \frac{\mathbf{d}}{\tau_3} \wedge IMB \frac{\mathbf{d}}{\tau_4} \wedge DC \frac{\mathbf{a}}{\tau_2} \frac{\mathbf{b}}{\tau_2} \wedge DC \frac{\mathbf{a}}{\tau_3} \frac{\mathbf{b}}{\tau_3} \wedge \\ &\quad DC \frac{\mathbf{a}}{\tau_3} \frac{\mathbf{d}}{\tau_3} \wedge DC \frac{\mathbf{a}}{\tau_4} \frac{\mathbf{d}}{\tau_4} \wedge DC \frac{\mathbf{c}}{\tau_3} \frac{\mathbf{d}}{\tau_3} \wedge DC \frac{\mathbf{c}}{\tau_4} \frac{\mathbf{d}}{\tau_4} \wedge GTrans(\tau_1, \tau_2)] \\ \Delta_H &= [IMB \frac{\mathbf{b}}{\tau_2} \wedge IMB \frac{\mathbf{b}}{\tau_3} \wedge IMB \frac{\mathbf{d}}{\tau_3} \wedge IMB \frac{\mathbf{d}}{\tau_4} \wedge DC \frac{\mathbf{a}}{\tau_2} \frac{\mathbf{b}}{\tau_2} \wedge DC \frac{\mathbf{a}}{\tau_3} \frac{\mathbf{b}}{\tau_3} \wedge \\ &\quad DC \frac{\mathbf{a}}{\tau_3} \frac{\mathbf{d}}{\tau_3} \wedge DC \frac{\mathbf{a}}{\tau_4} \frac{\mathbf{d}}{\tau_4} \wedge DC \frac{\mathbf{c}}{\tau_3} \frac{\mathbf{d}}{\tau_3} \wedge DC \frac{\mathbf{c}}{\tau_4} \frac{\mathbf{d}}{\tau_4} \wedge GTrans(\tau_3, \tau_4)] \end{aligned}$$

## Binary Behaviour Patterns

In my earlier presentation of spatial behaviour patterns, I only considered monadic patterns involving a single s-t history. However, in general one might consider patterns involving two or more histories and if such behaviour patterns can be preferentially associated with particular sorts of objects, then this will provide additional heuristic knowledge to constrain possible explanations. In the case of pairs of spatial entities,  $x, y$ , Figure 5.7 shows some possible patterns for rigid objects which do not interpenetrate each other. These are:

1. Coalescence COL $xy$ : a *coming together* of two bodies for a period.
2. Separation SEP $xy$ : Separation of two bodies that have previously behaved as a unit for a period. This is the dual of coalescence.
3. Collision CLN $xy$ : a dynamic event when two bodies come into *contact and separate again*. A collision could be *instantaneous* or a *coalescence* followed by a *separation*.
4. Disjointness DIS $xy$ : Two bodies remain disjoint for a period.
5. Attachment ATT $xy$ : Two bodies remain attached for a period.

It is straightforward to define these patterns in terms of the existing apparatus except that in order to define DIS $xy$ , I define a predicate IntP $xy$  :  $x$  is an interior part of  $y$ .

$$\mathbf{D64.} \quad \text{IntP}xy \equiv_{def} \exists z_1, z_2 [\text{TS}xy \wedge \text{IP}z_1y \wedge \text{FP}z_2y \wedge x \parallel_t (z_1; z_2)]$$

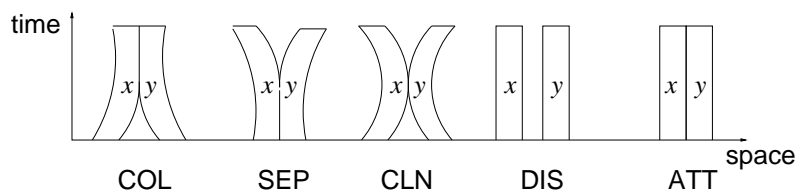

Figure 5.7: A selection of binary spatio-temporal patterns.

D65 through D67 provide the object level definitions for the first three binary spatio-temporal patterns. D68 and D69 define disjointness and attachment respectively.

$$\mathbf{D65.} \quad \text{COL}xy \equiv_{def} \exists u, v [u \sqsubset_t x \wedge u \bowtie_t v \wedge v \supset_t x \wedge x =_t y \wedge \text{Trans}(\text{dc}, \text{ec}, x, y, u, v)]$$

$$\mathbf{D66.} \quad \text{SEP}xy \equiv_{def} \exists u, v [u \sqsubset_t x \wedge u \bowtie_t v \wedge v \supset_t x \wedge x =_t y \wedge \text{Trans}(\text{ec}, \text{dc}, x, y, u, v)]$$

$$\mathbf{D67.} \quad \text{CLN}xy \equiv_{def} \exists u, v, w [u \sqsubset_t x \wedge v \parallel_t (u; w) \wedge w \supset_t x \wedge x =_t y \wedge [\text{Trans}(\text{dc}, \text{ec}, x, y, u, v) \wedge \text{Trans}(\text{ec}, \text{dc}, x, y, v, w)] \vee \text{InsRel3}(\text{dc}, \text{ec}, \text{dc}, x, y, u, v)]$$

$$\mathbf{D68.} \quad \text{DIS}xy \equiv_{def} \forall u, v [[\text{IntP}ux \wedge \text{IntP}vy] \rightarrow \text{DC}uv]$$

$$\mathbf{D69.} \quad \text{ATT}xy \equiv_{def} \forall t [(t \sqsubseteq_t x \wedge t \sqsubseteq_t y) \rightarrow \text{EC}_{\text{sp}} \frac{x}{t} \frac{y}{t}]$$

Clearly many other possible binary patterns are possible. For example, Muller [Muller, 1998b] presents other examples of binary patterns (for example, crossing, leaving, entering) including cases where interpenetration occurs. One can think of many domain examples where such patterns might be prototypically associated with particular kinds of object pairs; for example, in a woodworking domain, a nail and piece of wood would typically either have a COL or a DIS behaviour pattern. Similarly, Egenhofer [Egenhofer and Al-Taha, 1992] discusses how various patterns of behaviours for deformable objects can be associated with paths through a transition network (for example, expanding, contracting). These could form possible (complex) patterns.

My notion of generalized transition,  $\text{GTrans}$ , was defined in terms of monadic pattern transitions; clearly, including binary (or higher arity patterns) in my language would mean modifying  $\text{GTrans}$  in order to ensure that changes of these kinds of pattern also force an episodic boundary.

### 5.1.5 What is achieved?

I present here a method which exploits the mereotopological theory of space-time and the heuristic of spatio-temporal inertia in order to infer qualitative s-t world models from



local surveys using circumscription. The existence of multiple explanations is a general characteristic of abduction and even using inertia as a heuristic, many explanations will remain in general. I have discussed some possible further heuristics to prefer certain explanations, but without much more domain specific background knowledge, ambiguity will always be present.

## 5.2 Summary of Work

### 5.2.1 Contributions

I have developed a mereotopological spatio-temporal theory based on space-time histories. The explicit definition for qualitative continuity as initially proposed in [Muller, 1998b; 1998c] and thereafter (partially) corrected in [Muller, 1998a; 2002] is strengthened to capture accurately the intuitive notion of continuity. This is the notion implicitly assumed in the standard RCC-8 conceptual neighbourhood diagram. I refer to it as **StrFCONT**: *strong firm* continuity.

Relations holding between contemporaneous slices from a pair of **StrFCONT** histories change without spatial leaps, temporal gaps or temporal pinching. Any transition which does not fall into the above category is a non-transition under strong firm continuity. Such transitions do not appear in the standard RCC-8 transition graph. Formal proofs for non-transitions between **StrFCONT** histories were obtained and I have partially recovered the RCC-8 conceptual neighbourhood within pointless mereotopology.

I have pointed out a potential application based on the spatio-temporal language of histories. The envisaged application is of constructing a qualitative spatio-temporal world model from partial observations.

#### 5.2.1.1 Taking *histories* further

Even though very early on in AI, Hayes [1979; 1985b] suggested an ontology of space-time histories for commonsense reasoning, it was Muller who took up the idea seriously and developed a mereotopological theory of space-time [Muller, 1998c]. The spatio-temporal theory developed in this thesis is inspired by Muller's attempt at recovering the transition graph for RCC-8 through an explicitly stated intuitive notion of continuity in a language over histories.

In Chapter 3, I presented a mereotopological theory which closely follows [Muller, 1998c]. Muller makes topological distinctions viz. closed and open regions (as his theory is based on Asher and Vieu's [1995]), which according to us have no significance for a

commonsense theory. My mereotopological theory is based on RCC and (is simpler as) I do not make any such distinctions.

I include an explicit spatial connection  $C_{sp}$  apart from spatio-temporal and temporal connection. This is distinct from spatial connection of contemporaneous entities and captures directly the intuition of *same place, possibly different time*.

I introduce a function for a temporal slice. I define interval<sup>12</sup> relations over non-convex intervals and I am able to prove self-connected entities are temporally well ordered.

### 5.2.1.2 Intuitive Spatio-Temporal Continuity

Representing individual changes is a first step towards the integration of time with a spatial information system. For example, geographic entities have a transient life-style: they come into being and may subsequently go out of existence [Hornsby and Egenhofer, 2000]. There can be many other dimensions of change such as changing shape, location or thematic information [Galton, 2000a]. What is it that enables a geographic entity after any such change to be recognized as the one before (such a change)? Notions of spatio-temporal continuity holds a key to providing an answer to such queries. A complementary theoretical issue is the development of formal models for studying spatio-temporal interactions within an integrated spatio-temporal framework.

I have refined Muller's definition of intuitive spatio-temporal continuity [Muller, 1998b; 1998c]. To avoid temporal pinching, the notion of firm continuity was introduced<sup>13</sup>. The additional axioms A20 and A21 for capturing the intuitive notion of strong spatio-temporal continuity (within pointless mereotopology) are a significant addition to the explicit definition of strong firm continuity stated in a language over histories. These axioms reinforce that for an intuitive notion of continuity, it is important to consider relationship between parts of a history to other parts of the same history and to regions outside the history.

### 5.2.1.3 Transition between Histories

I have presented a general formal framework for continuous transitions in mereotopology for space-time histories. Transition rules for s-t histories were formulated in pure pointless mereotopology. StrFCONT histories do not allow transitions involving spatial leaps, temporal gaps or temporal pinching.

<sup>12</sup>Recall that "intervals" are in fact s-t histories, but where I am only interested in the temporal extent. An interval  $z$  is the temporal extent of  $z$ , where  $z$  can be any s-t history.

<sup>13</sup>Independently, I had arrived at the notion of firm continuity and discussed it in [Cohn and Hazarika, 2001a]. Personal communication with Muller brought to light he had a similar correction in temporal continuity [Muller, 2002].

## Recovering the RCC-8 Transition Graph

I axiomatise continuous transitions under strong firm continuity. By establishing that the links absent from the RCC-8 transition graph are non-transitions for StrFCONT histories, I have partially recovered the conceptual neighbourhood diagram.

Muller had flaws in the statement of his transition rules as pointed out by Davis [2001]. Davis presents an alternative characterization which however sacrifices the spirit of mereotopology. Our formulation of the transition rules require a simpler mereotopology which does not have closure and interior operators. I do not have explicit temporal points and do not need to introduce a set of RCC relations defined in terms of an instantaneous relation (holding at the transition) as in [Davis, 2000]. I analyze and axiomatize from first principles which relations can hold instantaneously at the temporal boundary of two intervals. This is based on Boolean combinations of the two regions and their FCON relationship, which prompted the analysis presented in Section 4.4, Chapter 4, leading to formulation of the instantaneous transition matrix. Transitions as understood for change of RCC-8 relations are defined in terms of *durative* relations - relations that hold continuously over an interval of time. This I feel is closer to the intuitive understanding of transition between spatial relations.

### 5.2.2 Critical Evaluation

I started with the motivation of correcting the statement of transition rules in Muller's language over histories. This led to the realization that Muller's definition of qualitative continuity is inadequate<sup>14</sup>.

#### 5.2.2.1 Continuity: What did we not attempt?

In Chapter 4, an intuitive notion of spatio-temporal continuity was defined. My attempt to categorize spatio-temporal continuity is not an attempt to clarify the wider philosophical question of identity criteria, which is difficult and beyond the scope of this thesis.

I acknowledge that identity and continuity are interdependent and make the following observations in regards to identity and continuity in geographic space: 1. Continuity is a necessary but not a sufficient condition for identity<sup>15</sup>.

<sup>14</sup>Davis' theorem concerning Muller's explicit definition of qualitative continuity and Galton's observation with respect to intuitive continuity (as stated in Section 2.7.2, Chapter 2) provides additional evidence.

<sup>15</sup>For fiat objects, the notion of continuity may not conform to *any* spatio-temporal form of continuity. For example, Stollberg a district in Saxony, Germany, dates back to the *Amtshauptmannschaft Stollberg*. The district was established in 1910. In 1939 it was renamed to Landkreis. In 1950 the district was dissolved and the municipalities were assigned to the neighbouring districts of Aue, Chemnitz and Zwickau. However two years later in another reform the district was recreated, only with a different layout. This history is not continuous in terms of the spatio-temporal form of continuity defined in Chapter 4. However, it does

Spatio-temporal continuity, then, is a criterion of identity on which I rely for most of my judgements of identity. Is it a metaphysically sufficient condition for the persistence of an object? Obviously not; a tree can burn until it is just a pile of ash, though there were no leaps through space or time. Is it a necessary condition? Apparently so, in my experience, and in the experience of a vast number of people who have expressed their opinions on the subject either implicitly or explicitly.

Ray[1998]

2. A change of the continuity criteria would change the identity criteria. For example, the notion of and what constitutes a river: depending on our notion of continuity, a river which had previously been dry can be regarded as a new river, or the same river as when it last ran.

### 5.2.2.2 Recovering the Transition Graph: What is left out?

For recovering the RCC-8 conceptual neighbourhood diagram, my approach is closer to Muller's than to Davis' in that I present a *naive physical* theory, rather than one closely based on mathematical topology. I present a comprehensive framework and introduce operators to characterize transitions. There are two aspects to proving the correctness of the conceptual neighbourhood diagram: (a) links that are present need to be shown to be necessary and (b) those absent to be shown to represent discontinuous transitions. The latter is a theorem proving task but the former requires model building and appears to be much harder to be automated (though see [Winker, 1982; McCune, 2001]). I confine myself only to the second task.

In the absence of intended models and a syntactic proof of completeness, the only way to know that the axiomatisation fulfills my intentions to characterize continuous transitions is by proving 'transition theorems'. I have shown links absent from the RCC-8 transition graph to be non-transitions for StrFCONT histories. The approach may not be entirely intuitively satisfying<sup>16</sup> but in itself is a non-trivial task.

Certainly, proving the correctness of rules that state the non-existence of transitions, or worse, those that state the existence of transitions, from plausible mereotopological axioms, would seem to be daunting if not hopeless . . . . It

---

have a notional *cultural* and *legal* continuity. Discussion of such notions of continuity is beyond the scope of this thesis.

<sup>16</sup>One might possibly object to use of the 4x4 transition matrix for characterizing the instantaneous transition.

seems doubtful to me, however, that such a characterization could be found that would be entirely satisfying.

Davis [2000, page 8]

Even though I have shown all non-existent links to be invalid transitions for StrFCONT histories, in absence of formal proofs for existence of transition for the links present in the RCC-8 transition graph the recovery of the conceptual neighbourhood remains partial.

## 5.3 Further Work

There remain many avenues for further research. Some of these concern the foundation of qualitative spatio-temporal reasoning encompassing automated reasoning and the use of space-time histories, whilst others are areas which may lead to application (including extension and development) of the mereotopological theory of space-time (proposed in Chapter 3).

### 5.3.1 Proof of Consistency

To prove consistency it would suffice to construct a model for the axioms, a concrete interpretation for the symbols of the theory under which all the axioms are true. The theory described here has the Region Connection Calculus as its basis, which is shown to be consistent by Gotts [1996] since he isolates a class of models. The introduction of the additional axioms extending RCC have all been justified, normally through a graphical illustration of an undesired model, and the resulting axioms are specifically designed and intended just to remove these undesired models.

Moreover, I have used SPASS to help justify the consistency of the theory: every time I introduced an additional axiom, I used SPASS to reason forward from the axioms and theorems in the theory thus far; if a refutation had been found, this would have indicated an inconsistent theory. In no case was an inconsistency detected. However, owing to the semi-decidability of FOPC, I had to resource limit SPASS, and thus no conclusive proof of consistency was obtained. I thus leave for future work the important issue of a formal demonstration of consistency of the space-time theory presented here. It is possible that the use of an automated model building techniques e.g. [Peltier, 2003; Caferra, 2004] may be of assistance, though the fact that any model of the theory will have an infinite universe (as an immediate consequence of C1). Alternatively methods such as demonstrated by [Davis and Morgenstern, 2004] may lead to a fully justified demonstration of the consistency of the theory.

### 5.3.2 Experiments with Theorem Proving

For me here, proving theorems was part of the process of verification of the axiomatisation. Although I was aware of the theoretical undecidability and intractability of 1st-order reasoning, the seriousness of the difficulties that these properties pose for automated reasoning was highlighted whilst working with the mereotopological theory. Even seemingly simple deductions (sought within the complete axiom set) would often exhaust the available resources. This isn't surprising or any different from what others have experienced and reported [Wos *et al.*, 1991; Reif and Schellhorn, 1997; Bennett, 1997].

During automated theorem proving, the success rates and the proof times strongly depend on how good provers are at finding out the few relevant axioms that are really needed in the proofs. Use of reduction techniques (see Appendix D) as suggested in [Reif and Schellhorn, 1997; Amir and McIlraith, 2000] did help in obtaining many of the proofs presented in Appendix D and Appendix E. A detailed study and complete analysis to explore how far automated reasoning (within qualitative spatio-temporal reasoning through space-time histories) can be achieved by a general purpose proof system is worthy of further research. For such a study, apart from the space-time and the transition theorems discussed here, of particular interest and of relevance to the work in this thesis would be including the hierarchy of CNDs presented in Section 4.2, Chapter 4.

### 5.3.3 Extending the Abductive Formalism

Facing the practical challenge of dealing with the potentially very large number of possible explanations that may be present in a realistic example and developing computational methods of ensuring that these are handled efficiently is an important area for future research.

I have restricted myself to a purely mereotopological qualitative s-t language. Increasing the expressiveness of the language by allowing other kinds of qualitative s-t knowledge (for example, of orientation, size, distance, shape [Cohn and Hazarika, 2001b]) may have benefits in reducing ambiguity as multiple kinds of knowledge interact. Similarly, metric s-t knowledge may be included where available. A priori knowledge about what kinds of behaviour patterns are (preferentially) associated with particular kinds of object or agent may help reduce the possible explanations that may be abduced. Creating suitable libraries of such behaviours is thus an important (probably domain specific) task. If there are a large number of possible such behaviours then this knowledge acquisition problem may be non-trivial. In such cases, it would be useful to learn these automatically from training data (cf. [Fernyhough *et al.*, 2000]).

Another problem (mentioned by Shanahan [1998]) of great practical importance in an abductive scenario is that of noise in the data. One advantage of using a qualitative representation is that some noise is lost in the abstraction process, though in general the problem will remain. In this context it will be useful to consider the use of qualitative languages which explicitly allow for this such as the extension of RCC to handle indeterminate boundaries [Cohn and Gotts, 1996].

One issue that I have totally ignored is the problem of object identification over time. For example, consider the problem of tracking a mobile object over time from video data. Of course, this problem could itself be made subject to abduction: one probable explanation of two similarly shaped objects close to each other in time and space is that they are the same object. Another restriction made for the sake of simplicity here is that there is a single time line  $(\tau_1, \dots, \tau_n)$ . However if we wanted to extend the theory to handle multiple cooperating local agents performing surveys asynchronously, then we would need to allow multiple time lines. How this is to be accomplished within the spatio-temporal language over histories requires further investigation.

Finally, I note that the theory is potentially applicable to various other domains in which partial s-t knowledge is available and it is desirable to infer a complete scenario. One such task would be the problem of inferring what has happened between various ‘global snapshots’ such as geographical surveys (or remote sensing data) taken at periodic intervals. Experimenting with and evaluating the approach outlined here in such contexts would also be an area worthy of research.





# Appendix A

## Reference of Formulae

---

The appendix lists all formulae which have appeared before in article(s) not authored by me. The column on the left lists the formula<sup>1</sup> and the reference on the right say where it appeared before.

<b>Formula</b>	<b>Reference</b>
<b><u>Axioms</u></b>	
A1-A2	[Cohn <i>et al.</i> , 1997b]
A3	[Bennett, 1997]
A4-A7	[Randell <i>et al.</i> , 1992b]
A8	[Cohn <i>et al.</i> , 1997a]
A9-A14	[Muller, 1998a]
A18	[Muller, 2002]
<b><u>Definitions</u></b>	
D1-D10	[Cohn <i>et al.</i> , 1997b]
D11-D14	[Bennett, 1997]
D16	[Cohn <i>et al.</i> , 1997b]
D19-D21	[Muller, 1998a]
D29	[Muller, 1998a]
D35	[Muller, 1998a]

---

<sup>1</sup>Note that I have not listed any theorems that have appeared before since my formulation differs from all previous formulations in at least some respects, and thus few proofs of theorems carry over directly.



# Appendix B

## Space-Time Theorems

---

I have a sorted formulation and use SPASS [Weidenbach, 2001] which is a sorted theorem prover. When presenting the proofs in Appendix B through E, resolutions involving sorts are left out and not recorded (for each of the proof) for ease of readability. Every resolution that I have recorded here is abstracted from a one with explicit sortal resolvents.

Proofs of theorems cited in Chapter 3 are collated below. In the interest of space, for simple proofs we only list the set of axioms and definitions that were used. For proofs of more involved theorems each inference step is made explicit. First the theorem is cited followed by the refutation set and then the proof is given. All proofs have been automatically generated using SPASS.

Clause normal form is used as the representational language and binary resolution is generally used. Additional rules where ever used are stated explicitly. I use SHy, Spt, EqR and Rew as abbreviation for Standard Hyper-Resolution, Splitting, Equality-Resolution and Rewriting respectively [Weidenbach, 2001]. Arbitrary constants (or ground terms) used in the proofs are selected from the set  $\{a, b, c, \dots\}$ . SKP $_n$  and skfn, for some  $n$ , denote skolem predicate and skolem function respectively.

**Th1.**  $P_\alpha(x, x)$ .

From D1.

**Th2.**  $[P_\alpha(x, y) \wedge P_\alpha(y, z)] \rightarrow P_\alpha(x, z)$ .

From D1.

**Th3.**  $\forall z[P_\alpha(z, x) \leftrightarrow P_\alpha(z, y)] \rightarrow [x =_\alpha y]$

From D8, Th1.

**Th4.**  $[NTPP_\alpha(x, y) \wedge C_\alpha(z, x)] \rightarrow O_\alpha(z, y)$ .

Refutation Set:

1.  $\neg NTPP_\alpha(u, v) \vee PP_\alpha(u, v)$  D10
2.  $\neg PP_\alpha(u, v) \vee P_\alpha(u, v)$  D3
3.  $\neg O_\alpha(u, v) \vee P_\alpha(\text{skf8}(v, u), u)$  D2
4.  $\neg O_\alpha(u, v) \vee P_\alpha(\text{skf8}(v, u), v)$  D2
5.  $\neg C_\alpha(u, v) \vee O_\alpha(u, v) \vee EC_\alpha(u, v)$  D6
6.  $\neg P_\alpha(u, v) \vee \neg P_\alpha(v, w) \vee P_\alpha(u, w)$  Th2
7.  $\neg P_\alpha(v, w) \vee \neg P_\alpha(v, u) \vee O_\alpha(u, w)$  D2
8.  $\neg C_\alpha(v, u) \vee \neg P_\alpha(u, w) \vee C_\alpha(v, w)$  D1
9.  $\neg EC_\alpha(v, u) \vee \neg EC_\alpha(v, w) \vee \neg NTPP_\alpha(u, w)$  D10
10.  $NTPP_\alpha(a, b)$
11.  $C_\alpha(c, a)$
12.  $\neg O_\alpha(c, b)$

Proof:

13.  $O_\alpha(c, a) \vee EC_\alpha(c, a)$  11,5
14.  $PP_\alpha(a, b)$  10,1
15.  $P_\alpha(a, b)$  14,2
16.  $C_\alpha(c, b)$  SHy 11,15,8
17.  $EC_\alpha(c, b) \vee O_\alpha(c, b)$  16,5
18.  $EC_\alpha(c, b)$  17,12
19.  $EC_\alpha(c, a)$  Spt 13
20.  $\square$  SHy 19,18,10,9
21.  $\neg EC_\alpha(c, a)$  Spt 20,19,13
22.  $O_\alpha(c, a)$  Spt 20,13
23.  $P_\alpha(\text{skf8}(a, c), c)$  22,3
24.  $P_\alpha(\text{skf8}(a, c), a)$  22,4
25.  $P_\alpha(\text{skf8}(a, c), b)$  SHy 24,15,6
26.  $O_\alpha(c, b)$  SHy 25,23,7
27.  $\square$  26,12

**Th5.**  $P_{\text{st}}(x, y) \rightarrow C_{\text{st}}(y, \bar{x})$

Refutation Set:

1.  $NTPP_{\text{st}}(u, v) \vee C_{\text{st}}(u, \bar{v})$  D14

2.	$P_{st}(u, v) \vee O_{st}(u, \bar{v})$	D14
3.	$\neg NTPP_{st}(u, v) \vee PP_{st}(u, v)$	D10
4.	$\neg PP_{st}(u, v) \vee \neg P_{st}(v, u)$	D3
5.	$\neg EC_{st}(u, v) \vee \neg O_{st}(u, v)$	D6
6.	$\neg O_{st}(u, v) \vee EC_{st}(u, v) \vee C_{st}(u, v)$	D6
7.	$\neg P_{st}(u, v) \vee \neg P_{st}(v, u) \vee EQ_{st}(u, v)$	D8
8.	$P_{st}(\bar{a}, b)$	
9.	$\neg C_{st}(b, \bar{a})$	

Proof:

10.	$\neg O_{st}(u, v) \vee C_{st}(u, v)$	6,5
11.	$\neg PP_{st}(b, a)$	8,4
12.	$\neg O_{st}(b, \bar{a})$	10,9
13.	$NTPP_{st}(b, a)$	9,1
14.	$O_{st}(b, \bar{a}) \vee EQ_{st}(a, b)$	SHy 8,7,2
15.	$EQ_{st}(a, b)$	14,12
16.	$NTPP_{st}(b, b)$	Rew 15,13
17.	$\neg PP_{st}(b, b)$	Rew 15,11
18.	$PP_{st}(b, b)$	16,3
19.	$\square$	18,17

**Th6.**  $EC_{st}(x, \bar{x})$ .

Refutation Set:

1.	$P_{st}(u, u)$	Th1
2.	$NTPP_{st}(u, v) \vee C_{st}(u, \bar{v})$	D14
3.	$\neg NTPP_{st}(u, v) \vee PP_{st}(u, v)$	D10
4.	$\neg PP_{st}(u, v) \vee \neg P_{st}(v, u)$	D3
5.	$\neg O_{st}(u, \bar{v}) \vee \neg P_{st}(u, v)$	D14
6.	$\neg C_{st}(u, v) \vee O_{st}(u, v) \vee EC_{st}(u, v)$	D6
7.	$\neg EC_{st}(a, \bar{a})$	

Proof:

8.	$\neg C_{st}(a, \bar{a}) \vee O_{st}(a, \bar{a})$	7,6
9.	$\neg C_{st}(a, \bar{a}) \vee P_{st}(a, a)$	8,5
10.	$\neg C_{st}(a, \bar{a})$	9,1
11.	$NTPP_{st}(a, a)$	10,2
12.	$PP_{st}(a, a)$	11,3
13.	$\square$	SHy 12,4,1

**Th7.**  $\neg EC_{st}(x, y) \leftrightarrow [C_{st}(x, y) \leftrightarrow O_{st}(x, y)]$

i.  $\neg EC_{st}(x, y) \rightarrow [C_{st}(x, y) \leftrightarrow O_{st}(x, y)]$

Refutation Set:

1.  $C_{st}(u, u)$  A1
2.  $\neg C_{st}(u, v) \vee C_{st}(v, u)$  A2
3.  $\neg O_{st}(u, v) \vee P_{st}(skf8(v, u), u)$  D2
4.  $\neg O_{st}(u, v) \vee P_{st}(skf8(v, u), v)$  D2
5.  $\neg C_{st}(u, v) \vee O_{st}(u, v) \vee EC_{st}(u, v)$  D6
6.  $\neg C_{st}(v, u) \vee \neg P_{st}(u, w) \vee C_{st}(v, w)$  D1
7.  $\neg EC_{st}(a, b)$
8.  $C_{st}(a, b) \vee O_{st}(a, b)$
9.  $\neg C_{st}(a, b) \vee \neg O_{st}(a, b)$

Proof:

10.  $\neg C_{st}(a, b) \vee O_{st}(a, b)$  7,5
11.  $O_{st}(a, b)$  10,8
12.  $\neg C_{st}(a, b)$  12,9
13.  $P_{st}(skf8(b, a), a)$  11,3
14.  $P_{st}(skf8(b, a), b)$  11,4
15.  $C_{st}(skf8(b, a), a)$  SHy 13,6,1
16.  $C_{st}(a, skf8(b, a))$  15,2
17.  $C_{st}(a, b)$  SHy 16,14,6
18.  $\square$  17,12

ii.  $[C_{st}(x, y) \leftrightarrow O_{st}(x, y)] \rightarrow \neg EC_{st}(x, y)$

Refutation Set:

1.  $\neg EC_{st}(u, v) \vee C_{st}(u, v)$  D6
2.  $\neg O_{st}(u, v) \vee \neg EC_{st}(u, v)$  D6
3.  $EC_{st}(a, b)$
4.  $\neg C_{st}(a, b) \vee O_{st}(a, b)$
5.  $\neg O_{st}(a, b) \vee C_{st}(a, b)$

Proof:

6.  $C_{st}(a, b)$  3,1
7.  $O_{st}(a, b)$  6,4
8.  $\neg O_{st}(a, b)$  3,2
9.  $\square$  8,7

Note : Clause 5 generated from the conjecture is not used in the proof. Conjecture remains valid for  $[O_{st}(x, y) \rightarrow C_{st}(x, y)]$  is a theorem (From D1, D2 and A1).

**Th8.**  $\text{FCON}(x, x)$

Note : In order to have the above theorem, I need to show that every region has an INCON part. I have the following conjecture:

**C3.**  $\forall y \exists x [\text{P}_{\text{st}}(x, y) \wedge \text{INCON}(x)]$

Refutation Set:

1.  $\text{INCON}(\text{skf33}(u))$  C3
2.  $\text{P}_{\text{st}}(\text{skf33}(u), u)$  C3
3.  $(u \cup u) =_{\text{st}} u$  Lemma
4.  $\neg \text{P}_{\text{st}}(u, v) \vee \neg \text{INCON}(u \cup w) \vee \neg \text{P}_{\text{st}}(w, x) \vee \text{FCON}(v, x)$  D18
5.  $\neg \text{FCON}(a, a)$

Proof:

6.  $\neg \text{P}_{\text{st}}(u, a) \vee \neg \text{INCON}(u \cup w) \vee \neg \text{P}_{\text{st}}(w, a)$  5,4
7.  $\neg \text{P}_{\text{st}}(u, a) \vee \neg \text{INCON}(u) \vee \neg \text{P}_{\text{st}}(u, a)$  6,3
8.  $\neg \text{INCON}(u) \vee \neg \text{P}_{\text{st}}(u, a)$  7
9.  $\neg \text{INCON}(\text{skf33}(a))$  8,3
10.  $\square$

**Th9.**  $\text{FCON}(x, y) \leftrightarrow \text{FCON}(y, x)$

From D18, D4, Th1

**Th10.**  $\neg(x <_t x)$

From A1, A9

**Th11.**  $[x <_t y \wedge y <_t z] \rightarrow (x <_t z)$

From A1, A11

**Th12.**  $[x <_t y \wedge y =_t z] \rightarrow (x <_t z)$

From D21, A12

**Th13.**  $[x <_t y \wedge y \sigma_t z \wedge z <_t t] \rightarrow (x <_t t)$

Refutation Set:

1.  $\text{C}_t(u, u)$  A1
2.  $\neg(u \sigma_t v) \vee \text{P}_t(\text{skf17}(v, u), v)$  D2
3.  $\neg(u \sigma_t v) \vee \text{P}_t(\text{skf17}(v, u), u)$  D2
4.  $\neg \text{P}_t(v, w) \vee \neg(u <_t w) \vee (u <_t v)$  A12
5.  $\neg \text{C}_t(v, u) \vee \neg \text{P}_t(u, w) \vee \text{C}_t(v, w)$  D1

6.  $\neg C_t(v, w) \vee \neg(w <_t x) \vee \neg(u <_t v) \vee (u <_t x)$  A11
7.  $a <_t b$
8.  $b \sigma_t c$
9.  $c <_t d$
10.  $\neg(a <_t d)$

Proof:

11.  $P_t(\text{skf17}(b, c), c)$  8,2
12.  $P_t(\text{skf17}(b, c), b)$  8,3
13.  $C_t(\text{skf17}(b, c), c)$  SHy 11,5,1
14.  $a <_t \text{skf17}(b, c)$  SHy 12,7,4
15.  $a <_t d$  SHy 14,13,9,6
16.  $\square$  15,10

**Th14.**  $[x <_t y \wedge y \subseteq_t z \wedge z <_t t] \rightarrow (x <_t t)$

Refutation Set:

1.  $C_t(u, u)$  A1
2.  $\neg(u \subseteq_t v) \vee \neg(w \bowtie u) \vee (w \bowtie v)$  D19
3.  $\neg(u <_t v) \vee \neg C_t(v, w) \vee \neg(w <_t x) \vee (u <_t x)$  A11
4.  $a <_t b$
5.  $b \subseteq_t c$
6.  $c <_t d$
7.  $\neg(a <_t d)$

Proof:

8.  $\neg C_t(u, b) \vee C_t(u, c)$  5,2
9.  $\neg C_t(b, u) \vee \neg(u <_t v) \vee (a <_t v)$  4,3
10.  $\neg C_t(b, c) \vee (a <_t d)$  9,6
11.  $\neg C_t(b, c)$  10,7
12.  $\neg C_t(b, b)$  11,8
13.  $\square$  12,1

**Th15.**  $x \subseteq_t y \rightarrow \forall z[(z <_t y \rightarrow z <_t x) \wedge (y <_t z \rightarrow x <_t z)]$

From A12

**Th16.**  $[x =_t y \wedge x \subseteq_t z] \rightarrow y \subseteq_t z$

From D19, D21



**Th17.**  $[x =_t x]$

From D21, Th1

**Th18.**  $EC_t(x, y) \rightarrow \exists z NECP(z, x, y)$

Refutation Set:

- |  |                    |
|--|--------------------|
| 1. $P_t(u, u)$   | Th1                |
| 2. $C_{st}(u, u)$  | A1                 |
| 3. $NTPP_{st}(skf15(u), u)$  | A1                 |
| 4. $P_t(skf13(u, v), v)$   | D2                 |
| 5. $P_{st}(skf11(u, v), v)$  | D2                 |
| 6. $[\neg NTPP_{st}(u, v) \vee NTPP_t(u, v)]$  | Lemma <sup>1</sup> |
| 7. $\neg P_{st}(u, v) \vee P_t(u, v)$  | C2                 |
| 8. $\neg EC_t(u, v) \vee C_t(u, v)$  | D6                 |
| 9. $\neg C_t(u, v) \vee C_t(v, u)$   | A2                 |
| 10. $\neg EC_t(u, v) \vee \neg O_t(u, v)$  | D6                 |
| 11. $\neg O_t(u, v) \vee P_t(skf13(v, u), v)$  | D2                 |
| 12. $\neg O_{st}(u, v) \vee P_{st}(skf11(v, u), v)$                                  | D2                 |
| 13. $\neg NTPP_{st}(u, v) \vee \neg C_{st}(w, u) \vee O_{st}(w, v)$                  | Th4                |
| 14. $\neg NTPP_t(u, v) \vee \neg C_t(w, u) \vee O_t(w, v)$                           | Th4                |
| 15. $\neg P_t(u, v) \vee \neg P_t(u, w) \vee O_t(v, w)$                              | D2                 |
| 16. $\neg P_t(u, v) \vee \neg C_t(w, u) \vee C_t(w, v)$                              | D1                 |
| 17. $\neg P_{st}(u, v) \vee \neg EC_t(v, w) \vee \neg EC_t(u, w) \vee NECP(u, v, w)$ | D22                |
| 18. $EC_t(a, b)$   |                    |
| 19. $[\neg NECP(u, a, b)]$   |                    |

Proof:

- |   |             |
|---|-------------|
| 20. $\neg O_t(a, b)$  | 18,10       |
| 21. $NECP(skf11(u, a), a, b) \vee EC_t(skf11(u, a), b)$           | SHy 18,17,5 |
| 22. $EC_t(skf11(u, a), b)$  | 21,19       |
| 23. $\neg P_t(u, a) \vee \neg P_t(u, b)$                          | 20,15       |
| 24. $C_t(skf11(u, a), b)$   | 22,8        |
| 25. $\neg P_t(b, u) \vee C_t(skf11(v, a), u)$                     | 24,16       |
| 26. $\neg O_t(u, a) \vee \neg P_t(skf13(a, u), b)$                | 23,11       |
| 27. $\neg P_t(b, u) \vee C_t(u, skf11(v, a))$                     | 25,9        |
| 28. $\neg P_t(b, u) \vee P_t(skf11(v, a), w) \vee C_t(u, w)$      | 27,16       |
| 29. $\neg O_t(b, a)$  | 26,4        |
| 30. $\neg P_t(skf11(u, a), v) \vee \neg P_t(b, w) \vee C_t(w, v)$ | 28,7        |

---

<sup>1</sup> $[NTPP_{st}(x, y) \rightarrow NTPP_t(x, y)].$

31. $\neg O_{st}(a, u) \vee \neg P_t(b, v) \vee C_t(v, u)$	30,12
32. $\neg P_t(u, a) \vee \neg P_{st}(u, v) \vee \neg P_t(b, w) \vee C_t(w, v)$	31,15
33. $\neg O_{st}(u, a) \vee \neg P_t(skf11(a, u), v) \vee \neg P_t(b, w) \vee C_t(w, v)$	
34. $\neg O_{st}(u, a) \vee \neg P_t(b, v) \vee C_t(v, u)$	33,5
35. $\neg NTPP_{st}(u, a) \vee \neg C_{st}(v, u) \vee \neg P_t(b, w) \vee C_t(w, v)$	
36. $C_t(b, skf15(a))$	SHy 35,3,2,1
37. $C_t(skf15(a), b)$	36,9
38. $\neg P_t(b, u) \vee C_t(skf15(a), u)$	37,16
39. $\neg P_t(b, u) \vee C_t(u, skf15(a))$	38,9
40. $\neg P_t(b, u) \vee \neg NTPP_t(skf15(a), v) \vee O_t(u, v)$	39,14
41. $\neg NTPP_{st}(skf15(a), u) \vee \neg P_t(b, v) \vee O_t(v, u)$	40,6
42. $O_t(b, a)$	SHy 41,3,1
43. $\square$	42,29

**Th19.**  $(x \cup y) \subseteq_t z \rightarrow [x \subseteq_t z \wedge y \subseteq_t z]$

Refutation Set:

1. $C_t(skf12(u, v), v)$	D1
2. $\neg C_t(u, v) \vee C_t(u, (w \cup v))$	A14
3. $\neg C_t(u, v) \vee C_t(u, (v \cup w))$	A14
4. $\neg C_t(skf12(u, v), u) \vee (v \subseteq_t u)$	D19
5. $\neg(u \subseteq_t v) \vee \neg(w \bowtie u) \vee (w \bowtie v)$	D19
6. $(a \cup b) \subseteq_t c$	
7. $\neg(a \subseteq_t c) \vee \neg(b \subseteq_t c)$	

Proof:

8. $\neg C_t(u, (a \cup b)) \vee C_t(u, c)$	6,5
9. $\neg C_t(u, a) \vee C_t(u, c)$	8,3
10. $\neg C_t(u, b) \vee C_t(u, c)$	8,2
11. $C_t(skf12(u, a), c)$	9,1
12. $(a \subseteq_t c)$	11,4
13. $\neg(b \subseteq_t c)$	12,7
14. $C_t(skf12(u, b), c)$	10,1
15. $(b \subseteq_t c)$	14,4
16. $\square$	15,13

**Th20.**  $\neg(x \bowtie_t x)$

Refutation Set:

1. $(u =_t u)$	Th17
----------------	------

2.  $\neg(u \bowtie_t v) \vee EC_t(u, v)$  D23
3.  $\neg(u =_t v) \vee u \subseteq_t v$  D21
4.  $\neg O_t(u, v) \vee \neg EC_t(u, v)$  D6
5.  $\neg P_t(v, w) \vee \neg P_t(v, u) \vee O_t(u, w)$  D2
6.  $a \bowtie_t a$

Proof:

7.  $EC_t(a, a)$  6,2
8.  $P_t(u, u)$  3,1
9.  $\neg P_t(u, w) \vee O_t(u, w)$  8,5
10.  $\neg P_t(u, w) \vee \neg EC_t(u, w)$  9,4
11.  $\neg EC_t(u, u)$  10,8
12.  $\square$  11,7

**Th21.**  $x \bowtie_t y \rightarrow \neg(y \bowtie_t x)$

Refutation Set:

1.  $\neg(u \bowtie_t v) \vee EC_t(u, v)$  D23
2.  $\neg(u <_t v) \vee \neg(v <_t u)$  A10
3.  $\neg EC_t(u, v) \vee NECP(\text{skf15}(v, u), u, v)$  Th19
4.  $\neg(u \bowtie_t v) \vee \neg NECP(w, v, u) \vee u <_t w$  D23
5.  $\neg(u \bowtie_t v) \vee \neg NECP(w, u, v) \vee w <_t v$  D23
6.  $a \bowtie_t b$
7.  $b \bowtie_t a$

Proof:

8.  $EC_t(b, a)$  7,1
9.  $NECP(\text{skf15}(a, b), b, a)$  8,3
10.  $a <_t \text{skf15}(a, b)$  SHy 9,6,4
11.  $\text{skf15}(a, b) <_t a$  SHy 9,7,5
12.  $\square$  SHy 11,10,2

**Th22.**  $x \sqsubset_t x$

From D25

**Th23.**  $x \sqsupset_t x$

From D24

**Th24.**  $x \sqsubset_t y \rightarrow y \sqsubset_t x$

From D25

**Th25.**  $x \sqsupset_t y \rightarrow y \sqsupset_t x$

From D24

**Th26.**  $[x \bowtie_t y \wedge y \bowtie_t z] \rightarrow (x <_t z)$

Refutation Set:

- |   |      |
|---|------|
| 1. $C_t(u, u)$  | A1   |
| 2. $C_{st}(u, u)$   | A1   |
| 3. $P_t(\text{skf12}(u, v), v)$   | D2   |
| 4. $C_{st}(\text{skf10}(u, v), v)$  | D1   |
| 5. $\neg(u \bowtie_t v) \vee EC_t(u, v)$  | D23  |
| 6. $C_{st}(u, v) \vee C_t(u, v)$  | A15  |
| 7. $\neg EC_t(u, v) \vee C_t(u, v)$   | D6   |
| 8. $\neg C_t(u, v) \vee C_t(v, u)$  | A2   |
| 9. $\neg C_{st}(u, v) \vee C_{st}(v, u)$  | A2   |
| 10. $\neg NECP(u, v, w) \vee P_{st}(u, v)$                                      | D22  |
| 11. $\neg EC_t(u, v) \vee \neg O_t(u, v)$                                       | D6   |
| 12. $\neg NECP(u, v, w) \vee EC_t(u, w)$  | D22  |
| 13. $\neg O_t(u, v) \vee P_t(\text{skf12}(v, u), v)$                            | D2   |
| 14. $\neg C_{st}(\text{skf10}(u, v), v) \vee P_{st}(v, u)$                      | D1   |
| 15. $\neg EC_t(u, v) \vee NECP(\text{skf13}(v, u), u, v)$                       | Th19 |
| 16. $\neg C_t(u, v) \vee O_t(u, v) \vee EC_t(u, v)$                             | D6   |
| 17. $\neg P_t(u, v) \vee \neg P_t(u, w) \vee O_t(v, w)$                         | D2   |
| 18. $\neg P_{st}(u, v) \vee \neg C_{st}(w, u) \vee C_{st}(w, v)$                | D1   |
| 19. $\neg(u \bowtie_t v) \vee \neg NECP(w, v, u) \vee u <_t w$                  | D23  |
| 20. $\neg(u \bowtie_t v) \vee \neg NECP(w, v, u) \vee w <_t v$                  | D23  |
| 21. $\neg EC_t(u, v) \vee \neg P_{st}(w, u) \vee NECP(w, u, v) \vee EC_t(w, v)$ | D22  |
| 22. $\neg(u <_t v) \vee \neg C_t(v, w) \vee \neg(w <_t x) \vee u <_t x$         | A11  |
| 23. $a \bowtie_t b$   |      |
| 24. $b \bowtie_t c$   |      |
| 25. $\neg(a <_t c)$   |      |

Proof:

- |  |       |
|--|-------|
| 26. $\neg NECP(u, b, c) \vee u <_t c$                      | 24,20 |
| 27. $EC_t(b, c)$   | 24,5  |
| 28. $\neg NECP(u, b, a) \vee a <_t u$                      | 23,19 |
| 29. $EC_t(a, b)$   | 23,5  |
| 30. $\neg(a <_t u) \vee \neg C_t(u, v) \vee \neg(v <_t c)$ | 25,22 |
| 31. $C_t(a, b)$  | 29,7  |

32. $C_t(b, a)$	31,8
33. $EC_t(b, a) \vee O_t(b, a)$	32,16
34. $\neg EC_t(b, c) \vee \neg P_{st}(u, b) \vee EC_t(u, c) \vee u <_t c$	26,21
35. $\neg P_{st}(u, b) \vee EC_t(u, c) \vee u <_t c$	34,27
36. $\neg EC_t(b, a) \vee a <_t skf13(a, b)$	28,15
37. $EC_t(b, a)$	Spt 33
38. $a <_t skf13(a, b)$	37,36
39. $NECP(skf13(a, b), b, a)$	27,15
40. $\neg C_t(skf13(a, b), u) \vee \neg(u <_t c)$	38,30
41. $P_{st}(skf13(a, b), b)$	39,10
42. $\neg C_{st}(u, skf13(a, b)) \vee C_{st}(u, b)$	41,18
43. $EC_t(skf13(a, b), c) \vee skf13(a, b) <_t c$	41,35
44. $skf13(a, b) <_t c$	40,1
45. $EC_t(skf13(a, b), c)$	44,43
46. $NECP(skf13(c, skf13(a, b)), skf13(a, b), c)$	45,15
47. $\neg EC_t(skf13(c, skf13(a, b)), c)$	46,12
48. $P_{st}(skf13(c, skf13(a, b)), skf13(a, b))$	46,10
49. $C_{st}(skf10(u, skf13(c, skf13(a, b))), skf13(a, b))$	SHy 48,18,4
50. $C_{st}(skf13(c, skf13(a, b)), skf13(a, b))$	SHy 48,18,2
51. $C_{st}(skf13(a, b), skf13(c, skf13(a, b)))$	50,9
52. $C_t(skf13(a, b), skf13(c, skf13(a, b)))$	51,9
53. $\neg(skf13(c, skf13(a, b)) <_t c)$	52,40
54. $\neg P_{st}(skf13(c, skf13(a, b)), b) \vee EC_t(skf13(c, skf13(a, b)), c)$	53,35
55. $\neg P_{st}(skf13(c, skf13(a, b)), b)$	54,47
56. $C_{st}(skf10(u, skf13(c, skf13(a, b))), b)$	49,42
57. $P_{st}(skf13(c, skf13(a, b)), b)$	56,14
58. $\square$	57,55
59. $\neg EC_t(b, a)$	Spt 58,37,33
60. $O_t(b, a)$	Spt 58,33
61. $P_t(skf12(a, b), a)$	60,13
62. $O_t(a, b)$	SHy 61,17,3
63. $\square$	SHy 62,29,11

**Th27.**  $[x \bowtie_t y \wedge y <_t z] \rightarrow (x <_t z)$

Refutation Set:

- |                          |    |
|--------------------------|----|
| 1. $C_{st}(u, u)$        | A1 |
| 2. $P_t(skf14(u, v), v)$ | D2 |

3. $\neg(u \bowtie_t v) \vee EC_t(u, v)$	D23
4. $C_{st}(u, v) \vee C_t(u, v)$	A15
5. $\neg EC_t(u, v) \vee C_t(u, v)$	D6
6. $\neg C_t(u, v) \vee C_t(v, u)$	A2
7. $\neg NECP(u, v, w) \vee P_{st}(u, v)$	D22
8. $\neg EC_t(u, v) \vee \neg O_t(u, v)$	D6
9. $\neg O_t(u, v) \vee P_t(skf14(v, u), v)$	D2
10. $\neg EC_t(u, v) \vee NECP(skf15(v, u), u, v)$	Th19
11. $\neg C_t(u, v) \vee O_t(u, v) \vee EC_t(u, v)$	D6
12. $\neg P_t(u, v) \vee \neg P_t(u, w) \vee O_t(v, w)$	D2
13. $\neg P_{st}(u, v) \vee \neg C_{st}(w, u) \vee C_{st}(w, v)$	D1
14. $\neg(u \bowtie_t v) \vee \neg NECP(w, v, u) \vee u <_t w$	D23
15. $\neg(u <_t v) \vee \neg C_t(v, w) \vee \neg(w <_t x) \vee u <_t x$	A11
16. $a \bowtie_t b$	
17. $b <_t c$	
18. $\neg(a <_t c)$	

Proof:

19. $EC_t(a, b)$	16,3
20. $C_t(a, b)$	19,5
21. $C_t(b, a)$	20,6
22. $O_t(b, a) \vee EC_t(b, a)$	21,11
23. $EC_t(b, a)$	Spt 22
24. $NECP(skf15(a, b), b, a)$	23,10
25. $P_{st}(skf15(a, b), b)$	24,7
26. $a <_t skf15(a, b)$	SHy 24,16,14
27. $C_{st}(skf15(a, b), b)$	SHy 25,13,1
28. $C_{st}(skf15(a, b), b)$	27,4
29. $a <_t c$	SHy 28,26,17,15
30. $\square$	29,18
31. $\neg EC_t(b, a)$	Spt 30,23,22
32. $O_t(b, a)$	Spt 30,22
33. $P_t(skf14(a, b), a)$	32,9
34. $O_t(a, b)$	SHy 33,12,2
35. $\square$	SHy 34,19,8

**Th28.**  $[x \sqsubset_t y \wedge y \sqsubset_t z] \rightarrow x \sqsubset_t z$

From D25

**Th29.**  $[x \sqsupset_t y \wedge y \sqsupset_t z] \rightarrow x \sqsupset_t z$

From D24

**Th30.**  $[x \sqsubseteq_t y \wedge y \bowtie_t z \wedge z <_t w] \rightarrow (x <_t w)$

Refutation Set:

1. $P_{st}(u, u)$	Th1
2. $C_{st}(u, u)$	A1
3. $skf12(u, v) \sqsubseteq_t v$	D2
4. $P_{st}(skf13(u, v, w), w)$	D22
5. $\neg(u \bowtie_t v) \vee EC_t(u, v)$	D23
6. $\neg P_{st}(u, v) \vee u \sqsubseteq_t v$	C2
7. $\neg EC_t(u, v) \vee C_t(u, v)$	D6
8. $\neg C_t(u, v) \vee C_t(u, v)$	A2
9. $\neg C_t(u, v) \vee \neg(u <_t v)$	A9
10. $\neg EC_t(u, v) \vee \neg O_t(u, v)$	D6
11. $\neg O_t(u, v) \vee (skf12(v, u) \sqsubseteq_t u)$	D2
12. $\neg C_t(u, v) \vee O_t(u, v) \vee EC_t(u, v)$	D6
13. $\neg(u <_t v) \vee (w \sqsubseteq_t u) \vee (w <_t v)$	A12
14. $\neg(u \sqsubseteq_t v) \vee \neg(u \sqsubseteq_t w) \vee O_t(v, w)$	D2
15. $\neg(u \sqsubseteq_t v) \vee \neg C_t(w, u) \vee C_t(w, v)$	D1
16. $\neg(u \bowtie_t v) \vee \neg NECP(w, u, v) \vee (u <_t w)$	D23
17. $\neg EC_t(u, v) \vee P_{st}(sf13(w, v, u), w) \vee NECP(w, u, v)$	D22
18. $a \sqsubseteq_t b$	
19. $b \bowtie_t c$	
20. $c <_t d$	
21. $\neg(a <_t d)$	

Proof:

22. $\neg NECP(u, c, b) \vee (b <_t u)$	19,16
23. $EC_t(b, c)$	19,5
24. $\neg(a \sqsubseteq_t u) \vee O_t(b, u)$	18,14
25. $\neg(u <_t d) \vee \neg(a \sqsubseteq_t u)$	21,13
26. $\neg(b <_t d)$	25,18
27. $skf12(u, c) <_t d$	SHy 20,13,3
28. $C_t(a, b)$	SHy 18,15,2
29. $C_t(b, c)$	23,7
30. $C_t(b, a)$	28,8
31. $C_t(c, b)$	29,8

32. $EC_t(b, a) \vee O_t(b, a)$	30,12
33. $EC_t(c, b) \vee O_t(c, b)$	31,12
34. $\neg C_t(sf12(u, c), d)$	27,9
35. $EC_t(b, a)$	Spt 32
36. $\neg(u \subseteq_t d) \vee C_t(skf12(v, c), u)$	34,15
37. $\neg(a \subseteq_t u) \vee \neg EC_t(b, u)$	24,10
38. $\neg(a \subseteq_t a)$	37,35
39. $P_{st}(a, a)$	38,6
40. $\square$	39,1
41. $\neg EC_t(b, a)$	Spt 40,35,32
42. $\neg O_t(b, a)$	Spt 40,32
43. $EC_t(c, b)$	Spt 33
44. $\neg(skf12(u, c) \subseteq_t d)$	36,2
45. $\neg O_t(c, d)$	44,11
46. $\neg(u \subseteq_t c) \vee \neg(u \subseteq_t d)$	45,14
47. $\neg P_{st}(u, c) \vee \neg(u \subseteq_t d)$	46,6
48. $\neg P_{st}(u, d) \vee \neg P_{st}(u, c)$	47,6
49. $\neg P_{st}(skf13(u, v, c), d)$	48,4
50. $EC_t(c, u) \vee NECP(d, c, u)$	49,17
51. $EC_t(c, b) \vee (b <_t d)$	50,22
52. $\square$	SHy 51,43,26
53. $\neg EC_t(c, b)$	Spt 52,43,33
54. $O_t(c, b)$	Spt 52,33
55. $P_{st}(skf12(b, c), b)$	SHy 54,11
56. $O_t(b, c)$	SHy 55,14,3
57. $\square$	SHy 56,23,10

**Th31.**  $x \bowtie_t y \rightarrow \forall z[(z <_t x \rightarrow z <_t y) \wedge (y <_t z \rightarrow x <_t z)]$

Refutation Set:

1. $C_t(u, u)$	A1
2. $\neg(u \bowtie_t v) \vee EC_t(u, v)$	D23
3. $\neg P_{st}(u, v) \vee P_t(u, v)$	C2
4. $\neg NECP(u, v, w) \vee P_{st}(u, v)$	D22
5. $\neg EC_t(u, v) \vee NECP(skf15(v, u), u, v)$	Th19
6. $\neg(u \bowtie_t v) \vee \neg(v <_t w) \vee (u <_t w)$	Th27
7. $\neg(u <_t v) \vee \neg P_t(w, v) \vee u <_t w$	A12
8. $\neg(u \bowtie_t v) \vee \neg NECP(w, u, v) \vee (w <_t v)$	D23



9.  $\neg(u <_t v) \vee \neg C_t(v, w) \vee \neg(w <_t x) \vee u <_t x$  A11  
 10.  $a \bowtie_t b$   
 11.  $\neg(a <_t d)$   
 12.  $(u <_t v) \vee \text{SkP}(w, v, u)$   
 13.  $\neg \text{SkP}(b, a, c) \vee (b <_t d)$   
 14.  $\neg(u <_t v) \vee \text{SkP}(v, w, u)$

Proof:

15.  $\text{EC}_t(a, b)$  10,2  
 16.  $\neg(a \bowtie_t u) \vee \neg(u \bowtie_t d)$  11,6  
 17.  $\neg(b <_t d)$  16,10  
 18.  $\neg \text{SkP}(b, a, c)$  17,13  
 19.  $\text{NECP}(\text{skf15}(b, a), a, b)$  15,5  
 20.  $c <_t a$  18,12  
 21.  $\neg(c <_t b)$  18,14  
 22.  $\text{P}_{\text{st}}(\text{skf15}(b, a), a)$  19,4  
 23.  $(\text{skf15}(b, a) <_t b)$  SHy 19,10,8  
 24.  $\text{P}_t(\text{skf15}(b, a), a)$  22,3  
 25.  $(c <_t \text{skf15}(b, a))$  SHy 24,20,7  
 26.  $c <_t b$  SHy 25,23,9,1  
 27.  $\square$  26,21

**Th32.**  $x \parallel_t (y; z) \rightarrow \forall w[(w \subseteq_t y \rightarrow w <_t z) \wedge (w \subseteq_t z \rightarrow y <_t w)]$

From D26, A12, Th26

**Th33.**  $\text{O}_{\text{st}}(x, y) \rightarrow [x \sigma_t y \wedge \text{O}_{\text{sp}}(x, y)]$

From D2, C2

**Th34.**  $\text{TS}(x, x).$

From D29, Th1

**Th35.**  $[\text{TS}(x, y) \wedge \text{TS}(y, x)] \rightarrow x = y.$

From D8, D29

**Th36.**  $[\text{TS}(x, y) \wedge \text{TS}(y, z)] \rightarrow \text{TS}(x, z).$

Refutation Set:

1.  $\neg \text{TS}(u, v) \vee \text{P}_{\text{st}}(u, v)$  D29  
 2.  $\neg \text{P}_{\text{st}}(u, v) \vee \text{P}_t(u, v)$  C2  
 3.  $\neg \text{P}_{\text{st}}(u, v) \vee \text{P}_t(\text{skf11}(u, v), u) \vee \text{TS}(u, v)$  D29

4.  $\neg P_{st}(u, v) \vee P_{st}(skf11(u, v), u) \vee TS(u, v)$  D29
5.  $\neg P_{st}(skf11(u, v), u) \vee \neg P_{st}(u, v) \vee TS(u, v)$  D29
6.  $\neg P_t(u, v) \vee \neg P_t(v, w) \vee P_t(u, w)$  Th2
7.  $\neg P_{st}(u, v) \vee \neg P_{st}(v, w) \vee P_{st}(u, w)$  Th2
8.  $\neg P_{st}(v, w) \vee \neg P_t(v, u) \vee \neg TS(u, w) \vee P_{st}(v, u)$  D29
9.  $TS(a, b)$
10.  $TS(b, c)$
11.  $\neg TS(a, c)$

Proof:

12.  $P_{st}(b, c)$  10,1
13.  $P_{st}(a, b)$  9,1
14.  $P_t(a, b)$  13,2
15.  $P_{st}(a, c)$  SHy 13,12,7
16.  $TS(a, c) \vee P_t(skf11(a, c), a)$  15,3
17.  $P_t(skf11(a, c), a)$  16,11
18.  $TS(a, c) \vee P_{st}(skf11(a, c), c)$  15,4
19.  $P_{st}(skf11(a, c), c)$  18,11
20.  $P_t(skf11(a, c), b)$  SHy 17,14,6
21.  $P_{st}(skf11(a, c), b)$  SHy 20,19,10,8
22.  $P_{st}(skf11(a, c), a)$  SHy 21,17,9,8
23.  $TS(a, c)$  SHy 22,15,5
24.  $\square$  23,11

**Th37.**  $[TS(x, y) \wedge TS(z, y) \wedge x =_t z] \rightarrow x =_{st} z$

Refutation Set:

1.  $\neg TS(u, v) \vee P_{st}(u, v)$  D29
2.  $\neg(u =_t v) \vee (v \subseteq_t u)$  D21
3.  $\neg(u =_t v) \vee (u \subseteq_t v)$  D21
4.  $\neg P_{st}(u, v) \vee \neg P_{st}(v, u) \vee EQ_{st}(u, v)$  D8
5.  $\neg TS(u, v) \vee \neg P_{st}(w, v) \vee \neg(w \subseteq_t u) \vee P_{st}(w, u)$  D29
6.  $TS(c, a)$
7.  $(c =_t b)$
8.  $TS(b, a)$
9.  $\neg EQ_{st}(c, b)$

Proof:

10.  $P_{st}(b, a)$  8,1
11.  $(b \subseteq_t c)$  7,2

12. $(c \subseteq_t b)$	8,3
13. $P_{st}(c, a)$	6,1
14. $\neg P_{st}(c, b) \vee \neg P_{st}(b, c)$	9,4
15. $P_{st}(c, b)$	SHy 13,12,9,5
16. $P_{st}(b, c)$	SHy 11,10,6,5
17. $\neg P_{st}(b, c)$	15,14
18. $\square$	17,16

**Th38.**  $ts(x, x) =_{st} x$

Refutation Set:

1. $TS(u, u)$	Th34
2. $(u =_t u)$	Th17
3. $P_t(u, u)$	Th1
4. $\neg(w =_t u) \vee (ts(v, u) = w) \vee \neg TS(w, v) \vee \neg(u \subseteq_t v)$	D30
5. $\neg(ts(a, a) = a)$	

Proof:

6. $\neg(a =_t a) \vee \neg TS(a, a) \vee \neg(a \subseteq_t a)$	5,4
7. $\square$	SHy 6,3,2,1

**Th39.**  $TS(ts(x, x), x)$

From Th34, Th38

**Th40.**  $C_{st}(x, y) \leftrightarrow \exists z[TS(z, y) \wedge C_{st}(z, x)]$

i.  $C_{st}(x, y) \rightarrow \exists z[TS(z, y) \wedge C_{st}(z, x)]$

Refutation Set:

1. $TS(u, u)$	Th34
2. $C_{st}(a, b)$	
3. $[\neg TS(u, b) \vee \neg C_{st}(u, a)]$	

Proof:

4. $\neg TS(b, b)$	3,2
5. $\square$	4,1

ii.  $\exists z[TS(z, y) \wedge C_{st}(z, x)] \rightarrow C_{st}(x, y)$

Refutation Set:

1. $\neg TS(u, v) \vee P_{st}(u, v)$	D29
2. $\neg P_{st}(u, v) \vee \neg C_{st}(w, u) \vee C_{st}(w, v)$	D1
3. $TS(c, b)$	

4.  $C_{st}(a, c)$
5.  $\neg C_{st}(a, b)$

Proof:

6.  $P_{st}(c, b)$  3,1
7.  $\neg P_{st}(u, b) \vee \neg C_{st}(a, u)$  5,2
8.  $\neg P_{st}(c, b)$  7,4
9.  $\square$  8,6

**Th41.**  $[TS(y_1, y) \wedge \neg C_{sp}(y_1, z) \wedge C_{st}(z, y)] \rightarrow \exists y_2 [TS(y_2, y) \wedge C_{st}(y_1, y_2) \wedge C_{st}(z, y_2) \wedge \neg(y_1 = y_2)]$

Refutation Set:

1.  $P_{st}(u, u)$  Th1
2.  $TS(u, u)$  Th34
3.  $C_{st}(u, u)$  A1
4.  $P_{st}(skf23(u, v), v)$  D29
5.  $C_{sp}(u, v) \vee DC_{sp}(u, v)$  D5
6.  $\neg TS(u, v) \vee P_{st}(u, v)$  D29
7.  $\neg C_{st}(u, v) \vee C_{sp}(u, v)$  A15
8.  $\neg DC_{sp}(u, v) \vee \neg C_{sp}(u, v)$  D5
9.  $\neg P_{st}(u, v) \vee \neg C_{st}(w, u) \vee C_{st}(w, v)$  D1
10.  $\neg P_{st}(u, v) \vee \neg P_{st}(skf23(u, v), u) \vee TS(u, v)$  D29
11.  $C_{st}(a, b)$
12.  $TS(c, b)$
13.  $\neg C_{sp}(a, c)$
14.  $[\neg TS(u, b) \vee \neg C_{st}(c, u) \vee \neg C_{st}(a, u) \vee (c = u)]$

Proof:

15.  $P_{st}(c, b)$  12,6
16.  $\neg TS(b, b) \vee \neg C_{st}(c, b) \vee (c = b)$  14,11
17.  $\neg C_{st}(c, b) \vee (c = b)$  16,2
18.  $C_{sp}(a, b)$  11,7
19.  $DC_{sp}(a, c)$  13,5
20.  $\neg DC_{sp}(a, b)$  18,8
21.  $\neg C_{st}(u, c) \vee C_{st}(u, b)$  15,9
22.  $C_{st}(c, b)$  21,3
23.  $c = b$  23,17
24.  $DC_{sp}(a, b)$  Rew 23,19
25.  $\square$  24,20

**Th42.**  $[\text{TS}(y_1, y) \wedge \neg \text{C}_{\text{sp}}(y_1, z) \wedge \text{C}_{\text{st}}(z, y) \wedge y_1 =_{\text{t}} z] \rightarrow \exists y_2 [\text{TS}(y_2, y) \wedge \text{C}_{\text{st}}(y_1, y_2) \wedge \text{EC}_{\text{st}}(z, y_2) \wedge \neg(y_1 = y_2)]$

Refutation Set:

- |   |      |
|---|------|
| 1. $\text{TS}(u, u)$  | Th34 |
| 2. $\text{P}_{\text{st}}(u, u)$   | Th1  |
| 3. $\text{C}_{\text{sp}}(u, u)$   | A1   |
| 4. $\text{C}_{\text{st}}(u, u)$   | A1   |
| 5. $\text{P}_{\text{st}}(\text{skf14}(u, v), v)$  | D2   |
| 6. $\text{C}_{\text{t}}(\text{skf13}(u, v), v)$   | D1   |
| 7. $\neg \text{TS}(u, v) \vee \text{P}_{\text{st}}(u, v)$   | D29  |
| 8. $\neg \text{P}_{\text{st}}(u, v) \vee \text{P}_{\text{sp}}(u, v)$  | C2   |
| 9. $\neg \text{P}_{\text{st}}(u, v) \vee \text{P}_{\text{t}}(u, v)$   | C2   |
| 10. $\neg \text{C}_{\text{st}}(u, v) \vee \text{C}_{\text{sp}}(u, v)$   | A15  |
| 11. $\neg(u =_{\text{t}} v) \vee (u \subseteq_{\text{t}} v)$  | D21  |
| 12. $\neg \text{C}_{\text{sp}}(u, v) \vee \text{C}_{\text{sp}}(v, u)$   | A2   |
| 13. $\neg \text{C}_{\text{st}}(u, v) \vee \text{C}_{\text{st}}(v, u)$   | A2   |
| 14. $\neg \text{O}_{\text{st}}(u, v) \vee \text{P}_{\text{st}}(\text{skf14}(u, v), v)$  | D2   |
| 15. $\neg \text{C}_{\text{t}}(\text{skf13}(u, v), v) \vee \text{P}_{\text{t}}(v, u)$  | D1   |
| 16. $\neg \text{C}_{\text{st}}(u, v) \vee \text{O}_{\text{st}}(u, v) \vee \text{EC}_{\text{st}}(u, v)$                              | D6   |
| 17. $\neg \text{P}_{\text{t}}(u, v) \vee \neg \text{C}_{\text{t}}(w, u) \vee \text{C}_{\text{t}}(w, v)$                             | D1   |
| 18. $\neg \text{P}_{\text{sp}}(u, v) \vee \neg \text{C}_{\text{sp}}(w, u) \vee \text{C}_{\text{sp}}(w, v)$                          | D1   |
| 19. $\neg \text{P}_{\text{st}}(u, v) \vee \neg \text{C}_{\text{st}}(w, u) \vee \text{C}_{\text{st}}(w, v)$                          | D1   |
| 20. $\neg \text{TS}(u, v) \vee \neg \text{P}_{\text{st}}(w, v) \vee \neg \text{P}_{\text{t}}(w, u) \vee \text{P}_{\text{st}}(w, u)$ | D29  |
| 21. $\text{TS}(b, a)$   |      |
| 22. $c =_{\text{t}} b$  |      |
| 23. $\neg \text{C}_{\text{sp}}(c, b)$   |      |
| 24. $\text{C}_{\text{st}}(c, a)$  |      |
| 25. $[\neg \text{TS}(u, a) \vee \neg \text{C}_{\text{st}}(b, u) \vee \neg \text{EC}_{\text{st}}(c, u) \vee (b = u)]$                |      |

Proof:

- |   |        |
|---|--------|
| 26. $\neg \text{P}_{\text{st}}(u, a) \vee \neg \text{P}_{\text{t}}(u, b) \vee \text{P}_{\text{st}}(u, b)$ | 21,20  |
| 27. $\text{P}_{\text{st}}(b, a)$  | 21,7   |
| 28. $\text{O}_{\text{st}}(c, a) \vee \text{EC}_{\text{st}}(c, a)$   | 24,16  |
| 29. $\text{C}_{\text{sp}}(c, a)$  | 24,10  |
| 30. $\text{P}_{\text{t}}(c, b)$   | 22,11  |
| 31. $\neg \text{P}_{\text{sp}}(u, b) \vee \neg \text{C}_{\text{sp}}(c, u)$                                | 22,18  |
| 32. $\neg \text{C}_{\text{st}}(b, a) \vee \neg \text{EC}_{\text{st}}(c, a) \vee (b = a)$                  | 25,1   |
| 33. $\text{O}_{\text{st}}(c, a)$  | Spt 28 |

34. $\neg P_{st}(u, b) \vee \neg C_{sp}(c, u)$	31,8
35. $\neg P_{st}(a, b)$	34,29
36. $\neg C_{st}(u, b) \vee C_{st}(u, a)$	27,19
37. $\neg P_{st}(u, v) \vee \neg C_{sp}(w, u) \vee C_{sp}(w, v)$	18,8
38. $\neg C_{st}(u, b) \vee C_{st}(a, u)$	36,13
39. $C_{st}(a, b)$	38,4
40. $C_{st}(b, a)$	39,13
41. $EC_{st}(c, a) \vee (a = b)$	40,32
42. $\neg C_t(u, c) \vee C_t(u, b)$	30,17
43. $\neg P_{st}(u, v) \vee \neg C_t(w, u) \vee C_t(w, v)$	17,9
44. $\neg C_t(skf13(b, u), c) \vee P_t(u, b)$	42,15
45. $\neg C_{sp}(u, skf14(v, w)) \vee C_{sp}(u, w)$	37,5
46. $\neg C_t(u, skf14(v, w)) \vee C_t(u, w)$	43,5
47. $C_{sp}(skf14(u, v), v)$	45,3
48. $C_t(skf13(u, skf14(v, w)), w)$	46,6
49. $C_{sp}(u, skf14(v, u))$	47,12
50. $\neg P_{st}(skf14(u, c), b)$	49,34
51. $P_t(skf14(u, c), b)$	48,44
52. $\neg P_{st}(skf14(u, c), a) \vee P_{st}(skf14(u, c), b)$	51,26
53. $\neg P_{st}(skf14(u, c), a)$	52,50
54. $\neg O_{st}(c, a)$	53,14
55. $\square$	54,33
56. $\neg O_{st}(c, a)$	Spt 55,33,28
57. $EC_{st}(c, a)$	Spt 55,28
58. $a = b$	57,41
59. $\neg P_{st}(b, b)$	Rew 58,35
60. $\square$	59,2

**Th43.**  $(x \subseteq_t y) \rightarrow TS(ts(y, x), y)$

From D30

**Th44.**  $P_{st}(x, y) \rightarrow \exists u[TS(u, y) \wedge u =_t x]$

From C2, A18

**Th45.**  $x \sigma_t y \rightarrow \exists u[TS(u, x) \wedge u \subseteq_t y]$

Refutation Set:

1.  $\neg(u =_t v) \vee u \subseteq_t v$  D21

2. $\neg(u =_t v) \vee v \subseteq_t u$	D21
3. $\neg(v \subseteq_t u) \vee \text{TS}(\text{skf14}(v, u), u)$	D29
4. $\neg(v \subseteq_t u) \vee \text{skf14}(v, u) =_t v$	A18
5. $\neg(u \sigma_t v) \vee \text{skf12}(v, u) \subseteq_t u$	D2
6. $\neg(u \sigma_t v) \vee \text{skf12}(v, u) \subseteq_t v$	D2
7. $\neg(v \subseteq_t u) \vee \neg(u \subseteq_t v) \vee u =_t v$	D21
8. $\neg(u =_t v) \vee \neg(u \subseteq_t w) \vee (v \subseteq_t w)$	Th16
9. $a \sigma_t b$	
10. $[\neg \text{TS}(u, a) \vee \neg(u \subseteq_t b)]$	

Proof:

11. $P_t(\text{skf12}(b, a), a)$	9,5
12. $P_t(\text{skf12}(b, a), b)$	9,6
13. $\text{TS}(\text{skf14}(\text{skf12}(b, a), a), a)$	11,3
14. $\text{EQ}_t(\text{skf14}(\text{skf12}(b, a), a), \text{skf12}(b, a))$	11,4
15. $\neg P_t(\text{skf14}(\text{skf12}(b, a), a), b)$	13,10
16. $P_t(\text{skf14}(\text{skf12}(b, a), a), \text{skf12}(b, a))$	14,1
17. $P_t(\text{skf12}(b, a), \text{skf14}(\text{skf12}(b, a), a))$	14,2
18. $\text{EQ}_t(\text{skf12}(b, a), \text{skf14}(\text{skf12}(b, a), a))$	SHy 17,16,7
19. $\neg \text{EQ}_t(\text{skf12}(b, a), u) \vee P_t(u, b)$	12,8
20. $P_t(\text{skf14}(\text{skf12}(b, a), a), b)$	19,18
21. $\square$	20,15

**Th46.**  $\neg \text{EMB}(x, x)$

Refutation Set:

1. $C_t(\text{skf15}(u, v), v)$	D1
2. $\neg \text{EMB}(u, v) \vee \text{DR}_t(u, v)$	D32
3. $\neg \text{DR}_t(u, v) \vee \neg O_t(u, v)$	D4
4. $\neg C_t(\text{skf15}(u, v), u) \vee P_t(v, u)$	D1
5. $\neg P_t(u, v) \vee \neg P_t(u, w) \vee O_t(v, w)$	D2
6. $\text{EMB}(a, a)$	

Proof:

7. $\text{DR}_t(a, a)$	6,2
8. $P_t(u, u)$	4,1
9. $\neg P_t(u, v) \vee O_t(u, v)$	8,5
10. $\neg P_t(u, v) \vee \neg \text{DR}_t(u, v)$	9,3
11. $\neg \text{DR}_t(u, u)$	10,8
12. $\square$	

**Th47.**  $[\text{CON}_t(x) \wedge \text{CON}_t(y)] \rightarrow [x <_t y \vee x \approx y \vee y <_t x]$

Refutation Set:

1.  $u \approx u$  A1
2.  $P_t(\text{skf16}(u, v), v)$  D2
3.  $\neg(u \bowtie_t v) \vee \text{EC}_t(u, v)$  D23
4.  $\neg\text{EC}_t(u, v) \vee u \approx v$  D6
5.  $\neg(u \approx v) \vee v \approx u$  A2
6.  $\neg O_t(u, v) \vee P_t(\text{skf16}(v, u), v)$  D2
7.  $\neg\text{CON}_t(u) \vee \neg\text{CON}_t(v) \vee \neg\text{EMB}(u, v)$  D32
8.  $\neg\text{ORD}(u, v) \vee u <_t v \vee u \bowtie_t v$  D31
9.  $\neg P_t(u, v) \vee \neg(w \approx u) \vee w \approx v$  D1
10.  $\text{EMB}(u, v) \vee \text{ORD}(u, v) \vee \text{ORD}(v, u) \vee O_t(u, v)$  A19
11.  $\text{CON}_t(a)$
12.  $\text{CON}_t(b)$
13.  $\neg(a <_t b)$
14.  $\neg(b <_t a)$
15.  $\neg(a \approx b)$

Proof:

16.  $\neg\text{CON}_t(u) \vee \neg\text{EMB}(u, a)$  11,7
17.  $\neg(b \approx a)$  15,5
18.  $\neg\text{EC}_t(a, b)$  15,4
19.  $\neg P_t(u, b) \vee \neg(a \approx u)$  15,9
20.  $\neg\text{ORD}(b, a) \vee b \bowtie_t a$  14,8
21.  $\neg\text{ORD}(a, b) \vee a \bowtie_t b$  13,8
22.  $\neg\text{EMB}(b, a)$  16,12
23.  $O_t(b, a) \vee \text{ORD}(a, b) \vee \text{ORD}(b, a)$  22,10
24.  $(a \approx \text{skf16}(u, b))$  19,2
25.  $O_t(b, a)$  Spt 23
26.  $P_t(\text{skf16}(a, b), a)$  25,6
27.  $C_t(\text{skf16}(a, b), a)$  SHy 26,9,1
28.  $C_t(a, \text{skf16}(a, b))$  27,5
29.  $\square$  28,24
30.  $\neg O_t(b, a)$  Spt 29,25,23
31.  $\text{ORD}(a, b) \vee \text{ORD}(b, a)$  Spt 29,23
32.  $\text{ORD}(a, b)$  Spt 31
33.  $a \bowtie_t b$  32,21
34.  $\text{EC}_t(a, b)$  33,3



---

35. $\square$	34,18
36. $\neg\text{ORD}(a, b)$	Spt 35,32,31
37. $\text{ORD}(b, a)$	Spt 35,31
38. $b \not\ll_t a$	37,20
39. $\text{EC}_t(b, a)$	38,3
40. $b \not\approx a$	39,4
41. $\square$	40,17



# Appendix C

## Transition Theorems I

---

Proofs of theorems cited in Section 4.3, Chapter 4 are presented below. First the theorem is cited followed by the refutation set and then the proof is given. Theorems presented in Appendix B are used as Lemmas. Additional Lemma wherever used is stated explicitly prior to proof of the theorem.

**Th48.**  $\text{CONT}w \rightarrow \forall u, v[\text{ECTS}(u, v, w) \rightarrow \neg\exists x[\text{P}_{\text{st}}(x, v) \wedge \text{C}_t(x, u) \wedge \neg\text{C}_{\text{st}}(x, u)]]$

Refutation Set:

1.  $\neg\text{CONT}u \vee \text{CON}_t(u)$  D35
2.  $\neg\text{TS}(u, v) \vee \text{P}_{\text{st}}(u, v)$  D29
3.  $\neg\text{C}_t(u, v) \vee \text{C}_t(v, u)$  A2
4.  $\neg\text{C}_{\text{st}}(u, v) \vee \text{C}_{\text{st}}(v, u)$  A2
5.  $\neg\text{ECTS}(u, v, w) \vee \text{TS}(v, w)$  D36
6.  $\neg\text{ECTS}(u, v, w) \vee \text{TS}(u, w)$  D36
7.  $\neg\text{P}_{\text{st}}(u, v) \vee \neg\text{P}_{\text{st}}(v, w) \vee \text{P}_{\text{st}}(u, w)$  Th2
8.  $\neg\text{CONT}u \vee \neg\text{TS}(v, u) \vee \neg\text{C}_t(v, w) \vee \neg\text{P}_{\text{st}}(w, u) \vee \text{C}_{\text{st}}(v, w)$  D35
9.  $\text{CON}_a$
10.  $\text{P}_{\text{st}}(d, c)$
11.  $\text{C}_t(d, b)$
12.  $\text{ECTS}(b, c, a)$
13.  $\neg\text{C}_{\text{st}}(d, b)$

Proof:

14.  $\text{CON}_t(a)$  9,1

15. $C_t(b, d)$	11,3
16. $\neg C_{st}(b, d)$	13,4
17. $TS(c, a)$	12,5
18. $TS(b, a)$	12,6
19. $P_{st}(c, a)$	17,2
20. $P_{st}(d, a)$	SHy 19,10,7
21. $\neg \text{CON}t a \vee C_{st}(b, d)$	SHy 20,18,15,8
22. $C_{st}(b, d)$	21,9
23. $\square$	22,16

**Th49.**  $[\text{ECTS}(u, v, w) \wedge \neg C_{sp}(u, z) \wedge \text{PP}_{sp}(v, z)] \rightarrow \neg \text{CON}t w$

Refutation Set:

1. $\neg \text{CON}t u \vee \text{CON}t(u)$	D35
2. $\neg TS(u, v) \vee P_{st}(u, v)$	D29
3. $\neg C_{st}(u, v) \vee C_{sp}(v, u)$	A15
4. $\neg \text{EC}t(u, v) \vee C_t(u, v)$	D6
5. $\neg \text{PP}_{sp}(u, v) \vee P_{sp}(u, v)$	D3
6. $\neg \text{ECTS}(u, v, w) \vee \text{EC}t(u, v)$	D36
7. $\neg \text{ECTS}(u, v, w) \vee TS(v, w)$	D36
8. $\neg \text{ECTS}(u, v, w) \vee TS(u, w)$	D36
9. $\neg P_{sp}(u, v) \vee \neg C_{sp}(w, u) \vee C_{sp}(w, v)$	D1
10. $\neg \text{CON}t u \vee \neg TS(v, u) \vee \neg C_t(v, w) \vee \neg P_{st}(w, u) \vee C_{st}(v, w)$	D35
11. $\text{CON}t a$	
12. $\text{PP}_{sp}(c, d)$	
13. $\text{ECTS}(b, c, a)$	
14. $\neg C_{sp}(b, d)$	

Proof:

15. $\text{CON}t(a)$	11,1
16. $P_{sp}(c, d)$	12,5
17. $\neg P_{sp}(u, d) \vee \neg C_{sp}(b, u)$	14,9
18. $\text{EC}t(b, c)$	13,6
19. $TS(c, a)$	13,7
20. $TS(b, a)$	13,8
21. $C_t(b, c)$	18,4
22. $P_{st}(c, a)$	19,2
23. $\neg \text{CON}t a \vee C_{st}(b, c)$	SHy 22,21,20,10
24. $C_{st}(b, c)$	23,11

25. $C_{sp}(b, c)$	24,3
26. $\neg C_{sp}(b, c)$	17,16
27. $\square$	26,25

**Th50.**  $[ECTS(x_1, x_2, x) \wedge EQ_t(z_1, x_1) \wedge NTPP_{st}(z_2, x_2)] \rightarrow [\neg CONT(z_1 \cup z_2) \vee \neg CONT x]$

**Lemma 1.**  $(u \cup v) = (v \cup u)$

From D11, A2

Proof of Theorem:

Refutation Set:

1. $\neg CONT u \vee CON_t(u)$	D35
2. $(u \cup v) = (v \cup u)$	Lemma 1
3. $\neg O_{st}(u, v) \vee O_t(u, v)$	Th33
4. $\neg NTPP_{st}(u, v) \vee P_{st}(u, v)$	D10
5. $\neg TS(u, v) \vee P_{st}(u, v)$	D29
6. $\neg EQ_t(u, v) \vee P_t(u, v)$	D8
7. $\neg C_t(u, v) \vee C_t(v, u)$	A2
8. $\neg ECTS(u, v, w) \vee EC_t(u, v)$	D36
9. $\neg ECTS(u, v, w) \vee TS(v, w)$	D36
10. $\neg ECTS(u, v, w) \vee TS(u, w)$	D36
11. $\neg CON_t(u \cup v) \vee C_t(u, v)$	D16
12. $\neg EC_t(u, v) \vee \neg O_t(u, v)$	D6
13. $\neg NTPP_{st}(u, v) \vee \neg C_{st}(w, u) \vee O_{st}(w, v)$	Th4
14. $\neg P_{st}(u, v) \vee \neg P_{st}(v, w) \vee P_{st}(u, w)$	Th2
15. $\neg P_t(u, v) \vee \neg C_t(w, u) \vee C_t(w, v)$	D1
16. $\neg CONT u \vee \neg TS(v, u) \vee \neg C_t(v, w) \vee \neg P_{st}(w, u) \vee C_{st}(v, w)$	D35
17. $CON_t a$	
18. $EQ_t(d, b)$	
19. $NTPP_{st}(e, c)$	
20. $CONT(d \cup e)$	
21. $ECTS(b, c, a)$	

Proof:

22. $CON_t(a)$	17,1
23. $P_{st}(e, c)$	19,4
24. $P_t(d, b)$	18,6
25. $EC_t(b, c)$	21,8
26. $TS(c, a)$	21,9
27. $TS(b, a)$	21,10

28. $\text{CON}_t(d \cup e)$	20,1
29. $\text{CON}_t(e \cup d)$	28,2
30. $\neg O_t(b, c)$	25,12
31. $P_{st}(c, a)$	26,5
32. $C_t(e, d)$	29,11
33. $P_{st}(e, a)$	SHy 31,23,14
34. $C_t(e, b)$	SHy 32,24,15
35. $C_t(b, e)$	34,7
36. $\neg \text{CON}_t a \vee C_{st}(b, e)$	SHy 35,33,27,16
37. $C_{st}(b, e)$	SHy 36,22,17
38. $O_{st}(b, c)$	SHy 37,19,13
39. $O_t(b, c)$	38,3
40. $\square$	39,30

**Th51.**  $[\text{ECTS}(y_1, y_2, y) \wedge \text{ECTS}(z_1, z_2, z) \wedge \text{EQ}_t(y_1, z_1) \wedge \neg C_{st}(y_1, z_1) \wedge \text{PP}_{st}(y_2, z_2)] \rightarrow [\neg \text{CON}_t y \vee \neg \text{CON}_t z]$

Refutation Set:

1. $\neg \text{CON}_t u \vee \text{CON}_t(u)$	D35
2. $\neg \text{TS}(u, v) \vee P_{st}(u, v)$	D29
3. $\neg \text{EC}_t(u, v) \vee C_t(u, v)$	D6
4. $\neg \text{PP}_{st}(u, v) \vee P_{st}(u, v)$	D3
5. $\neg \text{ECTS}(u, v, w) \vee \text{EC}_t(u, v)$	D36
6. $\neg \text{ECTS}(u, v, w) \vee \text{TS}(v, w)$	D36
7. $\neg \text{ECTS}(u, v, w) \vee \text{TS}(u, w)$	D36
8. $\neg P_{st}(u, v) \vee \neg C_{st}(w, u) \vee C_{st}(w, v)$	D1
9. $\neg \text{CON}_t u \vee \neg \text{TS}(v, u) \vee \neg C_{st}(w, u) \vee \neg \text{EQ}_t(w, v) \vee C_{st}(w, v)$	A20
10. $\neg \text{CON}_t u \vee \neg \text{TS}(v, u) \vee \neg C_t(v, w) \vee \neg P_{st}(w, u) \vee C_{st}(v, w)$	D35
11. $\text{CON}_t a$	
12. $\text{CON}_t b$	
13. $\text{EQ}_t(c, e)$	
14. $\text{PP}_{st}(d, f)$	
15. $\text{ECTS}(c, d, a)$	
16. $\neg C_{st}(c, e)$	
17. $\text{ECTS}(e, f, b)$	

Proof:

18. $\text{CON}_t(a)$	11,1
19. $P_{st}(d, f)$	14,4

20.	$\neg\text{CONT}u \vee \neg\text{TS}(e, u) \vee \neg\text{C}_{\text{st}}(c, u) \vee C(c, e)$	13,9
21.	$\text{TS}(f, b)$	17,6
22.	$\text{TS}(e, b)$	17,7
23.	$\text{EC}_t(c, d)$	15,5
24.	$\text{TS}(d, a)$	15,6
25.	$\text{TS}(c, a)$	15,7
26.	$\neg\text{CONT}u \vee \neg\text{TS}(e, u) \vee \neg\text{C}_{\text{st}}(c, u)$	20,16
27.	$\neg\text{TS}(e, b) \vee \neg\text{C}_{\text{st}}(c, b)$	26,12
28.	$\neg\text{C}_{\text{st}}(c, b)$	27,22
29.	$\text{P}_{\text{st}}(f, b)$	21,2
30.	$\text{C}_t(c, d)$	23,3
31.	$\text{P}_{\text{st}}(d, a)$	24,2
32.	$\neg\text{CON}T a \vee \text{C}_{\text{st}}(c, d)$	SHy 31,30,25,10
33.	$\text{C}_{\text{st}}(c, d)$	32,11
34.	$\text{C}_{\text{st}}(c, f)$	SHy 33,19,8
35.	$\text{C}_{\text{st}}(c, b)$	SHy 34,29,8
36.	$\square$	35,28

**Th52.**  $[\text{ECTS}(y_1, y_2, y) \wedge \text{ECTS}(z_1, z_2, z) \wedge \text{EQ}_t(y_1, z_1) \wedge \text{EC}_{\text{st}}(y_1, z_1) \wedge \text{PP}_{\text{st}}(y_2, z_2)] \rightarrow [\neg\text{FCON}T y \vee \neg\text{FCON}T z]$

**Lemma 2.**  $\text{EC}_{\text{st}}(x, y) \rightarrow \text{EC}_{\text{st}}(y, x)$

From D6, A2

Proof of Theorem:

Refutation Set:

1.	$\neg\text{FCON}T u \vee \text{NP}u$	D38
2.	$\neg\text{FCON}T u \vee \text{CON}T u$	D38
3.	$\text{P}_{\text{st}}(\text{skf58}(u, v), v)$	D18
4.	$\text{P}_{\text{st}}(\text{skf57}(u, v), u)$	D18
5.	$\neg\text{EC}_{\text{st}}(u, v) \vee \text{EC}_{\text{st}}(v, u)$	L2
6.	$\neg\text{EQ}_t(u, v) \vee \text{P}_t(v, u)$	D8
7.	$\neg\text{EQ}_t(u, v) \vee \text{P}_t(u, v)$	D8
8.	$\neg\text{PP}_{\text{st}}(u, v) \vee \text{P}_{\text{st}}(u, v)$	D3
9.	$\neg\text{P}_{\text{st}}(u, v) \vee \neg\text{P}_{\text{st}}(v, w) \vee \text{P}_{\text{st}}(u, w)$	Th2
10.	$\neg\text{NP}u \vee \neg\text{ECTS}(v, w, u) \vee \text{FCON}(v, w)$	D37
11.	$\neg\text{P}_t(u, v) \vee \neg\text{P}_t(v, u) \vee \text{EQ}_t(u, v)$	D8
12.	$\neg\text{FCON}(u, v) \vee \text{INCON}(\text{skf58}(v, u) \cup \text{skf57}(v, u))$	D18
13.	$\neg\text{P}_{\text{st}}(u, v) \vee \neg\text{INCON}(u \cup w) \vee \neg\text{P}_{\text{st}}(w, x) \vee \text{FCON}(v, x)$	D18

- |     |   |     |
|-----|---|-----|
| 14. | $\neg\text{CONT}u \vee \neg\text{EQ}_t(v, w) \vee \neg\text{EC}_{\text{st}}(v, w) \vee \neg\text{FCON}(w, x) \vee \text{ECTS}(v, x, u)$ | A21 |
| 15. | $\text{FCONT}a$   |     |
| 16. | $\text{FCONT}b$   |     |
| 17. | $\text{EC}_{\text{st}}(c, e)$   |     |
| 18. | $\text{EQ}_t(c, e)$   |     |
| 19. | $\text{PP}_{\text{st}}(d, f)$   |     |
| 20. | $\text{ECTS}(c, d, a)$  |     |
| 21. | $\text{ECTS}(e, f, b)$  |     |

Proof:

- |     |   |                 |
|-----|---|-----------------|
| 22. | $\text{CONT}b$  | 16,2            |
| 23. | $\text{NP}a$  | 15,1            |
| 24. | $\text{P}_{\text{st}}(d, f)$  | 19,8            |
| 25. | $\text{P}_t(e, c)$  | 18,6            |
| 26. | $\text{P}_t(c, e)$  | 18,7            |
| 27. | $\text{EC}_{\text{st}}(e, c)$   | 17,5            |
| 28. | $\neg\text{CONT}b \vee \neg\text{EQ}_t(e, u) \vee \neg\text{EC}_{\text{st}}(e, u) \vee \neg\text{FCON}(u, f)$ | 27,14           |
| 29. | $\neg\text{NP}a \vee \text{FCON}(c, d)$   | 20,10           |
| 30. | $\text{FCON}(c, d)$   | 29,23           |
| 31. | $\neg\text{EQ}_t(e, u) \vee \neg\text{EC}_{\text{st}}(e, u) \vee \neg\text{FCON}(u, f)$                       | 28,22           |
| 32. | $\text{P}_{\text{st}}(\text{skf}57(d, u), f)$   | SHy 24,9,4      |
| 33. | $\text{EQ}_t(e, c)$   | SHy 26,25,11    |
| 34. | $\text{INCON}(\text{skf}58(d, c) + \text{skf}57(d, c))$   | 30,12           |
| 35. | $\text{FCON}(c, f)$   | SHy 34,32,13,3  |
| 36. | $\square$   | SHy 35,33,31,27 |

**Th53.**  $[\text{ECTS}(y_1, y_2, y) \wedge \text{ECTS}(z_1, z_2, z) \wedge \text{EQ}_t(y_1, z_1) \wedge \text{DC}_{\text{st}}(y_1, z_1) \wedge \text{EQ}_{\text{st}}(y_2, z_2)] \rightarrow [\neg\text{CONT}y \vee \neg\text{CONT}z]$

Refutation Set:

- |    |  |     |
|----|--|-----|
| 1. | $\neg\text{CONT}u \vee \text{CON}_t u$   | D35 |
| 2. | $\neg\text{TS}(u, v) \vee \text{P}_{\text{st}}(u, v)$  | D29 |
| 3. | $\neg\text{EC}_t(u, v) \vee \text{C}_t(v, u)$  | D6  |
| 4. | $\neg\text{ECTS}(u, v, w) \vee \text{EC}_t(u, v)$  | D36 |
| 5. | $\neg\text{ECTS}(u, v, w) \vee \text{TS}(v, w)$  | D36 |
| 6. | $\neg\text{ECTS}(u, v, w) \vee \text{TS}(u, w)$  | D36 |
| 7. | $\neg\text{DC}_{\text{st}}(u, v) \vee \neg\text{C}_{\text{st}}(u, v)$  | D5  |
| 8. | $\neg\text{P}_{\text{st}}(u, v) \vee \neg\text{C}_{\text{st}}(w, u) \vee \text{C}_{\text{st}}(w, v)$                                       | D1  |
| 9. | $\neg\text{CONT}u \vee \neg\text{TS}(v, u) \vee \neg\text{EQ}_t(v, w) \vee \neg\text{C}_{\text{st}}(w, u) \vee \text{C}_{\text{st}}(v, w)$ | A20 |



10.  $\neg\text{CONT}u \vee \neg\text{P}_{\text{st}}(v, u) \vee \neg\text{TS}(w, u) \vee \neg\text{C}_t(w, v) \vee \text{C}_{\text{st}}(w, v)$  D35
11.  $\text{CONT}_a$
12.  $\text{CONT}_b$
13.  $\text{EQ}_t(c, d)$
14.  $\text{DC}_{\text{st}}(c, d)$
15.  $\text{EQ}_{\text{st}}(e, f)$
16.  $\text{ECTS}(c, e, b)$
17.  $\text{ECTS}(d, f, a)$

Proof:

18.  $\text{ECTS}(c, f, b)$  15,16
19.  $\text{CON}_t a$  11,1
20.  $\neg\text{C}_{\text{st}}(c, d)$  14,7
21.  $\neg\text{CONT}u \vee \neg\text{TS}(c, u) \vee \neg\text{C}_{\text{st}}(d, u) \vee \text{C}_{\text{st}}(c, d)$  13,9
22.  $\text{EC}_t(d, f)$  17,4
23.  $\text{TS}(f, a)$  17,5
24.  $\text{TS}(d, a)$  17,6
25.  $\text{TS}(f, b)$  16,5
26.  $\text{TS}(c, b)$  16,6
27.  $\neg\text{CONT}u \vee \neg\text{TS}(c, u) \vee \neg\text{C}_{\text{st}}(d, u)$  21,20
28.  $\neg\text{TS}(c, b) \vee \neg\text{C}_{\text{st}}(d, b)$  27,12
29.  $\neg\text{C}_{\text{st}}(d, b)$  28,26
30.  $\text{C}_t(d, f)$  22,3
31.  $\text{P}_{\text{st}}(f, a)$  22,2
32.  $\text{P}_{\text{st}}(f, b)$  25,2
33.  $\neg\text{CONT}_a \vee \text{C}_{\text{st}}(d, f)$  SHy 31,23,10
34.  $\text{C}_{\text{st}}(d, f) \vee \neg\text{C}_{\text{st}}(d, b)$  33,11
35.  $\text{C}_{\text{st}}(d, b)$  SHy 34,32,8
36.  $\square$  35,29

**Th54.**  $[\text{ECTS}(y_1, y_2, y) \wedge \text{ECTS}(z_1, z_2, z) \wedge \text{EQ}_t(y_1, z_1) \wedge \text{EC}_{\text{st}}(y_1, z_1) \wedge \text{EQ}_{\text{st}}(y_2, z_2)] \rightarrow [\neg\text{FCONT}y \vee \neg\text{FCONT}z]$

Refutation Set:

1.  $\neg\text{FCONT}u \vee \text{NP}u$  D38
2.  $\neg\text{FCONT}u \vee \text{CONT}u$  D38
3.  $\neg\text{NP}u \vee \neg\text{ECTS}(v, w, u) \vee \text{FCON}(v, w)$  D37
4.  $\neg\text{EC}_t(u, v) \vee \text{C}_t(v, u)$  D6
5.  $\neg\text{CONT}u \vee \neg\text{EQ}_t(v, w) \vee \neg\text{EC}_{\text{st}}(v, w) \vee \neg\text{FCON}(w, x) \vee \neg\text{ECTS}(v, x, u)$  A21

6. FCONT<sub>a</sub>
7. FCONT<sub>b</sub>
8. EQ<sub>t</sub>(c, d)
9. EC<sub>st</sub>(c, d)
10. EQ<sub>st</sub>(e, f)
11. ECTS(c, e, b)
12. ECTS(d, f, a)

Proof:

13. CONT<sub>b</sub> 7,2
14. NP<sub>a</sub> 6,1
15.  $\neg\text{CONT}_u \vee \neg\text{EQ}_t(c, d) \vee \neg\text{FCON}(d, v) \vee \neg\text{ECTS}(c, v, u)$  9,5
16. ECTS(c, f, b) Rew 11,10
17.  $\neg\text{NP}_a \vee \text{FCON}(d, f)$  12,3
18. FCON(d, f) 17,14
19.  $\neg\text{CONT}_u \vee \neg\text{FCON}(d, v) \vee \neg\text{ECTS}(c, v, u)$  15,8
20.  $\neg\text{CONT}_b \vee \neg\text{FCON}(d, f)$  19,16
21.  $\square$  SHy 20,18,13

**Th55.**  $[\text{EC}_{\text{sp}}^{\equiv}(z, x) \wedge \text{TS}(x, w)] \rightarrow \text{EC}_{\text{st}}(z, w)$

Refutation Set:

1. TS(u, u) Th34
2. P<sub>st</sub>(skf23(u, v), v) D2
3.  $\neg\text{EC}_{\text{sp}}^{\equiv}(u, v) \vee \text{EQ}_t(u, v)$  D43
4.  $\neg\text{P}_{\text{st}}(u, v) \vee \text{P}_t(u, v)$  C2
5.  $\neg\text{EQ}_t(u, v) \vee \text{P}_t(u, v)$  D8
6.  $\neg\text{EC}_{\text{st}}(u, v) \vee \text{C}_{\text{st}}(u, v)$  D6
7.  $\neg\text{EC}_{\text{st}}(u, v) \vee \neg\text{O}_{\text{st}}(u, v)$  D6
8.  $\neg\text{O}_{\text{st}}(u, v) \vee \text{P}_{\text{st}}(\text{skf23}(v, u), v)$  D2
9.  $\neg\text{C}_{\text{st}}(u, v) \vee \text{O}_{\text{st}}(u, v) \vee \text{EC}_{\text{st}}(u, v)$  D6
10.  $\neg\text{TS}(u, v) \vee \neg\text{C}_{\text{st}}(w, u) \vee \text{C}_{\text{st}}(w, v)$  Th40
11.  $\neg\text{P}_t(u, v) \vee \neg\text{P}_t(v, w) \vee \text{P}_t(u, w)$  Th2
12.  $\neg\text{P}_{\text{st}}(u, v) \vee \neg\text{P}_{\text{st}}(u, w) \vee \text{O}_{\text{st}}(v, w)$  D2
13.  $\neg\text{TS}(u, v) \vee \neg\text{P}_{\text{st}}(w, v) \vee \neg\text{P}_t(w, u) \vee \text{P}_{\text{st}}(w, u)$  D29
14.  $\neg\text{EC}_{\text{sp}}^{\equiv}(u, v) \vee \neg\text{TS}(w, u) \vee \neg\text{EQ}_t(w, x) \vee \neg\text{TS}(x, v) \vee \text{EC}_{\text{st}}(w, x)$  D43
15. EC<sub>sp</sub><sup>≡</sup>(a, b)
16. TS(b, c)
17.  $\neg\text{EC}_{\text{st}}(a, c)$

Proof:

18. $EQ_t(a, b)$	15,3
19. $\neg C_{st}(a, c) \vee O_{st}(a, c)$	17,9
20. $P_t(a, b)$	18,5
21. $EC_{st}(a, b)$	SHy 18,15,14,1
22. $\neg O_{st}(a, b)$	21,7
23. $C_{st}(a, b)$	21,6
24. $C_{st}(a, c)$	SHy 23,16,10
25. $O_{st}(a, c)$	24,19
26. $P_{st}(skf23(c, a), c)$	25,8
27. $O_{st}(c, a)$	SHy 26,12,2
28. $P_{st}(skf23(a, c), a)$	27,8
29. $P_t(skf23(a, c), a)$	28,4
30. $P_t(skf23(a, c), b)$	SHy 29,20,11
31. $P_{st}(skf23(a, c), b)$	SHy 30,16,13,2
32. $O_{st}(a, b)$	SHy 31,28,12
33. $\square$	32,22

**Th56.**  $[P_{sp}^{=*}(z, x) \wedge TS(z, w)] \rightarrow PP_{st}(z, w)$

Refutation Set:

1. $\neg TS(u, v) \vee P_{st}(u, v)$	D29
2. $\neg P_{sp}^{=*}(u, v) \vee P_{sp}^{=}(u, v)$	D44
3. $\neg P_{sp}^{=}(u, v) \vee P_{st}(u, v)$	D40
4. $\neg P_{sp}^{=}(u, v) \vee EQ_t(u, v)$	D40
5. $\neg P_{sp}^{=*}(u, v) \vee \neg P_{sp}^{=}(v, u)$	D44
6. $\neg P_{st}(u, v) \vee P_{st}(v, u) \vee PP_{st}(u, v)$	D3
7. $\neg P_{st}(u, v) \vee \neg P_{st}(v, w) \vee P_{st}(u, w)$	Th2
8. $\neg EQ_t(u, v) \vee \neg P_{st}(u, v) \vee P_{sp}^{=}(u, v)$	D40
9. $\neg P_{st}(u, v) \vee \neg P_{st}(v, u) \vee (u = v)$	D8
10. $P_{sp}^{=*}(a, b)$	
11. $TS(b, c)$	
12. $\neg PP_{st}(a, c)$	

Proof:

13. $P_{st}(b, c)$	11,1
14. $\neg P_{sp}^{=}(b, a)$	10,5
15. $P_{sp}^{=}(a, b)$	10,2
16. $\neg P_{st}(a, c) \vee P_{st}(c, a)$	12,6

17. $\neg P_{st}(c, b) \vee (c = b)$	13,9
18. $P_{st}(a, b)$	15,3
19. $EQ_t(a, b)$	15,4
20. $\neg EQ_t(b, a) \vee \neg P_{st}(b, a)$	14,8
21. $P_{st}(a, c)$	SHy 18,13,7
22. $P_{st}(c, a)$	21,16
23. $\neg P_{st}(a, c) \vee (a = c)$	22,9
24. $P_{st}(c, b)$	SHy 22,18,7
25. $P_{st}(b, a)$	SHy 22,13,7
26. $(c = b)$	24,17
27. $\neg EQ_t(b, a)$	25,20
28. $EQ_t(a, c)$	Rew 26,19
29. $\neg EQ_t(c, a)$	Rew 27,26
30. $(a = c)$	23,21
31. $\neg EQ_t(a, a)$	Rew 30,29
32. $EQ_t(a, a)$	Rew 30,28
33. $\square$	32,31

**Th57.**  $[DC_{sp}^=(z, x) \wedge TS(z, w) \wedge CONTw] \rightarrow DC_{st}(z, w)$

Refutation Set:

1. $\neg CONTu \vee CON_tu$	D35
2. $C_{st}(u, v) \vee DC_{st}(u, v)$	D5
3. $\neg DC_{sp}^=(u, v) \vee DC_{st}(u, v)$	D41
4. $\neg DC_{sp}^=(u, v) \vee EQ_t(u, v)$	D41
5. $\neg EQ_t(u, v) \vee P_t(v, u)$	D8
6. $\neg EQ_t(u, v) \vee P_t(u, v)$	D8
7. $\neg C_{st}(u, v) \vee C_{st}(v, u)$	A2
8. $\neg DC_{st}(u, v) \vee C_{st}(u, v)$	D5
9. $\neg P_t(u, v) \vee \neg P_t(v, u) \vee (uEQ_tv)$	D8
10. $\neg CONTu \vee \neg EQ_t(v, w) \vee \neg C_{st}(w, u) \vee \neg TS(v, u) \vee C_{st}(v, w)$	A20
11. $CON_t a$	
12. $DC_{sp}^=(c, b)$	
13. $TS(b, a)$	
14. $\neg DC_{st}(c, a)$	

Proof:

15. $CON_t a$	11,1
16. $DC_{st}(c, b)$	12,3

17. $EQ_t(c, b)$	12,4
18. $C_{st}(c, a)$	14,2
19. $\neg C_{st}(c, b)$	16,8
20. $P_t(b, c)$	17,5
21. $P_t(c, b)$	17,6
22. $EQ_t(b, c)$	SHy 20,21,9
23. $\neg \text{CON}T_a \vee C_{st}(b, c)$	SHy 22,18,13,10
24. $C_{st}(b, c)$	15,11,1
25. $C_{st}(c, b)$	24,7
26. $\square$	25,19

**Th58.**  $[TPP_{sp}^=(z, x) \wedge TS(z, w)] \rightarrow TPP_{st}(z, w)$

Refutation Set:

1. $TS(u, u)$	Th34
2. $\neg TPP_{sp}^=(u, v) \vee P_{sp}^{=*}(u, v)$	D47
3. $\neg TPP_{sp}^=(u, v) \vee EC_{sp}^=(\text{skf}71(v, w), v)$	D47
4. $\neg TPP_{sp}^=(u, v) \vee EC_{sp}^=(\text{skf}71(v, u), u)$	D47
5. $\neg EC_{sp}^=(u, v) \vee \neg TS(v, w) \vee EC_{st}(u, w)$	Th55
6. $\neg P_{sp}^{=*}(u, v) \vee \neg TS(v, w) \vee PP_{st}(u, w)$	Th56
7. $\neg PP_{st}(u, v) \vee \neg EC_{st}(w, u) \vee \neg EC_{st}(w, v) \vee TPP_{st}(u, v)$	D9
8. $TPP_{sp}^=(c, a)$	
9. $TS(a, b)$	
10. $\neg TPP_{st}(c, b)$	

Proof:

11. $EC_{sp}^=(\text{skf}71(a, u), a)$	8,3
12. $EC_{sp}^=(\text{skf}71(a, c), c)$	8,4
13. $P_{sp}^{=*}(c, a)$	8,2
14. $\neg PP_{st}(c, b) \vee \neg EC_{st}(u, c) \vee \neg EC_{st}(u, b)$	10,7
15. $PP_{st}(c, b)$	SHy 13,9,6
16. $\neg EC_{st}(u, c) \vee \neg EC_{st}(u, b)$	15,14
17. $EC_{st}(\text{skf}71(a, c), c)$	SHy 12,5,1
18. $EC_{st}(\text{skf}71(a, u), b)$	SHy 11,5,9
19. $\square$	SHy 18,17,16

**Th59.**  $[NTPP_{sp}^=(z, x) \wedge TS(z, w)] \rightarrow PP_{st}(z, w)$

From: D48, Th56

**Th60.**  $[EQ_{sp}^=(z, x) \wedge TS(z, w)] \rightarrow TS(z, w)$

Refutation Set:

1.  $\neg EQ_{sp}^=(u, v) \vee P_{sp}^=(u, v)$  D46
2.  $\neg EQ_{sp}^=(u, v) \vee P_{sp}^=(v, u)$  D46
3.  $\neg P_{sp}^=(u, v) \vee P_{st}(u, v)$  D40
4.  $\neg P_{sp}^=(u, v) \vee EQ_t(u, v)$  D40
5.  $\neg EQTS(u, v, w, x) \vee TS(v, x)$  D42
6.  $\neg P_{st}(u, v) \vee \neg P_{st}(v, u) \vee (u = v)$  D8
7.  $\neg TS(u, v) \vee \neg EQ_t(u, w) \vee \neg TS(w, x) \vee EQTS(u, w, v, x)$  D42
8.  $EQ_{sp}^=(c, a)$
9.  $TS(a, b)$
10.  $\neg TS(c, b)$

Proof:

11.  $\neg TS(u, v) \vee \neg EQ_t(u, a) \vee EQTS(u, a, v, b)$  9,7
12.  $P_{sp}^=(a, c)$  8,2
13.  $P_{sp}^=(c, a)$  8,1
14.  $\neg EQTS(u, c, v, b)$  10,5
15.  $\neg EQ_t(a, a) \vee EQTS(a, a, b, b)$  11,9
16.  $P_{st}(a, c)$  12,3
17.  $P_{st}(c, a)$  13,3
18.  $EQ_t(c, a)$  13,4
19.  $(a = c)$  SHy 17,16,6
20.  $\neg EQ_t(c, c) \vee EQTS(a, a, b, b)$  Rew 19,15
21.  $EQ_t(c, c)$  Rew 19,18
22.  $\neg EQ_t(c, c) \vee EQTS(c, c, b, b)$  Rew 20,19
23.  $\square$  SHy 22,21,14

**Th61.**  $[ECTS(y_1, y_2, y) \wedge ECTS(z_1, z_2, z) \wedge$

$$DC_{sp}^=(y_1, z_1) \wedge P_{sp}^{=*}(y_2, z_2)] \rightarrow [\neg CONT y \vee \neg CONT z]$$

**Lemma 3.**  $DC_{st}(x, y) \leftrightarrow DC_{st}(y, x)$

From: D5, A2

Proof of Theorem:

Refutation Set:

1.  $TS(u, u)$  Th34
2.  $\neg CONT u \vee CON_t u$  D35
3.  $\neg DC_{st}(u, v) \vee DC_{st}(v, u)$  Lemma 3
4.  $\neg P_{sp}^{=*}(u, v) \vee P_{sp}^=(u, v)$  D44

5. $\neg P_{sp}^=(u, v) \vee EQ_t(u, v)$	D40
6. $\neg DC_{sp}^=(u, v) \vee DC_{st}(u, v)$	D41
7. $\neg DC_{sp}^=(u, v) \vee EQ_t(u, v)$	D41
8. $\neg TS(u, v) \vee P_{st}(u, v)$	D29
9. $\neg EQ_t(u, v) \vee P_t(v, u)$	D8
10. $\neg EQ_t(u, v) \vee P_t(u, v)$	D8
11. $\neg EC_t(u, v) \vee C_t(u, v)$	D6
12. $\neg ECTS(u, v, w) \vee EC_t(u, v)$	D36
13. $\neg ECTS(u, v, w) \vee TS(v, w)$	D36
14. $\neg ECTS(u, v, w) \vee TS(u, w)$	D36
15. $\neg DC_{st}(u, v) \vee \neg C_{st}(u, v)$	D5
16. $\neg P_{st}(u, v) \vee \neg P_{st}(v, w) \vee P_{st}(u, w)$	Th2
17. $\neg P_t(u, v) \vee \neg P_t(v, w) \vee EQ_t(u, v)$	D8
18. $\neg P_{st}(u, v) \vee \neg C_{st}(w, u) \vee C_{st}(w, v)$	D1
19. $\neg CONT_u \vee \neg EQ_t(v, w) \vee \neg C_{st}(w, u) \vee \neg TS(v, u) \vee C_{st}(v, w)$	A20
20. $\neg CONT_u \vee \neg TS(v, u) \vee \neg C_t(v, w) \vee \neg P_{st}(w, u) \vee C_{st}(v, w)$	D35
21. $\neg P_{sp}^=(u, v) \vee \neg TS(w, u) \vee \neg EQ_t(w, x) \vee \neg TS(x, v) \vee P_{st}(w, x)$	D40
22. $CONT_a$	
23. $CONT_b$	
24. $DC_{sp}^=(e, c)$	
25. $P_{sp}^=(f, d)$	
26. $ECTS(e, f, a)$	
27. $ECTS(c, d, b)$	

Proof:

28. $\neg EQ_t(u, v) \vee \neg C_{st}(v, b) \vee \neg TS(u, b) \vee C_{st}(u, v)$	23,19
29. $CON_t(a)$	22,2
30. $P_{sp}^=(f, d)$	25,4
31. $DC_{st}(e, c)$	24,6
32. $EQ_t(e, c)$	24,7
33. $TS(d, b)$	27,13
34. $TS(c, b)$	27,14
35. $EC_t(f, e)$	26,12
36. $TS(f, a)$	26,13
37. $TS(e, a)$	26,14
38. $EQ_t(f, d)$	30,5
39. $DC_{st}(c, e)$	31,3
40. $P_t(c, e)$	32,9

41. $P_t(e, c)$	32,10
42. $P_{st}(d, b)$	33,8
43. $C_t(e, f)$	35,11
44. $P_{st}(f, a)$	36,8
45. $P_{st}(f, d)$	SHy 38,30,21,1
46. $\neg C_{st}(c, e)$	39,15
47. $EQ_t(c, e)$	41,40,17
48. $\neg \text{CONTa} \vee C_{st}(e, f)$	SHy 44,43,37,20
49. $C_{st}(e, f)$	48,29,22
50. $P_{st}(f, b)$	SHy 45,42,16
51. $\neg C_{st}(e, b) \vee \neg \text{TS}(c, b) \vee C_{st}(c, e)$	47,28
52. $\neg C_{st}(e, b) \vee C_{st}(c, e)$	51,34
53. $\neg C_{st}(e, b)$	52,46
54. $C_{st}(e, b)$	SHy 50,49,18
55. $\square$	54,53

**Th62.**  $[\text{ECTS}(y_1, y_2, y) \wedge \text{ECTS}(z_1, z_2, z) \wedge \text{EC}_{sp}^=(y_1, z_1) \wedge \text{P}_{sp}^*(y_2, z_2)] \rightarrow [\neg \text{FCONT}y \vee \neg \text{FCONT}z]$

Refutation Set:

1. $\text{TS}(u, u)$	Th34
2. $\neg \text{FCONT}u \vee \text{NP}u$	D38
3. $\neg \text{FCONT}u \vee \text{CONT}u$	D38
4. $P_{st}(\text{skf54}(u, v), v)$	D18
5. $P_{st}(\text{skf53}(u, v), u)$	D18
6. $P_{st}(\text{skf39}(u, v), v)$	D2
7. $\neg \text{P}_{sp}^*(u, v) \vee \text{P}_{sp}^=(u, v)$	D44
8. $\neg \text{EC}_{sp}^=(u, v) \vee \text{EQ}_t(u, v)$	D43
9. $\neg \text{P}_{sp}^=(u, v) \vee P_{st}(u, v)$	D40
10. $\neg \text{TS}(u, v) \vee P_{st}(u, v)$	D29
11. $\neg \text{EQ}_t(u, v) \vee P_t(v, u)$	D8
12. $\neg \text{EQ}_t(u, v) \vee P_t(u, v)$	D8
13. $\neg \text{EC}_{st}(u, v) \vee C_{st}(u, v)$	D6
14. $\neg C_{st}(u, v) \vee C_{st}(v, u)$	A2
15. $\neg \text{ECTS}(u, v, w) \vee \text{TS}(u, w)$	D36
16. $\neg \text{EC}_{st}(u, v) \vee \neg \text{O}_{st}(u, v)$	D6
17. $\neg \text{O}_{st}(u, v) \vee P_{st}(\text{skf39}(v, u), v)$	D2
18. $\neg C_{st}(u, v) \vee \text{O}_{st}(u, v) \vee \text{EC}_{st}(u, v)$	D6
19. $\neg P_{st}(u, v) \vee \neg P_{st}(v, w) \vee P_{st}(u, w)$	Th2



20. $[\neg EC_{sp}^=(u, v) \vee \neg TS(v, w) \vee EC_{st}(u, w)]$	Th55
21. $\neg NPu \vee \neg ECTS(v, w, u) \vee FCON(v, w)$	D37
22. $\neg P_t(u, v) \vee \neg P_t(v, u) \vee EQ_t(u, v)$	D8
23. $\neg P_{st}(u, v) \vee \neg P_{st}(u, w) \vee O_{st}(v, w)$	D2
24. $\neg FCON(u, v) \vee INCON(skf54(v, u) \cup skf53(v, u))$	D18
25. $\neg P_{st}(u, v) \vee \neg INCON(u \cup w) \vee \neg P_{st}(w, x) \vee FCON(v, x)$	D18
26. $\neg CONTu \vee \neg EQ_t(v, w) \vee \neg EC_{st}(v, w) \vee \neg FCON(w, x) \vee \neg ECTS(v, x, u)$	A21
27. FCONT <sub>a</sub>	
28. FCONT <sub>b</sub>	
29. $EC_{sp}^=(e, c)$	
30. $P_{sp}^*(f, d)$	
31. ECTS(e, f, a)	
32. ECTS(c, d, b)	

Proof:

1. CONT <sub>b</sub>	28,3
2. NP <sub>a</sub>	27,2
3. $P_{sp}^*(f, d)$	30,7
4. $EQ_t(e, c)$	29,8
5. TS(c, b)	32,15
6. $\neg CONT_b \vee \neg EQ_t(c, u) \vee \neg EC_{st}(c, u) \vee \neg FCON(u, d)$	32,26
7. $\neg NP_a \vee FCON(e, f)$	31,21
8. FCON(e, f)	39,34
9. $\neg EQ_t(c, u) \vee \neg EC_{st}(c, u) \vee \neg FCON(u, d)$	38,33
10. $EC_{st}(e, c)$	SHy 20,29,1
11. $P_{st}(f, d)$	35,9
12. $P_t(c, e)$	36,11
13. $P_t(e, c)$	36,12
14. $P_{st}(c, b)$	37,10
15. $EC_{st}(e, b)$	SHy 37,29,20
16. $INCON(skf54(f, e) \cup skf53(f, e))$	40,24
17. $C_{st}(e, c)$	42,13
18. $P_{st}(skf53(f, u), d)$	SHy 43,19,5
19. $EQ_t(c, e)$	SHy 45,44,22
20. $P_{st}(skf39(u, c), b)$	SHy 46,19,6
21. $\neg O_{st}(e, b)$	47,16,
22. $C_{st}(c, e)$	49,14
23. $EC_{st}(c, e) \vee O_{st}(c, e)$	54,18

24. $\text{FCON}(e, d)$	SHy 50,48,25,4
25. $\neg \text{EQ}_t(c, e) \vee \neg \text{EC}_{\text{st}}(c, e)$	56,41
26. $\neg \text{EC}_{\text{st}}(c, e)$	57,51
27. $\text{O}_{\text{st}}(c, e)$	58,55
28. $\text{P}_{\text{st}}(\text{skf39}(e, c), e)$	59,17
29. $\text{O}_{\text{st}}(e, b)$	SHy 60,52,23b
30. $\square$	61,53

**Th63.**  $[\text{ECTS}(y_1, y_2, y) \wedge \text{ECTS}(z_1, z_2, z) \wedge \text{DC}_{\text{sp}}^{\equiv}(y_1, z_1) \wedge \text{EQ}_{\text{sp}}^{\equiv}(y_2, z_2)] \rightarrow [\neg \text{CONT}y \vee \neg \text{CONT}z]$

Refutation Set:

1. $\neg \text{CONT}u \vee \text{CON}_t(u)$	D35
2. $\text{C}_{\text{st}}(u, v) \vee \text{DC}_{\text{st}}(u, v)$	D5
3. $\neg \text{EQ}_{\text{sp}}^{\equiv}(u, v) \vee \text{P}_{\text{sp}}^{\equiv}(v, u)$	D46
4. $\neg \text{EQ}_{\text{sp}}^{\equiv}(u, v) \vee \text{P}_{\text{sp}}^{\equiv}(u, v)$	D46
5. $\neg \text{P}_{\text{sp}}^{\equiv}(u, v) \vee \text{P}_{\text{st}}(u, v)$	D40
6. $\neg \text{DC}_{\text{sp}}^{\equiv}(u, v) \vee \text{DC}_{\text{st}}(u, v)$	D41
7. $\neg \text{DC}_{\text{sp}}^{\equiv}(u, v) \vee \text{EQ}_t(u, v)$	D41
8. $\neg \text{TS}(u, v) \vee \text{P}_{\text{st}}(u, v)$	D29
9. $\neg \text{EC}_t(u, v) \vee \text{C}_t(u, v)$	D6
10. $\neg \text{ECTS}(u, v, w) \vee \text{EC}_t(u, v)$	D36
11. $\neg \text{ECTS}(u, v, w) \vee \text{TS}(v, w)$	D36
12. $\neg \text{ECTS}(u, v, w) \vee \text{TS}(u, w)$	D36
13. $\neg \text{DC}_{\text{st}}(u, v) \vee \neg \text{C}_{\text{st}}(u, v)$	D5
14. $\neg \text{TS}(u, v) \vee \neg \text{C}_{\text{st}}(w, u) \vee \text{C}_{\text{st}}(w, v)$	Th40
15. $\neg \text{P}_{\text{st}}(u, v) \vee \neg \text{P}_{\text{st}}(v, u) \vee (u = v)$	D8
16. $\neg \text{CONT}u \vee \neg \text{EQ}_t(v, w) \vee \neg \text{C}_{\text{st}}(w, u) \vee \neg \text{TS}(v, u) \vee \text{C}_{\text{st}}(v, w)$	A20
17. $\neg \text{CONT}u \vee \neg \text{TS}(v, u) \vee \neg \text{C}_t(v, w) \vee \neg \text{P}_{\text{st}}(w, u) \vee \text{C}_{\text{st}}(v, w)$	D35
18. $\text{CON}_t a$	
19. $\text{CON}_t b$	
20. $\text{DC}_{\text{sp}}^{\equiv}(e, c)$	
21. $\text{EQ}_{\text{sp}}^{\equiv}(f, d)$	
22. $\text{ECTS}(e, f, b)$	
23. $\text{ECTS}(c, d, a)$	

Proof:

24. $\text{CON}_t(b)$	19,1
25. $\text{CON}_t(a)$	18,1

26.	$P_{sp}^{\equiv}(d, f)$	21,3
27.	$P_{sp}^{\equiv}(f, d)$	21,4
28.	$DC_{st}(e, c)$	20,6
29.	$EQ_t(e, c)$	20,7
30.	$EC_t(c, d)$	23,10
31.	$TS(d, a)$	23,11
32.	$TS(c, a)$	23,12
33.	$TS(f, b)$	22,11
34.	$TS(e, b)$	22,12
35.	$P_{st}(d, f)$	26,5
36.	$P_{st}(f, d)$	27,5
37.	$\neg C_{st}(e, c)$	28,13
38.	$C_t(c, d)$	30,9
39.	$P_{st}(d, a)$	31,8
40.	$\neg CONT_b \vee DC_{st}(c, b) \vee C_{st}(e, c)$	SHy 34,29,16,2
41.	$DC_{st}(c, b) \vee C_{st}(e, c)$	40,24,19
42.	$DC_{st}(c, b)$	41,37
43.	$\neg P_{st}(f, d) \vee (d = f)$	35,15
44.	$(d = f)$	43,36
45.	$C_t(c, f)$	Rew 44,38
46.	$P_{st}(f, a)$	Rew 44,39
47.	$\neg C_{st}(c, b)$	42,13
48.	$\neg CONT_a \vee C_{st}(c, f)$	SHy 46,45,32,17
49.	$C_{st}(c, f)$	48,25,18
50.	$C_{st}(c, b)$	SHy 49,33,14
51.	$\square$	50,47

**Th64.**  $[ECTS(y_1, y_2, y) \wedge ECTS(z_1, z_2, z) \wedge EC_{sp}^{\equiv}(y_1, z_1) \wedge EQ_{sp}^{\equiv}(y_2, z_2)] \rightarrow [\neg FCONT y \vee \neg FCONT z]$

Refutation Set:

1.	$TS(u, u)$	Th34
2.	$\neg FCONT u \vee NPu$	D38
3.	$\neg FCONT u \vee CONT u$	D38
4.	$\neg EQ_{sp}^{\equiv}(u, v) \vee P_{sp}^{\equiv}(v, u)$	D46
5.	$\neg EQ_{sp}^{\equiv}(u, v) \vee P_{sp}^{\equiv}(u, v)$	D46
6.	$\neg EC_{sp}^{\equiv}(u, v) \vee EQ_t(u, v)$	D43
7.	$\neg P_{sp}^{\equiv}(u, v) \vee P_{st}(u, v)$	D40
8.	$[\neg EC_{sp}^{\equiv}(u, v) \vee \neg TS(v, w) \vee EC_{st}(u, w)]$	Th55

- |     |  |     |
|-----|--|-----|
| 9.  | $\neg \text{NP}u \vee \neg \text{ECTS}(v, w, u) \vee \text{FCON}(v, w)$  | D37 |
| 10. | $\neg \text{P}_{\text{st}}(u, v) \vee \neg \text{P}_{\text{st}}(v, u) \vee (u = v)$  | D8  |
| 11. | $\neg \text{CONT}u \vee \neg \text{EQ}_t(v, w) \vee \neg \text{EC}_{\text{st}}(v, w) \vee \neg \text{FCON}(w, x) \vee \neg \text{ECTS}(v, x, u)$ | A21 |
| 12. | $\text{FCONT}_a$   |     |
| 13. | $\text{FCONT}_b$   |     |
| 14. | $\text{EC}_{\text{sp}}^=(e, c)$  |     |
| 15. | $\text{EQ}_{\text{sp}}^=(f, d)$  |     |
| 16. | $\text{ECTS}(e, f, b)$   |     |
| 17. | $\text{ECTS}(c, d, a)$   |     |

Proof:

- |     |   |                    |
|-----|---|--------------------|
| 18. | $\text{NP}_b$                             | 13,2               |
| 19. | $\text{CONT}_b$                           | 13,3               |
| 20. | $\text{NP}_a$                             | 12,2               |
| 21. | $\text{P}_{\text{sp}}^=(d, f)$            | 15,4               |
| 22. | $\text{P}_{\text{sp}}^=(f, d)$            | 15,5               |
| 23. | $\text{EQ}_t(e, c)$                       | 14,6               |
| 24. | $\neg \text{NP}_a \vee \text{FCON}(c, d)$ | 17,9               |
| 25. | $\text{FCON}(c, d)$                       | 24,20              |
| 26. | $\text{EC}_{\text{st}}(e, c)$             | SHy 14,8,1         |
| 27. | $\text{P}_{\text{st}}(d, f)$              | 21,7               |
| 28. | $\text{P}_{\text{st}}(f, d)$              | 22,7               |
| 29. | $(f = d)$                                 | SHy 28,27,10       |
| 30. | $\text{ECTS}(e, d, b)$                    | Rew 29,16          |
| 31. | $\neg \text{CONT}_b$                      | SHy 30,26,25,23,11 |
| 32. | $\square$                                 | 31,19              |

# Appendix D

## IM and NECP Theorems

---

Theorems cited in Section 4.4.4 through Section 4.6.3 of Chapter 4 are presented below. Getting machine generated proofs for this group of theorems was difficult. Most of the proofs required carefully crafted lemmas, proofs of which were subsequently machine generated. For proofs of theorems cited in Appendix D and Appendix E, we restricted the SPASS input file to axioms and definitions that are envisaged to be required for the proof<sup>1</sup> along the lines shown to be effective in [Reif and Schellhorn, 1997; Amir and McIraith, 2000].

**Th65.**  $\text{SBE}(z, x, y) \leftrightarrow \text{SBE}(z, y, x)$

From D51

**Th66.**  $\neg \text{SBE}(x - y, x, y)$

From D51, D12

**Th67.**  $\neg \text{SBE}(y - x, x, y)$

From D51, D12

---

<sup>1</sup>This is the set of formulae obtained by including axioms and definitions such as to have transitive closure (over the complete set of axioms and definitions) of the literals appearing in the conjecture. The main problem is partitioned into sub problems and solving the sub problems some potential Lemma(s) are worked out, which is then used for proof of the main theorem.

**Th68.**  $[[\text{FCONT}x \wedge \text{FCONT}y \wedge \text{ECTS}(x_1, x_2, x) \wedge \text{ECTS}(y_1, y_2, y) \wedge$   
 $\text{P}_{\text{sp}}^{\text{=}*}(x_1, y_1) \wedge \text{P}_{\text{sp}}^{\text{=}*}(y_2, x_2)] \rightarrow [\text{SBE}(x_1, x_1, y_1) \wedge \text{SBE}(y_2, x_2, y_2)]]$

**Lemma 4.**  $[\text{P}_{\text{sp}}^{\text{=}*}(x, y) \rightarrow [\text{EQ}_t(x, y) \wedge \text{PP}_{\text{st}}(x, y)]]$

From D1, D3, D8, D40, D44

**Lemma 5.**  $[\text{PP}_{\text{st}}(u, v) \rightarrow (u \cap v = u)]$

From D3, D13

**Lemma 6.**  $[[\text{CONT}w \wedge \text{TS}(x, w)] \rightarrow \text{CON}x]$

From D11, D16, D29, D35, A20

**Lemma 7.**  $[[\text{EQ}_t(x, y) \wedge \text{EC}_t(x, z)] \rightarrow \text{EC}_t(y, z)]$

From D6, D8

Proof of Theorem:

Refutation Set:

- |   |         |
|---|---------|
| 1. $\text{P}_{\text{st}}(u, u)$   | Th1     |
| 2. $\neg \text{FCONT}u \vee \text{NP}u$   | D38     |
| 3. $\neg \text{FCONT}u \vee \text{CONT}u$   | D38     |
| 4. $\text{P}_t(\text{skf}26(u, v), v)$  | D2      |
| 5. $\neg \text{P}_{\text{sp}}^{\text{=}*}(u, v) \vee \text{EQ}_t(u, v)$           | Lemma 4 |
| 6. $\neg \text{P}_{\text{sp}}^{\text{=}*}(u, v) \vee \text{PP}_{\text{st}}(u, v)$ | Lemma 4 |
| 7. $\neg \text{FCON}(u, v) \vee \text{FCON}(v, u)$                                | Th9     |
| 8. $\neg \text{P}_{\text{st}}(u, v) \vee \text{P}_t(u, v)$                        | C2      |
| 9. $\neg \text{EQ}_t(u, v) \vee \text{P}_t(v, u)$                                 | D8      |
| 10. $\neg \text{EQ}_t(u, v) \vee \text{P}_t(u, v)$                                | D8      |
| 11. $\neg \text{EC}_t(u, v) \vee \text{C}_t(u, v)$                                | D6      |
| 12. $\neg \text{PP}_{\text{st}}(u, v) \vee \text{P}_{\text{st}}(u, v)$            | D3      |
| 13. $\neg \text{C}_t(u, v) \vee \text{C}_t(v, u)$                                 | A2      |
| 14. $\neg \text{ECTS}(u, v, w) \vee \text{EC}_t(u, v)$                            | D36     |
| 15. $\neg \text{ECTS}(u, v, w) \vee \text{TS}(v, w)$                              | D36     |
| 16. $\neg \text{ECTS}(u, v, w) \vee \text{TS}(u, w)$                              | D36     |
| 17. $\neg \text{PO}_t(u, v) \vee \text{P}_t(v, u)$                                | D7      |
| 18. $\neg \text{EC}_t(u, v) \vee \neg \text{O}_t(v, u)$                           | D6      |
| 19. $\neg \text{PP}_{\text{st}}(u, v) \vee \text{P}_{\text{st}}(v, u)$            | D3      |
| 20. $\neg \text{PP}_{\text{st}}(u, v) \vee (u \cap v = u)$                        | Lemma 5 |
| 21. $\neg \text{SBE}(u, v, w) \vee \text{SBE}(u, w, v)$                           | Th65    |
| 22. $\neg \text{CONT}u \vee \neg \text{TS}(v, u) \vee \text{CON}v$                | Lemma 6 |
| 23. $\neg \text{O}_t(u, v) \vee \text{P}_t(\text{skf}26(v, u), u)$                | D2      |
| 24. $\neg \text{C}_t(u, v) \vee \text{O}_t(u, v) \vee \text{EC}_t(u, v)$          | D6      |
| 25. $\neg \text{EQ}_t(u, v) \vee \neg \text{EC}_t(u, w) \vee \text{EC}_t(v, w)$   | Lemma 7 |

26. $\neg NPu \vee \neg ECTS(v, w, u) \vee FCON(v, w)$	D37
27. $\neg P_t(u, v) \vee \neg P_t(u, w) \vee O_t(v, w)$	D2
28. $\neg P_{st}(u, v) \vee P_t(skf32(u, v), u) \vee TS(u, v)$	D29
29. $\neg O_t(u, v) \vee P_t(u, v) \vee P_t(v, u) \vee PO_t(u, v)$	D7
30. $\neg TS(u, v) \vee \neg P_{st}(w, v) \vee \neg P_t(w, u) \vee P_{st}(w, u)$	D29
31. $\neg CONu \vee \neg EC_t(v, u) \vee \neg EC_t(w, u) \vee$ $\neg FCON(w, u) \vee \neg EC_t(x, u) \vee \neg(w = x \cap v) \vee SBE(w, x, v)$	D51
32. FCONTa	
33. FCONTb	
34. $P_{sp}^{=*}(c, e)$	
35. $P_{sp}^{=*}(f, d)$	
36. ECTS(c, d, a)	
37. ECTS(e, f, b)	
38. $\neg SBE(c, c, e) \vee \neg SBE(f, d, f)$	

Proof:

39. NPb	33,2
40. CONTb	33,3
41. NPa	32,2
42. CONTa	32,3
43. $EQ_t(f, d)$	35,5
44. $PP_{st}(f, d)$	35,6
45. $EQ_t(c, e)$	11,5
46. $PP_{st}(c, e)$	11,6
47. $\neg NPb \vee FCON(e, f)$	37,26
48. $EC_t(e, f)$	37,14
49. $TS(e, b)$	37,16
50. $\neg NPa \vee FCON(c, d)$	36,26
51. $EC_t(c, d)$	36,14
52. $TS(d, a)$	36,15
53. $FCON(e, f)$	47,39
54. $FCON(c, d)$	50,41
55. $P_t(d, f)$	43,9
56. $P_t(f, d)$	43,10
57. $\neg P_{st}(d, f)$	44,19
58. $P_{st}(f, d)$	44,12
59. $(f \cap d = f)$	SHy 44,20
60. $P_t(e, c)$	45,9
61. $P_t(c, e)$	45,10

62. $\neg P_{st}(e, c)$	46,19
63. $P_{st}(c, e)$	46,12
64. $(c \cap e = c)$	SHy 46,20
65. $\neg O_t(e, f)$	48,18
66. $C_t(e, f)$	48,11
67. $\neg \text{CONT}_b \vee \text{CON}_e$	49,22
68. $\text{CON}_e$	67,40,39,33
69. $\text{EC}_t(e, d)$	SHy 51,45,25
70. $\neg \text{CON}_a \vee \text{CON}_d$	52,22
71. $\text{CON}_d$	70,42,41,32
72. $\text{FCON}(f, e)$	53,7
73. $O_t(f, f)$	SHy 55,27
74. $O_t(d, d)$	SHy 56,27
75. $\text{TS}(f, d) \vee P_t(\text{skf32}(f, d), f)$	SHy 58,28
76. $O_t(c, e)$	SHy 60,27
77. $O_t(e, e)$	SHy 61,27
78. $\text{TS}(c, e) \vee P_t(\text{skf32}(c, e), c)$	SHy 63,28
79. $C_t(f, e)$	SHy 66,13
80. $\text{PO}_t(f, f) \vee P_t(f, f) \vee P_t(f, f)$	SHy 73,29
81. $\text{PO}_t(f, f) \vee P_t(f, f)$	Obs80
82. $\text{PO}_t(d, d) \vee P_t(d, d) \vee P_t(d, d)$	SHy 74,29
83. $\text{PO}_t(d, d) \vee P_t(d, d)$	Obs82
84. $\text{PO}_t(c, c) \vee P_t(c, c) \vee P_t(c, c)$	SHy 76,29
85. $\text{PO}_t(c, c) \vee P_t(c, c)$	Obs84
86. $\text{PO}_t(e, e) \vee P_t(e, e) \vee P_t(e, e)$	SHy 77,29
87. $\text{PO}_t(e, e) \vee P_t(e, e)$	Obs86
88. $\neg P_t(u, e) \vee \neg P_t(u, f)$	65,27
89. $\text{EC}_t(f, e) \vee O_t(f, e)$	SHy 79,24
90. $\neg \text{CON}_d \vee \text{SBE}(c, c, e)$	SHy 69,64,54,51,31
91. $\text{SBE}(c, c, e)$	90,71
92. $\neg \text{SBE}(f, d, f)$	91,38
93. $\text{TS}(f, d)$	Spt 75
94. $P_{st}(d, f)$	SHy 93,55,30,1
95. $\square$	94,57
96. $\neg \text{TS}(f, d)$	Spt 95,93,75
97. $P_t(\text{skf32}(f, d), f)$	Spt 95,75
98. $\text{TS}(c, e)$	Spt 78
99. $P_{st}(e, c)$	SHy 98,60,30,1



100. $\square$	99,62
101. $\neg\text{TS}(c, e)$	Spt 100,98,78
102. $P_t(\text{skf}32(c, e), c)$	Spt 100,78
103. $\neg P_t(\text{skf}26(u, f), e)$	88,4
104. $\text{PO}_t(f, f)$	Spt 81
105. $\neg P_t(f, f)$	104,17
106. $\neg P_{st}(f, f)$	105,8
107. $\square$	106,1
108. $\neg\text{PO}_t(f, f)$	Spt 107,104,81
109. $P_t(f, f)$	Spt 107,81
110. $\text{PO}_t(d, d)$	Spt 83
111. $\neg P_t(d, d)$	110,17
112. $\neg P_{st}(d, d)$	111,8
113. $\square$	112,1
114. $\neg\text{PO}_t(d, d)$	Spt 113,110,83
115. $P_t(d, d)$	Spt 113,83
116. $\text{PO}_t(c, c)$	Spt 85
117. $\neg P_t(c, c)$	116,17
118. $\neg P_{st}(c, c)$	117,8
119. $\square$	118,1
120. $\neg\text{PO}_t(c, c)$	Spt 119,116,85
121. $P_t(c, c)$	Spt 119,85
122. $\text{PO}_t(e, e)$	Spt 87
123. $\neg P_t(e, e)$	122,17
124. $\neg P_{st}(e, e)$	123,8
125. $\square$	124,1
126. $\neg\text{PO}_t(e, e)$	Spt 125,122,87
127. $P_t(e, e)$	Spt 125,87
128. $\text{EC}_t(f, e)$	Spt 89
129. $\text{EC}_t(d, e)$	SHy 128,43,25
130. $\neg\text{CONe} \vee \text{SBE}(f, f, d)$	SHy 129,128,72,59,31
131. $\text{SBE}(f, f, d)$	130,68
132. $\text{SBE}(f, d, f)$	SHy 131,21
133. $\square$	132,92
134. $\neg\text{EC}_t(f, e)$	Spt 133,128,89
135. $\text{O}_t(f, e)$	Spt 133,89
136. $P_t(\text{skf}26(e, f), e)$	SHy 135,23
137. $\square$	136,103

**Th69.**  $[[\text{FCONT}x \wedge \text{FCONT}y \wedge \text{ECTS}(x_1, x_2, x) \wedge \text{ECTS}(y_1, y_2, y) \wedge$   
 $\text{PO}_{\text{sp}}^=(x_1, y_1) \wedge \text{P}_{\text{sp}}^*(x_2, y_2)] \rightarrow [\text{SBE}(x_1 \cap y_1, x_1, y_1) \wedge \text{SBE}(x_2, x_2, y_2)]]$

From D38, D44, D45, D51, Th9, Th65

**Th70.**  $[[\text{FCONT}x \wedge \text{FCONT}y \wedge \text{ECTS}(x_1, x_2, x) \wedge \text{ECTS}(y_1, y_2, y) \wedge \text{DR}_{\text{st}}(x_1, y_1) \wedge$   
 $\text{PO}_{\text{sp}}^=(x_2, y_2)] \rightarrow \neg \exists z_1, z_2 [\text{SBE}(z_1, x_1, y_1) \wedge \text{SBE}(z_2, x_2, y_2) \wedge \text{FCON}(z_2, x_1)]]$

From D4, D38, D45, D51, Th9, Th65

**Th71.**  $[[\text{FCONT}x \wedge \text{FCONT}y \wedge \text{ECTS}(x_1, x_2, x) \wedge \text{ECTS}(y_1, y_2, y) \wedge$   
 $\text{EC}_t(w, x_2) \wedge \text{FCON}(w, x_2) \wedge \text{EC}_t(z, x_1) \wedge \text{FCON}(z, x_1) \wedge$   
 $\text{SBE}(w, x_1, y_1) \wedge \text{SBE}(z, x_2, y_2)] \rightarrow \text{FCON}(z, w)]$

**Lemma 8.**  $u \cap v = v \cap u$

From D13, A2

**Lemma 9.**  $[[\text{FCON}(x_1, y_1) \wedge \text{EC}_t(x_1, y_1) \wedge \text{FCON}(x_2, y_2) \wedge \text{EC}_t(x_2, y_2) \wedge$   
 $\text{FCON}(x_1, y_2) \wedge \text{EC}_t(x_1, y_2) \wedge \text{FCON}(x_2, y_1) \wedge \text{EC}_t(x_2, y_1)] \rightarrow \text{FCON}(x_1 \cap y_1, x_2 \cap y_2)]$

From D18, D13, Th9

Proof of Theorem:

Refutation Set:

1.  $\neg \text{FCONT}u \vee \text{NP}u$  D38
2.  $(u \cap v = v \cap u)$  Lemma 8
3.  $\neg \text{FCON}(u, v) \vee \text{FCON}(v, u)$  Th9
4.  $\neg \text{ECTS}(u, v, w) \vee \text{EC}_t(u, v)$  D36
5.  $\neg \text{SBE}(u, v, w) \vee (u = v \cap w)$  D51
6.  $\neg \text{NP}u \vee \neg \text{ECTS}(v, w, u) \vee \text{FCON}(v, w)$  D37
7.  $\neg \text{EC}_t(u, v) \vee \neg \text{FCON}(u, v) \vee \neg \text{SBE}(u, w, x) \vee \text{FCON}(v, x)$  D51
8.  $\neg \text{EC}_t(u, v) \vee \neg \text{FCON}(u, v) \vee \neg \text{SBE}(u, w, x) \vee \text{EC}_t(x, v)$  D51
9.  $[\neg \text{EC}_t(u, v) \vee \neg \text{EC}_t(u, w) \vee \neg \text{FCON}(u, v) \vee \neg \text{FCON}(u, w) \vee \neg \text{FCON}(x, v) \vee$   
 $\neg \text{EC}_t(v, x) \vee \neg \text{EC}_t(x, w) \vee \neg \text{FCON}(x, w) \vee \text{FCON}(u \cap x, v \cap w)]$  Lemma 9
10.  $\text{FCONT}a$
11.  $\text{FCONT}b$
12.  $\text{FCON}(g, c)$
13.  $\text{EC}_t(g, c)$
14.  $\text{FCON}(h, d)$
15.  $\text{EC}_t(h, d)$
16.  $\text{ECTS}(c, d, a)$
17.  $\text{SBE}(h, c, e)$
18.  $\text{SBE}(g, d, f)$

19. ECTS(e, f, b)

20.  $\neg$ FCON(g, h)

Proof:

21. NPb	11,1
22. NPa	10,1
23. $\neg$ FCON(h, g)	20,3
24. $\neg$ NP(b) $\vee$ FCON(e, sk11)	19,6
25. EC <sub>t</sub> (e, f)	19,4
26. (d $\cap$ f) = g	18,5
27. $\neg$ EC <sub>t</sub> (g, u) $\vee$ $\neg$ FCON(g, u) $\vee$ FCON(u, f)	18,7
28. $\neg$ EC <sub>t</sub> (g, u) $\vee$ $\neg$ FCON(g, u) $\vee$ EC <sub>t</sub> (f, u)	18,8
29. (c $\cap$ e) = h	17,5
30. $\neg$ EC <sub>t</sub> (h, u) $\vee$ $\neg$ FCON(h, u) $\vee$ FCON(u, e)	17,7
31. $\neg$ EC <sub>t</sub> (h, u) $\vee$ $\neg$ FCON(h, u) $\vee$ EC <sub>t</sub> (e, u)	17,8
32. $\neg$ NP(a) $\vee$ FCON(c, sk14)	16,6
33. EC <sub>t</sub> (c, d)	16,4
34. (f $\cap$ d) = g	Rew 26,2
35. (e $\cap$ c) = h	Rew 29,2
36. FCON(e, f)	24,21
37. FCON(c, d)	32,22
38. $\neg$ FCON(h, d) $\vee$ EC <sub>t</sub> (e, d)	31,15
39. $\neg$ FCON(h, d) $\vee$ FCON(d, e)	30,15
40. $\neg$ FCON(g, c) $\vee$ EC <sub>t</sub> (f, c)	28,13
41. $\neg$ FCON(g, c) $\vee$ FCON(c, f)	27,13
42. EC <sub>t</sub> (e, d)	38,14
43. FCON(d, e)	39,14
44. EC <sub>t</sub> (f, c)	40,12
45. FCON(c, f)	41,12
46. FCON(e, d)	43,3
47. FCON(e $\cap$ c, f $\cap$ d)	SHy 46,45,42,37,36,33,25,9
48. FCON(h, g)	Rew 47,34
49. $\square$	48,23

**Th72.**  $[[\text{FCONT}x \wedge \text{FCONT}y \wedge \text{ECTS}(x_1, x_2, x) \wedge \text{ECTS}(y_1, y_2, y) \wedge$   
 $\text{EC}_t(w, x_2) \wedge \text{FCON}(w, x_2) \wedge \text{EC}_t(z, x_1) \wedge$   
 $\text{SBE}(w, x_1, y_1) \wedge \neg \text{SBE}(z, x_2, y_2)] \rightarrow \neg \text{FCON}(z, w)]$

From D36, D38, D51, Th9, Th65

$$\mathbf{Th73.} \quad \left[ \left[ \text{DR}_{\text{st}}\left(\frac{x}{z_1}, \frac{y}{z_1}\right) \wedge \text{PO}_{\text{sp}}^=\left(\frac{x}{z_2}, \frac{y}{z_2}\right) \wedge \text{ECTS}\left(\frac{x}{z_1}, \frac{x}{z_2}, \frac{x}{z_1 \cup z_2}\right) \wedge \right. \right. \\ \left. \left. \text{ECTS}\left(\frac{y}{z_1}, \frac{y}{z_2}, \frac{y}{z_1 \cup z_2}\right) \wedge \text{FCONT}\left(\frac{x}{z_1 \cup z_2}\right) \wedge \text{FCONT}\left(\frac{y}{z_1 \cup z_2}\right) \right] \rightarrow \mathbb{M}_{\text{ec}}(x, y, z_1, z_2) \right]$$

From D4, D45, D38, Th70, Th71, Th72, Proposition 1

$$\mathbf{Th74.} \quad \left[ \left[ \text{P}_{\text{sp}}^*\left(\frac{x}{z_1}, \frac{y}{z_1}\right) \wedge \text{P}_{\text{sp}}^*\left(\frac{y}{z_2}, \frac{x}{z_2}\right) \wedge \text{ECTS}\left(\frac{x}{z_1}, \frac{x}{z_2}, \frac{x}{z_1 \cup z_2}\right) \wedge \right. \right. \\ \left. \left. \text{ECTS}\left(\frac{y}{z_1}, \frac{y}{z_2}, \frac{y}{z_1 \cup z_2}\right) \wedge \text{FCONT}\left(\frac{x}{z_1 \cup z_2}\right) \wedge \text{FCONT}\left(\frac{y}{z_1 \cup z_2}\right) \right] \rightarrow \mathbb{M}_{\text{eq}}(x, y, z_1, z_2) \right]$$

From D44, D38, Th68, Th71, Th72, Proposition 1

$$\mathbf{Th75.} \quad \left[ \left[ \text{PO}_{\text{sp}}^=\left(\frac{x}{z_1}, \frac{y}{z_1}\right) \wedge \text{NTPP}_{\text{sp}}^=\left(\frac{x}{z_2}, \frac{y}{z_2}\right) \wedge \text{ECTS}\left(\frac{x}{z_1}, \frac{x}{z_2}, \frac{x}{z_1 \cup z_2}\right) \wedge \right. \right. \\ \left. \left. \text{ECTS}\left(\frac{y}{z_1}, \frac{y}{z_2}, \frac{y}{z_1 \cup z_2}\right) \wedge \text{FCONT}\left(\frac{x}{z_1 \cup z_2}\right) \wedge \right. \right. \\ \left. \left. \text{FCONT}\left(\frac{y}{z_1 \cup z_2}\right) \right] \rightarrow \left[ \mathbb{M}_{\text{eq}}(x, y, z_1, z_2) \vee \mathbb{M}_{\text{tpp}}(x, y, z_1, z_2) \right] \right]$$

From D45, D44, D38, Th69, Th71, Th72, Proposition 1

$$\mathbf{Th76.} \quad \left[ \left[ \text{PO}_{\text{sp}}^=\left(\frac{x}{z_1}, \frac{y}{z_1}\right) \wedge \text{NTPPi}_{\text{sp}}^=\left(\frac{y}{z_2}, \frac{x}{z_2}\right) \wedge \text{ECTS}\left(\frac{x}{z_1}, \frac{x}{z_2}, \frac{x}{z_1 \cup z_2}\right) \wedge \right. \right. \\ \left. \left. \text{ECTS}\left(\frac{y}{z_1}, \frac{y}{z_2}, \frac{y}{z_1 \cup z_2}\right) \wedge \text{FCONT}\left(\frac{x}{z_1 \cup z_2}\right) \wedge \right. \right. \\ \left. \left. \text{FCONT}\left(\frac{y}{z_1 \cup z_2}\right) \right] \rightarrow \left[ \mathbb{M}_{\text{eq}}(x, y, z_1, z_2) \vee \mathbb{M}_{\text{tppi}}(x, y, z_1, z_2) \right] \right]$$

From D45, D44, D38, Th69, Th71, Th72, Proposition 1

$$\mathbf{Th77.} \quad \left[ \text{EC}_t(x, z) \wedge \text{EC}_t(y, z) \wedge \forall u, v \left[ \left[ \text{NECP}(u, x, z) \wedge \right. \right. \right. \\ \left. \left. \left. \text{NECP}(v, y, z) \right] \rightarrow \neg \text{C}_{\text{st}}(u, v) \right] \rightarrow \left[ \neg \text{C}_{\text{st}}(x, y) \vee \text{EC}_{\text{st}}(x, y) \right] \right]$$

Refutation Set:

1.  $\text{C}_{\text{st}}(u, u)$  Th1
2.  $\text{P}_{\text{st}}(\text{skf11}(u, v), v)$  D2
3.  $\text{C}_{\text{st}}(\text{skf9}(u, v), v)$  D1
4.  $\neg \text{NECP}(u, v, w) \vee \text{P}_{\text{st}}(u, v)$  D22
5.  $\neg \text{EC}_t(u, v) \vee \neg \text{NECP}(u, w, v)$  D22
6.  $\neg \text{O}_{\text{st}}(u, v) \vee \text{P}_{\text{st}}(\text{skf11}(v, u), v)$  D2
7.  $\neg \text{C}_{\text{st}}(\text{skf9}(u, v), u) \vee \text{P}_{\text{st}}(v, u)$  D1
8.  $\neg \text{EC}_t(u, v) \vee \text{NECP}(\text{skf13}(v, u), u, v)$  Th19
9.  $\neg \text{C}_{\text{st}}(u, v) \vee \text{O}_{\text{st}}(u, v) \vee \text{EC}_{\text{st}}(u, v)$  D6
10.  $\neg \text{P}_{\text{st}}(u, v) \vee \neg \text{C}_{\text{st}}(w, u) \vee \text{C}_{\text{st}}(w, v)$  D1
11.  $\neg \text{P}_{\text{st}}(u, v) \vee \neg \text{EC}_t(v, w) \vee \text{EC}_t(u, w) \vee \text{NECP}(u, v, w)$  D22
12.  $\text{EC}_t(a, c)$
13.  $\text{EC}_t(b, c)$
14.  $\text{C}_{\text{st}}(a, b)$
15.  $\neg \text{EC}_{\text{st}}(a, b)$

$$16. [\neg C_{st}(u, v) \vee \neg NECP(u, a, c) \vee \neg NECP(v, b, c)]$$

Proof:

17. $\neg P_{st}(u, b) \vee EC_t(u, c) \vee NECP(u, b, c)$	13,11
18. $O_{st}(a, b) \vee EC_{st}(a, b)$	14,9
19. $\neg NECP(u, a, c) \vee \neg NECP(u, b, c)$	16,1
20. $O_{st}(a, b)$	18,15
21. $EC_t(skf11(u, a), c) \vee NECP(skf11(u, a), a, c)$	SHy 12,11,2
22. $P_{st}(skf11(b, a), b)$	SHy 20,6
23. $\neg C_{st}(u, skf11(b, a)) \vee C_{st}(u, b)$	22,10
24. $EC_t(skf11(b, a), c) \vee NECP(skf11(b, a), b, c)$	SHy 22,13,11
25. $\neg P_{st}(u, a) \vee \neg EC_t(a, c) \vee \neg NECP(u, b, c) \vee EC_t(u, c)$	19,11
26. $\neg P_{st}(u, a) \vee \neg NECP(u, b, c)$	25,12,5
27. $\neg NECP(skf11(u, a), b, c) \vee EC_t(skf11(u, a), c)$	21,19
28. $NECP(skf11(u, a), a, c) \vee NECP(skf13(c, skf11(u, a)), skf11(u, a), c)$	SHy 21,8
29. $\neg NECP(skf11(u, a), b, c)$	27,5
30. $EC_t(skf11(b, a), c)$	29,24
31. $NECP(skf13(c, skf11(b, a)), skf11(b, a), c)$	30,8
32. $\neg P_{st}(u, b) \vee \neg P_{st}(u, a) \vee EC_t(u, c)$	26,17
33. $NECP(skf11(u, a), a, c) \vee P_{st}(skf13(c, skf11(u, a)), skf11(u, a))$	28,4
34. $\neg P_{st}(u, skf11(b, a)) \vee \neg C_{st}(v, u) \vee C_{st}(v, b)$	23,10
35. $P_{st}(skf13(c, skf11(b, a)), skf11(b, a))$	SHy 38,30,5
36. $C_{st}(skf9(u, skf13(c, skf11(b, a))), skf11(b, a))$	SHy 35,10,3
37. $\neg EC_t(skf13(c, skf11(b, a)))$	31,5
38. $\neg P_{st}(skf13(c, skf11(b, a)), b) \vee \neg P_{st}(skf13(c, skf11(b, a)), a)$	37,32
39. $C_{st}(skf9(u, skf13(c, skf11(b, a))), b)$	SHy 35,34,3
40. $P_{st}(skf13(c, skf11(b, a)), b)$	39,7
41. $\neg P_{st}(skf13(c, skf11(b, a)), a)$	40,38
42. $C_{st}(skf9(u, skf13(c, skf11(b, a))), a)$	SHy 36,10,2
43. $P_{st}(skf13(c, skf11(b, a)), a)$	42,7
44. $\square$	43,41

**Th78.**  $[[EC_t(x, z) \wedge EC_t(y, z) \wedge \forall u, v[[P_{st}(u, x) \wedge \neg NECP(u, x, z) \wedge P_{st}(v, y) \wedge \neg NECP(v, y, z)]] \rightarrow \neg O_{st}(u, v)]] \rightarrow \neg O_{st}(x, y)]$

Refutation Set:

1. $P_{st}(u, u)$	Th1
2. $\neg NECP(u, v, w) \vee \neg EC_t(u, w)$	D22
3. $EC_t(a, c)$	

4.  $O_{st}(a, b)$
5.  $EC_t(b, c)$
6.  $[\neg P_{st}(u, a) \vee \neg O_{st}(u, v) \neg P_{st}(v, b) \vee NECP(u, a, c) \vee NECP(v, b, c)]$

Proof:

7.  $\neg NECP(b, u, c)$  5,2
8.  $\neg P_{st}(a, a) \vee \neg P_{st}(b, b) \vee NECP(a, a, c) \vee NECP(b, b, c)$  6,4
9.  $\neg NECP(a, v, c)$  3,2
10.  $\square$  SHy 9,8,7,1

**Th79.**  $[EC_t(x, z) \wedge EC_t(y, z) \wedge P_{st}(u, x) \wedge P_{st}(u, y) \wedge EC_t(u, z)] \rightarrow \exists w[P_{st}(w, u) \wedge NECP(w, x, z) \wedge NECP(w, y, z)]$

Refutation Set:

1.  $\neg NECP(u, v, w) \vee P_{st}(u, v)$  D22
2.  $\neg EC_t(u, v) \vee \neg NECP(u, w, v)$  D22
3.  $\neg EC_t(u, v) \vee NECP(skf19(v, u), u, v)$  Th19
4.  $\neg P_{st}(u, v) \vee \neg P_{st}(v, w) \vee P_{st}(u, w)$  Th2
5.  $\neg P_{st}(u, v) \vee \neg EC_t(v, w) \vee EC_t(u, w) \vee NECP(u, v, w)$  D22
6.  $P_{st}(d, c)$
7.  $P_{st}(d, a)$
8.  $EC_t(d, b)$
9.  $EC_t(c, b)$
10.  $EC_t(a, b)$
11.  $[\neg P_{st}(u, d) \vee \neg NECP(u, c, b) \vee \neg NECP(u, a, b)]$

Proof:

12.  $NECP(skf19(b, d), d, b)$  8,3
13.  $\neg P_{st}(u, d) \vee P_{st}(u, a)$  7,4
14.  $\neg P_{st}(u, d) \vee P_{st}(u, c)$  6,4
15.  $\neg P_{st}(u, c) \vee \neg EC_t(c, b) \vee \neg P_{st}(u, d) \vee \neg NECP(u, a, b) \vee EC_t(u, b)$  11,5
16.  $\neg P_{st}(u, c) \vee \neg P_{st}(u, d) \vee \neg NECP(u, a, b)$  15,9,2
17.  $\neg P_{st}(u, d) \vee \neg NECP(u, a, b)$  16,14
18.  $P_{st}(skf19(b, d), d)$  12,1
19.  $\neg EC_t(skf19(b, d), b)$  12,2
20.  $P_{st}(skf19(b, d), a)$  18,13
21.  $NECP(skf19(b, d), a, b) \vee EC_t(skf19(b, d), b)$  SHy 20,10,5
22.  $NECP(skf19(b, d), a, b)$  21,19
23.  $\square$  SHy 22,18,17

**Th80.**  $[[EC_t(x, z) \wedge EC_t(y, z) \wedge \forall u, v[[NECP(u, x, z) \wedge NECP(v, y, z)] \rightarrow \neg O_{st}(u, v)]] \rightarrow \neg O_{st}(x, y)]$

Refutation Set:

1.  $P_{st}(u, u)$  Th1
2.  $P_{st}(skf11(u, v), v)$  D2
3.  $P_{st}(skf13(u, v, w, x), x)$  D22
4.  $\neg O_{st}(u, v) \vee P_{st}(skf11(u, v), v)$  D2
5.  $\neg P_{st}(u, v) \vee \neg P_{st}(u, w) \vee O_{st}(v, w)$  D2
6.  $\neg P_{st}(u, v) \vee \neg EC_t(v, w) \vee EC_t(u, w) \vee NECP(u, v, w)$  D22
7.  $[\neg EC_t(u, v) \vee \neg P_{st}(w, u) \vee \neg P_{st}(w, x) \vee \neg EC_t(x, v) \vee \neg EC_t(w, v) \vee NECP(skf13(x, v, u, w), u, v)]$  Th79
8.  $[\neg EC_t(u, v) \vee \neg P_{st}(w, u) \vee \neg P_{st}(w, x) \vee \neg EC_t(x, v) \vee \neg EC_t(w, v) \vee NECP(skf13(x, v, u, w), x, v)]$  Th79
9.  $EC_t(a, c)$
10.  $O_{st}(a, b)$
11.  $EC_t(b, c)$
12.  $[\neg NECP(u, a, c) \vee \neg O_{st}(u, v) \vee \neg NECP(v, b, c)]$

Proof:

13.  $P_{st}(skf11(b, a), b)$  10,4
14.  $EC_t(skf11(u, b), c) \vee NECP(skf11(u, b), b, c)$  SHy 11,6,2
15.  $O_{st}(b, a)$  SHy 13,5,2
16.  $\neg P_{st}(u, a) \vee \neg EC_t(a, c) \vee \neg O_{st}(u, v) \vee NECP(v, b, c) \vee EC_t(u, c)$  12,6
17.  $[\neg EC_t(u, c) \vee \neg P_{st}(v, u) \vee \neg P_{st}(v, a) \vee \neg EC_t(a, c) \vee \neg EC_t(v, c) \vee \neg O_{st}(skf13(a, c, u, v), w) \vee \neg NECP(w, b, c)]$  12,8
18.  $\neg P_{st}(u, a) \vee \neg O_{st}(u, v) \vee NECP(v, b, c) \vee EC_t(u, c)$  16,9
19.  $[\neg EC_t(u, c) \vee \neg P_{st}(v, u) \vee \neg P_{st}(v, a) \vee \neg EC_t(v, c) \vee \neg O_{st}(skf13(a, c, u, v), w) \vee \neg NECP(w, b, c)]$  17,9
20.  $P_{st}(skf11(a, b), a)$  SHy 15,4
21.  $O_{st}(a, skf11(a, b))$  SHy 20,5,1
22.  $P_{st}(skf11(skf11(a, b), a), skf11(a, b))$  SHy 20,4
23.  $O_{st}(skf11(a, b), skf119(a, b))$  SHy 22,5
24.  $EC_t(skf11(a, b), c) \vee EC_t(skf11(a, b), c)$  SHy 23,18,14
25.  $EC_t(skf11(a, b), c)$  Obs24
26.  $NECP(skf13(a, c, b, skf11(a, b)), b, c)$  SHy 25,20,11,9,7,2
27.  $[\neg P_{st}(u, skf13(a, c, v, w)) \vee \neg P_{st}(u, x) \vee \neg EC_t(v, c) \vee \neg P_{st}(w, v) \vee \neg P_{st}(w, a) \vee \neg EC_t(w, c) \vee \neg NECP(x, b, c)]$  19,5
28.  $\square$  SHy 27,26,25,20,11,2,3

**Th81.**  $[[EC_t(x, z) \wedge EC_t(y, z) \wedge \forall u, v[[NECP(u, x, z) \wedge$   
 $NECP(v, y, z) \wedge EQTS(u, v, x, y)] \rightarrow DC_{sp}^=(u, v)]] \rightarrow DR_{st}(x, y)]$

**Lemma 10.**  $\neg DC_{sp}^=(x, x)$

From A1, D5, D41

**Lemma 11.**  $[EC_t(x, z) \wedge EC_t(y, z) \wedge O_{st}(x, y)] \rightarrow \exists u, v[EQTS(u, v, x, y) \wedge$   
 $NECP(u, x, z) \wedge NECP(v, y, z) \wedge O_{st}(u, v)]$

From D2, D6, D22, D42, Th19

Proof of Theorem:

Refutation Set:

1.  $EQ_t(u, u)$  Th17
2.  $\neg DC_{sp}^=(u, u)$  Lemma 10
3.  $P_{st}(skf23(u, v), v)$  D29
4.  $O_{st}(u, v) \vee DR_{st}(u, v)$  D4
5.  $\neg TS(u, v) \vee P_{st}(u, v)$  D29
6.  $\neg EQ_t(u, v) \vee P_t(v, u)$  D8
7.  $\neg NECP(u, v, w) \vee P_{st}(u, v)$  D22
8.  $\neg EQTS(u, v, w, x) \vee EQ_t(u, v)$  D42
9.  $\neg EQTS(u, v, w, x) \vee TS(v, x)$  D42
10.  $\neg EQTS(u, v, w, x) \vee TS(u, w)$  D42
11.  $\neg NECP(u, v, w) \vee \neg EC_t(u, w)$  D22
12.  $\neg EC_t(u, v) \vee NECP(skf26(v, u), u, v)$  Th19
13.  $\neg TS(u, v) \vee \neg TS(v, w) \vee TS(u, w)$  Th36
14.  $\neg P_{st}(u, v) \vee \neg P_{st}(v, w) \vee P_{st}(u, w)$  Th2
15.  $\neg P_{st}(u, v) \vee \neg P_{st}(u, w) \vee O_{st}(v, w)$  D2
16.  $\neg P_{st}(u, v) \vee P_t(skf23(u, v), u) \vee TS(u, v)$  D29
17.  $\neg P_{st}(u, v) \vee \neg P_{st}(skf23(u, v), u) \vee TS(u, v)$  D29
18.  $\neg P_{st}(u, v) \vee \neg EC_t(v, w) \vee EC_t(u, w) \vee NECP(u, v, w)$  D22
19.  $\neg TS(u, v) \vee \neg P_{st}(w, v) \vee P_t(w, u) \vee P_{st}(w, u)$  D29
20.  $\neg TS(u, v) \vee \neg EQ_t(u, w) \vee \neg TS(w, x) \vee EQTS(u, w, v, x)$  D42
21.  $\neg EC_t(u, w) \vee \neg O_{st}(u, v) \vee \neg EC_t(v, w) \vee NECP(skf37(v, u, w), v, w)$  Lemma 11
22.  $\neg EC_t(u, w) \vee \neg O_{st}(u, v) \vee \neg EC_t(v, w) \vee NECP(skf36(w, u, x), u, w)$  Lemma 11
23.  $[\neg EC_t(u, w) \vee \neg O_{st}(u, v) \vee \neg EC_t(v, w) \vee$   
 $EQTS(skf37(v, u, w), skf36(w, u, x), u, v)]$  Lemma 11
24.  $EC_t(c, b)$
25.  $EC_t(a, b)$
26.  $\neg DR_{st}(c, a)$
27.  $[\neg NECP(u, c, b) \vee \neg EQTS(u, v, c, a) \vee \neg NECP(v, a, b) \vee DC_{sp}^=(u, v)]$



Proof:

28. NECP(skf26(b, a), a, b)	25,12
29. $\neg P_{st}(u, a) \vee EC_t(u, b) \vee NECP(u, a, b)$	25,18
30. $\neg O_{st}(a, u) \vee \neg EC_t(u, b) \vee EQTS(skf37(u, a, b), skf36(b, a, u), a, u)$	25,23
31. $\neg O_{st}(a, u) \vee \neg EC_t(u, b) \vee NECP(skf36(b, a, v), a, b)$	25,22
32. $\neg O_{st}(u, c) \vee \neg EC_t(u, b) \vee EQTS(skf37(c, u, b), skf36(b, u, c), u, c)$	24,23
33. $\neg O_{st}(u, c) \vee \neg EC_t(u, b) \vee NECP(skf36(c, u, b), c, b)$	24,21
34. $\neg P_{st}(u, c) \vee \neg EC_t(u, b) \vee NECP(u, c, b)$	24,18
35. $\neg O_{st}(c, u) \vee \neg EC_t(u, b) \vee EQTS(skf37(u, c, b), skf36(b, c, u), c, u)$	24,23
36. $\neg O_{st}(c, u) \vee \neg EC_t(u, b) \vee NECP(skf36(u, c, b), u, b)$	24,21
37. $O_{st}(c, a)$	26,4
38. $\neg O_{st}(c, a) \vee EQTS(skf37(a, c, b), skf36(b, c, a), c, a)$	35,25
39. $\neg O_{st}(a, c) \vee EQTS(skf37(c, a, b), skf36(b, a, c), a, c)$	32,25
40. $\neg O_{st}(c, a) \vee NECP(skf37(a, c, b), a, b)$	36,25
41. $\neg O_{st}(a, c) \vee NECP(skf37(c, a, b), c, b)$	33,25
42. $\neg O_{st}(a, a) \vee NECP(skf37(b, a, u), a, b)$	31,25
43. NECP(skf37(a, c, b), a, b)	40,37
44. EQTS(skf37(a, c, b), skf36(b, c, a), c, a)	38,37
45. $[\neg TS(u, c) \vee \neg EQ_t(u, v) \vee \neg TS(u, a) \vee$ $\neg NECP(u, c, b) \vee \neg NECP(v, a, b) \vee DC_{sp}^=(u, v)]$	27,20
46. $P_{st}(skf26(b, a), a)$	28,7
47. $\neg P_{st}(skf26(b, a), u) \vee O_{st}(a, u)$	46,15
48. $P_{st}(skf37(a, c, b), a)$	43,7
49. $\neg P_{st}(skf37(a, c, b), u) \vee O(a, u)$	48,15
50. $O_{st}(a, a)$	47,46
51. NECP(skf36(b, a, u), a, b)	50,42
52. $\neg EC_t(skf36(b, a, u), b)$	51,11
53. $\neg P_{st}(skf26(b, a, u), a)$	51,7
54. $\neg O_{st}(a, u) \vee \neg EC_t(u, b) \vee EQ_t(skf37(u, a, b), skf36(b, a, u))$	30,8
55. $\neg O_{st}(a, u) \vee \neg EC_t(u, b) \vee TS(skf36(b, a, u), u)$	30,9
56. $\neg O_{st}(a, u) \vee \neg EC_t(u, b) \vee TS(skf37(u, a, b), a)$	30,10
57. $[\neg P_{st}(u, c) \vee \neg TS(u, c) \vee \neg EQ_t(u, v) \vee \neg TS(v, a) \vee$ $\neg NECP(v, a, b) \vee EC_t(u, b) \vee DC_{sp}^=(u, v)]$	45,34
58. $[\neg TS(u, c) \vee \neg EQ_t(u, v) \vee \neg TS(v, a) \vee$ $\neg NECP(v, a, b) \vee EC_t(u, b) \vee DC_{sp}^=(u, v)]$	57,5
59. $\neg O_{st}(a, c) \vee P_{st}(skf37(c, a, b), c)$	41,7
60. TS(skf37(a, c, b), c)	44,10
61. $P_{st}(skf37(a, c, b), c)$	60,5

62.	$[\neg O_{st}(a, u) \vee \neg EC_t(u, b) \vee \neg P_{st}(v, a) \vee$ $\neg P_t(v, skf37(u, a, b) \vee P_{st}(v, skf37(u, a, b))]$	56,19
63.	$[\neg O_{st}(a, u) \vee \neg EC_t(u, b) \vee \neg P_{st}(v, u) \vee$ $\neg P_t(v, skf36(b, a, u) \vee P_{st}(v, skf36(b, a, u))]$	55,19
64.	$\neg O_{st}(a, c) \vee \neg P_{st}(u, skf37(c, a, b)) \vee P_{st}(u, c)$	59,14
65.	$O_{st}(a, c)$	61,49
66.	$EQTS(skf37(c, a, b), skf36(b, a, c), a, c)$	65,39
67.	$\neg P_{st}(u, skf37(c, a, b)) \vee P_{st}(u, c)$	65,64
68.	$TS(skf36(b, a, c), c)$	66,9
69.	$TS(skf37(c, a, b), a)$	66,10
70.	$\neg TS(u, skf37(c, a, b)) \vee TS(u, a)$	69,13
71.	$\neg O_{st}(a, u) \vee \neg EC_t(u, b) \vee P_t(skf36(b, a, u), skf37(u, a, b))$	54,6
72.	$[\neg P_{st}(u, a) \vee \neg TS(v, c) \vee \neg EQ_t(u, v) \vee$ $\neg TS(u, a) \vee EC_t(u, b) \vee EC_t(v, b) \vee DC_{sp}^=(v, u)]$	58,29
73.	$[\neg TS(u, c) \vee \neg EQ_t(u, v) \vee \neg TS(v, a) \vee EC_t(v, b) \vee EC_t(u, b) \vee DC_{sp}^=(u, v)]$	72,5
74.	$\neg P_{st}(skf23(u, skf37(c, a, b)), c)$	67,3
75.	$[\neg EQ_t(skf36(b, a, c), u) \vee \neg TS(u, c) \vee EC_t(u, b) \vee$ $EC_t(skf36(b, a, c), b) \vee DC_{sp}^=(skf36(b, a, c), u)]$	74,68
76.	$\neg EQ_t(skf36(b, a, c), u) \vee \neg TS(u, c) \vee EC_t(u, b) \vee DC_{sp}^=(skf36(b, a, c), u)$	75,52
77.	$[\neg O_{st}(a, u) \vee \neg EC_t(u, b) \vee \neg O_{st}(a, u) \vee \neg EC_t(u, a) \vee$ $\neg P_{st}(skf36(b, a, u), a) \vee P_{st}(skf36(b, a, u), skf37(u, a, b))]$	71,62
78.	$[\neg O_{st}(a, u) \vee \neg EC_t(u, b) \vee$ $\neg P_{st}(skf36(b, a, u), a) \vee P_{st}(skf36(b, a, u), skf37(u, a, b))]$	Obs77
79.	$\neg O_{st}(a, u) \vee \neg EC_t(u, b) \vee P_{st}(skf36(b, a, u), skf37(u, a, b))$	78,53
80.	$[\neg P_{st}(skf36(b, a, u), v) \vee \neg O_{st}(a, u) \vee \neg EC_t(u, b) \vee$ $\neg P_{st}(skf23(skf36(b, a, u), v), u) \vee TS(skf36(b, a, u), v) \vee$ $P_{st}(skf23(skf36(b, a, u), v), skf36(b, a, u))]$	63,16
81.	$[\neg P_{st}(skf36(b, a, u), v) \vee \neg O_{st}(a, u) \vee \neg EC_t(u, b) \vee$ $\neg P_{st}(skf23(skf36(b, a, u), v), u) \vee TS(skf36(b, a, u), v)]$	80,17
82.	$[\neg EQ_t(skf36(b, a, c), skf36(b, a, c)) \vee$ $\neg TS(skf36(b, a, c), a) \vee EC_t(skf36(b, a, c), b)]$	76,2
83.	$\neg TS(skf36(b, a, c), a)$	82,52,2
84.	$[\neg P_{st}(skf36(b, a, c), skf37(c, a, b)) \vee \neg O_{st}(a, c) \vee$ $\neg EC_t(c, b) \vee TS(skf36(b, a, c), skf37(c, a, b))]$	74,81
85.	$TS(skf36(b, a, c), skf37(c, a, b))$	84,79,65,24
86.	$TS(skf36(b, a, c), a)$	85,70
87.	$\square$	86,83

**Th82.**  $[[EC_t(x, z) \wedge EC_t(y, z) \wedge EQ_t(x, y) \wedge \forall u, v[[NECP(u, x, z) \wedge$   
 $NECP(v, y, z) \wedge EQTS(u, v, x, y)] \rightarrow EC_{sp}^=(u, v)]] \rightarrow EC_{st}(x, y)]$

**Lemma 12.**  $[[O_{st}(x, y) \wedge TS(y, z)] \rightarrow O_{st}(x, z)]$

From D2, D29

**Lemma 13.**  $[EC_t(x, z) \wedge EC_t(y, z) \wedge O_t(x, y) \wedge DC_{st}(x, y)] \rightarrow \exists u, v[EQTS(u, v, x, y) \wedge$   
 $NECP(u, x, z) \wedge NECP(v, y, z) \wedge DC_{st}(u, v)]$

From D2, D5, D6, D22, D42, Th19

Proof of Theorem:

Refutation Set:

1.  $P_{st}(u, u)$  Th1
2.  $P_t(skf19(u, v), v)$  D2
3.  $C_{st}(u, v) \vee DC_{st}(u, v)$  D5
4.  $\neg P_{st}(u, v) \vee P_t(u, v)$  C2
5.  $\neg EQ_t(u, v) \vee P_t(v, u)$  D8
6.  $\neg EQ_t(u, v) \vee P_t(u, v)$  D8
7.  $\neg EC_t(u, v) \vee C_t(u, v)$  D6
8.  $\neg EC_{st}(u, v) \vee C_{st}(u, v)$  D6
9.  $\neg C_t(u, v) \vee C_t(v, u)$  A2
10.  $\neg C_{st}(u, v) \vee C_{st}(v, u)$  A2
11.  $\neg NECP(u, v, w) \vee P_{st}(u, v)$  D22
12.  $\neg PO_t(u, v) \vee \neg P_t(v, u)$  D7
13.  $\neg EC_t(u, v) \vee \neg O_t(u, v)$  D6
14.  $\neg EC_{st}(u, v) \vee \neg O_{st}(u, v)$  D6
15.  $\neg DC_{st}(u, v) \vee \neg C_{st}(u, v)$  D5
16.  $O_{st}(skf25(u, v, w), skf24(u, v, w))$  Lemma 11
17.  $\neg EQTS(u, v, w, x) \vee TS(v, x)$  D42
18.  $\neg O_t(u, v) \vee P_t(skf19(v, u), v)$  D2
19.  $\neg EC_t(u, v) \vee NECP(skf21(v, u), u, v)$  Th19
20.  $\neg C_t(u, v) \vee O_t(u, v) \vee EC_t(u, v)$  D6
21.  $\neg C_{st}(u, v) \vee O_{st}(u, v) \vee EC_{st}(u, v)$  D6
22.  $\neg O_{st}(u, v) \vee \neg TS(v, w)] \vee O_{st}(u, w)$  Lemma 12
23.  $\neg EC_{sp}^=(u, v) \neg TS(v, w) \vee EC_{st}(u, w)$  Th55
24.  $\neg P_t(u, v) \vee \neg P_t(u, w) \vee O_t(v, w)$  D2
25.  $\neg P_{st}(u, v) \vee \neg P_{st}(u, w) \vee O_{st}(v, w)$  D2
26.  $\neg P_{st}(u, v) \vee \neg C_{st}(w, u) \vee C_{st}(w, v)$  D1
27.  $\neg O_t(u, v) \vee P_t(u, v) \vee P_t(v, u) \vee PO_t(u, v)$  D2
28.  $\neg EC_t(u, v) \vee \neg O_{st}(u, w) \vee \neg EC_t(w, v) \vee NECP(skf25(w, v, u), u, v)$  Lemma 11

29.  $\neg EC_t(u, v) \vee \neg O_{st}(u, w) \vee \neg EC_t(w, v) \vee NECP(skf24(v, w, x), w, v)$  Lemma 11
30.  $\neg EC_t(u, v) \vee \neg O_t(u, w) \vee \neg DC_{st}(u, w) \vee$   
 $\neg EC_t(w, v) \vee NECP(skf27(v, u, x), u, v)$  Lemma 13
31.  $\neg EC_t(u, v) \vee \neg O_t(u, w) \vee \neg DC_{st}(u, w) \vee$   
 $\neg EC_t(w, v) \vee NECP(skf26(v, w, x), w, v)$  Lemma 13
32.  $[\neg EC_t(u, v) \vee \neg O_{st}(u, w) \vee \neg EC_t(w, v) \vee$   
 $EQTS(skf25(w, v, u), skf25(v, w, u), u, w)]$  Lemma 11
33.  $[\neg EC_t(u, v) \vee \neg O_t(u, w) \vee \neg DC_{st}(u, w) \vee$   
 $\neg EC_t(w, v) \vee EQTS(skf27(v, u, w), skf26(v, w, u), u, w)]$  Lemma 13
34.  $EC_t(c, b)$
35.  $EQ_t(c, a)$
36.  $EC_t(a, b)$
37.  $\neg EC_{st}(c, a)$
38.  $[\neg NECP(u, c, b) \vee \neg EQTS(u, v, c, a) \vee \neg NECP(v, a, b) \vee EC_{sp}^=(u, v)]$

Proof:

39.  $\neg NECP(skf21(b, a), a, b)$  36,19
40.  $\neg EC_t(u, b) \vee \neg O_{st}(u, a) \vee EQTS(skf25(a, b, u), skf24(b, a, u), u, a)$  36,32
41.  $\neg EC_t(u, b) \vee \neg O_{st}(u, a) \vee NECP(skf24(b, a, v), a, b)$  36,29
42.  $P_t(a, c)$  35,5
43.  $P_t(c, a)$  35,6
44.  $[\neg O_t(c, u) \vee \neg DC_{st}(c, u) \vee$   
 $\neg EC_t(u, b) \vee EQTS(skf27(b, c, u), skf26(b, u, c), c, u)]$  34,33
45.  $\neg O_t(c, u) \vee \neg DC_{st}(c, u) \vee \neg EC_t(u, b) \vee NECP(skf27(b, c, v), c, b)$  34,30
46.  $\neg O_t(c, u) \vee \neg DC_{st}(c, u) \vee \neg EC_t(u, b) \vee NECP(skf26(b, u, v), u, b)$  34,31
47.  $\neg O_t(c, u) \vee \neg EC_t(u, b) \vee EQTS(skf25(u, b, c), skf24(b, u, c), c, u)$  34,32
48.  $\neg O_t(c, u) \vee \neg EC_t(u, b) \vee NECP(skf24(u, b, c), c, b)$  34,28
49.  $\neg O_t(c, b)$  34,13
50.  $C_t(c, b)$  34,7
51.  $\neg C_t(c, a) \vee O_{st}(c, a)$  37,21
52.  $\neg O_t(c, a) \vee \neg DC_{st}(c, a) \vee EQTS(skf27(b, c, a), skf26(b, a, c), c, a)$  44,36
53.  $\neg O_t(c, a) \vee EQTS(skf25(a, b, c), skf24(b, a, c), c, a)$  47,36
54.  $\neg O_t(c, a) \vee \neg DC_{st}(c, a) \vee NECP(skf26(b, a, u), a, b)$  46,36
55.  $\neg O_t(c, a) \vee \neg DC_{st}(c, a) \vee NECP(skf27(b, c, u), c, b)$  45,36
56.  $\neg O_t(c, a) \vee NECP(skf25(a, b, c), c, b)$  48,36
57.  $\neg O_t(a, a) \vee NECP(skf24(b, a, u), a, b)$  41,36
58.  $O_t(c, c)$  SHy 42,24
59.  $O_t(a, a)$  SHy 43,24
60.  $C_t(b, c)$  SHy 50,9

61. $PO_t(c, c) \vee P_t(c, c) \vee P_t(c, c)$	SHy 58,27
62. $PO_t(c, c) \vee P_t(c, c)$	Obs61
63. $PO_t(a, a) \vee P_t(a, a) \vee P_t(a, a)$	SHy 59,27
64. $PO_t(a, a) \vee P_t(a, a)$	Obs63
65. $EC_t(b, c) \vee O_t(b, c)$	SHy 60,20
66. $\neg P_t(u, c) \vee \neg P_t(u, b)$	49,24
67. $P_{st}(skf21(b, a), a)$	39,11
68. $O_{st}(a, a)$	SHy 67,25
69. $NECP(skf24(b, a, u), a, b)$	68,57
70. $DC_{st}(c, a) \vee O_{st}(c, a)$	SHy 51,3
71. $PO_t(c, c)$	Spt 62
72. $\neg P_t(c, c)$	71,12
73. $\neg P_{st}(c, c)$	72,4
74. $\square$	73,1
75. $\neg PO_t(c, c)$	Spt 74,71,62
76. $P_t(c, c)$	Spt 74,62
77. $O_t(c, a)$	SHy 76,43,24
78. $\neg DC_{st}(c, a) \vee NECP(skf26(b, a, u), a, b)$	77,54
79. $\neg DC_{st}(c, a) \vee NECP(skf27(b, c, u), c, b)$	77,55
80. $\neg DC_{st}(c, a) \vee EQTS(skf27(b, c, a), skf26(b, a, c), c, a)$	77,52
81. $PO_t(a, a)$	Spt 64
82. $\neg P_t(a, a)$	81,12
83. $\neg P_{st}(a, a)$	82,4
84. $\square$	83,1
85. $\neg PO_t(a, a)$	Spt 84,81,64
86. $P_t(a, a)$	Spt 84,64
87. $EC_t(b, c)$	Spt 65
88. $NECP(skf21(c, b), b, c)$	SHy 87,19
89. $P_{st}(skf21(c, b), b)$	88,11
90. $P_t(skf21(c, b), b)$	SHy 89,4
91. $O_t(b, b)$	SHy 90,24
92. $[\neg EC_t(c, b) \vee \neg O_{st}(c, a) \vee \neg NECP(skf25(a, b, c), c, b) \vee$ $\neg NECP(skf24(b, a, c), a, b) \vee EC_{sp}^=(skf25(a, b, c), skf24(b, a, c))]$	40,38
93. $[\neg O_{st}(c, a) \vee \neg NECP(skf25(a, b, c), c, b) \vee$ $\neg NECP(skf24(b, a, c), a, b) \vee EC_{sp}^=(skf25(a, b, c), skf24(b, a, c))]$	92,34
94. $\neg O_{st}(c, a) \vee EC_{sp}^=(skf25(a, b, c), skf24(b, a, c))$	93,69,56
95. $PO_t(b, b) \vee P_t(b, b) \vee P_t(b, b)$	SHy 91,27
96. $PO_t(b, b) \vee P_t(b, b)$	Obs95

97. $PO_t(b, b)$	Spt 96
98. $\neg P_t(b, b)$	97,12
99. $\neg P_{st}(b, b)$	98,4
100. $\square$	99,1
101. $\neg PO_t(b, b)$	Spt 100,97,96
102. $P_t(b, b)$	Spt 100,96
103. $DC_{st}(c, a)$	Spt 70
104. $NECP(skf26(b, a, u), a, b)$	103,78
105. $NECP(skf27(b, c, u), c, b)$	103,79
106. $EQTS(skf27(b, c, a), skf26(b, a, c), c, a)$	103,80
107. $\neg C_{st}(c, a)$	103,15
108. $[\neg O_t(c, a) \vee \neg DC_{st}(c, a) \vee \neg EC_t(a, b) \vee \neg NECP(skf27(b, c, a), c, b) \vee$ $\neg NECP(skf26(b, a, c), a, b) \vee EC_{sp}^=(skf27(b, c, a), skf26(b, a, c))]$	44,38
109. $[\neg NECP(skf27(b, c, a), c, b) \vee \neg NECP(skf26(b, a, c), a, b) \vee$ $EC_{sp}^=(skf27(b, c, a), skf26(b, a, c))]$	107,103,77,36
110. $EC_{sp}^=(skf27(b, c, a), skf26(b, a, c))$	109,105,104
111. $P_{st}(skf27(b, c, u), c)$	105,11
112. $\neg P_t(skf19(u, b), c)$	66,2
113. $TS(skf26(b, a, c), a)$	106,17
114. $EC_{st}(skf27(b, c, a), a)$	SHy 113,110,23
115. $C_{st}(skf27(b, c, a), a)$	114,8
116. $C_{st}(a, skf27(b, c, a))$	115,10
117. $C_{st}(a, c)$	SHy 116,111,26
118. $C_{st}(c, a)$	SHy 117,10
119. $\square$	118,107
120. $\neg DC_{st}(c, a)$	Spt 119,103,70
121. $O_{st}(c, a)$	Spt 119,70
122. $EQTS(skf25(c, b, a), skf24(b, a, c), c, a)$	121,53
123. $EC_{sp}^=(skf25(a, b, c), skf24(b, a, c))$	121,94
124. $TS(skf24(b, a, c), a)$	122,17
125. $O_{st}(skf25(a, b, c), a)$	SHy 124,22,16
126. $EC_{st}(skf25(a, b, c), a)$	SHy 124,123,23
127. $\square$	SHy 126,125,14
128. $\neg EC_t(b, c)$	Spt 127,87,65
129. $O_t(b, c)$	Spt 127,65
130. $P_t(skf19(c, b), c)$	SHy 129,18
131. $\square$	130,112

**Th83.**  $[[EC_t(x, z) \wedge EC_t(y, z) \wedge EQ_t(x, y) \wedge \forall u, v[[NECP(u, x, z) \wedge$   
 $NECP(v, y, z) \wedge EQTS(u, v, x, y)] \rightarrow PO_{sp}^=(u, v)]] \rightarrow PO_{sp}^=(x, y)]$

From D7, D6, D22, D42, D45, Th19

**Th84.**  $[[EC_t(x, z) \wedge EC_t(y, z) \wedge EQ_t(x, y) \wedge \forall u, v[[NECP(u, x, z) \wedge$   
 $NECP(v, y, z) \wedge EQTS(u, v, x, y)] \rightarrow EQ_{sp}^=(u, v)]] \rightarrow EQ_{st}(x, y)]$

From D8, D6, D22, D42, D46, Th19

**Th85.**  $[[EC_t(x, z) \wedge EC_t(y, z) \wedge EQ_t(x, y) \wedge \forall u, v[[NECP(u, x, z) \wedge$   
 $NECP(v, y, z) \wedge EQTS(u, v, x, y)] \rightarrow TPP_{sp}^=(u, v)]] \rightarrow TPP_{st}(x, y)]$

From D3, D6, D8, D9, D22, D42, D47, Th19, Th58

**Th86.**  $[[EC_t(x, z) \wedge EC_t(y, z) \wedge EQ_t(x, y) \wedge \forall u, v[[NECP(u, x, z) \wedge$   
 $NECP(v, y, z) \wedge EQTS(u, v, x, y)] \rightarrow NTPP_{sp}^=(u, v)]] \rightarrow PP_{st}(x, y)]$

From D3, D6, D8, D9, D22, D42, D48, Th19, Th59

**Th87.**  $Trans(dc, r, x, y, z_1, z_2) \rightarrow DR_{st}(\frac{x}{z_1}, \frac{y}{z_2})$

**Lemma 14.**  $Trans(r_1, r_2, x, y, z_1, z_2) \rightarrow EC_t(\frac{x}{z_1}, z_2)$

From D6, D52, A30, Th18,

**Lemma 15.**  $Trans(r_1, r_2, x, y, z_1, z_2) \rightarrow EC_t(\frac{y}{z_1}, z_2)$

From D6, D52, A30, Th18

Proof of Theorem:

Refutation Set:

1.  $\neg rcc_{sp}^=(dc, u, v) \vee DC_{sp}^=(u, v)$  D49
2.  $\neg Trans(u, v, w, x, y, z) \vee EC_t(\frac{x}{y}, z)$  Lemma 14
3.  $\neg Trans(u, v, w, x, y, z) \vee EC_t(\frac{w}{y}, z)$  Lemma 15
4.  $\neg EC_t(u, v) \vee \neg EC_t(w, v) \vee NECP(skf9(v, w, x), w, v) \vee DR_{st}(u, w)$  Th81
5.  $\neg EC_t(u, v) \vee \neg EC_t(w, v) \vee NECP(skf10(v, u, x), u, v) \vee DR_{st}(u, w)$  Th81
6.  $[\neg EC_t(u, v) \vee \neg EC_t(w, v) \vee$   
 $\neg DC_{sp}^=(skf10(v, u, w), skf9(v, w, u)) \vee DR_{st}(u, w)]$  Th81
7.  $[\neg EC_t(u, v) \vee \neg EC_t(w, v) \vee$   
 $EQTS(skf10(v, u, w), skf9(v, w, u), u, w) \vee DR_{st}(u, w)]$  Th81
8.  $[\neg Trans(u, v, w, x, y, z) \vee \neg NECP(x1, \frac{w}{y}, z) \vee$   
 $\neg NECP(x2, \frac{x}{y}, z) \vee EQTS(x1, x2, \frac{w}{y}, \frac{x}{y}) \vee rcc_{sp}^=(u, x1, x2)]$  D52
9.  $Trans(dc, r, a, b, c, d)$
10.  $\neg DR_{st}(\frac{a}{c}, \frac{b}{c})$

Proof:

11.  $EC_t(\frac{b}{c}, d)$  9,2
12.  $EC_t(\frac{a}{c}, d)$  9,3
13.  $DR_{st}(\frac{a}{c}, \frac{b}{c}) \vee EQTS(\text{skf}10(d, \frac{a}{c}, \frac{b}{c}), \text{skf}9(d, \frac{b}{c}, \frac{a}{c}), \frac{a}{c}, \frac{b}{c})$  SHy 12,11,7
14.  $DR_{st}(\frac{a}{c}, \frac{b}{c}) \vee NECP(\text{skf}9(d, \frac{b}{c}, u), \frac{b}{c}, d)$  SHy 12,11,4
15.  $DR_{st}(\frac{a}{c}, \frac{b}{c}) \vee NECP(\text{skf}10(d, \frac{a}{c}, u), \frac{a}{c}, d)$  SHy 12,11,5
16.  $NECP(\text{skf}9(d, \frac{b}{c}, u), \frac{b}{c}, d)$  14,10
17.  $NECP(\text{skf}10(d, \frac{a}{c}, u), \frac{a}{c}, d)$  15,10
18.  $EQTS(\text{skf}10(d, \frac{a}{c}, \frac{b}{c}), \text{skf}9(d, \frac{b}{c}, \frac{a}{c}), \frac{a}{c}, \frac{b}{c})$  13,10
19.  $rcc_{sp}^{\equiv}(dc, \text{skf}10(d, \frac{a}{c}, \frac{b}{c}), \text{skf}9(d, \frac{b}{c}, \frac{a}{c}))$  SHy 18,17,16,9,8
20.  $DC_{sp}^{\equiv}(\text{skf}10(d, \frac{a}{c}, \frac{b}{c}), \text{skf}9(d, \frac{b}{c}, \frac{a}{c}))$  19,1
21.  $DR_{st}(\frac{a}{c}, \frac{b}{c})$  SHy 20,12,11,6
22.  $\square$  21,10

**Th88.**  $\text{Trans}(ec, r, x, y, z_1, z_2) \rightarrow EC_{st}(\frac{x}{z_1}, \frac{y}{z_1})$

**Lemma 16.**  $\text{Trans}(r_1, r_2, x, y, z_1, z_2) \rightarrow EQ_t(\frac{x}{z_1}, \frac{y}{z_1})$

From D8, D52, A30, Th18

Proof of Theorem:

Refutation Set:

1.  $\neg rcc_{sp}^{\equiv}(ec, u, v) \vee EC_{sp}^{\equiv}(u, v)$  D49
2.  $\neg \text{Trans}(u, v, w, x, y, z) \vee EC_t(\frac{x}{y}, z)$  Lemma 14
3.  $\neg \text{Trans}(u, v, w, x, y, z) \vee EC_t(\frac{w}{y}, z)$  Lemma 15
4.  $\neg \text{Trans}(u, v, w, x, y, z) \vee EQ_t(\frac{x}{z_1}, \frac{y}{z_1})$  Lemma 16
5.  $\neg EC_t(u, v) \vee \neg EQ_t(u, w) \vee \neg EC_t(w, v) \vee NECP(\text{skf}9(v, w, x), w, v) \vee EC_{st}(u, w)$  Th82
6.  $\neg EC_t(u, v) \vee \neg EC_t(w, v) \vee \neg EQ_t(u, w) \vee NECP(\text{skf}10(v, u, x), u, v) \vee EC_{st}(u, w)$  Th82
7.  $[\neg EC_t(u, v) \vee \neg EC_t(w, v) \vee \neg EQ_t(u, w) \vee \neg EC_{sp}^{\equiv}(\text{skf}10(v, u, w), \text{skf}9(v, w, u)) \vee EC_{st}(u, w)]$  Th82
8.  $[\neg EC_t(u, v) \vee \neg EQ_t(u, w) \vee \neg EC_t(w, v) \vee EQTS(\text{skf}10(v, u, w), \text{skf}9(v, w, u), u, w) \vee EC_{st}(u, w)]$  Th82
9.  $[\neg \text{Trans}(u, v, w, x, y, z) \vee \neg NECP(x1, \frac{w}{y}, z) \vee \neg NECP(x2, \frac{x}{y}, z) \vee EQTS(x1, x2, \frac{w}{y}, \frac{x}{y}) \vee rcc_{sp}^{\equiv}(u, x1, x2)]$  D52
10.  $\text{Trans}(ec, r, a, b, c, d)$
11.  $\neg EC_{st}(\frac{a}{c}, \frac{b}{c})$

Proof:

12.  $EC_t(\frac{b}{c}, d)$  10,2
13.  $EC_t(\frac{a}{c}, d)$  10,3
14.  $EQ_t(\frac{x}{z_1}, \frac{y}{z_1})$  10,4



15.	$EC_{st}(\frac{a}{c}, \frac{b}{c}) \vee EQTS(\text{skf}10(d, \frac{a}{c}, \frac{b}{c}), \text{skf}9(d, \frac{b}{c}, \frac{a}{c}), \frac{a}{c}, \frac{b}{c})$	SHy 14,13,12,8
16.	$EC_{st}(\frac{a}{c}, \frac{b}{c}) \vee NECP(\text{skf}9(d, \frac{b}{c}, u), \frac{b}{c}, d)$	SHy 14,13,12,5
17.	$EC_{st}(\frac{a}{c}, \frac{b}{c}) \vee NECP(\text{skf}10(d, \frac{a}{c}, u), \frac{a}{c}, d)$	SHy 14,13,12,6
18.	$NECP(\text{skf}9(d, \frac{b}{c}, u), \frac{b}{c}, d)$	16,11
19.	$NECP(\text{skf}10(d, \frac{a}{c}, u), \frac{a}{c}, d)$	17,11
20.	$EQTS(\text{skf}10(d, \frac{a}{c}, \frac{b}{c}), \text{skf}9(d, \frac{b}{c}, \frac{a}{c}), \frac{a}{c}, \frac{b}{c})$	15,11
21.	$rcc_{sp}^{\equiv}(ec, \text{skf}10(d, \frac{a}{c}, \frac{b}{c}), \text{skf}9(d, \frac{b}{c}, \frac{a}{c}))$	SHy 20,19,18,10,9
22.	$EC_{sp}^{\equiv}(\text{skf}10(d, \frac{a}{c}, \frac{b}{c}), \text{skf}9(d, \frac{b}{c}, \frac{a}{c}))$	21,1
23.	$EC_{st}(\frac{a}{c}, \frac{b}{c})$	SHy 22,13,12,7
24.	$\square$	23,11

**Th89.**  $\text{Trans}(\text{po}, r, x, y, z_1, z_2) \rightarrow \text{PO}_{sp}^{\equiv}(\frac{x}{z_1}, \frac{y}{z_1})$

From D49, D52, Th83

**Th90.**  $\text{Trans}(\text{tpp}, r, x, y, z_1, z_2) \rightarrow \text{TPP}_{st}(\frac{x}{z_1}, \frac{y}{z_1})$

From D49, D52, Th85

**Th91.**  $\text{Trans}(\text{ntpp}, r, x, y, z_1, z_2) \rightarrow \text{PP}_{st}(\frac{x}{z_1}, \frac{y}{z_1})$

From D49, D52, Th86

**Th92.**  $\text{Trans}(\text{tppi}, r, x, y, z_1, z_2) \rightarrow \text{TPP}_{st}(\frac{y}{z_1}, \frac{x}{z_1})$

From D49, D52, Th85

**Th93.**  $\text{Trans}(r, \text{eq}, x, y, z_1, z_2) \rightarrow \text{EQ}_{st}(\frac{x}{z_2}, \frac{y}{z_2})$

From D49, D52, Th84

**Th94.**  $\text{Trans}(r, \text{po}, x, y, z_1, z_2) \rightarrow \text{PO}_{sp}^{\equiv}(\frac{x}{z_2}, \frac{y}{z_2})$

From D49, D52, Th83

**Th95.**  $\text{Trans}(r, \text{tpp}, x, y, z_1, z_2) \rightarrow \text{TPP}_{st}(\frac{x}{z_2}, \frac{y}{z_2})$

From D49, D52, Th85

**Th96.**  $\text{Trans}(r, \text{ntpp}, x, y, z_1, z_2) \rightarrow \text{PP}_{st}(\frac{x}{z_2}, \frac{y}{z_2})$

From D49, D52, Th86

**Th97.**  $\text{Trans}(r, \text{tppi}, x, y, z_1, z_2) \rightarrow \text{TPP}_{st}(\frac{y}{z_2}, \frac{x}{z_2})$

From D49, D52, Th85

**Th98.**  $\text{Trans}(r, \text{ntppi}, x, y, z_1, z_2) \rightarrow \text{PP}_{\text{st}}(\frac{y}{z_2}, \frac{x}{z_2})$

From D49, D52, Th86

**Th99.**  $[\text{StrFCONT}(\frac{x}{z_1 \cup z_2}) \wedge \text{StrFCONT}(\frac{y}{z_1 \cup z_2})] \rightarrow \neg \text{InsRel3}(r_1, \text{dc}, r_2, x, y, z_1, z_2)$

**Lemma 17.**  $\neg(\text{dc} = \text{ec})$

From D5, D6, D49

**Lemma 18.**  $\neg(\text{dc} = \text{eq})$

From D5, D8, D49

**Lemma 19.**  $\neg(\text{dc} = \text{tpp})$

From D5, D9, D49

**Lemma 20.**  $\neg(\text{dc} = \text{tppi})$

From D5, D9, D49

Proof of Theorem:

Refutation Set:

- |   |          |
|---|----------|
| 1. $\neg(\text{dc} = \text{tppi})$  | Lemma 20 |
| 2. $\neg(\text{dc} = \text{tpp})$   | Lemma 19 |
| 3. $\neg(\text{dc} = \text{eq})$  | Lemma 18 |
| 4. $\neg(\text{dc} = \text{ec})$  | Lemma 17 |
| 5. $\neg \text{SKP1}(u, v, w, x, y) \vee (y = \text{tppi})$   | A22      |
| 6. $\neg \text{SKP2}(u, v, w, x, y) \vee (y = \text{ec})$   | A22      |
| 7. $\neg \text{SKP3}(u, v, w, x, y) \vee (y = \text{eq})$   | A22      |
| 8. $\neg \text{InsRel}(u, v, w, x, y) \vee \text{IM}(u, v, w, x, y)$  | D53      |
| 9. $\neg \text{InsRel3}(u, v, w, x, y, z, x1) \vee \text{InsRel}(v, x, y, z, x1)$   | D54      |
| 10. $[\neg \text{StrFCONT}(\frac{w}{x \cup y}) \vee \neg \text{StrFCONT}(\frac{w}{x \cup y}) \vee \neg \text{IM}(u, v, w, x, y) \vee$<br>$\text{SKP3}(y, x, w, v, u) \vee \text{SKP2}(y, x, w, v, u) \vee \text{SKP1}(y, x, w, v, u) \vee (u = \text{tppi})]$ | A22      |
| 11. $\text{StrFCONT}(\frac{a}{c \cup d})$   |          |
| 12. $\text{StrFCONT}(\frac{b}{c \cup d})$   |          |
| 13. $\text{InsRel3}(p, \text{dc}, q, a, b, c, d)$   |          |

Proof:

- |  |                |
|--|----------------|
| 14. $\text{InsRel}(\text{dc}, a, b, c, d)$   | 13,9           |
| 15. $\text{IM}(\text{dc}, a, b, c, d)$   | 14,8           |
| 16. $[(\text{dc} = \text{tppi}) \vee \text{SKP1}(d, c, b, a, \text{dc}) \vee$<br>$\text{SKP2}(d, c, b, a, \text{dc}) \vee \text{SKP3}(d, c, b, a, \text{dc})]$ | SHy 12,11,10,5 |
| 17. $\text{SKP1}(d, c, b, a, \text{dc}) \vee \text{SKP2}(d, c, b, a, \text{dc}) \vee \text{SKP3}(d, c, b, a, \text{dc})$                                       | 16,1           |
| 18. $\text{SKP1}(d, c, b, a, \text{dc})$   | Spt 17         |
| 19. $(\text{dc} = \text{tpp})$   | 18,5           |

20. $\square$	19,2
21. $\neg\text{SKP1}(d, c, b, a, dc)$	Spt 20,18,17
22. $\text{SKP2}(d, c, b, a, dc) \vee \text{SKP3}(d, c, b, a, dc)$	Spt 20,17
23. $\text{SKP2}(d, c, b, a, dc)$	Spt 22
24. $(dc = ec)$	23,6
25. $\square$	24,4
26. $\neg\text{SKP2}(d, c, b, a, dc)$	Spt 25,23,22
27. $\text{SKP3}(d, c, b, a, dc)$	Spt 25,22
28. $(dc = eq)$	27,7
29. $\square$	28,3

**Th100.**  $[\text{StrFCONT}(\frac{x}{z_1 \cup z_2}) \wedge \text{StrFCONT}(\frac{y}{z_1 \cup z_2})] \rightarrow \neg\text{InsRel3}(r_1, po, r_2, x, y, z_1, z_2)$

From A22, D53, D54

**Th101.**  $[\text{StrFCONT}(\frac{x}{z_1 \cup z_2}) \wedge \text{StrFCONT}(\frac{y}{z_1 \cup z_2})] \rightarrow \neg\text{InsRel3}(r_1, ntp, r_2, x, y, z_1, z_2)$

From A22, D53, D54

**Th102.**  $[\text{StrFCONT}(\frac{x}{z_1 \cup z_2}) \wedge \text{StrFCONT}(\frac{y}{z_1 \cup z_2})] \rightarrow \neg\text{InsRel3}(r_1, ntppi, r_2, x, y, z_1, z_2)$

From A22, D53, D54

**Th103.**  $\text{InsRel3}(dc, eq, r, x, y, z_1, z_2) \rightarrow [\neg\text{StrFCONT}(\frac{x}{z_1 \cup z_2}) \vee \neg\text{StrFCONT}(\frac{y}{z_1 \cup z_2})]$

**Lemma 21.**  $(\frac{x \cap y}{z}) = [\frac{x}{z} \cap \frac{y}{z}]$

From D13, D30

**Lemma 22.**  $\text{InsRel3}(dc, r_1, r_2, x, y, z_1, z_2) \rightarrow \text{DR}_{\text{st}}(\frac{x}{z_1}, \frac{y}{z_2})$

From D49, D54, Th81

**Lemma 23.**  $\neg(\text{tpi} = eq)$

From D9, D8, D49

**Lemma 24.**  $\neg(\text{tpp} = eq)$

From D9, D8, D49

**Lemma 25.**  $\neg(eq = ec)$

From D6, D8, D49

**Lemma 26.**  $\text{InsRel3}(dc, r_1, r_2, x, y, z_1, z_2) \rightarrow \neg\text{FCON}(\frac{(x \cap y)}{z_1}, \frac{(x \cap y)}{z_1})$

Refutation Set:

1.  $\neg\text{Null}(u) \vee \neg\text{FCON}(u, v)$

2.  $\neg\text{DR}_{\text{st}}(u, v) \vee \text{Null}(u \cap v)$

3.  $(\frac{x \cap y}{z}) = [\frac{x}{z} \cap \frac{y}{z}]$

A8

Lemma 21

4.  $\text{InsRel3}(\text{dc}, r_1, r_2, x, y, z_1, z_2) \rightarrow \text{DR}_{\text{st}}\left(\frac{x}{z_1}, \frac{y}{z_2}\right)$  Lemma 22
5.  $\text{InsRel3}(\text{dc}, p, q, a, b, c, d)$
6.  $\text{FCON}\left(\frac{a \cap b}{c}, \frac{a \cap b}{d}\right)$

Proof:

1.  $\text{DR}_{\text{st}}\left(\frac{a}{c}, \frac{b}{c}\right)$  5,4
2.  $\neg \text{Null}\left(\frac{a \cap b}{c}\right)$  6,1
3.  $\text{Null}\left(\frac{a}{c} \cap \frac{b}{c}\right)$  7,2
4.  $\text{Null}\left(\frac{a \cap b}{c}\right)$  9,3
5.  $\square$  10,8

Note : Recall that the instantaneous matrix analysis is based on checking FCONnectivity of Boolean combinations, with non-existing ones assumed  $\neg \text{FCON}$  (Section 4.4, Chapter 4). Include an explicit statement of the form  $\forall[\text{Null}(u), \text{Region}(v)] \neg \text{FCON}(u, v)$ . Since FCON is symmetric  $\forall[\text{Null}(u), \text{Region}(v)] \neg \text{FCON}(v, u)$  also holds.

Proof of Theorem:

Refutation Set:

1.  $\neg(\text{tpi} = \text{eq})$  Lemma 23
2.  $\neg(\text{tpp} = \text{eq})$  Lemma 24
3.  $\neg(\text{eq} = \text{ec})$  Lemma 25
4.  $\neg \text{SKP2}(u, v, w, x, y) \vee (y = \text{ec})$  A22
5.  $\neg \text{SKP1}(u, v, w, x, y) \vee \mathbb{M}_{\text{eq}}(x, w, v, u)$  A22
6.  $\neg \text{InsRel}(u, v, w, x, y) \vee \text{IM}(u, v, w, x, y)$  D53
7.  $\neg \mathbb{M}_{\text{eq}}(x, w, v, u) \vee \text{FCON}\left(\frac{u \cap v}{w}, \frac{u \cap v}{x}\right)$  Proposition 1
8.  $\neg \text{InsRel3}(u, v, w, x, y, z, x1) \vee \text{InsRel}(v, x, y, z, x1)$  D54
9.  $\neg \text{InsRel3}(\text{dc}, z, y, u, v, w, x) \vee \neg \text{FCON}\left(\frac{u \cap v}{w}, \frac{u \cap v}{x}\right)$  Lemma 26
10.  $[\neg \text{StrFCONT}\left(\frac{w}{x \cup y}\right) \vee \neg \text{StrFCONT}\left(\frac{w}{x \cup y}\right) \vee \neg \text{IM}(u, v, w, x, y) \vee$   
 $\text{SKP1}(y, x, w, v, u) \vee \text{SKP2}(y, x, w, v, u) \vee (u = \text{tpp}) \vee (u = \text{tpi})]$  A22
11.  $\text{StrFCONT}\left(\frac{a}{c \cup d}\right)$
12.  $\text{StrFCONT}\left(\frac{b}{c \cup d}\right)$
13.  $\text{InsRel3}(\text{dc}, \text{eq}, p, a, b, c, d)$

Proof:

14.  $\text{InsRel}(\text{eq}, a, b, c, d)$  13,8
15.  $\text{IM}(\text{eq}, a, b, c, d)$  14,6
16.  $[\text{SKP1}(d, c, b, a, \text{eq}) \vee$   
 $\text{SKP2}(d, c, b, a, \text{eq}) \vee (\text{eq} = \text{tpp}) \vee (\text{eq} = \text{tpi})]$  SHy 15,12,11,10
17.  $\text{SKP1}(d, c, b, a, \text{eq}) \vee \text{SKP2}(d, c, b, a, \text{eq})$  16,2,1
18.  $\text{SKP2}(d, c, b, a, \text{eq})$  Spt 17
19.  $(\text{eq} = \text{ec})$  SHy 18,4

20. $\square$	19,3
21. $\neg\text{SKP2}(d, c, b, a, \text{eq})$	Spt 20,18,17
22. $\text{SKP1}(d, c, b, a, \text{eq})$	Spt 20,17
23. $\mathbb{M}_{\text{eq}}(a, b, c, d)$	22,5
24. $\text{FCON}(\frac{a \cap b}{c}, \frac{a \cap b}{d})$	23,7
25. $\square$	SHy 24,13,9

**Th104.**  $\text{InsRel3}(\text{ec}, \text{eq}, r, x, y, z_1, z_2) \rightarrow [\neg\text{StrFCONT}(\frac{x}{z_1 \cup z_2}) \vee \neg\text{StrFCONT}(\frac{y}{z_1 \cup z_2})]$

**Lemma 27.**  $\text{DR}_{\text{st}}(u, v) \leftrightarrow [\neg\text{C}_{\text{st}}(u, v) \vee \text{EC}_{\text{st}}(u, v)]$

From D5, D6, D4

**Lemma 28.**  $\text{InsRel3}(\text{ec}, r_1, r_2, x, y, z_1, z_2) \rightarrow \text{EC}_{\text{st}}(\frac{x}{z_1}, \frac{y}{z_1})$

From D49, D54, Th82

**Lemma 29.**  $\text{InsRel3}(\text{ec}, r_1, r_2, x, y, z_1, z_2) \rightarrow \neg\text{FCON}(\frac{(x \cap y)}{z_1}, \frac{(x \cap y)}{z_2})$

Refutation Set:

1.  $\neg\text{Null}(u) \vee \neg\text{FCON}(u, v)$
2.  $\neg\text{EC}_{\text{st}}(u, v) \vee \text{DR}_{\text{st}}(u, v)$  Lemma 27
3.  $\neg\text{DR}_{\text{st}}(u, v) \vee \text{Null}(u \cap v)$  A8
4.  $(\frac{x \cap y}{z}) = [\frac{x}{z} \cap \frac{y}{z}]$  Lemma 21
5.  $\text{InsRel3}(\text{ec}, r_1, r_2, x, y, z_1, z_2) \rightarrow \text{EC}_{\text{st}}(\frac{x}{z_1}, \frac{y}{z_2})$  Lemma 28
6.  $\text{InsRel3}(\text{ec}, p, q, a, b, c, d)$
7.  $\text{FCON}(\frac{(a \cap b)}{c}, \frac{(a \cap b)}{d})$

Proof:

1.  $\text{EC}_{\text{st}}(\frac{a}{c}, \frac{b}{c})$
2.  $\text{DR}_{\text{st}}(\frac{a}{c}, \frac{b}{c})$
3.  $\neg\text{Null}(\frac{a \cap b}{c})$
4.  $\text{Null}(\frac{a}{c} \cap \frac{b}{c})$
5.  $\text{Null}(\frac{a \cap b}{c})$
6.  $\square$

Proof of Theorem:

Refutation Set:

1.  $\neg(\text{tppi} = \text{eq})$  Lemma 23
2.  $\neg(\text{tpp} = \text{eq})$  Lemma 24
3.  $\neg(\text{eq} = \text{ec})$  Lemma 25
4.  $\neg\text{SKP2}(u, v, w, x, y) \vee (y = \text{ec})$  A22
5.  $\neg\text{SKP1}(u, v, w, x, y) \vee \mathbb{M}_{\text{eq}}(x, w, v, u)$  A22

6.  $\neg \text{InsRel}(u, v, w, x, y) \vee \text{IM}(u, v, w, x, y)$  D53
7.  $\neg \mathbb{M}_{\text{eq}}(u, v, w, x) \vee \text{FCON}(\frac{u \sqcap v}{w}, \frac{u \sqcap v}{x})$  Proposition 1
8.  $\neg \text{InsRel3}(u, v, w, x, y, z, x1) \vee \text{InsRel}(v, x, y, z, x1)$  D54
9.  $\neg \text{InsRel3}(\text{ec}, z, y, u, v, w, x) \vee \neg \text{FCON}(\frac{u \sqcap v}{w}, \frac{u \sqcap v}{x})$  Lemma 29
10.  $[\neg \text{StrFCONT}(\frac{w}{x \cup y}) \vee \neg \text{StrFCONT}(\frac{w}{x \cup y}) \vee \neg \text{IM}(u, v, w, x, y) \vee$   
 $\text{SKP1}(y, x, w, v, u) \vee \text{SKP2}(y, x, w, v, u) \vee (u = \text{tpp}) \vee (u = \text{tppi})]$  A22
11.  $\text{StrFCONT}(\frac{a}{c \cup d})$
12.  $\text{StrFCONT}(\frac{b}{c \cup d})$
13.  $\text{InsRel3}(\text{ec}, \text{eq}, p, a, b, c, d)$

Proof:

14.  $\text{InsRel}(\text{eq}, a, b, c, d)$  13,8
15.  $\text{IM}(\text{eq}, a, b, c, d)$  14,6
16.  $[\text{SKP1}(d, c, b, a, \text{eq}) \vee$   
 $\text{SKP2}(d, c, b, a, \text{eq}) \vee (\text{eq} = \text{tpp}) \vee (\text{eq} = \text{tppi})]$  SHy 15,12,11,10
17.  $\text{SKP1}(d, c, b, a, \text{eq}) \vee \text{SKP2}(d, c, b, a, \text{eq})$  16,2,1
18.  $\text{SKP2}(d, c, b, a, \text{eq})$  Spt 17
19.  $(\text{eq} = \text{ec})$  SHy 18,4
20.  $\square$  19,3
21.  $\neg \text{SKP2}(d, c, b, a, \text{eq})$  Spt 20,18,17
22.  $\text{SKP1}(d, c, b, a, \text{eq})$  Spt 20,17
23.  $\mathbb{M}_{\text{eq}}(a, b, c, d)$  22,5
24.  $\text{FCON}(\frac{a \sqcap b}{c}, \frac{a \sqcap b}{d})$  23,7
25.  $\square$  SHy 24,13,9

**Th105.**  $\text{InsRel3}(r, \text{ec}, \text{eq}, x, y, z_1, z_2) \rightarrow [\neg \text{StrFCONT}(\frac{x}{z_1 \cup z_2}) \vee \neg \text{StrFCONT}(\frac{y}{z_1 \cup z_2})]$

**Lemma 30.**  $\neg(\text{tppi} = \text{ec})$

From D6, D9, D49

**Lemma 31.**  $\neg(\text{tpp} = \text{ec})$

From D6, D9, D49

**Lemma 32.**  $\text{InsRel3}(r_1, r_2, \text{eq}, x, y, z_1, z_2) \rightarrow \text{EQ}_{\text{st}}(\frac{x}{z_2}, \frac{y}{z_2})$

From D49, D54, Th84

**Lemma 33.**  $\text{InsRel3}(r_1, r_2, \text{eq}, x, y, z_1, z_2) \rightarrow \neg \text{FCON}(\frac{(x \cup y)}{z_1}, \frac{(x-y)}{z_2})$

From A8, D12

Proof of Theorem

Refutation Set:

1.  $\neg(\text{tppi} = \text{ec})$

Lemma 30

2.  $\neg(\text{tpp} = \text{ec})$  Lemma 31
3.  $\neg(\text{eq} = \text{ec})$  Lemma 25
4.  $\neg\text{SKP1}(u, v, w, x, y) \vee (y = \text{eq})$  A22
5.  $\neg\text{SKP2}(u, v, w, x, y) \vee \mathbb{M}_{\text{ec}}(x, w, v, u)$  A22
6.  $\neg\text{InsRel}(u, v, w, x, y) \vee \text{IM}(u, v, w, x, y)$  D53
7.  $\neg\text{InsRel3}(u, v, w, x, y, z, x1) \vee \text{InsRel}(v, x, y, z, x1)$  D54
8.  $\neg\mathbb{M}_{\text{ec}}(u, v, w, x) \vee \text{FCON}(\frac{u \cup v}{w}, \frac{(u-v)}{x})$  Proposition 1
9.  $\neg\text{InsRel3}(y, z, \text{eq}, u, v, w, x) \vee \neg\text{FCON}(\frac{u \cup v}{w}, \frac{(u-v)}{x})$  Lemma 29
10.  $[\neg\text{StrFCONT}(\frac{w}{x \cup y}) \vee \neg\text{StrFCONT}(\frac{w}{x \cup y}) \vee \neg\text{IM}(u, v, w, x, y) \vee$   
 $\text{SKP1}(y, x, w, v, u) \vee \text{SKP2}(y, x, w, v, u) \vee (u = \text{tpp}) \vee (u = \text{tppi})]$  A22
11.  $\text{StrFCONT}(\frac{a}{c \cup d})$
12.  $\text{StrFCONT}(\frac{b}{c \cup d})$
13.  $\text{InsRel3}(p, \text{ec}, \text{eq}, a, b, c, d)$

Proof:

14.  $\neg\text{FCON}(\frac{a \cup b}{c}, \frac{(a-b)}{d})$  13,9
15.  $\text{InsRel}(\text{ec}, a, b, c, d)$  13,7
16.  $\text{IM}(\text{ec}, a, b, c, d)$  15,6
17.  $\neg\mathbb{M}_{\text{ec}}(a, b, c, d)$  14,8
18.  $[\text{SKP1}(d, c, b, a, \text{ec}) \vee$   
 $\text{SKP2}(d, c, b, a, \text{ec}) \vee (\text{ec} = \text{tpp}) \vee (\text{ec} = \text{tppi})]$  SHy 16,12,11,10
19.  $\text{SKP1}(d, c, b, a, \text{ec}) \vee \text{SKP2}(d, c, b, a, \text{ec})$  18,2,1
20.  $\text{SKP2}(d, c, b, a, \text{ec})$  Spt 19
21.  $\mathbb{M}_{\text{ec}}(a, b, c, d)$  20,5
22.  $\square$  21,17
23.  $\neg\text{SKP2}(d, c, b, a, \text{ec})$  Spt 22,20,19
24.  $\text{SKP1}(d, c, b, a, \text{ec})$  Spt 22,19
25.  $(\text{eq} = \text{ec})$  24,4
26.  $\square$  25,3

**Th106.**  $\text{InsRel3}(r, \text{ec}, \text{tpp}, x, y, z_1, z_2) \rightarrow [\neg\text{StrFCONT}(\frac{x}{z_1 \cup z_2}) \vee \neg\text{StrFCONT}(\frac{y}{z_1 \cup z_2})]$

**Lemma 34.**  $\text{InsRel3}(r_1, r_2, \text{tpp}, x, y, z_1, z_2) \rightarrow \neg\text{FCON}(\frac{(x \cup y)}{z_1}, \frac{(x-y)}{z_2})$

From A8, D12

### Proof of Theorem

Refutation Set:

1.  $\neg(\text{eq} = \text{ec})$  Lemma 25
2.  $\neg(\text{tpp} = \text{ec})$  Lemma 31

3.  $\neg(\text{tpi} = \text{ec})$  Lemma 30
4.  $\neg\text{SKP1}(u, v, w, x, y) \vee (y = \text{eq})$  A22
5.  $\neg\text{SKP2}(u, v, w, x, y) \vee \mathbb{M}_{\text{ec}}(x, w, v, u)$  A22
6.  $\neg\text{InsRel}(u, v, w, x, y) \vee \text{IM}(u, v, w, x, y)$  D53
7.  $\neg\text{InsRel3}(u, v, w, x, y, z, x1) \vee \text{InsRel}(v, x, y, z, x1)$  D54
8.  $\neg\mathbb{M}_{\text{ec}}(u, v, w, x) \vee \text{FCON}(\frac{u \cup v}{w}, \frac{(u-v)}{x})$  Proposition 1
9.  $\neg\text{InsRel3}(y, z, \text{tpp}, u, v, w, x) \vee \neg\text{FCON}(\frac{u \cup v}{w}, \frac{(u-v)}{x})$  Lemma 34
10.  $[\neg\text{StrFCONT}(\frac{w}{x \cup y}) \vee \neg\text{StrFCONT}(\frac{w}{x \cup y}) \vee \neg\text{IM}(u, v, w, x, y) \vee$   
 $\text{SKP1}(y, x, w, v, u) \vee \text{SKP2}(y, x, w, v, u) \vee (u = \text{tpp}) \vee (u = \text{tpi})]$  A22
11.  $\text{StrFCONT}(\frac{a}{c \cup d})$
12.  $\text{StrFCONT}(\frac{b}{c \cup d})$
13.  $\text{InsRel3}(p, \text{ec}, \text{tpp}, a, b, c, d)$

Proof:

14.  $\neg\text{FCON}(\frac{a \cup b}{c}, \frac{(a-b)}{d})$  13,9
15.  $\text{InsRel}(\text{ec}, a, b, c, d)$  13,7
16.  $\text{IM}(\text{ec}, a, b, c, d)$  15,6
17.  $\neg\mathbb{M}_{\text{ec}}(a, b, c, d)$  14,8
18.  $[\text{SKP1}(d, c, b, a, \text{ec}) \vee$   
 $\text{SKP2}(d, c, b, a, \text{ec}) \vee (\text{ec} = \text{tpp}) \vee (\text{ec} = \text{tpi})]$  SHy 16,12,11,10
19.  $\text{SKP1}(d, c, b, a, \text{ec}) \vee \text{SKP2}(d, c, b, a, \text{ec})$  18,2,1
20.  $\text{SKP2}(d, c, b, a, \text{ec})$  Spt 19
21.  $\mathbb{M}_{\text{ec}}(a, b, c, d)$  20,5
22.  $\square$  21,17
23.  $\neg\text{SKP2}(d, c, b, a, \text{ec})$  Spt 22,20,19
24.  $\text{SKP1}(d, c, b, a, \text{ec})$  Spt 22,19
25.  $(\text{eq} = \text{ec})$  24,4
26.  $\square$  25,3

**Th107.**  $\text{InsRel3}(r, \text{ec}, \text{ntpp}, x, y, z_1, z_2) \rightarrow [\neg\text{StrFCONT}(\frac{x}{z_1 \cup z_2}) \vee \neg\text{StrFCONT}(\frac{y}{z_1 \cup z_2})]$

From D10, D53, D54, A22, Proposition 1

**Th108.**  $\text{InsRel3}(r, \text{ec}, \text{tpi}, x, y, z_1, z_2) \rightarrow [\neg\text{StrFCONT}(\frac{x}{z_1 \cup z_2}) \vee \neg\text{StrFCONT}(\frac{y}{z_1 \cup z_2})]$

From D9, D53, D54, A22, Proposition 1

**Th109.**  $\text{InsRel3}(r, \text{ec}, \text{ntppi}, x, y, z_1, z_2) \rightarrow [\neg\text{StrFCONT}(\frac{x}{z_1 \cup z_2}) \vee \neg\text{StrFCONT}(\frac{y}{z_1 \cup z_2})]$

From D10, D53, D54, A22, Proposition 1



**Th110.**  $\text{InsRel3}(\text{dc}, \text{tpp}, r, x, y, z_1, z_2) \rightarrow [\neg \text{StrFCONT}(\frac{x}{z_1 \cup z_2}) \vee \neg \text{StrFCONT}(\frac{y}{z_1 \cup z_2})]$

**Lemma 35.**  $\neg(\text{tppi} = \text{tpp})$

From D9, D49

Proof of Theorem:

Refutation Set:

1.  $\neg(\text{tppi} = \text{tpp})$  Lemma 35
2.  $\neg(\text{tpp} = \text{eq})$  Lemma 24
3.  $\neg(\text{tpp} = \text{ec})$  Lemma 31
4.  $\neg \text{SKP1}(u, v, w, x, y) \vee (y = \text{eq})$  A22
5.  $\neg \text{SKP2}(u, v, w, x, y) \vee (y = \text{ec})$  A22
6.  $\neg \text{InsRel}(u, v, w, x, y) \vee \text{IM}(u, v, w, x, y)$  D53
7.  $\neg \mathbb{M}_{\text{tpp}}(u, v, w, x) \vee \text{FCON}(\frac{u \cap v}{w}, \frac{u \cap v}{x})$  Proposition 1
8.  $\neg \text{InsRel3}(u, v, w, x, y, z, x1) \vee \text{InsRel}(v, x, y, z, x1)$  D54
9.  $\neg \text{InsRel3}(\text{dc}, z, y, u, v, w, x) \vee \neg \text{FCON}(\frac{u \cap v}{w}, \frac{u \cap v}{x})$  Lemma 26
10.  $[\neg \text{StrFCONT}(\frac{w}{x \cup y}) \vee \neg \text{StrFCONT}(\frac{v}{x \cup y}) \vee \neg \text{IM}(u, v, w, x, y) \vee$   
 $\text{SKP1}(y, x, w, v, u) \vee \text{SKP2}(y, x, w, v, u) \vee (u = \text{tppi}) \vee \mathbb{M}_{\text{tpp}}(v, w, x, y)]$  A22
11.  $\text{StrFCONT}(\frac{a}{c \cup d})$
12.  $\text{StrFCONT}(\frac{b}{c \cup d})$
13.  $\text{InsRel3}(\text{dc}, \text{tpp}, p, a, b, c, d)$

Proof:

14.  $\text{InsRel}(\text{tpp}, a, b, c, d)$  13,8
15.  $\text{IM}(\text{tpp}, a, b, c, d)$  14,6
16.  $[\text{SKP1}(d, c, b, a, \text{tpp}) \vee$   
 $\text{SKP2}(d, c, b, a, \text{tpp}) \vee \mathbb{M}_{\text{tpp}}(a, b, c, d) \vee (\text{tppi} = \text{tpp})]$  SHy 15,12,11,10
17.  $\text{SKP1}(d, c, b, a, \text{tpp}) \vee \text{SKP2}(d, c, b, a, \text{tpp}) \vee \mathbb{M}_{\text{tpp}}(a, b, c, d)$  16,1
18.  $\text{SKP2}(d, c, b, a, \text{tpp})$  Spt 17
19.  $(\text{tpp} = \text{ec})$  SHy 18,5
20.  $\square$  19,3
21.  $\neg \text{SKP2}(d, c, b, a, \text{tpp})$  Spt 20,18,17
22.  $\text{SKP1}(d, c, b, a, \text{tpp}) \vee \mathbb{M}_{\text{tpp}}(a, b, c, d)$  Spt 20,17
23.  $\text{SKP1}(d, c, b, a, \text{tpp})$  Spt 22
24.  $(\text{tpp} = \text{eq})$  SHy 23,4
25.  $\square$  24,2
26.  $\neg \text{SKP1}(d, c, b, a, \text{tpp})$  Spt 25,23,22
27.  $\mathbb{M}_{\text{tpp}}(a, b, c, d)$  25,22
28.  $\text{FCON}(\frac{a \cap b}{c}, \frac{a \cap b}{d})$  27,7
29.  $\square$  SHy 28,13,9

**Th111.**  $\text{InsRel3}(\text{ec}, \text{tpp}, r, x, y, z_1, z_2) \rightarrow [\neg \text{StrFCONT}(\frac{x}{z_1 \cup z_2}) \vee \neg \text{StrFCONT}(\frac{y}{z_1 \cup z_2})]$

From D6, D53, D54, A22, Proposition 1

**Th112.**  $\text{InsRel3}(r, \text{tpp}, \text{tppi}, x, y, z_1, z_2) \rightarrow [\neg \text{StrFCONT}(\frac{x}{z_1 \cup z_2}) \vee \neg \text{StrFCONT}(\frac{y}{z_1 \cup z_2})]$

From D9, D53, D54, A22, Proposition 1

**Th113.**  $\text{InsRel3}(r, \text{tpp}, \text{ntppi}, x, y, z_1, z_2) \rightarrow [\neg \text{StrFCONT}(\frac{x}{z_1 \cup z_2}) \vee \neg \text{StrFCONT}(\frac{y}{z_1 \cup z_2})]$

From D10, D53, D54, A22, Proposition 1

**Th114.**  $\text{InsRel3}(\text{dc}, \text{tppi}, r, x, y, z_1, z_2) \rightarrow [\neg \text{StrFCONT}(\frac{x}{z_1 \cup z_2}) \vee \neg \text{StrFCONT}(\frac{y}{z_1 \cup z_2})]$

From D9, D53, D54, A22, Proposition 1

**Th115.**  $\text{InsRel3}(\text{ec}, \text{tppi}, r, x, y, z_1, z_2) \rightarrow [\neg \text{StrFCONT}(\frac{x}{z_1 \cup z_2}) \vee \neg \text{StrFCONT}(\frac{y}{z_1 \cup z_2})]$

From D6 D53, D54, A22, Proposition 1

**Th116.**  $\text{InsRel3}(\text{tpp}, \text{tppi}, r, x, y, z_1, z_2) \rightarrow [\neg \text{StrFCONT}(\frac{x}{z_1 \cup z_2}) \vee \neg \text{StrFCONT}(\frac{y}{z_1 \cup z_2})]$

**Lemma 36.**  $(\frac{x-y}{z}) = [\frac{x}{z} - \frac{y}{z}]$

From D12, D30

**Lemma 37.**  $\text{InsRel3}(\text{tpp}, r_1, r_2, x, y, z_1, z_2) \rightarrow \text{TPP}_{\text{st}}(\frac{x}{z_1}, \frac{y}{z_1})$

From D49, D54, Th85

**Lemma 38.**  $\text{InsRel3}(\text{tpp}, r_1, r_2, x, y, z_1, z_2) \rightarrow \neg \text{FCON}(\frac{(x-y)}{z_1}, \frac{(x \cup y)}{z_1})$

Refutation Set:

1.  $\neg \text{Null}(u) \vee \neg \text{FCON}(u, v)$
2.  $\neg \text{PP}_{\text{st}}(u, v) \vee \text{Null}(u - v)$
3.  $\neg \text{TPP}_{\text{st}}(u, v) \vee \text{PP}_{\text{st}}(u, v)$  D9
4.  $(\frac{x-y}{z}) = [\frac{x}{z} - \frac{y}{z}]$  Lemma 36
5.  $\text{InsRel3}(\text{tpp}, r_1, r_2, x, y, z_1, z_2) \rightarrow \text{TPP}_{\text{st}}(\frac{x}{z_1}, \frac{y}{z_2})$  Lemma 37
6.  $\text{InsRel3}(\text{tpp}, p, q, a, b, c, d)$
7.  $\text{FCON}(\frac{(a-b)}{c}, \frac{(a \cup b)}{d})$

Proof:

1.  $\text{TPP}_{\text{st}}(\frac{a}{c}, \frac{b}{c})$  6,5
2.  $\neg \text{Null}(\frac{a-b}{c})$  7,1
3.  $\text{PP}_{\text{st}}(\frac{a}{c}, \frac{b}{c})$  8,3
4.  $\text{Null}(\frac{a}{c} - \frac{b}{c})$  10,2
5.  $\text{Null}(\frac{a-b}{c})$  11,4
6.  $\square$  13,9

Note : Lemma 38 require inclusion of an explicit statement of the form  $\forall u, v [\text{PP}_{\text{st}}(u, v) \rightarrow \text{Null}(u - v)]$ . This is a theorem from D3, D5 and A8.

Proof of Theorem:

Refutation Set:

1.  $\neg(\text{tppi} = \text{tpp})$  Lemma 35
2.  $\neg(\text{tppi} = \text{eq})$  Lemma 23
3.  $\neg(\text{tppi} = \text{ec})$  Lemma 30
4.  $\neg\text{SKP1}(u, v, w, x, y) \vee (y = \text{eq})$  A22
5.  $\neg\text{SKP2}(u, v, w, x, y) \vee (y = \text{ec})$  A22
6.  $\neg\text{InsRel}(u, v, w, x, y) \vee \text{IM}(u, v, w, x, y)$  D53
7.  $\neg\mathbb{M}_{\text{tppi}}(u, v, w, x) \vee \text{FCON}(\frac{u-v}{w}, \frac{u \cup v}{x})$  Proposition 1
8.  $\neg\text{InsRel3}(u, v, w, x, y, z, x1) \vee \text{InsRel}(v, x, y, z, x1)$  D54
9.  $\neg\text{InsRel3}(\text{tpp}, z, y, u, v, w, x) \vee \neg\text{FCON}(\frac{u-v}{w}, \frac{u \cup v}{x})$  Lemma 38
10.  $[\neg\text{StrFCONT}(\frac{w}{x \cup y}) \vee \neg\text{StrFCONT}(\frac{v}{x \cup y}) \vee \neg\text{IM}(u, v, w, x, y) \vee$   
 $\text{SKP1}(y, x, w, v, u) \vee \text{SKP2}(y, x, w, v, u) \vee (u = \text{tpp}) \vee \mathbb{M}_{\text{tppi}}(v, w, x, y)]$  A22
11.  $\text{StrFCONT}(\frac{a}{c \cup d})$
12.  $\text{StrFCONT}(\frac{b}{c \cup d})$
13.  $\text{InsRel3}(\text{tpp}, \text{tppi}, p, a, b, c, d)$

Proof:

14.  $\text{InsRel}(\text{tppi}, a, b, c, d)$  13,8
15.  $\text{IM}(\text{tppi}, a, b, c, d)$  14,6
16.  $[\text{SKP1}(d, c, b, a, \text{tppi}) \vee$   
 $\text{SKP2}(d, c, b, a, \text{tppi}) \vee \mathbb{M}_{\text{tppi}}(a, b, c, d) \vee (\text{tppi} = \text{tpp})]$  SHy 15,12,11,10
17.  $\text{SKP1}(d, c, b, a, \text{tppi}) \vee \text{SKP2}(d, c, b, a, \text{tppi}) \vee \mathbb{M}_{\text{tppi}}(a, b, c, d)$  16,1
18.  $\text{SKP2}(d, c, b, a, \text{tppi})$  Spt 17
19.  $(\text{tppi} = \text{ec})$  SHy 18,5
20.  $\square$  19,3
21.  $\neg\text{SKP2}(d, c, b, a, \text{tppi})$  Spt 20,18,17
22.  $\text{SKP1}(d, c, b, a, \text{tppi}) \vee \mathbb{M}_{\text{tppi}}(a, b, c, d)$  Spt 20,17
23.  $\text{SKP1}(d, c, b, a, \text{tppi})$  Spt 22
24.  $(\text{tppi} = \text{eq})$  SHy 23,4
25.  $\square$  24,2
26.  $\neg\text{SKP1}(d, c, b, a, \text{tppi})$  Spt 25,23,22
27.  $\mathbb{M}_{\text{tppi}}(a, b, c, d)$  25,22
28.  $\text{FCON}(\frac{a-b}{c}, \frac{a \cup b}{d})$  27,7
29.  $\square$  SHy 28,13,9

**Th117.**  $\text{InsRel3}(r, \text{tppi}, \text{ntpp}, x, y, z_1, z_2) \rightarrow [\neg \text{StrFCONT}(\frac{x}{z_1 \cup z_2}) \vee \neg \text{StrFCONT}(\frac{y}{z_1 \cup z_2})]$

From D9, D53, D54, A22, Proposition 1

# Appendix E

## Transition Theorems II

---

Proofs of theorems for the non-existence of transitions cited in Section 4.6.4, Chapter 4 are presented below. Proofs for these 17 theorems fall into two broad groups: one that forces histories to be  $\neg\text{StrFCONT}$  for the given transition and the other that have a relation holding instantaneously in between (for  $\text{StrFCONT}$  histories). Proofs in each group, although look similar, have subtle differences based on the relations involved. Lemmas wherever used are stated prior to proof of the theorem. All proofs have been automatically generated using SPASS [Weidenbach, 2001].

**Th118.**  $[\text{StrFCONT}(\frac{x}{z_1 \cup z_2}) \wedge \text{StrFCONT}(\frac{y}{z_1 \cup z_2})] \rightarrow \neg\text{DirTran}(\text{dc}, \text{eq}, x, y, z_1, z_2)$

**Lemma 39.**  $[[u \subseteq_{\text{t}} v \wedge u \subseteq_{\text{t}} w] \rightarrow \text{EQ}_{\text{t}}(\frac{v}{u}, \frac{w}{u})]$

From D1, D8, D30

**Lemma 40.**  $[[\text{EC}_{\text{t}}(z_1, z_2) \wedge (z_1 \cup z_2) \subseteq_{\text{t}} w] \rightarrow \text{ECTS}(\frac{w}{z_1}, \frac{w}{z_2}, \frac{w}{z_1 \cup z_2})]$

From D6, D30, D36, Th18

**Lemma 41.**  $[\text{Trans}(\text{dc}, \text{eq}, x, y, z_1, z_2) \rightarrow [\neg\text{StrFCONT}(\frac{x}{z_1 \cup z_2}) \vee \neg\text{StrFCONT}(\frac{y}{z_1 \cup z_2})]]$

Refutation Set:

1.  $\neg\text{StrFCONT}u \vee \text{FCONT}u$  D39
2.  $\neg\text{StrFCONT}u \vee \text{StrCONT}_{\text{st}}u$  D39
3.  $\neg\text{FCONT}u \vee \text{CONT}u$  D38
4.  $\text{C}_{\text{st}}(u, v) \vee \text{DC}_{\text{st}}(u, v)$  D5
5.  $\neg\text{P}_{\text{t}}(u \cup v, w) \vee \text{P}_{\text{t}}(u, w)$  Th18
6.  $\neg\text{DR}_{\text{st}}(u, v) \vee \neg\text{C}_{\text{st}}(u, v) \vee \text{EC}_{\text{st}}(u, v)$  Lemma 27

7.  $\neg \text{Trans}(u, v, w, x, y, z) \vee \text{EC}_t(y, z)$  D52
8.  $\neg \text{Trans}(u, v, w, x, y, z) \vee \text{P}_t(y \cup z, x)$  D52
9.  $\neg \text{Trans}(u, v, w, x, y, z) \vee \text{P}_t(y \cup z, w)$  D52
10.  $\neg \text{Trans}(u, \text{eq}, v, w, x, y) \vee \text{EQ}_{\text{st}}(\frac{v}{y}, \frac{w}{y})$  Th93
11.  $\neg \text{Trans}(\text{dc}, u, v, w, x, y) \vee \text{DR}_{\text{st}}(\frac{v}{x}, \frac{w}{x})$  Th87
12.  $\neg \text{P}_t(u, v) \vee \neg \text{P}_t(u, w) \vee \text{EQ}_t(\frac{v}{u}, \frac{w}{u})$  Lemma 39
13.  $\neg \text{EC}_t(u, v) \vee \neg \text{P}_t(u \cup v, w) \vee \text{ECTS}(\frac{w}{u}, \frac{w}{v}, \frac{w}{(u \cup v)})$  Lemma 40
14.  $[\neg \text{CONT}u \vee \neg \text{CONT}v \vee \neg \text{EQ}_t(w, x) \vee$   
 $\neg \text{DC}_{\text{st}}(w, x) \vee \neg \text{ECTS}(w, y, u) \vee \neg \text{ECTS}(x, y, v)]$  Th53
15.  $[\neg \text{FCONT}u \vee \neg \text{FCONT}v \vee \neg \text{EQ}_t(w, x) \vee$   
 $\neg \text{EC}_{\text{st}}(w, x) \vee \neg \text{ECTS}(w, y, u) \vee \neg \text{ECTS}(x, y, v)]$  Th54
16.  $\text{StrFCONT}(\frac{a}{c \cup d})$
17.  $\text{StrFCONT}(\frac{b}{c \cup d})$
18.  $\text{Trans}(\text{dc}, \text{eq}, a, b, c, d)$

Proof:

19.  $\text{FCONT}(\frac{b}{c \cup d})$  17,1
20.  $\text{StrCONT}_{\text{st}}(\frac{b}{c \cup d})$  17,2
21.  $\text{FCONT}(\frac{a}{c \cup d})$  16,1
22.  $\text{StrCONT}_{\text{st}}(\frac{a}{c \cup d})$  16,2
23.  $\text{DR}_{\text{st}}(\frac{a}{c}, \frac{b}{c})$  18,11
24.  $\text{P}_t(c \cup d, b)$  18,8
25.  $\text{P}_t(c \cup d, a)$  18,9
26.  $\text{EC}_t(c, d)$  18,7
27.  $\text{EQ}_{\text{st}}(\frac{a}{d}, \frac{b}{d})$  18,10
28.  $\text{P}_t(c, b)$  24,5
29.  $\text{ECTS}(\frac{b}{c}, \frac{b}{d}, \frac{b}{(c \cup d)})$  SHy 26,24,13
30.  $\text{P}_t(c, a)$  25,5
31.  $\text{ECTS}(\frac{a}{c}, \frac{a}{d}, \frac{a}{(c \cup d)})$  SHy 26,25,13
32.  $\text{ECTS}(\frac{a}{c}, \frac{b}{d}, \frac{a}{(c \cup d)})$  Rew 31,27
33.  $\text{EQ}_t(\frac{a}{c}, \frac{b}{c})$  SHy 30,28,12
34.  $\neg \text{CONT}(\frac{b}{c \cup d}) \vee \neg \text{CONT}(\frac{a}{c \cup d}) \vee \text{C}_{\text{st}}(\frac{a}{c}, \frac{b}{c})$  SHy 33,32,29,14,4
35.  $\text{C}_{\text{st}}(\frac{a}{c}, \frac{b}{c})$  34,22,21,20,19,17,16,3
36.  $\text{EC}_{\text{st}}(\frac{a}{c}, \frac{b}{c})$  SHy 35,23,6
37.  $\neg \text{FCONT}(\frac{b}{c \cup d}) \vee \neg \text{FCONT}(\frac{a}{c \cup d})$  SHy 36,33,32,29,15
38.  $\square$  37,22,21,20,19,17,16

Note : Clauses 14 and 15 have been generated from Th53 and Th54 respectively after equality resolution. Note the pair of ECTS terms in each clause; the second variable (corresponding to

one of the externally connected temporal slice) is made equal through reduction of the  $EQ_{st}$  term present in Th54 and Th53.

Proof of Theorem:

Refutation Set:

1.  $\neg(dc = eq)$  Lemma 18
2.  $\neg Trans(dc, eq, u, v, w, x) \vee \neg StrFCONT(\frac{u}{w \cup x}) \vee \neg StrFCONT(\frac{v}{w \cup x})$  Lemma 41
3.  $\neg InsRel3(dc, eq, u, v, w, x, y) \vee \neg StrFCONT(\frac{v}{x \cup y}) \vee \neg StrFCONT(\frac{w}{x \cup y})$  Th103
4.  $\neg InsRel3(u, dc, v, w, x, y, z) \vee \neg StrFCONT(\frac{w}{y \cup z}) \vee \neg StrFCONT(\frac{x}{y \cup z})$  Th99
5.  $[\neg EleTran(u, v, w, x, y, z, x1) \vee (v = w) \vee (v = u) \vee InsRel3(u, v, w, x, y, z, x1)]$  D55
6.  $[\neg EleTran(u, v, w, x, y, z, x1) \vee Trans(u, w, x, y, z, x1) \vee InsRel3(u, v, w, x, y, z, x1)]$  D55
7.  $[EleTran(u, v, skf62(z, y, x, w, v, u), w, x, y, z) \vee EleTran(skf63(z, y, x, w, v, u), u, v, w, x, y, z) \vee \neg DirTran(u, v, w, x, y, z)]$  D56
8.  $StrFCONT(\frac{a}{c \cup d})$
9.  $StrFCONT(\frac{b}{c \cup d})$
10.  $DirTran(dc, eq, a, b, c, d)$

Proof:

11.  $\neg Trans(dc, eq, a, u, c, d) \vee \neg StrFCONT(\frac{u}{c \cup d})$  8,2
12.  $\neg InsRel3(u, dc, v, a, w, c, d) \vee \neg StrFCONT(\frac{w}{c \cup d})$  8,4
13.  $\neg InsRel3(dc, eq, u, a, v, c, d) \vee \neg StrFCONT(\frac{v}{c \cup d})$  8,3
14.  $[EleTran(dc, eq, skf62(d, c, b, a, eq, dc), a, b, c, d) \vee EleTran(skf63(d, c, b, a, eq, dc), dc, eq, a, b, c, d)]$  10,7
15.  $\neg Trans(dc, eq, a, b, c, d)$  11,9
16.  $\neg InsRel3(u, dc, v, a, b, c, d)$  12,9
17.  $\neg InsRel3(dc, eq, u, a, b, c, d)$  13,9
18.  $[EleTran(dc, eq, skf62(d, c, b, a, eq, dc), a, b, c, d)$  Spt 14
19.  $[Trans(dc, skf62(d, c, b, a, eq, dc), a, b, c, d) \vee InsRel3(dc, eq, skf62(d, c, b, a, eq, dc), a, b, c, d)]$  18,6
20.  $[(dc = eq) \vee (skf62(d, c, b, a, eq, dc) = eq) \vee InsRel3(dc, eq, skf62(d, c, b, a, eq, dc), a, b, c, d)]$  18,5
21.  $(skf62(d, c, b, a, eq, dc) = eq)$  20,17,1
22.  $[Trans(dc, eq, a, b, c, d) \vee InsRel3(dc, eq, eq, a, b, c, d)]$  Rew 21,19
23.  $\square$  22,17,15
24.  $\neg EleTran(dc, eq, skf62(d, c, b, a, eq, dc), a, b, c, d)$  Spt 23,18,14
25.  $EleTran(skf63(d, c, b, a, eq, dc), dc, eq, a, b, c, d)$  Spt 23,14
26.  $[(dc = eq) \vee (skf63(d, c, b, a, eq, dc) = dc) \vee InsRel3(skf63(d, c, b, a, eq, dc), dc, eq, a, b, c, d)]$  25,5

27.  $\text{InsRel3}(\text{skf63}(d, c, b, a, \text{eq}, \text{dc}), \text{dc}, \text{eq}, a, b, c, d) \vee$   
 $\text{Trans}(\text{skf63}(d, c, b, a, \text{eq}, \text{dc}), \text{eq}, a, b, c, d)$  25,6
28.  $(\text{skf63}(d, c, b, a, \text{eq}, \text{dc}) = \text{dc})$  26,12,1
29.  $\text{InsRel3}(\text{dc}, \text{dc}, \text{eq}, a, b, c, d) \vee \text{Trans}(\text{dc}, \text{eq}, a, b, c, d)$  Rew 28,27
30.  $\square$  29,16,15

**Th119.**  $[\text{StrFCONT}(\frac{x}{z_1 \cup z_2}) \wedge \text{StrFCONT}(\frac{y}{z_1 \cup z_2})] \rightarrow \neg \text{DirTran}(\text{ec}, \text{eq}, x, y, z_1, z_2)$

**Lemma 42.**  $[\text{Trans}(\text{ec}, \text{eq}, x, y, z_1, z_2) \rightarrow [\neg \text{StrFCONT}(\frac{x}{z_1 \cup z_2}) \vee \neg \text{StrFCONT}(\frac{y}{z_1 \cup z_2})]]$

Refutation Set:

1.  $\neg \text{StrFCONT}u \vee \text{FCONT}u$  D39
2.  $\neg \text{StrFCONT}u \vee \text{StrCONT}_{\text{st}}u$  D39
3.  $\neg \text{P}_t(u \cup v, w) \vee \text{P}_t(u, w)$  Th18
4.  $\neg \text{Trans}(u, v, w, x, y, z) \vee \text{EC}_t(y, z)$  D52
5.  $\neg \text{Trans}(u, v, w, x, y, z) \vee \text{P}_t(y \cup z, x)$  D52
6.  $\neg \text{Trans}(u, v, w, x, y, z) \vee \text{P}_t(y \cup z, w)$  D52
7.  $\neg \text{P}_t(u, v) \vee \neg \text{P}_t(u, w) \vee \text{EQ}_t(\frac{v}{u}, \frac{w}{u})$  Lemma 39
8.  $\neg \text{Trans}(\text{ec}, u, v, w, x, y) \vee \text{EC}_{\text{st}}(\frac{v}{x}, \frac{w}{x})$  Th88
9.  $\neg \text{Trans}(u, \text{eq}, v, w, x, y) \vee \text{EQ}_{\text{st}}(\frac{v}{y}, \frac{w}{y})$  Th93
10.  $\neg \text{EC}_t(u, v) \vee \neg \text{P}_t(u \cup v, w) \vee \text{ECTS}(\frac{w}{u}, \frac{w}{v}, \frac{w}{(u \cup v)})$  Lemma 40
11.  $[\neg \text{FCONT}u \vee \neg \text{FCONT}v \vee \neg \text{EQ}_t(w, x) \vee$   
 $\neg \text{EC}_{\text{st}}(w, x) \vee \neg \text{ECTS}(w, y, u) \vee \neg \text{ECTS}(x, y, v)]$  Th54
12.  $\text{StrFCONT}(\frac{a}{c \cup d})$
13.  $\text{StrFCONT}(\frac{b}{c \cup d})$
14.  $\text{Trans}(\text{ec}, \text{eq}, a, b, c, d)$

Proof:

15.  $\text{FCONT}(\frac{b}{c \cup d})$  13,1
16.  $\text{StrCONT}_{\text{st}}(\frac{b}{c \cup d})$  13,2
17.  $\text{FCONT}(\frac{a}{c \cup d})$  12,1
18.  $\text{StrCONT}_{\text{st}}(\frac{a}{c \cup d})$  12,2
19.  $\text{EC}_{\text{st}}(\frac{a}{c}, \frac{b}{c})$  14,8
20.  $\text{P}_t(c \cup d, b)$  14,5
21.  $\text{P}_t(c \cup d, a)$  14,6
22.  $\text{EC}_t(c, d)$  14,4
23.  $\text{EQ}_{\text{st}}(\frac{a}{d}, \frac{b}{d})$  14,9
24.  $\text{P}_t(c, b)$  20,3
25.  $\text{ECTS}(\frac{b}{c}, \frac{b}{d}, \frac{b}{(c \cup d)})$  SHy 22,20,10
26.  $\text{P}_t(c, a)$  21,3



- |  |                      |
|--|----------------------|
| 27. $\text{ECTS}(\frac{a}{c}, \frac{a}{d}, \frac{a}{c \cup d})$                        | SHy 22,21,10         |
| 28. $\text{ECTS}(\frac{a}{c}, \frac{b}{d}, \frac{a}{c \cup d})$                        | Rew 46,39            |
| 29. $\text{EQ}_t(\frac{a}{c}, \frac{b}{c})$  | SHy 26,24,7          |
| 30. $\neg \text{FCONT}(\frac{a}{c \cup d}) \vee \neg \text{FCONT}(\frac{b}{c \cup d})$ | SHy 29,28,25,19,11   |
| 31. $\square$  | 30,18,17,16,15,13,12 |

Proof of Theorem:

Refutation Set:

- |   |          |
|---|----------|
| 1. $\neg(\text{ec} = \text{eq})$  | Lemma 25 |
| 2. $\neg \text{Trans}(\text{ec}, \text{eq}, u, v, w, x) \vee \neg \text{StrFCONT}(\frac{u}{w \cup x}) \vee \neg \text{StrFCONT}(\frac{v}{w \cup x})$  | Lemma 42 |
| 3. $\neg \text{InsRel3}(\text{ec}, \text{eq}, u, v, w, x, y) \vee \neg \text{StrFCONT}(\frac{v}{x \cup y}) \vee \neg \text{StrFCONT}(\frac{w}{x \cup y})$                                     | Th104    |
| 4. $\neg \text{InsRel3}(u, \text{ec}, \text{eq}, v, w, x, y) \vee \neg \text{StrFCONT}(\frac{v}{x \cup y}) \vee \neg \text{StrFCONT}(\frac{w}{x \cup y})$                                     | Th105    |
| 5. $[\neg \text{EleTran}(u, v, w, x, y, z, x1) \vee (v = w) \vee$<br>$(v = u) \vee \text{InsRel3}(u, v, w, x, y, z, x1)]$   | D55      |
| 6. $[\neg \text{EleTran}(u, v, w, x, y, z, x1) \vee$<br>$\text{Trans}(u, w, x, y, z, x1) \vee \text{InsRel3}(u, v, w, x, y, z, x1)]$  | D55      |
| 7. $[\text{EleTran}(u, v, \text{skf62}(z, y, x, w, v, u), w, x, y, z) \vee$<br>$\text{EleTran}(\text{skf63}(z, y, x, w, v, u), u, v, w, x, y, z) \vee \neg \text{DirTran}(u, v, w, x, y, z)]$ | D56      |
| 8. $\text{StrFCONT}(\frac{a}{c \cup d})$  |          |
| 9. $\text{StrFCONT}(\frac{b}{c \cup d})$  |          |
| 10. $\text{DirTran}(\text{ec}, \text{eq}, a, b, c, d)$  |          |

Proof:

- |   |           |
|---|-----------|
| 11. $\neg \text{Trans}(\text{ec}, \text{eq}, a, u, c, d) \vee \neg \text{StrFCONT}(\frac{u}{c \cup d})$   | 8,2       |
| 12. $\neg \text{InsRel3}(\text{ec}, \text{eq}, u, a, v, c, d) \vee \neg \text{StrFCONT}(\frac{v}{c \cup d})$  | 8,3       |
| 13. $\neg \text{InsRel3}(u, \text{ec}, \text{eq}, a, v, c, d) \vee \neg \text{StrFCONT}(\frac{v}{c \cup d})$  | 8,4       |
| 14. $[\text{EleTran}(\text{ec}, \text{eq}, \text{skf62}(d, c, b, a, \text{eq}, \text{ec}), a, b, c, d) \vee$<br>$\text{EleTran}(\text{skf63}(d, c, b, a, \text{eq}, \text{ec}), \text{ec}, \text{eq}, a, b, c, d)]$ | 10,7      |
| 15. $\neg \text{Trans}(\text{ec}, \text{eq}, a, b, c, d)$   | 11,9      |
| 16. $\neg \text{InsRel3}(u, \text{ec}, \text{eq}, a, b, c, d)$  | 13,9      |
| 17. $\neg \text{InsRel3}(\text{ec}, \text{eq}, u, a, b, c, d)$  | 12,9      |
| 18. $\text{EleTran}(\text{ec}, \text{eq}, \text{skf62}(d, c, b, a, \text{eq}, \text{ec}), a, b, c, d)$  | Spt 14    |
| 19. $[\text{Trans}(\text{ec}, \text{skf62}(d, c, b, a, \text{eq}, \text{ec}), a, b, c, d) \vee$<br>$\text{InsRel3}(\text{ec}, \text{eq}, \text{skf62}(d, c, b, a, \text{eq}, \text{ec}), a, b, c, d)]$              | 18,6      |
| 20. $[(\text{ec} = \text{eq}) \vee (\text{skf62}(d, c, b, a, \text{eq}, \text{ec}) = \text{eq}) \vee$<br>$\text{InsRel3}(\text{ec}, \text{eq}, \text{skf62}(d, c, b, a, \text{eq}, \text{dc}), a, b, c, d)]$        | 18,5      |
| 21. $(\text{skf62}(d, c, b, a, \text{eq}, \text{ec}) = \text{eq})$  | 20,17,1   |
| 22. $[\text{Trans}(\text{ec}, \text{eq}, a, b, c, d) \vee \text{InsRel3}(\text{ec}, \text{eq}, \text{eq}, a, b, c, d)]$   | Rew 21,19 |
| 23. $\square$   | 22,17,15  |

24.  $\neg \text{EleTran}(\text{ec}, \text{eq}, \text{skf62}(\text{d}, \text{c}, \text{b}, \text{a}, \text{eq}, \text{ec}), \text{a}, \text{b}, \text{c}, \text{d})$  Spt 23,18,14
25.  $\text{EleTran}(\text{skf63}(\text{d}, \text{c}, \text{b}, \text{a}, \text{eq}, \text{ec}), \text{ec}, \text{eq}, \text{a}, \text{b}, \text{c}, \text{d})$  Spt 23,14
26.  $[(\text{ec} = \text{eq}) \vee (\text{skf63}(\text{d}, \text{c}, \text{b}, \text{a}, \text{eq}, \text{ec}) = \text{ec}) \vee$   
 $\text{InsRel3}(\text{skf63}(\text{d}, \text{c}, \text{b}, \text{a}, \text{eq}, \text{ec}), \text{ec}, \text{eq}, \text{a}, \text{b}, \text{c}, \text{d})]$  25,5
27.  $\text{InsRel3}(\text{skf63}(\text{d}, \text{c}, \text{b}, \text{a}, \text{eq}, \text{ec}), \text{ec}, \text{eq}, \text{a}, \text{b}, \text{c}, \text{d}) \vee$   
 $\text{Trans}(\text{skf63}(\text{d}, \text{c}, \text{b}, \text{a}, \text{eq}, \text{ec}), \text{eq}, \text{a}, \text{b}, \text{c}, \text{d})$  25,6
28.  $(\text{skf63}(\text{d}, \text{c}, \text{b}, \text{a}, \text{eq}, \text{ec}) = \text{ec})$  26,12,1
29.  $\text{InsRel3}(\text{ec}, \text{ec}, \text{eq}, \text{a}, \text{b}, \text{c}, \text{d}) \vee \text{Trans}(\text{ec}, \text{eq}, \text{a}, \text{b}, \text{c}, \text{d})$  Rew 28,27
30.  $\square$  29,16,15

**Th120.**  $[\text{StrFCONT}(\frac{x}{z_1 \cup z_2}) \wedge \text{StrFCONT}(\frac{y}{z_1 \cup z_2})] \rightarrow \neg \text{DirTran}(\text{dc}, \text{po}, x, y, z_1, z_2)$

**Lemma 43.**  $[\neg(\text{dc} = \text{po})]$

From D5, D7, D49

**Lemma 44.**  $[\neg(\text{ec} = \text{po})]$

From D6, D7, D49

**Lemma 45.**  $[\text{Trans}(\text{dc}, \text{po}, x, y, z_1, z_2) \wedge \text{StrFCONT}(\frac{x}{z_1 \cup z_2}) \wedge \text{StrFCONT}(\frac{y}{z_1 \cup z_2})] \rightarrow$   
 $\text{InsRel3}(\text{dc}, \text{ec}, \text{po}, x, y, z_1, z_2)]$

Refutation Set:

1.  $\neg(\text{ec} = \text{po})$  Lemma 44
2.  $\neg(\text{dc} = \text{ec})$  Lemma 17
3.  $\neg \text{StrFCONT}u \vee \text{FCONT}u$  D39
4.  $\neg \text{Trans}(u, v, w, x, y, z) \vee \text{EC}_t(y, z)$  D52
5.  $\neg \text{Trans}(u, v, w, x, y, z) \vee \text{P}_t(y \cup z, x)$  D52
6.  $\neg \text{Trans}(u, v, w, x, y, z) \vee \text{P}_t(y \cup z, w)$  D52
7.  $\neg \text{Trans}(u, \text{po}, v, w, x, y) \vee \text{PO}_{\text{sp}}^{\equiv}(\frac{v}{y}, \frac{w}{y})$  Th94
8.  $\neg \text{Trans}(\text{dc}, u, v, w, x, y) \vee \text{DR}_{\text{st}}(\frac{v}{x}, \frac{w}{x})$  Th87
9.  $\neg \mathbb{M}_{\text{ec}}(u, v, w, x) \vee \neg(\text{ec} = y) \vee \text{SKP1}(x, w, v, u, y)$  A22
10.  $\text{NECP}(\text{skf16}(u, v, w, x, y), \frac{w}{v}, u) \vee \text{SKP3}(z, w, u, v, x1)$  D54
11.  $\text{NECP}(\text{skf17}(u, v, w, x, y), \frac{w}{v}, u) \vee \text{SKP3}(z, x1, u, v, w)$  D54
12.  $\neg \text{rcc}_{\text{sp}}^{\equiv}(u, \text{skf17}(v, w, x, y, u), \text{skf16}(v, w, y, u, x)) \vee \text{SKP3}(u, y, v, w, x)$  D54
13.  $\neg \text{EC}_t(u, v) \vee \neg \text{P}_t(u \cup v, w) \vee \text{ECTS}(\frac{w}{u}, \frac{w}{v}, \frac{w}{u \cup v})$  Lemma 40
14.  $\text{EQTS}(\text{skf17}(u, v, w, x, y), \text{skf16}(u, v, x, y, w), \frac{w}{v}, \frac{x}{v}) \vee \text{SKP3}(y, x, u, v, w)$  D54
15.  $[\neg \text{SKP1}(u, v, w, x, y) \vee \neg \text{StrFCONT}(\frac{x}{v \cup u}) \vee$   
 $\neg \text{StrFCONT}(\frac{w}{v \cup u}) \vee \text{IM}(y, x, w, v, u)]$  A22
16.  $[\neg \text{IM}(u, v, w, x, y) \vee \neg \text{P}_t(x \cup y, w) \vee \neg \text{P}_t(x \cup y, v) \vee$   
 $\neg \text{EC}_t(x, y) \vee \text{InsRel}(u, v, w, x, y)]$  D53
17.  $[\neg \text{SKP3}(u, v, w, x, y) \vee \neg \text{SKP3}(z, v, x, w, y) \vee \neg \text{InsRel}(x1, y, v, w, x) \vee$

- $(u = x1) \vee \text{InsRel3}(z, x1, u, y, v, w, x) \vee (z = x1)$  D54
18.  $[\neg \text{Trans}(u, v, w, x, y, z) \vee \neg \text{NECP}(x1, \frac{w}{z}, y) \vee \neg \text{EQTS}(x1, x2, \frac{w}{z}, \frac{x}{z}) \vee$   
 $\neg \text{NECP}(x2, \frac{x}{z}, y) \vee \text{rcc}_{\text{sp}}^{\equiv}(v, x1, x2)]$  D52
19.  $[\neg \text{Trans}(u, v, w, x, y, z) \vee \neg \text{NECP}(x1, \frac{w}{y}, z) \vee \neg \text{EQTS}(x1, x2, \frac{w}{y}, \frac{x}{y}) \vee$   
 $\neg \text{NECP}(x2, \frac{x}{y}, z) \vee \text{rcc}_{\text{sp}}^{\equiv}(u, x1, x2)]$  D52
20.  $[\neg \text{DR}_{\text{st}}(\frac{u}{v}, \frac{w}{v}) \vee \neg \text{PO}_{\text{sp}}^{\equiv}(\frac{u}{x}, \frac{w}{x}) \vee \neg \text{FCONT}(\frac{u}{v \cup x}) \vee \neg \text{FCONT}(\frac{w}{v \cup x}) \vee$   
 $\neg \text{ECTS}(\frac{u}{v}, \frac{u}{x}, \frac{u}{v \cup x}) \vee \neg \text{ECTS}(\frac{w}{v}, \frac{w}{x}, \frac{w}{v \cup x}) \vee \mathbb{M}_{\text{ec}}(u, w, v, x)]$  Th73
21.  $\text{StrFCONT}(\frac{a}{c \cup d})$
22.  $\text{StrFCONT}(\frac{b}{c \cup d})$
23.  $\text{Trans}(dc, po, a, b, c, d)$
24.  $\neg \text{InsRel3}(dc, ec, po, a, b, c, d)$

Proof:

25.  $\neg \text{FCONT}(\frac{a}{c \cup d})$  21,3
26.  $\neg \text{FCONT}(\frac{b}{c \cup d})$  22,3
27.  $\neg \text{SKP1}(d, c, u, a, v) \vee \neg \text{StrFCONT}(\frac{u}{c \cup d}) \vee \text{IM}(v, a, u, c, d)$  21,15
28.  $\text{DR}_{\text{st}}(\frac{a}{c}, \frac{b}{c})$  23,8
29.  $\text{P}_t(c \cup d, b)$  23,5
30.  $\text{P}_t(c \cup d, a)$  23,6
31.  $\text{EC}_t(c, d)$  23,4
32.  $\text{PO}_{\text{sp}}^{\equiv}(\frac{a}{d}, \frac{b}{d})$  23,7
33.  $\neg \text{SKP3}(po, b, c, d, a) \vee \neg \text{SKP3}(dc, b, d, c, a) \vee$   
 $\neg \text{InsRel}(ec, a, b, c, d) \vee (ec = po) \vee (dc = ec)$  24,17
34.  $\neg \text{SKP3}(po, b, c, d, a) \vee \neg \text{SKP3}(dc, b, d, c, a) \vee \neg \text{InsRel}(ec, a, b, c, d)$  32,2,1
35.  $\neg \text{SKP1}(d, c, b, a, u) \vee \text{IM}(u, a, b, c, d)$  22,17
36.  $\text{ECTS}(\frac{b}{c}, \frac{b}{d}, \frac{b}{c \cup d})$  SHy 31,29,13
37.  $\text{ECTS}(\frac{a}{c}, \frac{a}{d}, \frac{a}{c \cup d})$  SHy 31,30,13
38.  $[\text{SKP3}(u, b, c, d, v) \vee \text{SKP3}(w, b, c, d, a) \vee \text{SKP3}(x, y, c, d, a) \vee$   
 $\text{rcc}_{\text{sp}}^{\equiv}(po, \text{skf17}(c, d, a, b, w), \text{skf16}(c, d, b, w, a))]$  SHy 23,18,14,11,10
39.  $[\text{SKP3}(u, b, d, c, v) \vee \text{SKP3}(w, b, d, c, a) \vee \text{SKP3}(x, y, d, c, a) \vee$   
 $\text{rcc}_{\text{sp}}^{\equiv}(dc, \text{skf17}(d, c, a, b, w), \text{skf16}(d, c, b, w, a))]$  SHy 23,19,14,11,10
40.  $\text{SKP3}(u, b, c, d, a) \vee \text{rcc}_{\text{sp}}^{\equiv}(po, \text{skf17}(c, d, a, b, u), \text{skf16}(c, d, b, u, a))$  Con 38
41.  $\text{SKP3}(u, b, d, c, a) \vee \text{rcc}_{\text{sp}}^{\equiv}(dc, \text{skf17}(d, c, a, b, u), \text{skf16}(d, c, b, u, a))$  Con 39
42.  $\text{SKP3}(po, b, c, d, a) \vee \text{SKP3}(po, b, c, d, a)$  40,12
43.  $\text{SKP3}(po, b, c, d, a)$  Obs42
44.  $\neg \text{SKP3}(dc, b, d, c, a) \vee \neg \text{InsRel}(ec, a, b, c, d)$  43,34
45.  $\text{SKP3}(dc, b, d, c, a) \vee \text{SKP3}(dc, b, d, c, a)$  41,12
46.  $\text{SKP3}(dc, b, d, c, a)$  Obs45
47.  $\neg \text{InsRel}(ec, a, b, c, d)$  46,44

48.	$\neg \text{IM}(\text{ec}, a, b, c, d) \vee \neg \text{P}_t(c \cup d, b) \vee \neg \text{Pt}(c \cup d, a) \vee \neg \text{EC}_t(c, d)$	47,16
49.	$\neg \text{IM}(\text{ec}, a, b, c, d)$	48,31,30,29
50.	$\mathbb{M}_{\text{ec}}(a, b, c, d)$	SHy 37,36,32,28,26,25,20
51.	$\neg \mathbb{M}_{\text{ec}}(a, b, c, d) \vee \neg(u = \text{ec}) \vee \text{IM}(u, a, b, c, d)$	35,9
52.	$\neg(u = \text{ec}) \vee \text{IM}(u, a, b, c, d)$	51,50
53.	$\neg(\text{ec} = \text{ec})$	52,49
54.	$\square$	Obs53

Proof of Theorem:

Refutation Set:

1.	$\neg(\text{ec} = \text{po})$	Lemma 44
2.	$\neg(\text{dc} = \text{ec})$	Lemma 17
3.	$\neg(\text{dc} = \text{po})$	Lemma 43
4.	$\neg \text{InsRel3}(u, v, w, x, y, z, x1) \vee \text{EleTran}(u, v, w, x, y, z, x1)$	D55
5.	$\neg \text{InsRel3}(u, \text{po}, v, w, x, y, z) \vee \neg \text{StrFCONT}(\frac{w}{y \cup z}) \vee \neg \text{StrFCONT}(\frac{x}{y \cup z})$	Th100
6.	$\neg \text{InsRel3}(u, \text{dc}, v, w, x, y, z) \vee \neg \text{StrFCONT}(\frac{w}{y \cup z}) \vee \neg \text{StrFCONT}(\frac{x}{y \cup z})$	Th99
7.	$[\neg \text{DirTran}(u, v, w, x, y, z) \vee$ $\neg \text{EleTran}(u, x1, v, w, x, y, z) \vee (x1 = u) \vee (x1 = v)]$	D56
8.	$[\neg \text{EleTran}(u, v, w, x, y, z, x1) \vee (v = w) \vee$ $(v = u) \vee \text{InsRel3}(u, v, w, x, y, z, x1)]$	D55
9.	$[\neg \text{EleTran}(u, v, w, x, y, z, x1) \vee \text{Trans}(u, w, x, y, z, x1) \vee$ $\text{InsRel3}(u, v, w, x, y, z, x1)]$	D55
10.	$\neg \text{Trans}(\text{dc}, \text{po}, u, v, w, x) \vee \neg \text{StrFCONT}(\frac{u}{w \cup x}) \vee$ $\neg \text{StrFCONT}(\frac{v}{w \cup x}) \vee \text{InsRel3}(\text{dc}, \text{ec}, \text{po}, u, v, w, x)$	Lemma 45
11.	$[\text{EleTran}(u, v, \text{skf62}(z, y, x, w, v, u), w, x, y, z) \vee$ $\text{EleTran}(\text{skf63}(z, y, x, w, v, u), u, v, w, x, y, z) \vee \neg \text{DirTran}(u, v, w, x, y, z)]$	D56
12.	$\text{StrFCONT}(\frac{a}{c \cup d})$	
13.	$\text{StrFCONT}(\frac{b}{c \cup d})$	
14.	$\text{DirTran}(\text{dc}, \text{po}, a, b, c, d)$	

Proof:

15.	$\neg \text{InsRel3}(u, \text{po}, v, a, w, c, d) \vee \neg \text{StrFCONT}(\frac{w}{c \cup d})$	12,5
16.	$\neg \text{InsRel3}(u, \text{dc}, v, a, w, c, d) \vee \neg \text{StrFCONT}(\frac{w}{c \cup d})$	12,6
17.	$[\text{EleTran}(\text{dc}, \text{po}, \text{skf62}(d, c, b, a, \text{po}, \text{dc}), a, b, c, d) \vee$ $\text{EleTran}(\text{skf63}(d, c, b, a, \text{po}, \text{dc}), \text{dc}, \text{po}, a, b, c, d)]$	14,11
18.	$\neg \text{EleTran}(\text{dc}, u, \text{po}, a, b, c, d) \vee (u = \text{dc}) \vee (u = \text{po})$	14,7
19.	$\neg \text{InsRel3}(u, \text{dc}, v, a, b, c, d)$	16,13
20.	$\neg \text{InsRel3}(u, \text{po}, v, a, b, c, d)$	15,13
21.	$\neg \text{InsRel3}(\text{dc}, u, \text{po}, a, b, c, d) \vee (u = \text{dc}) \vee (u = \text{po})$	18,4

22.  $\neg\text{Trans}(dc, po, a, b, c, d) \vee \neg\text{StrFCONT}(\frac{a}{c \cup d}) \vee$   
 $\neg\text{StrFCONT}(\frac{b}{c \cup d}) \vee (ec = dc) \vee (ec = po)$  21,10
23.  $\neg\text{Transdc}, po, a, b, c, d)$  22,13,12,2,1
24.  $\text{EleTran}(dc, po, \text{skf62}(d, c, b, a, po, dc), a, b, c, d)$  Spt 17
25.  $[\text{Trans}(dc, \text{skf62}(d, c, b, a, po, dc), a, b, c, d) \vee$   
 $\text{InsRel3}(dc, po, \text{skf62}(d, c, b, a, po, dc), a, b, c, d)]$  24,9
26.  $[(dc = po) \vee (\text{skf62}(d, c, b, a, po, dc) = po) \vee$   
 $\text{InsRel3}(dc, po, \text{skf62}(d, c, b, a, po, dc), a, b, c, d)]$  24,8
27.  $(\text{skf62}(d, c, b, a, po, dc) = po)$  26,20,3
28.  $[\text{Trans}(dc, po, a, b, c, d) \vee \text{InsRel3}(dc, po, po, a, b, c, d)]$  Rew 27,25
29.  $\square$  28,23,20
30.  $\neg\text{EleTran}(dc, po, \text{skf62}(d, c, b, a, po, dc), a, b, c, d)$  Spt 29,24,17
31.  $\text{EleTran}(\text{skf63}(d, c, b, a, po, dc), dc, po, a, b, c, d)$  Spt 29,17
32.  $[(dc = po) \vee (\text{skf63}(d, c, b, a, po, dc) = dc) \vee$   
 $\text{InsRel3}(\text{skf63}(d, c, b, a, po, dc), dc, po, a, b, c, d)]$  31,8
33.  $\text{InsRel3}(\text{skf63}(d, c, b, a, po, dc), dc, po, a, b, c, d) \vee$   
 $\text{Trans}(\text{skf63}(d, c, b, a, po, dc), po, a, b, c, d)$  31,9
34.  $(\text{skf63}(d, c, b, a, po, dc) = dc)$  32,19,3
35.  $\text{InsRel3}(dc, dc, po, a, b, c, d) \vee \text{Trans}(dc, po, a, b, c, d)$  Rew 34,33
36.  $\square$  35,23,19

**Th121.**  $[\text{StrFCONT}(\frac{x}{z_1 \cup z_2}) \wedge \text{StrFCONT}(\frac{y}{z_1 \cup z_2})] \rightarrow \neg\text{DirTran}(dc, \text{tpp}, x, y, z_1, z_2)$

**Lemma 46.**  $[\text{Trans}(dc, \text{tpp}, x, y, z_1, z_2) \rightarrow [\neg\text{StrFCONT}(\frac{x}{z_1 \cup z_2}) \vee \neg\text{StrFCONT}(\frac{y}{z_1 \cup z_2})]]$

Refutation Set:

1.  $\neg\text{StrFCONT}u \vee \text{FCONT}u$  D39
2.  $\neg\text{StrFCONT}u \vee \text{StrCONT}_{\text{st}}u$  D39
3.  $\neg\text{FCONT}u \vee \text{CONT}u$  D38
4.  $\neg\text{TPP}_{\text{st}}(u, v) \vee \text{PP}_{\text{st}}(u, v)$  D47
5.  $\neg\text{P}_t(u \cup v, w) \vee \text{P}_t(u, w)$  Th18
6.  $\neg\text{DR}_{\text{st}}(u, v) \vee \neg\text{C}_{\text{st}}(u, v) \vee \text{EC}_{\text{st}}(u, v)$  Lemma 27
7.  $\neg\text{Trans}(u, v, w, x, y, z) \vee \text{EC}_t(y, z)$  D52
8.  $\neg\text{Trans}(u, v, w, x, y, z) \vee \text{P}_t(y \cup z, x)$  D52
9.  $\neg\text{Trans}(u, v, w, x, y, z) \vee \text{P}_t(y \cup z, w)$  D52
10.  $\neg\text{P}_t(u, v) \vee \neg\text{P}_t(u, w) \vee \text{EQ}_t(\frac{v}{u}, \frac{w}{u})$  Lemma 39
11.  $\neg\text{Trans}(dc, u, v, w, x, y) \vee \text{DR}_{\text{st}}(\frac{v}{x}, \frac{w}{x})$  Th87
12.  $\neg\text{Trans}(u, \text{tpp}, v, w, x, y) \vee \text{TPP}_{\text{st}}(\frac{v}{y}, \frac{w}{y})$  Th95
13.  $\neg\text{EC}_t(u, v) \vee \neg\text{P}_t((u \cup v), w) \vee \text{ECTS}(\frac{w}{u}, \frac{w}{v}, \frac{w}{(u \cup v)})$  Lemma 40
14.  $[\neg\text{CONT}u \vee \neg\text{CONT}v \vee \neg\text{EQ}_t(w, x) \vee \neg\text{PP}_{\text{st}}(y, z) \vee$

- $\neg\text{ECTS}(w, y, u) \vee \neg\text{ECTS}(x, z, v) \vee \text{C}_{\text{st}}(w, x)$  Th51
15.  $[\neg\text{FCONT}u \vee \neg\text{FCONT}v \vee \neg\text{EQ}_t(w, x) \vee \neg\text{EC}_{\text{st}}(w, x) \vee$   
 $\neg\text{PP}_{\text{st}}(y, z) \vee \neg\text{ECTS}(w, y, u) \vee \neg\text{ECTS}(x, z, v)]$  Th52
16.  $\text{StrFCONT}(\frac{a}{c \cup d})$
17.  $\text{StrFCONT}(\frac{b}{c \cup d})$
18.  $\text{Trans}(\text{dc}, \text{tpp}, a, b, c, d)$

Proof:

19.  $\text{FCONT}(\frac{b}{c \cup d})$  17,1
20.  $\text{StrCONT}_{\text{st}}(\frac{b}{c \cup d})$  17,2
21.  $\text{FCONT}(\frac{a}{c \cup d})$  16,1
22.  $\text{StrCONT}_{\text{st}}(\frac{a}{c \cup d})$  16,2
23.  $\text{DR}_{\text{st}}(\frac{a}{c}, \frac{b}{c})$  18,11
24.  $\text{P}_t(c \cup d, b)$  18,8
25.  $\text{P}_t(c \cup d, a)$  18,9
26.  $\text{EC}_t(c, d)$  18,7
27.  $\text{TPP}_{\text{st}}(\frac{a}{d}, \frac{b}{d})$  18,12
28.  $\text{P}_t(c, b)$  24,5
29.  $\text{ECTS}(\frac{b}{c}, \frac{b}{d}, \frac{b}{c \cup d})$  SHy 26,24,13
30.  $\text{P}_t(c, a)$  25,5
31.  $\text{ECTS}(\frac{a}{c}, \frac{a}{d}, \frac{a}{c \cup d})$  SHy 26,25,13
32.  $\text{EQ}_t(\frac{a}{c}, \frac{b}{c})$  SHy 30,28,10
33.  $\text{PP}_{\text{st}}(\frac{a}{d}, \frac{b}{d})$  27,4
34.  $\neg\text{CONT}(\frac{b}{c \cup d}) \vee \neg\text{CONT}(\frac{a}{c \cup d}) \vee \text{C}_{\text{st}}(\frac{a}{c}, \frac{b}{c})$  SHy 33,32,31,29,14
35.  $\text{C}_{\text{st}}(\frac{a}{c}, \frac{b}{c})$  34,22,21,20,19,17,16,3
36.  $\text{EC}_{\text{st}}(\frac{a}{c}, \frac{b}{c})$  SHy 35,23,6
37.  $\neg\text{FCONT}(\frac{b}{c \cup d}) \vee \neg\text{FCONT}(\frac{a}{c \cup d})$  SHy 36,33,32,31,29,15
38.  $\square$  37,22,21,20,19,17,16

Proof of Theorem:

Refutation Set:

1.  $\neg(\text{dc} = \text{tpp})$  Lemma 19
2.  $\neg\text{Trans}(\text{dc}, \text{tpp}, u, v, w, x) \vee \neg\text{StrFCONT}(\frac{u}{w \cup x}) \vee \neg\text{StrFCONT}(\frac{v}{w \cup x})$  Lemma 46
3.  $\neg\text{InsRel3}(\text{dc}, \text{tpp}, u, v, w, x, y) \vee \neg\text{StrFCONT}(\frac{v}{x \cup y}) \vee \neg\text{StrFCONT}(\frac{w}{x \cup y})$  Th110
4.  $\neg\text{InsRel3}(u, \text{dc}, v, w, x, y, z) \vee \neg\text{StrFCONT}(\frac{w}{y \cup z}) \vee \neg\text{StrFCONT}(\frac{x}{y \cup z})$  Th99
5.  $[\neg\text{EleTran}(u, v, w, x, y, z, x1) \vee (v = w) \vee$   
 $(v = u) \vee \text{InsRel3}(u, v, w, x, y, z, x1)]$  D55
6.  $[\neg\text{EleTran}(u, v, w, x, y, z, x1) \vee$   
 $\text{Trans}(u, w, x, y, z, x1) \vee \text{InsRel3}(u, v, w, x, y, z, x1)]$  D55
7.  $[\text{EleTran}(u, v, \text{skf62}(z, y, x, w, v, u), w, x, y, z) \vee$

- EleTran(skf63( $z, y, x, w, v, u$ ),  $u, v, w, x, y, z$ )  $\vee$   $\neg$ DirTran( $u, v, w, x, y, z$ )) D56
8. StrFCONT( $\frac{a}{c \cup d}$ )
  9. StrFCONT( $\frac{b}{c \cup d}$ )
  10. DirTran(dc, tpp, a, b, c, d)
- Proof:
11.  $\neg$ Trans(dc, tpp, a, u, c, d)  $\vee$   $\neg$ StrFCONT( $\frac{u}{c \cup d}$ ) 8,2
  12.  $\neg$ InsRel3(dc, tpp, u, a, v, c, d)  $\vee$   $\neg$ StrFCONT( $\frac{v}{c \cup d}$ ) 8,3
  13.  $\neg$ InsRel3( $u, dc, tpp, a, v, c, d$ )  $\vee$   $\neg$ StrFCONT( $\frac{v}{c \cup d}$ ) 8,4
  14. [EleTran(dc, tpp, skf62(d, c, b, a, tpp, dc), a, b, c, d)  $\vee$   
EleTran(skf63(d, c, b, a, tpp, dc), dc, tpp, a, b, c, d)] 10,7
  15.  $\neg$ Trans(dc, tpp, a, b, c, d) 11,9
  16.  $\neg$ InsRel3( $u, dc, tpp, a, b, c, d$ ) 13,9
  17.  $\neg$ InsRel3(dc, tpp,  $u, a, b, c, d$ ) 12,9
  18. EleTran(dc, tpp, skf62(d, c, b, a, tpp, dc), a, b, c, d) Spt 14
  19. [Trans(dc, skf62(d, c, b, a, tpp, dc), a, b, c, d)  $\vee$   
InsRel3(dc, tpp, skf62(d, c, b, a, tpp, dc), a, b, c, d)] 18,6
  20. [(dc = tpp)  $\vee$  (skf62(d, c, b, a, tpp, dc) = tpp)  $\vee$   
InsRel3(dc, tpp, skf62(d, c, b, a, tpp, dc), a, b, c, d)] 18,5
  21. (skf62(d, c, b, a, tpp, dc) = tpp) 20,17,1
  22. [Trans(dc, tpp, a, b, c, d)  $\vee$  InsRel3(dc, tpp, tpp, a, b, c, d)] Rew 21,19
  23.  $\square$  22,17,15
  24.  $\neg$ EleTran(dc, tpp, skf62(d, c, b, a, tpp, dc), a, b, c, d) Spt 23,18,14
  25. EleTran(skf63(d, c, b, a, tpp, dc), dc, tpp, a, b, c, d) Spt 23,14
  26. [(dc = tpp)  $\vee$  (skf63(d, c, b, a, tpp, dc) = dc)  $\vee$   
InsRel3(skf63(d, c, b, a, tpp, dc), dc, tpp, a, b, c, d)] 25,5
  27. InsRel3(skf63(d, c, b, a, tpp, dc), dc, tpp, a, b, c, d)  $\vee$   
Trans(skf63(d, c, b, a, tpp, dc), tpp, a, b, c, d) 25,6
  28. (skf63(d, c, b, a, tpp, dc) = dc) 26,12,1
  29. InsRel3(dc, dc, tpp, a, b, c, d)  $\vee$  Trans(dc, tpp, a, b, c, d) Rew 28,27
  30.  $\square$  29,16,15

**Th122.** [StrFCONT( $\frac{x}{z_1 \cup z_2}$ )  $\wedge$  StrFCONT( $\frac{y}{z_1 \cup z_2}$ )]  $\rightarrow$   $\neg$ DirTran(ec, tpp,  $x, y, z_1, z_2$ )

**Lemma 47.** [Trans(ec, tpp,  $x, y, z_1, z_2$ )  $\rightarrow$  [ $\neg$ StrFCONT( $\frac{x}{z_1 \cup z_2}$ )  $\vee$   $\neg$ StrFCONT( $\frac{y}{z_1 \cup z_2}$ )]]

Refutation Set:

1.  $\neg$ StrFCONT  $u \vee$  FCONT  $u$  D39
2.  $\neg$ StrFCONT  $u \vee$  StrCONT<sub>st</sub>  $u$  D39
3.  $\neg$ TPP<sub>st</sub>( $u, v$ )  $\vee$  PP<sub>st</sub>( $u, v$ ) D47
4.  $\neg$ P<sub>t</sub>( $u \cup v, w$ )  $\vee$  P<sub>t</sub>( $u, w$ ) Th18

5.  $\neg \text{Trans}(u, v, w, x, y, z) \vee \text{EC}_t(y, z)$  D52
6.  $\neg \text{Trans}(u, v, w, x, y, z) \vee \text{P}_t(y \cup z, x)$  D52
7.  $\neg \text{Trans}(u, v, w, x, y, z) \vee \text{P}_t(y \cup z, w)$  D52
8.  $\neg \text{P}_t(u, v) \vee \neg \text{P}_t(u, w) \vee \text{EQ}_t(\frac{v}{u}, \frac{w}{u})$  Lemma 39
9.  $\neg \text{Trans}(\text{ec}, u, v, w, x, y) \vee \text{EC}_{\text{st}}(\frac{v}{x}, \frac{w}{x})$  Th88
10.  $\neg \text{Trans}(u, \text{tpp}, v, w, x, y) \vee \text{TPP}_{\text{st}}(\frac{v}{y}, \frac{w}{y})$  Th95
11.  $\neg \text{EC}_t(u, v) \vee \neg \text{P}_t((u \cup v), w) \vee \text{ECTS}(\frac{w}{u}, \frac{w}{v}, \frac{w}{(u \cup v)})$  Lemma 40
12.  $[\neg \text{FCONT}u \vee \neg \text{FCONT}v \vee \neg \text{EQ}_t(w, x) \vee \neg \text{EC}_{\text{st}}(w, x) \vee$   
 $\neg \text{PP}_{\text{st}}(y, z) \vee \neg \text{ECTS}(w, y, u) \vee \neg \text{ECTS}(x, z, v)]$  Th52
13.  $\text{StrFCONT}(\frac{a}{c \cup d})$
14.  $\text{StrFCONT}(\frac{b}{c \cup d})$
15.  $\text{Trans}(\text{ec}, \text{tpp}, a, b, c, d)$

Proof:

16.  $\text{FCONT}(\frac{b}{c \cup d})$  14,1
17.  $\text{StrCONT}_{\text{st}}(\frac{b}{c \cup d})$  14,2
18.  $\text{FCONT}(\frac{a}{c \cup d})$  13,1
19.  $\text{StrCONT}_{\text{st}}(\frac{a}{c \cup d})$  13,2
20.  $\text{EC}_{\text{st}}(\frac{a}{c}, \frac{b}{c})$  15,9
21.  $\text{P}_t(c \cup d, b)$  15,6
22.  $\text{P}_t(c \cup d, a)$  15,7
23.  $\text{EC}_t(c, d)$  15,5
24.  $\text{TPP}_{\text{st}}(\frac{a}{d}, \frac{b}{d})$  15,10
25.  $\text{P}_t(c, b)$  21,4
26.  $\text{ECTS}(\frac{b}{c}, \frac{b}{d}, \frac{b}{(c \cup d)})$  SHy 23,21,11
27.  $\text{P}_t(c, a)$  21,4
28.  $\text{ECTS}(\frac{a}{c}, \frac{a}{d}, \frac{a}{(c \cup d)})$  SHy 23,22,11
29.  $\text{EQ}_t(\frac{a}{c}, \frac{b}{c})$  SHy 29,25,8
30.  $\text{PP}_{\text{st}}(\frac{a}{d}, \frac{b}{d})$  24,3
31.  $\neg \text{FCONT}(\frac{b}{c \cup d}) \vee \neg \text{FCONT}(\frac{a}{c \cup d})$  SHy 30,29,28,26,20,12
32.  $\square$  31,19,18,17,16,14,13

Proof of Theorem:

Refutation Set:

1.  $\neg(\text{tpp} = \text{ec})$  Lemma 31
2.  $\neg \text{Trans}(\text{ec}, \text{tpp}, u, v, w, x) \vee \neg \text{StrFCONT}(\frac{u}{w \cup x}) \vee \neg \text{StrFCONT}(\frac{v}{w \cup x})$  Lemma 47
3.  $\neg \text{InsRel3}(u, \text{ec}, \text{tpp}, v, w, x, y) \vee \neg \text{StrFCONT}(\frac{v}{x \cup y}) \vee \neg \text{StrFCONT}(\frac{w}{x \cup y})$  Th106
4.  $\neg \text{InsRel3}(\text{ec}, \text{tpp}, u, v, w, x, y) \vee \neg \text{StrFCONT}(\frac{v}{x \cup y}) \vee \neg \text{StrFCONT}(\frac{w}{x \cup y})$  Th111
5.  $[\neg \text{EleTran}(u, v, w, x, y, z, x1) \vee (v = w) \vee$



- $(v = u) \vee \text{InsRel3}(u, v, w, x, y, z, x1)$  D55
6.  $[\neg \text{EleTran}(u, v, w, x, y, z, x1) \vee \text{Trans}(u, w, x, y, z, x1) \vee$   
 $\text{InsRel3}(u, v, w, x, y, z, x1)]$  D55
7.  $[\text{EleTran}(u, v, \text{skf62}(z, y, x, w, v, u), w, x, y, z)$   
 $\vee \text{EleTran}(\text{skf63}(z, y, x, w, v, u), u, v, w, x, y, z) \vee \neg \text{DirTran}(u, v, w, x, y, z)]$  D56
8.  $\text{StrFCONT}(\frac{a}{c \cup d})$
9.  $\text{StrFCONT}(\frac{b}{c \cup d})$
10.  $\text{DirTran}(\text{ec}, \text{tpp}, a, b, c, d)$

Proof:

11.  $\neg \text{Trans}(\text{ec}, \text{tpp}, a, u, c, d) \vee \neg \text{StrFCONT}(\frac{u}{c \cup d})$  8,2
12.  $\neg \text{InsRel3}(u, \text{ec}, \text{tpp}, a, v, c, d) \vee \neg \text{StrFCONT}(\frac{v}{c \cup d})$  8,3
13.  $\neg \text{InsRel3}(\text{ec}, \text{tpp}, u, a, v, c, d) \vee \neg \text{StrFCONT}(\frac{v}{c \cup d})$  8,4
14.  $[\text{EleTran}(\text{ec}, \text{tpp}, \text{skf62}(d, c, b, a, \text{tpp}, \text{ec}), a, b, c, d) \vee$   
 $\text{EleTran}(\text{skf63}(d, c, b, a, \text{tpp}, \text{ec}), \text{ec}, \text{tpp}, a, b, c, d)]$  10,7
15.  $\neg \text{Trans}(\text{ec}, \text{tpp}, a, b, c, d)$  11,9
16.  $\neg \text{InsRel3}(\text{ec}, \text{tpp}, u, a, b, c, d)$  12,9
17.  $\neg \text{InsRel3}(u, \text{ec}, \text{tpp}, a, b, c, d)$  13,9
18.  $\text{EleTran}(\text{ec}, \text{tpp}, \text{skf62}(d, c, b, a, \text{tpp}, \text{ec}), a, b, c, d)$  Spt 14
19.  $\text{Trans}(\text{ec}, \text{skf62}(d, c, b, a, \text{tpp}, \text{ec}), a, b, c, d)$   
 $\vee \text{InsRel3}(\text{ec}, \text{tpp}, \text{skf62}(d, c, b, a, \text{tpp}, \text{ec}), a, b, c, d)$  18,6
20.  $[(\text{ec} = \text{tpp}) \vee (\text{skf62}(d, c, b, a, \text{tpp}, \text{ec}) = \text{tpp}) \vee$   
 $\text{InsRel3}(\text{ec}, \text{tpp}, \text{skf62}(d, c, b, a, \text{tpp}, \text{ec}), a, b, c, d)]$  18,5
21.  $(\text{skf62}(d, c, b, a, \text{tpp}, \text{ec}) = \text{tpp})$  20,17,1
22.  $\text{Trans}(\text{ec}, \text{tpp}, a, b, c, d) \vee \text{InsRel3}(\text{ec}, \text{tpp}, \text{tpp}, a, b, c, d)$  Rew 21,19
23.  $\square$  22,17,15
24.  $\neg \text{EleTran}(\text{ec}, \text{tpp}, \text{skf62}(d, c, b, a, \text{tpp}, \text{ec}), a, b, c, d)$  Spt 23,18,14
25.  $\text{EleTran}(\text{skf63}(d, c, b, a, \text{tpp}, \text{ec}), \text{ec}, \text{tpp}, a, b, c, d)$  Spt 23,14
26.  $[(\text{ec} = \text{tpp}) \vee (\text{skf63}(d, c, b, a, \text{tpp}, \text{ec}) = \text{tpp}) \vee$   
 $\text{InsRel3}(\text{skf63}(d, c, b, a, \text{tpp}, \text{ec}), \text{ec}, \text{tpp}, a, b, c, d)]$  25,5
27.  $[\text{InsRel3}(\text{skf63}(d, c, b, a, \text{tpp}, \text{ec}), \text{ec}, \text{tpp}, a, b, c, d) \vee$   
 $\text{Trans}(\text{skf63}(d, c, b, a, \text{tpp}, \text{ec}), \text{tpp}, a, b, c, d)]$  25,6
28.  $(\text{skf62}(d, c, b, a, \text{tpp}, \text{ec}) = \text{ec})$  26,12,1
29.  $\text{Trans}(\text{ec}, \text{tpp}, a, b, c, d) \vee \text{InsRel3}(\text{ec}, \text{ec}, \text{tpp}, a, b, c, d)$  Rew 28,27
30.  $\square$  29,16,15

**Th123.**  $[\text{StrFCONT}(\frac{x}{z_1 \cup z_2}) \wedge \text{StrFCONT}(\frac{y}{z_1 \cup z_2})] \rightarrow \neg \text{DirTran}(\text{dc}, \text{ntpp}, x, y, z_1, z_2)$

**Lemma 48.**  $[\neg(\text{dc} = \text{ntpp})]$

From D5, D10, D49

**Lemma 49.**  $[\text{Trans}(\text{dc}, \text{ntpp}, x, y, z_1, z_2) \rightarrow [\neg \text{StrFCONT}(\frac{x}{z_1 \cup z_2}) \vee \neg \text{StrFCONT}(\frac{y}{z_1 \cup z_2})]]$

Refutation Set:

1.  $\neg \text{StrFCONT}u \vee \text{FCONT}u$  D39
2.  $\neg \text{StrFCONT}u \vee \text{StrCONT}_{\text{st}}u$  D39
3.  $\neg \text{FCONT}u \vee \text{CONT}u$  D38
4.  $\neg \text{P}_t(u \cup v, w) \vee \text{P}_t(u, w)$  Th18
5.  $\neg \text{DR}_{\text{st}}(u, v) \vee \neg \text{C}_{\text{st}}(u, v) \vee \text{EC}_{\text{st}}(u, v)$  Lemma 27
6.  $\neg \text{Trans}(u, v, w, x, y, z) \vee \text{EC}_t(y, z)$  D52
7.  $\neg \text{Trans}(u, v, w, x, y, z) \vee \text{P}_t(y \cup z, x)$  D52
8.  $\neg \text{Trans}(u, v, w, x, y, z) \vee \text{P}_t(y \cup z, w)$  D52
9.  $\neg \text{P}_t(u, v) \vee \neg \text{P}_t(u, w) \vee \text{EQ}_t(\frac{v}{u}, \frac{w}{u})$  Lemma 39
10.  $\neg \text{Trans}(\text{dc}, u, v, w, x, y) \vee \text{DR}_{\text{st}}(\frac{v}{x}, \frac{w}{x})$  Th87
11.  $\neg \text{Trans}(u, \text{ntpp}, v, w, x, y) \vee \text{PP}_{\text{st}}(\frac{v}{y}, \frac{w}{y})$  Th96
12.  $[\neg \text{EC}_t(u, v) \vee \neg \text{P}_t((u \cup v), w) \vee \text{ECTS}(\frac{w}{u}, \frac{w}{v}, \frac{w}{(u \cup v)})]$  Lemma 40
13.  $[\neg \text{CONT}u \vee \neg \text{CONT}v \vee \neg \text{EQ}_t(w, x) \vee \neg \text{PP}_{\text{st}}(y, z) \vee$   
 $\neg \text{ECTS}(w, y, u) \vee \neg \text{ECTS}(x, z, v) \vee \text{C}_{\text{st}}(w, x)]$  Th51
14.  $[\neg \text{FCONT}u \vee \neg \text{FCONT}v \vee \neg \text{EQ}_t(w, x) \vee \neg \text{EC}_{\text{st}}(w, x) \vee$   
 $\neg \text{PP}_{\text{st}}(y, z) \vee \neg \text{ECTS}(w, y, u) \vee \neg \text{ECTS}(x, z, v)]$  Th52
15.  $\text{StrFCONT}(\frac{a}{c \cup d})$
16.  $\text{StrFCONT}(\frac{b}{c \cup d})$
17.  $\text{Trans}(\text{dc}, \text{ntpp}, a, b, c, d)$

Proof:

18.  $\text{FCONT}(\frac{b}{c \cup d})$  16,1
19.  $\text{StrCONT}_{\text{st}}(\frac{b}{c \cup d})$  16,2
20.  $\text{FCONT}(\frac{a}{c \cup d})$  15,1
21.  $\text{StrCONT}_{\text{st}}(\frac{a}{c \cup d})$  15,2
22.  $\text{DR}_{\text{st}}(\frac{a}{c}, \frac{b}{c})$  17,10
23.  $\text{P}_t(c \cup d, b)$  17,7
24.  $\text{P}_t(c \cup d, a)$  17,8
25.  $\text{EC}_t(c, d)$  17,6
26.  $\text{PP}_{\text{st}}(\frac{a}{d}, \frac{b}{d})$  17,11
27.  $\text{P}_t(c, b)$  23,4
28.  $\text{ECTS}(\frac{b}{c}, \frac{b}{d}, \frac{b}{(c \cup d)})$  SHy 25,23,12
29.  $\text{P}_t(c, a)$  24,4
30.  $\text{ECTS}(\frac{a}{c}, \frac{a}{d}, \frac{a}{(c \cup d)})$  SHy 25,24,12
31.  $\text{EQ}_t(\frac{a}{c}, \frac{b}{c})$  SHy 29,27,9
32.  $\neg \text{CONT}(\frac{b}{c \cup d}) \vee \neg \text{CONT}(\frac{a}{c \cup d}) \vee \text{C}_{\text{st}}(\frac{a}{c}, \frac{b}{c})$  SHy 31,30,28,26,13

33. $C_{st}(\frac{a}{c}, \frac{b}{c})$	32,21,20,19,18,16,15,4
34. $EC_{st}(\frac{a}{c}, \frac{b}{c})$	SHy 33,22,5
35. $\neg FCNT(\frac{b}{c \cup d}) \vee \neg FCNT(\frac{a}{c \cup d})$	SHy 34,31,30,28,26,14
36. $\square$	35,21,20,19,18,16,15

Proof of Theorem:

## Refutation Set:

1. $\neg(dc = ntp)$	Lemma 48
2. $\neg Trans(dc, ntp, u, v, w, x) \vee \neg StrFCNT(\frac{u}{w \cup x}) \vee \neg StrFCNT(\frac{v}{w \cup x})$	Lemma 49
3. $\neg InsRel3(u, ntp, v, w, x, y, z) \vee \neg StrFCNT(\frac{w}{y \cup z}) \vee \neg StrFCNT(\frac{x}{y \cup z})$	Th101
4. $\neg InsRel3(u, dc, v, w, x, y, z) \vee \neg StrFCNT(\frac{w}{y \cup z}) \vee \neg StrFCNT(\frac{x}{y \cup z})$	Th99
5. $[\neg EleTran(u, v, w, x, y, z, x1) \vee (v = u) \vee (v = w) \vee InsRel3(u, v, w, x, y, z, x1)]$	D55
6. $[\neg EleTran(u, v, w, x, y, z, x1) \vee Trans(u, w, x, y, z, x1) \vee InsRel3(u, v, w, x, y, z, x1)]$	D55
7. $[EleTran(u, v, skf62(z, y, x, w, v, u), w, x, y, z) \vee EleTran(skf63(z, y, x, w, v, u), u, v, w, x, y, z) \vee \neg DirTran(u, v, w, x, y, z)]$	D56
8. $StrFCNT(\frac{a}{c \cup d})$	
9. $StrFCNT(\frac{b}{c \cup d})$	
10. $DirTran(dc, ntp, a, b, c, d)$	

## Proof:

11. $\neg Trans(dc, ntp, a, u, c, d) \vee \neg StrFCNT(\frac{u}{c \cup d})$	8,2
12. $\neg InsRel3(u, ntp, v, a, w, c, d) \vee \neg StrFCNT(\frac{w}{c \cup d})$	8,3
13. $\neg InsRel3(u, dc, v, a, w, c, d) \vee \neg StrFCNT(\frac{w}{c \cup d})$	8,4
14. $[EleTran(dc, ntp, skf62(d, c, b, a, ntp, dc), a, b, c, d) \vee EleTran(skf63(d, c, b, a, ntp, dc), dc, ntp, a, b, c, d)]$	10,7
15. $\neg Trans(dc, ntp, a, b, c, d)$	11,9
16. $\neg InsRel3(u, dc, v, a, b, c, d)$	13,9
17. $\neg InsRel3(u, ntp, v, a, b, c, d)$	12,9
18. $EleTran(dc, ntp, skf62(d, c, b, a, ntp, dc), a, b, c, d)$	Spt 14
19. $Trans(dc, skf62(d, c, b, a, ntp, dc), a, b, c, d) \vee InsRel3(dc, ntp, skf62(d, c, b, a, ntp, dc), a, b, c, d)$	18,6
20. $[(dc = ntp) \vee (skf62(d, c, b, a, ntp, dc) = ntp) \vee InsRel3(dc, ntp, skf62(d, c, b, a, ntp, dc), a, b, c, d)]$	18,5
21. $(skf62(d, c, b, a, ntp, dc) = ntp)$	20,17,1
22. $Trans(dc, ntp, a, b, c, d) \vee InsRel3(dc, ntp, ntp, a, b, c, d)$	Rew 21,19
23. $\square$	22,17,15
24. $\neg EleTran(dc, ntp, skf62(d, c, b, a, ntp, dc), a, b, c, d)$	Spt 23,18,14
25. $EleTran(skf63(d, c, b, a, ntp, dc), dc, ntp, a, b, c, d)$	Spt 23,14

26.  $[(dc = ntp) \vee (\text{skf63}(d, c, b, a, ntp, dc) = ntp) \vee$   
 $\text{InsRel3}(\text{skf63}(d, c, b, a, ntp, dc), dc, ntp, a, b, c, d)]$  25,5
27.  $[\text{InsRel3}(\text{skf63}(d, c, b, a, ntp, dc), dc, ntp, a, b, c, d) \vee$   
 $\text{Trans}(\text{skf63}(d, c, b, a, ntp, dc), ntp, a, b, c, d)]$  25,6
28.  $(\text{skf62}(d, c, b, a, ntp, dc) = dc)$  26,12,1
29.  $\text{Trans}(dc, ntp, a, b, c, d) \vee \text{InsRel3}(dc, dc, ntp, a, b, c, d)$  Rew 28,27
30.  $\square$  29,16,15

**Th124.**  $[\text{StrFCONT}(\frac{x}{z_1 \cup z_2}) \wedge \text{StrFCONT}(\frac{y}{z_1 \cup z_2})] \rightarrow \neg \text{DirTran}(ec, ntp, x, y, z_1, z_2)$

**Lemma 50.**  $[\neg(ec = ntp)]$

From D6, D10, D49

**Lemma 51.**  $[\text{Trans}(ec, ntp, x, y, z_1, z_2) \rightarrow [\neg \text{StrFCONT}(\frac{x}{z_1 \cup z_2}) \vee \neg \text{StrFCONT}(\frac{y}{z_1 \cup z_2})]]$

Refutation Set:

1.  $\neg \text{StrFCONT}u \vee \text{FCONT}u$  D39
2.  $\neg \text{StrFCONT}u \vee \text{StrCONT}_{st}u$  D39
3.  $\neg P_t(u \cup v, w) \vee P_t(u, w)$  Th18
4.  $\neg \text{Trans}(u, v, w, x, y, z) \vee EC_t(y, z)$  D52
5.  $\neg \text{Trans}(u, v, w, x, y, z) \vee P_t(y \cup z, x)$  D52
6.  $\neg \text{Trans}(u, v, w, x, y, z) \vee P_t(y \cup z, w)$  D52
7.  $\neg P_t(u, v) \vee \neg P_t(u, w) \vee EQ_t(\frac{v}{u}, \frac{w}{u})$  Lemma 39
8.  $\neg \text{Trans}(ec, u, v, w, x, y) \vee EC_{st}(\frac{v}{x}, \frac{w}{x})$  Th87
9.  $\neg \text{Trans}(u, , ntp, v, w, x, y) \vee PP_{st}(\frac{v}{y}, \frac{w}{y})$  Th96
10.  $[\neg EC_t(u, v) \vee \neg P_t((u \cup v), w) \vee ECTS(\frac{w}{u}, \frac{w}{v}, \frac{w}{(u \cup v)})]$  Lemma 40
11.  $[\neg \text{FCONT}u \vee \neg \text{FCONT}v \vee \neg EQ_t(w, x) \vee \neg EC_{st}(w, x) \vee$   
 $\neg PP_{st}(y, z) \vee \neg ECTS(w, y, u) \vee \neg ECTS(x, z, v)]$  Th52
12.  $\text{StrFCONT}(\frac{a}{c \cup d})$
13.  $\text{StrFCONT}(\frac{b}{c \cup d})$
14.  $\text{Trans}(ec, ntp, a, b, c, d)$

Proof:

15.  $\text{FCONT}(\frac{b}{c \cup d})$  13,1
16.  $\text{StrCONT}_{st}(\frac{b}{c \cup d})$  13,2
17.  $\text{FCONT}(\frac{a}{c \cup d})$  12,1
18.  $\text{StrCONT}_{st}(\frac{a}{c \cup d})$  12,2
19.  $EC_{st}(\frac{a}{c}, \frac{b}{c})$  14,8
20.  $P_t(c \cup d, b)$  14,5
21.  $P_t(c \cup d, a)$  14,6
22.  $EC_t(c, d)$  14,4

23. $PP_{st}(\frac{a}{d}, \frac{b}{d})$	14,9
24. $P_t(c, b)$	20,3
25. $ECTS(\frac{b}{c}, \frac{b}{d}, \frac{b}{c \cup d})$	SHy 22,20,10
26. $P_t(c, a)$	21,3
27. $ECTS(\frac{a}{c}, \frac{a}{d}, \frac{a}{c \cup d})$	SHy 22,21,10
28. $EQ_t(\frac{a}{c}, \frac{b}{c})$	SHy 26,24,7
29. $\neg FCNT(\frac{b}{c \cup d}) \vee \neg FCNT(\frac{a}{c \cup d})$	SHy 28,27,25,23,19,11
30. $\square$	29,18,17,16,15,13,12

Proof of Theorem:

## Refutation Set:

1. $\neg(ec = ntp)$	Lemma 50
2. $\neg Trans(ec, ntp, u, v, w, x) \vee \neg StrFCNT(\frac{u}{w \cup x}) \vee \neg StrFCNT(\frac{v}{w \cup x})$	Lemma 51
3. $\neg InsRel3(u, ntp, v, w, x, y, z) \vee \neg StrFCNT(\frac{w}{y \cup z}) \vee \neg StrFCNT(\frac{x}{y \cup z})$	Th101
4. $\neg InsRel3(u, ec, ntp, v, w, x, y) \vee \neg StrFCNT(\frac{v}{x \cup y}) \vee \neg StrFCNT(\frac{w}{x \cup y})$	Th107
5. $[\neg EleTran(u, v, w, x, y, z, x1) \vee (v = u) \vee$ $(v = w) \vee InsRel3(u, v, w, x, y, z, x1)]$	D55
6. $[\neg EleTran(u, v, w, x, y, z, x1) \vee Trans(u, w, x, y, z, x1)$ $\vee InsRel3(u, v, w, x, y, z, x1)]$	D55
7. $[EleTran(u, v, skf80(z, y, x, w, v, u), w, x, y, z)$ $\vee EleTran(skf81(z, y, x, w, v, u), u, v, w, x, y, z) \vee \neg DirTran(u, v, w, x, y, z)]$	D56
8. $StrFCNT(\frac{a}{c \cup d})$	
9. $StrFCNT(\frac{b}{c \cup d})$	
10. $DirTran(ec, ntp, a, b, c, d)$	

## Proof:

11. $\neg Trans(ec, ntp, a, u, c, d) \vee \neg StrFCNT(\frac{u}{c \cup d})$	8,2
12. $\neg InsRel3(u, ntp, v, a, w, c, d) \vee \neg StrFCNT(\frac{w}{c \cup d})$	8,3
13. $\neg InsRel3(u, ec, ntp, a, v, c, d) \vee \neg StrFCNT(\frac{v}{c \cup d})$	8,4
14. $[EleTran(ec, ntp, skf62(d, c, b, a, ntp, ec), a, b, c, d) \vee$ $EleTran(skf63(d, c, b, a, ntp, ec), ec, ntp, a, b, c, d)]$	10,7
15. $\neg Trans(ec, ntp, a, b, c, d)$	11,9
16. $\neg InsRel3(u, ntp, v, a, b, c, d)$	12,9
17. $\neg InsRel3(u, ec, ntp, a, b, c, d)$	13,9
18. $EleTran(ec, ntp, skf62(d, c, b, a, ntp, ec), a, b, c, d)$	Spt 14
19. $Trans(ec, skf62(d, c, b, a, ntp, ec), a, b, c, d)$ $\vee InsRel3(ec, ntp, skf62(d, c, b, a, ntp, ec), a, b, c, d)$	18,6
20. $[(ec = ntp) \vee (skf62(d, c, b, a, ntp, ec) = ntp) \vee$ $InsRel3(ec, ntp, skf62(d, c, b, a, ntp, ec), a, b, c, d)]$	18,5

21.  $(\text{skf62}(d, c, b, a, \text{ntpp}, \text{ec}) = \text{ntpp})$  20,17,1
22.  $\text{Trans}(\text{ec}, \text{ntpp}, a, b, c, d) \vee \text{InsRel3}(\text{ec}, \text{ntpp}, \text{ntpp}, a, b, c, d)$  Rew 21,19
23.  $\square$  22,17,15
24.  $\neg \text{EleTran}(\text{ec}, \text{ntpp}, \text{skf62}(d, c, b, a, \text{ntpp}, \text{ec}), a, b, c, d)$  Spt 23,18,14
25.  $\text{EleTran}(\text{skf63}(d, c, b, a, \text{ntpp}, \text{ec}), \text{ec}, \text{ntpp}, a, b, c, d)$  Spt 23,14
26.  $[(\text{ec} = \text{ntpp}) \vee (\text{skf63}(d, c, b, a, \text{ntpp}, \text{ec}) = \text{ntpp}) \vee$   
 $\text{InsRel3}(\text{skf63}(d, c, b, a, \text{ntpp}, \text{ec}), \text{ec}, \text{ntpp}, a, b, c, d)]$  25,5
27.  $[\text{InsRel3}(\text{skf63}(d, c, b, a, \text{ntpp}, \text{ec}), \text{ec}, \text{ntpp}, a, b, c, d) \vee$   
 $\text{Trans}(\text{skf63}(d, c, b, a, \text{ntpp}, \text{ec}), \text{ntpp}, a, b, c, d)]$  25,6
28.  $(\text{skf62}(d, c, b, a, \text{ntpp}, \text{ec}) = \text{ec})$  26,12,1
29.  $\text{Trans}(\text{ec}, \text{ntpp}, a, b, c, d) \vee \text{InsRel3}(\text{ec}, \text{ec}, \text{ntpp}, a, b, c, d)$  Rew 28,27
30.  $\square$  29,16,15

**Th125.**  $[\text{StrFCONT}(\frac{x}{z_1 \cup z_2}) \wedge \text{StrFCONT}(\frac{y}{z_1 \cup z_2})] \rightarrow \neg \text{DirTran}(dc, \text{tppi}, x, y, z_1, z_2)$

**Lemma 52.**  $\text{DR}_{\text{st}}(x, y) \leftrightarrow \text{DR}_{\text{st}}(y, x)$

From D4, D5, D6, A2

**Lemma 53.**  $[\text{Trans}(dc, \text{tppi}, x, y, z_1, z_2) \rightarrow [\neg \text{StrFCONT}(\frac{x}{z_1 \cup z_2}) \vee \neg \text{StrFCONT}(\frac{y}{z_1 \cup z_2})]]$

Refutation Set:

1.  $\neg \text{StrFCONT}u \vee \text{FCONT}u$  D39
2.  $\neg \text{StrFCONT}u \vee \text{StrCONT}_{\text{st}}u$  D39
3.  $\neg \text{FCONT}u \vee \text{CONT}u$  D38
4.  $\neg \text{DR}_{\text{st}}(u, v) \vee \text{DR}_{\text{st}}(v, u)$  Lemma 52
5.  $\neg \text{TPP}_{\text{st}}(u, v) \vee \text{PP}_{\text{st}}(u, v)$  D9
6.  $\neg \text{P}_t(u \cup v, w) \vee \text{P}_t(u, w)$  Th18
7.  $\neg \text{DR}_{\text{st}}(u, v) \vee \neg \text{C}_{\text{st}}(u, v) \vee \text{EC}_{\text{st}}(u, v)$  Lemma 27
8.  $\neg \text{Trans}(u, v, w, x, y, z) \vee \text{EC}_t(y, z)$  D52
9.  $\neg \text{Trans}(u, v, w, x, y, z) \vee \text{P}_t(y \cup z, x)$  D52
10.  $\neg \text{Trans}(u, v, w, x, y, z) \vee \text{P}_t(y \cup z, w)$  D52
11.  $\neg \text{P}_t(u, v) \vee \neg \text{P}_t(u, w) \vee \text{EQ}_t(\frac{v}{u}, \frac{w}{u})$  Lemma 39
12.  $\neg \text{Trans}(dc, u, v, w, x, y) \vee \text{DR}_{\text{st}}(\frac{v}{x}, \frac{w}{x})$  Th87
13.  $\neg \text{Trans}(u, \text{tppi}, v, w, x, y) \vee \text{TPP}_{\text{st}}(\frac{w}{y}, \frac{v}{y})$
14.  $[\neg \text{EC}_t(u, v) \vee \neg \text{P}_t(u \cup v, w) \vee \text{ECTS}(\frac{w}{u}, \frac{w}{v}, \frac{w}{u \cup v})]$  Lemma 40
15.  $[\neg \text{CONT}u \vee \neg \text{CONT}v \vee \neg \text{EQ}_t(w, x) \vee \neg \text{PP}_{\text{st}}(y, z) \vee$   
 $\neg \text{ECTS}(w, y, u) \vee \neg \text{ECTS}(x, z, v) \vee \text{C}_{\text{st}}(w, x)]$  Th51
16.  $[\neg \text{FCONT}u \vee \neg \text{FCONT}v \vee \neg \text{EQ}_t(w, x) \vee \neg \text{EC}_{\text{st}}(w, x) \vee$   
 $\neg \text{PP}_{\text{st}}(y, z) \vee \neg \text{ECTS}(w, y, u) \vee \neg \text{ECTS}(x, z, v)]$  Th52
17.  $\text{StrFCONT}(\frac{a}{c \cup d})$

18. StrFCONT( $\frac{b}{c \cup d}$ )
19. Trans(dc, tppi, a, b, c, d)

Proof:

20. FCONT( $\frac{b}{c \cup d}$ ) 22,2
21. StrCONT<sub>st</sub>( $\frac{b}{c \cup d}$ ) 22,3
22. FCONT( $\frac{a}{c \cup d}$ ) 21,2
23. StrCONT<sub>st</sub>( $\frac{a}{c \cup d}$ ) 21,3
24. DR<sub>st</sub>( $\frac{a}{c}, \frac{b}{c}$ ) 23,16
25. P<sub>t</sub>(c ∪ d, b) 23,13
26. P<sub>t</sub>(c ∪ d, a) 23,14
27. EC<sub>t</sub>(c, d) 23,12
28. TPP<sub>st</sub>( $\frac{a}{d}, \frac{b}{d}$ ) 23,16
29. P<sub>t</sub>(c, b) 30,9
30. ECTS( $\frac{b}{c}, \frac{b}{d}, \frac{b}{c \cup d}$ ) SHy 32,30,18
31. P<sub>t</sub>(c, a) 31,9
32. ECTS( $\frac{a}{c}, \frac{a}{d}, \frac{a}{c \cup d}$ ) SHy 32,31,18
33. EQ<sub>t</sub>( $\frac{b}{c}, \frac{a}{c}$ ) SHy 35,33,15
34. DR<sub>st</sub>( $\frac{b}{c}, \frac{a}{c}$ ) 28,5
35. PP<sub>st</sub>( $\frac{b}{d}, \frac{a}{d}$ ) SHy 41,11,1
36. ¬CONT( $\frac{a}{c \cup d}$ ) ∨ ¬CONT( $\frac{b}{c \cup d}$ ) ∨ C<sub>st</sub>( $\frac{b}{c}, \frac{a}{c}$ ) SHy 42,37,36,34,19
37. C<sub>st</sub>( $\frac{b}{c}, \frac{a}{c}$ ) 43,27,26,25,24,22,21,4
38. EC<sub>st</sub>( $\frac{b}{c}, \frac{a}{c}$ ) SHy 44,38,10
39. ¬FCONT( $\frac{a}{c \cup d}$ ) ∨ ¬FCONT( $\frac{b}{c \cup d}$ ) SHy 45,42,37,36,34,20
40. □ 46,27,26,25,24,22,21

Proof of Theorem:

Refutation Set:

1. ¬(dc = tppi) Lemma 20
2. ¬Trans(dc, tppi, u, v, w, x) ∨ ¬StrFCONT( $\frac{u}{w \cup x}$ ) ∨ ¬StrFCONT( $\frac{v}{w \cup x}$ ) Lemma 53
3. ¬InsRel3(dc, tppi, v, w, x, y, z) ∨ ¬StrFCONT( $\frac{w}{y \cup z}$ ) ∨ ¬StrFCONT( $\frac{x}{y \cup z}$ ) Th114
4. ¬InsRel3(u, dc, v, w, x, y, z) ∨ ¬StrFCONT( $\frac{w}{y \cup z}$ ) ∨ ¬StrFCONT( $\frac{x}{y \cup z}$ ) Th99
5. [¬EleTran(u, v, w, x, y, z, x1) ∨ (v = w) ∨  
(v = u) ∨ InsRel3(u, v, w, x, y, z, x1)] D55
6. [¬EleTran(u, v, w, x, y, z, x1) ∨ Trans(u, w, x, y, z, x1) ∨  
InsRel3(u, v, w, x, y, z, x1)] D55
7. [EleTran(u, v, skf62(z, y, x, w, v, u), w, x, y, z)  
∨ EleTran(skf63(z, y, x, w, v, u), u, v, w, x, y, z) ∨ ¬DirTran(u, v, w, x, y, z)] D56
8. StrFCONT( $\frac{a}{c \cup d}$ )
9. StrFCONT( $\frac{b}{c \cup d}$ )

10. DirTran(dc, tppi, a, b, c, d)

Proof:

11.  $\neg \text{Trans}(dc, \text{tppi}, a, u, c, d) \vee \neg \text{StrFCONT}(\frac{u}{c \cup d})$  8,2
12.  $\neg \text{InsRel3}(u, dc, v, a, w, c, d) \vee \neg \text{StrFCONT}(\frac{w}{c \cup d})$  8,4
13.  $\neg \text{InsRel3}(dc, \text{tppi}, v, a, w, c, d) \vee \neg \text{StrFCONT}(\frac{w}{c \cup d})$  8,3
14.  $[\text{EleTran}(dc, \text{tppi}, \text{skf62}(d, c, b, a, \text{tppi}, dc), a, b, c, d) \vee$   
 $\text{EleTran}(\text{skf63}(d, c, b, a, \text{tppi}, dc), dc, \text{tppi}, a, b, c, d)]$  10,7
15.  $\neg \text{Trans}(dc, \text{tppi}, a, b, c, d)$  11,9
16.  $\neg \text{InsRel3}(u, dc, v, a, b, c, d)$  12,9
17.  $\neg \text{InsRel3}(dc, \text{tppi}, u, a, b, c, d)$  13,9
18.  $\text{EleTran}(dc, \text{tppi}, \text{skf62}(d, c, b, a, \text{tppi}, dc), a, b, c, d)$  Spt 14
19.  $[\text{Trans}(dc, \text{skf62}(d, c, b, a, \text{tppi}, dc), a, b, c, d) \vee$   
 $\text{InsRel3}(dc, \text{tppi}, \text{skf62}(d, c, b, a, \text{tppi}, dc), a, b, c, d)]$  18,6
20.  $[(dc = \text{tppi}) \vee (\text{skf62}(d, c, b, a, \text{tppi}, dc) = \text{tppi}) \vee$   
 $\text{InsRel3}(dc, \text{tppi}, \text{skf62}(d, c, b, a, \text{tppi}, dc), a, b, c, d)]$  18,5
21.  $(\text{skf62}(d, c, b, a, \text{tppi}, dc) = \text{tppi})$  20,17,1
22.  $[\text{Trans}(dc, \text{tppi}, a, b, c, d) \vee \text{InsRel3}(dc, \text{tppi}, \text{tppi}, a, b, c, d)]$  Rew 21,19
23.  $\square$  22,17,15
24.  $\neg \text{EleTran}(dc, \text{tppi}, \text{skf62}(d, c, b, a, \text{tppi}, dc), a, b, c, d)$  Spt 23,18,14
25.  $\text{EleTran}(\text{skf63}(d, c, b, a, \text{tppi}, dc), dc, \text{tppi}, a, b, c, d)$  Spt 23,14
26.  $[(dc = \text{tppi}) \vee (\text{skf63}(d, c, b, a, \text{tppi}, dc) = dc) \vee$   
 $\text{InsRel3}(\text{skf63}(d, c, b, a, \text{tppi}, dc), dc, \text{tppi}, a, b, c, d)]$  25,5
27.  $\text{InsRel3}(\text{skf63}(d, c, b, a, \text{tppi}, dc), dc, \text{tppi}, a, b, c, d) \vee$   
 $\text{Trans}(\text{skf63}(d, c, b, a, \text{tppi}, dc), \text{tppi}, a, b, c, d)$  25,6
28.  $(\text{skf63}(d, c, b, a, \text{tppi}, dc) = dc)$  26,12,1
29.  $\text{InsRel3}(dc, dc, \text{tppi}, a, b, c, d) \vee \text{Trans}(dc, \text{tppi}, a, b, c, d)$  Rew 28,27
30.  $\square$  29,16,15

**Th126.**  $[\text{StrFCONT}(\frac{x}{z_1 \cup z_2}) \wedge \text{StrFCONT}(\frac{y}{z_1 \cup z_2})] \rightarrow \neg \text{DirTran}(ec, \text{tppi}, x, y, z_1, z_2)$

**Lemma 54.**  $[\text{Trans}(ec, \text{tppi}, x, y, z_1, z_2) \rightarrow [\neg \text{StrFCONT}(\frac{x}{z_1 \cup z_2}) \vee \neg \text{StrFCONT}(\frac{y}{z_1 \cup z_2})]]$

Refutation Set:

1.  $\neg \text{StrFCONT}u \vee \text{FCONT}u$  D39
2.  $\neg \text{StrFCONT}u \vee \text{StrCONT}_{\text{st}}u$  D39
3.  $\neg \text{FCONT}u \vee \text{CONT}u$  D38
4.  $\neg \text{EC}_{\text{st}}(u, v) \vee \text{EC}_{\text{st}}(v, u)$  Lemma 52
5.  $\neg \text{TPP}_{\text{st}}(u, v) \vee \text{PP}_{\text{st}}(u, v)$  D9
6.  $\neg \text{P}_t(u \cup v, w) \vee \text{P}_t(u, w)$  Th18
7.  $\neg \text{Trans}(u, v, w, x, y, z) \vee \text{EC}_t(y, z)$  D52



8.  $\neg\text{Trans}(u, v, w, x, y, z) \vee P_t(y \cup z, x)$  D52
9.  $\neg\text{Trans}(u, v, w, x, y, z) \vee P_t(y \cup z, w)$  D52
10.  $\neg P_t(u, v) \vee \neg P_t(u, w) \vee \text{EQ}_t(\frac{v}{u}, \frac{w}{u})$  Lemma 39
11.  $\neg\text{Trans}(\text{ec}, u, v, w, x, y) \vee \text{EC}_{\text{st}}(\frac{v}{x}, \frac{w}{x})$  Th87
12.  $\neg\text{Trans}(u, \text{tppi}, v, w, x, y) \vee \text{TPP}_{\text{st}}(\frac{w}{y}, \frac{v}{y})$  Th97
13.  $[\neg\text{EC}_t(u, v) \vee \neg P_t((u \cup v), w) \vee \text{ECTS}(\frac{w}{u}, \frac{w}{v}, \frac{w}{u \cup v})]$  Lemma 40
14.  $[\neg\text{FCONT}u \vee \neg\text{FCONT}v \vee \neg\text{EQ}_t(w, x) \vee \neg\text{EC}_{\text{st}}(w, x) \vee$   
 $\neg\text{PP}_{\text{st}}(y, z) \vee \neg\text{ECTS}(w, y, u) \vee \neg\text{ECTS}(x, z, v)]$  Th52
15.  $\text{StrFCONT}(\frac{a}{c \cup d})$
16.  $\text{StrFCONT}(\frac{b}{c \cup d})$
17.  $\text{Trans}(\text{ec}, \text{tppi}, a, b, c, d)$

Proof:

22.  $\text{FCONT}(\frac{b}{c \cup d})$  19,2
23.  $\text{StrCONT}_{\text{st}}(\frac{b}{c \cup d})$  19,3
24.  $\text{FCONT}(\frac{a}{c \cup d})$  18,2
25.  $\text{StrCONT}_{\text{st}}(\frac{a}{c \cup d})$  18,3
26.  $\text{EC}_{\text{st}}(\frac{a}{c}, \frac{b}{c})$  20,14
27.  $P_t(c \cup d, b)$  20,11
28.  $P_t(c \cup d, a)$  20,12
29.  $\text{EC}_t(c, d)$  20,10
30.  $\text{TPP}_{\text{st}}(\frac{b}{d}, \frac{a}{d})$  20,14
31.  $P_t(c, b)$  27,8
32.  $\text{ECTS}(\frac{b}{c}, \frac{b}{d}, \frac{b}{c \cup d})$  SHy 29,27,16
33.  $P_t(c, a)$  28,8
34.  $\text{ECTS}(\frac{a}{c}, \frac{a}{d}, \frac{a}{c \cup d})$  SHy 29,28,16
35.  $\text{EQ}_t(\frac{b}{c}, \frac{a}{c})$  SHy 32,30,13
36.  $\text{EC}_{\text{st}}(\frac{b}{c}, \frac{a}{c})$  25,4
37.  $\text{PP}_{\text{st}}(\frac{b}{d}, \frac{a}{d})$  SHy 38,9,1
38.  $\neg\text{FCONT}(\frac{a}{c \cup d}) \vee \neg\text{FCONT}(\frac{b}{c \cup d})$  SHy 39,35,34,33,31,17
39.  $\square$  40,24,23,22,21,19,18

Proof of Theorem:

Refutation Set:

1.  $\neg(\text{tppi} = \text{ec})$  Lemma 30
2.  $\neg\text{Trans}(\text{ec}, \text{tppi}, u, v, w, x) \vee \neg\text{StrFCONT}(\frac{u}{w \cup x}) \vee \neg\text{StrFCONT}(\frac{v}{w \cup x})$  Lemma 54
3.  $\neg\text{InsRel3}(u, \text{ec}, \text{tppi}, v, w, x, y) \vee \neg\text{StrFCONT}(\frac{v}{x \cup y}) \vee \neg\text{StrFCONT}(\frac{w}{x \cup y})$  Th108
4.  $\neg\text{InsRel3}(\text{ec}, \text{tppi}, u, v, w, x, y) \vee \neg\text{StrFCONT}(\frac{v}{x \cup y}) \vee \neg\text{StrFCONT}(\frac{w}{x \cup y})$  Th114
5.  $[\neg\text{EleTran}(u, v, w, x, y, z, x1) \vee (v = w) \vee$   
 $(v = u) \vee \text{InsRel3}(u, v, w, x, y, z, x1)]$  D55

6.  $[\neg \text{EleTran}(u, v, w, x, y, z, x1) \vee \text{Trans}(u, w, x, y, z, x1) \vee$   
 $\text{InsRel3}(u, v, w, x, y, z, x1)]$  D55
7.  $[\text{EleTran}(u, v, \text{skf62}(z, y, x, w, v, u), w, x, y, z)$   
 $\vee \text{EleTran}(\text{skf63}(z, y, x, w, v, u), u, v, w, x, y, z) \vee \neg \text{DirTran}(u, v, w, x, y, z)]$  D56
8.  $\text{StrFCONT}(\frac{a}{c \cup d})$
9.  $\text{StrFCONT}(\frac{b}{c \cup d})$
10.  $\text{DirTran}(\text{ec}, \text{tppi}, a, b, c, d)$

Proof:

11.  $\neg \text{Trans}(\text{ec}, \text{tppi}, a, u, c, d) \vee \neg \text{StrFCONT}(\frac{u}{c \cup d})$  8,2
12.  $\neg \text{InsRel3}(u, \text{ec}, \text{tppi}, a, w, c, d) \vee \neg \text{StrFCONT}(\frac{w}{c \cup d})$  8,3
13.  $\neg \text{InsRel3}(\text{ec}, \text{tppi}, v, a, w, c, d) \vee \neg \text{StrFCONT}(\frac{w}{c \cup d})$  8,4
14.  $[\text{EleTran}(\text{ec}, \text{tppi}, \text{skf62}(d, c, b, a, \text{tppi}, \text{ec}), a, b, c, d) \vee$   
 $\text{EleTran}(\text{skf63}(d, c, b, a, \text{tppi}, \text{ec}), \text{ec}, \text{tppi}, a, b, c, d)]$  10,7
15.  $\neg \text{Trans}(\text{ec}, \text{tppi}, a, b, c, d)$  11,9
16.  $\neg \text{InsRel3}(\text{ec}, \text{tppi}, u, a, b, c, d)$  12,9
17.  $\neg \text{InsRel3}(u, \text{ec}, \text{tppi}, a, b, c, d)$  13,9
18.  $\text{EleTran}(\text{ec}, \text{tppi}, \text{skf62}(d, c, b, a, \text{tppi}, \text{ec}), a, b, c, d)$  Spt 14
19.  $\text{Trans}(\text{ec}, \text{skf62}(d, c, b, a, \text{tppi}, \text{ec}), a, b, c, d)$   
 $\vee \text{InsRel3}(\text{ec}, \text{tppi}, \text{skf62}(d, c, b, a, \text{tppi}, \text{ec}), a, b, c, d)$  18,6
20.  $[(\text{ec} = \text{tppi}) \vee (\text{skf62}(d, c, b, a, \text{tppi}, \text{ec}) = \text{tppi}) \vee$   
 $\text{InsRel3}(\text{ec}, \text{tppi}, \text{skf62}(d, c, b, a, \text{tppi}, \text{ec}), a, b, c, d)]$  18,5
21.  $(\text{skf62}(d, c, b, a, \text{tppi}, \text{ec}) = \text{tppi})$  20,17,1
22.  $\text{Trans}(\text{ec}, \text{tppi}, a, b, c, d) \vee \text{InsRel3}(\text{ec}, \text{tppi}, \text{tppi}, a, b, c, d)$  Rew 21,19
23.  $\square$  22,17,15
24.  $\neg \text{EleTran}(\text{ec}, \text{tppi}, \text{skf62}(d, c, b, a, \text{tppi}, \text{ec}), a, b, c, d)$  Spt 23,18,14
25.  $\text{EleTran}(\text{skf63}(d, c, b, a, \text{tppi}, \text{ec}), \text{ec}, \text{tppi}, a, b, c, d)$  Spt 23,14
26.  $[(\text{ec} = \text{tppi}) \vee (\text{skf63}(d, c, b, a, \text{tppi}, \text{ec}) = \text{tppi}) \vee$   
 $\text{InsRel3}(\text{skf63}(d, c, b, a, \text{tppi}, \text{ec}), \text{ec}, \text{tppi}, a, b, c, d)]$  25,5
27.  $[\text{InsRel3}(\text{skf63}(d, c, b, a, \text{tppi}, \text{ec}), \text{ec}, \text{tppi}, a, b, c, d) \vee$   
 $\text{Trans}(\text{skf63}(d, c, b, a, \text{tppi}, \text{ec}), \text{tppi}, a, b, c, d)]$  25,6
28.  $(\text{skf62}(d, c, b, a, \text{tppi}, \text{ec}) = \text{ec})$  26,12,1
29.  $\text{Trans}(\text{ec}, \text{tppi}, a, b, c, d) \vee \text{InsRel3}(\text{ec}, \text{ec}, \text{tppi}, a, b, c, d)$  Rew 28,27
30.  $\square$  29,16,15

**Th127.**  $[\text{StrFCONT}(\frac{x}{z_1 \cup z_2}) \wedge \text{StrFCONT}(\frac{y}{z_1 \cup z_2})] \rightarrow \neg \text{DirTran}(\text{dc}, \text{ntppi}, x, y, z_1, z_2)$

**Lemma 55.**  $[\neg(\text{dc} = \text{ntppi})]$

From D5, D10, D49

**Lemma 56.**  $[\text{Trans}(\text{dc}, \text{ntppi}, x, y, z_1, z_2) \rightarrow [\neg \text{StrFCONT}(\frac{x}{z_1 \cup z_2}) \vee \neg \text{StrFCONT}(\frac{y}{z_1 \cup z_2})]]$

Refutation Set:

1.  $\neg \text{StrFCONT}u \vee \text{FCONT}u$  D39
2.  $\neg \text{StrFCONT}u \vee \text{StrCONT}_{\text{st}}u$  D39
3.  $\neg \text{FCONT}u \vee \text{CONT}u$  D38
4.  $\neg \text{DR}_{\text{st}}(u, v) \vee \text{DR}_{\text{st}}(v, u)$  Lemma 52
5.  $\neg \text{P}_t(u \cup v, w) \vee \text{P}_t(u, w)$  Th18
6.  $\neg \text{DR}_{\text{st}}(u, v) \vee \neg \text{C}_{\text{st}}(u, v) \vee \text{EC}_{\text{st}}(u, v)$  Lemma 27
7.  $\neg \text{Trans}(u, v, w, x, y, z) \vee \text{EC}_t(y, z)$  D52
8.  $\neg \text{Trans}(u, v, w, x, y, z) \vee \text{P}_t(y \cup z, x)$  D52
9.  $\neg \text{Trans}(u, v, w, x, y, z) \vee \text{P}_t(y \cup z, w)$  D52
10.  $\neg \text{P}_t(u, v) \vee \neg \text{P}_t(u, w) \vee \text{EQ}_t(\frac{v}{u}, \frac{w}{u})$  Lemma 39
11.  $\neg \text{Trans}(\text{dc}, u, v, w, x, y) \vee \text{DR}_{\text{st}}(\frac{v}{x}, \frac{w}{x})$  Th87
12.  $\neg \text{Trans}(u, \text{ntppi}, v, w, x, y) \vee \text{PP}_{\text{st}}(\frac{w}{y}, \frac{v}{y})$
13.  $[\neg \text{EC}_t(u, v) \vee \neg \text{P}_t((u \cup v), w) \vee \text{ECTS}(\frac{w}{u}, \frac{w}{v}, \frac{w}{(u \cup v)})]$  Lemma 40
14.  $[\neg \text{CONT}u \vee \neg \text{CONT}v \vee \neg \text{EQ}_t(w, x) \vee \neg \text{PP}_{\text{st}}(y, z) \vee$   
 $\neg \text{ECTS}(w, y, u) \vee \neg \text{ECTS}(x, z, v) \vee \text{C}_{\text{st}}(w, x)]$  Th51
15.  $[\neg \text{FCONT}u \vee \neg \text{FCONT}v \vee \neg \text{EQ}_t(w, x) \vee \neg \text{EC}_{\text{st}}(w, x) \vee$   
 $\neg \text{PP}_{\text{st}}(y, z) \vee \neg \text{ECTS}(w, y, u) \vee \neg \text{ECTS}(x, z, v)]$  Th52
16.  $\text{StrFCONT}(\frac{a}{c \cup d})$
17.  $\text{StrFCONT}(\frac{b}{c \cup d})$
18.  $\text{Trans}(\text{dc}, \text{ntppi}, a, b, c, d)$

Proof:

22.  $\text{FCONT}(\frac{b}{c \cup d})$  21,2
23.  $\text{StrCONT}_{\text{st}}(\frac{b}{c \cup d})$  21,3
24.  $\text{FCONT}(\frac{a}{c \cup d})$  20,2
25.  $\text{StrCONT}_{\text{st}}(\frac{a}{c \cup d})$  20,3
26.  $\text{DR}_{\text{st}}(\frac{a}{c}, \frac{b}{c})$  22,15
27.  $\text{P}_t(c \cup d, b)$  22,12
28.  $\text{P}_t(c \cup d, a)$  22,13
29.  $\text{EC}_t(c, d)$  22,11
30.  $\text{PP}_{\text{st}}(\frac{b}{d}, \frac{a}{d})$  22,15
31.  $\text{P}_t(c, b)$  29,8
32.  $\text{ECTS}(\frac{b}{c}, \frac{b}{d}, \frac{b}{(c \cup d)})$  SHy 31,29,17
33.  $\text{P}_t(c, a)$  30,8
34.  $\text{ECTS}(\frac{a}{c}, \frac{a}{d}, \frac{a}{(c \cup d)})$  SHy 31,30,17
35.  $\text{EQ}_t(\frac{b}{c}, \frac{a}{c})$  SHy 34,32,14

36.  $DR_{st}(\frac{b}{c}, \frac{a}{c})$  27,5  
 37.  $\neg CONT(\frac{a}{c \cup d}) \vee \neg CONT(\frac{b}{c \cup d}) \vee C_{st}(\frac{b}{c}, \frac{a}{c})$  SHy 40,36,35,33,18  
 38.  $C_{st}(\frac{b}{c}, \frac{a}{c})$  41,26,25,24,23,21,20,4  
 39.  $EC_{st}(\frac{b}{c}, \frac{a}{c})$  SHy 42,37,9  
 40.  $\neg FCONT(\frac{a}{c \cup d}) \vee \neg FCONT(\frac{b}{c \cup d})$  SHy 43,40,36,35,33,19  
 41.  $\square$  44,26,25,24,23,21,20

Proof of Theorem:

## Refutation Set:

1.  $\neg(ntppi = dc)$  Lemma 55  
 2.  $\neg Trans(dc, ntpi, u, v, w, x) \vee \neg StrFCONT(\frac{u}{w \cup x}) \vee \neg StrFCONT(\frac{v}{w \cup x})$  Lemma 56  
 3.  $\neg InsRel3(u, ntpi, v, w, x, y, z) \vee \neg StrFCONT(\frac{w}{y \cup z}) \vee \neg StrFCONT(\frac{x}{y \cup z})$  Th102  
 4.  $\neg InsRel3(u, dc, v, w, x, y, z) \vee \neg StrFCONT(\frac{w}{y \cup z}) \vee \neg StrFCONT(\frac{x}{y \cup z})$  Th99  
 5.  $[\neg EleTran(u, v, w, x, y, z, x1) \vee (v = w) \vee (v = u) \vee InsRel3(u, v, w, x, y, z, x1)]$  D55  
 6.  $[\neg EleTran(u, v, w, x, y, z, x1) \vee Trans(u, w, x, y, z, x1) \vee InsRel3(u, v, w, x, y, z, x1)]$  D55  
 7.  $[EleTran(u, v, skf62(z, y, x, w, v, u), w, x, y, z) \vee EleTran(skf63(z, y, x, w, v, u), u, v, w, x, y, z) \vee \neg DirTran(u, v, w, x, y, z)]$  D56  
 8.  $StrFCONT(\frac{a}{c \cup d})$   
 9.  $StrFCONT(\frac{b}{c \cup d})$   
 10.  $DirTran(dc, ntpi, a, b, c, d)$

## Proof:

11.  $\neg Trans(dc, ntpi, a, u, c, d) \vee \neg StrFCONT(\frac{u}{c \cup d})$  8,2  
 12.  $\neg InsRel3(u, ntpi, v, a, w, c, d) \vee \neg StrFCONT(\frac{w}{c \cup d})$  8,4  
 13.  $\neg InsRel3(u, dc, v, a, w, c, d) \vee \neg StrFCONT(\frac{w}{c \cup d})$  8,3  
 14.  $[EleTran(dc, ntpi, skf62(d, c, b, a, ntpi, dc), a, b, c, d) \vee EleTran(skf63(d, c, b, a, ntpi, dc), dc, ntpi, a, b, c, d)]$  10,7  
 15.  $\neg Trans(dc, ntpi, a, b, c, d)$  11,9  
 16.  $\neg InsRel3(u, dc, v, a, b, c, d)$  12,9  
 17.  $\neg InsRel3(u, ntpi, v, a, b, c, d)$  13,9  
 18.  $EleTran(dc, ntpi, skf62(d, c, b, a, ntpi, dc), a, b, c, d)$  Spt 14  
 19.  $Trans(dc, skf62(d, c, b, a, ntpi, dc), a, b, c, d) \vee InsRel3(dc, ntpi, skf62(d, c, b, a, ntpi, dc), a, b, c, d)$  18,6  
 20.  $[(dc = ntpi) \vee (skf62(d, c, b, a, ntpi, dc) = ntpi) \vee InsRel3(dc, ntpi, skf62(d, c, b, a, ntpi, dc), a, b, c, d)]$  18,5  
 21.  $(skf62(d, c, b, a, ntpi, dc) = ntpi)$  20,17,1  
 22.  $Trans(dc, ntpi, a, b, c, d) \vee InsRel3(dc, ntpi, ntpi, a, b, c, d)$  Rew 21,19  
 23.  $\square$  22,17,15

24.  $\neg \text{EleTran}(\text{dc}, \text{ntppi}, \text{skf62}(\text{d}, \text{c}, \text{b}, \text{a}, \text{ntppi}, \text{dc}), \text{a}, \text{b}, \text{c}, \text{d})$  Spt 23,18,14
25.  $\text{EleTran}(\text{skf63}(\text{d}, \text{c}, \text{b}, \text{a}, \text{ntppi}, \text{dc}), \text{dc}, \text{ntppi}, \text{a}, \text{b}, \text{c}, \text{d})$  Spt 23,14
26.  $[(\text{dc} = \text{ntppi}) \vee (\text{skf63}(\text{d}, \text{c}, \text{b}, \text{a}, \text{ntppi}, \text{dc}) = \text{ntppi}) \vee$   
 $\text{InsRel3}(\text{skf63}(\text{d}, \text{c}, \text{b}, \text{a}, \text{ntppi}, \text{dc}), \text{dc}, \text{ntppi}, \text{a}, \text{b}, \text{c}, \text{d})]$  25,5
27.  $[\text{InsRel3}(\text{skf63}(\text{d}, \text{c}, \text{b}, \text{a}, \text{ntppi}, \text{dc}), \text{dc}, \text{ntppi}, \text{a}, \text{b}, \text{c}, \text{d}) \vee$   
 $\text{Trans}(\text{skf63}(\text{d}, \text{c}, \text{b}, \text{a}, \text{ntppi}, \text{dc}), \text{ntppi}, \text{a}, \text{b}, \text{c}, \text{d})]$  25,6
28.  $(\text{skf62}(\text{d}, \text{c}, \text{b}, \text{a}, \text{ntppi}, \text{dc}) = \text{dc})$  26,12,1
29.  $\text{Trans}(\text{dc}, \text{ntppi}, \text{a}, \text{b}, \text{c}, \text{d}) \vee \text{InsRel3}(\text{dc}, \text{dc}, \text{ntppi}, \text{a}, \text{b}, \text{c}, \text{d})$  Rew 28,27
30.  $\square$  29,16,15

**Th128.**  $[\text{StrFCONT}(\frac{x}{z_1 \cup z_2}) \wedge \text{StrFCONT}(\frac{y}{z_1 \cup z_2})] \rightarrow \neg \text{DirTran}(\text{ec}, \text{ntppi}, x, y, z_1, z_2)$

**Lemma 57.**  $[\neg(\text{ntppi} = \text{ec})]$

From D6, D10, D49

**Lemma 58.**  $[\text{Trans}(\text{ec}, \text{ntppi}, x, y, z_1, z_2) \rightarrow [\neg \text{StrFCONT}(\frac{x}{z_1 \cup z_2}) \vee \neg \text{StrFCONT}(\frac{y}{z_1 \cup z_2})]]$

Refutation Set:

1.  $\neg \text{StrFCONT}u \vee \text{FCONT}u$  D39
2.  $\neg \text{StrFCONT}u \vee \text{StrCONT}_{\text{st}}u$  D39
3.  $\neg \text{EC}_{\text{st}}(u, v) \vee \text{EC}_{\text{st}}(v, u)$  Lemma 52
4.  $\neg \text{P}_t(u \cup v, w) \vee \text{P}_t(u, w)$  Th18
5.  $\neg \text{Trans}(u, v, w, x, y, z) \vee \text{EC}_t(y, z)$  D52
6.  $\neg \text{Trans}(u, v, w, x, y, z) \vee \text{P}_t(y \cup z, x)$  D52
7.  $\neg \text{Trans}(u, v, w, x, y, z) \vee \text{P}_t(y \cup z, w)$  D52
8.  $\neg \text{P}_t(u, v) \vee \neg \text{P}_t(u, w) \vee \text{EQ}_t(\frac{v}{u}, \frac{w}{u})$  Lemma 39
9.  $\neg \text{Trans}(\text{ec}, u, v, w, x, y) \vee \text{EC}_{\text{st}}(\frac{v}{x}, \frac{w}{x})$  Th87
10.  $\neg \text{Trans}(u, \text{ntppi}, v, w, x, y) \vee \text{PP}_{\text{st}}(\frac{w}{y}, \frac{v}{y})$
11.  $[\neg \text{EC}_t(u, v) \vee \neg \text{P}_t((u \cup v), w) \vee \text{ECTS}(\frac{w}{u}, \frac{w}{v}, \frac{w}{(u \cup v)})]$  Lemma 40
12.  $[\neg \text{FCONT}u \vee \neg \text{FCONT}v \vee \neg \text{EQ}_t(w, x) \vee \neg \text{EC}_{\text{st}}(w, x) \vee$   
 $\neg \text{PP}_{\text{st}}(y, z) \vee \neg \text{ECTS}(w, y, u) \vee \neg \text{ECTS}(x, z, v)]$  Th52
13.  $\text{StrFCONT}(\frac{a}{c \cup d})$
14.  $\text{StrFCONT}(\frac{b}{c \cup d})$
15.  $\text{Trans}(\text{ec}, \text{ntppi}, \text{a}, \text{b}, \text{c}, \text{d})$

Proof:

22.  $\text{FCONT}(\frac{b}{c \cup d})$  19,2
23.  $\text{StrCONT}_{\text{st}}(\frac{b}{c \cup d})$  19,3
24.  $\text{FCONT}(\frac{a}{c \cup d})$  18,2
25.  $\text{StrCONT}_{\text{st}}(\frac{a}{c \cup d})$  18,3
26.  $\text{EC}_{\text{st}}(\frac{a}{c}, \frac{b}{c})$  20,14

27. $P_t(c \cup d, b)$	20,11
28. $P_t(c \cup d, a)$	20,12
29. $EC_t(c, d)$	20,10
30. $PP_{st}(\frac{b}{d}, \frac{a}{d})$	20,14
31. $P_t(c, b)$	27,8
32. $ECTS(\frac{b}{c}, \frac{b}{d}, \frac{b}{c \cup d})$	SHy 29,27,16
33. $P_t(c, a)$	28,8
34. $ECTS(\frac{a}{c}, \frac{a}{d}, \frac{a}{c \cup d})$	SHy 29,28,16
35. $EQ_t(\frac{b}{c}, \frac{a}{c})$	SHy 32,30,13
36. $EC_{st}(\frac{b}{c}, \frac{a}{c})$	25,4
37. $\neg FCONT(\frac{a}{c \cup d}) \vee \neg FCONT(\frac{b}{c \cup d})$	SHy 39,35,34,33,31,17
38. $\square$	40,24,23,22,21,19,18

Proof of Theorem:

## Refutation Set:

1. $\neg(ntppi = ec)$	Lemma 57
2. $\neg Trans(ec, ntpi, u, v, w, x) \vee \neg StrFCONT(\frac{u}{w \cup x}) \vee \neg StrFCONT(\frac{v}{w \cup x})$	Lemma 58
3. $\neg InsRel3(u, ec, ntpi, v, w, x, y) \vee \neg StrFCONT(\frac{v}{x \cup y}) \vee \neg StrFCONT(\frac{w}{x \cup y})$	Th108
4. $\neg InsRel3(u, tppi, v, w, x, y, z) \vee \neg StrFCONT(\frac{w}{y \cup z}) \vee \neg StrFCONT(\frac{x}{y \cup z})$	Th114
5. $[\neg EleTran(u, v, w, x, y, z, x1) \vee (v = w)$ $\vee (v = u) \vee InsRel3(u, v, w, x, y, z, x1)]$	D55
6. $[\neg EleTran(u, v, w, x, y, z, x1) \vee Trans(u, w, x, y, z, x1)$ $\vee InsRel3(u, v, w, x, y, z, x1)]$	D55
7. $[EleTran(u, v, skf62(z, y, x, w, v, u), w, x, y, z)$ $\vee EleTran(skf63(z, y, x, w, v, u), u, v, w, x, y, z) \vee \neg DirTran(u, v, w, x, y, z)]$	D56
8. $StrFCONT(\frac{a}{c \cup d})$	
9. $StrFCONT(\frac{b}{c \cup d})$	
10. $DirTran(ec, ntpi, a, b, c, d)$	

## Proof:

11. $\neg Trans(ec, ntpi, a, u, c, d) \vee \neg StrFCONT(\frac{u}{c \cup d})$	8,2
12. $\neg InsRel3(u, ntpi, v, a, w, c, d) \vee \neg StrFCONT(\frac{w}{c \cup d})$	8,3
13. $\neg InsRel3(u, ec, ntpi, v, a, w, c, d) \vee \neg StrFCONT(\frac{w}{c \cup d})$	8,4
14. $[EleTran(ec, ntpi, skf62(d, c, b, a, ntpi, ec), a, b, c, d) \vee$ $EleTran(skf63(d, c, b, a, ntpi, ec), ec, ntpi, a, b, c, d)]$	10,7
15. $\neg Trans(ec, ntpi, a, b, c, d)$	11,9
16. $\neg InsRel3(u, ntpi, v, a, b, c, d)$	12,9
17. $\neg InsRel3(u, ec, ntpi, a, b, c, d)$	13,9
18. $EleTran(ec, ntpi, skf62(d, c, b, a, ntpi, ec), a, b, c, d)$	Spt 14
19. $Trans(ec, skf62(d, c, b, a, ntpi, ec), a, b, c, d)$	

	$\vee \text{InsRel3}(\text{ec}, \text{ntppi}, \text{skf62}(\text{d}, \text{c}, \text{b}, \text{a}, \text{ntppi}, \text{ec}), \text{a}, \text{b}, \text{c}, \text{d})$	18,6
20.	$[(\text{ec} = \text{ntppi}) \vee (\text{skf62}(\text{d}, \text{c}, \text{b}, \text{a}, \text{ntppi}, \text{ec}) = \text{ntppi}) \vee$ $\text{InsRel3}(\text{ec}, \text{ntppi}, \text{skf62}(\text{d}, \text{c}, \text{b}, \text{a}, \text{ntppi}, \text{ec}), \text{a}, \text{b}, \text{c}, \text{d})]$	18,5
21.	$(\text{skf62}(\text{d}, \text{c}, \text{b}, \text{a}, \text{ntppi}, \text{ec}) = \text{ntppi})$	20,17,1
22.	$\text{Trans}(\text{ec}, \text{ntppi}, \text{a}, \text{b}, \text{c}, \text{d}) \vee \text{InsRel3}(\text{ec}, \text{ntppi}, \text{ntppi}, \text{a}, \text{b}, \text{c}, \text{d})$	Rew 21,19
23.	$\square$	22,17,15
24.	$\neg \text{EleTran}(\text{ec}, \text{ntppi}, \text{skf62}(\text{d}, \text{c}, \text{b}, \text{a}, \text{ntppi}, \text{ec}), \text{a}, \text{b}, \text{c}, \text{d})$	Spt 23,18,14
25.	$\text{EleTran}(\text{skf63}(\text{d}, \text{c}, \text{b}, \text{a}, \text{ntppi}, \text{ec}), \text{ec}, \text{ntppi}, \text{a}, \text{b}, \text{c}, \text{d})$	Spt 23,14
26.	$[(\text{ec} = \text{ntppi}) \vee (\text{skf63}(\text{d}, \text{c}, \text{b}, \text{a}, \text{ntppi}, \text{ec}) = \text{ntppi}) \vee$ $\text{InsRel3}(\text{skf63}(\text{d}, \text{c}, \text{b}, \text{a}, \text{ntppi}, \text{ec}), \text{ec}, \text{ntppi}, \text{a}, \text{b}, \text{c}, \text{d})]$	25,5
27.	$[\text{InsRel3}(\text{skf63}(\text{d}, \text{c}, \text{b}, \text{a}, \text{ntppi}, \text{ec}), \text{ec}, \text{ntppi}, \text{a}, \text{b}, \text{c}, \text{d}) \vee$ $\text{Trans}(\text{skf63}(\text{d}, \text{c}, \text{b}, \text{a}, \text{ntppi}, \text{ec}), \text{ntppi}, \text{a}, \text{b}, \text{c}, \text{d})]$	25,6
28.	$(\text{skf62}(\text{d}, \text{c}, \text{b}, \text{a}, \text{ntppi}, \text{ec}) = \text{ec})$	26,12,1
29.	$\text{Trans}(\text{ec}, \text{ntppi}, \text{a}, \text{b}, \text{c}, \text{d}) \vee \text{InsRel3}(\text{ec}, \text{ec}, \text{ntppi}, \text{a}, \text{b}, \text{c}, \text{d})$	Rew 28,27
30.	$\square$	29,16,15

**Th129.**  $[\text{StrFCONT}(\frac{x}{z_1 \cup z_2}) \wedge \text{StrFCONT}(\frac{y}{z_1 \cup z_2})] \rightarrow \neg \text{DirTran}(\text{po}, \text{ntpp}, x, y, z_1, z_2)$

**Lemma 59.**  $[\neg(\text{po} = \text{ntpp})]$

From D7, D10, D49

**Lemma 60.**  $[\neg(\text{po} = \text{eq})]$

From D7, D8, D49

**Lemma 61.**  $[\neg(\text{po} = \text{tpp})]$

From D7, D9, D49

**Lemma 62.**  $[\neg(\text{eq} = \text{ntpp})]$

From D8, D10, D49

**Lemma 63.**  $[\neg(\text{tpp} = \text{ntpp})]$

From D9, D10, D49

**Lemma 64.**  $[[\text{PP}_{\text{st}}(x, y) \wedge \text{EQ}_t(x, y)] \rightarrow \text{P}_{\text{sp}}^{=*}(x, y)]$

From D3, D40, D44

**Lemma 65.**  $[[\text{Trans}(\text{po}, \text{ntpp}, x, y, z_1, z_2) \wedge \text{StrFCONT}(\frac{x}{z_1 \cup z_2}) \wedge \text{StrFCONT}(\frac{y}{z_1 \cup z_2})] \rightarrow$   
 $[\text{InsRel3}(\text{po}, \text{eq}, \text{ntpp}, x, y, z_1, z_2) \vee \text{InsRel3}(\text{po}, \text{tpp}, \text{ntpp}, x, y, z_1, z_2)]]$

Refutation Set:

1.  $\neg(\text{tpp} = \text{ntpp})$  Lemma 63
2.  $\neg(\text{eq} = \text{ntpp})$  Lemma 62
3.  $\neg(\text{po} = \text{eq})$  Lemma 60
4.  $\neg(\text{po} = \text{tpp})$  Lemma 61

5.  $\neg \text{StrFCONT}u \vee \text{FCONT}u$  D39
6.  $\neg P_t(u \cup v, w) \vee P_t(v, w)$  Th18
7.  $\neg \text{PP}_{\text{st}}(x, y) \vee \neg \text{EQ}_t(x, y) \vee P_{\text{sp}}^*(x, y)$  Lemma 64
8.  $\neg \text{Trans}(u, v, w, x, y, z) \vee \text{EC}_t(y, z)$  D52
9.  $\neg \text{Trans}(u, v, w, x, y, z) \vee P_t(y \cup z, x)$  D52
10.  $\neg \text{Trans}(u, v, w, x, y, z) \vee P_t(y \cup z, w)$  D52
11.  $\neg \text{Trans}(u, \text{ntpp}, v, w, x, y) \vee \text{PP}_{\text{st}}(\frac{v}{y}, \frac{w}{y})$  Th94
12.  $\neg \text{Trans}(\text{po}, u, v, w, x, y) \vee \text{PO}_{\text{sp}}^*(\frac{v}{x}, \frac{w}{x})$  Th87
13.  $\neg P_t(u, v) \vee \neg P_t(u, w) \vee \text{EQ}_t(\frac{v}{u}, \frac{w}{u})$  Lemma 39
14.  $\neg \mathbb{M}_{\text{eq}}(u, v, w, x) \vee \neg(\text{eq} = y) \vee \text{SKP2}(x, w, v, u, y)$  A22
15.  $\text{NECP}(\text{skf17}(u, v, w, x, y), \frac{w}{v}, u) \vee \text{SKP3}(z, w, u, v, x1)$  D54
16.  $\text{NECP}(\text{skf18}(u, v, w, x, y), \frac{w}{v}, u) \vee \text{SKP3}(z, x1, u, v, w)$  D54
17.  $\neg \text{rcc}_{\text{sp}}^*(u, \text{skf18}(v, w, x, y, u), \text{skf17}(v, w, y, u, x)) \vee \text{SKP3}(u, y, v, w, x)$  D54
18.  $\neg \text{EC}_t(u, v) \vee \neg P_t(u \cup v, w) \vee \text{ECTS}(\frac{w}{u}, \frac{w}{v}, \frac{w}{u \cup v})$  Lemma 40
19.  $\text{EQTS}(\text{skf18}(u, v, w, x, y), \text{skf17}(u, v, x, y, w), \frac{w}{v}, \frac{x}{v}) \vee \text{SKP3}(y, x, u, v, w)$  D54
20.  $[\neg \text{SKP2}(u, v, w, x, y) \vee \neg \text{StrFCONT}(\frac{x}{v \cup u}) \vee$   
 $\neg \text{StrFCONT}(\frac{w}{v \cup u}) \vee \text{IM}(y, x, w, v, u)]$  A22
21.  $[\neg \text{IM}(u, v, w, x, y) \vee \neg P_t(x \cup y, w) \vee \neg P_t(x \cup y, v) \vee$   
 $\neg \text{EC}_t(x, y) \vee \text{InsRel}(u, v, w, x, y)]$  D53
22.  $\neg \mathbb{M}_{\text{tpp}}(v, w, x, y) \vee \neg(\text{tpp} = u) \vee \neg \text{StrFCONT}(\frac{v}{x \cup y}) \vee$   
 $\neg \text{StrFCONT}(\frac{w}{x \cup y}) \vee \text{IM}(u, v, w, x, y)]$  A22
23.  $[\neg \text{SKP3}(u, v, w, x, y) \vee \neg \text{SKP3}(x1, v, x, w, y) \vee \neg \text{InsRel}(z, y, v, x, w) \vee$   
 $(u = z) \vee \text{InsRel3}(u, z, x1, y, v, x, w) \vee (z = x1)]$  D54
24.  $[\neg \text{Trans}(u, v, w, x, y, z) \vee \neg \text{NECP}(x1, \frac{w}{z}, y) \vee \neg \text{EQTS}(x1, x2, \frac{w}{z}, \frac{x}{z}) \vee$   
 $\neg \text{NECP}(x2, \frac{x}{z}, y) \vee \text{rcc}_{\text{sp}}^*(v, x1, x2)]$  D52
25.  $[\neg \text{Trans}(u, v, w, x, y, z) \vee \neg \text{NECP}(x1, \frac{w}{y}, z) \vee \neg \text{EQTS}(x1, x2, \frac{w}{y}, \frac{x}{y}) \vee$   
 $\neg \text{NECP}(x2, \frac{x}{y}, z) \vee \text{rcc}_{\text{sp}}^*(u, x1, x2)]$  D52
26.  $[\neg \text{PO}_{\text{sp}}^*(\frac{u}{v}, \frac{w}{v}) \vee \neg P_{\text{sp}}^*(\frac{u}{x}, \frac{w}{x}) \vee \neg \text{FCONT}(\frac{u}{v \cup x}) \vee \neg \text{FCONT}(\frac{w}{v \cup x}) \vee$   
 $\neg \text{ECTS}(\frac{u}{v}, \frac{u}{x}, \frac{u}{v \cup x}) \vee \neg \text{ECTS}(\frac{w}{v}, \frac{w}{x}, \frac{w}{v \cup x}) \vee$   
 $\mathbb{M}_{\text{tpp}}(u, w, v, x) \vee \mathbb{M}_{\text{eq}}(u, w, v, x)]$  Th73
27.  $\text{StrFCONT}(\frac{a}{c \cup d})$
28.  $\text{StrFCONT}(\frac{b}{c \cup d})$
29.  $\text{Trans}(\text{po}, \text{ntpp}, a, b, c, d)$
30.  $\neg \text{InsRel3}(\text{po}, \text{eq}, \text{ntpp}, a, b, c, d)$
31.  $\neg \text{InsRel3}(\text{po}, \text{tpp}, \text{ntpp}, a, b, c, d)$

Proof:

32.  $\neg \text{FCONT}(\frac{b}{c \cup d})$  28,5
33.  $\neg \text{FCONT}(\frac{a}{c \cup d})$  27,5



34.	$\neg\text{SKP2}(d, c, u, a, v) \vee \neg\text{StrFCONT}(\frac{u}{c \cup d}) \vee \text{IM}(v, a, u, c, d)$	27,20
35.	$\text{PO}_{\text{sp}}^{\equiv}(\frac{a}{c}, \frac{b}{c})$	29,12
36.	$\text{P}_t(c \cup d, b)$	29,9
37.	$\text{P}_t(c \cup d, a)$	29,10
38.	$\text{EC}_t(c, d)$	29,8
39.	$\text{PP}_{\text{st}}(\frac{a}{d}, \frac{b}{d})$	29,11
40.	$[\neg\text{SKP3}(\text{po}, b, d, c, a) \vee \neg\text{SKP3}(\text{ntpp}, b, c, d, a) \vee$ $\neg\text{InsRel}(\text{tpp}, a, b, c, d) \vee (\text{po} = \text{tpp}) \vee (\text{tpp} = \text{ntpp})]$	31,23
41.	$[\neg\text{SKP3}(\text{po}, b, d, c, a) \vee \neg\text{SKP3}(\text{ntpp}, b, c, d, a) \vee$ $\neg\text{InsRel}(\text{eq}, a, b, c, d) \vee (\text{eq} = \text{po}) \vee (\text{eq} = \text{ntpp})]$	30,23
42.	$\neg\text{SKP3}(\text{po}, b, d, c, a) \vee \neg\text{SKP3}(\text{ntpp}, b, c, d, a) \vee \neg\text{InsRel}(\text{tpp}, a, b, c, d)$	40,4,1
43.	$\neg\text{SKP3}(\text{po}, b, d, c, a) \vee \neg\text{SKP3}(\text{ntpp}, b, c, d, a) \vee \neg\text{InsRel}(\text{eq}, a, b, c, d)$	41,3,2
44.	$\neg\text{SKP2}(d, c, b, a, u) \vee \text{IM}(u, a, b, c, d)$	34,28
45.	$\text{P}_t(d, b)$	36,6
46.	$\text{ECTS}(\frac{b}{c}, \frac{b}{d}, \frac{b}{c \cup d})$	SHy 38,36,18
47.	$\text{P}_t(d, a)$	37,6
48.	$\text{ECTS}(\frac{a}{c}, \frac{a}{d}, \frac{a}{c \cup d})$	SHy 38,37,18
49.	$\text{EQ}_t(\frac{a}{d}, \frac{b}{d})$	SHy 47,45,13
50.	$[\text{SKP3}(u, b, d, c, v) \vee \text{SKP3}(w, b, d, c, a) \vee \text{SKP3}(x, y, d, c, a) \vee$ $\text{rcc}_{\text{sp}}^{\equiv}(\text{po}, \text{skf18}(d, c, a, b, w), \text{skf17}(d, c, b, w, a))]$	SHy 29,25,19,16,15
51.	$[\text{SKP3}(u, b, c, d, v) \vee \text{SKP3}(w, b, c, d, a) \vee \text{SKP3}(x, y, c, d, a) \vee$ $\text{rcc}_{\text{sp}}^{\equiv}(\text{ntpp}, \text{skf18}(c, d, a, b, w), \text{skf17}(c, d, b, w, a))]$	SHy 29,24,19,16,15
52.	$[\text{SKP3}(u, b, d, c, v) \vee \text{rcc}_{\text{sp}}^{\equiv}(\text{po}, \text{skf18}(d, c, a, b, u), \text{skf17}(d, c, b, u, a))]$	Con 50
53.	$\text{SKP3}(u, b, c, d, a) \vee \text{rcc}_{\text{sp}}^{\equiv}(\text{ntpp}, \text{skf18}(c, d, a, b, u), \text{skf17}(c, d, b, u, a))]$	Con 51
54.	$\text{SKP3}(\text{po}, b, d, c, a) \vee \text{SKP3}(\text{po}, b, d, c, a)$	52,17
55.	$\text{SKP3}(\text{po}, b, d, c, a)$	Obs54
56.	$\neg\text{SKP3}(\text{ntpp}, b, c, d, a) \vee \neg\text{InsRel}(\text{tpp}, a, b, c, d)$	55,42
57.	$\neg\text{SKP3}(\text{ntpp}, b, c, d, a) \vee \neg\text{InsRel}(\text{eq}, a, b, c, d)$	55,43
58.	$\text{P}_{\text{sp}}^{\equiv *}(\frac{a}{d}, \frac{b}{d})$	SHy 49,39,7
59.	$\text{SKP3}(\text{ntpp}, b, c, d, a) \vee \text{SKP3}(\text{ntpp}, b, c, d, a)$	53,17
60.	$\text{SKP3}(\text{ntpp}, b, c, d, a)$	Obs59
61.	$\neg\text{InsRel}(\text{eq}, a, b, c, d)$	57,60
62.	$\neg\text{InsRel}(\text{tpp}, a, b, c, d)$	56,60
63.	$\neg\text{IM}(\text{tpp}, a, b, c, d) \vee \neg\text{P}_t(c \cup d, b) \vee \neg\text{P}_t(c \cup d, a) \vee \neg\text{EC}_t(c, d)$	62,21
64.	$\neg\text{IM}(\text{tpp}, a, b, c, d)$	63,38,37,36
65.	$\neg\text{IM}(\text{eq}, a, b, c, d) \vee \neg\text{P}_t(c \cup d, b) \vee \neg\text{P}_t(c \cup d, a) \vee \neg\text{EC}_t(c, d)$	61,22
66.	$\neg\text{IM}(\text{eq}, a, b, c, d)$	65,38,36,37
67.	$[\neg(\text{tpp} = \text{tpp}) \vee \neg\mathbb{M}_{\text{tpp}}(a, b, c, d) \vee$	

	$\neg\text{StrFCONT}(\frac{a}{c \cup d}) \vee \neg\text{StrFCONT}(\frac{b}{c \cup d})]$	64,22
68.	$\neg\mathbb{M}_{\text{tpp}}(a, b, c, d) \vee \neg\text{StrFCONT}(\frac{a}{c \cup d}) \vee \neg\text{StrFCONT}(\frac{b}{c \cup d})$	Obs67
69.	$\neg\mathbb{M}_{\text{tpp}}(a, b, c, d)$	68,28,27
70.	$\mathbb{M}_{\text{eq}}(a, b, c, d) \vee \mathbb{M}_{\text{tpp}}(a, b, c, d)$	SHy 58,48,46,35,33,32,26
71.	$\mathbb{M}_{\text{eq}}(a, b, c, d)$	70,69
72.	$\neg\mathbb{M}_{\text{eq}}(a, b, c, d) \vee \neg(u = \text{eq}) \vee \text{IM}(u, a, b, c, d)$	SHy 44,14
73.	$\neg(u = \text{eq}) \vee \text{IM}(u, a, b, c, d)$	72,71
74.	$\neg(\text{eq} = \text{eq})$	73,66
75.	$\square$	Obs74

Proof of Theorem:

## Refutation Set:

1.	$\neg(\text{tpp} = \text{ntpp})$	Lemma 63
2.	$\neg(\text{eq} = \text{ntpp})$	Lemma 62
3.	$\neg(\text{po} = \text{eq})$	Lemma 60
4.	$\neg(\text{po} = \text{tpp})$	Lemma 61
5.	$\neg(\text{po} = \text{ntpp})$	Lemma 59
6.	$\neg\text{InsRel3}(u, v, w, x, y, z, x1) \vee \text{EleTran}(u, v, w, x, y, z, x1)$	D55
7.	$\neg\text{InsRel3}(u, \text{ntpp}, v, w, x, y, z) \vee \neg\text{StrFCONT}(\frac{w}{y \cup z}) \vee \neg\text{StrFCONT}(\frac{x}{y \cup z})$	Th101
8.	$\neg\text{InsRel3}(u, \text{po}, v, w, x, y, z) \vee \neg\text{StrFCONT}(\frac{w}{y \cup z}) \vee \neg\text{StrFCONT}(\frac{x}{y \cup z})$	Th100
9.	$[\neg\text{DirTran}(u, v, w, x, y, z) \vee$ $\neg\text{EleTran}(u, x1, v, w, x, y, z) \vee (x1 = u) \vee (x1 = v)]$	D56
10.	$[\neg\text{EleTran}(u, v, w, x, y, z, x1) \vee (v = w) \vee$ $(v = u) \vee \text{InsRel3}(u, v, w, x, y, z, x1)]$	D55
11.	$[\neg\text{EleTran}(u, v, w, x, y, z, x1) \vee \text{Trans}(u, w, x, y, z, x1) \vee$ $\text{InsRel3}(u, v, w, x, y, z, x1)]$	D55
12.	$[\neg\text{Trans}(\text{po}, \text{ntpp}, u, v, w, x) \vee \neg\text{StrFCONT}(\frac{u}{w \cup x}) \vee \neg\text{StrFCONT}(\frac{v}{w \cup x}) \vee$ $\text{InsRel3}(\text{po}, \text{eq}, \text{ntpp}, u, v, w, x) \vee \text{InsRel3}(\text{po}, \text{tpp}, \text{ntpp}, u, v, w, x)]$	Lemma 65
13.	$[\text{EleTran}(u, v, \text{skf62}(z, y, x, w, v, u), w, x, y, z) \vee$ $\text{EleTran}(\text{skf63}(z, y, x, w, v, u), u, v, w, x, y, z) \vee \neg\text{DirTran}(u, v, w, x, y, z)]$	D56
14.	$\text{StrFCONT}(\frac{a}{c \cup d})$	
15.	$\text{StrFCONT}(\frac{b}{c \cup d})$	
16.	$\text{DirTran}(\text{po}, \text{ntpp}, a, b, c, d)$	

## Proof:

17.	$\neg\text{InsRel3}(u, \text{ntpp}, v, a, w, c, d) \vee \neg\text{StrFCONT}(\frac{w}{c \cup d})$	14,7
18.	$\neg\text{InsRel3}(u, \text{po}, v, a, w, c, d) \vee \neg\text{StrFCONT}(\frac{w}{c \cup d})$	14,8
19.	$[\text{EleTran}(\text{po}, \text{ntpp}, \text{skf62}(d, c, b, a, \text{po}, \text{ntpp}), a, b, c, d) \vee$ $\text{EleTran}(\text{skf63}(d, c, b, a, \text{po}, \text{ntpp}), \text{ntpp}, \text{po}, a, b, c, d)]$	16,13
20.	$\neg\text{EleTran}(\text{po}, u, \text{ntpp}, a, b, c, d) \vee (u = \text{po}) \vee (u = \text{ntpp})$	16,9

21. $\neg \text{InsRel3}(u, \text{po}, v, a, b, c, d)$	18,15
22. $\neg \text{InsRel3}(u, \text{ntpp}, v, a, b, c, d)$	17,15
23. $\neg \text{InsRel3}(\text{po}, u, \text{ntpp}, a, b, c, d) \vee (u = \text{po}) \vee (u = \text{ntpp})$	20,6
24. $[\neg \text{Trans}(\text{po}, \text{ntpp}, a, b, c, d) \vee \neg \text{StrFCONT}(\frac{a}{c \cup d}) \vee \neg \text{StrFCONT}(\frac{b}{c \cup d}) \vee \text{InsRel3}(\text{po}, \text{tpp}, \text{ntpp}, a, b, c, d) \vee (\text{po} = \text{eq}) \vee (\text{eq} = \text{ntpp})]$	23,12
25. $\neg \text{Trans}(\text{po}, \text{ntpp}, a, b, c, d) \vee \text{InsRel3}(\text{po}, \text{tpp}, \text{ntpp}, a, b, c, d)$	24,14,15,3,2
26. $\neg \text{Trans}(\text{po}, \text{ntpp}, a, b, c, d)(\text{po} = \text{tpp}) \vee (\text{tpp} = \text{ntpp})$	25,23
27. $\neg \text{Trans}(\text{po}, \text{ntpp}, a, b, c, d)$	26,4,1
28. $\text{EleTran}(\text{po}, \text{ntpp}, \text{skf62}(d, c, b, a, \text{ntpp}, \text{po}), a, b, c, d)$	Spt 19
29. $[\text{Trans}(\text{po}, \text{skf62}(d, c, b, a, \text{ntpp}, \text{po}), a, b, c, d) \vee \text{InsRel3}(\text{po}, \text{ntpp}, \text{skf62}(d, c, b, a, \text{ntpp}, \text{po}), a, b, c, d)]$	28,11
30. $[(\text{po} = \text{ntpp}) \vee (\text{skf62}(d, c, b, a, \text{ntpp}, \text{po}) = \text{ntpp}) \vee \text{InsRel3}(\text{po}, \text{ntpp}, \text{skf62}(d, c, b, a, \text{ntpp}, \text{po}), a, b, c, d)]$	28,10
31. $(\text{skf62}(d, c, b, a, \text{ntpp}, \text{po}) = \text{ntpp})$	30,22,5
32. $[\text{Trans}(\text{po}, \text{ntpp}, a, b, c, d) \vee \text{InsRel3}(\text{po}, \text{ntpp}, \text{ntpp}, a, b, c, d)]$	Rew 31,29
33. $\square$	32,27,22
34. $\neg \text{EleTran}(\text{po}, \text{ntpp}, \text{skf62}(d, c, b, a, \text{ntpp}, \text{po}), a, b, c, d)$	Spt 33,28,19
35. $\text{EleTran}(\text{skf63}(d, c, b, a, \text{ntpp}, \text{po}), \text{po}, \text{ntpp}, a, b, c, d)$	Spt 33,19
36. $[(\text{po} = \text{ntpp}) \vee (\text{skf63}(d, c, b, a, \text{ntpp}, \text{po}) = \text{po}) \vee \text{InsRel3}(\text{skf63}(d, c, b, a, \text{ntpp}, \text{po}), \text{po}, \text{ntpp}, a, b, c, d)]$	35,10
37. $\text{InsRel3}(\text{skf63}(d, c, b, a, \text{ntpp}, \text{po}), \text{po}, \text{ntpp}, a, b, c, d) \vee \text{Trans}(\text{skf63}(d, c, b, a, \text{ntpp}, \text{po}), \text{ntpp}, a, b, c, d)$	SHy 35,11
38. $(\text{skf63}(d, c, b, a, \text{ntpp}, \text{po}) = \text{po})$	36,21,5
39. $\text{InsRel3}(\text{po}, \text{po}, \text{ntpp}, a, b, c, d) \vee \text{Trans}(\text{po}, \text{ntpp}, a, b, c, d)$	Rew 38,37
40. $\square$	39,21,27

**Th130.**  $[\text{StrFCONT}(\frac{x}{z_1 \cup z_2}) \wedge \text{StrFCONT}(\frac{y}{z_1 \cup z_2})] \rightarrow \neg \text{DirTran}(\text{po}, \text{ntppi}, x, y, z_1, z_2)$

**Lemma 66.**  $[\neg(\text{po} = \text{ntppi})]$

From D7, D10, D49

**Lemma 67.**  $[\neg(\text{po} = \text{tppi})]$

From D7, D9, D49

**Lemma 68.**  $[\neg(\text{tppi} = \text{ntppi})]$

From D9, D10, D49

**Lemma 69.**  $[\neg(\text{eq} = \text{ntppi})]$

From D8, D10, D49

**Lemma 70.**  $[[\text{Trans}(\text{po}, \text{ntppi}, x, y, z_1, z_2) \wedge \text{StrFCONT}(\frac{x}{z_1 \cup z_2}) \wedge \text{StrFCONT}(\frac{y}{z_1 \cup z_2})] \rightarrow$

$$[\text{InsRel3}(\text{po}, \text{eq}, \text{ntppi}, x, y, z_1, z_2) \vee \text{InsRel3}(\text{po}, \text{tppi}, \text{ntppi}, x, y, z_1, z_2)]$$

From D39, D52, D54, A22, Th76

Proof of Theorem:

Refutation Set:

1.  $\neg(\text{tppi} = \text{ntppi})$  Lemma 68
2.  $\neg(\text{eq} = \text{ntppi})$  Lemma 69
3.  $\neg(\text{po} = \text{eq})$  Lemma 60
4.  $\neg(\text{po} = \text{tppi})$  Lemma 67
5.  $\neg(\text{po} = \text{ntppi})$  Lemma 66
6.  $\neg\text{InsRel3}(u, v, w, x, y, z, x1) \vee \text{EleTran}(u, v, w, x, y, z, x1)$  D55
7.  $\neg\text{InsRel3}(u, \text{ntppi}, v, w, x, y, z) \vee \neg\text{StrFCONT}(\frac{w}{y \cup z}) \vee \neg\text{StrFCONT}(\frac{x}{y \cup z})$  Th102
8.  $\neg\text{InsRel3}(u, \text{po}, v, w, x, y, z) \vee \neg\text{StrFCONT}(\frac{w}{y \cup z}) \vee \neg\text{StrFCONT}(\frac{x}{y \cup z})$  Th100
9.  $[\neg\text{DirTran}(u, v, w, x, y, z) \vee$   
 $\neg\text{EleTran}(u, x1, v, w, x, y, z) \vee (x1 = u) \vee (x1 = v)]$  D56
10.  $[\neg\text{EleTran}(u, v, w, x, y, z, x1) \vee (v = w)$   
 $\vee (v = u) \vee \text{InsRel3}(u, v, w, x, y, z, x1)]$  D55
11.  $[\neg\text{EleTran}(u, v, w, x, y, z, x1) \vee \text{Trans}(u, w, x, y, z, x1)$   
 $\vee \text{InsRel3}(u, v, w, x, y, z, x1)]$  D55
12.  $\neg\text{Transpo}, \text{ntppi}, u, v, w, x) \vee \neg\text{StrFCONT}(\frac{u}{w \cup x}) \vee \neg\text{StrFCONT}(\frac{v}{w \cup x}) \vee$   
 $\text{InsRel3}(\text{po}, \text{eq}, \text{ntppi}, u, v, w, x) \vee \text{InsRel3}(\text{po}, \text{tppi}, \text{ntppi}, u, v, w, x)$  Lemma 70
13.  $[\text{EleTran}(u, v, \text{skf62}(z, y, x, w, v, u), w, x, y, z) \vee$   
 $\text{EleTran}(\text{skf63}(z, y, x, w, v, u), u, v, w, x, y, z) \vee \neg\text{DirTran}(u, v, w, x, y, z)]$  D56
14.  $\text{StrFCONT}(\frac{a}{c \cup d})$
15.  $\text{StrFCONT}(\frac{b}{c \cup d})$
16.  $\text{DirTran}(\text{po}, \text{ntppi}, a, b, c, d)$

Proof:

17.  $\neg\text{InsRel3}(u, \text{ntppi}, v, a, w, c, d) \vee \neg\text{StrFCONT}(\frac{w}{c \cup d})$  14,7
18.  $\neg\text{InsRel3}(u, \text{po}, v, a, w, c, d) \vee \neg\text{StrFCONT}(\frac{w}{c \cup d})$  14,8
19.  $[\text{EleTran}(\text{po}, \text{ntppi}, \text{skf62}(d, c, b, a, \text{po}, \text{ntppi}), a, b, c, d) \vee$   
 $\text{EleTran}(\text{skf63}(d, c, b, a, \text{po}, \text{ntppi}), \text{ntppi}, \text{po}, a, b, c, d)]$  16,13
20.  $\neg\text{EleTran}(\text{po}, u, \text{ntppi}, a, b, c, d) \vee (u = \text{po}) \vee (u = \text{ntppi})$  16,9
21.  $\neg\text{InsRel3}(u, \text{po}, v, a, b, c, d)$  18,15
22.  $\neg\text{InsRel3}(u, \text{ntppi}, v, a, b, c, d)$  17,15
23.  $\neg\text{InsRel3}(\text{po}, u, \text{ntppi}, a, b, c, d) \vee (u = \text{po}) \vee (u = \text{ntppi})$  20,6
24.  $\neg\text{Trans}(\text{po}, \text{ntppi}, a, b, c, d) \vee \neg\text{StrFCONT}(\frac{a}{c \cup d}) \vee \neg\text{StrFCONT}(\frac{b}{c \cup d}) \vee$   
 $\text{InsRel3}(\text{po}, \text{eq}, \text{ntppi}, a, b, c, d) \vee (\text{tppi} = \text{po}) \vee (\text{tppi} = \text{ntppi})$  23,12
25.  $\neg\text{Trans}(\text{po}, \text{ntppi}, a, b, c, d) \vee \text{InsRel3}(\text{po}, \text{eq}, \text{ntppi}, a, b, c, d)$  24,15,14,3,2

26. $\neg\text{Trans}(\text{po}, \text{ntppi}, a, b, c, d)(\text{po} = \text{eq}) \vee (\text{ntppi} = \text{eq})$	25,23
27. $\neg\text{Trans}(\text{po}, \text{ntpp}, a, b, c, d)$	26,4,1
28. $\text{EleTran}(\text{po}, \text{ntppi}, \text{skf62}(d, c, b, a, \text{ntppi}, \text{po}), a, b, c, d)$	Spt 19
29. $[\text{Trans}(\text{po}, \text{skf62}(d, c, b, a, \text{ntppi}, \text{po}), a, b, c, d) \vee$ $\text{InsRel3}(\text{po}, \text{ntppi}, \text{skf62}(d, c, b, a, \text{ntppi}, \text{po}), a, b, c, d)]$	28,11
30. $[(\text{po} = \text{ntppi}) \vee (\text{skf62}(d, c, b, a, \text{ntppi}, \text{po}) = \text{ntppi}) \vee$ $\text{InsRel3}(\text{po}, \text{ntppi}, \text{skf62}(d, c, b, a, \text{ntppi}, \text{po}), a, b, c, d)]$	28,10
31. $(\text{skf62}(d, c, b, a, \text{ntppi}, \text{po}) = \text{ntppi})$	30,22,5
32. $[\text{Trans}(\text{po}, \text{ntppi}, a, b, c, d) \vee \text{InsRel3}(\text{po}, \text{ntppi}, \text{ntppi}, a, b, c, d)]$	Rew 31,29
33. $\square$	32,27,22
34. $\neg\text{EleTran}(\text{po}, \text{ntppi}, \text{skf62}(d, c, b, a, \text{ntppi}, \text{po}), a, b, c, d)$	Spt 33,19,28
35. $\text{EleTran}(\text{skf63}(d, c, b, a, \text{ntppi}, \text{po}), \text{po}, \text{ntppi}, a, b, c, d)$	Spt 33,19
36. $[(\text{po} = \text{ntppi}) \vee (\text{skf63}(d, c, b, a, \text{ntppi}, \text{po}) = \text{po}) \vee$ $\text{InsRel3}(\text{skf63}(d, c, b, a, \text{ntppi}, \text{po}), \text{po}, \text{ntppi}, a, b, c, d)]$	35,10
37. $\text{InsRel3}(\text{skf63}(d, c, b, a, \text{ntppi}, \text{po}), \text{po}, \text{ntppi}, a, b, c, d) \vee$ $\text{Trans}(\text{skf63}(d, c, b, a, \text{ntppi}, \text{po}), \text{ntppi}, a, b, c, d)$	SHy 35,11
38. $(\text{skf63}(d, c, b, a, \text{ntppi}, \text{po}) = \text{po})$	36,21,5
39. $\text{InsRel3}(\text{po}, \text{po}, \text{ntppi}, a, b, c, d) \vee \text{Trans}(\text{po}, \text{ntppi}, a, b, c, d)$	Rew 38,37
40. $\square$	39,27,21

**Th131.**  $[\text{StrFCONT}(\frac{x}{z_1 \cup z_2}) \wedge \text{StrFCONT}(\frac{y}{z_1 \cup z_2})] \rightarrow \neg\text{DirTran}(\text{tpp}, \text{tppi}, x, y, z_1, z_2)$

**Lemma 71.**  $[[\text{Trans}(\text{tpp}, \text{tppi}, x, y, z_1, z_2) \wedge \text{StrFCONT}(\frac{x}{z_1 \cup z_2}) \wedge \text{StrFCONT}(\frac{y}{z_1 \cup z_2})] \rightarrow$   
 $\text{InsRel3}(\text{tpp}, \text{eq}, \text{tppi}, x, y, z_1, z_2)]$

Refutation Set:

1. $\neg(\text{tpp} = \text{eq})$	Lemma 24
2. $\neg(\text{tppi} = \text{eq})$	Lemma 23
3. $\neg\text{StrFCONT}u \vee \text{FCONT}u$	D39
4. $\neg\text{P}_t(u \cup v, w) \vee \text{P}_t(v, w)$	Th18
5. $\neg\text{P}_t(u \cup v, w) \vee \text{P}_t(u, w)$	Th18
6. $\neg\text{PP}_{\text{st}}(x, y) \vee \neg\text{EQ}_t(x, y) \vee \text{P}_{\text{sp}}^*(x, y)$	Lemma 64
7. $\neg\text{Trans}(u, v, w, x, y, z) \vee \text{EC}_t(y, z)$	D52
8. $\neg\text{Trans}(u, v, w, x, y, z) \vee \text{P}_t(y \cup z, x)$	D52
9. $\neg\text{Trans}(u, v, w, x, y, z) \vee \text{P}_t(y \cup z, w)$	D52
10. $\neg\text{Trans}(u, \text{tppi}, v, w, x, y) \vee \text{PP}_{\text{st}}(\frac{w}{y}, \frac{v}{y})$	Th97
11. $\neg\text{Trans}(\text{tpp}, u, v, w, x, y) \vee \text{PP}_{\text{st}}(\frac{v}{x}, \frac{w}{x})$	Th90
12. $\neg\text{P}_t(u, v) \vee \neg\text{P}_t(u, w) \vee \text{EQ}_t(\frac{v}{u}, \frac{w}{u})$	Lemma 39
13. $\neg\mathbb{M}_{\text{eq}}(u, v, w, x) \vee \neg(\text{eq} = y) \vee \text{SKP2}(x, w, v, u, y)$	A22
14. $\text{NECP}(\text{skf17}(u, v, w, x, y), \frac{w}{v}, u) \vee \text{SKP3}(z, w, u, v, x1)$	D54

15.  $\text{NECP}(\text{skf18}(u, v, w, x, y), \frac{w}{v}, u) \vee \text{SKP3}(z, x1, u, v, w)$  D54
16.  $\neg \text{rcc}_{\text{sp}}^{\equiv}(u, \text{skf18}(v, w, x, y, u), \text{skf17}(v, w, y, u, x)) \vee \text{SKP3}(u, y, v, w, x)$  D54
17.  $\neg \text{EC}_t(u, v) \vee \neg \text{P}_t(u \cup v, w) \vee \text{ECTS}(\frac{w}{u}, \frac{w}{v}, \frac{w}{u \cup v})$  Lemma 40
18.  $\text{EQTS}(\text{skf18}(u, v, w, x, y), \text{skf17}(u, v, x, y, w), \frac{w}{v}, \frac{x}{v}) \vee \text{SKP3}(y, x, u, v, w)$  D54
19.  $[\neg \text{SKP2}(u, v, w, x, y) \vee \neg \text{StrFCONT}(\frac{x}{v \cup u}) \vee$   
 $\neg \text{StrFCONT}(\frac{w}{v \cup u}) \vee \text{IM}(y, x, w, v, u)]$  A22
20.  $[\neg \text{IM}(u, v, w, x, y) \vee \neg \text{P}_t(x \cup y, w) \vee \neg \text{P}_t(x \cup y, v) \vee$   
 $\neg \text{EC}_t(x, y) \vee \text{InsRel}(u, v, w, x, y)]$  D53
21.  $[\neg \text{SKP3}(u, v, w, x, y) \vee \neg \text{SKP3}(x1, v, x, w, y) \vee \neg \text{InsRel}(z, y, v, x, w) \vee$   
 $(u = z) \vee \text{InsRel3}(u, z, x1, y, v, x, w) \vee (z = x1)]$  D54
22.  $[\neg \text{Trans}(u, v, w, x, y, z) \vee \neg \text{NECP}(x1, \frac{w}{z}, y) \vee \neg \text{EQTS}(x1, x2, \frac{w}{z}, \frac{x}{z}) \vee$   
 $\neg \text{NECP}(x2, \frac{x}{z}, y) \vee \text{rcc}_{\text{sp}}^{\equiv}(v, x1, x2)]$  D52
23.  $[\neg \text{Trans}(u, v, w, x, y, z) \vee \neg \text{NECP}(x1, \frac{w}{y}, z) \vee \neg \text{EQTS}(x1, x2, \frac{w}{y}, \frac{x}{y}) \vee$   
 $\neg \text{NECP}(x2, \frac{x}{y}, z) \vee \text{rcc}_{\text{sp}}^{\equiv}(u, x1, x2)]$  D52
24.  $[\neg \text{P}_{\text{sp}}^{\equiv*}(\frac{u}{v}, \frac{w}{v}) \vee \neg \text{P}_{\text{sp}}^{\equiv*}(\frac{w}{x}, \frac{u}{x}) \vee \neg \text{FCONT}(\frac{u}{v \cup x}) \vee \neg \text{FCONT}(\frac{w}{v \cup x}) \vee$   
 $\neg \text{ECTS}(\frac{u}{v}, \frac{u}{x}, \frac{u}{v \cup x}) \vee \neg \text{ECTS}(\frac{w}{v}, \frac{w}{x}, \frac{w}{v \cup x}) \vee \text{M}_{\text{eq}}(u, w, v, x)]$  Th74
25.  $\text{StrFCONT}(\frac{a}{c \cup d})$
26.  $\text{StrFCONT}(\frac{b}{c \cup d})$
27.  $\text{Trans}(\text{tpp}, \text{tppi}, a, b, c, d)$
28.  $\neg \text{InsRel3}(\text{tpp}, \text{eq}, \text{tppi}, a, b, c, d)$

Proof:

29.  $\neg \text{FCONT}(\frac{b}{c \cup d})$  28,5
30.  $\neg \text{FCONT}(\frac{a}{c \cup d})$  27,5
31.  $\neg \text{SKP2}(d, c, u, a, v) \vee \neg \text{StrFCONT}(\frac{u}{c \cup d}) \vee \text{IM}(v, a, u, c, d)$  27,20
32.  $\text{PP}_{\text{st}}(\frac{a}{c}, \frac{b}{c})$  29,12
33.  $\text{P}_t(c \cup d, b)$  29,9
34.  $\text{P}_t(c \cup d, a)$  29,10
35.  $\text{EC}_t(c, d)$  29,8
36.  $\text{PP}_{\text{st}}(\frac{b}{d}, \frac{a}{d})$  29,11
37.  $[\neg \text{SKP3}(\text{tpp}, b, d, c, a) \vee \neg \text{SKP3}(\text{tppi}, b, c, d, a) \vee$   
 $\neg \text{InsRel}(\text{eq}, a, b, c, d) \vee (\text{eq} = \text{tpp}) \vee (\text{eq} = \text{tppi})]$  31,23
38.  $\neg \text{SKP3}(\text{tpp}, b, d, c, a) \vee \neg \text{SKP3}(\text{tppi}, b, c, d, a) \vee \neg \text{InsRel}(\text{eq}, a, b, c, d)$  41,3,2
39.  $\neg \text{SKP2}(d, c, b, a, u) \vee \text{IM}(u, a, b, c, d)$  34,28
40.  $\text{P}_t(d, b)$  36,6
41.  $\text{P}_t(c, b)$  37,6
42.  $\text{P}_t(d, a)$  37,6
43.  $\text{P}_t(c, a)$  37,6
44.  $\text{ECTS}(\frac{b}{c}, \frac{b}{d}, \frac{b}{c \cup d})$  SHy 38,36,18

45. $ECTS(\frac{a}{c}, \frac{a}{d}, \frac{a}{c \cup d})$	SHy 38,37,18
46. $EQ_t(\frac{a}{d}, \frac{b}{d})$	SHy 47,45,13
47. $EQ_t(\frac{a}{c}, \frac{b}{c})$	SHy 47,45,13
48. $[SKP3(u, b, d, c, v) \vee SKP3(w, b, d, c, a) \vee SKP3(x, y, d, c, a) \vee$ $rcc_{sp}^{\equiv}(tpp, skf18(d, c, a, b, w), skf17(d, c, b, w, a))]$	SHy 29,25,19,16,15
49. $[SKP3(u, b, c, d, v) \vee SKP3(w, b, c, d, a) \vee SKP3(x, y, c, d, a) \vee$ $rcc_{sp}^{\equiv}(tppi, skf18(c, d, a, b, w), skf17(c, d, b, w, a))]$	SHy 29,24,19,16,15
50. $[SKP3(u, b, d, c, v) \vee rcc_{sp}^{\equiv}(tpp, skf18(d, c, a, b, u), skf17(d, c, b, u, a))]$	Con 50
51. $SKP3(u, b, c, d, a) \vee rcc_{sp}^{\equiv}(tppi, skf18(c, d, a, b, u), skf17(c, d, b, u, a))$	Con 51
52. $SKP3(tpp, b, d, c, a) \vee SKP3(tppi, b, d, c, a)$	52,17
53. $SKP3(tpp, b, d, c, a)$	Obs54
54. $\neg SKP3(tppi, b, c, d, a) \vee \neg InsRel(eq, a, b, c, d)$	55,42
55. $P_{sp}^* (\frac{b}{d}, \frac{a}{d})$	SHy 49,39,7
56. $P_{sp}^* (\frac{a}{c}, \frac{b}{c})$	SHy 49,39,7
57. $SKP3(tppi, b, c, d, a) \vee SKP3(tpp, b, c, d, a)$	53,17
58. $SKP3(tppi, b, c, d, a)$	Obs59
59. $\neg InsRel(eq, a, b, c, d)$	57,60
60. $\neg IM(eq, a, b, c, d) \vee \neg P_t(c \cup d, b) \vee \neg P_t(c \cup d, a) \vee \neg EC_t(c, d)$	61,22
61. $\neg IM(eq, a, b, c, d)$	65,38,36,37
62. $M_{eq}(a, b, c, d)$	68,28,27
63. $\neg M_{eq}(a, b, c, d) \vee \neg(u = eq) \vee IM(u, a, b, c, d)$	SHy 44,14
64. $\neg(u = eq) \vee IM(u, a, b, c, d)$	72,71
65. $\neg(eq = eq)$	73,66
66. $\square$	Obs74

Proof of Theorem:

## Refutation Set:

1. $\neg(tppi = tpp)$	Lemma 35
2. $\neg(tpp = eq)$	Lemma 24
3. $\neg(tppi = eq)$	Lemma 23
4. $\neg InsRel3(u, v, w, x, y, z, x1) \vee EleTran(u, v, w, x, y, z, x1)$	D55
5. $\neg InsRel3(u, tpp, tppi, v, w, x, y) \vee \neg StrFCONT(\frac{v}{x \cup y}) \vee \neg StrFCONT(\frac{w}{x \cup y})$	Th112
6. $\neg InsRel3(tpp, tppi, u, v, w, x, y) \vee \neg StrFCONT(\frac{v}{x \cup y}) \vee \neg StrFCONT(\frac{w}{x \cup y})$	Th116
7. $[\neg DirTran(u, v, w, x, y, z) \vee$ $\neg EleTran(u, x1, v, w, x, y, z) \vee (x1 = u) \vee (x1 = v)]$	D56
8. $[\neg EleTran(u, v, w, x, y, z, x1) \vee (v = w)$ $\vee (v = u) \vee InsRel3(u, v, w, x, y, z, x1)]$	D55
9. $[\neg EleTran(u, v, w, x, y, z, x1) \vee Trans(u, w, x, y, z, x1)]$	

- $\vee \text{InsRel3}(u, v, w, x, y, z, x1)]$  D55
10.  $\neg \text{Trans}(tpp, tppi, u, v, w, x) \vee \neg \text{StrFCONT}(\frac{u}{w \cup x}) \vee$   
 $\neg \text{StrFCONT}(\frac{v}{w \cup x}) \vee \text{InsRel3}(tpp, eq, tppi, u, v, w, x)$  Lemma 71
11.  $[\text{EleTran}(u, v, \text{skf62}(z, y, x, w, v, u), w, x, y, z) \vee$   
 $\text{EleTran}(\text{skf63}(z, y, x, w, v, u), u, v, w, x, y, z) \vee \neg \text{DirTran}(u, v, w, x, y, z)]$  D56
12.  $\text{StrFCONT}(\frac{a}{c \cup d})$
13.  $\text{StrFCONT}(\frac{b}{c \cup d})$
14.  $\text{DirTran}(tpp, tppi, a, b, c, d)$

Proof:

15.  $\neg \text{InsRel3}(tpp, tppi, u, a, v, c, d) \vee \neg \text{StrFCONT}(\frac{v}{c \cup d})$  12,6
16.  $\neg \text{InsRel3}(u, tpp, tppi, a, v, c, d) \vee \neg \text{StrFCONT}(\frac{v}{c \cup d})$  12,5
17.  $[\text{EleTran}(tpp, tppi, \text{skf62}(d, c, b, a, tppi, tpp), a, b, c, d) \vee$   
 $\text{EleTran}(\text{skf63}(d, c, b, a, tppi, tpp), tpp, tppi, a, b, c, d)]$  14,11
18.  $\neg \text{EleTran}(tpp, u, tppi, a, b, c, d) \vee (u = tpp) \vee (u = tppi)$  14,7
19.  $\neg \text{InsRel3}(u, tpp, tppi, a, b, c, d)$  13,16
20.  $\neg \text{InsRel3}(tpp, tppi, u, a, b, c, d)$  13,15
21.  $\neg \text{InsRel3}(tpp, u, tppi, a, b, c, d) \vee (u = tpp) \vee (u = tppi)$  18,4
22.  $\neg \text{Trans}(tpp, tppi, a, b, c, d) \vee \neg \text{StrFCONT}(\frac{a}{c \cup d}) \vee$   
 $\neg \text{StrFCONT}(\frac{b}{c \cup d}) \vee (eq = tpp) \vee (eq = tppi)$  21,10
23.  $\neg \text{Trans}(tpp, tppi, a, b, c, d)$  22,13,12,2,3
24.  $\text{EleTran}(tpp, tppi, \text{skf62}(d, c, b, a, tppi, tpp), a, b, c, d)$  Spt 17
25.  $[\text{Trans}(tpp, \text{skf62}(d, c, b, a, tppi, tpp), a, b, c, d) \vee$   
 $\text{InsRel3}(tpp, tppi, \text{skf62}(d, c, b, a, tppi, tpp), a, b, c, d)]$  24,9
26.  $[(tpp = tppi) \vee (\text{skf62}(d, c, b, a, tppi, tpp) = tppi) \vee$   
 $\text{InsRel3}(tpp, tppi, \text{skf62}(d, c, b, a, tppi, tpp), a, b, c, d)]$  24,8
27.  $(\text{skf62}(d, c, b, a, tppi, tpp) = tppi)$  26,20,1
28.  $[\text{Trans}(tpp, tppi, a, b, c, d) \vee \text{InsRel3}(tpp, tppi, tppi, a, b, c, d)]$  Rew 27,25
29.  $\square$  28,23,20
30.  $\neg \text{EleTran}(tpp, tppi, \text{skf62}(d, c, b, a, tppi, tpp), a, b, c, d)$  Spt 29,24,17
31.  $\text{EleTran}(\text{skf63}(d, c, b, a, tppi, tpp), tpp, tppi, a, b, c, d)$  Spt 29,17
32.  $[(tpp = tppi) \vee (\text{skf63}(d, c, b, a, tppi, tpp) = tpp) \vee$   
 $\text{InsRel3}(\text{skf63}(d, c, b, a, tppi, tpp), tpp, tppi, a, b, c, d)]$  31,7
33.  $\text{InsRel3}(\text{skf63}(d, c, b, a, tppi, tpp), tpp, tppi, a, b, c, d) \vee$   
 $\text{Trans}(\text{skf63}(d, c, b, a, tppi, tpp), tppi, a, b, c, d)$  SHy 31,9
34.  $(\text{skf63}(d, c, b, a, tppi, tpp) = tpp)$  32,19,1
35.  $\text{InsRel3}(tpp, tpp, tppi, a, b, c, d) \vee \text{Trans}(tpp, tppi, a, b, c, d)$  Rew 34,33
36.  $\square$  35,23,19



**Th132.**  $[\text{StrFCONT}(\frac{x}{z_1 \cup z_2}) \wedge \text{StrFCONT}(\frac{y}{z_1 \cup z_2})] \rightarrow \neg \text{DirTran}(\text{ntpp}, \text{ntppi}, x, y, z_1, z_2)$

**Lemma 72.**  $[\neg(\text{ntppi} = \text{tpp})]$

From D9, D10, D49

**Lemma 73.**  $[[\text{Trans}(\text{ntpp}, \text{ntppi}, x, y, z_1, z_2) \wedge \text{StrFCONT}(\frac{x}{z_1 \cup z_2}) \wedge \text{StrFCONT}(\frac{y}{z_1 \cup z_2})] \rightarrow \text{InsRel3}(\text{ntpp}, \text{eq}, \text{ntppi}, x, y, z_1, z_2)]$

From D39, D52, D54, A22, Th74

Proof of Theorem:

Refutation Set:

1.  $\neg(\text{ntppi} = \text{tpp})$  Lemma 72
2.  $\neg(\text{eq} = \text{ntpp})$  Lemma 62
3.  $\neg(\text{eq} = \text{ntppi})$  Lemma 69
4.  $\neg \text{InsRel3}(u, v, w, x, y, z, x1) \vee \text{EleTran}(u, v, w, x, y, z, x1)$  D55
5.  $\neg \text{InsRel3}(u, \text{ntppi}, v, w, x, y, z) \vee \neg \text{StrFCONT}(\frac{w}{y \cup z}) \vee \neg \text{StrFCONT}(\frac{x}{y \cup z})$  Th102
6.  $\neg \text{InsRel3}(u, \text{ntpp}, v, w, x, y, z) \vee \neg \text{StrFCONT}(\frac{w}{y \cup z}) \vee \neg \text{StrFCONT}(\frac{x}{y \cup z})$  Th101
7.  $[\neg \text{DirTran}(u, v, w, x, y, z) \vee \neg \text{EleTran}(u, x1, v, w, x, y, z) \vee (x1 = u) \vee (x1 = v)]$  D56
8.  $[\neg \text{EleTran}(u, v, w, x, y, z, x1) \vee (v = w) \vee (v = u) \vee \text{InsRel3}(u, v, w, x, y, z, x1)]$  D55
9.  $[\neg \text{EleTran}(u, v, w, x, y, z, x1) \vee \text{Trans}(u, w, x, y, z, x1) \vee \text{InsRel3}(u, v, w, x, y, z, x1)]$  D55
10.  $\neg \text{Trans}(\text{ntpp}, \text{ntppi}, u, v, w, x) \vee \neg \text{StrFCONT}(\frac{u}{w \cup x}) \vee \neg \text{StrFCONT}(\frac{v}{w \cup x}) \vee \text{InsRel3}(\text{ntpp}, \text{eq}, \text{ntppi}, u, v, w, x)$  Lemma 73
11.  $[\text{EleTran}(u, v, \text{skf62}(z, y, x, w, v, u), w, x, y, z) \vee \text{EleTran}(\text{skf63}(z, y, x, w, v, u), u, v, w, x, y, z) \vee \neg \text{DirTran}(u, v, w, x, y, z)]$  D56
12.  $\text{StrFCONT}(\frac{a}{c \cup d})$
13.  $\text{StrFCONT}(\frac{b}{c \cup d})$
14.  $\text{DirTran}(\text{ntpp}, \text{ntppi}, a, b, c, d)$

Proof:

15.  $\neg \text{InsRel3}(u, \text{ntppi}, u, a, v, c, d) \vee \neg \text{StrFCONT}(\frac{v}{c \cup d})$  12,6
16.  $\neg \text{InsRel3}(u, \text{tpp}, \text{tppi}, a, v, c, d) \vee \neg \text{StrFCONT}(\frac{v}{c \cup d})$  12,5
17.  $[\text{EleTran}(\text{tpp}, \text{tppi}, \text{skf62}(d, c, b, a, \text{tppi}, \text{tpp}), a, b, c, d) \vee \text{EleTran}(\text{skf63}(d, c, b, a, \text{tppi}, \text{tpp}), \text{tpp}, \text{tppi}, a, b, c, d)]$  14,11
18.  $\neg \text{EleTran}(\text{tpp}, u, \text{tppi}, a, b, c, d) \vee (u = \text{tpp}) \vee (u = \text{tppi})$  14,7
19.  $\neg \text{InsRel3}(u, \text{tpp}, \text{tppi}, a, b, c, d)$  16,13
20.  $\neg \text{InsRel3}(\text{tpp}, \text{tppi}, u, a, b, c, d)$  15,13
21.  $\neg \text{InsRel3}(\text{tpp}, u, \text{tppi}, a, b, c, d) \vee (u = \text{tpp}) \vee (u = \text{tppi})$  18,4
22.  $\neg \text{Trans}(\text{tpp}, \text{tppi}, a, b, c, d) \vee \neg \text{StrFCONT}(\frac{a}{c \cup d}) \vee$

- $\neg\text{StrFCONT}(\frac{b}{c \cup d}) \vee (\text{eq} = \text{tpp}) \vee (\text{eq} = \text{tppi})$  21,10
23.  $\neg\text{Trans}(\text{tpp}, \text{tppi}, a, b, c, d)$  22,13,12,3,2
24.  $\text{EleTran}(\text{tpp}, \text{tppi}, \text{skf62}(d, c, b, a, \text{tppi}, \text{tpp}), a, b, c, d)$  Spt 17
25.  $[\text{Trans}(\text{tpp}, \text{skf62}(d, c, b, a, \text{tppi}, \text{tpp}), a, b, c, d) \vee$   
 $\text{InsRel3}(\text{tpp}, \text{tppi}, \text{skf62}(d, c, b, a, \text{tppi}, \text{tpp}), a, b, c, d)]$  24,9
26.  $[(\text{tpp} = \text{tppi}) \vee (\text{skf62}(d, c, b, a, \text{tppi}, \text{tpp}) = \text{tppi}) \vee$   
 $\text{InsRel3}(\text{tpp}, \text{tppi}, \text{skf62}(d, c, b, a, \text{tppi}, \text{tpp}), a, b, c, d)]$  24,8
27.  $(\text{skf62}(d, c, b, a, \text{tppi}, \text{tpp}) = \text{tppi})$  26,20,1
28.  $[\text{Trans}(\text{tpp}, \text{tppi}, a, b, c, d) \vee \text{InsRel3}(\text{tpp}, \text{tppi}, \text{tppi}, a, b, c, d)]$  Rew 27,25
29.  $\square$  28,23,20
30.  $\neg\text{EleTran}(\text{tpp}, \text{tppi}, \text{skf62}(d, c, b, a, \text{tppi}, \text{tpp}), a, b, c, d)$  Spt 29,24,17
31.  $\text{EleTran}(\text{skf63}(d, c, b, a, \text{tppi}, \text{tpp}), \text{tpp}, \text{tppi}, a, b, c, d)$  Spt 29,17
32.  $[(\text{tpp} = \text{tppi}) \vee (\text{skf63}(d, c, b, a, \text{tppi}, \text{tpp}) = \text{tpp}) \vee$   
 $\text{InsRel3}(\text{skf63}(d, c, b, a, \text{tppi}, \text{tpp}), \text{tpp}, \text{tppi}, a, b, c, d)]$  31,7
33.  $\text{InsRel3}(\text{skf63}(d, c, b, a, \text{tppi}, \text{tpp}), \text{tpp}, \text{tppi}, a, b, c, d) \vee$   
 $\text{Trans}(\text{skf63}(d, c, b, a, \text{tppi}, \text{tpp}), \text{tppi}, a, b, c, d)$  SHy 31,9
34.  $(\text{skf63}(d, c, b, a, \text{tppi}, \text{tpp}) = \text{tpp})$  32,19,1
35.  $\text{InsRel3}(\text{tpp}, \text{tpp}, \text{tppi}, a, b, c, d) \vee \text{Trans}(\text{tpp}, \text{tppi}, a, b, c, d)$  Rew 34,33
36.  $\square$  35,23,19

**Th133.**  $[\text{StrFCONT}(\frac{x}{z_1 \cup z_2}) \wedge \text{StrFCONT}(\frac{y}{z_1 \cup z_2})] \rightarrow \neg\text{DirTran}(\text{tpp}, \text{ntppi}, x, y, z_1, z_2)$

**Lemma 74.**  $[[\text{Trans}(\text{tpp}, \text{ntppi}, x, y, z_1, z_2) \wedge \text{StrFCONT}(\frac{x}{z_1 \cup z_2}) \wedge \text{StrFCONT}(\frac{y}{z_1 \cup z_2})] \rightarrow$   
 $\text{InsRel3}(\text{tpp}, \text{eq}, \text{ntppi}, x, y, z_1, z_2)]$

From D39, D52, D54, A22, Th74

Proof of Theorem:

Refutation Set:

1.  $\neg(\text{ntppi} = \text{tpp})$  Lemma 72
2.  $\neg(\text{tpp} = \text{eq})$  Lemma 24
3.  $\neg(\text{eq} = \text{ntppi})$  Lemma 69
4.  $\neg\text{InsRel3}(u, v, w, x, y, z, x1) \vee \text{EleTran}(u, v, w, x, y, z, x1)$  D55
5.  $\neg\text{InsRel3}(u, \text{tpp}, \text{ntppi}, v, w, x, y) \vee \neg\text{StrFCONT}(\frac{v}{x \cup y}) \vee \neg\text{StrFCONT}(\frac{w}{x \cup y})$  Th113
6.  $\neg\text{InsRel3}(u, \text{ntppi}, v, w, x, y, z) \vee \neg\text{StrFCONT}(\frac{w}{y \cup z}) \vee \neg\text{StrFCONT}(\frac{x}{y \cup z})$  Th102
7.  $[\neg\text{DirTran}(u, v, w, x, y, z) \vee$   
 $\neg\text{EleTran}(u, x1, v, w, x, y, z) \vee (x1 = u) \vee (x1 = v)]$  D56
8.  $[\neg\text{EleTran}(u, v, w, x, y, z, x1) \vee (v = w)$   
 $\vee (v = u) \vee \text{InsRel3}(u, v, w, x, y, z, x1)]$  D55
9.  $[\neg\text{EleTran}(u, v, w, x, y, z, x1) \vee \text{Trans}(u, w, x, y, z, x1)]$

- $\vee \text{InsRel3}(u, v, w, x, y, z, x1)]$  D55
10.  $\neg \text{Trans}(\text{tpp}, \text{ntppi}, u, v, w, x) \vee \neg \text{StrFCONT}(\frac{u}{w \cup x}) \vee$   
 $\neg \text{StrFCONT}(\frac{v}{w \cup x}) \vee \text{InsRel3}(\text{tpp}, \text{eq}, \text{ntppi}, u, v, w, x)$  Lemma 74
11.  $[\text{EleTran}(u, v, \text{skf62}(z, y, x, w, v, u), w, x, y, z) \vee$   
 $\text{EleTran}(\text{skf63}(z, y, x, w, v, u), u, v, w, x, y, z) \vee \neg \text{DirTran}(u, v, w, x, y, z)]$  D56
12.  $\text{StrFCONT}(\frac{a}{c \cup d})$
13.  $\text{StrFCONT}(\frac{b}{c \cup d})$
14.  $\text{DirTran}(\text{tpp}, \text{ntppi}, a, b, c, d)$

Proof:

15.  $\neg \text{InsRel3}(u, \text{ntppi}, u, a, v, c, d) \vee \neg \text{StrFCONT}(\frac{v}{c \cup d})$  12,6
16.  $\neg \text{InsRel3}(u, \text{tpp}, \text{ntppi}, a, v, c, d) \vee \neg \text{StrFCONT}(\frac{v}{c \cup d})$  12,5
17.  $[\text{EleTran}(\text{tpp}, \text{ntppi}, \text{skf62}(d, c, b, a, \text{ntppi}, \text{tpp}), a, b, c, d) \vee$   
 $\text{EleTran}(\text{skf63}(d, c, b, a, \text{ntppi}, \text{tpp}), \text{tpp}, \text{ntppi}, a, b, c, d)]$  14,11
18.  $\neg \text{EleTran}(\text{tpp}, u, \text{ntppi}, a, b, c, d) \vee (u = \text{tpp}) \vee (u = \text{ntppi})$  14,7
19.  $\neg \text{InsRel3}(u, \text{tpp}, \text{ntppi}, a, b, c, d)$  16,13
20.  $\neg \text{InsRel3}(\text{tpp}, \text{ntppi}, u, a, b, c, d)$  15,13
21.  $\neg \text{InsRel3}(\text{tpp}, u, \text{ntppi}, a, b, c, d) \vee (u = \text{tpp}) \vee (u = \text{ntppi})$  18,4
22.  $\neg \text{Trans}(\text{tpp}, \text{ntppi}, a, b, c, d) \vee \neg \text{StrFCONT}(\frac{a}{c \cup d}) \vee$   
 $\neg \text{StrFCONT}(\frac{b}{c \cup d}) \vee (\text{eq} = \text{tpp}) \vee (\text{eq} = \text{ntppi})$  21,10
23.  $\neg \text{Trans}(\text{tpp}, \text{ntppi}, a, b, c, d)$  22,13,12,2,3
24.  $\text{EleTran}(\text{tpp}, \text{ntppi}, \text{skf62}(d, c, b, a, \text{ntppi}, \text{tpp}), a, b, c, d)$  Spt 17
25.  $[\text{Trans}(\text{tpp}, \text{skf62}(d, c, b, a, \text{ntppi}, \text{tpp}), a, b, c, d) \vee$   
 $\text{InsRel3}(\text{tpp}, \text{ntppi}, \text{skf62}(d, c, b, a, \text{ntppi}, \text{tpp}), a, b, c, d)]$  24,9
26.  $[(\text{tpp} = \text{ntppi}) \vee (\text{skf62}(d, c, b, a, \text{ntppi}, \text{tpp}) = \text{ntppi}) \vee$   
 $\text{InsRel3}(\text{tpp}, \text{ntppi}, \text{skf62}(d, c, b, a, \text{ntppi}, \text{tpp}), a, b, c, d)]$  24,8
27.  $(\text{skf62}(d, c, b, a, \text{ntppi}, \text{tpp}) = \text{ntppi})$  26,1,20
28.  $[\text{Trans}(\text{tpp}, \text{ntppi}, a, b, c, d) \vee \text{InsRel3}(\text{tpp}, \text{ntppi}, \text{ntppi}, a, b, c, d)]$  Rew 27,25
29.  $\square$  28,23,20
30.  $\neg \text{EleTran}(\text{tpp}, \text{ntppi}, \text{skf62}(d, c, b, a, \text{ntppi}, \text{tpp}), a, b, c, d)$  Spt 29,17,24
31.  $\text{EleTran}(\text{skf63}(d, c, b, a, \text{ntppi}, \text{tpp}), \text{tpp}, \text{ntppi}, a, b, c, d)$  Spt 29,17
32.  $[(\text{tpp} = \text{ntppi}) \vee (\text{skf63}(d, c, b, a, \text{ntppi}, \text{tpp}) = \text{tpp}) \vee$   
 $\text{InsRel3}(\text{skf63}(d, c, b, a, \text{ntppi}, \text{tpp}), \text{tpp}, \text{ntppi}, a, b, c, d)]$  31,7
33.  $\text{InsRel3}(\text{skf63}(d, c, b, a, \text{ntppi}, \text{tpp}), \text{tpp}, \text{ntppi}, a, b, c, d) \vee$   
 $\text{Trans}(\text{skf63}(d, c, b, a, \text{ntppi}, \text{tpp}), \text{ntppi}, a, b, c, d)$  SHy 31,9
34.  $(\text{skf63}(d, c, b, a, \text{ntppi}, \text{tpp}) = \text{tpp})$  32,19,1
35.  $\text{InsRel3}(\text{tpp}, \text{tpp}, \text{ntppi}, a, b, c, d) \vee \text{Trans}(\text{tpp}, \text{ntppi}, a, b, c, d)$  Rew 34,33
36.  $\square$  35,23,19

**Th134.**  $[\text{StrFCONT}(\frac{x}{z_1 \cup z_2}) \wedge \text{StrFCONT}(\frac{y}{z_1 \cup z_2})] \rightarrow \neg \text{DirTran}(\text{tppi}, \text{ntpp}, x, y, z_1, z_2)$

**Lemma 75.**  $[\neg(\text{tppi} = \text{ntpp})]$

From D9, D10, D49

**Lemma 76.**  $[[\text{Trans}(\text{tppi}, \text{ntpp}, x, y, z_1, z_2) \wedge \text{StrFCONT}(\frac{x}{z_1 \cup z_2}) \wedge \text{StrFCONT}(\frac{y}{z_1 \cup z_2})] \rightarrow \text{InsRel3}(\text{tppi}, \text{eq}, \text{ntpp}, x, y, z_1, z_2)]$

From D39, D52, D54, A22, Th74

Proof of Theorem:

Refutation Set:

1.  $\neg(\text{tppi} = \text{ntpp})$  Lemma 75
2.  $\neg(\text{eq} = \text{tppi})$  Lemma 23
3.  $\neg(\text{ntpp} = \text{eq})$  Lemma 62
4.  $\neg \text{InsRel3}(u, v, w, x, y, z, x1) \vee \text{EleTran}(u, v, w, x, y, z, x1)$  D55
5.  $\neg \text{InsRel3}(u, \text{tppi}, \text{ntpp}, v, w, x, y) \vee \neg \text{StrFCONT}(\frac{v}{x \cup y}) \vee \neg \text{StrFCONT}(\frac{w}{x \cup y})$  Th117
6.  $\neg \text{InsRel3}(u, \text{ntpp}, v, w, x, y, z) \vee \neg \text{StrFCONT}(\frac{w}{y \cup z}) \vee \neg \text{StrFCONT}(\frac{x}{y \cup z})$  Th101
7.  $[\neg \text{DirTran}(u, v, w, x, y, z) \vee \neg \text{EleTran}(u, x1, v, w, x, y, z) \vee (x1 = u) \vee (x1 = v)]$  D56
8.  $[\neg \text{EleTran}(u, v, w, x, y, z, x1) \vee (v = w) \vee (v = u) \vee \text{InsRel3}(u, v, w, x, y, z, x1)]$  D55
9.  $[\neg \text{EleTran}(u, v, w, x, y, z, x1) \vee \text{Trans}(u, w, x, y, z, x1) \vee \text{InsRel3}(u, v, w, x, y, z, x1)]$  D55
10.  $\neg \text{Trans}(\text{tpp}, \text{ntppi}, u, v, w, x) \vee \neg \text{StrFCONT}(\frac{u}{w \cup x}) \vee \neg \text{StrFCONT}(\frac{v}{w \cup x}) \vee \text{InsRel3}(\text{tpp}, \text{eq}, \text{ntppi}, u, v, w, x)$  Lemma 76
11.  $[\text{EleTran}(u, v, \text{skf62}(z, y, x, w, v, u), w, x, y, z) \vee \text{EleTran}(\text{skf63}(z, y, x, w, v, u), u, v, w, x, y, z) \vee \neg \text{DirTran}(u, v, w, x, y, z)]$  D56
12.  $\text{StrFCONT}(\frac{a}{c \cup d})$
13.  $\text{StrFCONT}(\frac{b}{c \cup d})$
14.  $\text{DirTran}(\text{tppi}, \text{ntpp}, a, b, c, d)$

Proof:

15.  $\neg \text{InsRel3}(u, \text{ntpp}, u, a, v, c, d) \vee \neg \text{StrFCONT}(\frac{v}{c \cup d})$  12,6
16.  $\neg \text{InsRel3}(u, \text{tppi}, \text{ntpp}, a, v, c, d) \vee \neg \text{StrFCONT}(\frac{v}{c \cup d})$  12,5
17.  $[\text{EleTran}(\text{tppi}, \text{ntpp}, \text{skf62}(d, c, b, a, \text{ntpp}, \text{tppi}), a, b, c, d) \vee \text{EleTran}(\text{skf63}(d, c, b, a, \text{ntpp}, \text{tppi}), \text{tppi}, \text{ntpp}, a, b, c, d)]$  14,11
18.  $\neg \text{EleTran}(\text{tppi}, u, \text{ntpp}, a, b, c, d) \vee (u = \text{tppi}) \vee (u = \text{ntpp})$  14,7
19.  $\neg \text{InsRel3}(u, \text{tppi}, \text{ntpp}, a, b, c, d)$  16,13
20.  $\neg \text{InsRel3}(\text{tppi}, \text{ntpp}, u, a, b, c, d)$  15,13
21.  $\neg \text{InsRel3}(\text{tppi}, u, \text{ntpp}, a, b, c, d) \vee (u = \text{tppi}) \vee (u = \text{ntpp})$  18,4
22.  $\neg \text{Trans}(\text{tppi}, \text{ntpp}, a, b, c, d) \vee \neg \text{StrFCONT}(\frac{a}{c \cup d}) \vee$

	$\neg \text{StrFCONT}(\frac{b}{cud}) \vee (\text{eq} = \text{tppi}) \vee (\text{eq} = \text{ntpp})$	21,10
23.	$\neg \text{Trans}(\text{tppi}, \text{ntpp}, a, b, c, d)$	22,12,13,2,3
24.	$\text{EleTran}(\text{tppi}, \text{ntpp}, \text{skf62}(d, c, b, a, \text{ntpp}, \text{tppi}), a, b, c, d)$	Spt 17
25.	$[\text{Trans}(\text{tppi}, \text{skf62}(d, c, b, a, \text{ntpp}, \text{tppi}), a, b, c, d) \vee$ $\text{InsRel3}(\text{tppi}, \text{ntpp}, \text{skf62}(d, c, b, a, \text{ntpp}, \text{tppi}), a, b, c, d)]$	24,9
26.	$[(\text{tppi} = \text{ntpp}) \vee (\text{skf62}(d, c, b, a, \text{ntpp}, \text{tppi}) = \text{ntpp}) \vee$ $\text{InsRel3}(\text{tppi}, \text{ntpp}, \text{skf62}(d, c, b, a, \text{ntpp}, \text{tppi}), a, b, c, d)]$	24,8
27.	$(\text{skf62}(d, c, b, a, \text{ntpp}, \text{tppi}) = \text{ntpp})$	26,20,1
28.	$[\text{Trans}(\text{tppi}, \text{ntpp}, a, b, c, d) \vee \text{InsRel3}(\text{tppi}, \text{ntpp}, \text{ntpp}, a, b, c, d)]$	Rew 27,25
29.	$\square$	28,23,20
30.	$\neg \text{EleTran}(\text{tppi}, \text{ntpp}, \text{skf62}(d, c, b, a, \text{ntpp}, \text{tppi}), a, b, c, d)$	Spt 29,24,17
31.	$\text{EleTran}(\text{skf63}(d, c, b, a, \text{ntpp}, \text{tppi}), \text{tppi}, \text{ntpp}, a, b, c, d)$	Spt 29,17
32.	$[(\text{tppi} = \text{ntpp}) \vee (\text{skf63}(d, c, b, a, \text{ntpp}, \text{tppi}) = \text{tppi}) \vee$ $\text{InsRel3}(\text{skf63}(d, c, b, a, \text{ntpp}, \text{tppi}), \text{tppi}, \text{ntpp}, a, b, c, d)]$	31,7
33.	$\text{InsRel3}(\text{skf63}(d, c, b, a, \text{ntpp}, \text{tppi}), \text{tppi}, \text{ntpp}, a, b, c, d) \vee$ $\text{Trans}(\text{skf63}(d, c, b, a, \text{ntpp}, \text{tppi}), \text{ntpp}, a, b, c, d)$	SHy 31,9
34.	$(\text{skf63}(d, c, b, a, \text{ntpp}, \text{tppi}) = \text{tppi})$	32,19,1
35.	$\text{InsRel3}(\text{tppi}, \text{tppi}, \text{ntpp}, a, b, c, d) \vee \text{Trans}(\text{tppi}, \text{ntpp}, a, b, c, d)$	Rew 34,33
36.	$\square$	35,23,19



# Bibliography

- [Agouris *et al.*, 2000] P. Agouris, K. Beard, G. Mountrakis, and A. Stefanidis. Capturing and modeling geographic object change: A spatio-temporal gazetteer framework. *Photogrammetric Engineering and Remote Sensing*, 66(10):1241–1250, 2000.
- [Allen and Hayes, 1985] J. F. Allen and P. J. Hayes. A common sense theory of time. In *Proceedings of the 9th International Joint Conference on AI (IJCAI-85)*, pages 528–531, Los Angeles, USA, 1985.
- [Allen and Koomen, 1983] J. F. Allen and J. A. Koomen. Planning using a temporal world model. In *Proceedings of the 8th International Joint Conference on AI (IJCAI-83)*, pages 741–747, Karlsruhe, Germany, 1983.
- [Allen, 1981] J. F. Allen. An interval-based representation of temporal knowledge. In *Proceedings of the 7th International Joint Conference on AI (IJCAI-81)*, pages 221–226, 1981.
- [Allen, 1983] J. F. Allen. Maintaining knowledge about temporal intervals. *Communications of the ACM*, 26(11):832–843, 1983.
- [Allen, 1984] J. F. Allen. Towards a general theory of action and time. *Artificial Intelligence*, 23(2):123–154, 1984.
- [Amir and McIlraith, 2000] A. Amir and S. McIlraith. Partition-based logical reasoning. In A. G. Cohn, F. Giunchiglia, and B. Selman, editors, *Principles of Knowledge Representation and Reasoning: Proceedings of the 7th International Conference (KR-2000)*. Morgan Kaufmann, 2000.
- [Asher and Vieu, 1995] N. Asher and L. Vieu. Towards a geometry of common sense: A semantics and a complete axiomatization of mereotopology. In *Proceedings of 14th International Joint Conference on AI (IJCAI-95)*, pages 846–852, Montreal, 1995.

- [Bennett and Cohn, 1999] B. Bennett and A. G. Cohn. Multi-dimensional multi-modal logics as a framework for spatio-temporal reasoning. In *Working Notes of IJCAI-99 Workshop on Hot Topics in Spatio-Temporal Reasoning*, Stockholm, 1999.
- [Bennett *et al.*, 2000a] B. Bennett, A. G. Cohn, P. Torrini, and S. M. Hazarika. Describing rigid body motions in a qualitative theory of spatial regions. In *Proceedings of 17th National Conference on AI (AAAI-2000)*, pages 503–509, Austin, Texas, 2000.
- [Bennett *et al.*, 2000b] B. Bennett, A. G. Cohn, P. Torrini, and S. M. Hazarika. A foundation for region-based qualitative geometry. In W. Horn, editor, *Proceedings of 14th European Conference on AI (ECAI-2000)*, pages 204–208, Berlin, 2000.
- [Bennett *et al.*, 2000c] B. Bennett, A.G. Cohn, P. Torrini, and S.M. Hazarika. Region-based qualitative geometry. Technical Report 2000.07, School of Computing, University of Leeds, LS2 9JT, UK, 2000.
- [Bennett *et al.*, 2002] B. Bennett, A.G. Cohn, F. Wolter, and M. Zakharyashev. Multi-dimensional modal logic as a framework for spatio-temporal reasoning. *Applied Intelligence*, 17(3):239–251, 2002.
- [Bennett, 1994] B. Bennett. Spatial reasoning with propositional logics. In J. Doyle, E. Sandewall, and P. Torasso, editors, *Principles of Knowledge Representation and Reasoning: Proceedings of the 4th International Conference (KR-94)*, pages 51–62, San Francisco, CA., 1994. Morgan Kaufmann.
- [Bennett, 1997] B. Bennett. *Logical Representations for Automated Reasoning about Spatial Relationships*. PhD thesis, School of Computer Studies, The University of Leeds, 1997. Available from <http://www.comp.leeds.ac.uk/brandon/thesis.html>.
- [Bennett, 2001a] B. Bennett. A categorical axiomatisation of region-based geometry. *Fundamenta Informaticae*, 46(1-2):145–158, 2001.
- [Bennett, 2001b] B. Bennett. Space, time, matter and things. In C. Welty and B. Smith, editors, *Proceedings of 2nd International Conference on Formal Ontology in Information Systems (FOIS-01)*, pages 105–116. ACM, 2001.
- [Biacino and Gerla, 1991] L. Biacino and G. Gerla. Connection structures. *Notre Dame Journal of Formal Logic*, 32(2):242–247, 1991.
- [Bittner and Smith, 2003] T. Bittner and B. Smith. Granular spatio-temporal ontologies. In *AAAI Symposium: Foundations and Applications of Spatio-Temporal Reasoning (FASTR)*, pages 12–17. AAAI Press, 2003.



- [Bittner, 2002a] T. Bittner. Judgements about spatio-temporal relations. In D. Fensel, F. Guinchiglia, D. McGuinness, and Mary-Anne Williams, editors, *Principles of Knowledge Representation and Reasoning: Proceedings of 8th International Conference (KR-02)*, pages 521–532. Morgan Kaufmann, 2002.
- [Bittner, 2002b] T. Bittner. Reasoning about qualitative spatio-temporal relations at multiple levels of granularity. In F. van Harmelen, editor, *Proceedings of the 15th European Conference on AI (ECAI-02)*. IOS Press, 2002.
- [Bobrow, 1968] D. Bobrow. Natural language input for a computer problem-solving system. In M. Minsky, editor, *Semantic Information Processing*. MIT Press, Cambridge, MA, 1968.
- [Borgo *et al.*, 1996] S. Borgo, N. Guarino, and C. Masolo. A pointless theory of space based on strong connection and congruence. In L. Carlucci Aiello and J. Doyle, editors, *Principles of Knowledge Representation and Reasoning: Proceedings of the 5th International Conference (KR-96)*. Morgan Kaufmann, 1996.
- [Brajnik and Lines, 1988] G. Brajnik and M. Lines. Qualitative modeling and simulation of socio-economic phenomena. *Journal of Artificial Societies and Social Simulation*, 1(1), 1988.
- [Bruns and Egenhofer, 1996] H. T. Bruns and M. J. Egenhofer. Similarity of spatial scenes. In *Proceedings of the 7th International Symposium on Spatial Data Handling (SDH-96)*, pages 173–184. Taylor and Francis, 1996.
- [Bundy *et al.*, 1979] A. Bundy, L. Byrd, G. Luger, C. Mellish, R. Milne, and M. Palmer. MECHO : A program to solve mechanics problems. Technical Report : Working Paper 50, Department of Artificial Intelligence, Edinburgh University, 1979.
- [Caferra, 2004] R. Caferra. Automated model building. In *Applied Logic Series*, volume 31. Kluwer, 2004.
- [Carnap, 1958] R. Carnap. *Introduction to Symbolic Logic and its Applications*. Dover Publications, Inc., New York, 1958. Translated by W. H. Meyer, Univ. of Chicago and J. Wilkinson, Wesleyan Univ.
- [Charniak, 1968] E. Charniak. CARPS a program which solves calculus word problems. Technical Report MAC-TR-51, Project MAC, MIT, 1968.

- [Claramunt and Thériault, 1996] C. Claramunt and M. Thériault. Towards semantics for modelling spatio-temporal processes within GIS. In *Proceedings of 7th International Symposium on Spatial Data Handling (SDH-96)*, pages 47–63. Taylor and Francis., 1996.
- [Clarke, 1981] B. L. Clarke. A calculus of individuals based on ‘connection’. *Notre Dame Journal of Formal Logic*, 22(3):204–218, 1981.
- [Clarke, 1985] B. L. Clarke. Individuals and points. *Notre Dame Journal of Formal Logic*, 26(1):61–75, 1985.
- [Clementini and Di Felice, 1995] E. Clementini and P. Di Felice. A comparison of methods for representing topological relationships. *Information Sciences*, 3:149–178, 1995.
- [Clementini and Di Felice, 1997] E. Clementini and P. Di Felice. Approximate topological relations. *International Journal of Approximate Reasoning*, 16:173–204, 1997.
- [Clementini *et al.*, 1994] E. Clementini, J. Sharma, and M. J. Egenhofer. Modeling topological spatial relations: strategies for query processing. *Computers and Graphics*, 18(6):815–822, 1994.
- [Clementini *et al.*, 1997] E. Clementini, P. Di Felice, and D. Hernández. Qualitative representation of positional information. *Artificial Intelligence*, 95(2):317–356, 1997.
- [Cohn and Gotts, 1996] A. G. Cohn and N. M. Gotts. Representing spatial vagueness: A Mereological Approach. In L. C. Aiello, J. Doyle, and S. Shapiro, editors, *Principles of Knowledge Representation and Reasoning: Proceedings of the 5th International Conference (KR-96)*, pages 230–241. Morgan Kaufmann, 1996.
- [Cohn and Hazarika, 2001a] A. G. Cohn and S. M. Hazarika. Continuous transitions in mereotopology. In *Working Notes of Commonsense-2001: 5th Symposium on Logical Formalizations of Commonsense Reasoning*, pages 71–80, New York, 2001.
- [Cohn and Hazarika, 2001b] A. G. Cohn and S. M. Hazarika. Qualitative spatial representation and reasoning: an overview. *Fundamenta Informaticae*, 46(1-2):1–29, 2001.
- [Cohn and Varzi, 1998] A. G. Cohn and A. Varzi. Connection relations in mereotopology. In H. Prade, editor, *Proceedings of the 13th European Conference on AI (ECAI-98)*, pages 150–154. John Wiley & Sons, 1998.
- [Cohn and Varzi, 2003] A. G. Cohn and A. Varzi. Mereotopological connection. *Journal of Philosophical Logic*, 32:357–390, 2003.

- [Cohn *et al.*, 1994] A. G. Cohn, J. M. Gooday, and B. Bennett. A comparison of structures in spatial and temporal logics. In R. Casati, B. Smith, and G. White, editors, *Philosophy and the Cognitive Sciences: Proceedings of the 16th International Wittgenstein Symposium*, Vienna, 1994. Hölder-Pichler-Tempsky.
- [Cohn *et al.*, 1997a] A. G. Cohn, B. Bennett, J. Gooday, and N. Gotts. Representing and reasoning with qualitative spatial relations about regions. In O. Stock, editor, *Spatial and Temporal Reasoning*, pages 97–134. Kluwer, 1997.
- [Cohn *et al.*, 1997b] A. G. Cohn, B. Bennett, J. Gooday, and N. M. Gotts. RCC: A Calculus for Region based Qualitative Spatial Reasoning. *GeoInformatica*, 1(3):275–316, 1997.
- [Cohn *et al.*, 1998] A. G. Cohn, N. M. Gotts, Z. Cui, D. A. Randell, B. Bennett, and J. M. Gooday. Exploiting temporal continuity in qualitative spatial calculi. In M. J. Egenhofer and R. G. Golledge, editors, *Spatial and Temporal Reasoning in Geographical Information Systems*, pages 5–24. Oxford University Press, 1998.
- [Cohn, 1983] A. G. Cohn. *Mechanising a particularly expressive many sorted logic*. PhD thesis, University of Essex, 1983.
- [Cohn, 1987] A. G. Cohn. A more expressive formulation of many sorted logic. *Journal of Automated Reasoning*, 3:113–200, 1987.
- [Cohn, 1995] A. G. Cohn. A hierarchical representation of qualitative shape based on connection and convexity. In A. M. Frank and W. Kuhn, editors, *Spatial Information Theory: A Theoretical Basis for GIS (COSIT-95)*, number 988 in Lecture Notes in Computer Science, pages 311–326. Springer Verlag, 1995.
- [Cohn, 1997] A. G. Cohn. Qualitative spatial representation and reasoning techniques. In G. Brewka, C. Habel, and B. Nebel, editors, *KI-97: Advances in Artificial Intelligence*, number 1303 in Lecture Notes in Artificial Intelligence, pages 1–30. Springer Verlag, 1997.
- [Cohn, 1999] A. G. Cohn. Qualitative spatial representations. In *Working Notes of IJCAI-99 Workshop on Adaptive Spatial Representations of Dynamic Environment*, pages 33–52, 1999.
- [Cohn, 2001] A. G. Cohn. Formalising bio-spatial knowledge. In C. Welty and B. Smith, editors, *Proceedings of 2nd International Conference on Formal Ontology in Information Systems (FOIS-01)*, pages 198–209. ACM, 2001.

- [Cristani *et al.*, 2000] M. Cristani, A. G. Cohn, and B. Bennett. Spatial locations via morpho-mereology. In A. G. Cohn, F. Giunchiglia, and B. Selman, editors, *Principles of Knowledge Representation and Reasoning: Proceedings of the 7th International Conference (KR-2000)*, pages 15–25. Morgan Kaufmann, 2000.
- [Cui *et al.*, 1992] Z. Cui, A. G. Cohn, and D. A. Randell. Qualitative simulation based on a logical formalism of space and time. In *Proceedings of the 10th National Conference on AI (AAAI-92)*, pages 679–684, Menlo Park, California, 1992. AAAI Press.
- [Davis and Morgenstern, 2004] E. Davis and L. Morgenstern. A first-order theory of communication and multi-agent plans. *Journal of Logic and Computation*, 2004. To appear.
- [Davis *et al.*, 1999] E. Davis, N. M. Gotts, and A. G. Cohn. Constraint networks of topological relations and convexity. *Constraints*, 4(3):241–280, 1999.
- [Davis, 1990] E. Davis. *Representations of Commonsense Knowledge*. Morgan Kaufmann, San Mateo, California, 1990.
- [Davis, 2000] E. Davis. Describing spatial transitions using mereotopological relations over histories. Technical Report TR2000-809, Courant Institute, New York University, 2000.
- [Davis, 2001] E. Davis. Continuous shape transformation and metrics of shape. *Fundamenta Informaticae*, 46(1-2):31–54, 2001.
- [de Kleer, 1975] J. de Kleer. Qualitative and Quantitative knowledge in classical mechanics. Technical Report AI Lab TR-352, M.I.T, 1975.
- [De Laguna, 1922] T. De Laguna. Point, line and surface as sets of solids. *The Journal of Philosophy*, 19:449–461, 1922.
- [Dornheim, 1995] C. Dornheim. Vergleichende analyse topologischer ansaetze des qualitativen raeumlichen siessens. Studienarbeit, Fachereich Informatik, Universitaet Hamburg, 1995.
- [Düntsche *et al.*, 2001] I. Düntsche, H. Wang, and S. McCloskey. A relation-algebraic approach to Region Connection Calculus. *Theoretical Computer Science*, 255:63–83, 2001.
- [Egenhofer and Al-Taha, 1992] M. J. Egenhofer and K. K. Al-Taha. Reasoning about gradual changes of topological relationships. In A. U. Frank, I. Campari, and U. Formentini, editors, *Theories and Methods of Spatio-temporal Reasoning in Geographic Space*, number 639 in Lecture Notes in Computer Science, pages 196–219. Springer-Verlag, Berlin, 1992.

- [Egenhofer and Franzosa, 1991] M. J. Egenhofer and R. Franzosa. Point-set topological spatial relations. *International Journal of Geographical Information Systems*, 5(2):161–174, 1991.
- [Egenhofer and Franzosa, 1995] M. J. Egenhofer and R. D. Franzosa. On the equivalence of topological relations. *International Journal of Geographical Information Systems*, 9(2):133–152, 1995.
- [Egenhofer and Golledge, 1998] M. J. Egenhofer and R. G. Golledge, editors. *Spatial and Temporal Reasoning in Geographic Information Systems*. Spatial Information Series. Oxford University Press, 1998.
- [Egenhofer and Herring, 1994] M. J. Egenhofer and J. Herring. Categorizing topological spatial relationships between point, line and area objects. In *The 9-intersection: formalism and its use for natural language spatial predicates*. Technical Report 94-1, National Center for Geographic Information and Analysis, Santa Barbara, 1994.
- [Egenhofer and Sharma, 1993] M. J. Egenhofer and J. Sharma. Topological relations between regions in  $R^2$  and  $Z^2$ . In D. Abel and B. C. Ooi, editors, *Proceedings of the 3rd International Symposium on Advances in Spatial Databases (SSD-93)*, Singapore, number 692 in Lecture Notes Computer Science, June 1993.
- [Egenhofer *et al.*, 1994] M. J. Egenhofer, E. Clementini, and P. Di Felice. Topological relations between regions with holes. *International Journal of Geographical Information Systems*, 8(2):129–144, 1994.
- [Egenhofer, 1989] M. J. Egenhofer. A formal definition of binary topological relationships. In W. Litwin and H. Schek, editors, *Third International Conference on Foundations of Data Organization and Algorithms*, number 367 in Lecture Notes in Computer Science, pages 457–472. Springer Verlag, 1989.
- [Egenhofer, 1994] M. J. Egenhofer. Topological similarity. In *Proceedings of the FISU workshop on the Topological Foundations of Cognitive Science*, volume 37 of *Reports of the Doctoral Series in Cognitive Science*. University of Hamburg, 1994.
- [El-Geresy *et al.*, 2000] B. A. El-Geresy, A. I. Abdelmoty, and C. B. Jones. Episodes in space: Qualitative representation and reasoning over spatio-temporal objects. *International Journal on Artificial Intelligence Tools*, 9(1):131–152, 2000.

- [Eschenbach and Heydrich, 1995] C. Eschenbach and W. Heydrich. Classical mereology and restricted domains. *International Journal of Human-Computer Studies*, 43:723–740, 1995.
- [Escrig and Toledo, 1998a] M. T. Escrig and F. Toledo. A framework based on CLP extended with CHRs for reasoning with qualitative orientation and positional information. *Journal of Visual Languages and Computing*, 9:81–101, 1998.
- [Escrig and Toledo, 1998b] M. T. Escrig and F. Toledo. *Qualitative Spatial Reasoning: Theory and Practice - Application to Robot Navigation*, volume 47 of *Frontiers in AI and applications*. IOS Press, Amsterdam, 1998.
- [Fernyhough *et al.*, 1996] J. Fernyhough, A. G. Cohn, and D. C. Hogg. Real time generation of semantic regions from video sequences. In *Proc. ECCV96*, LNCS. Springer Verlag, 1996.
- [Fernyhough *et al.*, 2000] J. H. Fernyhough, A. G. Cohn, and D. C. Hogg. Constructing qualitative event models automatically from video input. *Image and Vision Computing*, 18(2):81–103, 2000.
- [Forbus *et al.*, 1987] K. D. Forbus, P. Nielsen, and B. Faltings. Qualitative kinematics: A framework. In *Proceedings of 10th International Joint Conference on AI (IJCAI-87)*, pages 430–436, 1987.
- [Forbus, 1980] K. D. Forbus. Spatial and qualitative aspects of reasoning about motion. In *Proceedings 1st National Conference on AI (AAAI-80)*, 1980.
- [Forbus, 1983] K. D. Forbus. Qualitative reasoning about space and motion. In D. Gentner and A. L. Stevens, editors, *Mental Models*, pages 53–73. Erlbaum, Hillsdale, NJ, 1983.
- [Forbus, 1984] K. D. Forbus. Qualitative Process Theory. *Artificial Intelligence*, 24:85–168, 1984.
- [Forbus, 1989] K. D. Forbus. Qualitative Physics: Past, Present and Future. In D. S. Weld and J. de Kleer, editors, *Readings in Qualitative Reasoning about Physical Systems*, pages 11–3. Morgan Kaufmann, 1989.
- [Frank, 1992] A. Frank. Qualitative spatial reasoning about distance and directions in geographic space. *Journal of Visual Languages and Computing*, 3:343–373, 1992.
- [Freksa, 1992] C. Freksa. Temporal reasoning based on semi-intervals. *Artificial Intelligence*, 54:199–227, 1992.

- [Gabbay *et al.*, 1994] D. M. Gabbay, I. Hodkinson, and M. Reynolds. *Temporal Logic: mathematical foundations and computational aspects*, volume I. Clarendon Press, Oxford, 1994.
- [Galata *et al.*, 2002] A. Galata, A. G. Cohn, D. Magee, and D. Hogg. Modeling interaction using learnt qualitative spatio-temporal relations and variable length markov models. In F. van Harmelen, editor, *Proceedings of the 15th European Conference on AI (ECAI-02)*, pages 741–745, 2002.
- [Galton and Meathrel, 1999] A. P. Galton and R. Meathrel. Qualitative Outline Theory. In *Proceedings of 16th International Joint Conference on AI (IJCAI-99)*, pages 1061–1066, 1999.
- [Galton, 1993] A. P. Galton. Towards an integrated logic of space, time and motion. In *Proceedings of International Joint Conference on AI (IJCAI-93)*, pages 1550–1555, 1993.
- [Galton, 1995] A. P. Galton. Towards a qualitative theory of movement. In W. Kuhn A. U. Frank, editor, *Spatial Information Theory: A Theoretical Basis for GIS (COSIT-95)*, number 988 in Lecture Notes in Computer Science, pages 377–396, Berlin, 1995. Springer.
- [Galton, 1996] A. P. Galton. Taking dimension seriously in qualitative spatial reasoning. In W. Wahlster, editor, *Proceedings of the 12th European Conference on AI (ECAI-96)*, pages 501–505. John Wiley & Sons, 1996.
- [Galton, 1997a] A. P. Galton. Continuous change in spatial regions. In S. C. Hirtle and A. U. Frank, editors, *Spatial Information Theory: A Theoretical Basis for GIS (COSIT-97)*, number 1329 in Lecture Notes in Computer Science, pages 1–13. Springer, 1997.
- [Galton, 1997b] A. P. Galton. Space, time and movement. In Olivero Stock, editor, *Spatial and Temporal Reasoning*, pages 321–352. Kluwer, Dordrecht, 1997.
- [Galton, 1999] A. P. Galton. The mereotopology of discrete space. In C. Freksa and D. M. Mark, editors, *Spatial Information Theory: Cognitive and Computational Foundations of Geographic Information Science (COSIT-99)*, number 1661 in Lecture Notes in Computer Science, pages 251–266, 1999.
- [Galton, 2000a] A. P. Galton. *Qualitative Spatial Change*. Oxford University Press, 2000.

- [Galton, 2000b] A. P. Galton. Transitions in continuous time, with an application to qualitative changes in spatial relations. In H. Barringer et al., editor, *Advances in Temporal Logic*, pages 279–297. Kluwer, 2000.
- [Galton, 2001] A. P. Galton. Dominance diagrams: A tool for qualitative reasoning about continuous systems. *Fundamenta Informaticae*, 46(1-2):55–70, 2001.
- [Gooday and Cohn, 1996] J. Gooday and A. G. Cohn. Transition-based qualitative simulation. In *Proceeding of the 10th International Workshop on Qualitative Reasoning*, pages 74–82. AAAI press, 1996.
- [Goodman and Pollack, 1993] J. Goodman and R. Pollack. Allowable sequences and order types in discrete and computational geometry. In J. Pach, editor, *New Trends in Discrete and Computational Geometry*, pages 103–134. Springer-Verlag, 1993.
- [Gotts et al., 1996] N. M. Gotts, J. M. Gooday, and A. G. Cohn. A connection based approach to common-sense topological description and reasoning. *The Monist*, 79(1):51–75, 1996.
- [Gotts, 1994a] N. M. Gotts. Defining a ‘doughnut’ made difficult. In C. Eschenbach, C. Habel, and B. Smith, editors, *Topological Foundations of Cognitive Science*, volume 37 of *Reports of the Doctoral Series in Cognitive Science*. University of Hamburg, 1994.
- [Gotts, 1994b] N. M. Gotts. How far can we C? Defining a ‘doughnut’ using connection alone. In E Sandewall J Doyle and P Torasso, editors, *Principles of Knowledge Representation and Reasoning: Proceedings of the 4th International Conference (KR-94)*. Morgan Kaufmann, 1994.
- [Gotts, 1996a] N. M. Gotts. An axiomatic approach to topology for spatial information systems. Technical Report 96.25, School of Computer Studies, University of Leeds, 1996.
- [Gotts, 1996b] N. M. Gotts. Formalising commonsense topology: The INCH calculus. In *Proceedings of Fourth International Symposium on Artificial Intelligence and Mathematics*, 1996.
- [Gotts, 1996c] N. M. Gotts. Topology from a single primitive relation: defining topological properties and relations in terms of connection. Technical Report 96.23, School of Computer Studies, University of Leeds, 1996.



- [Gotts, 1996d] N. M. Gotts. Using the RCC formalism to describe the topology of spherical regions. Technical Report 96.24, School of Computer Studies, University of Leeds, 1996.
- [Guesgen and Hertzberg, 1992] H. Guesgen and J. Hertzberg. A constraint-based approach to spatio-temporal reasoning. *Journal of Applied Intelligence*, 3:71–90, 1992.
- [Haarslev *et al.*, 1999] V. Haarslev, C. Lutz, and R. Möller. A description logic with concrete domains and role-forming predicates. *Journal of Logic and Computation*, 9(3), 1999.
- [Hägerstrand, 1967] T. Hägerstrand. *Innovation diffusion as a spatial process*. Chicago: University of Chicago Press, 1967.
- [Hamblin, 1971] C. L. Hamblin. Instants and intervals. *Studium Generale*, 24:127–134, 1971.
- [Hayes, 1979] P. J. Hayes. The Naive Physics Manifesto. In D. Mitchie, editor, *Expert systems in the micro-electronic age*. Edinburgh University Press, 1979.
- [Hayes, 1985a] P. J. Hayes. Naive Physics I: Ontology for Liquids. In J. R. Hubbs and R. C. Moore, editors, *Formal Theories of the Commonsense World*, pages 71–89. Ablex Publishing Corporation, Norwood, NJ, 1985.
- [Hayes, 1985b] P. J. Hayes. The Second Naive Physics Manifesto. In J. R. Hubbs and R. C. Moore, editors, *Formal Theories of the Commonsense World*. Ablex Publishing Corporation, Norwood, NJ, 1985.
- [Hays, 1989] E. Hays. On defining motion verbs and spatial prepositions. Technical report, Universitat des Saarlandes, 1989.
- [Hazarika and Cohn, 2001] S. M. Hazarika and A. G. Cohn. Qualitative spatio-temporal continuity. In D. R. Montello, editor, *Spatial Information Theory: Foundations of GIS(COSIT-01)*, number 2205 in Lecture Notes in Computer Science, pages 92–107. Springer, 2001.
- [Hazarika and Cohn, 2002] S. M. Hazarika and A. G. Cohn. Abducing qualitative spatio-temporal histories from partial observations. In D. Fensel, F. Guinchiglia, D. McGuinness, and Mary-Anne Williams, editors, *Principles of Knowledge Representation and Reasoning: Proceedings of the 8th International Conference (KR-02)*, pages 14–25. Morgan Kaufmann, 2002.

- [Heller, 1990] M. Heller. *The Ontology of Physical Objects: Four Dimensional Hunks of Matter*. Cambridge University Press, Cambridge, 1990.
- [Hernández *et al.*, 1995] D. Hernández, E. Clementini, and P. Di Felice. Qualitative distances. In A. U. Frank and W. Kuhn, editors, *Spatial Information Theory: A Theoretical Basis for GIS (COSIT-95)*, number 988 in Lecture Notes in Computer Science, pages 45–58, Berlin, 1995. Springer Verlag.
- [Hernández, 1994] D. Hernández. *Qualitative Representation of Spatial Knowledge*. Number 804 in Lecture Notes in Artificial Intelligence. Springer-Verlag, 1994.
- [Hornsby and Egenhofer, 2000] K. Hornsby and M. J. Egenhofer. Identity-based changes: A foundation for spatio-temporal knowledge representation. *International Journal of Geographical Information Science*, 14(3):207–224, 2000.
- [Isli and Cohn, 1998] A. Isli and A. G. Cohn. An algebra for cyclic ordering of 2D orientations. In *Proceedings of the 15th National Conference on AI (AAAI-98)*, pages 643–649, Madison, WI, 1998.
- [Isli and Cohn, 2000] A. Isli and A.G. Cohn. A new approach to cyclic ordering of 2D orientations using ternary relation algebras. *Artificial Intelligence*, 122(1–2):137–187, 2000.
- [Isli and Moratz, 1999] A. Isli and R. Moratz. Qualitative spatial representation and reasoning: algebraic models for relative position. Technical report, Fachbereich Informatik, Universitaet Hamburg, 1999.
- [Kamp, 1979] H. Kamp. Events, instants and temporal reference. In Von Stechow Bäuerle, editor, *Meaning, Use and Interpretation of Language*, pages 376–417. de Gruyter, Berlin, 1979.
- [Kesten *et al.*, 1993] Y. Kesten, Z. Manna, H. Mc Guire, and A. Pnueli. A decision algorithm for full propositional temporal logic. In C. Courcoubetis, editor, *Computer Aided Verification*, pages 97–109. Springer-Verlag, Berlin, 1993.
- [Knauff *et al.*, 1998] M. Knauff, R. Rauh, C. Schlieder, and G. Strube. Mental models in spatial reasoning. In C. Freksa, C. Habel, and K. F. Wender, editors, *Spatial Cognition*, number 1404 in Lecture Notes in Artificial Intelligence, pages 267–292. Springer, 1998.
- [Konolige, 1988] K. Konolige. Belief and incompleteness. In J. R. Hobbs and R. C. Moore, editors, *Formal Theories of the Commonsense World*, pages 359–403. Ablex Publishing Corporation, New Jersey, 1988.

- [Ladkin and Maddux, 1988] P. Ladkin and R. Maddux. Representation and reasoning with convex time intervals. Technical Report KES.U.88.2, Kestrel Institute, 1988.
- [Ladkin, 1987] P. Ladkin. *The Logic of Time Representation*. PhD thesis, University of California, Berkeley, November 1987. Kestrel Institute Report KES.U.87.13.
- [Lemon and Pratt, 1998] O. Lemon and I. Pratt. On the incompleteness of modal logics of space: advancing complete modal logics of place. In M. Karcht, M. de Rijke, H. Wansing, and M. Zakharyashev, editors, *Advances in Modal Logic*, volume 1, pages 115–132. CSLI Publications, 1998.
- [Leonard and Goodman, 1940] H. S. Leonard and N. Goodman. The calculus of individuals and its uses. *Journal of Symbolic Logic*, 5:45–55, 1940.
- [Leśniewski, 1927 1931] S. Leśniewski. O podstawach matematyki. *Przegląd Filozoficzny*, 30-34, 1927-1931.
- [Leyton, 1988] M. Leyton. A Process Grammar for Shape. *Artificial Intelligence*, 34:213–247, 1988.
- [Lifschitz, 1994] V. Lifschitz. Circumscription. In D. M. Gabbay, C. J. Hogger, and J. A. Robinson, editors, *Handbook of Logic in Artificial Intelligence and Logic Programming*, volume 4, pages 297–352. Oxford Science Publications, 1994.
- [Ligozat, 1994] G. Ligozat. Towards a general characterization of conceptual neighbourhoods in temporal and spatial reasoning. In F. D. Anger and R. Loganatharajah, editors, *Proceedings AAAI-94 Workshop on Spatial and Temporal Reasoning*, 1994.
- [Liu, 1998] J. Liu. A method of spatial reasoning based on qualitative trigonometry. *Artificial Intelligence*, 98:137–168, 1998.
- [Lundell, 1996] M. Lundell. A qualitative model of physical fields. In *Proceedings of the 13th National Conference on AI (AAAI-96)*, pages 1016–1021. AAAI press, 1996.
- [Masolo and Vieu, 1999] C. Masolo and L. Vieu. Atomicity vs. infinite divisibility of space. In C. Freksa and D. M. Mark, editors, *Spatial Information Theory - Cognitive and Computational Foundations of Geographic Information Science (COSIT-99)*, number 1661 in Lecture Notes in Computer Science, pages 235–250, 1999.
- [Mavrouniotis and Stephanopoulos, 1988] M. Mavrouniotis and G. Stephanopoulos. Formal order-of-magnitude reasoning in process engineering. *Computers and Chemical Engineering*, 12:867–881, 1988.

- [McCarthy, 1959] J. McCarthy. Programs with common senses. In *Proceedings of Symposium on Mechanization of Thought Processes*, 1959. Available from web <http://www-formal.stanford.edu/jmc/mcc59.pdf>.
- [McCarthy, 1980] J. McCarthy. Circumscription: A form of non-monotonic reasoning. *Artificial Intelligence*, 13(1):27–39, 1980.
- [McCune, 1994] W. McCune. OTTER 3.0 Reference Manual and Guide. Technical Report ANL/94-6, Argonne National Laboratory, Argonne, Illinois, 1994. OTTER is available from <http://www-unix.mcs.anl.gov/AR/otter/>.
- [McCune, 2001] W. McCune. MACE 2.0 Reference Manual and Guide. Technical Report ANL/MCS-TM-249, Argonne National Laboratory, Argonne, Illinois, 2001. MACE is available from <http://www-unix.mcs.anl.gov/AR/mace/>.
- [Meathrel and Galton, 2000] R. Meathrel and A. P. Galton. Qualitative representation of planar outlines. In W. Horn, editor, *Proceedings of 14th European Conference on AI (ECAI-2000)*, pages 224–228, 2000.
- [Meathrel, 2001] R. Meathrel. *A general theory of boundary-based qualitative representation of two-dimensional shape*. PhD thesis, Department of Computer Science, School of Engineering and Computer Science, University of Exeter, 2001.
- [Mukerjee and Joe, 1990] A. Mukerjee and G. Joe. A qualitative model for space. In *Proceedings of the 8th National Conference on AI (AAAI-90)*, volume 2, pages 721–727, Menlo Park, 1990.
- [Muller, 1998a] P. Muller. *Éléments d’une théorie du mouvement pour la formalisation du raisonnement spatio-temporel de sens commun*. PhD thesis, Université Paul Sabatier - Toulouse III, 1998.
- [Muller, 1998b] P. Muller. A qualitative theory of motion based on spatio-temporal primitives. In A. G. Cohn, L. Schubert, and S. Shapiro, editors, *Principles of Knowledge Representation and Reasoning: Proceedings of 6th International Conference (KR-98)*, pages 131–141. Morgan Kaufman, 1998.
- [Muller, 1998c] P. Muller. Space-time as a primitive for space and motion. In N. Guarino, editor, *Formal ontology in Information Systems*, volume 46 of *Frontiers in Artificial Intelligence and Applications*, pages 63–76, Trento, Italy, June 1998. IOS Press.
- [Muller, 2002] P. Muller. Topological spatio-temporal reasoning and representation. *Computational Intelligence*, 18(3):420–450, 2002.

- [Musto *et al.*, 1999] A. Musto, K. Stein, K. Schill, A. Eisenkolb, and W. Brauer. Qualitative motion representation in egocentric and allocentric frames of reference. In C. Freksa and D. M. Mark, editors, *Spatial Information Theory - Cognitive and Computational Foundations of Geographic Information Science (COSIT-99)*, number 1661 in Lecture Notes in Computer Science, pages 461–476. Springer, 1999.
- [Nicod, 1924] J. Nicod. *Geometry in the Sensible World*. PhD thesis, Sorbonne, 1924. English translation in *Geometry and Induction*, Routledge and Kegan Paul, 1969.
- [Novak, 1976] G. Novak. *Computer Understanding of Physics Problems Stated in natural Language*. PhD thesis, Department of Computer Science, University of Texas at Austin, 1976.
- [Peltier, 2003] N. Peltier. Model building with ordered resolution: extracting models from saturated clause sets. *J. Symb. Comput.*, 36(1-2):5–48, 2003.
- [Peuquet, 1999] D. J. Peuquet. Making space for time: Issues in space-time data representation. In *Proceedings of the 10th International Workshop on Database and Expert Systems Applications*, pages 404–408, 1999.
- [Piaget and Inhelder, 1967] J. Piaget and B. Inhelder. *The Child's Conception of Space*. Basic Books, New York, 1967.
- [Pinhanez and Bobick, 1996] C. Pinhanez and A. Bobick. Approximate world models: Incorporating qualitative and linguistic information into vision systems. In *Proceedings of 13th National Conference on AI (AAAI'96)*, pages 1116–1123, Portland, Oregon, 1996.
- [Plaisted, 1986] D. Plaisted. A decision procedure for combination of propositional temporal logic and other specialized theories. *Journal of Automated Reasoning*, 2:171–190, 1986.
- [Pratt and Lemon, 1997] I. Pratt and O. Lemon. Ontologies for Plane, Polygonal Mereotopology. *Notre Dame Journal of Formal Logic*, 38(2):225–245, 1997.
- [Pratt and Schoop, 1998] I. Pratt and D. Schoop. A complete axiom system for polygonal mereotopology of the plane. *Journal of Philosophical Logic*, 28(6), 1998.
- [Quine, 1960] Quine. *Word and Object*. MIT Press, 1960.
- [Raiman, 1986] O. Raiman. Order of magnitude reasoning. In *Proceedings of the National Conference on AI (AAAI-86)*, pages 100–104, 1986.

- [Rajagopalan and Kuipers, 1994] R. Rajagopalan and B. Kuipers. Qualitative spatial reasoning about objects in motion: application to physics problem solving. In *IEEE Conference on Artificial Intelligence for Applications*, San Antonio, TX, 1994.
- [Randell and Cohn, 1989] D. A. Randell and A. G. Cohn. Modelling topological and metrical properties of physical processes. In R. Brachman, H. Levesque, and R. Reiter, editors, *Principles of Knowledge Representation and Reasoning: Proceedings 1st International Conference (KR-89)*, pages 55–66. Morgan Kaufmann, 1989.
- [Randell and Cohn, 1992] D. A. Randell and A. G. Cohn. Exploiting lattices in a theory of space and time. *Computers and Mathematics with Applications*, 23(6–9):459–476, 1992.
- [Randell *et al.*, 1992a] D. A. Randell, A. G. Cohn, and Z. Cui. Naive topology: Modelling the force pump. In P. Struss and B. Faltings, editors, *Advances in Qualitative Physics*, pages 177–192. MIT Press, 1992.
- [Randell *et al.*, 1992b] D. A. Randell, Z. Cui, and A. G. Cohn. A spatial logic based on regions and connection. In B. Nebel, C. Rich, and W. Swartout, editors, *Proceedings of 3rd International Conference on Knowledge Representation and Reasoning (KR-92)*, pages 165–176. Morgan Kaufmann, 1992.
- [Ray, 1998] C. Ray. *Identity and Universals: A Conceptualist Approach to Logical, Metaphysical, and Epistemological Problems of Contemporary Identity Theory*. PhD thesis, Indiana University, Bloomington, 1998.
- [Reif and Schellhorn, 1997] W. Reif and G. Schellhorn. Theorem proving in large theories. In M. P. Bonacina and U. Furbach, editors, *Int. Workshop on First-Order Theorem Proving, (FTP-97)*, pages 119–124. Johannes Kepler Universität, Linz (Austria), 1997.
- [Renz and Nebel, 1998] J. Renz and B. Nebel. A canonical model of the Region Connection Calculus. In A. G. Cohn, L. Schubert, and S. Shapiro, editors, *Principles of Knowledge Representation and Reasoning: Proceedings of the 6th International Conference (KR-98)*, pages 330–341. Morgan Kaufman, 1998.
- [Renz and Nebel, 1999] J. Renz and B. Nebel. On the complexity of qualitative spatial reasoning: A maximal tractable fragment of the region connection calculus. *Artificial Intelligence*, 108(1-2):69–123, 1999.

- [Requicha and Boelcke, 1992] A. G. Requicha and H. B. Boelcke. Solid modelling: a historical summary and a contemporary assessment. *IEEE Computer Graphics and Applications*, 2:9–24, 1992.
- [Richards and Hoffman, 1985] W. Richards and D. D. Hoffman. Codon constraints on closed 2D shapes. *Computer Vision, Graphics and Image Processing*, 31:265–281, 1985.
- [Röhrig, 1994] R. Röhrig. A theory for qualitative spatial reasoning based on order relations. In *Proceedings of the 12th National Conference on AI (AAAI-94)*, volume 2, pages 1418–1423, Seattle, 1994.
- [Roy and Stell, 2002] A. J. Roy and J. G. Stell. A qualitative account of discrete space. In M. J. Egenhofer and D. M. Mark, editors, *Proceedings of GIScience 2002*, volume 2478 of *Lecture Notes in Computer Science*, pages 276–290. Springer-Verlag, 2002.
- [Russell, 1914] B. A. W. Russell. *Our Knowledge of the External World*. Routledge, 1914.
- [Sandewall, 1989] E. Sandewall. Filter preferential entailment for the logic of action in almost continuous worlds. In *Proceedings of 11th International Conference on Artificial Intelligence (IJCAI-89)*, pages 894–899, 1989.
- [Sandewall, 1994] E. Sandewall. *Features and Fluents: The Representation of Knowledge about Dynamical Systems*, volume I. Oxford University Press, 1994.
- [Schlieder, 1993] C. Schlieder. Representing visible locations for qualitative navigation. In N. Piera Carreté and M. G. Singh, editors, *Qualitative Reasoning and Decision Technologies*, pages 523–532, Barcelona, 1993.
- [Schlieder, 1995] C. Schlieder. Reasoning about ordering. In A. U. Frank and W. Kuhn, editors, *Spatial Information Theory: A Theoretical Basis for GIS (COSIT-95)*, number 988 in *Lecture Notes in Computer Science*, pages 341–349, Berlin, 1995. Springer Verlag.
- [Shanahan, 1997] M. Shanahan. *Solving the Frame Problem: a mathematical investigation of the common sense law of inertia*. The MIT Press, Cambridge, Massachusetts, 1997.
- [Shanahan, 1998] M. Shanahan. A logical account of the common sense informatic situation for a mobile robot. *Electronic Transactions on Artificial Intelligence*, 2:69–104, 1998.
- [Simons, 1987] P. Simons. *Parts: A Study In Ontology*. Clarendon Press, Oxford, 1987.
- [Sklansky, 1972] J. Sklansky. Measuring concavity on a rectangular mosaic. *IEEE Transactions on Computers*, C-21(12):1355–1364, 1972.

- [Smith, 1997] B. Smith. Boundaries: An essay in mereotopology. In L. H. Hahn, editor, *The Philosophy of Roderick Chisholm*, Library of Living Philosophers, pages 534–561. Open Court, Chicago and La Salle, 1997.
- [Stell and Worboys, 1997] J. G. Stell and M. F. Worboys. The algebraic structure of sets of regions. In S. C. Hirtle and A. U. Frank, editors, *Spatial Information Theory: A Theoretical Basis for GIS (COSIT-97)*, number 1329 in Lecture Notes in Computer Science, pages 163–174. Springer, 1997.
- [Tarski, 1929] A. Tarski. Les fondements de la géométrie des corps. *Księga Pamiatkowa Pierwszego Polskiego Zjazdu Matematycznego*, pages 29–33, 1929. A suplement to *Annales de la Société Polonaise de Mathématique*. English translation, ‘Foundations of the Geometry of Solids’, in A. Tarski, *Logic, Semantics, Metamathematics*, Oxford Clarendon Press, 1956.
- [Tarski, 1959] A. Tarski. What is elementary geometry? In L. E. J. Brouwer, E. W. Beth, and A. Heyting, editors, *The Axiomatic Method (with special reference to geometry and physics)*, pages 16–29, Amsterdam, 1959. North-Holland.
- [Thomson, 1983] J. J. Thomson. Parthood and identity across time. *Journal of Philosophy*, 80:201–220, 1983.
- [van Benthem, 1983] J. van Benthem. *The Logic of Time*. D. Reidel Publishing Company, Dordrecht, Holland, 1983.
- [van Benthem, 1996] J. van Benthem. Temporal logic. In D. M. Gabbay, C. J. Hogger, and J. A. Robinson, editors, *Handbook of Logic in Artificial Intelligence and Logic Programming*, volume 4. Oxford Scientific Publishers, 1996.
- [Varzi, 1994] A. C. Varzi. On the boundary between mereology and topology. In R. Casati, B. Smith, and G. White, editors, *Philosophy and the Cognitive Sciences: Proceedings of the 16th Wittgenstein Symposium*. Hölder-Pichler-Tempsky, Vienna, 1994, 1994.
- [Varzi, 1996] A. C. Varzi. Parts, wholes and part-whole relations: the prospects of mereotopology. *Data and Knowledge Engineering*, 20(3):259–286, 1996.
- [Vieu, 1991] L. Vieu. *Sémantique des relations spatiales et inférences spatio-temporelles: une contribution à l’étude des structures formelles de l’espace en langage naturel*. PhD thesis, Université Paul Sabatier, Toulouse, 1991.
- [Vieu, 1997] L. Vieu. Spatial representation and reasoning in AI. In O. Stock, editor, *Spatial and Temporal Reasoning*, pages 5–40. Kluwer, 1997.



- [Walischewski, 1999] H. Walischewski. Learning regions of interest in postal automation. In *Proceedings of 5th International Conference on Document Analysis and Recognition (ICDAR'99)*, 1999.
- [Weidenbach, 2001] C. Weidenbach. SPASS: Combining superposition, sorts and splitting. In A. Robinson and A. Voronkov, editors, *Handbook of Automated Reasoning*, volume II, pages 1965–2013. Elsevier Science, 2001. SPASS is available from <http://spass.mpi-sb.mpg.de/>.
- [Weld and De Kleer, 1990] D. S. Weld and J. De Kleer, editors. *Readings in Qualitative Reasoning About Physical Systems*. Morgan Kaufman, San Mateo, Ca, 1990.
- [Whitehead, 1920] A. N. Whitehead. *The Concept of Nature*. Cambridge University Press, 1920.
- [Whitehead, 1929] A. N. Whitehead. *Process and Reality*. The MacMillan Company, New York, 1929. Process and Reality: Corrected Edition, edited by D. R. Griffin and D. W. Sherburne, Published in 1978 by MacMillan.
- [Wiggins, 1980] D. Wiggins. *Sameness and Substance*. Blackwell, Oxford, 1980.
- [Winker, 1982] S. Winker. Generation and verification of finite models and counterexamples using an automated theorem prover: Answering two open questions. *Journal of the Association for Computing Machinery*, 29(2):273–284, 1982.
- [Wolter and Zakharyashev, 2000] F. Wolter and M. Zakharyashev. Spatio-temporal representation and reasoning based on RCC-8. In A. G. Cohn, F. Giunchiglia, and B. Selman, editors, *Principles of Knowledge Representation and Reasoning: Proceedings of the 7th International Conference (KR-2000)*, pages 3–14. Morgan Kaufmann, 2000.
- [Woodger, 1937] J. H. Woodger. *The Axiomatic Method in Biology*. Cambridge University Press, 1937.
- [Worboys and Bofakos, 1993] M. F. Worboys and P. Bofakos. A canonical model for a class of real spatial objects. In D. Abel and B. C. Ooi, editors, *Advances in Spatial Databases: 3rd International Symposium (SSD-93)*, number 692 in Lecture Notes in Computer Science, pages 36–52. Springer-Verlag, 1993.
- [Wos *et al.*, 1991] L. Wos, R. Overbeek, E. Lusk, and J. Boyle. *Automated Reasoning: Introduction and Applications, 2nd Edition*. McGraw-Hill, Inc., New York, 1991.

- [Zimmermann and Freksa, 1993] K. Zimmermann and C. Freksa. Enhancing spatial reasoning by the concept of motion. In A. Sloman, editor, *Prospects for Artificial Intelligence*, pages 140–147. IOS Press, 1993.
- [Zimmermann, 1993] K. Zimmermann. Enhancing qualitative spatial reasoning – combining orientation and distance. In A. U. Frank and I. Campari, editors, *Spatial Information Theory: A Theoretical Basis for GIS (COSIT-93)*, number 716 in Lecture Notes in Computer Science, pages 69–76, Berlin, 1993. Springer Verlag.

# Index

## abductive

framework, 88

axiomatisation, 38

## Axioms

A1-A2, 38

A3, 40

A4-A7, 41

A8, 42

A9-A11, 44

A12-A14, 45

A15, 48

A16-A17, 49

A18, 50

A19, 53

A20, 62

A21, 64

A22, 73

A23, 79

## Boolean

### functions

axioms, 41

definitions, 41

circumscription, 94

conceptual neighbourhood, 27, 31

diagram, 79

hierarchy of, 60

## Conjectures

C1, 43

C2, 48

## connection

firm, 43, 70

spatial, 38

spatio-temporal, 38

temporal, 38

## continuity

firm, 58

strong, 59

qualitative, 30

## Definitions

D1-D10, 39

D11-D14, 41

D15, 42

D16-D17, 43

D18-D21, 44

D22, 46

D23-D26, 47

D27-D28, 48

D29, 49

D30, 50

D31-D32, 52

D33-D34, 57

D35, 58

D36-D39, 59

D40-D41, 65

D42-D45, 66

D46-D48, 67

D49, 69

D50, 70

D51, 75

- D52-D54, 78
- D55-D56, 79
- D57-D59, 90
- D60-D62, 91
- D63, 94
- D64, 99
- D65-D69, 100
- durative relations, 65
- ECTS, 59
- envisioning axioms, 27
- episode, 94
- EQTS, 66
- extensionality, 15
  - axiom, 40
- extensive abstraction, 14
- firm-connection
  - definition, 44
- heuristics
  - additional, 97
  - selection, 88, 93
- IM, 73
- instantaneous
  - relations, 69, 72
  - transition
    - matrix, 70, 72, 83
- interval relations
  - embeds, 52
  - meets, 46
- JEPD, 18
- local survey, 88
  - specifying, 92
- mereology, 11, 15
  - mereotopological
    - framework, 37
    - relations, 39
      - RCC-8, 39
    - durative, 65
    - parthood, 39
  - mereotopology
    - what is, 11
- NECP, 46
- one-piece
  - definition, 43
- poverty conjecture, 6
- primitive relations, 37
- qualitative
  - continuity, 30
    - axiom, 62, 64
    - definition, 58
  - reasoning, 6
  - spatial reasoning
    - approaches, 10
    - what is, 8
- Region Connection Calculus
  - about, 17
  - references, 10
- snapshot, 87
  - global, 87
- sorts, 41
  - LLAMA, 37
  - sorted logic, 41
- space-time
  - histories, 6, 28, 101
    - continuous, 61
- spatial

- connection, 38
- leap, 61
- spatio-temporal
  - change, 93
    - minimizing, 95
  - connection, 38
  - continuity
    - firm, 58
    - intuitive, 58
    - sideways leaps, 58
  - fluent, 93
  - inertia, 93
  - interactions, 48
  - patterns, 89
    - binary, 99
- temporal
  - connection, 38
  - equivalence, 44
  - inclusion, 44
  - overlap, 44
  - pinching, 33, 36, 58
  - relations, 44
    - equivalence, 45
    - inclusion, 45
    - order, 44
    - overlap, 45
  - slice, 23, 36
    - contemporaneous pair, 65
    - definition, 49
    - existence of, 50
  - underlying structure, 51
- Theorems
  - Th1-Th2, 39
  - Th3, 41
  - Th4-Th7, 42
  - Th8-Th9, 44
  - Th10-Th18, 45
  - Th19, 46
  - Th20-Th27, 47
  - Th28-Th32, 48
  - Th33, 49
  - Th34-Th41, 50
  - Th42-Th45, 51
  - Th46-Th47, 53
  - Th48-Th49, 61
  - Th50, 62
  - Th51, 63
  - Th52-Th54, 64
  - Th55-Th60, 67
  - Th61-Th64, 68
  - Th65-Th70, 75
  - Th71-Th75, 76
  - Th76, 77
  - Th77-Th80, 80
  - Th81-Th90, 81
  - Th91-Th98, 82
  - Th99-Th111, 83
  - Th112-Th119, 84
  - Th120-Th128, 85
  - Th129-Th134, 86
  - topology, 10
  - transition
    - direct, 79
    - elementary, 78
    - generalized, 91
    - graph, 32
    - inconsistent, 79
    - instantaneous, 70
    - intuitive, 60
    - operators, 77
      - durative, 77

pattern, 91

weird, 60