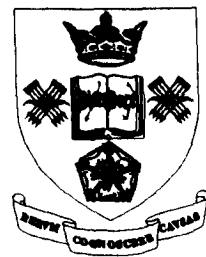


An Aesthetic Approach to the Soundscape of Urban Public Open Spaces

Wei Yang

May 2005



**Thesis submitted for the fulfilment of
the degree of Doctor of Philosophy in Architecture**

**School of Architecture
The University of Sheffield**

**CONTAINS
PULLOUTS**

SUMMARY

The main aim of this thesis is to establish a systematic framework for the soundscape design considerations of urban public open spaces. With an aesthetic approach, the thesis focuses on the essential characteristics of sound in the context of urban public open space, as well as its interaction with people – users of public open space, and spaces – containers of soundscape.

Through reviewing urban aesthetic theory, previous soundscape studies, relevant environmental psychology theories, typological urban design, and computer simulation in acoustics, a systematic methodology is set up for soundscape study in urban public open spaces.

The core of this thesis is in two parts. Part I, '*Soundscape by listening - field survey*', focuses on perception and evaluation of soundscape. Based on the field survey data, which includes 9,200 questionnaire interviews, measurements, and observations of 14 case study sites across Europe, it is proved that soundscape is an important aspect affecting people's evaluation and behaviours in urban public open spaces. Acoustic comfort/pleasant evaluation are more complicated than merely sound level evaluation. A lower background sound level can lead to a systematic sound level evaluation improvement, whereas the involvement of favourable sound elements and the feeling of dominance can dramatically improve the acoustic comfort evaluation. Personal differences, especially in cultural background and age, have significant influences in soundscape evaluation.

Part II of the thesis, '*Soundscape by design*', focuses on the designable part of soundscape, spatial forms and sound elements. Through the typological soundscape study, the soundscape characteristics of different shaped, sized and opening conditioned urban spaces are identified, from which many typologically classifiable forms can be created. Analyses and suggestions are made for sound element design, including the creation of active soundmarks and the design of passive soundmarks. The former relies upon on suitable spatial forms and physical factors. The latter depends on specifically designed landscape elements, such as fountains. As an example, fountains' spectrum and form are described and analysed in depth.

It is expected that this thesis will be of practical value and will help to inform the design process.

ACKNOWLEDGEMENT

I would like to express my sincere gratitude to my supervisor, Professor Jian Kang, for his valuable supervision and encouragement since my MSc study.

I feel the deepest gratitude to my uncle, Ting Shao Kuang. It is true that without his financial support, the completion of the study would have been impossible.

I would like to thank the colleagues in RUROS Project, especially Dr. Mei Zhang for her useful discussion. It has been a pleasure to work in close co-operation with other partners and thousands of interviewees throughout the Europe.

I appreciate American Academy in Rome, for offering me the visiting scholar opportunity and providing accommodation to carry out my research in Rome.

I am greatly indebted to my friends who proofread my thesis and publications: Stephen Peart, John Evans, Jonathan Abbott, Andrew Guyton, John and Sheila Holt, Iain MacLauchlan, and Jennifer Louise Rose Joynt. I feel grateful to their valuable time and patience.

My appreciation also extends to the staff and friends in the School of Architecture, the University of Sheffield, and colleagues in Byron Clarke Robert Ltd. and David Lock Associates. I greatly appreciate their encouragement and support.

Last but not least, to my family, husband Jun Huang, mother Xiaoxia Ding, father Shengye Yang, mother in law Rui Wang and father in law Zhenlei Huang, for their understanding, encouragement and support.

CONTENTS

Summary.....	i
Acknowledgements.....	ii
Contents.....	iii
Chapter 1 Introduction.....	1
1.1 Research background.....	1
1.2 Aim of the study.....	2
1.3 Thesis outline.....	3
Chapter 2 Literature Review.....	5
2.1 Soundscape as a part of urban imageability study.....	5
2.1.1 Urban cognition and aesthetics.....	5
2.1.2 The characters of sonic environment.....	8
2.1.3 The aesthetic approach for the sonic environment – soundscape.....	9
2.2 Soundscape study.....	10
2.2.1 The classification of sound.....	10
2.2.2 Previous soundscape studies.....	12
<i>Pioneering soundscape researches</i>	12
<i>Soundscape perception and evaluation</i>	14
<i>Audio-visual interactions</i>	15
<i>Personal differences</i>	16
2.2.3 The methodology of the soundscape study.....	18
2.3 Remarks of environmental psychology.....	19
2.3.1 Emotional dimensions.....	19
2.3.2 Individual differences.....	22
2.4 Typological soundscape study.....	23
2.4.1 Spatial characteristics of urban soundscape.....	24
2.4.2 Typological urban design.....	25
2.4.3 The concept of the typological soundscape study.....	27
2.5 Computer simulation methods.....	28
2.5.1 Energy-based room acoustics simulation methods and Raynoise.....	29
2.5.2 Noise-mapping methods and Canda/A.....	30
2.6 Summary - a theoretical framework of soundscape study.....	32
PART I: SOUNDSCAPE BY LISTENING – FIELD SURVEY.....	34
Chapter 3 Methodology for the Field Survey.....	35
3.1 Research methods.....	36

3.1.1	Questionnaire survey.....	37
3.1.2	Physical parameter monitoring.....	39
3.2	Field survey sites.....	40
3.2.1	Field survey sites in the Municipality of Alimos, Greece.....	41
	<i>Karuiskaki Square</i>	41
	<i>The Seashore</i>	43
3.2.2	Field survey sites in Thessaloniki, Greece.....	44
	<i>Makedonomahon Square</i>	44
	<i>Kritis Square</i>	45
3.2.3	Field survey sites in the City of Sesto San Giovanni, Italy.....	46
	<i>Petazzi Square</i>	46
	<i>IV Novembre Square</i>	47
3.2.4	Field survey sites in Sheffield, UK.....	48
	<i>The Peace Gardens</i>	48
	<i>The Barkers Pool</i>	49
3.2.5	Field survey sites in Cambridge, UK.....	50
	<i>All Saint's Garden</i>	51
	<i>Silver Street Bridge</i>	52
3.2.6	Field survey sites in Kassel, Germany.....	53
	<i>Florentiner Square</i>	53
	<i>Bahnhofsplatz (Station Square)</i>	54
3.2.7	Field survey sites in Fribourg, Switzerland.....	55
	<i>Jardin de Perolles</i>	55
	<i>Place de la Gare (Station Square)</i>	56
3.2.8	Summary.....	56
3.3	Data analysis.....	59
3.3.1	Data treatment.....	59
3.3.2	Basic data of the interviewees.....	60
3.3.3	Basic data of micro-climate conditions.....	64
3.4	Summary.....	65
 Chapter 4 Soundscape Perception and Evaluation.....		67
4.1	Perception and evaluation of sound levels.....	68
4.2	Perception and evaluation of sound elements.....	73
4.2.1	Perception of sound elements.....	73
4.2.2	Evaluation of sound elements - sound preference.....	76
4.3	Acoustic comfort.....	81
4.4	Psychological adaptation	
	– Interaction between sound preference and acoustic comfort	84
4.5	Other physical factors	
	– Interactive relationships between aural and visual perception.....	89
4.6	Summary.....	90

Chapter 5 Personal Variables in Evaluating Urban Soundscapes.....	93
5.1 Acoustic experience and cultural differences.....	93
5.1.1 Sound level and acoustic comfort evaluations.....	93
5.1.2 Sound preferences.....	98
5.2 Demographic differences.....	100
5.2.1 Sound level and acoustic comfort evaluations.....	100
5.2.2 Sound preferences.....	103
<i>Age</i>	103
<i>Gender</i>	108
<i>Others</i>	110
5.3 Temporary status variables.....	111
5.3.1 Activities.....	112
5.3.2 Size of groups.....	115
5.3.3 Frequency of visits to the sites.....	116
5.4 Summary.....	118
PART II: SOUNDSCAPE BY DESIGN.....	121
Chapter 6 Typological Soundscape Study.....	122
6.1 Raynoise: methodology of simulation.....	123
6.1.1 Methods.....	123
6.1.2 Model.....	124
6.1.3 Reflection orders and ray numbers.....	124
6.1.4 The comparison of boundary absorption.....	128
6.1.5 Summary.....	129
6.2 Shape.....	130
6.2.1 Models for shape analysis.....	130
6.2.2 Boundary absorption.....	131
<i>SPL</i>	131
<i>RT30</i>	134
<i>EDT</i>	138
6.2.3 Boundary diffusion.....	140
<i>SPL</i>	140
<i>RT30</i>	144
<i>EDT</i>	147
6.3 Size.....	149
6.4 Openness.....	154
6.5 Summary.....	160
Chapter 7 Topological Soundscape Study of Urban Space Precedents.....	162
7.1 Classic urban form.....	162

7.2	Enclosure – Campidoglio.....	164
7.2.1	SPL.....	167
7.2.2	RT30.....	169
7.2.3	EDT.....	170
7.2.4	Sound reflection and impulse response.....	172
7.2.5	Summary.....	173
7.3	Continuity – Piazza Navona.....	174
7.4	Contrast spaces – Piazza della Signoria.....	179
7.5	Summary.....	184
Chapter 8 Sound Elements and Activities.....		186
8.1	Soundscape elements – water feature as an example.....	186
8.1.1	Water as sound masker - fountains in the Peace Gardens.....	187
8.1.2	Water as spectrum enricher – water features in the Chatsworth Garden.....	192
8.1.3	Water as legend - fountains in Rome.....	198
8.1.4	Water as music and fun - fountains in Villa d’Este, Tivoli.....	201
8.1.5	Water as urban oases - contemporary fountains.....	204
8.2	People’s activities.....	204
8.2.1	Providing opportunities for outdoor activities.....	205
8.2.2	Music.....	206
8.3	Summary.....	210
Chapter 9 Conclusions and Future Work.....		212
9.1	Contributions of the study.....	212
9.1.1	Theoretical framework.....	212
9.1.2	Systematic methodology.....	213
9.1.3	Identity of soundscape.....	213
9.1.4	The emotional dimensions of soundscape.....	214
9.1.5	Personal differences.....	215
9.1.6	Other physical factors.....	217
9.1.7	Typological soundscape design.....	218
9.1.8	Passive and active soundmark design.....	220
9.1.9	Soundscape design considerations.....	221
9.2	Future work.....	223
References.....		224
Appendix: Sheffield Field Survey Questionnaires.....		236

Chapter 1

Introduction

1.1 RESEARCH BACKGROUND

People have been encouraged by recent urban planning policies (Urban Task Force, 1999; DETR, 2000) to return to the hearts of cities, reversing the tendency of migration out of city centres into suburbs and the surrounding countryside. However our cities are always overshadowed by continuous mechanical noise. 'Grey' ambient noise fills in the spaces between buildings and results in a "brown-field" of soundscape. Beautiful sounds, such as bird song, live music, and the murmur of water, etc. all seem far away from our urban lives.

As one of the most important elements in the heart of the city, the urban public open space is a stage and an oasis from our busy city lives; it is framed by buildings, decorated by design features and staged by the general public. An ideal public open space is for people to relax, to communicate, to see others and to be seen. However, almost all cities have some places which are more popular than others. Besides social issues, it is vital to consider the environmental conditions of such places and how they attract people to use them.

Sound is one of the essential ways for us to perceive and communicate with the world. The assessment of soundscape is a part of sensory aesthetics research that is concerned with the sensation of pleasure one receives from the environment. The urban acoustic researches have long been concentrated on problematic issues (ICA, 2001; ICA, 2004; ASA, 2005; Inter-noise, 2004), such as traffic noise, noise propagation, vibrations, noise effect, etc. However, studies about how to create a pleasant acoustic environment in urban public open spaces are rather limited.

As an urban designer, my objective is to design successful places for people to enjoy and relax in. I have visited and revisited places in Rome, Venice, Florence, etc.

considering and reconsidering the secret of their success. It was water sound that led my way in the medieval town and it was people's sound that made the place alive.

Therefore, in this thesis, soundscape in urban public open spaces is studied from an aesthetic approach. It is believed that this study will benefit urban designers, architects, and planners, to help them create successful soundscapes in urban public open spaces.

1.2 AIM OF THE STUDY

The aim of this thesis is to establish a systematic framework for the soundscape design consideration of urban public open spaces. With an aesthetic approach, in the thesis, the role of soundscape and how various aspects of soundscape work together in influencing people's perception and evaluation are examined. Sounds and the information contained therein, urban context and people are the three key factors involved in this study. The detailed research objectives are:

- Put soundscape study into an environmental aesthetic framework;
 - Develop a systematic methodology for soundscape study;
 - Examine how people perceive soundscape in urban public open spaces;
 - Identify the key components of a comfortable and pleasant soundscape;
 - Identify the personal differences in perceiving the soundscape;
 - Develop a research method to explore the influence of spatial characteristics to soundscape;
 - Examine the soundscape characteristics of classic urban design principles;
 - Examine key components of useful soundscape design elements; and
 - Develop design suggestions for soundscape design in urban public open spaces.
-

1.3 THESIS OUTLINE

Chapter 2, '*Literature review*', reviews urban imageability theory; concept of soundscape, previous researches of soundscape study; emotional dimensions and individual differences; typological urban design theory; and acoustic computer simulation method. Through the review, the methodology framework and new research concept – typological soundscape study have been defined for further study. The thesis contains two core parts:

Part I – Soundscape by Listening – Field Survey

As a part of the *RUROS* project, in Part I of the thesis, discussions are focused on how people perceive and evaluate soundscape in urban public open spaces. Part I contains three chapters:

Chapter 3, '*Methodology for the field survey*', describes the methodology used for the intensive questionnaire survey and the analysis methods used in the research.

Chapter 4, '*Soundscape perception and evaluation*', focuses on the interaction between people and two essential aspects of the urban soundscape: the sound levels and the sound elements contained in the soundscape. This discussion examines people's perception and evaluation of sound levels; people's perception and evaluation of sound elements; the difference between sound level evaluation and acoustic comfort evaluation; the interaction between sound preference and acoustic comfort; and the relationship between soundscape and other physical factors.

Chapter 5, '*Personal variables in evaluating urban soundscapes*', focuses on personal variables, i.e. acoustic experiences and cultural differences, demographic and temporary status differences, in evaluating the soundscape in urban public open spaces. In the analysis, sound level and acoustic comfort evaluations and sound preferences are the key aspects considered in soundscape evaluation.

Part II – Soundscape by Design

In Part II of this thesis, with the objective of benefiting soundscape design, the designable elements of urban public open spaces, i.e. spatial characteristics and sound elements, are studied. Part II of the thesis contains three chapters:

Chapter 6, '*Typological soundscape study*', examines how spatial characteristics influence the sound field distribution in urban public open spaces. Firstly, the software employed for the typological soundscape study, Raynoise, has been examined in terms of urban spaces. Secondly, the study methodology and models have been described. Finally, the typological soundscape study has been carried out to study the soundscape characteristics of different shaped, scaled and opened spaces.

Chapter 7, '*Topological soundscape study of urban space precedents*', analyses three classic urban design principles, enclosure, continuity and contrast, from a soundscape design point of view. By using the typological soundscape study method, Campidoglio, Piazza Navona, and Piazza della Signoria are studied as representative of the three principles, respectively.

Chapter 8, '*Sound elements and activities*', examines the soundscape characteristics of designable features, i.e. water, music, and people's activities. Firstly, the masking effect of water features, the rich spectrum characteristic, unlimited forms, function of entertainment, and contemporary design tendency are discussed. Secondly, the importance and the principles of providing a suitable place for people to generate active sounds are discussed. Finally, as one of the most popular street activities, music is studied in terms of soundscape.

Finally, in Chapter 9, '*Conclusions and future work*', the contributions of the study are summarised in terms of study methodology, soundscape theory, various soundscape perception and evaluation facets, soundscape spatial design and soundscape element design. Suggestions for further studies are also made.

Chapter 2

Literature Review

This chapter aims to set up a systematic framework and methodology for soundscape study in urban public open spaces. Section 2.1 reviews urban aesthetics study, in which it is argued that the soundscape study should be an essential part of it. The concept of soundscape is defined as an aesthetic approach for the sonic environment. Section 2.2 revisits previous soundscape studies. Based upon these, a systematic methodology for the soundscape study is set out. To help the understanding of the basic theory of environmental psychology, Section 2.3 further reviews the concept of emotional dimensions and individual differences. Section 2.4 defines a new soundscape concept, typological soundscape study, which is inspired from typological urban design theories. Finally, in Section 2.5, basic theories of computer simulation in acoustics are reviewed.

2.1 SOUNDSCAPE AS A PART OF URBAN IMAGEABILITY STUDY

2.1.1 Urban Cognition and Aesthetics

In terms of public experience of urban areas, urban cognition and aesthetics are the most crucial parts (Nasar, 1990). However, in the field of urban cognition and aesthetics, work is generally based on visual perception studies, which is certainly the most important part of our six sensory modalities, but is obviously not the only one.

The concept of urban cognition is developed from Lynch's (1960) theory of imageability (clear identity and structure). Lynch stated that structuring and identifying the environment is a vital ability among all mobile animals. Many kinds of cues are used: the visual sensations of colour, shape, motion, or polarization of light, as well as other senses such as smell, sound, touch, kinesthesia, sense of gravity, and perhaps of electric or magnetic fields.

In the book, *A Theory of Good City Form*, Lynch (1981) described:

Perception is a creative act, not a passive reception... .. Most people have had the experience of being in a very special place, and they prize it and lament its common lack. There is a sheer delight in sensing the world: the play of light, the feel and smell of the wind, touches, sounds, colours, forms. A good place is accessible to all the senses, makes visible the currents of the air, engages the perceptions of its inhabitants. The direct enjoyment of vivid perception is further enlarged because sensible, identifiable places are convenient pegs on which to hang personal memories, feelings and values. Place identity is closely linked to personal identity. 'I am here' supports 'I am'.

Lynch (1981) also stated that intense familiarity, events and structure will create the sense of place. These factors are formal components of sense, which allow us to recognize and pattern space and time in themselves. The next kind of specific components of senses help us to connect settlement form with other aspects of our lives. Congruence, transparency (immediacy), and legibility describe explicit connections of settlement form to nonspatial concepts and values.

Although emphasizing the imageability relates not only to peoples' visual memory, at the beginning of his most famous book, *the Image of the City* (1960), Lynch clearly stated that in the book he only chose to analyse the visual quality of the American city. Supported by many later researches, Lynch's contention is that the identity and structure of a city is influenced by five physical elements: paths, edges, districts, nodes, and landmarks. Furthermore, Nasar (1990) summarized that building imageability is enhanced by exposure, use significance, and visual contrast, but the influence of these factors may vary with the sociophysical milieu. Imageable elements define the evaluative image of a city, but the direction of that evaluation – pleasant or unpleasant – depends on the perceived quality of the elements.

Aesthetics quality has been identified as a major dimension in the public's perception of their surroundings (Nasar, 1990). Variables such as pleasure or beauty represent the

most influential dimension of environmental assessments; and aesthetic factors have major influences on judgments of community satisfaction.

In attempting to understand the nature of the aesthetic experience, Lang (1988) summarized three types of aesthetic: sensory, formal, and symbolic aesthetics. Sensory aesthetics are concerned with the pleasurableness of the sensations one receives from the environment. It involves the arousal of one's perceptual systems, is multidimensional, and is concerned with sounds, colours, textures, and smells. Formal aesthetics in architecture are concerned primarily with the appreciation of the shapes, rhythms, complexities and sequences of the visual world. However, he also mentioned that the concepts of formal aesthetics could be extended to the sonic, olfactory, and haptic worlds. Symbolic aesthetics involves the appreciation of the meanings of the environments that give people pleasure, or otherwise.

In sequence, aesthetic response is to be considered as a mix of high pleasure, excitement, and relaxation. All aesthetic questions involve preference (Prall, 1929) and the art of discrimination, of making judgments. Of more relevance to urban design is how the physical surroundings influence affective response. In simple words, urban aesthetics refers to positive feelings in relation to the urban surroundings. In sum, Nasar (1990) suggested five kinds of variables: urban physical features, perceptual/cognitive measures of those features, affective appraisals of the scene, psychological well-being, and spatial behaviour.

Nasar, in the book *Environmental Aesthetics* (1988), concluded that environmental evaluation involves three major components, pleasantness, excitement, and distress; that the salient perceptual and cognitive features in prompting pleasantness and excitement are visual richness (complexity, mystery), clarity (legibility, coherence) and the unobstrusiveness of built elements. In terms of visual preferences, there is a great variety according to observers, scenes and kind of activity studied. In general, however, aesthetic quality expressed as preference appears to be enhanced by coherence, order, complexity, and compatibility of scene elements, and by the appearance of naturalism.

Aesthetic quality is almost universally reduced, especially in nonurban scenes, by man-made intrusions.

2.1.2 The Characters of Sonic Environment

Sound contrasts vision in many ways. Porteous and Mastin (1985) have pointed out that the visual sense, in fact, distances the perceiver from his environment, an ultimately destructive detachment that fits well with the Western concept of man and environment as separate entities. They also indicated that the sonic environment, in contrast, extends from the most intimate distances (the sound of one's own bodily functions) to the farthest distances at which sense data can be perceived (remote thunder).

As reviewed in the above section, most environmental aesthetic researches, however, have been concentrated on visual quality. The urge of expanding environmental aesthetic research into other sensory fields has been mentioned by many researchers (Lynch, 1981; Lang, 1988).

In order to establish a theoretical framework for sonic aesthetics, it is vital to understand the difference between sonic and visual spaces. Although sound and light are both wave phenomena, aural perception differs from visual perception in many ways (Porteous & Mastin, 1985; Porteous, 1996; Apfel, 1998). First, sound is ubiquitous. Unlike visual space, which is sectorial, acoustic space is non-locational, spherical and all-surrounding. Acoustic space has no obvious boundaries and tends to emphasize a space itself rather than objects in the space. Aural harmonization is temporal, whereas visual harmonization is spatial. Sounds, compared with things seen, are more transitory, more fluid, more unfocused, more lacking in context, less precise in terms of orientation and localization and less capturable. Therefore, audition is a fairly passive sense. Sound provides dynamism and a sense of reality, helping us to get the senses of the progression of time and the scale of space. Moreover, compared to vision, sound perception is usually information-poor but emotion-rich. People are often

moved by a piece of music, or soothed by certain natural sounds such as from water and leaves. Vision is not pictorial (Rapport, 1977); instead, it is active and searching: We look; however, smells and sounds come to us. Visual perception relies on space, distance, light quality, colour, shape, textural and contrast gradients, and the like. It is a highly complex phenomenon. When vision is experimentally placed in conflict with other senses it inevitably turns out to be the dominant sense (Rock and Harris, 1967). Given the differences between visual and auditory sensation, it is of great significance to study soundscape as part of urban aesthetics research.

2.1.3 The Aesthetic Approach for the Sonic Environment – Soundscape

Although more than eighty percent of our sensory input is visual (Rock and Harris, 1967), other senses are still extremely important in terms of emotional, and thus aesthetic impacts. Porteous (1996) attempted to introduce the sound aesthetics into the whole aesthetic research system. As he stated that, psychologists, urban designers, landscape architects, and advertisers all stress vision as the chief mode of knowing about the world. Yet the emphasis on vision seems rather quantitative; we have little information on the qualitative importance of other perceptual modes (Howes, 1991). Porteous further stated the two basic modes of perception, which were developed by Schachtel in 1959, autocentric (subject-centred) and allocentric (object-centred) senses. Autocentric senses combine sensory quality and pleasure. The core point here is how people feel. In contrast, allocentric senses are concerned with objectification and knowledge. Allocentric senses involve attention and directionality. Vision, except colour perception to some extent, is chiefly allocentric. Speech sounds are allocentric, whereas most sounds, as with all other senses, are autocentric.

Therefore, the term '*soundscape*' applies specifically to the sonic environment of the receiver of a sound; the receiver is at the centre of the sonic landscape (Porteous & Mastin, 1985). This concept of the universality of the soundscape was developed over half a century ago by the Finnish geographer Granö (1929). After Granö, Ohlson (1976) and other researchers have divided the anthropocentric sonic landscape into an

immediate soundscape (20-200 m from the receiver) and a distant soundscape (15-20 km from the receiver). The term soundscape contrasts with the term ‘*soundfield*’, which is the sonic environment of a sound source, the latter being central. Soundscape is naturally of more interest to social scientists than soundfield, a technical definition. In more general expressions, the word soundscape is used as an analogy to ‘*landscape*’, to denote the overall sonic environment of a designated area. In environmental terms, soundscape is an important component of our sensory environment; it is an emotive environment, not an intellectual one (Porteous, 1996).

2.2 SOUNDSCAPE STUDY

2.2.1 The Classification of Sound

As has been clarified in the above section, soundscape is an aesthetic approach of sonic environmental study, within which people are at the centre of the sonic landscape. Sound phenomena may, accordingly, be subdivided into two principal groups, due account being taken of an individual’s perception of it: (1) useful and meaningful sound, and (2) disturbing and meaningless sound (Porteous & Mastin, 1985; Truax, 1984). Interest in the acoustic environment has been, until recently, highly specialized and problem specific. Research has concentrated mainly upon a single aspect of sound: that is the concept of noise or “unwanted sound”. Noise studies are fundamentally concerned with sound measurement and the development of statistical procedures capable of examining physical and psychological effects (Inter-noise, 2004). The result of noise studies has been a profusion of indices specifying intensities that are permissible or desirable in special areas, e.g. airports, residential areas and so on. However, another aspect is that sound is one of the essential ways for us to understand and communicate with the world, and this is often ignored.

As a musician, Schafer (1977a) revolutionarily defined sounds as ‘*keynotes*’, ‘*signals/foreground*’ sounds and ‘*soundmarks*’, in his book *The Turning of the World*. Keynotes are in analogy to music where a keynote identifies the fundamental tonality

of a composition around which the music modulates. Foreground sounds, also termed signals, are intended to attract attention. Sounds that are particularly regarded by a community and its visitors are called soundmarks, in analogy to landmarks. The greatest contribution of Schafer's classification of sound is that he equitably treated all the sounds in the universe.

Sound itself is ecologically neutral and the desirability of such sound depends on the receiver's physiological and psychological parameters. In the study of De Ruiter (2000), it was suggested that the required masking sound level could be used as an indicator for the quality of the exterior space of dwellings with respect to speech privacy. Interestingly, traffic sounds downtown have been found to be related to favourable responses (Anderson *et al.*, 1983; Southworth, 1969). Therefore, town planning and urban design need more and better indicators for the liveability of the acoustic environment. It is important to consider the context of a sound, as well as where and when it happens.

The true soundscape study examines the entire continuum of sound, including both negative and positive qualities, and thereby includes both wanted and unwanted sounds. The sonic environment is not treated as an object that can be reduced to a single measurement or group of measurements; instead, it is taken to comprise a vast array of stimuli, each representing a wealth of information capable of providing a variety of environmental experiences (Porteous, 1996).

To sum up, the essential difference between the noise study and the soundscape study as summarized by Porteous & Mastin (1985) is that the soundscape is considered to be a phenomenon with perceptual content. It is not wholly reducible to a series of physically measured parameters. The aim of the soundscape study is to reintroduce the primacy of the human element. This goal may be realized through an understanding of the physical presence of the soundscape, the perceptual processing of the sound input, and the relationship between the two.

2.2.2 Previous Soundscape Studies

Pioneering Soundscape Researches

In the late 1960's and early 1970's, a sustained contribution has emerged from the World Soundscape Project (WSP) inaugurated by the environmental musician, Schafer (1977a & b). The pioneering soundscape research was about relationships between ear, human being, sound environment and society. The research was focused on the way people perceive their environment consciously and the chance to change the orchestrating of the global soundscape (Truax, 1978). Five villages were visited and revisited by a group of Canadian soundscape researchers in 1975 and 2000 respectively. The study examined the soundscapes of the five villages in great detail. It became immediately apparent that most rural soundscapes were radically changing and included an increasing number of technological sounds, with a loss in soundscape complexity. Residents identified this loss in terms of an absence of certain sounds that they had previously ^{been} used to gain information about their environment. Here, soundscape has been clearly proved as a definite element in the individual's perception of an environment.

Further pioneering research was carried out by Southworth (1969). In the research, reactions of different population groups to soundscape were studied during a tour around Boston. The study evaluated the identity of the sounds and analysed their pleasantness. It was suggested that the pleasantness of a sound is much more complicated than its physical qualities. Generally sounds of low to middle frequency and intensity were preferred, but delight increased when sounds were novel, informative, responsive to personal action and culturally approved. It was concluded that the information contained in the sound, the context in which it is perceived and its level are three aspects which influence people's evaluation of a city's soundscape.

Porteous & Mastin (1985) mentioned that interest in soundscape was also revived as part of a growing dissatisfaction with the quality of urban environments, and growing concern for the plight of handicapped persons in modern society. The authors cited Southworth's (1969) study where, in respect to newly deaf people, it was noted that

‘All of them felt a poignant loss of background sounds, especially of nature, which had been almost unnoticed before deafness’. Moreover, it is difficult for blind people to grasp a sense of events, or the flow of time, without a background sonic ambience. Southworth’s work strongly suggested the necessity of soundscape planning and design.

Porteous & Mastin (1985) investigated the soundscape of the South Fairfield urban neighbourhood, Victoria, British Columbia, Canada. The soundscape was regionalized objectively by machine recording and analysis and expert listening, and subjectively by means of a survey of residents based on a community sound list developed from the objective study. The study suggested that urban residents have low levels of awareness of soundscape and that the experience of modern urban life involves a high degree of sensory privation.

Dubois & David (1999) studied the cognitive approach of urban soundscape. Their research focused on meaning and as such integrates linguistic, psychological, and acoustic conceptualisations and methodologies. It dealt with the acoustic phenomena that are perceived, conceived, and identified as relevant by the subjects. The productivity of this approach has been evaluated in two research programs. Experiments combining linguistic and psychological analyses showed that urban soundscapes include a complex combination of unpleasant and pleasant noises. The identity of the source and the temporal and spatial contexts of occurrence of the noises are present in subjects’ cognitive representation and influence their perception. Experiments on alarm signals showed that contextual constraints influence the perceptual thresholds of the signals, their identification, and their efficiency, contrasting signals as such with nonmeaningful noises. They concluded in their research that, such a “situated” cognitive (and pluridisciplinary) approach allows (1) at a theoretical level, to identify the role of top down (high level) constraints on low-level perceptual processing and (2) at a methodological level, it suggests to first design procedures to identify the meaningful categories of sounds and their properties at linguistic and psychological levels before describing them in physical dimensions and experimentally manipulating them in psychophysical paradigms. In a field study

carried out in three Spanish cities (Barrio & Carles, 1995), it was shown that the acoustic identity of different urban environments influenced subjects' evaluation of these places.

Soundscape Perception and Evaluation

Cresson Laboratory's research (Couic & Deletre, 1999) on sound in urban spaces led to the development of a theoretical model called "sonic effect" that takes into account, not only the physical and space aspects of the sound, but also the user's perception. With this model, some interactions between senses were observed that have been analysed from an intersensory standpoint. The first step of the method was to register on tape the feelings of candidates when walking through a selected area of the city. This raw material was then analysed by dedicated software that extracts a few classes where expressions were closed from a semantic standpoint. These classes correspond to specific areas and overlap in transition zones where intersensory perception was expected. Physical measurements (sonic, thermodynamic, luminous) confirmed these locations. Further analysis was then performed to reveal dynamic schemes of interaction. The evolution of the relationship between the most salient urban objects and the user was examined in order to consider the interaction between expression (description, evocation...), motion, and senses.

The first step of investigating an existing acoustic environment or designing a new soundscape in urban public open spaces is to use an appropriate system to describe it. It was suggested that three categories of analysis should be considered for such spaces: activities such as human presence or transport, spatial attributes including location or nature, and time history including moment or period (Raimbault *et al.*, 2001).

The semantic analysis (Osgood *et al.*, 1957) has also been proved to be a useful method to identify the most important factors in evaluating a sound. For product sound quality, it was suggested that three main factors were powerful, metallic and pleasant (Kuwano & Namba, 2001). Additional factors can be used for any special sound, such

as 'dieselness' for diesel cars (Patsouras *et al.*, 2001). For general environmental sounds, it was demonstrated that evaluation, timbre, power and temporal change were four essential factors (Zeitler & Hellbrück, 1999; Zeitler & Hellbrück, 2001). For residential areas, a research in Sweden showed that the soundscape was characterised in four dimensions, namely adverse, reposing, affective and expressionless (Berglund *et al.*, 2001). A recent study based on the semantic differential analysis showed that relaxation, including comfort-discomfort, quiet-noisy, pleasant-unpleasant, natural-artificial, like-dislike and gentle-harsh, is a main factor for people's soundscape evaluation in urban public open spaces (Kang & Zhang, 2002).

Audio-visual Interactions

Another approach of the soundscape study is to focus on the sound influence on landscape values. A number of studies have coincided in stressing the key role of soundscapes (Schafer, 1977a) in environmental evaluation. Several authors have attempted to identify the informational, aesthetic or affective qualities of sound, which help to confer quality on a given landscape. The results of these studies indicated that both the emotional meaning attributed to a sound and the importance of the context in which it occurs determine the degree of liking felt for a particular landscape (Carles *et al.*, 1999).

In order to study the influence of the interaction between visual and acoustic stimuli on perception of the environment, Carles *et al.* (1999) made 36 combinations of sound and image and presented them to 75 subjects. The sounds and images used were of natural / semi-natural settings and urban green spaces. Affective response was measured in terms of pleasure. The results showed a rank of preferences running from natural to man-made sounds, with the nuance of a potential alert or alarm-raising component of the sound. The results of their corresponding analysis point to two main functions of sound in the landscape as regards the provision of information, which complements visual data. One function is related to the interpretation of the sound identified, such as water, birdsong, voice and cars, and the other is related to the

abstract structure of sound information. The results of their study also showed how human sounds (voices, footsteps and conversations, etc.) fit in relative to natural sounds (highly rated) and technological sounds (widely rejected). In certain places with a distinct environmental identity, any acoustic disturbance can lead to a rapid deterioration in quality. Natural sounds, meanwhile, may improve the quality of built-up environments to a certain extent. More research to enlarge the sample to other population groups to establish control over the preference impact of factors such as age, sex, cultural origin, etc. were suggested for further study.

A similar laboratory research by Viollon *et al.* (2002) found that the impact of visual settings depended on the urban sound scenes involved in the audio-visual combinations. For all sound environments which did not involve any human sound, visual influence was significant and negative: the more urban the visual setting, the less pleasant and relaxing the perceived sound environment was.

Although these studies only remained at the laboratory stage, they did make a useful contribution towards the body of research about soundscape preferences. However, the reality in the urban context of public spaces is far more complex. The listener is exposed to a wide mixture of both wanted and unwanted sounds, which together with other factors of the microclimate affect the overall influence on the individual. Hence, soundscape preferences are in fact a highly complex problem.

Personal Differences

As listening is one of the psychological functions through which people perceive the world, physiological and psychological factors are present in everybody's evaluations. Ellermeier *et al.* (2001) characterized individual noise sensitivity as a stable personality trait that captures attitudes towards a wide range of environmental sounds. Individual annoyance reactions to noise have been found to depend on physical attributes of the noise, attitudes towards the noise source and personal characteristics of receivers. In their research, a sample of 61 unselected listeners was subjected to a battery of

psychoacoustic procedures ranging from threshold determinations to loudness scaling tasks. They found small, but systematic differences in participants' verbal loudness estimates, and in the rating of the unpleasantness of natural sounds. The results suggested that what is psychophysically tractable in the concept of noise sensitivity might primarily reflect attitudinal / evaluative rather than sensory components. In other words, there are predictor sound preferences, which affect people's judgement.

Kariel (1980) examined the effects of sounds on outdoor recreation environments. A group of mountaineers and a group of campers in a developed campground were selected to evaluate some verbally described sounds. Although some differences were found between the two sample groups, the presence of sounds was more significant than the difference between the two groups. Kariel's result suggested that the sounds themselves have an impact that may exceed that of group differences.

From the above review it can be seen that the soundscape study, in a similar way to the visual aesthetic study, is a multi-discipline subject that needs to be studied by experts in many areas, including acousticians, urban designers, architects, geographers, sociologists, psychologist and artists. Although the soundscape study has been an area with increasing researches in recent years, current researches are mainly assigned to the acoustic and human-geographic field (ICA, 2004; Porteous, 1996). Substantial useful knowledge has been acquired and considerable progress has been made in the methodologies of study. Nevertheless, the tendency to fragmentary, unrelated research efforts apparently remains. The perception of an outdoor sound environment is a sophisticated phenomenon, which depends not only on the physical features, but also on the characteristics of the users. To study interactions between the two, it is vital to allow the complexity and diversity of the environment and users. However, existing researches in this aspect are rather limited and mostly laboratory-based. The number of subjects studied is normally rather small and often, subjects have a similar social or demographic background. Therefore, it is important to set up a more reliable and systematic methodology for the soundscape study in urban public open spaces.

2.2.3 The Methodology of the Soundscape Study

The essential requirement for any soundscape study is an appropriate setting, within which the sonic environment can be fully perceived. In the previous soundscape study, some methodologies have been borrowed from visual aesthetic research, such as slides evaluation in laboratory (Carles *et al.*, 1999; Viollon *et al.*, 2002). However, Nasar (1990) pointed out that related to the urban environment simulation, the visual and aural researches are fundamentally different. It has been found that human responses to colour slides or photos of urban or architectural scenes have been consistently shown to accurately reflect onsite responses. That is because of the evidence that visual cues dominate auditory cues in judgments of the pleasantness of environments (Gifford & Ng, 1982) and ambient sound has little effect on scene judgment (Esposito, 1984). The relative influence of visual and auditory cues has been found to vary in relation to arousal (Gifford & Ng, 1982). Noise, especially from traffic, has been found to produce major decrements in judgments of environmental quality (Esposito, 1984). As a result, Nasar (1990) advised that when seeking information for specific settings, on-site response for familiar observers is more appropriate. Colour slides and photos are only suitable for identifying salient dimensions of environment response.

The second requirement of the soundscape study is to derive information on the actual elements that make up a soundscape, based on some form of notation that will provide the same overall information as cartography or photography. With the use of sound-recording equipment, the problem of a historical account (ear-witness) becomes one of analysis. Porteous & Mastin (1985) noted that listening is the chief research tool of sound research; the receptor may be mechanical or human. The features of what may be termed an objective analysis of soundscape may be ascertained by means of tape recorders and sound-level meters, and by trained listeners. Machines store or monitor, providing information on the general sonic environment, but a sensitised listener is required for the identification of discrete sound events. A subjective analysis of soundscape requires the use of social science techniques such as questionnaires. A carefully structured research design involving listening, recording, monitoring, and

survey techniques is necessary to provide not only a descriptive analysis but also an indication of the meaning and value of the soundscape.

In conclusion, a successful soundscape study requires a comprehensive consideration of the environment, sound and people. For the soundscape study in urban squares, it is more appropriate to carry out on-site studies, given the difficulty of simulating complex sound sources, and the interaction between sound and other microclimate and social factors. Thus to ensure the complex aural perception process can be fully studied.

2.3 REMARKS OF ENVIRONMENTAL PSYCHOLOGY

As a multi-discipline subject, for soundscape, people are at the centre of the study. The interactions between people and sound environment, as well as their context are the key issues to be studied. Understanding the basic theory of environmental psychology can help to explain the fundamental reasons of the interactions.

2.3.1 Emotional Dimensions

People react to enormously varied environments in terms of a few basic emotional dimensions, and these basic emotional dimensions can in turn produce enormously varied kinds of behaviour (Mehrabian & Russel, 1974; Mehrabian, 1976). This proposition can be described as a kind of input-output system. Mehrabian & Russel (1974) defined three emotional response variables, i.e. arousal, pleasure, and dominance. The three variables summarize the emotion-eliciting qualities of environments and also serve as mediating variables in determining a variety of approach-avoidance behaviour such as social interaction, physical approach, work performance, and exploration.

The three variables present the fundamental nature of human behaviour. As described by Mehrabian & Russel (1974):

-
- **Arousal** means the level of activation or activity. When a person is aroused, the skin temperature is lower, the bleed less if cut, and in some cases feel less pain if there is external injury. Conversely, if you are unaroused, you are relaxed, calm, sluggish, dull, sleepy, or inattentive; the parasympathetic nervous system is in control and is producing a slow pulse, muscular relaxation, slow breathing, and so on.
 - **Pleasure** means joyful, happy, satisfied, contented, or feel good. Pleasure expresses itself in terms of overt responses that we can instantly recognize in ourselves and in others – smiles, chuckles, meaningful gestures, a warm tone of voice, and positive verbal expressions.
 - **Dominance** means the feeling of being in control – feeling influential, unrestricted, important, or in command of the situation. In feeling dominant, people feel free to act in a variety of ways. In feeling submissive, it is a feeling a being awed, guided, circumscribed, or looked after in such a way that one does not or cannot make decisions. In public spaces, public behaviour is between dominance and submissiveness. On one hand, people are free to speak, light a cigarette, have a sandwich, on the other hand, people have to restrict themselves not to speak too loud, throw rubbish on the ground... to behave in a good way, to do whatever is right for a public environment.

The arousal-pleasure-dominance dimensions provide a workable grid, which can be placed over the buzzing confusion of human emotionality. An environment causes in us an emotional reaction that is distinctive, measurable combination of arousal, pleasure, and dominance. This emotional reaction in turn causes us to approach or avoid that environment.

The three dimensions of emotional reaction form the basic palette from which all the feelings are created (Mehrabian & Russel, 1974). Each dimension is independent of the

other two. That is, there are environments, which can cause radical changes in one feeling dimension without affecting the other two. Of the three emotional dimensions, arousal has the most direct connection with environmental load. The greater the load, the higher a person's arousal level (Mehrabian, 1976). Berlyne (1960) defines the arousal level as "a measure of how awake the organism is and how ready it is to react". Croome (1977) summarized that the arousal level is determined by environment (i.e. changes, information rate, task being performed) and by internal human states (i.e. level of anxiety, drowsiness, alcohol, drugs). He also suggested that arousal level increases when an increase in activation of the reticular system occurs. An environment that is novel, surprising, crowded, and complex will produce feelings of high arousal.

Table 2.1 (Croome, 1977) describes some typical environments with their arousal-pleasure-dominance dimensions. An environment that causes a person to feel optimum arousal, high pleasure, and some dominance will be perceived as comfortable, or enjoyable, and the person in it will feel good and relaxed. He will remain in this environment and manifest other kinds of approach behaviour, including perhaps a verbal expression of satisfaction. On the other hand, in an environment that causes feelings of high arousal, low pleasure, and some submissiveness, the person will feel stressed and actually willing to leave the place as quickly as possible.

Table 2.1 Environment described in arousal-pleasure-dominance dimensions
(source: Croome, 1977)

Environment judged to be	Level of variables		
	Arousal	Pleasure	Dominance
Exciting	High	High	High
Comfortable	Optimum	High	High
Boring	Low	Low	Low
Stressful	High	Low	Low

Of more relevance to soundscape, the typical sonic environments of our cities are boring, with low arousal level, less pleasure and some boredom. The traffic noise fills all the gaps between buildings and leaves us a soundscape brown-field. With arousal increasing directly with the increase of sound level, the sonic environment can be stressful.

On the other hand, the subject of this thesis, urban public open spaces, is the oasis of our cities. They should be places for people to relax and enjoy their city lives. Consequently, the preferable sonic environment in urban public open spaces should be comfortable and occasionally exciting, such as at special events.

2.3.2 Individual Differences

In the book *Public Places and Private Spaces*, Mehrabian (1976) uses the three basic emotional dimensions to describe different person's characteristic emotional traits or temperaments. For example, people can have a generally pleasant (or unpleasant) disposition; a characteristic levels of dominance or submissiveness. The third and perhaps the most important innate personality dimension relates to arousal. The key term here is stimulus screening, or how much a person characteristically screens out the less relevant parts of his environment, thereby effectively reducing the environmental load and his arousal level. In Mehrabian's own words:

*People who characteristically do less stimulus screening, and whom will be called as **nonscreeners**, are by definition less selective in what they respond to in any environment. Their attention to the various parts of, and happenings in, their environment tends to be diffuse – they tend to hear, see, smell, or otherwise sense more stimuli. They are less prone to hierarchize or pattern the various components of a situation as to relevance or importance. As a result, nonscreeners experience places as being more complex and more loaded.*

*Those who do more stimulus screening, and whom will be called as **screeners**, are by definition more selective in what they respond to. Screeners automatically (unconsciously) impose a hierarchy of importance or pattern on the various components of a complex situation, thereby effectively reducing its load. In other words, their attention to*

various parts of, or happenings in, an environment is more focused, with the less relevant components having been screened out.

Mehrabian (1976) also suggested that nonscreeners show a high degree of empathy – they are more sensitive to the emotional reactions of others and are more likely to feel or imagine others' emotions. They are more sensitive to subtle changes in their environments and react more vividly to these changes.

Results obtained in Mehrabian's laboratory demonstrate that in general there is a slight tendency for women to screen less than men. It suggests that women act with greater arousal to obviously emotional situations. From other researches, it has been found that differences between ages appear to be extremely significant. In terms of landscape settings, adults were far more sensitive than children to landscape form and land-use compatibility, whereas children seemed far more sensitive than adults to water (Zube *et al.*, 1983). It has also been found that children under 12 have little interest in high naturalism in landscape and are less likely to view human intervention in the landscape as detrimental.

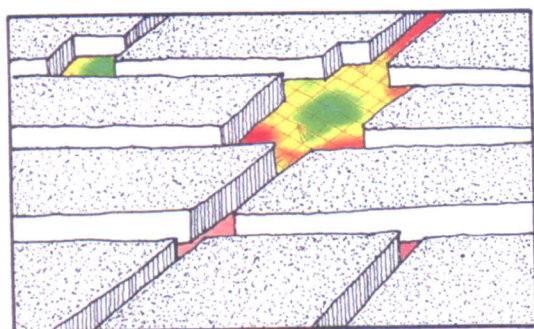
2.4 TYPOLOGICAL SOUNDSCAPE STUDY

In common with other applied sciences, the intention of this research is to find practical applications to enhance everyday life. Urban designers, planners and architects unavoidably have the duty to apply the soundscape theories into their practices. The aim of soundscape design is to provide a relatively comfortable or pleasant acoustic environment. In terms of urban design, as the container of soundscape, the spatial characteristics of a place are vital in distributing the sound and visual field and further influencing people's feeling of that space. To strengthen the audibility of the urban environment is to facilitate its aural identification and structure. As the carrier of the sound environment, the spatial form of urban public open spaces is certainly the most important part of the soundscape design.

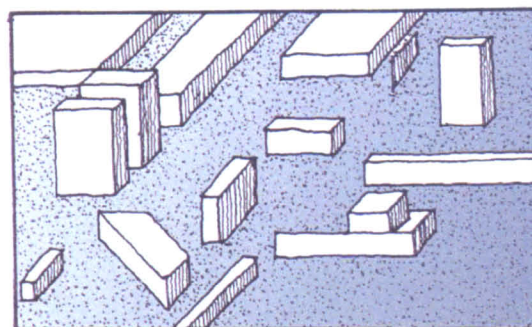
2.4.1 Spatial Characteristics of Urban Soundscape

As reviewed in Section 2.1, in the imageable townscape theory of Lynch (1960), visibility, coherency, and clarity are the key rules to form urban spaces. He stated that as an artificial world, the city should be in the best sense: made by art and shaped for human purposes. In Lynch's theory, to heighten the imageability of the urban environment is to facilitate its visual identification and structuring. The elements - paths, edges, landmarks, nodes, and regions - are the building blocks in the process of making firm, differentiated structures at the urban scale.

As one of the most important elements in the heart of the city, the urban square is a stage and an oasis for our busy city lives. A well-defined urban square is framed by buildings, decorated by design features and staged by the general public. An ideal square is for people to relax, to communicate, to see others and to be seen. People's image of and reaction to a space is largely determined by the way it is enclosed (Trancik, 1986). In the historical urban design, the exterior urban spaces were conceived as figural volume rather than structureless void. As Figure 2.1(a) shows, because of the enclosure, the soundscape in each space has its own identity. People's voice, footstep, bird singing, water sound and so on make people feel the existence and the characteristic of each space. Therefore, in traditional cities, urban blocks direct movement and establish orientation. Nowadays, however, highways, modern building form, urban renewal and zoning, and changing patterns of land use in the inner city, have altogether formed the dilemma of modern urban space – fragmentary and confused spaces. Our cities are always overshadowed by continuous mechanical noise. As illustrated in Figure 2.1(b), 'Grey' ambient noise fills in the spaces between buildings and results in a 'brownfield' of soundscape.



(a) traditional urban form



(b) modern urban form

Figure 2.1 Traditional and modern urban form (drawing based on diagrams by Trancik, 1986)

2.4.2 Typological Urban Design

As the pioneer of typological urban design and Rational Architecture, Leon Krier (1984) classified three types of urban space in their different ways of generation. Figure 2.2(a) illustrates the first type - the urban blocks are the result of a pattern of streets and squares. The pattern is typologically classifiable. In this type of urban space, the streets and squares are self-defined spaces. There are no definite relationships between these streets and squares. For the second type of urban space, as shown in Figure 2.2(b), the pattern of streets and squares is the result of the position of the blocks. The blocks are typologically classifiable. However, urban spaces are left as the wasteland at block edges. The lack of definition to the borders and the disorientation of the urban space result in a lost-space. Figure 2.2(c) illustrates the third type of urban space - the streets and squares are precise formal types. They are typologically classifiable and acting as public rooms for the city. From an urban design point of view, the third type of urban space is the ideal type of organizing a city. It is because in the third type of urban spaces, the emphasis is on the groups and sequences of typologically classifiable exterior spaces, which act as outdoor rooms and corridors, rather than on the individual space as an isolated entity.

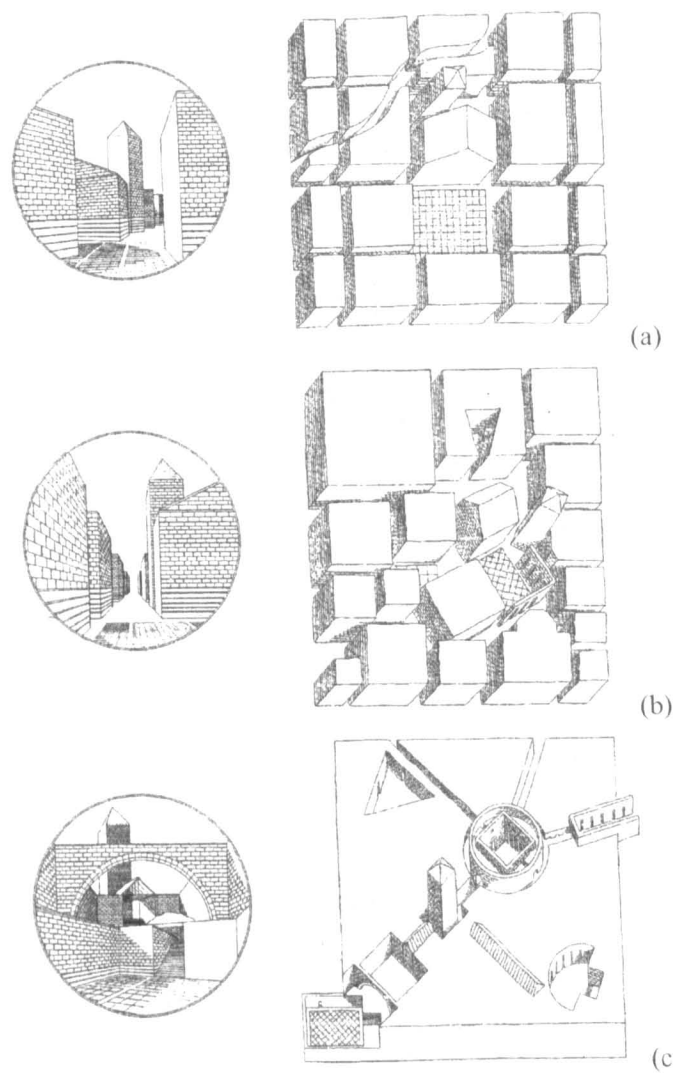


Figure 2.2 Three types of urban spaces (source: Krier, 1984)

The complexity of urban form has been extracted by Rob Krier (1979) to three typologically classifiable shapes, i.e. square, circle and triangular. As Figure 2.3 shows, by angling, segmenting, adding, merging, overlapping and distributing of the three basic spatial forms, the urban spatial forms can be generated as regular or irregular, in terms of shape and surrounding boundary sections. Then the terms ‘closed’ and ‘open’, spaces which are completely or partially surrounded by buildings, may be applied to form the enclosure or openness. Finally, the differentiation of ‘scale’ applies to adjust the size of urban spaces.

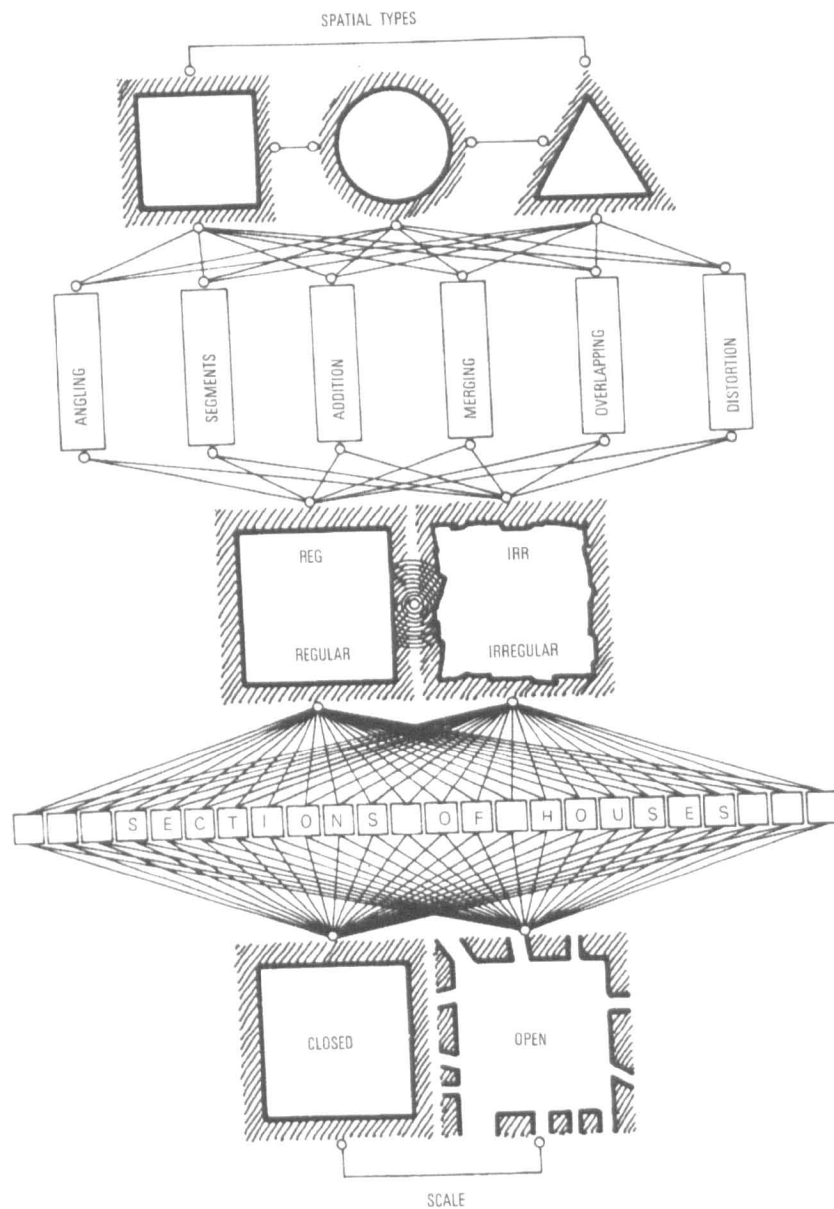


Figure 2.3 Spatial types and their combinations
(source: Krier, 1979)

2.4.3 The Concept of the Typological Soundscape Study

As mentioned before, the audibility is an essential quality of a successful urban space and the quality of soundscape influences people's perception and uses of urban spaces. Therefore, from an urban designer point of view, it is vital to understand the soundscape characteristics of these typologically classifiable exterior spaces, thus to specifically design the soundscape in urban public open spaces.

Inspired by the typological urban study, the concept of the typological soundscape study is defined. The aim of the typological soundscape study is to benefit the acoustic understanding of urban designers in specifically designing typologically classified urban spaces. The scope of the typological soundscape study is to analyse the acoustic characteristics of abstract urban forms, rather than the exact simulation of actual urban spaces. Indices considered in the study include sound pressure level (SPL), reverberation time (RT30 in this thesis), and early decay time (EDT). Although there are still discussions about the suitability of using reverberation in outdoor spaces, it is a useful index at least for relative comparisons (Kang, 2002a). The method of the typological soundscape study used in this research is computer simulation, which has the obvious advantage of building models and applying different materials compared with scale models and actual measurement.

2.5 COMPUTER SIMULATION METHODS

In the area of acoustics, computer simulation techniques have undergone continuous development during the last 40 years. The modelling techniques can be generally divided into micro-scale and macro-scale (Kang, 2002a). The former, based on simulating sound energy or wave motion, offers an accurate way of assessing noise climate at a small scale such as in a street and a square. The latter, also called noise-mapping, has been developed to cover a larger area in order to consider population exposure to noise in a broader way.

In this section, energy-based room acoustic simulation methods and noise-mapping methods are briefly reviewed. For the sake of the availability in this research, Raynoise (LMS Numerical Technologies N.V., 1997) and Cadna/A (DataKustik GmbH, 1998) are the two typical software packages reviewed.

2.5.1 Energy-based Room Acoustics Simulation Methods and Raynoise

There are three typical energy-based room-acoustics simulation methods: the mirror image source method, the ray tracing method and the beam tracing method.

The image source method only considers geometrically reflecting boundaries (Kang 2000; Kang 2002a). It treats building façades and square ground as mirrors and creates a series of image sources. The reflected sound is modelled with a sound path directly from the image source to a receiver. Multiple reflections are achieved by considering further images of the image source. At each reflection the strength of the image source is reduced due to the surface absorption. With the image source method the situation of a source in an enclosure is replaced by a mirror source in a free field visible from the receiver being considered. The acoustics indices at the receiver are determined by summing the contribution from all the image sources.

The ray tracing method assumes that the energy emitted by the sound sources is distributed into quanta of sound rays (LMS Numerical Technologies N.V., 1997). Each ray has an initial energy equal to the total energy of the source divided by the number of rays. Each one travels at the speed of sound and collides with the reflectors, where it is reflected in according to the law of specular reflection. Receiver locations are defined as a grid of cells and the level in a cell is calculated by summing the sound quanta (decreased in magnitude due to surface absorption at reflecting surfaces and air absorptions) arriving in that cell.

Comparing the mirror image source method and the ray tracing method, the former can be used to calculate the sound level at a point whilst the latter can only calculate a value of a sound energy in a cell and the accuracy of the results obtained are very much dependent upon the number of rays employed during calculation (Ismail & Oldham, 2003; LMS Numerical Technologies N.V., 1997). The larger number of rays calculated, the more reliable the results would be. Consequently, a long calculation time is required. In terms of the simulation accuracy, the mirror image source method is more accurate. However, its calculation time increases exponentially with the mirror order, whilst for the ray tracing method this increase is only linear.

The beam tracing method includes the conical beam method and the triangular beam method (LMS Numerical Technologies N.V., 1997). The conical beam method is based upon a sound source emitting a large number of uniformed cones to all directions with their vertices at the source. The propagation of the cones through a space is handled by applying a ray-tracing algorithm to the axes of the cones. Receivers are points, not volumes as in the ray tracing method. When a receiver point lies inside a truncated cone, between two successive reflections, a visible image source has been found. Its contribution is easily calculated, using spherical divergence in the cone. However, there are two problems with conical beam method, gaps between the cones and cone widening with increasing time. Hence, weighting and cone narrowing technology are used to overcome the problems. Instead of emitting cones, triangular-based pyramids are used to discretize the spherical wave front in triangular beam method (Lewers, 1993). The advantage of this method is that no ‘overlapping’ takes place, and so no weighting functions are needed.

In Raynoise, both conical beam method and the triangular beam method are included, for simulating the acoustic behaviour of enclosed or open spaces (LMS Numerical Technologies N.V., 1997). It is suggested that the calculation results of the triangular beam method are more accurate than the conical beam method, but with the former the convergence rate is somewhat lower. Therefore, the software recommends to use the triangular beam method for exterior applications, where most reflections will have a low order and also the maximum order set for the calculation will usually be given a low value.

2.5.2 Noise-mapping Methods and Canda/A

Noise-mapping, based on macro-scale noise modelling techniques, is being used to create urban or even national scale noise map. Noise-mapping method is developed as an effective, yet relatively inexpensive way to visualise and assess the acoustic environment and to help develop noise policies/strategies to improve the acoustic environment.

A common factor of all noise-mapping programs is the combination of noise propagation calculations with a mapping and scheme editing facility, consisting of geo-referenced, three-dimensional input data, usually associated with Geographical Information Systems (GIS). GIS has been primarily used as a planning and management tool for all geo-referenced data. The interaction of the calculated acoustic parameters in association with GIS mapping systems results in a noise map (Huang, 2003). The algorithms adopted by noise-mapping software are based on agreed principles and techniques, rather than accurate simulation.

Cadna/A is developed in Germany (DataKustik GmbH, 1998) and is written in C++. Although the image source method can be taken into account for building elements (e.g. buildings, barriers), for road and railway noise, the calculation methods are determined based on the standards of a specific country. For example, in the UK, the calculation method is the Cadna/A implementation of the UK standard CRTN (HMSO, 1988) for calculation of the noise levels from road traffic.

The CRTN model was developed by the UK Department of Transport in 1988. It gives the summary of the method of predicting noise at a reception point in a road scheme. It assumes a source with a height of 0.5 metres, and a distance of 3.5 metres from the edge of the road. Noise is estimated one metre in front of the most exposed part of an external window or door. The disadvantage of the CRTN method is that the algorithms used to predict noise levels are only approximations and no simulation is involved. There are a lot of issues that are not considered (Huang, 2003).

Although noise mapping has been used in many projects (Stedman, 2002; Stocker, 2002) in recent years, its uncertainty of accuracy and high costs has brought about many debates on the necessity of carrying out the exercise (Sheild, 2002; Jopson, 2002). The calculation results are criticised by professionals for wasting money in showing some obviously main noise sources, such as roads and railways (Pease, 2000). These debates are particular valuable in highlighting the limitations of the noise-mapping exercise.

On the other hand, for urban designers and planners, the noise-mapping exercise is useful to visualise the sound level distributions of large areas. Existing noise-mapping researches and exercises (Tompsett, 2002) have proved that a satisfactory accuracy and efficiency of noise-mapping could be achieved by more accurate data and model input. Based on a validation study in Sheffield city centre, carried out by Huang (2003), it was found that the calculation result of Cadna/A is acceptable, regarding the common agreed margin of 2dB, especially for the areas where the direct sound plays an important role. It is also noted that further improvements of the calculation methods are being considered (Kang, 2005).

2.6 SUMMARY - A THEORETICAL FRAMEWORK OF SOUNDSCAPE STUDY

From the review in this chapter, it is clearly shown that soundscape is not only an important physical factor, but also an essential aesthetic element of urban squares. However, most of the existing studies have concentrated mainly upon a single aspect of sound: unwanted sound. In this chapter, the concept of soundscape has been introduced from an aesthetic approach, aiming to introduce the complexity and diversity of the whole sonic environment to the general public.

In particular, the review suggests that the perception of an outdoor environment depends not only on the physical features, but also on the characteristics of the users and the surrounding context. Of more relevance to this study, it is vital to study interactions between people's characteristics and their perception of sounds. However, existing research in this aspect is rather limited and mostly laboratory-based. For soundscape in urban squares, it is more appropriate to carry out on-site surveys, given the difficulty of simulating complex sound sources, and the interaction between sound and other microclimate and social factors. Also, previous field surveys on soundscape mainly dealt with relatively large rural or urban areas, and studies at the scale of urban public open spaces, the focus of this research, have been limited.

More importantly, most existing research has treated soundscape as a passive perceiving factor of the environment. From an urban design point of view, it is useful to put the soundscape onto a specifically design process comparable to landscape, considering aesthetics and social/cultural factors.

Of more relevance to urban design, the spatial characteristics of a place, which is the container of the soundscape, are vital in distributing the sound. Inspired from typological urban study, it is important to carry out the typological soundscape study, an acoustic study aiming to benefit the spatial form design of urban public open spaces. At first it is of significance to study the acoustic characteristics of abstract urban forms rather than to study the exact sound field of actual urban spaces. Such a study will benefit urban designers, planners and architects for their understanding of soundscape design.

In the last section of this chapter, the energy-based room acoustics simulation methods and noise-mapping methods are reviewed. In energy-based room acoustics simulation methods, the beam-tracing method has an obvious advantage in balancing the accuracy and efficiency. Therefore, Raynoise, based on the beam-tracing method, is suitable for the further typological soundscape study. In terms of noise-mapping method, although there are debates on the accuracy and efficiency, it is useful for giving overall pictures for relatively large urban areas.

PART I

SOUNDSCAPE BY LISTENING – FIELD SURVEY

Chapter 3

Methodology for the Field Survey

Given the difficulty of simulating complex sound sources, and the interactions between sound, people, social factors and other microclimate conditions, at the first part of the research, field survey has been selected as the study method. The objective of the field survey is to identify the key aspects, as well as their relationships, which affect people's perception and evaluation of the soundscape in urban public open spaces. With long history of civic urban lives, European cities have been selected for the field survey.

This soundscape field survey was a part of an EU funded project - Rediscovering the Urban Realm and Open Spaces (RUROS). The RUROS project was a part of Key Action 4 "City of Tomorrow and Cultural Heritage" from the programme "Energy, Environment and Sustainable Development" within the Fifth Framework Programme of the EU (Nikolopoulou, 2004). The partners involved in the field survey were the Centre for Renewable Energy Sources (CRES), Aristotle University Thessaloniki (AUTH), Polytechnic University of Milan (DITEC), the School of Architecture^a in Sheffield University, the Martin Centre of in Cambridge University, Kassel University and the University of Applied Sciences of Western Switzerland (EIF). The seven institutes are located in seven cities of five European countries, namely Greece, Italy, the UK, Germany and Switzerland.

The RUROS project was a comprehensive co-operation of group and individual work. The former includes field survey questionnaire development and raw data collection i.e. questionnaire survey, observation, and physical parameter measurement. The latter includes data analysis on a specific aspect, including thermal, lighting, soundscape and

^a In the RUROS project, the author was the only PhD student specialized in soundscape. The supervisor, Professor J. Kang, was the principal investigator of the RUROS project.

visual aspects in each research partner. The Sheffield team focused on soundscape aspect.

An identical questionnaire was developed by the co-operative work of all the partners. The soundscape aspect of the questionnaire was developed by the author. In terms of the field survey sites, two public open spaces were selected in each of the seven cities, where project partner institutes are located. With the identical questionnaire and the same standard measurement equipment, the overall field surveys begun in July 2001 and were completed in September 2002, for all the cities, covering all seasons, i.e. summer, autumn, winter and spring.

The data collected during the field survey was then shared amongst research partners, for each institute to carry on the detailed analysis on their specific aspects. The overall data related to soundscape have been analysed in Sheffield University by the author.

This chapter includes three parts. In the first part, the research methods are discussed in detail regarding the questionnaire design and physical parameter monitoring. In the second part, the fourteen field survey sites are described especially from a soundscape point of view. In the third part, the data treatment methods as well as the basic data of the interviewees and the physical parameters monitored are presented.

3.1 RESEARCH METHODS

As already mentioned, the intensive questionnaire survey was carried out in four seasons between the summer of 2001 and the spring of 2002 in 14 case study sites across Europe. The research methods employed include questionnaire survey, observation and physical parameter measurements. The soundscape study was carried out as part of an overall physical comfort investigation, including thermal, lighting, aural and visual aspects.

3.1.1 Questionnaire Survey

The questionnaire includes two separate parts (see Appendix): the first part is an observation sheet to be filled by the interviewer during the interview; the second part is a question sheet to be filled by the interviewees.

The observation sheet contained spaces for filling in the information about the time and the interview position on the site, as well as the information about the interviewees, such as their gender, activity conditions, clothing conditions, food/drink consumptions, group sizes and so on.

The question sheet to be filled by the randomly selected interviewees contained questions on demographic data (e.g. age group, local/non-local inhabitant, occupation, educational level, etc.), users' details of using the sites (e.g. frequency of visiting, etc.), and evaluations regarding the overall site environment, as well as separate physical comfort factors (e.g. thermal, lighting, visual, and aural) of the site. The survey was introduced as an enquiry regarding the general environmental conditions in urban public open spaces.

The questionnaire was developed to generate a quantitative assessment of the physical environment in public open spaces. Questionnaires set out verbal descriptions of physical factors and different sounds. A linear scale for evaluating different physical factors on site generally ranged from 1-5 points, 3 being medium. For example, the scale ranged from 'very cold' to 'very hot' for temperature evaluation, from 'stale' to 'too much wind' for wind evaluation, from 'very dark' to 'very bright' for brightness evaluation. In order to make sure that the interviewees have a similar understanding of the linear scale, in the questionnaire the verbal descriptions were given together with the linear scale numbers to each response option.

In terms of the soundscape questions developed by the author, interviewees were asked to evaluate the sound environment of the site and of their homes. Five linear scales similar to the above were used: 1, very quiet; 2, quiet; 3, neither quiet nor noisy; 4, noisy; and 5, very noisy. They were also asked to classify at least three sounds as

‘favourable’ (F), ‘neither favourable nor annoying’ (N), or ‘annoying’ (A). The sounds were those frequently heard in a particular site, and were selected from a list of typical sound sources in urban public open spaces. The 5-scaled questions have often been employed in aesthetics preference research (Kaplan, 1987), but in this research, in order to simplify the survey process, 3-scaled questions were used. No question about reverberation was asked, since (1) many people did not fully understand the meaning of reverberation, according to a pilot study (Yang, 2000); (2) the situation of the 14 case study sites were rather complicated in terms of their openness and sound source conditions; (3) the space in the questionnaire was limited.

The questionnaire was initially developed in English, and then translated into other languages by native speakers. This identical questionnaire was employed to carry out the field survey by the seven partner institutes of the EU project in fourteen case study sites.

In addition, more detailed soundscape questions were designed by the author to be added to the field survey in Sheffield. The additional soundscape questions include an evaluation of the acoustic comfort of the site, the classification of fifteen listed sounds and the indication of recognised sounds on the case study sites as well as semi-structured questions related to the preferred relaxing sound environment. In the acoustic comfort evaluation five scales were used: 1, very comfortable; 2, comfortable; 3, neither comfortable nor uncomfortable; 4, uncomfortable; and 5, very uncomfortable. The fifteen verbally described sounds, which were asked to be classified as ‘favourable’ (F), ‘neither favourable nor annoying’ (N), or ‘annoying’ (A), were selected from typical urban soundscape elements. These sounds were most likely to be heard in the two squares, although during the interview those sounds were not necessarily heard.

The time period of the survey was varied in different seasons, also aiming to get the daily, as well as the seasonal, and pattern of use. The periods were roughly separated in

four different categories, the morning period (10:00 – 11:59), the midday period (12:00 – 14:59), the afternoon (15:00 – 17:59) and the evening period (18:00 – 20:59).

3.1.2 Physical Parameter Monitoring

In order to examine and record the microclimatic conditions that the interviewees were experiencing during the interview, environmental monitoring was taking place while the interviews were carried out.

In terms of acoustic environment monitoring, a one-minute Leq (Equivalent Continuous Noise Levels) was selected as the parameter to be recorded. A sound level monitoring instruction was designed by the author according to *Noise Guidance* (Environment Agency, 2000). During the questionnaire preparation period, the instruction was distributed to each project partner as the sound level monitoring standard of the RUROS project.

The one-minute Leq was measured for each interview of the fourteen sites, either when the interviewee filled in the questionnaire silently, or immediately after the interview. Integrating-averaging sound level metres, which can give Leq value automatically, were used in every site. Before and after taking the measurement of each survey period, acoustic calibrators were used to calibrate the sound level meters on every site. The value of the one-minute Leq, as well as sound elements during the interview were recorded in the observation sheet by the interviewer.

In terms of microclimate monitoring, as illustrated in Figure 3.1, weather stations were used to record the microclimate data. The weather station included a temperature and humidity probe with a radiation screen, a gray globe thermometer, a hot-wire anemometer, a pyranometer and a cylindrical illuminance meter. The data was recorded with a data logger at a 30 seconds interval during the survey.

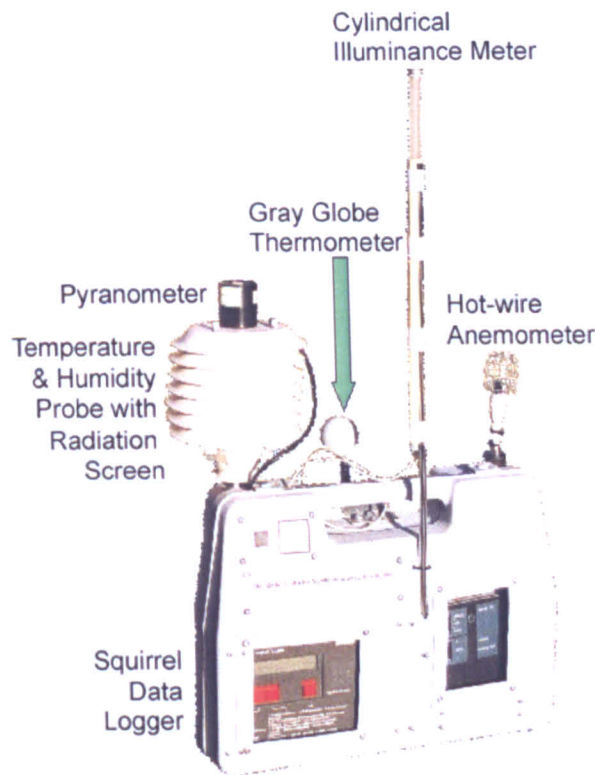


Figure 3.1 The weather station used for microclimate data recording

3.2 FIELD SURVEY SITES

With their wide variations in climate conditions and urban morphology, as shown in Figure 3.2, the seven cities, namely the Municipality of Alimos (one of the municipalities of Athens), Thessaloniki, the City of Sesto San Giovanni (one of the municipalities of Milan), Sheffield, Cambridge, Kassel and Fribourg, were selected as the host cities for the intensive questionnaire survey. In each city, two urban public open spaces were chosen as the case study sites. A wide variation of functions and soundscape were used as the criteria for the selection of the case study sites. Based on the author's site visit notes and the information provided by research partners, in this section, the 14 case study sites are described in terms of their functions, site features, main users, and soundscape characteristics.



Figure 3.2 Location of the seven case study cities
(Source: U.S. Central Intelligence Agency, Europe map 2003)

3.2.1 Field Survey Sites in the Municipality of Alimos, Greece

Located in the south of Athens metropolitan area, the Municipality of Alimos, with a population of 32,000, is one of the 54 municipalities of Greater Athens.

Karaiskaki Square

Karaiskaki Square, as shown in Figure 3.3, is the central square of the Northern Alimos. The surrounding area of the square is mainly residential, with a market for the

local community. The site includes a coffee shop, a small open theatre with a capacity of 300 spectators, a play ground for small children, as well as an open basketball and volleyball field. At the north of the square, the local open market takes place once a week, offering fruit, vegetables, etc. At the southern end of the square, there is a big complex of two elementary schools, two secondary education schools and one college of higher education, whereas in the surrounding blocks there are different tuition schools for foreign languages, sporting activities, as well as the Alimos Indoor Sports Centre. In addition, there are a few municipal buildings in the area, together with the Centre for Preoccupation of Elderly Persons, at the eastern side of the square.

The size of the square was approximately 80x50m, mostly covered with grass and tree planting. Stone paved footpaths are arranged across the square. Some benches are provided in the square.



Figure 3.3 The Karaiskaki Square

Users of the square are mainly local residents. With its various facilities and activity zones, there is a variety of age groups appearing in the Karaiskaki Square; elderly people sitting and chatting at the benches, small children with parents at the playground, older children playing basket ball and volley ball, etc.

Mainly reflecting users' activities of the square, the main sounds that can be heard in the Karaiskaki Square were footsteps, speech and children's play sounds. Surrounded by several roads, the traffic noise was a noticeable background sound of the square.

The Seashore

The Seashore, as illustrated in Figure 3.4, is the central part of the beautiful coastline of Alimos. Since the site is the only beach which can be visited free of charge, it becomes one of the most important public spaces in Alimos and is enjoyed by the general public. Isolated from the built-up area, to the south of the site is the sea and to the north of the site is a rather busy road to the southern part of the metropolitan area of Athens.

With about 2,000m² in size, the area includes rocky / sandy seashore, thoroughfares paved with marble and stone, a big wooden play yard and two bars/coffee-houses. A few benches are provided along the walking paths by the seaside, where people can rest and enjoy the view. A car park to the north of the seashore is available for the visitors, whereas a service road protects the pedestrians from the heavy traffic of the coastline highway. Indigenous vegetation is relatively poor on the site. Only the playground and coffee house areas are heavily vegetated.



Figure 3.4 The Seashore

People visiting the Seashore are not only locals from Alimos, but also people from the surrounding areas and municipalities. Generally speaking, activities in the area largely depend on the seasons. The most popular seasons are the summer and spring. Typical activities include swimming, walking along the seaside, children playing in the play field, having a drink while enjoying the view at the bars/coffee houses. During the autumn and winter survey periods, the number of users drops considerably.

Because of the recreational activities, the most typical sounds on the Seashore were footsteps, surrounding speech and children's play sounds. The heavy traffic to the north of the site generated a rather high level background noise.

3.2.2 Field Survey Sites in Thessaloniki, Greece

Thessaloniki, the second largest city in Greece with a population of 1 million people, is one of the oldest cities in Europe. Nowadays, Thessaloniki is a thriving city and one of the most important trade and communication centres in the Mediterranean.

Makedonomahon Square

Figure 3.5 shows the Makedonomahon Square, located at the centre of Thessaloniki. An historic monument, the byzantine church of Ahropiitos is located on the east side of the square. The square is surrounded by 6 to 8 storey apartment buildings. The local residents are mostly elderly and lower income families. Several small businesses are located at the ground level of surrounding buildings. More and more upper floor apartments are gradually changing from private homes to offices.



Figure 3.5 The Makedonomahon Square

This 90x45m sized square is dominated by well established plantations. Some benches and children's play facilities are provided in the square. Block paving is the main pavement material used in the square. The square is an open gathering and socializing place for lower income families, mostly migrants from Eastern European countries and the former Soviet Union. Also, the small playfield has made it popular for children to play all day long.

In terms of its soundscape, the Makedonomahon Square was a vivid place. With traffic noise and construction noise from the surrounding building blocks as its background noise, children's sound and speech sound were quite distinctive in the square.

Kritis Square

The Kritis Square, as illustrated in Figure 3.6, is located in a quiet residential neighbourhood. The surrounding buildings are 4 to 5 storey apartment buildings built in the mid-seventies or later. Few small convenience shops are located on the ground floors. A limited access open space is adjacent to the square on the northeast side and an outdoor café is located on the eastern side. Local residents are mainly middle class citizens.



Figure 3.6 The Kritis Square

Most of the space in this 85x85m sized square is block paved thoroughfares and playfield, with semi-matured trees and hedges arranged around the square. Generally speaking, the square is well facilitated and kept in good condition. Pre-school children and their parents are the main users of the square during the daytime, while after-school teenagers become the main users in the afternoon and early evening.

The soundscape of the Kritis Square represented a typical quiet residential neighbourhood - with rather low traffic noise in the background, people's speech, shouting from children's play and some construction noise from surrounding buildings combined together.

3.2.3 Field Survey Sites in the City of Sesto San Giovanni, Italy

The City of Sesto San Giovanni is a part of the North Milan hinterland, which developed as one of the most important centres of heavy industries in Italy. Nowadays, the City of Sesto San Giovanni is also a residential zone, with a population of 80,000.

Petazzi Square

Located in a quiet residential area, Petazzi Square, as can be seen in Figure 3.7, is a traditional public space. The public space is characterised by an historical church in the main front of the square. Other buildings facing the square were mainly 7-8 storey apartment blocks built in the 1960-70's. Most of the ground floor units are occupied by small stores. A popular coffee bar adjoins the square.



Figure 3.7 The Petazzi Square

This 2,800m² square is all covered by hard surface paving, with some stone benches provided and young trees placed in rows. Because of the church and local shops, the Petazzi Square acts as a meeting place for the local residents. The users of the square present a wide variation of age groups.

As a result, the soundscape of the Petazzi Square showed its distinct characteristic. Church bells, speech and children's running and laughing sound create a unique 'scene' of soundscape.

IV Novembre Square

The IV Novembre Square, as shown in Figure 3.8, is an enlarged open space developed along a roundabout in the centre of Sesto San Giovanni. The square is surrounded by 8-10 storey blocks, mainly for commercial and residential uses. There are a few large shops on the ground floor of these buildings.



Figure 3.8 The IV Novembre Square

All the area around the square was redeveloped about 10 years ago. The surface finishing on IV Novembre Square is mainly block paving. In the square, some trees are formally planted, with benches provided under the trees. A modern styled fountain is located in the corner of the square. The IV Novembre Square is an important interchange for urban and extra-urban traffic. A bus shelter and a subway exit are located at the edge of the square. No surprise, the square is always busy from morning to evening. Apart from walking straight across the square, a considerable number of people would stay a while in the place, for resting, short meetings, chatting, looking at shops and waiting to cross the busy roads.

With high level traffic noise, rushing footsteps, as well as people chatting and water sounds in the background, the soundscape of the IV Novembre Square illustrated a 'picture' of busy city lives.

3.2.4 Field Survey Sites in Sheffield, UK

Sheffield, located in north England, with a population of 0.65 million, is the fourth largest city in England. The city centre, where the two case study sites are located, is the business and commercial centre of Sheffield and is mainly a pedestrian area.

In Sheffield, as mentioned before, except for the RUROS overall survey, a more detailed soundscape study was carried out. The two sites studied are the Peace Gardens and the Barkers Pool.

The Peace Gardens

The Peace Gardens, as illustrated in Figure 3.9, was opened in late 1998. Covering an area of about 3,000m², it is one of the most popular squares in Sheffield. Most of the buildings around this sunken square date from the turn of the 19th century. The background scene of the square is the old Town Hall, which is a Grade 1 listed building of outstanding architectural interest. The concrete Town Hall Extension to the rear of the Peace Gardens was demolished during the one-year survey process (see Figure 3.9a & 3.9b). On the west side of the Peace Gardens is a busy one-way road. Most of the vehicles passing through are buses.

There are large areas of grass suitable for sitting. Benches are also provided around the grass areas. The water features provide the most attractive characteristic of the Peace Gardens, notably the 89 individual jets of the Goodwin Fountain in the centre, together with the Holberry Cascades, which are positioned on the top of the stone staircases that lead visitors from street level down into the garden. The square attracts hundreds of visitors and locals on a fine day to relax amongst the dramatic water features, intricate stone carvings and colourful flowers. Especially during lunchtime, people from surrounding offices and shops come to the square to have a rest. The Peace Gardens thus acts as a central focal point in the city centre. It provides opportunity for adults to relax and children to play.



Figure 3.9 The Peace Gardens
 (a) before demolition of the Town Hall Extension
 (b) after demolition of the Town Hall Extension

In the Peace Gardens, constant sounds from the water features, one of the landscape features, had the dominating effect for the overall soundscape. Bird's singing, footsteps, friends' chatting, and children laughing, were all the keynotes of the fountain's orchestra. Within this, sometimes background traffic noise was almost negligible. Another important sound element during the survey was the sound from the demolition work of the Sheffield Town Hall Extension. The demolition work was taking place during the autumn, winter and spring survey period.

The Barkers Pool

Shown in Figure 3.10, the Barker's Pool is adjacent to the Peace Gardens. This rectangular square is shaped by Sheffield City Hall and Cole Brothers (now John Lewis). The former is a 1930's neo-classical styled building and the latter is one of the largest and finest quality department stores in Sheffield. Another important design feature of this pedestrian square is the city's War Memorial, which helps to create a

solemn and peaceful atmosphere in the square. The Sheffield City Hall has music shows almost everynight. The box office is located in the front entrance of the City Hall. To attract visitors, the box office sometimes plays classical music from the loud speaker inside the building. At the corner of the City Hall, there is a small music store selling jazz music CDs. Sometimes, the shop plays jazz music from its own loud speaker to the outside. Interestingly, the Barkers Pool is also a popular place for the street musicians. Quite often, saxophone or country music is played on the street of the Barkers Pool. On two sides of the square there is low-density traffic.

This 50x50m sized square is mainly paved as a hard surface. Some benches in front of Cole Brothers are frequently used, especially by customers. The large steps in front of the City Hall are also a popular sitting place. On a fine day, young people like to sit on the steps and enjoy watching people and listening to the music played.



Figure 3.10 The Barkers Pool

Without music, the soundscape of the quiet Barkers Pool was rather typical. Speeches, footsteps, wind and traffic noise, etc. were more likely to be heard. It is the classical music played from the City Hall, jazz music from the music store, or the saxophone and country music played in the Barkers Pool, which added some bright ‘colours’ to the originally ‘grey’ soundscape.

3.2.5 Field Survey Sites in Cambridge, UK

Cambridge is a university city with a population of over 110,000. In addition to this population, there is a large migratory population, with an influx of academics, both students and researchers, in September/October and an exodus during the summer

months. Cambridge is also a popular tourist destination with more than 3.5 million tourists each year.

All Saint's Garden

All Saints' Garden is an open area adjacent to All Saints' Passage, which is a narrow pedestrian street in Cambridge city centre. The triangular square is closely surrounded by historical stone buildings on the two sides and a busy road on the other side. The history of the two-storey Lichfield House along All Saints' Passage can be traced back to the 17th century. There are a few shops along one side of the garden, which vary from a bookstore, music shop, designer jewellery to a cheese and chocolate shop. They are good attractions for the visitors of Cambridge. Every Saturday, the garden also hosts a local craft market.



Figure 3.11 The All Saint's Garden

This 35x35m sized site is defined by railings. The surrounding mature House Chestnut trees overshadow most parts of the triangular garden, in which 4 benches are provided under the trees. The users of the garden show a large variation, from local residents, university students, and to tourists.

The soundscape of the All Saint's Garden was quite vivid. The bird song and people's talking could be heard all day long, whereas the traffic noise was a noticeable background sound of the square.

Silver Street Bridge

This site is the pavement area that crosses the River Cam at the Silver Street Bridge - a bridge that spanned the river at this point from as early as the fourteenth century. Silver Street forms one of the main routes into the centre of the city and is used as a local traffic route and as a drop-off point for tourist coaches. A bus stop for the 'Guide Friday' tours of the city can be found just along from the bridge. A pub, the Anchor, has its main door open onto the area. During the summer months, people drink and chat on the bridge. Steps at the corner of the bridge lead people down to the river, where punts can be hired. Watching over the Cam River, the bridge is also a good scenic spot for visitors.



Figure 3.12 The Silver Street Bridge

The current bridge paved with concrete blocks, which was faced with Portland stone designed by Sir Edwin Lutyens and replaced a cast-iron bridge, which was erected in 1843. Nowadays, the pavement has been widened for pedestrians. Seven seats have been installed. With only a few willow trees at the corner of the bridge, the hard surface of the bridge is mainly exposed to the sunshine.

The soundscape of the Silver Street Bridge was characterised by the water sound from the River Cam. Surrounded with busy traffic, it was the water sound that told the story of the River Cam and attracted people to stop and enjoy the beautiful scene.

3.2.6 Field Survey Sites in Kassel, Germany

The city of Kassel is located in the middle of Germany and is the cultural and economic centre of northern Hesse, with a population of about 200,000.

Florentiner Square

The Florentiner Square is situated very close to the central shopping mall of Kassel. The surrounding buildings dated back to 1950's and have almost the same height of 4 to 6 storeys. The "Treppenstraße" bordering on to the square in the northeast is a pedestrian precinct and leads from the shopping street to the main station. Its most noticeable characteristics are the stairs with a level difference of 15 meters. The Florentiner Platz itself has a level difference of 2.5m, which is shored up by walls. The street "Neue Fahrt" runs parallel to the central shopping street of Kassel and is the typical back of a pedestrian area; it can be characterized as a second-class business location with delivery traffic. Only a few years ago nearly the whole Florentiner Platz was used as parking space. Today it is reserved for pedestrians and during the summer months there is an extensive open-air gastronomic on offer.



Figure 3.13 The Florentiner Square

Located in the central Kassel, the Florentiner square represented a typical urban soundscape. Traffic, footsteps and surrounding people's speech were the most common sounds.

Bahnhofplatz (Station Square)

The main station of Kassel is situated at the western edge of the city centre. Being one of the largest squares of the city centre, the Bahnhofplatz (station square) sits in front of this terminus station. Topographically the square is sloped from southwest to northeast with a difference in level of about 9 meters. The distance from the square to the central shopping mall is about five hundred meters.

As shown in Figure 3.14, the surrounding buildings of the square are mainly offices, which are rather convenient for commuters to reach on foot. The buildings date from the post-war era, because the city centre of Kassel was destroyed almost completely. The buildings in the northern and southern edge of the station square (IHK and Polizeipräsidium) were built in the last ten years. The height of the buildings varies from 4 to 10 floors.

The 1,000 m² square is divided into different functions by green structures, walls, and chains. Therefore, it is hard to have an overall impression about this large square. Instead, the square is divided by broad streets at the northern and eastern edge, a bus station in the northern part, a parking area together with taxi rank in the southern part and a pedestrian area with a fountain directly in front of the station. The connections to the local tramway and pedestrian subway crossing are also located in the square.



Figure 3.14 Bahnhofplatz

Since the Second World War and especially due to the completion of a new railway station at the western outskirts of Kassel in 1991, the main station of Kassel gradually lost its former importance. The Bahnhofplatz has experienced a series of social problems. Nowadays, through the conversion to a cultural square with cinema and

exhibition areas, the desolate situation has been improved. Furthermore the pedestrian subways were replaced by crossings at ground level.

Generally speaking, the soundscape of the Bahnhofplatz was rather typical. Notably, the water sound from the fountains in front of the station gave some freshness to the mixed sounds of the traffic, speech and footsteps.

3.2.7 Field Survey Sites in Fribourg, Switzerland

Located 34km southwest of Bern, Fribourg links the French-speaking and German-speaking parts of Switzerland. With a population of 33,000, the Fribourg Commune has an almost perfectly preserved medieval old town.

Jardin de Perolles

Jardin de Perolles, as illustrated in Figure 3.15, was completely redeveloped around the year of 2000 through a local competition. Three sides of this considerably sized square are surrounded by newly developed high quality apartments. The surrounding buildings are 8 to 10 storey blocks. On the other side of the square is a busy road linking the new part and the old part of Fribourg.



Figure 3.15 Jardin de Perolles

With an overall size of around 170x100m, the square is mainly covered with high quality lawns. Some benches and trees are scattered around. To the southern part of the square, a large sized playground is provided. Most of the users are local residents, especially mothers bringing their children to the playground during the daytime.

Generally speaking, Jardin de Perolles was a very quiet place, slightly over-shadowed by low level traffic noise. With its enormous size, only in the playing field corner of Jardin de Perolles, sounds from people's activity can be heard.

Place de la Gare (Station Square)

Fribourg's train station is located on the hill overlooking the old town from the northwest, with a brand-new bus terminal beneath. Acting like the entrance of the city, the Place de la Gare (station square), has an important image function. However, as shown in Figure 3.16, the old station building, surrounding shops and restaurants, extensive bus stops and parking spaces present a rather messy picture. Although all paved as hard surfaces, there are no space in the square for people to stop. The whole station square acts as a large thoroughfare for people getting through. Due to the unsatisfactory nature of the square, the city council is considering a refurbishment in the near future.



Figure 3.16 Place de la Gare

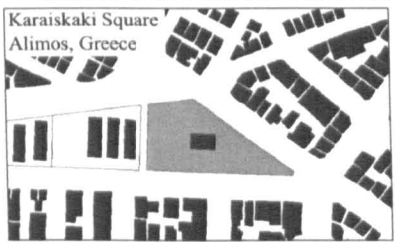

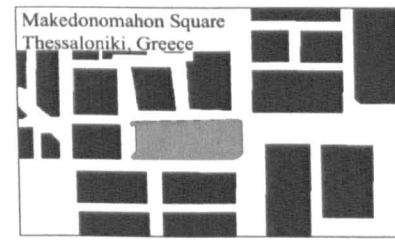
Being too exposed to the busy traffic, the soundscape of the Place de la Gare was dominated by the high level traffic noise as well as people shouting and busy footsteps.

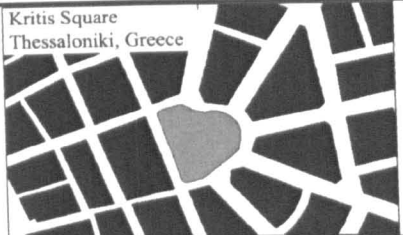

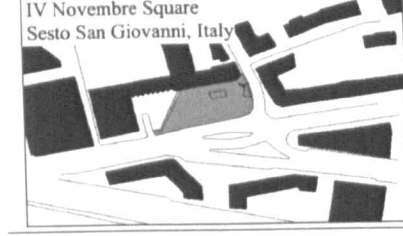




3.2.8 Summary



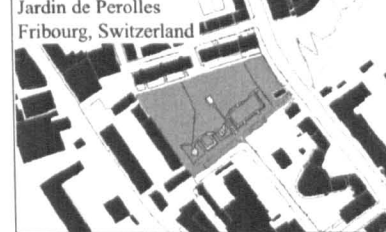

Table 3.1 shows the site plan and area, main functions, major sound sources and the number of interviews for the 14 field survey site. It can be seen that the field survey

sites exhibited a wide variation. In terms of function, the sites included residential squares (e.g. Kritis Square, Petazzi Square, Jardin de Perolles), cultural and tourism squares (e.g. the Seashore of Alimos, the Peace Gardens, the Barkers Pool, All Saint's Garden, Silver Street Bridge, Florentiner Square), railway station squares (e.g. Bahnhofspatz, Place de la Gare), and multi-functional squares (e.g. Karaiskaki Square, Makedonomahon Square, IV Novembre Square). In terms of soundscape, traffic noise appeared in all the case study sites, although in some squares it was the main sound source (e.g. IV Novembre Square and Place de la Gare), whereas in other squares it could be regarded as the general background noise (e.g. the Peace Gardens and Jardin de Perolles). On the other hand, a number of sites were featured by their unique sound elements, for example, water sounds in the IV Novembre Square, the Peace Gardens, Silver Street Bridge and Bahnhofspatz, music in the Barkers Pool, church bells in the Petazzi Square, construction/demolition sounds in the Makedonomahon Square, Kritis Square and the Peace Gardens. Users' activities were another source of sounds, such as footsteps, surrounding speech and children shouting.

Table 3.1 Basic information of the field survey sites

Sites [survey areas in grey]	Size	Main functions	Main sound sources	No. of interviews
 <p>Karaiskaki Square Alimos, Greece</p>	80x50m (approx. 4,000m ²)	Residential, commercial	Traffic, footsteps, surrounding speech, children	655
 <p>Seashore, Alimos, Greece</p>	85x25m (approx. 2,100m ²)	Tourism, recreation	Traffic, footsteps, surrounding speech, children	848
 <p>Makedonomahon Square Thessaloniki, Greece</p>	90x45m (approx. 4,000m ²)	Residential, office, relaxation	Traffic, construction, children, surrounding speech	1037

 <p>Kritis Square Thessaloniki, Greece</p>	85x85m (approx. 4,500m ²)	Residential, relaxation	Traffic, construction, surrounding speech, children	777
 <p>Petazzi Square Sesto San Giovanni, Italy</p>	70x40m (approx. 2,600m ²)	Cultural (church), commercial, relaxation	Traffic, church bell, surrounding speech, children	599
 <p>IV Novembre Square Sesto San Giovanni, Italy</p>	80x35m (approx. 3,000m ²)	Public transport, residential, commercial	Traffic, footsteps, surrounding speech, water (fountains)	574
 <p>The Peace Gardens, Sheffield, UK</p>	70x50m (approx. 3,000m ²)	Recreation, cultural (historical buildings)	Water (fountains), demolition, children, surrounding speech, traffic	510
 <p>The Barkers Pool Sheffield, UK</p>	50x50m (approx. 2,500m ²)	Commercial, cultural (music hall)	Traffic, footsteps, music, surrounding speech	499
 <p>All Saint's Garden Cambridge, UK</p>	38x35m (approx. 1,000m ²)	Relaxation, commercial, cultural (historical buildings), residential	Traffic, surrounding speech, birds	459
 <p>Silver Street Bridge Cambridge, UK</p>	30x18m (approx. 500m ²)	Tourism, relaxation	Traffic, water (river), surrounding speech	489

 <p>Florentiner Square Kassel, Germany</p>	35x20m (approx. 700m ²)	Commercial, recreation	Traffic, footsteps, surrounding speech	406
 <p>Bahnhofplatz Kassel, Germany</p>	40x25m (approx. 1,000m ²)	Railway station square	Traffic, footsteps, surrounding speech, water (fountains)	418
 <p>Jardin de Perolles Fribourg, Switzerland</p>	170x100m (approx. 1,5000m ²)	Residential, recreation	Footsteps, surrounding speech, children, traffic	888
 <p>Place de la Gare Fribourg, Switzerland</p>	80x20m (approx. 1,400m ²)	Railway station square	Traffic, footsteps, surrounding speech	1041

3.3 DATA ANALYSIS

3.3.1 Data Treatment

After the one-year field survey, the raw data were input into ‘*SPSS - Statistical Package for the Social Sciences*’ (Field, 2000), by each research partner as the database for further analysis. The database was exchanged between the partners for specialised analysis. Based in Sheffield, the author carried out the analysis for the soundscape aspect.

Firstly, the soundscape analysis was focused on examining whether the subjective evaluation results were fully consistent with the objective measurement results.

Secondly, the relationships of the sound level and acoustic comfort evaluations were tested. Thirdly, the subjective evaluations of the acoustic environments and sound preferences were compared in terms of long-term and cultural differences, as well as demographic variables. Finally, the subjective evaluations of the acoustic environments for the sites were compared according to different temporary status in using the sites.

3.3.2 Basic Data of the Interviewees

In total 9,200 interviews were made over the one-year survey for the 14 case study sites. As shown in Table 3.1, for each site around 400-1,000 interviews were carried out with an identical questionnaire. The subjects were selected at random. Shown in Table 3.2, the age distributions of the subjects were rather wide, ranging from children to the elderly. Generally speaking, people aged 18-54 present the majority of the interviewees. In Karaiskaki Square (Alimos), the Seashore (Alimos), Makedonomahon Square (Thessaloniki), Kritis Square (Thessaloniki) and Petazzi Square (Sesto San Giovanni), relatively large numbers of elderly people (aged>65) were interviewed. Because of the difficulty in filling in the questionnaire and communicating, the percentage of children was very low (0-3.15%) in all the case study sites. Therefore the data for children are treated as missing values in the further analyses.

The numbers of males and females were generally the same for all the case study sites (see Table 3.3). Only in IV Novembre Square (Sesto San Ginvanni), the gender distribution was relatively unbalanced - in this case more than 64% of the interviewees were male.

For most of the 14 case study sites, as Table 3.4 shows, local people presented the majority. Except All Saint's Garden (Cambridge), Silver Street Bridge (Cambridge),

Bahnhofplatz (Germany) and Place de la Gare (Fribourg), where more than 50% of the interviewees were non-local. It was because the first two sites in Cambridge are tourist sites, and the third and fourth sites are railway station squares.

The interviewees were classified into five categories: student, working people, pensioner, housekeeper and others (e.g. unemployed). Shown in Table 3.5, the majority of the interviewees in the case study sites were either students or working people. Residential squares, Kritis Square in Thessaloniki and Petazzi Square in Sesto San Giovanni had more than 25% interviewees as pensioners and more than 10% as housekeepers.

In Sheffield, over 1,000 interviews were made in the Peace Gardens and the Barkers Pool. In both squares around 50% of the interviewees were young people between 18 and 34 years old. The numbers of male and female interviewees were generally the same, but in the winter survey period there were more male users (about 60%) in both squares. In the Peace Gardens and the Barkers Pool 74.5% and 81.6% of the interviewees were local people respectively. The Peace Gardens attracts more tourists, 19.9% of the non-local users were from overseas. The distribution of various categories in both squares is rather similar. 43% and 35% of the interviewees were students and working people respectively. This is because, as mentioned before, the two sites are located in the business centre of Sheffield and close to the two universities. 12% of the interviewees were pensioners, 3% housekeepers and 7% others.

Table 3.2 Age distributions of the interviewees

	Alimos		Thessaloniki		Sesto San Giovanni		Sheffield		Cambridge		Kassel		Fribourg	
	Kara. Square	Seashore	Maked. Square	Kritis Square	Petazzi Square	IV Nov. Square	Peace Gardens	Barkers Pool	All St. Passage	Silver Street	Flor. Square	Bahn. Square	Jard. de Perolles	Place de la Gare
Children	6	5	23	16	12	7	6	6	0	2	4	0	28	10
Teenager	23	22	34	18	47	26	62	65	26	35	31	48	90	101
18-24	28	59	307	156	81	112	132	138	88	150	77	74	184	301
25-34	190	229	180	116	138	144	121	149	118	104	103	80	194	217
35-44	171	220	163	147	99	126	60	39	98	82	99	77	143	123
45-54	56	84	117	102	56	58	45	22	69	59	56	78	95	125
55-64	39	65	50	35	76	62	41	36	40	31	23	37	72	88
>65	142	164	162	187	90	39	43	44	20	26	13	24	77	69
Missing	0	0	1	0	0	0	0	0	0	0	0	0	5	7
Total	655	848	1037	777	599	574	510	499	459	489	406	418	888	1041

Table 3.3 Gender distributions of the interviewees

	Alimos		Thessaloniki		Sesto San Giovanni		Sheffield		Cambridge		Kassel		Fribourg	
	Kara. Square	Seashore	Maked. Square	Kritis Square	Petazzi Square	IV Nov. Square	Peace Gardens	Barkers Pool	All St. Passage	Silver Street	Flor. Square	Bahn. Square	Jard. de Perolles	Place de la Gare
Male	302	386	548	443	316	371	281	266	216	280	234	225	436	579
Female	352	462	489	334	281	202	229	233	243	209	172	192	446	446
Missing	1	0	0	0	2	1	0	0	0	0	0	1	6	16
Total	655	848	1037	777	599	574	510	499	459	489	406	418	888	1041

Table 3.4 Number of local and non-local interviewees

	Alimos		Thessaloniki		Sesto San Giovanni		Sheffield		Cambridge		Kassel		Fribourg	
	Kara. Square	Seashore	Maked. Square	Kritis Square	Petazzi Square	IV Nov. Square	Peace Gardens	Barkers Pool	All St. Passage	Silver Street	Flor. Square	Bahn. Square	Jard. de Perolles	Place de la Gare
Local	--	--	543	548	528	400	380	407	172	117	242	182	631	501
Non-local	--	--	492	228	67	171	130	92	287	372	164	236	256	535
Missing	655	848	2	1	4	3	0	0	0	0	0	0	1	5
Total	655	848	1037	777	599	574	510	499	459	489	406	418	888	1041

Table 3.5 Occupation distributions of the interviewees

	Alimos		Thessaloniki		Sesto San Giovanni		Sheffield		Cambridge		Kassel		Fribourg	
	Kara. Square	Seashore	Maked. Square	Kritis Square	Petazzi Square	IV Nov. Square	Peace Gardens	Barkers Pool	All St. Passage	Silver Street	Flor. Square	Bahn. Square	Jard. de Perolles	Place de la Gare
Pupil/student	--	--	341	171	139	142	221	214	112	159	93	105	284	386
Working person	--	--	396	288	220	289	186	177	244	221	243	237	413	455
Pensioner	--	--	194	209	166	114	62	59	39	48	25	40	66	45
Housekeeper	--	--	88	104	67	18	16	16	41	15	29	28	3	6
Other	--	--	0	0	4	10	15	26	18	38	0	1	108	117
Tourist	--	--	0	0	0	0	3	0	3	2	15	5	12	26
Unemployed	--	--	18	5	0	0	7	7	2	6	1	2	1	3
Missing	655	848	0	0	3	1	0	0	0	0	0	0	1	3
Total	655	848	1037	777	599	574	510	499	459	489	406	418	888	1041

3.3.3 Basic Data of Micro-climate Conditions

Table 3.6 shows the average air temperature ($^{\circ}\text{C}$), wind speed (m/s), and relative humidity (%) during the interview for each survey season of the seven cities. It can be seen that the four-season survey covered a wide variation of micro-climate conditions as expected. Also the same season comparisons between cities indicate their climate difference.

In the same season, the air temperature shows the largest variation between cities. Alimos had the warmest climate, with an average 30.1°C in summer and 16.4°C in winter. Generally speaking, Kassel was the coldest city, with an average of 22°C in the summer and 5.3°C in winter. The average difference between the two cities was more than 10°C . Generally speaking, Sheffield, Cambridge, Kassel and Fribourg had relatively cooler climate, whereas Alimos and Thessaloniki had much warmer climate. Sesto San Giovanni in northern Italy showed a wider range of temperature change compared to other cities.

In terms of the wind speed, the variation range of each city was almost constant for different seasons. For example, in Thessaloniki and Kassel the average wind speed is about 0.2m/s and 1.2m/s for all the four seasons, respectively. However, the relatively large STD values also indicate the temporary variation during the interview time.

The relative humidity of different cities also indicates the wide variation of climate. With Relative Humidity more than 57%, Kassel was the most humid city during the interview. Also, it is found that the most humid season was different in each city. For example, autumn was the most humid season for Alimos, Sesto San Giovanni, Sheffield, Cambridge, and Kassel. However, spring was the most humid season for Thessaloniki.

From the above comparison, it can be seen that although showing wide variations in terms of micro-climate conditions, there were no extreme weather conditions during the field survey. In terms of acoustic measure, these micro-climate conditions should have no effect on the accuracy of sound level meters.

Because of the considerable micro-climate difference and the possible cultural and long-term background difference between interviewees in different cities, in the further soundscape analysis, interviewees from different field survey cities have been treated as different samples.

Table 3.6 Micro-climate conditions of the field survey cities

Seasons			Alimos	Thessaloniki	S. S. Giovanni	Sheffield	Cambridge	Kassel	Fribourg	
Air Temperature (°C)	Summer, 2002	Mean	30.1	26.5	26.4	21.3	23.1	22.0	23.2	
		STD	2.0	2.5	2.4	3.3	3.6	3.2	3.8	
	Autumn, 2002	Mean	18.8	10.6	14.4	16.7	9.0	16.4	11.7	
		STD	2.9	2.3	3.4	1.8	2.7	1.7	3.2	
	Winter, 2002	Mean	16.4	15.7	10.8	9.5	11.0	5.3	6.8	
		STD	1.2	2.5	1.5	2.2	2.1	2.1	3.8	
	Spring, 2003	Mean	21.9	21.6	2.5	13.2	23.0	22.1	14.0	
		STD	2.9	2.1	2.8	2.7	3.6	3.6	3.2	
	Wind Speed (m/s)	Summer, 2002	Mean	1.0	0.2	0.5	1.1	1.0	1.2	1.1
			STD	0.6	0.2	0.2	0.5	0.6	0.6	0.4
Autumn, 2002		Mean	0.7	0.2	0.5	0.9	0.5	1.1	1.0	
		STD	0.6	0.1	0.3	0.4	0.3	0.6	0.7	
Winter, 2002		Mean	0.7	0.2	0.9	0.5	0.9	1.2	1.2	
		STD	0.5	0.1	0.8	0.3	0.5	0.7	0.7	
Spring, 2003		Mean	1.1	0.2	0.6	0.5	1.0	1.2	1.1	
		STD	0.7	0.1	0.2	0.2	0.6	0.5	0.6	
Relative Humidity (%)		Summer, 2002	Mean	46.6	41.4	60.9	58.6	55.6	66.8	42.5
			STD	13.7	10.0	7.5	12.9	13.2	10.6	12.1
	Autumn, 2002	Mean	62.4	51.0	62.8	69.1	74.4	76.3	55.5	
		STD	9.8	13.2	16.0	7.7	8.2	10.4	15.3	
	Winter, 2002	Mean	51.5	59.1	57.7	63.2	59.7	60.1	62.0	
		STD	10.2	14.3	14.7	8.6	11.0	15.5	13.0	
	Spring, 2003	Mean	48.5	63.4	56.2	48.6	56.2	57.9	49.6	
		STD	13.2	11.1	9.5	9.3	13.1	7.3	13.0	

3.4 SUMMARY

This chapter has described the intensive questionnaire survey of RUROS project carried out in four seasons between the summer of 2001 and the spring of 2002 in 14 case study sites across Europe. With 9,200 people interviewed on site, the research is one of the most comprehensive soundscape studies carried out in European urban public open spaces. Wide variations were given to demographic data, site functions, as well as micro-climate conditions. A comprehensive methodology, including on-site questionnaire survey, observation and physical parameter measurements was employed for the research. More

importantly, to avoid any possibility of bias, the soundscape study was carried out as part of an overall physical comfort investigation, including thermal, lighting, aural and visual aspects.

To carry out specialised soundscape analysis, in Sheffield, more soundscape related questions were added into the overall RUROS questionnaire, and more detailed soundscape observation was taken during the field survey.

After the one-year survey, a RUROS database was established for each specialist team to share the data and to carry on detailed analysis. As the only PhD student specialised in soundscape in RUROS project, the author carried out the soundscape related analysis.

To establish further analysis, in this chapter, the demographic and micro-climate analyses were also made. The demographic distribution of the survey results indicated a wide variation of age group, gender, residency and occupation. The micro-climate data showed a considerable but non-extreme variation between different sites. Therefore, based on the database, detailed soundscape analyses have been carried out in the next two chapters.

Chapter 4

Soundscape Perception and Evaluation

The importance of assessing soundscape as a part of sensory aesthetics research, which is concerned with the pleasantness of the sensations one receives from the environment, has been discussed in the Chapter 2. In this context, it is assumed that people's judgement of a given soundscape involves more factors than just physical parameters. It has been found that variables such as pleasure or beauty represent the most influential dimension of the environmental assessment (Nasar, 1988). The aesthetic response of the soundscape is to be considered as a mix of high pleasure, excitement, and relaxation. Of more relevance to soundscape design is how various aspects of soundscape influence affective response.

Some key questions need to be answered. Is people's perception of the sound level correlated to the measured sound level? Does aural perception play an important role in influencing people's choice of using an urban public open space? How does it happen? What are people's sound preferences? Correspondingly, how can we specifically design soundscape in urban public open spaces?

In this chapter, the discussion is focused on the interaction between people and two essential aspects of the urban soundscape: the sound levels and the sound elements contained in soundscape. The discussion falls into five parts: the first part examines people's perception and evaluation of sound levels; the second part examines people's perception and evaluation of sound elements; the third part discusses the difference between sound level evaluation and acoustic comfort evaluation; the fourth part further explores the interaction between sound preference and acoustic comfort; and the fifth part discusses the relationship between soundscape and other physical factors.

4.1 PERCEPTION AND EVALUATION OF SOUND LEVELS

As stated in Chapter 3, for the 14 case study sites across Europe, one-minute L_{eq} was measured during each interview. The measured sound levels in each site are shown in Table 4.1, including the mean and standard deviation (STD) of the one-minute L_{eq} values (see Section 3.1.2), as well as their statistical levels L_{eq90} , L_{eq50} and L_{eq10} . It can be seen that different case sites have rather different sound levels. The difference amongst the sites can be over 13dBA. Amongst all the sites, the Jardin de Perolles in Fribourg is the quietest, with a mean L_{eq} of 55.9dBA. Its acoustic environment is also rather stable, with a STD of 4dBA. The noisiest sites are the Makedonomahon Square in Thessaloniki and the IV Novembre Square in Sesto San Giovanni. The mean L_{eq} is over 69dBA and the STD is over 5dBA.

The mean subjective evaluations of sound level for each site are shown in Table 4.2. It is interesting to note that the mean subjective evaluation is not well correlated to the measured sound levels. For example, in terms of the subjective evaluation, rather than the Jardin de Perolles, the Petazzi Square in Sesto San Giovanni is the quietest site, although the mean L_{eq} of the latter is much higher, 66.2dBA. As with the measured sound level results, the Makedonomahon Square in Thessaloniki is the noisiest in terms of the subjective evaluation. However, although the IV Novembre Square in Sesto San Giovanni and the Makedonomahon Square have a similar sound level ranges, 69dBA, the former has a better subjective evaluation than the latter.

Therefore, considering the possible influences of long-term sound environment and cultural differences between different cities, comparisons of the measured sound levels and the subjective evaluations are made for each city. Figure 4.1 shows the relationships between the sound level and the subjective evaluation of the sound levels in twelve sites, with linear regressions and correlation coefficients R . In the figure each symbol represents the average of the subjective evaluations at a one-dBA scale. Corresponding to the conventional understanding, there is generally a strong positive correlation between the sound level and the subjective evaluation. With an increase in L_{eq} , the mean evaluation score also becomes higher. However, from Figure 4.1 it can

Table 4.1 Measured sound levels of the field survey sites

	Alimos	Thessaloniki		Sesto San Giovanni		Sheffield		Cambridge		Kassel		Fribourg		
		Kara. Square	Sea-shore	Maked. Square	Kritis Square	Petazzi Square	IV Nov. Square	Peace Gardens	Barkers Pool	All St. Garden	Silver St. Bridge	Flor. Square	Bahn. Square	Place de la Gare
Leq, dBA	Mean	62.8	64.4	69.3	66	66.2	69.1	67.4	60.2	-	61.3	64.7	67.9	55.9
	STD	3.9	3.6	6	7.9	4.8	5.2	6.3	3.4	-	4	4.2	2.9	4
	Leq90	57.7	60.5	63.5	57.4	60.7	65	57.9	56.5	-	57.1	60.1	63.9	51.2
	Leq50	62.8	64.1	68.2	64.1	66.2	68.4	68.5	59.9	-	60.7	63.7	67.9	55.5
	Leq10	67.8	68.5	76.4	78.9	72.1	76.5	74.5	63.6	-	65.8	70.1	71.2	61.1

Table 4.2 The subjective evaluation of the sound levels in the field survey sites

Evaluation: site	Alimos	Thessaloniki		Sesto San Giovanni		Sheffield		Cambridge		Kassel		Fribourg			
		Kara. Square	Sea-shore	Maked. Square	Kritis Square	Petazzi Square	IV Nov. Square	Peace Gardens	Barkers Pool	All St. Garden	Silver St. Bridge	Flor. Square	Bahn. Square	Place de la Gare	Jardin de Perolles
Mean	2.7	2.79	3.85	2.79	2.46	2.46	3.25	3.4	2.92	2.48	3.2	3.18	3.42	3.59	2.49
STD	0.86	0.95	0.89	0.89	0.92	0.92	0.99	0.92	0.76	0.83	0.88	0.62	0.64	0.83	0.8

be seen that although all the linear regressions have a similar tendency, their positions are rather different. This suggests that with a given sound level, the subjective evaluations are different.

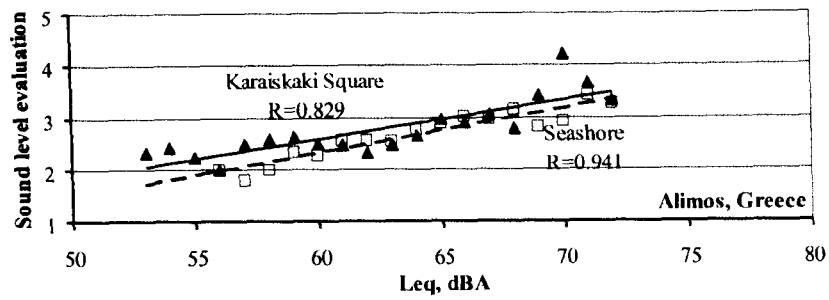
It is interesting to note that the differences exist not only between cities, which might be caused by the long-term sound environment and cultural differences, but also between two sites in the same city. For example, in Figure 4.1b, with a L_{eq} of approximately 70dBA, the mean subjective evaluation score is about 3 (neither quiet nor noisy) in the Kritis Square, whereas it is about 4 (noisy) in the Makedonomahon Square. As can be seen in the figure, the two sites have rather different sound level ranges. In the Kritis Square the L_{eq} varies from 53 to 71dBA, whereas in the Makedonomahon Square it ranges from 61 to 80dBA. The difference between the two squares in L_{eq90} is about 6dBA (see Table 4.1). Similar situations can also be seen in Figure 4.1c between the IV Novembre Square and the Petazzi Square in Sesto San Giovanni and in Figure 4.1f between the Place de la Gare and the Jardin de Perolles in Fribourg. The results might suggest that because of the different sound level ranges of the sites, people have different evaluations at the same sound level. At a lower overall sound level range and a lower L_{eq90} , people may feel it quieter at a given sound level.

The importance of L_{eq90} can be further proved in Figure 4.1(d). Although the Peace Gardens and the Barkers Pool have a 7.2dBA difference in the mean L_{eq} , however, with a similar L_{eq90} , the linear regressions of the two squares are rather close. In other words, with a given sound level, the subjects' evaluation scores are about the same in the two squares. Similar results can also be found in Figure 4.1(a) between the Karaiskaki Square and the Seashore in Alimos and in Figure 4.1(e) between the Florentiner Square and the Bahnhofspatz in Kassel. The results further suggest that even rather different in the mean L_{eq} levels, when two sites have a similar L_{eq90} level, people may have a similar evaluation towards sound levels.

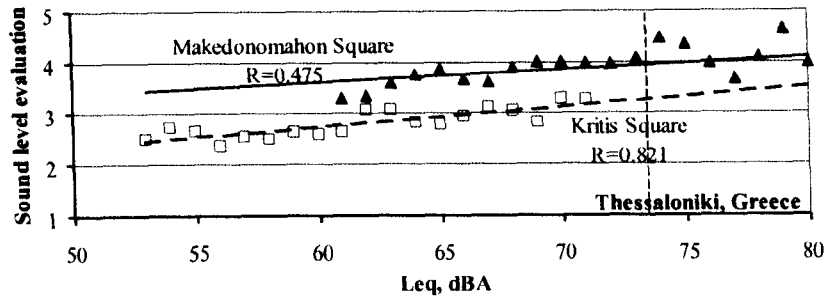
Currently, in general environmental noise assessment, the L_{eq} over a time period has been widely adopted as a general-purpose index (Department of the Environment, 1994). However, for urban public open spaces, the results in this study suggest that the background sound level is another essential index. A lower background sound level can make people feel quieter, even when the foreground sounds reach a rather high level.

Another interesting phenomenon is that below a certain sound level, which is 73dBA on the basis of this research, there is generally a good correlation between L_{eq} and the subjective evaluation, but the correlation coefficient becomes rather low beyond this sound level. In Figure 4.1(b) and 4.1(c), if only the range of $L_{eq} < 73\text{dBA}$ is considered, the correlation coefficient is increased from 0.475 to 0.879 ($p < 0.01$) in the Makedonomahon Square, from 0.472 to 0.803 ($p < 0.01$) in the Petazzi Square and from 0.373 to 0.802 ($p < 0.01$) in the IV Novembre Square. This suggests that when the sound level reaches a certain value, the subjects' evaluation varies significantly and becomes more unpredictable.

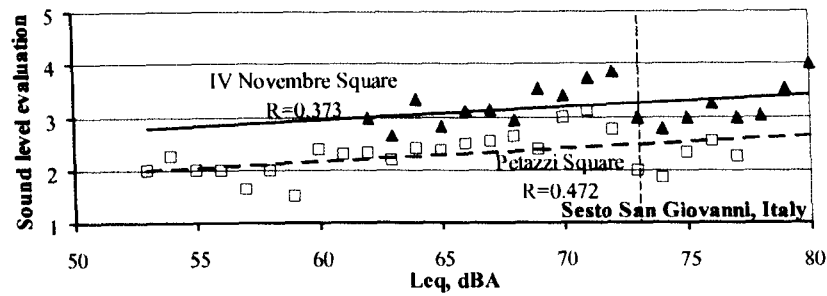
To summarise the section, based on the field survey results of 14 case study sites across Europe, it was found that the subjective evaluation generally relates well with the mean L_{eq} , especially when the L_{eq} is lower than a certain value, which is 73dBA on the basis of this research. However, this relation varies in different cities. Importantly, the background sound level has been found to be a vital index in evaluating soundscape in urban public open spaces - a lower background sound level can make people feel quieter. In other words, to create a comfortable acoustic environment in an urban public open space, it is important to reduce the background sound level.



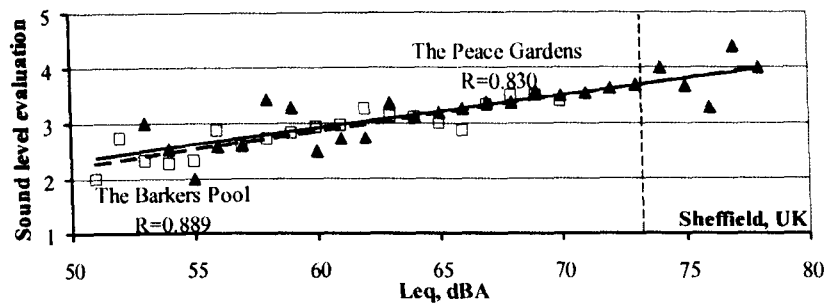
(a)



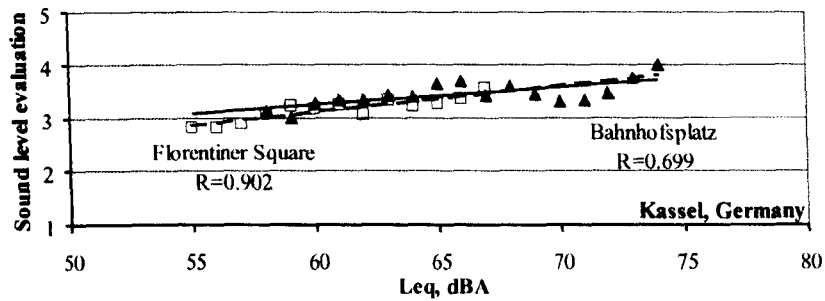
(b)



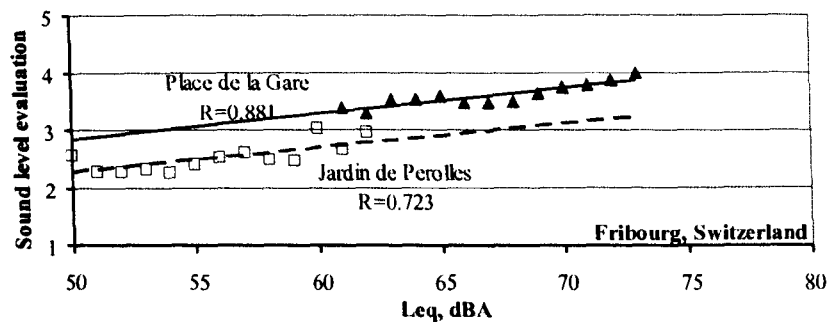
(c)



(d)



(e)



(f)

Figure 4.1 Relationships between the measured sound level and the subjective evaluation of the sound level, with linear regressions and correlation coefficients R

4.2 PERCEPTION AND EVALUATION OF SOUND ELEMENTS

4.2.1 Perception of Sound Elements

As mentioned in Chapter 3, a more detailed survey was carried out in the two Sheffield sites, namely the Peace Gardens and the Barkers Pool. Although the two field survey sites are rather close, their soundscapes are considerably different, in terms of both design features and activities. In the Peace Gardens the most significant design feature is the fountains. Therefore, sounds of the water are the dominant soundscape element. Another important sound element during the survey was the demolition work of the Sheffield Town Hall extension during the autumn, winter and spring survey periods. In the autumn survey period, due to the preparation for the demolition work, the fountains were often not operating. In the Barkers Pool, during most of the survey period (65%), the main sound elements were surrounding speech sounds, footsteps, wind and traffic noises. During 35% of the survey period, classical music from the City Hall, jazz music from the music store, or street music (i.e. saxophone or country music) could be heard in the square.

The site plan with the sound pressure level (SPL) distributions of the Peace Gardens and the Barkers Pool is shown in Figures 4.2(a) and 4.2(b), respectively. The SPL is calculated using noise-mapping software Cadna/A (see Section 2.5.2). The sound sources considered are traffic and fountains in the Peace Gardens, and traffic only in the Barkers Pool (Huang, 2003). In this study, the purpose of using Cadna/A is not for simulating the accurate sound field in the sites, it is rather a rough indication for the sound source distributions.

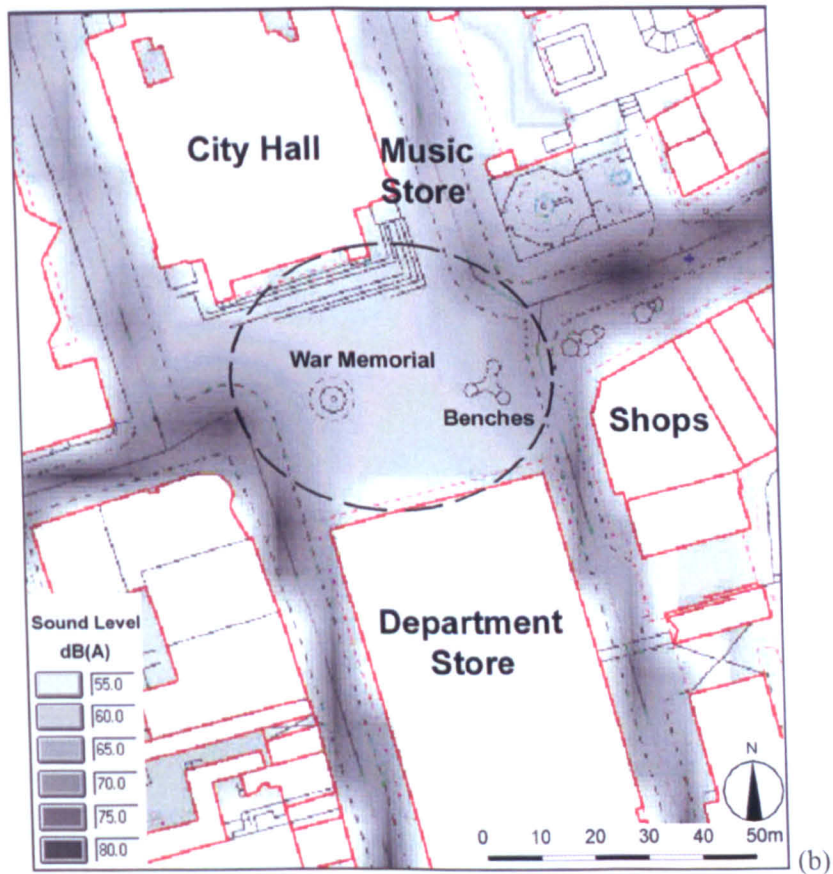
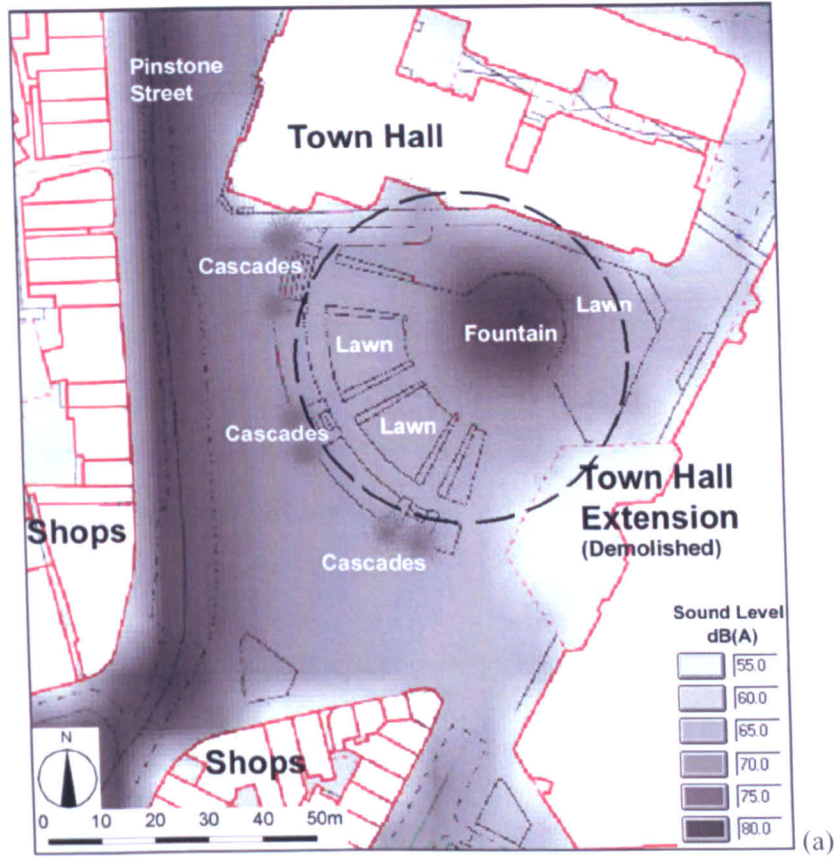


Figure 4.2 The site plan of the Peace Gardens (a) and the Barkers Pool (b) (The plan is based on the EDINA Digmap. The grey scale in the plan corresponds to sound levels. The dashed circle indicates where the interviews were conducted)

As mentioned before, the interviewees were asked to describe up to three sounds they heard in the square during the interview period. The results in the Peace Gardens and the Barkers Pool are illustrated in Figures 4.3 and 4.4, respectively. In the Peace Gardens, the soundmark - water sounds from the fountains - was heard most often. In addition, as shown in Figure 4.3, the fountain sounds were more likely to be mentioned as the first-noticed sound. The foreground sounds, from demolition work, digger machines and lawn mowers, also show a high level of awareness from the interviewees. The keynote sounds of the Peace Gardens exhibited a wide variation, including motor, human and natural sounds, which were more likely to be noticed secondly or thirdly.

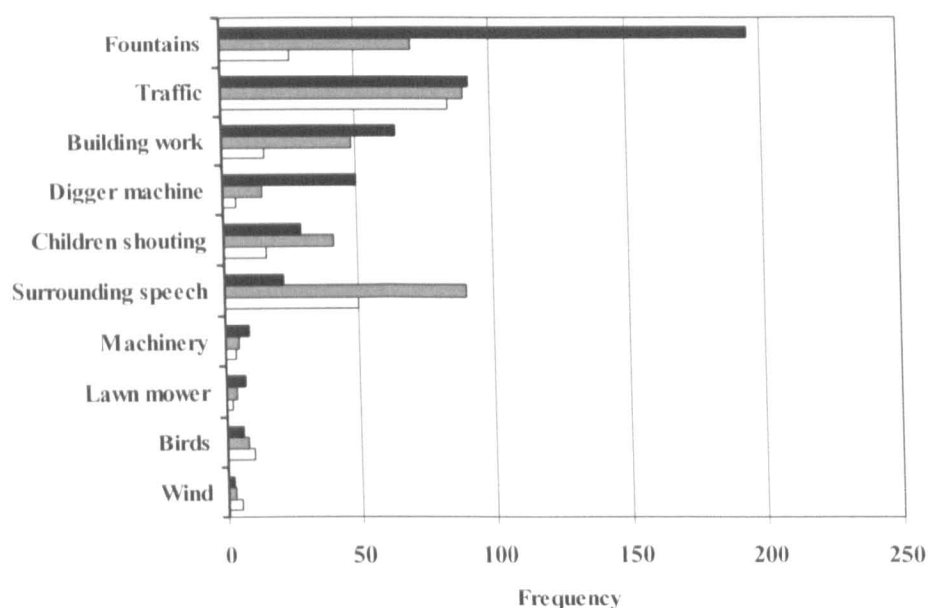


Figure 4.3 Main sounds identified by the interviewees in the Peace Gardens
 ■, first noticed sound; ■, second noticed sound; □, third noticed sound
 (The figure does not include those sounds that were mentioned less than 10 times)

Compared to the Peace Gardens, the soundscape in the Barkers Pool was more fragmented. As shown in Figure 4.4, the relatively low levels of the traffic noise gave people more chances to hear other keynote sounds, such as surrounding speech, footsteps, wind, hawker's shouting, skateboarders' playing, birds singing and leaves rustling. Music from the buildings and streets was always played quite smoothly and can just be described as noticeable. In terms of sound level, the music sound could not mask the keynote sounds. However, as a dramatic soundmark, the music sounds were more frequently noticed in the first instance.

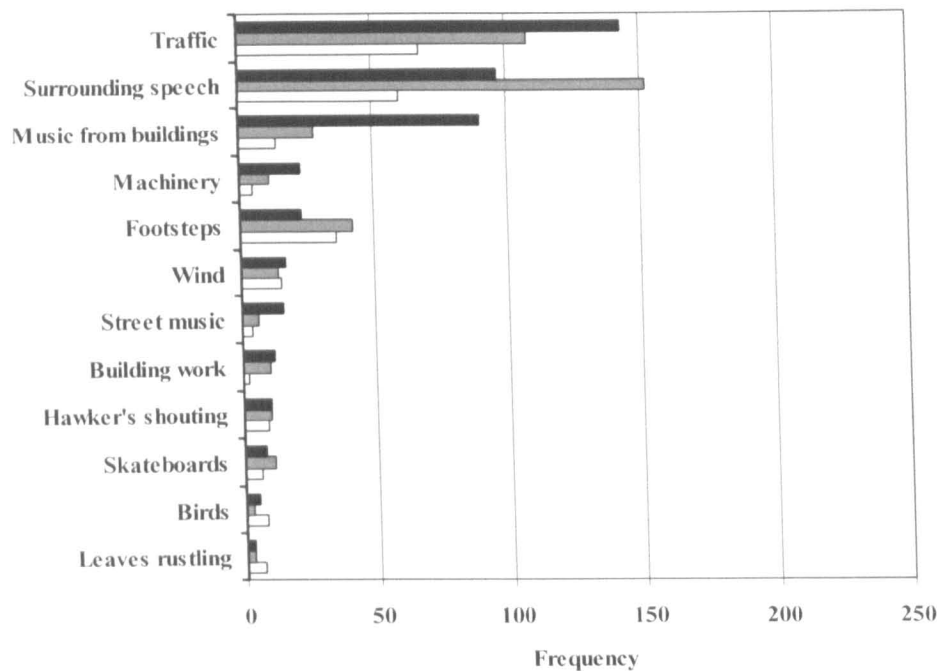


Figure 4.4 Main sounds identified by the interviewees in the Barkers Pool
 ■, first noticed sound; ■, second noticed sound; □, third noticed sound
 (The figure does not include those sounds that were mentioned less than 10 times)

The way that people list their heard sounds gives a bridge to seeing how they perceive sounds in urban public open spaces. Not only are researchers keen to discover the significant features of the soundscape, but also the ordinary people have the instinct to distinguish what researchers defined as keynote sounds, foreground sounds and soundmarks.

4.2.2 Evaluation of Sound Elements - Sound Preference

In the Peace Gardens and the Barkers Pool, the interviewees were requested to classify 15 verbally described sounds into 'favourable', 'neither favourable nor annoying' and 'annoying'. These 15 sounds were selected from typical urban soundscape elements, which were more likely to be heard in the two squares, although during the interview these sounds were not necessarily heard. The results are shown in Figure 4.5. Corresponding to the results by other researchers (Kariel, 1980; Porteous & Mastin, 1985; Carles *et al.*, 1999; Tamura, 1998), people showed a very positive attitude towards the natural sounds. More than 75% of the interviewees were favourable to

water sound and bird songs, and only less than 10% of the people thought the sounds were annoying. As a university student described: “*Natural sounds tend to be more tranquil and feel less invasive*”. For culturally related sounds, such as church bells, music played on the street and clock chimes or music, people also showed relatively high levels of preference. For human sounds such as surrounding speech, most people thought they were neither favourable nor annoying. The most unpopular sounds were mechanical sounds, such as construction sounds, music from passenger cars, and vehicle sounds. As a young man said, “*I cannot think very well if there are too many cars*”.

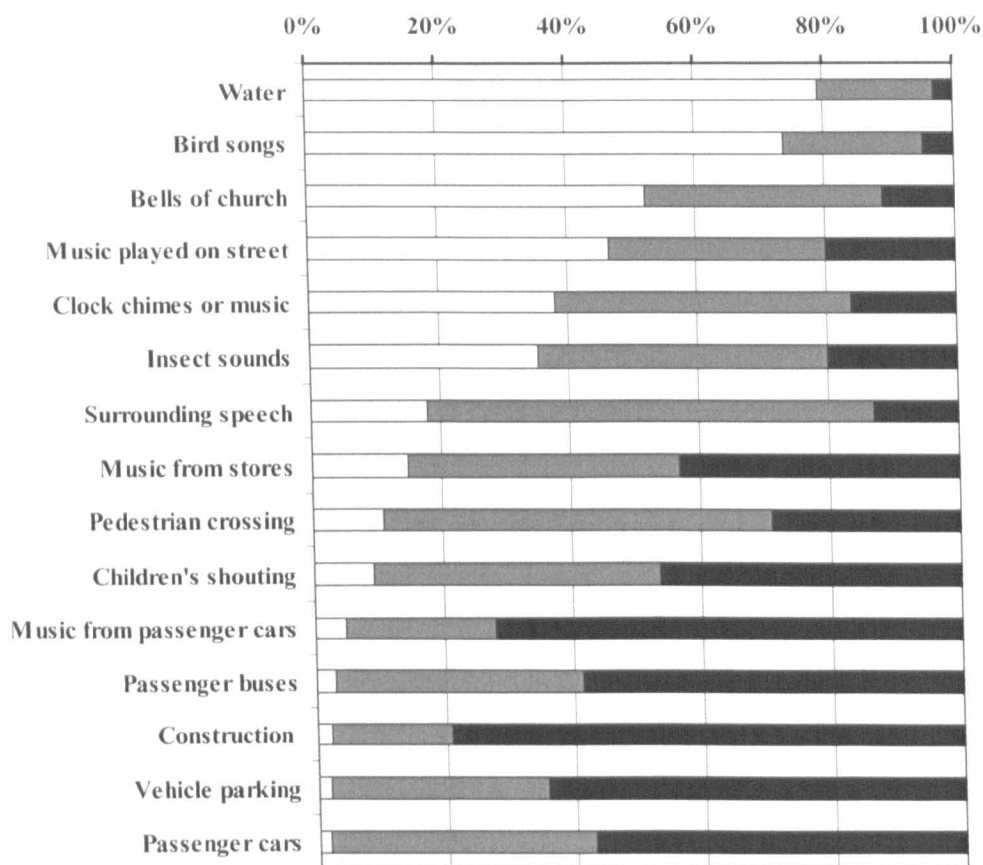


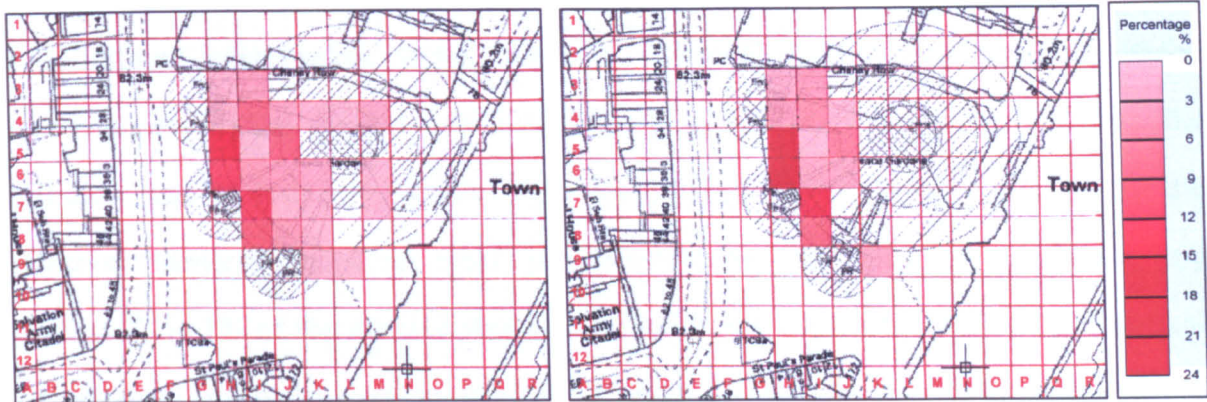
Figure 4.5 Interviewees' classification for the sound elements
 □, favourable; ■, neither favourable nor annoying; ■, annoying

Whilst the above results are somewhat expected, it is interesting to compare the three kinds of music shown in Figure 4.5. For the music played on street, nearly half of the interviewees chose 'favourable'. For the music from stores, 40% of the interviewees chose 'neither favourable nor annoying', whilst 43% chose 'annoying'. However, more than 70% of the interviewees felt the music from passenger cars was annoying. A

possible reason for the different reactions to various music is that the street music involves human activities and thus is less disturbing, whereas the car music always comes with mechanical sounds and a high level of low-frequency sound, and hence tends to be more annoying.

Pearson's chi-square test (Siegel & Castellan, 1988) was employed to compare the sound preference between the two squares. It is interesting to note that the interviewees in the two squares had significant differences in evaluating some of the sounds. The interviewees in the Peace Gardens were more favourable to the bird songs ($p < 0.05$), church bells ($p < 0.01$), water ($p < 0.001$) and children's shouting ($p < 0.001$), whereas the interviewees in the Barkers Pool were more favourable to the music played on the street ($p < 0.05$) and music from stores ($p < 0.001$). As shown in Figure 4.3 and Figure 4.4, most of these sounds were exactly the soundmarks of the square. However, regarding the keynote and foreground sounds, such as surrounding speech sounds, pedestrian crossing, vehicle parking, passenger cars and construction, there was no significant difference between the two squares. This result suggests that when people choose a square to use, their soundscape preferences do play an important role. The appearances of their favourable sounds make people feel more comfortable. Therefore they choose that square to use. This is described by some interviewees: *"To feel completely relaxed and comfortable in my surroundings. I like the Peace Gardens – water sounds and relaxing"*; *"The water sounds quite comforting"*; *"I enjoy listening to music"*; *"I like hearing birds, but music is nice too"*.

In order to further analyse the interaction between sound elements contained in the soundscape and people's behaviour, Figure 4.6 is drawn to compare interviewees' distribution in the Peace Gardens between, with, and without fountains in operation. Each grid in the Figure represents a 10x10m area. The colour filled in the grid represents the percentage of the interviews conducted. By comparing Figure 4.6(a) and (b), it can be seen clearly that when fountains were in operation, people distribute widely across the Peace Gardens. Some people may even stay very close to the central fountains. However, when the fountains were not in operation, people mainly stayed around the outer circle of the Peace Gardens where the wooden benches were provided.

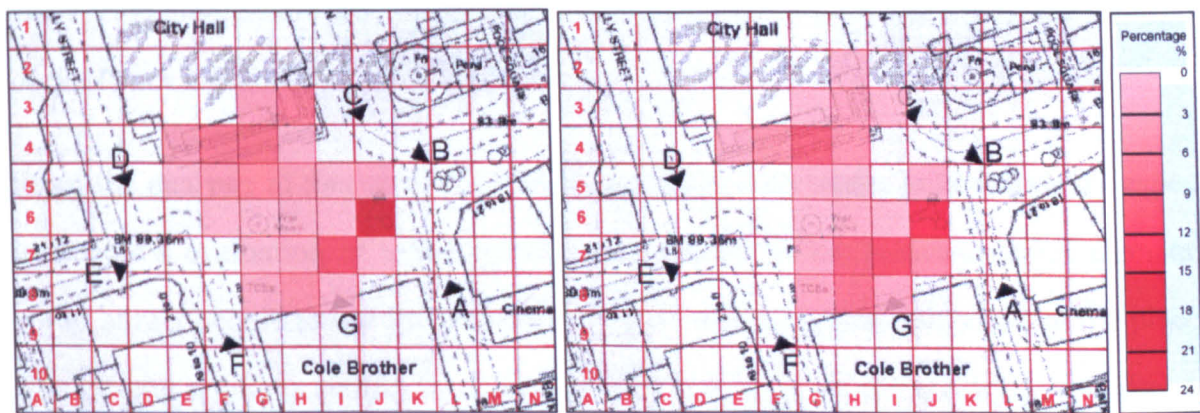


(a) fountains in operation

(b) fountains not in operation

Figure 4.6 The comparison of the interviewees' distribution in the Peace Gardens between with and without fountains in operation

Similarly, Figure 4.7 is produced to compare interviewees' distribution in the Barkers Pool between, with, and without music. As mentioned before, the music of the Barkers Pool was mainly coming from the City Hall and the small music store adjacent to the City Hall. It can be seen that there was a tendency for more people to stay close to the City Hall where music can be heard. Whereas when no music can be heard in the square, the majority of people stayed in front of the department store, Cole Brother, where some benches were provided.



(a) with music

(b) without music

Figure 4.7 The comparison of the interviewees' distribution in the Barkers Pool between when with music and without music

The results from Figure 4.6 and Figure 4.7 further suggest that the sound elements contained in soundscape not only influence people's selection of staying in a public space, but also influence people's behaviour when staying in it. There is a tendency to show that people sit close to their favourable sounds, thus effectively masking other unwanted sounds.

In addition, interviewees were asked to select their preferred relaxing sound environments in the questionnaire. As natural sounds are commonly preferred, the question was to test how people want the natural sounds to be presented. In the question “Generally speaking, when you want to relax for a short period outside, you prefer...”, 56.1% of the interviewees chose ‘quiet natural sounds only’, 21.3% ‘natural sounds with artificial sounds in far distance’ and the other 22.6% ‘natural and artificial sounds mixed’.

Some interviewees explained the reasons: *“It is more relaxing to hear natural sounds, when all day you are generally hearing artificial sounds”*; *“To completely escape the hustle and bustle without background reminders”*; *“More relaxing and different to my normal experience”*; *“Want to feel like in a natural space, but don’t expect cities to be sanitized”*; *“Escape from usual busy life more pleasurable environment for eating and reading”*; *“It’s peaceful and makes me appreciate the world around us”*; *“It gets you away from modern life and its pressures - to make them more interesting, the fountain in the Peace Gardens is a good example”*.

From the analysis in this section it can be seen that soundscape is an important aspect in people’s evaluation of urban public open spaces. Some pleasant sound elements could attract people to use the place and further influence their behaviour in the place. The general public is calling for more naturally and aesthetically appealing soundscape in urban public open spaces. It is therefore important to introduce ‘colourful’ soundscape to urban public open spaces within the ‘brownfield’ city soundscape. Furthermore, the appearance of people’s favourable sound in urban public open spaces gives people more choices in selecting their preferable sitting place. It is important in helping people feel more emotional dominant in such places.

4.3 ACOUSTIC COMFORT

As discussed in the previous sections, people can respond well to the increase of the sound level. A lower background sound level generally makes people feel quieter. People have different preferences towards different sound elements. Generally speaking, natural and culturally approved sounds are more favourably received than mechanical sounds. It has been proved that the preferences for different sound elements influence people's selection and evaluation of urban public open spaces. However, in which way the sound preferences influence people's evaluations is still unclear.

Figure 4.8(a) and (b) shows the relationships between the subjective evaluation of the sound level and the acoustic comfort evaluation in the Peace Gardens and the Barkers Pool respectively, with binominal regressions and the correlation coefficients squared R^2 . The correlation coefficient squared is a measure of the amount of variability in one variable that is explained by another variable (Field, 2000). Again in the figure each symbol represents the mean subjective evaluations of sound level or acoustic comfort at a one-dBA scale. Corresponding to Figure 4.1, there is a strong positive correlation between the measured sound level and the subjective evaluation of sound level ($p < 0.01$). The R^2 is 0.772 in the Peace Gardens and 0.795 in the Barkers Pool, indicating that the sound level variation accounts for 77.2% and 79.5% of the variability in the sound level evaluation. However, it is interesting to note that the R^2 between the measured sound level and the acoustic comfort evaluation is much lower, at only 0.541 in the Peace Gardens and 0.404 in the Barkers Pool. From Figure 4.8 it can be seen that the regression of the sound level evaluation is nearly linear, whereas the regression of acoustic comfort evaluation is curved. In particular, when the sound level is lower than a certain value, say 70dBA, with increasing Leq there is no significant change in acoustic comfort evaluation, whereas the sound level evaluation changes continuously.

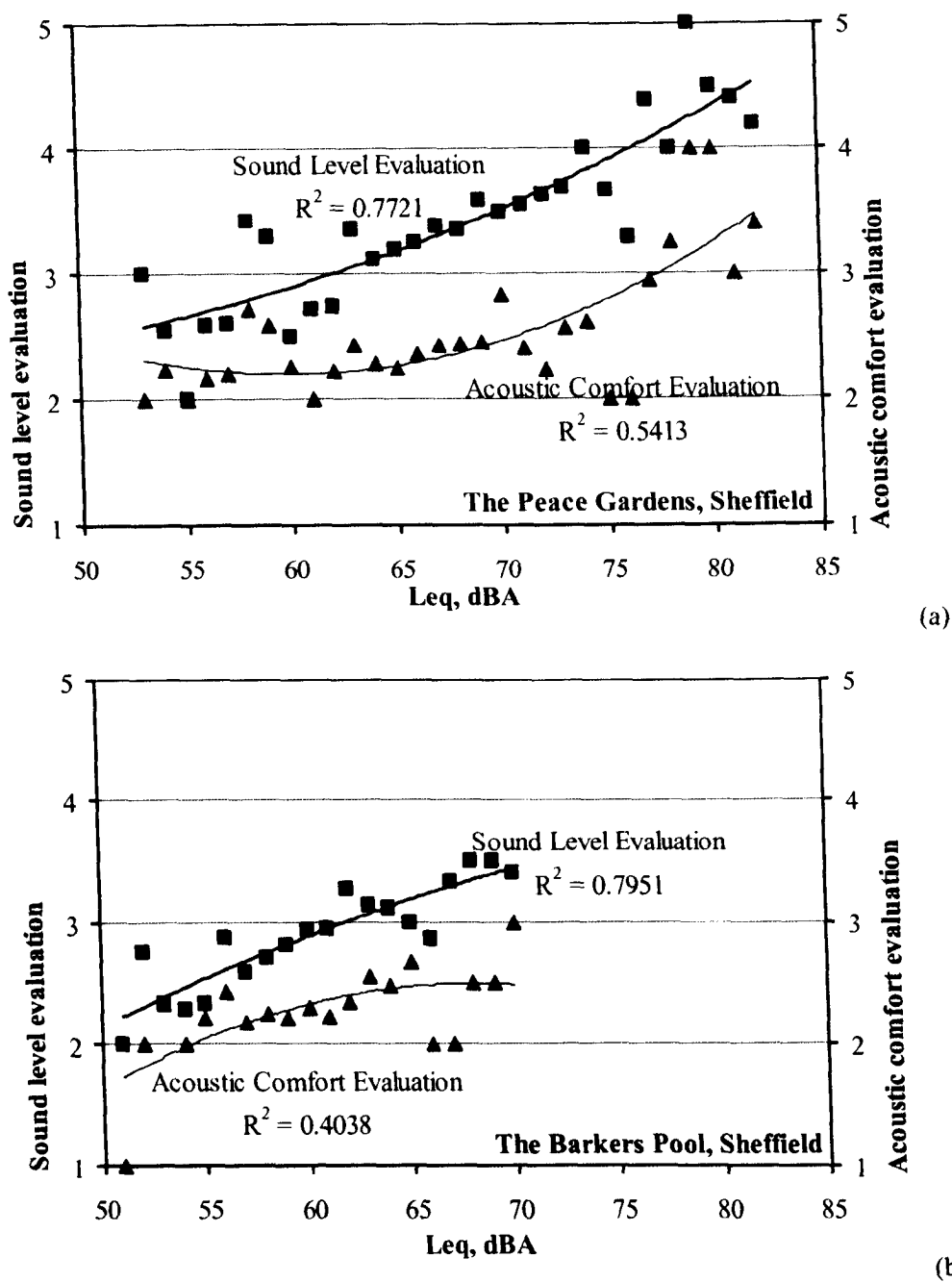


Figure 4.8 Relationships between the measured sound level, the subjective evaluation of the sound level, and acoustic comfort, with binominal regressions and correlation coefficients squared R^2
 (a) the Peace Gardens (b) the Barkers Pool

In addition to the differences between the evaluation of sound level and acoustic comfort, the results in Figure 4.8 also indicate people's tolerance in terms of the acoustic comfort in urban public open spaces. For example, as shown in Figure 4.8a, with a Leq of 61 dBA, people referred to 'neither quiet nor noisy' in terms of the sound level, whereas they also evaluated the sound environment as 'comfortable'. When the Leq became 76 dBA, people referred to 'noisy', but they evaluated the sound environment as 'neither comfortable nor uncomfortable'. In Figure 4.9(a) comparison

is made between the percentages of people in each category of the sound level and acoustic comfort evaluations. In the Peace Gardens, as shown in Figure 4.9(a), 31% and 41% of the interviewees referred to 'neither quiet nor noisy' and 'noisy' respectively, whereas 56.5% of them thought it was 'comfortable'. In the Barkers Pool, as can be seen in Figure 4.9(b), similarly, 51.5% of the interviewees rated the sound level as 'neither quiet nor noisy', whereas 64.5% of them evaluated the site as 'comfortable'.

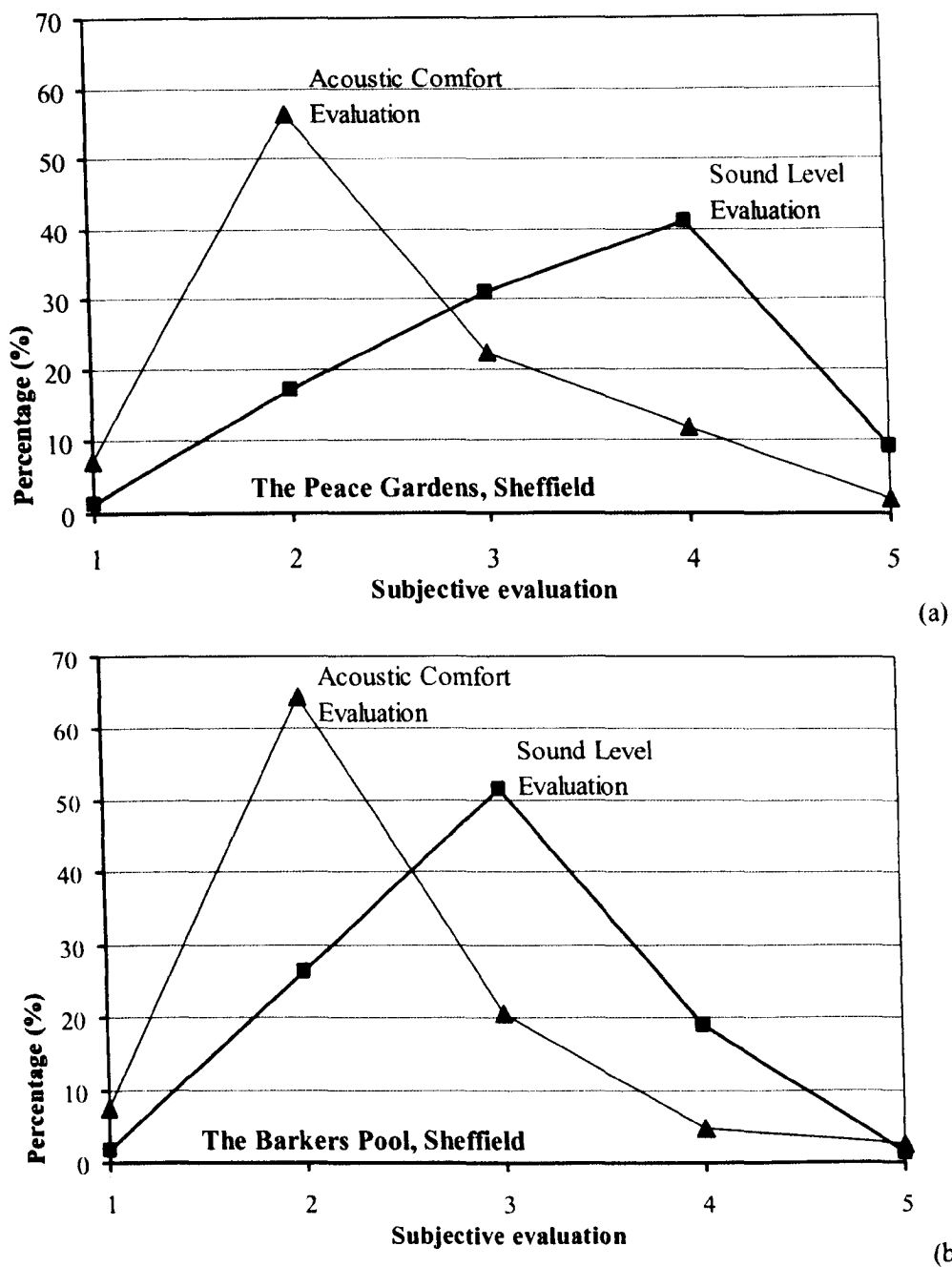


Figure 4.9 The comparison between the subjective evaluation of sound level and acoustic comfort (a) the Peace Gardens (b) the Barkers Pool

To sum up, the above analysis shows that in urban public open spaces, people's evaluation towards sound level corresponds well to the changes of measured sound levels. However, the acoustic comfort evaluation is much more complicated. People tend to be more tolerant in acoustic comfort. This result suggests that acoustic comfort is determined by more factors than just the sound level. Therefore, in the next section, the effects of sound preference are analysed based on the results in the Peace Gardens and the Barkers Pool.

4.4 PSYCHOLOGICAL ADAPTATION – INTERACTION BETWEEN SOUND PREFERENCE AND ACOUSTIC COMFORT

As found out in the previous section, in urban public open spaces, people's evaluations of sound level and acoustic comfort have rather different standards. People tend to be more tolerant in acoustic comfort. In this section, in order to find out the reason, comparisons of sound level evaluation and acoustic comfort evaluation are made between different soundscape situations in the Peace Gardens and the Barkers Pool.

In the Peace Gardens, fountains and demolition sounds were the two main foreground sound elements during the survey period. As analysed in Section 4.2, water sounds are normally regarded as favourable sounds for most people, whereas demolition and construction sounds are regarded as annoying sounds. During the field survey period, there were three typical soundscape situations in the Peace Gardens: fountains only, with a mean Leq of 67.8dBA and STD of 4.1dBA; fountains and demolition, with a mean Leq of 71dBA and STD of 4.2dBA; and demolition only, with a mean Leq of 65.2dBA and STD of 7.7dBA. The high STD with the demolition sounds was mainly caused by the rumbling noise from the diggers.

Figure 4.10 compares subjective evaluation of the sound level in the Peace Gardens amongst the three soundscape situations: fountains only, fountain and demolition, and demolition only. In the figure the relationships between the measured sound level and

the subjective evaluation of the sound level are shown according to different soundscape situations, with binominal regressions and R^2 . It can be seen that there are strong positive correlations in all the three conditions, and the tendencies of the three regression curves are rather similar. However, the positions of the curves are different, which means that with a given sound level, people have a different perception of the different sounds. Generally the demolition sounds are perceived as the noisiest, followed by a mixture of the fountains and demolition, and then the fountains only.

For the acoustic comfort evaluation of the three soundscape situations, as shown in Figure 4.11, the tendencies of the three regression curves are significantly different. The regression is nearly linear for the demolition sounds, which means that the changes in sound level directly contribute to the evaluation of acoustic comfort. For the mixture of the fountains and demolition, however, the regression is a U-shaped curve and R^2 is only 0.5. When the sound level is lower than around 70dBA, the variation in the acoustic comfort evaluation is almost negligible, possibly due to the masking effect of the fountains, whereas when the sound level is over 70dBA, the masking effect of the fountains becomes less significant and thus, the evaluation of acoustic comfort is more affected by the sound level changes. For the fountains only, the increase in the sound level has almost no effect on the acoustic comfort evaluation and the evaluations are all around 'comfortable' scale.

In addition to the recognition of sound sources, the preference of water sounds rather than demolition sounds might be caused by the differences in the spectrum and temporal distribution between the two types of sound (Gifford, 1996; Kang & Du, 2003). Further recording and analysis have been carried out in Chapter 8 to explore the spectrum characteristic of different sounds. When introducing a pleasant sound in urban public open spaces as a masking sound, there is always a concern regarding its level. From the above results, it can be seen that this level could be over 70dBA.

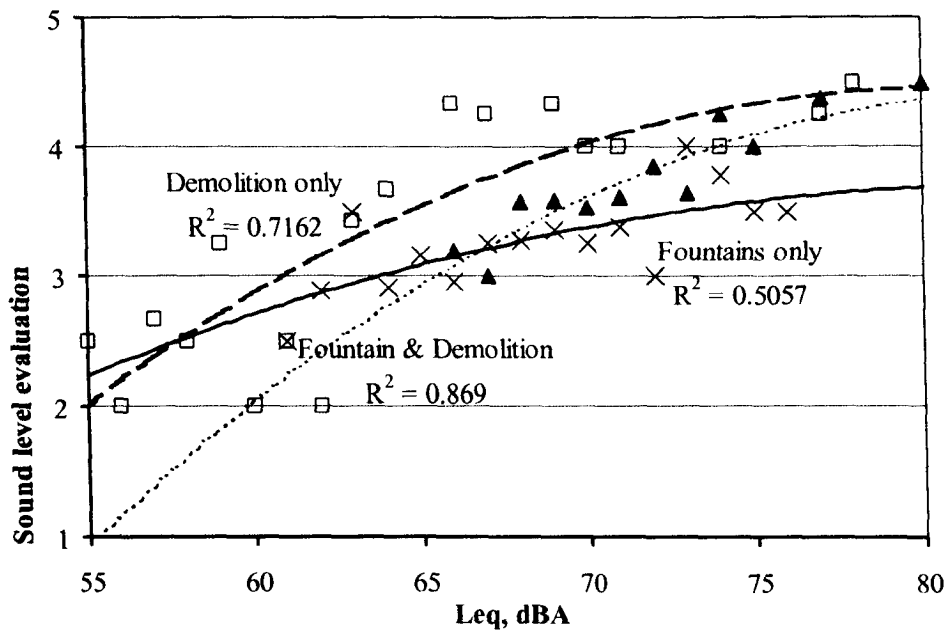


Figure 4.10 Relationships between the measured sound level and the subjective evaluation of the sound level in three source conditions in the Peace Gardens, with binominal regressions and R^2
 □ and ---, demolition only; ▲ and ·····, fountains and demolition mixture;
 × and —, fountains only

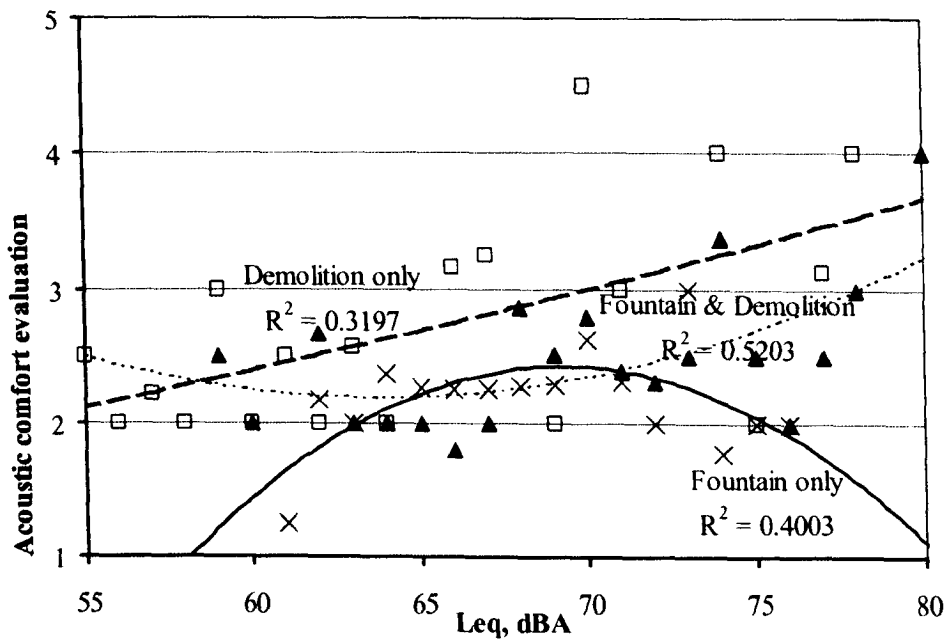


Figure 4.11 Relationships between the measured sound level and the acoustic comfort evaluation in three source conditions in the Peace Gardens, with binominal regressions and R^2
 □ and ---, demolition only; ▲ and ·····, fountains and demolition mixture;
 × and —, fountains only

In the Barkers Pool, as mentioned previously, music could be heard during 35% of the survey period. With music the mean Leq was 61.1dBA (STD 2.2dBA), which is only slightly higher than that without music, 59.7dBA (STD 3.8dBA). As shown in Figure

4.4, other sounds in the Barkers Pool included footsteps, surrounding people's speech, traffic and wind, representing a typical soundscape of an urban square.

In Figure 4.12 correlations between the measured sound level and the subjective evaluation of the sound level are shown with two conditions, with, and without music. A significant difference has been found between the two conditions in terms of the subjective evaluation of sound levels ($p < 0.001$). People felt quieter when there was no music, with a given Leq. This suggests that music can be easily noticed by the users of the square, and thus the perceived sound level is higher.

In Figure 4.13, corresponding to Figure 4.12, correlations between the measured sound level and the acoustic comfort evaluations are given. It is seen that the tendencies are rather different in the two conditions. With music the correlation coefficient is considerably lower than that without music. When there is music, the variation in acoustic comfort evaluation is negligible with an increase in sound level suggesting that the existence of music can make people feel more acoustically comfortable.

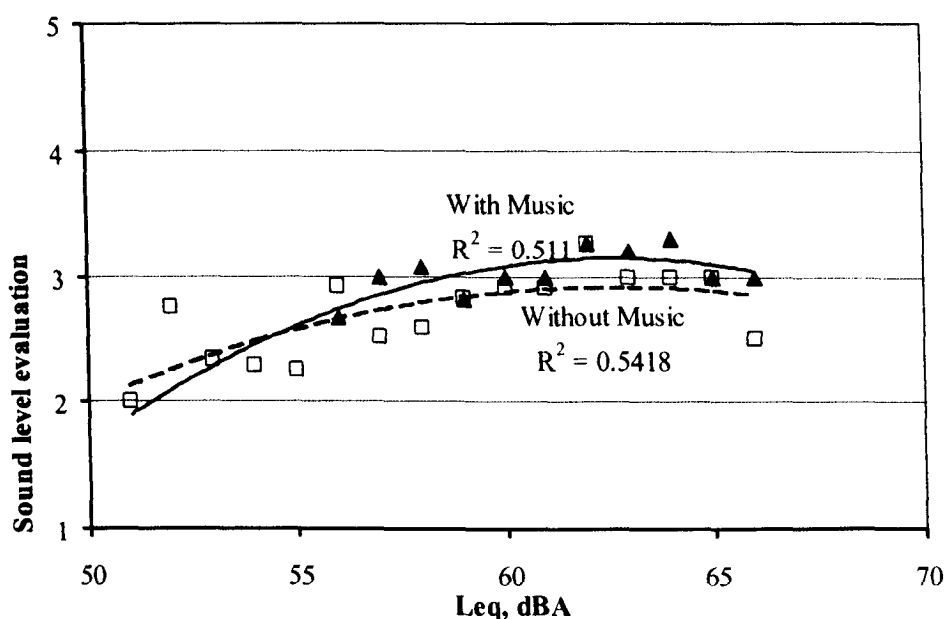


Figure 4.12 Relationships between the measured sound level and the subjective evaluation of the sound level in two source conditions in the Barkers Pool, with binomial regressions and R^2
 □ and --, without music; ▲ and —, with music

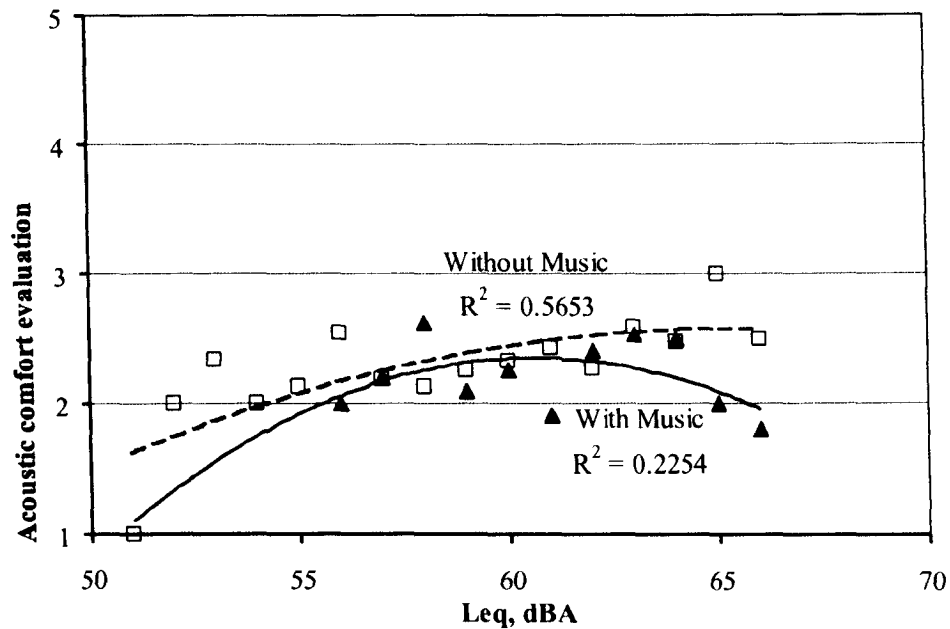


Figure 4.13 Relationships between the measured sound level and the acoustic comfort evaluation in two source conditions in the Barkers Pool, with binominal regressions and R^2
 □ and - - , without music; ▲ and — , with music

However, from the survey it has been found that not all kinds of music are preferred. Based on the results of Figure 4.5, Table 4.3 summarises people's preference for different types of music. Generally speaking, live music is much more preferred than other types. Also, the preferences of music are closely related to the activities/performances of the players.

Table 4.3 People's preferences for various types of music (%)

	Music played on street	Music from passenger cars	Music from surrounding buildings
Favourable	48.8	4	19.2
Neither favourable nor annoying	28.8	22	42
Annoying	22.4	73.5	38.8

In this section, by analysing the interaction between acoustic comfort and sound elements, the evidence of psychological adaptation can be clearly identified. In terms of acoustic comfort, people's response to the sound stimulus is not only in relationship to its magnitude, but also depends on what individual sound elements contained in the overall soundscape. The more pleasant the sound elements are, the more positive in people's evaluation towards the soundscape, even when the sound level was greater than 70dBA.

4.5 OTHER PHYSICAL FACTORS - INTERACTIVE RELATIONSHIPS BETWEEN AURAL AND VISUAL PERCEPTION

To analyse the relationship between the overall physical comfort evaluation of an urban public open space and the subjective evaluation of various physical indices, including temperature (very cold, cold, neither cold nor warm, warm, very hot), sunshine (prefer more, ok, too much sunshine), brightness (very dark, dark, neither dark nor bright, bright, very bright), wind (static, little wind, ok, windy, too much wind), view (negative, neither negative nor positive, positive), sound level (very quiet, quiet, neither quiet nor noisy, noisy, very noisy), and humidity (damp, ok, dry), varimax rotated principal component analysis was employed. Based on the data of the fourteen sites, with a criterion factor of eigenvalues over 1, three factors were determined, which covered 55% of the total variance. Table 4.4 shows the rotated component matrix. Factor 1 (22.8%) is mainly associated with thermal comfort, including thermal, sunshine, luminance and wind. Factor 2 (17.5%) is associated with visual and auditory senses. Factor 3 (14.8%) is principally related to humidity, including humidity and wind. The above factors cover 55% of the total variance, which indicates the complexity in evaluating comfort conditions of urban public open spaces. In other words, other aspects, such as social/cultural factors, may also influence the evaluation.

Table 4.4 Factor analysis of the overall physical comfort evaluation. Kaiser-Meyer-Olkin measure of sampling adequacy, 0.613; cumulative, 55.1%; extraction method, principal component analysis; rotation method, varimax with Kaiser normalization; N=9200

	<i>Factors</i>		
	1	2	3
Temperature	.696		
Sunshine	.650		
Brightness	.599		
Wind	-.532		.521
View		.769	
Sound level		-.734	
Humidity			.828

The factor analysis was also carried out for each country, given the considerable variation in their climatic conditions. The results are generally rather similar to that in Table 4.4. It is interesting to note that for all countries, visual and auditory aspects are

always in the same factor, covering 17-19% of the total variance. This suggests that these two aspects may have certain interactions, working together as an aesthetic comfort factor. It seems that this is in correspondence with the findings by Southworth (1969) and Viollon (2003). In Southworth's (1969) research, three groups of people, including auditory only subjects, visual only subjects and visual-auditory subjects, were guided in a Boston city tour. By analysing the reports of visual and auditory elements they saw or heard during the tour, it was found that when sonic and visual settings were coupled, attention to the visual form reduced the conscious perception of sound, and *vice versa*. The interactions between visual and auditory perception, especially when the sounds are related to the scenes, give people a sense of involvement and lead to a more comfortable feeling. Viollon's (2003) research was carried out in laboratory conditions with controlled auditory and visual stimuli. It was found that the visual parameter is a predominant variable as regards audio-visual interactions. All the visual information has different ways and different efficiency in affecting the auditory judgement. For the overall urban sound scenes, the more pleasant the visual setting, the less contaminated the auditory judgement.

Although seasonal variation is a main consideration in the overall comfort evaluation, no significant difference has been found between different seasons in terms of acoustic evaluation. Therefore, in this thesis no separate analysis for different seasons has been presented.

4.6 SUMMARY

This chapter is focused on the analysis of the interaction between people and two essential aspects of the urban soundscape: the sound levels and the sound elements contained therein.

Through analysis of the data gathered from 14 European sites, the results suggest that the subjective evaluation of sound level generally relates well with the mean Leq , especially when the Leq is lower than a certain value, which is 73dBA on the basis of

this research. However, this relationship varies in different cities. Moreover, the background sound level has been found to be an important index in evaluating soundscape in urban public open spaces - a lower background sound level can make people feel quieter. In other words, to create a comfortable acoustic environment in an urban public open space, it is important to reduce the background sound level.

Considerable differences have been found between the subjective evaluation of sound level and the acoustic comfort evaluation. The latter is much more complicated and its correlation with a measured sound level is systematically less significant than that between the sound level evaluation and measured sound level. More importantly, people tend to show more tolerance in terms of acoustic comfort evaluation.

Based on the survey results from two case study sites in Sheffield, it is interesting to find that in perceiving the sound elements in a given soundscape, the first noticed sounds do not have to be the loudest - people always mention the soundmarks as their first noticed sounds. Moreover, the preferences of soundscape elements are proved to influence people's choice of using an urban public open space. Therefore, the soundscape identity is important for a designated space. A more aesthetically appealing soundscape would attract more users to a public open space. The results of this research also further confirm that natural sounds as a group are generally preferred in urban public open spaces.

The further analysis of individual sound elements shows that the acoustic comfort evaluation is greatly affected by the sound elements contained therein. When a pleasant sound such as music or water dominates the soundscape of an urban public open space, the relationship between the acoustic comfort evaluation and the sound level is considerably weaker than that of other sound sources such as traffic and demolition sounds. In other words, the introduction of a pleasant sound, especially as a masking sound, could considerably improve the acoustic comfort, even when its sound level is rather high.

To sum up, the findings in this chapter have confirmed that the soundscape perception and evaluation directly relates to three basic emotional response variables, i.e. arousal,

pleasure, and dominance (see Section 2.3.1 for the concept). Sound level has a direct relationship with arousal level, sound elements relate to pleasure and an opportunity to choose a preferred sound relates to dominance. With an increase in sound level, people's arousal level increases correspondingly. Within a reasonable sound level, the appearance of people's favourable sound elements significantly increases people's pleasure level. In the meantime, the opportunity of allowing people to get close to their favourable sounds or to step away from their unwanted sounds increases the feeling of control. Therefore, in this situation, people feel acoustically comfortable. The further increase of sound level, when it is related to favourable sounds, could lead to a high arousal and high pleasure – an exciting soundscape (e.g. the Peace Gardens with fountain sounds).

The factor analysis shows that the acoustic environment is one of the main factors influencing the overall comfort in an urban public open space. It has also been shown that visual and auditory feelings always appear in the same factor, suggesting interactions between the two aspects, working together as an aesthetic comfort factor.

Chapter 5

Personal Variables in Evaluating Urban Soundscapes

As mentioned in Chapter 2, previous researches in environment psychology have demonstrated that personal variables have significant influence in people's evaluation of their surrounding world. In this Chapter, discussions are focused on personal variables, i.e. acoustic experience and cultural differences, demographic and temporary status differences, in evaluating the soundscape in urban public open spaces.

5.1 ACOUSTIC EXPERIENCE AND CULTURAL DIFFERENCES

5.1.1 Sound Level and Acoustic Comfort Evaluations

As discussed in Section 4.1, the mean subjective evaluation of the 14 case study sites across Europe is not well correlated to their measured sound levels. One possible reason for the difference is the influence of the long-term sound environment experience of the interviewees. In Table 5.1, a comparison is made between different cities in terms of the subjective evaluation of the sound environment at interviewees' homes. Generally speaking, the majority of the interviewees evaluated their homes as 'quiet'. Amongst the seven cities, Kassel has the quietest home environment, whereas Alimos has the noisiest. As illustrated in Figure 5.1, 18.7% and 56.4% of the interviewees in Kassel have 'very quiet' and 'quiet' home acoustic environments respectively, whereas a relatively low percentage of the interviewees in Alimos think their homes are 'very quiet' (10.4%) and 'quiet' (44.5%). Particularly, as much as 21% of the interviewees in Alimos have a 'noisy' home acoustic environment, whereas the percentage is only 7.3% in Kassel.

Table 5.1 The subjective evaluation towards the sound environment at users' homes

	Alimos		Thessaloniki		Sesto San Giovanni		Sheffield		Cambridge		Kassel		Fribourg	
	Kara. Square	Sea-shore	Maked. Square	Kritis Square	Petazzi Square	IV Nov. Square	Peace Gardens	Barkers Pool	All St. Garden	Silver St. Bridge	Flor. Square	Bahn. Square	Place de la Gare	Jardin de Perolles
Mean	2.65	2.65	2.49	2.29	2.50	2.43	2.50	2.55	2.55	2.32	2.18	2.10	2.13	2.30
STD	1.05	1.04	0.98	0.77	1.12	1.14	0.98	1.10	1.27	1.16	0.84	0.79	1.03	1.02
Mean	2.65		2.4		2.47		2.52		2.43		2.14		2.21	
STD	1.04		0.9		1.13		1.04		1.22		0.82		1.03	

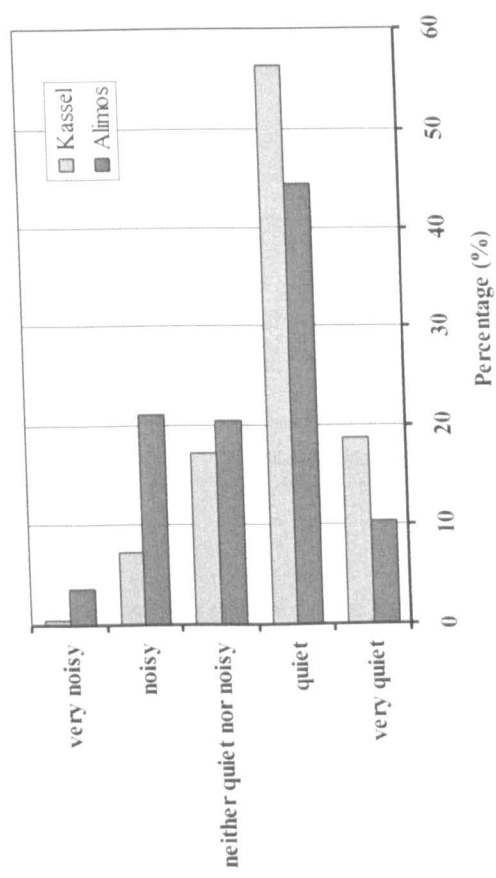


Figure 5.1 The comparison of the home acoustic environment between Alimos (Greece) and Kassel (Germany)

In Figure 5.2 (a) and (b), comparisons of the sound level evaluations are made between two pairs of the case study sites in Alimos and Kassel. With a similar sound level range, the evaluations are compared between the Karaiskaki Square (mean $Leq=62.8$ dBA, $STD=3.9$ dBA) in Alimos and the Florentiner Square (mean $Leq=61.3$ dBA, $STD=4$ dBA) in Kassel, and between the Seashore (mean $Leq=64.4$ dBA, $STD=3.6$ dBA) in Alimos and the Bahnhofspatz (mean $Leq=64.7$ dBA, $STD=4.2$ dBA) in Kassel. In the figure, each symbol represents the average of the sound level evaluation at a one-dBA scale. As can be seen in Figure 5.2, it is interesting to find out that people in Kassel generally felt noisier than people in Alimos at the same sound level. The mean score of evaluation in Kassel is 3.18 for Florentiner Square and 3.42 for Bahnhofspatz. However, it is 2.7 for Karaiskaki Square and 2.79 for the Seashore in Alimos.

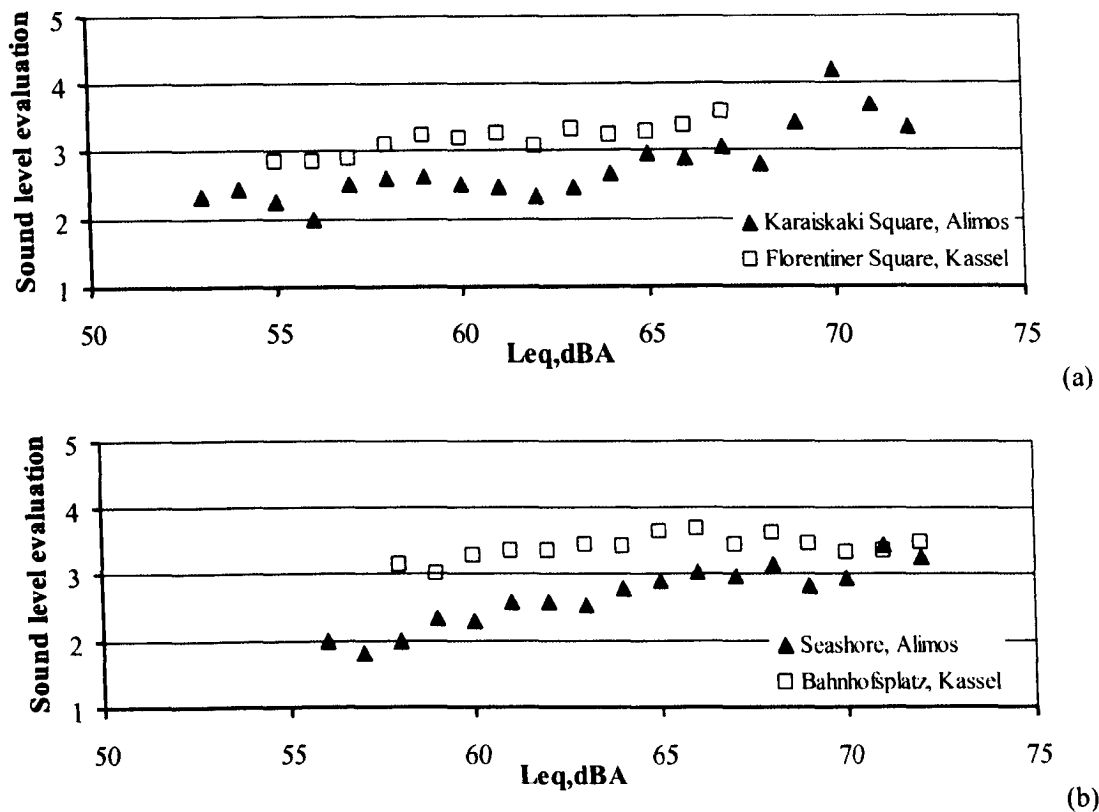


Figure 5.2 The comparison of the subjective evaluation towards sound levels between Alimos and Kassel

It is possible that people from a noisy home environment adapt more to noisy urban public open spaces. Another possible reason for the difference between the two cities is cultural and life style differences. Perhaps people in Germany are more aware and/or

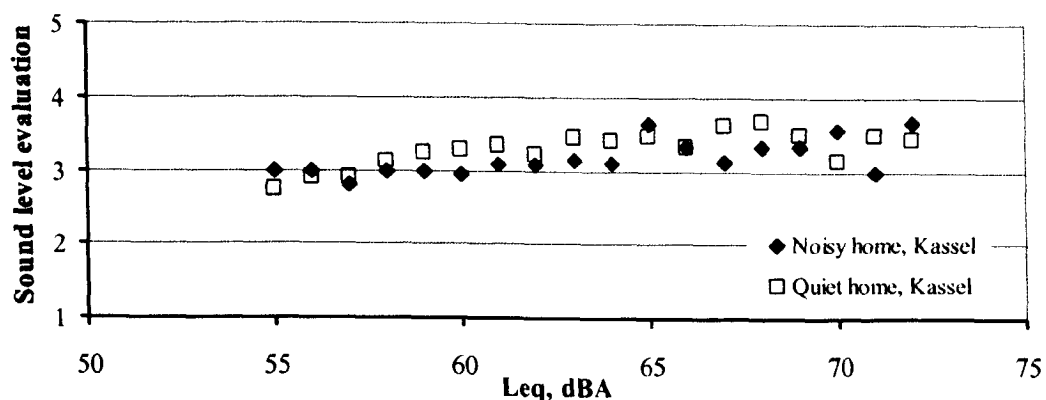
less tolerant of urban noises, whereas people from warm climates where windows have to be open learn to be tolerant.

To further study the reason for the above differences, in Table 5.2, the mean subjective evaluations towards the sound levels are compared amongst different home acoustic environments. It can be seen that in Sheffield, Kassel and Fribourg, a tendency is shown that people from quiet homes are more sensitive towards noise. However, in other cities, the tendency is not clear.

Table 5.2 The comparison of the mean subjective evaluation towards the sound levels amongst interviewees with different home acoustic environments

Home acoustic environment evaluation	Alimos	Thessaloniki	Sesto San Giovanni	Sheffield	Cambridge	Kassel	Fribourg
Quiet/very quiet	2.69	3.34	2.77	3.19	2.91	3.35	3.11
Neither nor	2.89	3.33	3	3.17	2.92	3.18	3.02
Noisy/very noisy	2.76	3.70	2.98	3.07	2.65	3.10	3.02

A further comparison is made, in Figure 5.3(a), between people in Kassel with self-evaluated quiet home environments and noisy home environments. As shown in the figure, there is a tendency that people with a quiet home environment are slightly sensitive towards the sound level. They tend to feel noisier than people who have a noisy home environment. However, despite the tendency found, the difference of the sound level evaluation between people in quiet homes and in noisy homes does not reach a significant level. The same comparison is then made in Alimos. There is no significant difference of the sound level evaluation between people with quiet home environment and with noisy home environment, as shown in Figure 5.3(b). Similar situations are also found in other case study cities, namely Thessaloniki, Sesto San Giovanni, Sheffield, Cambridge, and Fribourg.



(a)

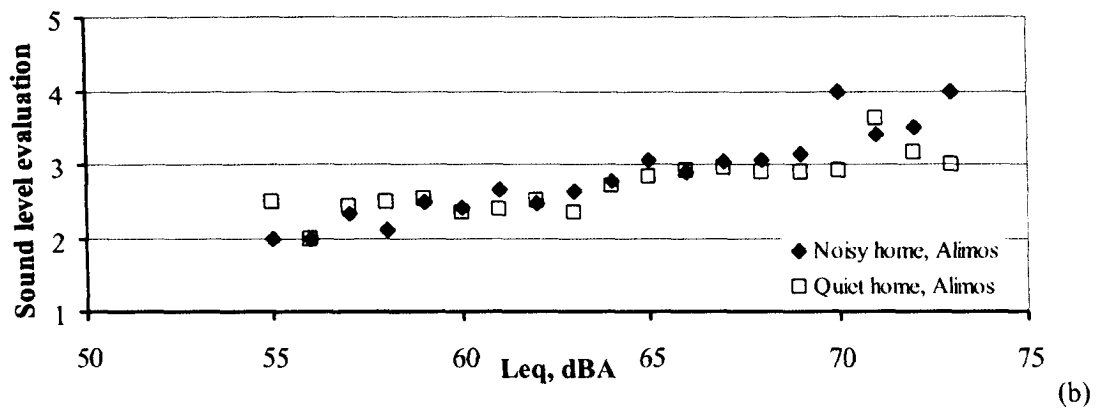


Figure 5.3 The comparison of the subjective evaluation towards sound levels between different home acoustic environments in (a) Kassel and (b) Alimos

Therefore, the above analyses suggest that in terms of the sound level evaluation in urban public open spaces, cultural differences (e.g. between Greece and Germany) play a more important role than the long-term home acoustic environment. Because of the cultural difference, people from certain countries may become significantly more sensitive to sound level than people from other countries.

In terms of acoustic comfort evaluation, a comparison is made between interviewees in Sheffield with a self-evaluated quiet home acoustic environment and a noisy home acoustic environment. Again, the mean evaluation of the acoustic comfort of the two groups is compared at a one-dBA scale. As illustrated in Figure 5.4, there is a tendency that people with a noisy home environment felt more comfortable towards the acoustic environment in squares. However, similar to sound level evaluation, the acoustic comfort evaluation differences between people in a quiet home and in a noisy home doesn't reach a significant level.

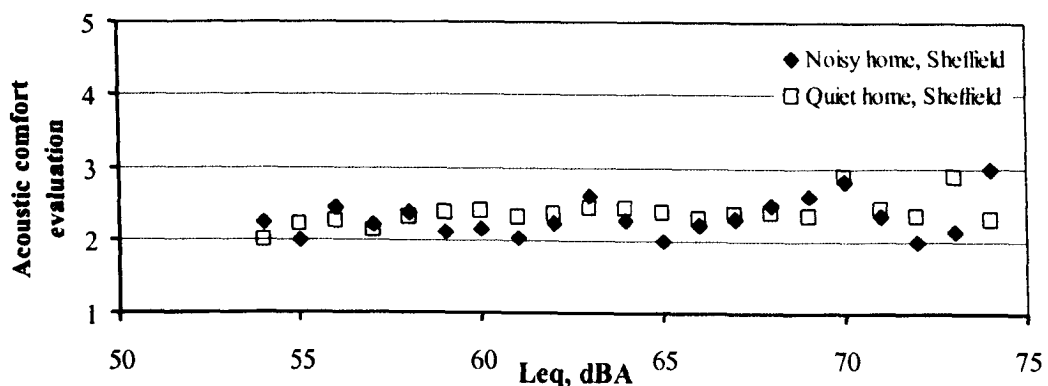


Figure 5.4 The comparison of the acoustic comfort evaluation between different home acoustic environments in Sheffield

The analysis suggests that the home acoustic environment may influence people's sensitivity towards the sound environment in public open spaces. However, the effect of the home acoustic environment is less significant than the influence of cultural differences.

5.1.2 Sound Preferences

Sound preference, one of the most important factors in influencing people's judgement of the sound environment, is also compared among different case study sites. Table 5.3 shows the results of sound preference rating in the 14 case study sites. In broad terms, corresponding to previous studies by other researchers (Moreira & Bryan, 1972; Zimmer & Ellermeier, 1999; Ellermeier *et al.*, 2001), people exhibit a positive attitude towards natural sounds and culture-related sounds. Vehicle sounds and construction sounds are regarded as the most unpopular, whereas sounds like those from human activities are normally rated as neutral.

However, from Table 5.3 it can be seen that the level of people's positive or negative attitudes is generally similar in the same city, whereas it can be significantly different between different cities. For example, when classifying water sounds, in Sheffield the results in the two squares are very close, with over 70% of the interviewees choosing 'favourable', whereas in the IV Novembre Square of Sesto San Giovanni this value is less than 30%. The result in Kassel is similar to that in Sheffield. In the case of surrounding speech sounds, over 50% of the interviewees in the Kritis Square of Thessaloniki rated 'annoying', whereas this figure is less than 1% in the two squares in Kassel. In the IV Novembre Square of Sesto San Giovanni about 45% of the interviewees rated surrounding speech sounds as 'favourable'. An important reason for these differences is probably due to the cultural and long-term environmental differences. Generally speaking, city-living people share a common opinion in preferring natural and culture-related sounds rather than artificial sounds. However, cultural background and long-term environmental experience play an important role in people's judgement of sound preference. People from a similar cultural background and long-term environment may show a similar tendency on their sound preferences.

Table 5.3 Classifications for various sounds in urban public open spaces (%)

	Alimos		Thessalonki		Sesto San Giovanni		Sheffield		Cambridge		Kassel		Fribourg	
	Kara. Square	Seashore Square	Maked. Square	Kritis Square	Petazzi Square	IV Nov. Square	Peace Gardens	Barkers Pool	All St. Passage	Silver Street	Flor. Square	Bahn. Square	Jard. de Perolles	Place de la Gare
Water	F		27.7				84.0	74.7		79.5	80.3	74.5		
	N		66.6				14.8	20.5		20.5	17.9	22.4		
	A		5.7				1.2	4.8		0.0	1.8	3.1		
Bird sounds	F					74.5	72.9	71.1						86.1
	N					22.8	20.5	28.9						13.1
	A					2.7	6.6	0						0.8
Insect sounds	F					37.7	33.2				34.0	23.5		
	N					43.1	46.1				59.1	75.3		
	A					19.2	20.7				6.9	1.2		
Bells of church	F			31.1		56.8	47.9	72.1						
	N			68.9		35.4	37.6	27.9						
	A			0.0		7.8	14.5	0.0						
Music played on street	F					44.2	48.8	69.1			57.3	88.0		
	N					38.3	28.8	27.2			27.2	12.0		
	A					17.5	22.4	3.7			15.5	0		
Surrounding speech	F	2.3	7.0	32.2	23.5	44.6	17.9	18.0	34.7	32.3	18.5	15.3	35.0	32.0
	N	77.8	77.6	17.0	69.8	47.2	68.3	69.3	62.6	55.0	80.5	84.7	57.9	61.7
	A	19.9	15.4	50.8	6.7	8.2	13.8	12.7	2.7	12.7	1.0	0	7.1	6.3
Children's shouting	F	20.3	25.5	54.1	29.5	27.4	11.7	6.9			1.7	1.0	37.3	
	N	54.3	50.8	19.9	53.0	53.4	48.4	40.3			69.0	54.8	51.1	
	A	25.4	23.7	26.0	17.5	19.2	39.9	52.8			29.3	44.2	11.4	
Pedestrian crossing	F	5.5	8.0				8.6	12.9			7.1			22.8
	N	89.9	84.7				62.0	58.4			65.3	17.9		70.0
	A	4.6	7.3				29.4	28.7			34.7	75.0		7.2
Passenger cars	F	0.6		3.5	31.3	2.7	1.6	2.4	1.0	0.0			3.5	2.7
	N	26.0		53.0	16.6	59.8	35.4	38.7	43.6	45.1	47.6		54.8	30.2
	A	73.4		43.5	52.1	37.5	63.0	58.9	55.4	54.9	52.4		41.7	67.1
Passenger buses	F			3.4	1.3		1.6	3.7	2.1	0.0	1.0		9.4	
	N			52.3	84.3		39.2	38.9	37.9	36.2	34.2		49.4	
	A			44.3	14.4		59.2	57.4	60.0	63.8	64.8		41.2	
Vehicle parking	F						2.9	1.0			1.4	2.0		
	N						32.2	35.3			57.9	54.7		
	A						64.9	63.7			40.7	43.3		
Construction	F			2.1	32.5		2.2	2.1	5.0					
	N			52.9	11.5		18.0	19.2	35.0					
	A			45.0	56.0		79.8	78.7	60.0					

However, as can be seen in Table 5.3, in two Thessaloniki squares, people's sound preference rating is rather different. For example, regarding children shouting, more than 50% of the interviewees in Makedonomahon Square rated it as 'favourable', whereas the percentage was less than 30% in Kritis Square. One possible reason is that the main users of the Makedonomahon Square are not Greeks. As described in Section 3.2.2, the square is used as an open gathering and socialising place for immigrants from Eastern European countries and the former Soviet Union. Therefore, the differences between the Makedonomahon Square and the local Greek-used Kritis Square, may be as a result of cultural differences.

Between the two Greek cities there are also some degrees of dissimilarity, especially for sounds with regard to surrounding speech and passenger cars. This suggests that although the cultural background is similar, other factors such as differences in city sizes and climatic conditions may cause differences in sound preferences.

5.2 DEMOGRAPHIC DIFFERENCES

5.2.1 Sound Level and Acoustic Comfort Evaluations

In this section, sound level and acoustic comfort evaluations are further compared between different age groups and gender. In terms of the subjective evaluation of sound levels, as an example, Figure 5.5 shows the comparison amongst age groups in the Barkers Pool. The curves in the figure represent the evaluation percentage for each age group. As can be seen, generally speaking, all the age groups have a rather similar tendency in evaluating the sound levels. Except for some slight differences shown among age groups, it is found that none of the differences reaches a significant level.

However, in terms of acoustic comfort, there are significant differences ($p < 0.05$) amongst different age groups. Figure 5.6 illustrated the comparison of acoustic comfort evaluations amongst age groups in Barkers Pool. As can be seen clearly, different age groups have rather different evaluations towards acoustic comfort, in particular in the percentage of rating the acoustic environment as 'comfortable' and 'neither comfortable nor uncomfortable'. There is a clear tendency showing that young people felt less comfortable than older aged people. Teenagers have the highest

percentage (i.e. 8%) referred to 'very uncomfortable', whereas people above 55 years old are the most satisfied group.

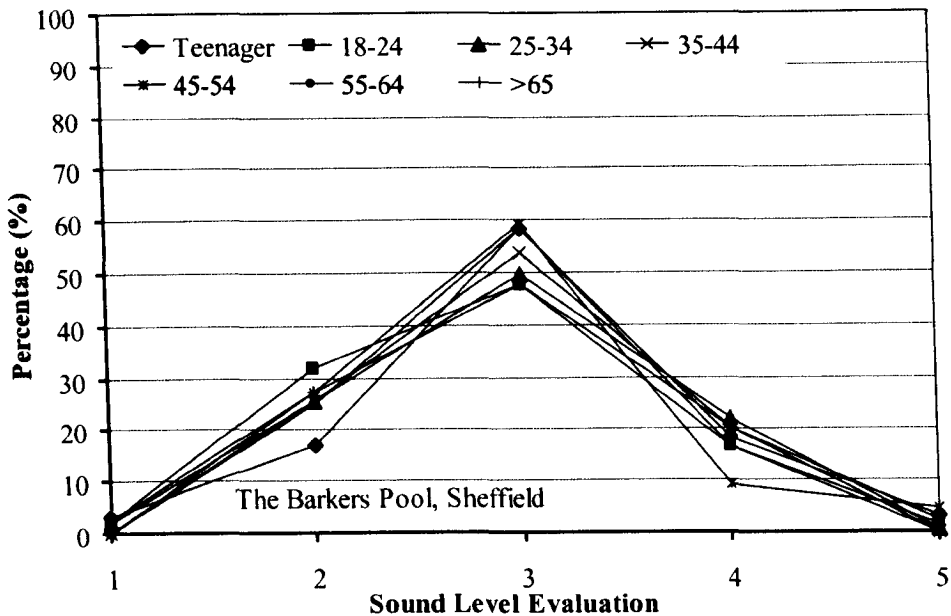


Figure 5.5 Differences of sound level evaluation among age groups

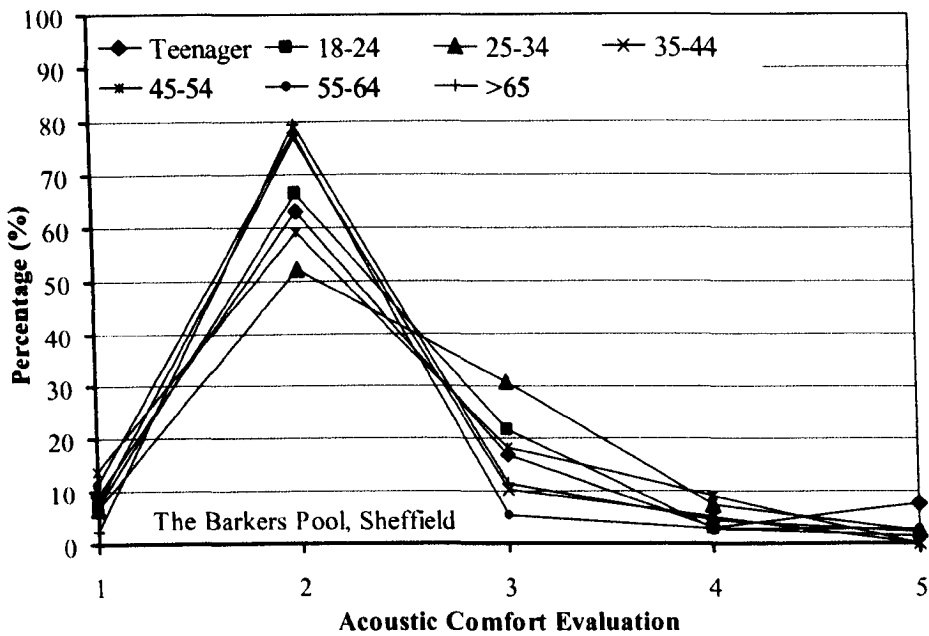


Figure 5.6 Differences of acoustic comfort evaluation among age groups

No significant difference is found between males and females, both in terms of the sound level evaluation and acoustic comfort evaluation. In Figure 5.7 and 5.8, comparisons between males and females in Barkers Pool are shown for sound level evaluation and acoustic comfort evaluation, respectively. As can be seen clearly, males

and females almost have identical tendencies in evaluating sound levels and acoustic comfort.

The above results correspond to the findings of previous researches (Weinstein, 1978; Taylor, 1984; Yang & Kang, 2001). It was reported that there was no correlation between noise sensitivity and demographic characteristics other than age.

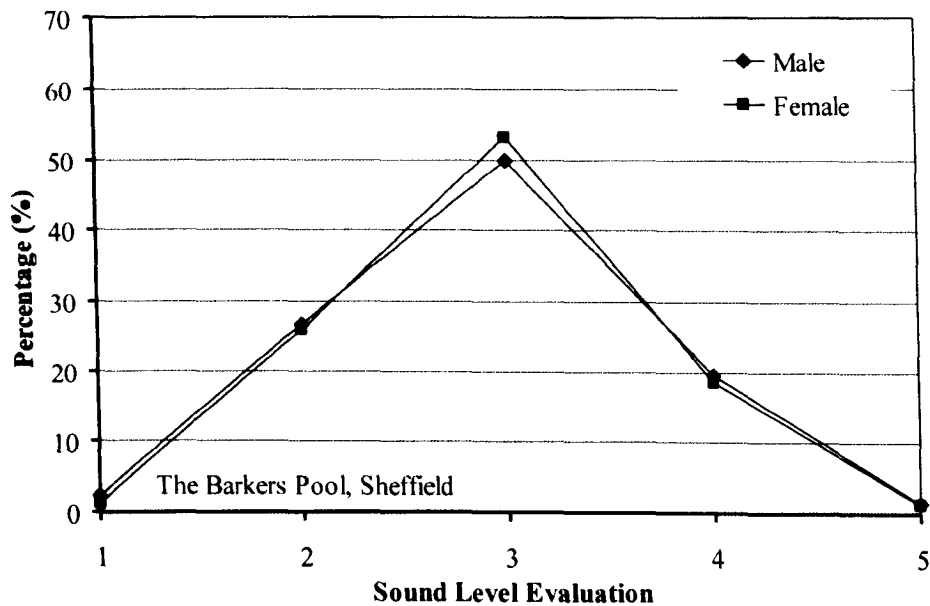


Figure 5.7 Sound level evaluation differences between males and females

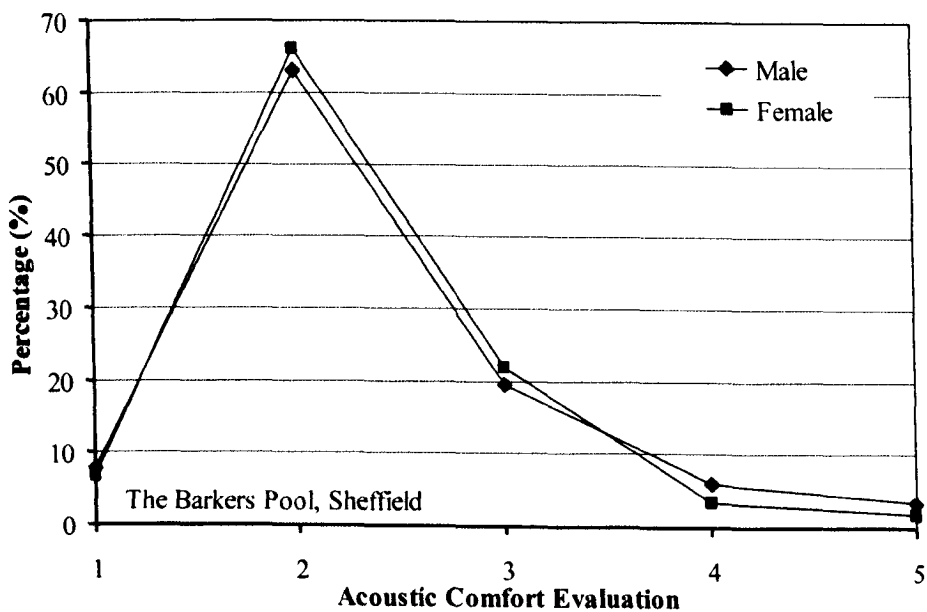


Figure 5.8 Acoustic comfort evaluation differences between males and females

5.2.2 Sound Preferences

In order to check the effects of demographic variables on the frequency of noticed sounds, Pearson's chi-square test was carried out. The results show that there were no significant differences between males and females, different age groups, local and non-local people or different occupations. This suggests that people in different demographic groups have a similar ability to notice the sounds in the squares. However, whether they have a similar way of evaluating these sounds is a different issue, which will be analysed below.

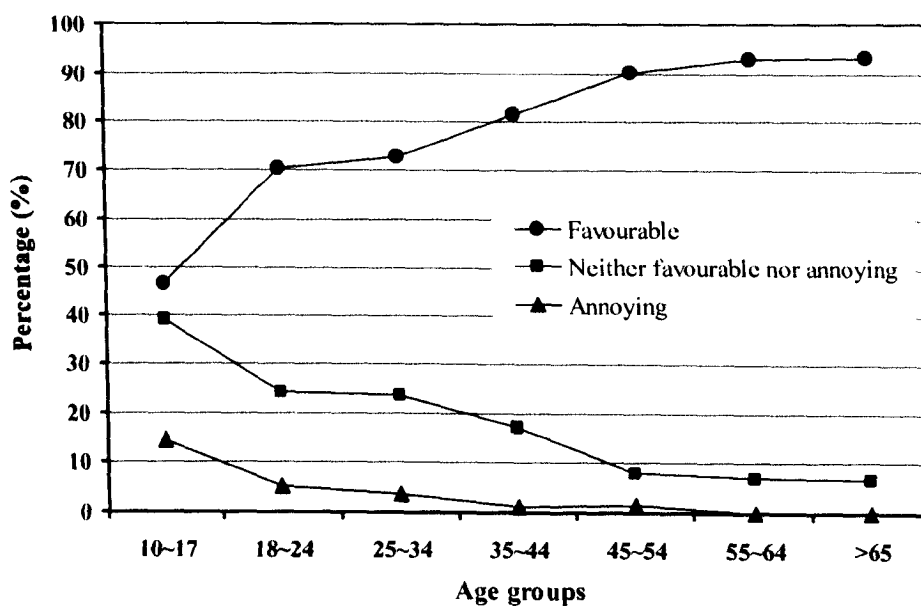
As noticed in Section 4.2.2, large variations (see Figure 4.5) can be found in interviewees' classification for various sounds. For instance, regarding the music from stores, the percentages of people who chose 'favourable', 'neither favourable nor annoying', and 'annoying' were 14.9%, 43.3% and 41.8%, respectively. Other researchers have also reported such significant variations. In Porteous & Mastin's (1985) research, on a six-scale rating of the neighbourhood soundscape elements, over 70% of the responses had a standard deviation of over 1.0 and 23% clustered around 1.5. In order to explore the factors that lead to the lack of agreement in sound preferences, the effects of demographic variables are analysed below.

Age

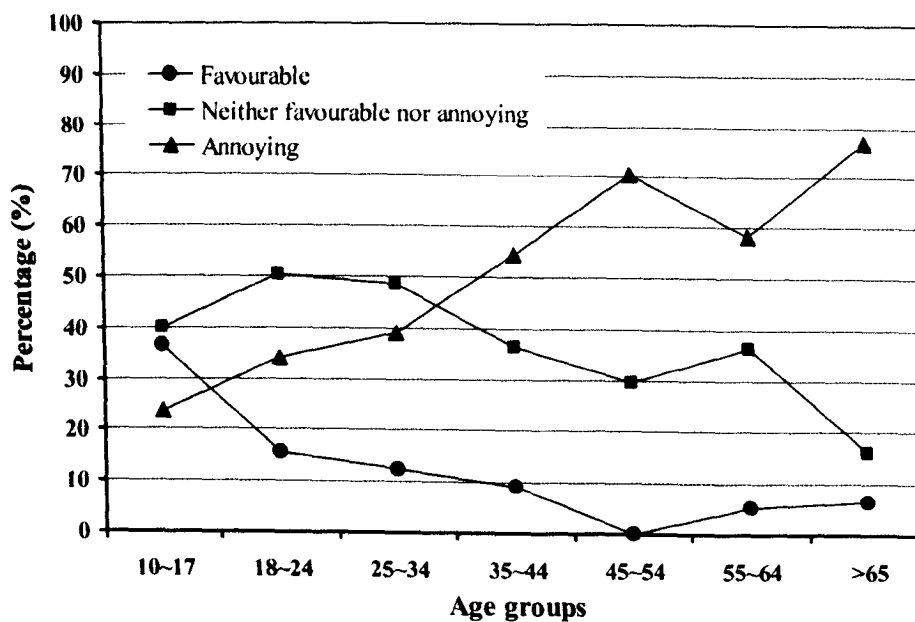
Distinct differences were found between age groups regarding sound preferences. It is interesting to note that with an increase in age, people are more favourable to, or tolerant towards, sounds relating to nature, culture or human activities. For example, for bird songs ($p < 0.001$), Figure 5.9(a) shows that 93% of the people aged over 65 favoured bird songs, whereas only 46.4% of the 10-17 age group rated bird songs as 'favourable' and 14.3% of them even chose 'annoying'. Significant differences have also been found amongst age groups for other sounds: church bells ($p < 0.001$), water sound ($p < 0.001$), insect sounds ($p < 0.001$), clock chimes or music ($p < 0.001$), children's shouting ($p < 0.01$), pedestrian crossing ($p < 0.001$) and construction sound ($p < 0.05$).

However, younger people, conversely, are more favourable to, or tolerant towards, music and mechanical sounds. Significant differences were found between age groups

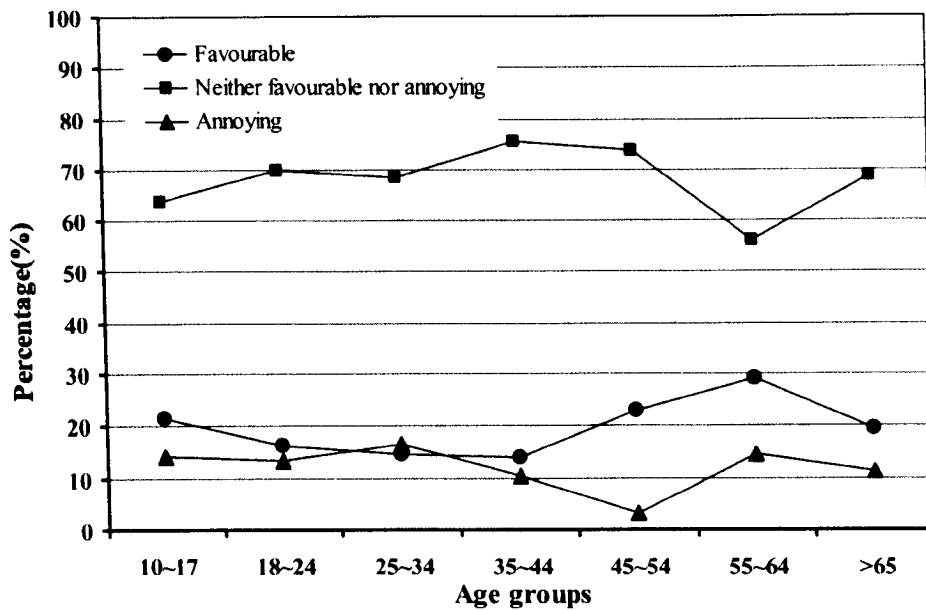
for music played on streets ($p < 0.05$), music from passenger cars ($p < 0.001$), vehicle parking ($p < 0.001$) and music from stores ($p < 0.001$). As an example, Figure 5.9(b) shows the differences towards music from stores. It can be seen that for the over 65 age group only 6.5% classified it as 'favourable', whereas most of them (77%) rated it as 'annoying'. By contrast, for the 10-17 age group the 'annoying' percentage was only 23.6%. Instead, 36.3% of them rated the sound as 'favourable' and 40% of them rated it as 'neither favourable nor annoying'.



(a) bird songs



(b) music from stores



(c) surrounding speech sounds

Figure 5.9 Sound preference differences amongst age groups

For sounds from passenger cars ($p < 0.01$) and buses ($p < 0.001$), people in the 25-44 and 55-64 age ranges are the groups most annoyed.

The only sound for which the classifications agree between various age groups seems to be surrounding speech sounds, as shown in Figure 5.9(c). About 70% of the interviewees rated the sound as 'neither favourable nor annoying'.

Although differences exist between various age groups, the difference between the 10-17 age group and the other groups is particularly significant. For example, Figure 5.9(a) and 5.9(b) show that between the 10-17 and 18-24 age groups there is usually a significant change in the curve. Similar results exist for church bells, water sound, insect sounds and clock chimes and music.

In terms of the preferred relaxing sound environments, comparison was made between different age groups, and a significant difference ($p < 0.001$) was again found. Figure 5.10 shows the preferred relaxing sound environment between different age groups. It can be seen that most people preferred quiet natural sounds only. With an increase in age, people showed more preference to the quiet natural sound environment, whereas 37.6% of the age group of 10-17 preferred a mixture of natural and artificial sounds. From the following typical comments the changes in sound preference with increasing age can be clearly seen:

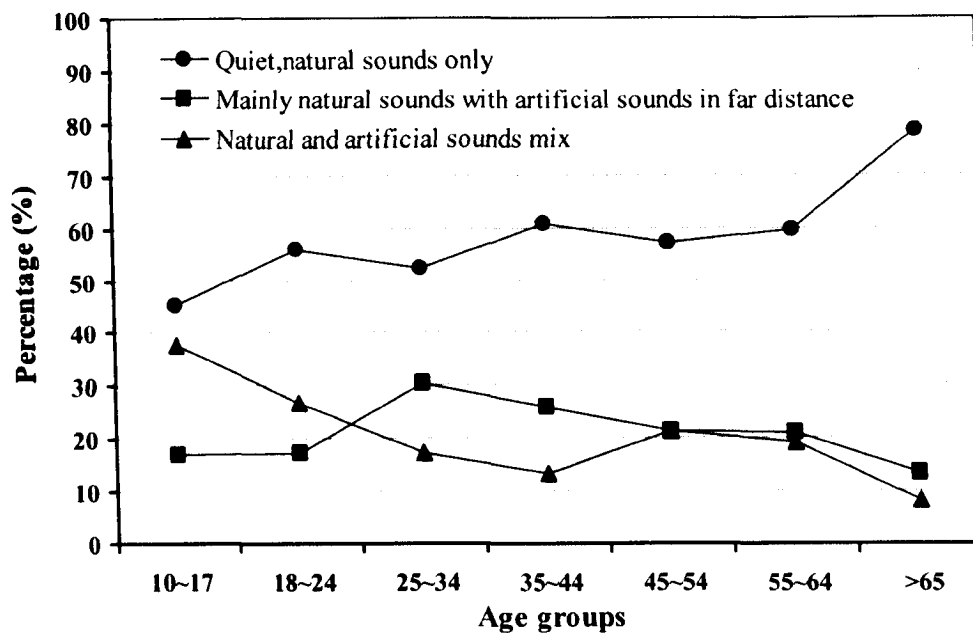


Figure 5.10 Differences amongst age groups towards preferred relaxing sound environment

"I like listening to music, the skate park and spotting nice boys." (Female, aged 10-17, who preferred a mixture of natural and artificial sounds)

"I don't mind having a little of both, it makes the sound environment more interesting with other noises as well as natural." (Male, aged 10-17, who preferred mainly natural sounds, but also artificial sounds in far distance)

"Natural sounds help me to relax, but I like to hear other people getting on with their lives." (Male, aged 18-24, who preferred a mixture of natural and artificial sounds)

"Natural sounds are relaxing, but artificial sounds can be inspiring." (Male, aged 18-24, who preferred a mixture of natural and artificial sounds)

"Because it needs to be quiet, quiet to relax, but I will know I'm not alone." (Female, aged 18-24, who preferred mainly natural sounds, but also artificial sounds in far distance)

"Natural and artificial sounds mix shows that there are many things going on around you and that even though it is relaxing where you are, you are close to a more active social environment." (Male, aged 18-24, who preferred a mixture of natural and artificial sounds)

"I like the peace of my home, but I don't want to be detached from the outer world." (Male, aged 18-24, who preferred mainly natural sounds, but also artificial sounds in far distance)

"I admit to relying upon artificial sounds, e.g. CD stereo etc. for stimulation, but natural sounds are very important for peace, tranquillity and reassurance." (Male, aged 25-34, who preferred a mixture of natural and artificial sounds)

"If I want to relax, I want as much peace and quiet as possible." (Male, aged 35-44, who preferred quiet natural sounds only)

"I want to feel as if I have stepped outside of the hubbub of city life." (Male, aged 35-44, who preferred quiet natural sounds only)

"As I get older, I prefer peace and quiet." (Male, aged 35-44, who preferred quiet natural sounds only)

"Noise today is too much of an intrusion in our lives." (Male, 55-64, who preferred quiet natural sounds only)

A possible reason for the above differences between age groups is that as people grow older, their sound preferences tend to be shaped by experience. The older people are, the more emotion they have when they hear the sound environment. As a result, they may be more appreciative of natural and culturally approved sound elements. However, for young people, say aged 10-17, their social lives are just starting, and they may prefer a high-arousal soundscape in public open spaces.

Significant age differences were also found in landscape preference (Lyons, 1983) - children under 12 were less discriminating than adults and showed much greater variability in response to landscapes, having little interest in high naturalism in landscape and being less likely to view human intervention in the landscape as detrimental (Zube *et al.*, 1983). However, the tendencies of the age difference between landscape preference and soundscape preference are different. In soundscape preference, with an increase in age, people are more favourable to, or tolerant towards, sounds relating to nature, culture or human activities. As much as 80% of the elderly people interviewed in this research preferred soundscape in urban public open spaces to be quiet and natural only (see Figure 5.10). In landscape preference, however,

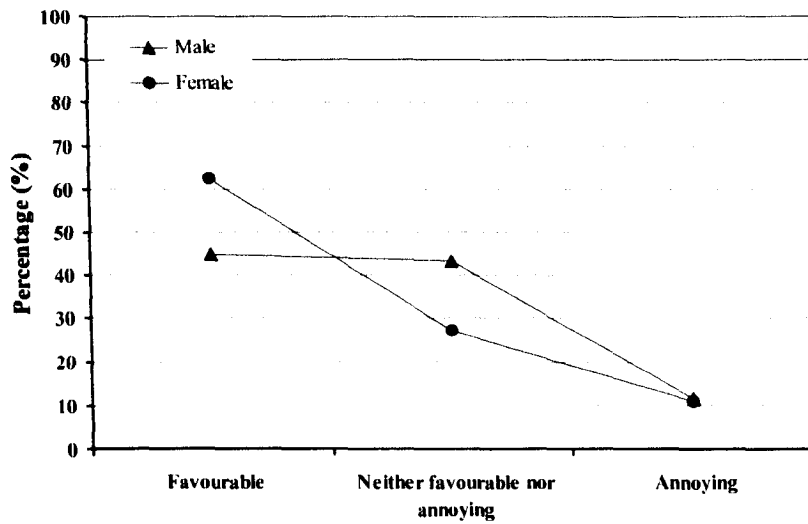
neither children nor the elderly seemed to be strongly affected by human influences in natural scenes, and adolescents and adults tended to judge scenes as of ever-lower value as the man-made components increase (Zube *et al.*, 1983). From the viewpoint of urban design, it is important to understand people's different preferences according to age between soundscape and landscape.

Gender

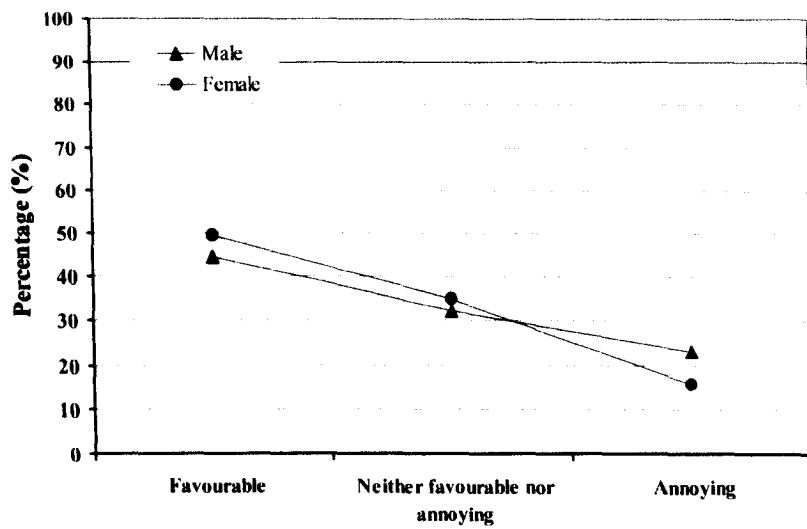
There are also some differences between males and females in sound preference, although these are less significant than those amongst age groups. Compared with males, female interviewees are more favourable towards the following sounds: church bells ($p < 0.001$), water ($p < 0.001$), music played on the street ($p < 0.05$), clock chimes or music ($p < 0.01$) and children's shouting ($p < 0.05$). It seems that the emotional effect is a common characteristic of these sounds.

Figure 5.11(a) shows the differences between males and females in rating the church bell sounds. Over 60% of the female interviewees classified church bell sounds as 'favourable', and less than 30% as 'neither favourable nor annoying', whereas these values for males were 44.9% and 43.5%, respectively. Similar differences between males and females have also been reported by other researchers, as discussed below.

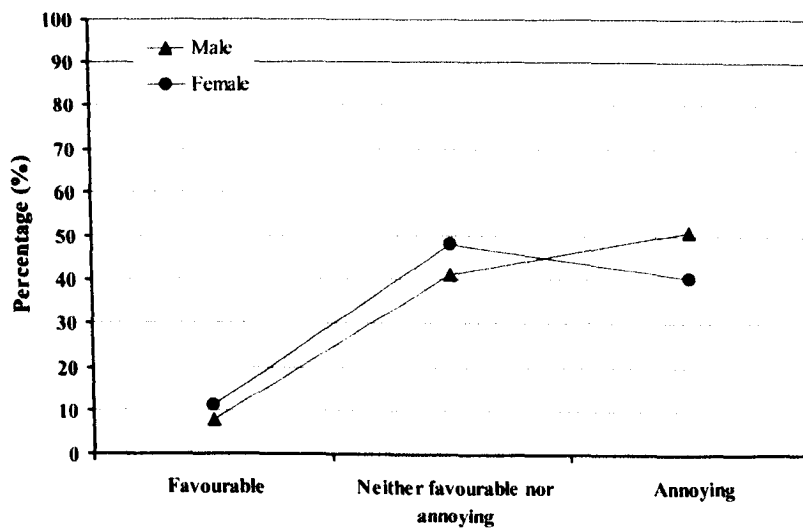
Mehrabian's (1976) has demonstrated that in general there is a slight tendency for women to screen less than men. It has often been remarked, for example, that women are more "emotional" than men, meaning that they act with greater arousal to obviously emotional situations, or that they are emotionally more sensitive to seemingly minute changes in the environment, changes that sometimes are not even perceived by males. There is some evidence to suggest that females generally have a higher arousal level than males, and can hence tolerate sensory deprivation situations better (Croome, 1977).



(a) church bell



(b) music played on street



(c) children's shouting

Figure 5.11 Sound preference differences between males and females

Figure 5.11(b) and 5.11(c) illustrate the differences between males and females in rating music played on the street and children's shouting, respectively. It can be seen that despite some small differences, male and female interviewees show a similarity in classifying the sounds. Overall, the results in Figure 5.11 suggest that the differences between sounds may exceed gender differences.

Others

Between local and non-local interviewees, it is interesting to note that the difference in sound preference is only significant for surrounding speech sounds ($p < 0.001$). Non-local people tend to be more annoyed by this sound. As shown in Figure 5.12, about 10% more of the non-local interviewees felt the sound is annoying than local interviewees. A possible reason for this significant difference is caused by unfamiliarity of the local language to non-local people.

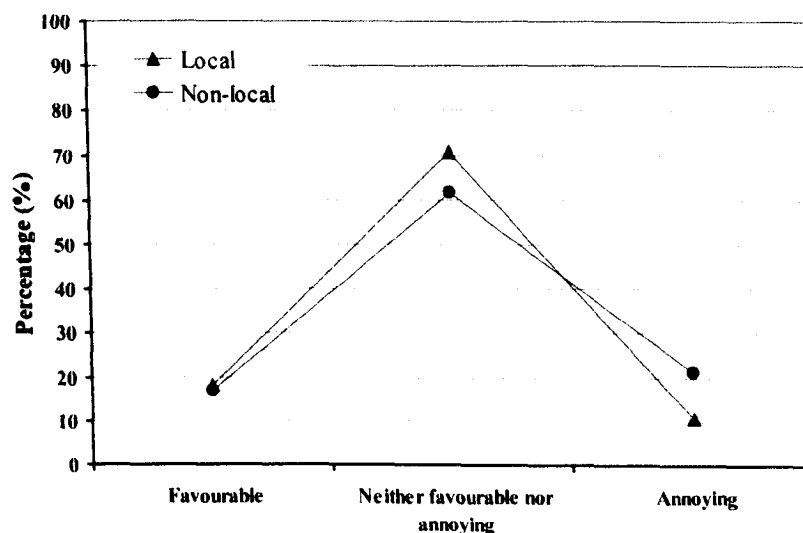
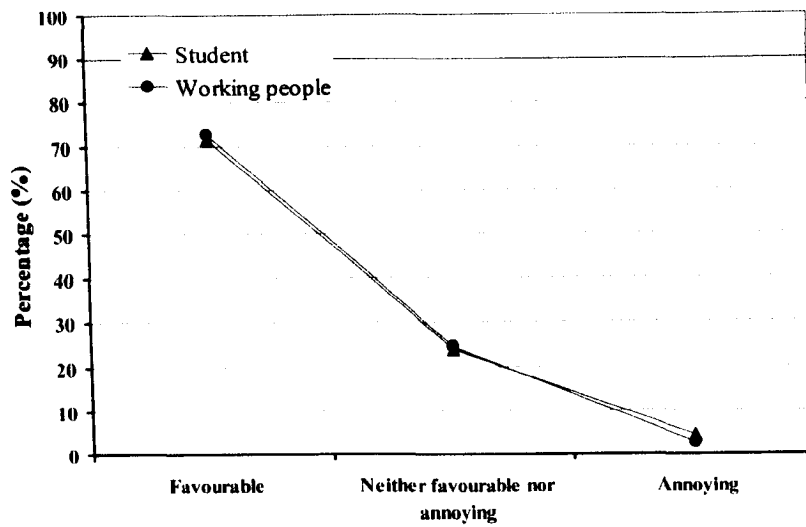


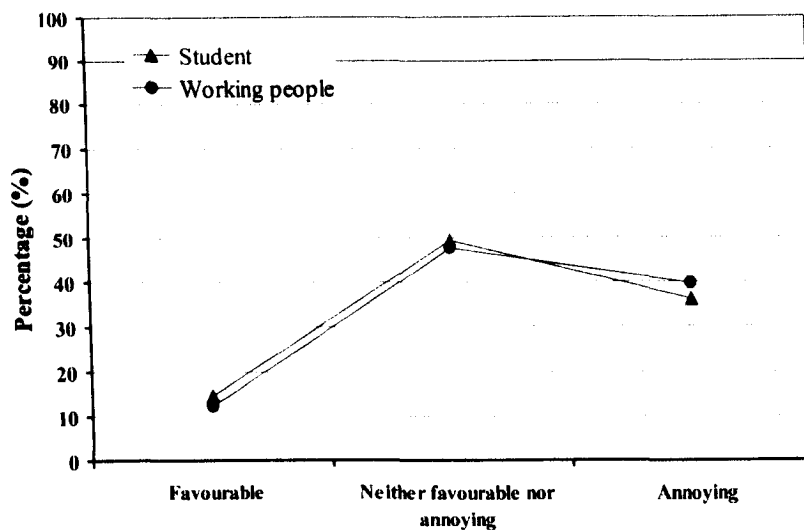
Figure 5.12 Sound preference differences between local and non-local interviewees

Between various professions, except between students and other professions, no significant difference is found. However, it is noted that since the majority of the students are young people, the differences could be related to the differences between age groups. Therefore, a further comparison is made between students and working people in the same age group. As an example, Figure 5.13 illustrates the comparison between students and working people in the 25-34 age groups. It clearly shows that within the same age group, the sound preference is rather similar between different

professions. A further statistical analysis indicates that there is no significant difference amongst different professions in the same age group.



(a) bird songs



(b) music from stores

Figure 5.13 Sound preference differences between different professionals within 25-34 age group

5.3 TEMPORARY STATUS VARIABLES

In order to find out whether the interviewees' temporary statuses, namely frequency of visiting, activities during visiting, and size of group, influence their evaluations of the soundscape in urban public open spaces, Pearson's chi-square test was carried out between different temporary status groups of all the 14 case study sites.

5.3.1 Activities

The interviewees' activities before the interview were recorded by the interviewers during the interview. Four statuses were used to describe the activities of the interviewee, namely 'sitting as consumer', 'sitting freely or lying down', 'standing', and 'walking'.

In Markdonomahon Square, there was a significant difference ($p < 0.001$) for the sound level evaluation between interviewees with different activities taken place in the square. Figure 5.14 shows the comparison between interviewees with different activities. It can be seen that the interviewees who were standing or sitting as consumers were more sensitive with the sound level. As shown in the figure, 37% of the interviewees who were standing referred to 'very noisy' and another 46% referred to 'noisy' on the site. It is possible that when people were standing, they could see further than other users who were sitting or walking. Standing interviewees could easily see how busy the square was. Therefore, psychologically they were more aware of the fact that the square was very noisy. It was also found that about 45% of the interviewees, sitting as consumers, referred to Markdonomahon Square as 'very noisy'. However, in the mean time, more than 30% of them felt it was 'quiet' or 'neither quiet nor noisy'. This is perhaps because as consumers, some of them could choose where they wanted to sit, whilst for others there was no choice. Hence sitting consumers' attitudes varied considerably. Some may felt very annoyed because of their unsatisfactory sitting position. However, for interviewees who were taking other activities, especially walking through the square, their activities focused on a relatively narrower scope, such as the route they were walking. As a result, they were less concerned about the sound levels in the square.

The similar tendency is also found in other case study sites. However, only IV Novembre Square reaches the statistically significant difference ($p < 0.001$).

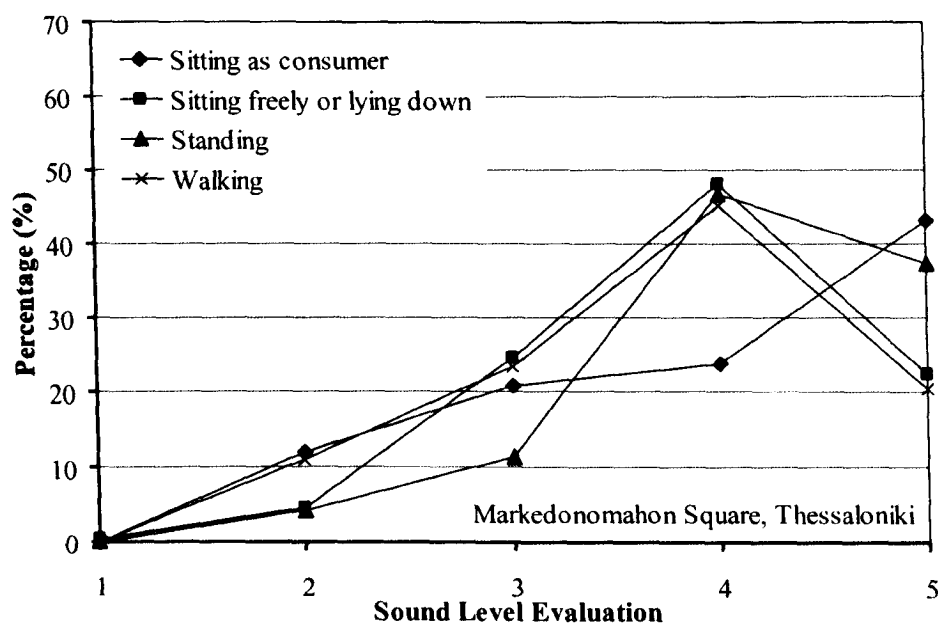


Figure 5.14 The comparison of sound level evaluation between different activities in Markdonomahon Square

Figure 5.15 shows the comparison of sound level evaluation between different activities in the Peace Gardens. It can be seen that, similar to the tendencies in Markdonomahon Square and IV Novembre Square, users who were standing in the Peace Gardens were the most annoyed groups. However, the differences between the groups do not reach a significant level in statistical terms.

In the Peace Gardens, a further comparison is made to compare the acoustic comfort evaluations between the groups. A significant difference ($p < 0.001$) is found between interviewees with different activities. As illustrated in Figure 5.16, interviewees standing in the square were the most acoustically uncomfortable users, whereas sitting interviewees were the most comfortable users. It can be seen that in total about 70% of the sitting interviewees felt 'very comfortable' or 'comfortable', whereas it was less than 50% for the standing users. In particular, about 20% of them felt 'very uncomfortable' compared with only less than 3% in the other groups.

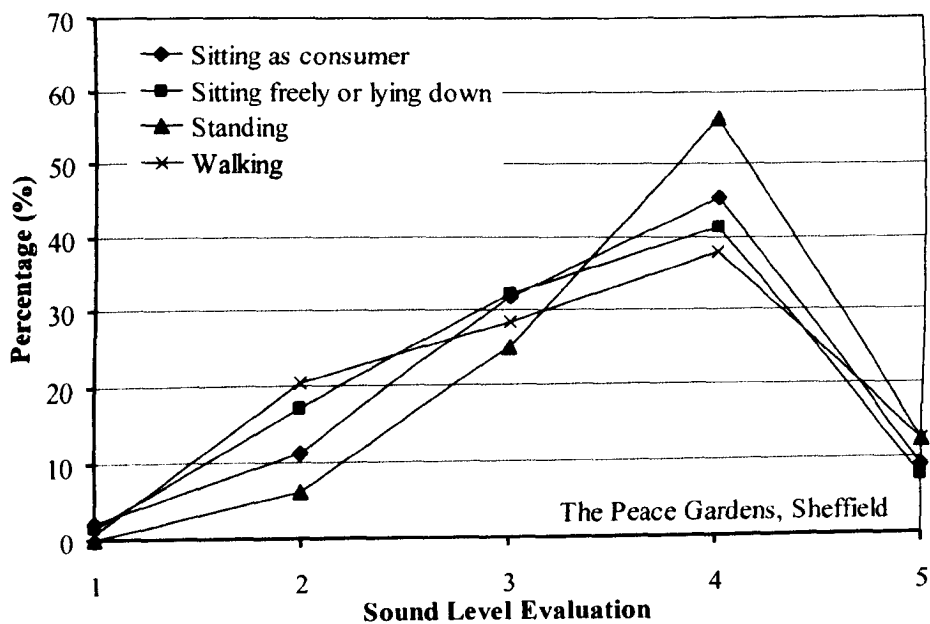


Figure 5.15 The comparison of sound level evaluation between different activities in the Peace Gardens

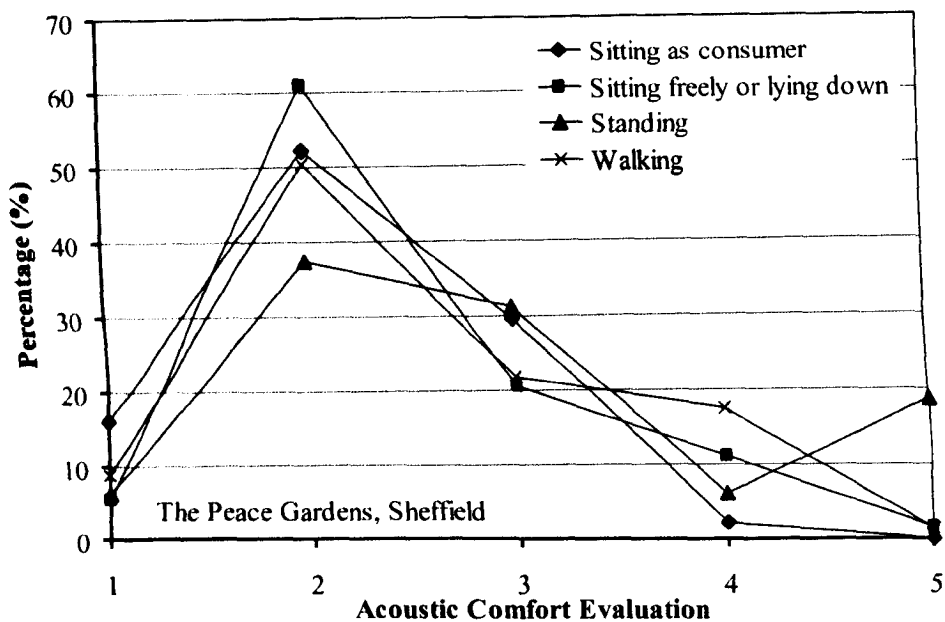


Figure 5.16 The comparison of acoustic comfort evaluation between different activities in the Peace Gardens

The analysis results indicate that users' activities influenced their evaluation of the acoustic environment. The users who were standing in the sites acted more like observers. They showed a more critical view of the sound environment. Therefore, from a design viewpoint, it would be more helpful to provide attractive and comfortable sitting areas. It is also important to design a focus point, either visually or aurally, to attract the attentions of the users.

5.3.2 Size of Groups

During the field survey, the size of interviewee groups was recorded as 'alone', 'two people', or 'more than two people'.

It is interesting that in Markdonomahon Square there was a continuous tendency and a significant difference for the sound level evaluation between different sizes of group ($p < 0.005$). As Figure 5.17 shows, the tendency in Markdonomahon Square was that the groups with more than two people were the least annoyed by the noise. Groups with two people were the most sensitive. Only 11% of interviewees in groups with more than two people referred to 'very noisy', whilst the figure was 30% for two people groups. A possible reason is that people in large groups need to pay more attention to other group members. Therefore, they care less about the sound levels of the surrounding environment. Indeed, with some activities, the communication sounds within the groups may overwhelm the environmental sounds. However, when two users talk together, a low noise level would be conducive an efficient conversation. As a result, groups with two people were more likely to be annoyed by surrounding noise.

However, in terms of group size differences, a statistical significance is only found in Markdonomahon Square. A similar tendency has also been found in some other case study sites. However, the differences did not reach a statistical significant level.

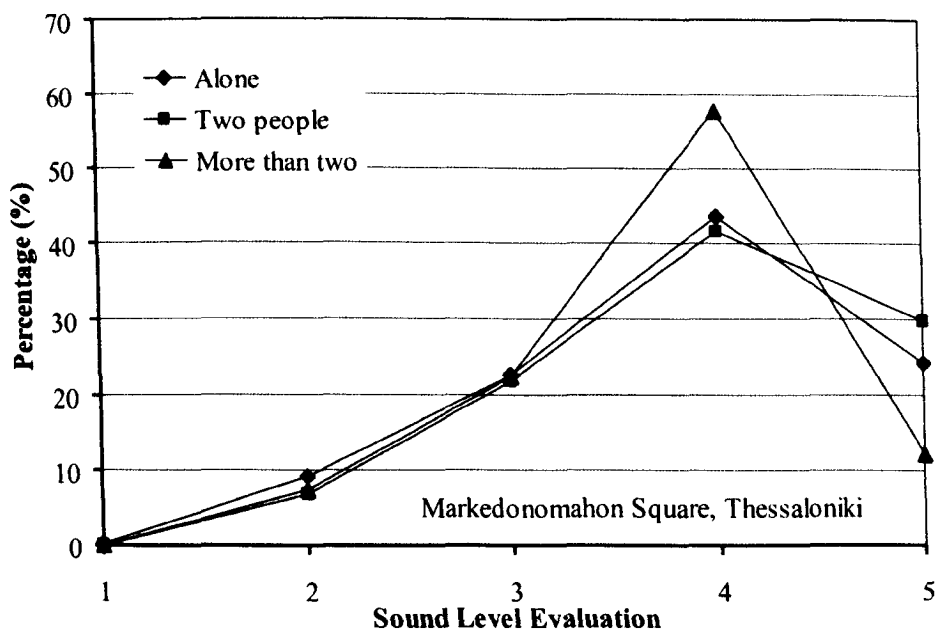


Figure 5.17 The comparison of sound level evaluation between different sized groups in Markdonomahon Square

A further analysis is made for acoustic comfort evaluation in the Peace Gardens and the Barkers Pool. Figure 5.18 illustrates the comparison of the acoustic comfort evaluation between different sized groups in the Barkers Pool. As can be seen in the figure, different sized groups show a rather similar tendency towards the acoustic comfort evaluation. There is no significant difference in the acoustic comfort comparison between different sized groups.

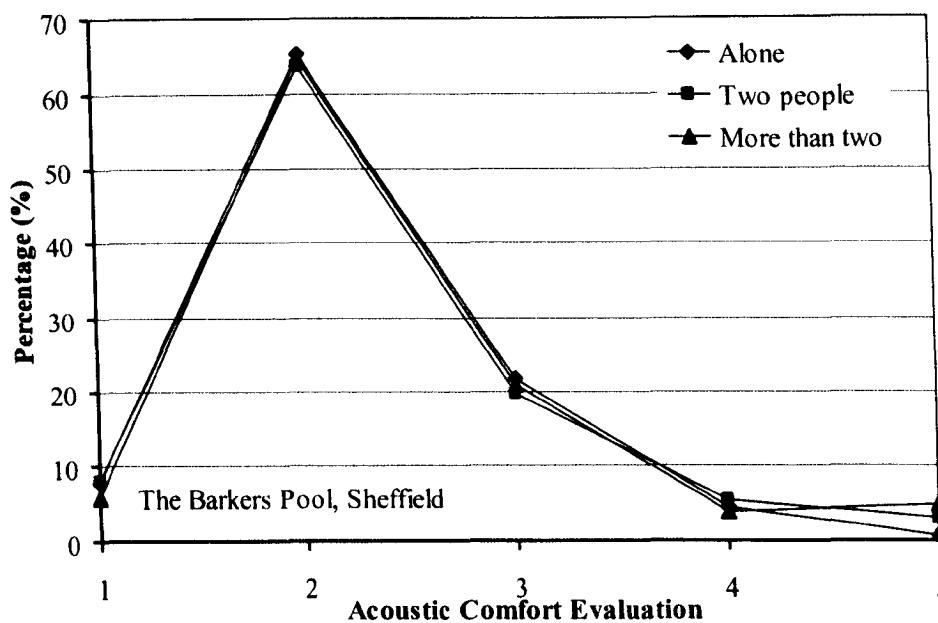


Figure 5.18 The comparison of acoustic comfort evaluation between different sized groups in the Barkers Pool

5.3.3 Frequency of Visits to the Sites

During the questionnaire survey in the 14 sites, interviewees were asked how frequently they were coming to the site. The answers were divided into four categories, namely daily, weekly, monthly, and yearly. It is interesting to find that, in Markdonomahon Square ($p < 0.001$) and IV Novembre Square ($p < 0.05$), interviewees who visit the sites daily were the most sensitive group towards the sound levels and interviewees who visit the sites yearly were the most tolerant group towards the sound level. The comparisons between different frequency groups are shown in Figure 5.19 and Figure 5.20 for Markdonomahon Square and IV Novembre Square, respectively.

In Figure 5.19, it can be seen that more than 30% of the interviewees who visit the sites daily in Markdonomahon Square evaluated the sound environment as 'very

noisy', which is more than 10% of other interviewees' evaluation. As shown in Figure 5.20, in IV Novembre Square, nearly 60% of the interviewees who visit the site yearly evaluated the sound environment as quiet, whereas most other people felt it was noisy.

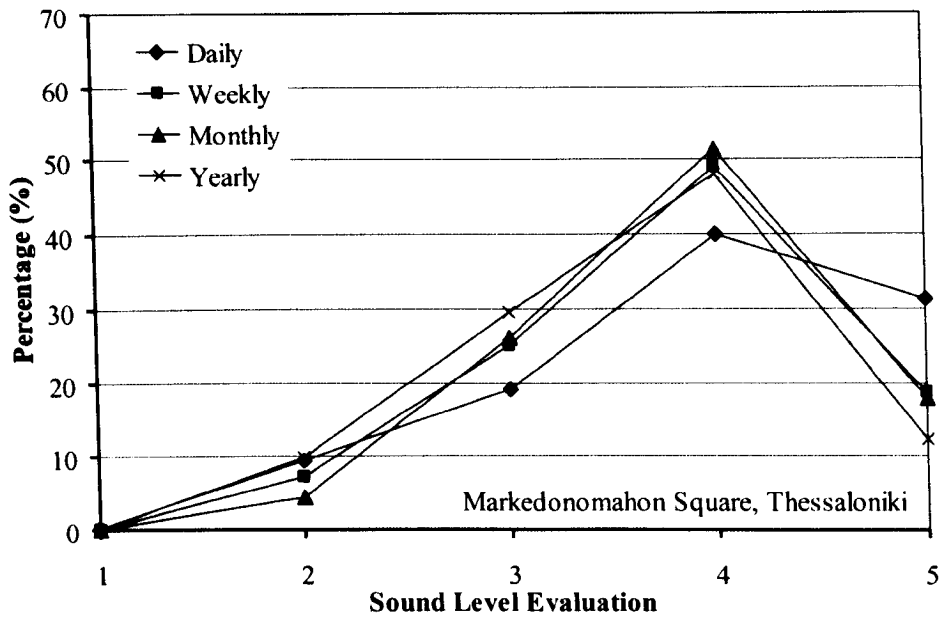


Figure 5.19 The comparison of sound level evaluation between different visiting frequencies in Markdonomahon Square

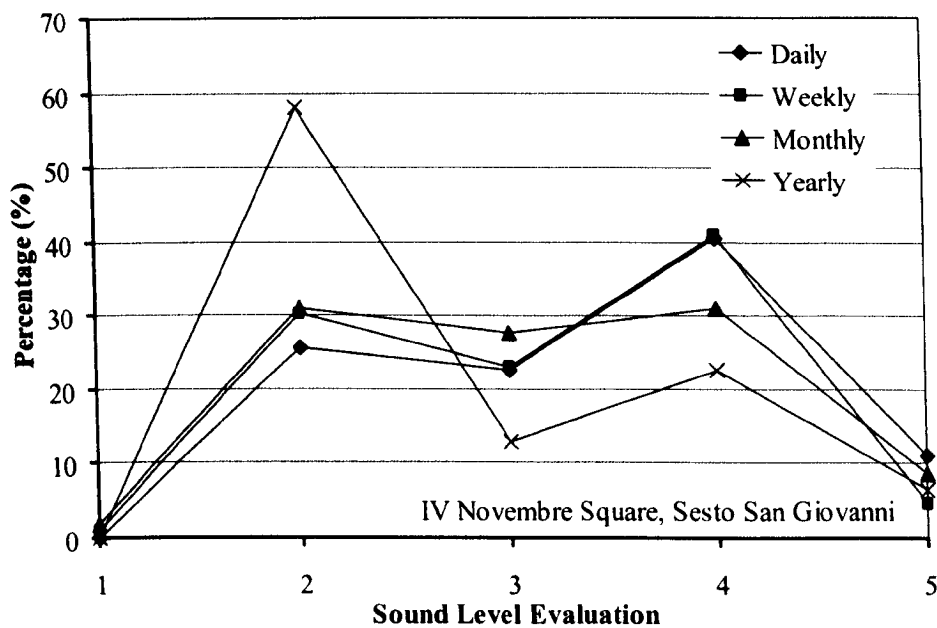


Figure 5.20 The comparison of sound level evaluation between different visiting frequencies in IV Novembre Square

However, although showing the tendency in some of the case study sites, the differences only reached a statistical significance in the case of Markdonomahon Square and IV Novembre Square.

To explain the relationship between sound level evaluation and frequency of site visiting, it is possible that people who visit the site more frequently are already familiar with the environment. For them, the conditions of the site are clear. As introduced in Chapter 2, both Markdonomahon Square and IV Novembre Square, are rather busy and are the noisiest squares amongst all the case study sites. Frequent users have already mentally imagined what the sound level will be like. In other words, the user, who frequently uses the sites, has a preconception of the noise level.

Furthermore, comparisons are made for acoustic comfort evaluations between different visiting frequency groups. Figure 5.21 shows the comparison in the Peace Gardens. As can be seen there is no significant difference between groups with different visiting frequency.

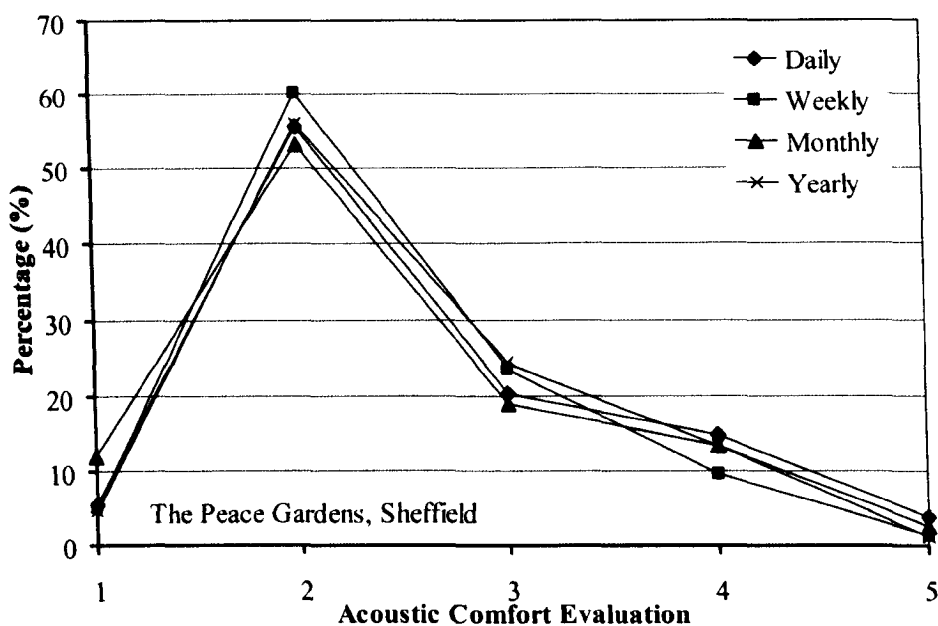


Figure 5.21 The comparison of acoustic comfort evaluations between different visiting frequencies in the Peace Gardens

5.4 SUMMARY

This chapter has investigated the personal variables, i.e. acoustic experience and cultural differences, demographic and temporary status differences, in evaluating the soundscape in urban public open spaces.

It is found that both cultural differences and long-term acoustic experience influence people's sensitivity towards sound levels in urban public open spaces. However, cultural differences play a more important role than acoustic experience. In terms of sound preferences, it is found that city-living people generally share a common preference for natural and culture-related sounds rather than artificial sounds. However, cultural background and long-term environmental experience play an important role in people's judgement of sound preference. People from a similar cultural background and long-term environment may show a similar tendency on their sound preferences.

In terms of demographic differences, it was reported that except for a slight tendency for older people to feel more comfortable with a sound environment than teenagers, there was no correlation between noise sensitivity and other demographic characteristics.

However, in terms of the effects of demographic factors in soundscape preferences, it has been shown that the differences between age groups are rather significant. Young people and old people may have some essential differences in evaluating sounds. Generally speaking, with an increase in age, people are more favourable to, or tolerant towards, sounds relating to nature, culture or human activities. By contrast, younger people are more favourable to, or tolerant towards, music and mechanical sounds. Between males and females there are only slight differences. Females tend to put more emotional colours into their sound preference. For example, they are more favourable to, or tolerant towards, sounds like church bells, water, music played on the street, clock chimes or music and children's shouting. It is noted that differences between sounds exceed gender differences.

The results of current and previous studies suggest that the sound preference differences are at three levels. The first can be defined as basic preference. People generally share a common opinion in preferring nature and culture related sounds

rather than artificial sounds. However, cultural background and long-term environmental experience play an important role in people's judgment of sound preference (Yang & Kang, 2003; Yang & Kang, 2005b). People from different backgrounds may show rather different tendencies on their sound preferences. Thus there is a second level sound preference, which can be defined as macro-preference. At the third level, within the same cultural background and long-term environmental experience, personal differences exist. This can be defined as micro-preference. In particular, the differences between age groups are more significant than other factors.

Finally, in examining the temporary status, tendencies are found (1) users who were standing were most acoustically uncomfortable, while users who were sitting were most acoustically comfortable; (2) groups with two people were more likely to be annoyed by the surrounding noise, whereas groups with more than two people were more insensitive towards soundscape; (3) users who came to the sites daily were most annoyed by the sound levels and users who came yearly were most tolerant. However, these tendencies do not apply to all 14 case study sites; only certain sites with relatively more activities. Psychological adaptation is probably more significant in such situations.

PART II

SOUNDSCAPE BY DESIGN

Chapter 6

Typological Soundscape Study

In Part I of this thesis, by means of social survey, soundscape was studied from the users' point of view. The study was focused on the interaction between people and soundscape in urban public open spaces. The discussion was mainly about "what kind of soundscape is more desirable in urban public open spaces?" The information contained in sounds, sound levels, people's preferences and behaviours, and their evaluation of soundscape, were the key factors involved in the discussion. It has been proved in Part I, that soundscape quality is important in influencing users' evaluation of urban public open spaces. There is also strong evidence showing the interaction between aural and visual perceptions.

Consequently, the following question has emerged, "how to design a desirable soundscape in urban public open spaces?" To answer this question, further study is necessary to understand the designable elements of urban public open spaces, i.e. the spatial characteristics of the space and the sound sources. As stated in Section 2.4.3, a new soundscape study approach, typological soundscape study, has been defined to carry out the spatial characteristics study. From an urban design point of view, as the container of soundscape, the spatial characteristics of a place are vital in distributing the sound and visual field and further influencing people's feeling of that space. To strengthen the audibility of the urban environment is to facilitate its aural identification and structure.

Therefore, in this chapter the typological soundscape study is carried out to examine soundscape characteristics of different spatial forms. This chapter includes five parts: Section 6.1 tests the validity of Raynoise in urban public open spaces. In the meantime, calculation parameters in Raynoise are also discussed. In the core part of this chapter, Section 6.2, 6.3 and 6.4 examine the soundscape characteristics of different shaped, scaled and opened urban forms, respectively. Finally, from a soundscape design

viewpoint, Section 6.5 summarises the findings and gives design suggestions for the spatial forms in urban public open spaces.

6.1 RAYNOISE: METHODOLOGY OF SIMULATION

The validation of computer models in actual urban situations has been carried out by other researchers, including the validation of the image source method for geometrically reflecting boundaries (Ismail & Oldham, 2003), and the validation of the radiosity model for diffusely reflecting boundaries (Kang, 2002c). In order to test the validity of Raynoise in urban public open spaces, a comparison between Raynoise and the image source model software developed by Kang (2000) is made, which is regarded as a validation of Raynoise in this study.

6.1.1 Methods

Suggested for exterior applications, the triangular beam method was used in Raynoise calculations (see Section 2.5.1). In Raynoise, absorption coefficient (α) and diffusion coefficient (d) can both be considered, which is useful to simulate partially diffusely and partially geometrically reflecting boundaries.

A series of comparisons between Raynoise and the image source model are carried out using a basic configuration. Indices for comparison include SPL and RT30. With the image source method, according to Kang (2002a), the change of SPL and RT30 with increasing reflection order becomes stable when the reflection order is greater than 100. Therefore, the image source model with the reflection order of 100, named as the image source RO100, is taken as the reference results to be compared with. In order to conduct accurate calculation results from Raynoise, the first comparison studies the appropriate setting of reflection orders and number of rays emitted from sound sources. The second comparison is to compare the calculation results of Raynoise and the image source model with different boundary absorption coefficients. In the analysis, air

absorption at 20°C and 50% relative humidity is considered for both calculation methods. A single frequency, 1kHz, is used.

6.1.2 Model

A basic configuration, namely Model-V1, is developed for the comparisons between Raynoise and the mirror image source model software. Figure 6.1 illustrates the plan of the Model-V1, which is designed to simulate a typical urban square situation of 50m by 50m. The four surrounding block buildings have the identical dimension, and a height of 20m. A single point source is shown as a red dot in Figure 6.1 (positioned at $x=10\text{m}$, $y=10\text{m}$, $z=1.5\text{m}$), with a sound power level of 100dB. A total of 100 receivers are evenly distributed at each grid point, with a constant height of 1.2m. Ten typical receivers along the diagonal of the square are shown in blue in Figure 6.1, namely Point 1, 12, 23, 34, 45, 56, 67, 78, 89 and 100, at an interval of approximately 7.07m.

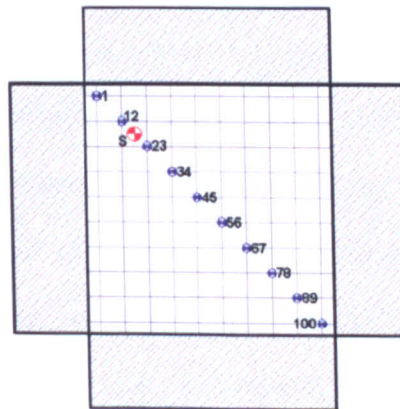


Figure 6.1 Site plan of Model-V1

6.1.3 Reflection Orders and Ray Numbers

With Model-V1, a series of calculations are conducted with reflection orders taken as 5, 20, and 100 respectively, with 0.2 million and 2 million rays calculated in turn. The absorption coefficient of all the boundaries (including ground and building façades) is defined as 0.1 in both Raynoise and the image source model calculations.

Figure 6.2(a) compares the SPL difference between the image source model and Raynoise. From this figure, it can be seen that the SPL calculated with Raynoise are generally higher than that with the image source model. The more reflection orders and the more ray numbers considered, the higher the SPL calculation results in Raynoise. In terms of reflection orders, the SPL results of a reflection order of 5 in Raynoise are the closest compared to the image source RO100. The average difference of the selected points between Raynoise RO5 (i.e. reflection order of 5) and the image source RO100 is less than 0.5dB. When the reflection order increases to 20, the difference increases to around 1dB. With the further increase of the reflection order, e.g. to 100, the increase of differences between the Raynoise and the image source method are about 0.1dB maximum. It suggests that the change of SPL in Raynoise is relatively stable when the reflection order is about 100 and with the further increasing reflection order the change of SPL is negligible. As indicated in Figure 6.2(a), the average difference between 20 and 100 reflection order in Raynoise is only 0.05dB. In terms of the ray numbers, when the reflection order is 5, the SPL results of 2 million rays and 0.2 million rays are rather similar. When the reflection order increases, the SPL with 2 million rays is 0.2dB higher than that of 0.2 million rays on average. From the above comparison, it can be seen that with low reflection orders, Raynoise has a close result compared to the image source method in terms of SPL calculation. The increase of reflection orders and ray numbers has increased the error compared to the accurate results. However, the error is in an acceptable scale, say within 1.5dB, which is unnoticeable for normal people.

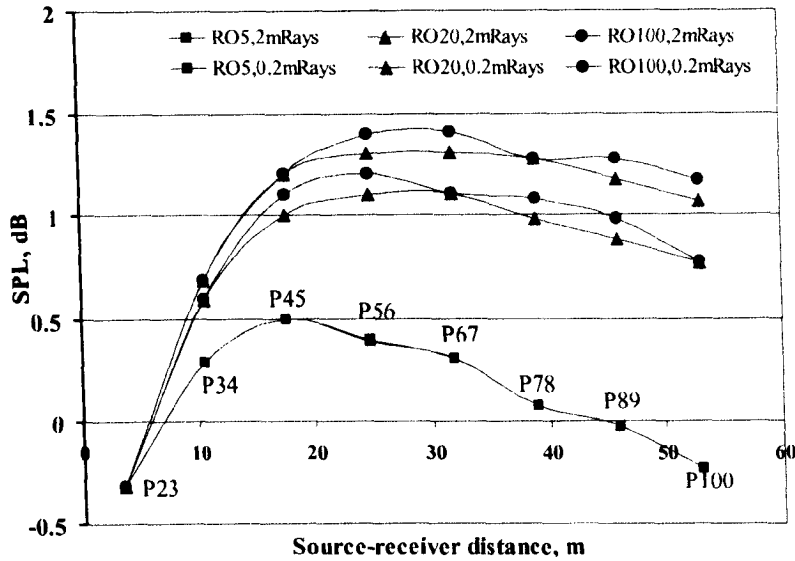
Figure 6.2(b) shows the comparison of RT30 between the image source model and Raynoise with different reflection orders and ray numbers considered. Different from SPL, the RT30 with Raynoise is lower than that with the image source method. A possible reason is that the triangular beam method has relatively low convergence rate, so that, some relatively later reflections become weaker leading to a shorter RT30. For the parameters considered in this comparison, the increase of reflection order has a

more significant influence to the RT30 results than that of the ray number. Generally speaking, the more reflection orders considered the closer the RT30 results are to the image source RO100. When 0.2 million rays are considered, the average difference of RT30 at the selected points between Raynoise RO100 and the image source RO100 is about 13%, whereas it is 68% between Raynoise RO5 and the image source RO100. In terms of the ray number, the average difference of RT30 at the selected points between Raynoise RO100 with 2 million rays and Raynoise RO100 with 0.2 million rays is less than 2%. From the above comparison it is important to note that in terms of RT30 calculation, less reflection orders leads to rather unsatisfactory results, e.g. when the reflection order is 5, the error rate is about 68%. Therefore, it is vital to choose a large reflection order, e.g. 100, to ensure acceptable results.

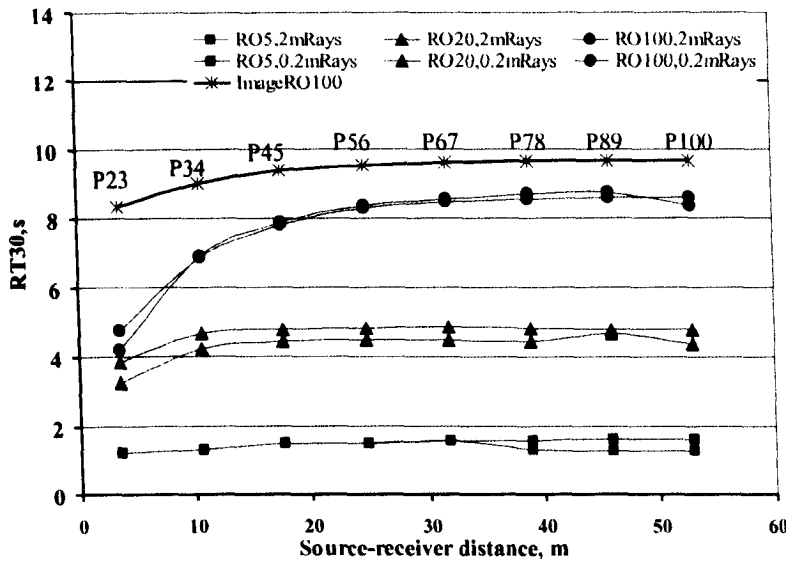
In order to further prove the above analysis results, a more detailed comparison is made between Raynoise and the image source model. In the comparison, the 100 evenly distributed receivers are considered with various reflection orders and ray numbers.

Table 6.1 shows the results of the comparison, both average difference and STD (standard deviation) have been taken into account. The results shown in the table have further confirmed the finding from analysing typical receivers. When a reflection order of 100 and a ray number of 0.2 million is considered, the average error rate of RT30 is within -20% and SPL is within 1.2dB. Also, from Figure 6.2 it can be seen that with the exception of the receiver very close to the sound source, the errors of RT30 and SPL results are rather systematic, which is likely caused by the system error of the beam-tracing method. It is possible that in later reflections, the beam expansions cover a larger area than the earlier reflections. Therefore later energy was under-estimated in the calculation. Considering the scope (within 20% for RT30 and 1.2dB for SPL) and the systematic character of the error, as well as the purpose of relative comparison in

this study, the error of Raynoise with the reflection order as 100 and ray number as 0.2 million is regarded as acceptable for this research.



(a)



(b)

Figure 6.2 The comparison of SPL and RT30 between the image source model and Raynoise with different reflection orders and number of rays in Model-V1
(a) relative SPL compared with ImageRO100; (b) RT30

Table 6.1 The comparison of SPL and RT30 with different reflection orders and ray numbers between the image source model and Raynoise (result based on the 100 evenly distributed receivers, the number showing are relative differences compared to the image source model)

		Raynoise, 0.2m rays			Raynoise, 2m rays		
		RO5	RO20	RO100	RO5	RO20	RO100
SPL (dB)	Average difference	0.50	1.13	1.16	0.50	1.34	1.38
	STD	0.44	0.42	0.42	0.44	0.43	0.42
RT30	Average difference	-85%	-53%	-17%	-86%	-51%	-17%
	STD	3%	1%	8%	3%	1%	9%

6.1.4 The Comparison of Boundary Absorption

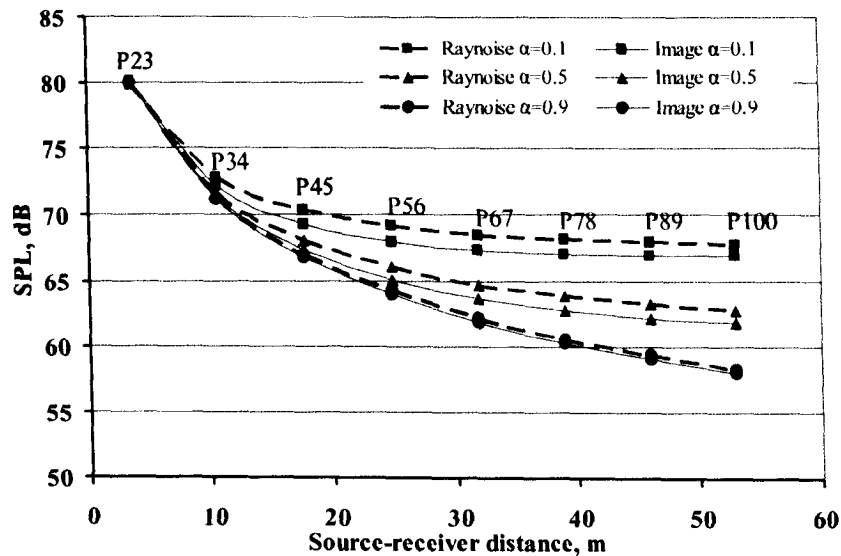
Based on the findings from the previous section, the second comparison is to compare the calculation results of Raynoise and the image source model with different boundary absorption coefficients. A series of calculations are carried out using Model-V1 with the absorption coefficient of 0.1, 0.5 and 0.9 respectively. 100 reflection orders and 0.2 million rays are considered in all the calculations.

Figure 6.3 illustrates the comparison between Raynoise and the image source model with different boundary absorption coefficients for SPL and RT30 respectively. As expected, it can be seen from Figure 6.3(a) that when the absorption coefficient increases from 0.1 to 0.9, the SPL curves in both Raynoise and the image source model drop considerably; and the higher the coefficient value is, the sharper the SPL decreases with the increasing distance from the source.

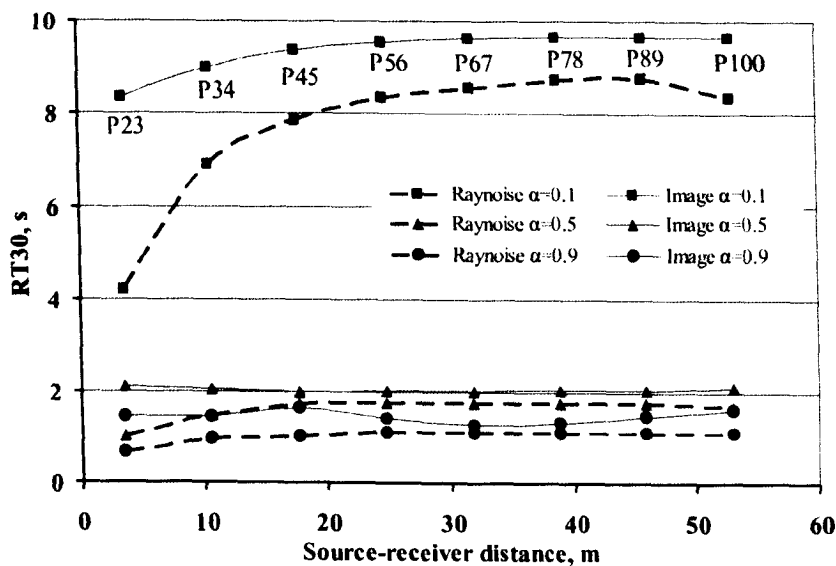
Figure 6.3(a) also indicates that with different absorption coefficient values, the difference of SPL calculation results between Raynoise and the image source model has noticeably changed. When $\alpha=0.1$, the SPL results with Raynoise are higher than that of the image source model, with an average difference of 0.81dB. When $\alpha=0.5$, the SPL results from Raynoise are 0.76dB higher than the image source model results on average, whereas it is 0.21dB on average when $\alpha=0.9$. In Figure 6.3(a), it is also important to note that except at the point very close to the sound source, the SPL differences between Raynoise and the image source model are almost the same at each point across the diagonal with the same absorption coefficient value.

Figure 6.3(b) illustrates the comparison of RT30 between Raynoise and the image source model with different absorption coefficients. It can be seen that with the same absorption coefficient, the RT30 calculation results of Raynoise are always lower than that of the image source model. It is also found that with an increase in the absorption coefficient, the differences between Raynoise and the image source model are getting greater in terms of the percentage. When $\alpha=0.1$, the average difference is about 18%; when $\alpha=0.5$, the average difference is about 20%; however when $\alpha=0.9$, the difference is about 29%, although in terms of absolute value, the difference between Raynoise

and the image source model is 0.43 and 0.42s on average when $\alpha=0.5$ and 0.9 respectively. Also as found out in the previous section, it is important to note that except within a very short source-receiver distance, the difference between Raynoise and the image source model is generally systematic for all the points.



(a) SPL



(b) RT30

Figure 6.3 The comparison of SPL and RT30 between the image source model and Raynoise with different absorption coefficients of Model-V1

6.1.5 Summary

From the above analyses, it has been demonstrated that except at the receiver point very close to the sound source, the differences of SPL and RT30 between Raynoise and

the image source model are almost systematic from all the points of the square. This suggests that compared to the image source model, the error of Raynoise is approximately constant for all the calculation points. In other words, the increase of source-receiver distance does not increase the difference between Raynoise and the image source model. This finding suggests that Raynoise can be used in indicating tendencies. However, in terms of the accuracy of the results, Raynoise is with typical error within 1-2dB and RT30 within 20%. Since the purpose of this research focuses on the conceptual soundscape study rather than the simulation of the actual situation, the comparison of relative sound distributions for typological square forms rather than the exact values of the SPL and RT30 will be considered as key issues. From this point, Raynoise has fulfilled the accuracy requirements of the study. Also, considering its obvious advantage of building models and applying different absorption and diffusion coefficients, Raynoise has been selected to carry out the typological soundscape studies. In order to understand the essential characters of the typological square forms, in the next section, a series of Raynoise models are developed. Shape, size and openness are the three basic factors studied in this chapter.

6.2 SHAPE

6.2.1 Models for Shape Analysis

To investigate the fundamental sound distribution characteristics of the three basic spatial forms, three configurations, namely Square-Model, Triangle-Model and Circle-Model, are developed, which are shown in Figure 6.4. In Raynoise, the Circle-Model is represented approximately by using a series of planes in a polygon, as can be seen in Figure 6.5. A similar treatment for curved surfaces has been used previously (Yang & Shield, 1999; Yang & Shield, 2000).

The three models are designed to have the same area of 2,500m², which is a typical urban square size, and an identical surrounding building height of 20m, which is the typical height of 4-5 storey buildings. A single point source is positioned at $x=10m$,

$y=10\text{m}$, $z=1.5\text{m}$, with a sound pressure level of 100dB. Three representative receivers along the diagonal of the three models are shown in blue, namely point 34 (10.6m to sound source), point 56 (24.75m to the sound source), and point 78 (38.9m to the sound source), with a constant height of 1.2m.

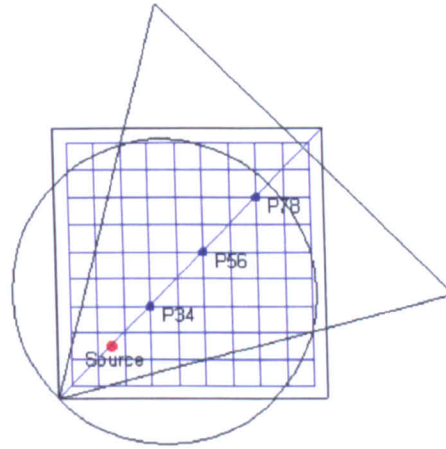


Figure 6.4 Three basic spatial forms for the typological soundscape analysis

Two comparisons have been made between the models, studying the effect of absorption coefficient and diffusion coefficient respectively. In the first comparison, the diffusion coefficient of all the boundaries, including ground and building facades, is defined as 0.1. SPL, RT30 and EDT have been compared between three models with various absorption coefficients. In the second comparison, the absorption coefficient of all the boundaries is defined as 0.1, and SPL, RT30 and EDT have been compared with various diffusion coefficients. In this analysis excess attenuation due to ground interference and temperature or wind-gradient induced refraction is not taken into account. Except where indicated, air absorption is not included.

6.2.2 Boundary Absorption

SPL

Figure 6.5 illustrates the SPL distribution of the three models with three representative absorption coefficient values, i.e. 0.1, 0.3, and 0.7. In Figure 6.6, the SPL at point 34,

56, and 78 with different absorption coefficients of the three models are shown. It can be seen that at point 34, the three models have a rather similar SPL distribution. It suggests that the SPL is almost shape independent when the receiver point is close to the sound source. The maximum SPL difference between the three models is less than 0.5dB at point 34. Clearly this is due to the dominant role of direct sound. With increasing source-receiver distance, at point 56 and 78, the Square-Model and the Triangle-Model still have a similar SPL distribution, whereas the Circle-Model has the highest SPL. For example, at point 56, the maximum difference between the Square-Model and the Circle-Model is 2.1dB, whereas it is 0.3dB between the Square-Model and the Triangle-Model. This is because that compared to the other two models, the distance between the sound source and reflection surface distance is the shortest in the Circle-Model. Therefore, with a constant site area of 2,500m², the sound distribution is more even and stronger in the Circle-Model. As expected, from Figure 6.5, it can also be seen that with an increase in surface absorption coefficient, the sound distribution difference between the three models becomes less significant.

Figure 6.6 also indicates that the relationship between absorption coefficient and SPL is close to linear. For the three models, as expected, with an increase in absorption coefficient, SPL decreases proportionally. By comparing the attenuation tendency of Figure 6.6 (a), (b), and (c), it is also suggested that the increase of absorption coefficient has more influence for the receivers farther from the sound source. For example, when absorption coefficient increases from 0 to 1, SPL decreases about 5dB at point 34, whereas at point 78, SPL decreases about 11-13dB. It is clearly because the SPL of the farther receiver points depends more on the reflection sound rather than direct sound. Similarly, the increase of absorption coefficient reduced the SPL difference between the three models. However, it is noted that a significant reduction only happens when $\alpha > 0.7$.

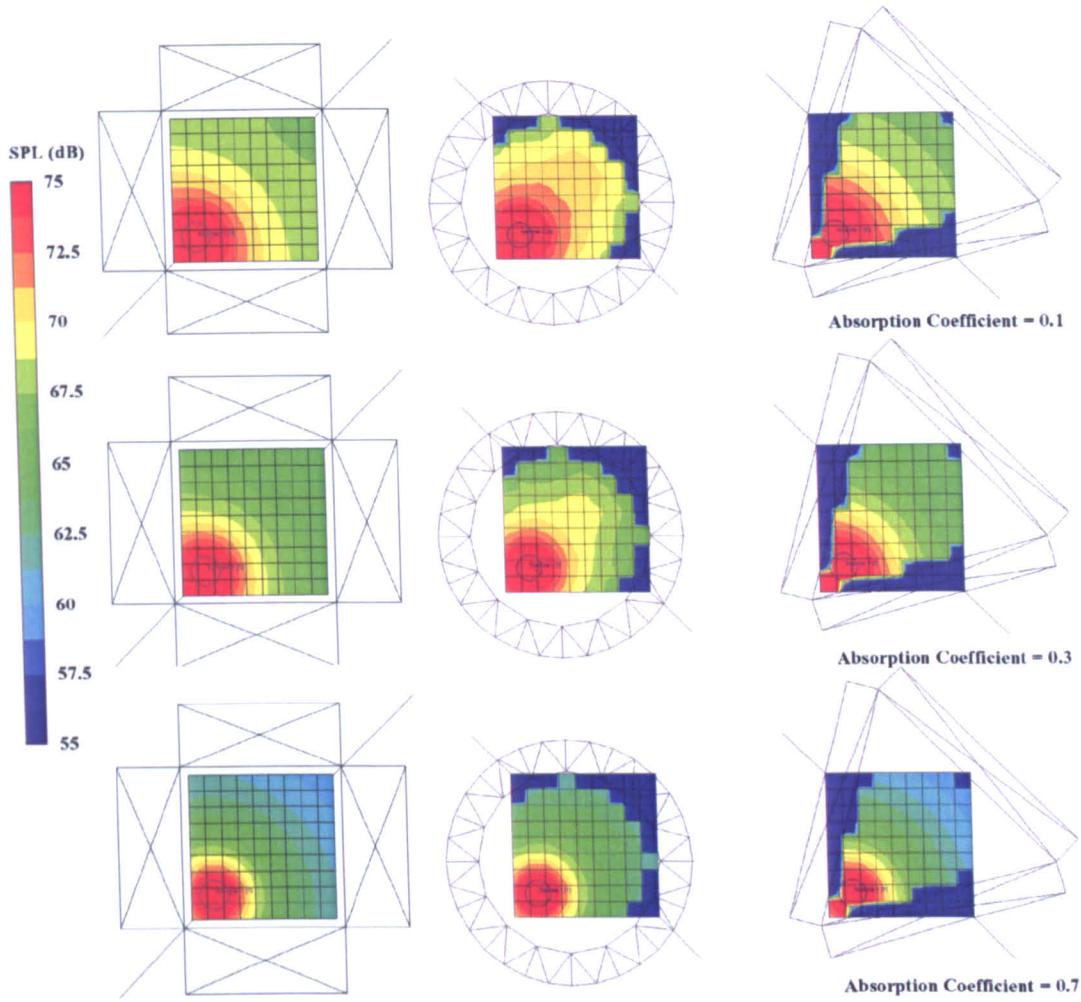
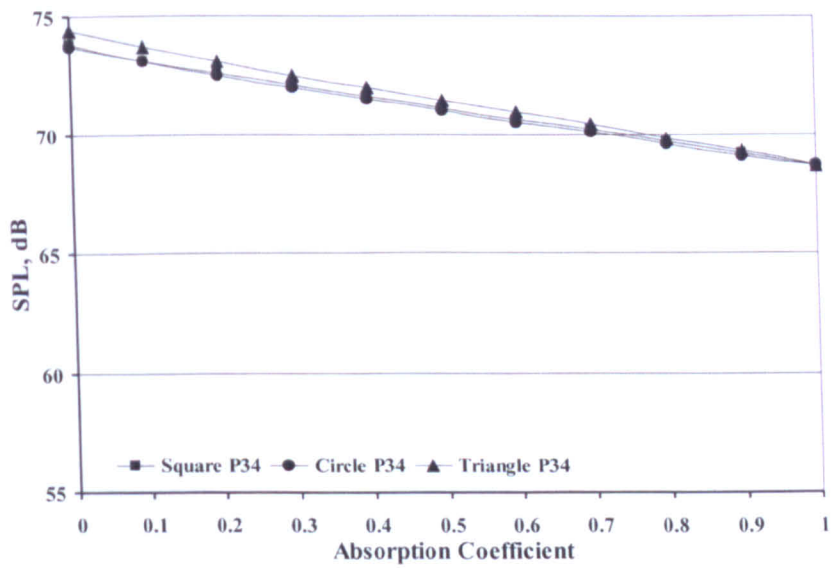
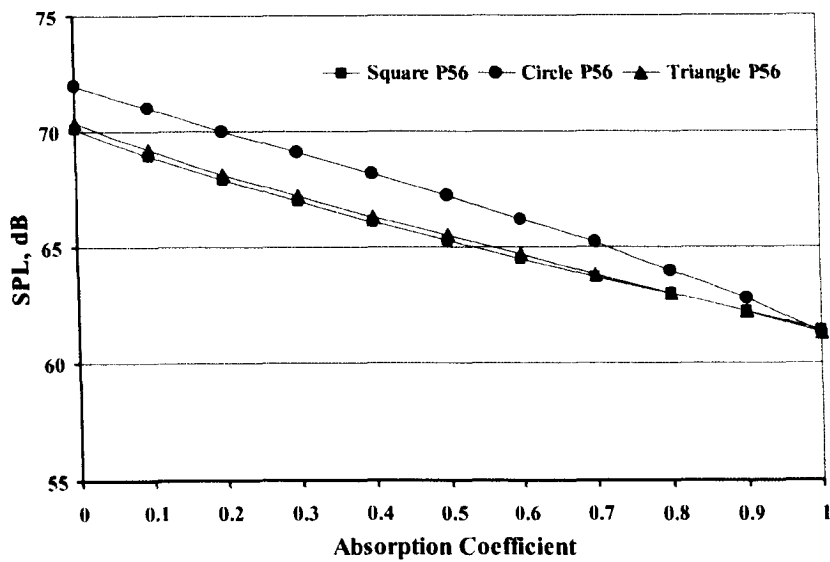


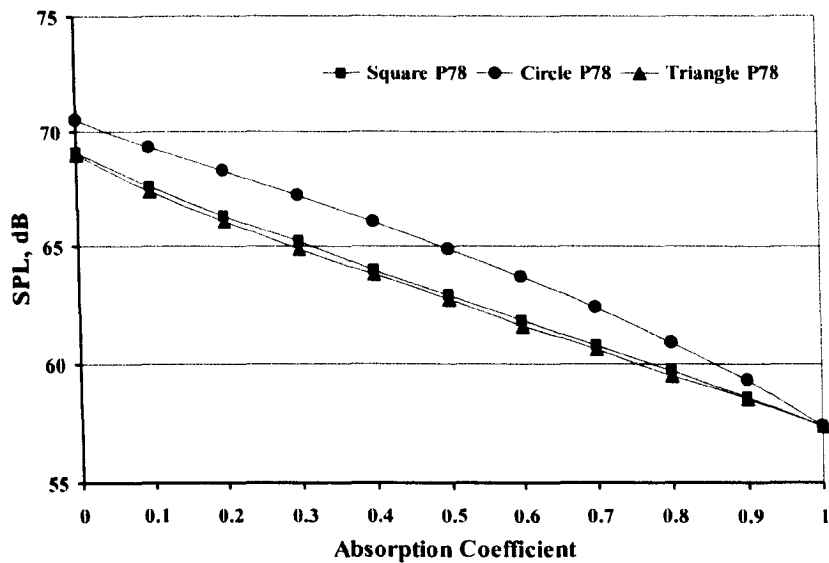
Figure 6.5 SPL distributions between three spatial forms with various absorption coefficients



(a) point 34



(b) point 56



(c) point 78

Figure 6.6 The comparison of SPL between three spatial forms with various absorption coefficients

RT30

Figure 6.7 illustrates the RT30 distributions of the three models with different absorption coefficients. It can be seen that there are significant differences between the three models. The Circle-Model has the longest RT30 and the Triangle-Model has the shortest. Although Sabine Formula is not applicable because the sound field is not diffuse in the study, the principle can be used to explain the situation. It is probably

because with the same volume $2,500\text{m}^2 \times 20\text{m}$, the Circle-Model has the smallest surface area, whereas the Triangle-Model has the largest.

However, it is also important to find that in the Circle-Model, the RT30 distribution is more even than the other two models. For example, when $\alpha=0.1$, the RT30 difference between point 34 and 78 is 8% in the Circle-Model, whereas it is 27% in the Triangle-Model. When $\alpha=0.5$, the RT30 difference between point 34 and 78 is 2% in the Circle Model, whereas it is 25% in the Triangle-Model. The main reason for this phenomenon is because in the Circle-Model, conceptually the reflection surface covers 360° . At each receiver point, reflection sounds may come from any direction, and there is no deep corner to sharply increase the reflection distance. Therefore, the RT30 distribution in the Circle-Model is more even and longer. With less reflection surfaces and directions, (e.g. the Square-Model has four reflection surface directions, the Triangle-Model has three reflection surface directions), the reflection sounds' travel distance and angle increase in difference. Therefore, the less reflection directions a form has, the more uneven and shorter the RT30 will be. It is worth to mention that in the Raynoise model, circle is actually simulated as a multi-plane polygon. If it can be simulated as a perfect circle, a focus may form, so that affects the evenness of the sound field. Nevertheless, a perfect circle form is not common in actual urban spaces.

In Figure 6.8 detailed RT30 comparisons between the three models are made for point 34, 56, and 78 with different absorption coefficients. As expected, The RT30 decreases with increasing boundary absorption. But it is interesting to note that RT30 decreases sharply when the absorption coefficient increases from 0 to 0.1. The further increase of absorption coefficient has less effect to the RT30 value. For example, in the Square-Model at point 56, when $\alpha=0.1$, RT30 is 4.08s, whereas RT30 is 2.72s, 2s, 1.68s, and 1.4s, when $\alpha=0.2$, 0.3, 0.4, and 0.5 respectively. It is because the reflection is more significant when the absorption coefficient is small. Similar ratios can be worked out by Sabine Formula.

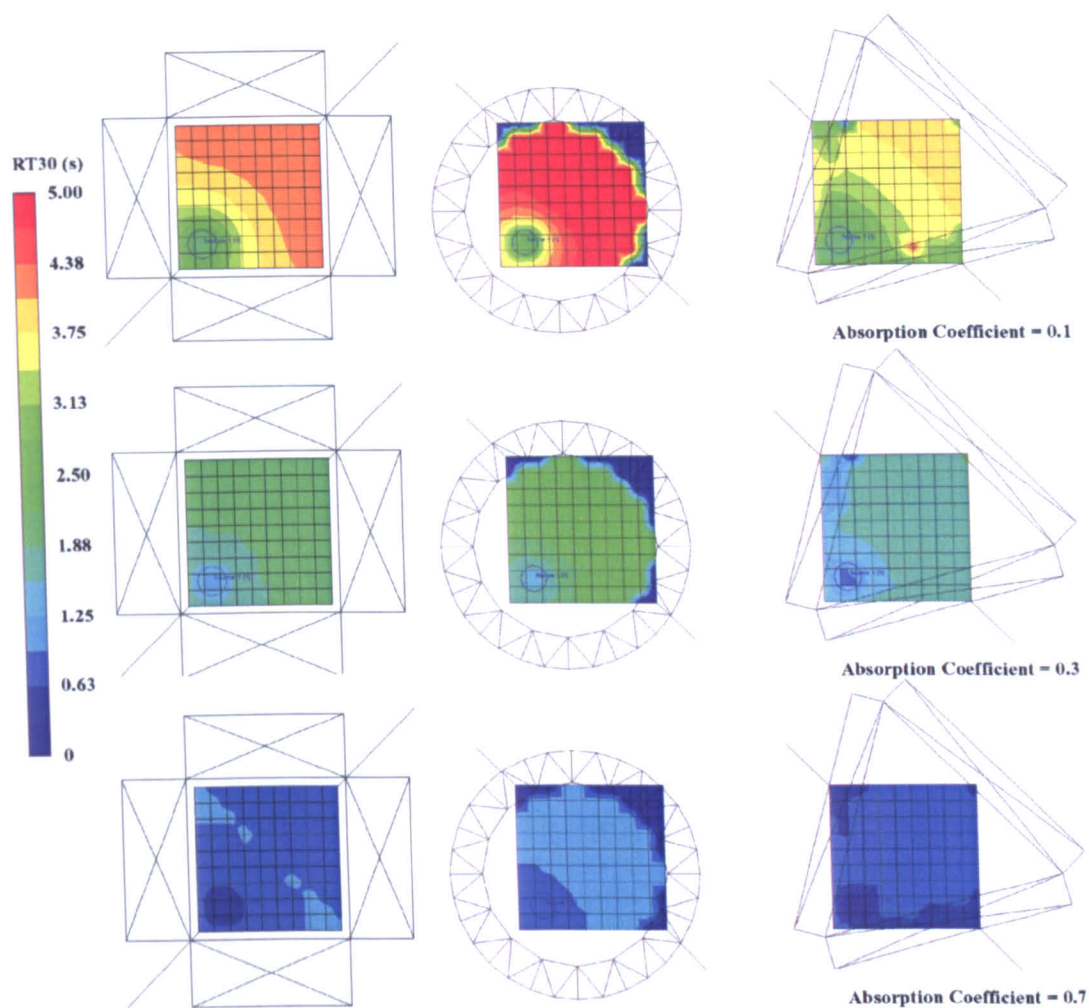
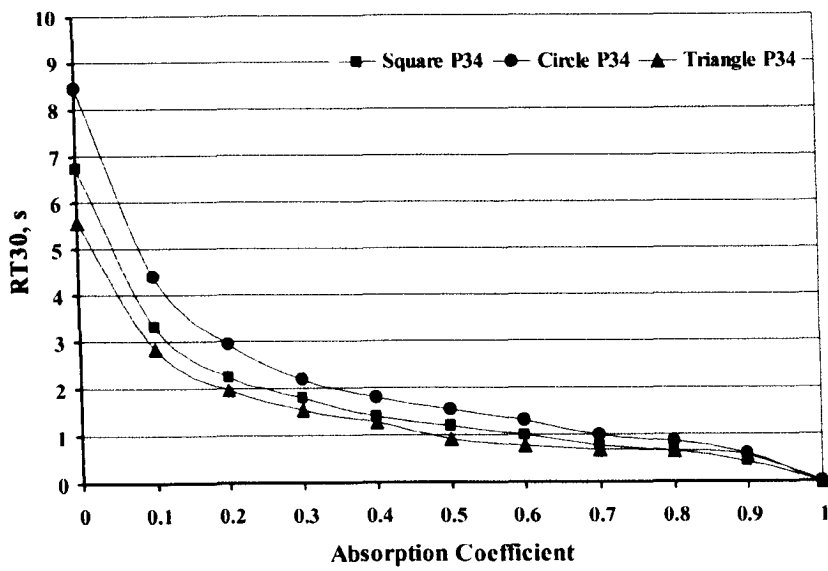
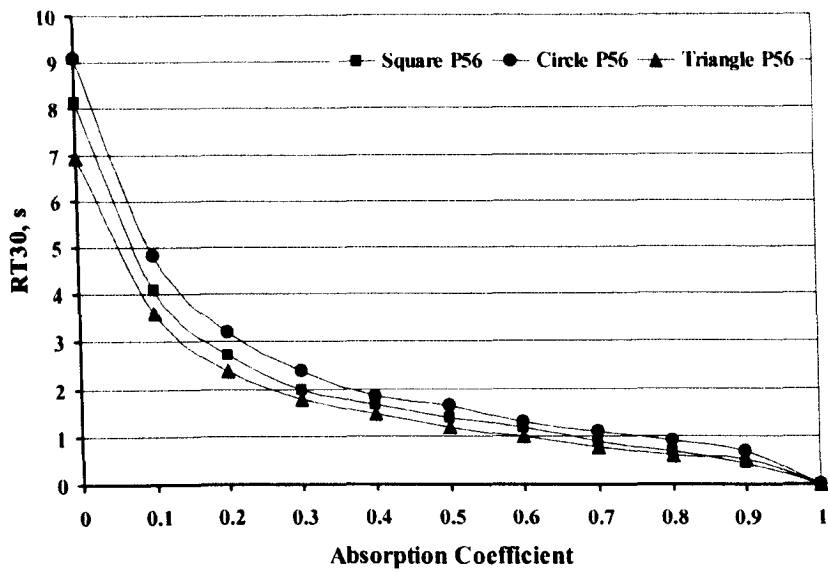


Figure 6.7 RT30 distributions between three spatial forms with various absorption coefficients

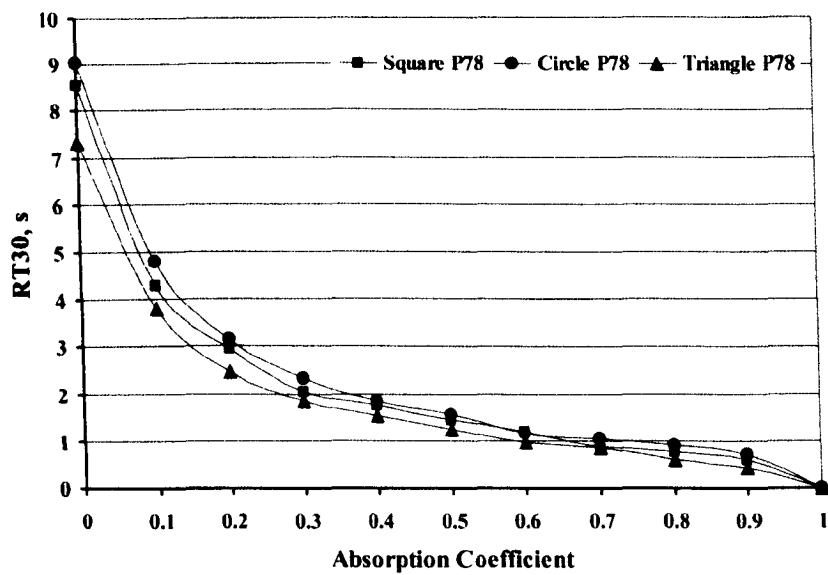
By comparing the three diagrams in Figure 6.8, it is important to find that the shape of the enclosure has a significant influence on the RT30. The closer a receiver point to the sound source, the bigger the difference between the three models. For example, at point 34, when $\alpha=0.1$ the RT30 difference between the Circle-Model and the Triangle-Model is 35%, and it is 26% and 21% at point 56 and 78 respectively. This suggests that in the far field, the sound field is closer to diffuse.



(a) point 34



(b) point 56



(c) point 78

Figure 6.8 The comparison of RT30 between three spatial forms with various absorption coefficients

EDT

Figure 6.9 shows that the EDT distributions of the three models. Generally speaking, Circle-Model has the longest EDT among the three models. It is also found that for the Square-Model and the Triangle-Model the longer the source-receiver distance is, the longer the EDT is. For example, in the Square-Model, when $\alpha=0.1$, the EDT at point 34, 56 and 78 is 1.68s, 2.76s, and 2.88s respectively. However, in the Circle-Model, the longest EDT appears in the mid-field. For example, when $\alpha=0.1$, the EDT at point 34, 56 and 78 is 2.64s, 3.24s and 2.88s, respectively. It is probably because in the Circle-Model, sound is reflected towards the centre. Therefore in the mid-field, there are more early reflections sounds.

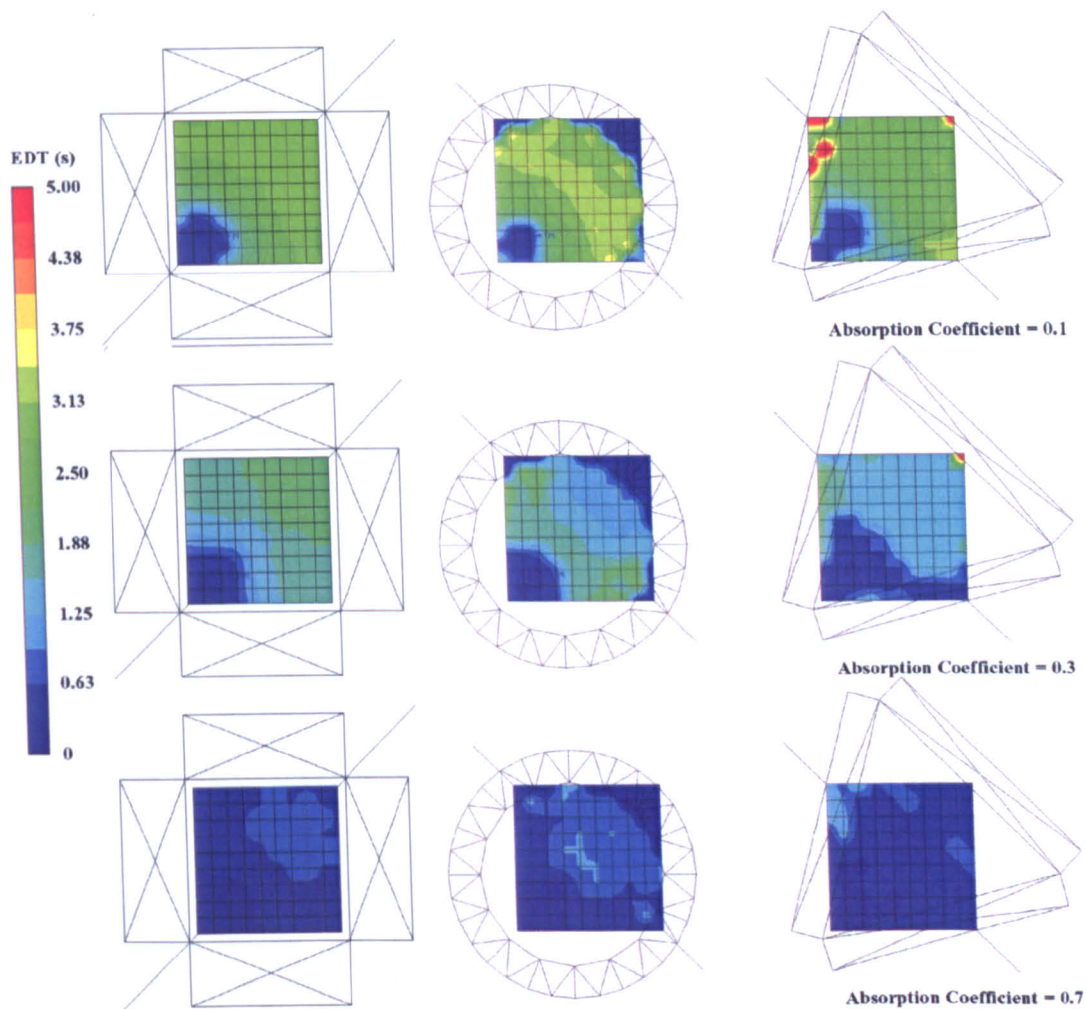
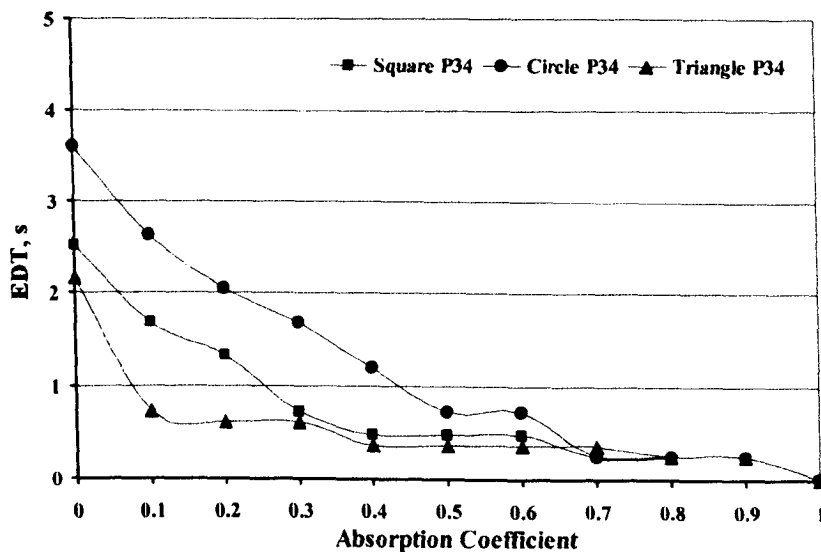
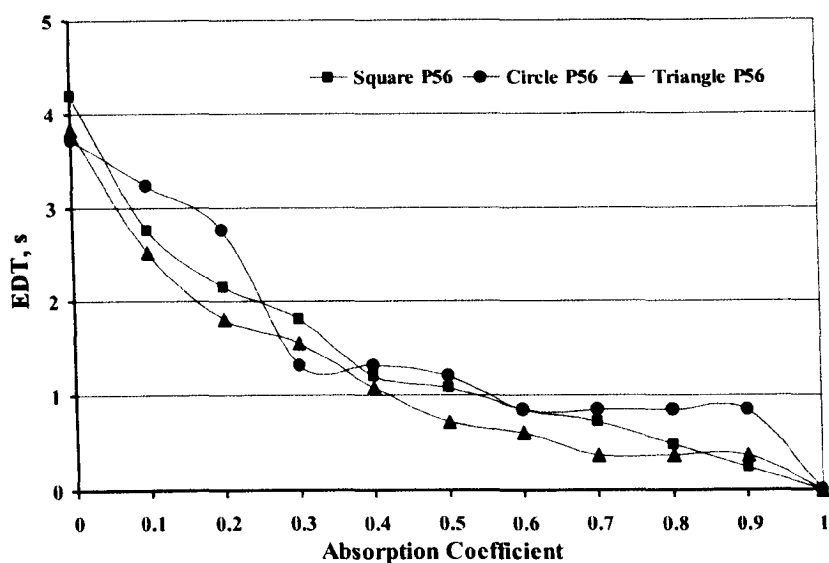


Figure 6.9 EDT distributions between three spatial forms with various absorption coefficients

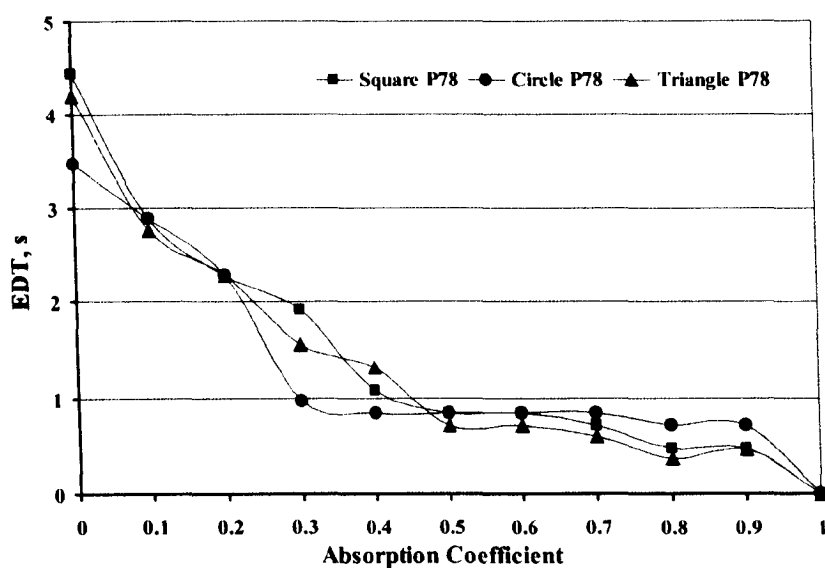
Figure 6.10 shows a detailed comparison of EDT between the three models at point 34, 56, and 78 with different absorption coefficients. As expected, with an increase in absorption coefficient, EDT decreases. Generally speaking, the tendencies of the Square-Model and the Triangle-Model are rather similar. Again due to the uneven distribution of reflection, in the Circle-Model the variation with increasing absorption coefficient is more irregular. In the Triangle-Model, at point 34, when absorption coefficient increases from 0 to 0.1, the EDT decreases 77% and then becomes almost flat with the further increase of absorption coefficient. However, in the Circle-Model, the decrease of EDT with an increase in absorption coefficient has a constant slope. When the absorption coefficient is increased from 0.1 to 0.3, 0.3 to 0.5, the EDT decreases 0.96s at each range. At point 56 and 78, with an increase in absorption coefficient, the EDT of the Square-Model and the Triangle-Model gradually decreases, whereas in the Circle-Model the EDT drops 50% when absorption changes from 0.2 to 0.3.



(a) point 34



(b) point 56



(c) point 78

Figure 6.10 The comparison of EDT between three spatial forms with various absorption coefficients

6.2.3 Boundary Diffusion

SPL

A series of comparisons is also conducted in the Square-Model, the Triangle-Model and the Circle-Model to analyse the SPL distribution with various diffusion coefficients. Figure 6.11 shows the SPL distribution of the three models with three representative diffusion coefficient values, i.e. 0.1, 0.3, and 0.7. Corresponding to Kang (2002a), due to the general increase of the sound path, with increasing diffusion

coefficient, SPL decreases at all the three models. However, the three models have rather different SPL distribution. Generally speaking, the Circle-Model has the highest SPL and the Triangle-Model has the lowest SPL with the same diffusion coefficient.

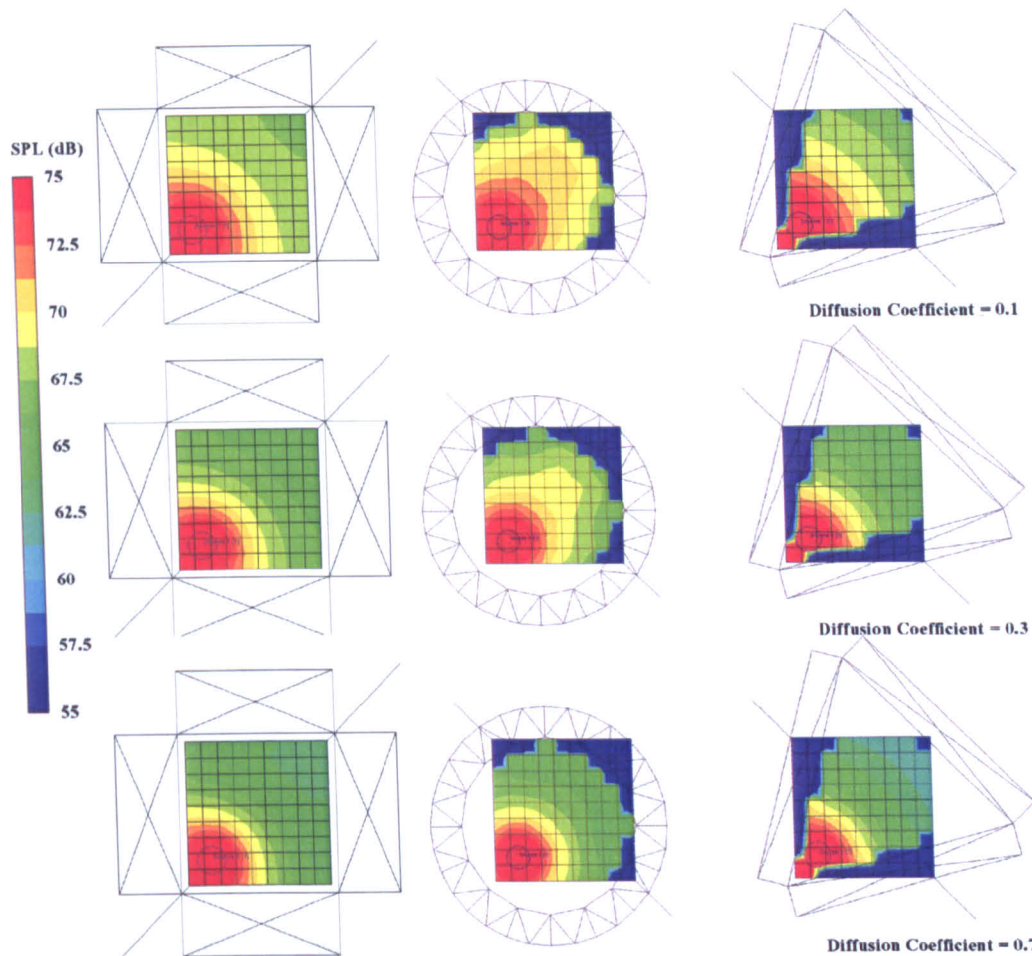


Figure 6.11 SPL distributions between three spatial forms with different diffusion coefficients

In Figure 6.12, detailed comparisons are made for the three representative points, i.e. points 34, 56, and 78, with various diffusion coefficients. It is important to note that although with an increase in diffusion coefficient the SPL decreases, the lowest level of SPL occurs when $d=0.7$ to 0.8 . When the diffusion coefficient further increases, the SPL slightly increases. With increasing source-receiver distance, the increase of SPL is more significant. For example, at point 78, when the diffusion coefficient increases from 0.7 to 1 , the SPL increases by 1.3dB in the Square-Model. A possible reason for this is that in the far field the direct sound plays a less important role. The increasing diffusion coefficient helps to evenly distribute the energy in the models.

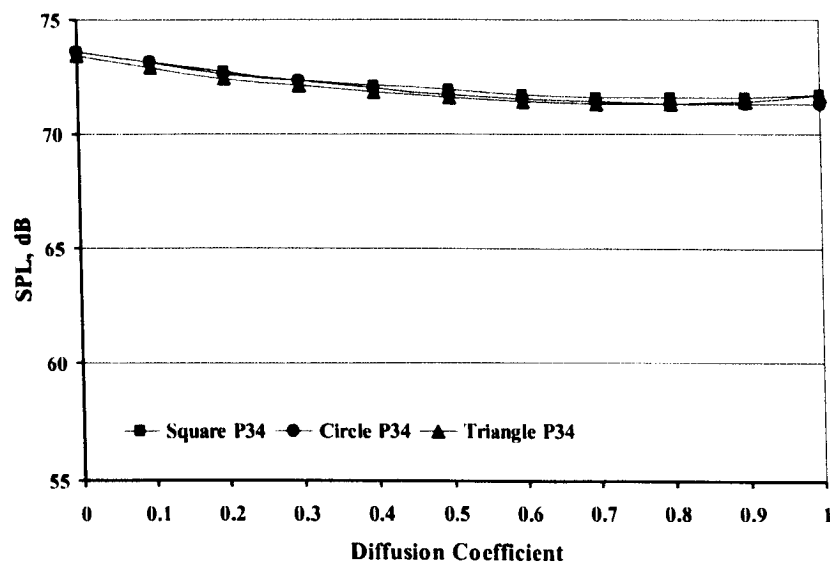
From Figure 6.12, it is also interesting to note that with increasing the source-receiver distance, the differences between the three models become more significant. As shown in Figure 6.12(a), at point 34, the three models have rather similar SPL distributions. The average SPL difference between the three models is only 0.1dB. The tendency of the SPL to change with the increasing diffusion coefficient is also similar for the three models. When the diffusion coefficient increases from 0 to 0.7, the average decrease of the three models is only 2dB. This is clearly due to the dominant influence of direct sound.

With increasing source-receiver distance, in the mid-field of the models, e.g. point 56, as shown in Figure 6.12(b), the SPL differences of the three become more significant. Similar to the situation in Figure 6.6b, the Circle-Model has the highest SPL, whereas the Triangle-Model has the lowest. The value of SPL in the Square-Model is close to the Triangle-Model. When $d=0$, the maximum difference between the Circle-Model and the Triangle-Model is 2.6dB, whereas it is 0.5dB between the Square-Model and the Triangle-Model. However, with increasing diffusion coefficient, not only the SPL of the three models decreases, but also the difference between them decreases, which indicates that increasing the diffusion coefficient makes the sound field more even. When $d=1$, SPL difference between the Circle-Model and the Triangle-Model decreases to 0.1dB. When the diffusion coefficient increases from 0 to 0.7, the SPL decreases 5.9dB in the Circle-Model, whereas it is 4.3dB in the Triangle-Model.

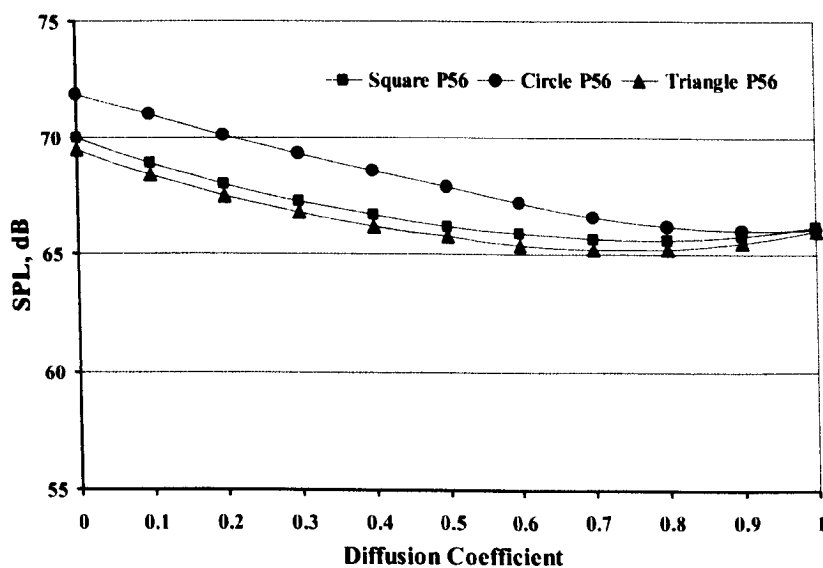
As illustrated in Figure 6.12(c), with the further increase of source-receiver distance, at point 78, the SPL differences between the three models are almost unchanged with increasing diffusion coefficient. In the Circle-Model, when the diffusion coefficient increases from 0 to 0.7, the SPL decreases 5.3dB. Similarly in the Square-Model and the Triangle-Model the SPL decrease is 5.3dB and 5.6dB respectively. This is probably because in the far field, reflections are more evenly distributed than in the near field.

Therefore, the increasing diffusion coefficient has a negligible effect to even out the sound field in the far field.

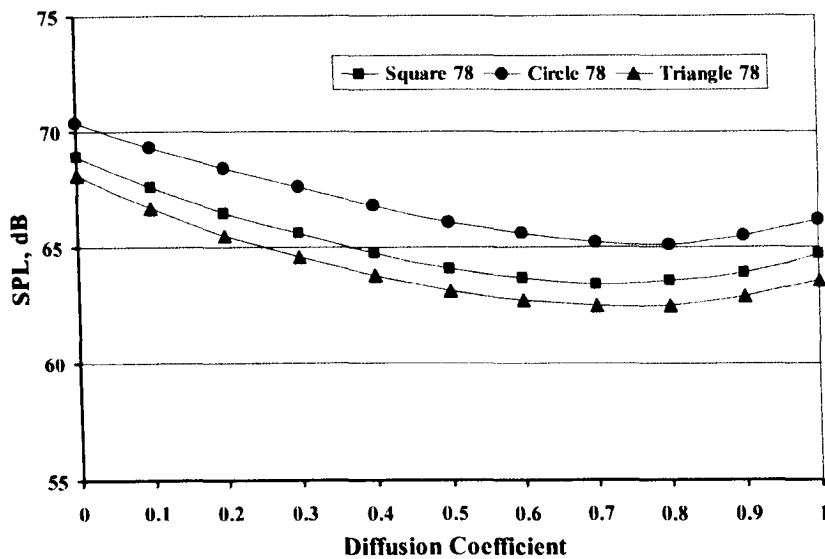
Also, at point 78, because of the increasing source-receiver distance, the average difference between the Circle-Model and the Triangle-Model increases to 2.75dB. The difference between the Square-Model and the Triangle-Model is also increased, with the average difference of 1dB. A possible reason of this phenomenon is the general increase of the sound path.



(a) point 34



(b) point 56



(c) point 78

Figure 6.12 The comparison of SPL between three spatial forms with various diffusion coefficients

RT30

Figure 6.13 shows the RT30 distribution of the three models with various diffusion coefficients. It can be seen that there are significant differences between the three models. The Circle-Model has the longest RT30 and the distribution of RT30 is more even than the other two models. This is probably due to more reflection surfaces in the Circle-Model make the diffusion more efficient. For example, when $d=0.1$, the RT30 difference between point 34 and 78 is 8% in the Circle-Model, whereas it is 27% in the Triangle-Model. When $d=0.5$, the RT30 difference between point 34 and 78 is 0% in the Circle-Model, whereas it is 15% in the Triangle-Model.

In Figure 6.14, detailed comparison is conducted for RT30 between the three models for points 34, 56 and 78. Generally speaking, RT30 decreases with an increase in diffusion coefficient. Also, it is interesting to note that when the diffusion coefficient increases from 0 to 0.2, RT30 decreases sharply, whereas when the diffusion coefficient is further increased, the change becomes less significant. Similar results have been obtained in other types of urban spaces (Kang, 2002b). This suggests that with only about 20% of the energy incident upon the boundaries diffusely reflective,

the sound field in an urban square is rather similar to the purely diffusely reflecting boundaries.

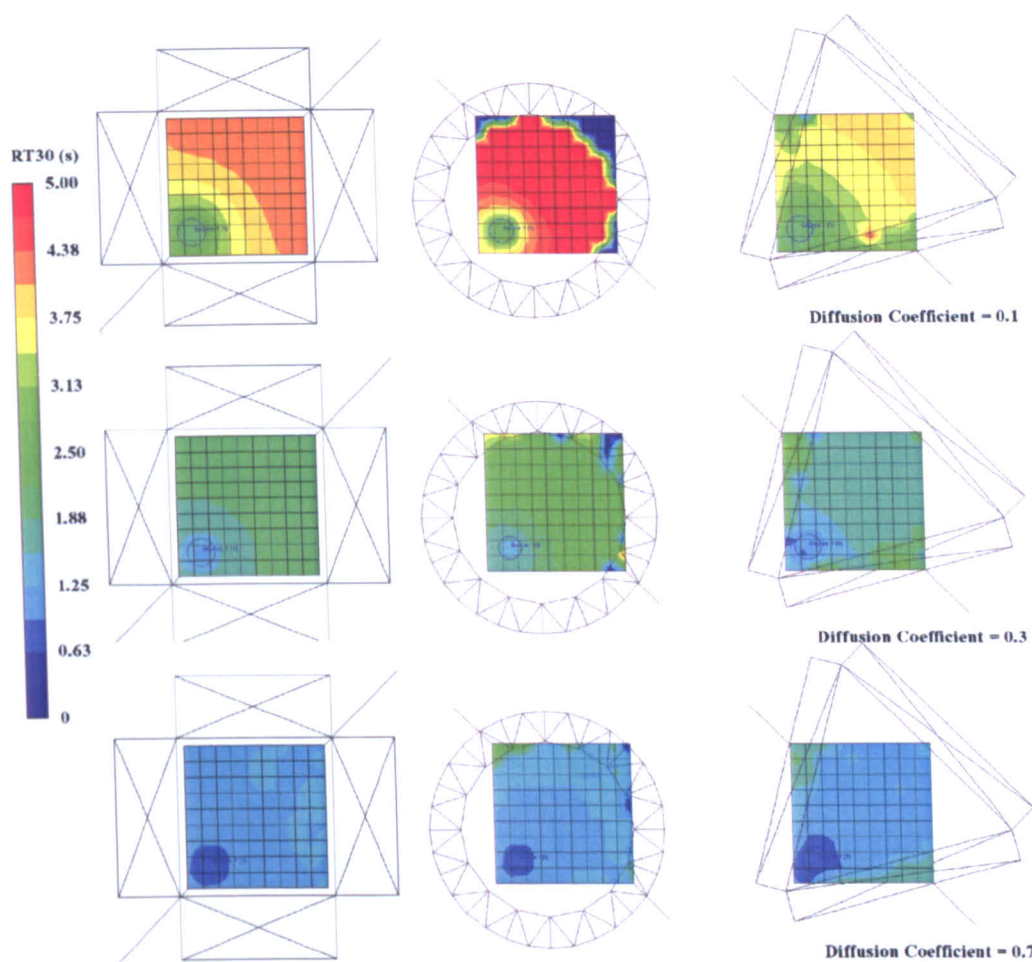
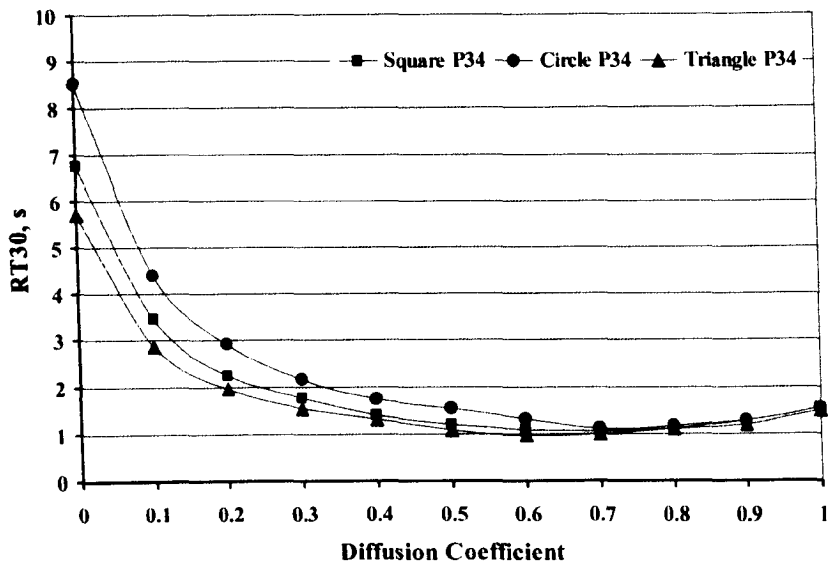
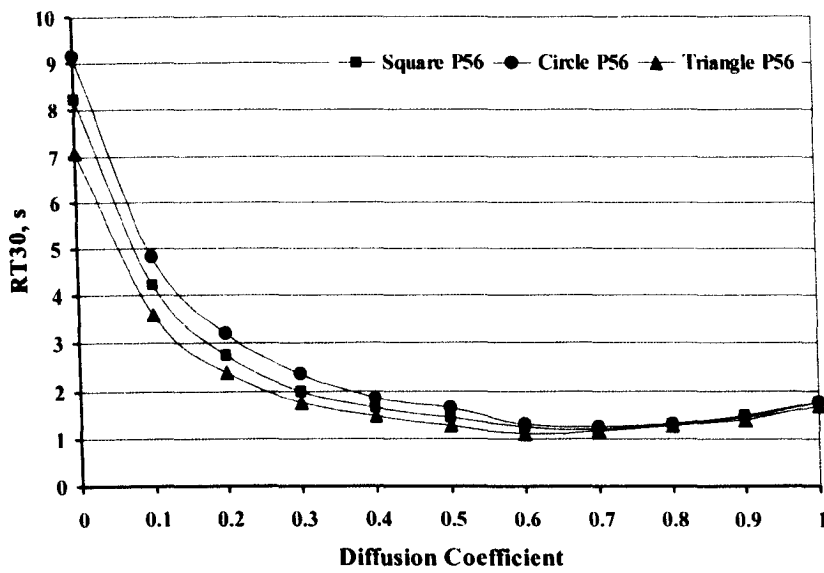


Figure 6.13 RT30 distributions between three spatial forms with various diffusion coefficients

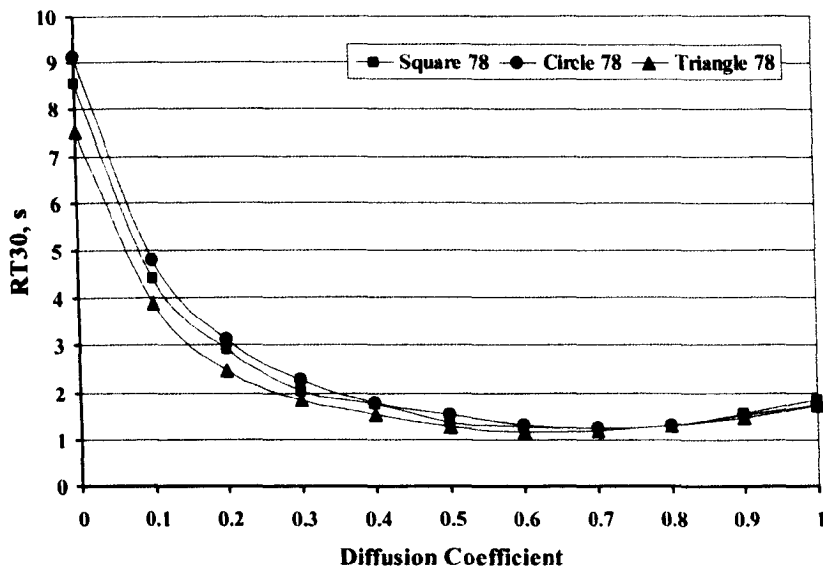
In Figure 6.14, it is also found that the increase of diffusion coefficient has reduced the RT30 difference between the three models, suggesting the sound field tends to be more diffuse. When $d > 0.7$, the RT30 values of the three models are rather similar. However, the lowest RT30 appears when $d = 0.7$ for all the three models. With the further increase of the diffusion coefficient from 0.7 to 1, the RT30 values increase in all the models. The average increase is 0.45s, 0.53s and 0.53s at point 34, 56 and 78 respectively. A possible reason is that due to the high diffusion coefficient, a considerable amount of high order reflections are shifted to a later arriving time.



(a) point 34



(b) point 56



(c) point 78

Figure 6.14 The comparison of RT30 between three spatial forms with various diffusion coefficients

EDT

Figure 6.15 shows the EDT distribution of the three models with representative diffusion coefficients. As can be seen, the three models have rather different EDT distribution. Generally speaking, the Circle-Model has longer EDT than the other two models. Figure 6.16 illustrates the detailed comparison of EDT for point 34, 56 and 78 with various diffusion coefficients between the three models. With an increasing diffusion coefficient, the EDT differences between the three models are decreased, which is similar to the situation of RT30. In the figure, for all the three models, when $d < 0.7$, EDT decreases sharply with an increase in the diffusion coefficient. However, from $d = 0.7$, with the further increase of the diffusion coefficient, the EDT values increases. The average increase of EDT is 0.36s, 0.60s and 0.64s at point 34, 56 and 78 respectively. Again, it is due to the high order reflections arriving later to the receiver point due to diffusions.

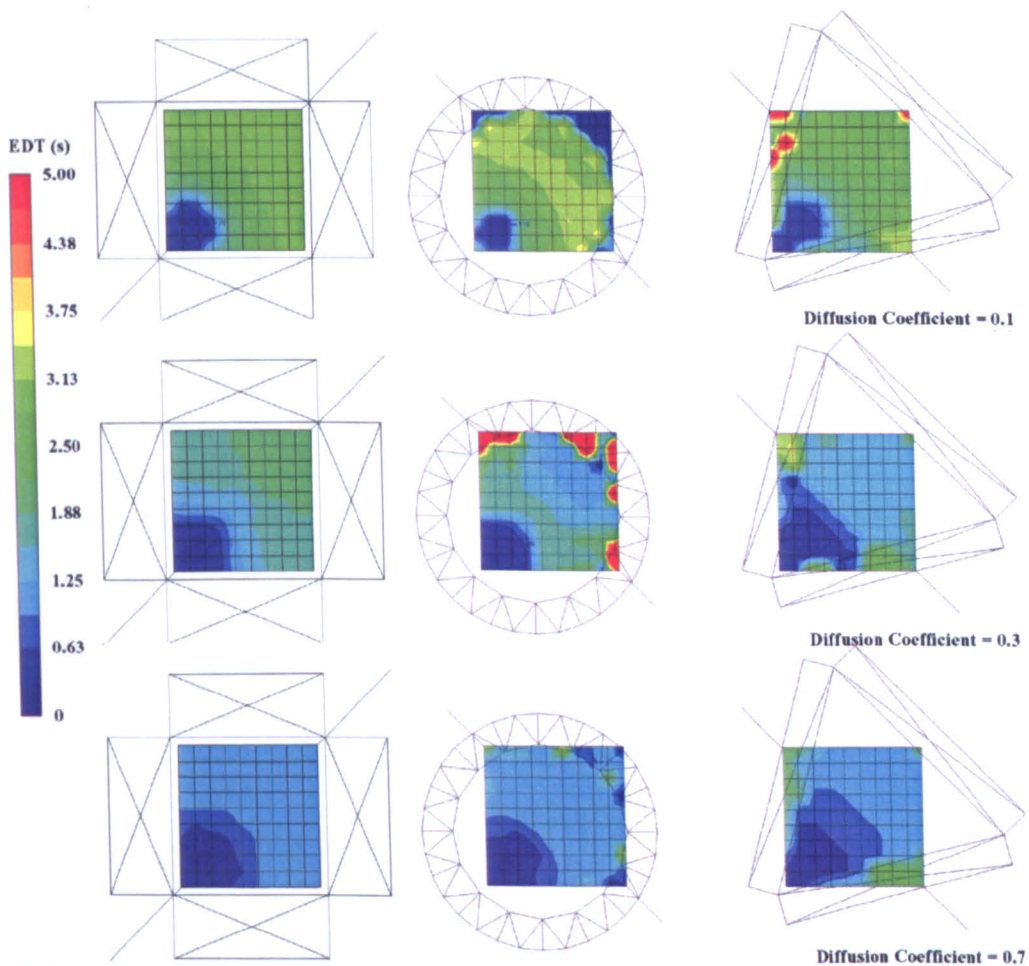
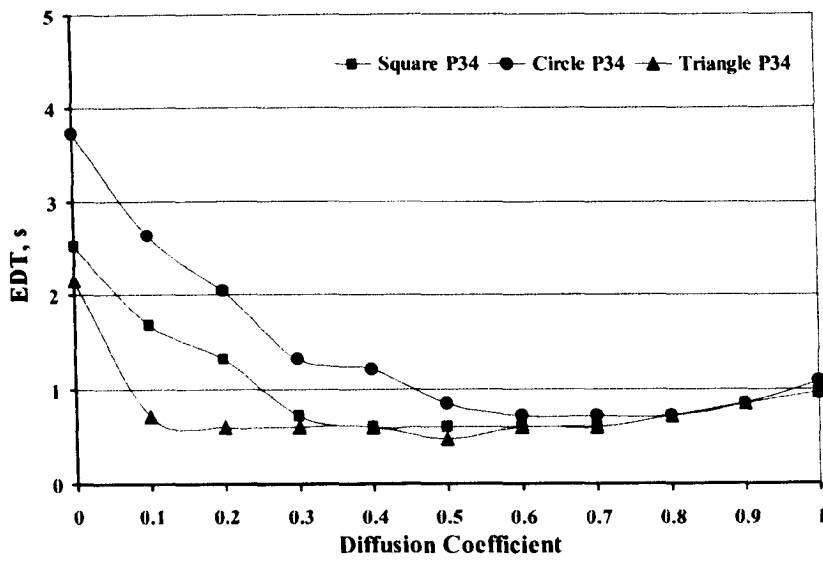
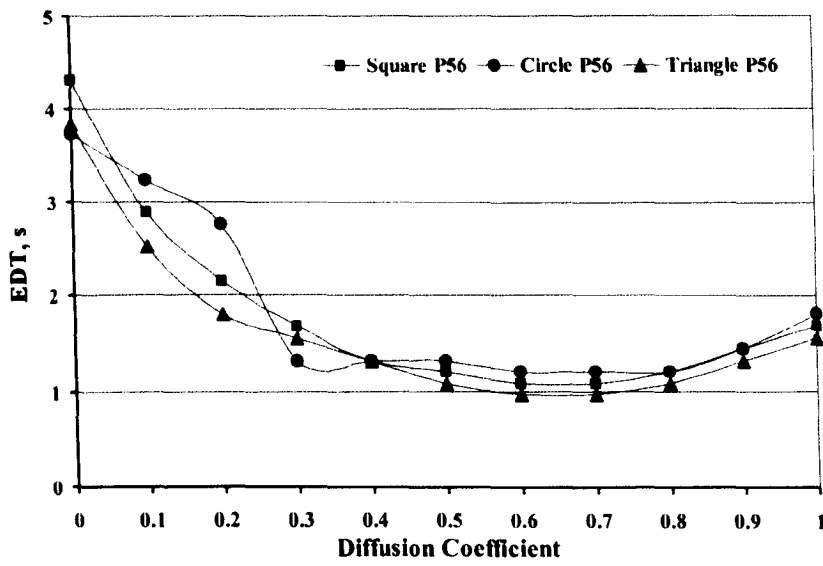


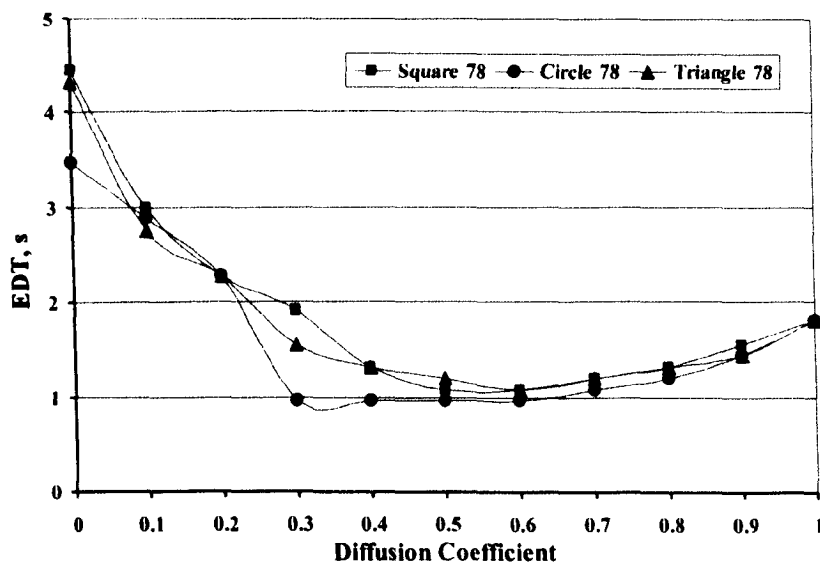
Figure 6.15 EDT distributions between three spatial forms with various diffusion coefficients



(a) point 34



(b) point 56



(c) point 78

Figure 6.16 The comparison of EDT between three spatial forms with various diffusion coefficients

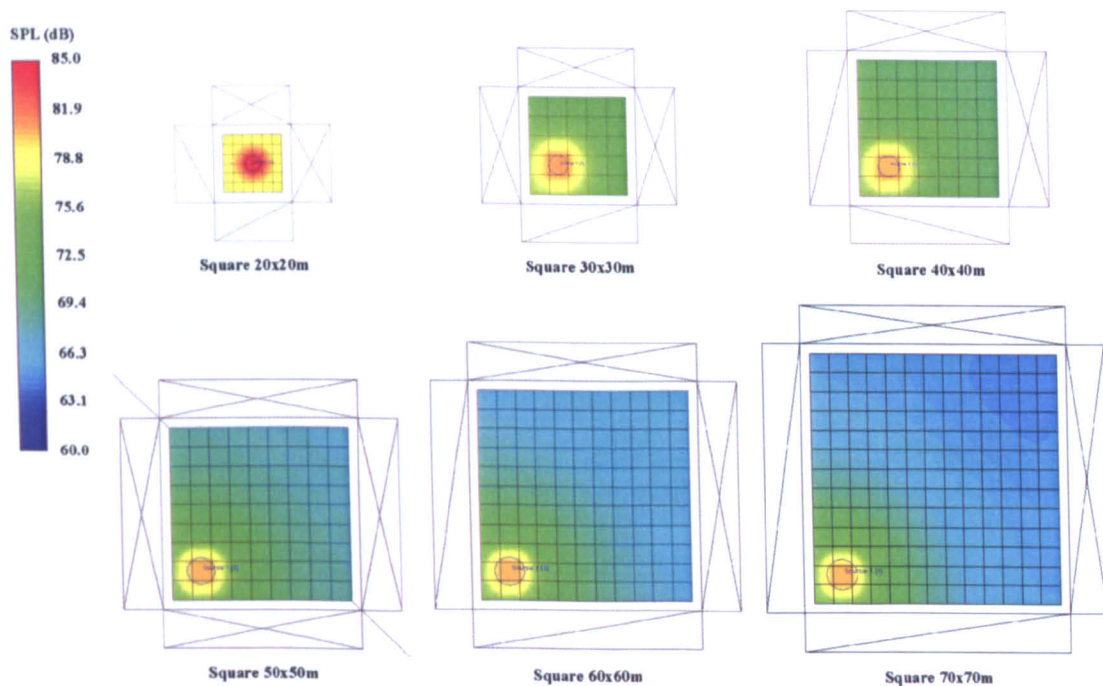
6.3 SIZE

To investigate the characteristics of sound fields of various sizes, six configurations are developed for comparison. The configurations have the same shape as the Square-Model, with the size varying from 20x20m, 30x30m, 40mx40m, 50x50m, 60x60m to 70x70m, which are typical ranges for urban squares. The height of all the configurations is defined as 20m, as mentioned before, which is typical 4-5 storey building height. A single point source of 100dB sound power level is positioned at a constant location ($x=10\text{m}$, $y=10\text{m}$, $z=1.5\text{m}$) for each model. The absorption coefficient and diffusion coefficient of all the boundaries (including ground and building façades) are defined as 0.1. Similar to the shape comparison, some representative receivers are evenly distributed along the diagonal of the square at 7.07m interval and 1.2m high. SPL, RT30 and EDT are the indices compared between different scaled configurations.

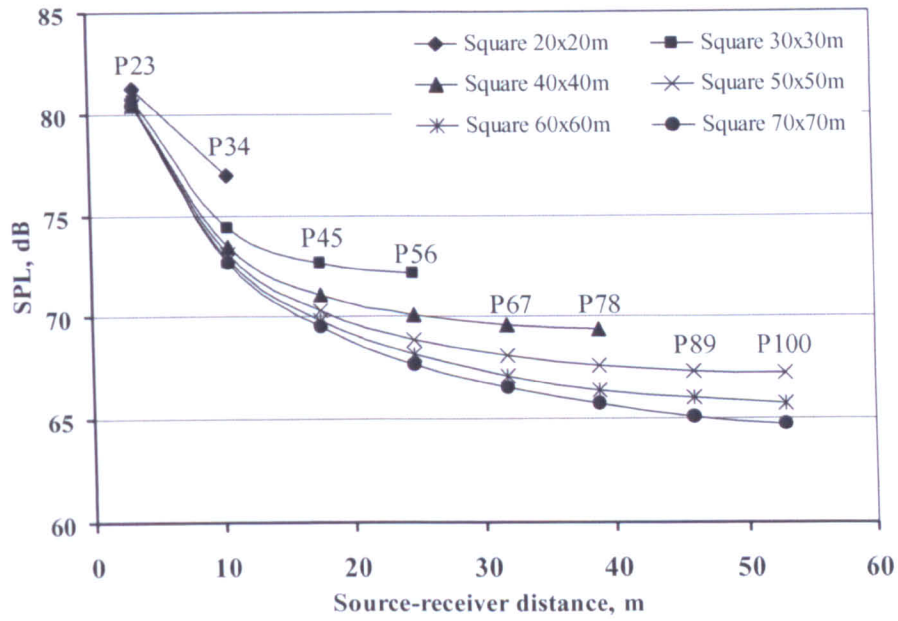
Figure 6.17 illustrates the SPL distribution of various sizes. Similar to the findings by Kang & Zhang (2003), it can be seen that the SPL initially decreases significantly with increasing source-receiver distance, and then becomes approximately stable. In the near field, within a source-receiver distance of 5-10m, because of the dominant role of direct sound, there is no significant difference in SPL between the configurations. The only exception is Square 20x20m, where sound source is located at the middle of the square, clearly direct sound and early reflection both contribute to the SPL in the near field. With the same source-receiver distance, the SPL becomes systematically less with increased square size. In the far field of the configurations, the SPL is approximately 6-8dB lower when the square size is doubled. Also, with an increase in square size, the SPL difference at the same receiver point systematically decreases. For example, at point 45, the difference between square 30x30m to 40x40m, 40x40m to 50x50m, 50x50m to 60x60m, and 60x60m to 70x70m is 1.6dB, 0.8dB, 0.5dB, and 0.3dB respectively. With every increase of 10x10m square size, the SPL almost decreases by half of the original difference.

Figure 6.18(a) shows the RT30 distribution of different sized squares. As expected, the RT30 increases with increasing square size. The average RT30 is 1.9, 2.4, 3.1, 3.9, 4.7, and 5.5s for the six configurations calculated. The ratio between different square sizes is similar to what is predicted using the principle of Sabine Formula.

In Figure 6.18(b), detailed comparison is conducted for the RT30 between the configurations along the diagonal. It can be seen that significant RT30 differences between various sized configurations appears from the near field. It further increases with increasing source-receiver distance until the far field. For example, at point 34, which is about 10m from the sound source, the RT30 difference between Square 60x60m and Square 70x70m is already 10%. With increasing source-receiver distance, at point 100, which is about 55m from the sound source, the RT30 difference between the two configurations increases to 16%. Corresponding to the calculation of Sabine Formula, the result suggests that RT30 values of all the receiver points have a direct relationship with the size of the configurations. The results also suggest that for the receivers in the far field the RT30 values increase more than those in the near field.

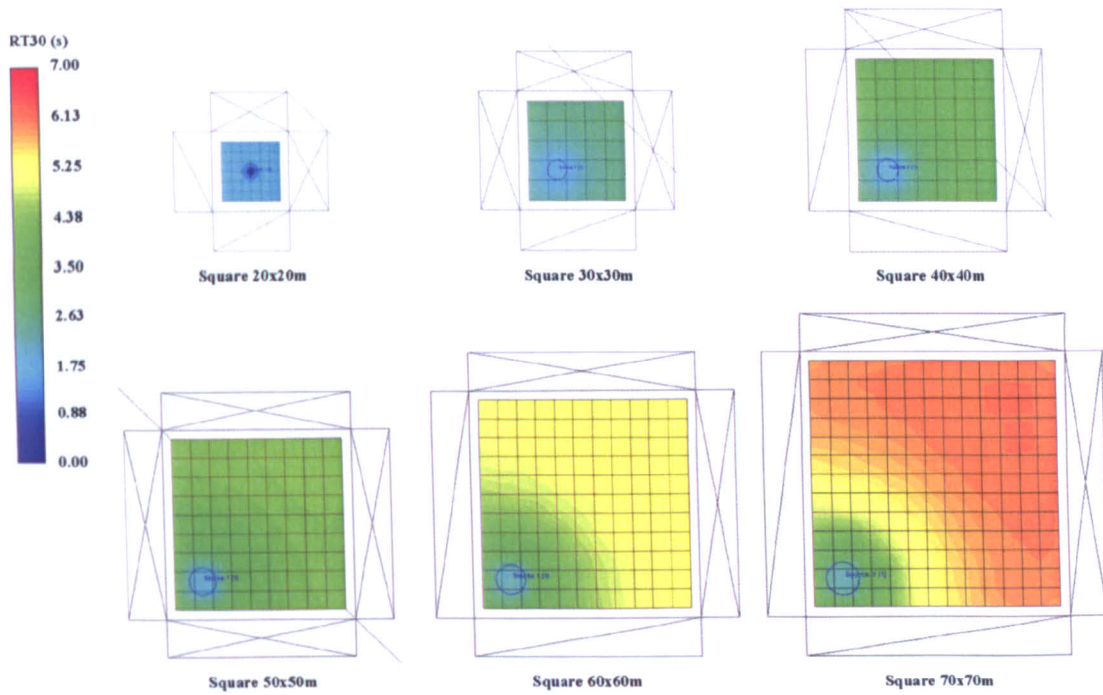


(a) SPL colour map

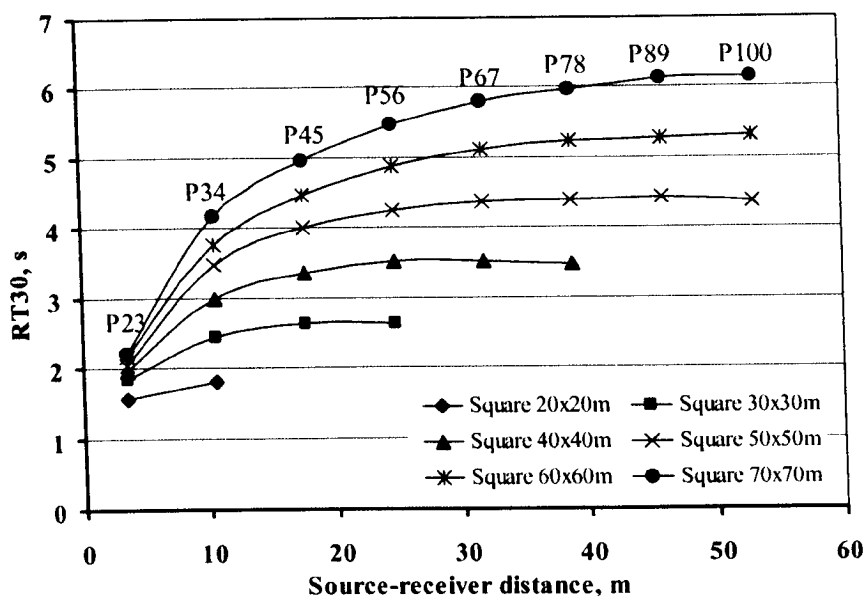


(b) SPL comparisons

Figure 6.17 SPL distributions of various sized squares



(a) RT30 colour map



(b) RT30 comparisons

Figure 6.18 RT30 distributions of various sized squares

Figure 6.19(a) illustrates the EDT distribution of different sized configurations. As expected, a larger sized configuration results in a higher EDT value. This is obviously because the sound paths become longer with the increased square size, the lack of initial reflections results in the high EDT value.

In Figure 6.19(b), detailed comparison is conducted for the EDT between the configurations along the diagonal. Different from the RT30 distribution, it is found that although with difference sizes, the EDT of the configurations increases similarly with increasing source-receiver distance until it reaches the mid-field of a particular sized configuration. Then the EDT of that sized configuration becomes relatively stable, where the RT30/EDT ratio is about 3/2. For example, within 25m from the sound source, the average EDT difference between Square 50x50m and Square 60x60m is only 1%. Beyond 25m from the sound source, the EDT difference between the two configurations rapidly increases to 11.5% and is almost constant until into the far field. This phenomenon suggests that the EDT variation of different sized configurations is not constant across the whole sound field. From the near field to the mid-field, the increased EDT value with increasing source-receiver distance is almost identical for different sized configurations. However, from the mid-field to the far field, the configuration size has a direct relationship with the EDT value. But, beyond the mid-

field, the EDT value is almost constant for a given sized configuration. A possible reason of this phenomenon is that the EDT value is more dependent on the direct sound and early reflections, so that the position of reflecting surfaces close to the receivers is more important. Of all the configurations studied, in the near field they have identical source-reflection surface arrangement. Therefore, in the near field the EDT values are almost identical between the configurations. From the mid-field to the far field, other reflection surfaces play more important roles, thus the size of the configurations becomes a significant factor influencing the EDT values.

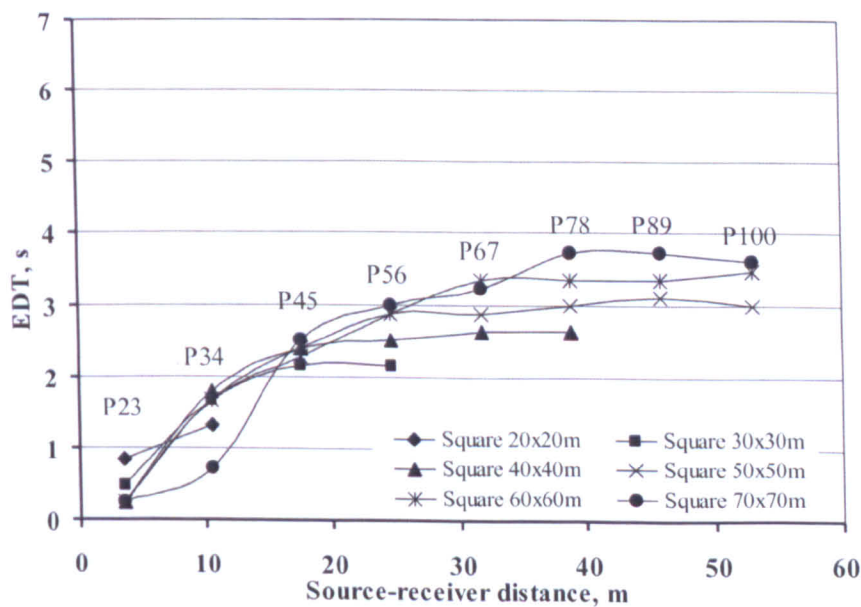
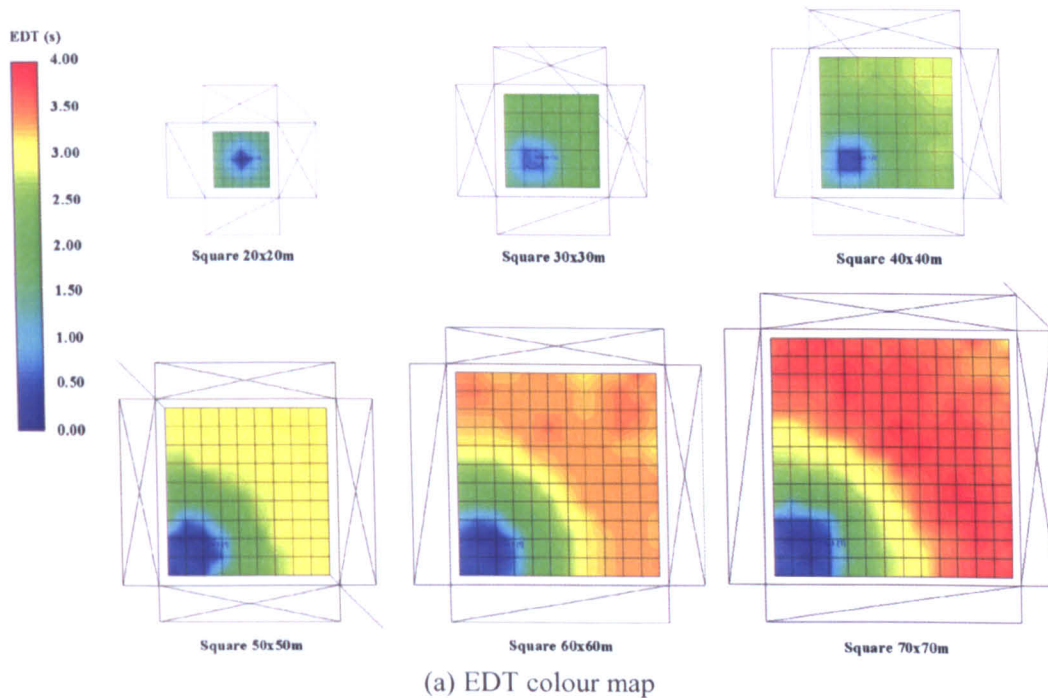


Figure 6.19 EDT distributions of various sized squares

6.4 OPENNESS

In order to compare the sound distribution of urban spaces with different boundary openness situations, 9 configurations are developed. All the configurations are developed from the 50x50x20m rectangle square. Figure 6.20 illustrates a typical configuration. Based on this, three groups of configurations are developed to simulate different opening situations, as shown in Figure 6.21. The first group of the configurations have openness on one side of the surrounding buildings; the second group has openness on four-side of the surrounding buildings; and the third group has the openness at four corners of the square. For each group of the configurations, three opening sizes, 2.5m, 10m, and 25m, are used respectively. Similar to previous typological soundscape analyses, a single point source of 100dB is positioned at a constant position ($x=10m$, $y=10m$, $z=1.5m$) for each configuration. The absorption coefficient and diffusion coefficient of all the boundaries, including ground and building facades, are both defined as 0.1. Some representative receivers are evenly distributed along the diagonal of the square at 7.07m interval and 1.2m high. SPL, RT30 and EDT are the indices have been compared between various configurations.

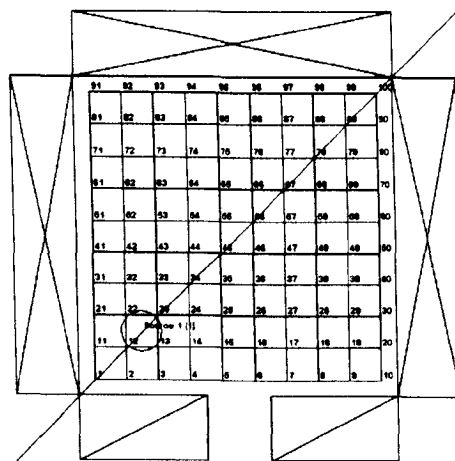


Figure 6.20 A typical configuration for openness analysis

The SPL distribution of the 9 configurations with different openings are illustrated in Figure 6.21. Correspondingly, Figure 6.22 compares the SPL along the diagonal of the configurations. As a reference configuration, the SPL of a square configuration of 50x50x20m without any opening is also shown in Figure 6.22. It can be seen that when

the opening size is on one side only, e.g. 2.5mx1, the overall SPL attenuation is rather similar to no-opening configuration. However, the overall SPL of the configuration 2.5mx1 is about 0.84dB less than the no-opening configuration in average. With further increasing opening size, the SPL attenuation systematically decreases. The average SPL of the configuration 10mx1 and 25mx1 is about 1.08dB and 1.98dB less than no-opening configuration respectively. It is interesting to note that the opening has more influence in decreasing the overall SPL of the configuration rather than the vicinity of the opening. It is probably because without any opening in the other three boundaries, the reflection sounds are still able to cover most of the sound field.

It can also be seen that when the number of opening increases to four, the SPL attenuation of the configuration 2.5mx4 is rather similar to the attenuation of the configuration 10mx1. The average SPL difference is 0.1dB only between the configuration 2.5mx4 and 10mx1. With the further increase of opening size, the overall SPL decreases more significantly. The SPL of the opening vicinity decreases slightly more than that of the other parts of the configuration. Consequently, as shown in Figure 6.22, the attenuation curves of the configurations 10mx4 and 25mx4 both have a U-sharp. The maximum SPL difference between the configuration 25mx4 and the no-opening configuration is 7dB.

When the opening appears at the corner of the square (i.e. the configuration B45m, B35m, and B25m in Figure 6.21), the overall SPL of the configuration decreases. However, the tendency of the attenuation curves does not change significantly until reaching the opposite opened corner. It is also important to note that with the same opening size of 25m at each side, the SPL reduces more significantly in configuration 25mx4 than in configuration B25m. The maximum difference is about 3.6dB. It is probably because, except the direct sound, mid-field reflections play a more important role in contributing to the overall SPL.

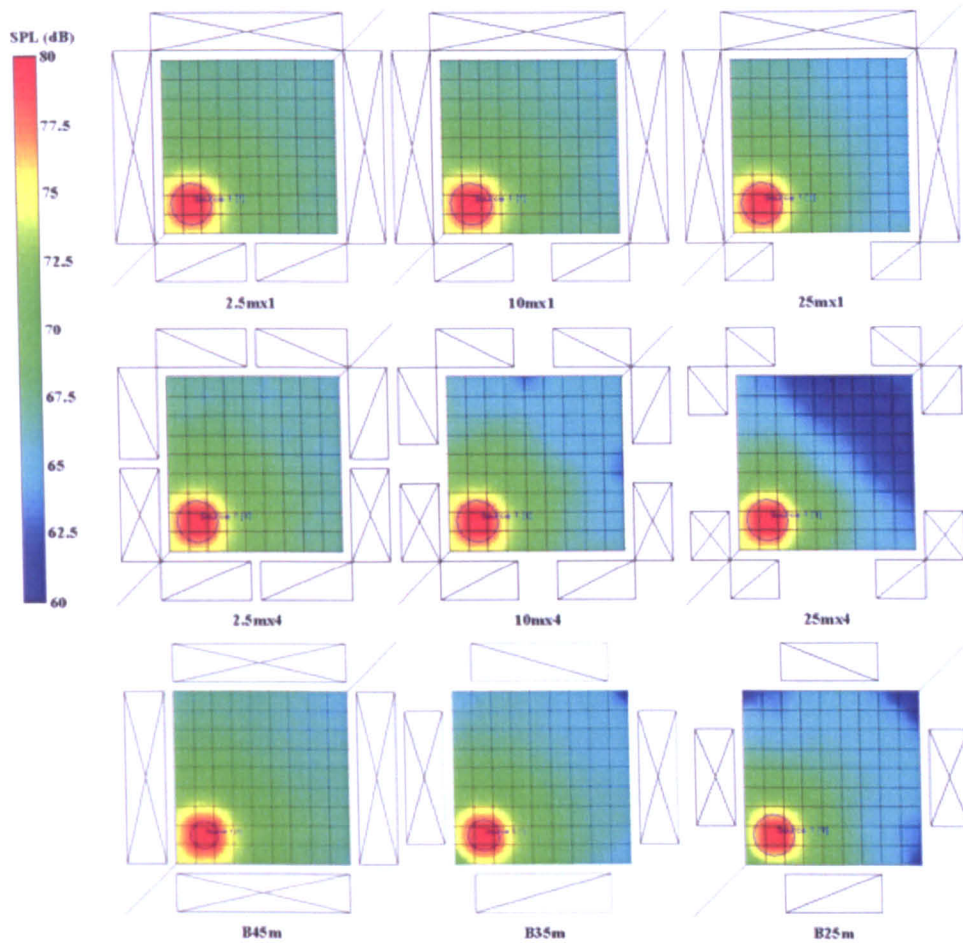


Figure 6.21 SPL distributions of configurations with various boundary openness situations

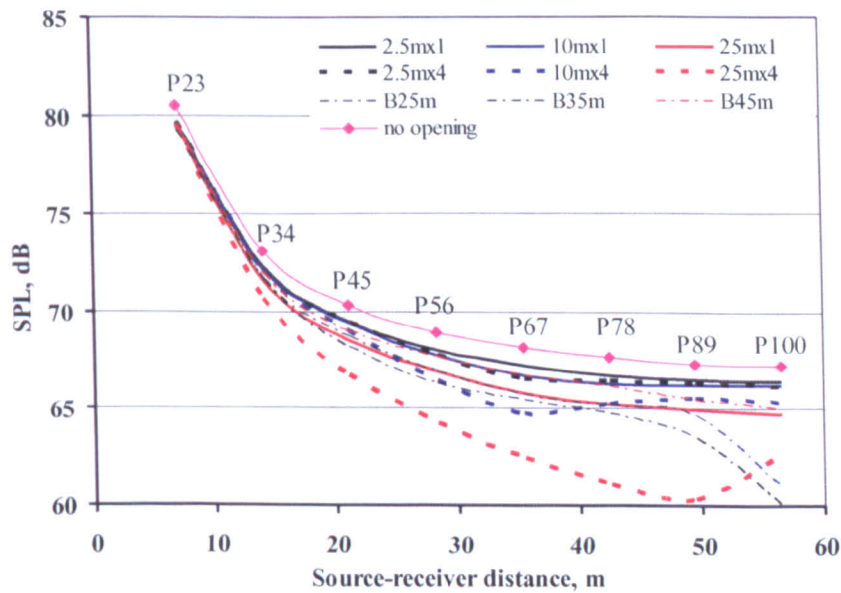


Figure 6.22 SPL comparisons between configurations with various boundary openness situations

Figure 6.23 illustrates the RT30 distribution of the 9 configurations with different openings and Figure 6.24 compares the RT30 along the diagonal of the configurations.

It is found that the position and the size of the openness have a significant influence on the RT30. Different arrangements of the same sized openings result in rather different RT30 distributions. For example, with the total opening size of 10m, in the configuration 2.5mx4, the RT30 decreases 5% sharper than the configuration 10mx1. In configuration 25mx1, where on one side the boundary opening reaches half size, on average the RT30 decrease 25% comparing to the no-opening configuration. However, in configuration 25mx1, the RT30 distribution of the square still keeps the similar tendency as the no-opening configuration. Whereas when the openings appear on four sides of the boundary, the RT30 distribution is significantly changed. Except the significant overall decrease of the RT30 values, a further decrease appears around the opening vicinity. In the configuration 25mx4, where the opening reaches half the size of the overall boundary, the average RT30 value drops 57% comparing to the no-opening configuration. When an opening appears at the corner of the square, the overall RT30 decreases sharply in the near field and far field. The average RT30 difference between the configuration B25m and no-opening is 69%. It is probably because the opening at the corner which is very close to the sound source has significantly reduced the number of early reflections in the overall sound field.

Figure 6.25 illustrates the EDT distribution of the 9 configurations with different openings. Correspondingly Figure 6.26 compares the EDT along the diagonal of the configurations. It is important to note that different from the situation of RT30 and SPL, the EDT value at a certain receiver largely depends on the position and size of the opening near the receiver, rather than the overall sound field of the configuration. For example, when the boundary around the sound source is closed, the EDT of the near field is rather similar to the EDT of no-opening configuration. However, when the opening appears at a different position and with a different size the EDT varies considerably. When the opening appears at the boundaries close to the sound source, the lack of early reflections has significantly reduced the EDT of the overall configuration. Due to the dependence of EDT on the position of openings, the variation of EDT is greater comparing to that of RT30.

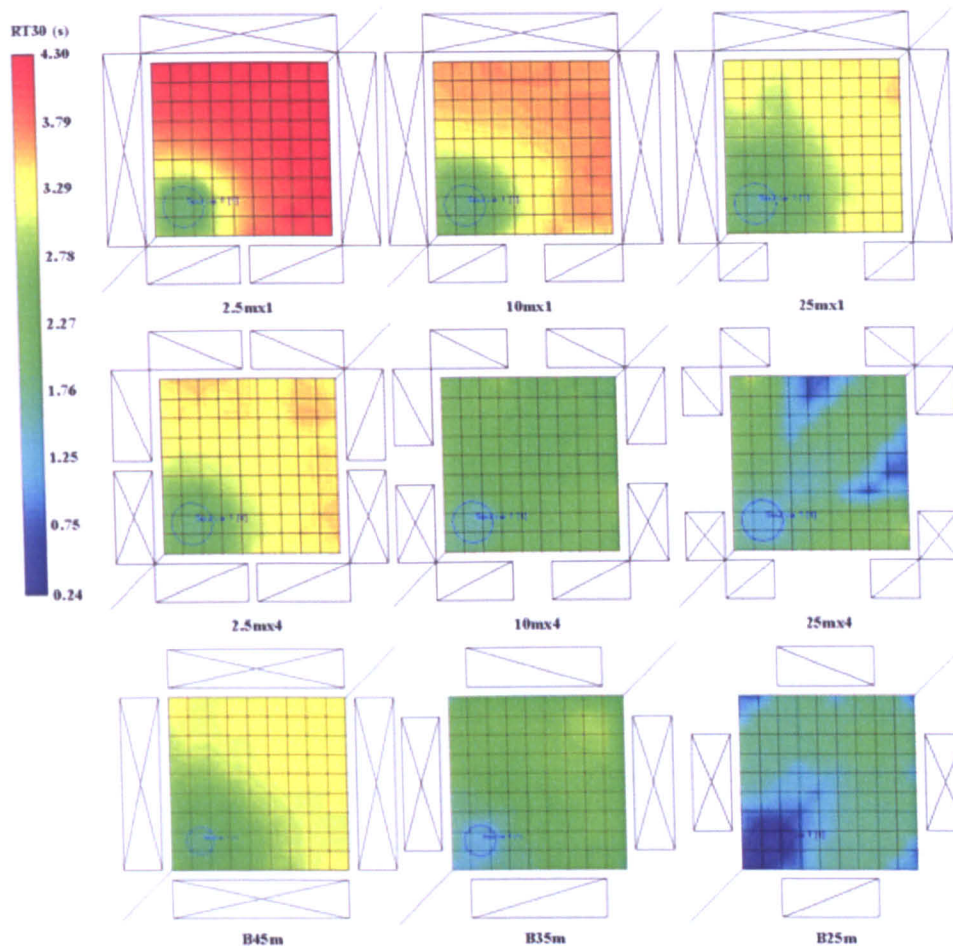


Figure 6.23 RT30 distributions of configurations with various boundary openness situations

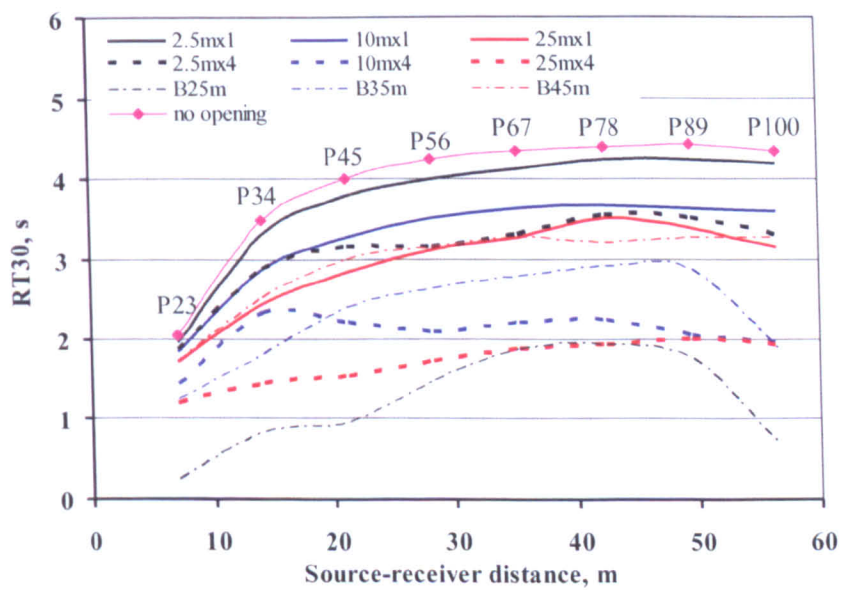


Figure 6.24 RT30 comparisons between configurations with various boundary openness situations

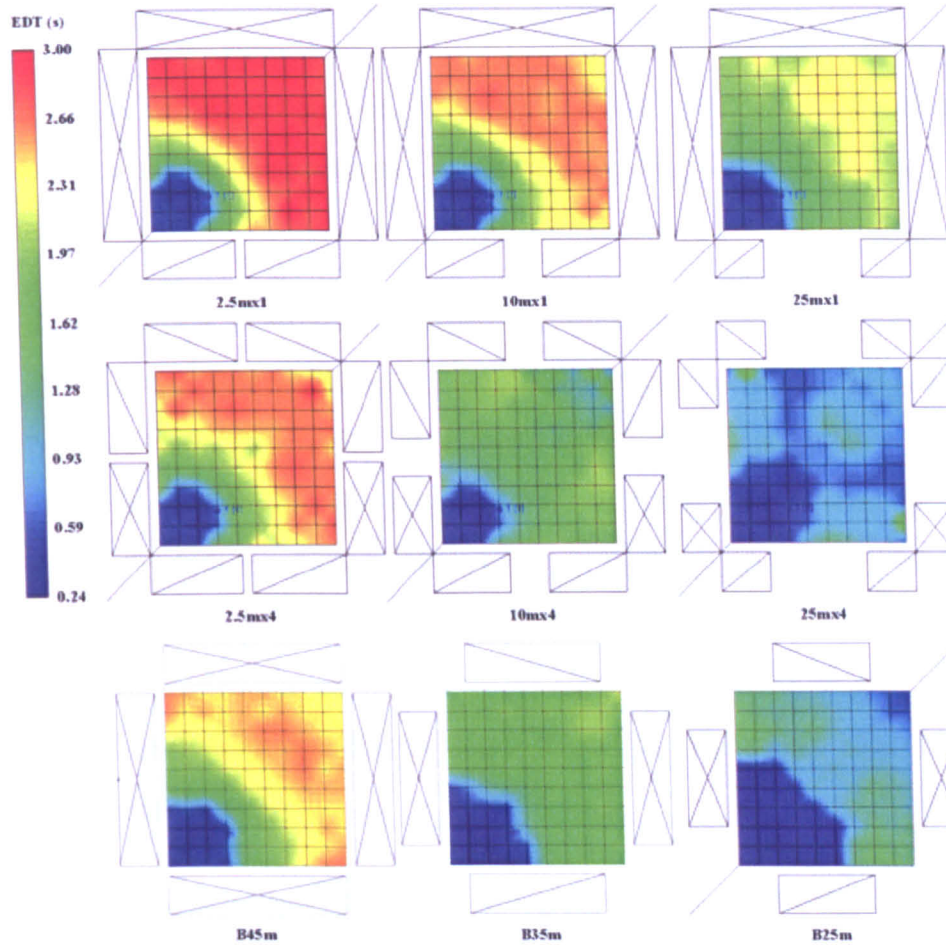


Figure 6.25 EDT distributions of configurations with various boundary openness situations

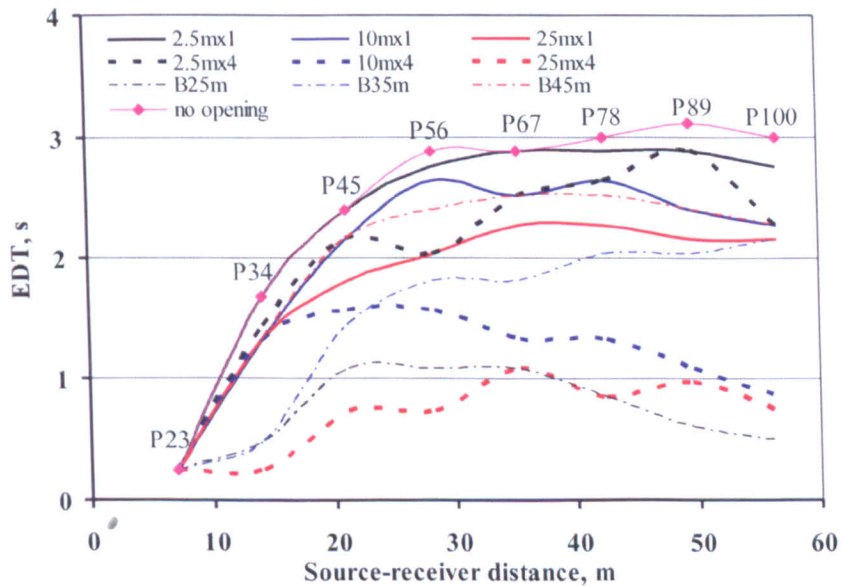


Figure 6.26 EDT comparisons between configurations with various boundary openness situations

6.5 SUMMARY

In this chapter, to benefit urban designers' understanding of the relationship between the spatial forms and the soundscape, a series of typologically classified forms have been studied.

First, based on analyses of different shaped configurations, i.e. the Square-Model, the Circle-Model and the Triangle Model, it is found that the sound fields of different spatial forms are rather different. Generally speaking, at a given source-receiver distance, the Circle-Model has the highest SPL and longest RT30 and EDT, whereas the Triangle-Model has the lowest SPL and shortest RT30 and EDT. In the Square-Model, these indices are generally close to the Triangle-Model. The results suggest that the more reflection surfaces are included in the enclosure, the higher value of the indices. In terms of the distribution of these indices, it is found that in the Circle-Model the sound field is more even.

The effect of boundary absorption and diffusion is also analysed between the three shapes. Although for different reasons, the increase of boundary absorption and diffusion can both reduce the overall SPL, RT30 and EDT. In terms of SPL, for the size of the studied square, 2,500m², when the absorption coefficient increases from 0 to 1, the SPL decreases 11-13dB, whereas it is approximately 6dB when diffusion coefficient increases from 0 to 1. From the design point of view, in terms of reducing SPL, increasing the absorption coefficient is more effective than increasing diffusion coefficient. However, increasing the diffusion coefficient is more effective in making the RT30 and EDT distribution more even in the configurations. The difference ratio is about 10%.

It is also found that increasing the absorption coefficient can reduce the SPL, RT30 and EDT differences between different shapes, whereas the reduction of the differences by increasing the diffusion coefficient is dependent on the location of a receiver. It has a less significant effect when the receiver point is in the far field.

Secondly, sound field of various sized configurations are compared. As expected, the SPL becomes systematically less with increasing square size. In the far field of the configurations, the SPL is approximately 6-8dB lower when the square size is doubled. In terms of RT30 distribution, the configuration size has a significant influence on the overall sound field. The RT30 increases systematically with increasing square size. The RT30 of the receivers in the far field increase more than that in the near field. However, in terms of EDT distribution, the variation of different sized configurations is not constant across the whole sound field. It is found that the position of the reflection surfaces around the receiver plays a more important role than the overall configuration size.

Finally, sound distributions of urban space with different boundary openness situations are studied. Generally speaking, as expected, the overall SPL, RT30 and EDT values decrease with increasing opening size. However, it is found that the SPL decreases more when the openings appear at the mid-field, whereas the RT30 decreases more when the openings appear at the near field. It is also important to note that the opening has more influence in reducing the overall SPL and RT30 of the configuration rather than the vicinity of the opening. However, the EDT value at a certain receiver largely depends on the position and the size of the opening near the receiver. It means that the EDT distribution is more directly related to the change of the physical forms than the SPL and RT30. This finding may suggest that the EDT value should be paid special attention in analysing a complex urban space.

As summarised above, in urban spaces, typological spatial forms as well as spaces with various sizes and openness play significant roles in contributing to the sound field characteristics. In urban design processes, complex urban spaces are generated from these simple spatial forms. Selectively combining the soundscape principles can help to achieve a more desirable sound field in urban spaces. To demonstrate the application of these soundscape design principles, in the next chapter, a series of precedent urban spaces are analysed from a typological soundscape point of view.

Chapter 7

Topological Soundscape Study of Urban Space Precedents

From the typological soundscape study in the previous chapter, the essential acoustic characteristics of the three basic spatial forms, as well as spaces with various sizes and openness have been revealed. Following the general urban design principles, these typologically classifiable shapes can be combined in different forms to create successful urban public open spaces. There are many examples – the traditional cities of Europe and Asia offer numerous places that attract people to use and enjoy them. Numerous texts analyse the reasons for the success of these places identifying urban design principles and focusing on the visual impact of these places. However, a visually beautiful place without sound has the potential to be a dead space. Urban design books rarely mention the soundscape of these places and none of them analyse the relationship between spatial forms and the soundscape yet. It is undoubtedly true that the unique soundscape of these urban spaces gives life to the place and thereby to the whole city.

Therefore, in this chapter, urban design principles are examined from the soundscape point of view. By means of computer simulation, typological soundscape characteristics of a number of urban space precedents are studied.

7.1 CLASSIC URBAN FORM

In the following discussion of typological soundscape characteristics of urban design principles, urban spaces from Renaissance urbanism have been selected as key examples. This is because during the Renaissance period (15th to 18th century), the aesthetic determination of spatial design and that of the enveloping architecture was more closely integrated than at any other time. Renaissance architecture – the essential precursor of urbanism – took over from Gothic as the momentum of the latter style waned. Summarised by Morris (1994), Renaissance architecture rejected asymmetrical

informality for a classic sense of balance and regularity: emphasis was placed on the horizontal instead of the vertical. Throughout the Renaissance period several dominant aesthetic considerations determined general attitudes to urbanization in all countries. As demonstrated by examples of Renaissance urbanism, the main components of Renaissance planning are: the primary straight street, grid-iron based districts, and regularly shaped enclosed spaces, such as the Baroque Rome illustrated in Figure 7.1. Perspective effects were emphasized by the location of terminal features, both architectural and sculptural, in the form of statues, fountains and obelisks. Designed as regularly shaped enclosed spaces (i.e. combining typological recognisable basic forms as discussed in Chapter 6), urban squares were the key components of Renaissance urban life. They were the place of religious services, markets, as well as entertainment.

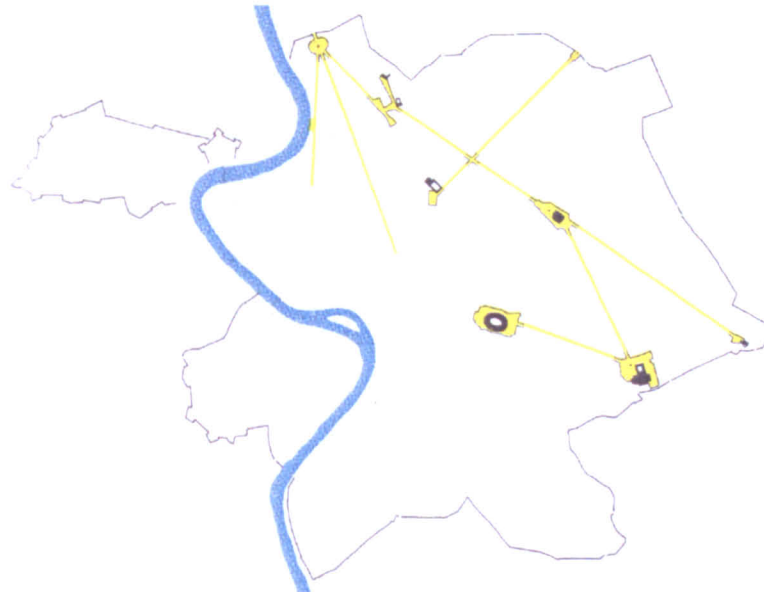


Figure 7.1 Map of Baroque Rome
(source: Bacon, 1975)

Among all the classic urban design principles, enclosure, continuity, and contrast spaces are the most famous ones, which have been analysed and referred to numerous times in urban design books (Bacon, 1975; Moughtin 2003; Trancik, 1986). However, as mentioned at the beginning of this chapter, soundscape characteristics of such principles have never been studied. Therefore, in the following sections, three urban squares: Campidoglio, Piazza Navona, and Piazza della Signoria have been selected respectively to represent enclosure, continuity, and contrast, for soundscape analysis. Raynoise (see Section 2.5.1) has again been applied to conduct the calculation.

The purpose of the Raynoise calculation in this chapter is to conceptually analyse the soundscape characteristics of various urban design principles, rather than accurately simulate the sound environment to compare with the actual spaces. Therefore, several simplifications have been applied to the calculation. Computer models of the selected squares are first built in AutoCAD and then imported into Raynoise. Only objects with more than 1m size in the squares are included in the models. The building heights are estimated from site visits and photos. All the openings on building façades are not included in the models. The absorption coefficient for all the surfaces is assumed as 0.1. Similar to other outdoor space studies (Kang, 2002b), ground diffusion coefficient is assumed as 0.1. Taking into account the rich decorative characteristics of Renaissance architecture, the diffusion coefficient for surrounding building surfaces is assumed as 0.2. A single point source with a sound power level of 100dB is positioned at 1.5m high around the centre of each Raynoise model. Receivers are evenly distributed at every 5m or 10m interval along horizontal (X) and vertical (Y) direction, with a constant height of 1.2m. Air absorption is not considered in the simulation. Without air absorption, the calculation results of Raynoise should be frequency independent. A single frequency of 1kHz is used in the calculations.

7.2 ENCLOSURE - CAMPIDOGLIO

The creation of spatial enclosure is one of the most important factors in designing a successful urban public open space. As Venturi (1966) pointed out, the problem of the contemporary city is not the lack of open space in the city, but its openness. Space can be measured, it has definite and perceivable boundaries, and it is discontinuous in principle, closed, static, yet serial in composition (Peterson, 1979). Anti-space, on the other hand, is shapeless, lacking perceivable edge or form. As summarized by Trancik (1986), the distinction between space and anti-space has much to do with finite boundaries, a primary element of good urban space.

Michelangelo's triangulated Campidoglio in Rome is an outstanding example of space enclosure and order. This masterpiece forms a link between the early Renaissance expressions of urban design in Florence and the great Baroque developments in Rome (Bacon, 1975). Figure 7.2(a) reconstructs the picture of Capitoline Hill as it existed in 1538, when Michelangelo began to work. Figure 7.2(b) shows the finished Campidoglio as we see it today. Figure 7.3 shows the site plan and photo of Campidoglio. These drawings clearly show how a coherent space can be created despite diverse architecture, steep topography, and an irregularly shaped site. By altering the facades and alignments of existing buildings (Palazzo del Senator & Palazzo del Conservatori) and connecting new buildings (Capitoline Museum) to them, the master transformed a derelict piece of land into a composition at once powerful and subtle (Norberg-Schulz, 1979). Michelangelo also took advantage of the triangular site to establish a "forced perspective" while using an elliptical paving pattern to provide a stable centre to the *piazza*.

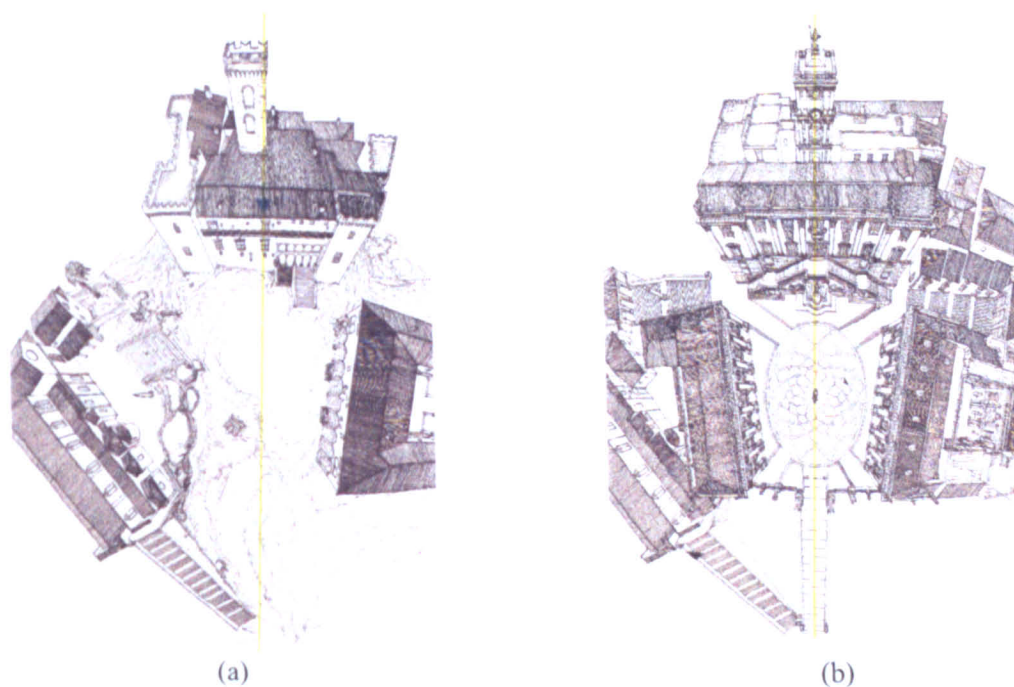


Figure 7.2 The Campidoglio, Rome
(a) the Campidoglio before Michelangelo's work (1538);
(b) the Campidoglio after Michelangelo's work (17 Century to today)
(source: Bacon, 1975, drawn by J.H. Aronson)

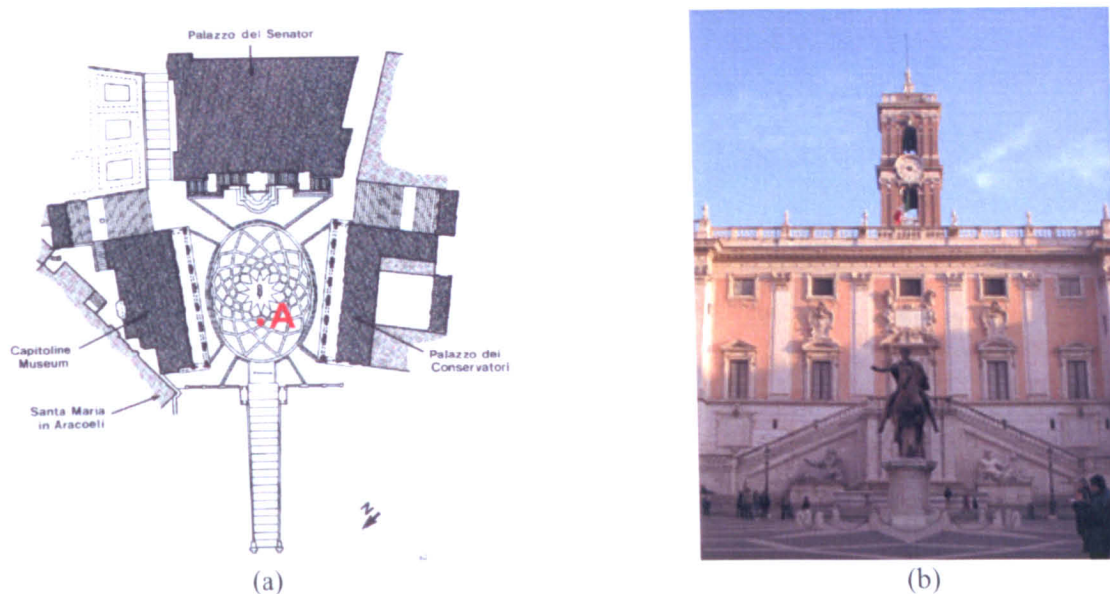


Figure 7.3 Site plan and photo of the Campidoglio
 (a) site plan (source: Moughtin, 2003); (b) photo from point A

In order to compare soundscape characteristics of different enclosure situations of the Campidoglio, three simplified models, namely configuration C1, C2 and C3, are developed. In the typological soundscape study, these three configurations represent an angled rectangular enclosure space, a half openness space, and a rectangular enclosure space, respectively. As shown in Figure 7.4(a), configuration C1 simulates the Campidoglio after Michelangelo's work (from 17th century to today). The building heights are estimated as 20m for the Palazzo del Senator, 18m for the Palazzo del Conservatori and Capitoline Museum, and 28m for Santa Maria in Aracoeli. configuration C2, as illustrated in Figure 7.4(b), simulates the Campidoglio before Michelangelo's work, where the Capitoline Museum was not present. The building heights of the Palazzo del Senator, the Palazzo del Conservatori, and Santa Maria in Aracoeli are the same as configuration C1. Figure 7.4(c) illustrates configuration C3, which is similar to configuration C1. But, in order to compare the different soundscape characteristics, the two front buildings, the Palazzo del Conservatori and Capitoline Museum, have been rotated to become parallel to each other.

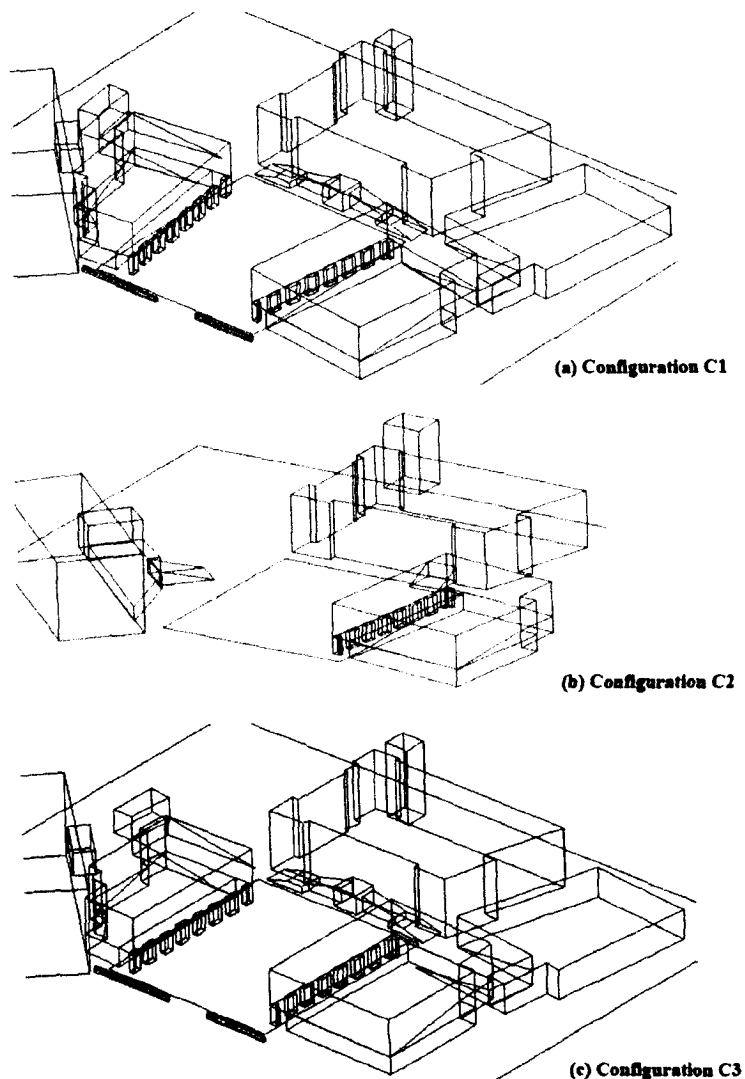


Figure 7.4 Three simplified models of Campidoglio in Raynoise
(a) configuration C1: Campidoglio after Michelangelo's work (17 Century to today)
(b) configuration C2: Campidoglio before Michelangelo's work (1538)
(c) configuration C3: Similar to configuration 1, but with two front buildings parallel to each other

7.2.1 SPL

Figure 7.5 shows the SPL distribution of the three configurations. Significant in their enclosure difference, the SPL of configuration C2 is about average 0.7dB lower than the other two configurations. Due to the notable sized opening of configuration C2, at the edge of the square, the maximum SPL difference between configuration C2 and the other two configurations is about 2-3dB.

The comparison of SPL with three simplified models of the Campidoglio along X axis and Y axis of the configurations are shown in Figure 7.6(a) and (b), respectively. It can be seen that within about a 5m diameter of the sound source, the SPL mainly depends on the direct sound level input from the source, but not on the shape of the configurations. However, for receiver points beyond 5m from the sound source, the shape of configurations starts to influence the sound level distribution. The further the distance is, the more significant the influence. As mentioned above, due to the openness, configuration C2 has the lowest SPL amongst the three configurations at the same receiver point. With a similar enclosure, configuration C1 and C3 have rather similar SPL ranges. However, it is found that the variation of the sound level distribution in configuration C1 is smoother than configuration C3. It is probably because the angled walls on both side of configuration C1 have more balanced reflections and results in a more even sound field.

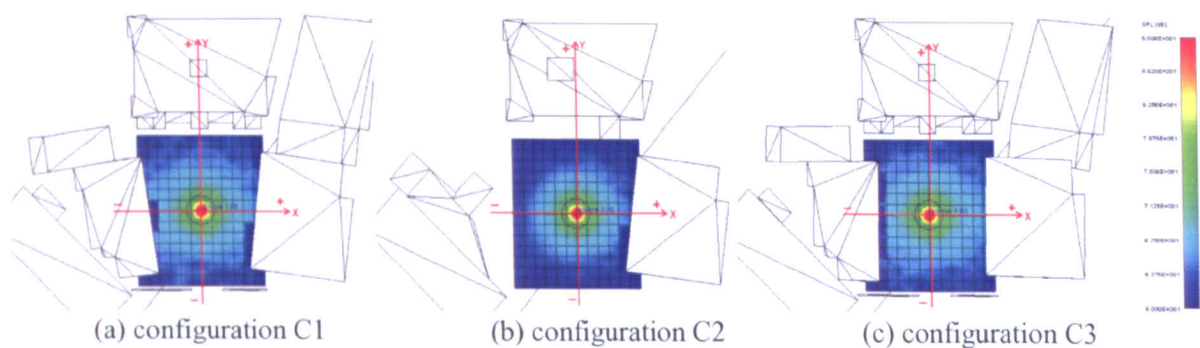
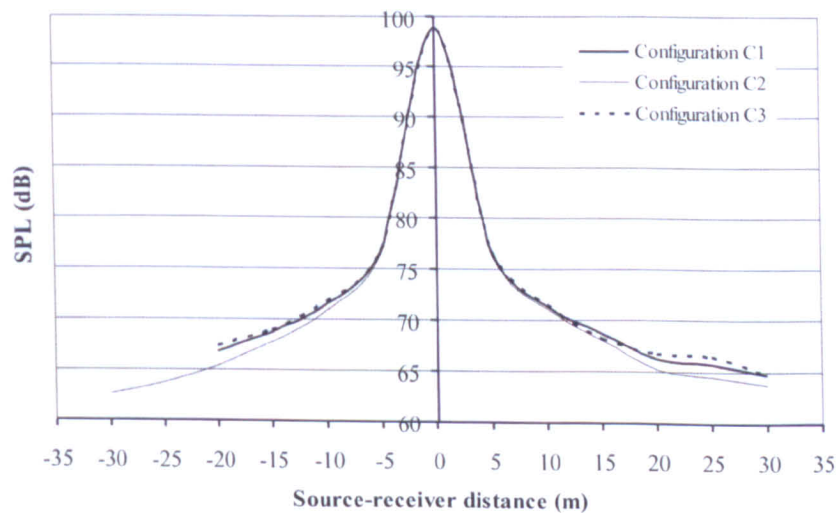


Figure 7.5 The comparison of SPL with three simplified models of the Campidoglio



(a)

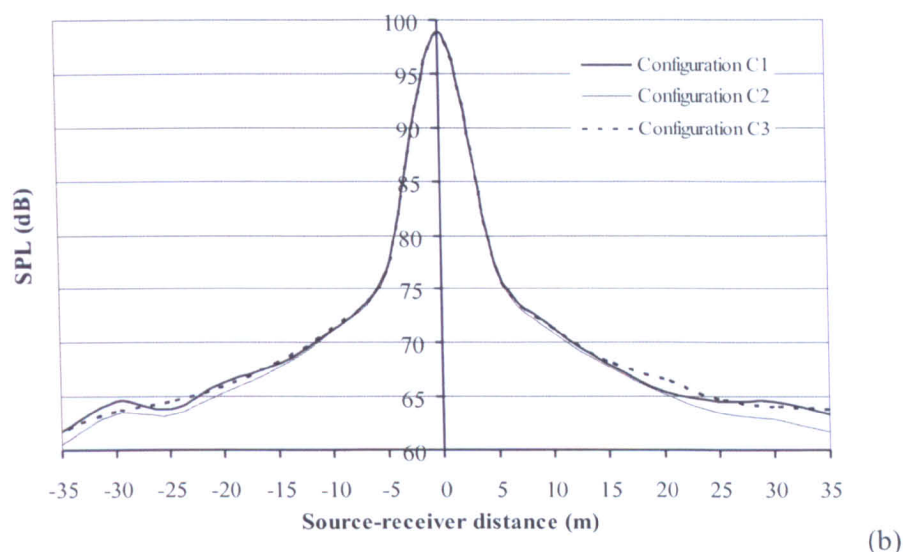


Figure 7.6 The comparison of SPL with three simplified models of the Campidoglio along (a) X axis (b) Y axis of the configurations

7.2.2 RT30

Figure 7.7 illustrates the RT30 of the three configurations. The average RT30 for configuration C1, C2 and C3 are 1.87, 1.70, and 1.94s, respectively. Obviously, due to the openness, configuration C2 has the shortest RT30. Furthermore, in Figure 7.8(a) and (b), RT30 of the three configurations is compared along X and Y axis, respectively. Again due to the openness of configuration C2, the average RT30 differences between configuration C1 and C2 are 17% both along X axis and Y axis. However, a more significant RT30 difference, 22%, is found between configuration C1 and C3 along the Y axis. It is because the angled walls in configuration C1 result in varied cross section width along the Y axis, which generate different length of reflection paths and angles. Therefore the reverberation characteristic of the square is considerably changed, in particular along the Y axis.

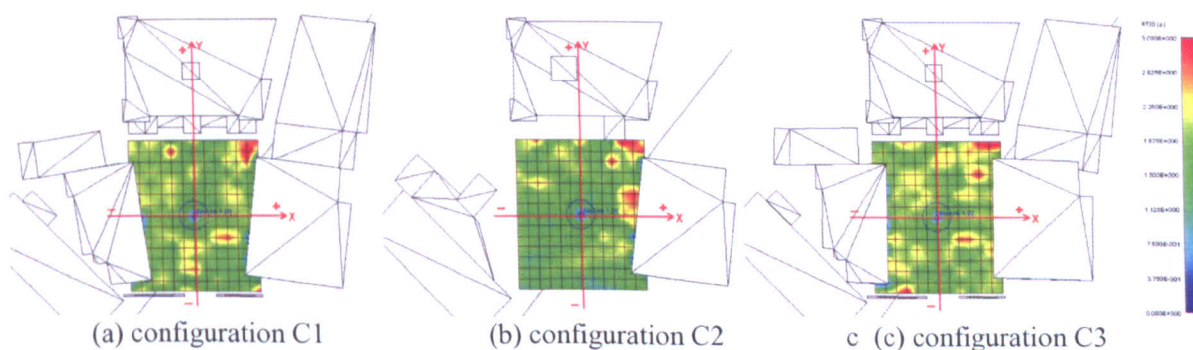
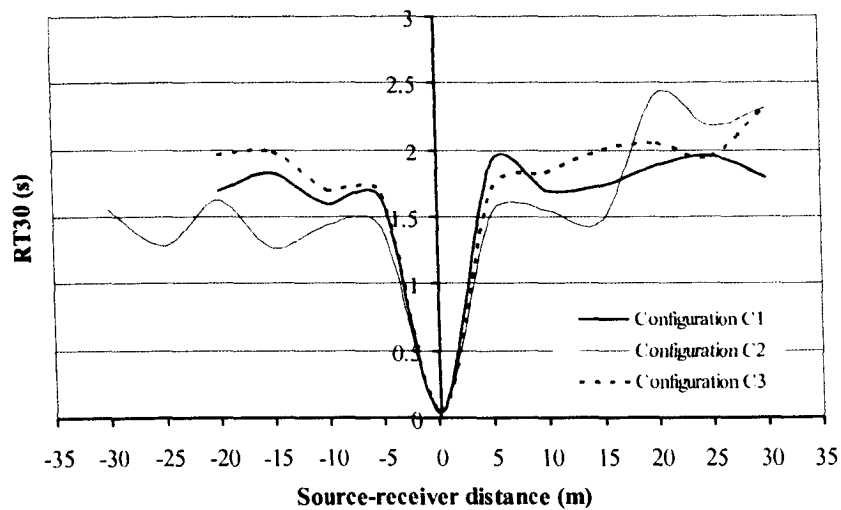
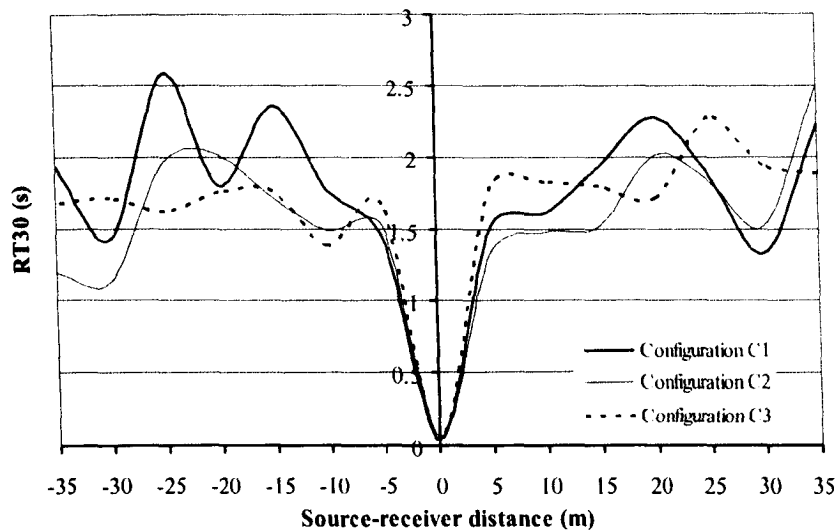


Figure 7.7 The comparison of RT30 with three simplified models of the Campidoglio



(a)



(b)

Figure 7.8 The comparison of RT30 with three simplified models of the Campidoglio along (a) X axis (b) Y axis of the models

7.2.3 EDT

Figure 7.9 illustrates the EDT distribution of the three configurations of the Campidoglio. Again due to the openness, configuration C2 has much lower EDT than the other two configurations. Due to its rectangular shape and parallel boundaries, configuration C3 has the longest EDT. The average EDT is 1.18, 0.82, and 1.21s for configuration C1, C2, and C3, respectively. In Figure 7.10(a) and (b), the EDT of the three configurations is compared along X and Y axis, respectively. Comparing with RT30 variation, the EDT variation and its variation tendency between three

configurations is more significant and clearer. Generally speaking, within a source-receiver distance of 5m, the EDT of configuration C1 and C3 both have a significant increase. However, in configuration C2, EDT increases beyond 10m distance from the sound source. Along the X axis, the EDT variation between configuration C1 and C3 is 12%, whereas it is 53% between configuration C1 and C2. It is interesting to find that along the X axis, the EDT distribution of configuration C1 and C3 are rather similar. It is probably because the two configurations have the same distance across the X axis. However, along the Y axis, because of the wider opening on the top part of configuration C1, the EDT values are considerably lower than that of configuration C3. Along the Y axis, the EDT variation between configuration C1 and C3 is 22%, and it is 34% between configuration C1 and C2.

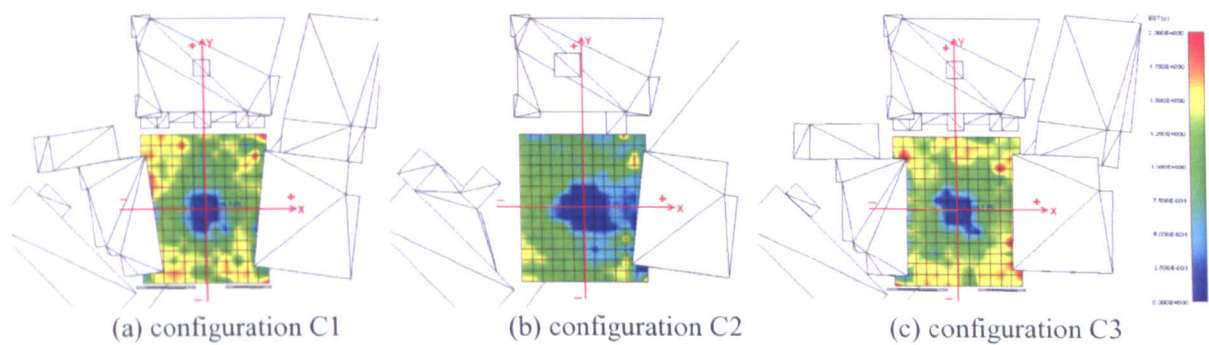
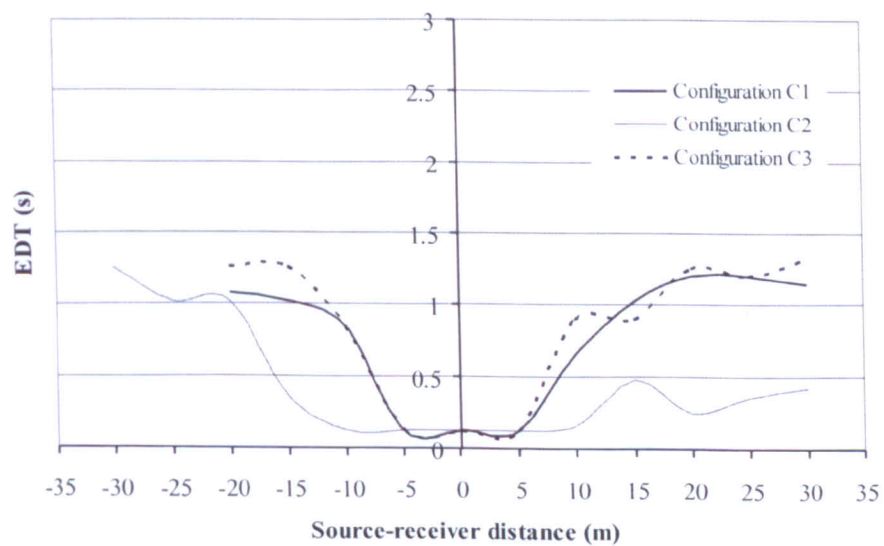


Figure 7.9 The comparison of EDT with three simplified models of the Campidoglio



(a)

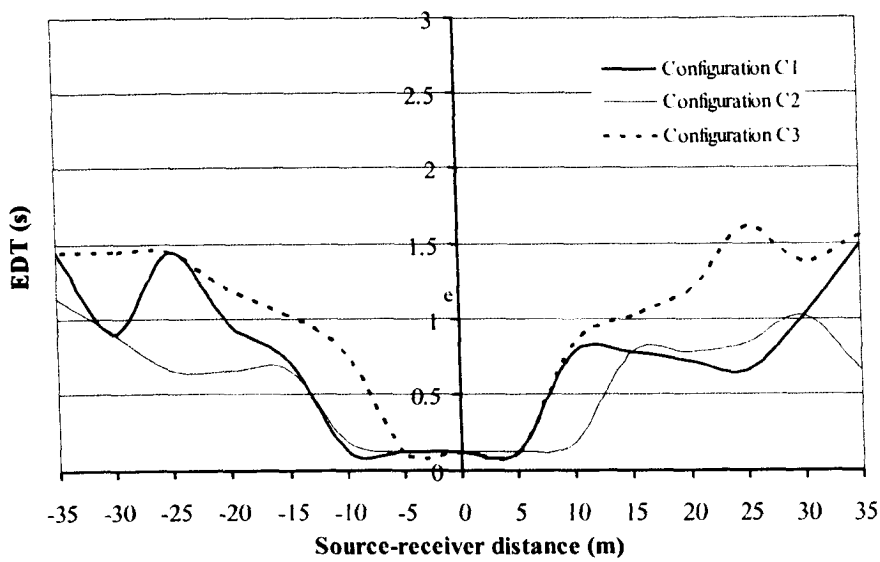


Figure 7.10 The comparison of EDT with three simplified models of the Campidoglio along (a) X axis (b) Y axis of the models

7.2.4 Sound Reflection and Impulse Response

As analysed above, different spatial arrangements of the Campidoglio have resulted in rather different sound distributions. In order to fully understand the related sound field, a sound reflection plan and an impulse response diagram for each configuration have been produced, as shown in Figure 7.11. The sound reflection pattern shows the reflection behaviour of the sound energy received in a given receiver point. The impulse response diagram shows the amount of energy received in a given receiver point at different time scale (in ms). A typical receiver point in the configurations, Point 59, which is 15m away from the sound source along the Y axis, has been selected for the analysis. From Figure 7.11 it is important to note that due to the different shape of the three configurations, their sound reflection behaviours are rather different. In configuration C1, a simplified model of the actual Campidoglio, the sound energy received in Point 59 is from different directions. It is because the two building façades in front are not parallel to each other. The sound energy has been evenly reflected in different angles and routes within the square. Therefore, in the impulse response diagram of configuration C1, after direct sound, early reflection sounds are relatively even distributed. In configuration C2, the openness has caused many reflections to be

moved to the outside of the square. Therefore after a few reflections, the sound energy decreases rapidly. In configuration C3, due to the pair of parallel walls, the sound has been reflected in the same area, which causes gaps between groups of reflections.

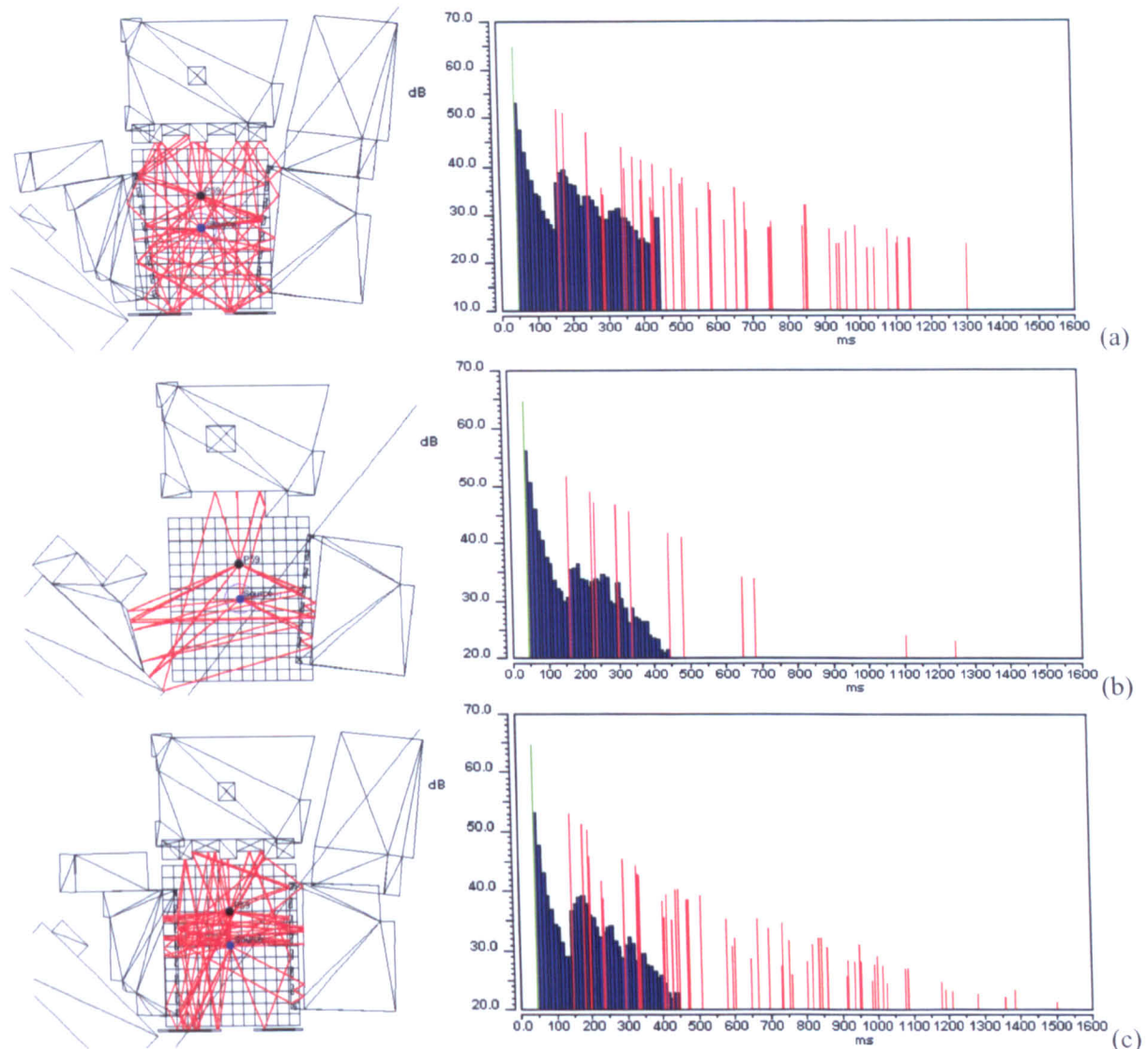


Figure 7.11 Sound reflection distribution in plan of the three simplified models of the Campidoglio and the echogram

7.2.5 Summary

In the topological soundscape study of the Campidoglio, three configurations which represent an angled rectangular enclosure space, a half openness space, and a rectangular space have been developed. In terms of SPL, from the originally half opened square, the overall SPL has increased 0.7dB in average and 2-3dB maximum in the designed enclosure square. However, this increase is possibly unnoticeable by

ordinary people. It is also found that between the two enclosure configurations, the influence to the SPL value from the angled walls and the paralleled walls is almost negligible.

In terms of reverberation, Michelangelo's enclosure space of the Campidoglio has increased 17% of the RT30 value and 35% of the EDT value comparing to the space before his design. However, the angled walls designed by Michelangelo have created a more even sound field comparing to normal rectangular enclosure space. The RT30 and EDT of the angled rectangular enclosure space are lower than normal rectangular spaces.

7.3 CONTINUITY - PIAZZA NAVONA

Piazza Navona is probably Rome's most famous example of continuity in urban design. As shown in Figure 7.12 and 7.13, its long plan at the ratio of approximately 1:5, with a curving narrow side to the north, retains the form of the stadium built around A.D. 81-96 (Moughtin, 2003). In the typological soundscape study, the form of Piazza Navona is an excellent example of a stretched rectangular space with a half-circle shape in the end. This space has formed a great enclosure. The whole space is just like the dancing hall of a huge estate house. The great success of the Piazza Navona is because of its strong sense of place. Only a few narrow streets link the square with the other part of the city. The emphasis on the length of the space is reflected in the bold, horizontal treatment of the façade of Sant' Agnese. The long and narrow form of the square meant that all views had to be designed as oblique perspectives. However the arrangement of the three richly modelled fountains helps to coordinate the otherwise uneven balance of the perspective view. The most magnificent finishing touch of the Piazza Navona is Bernini's Fountains of the Rivers, which define the form and the rhythm of the square. The fountain, composed around the ancient obelisk of Domitian, is placed on the longitudinal axis of the square but removed from its central axis. The other two fountains are located at each end of the square. The Piazza Navona is a square dominated by the fountains which give soul and

life to the place. Not only from their magnificent sculptural appearance, but also from the sound they produce (see Section 8.1.3). For centuries, the piazza was the scene of magnificent tournaments and festive processions (Hintzen-Bohlen, 2001). Water festivals took place here until the 19th century. In that time, the square was flooded to a certain level for the festival every August. Today, the piazza Navona is one of the liveliest squares in the city of Rome. As the Roman author Giuseppe Gioacchino Belli wrote in the early 19th century: “*Ah, the Piazza Navona! It cares not a whit for the Piazza di Spagna or St. Peter’s square. It is not a square but the great outdoors, a festival, a stage, and wonderful fun.*”

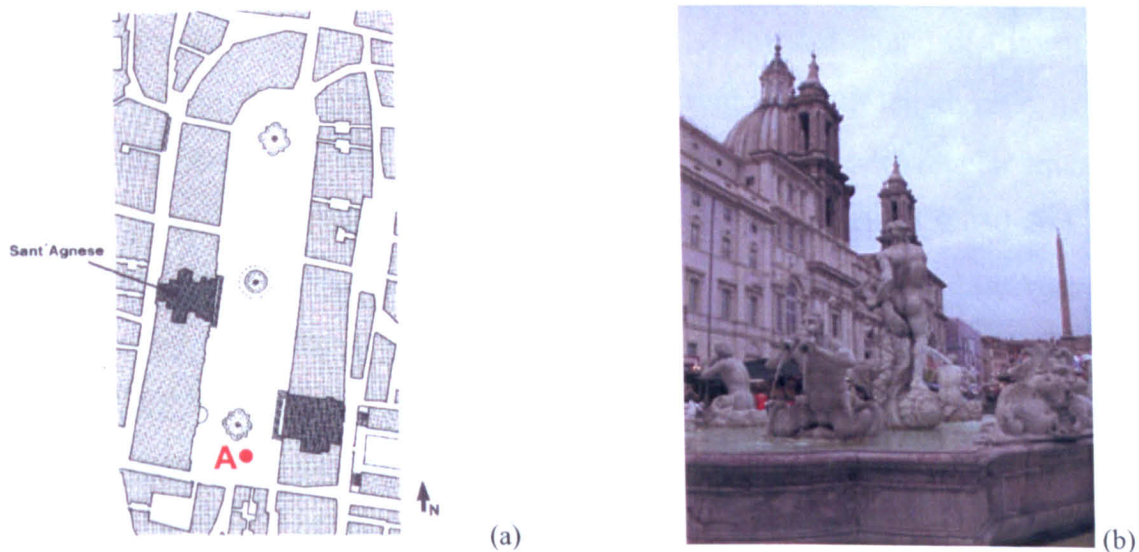
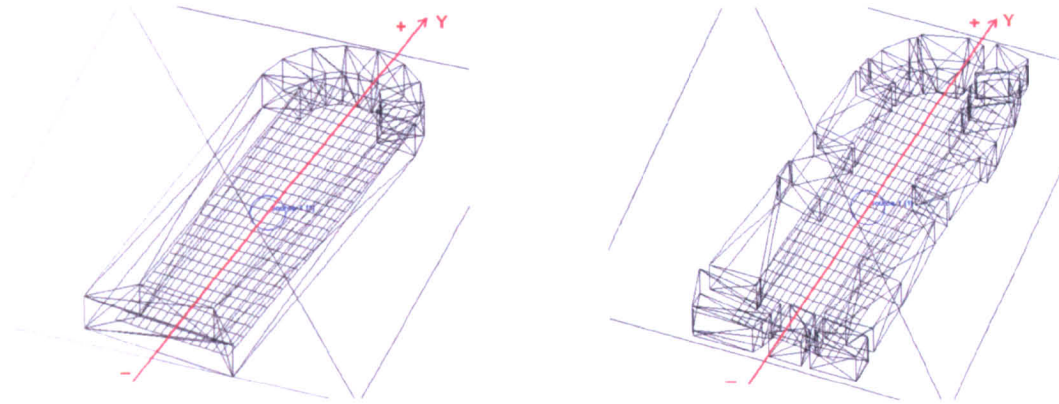


Figure 7.12 Site plan and photo of Piazza Navona
 (a) site plan (source: Moughtin, 2003) (b) photo from point A

To analyse the typological soundscape characteristic of this stretched rectangular space, two configurations, namely configuration N1 and N2 are developed. As shown in Figure 7.13(a), configuration N1 is an abstract model of Piazza Navona without any opening. The dimension of the model is taken from the actual square, but the north and south end of the square have been simplified as half-circle and rectangle respectively. configuration N2 simulates the Piazza Navona with the actual sized surrounding building blocks, as can be seen in Figure 7.13(b). According to the site plan from Moughtin (2003), a few narrow openings have been built in the model. For both models, the height of surrounding buildings is assumed as 25m.



(a) configuration N1

(b) configuration N2

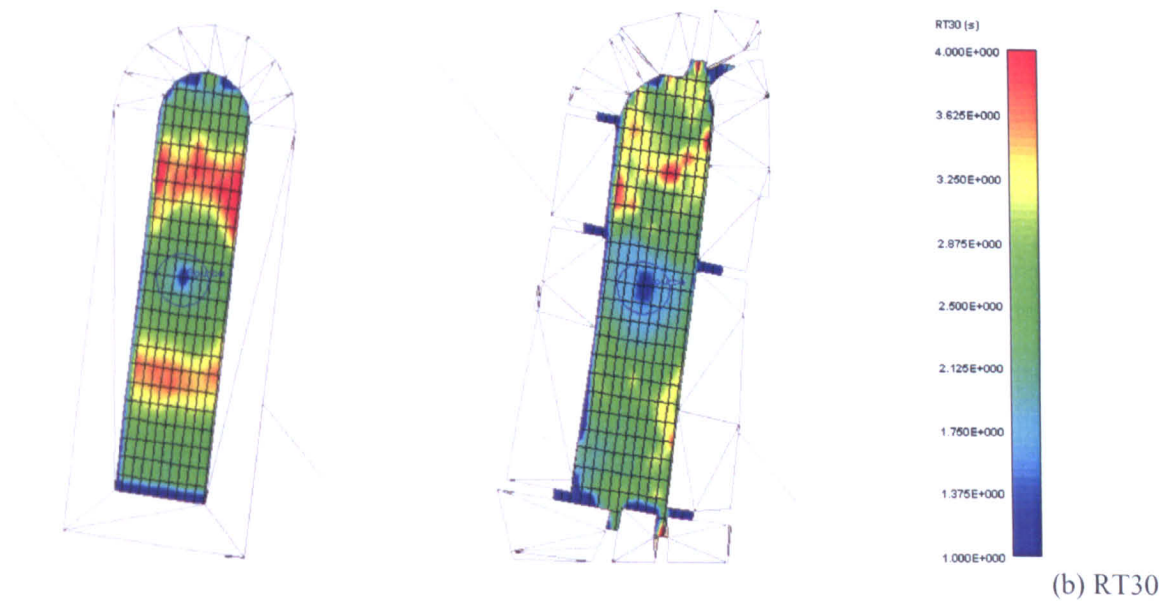
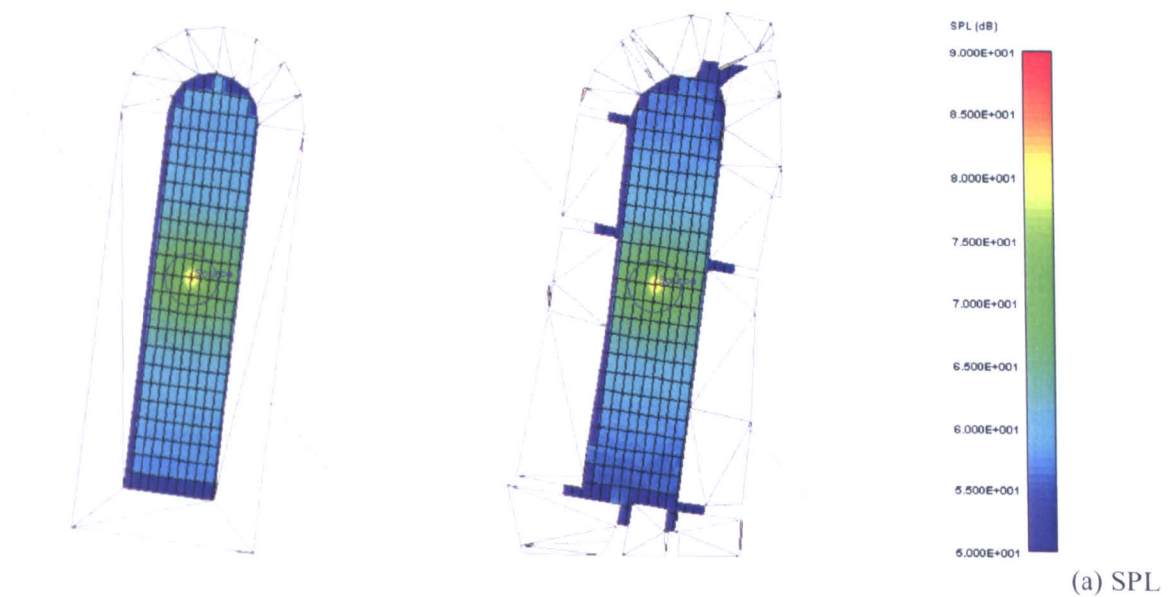
Figure 7.13 Two simplified models of Piazza Navona in Raynoise

Figure 7.14 shows the SPL, RT30 and EDT contributions of the two configurations. Correspondingly, Figure 7.15 further illustrates the detailed sound distribution along the Y axis. From the figures, it can be seen that with a width-length ratio of 1:5, the sound field of configuration N1 is distributed differently than with regular square shape (e.g. the square shaped configurations in Chapter 6), in particular RT30 and EDT. In configuration N1, the average RT30 and EDT is 2.83s and 2.28s, respectively. Unexpectedly, the longest RT30 and EDT appear to be around 60m from the sound source. This distance is the middle field between the square end and the sound source. A possible reason is because the unbalanced width-length ratio of the square, which results in the lack of early reflections. Similar to a regular square shape, with increasing source-receiver distance, the SPL constantly decreases in configuration N1. However, with a half circle shape in the end, the SPL around the circle centre has slightly increased to about 1dB. As found out in the Section 6.2, it is due to the characteristic of the circle shape, which tends to have a higher SPL than other shapes.

In configuration N2, although with no more than 10% of opening, the sound field is significantly different from configuration N1. The openings have made the sound field more even. The longest RT30 and EDT extend to a larger area around the two ends of the square. In configuration N2, the average RT30 and EDT values have dropped to 2.05s and 1.23s, respectively. The peak RT30 and EDT both appear at a similar position as configuration N1 and almost levelled until the end of the configuration. The average difference between the two configurations is 29% and 48% for the RT30 and

EDT, respectively. Also due to the openings, the SPL in configuration N2 has decreased 2.1dB in average comparing to configuration N1.

This result suggests that although the opening in the configuration has changed the actual values of soundscape indices, the tendency of the soundscape characteristic is still similar. The soundscape characteristic of this stretched rectangular space is still kept.



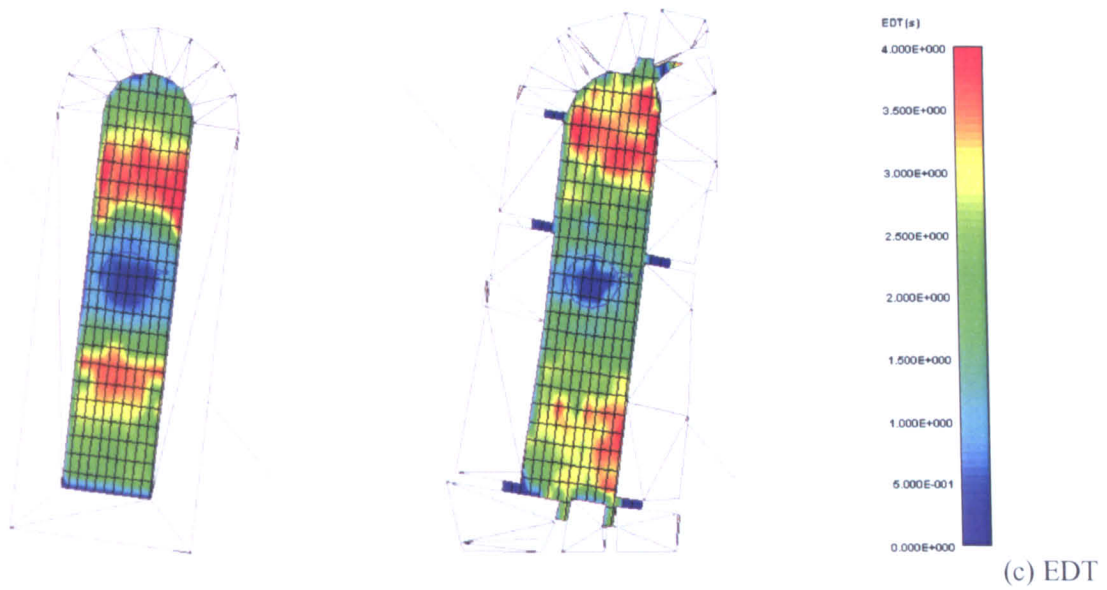
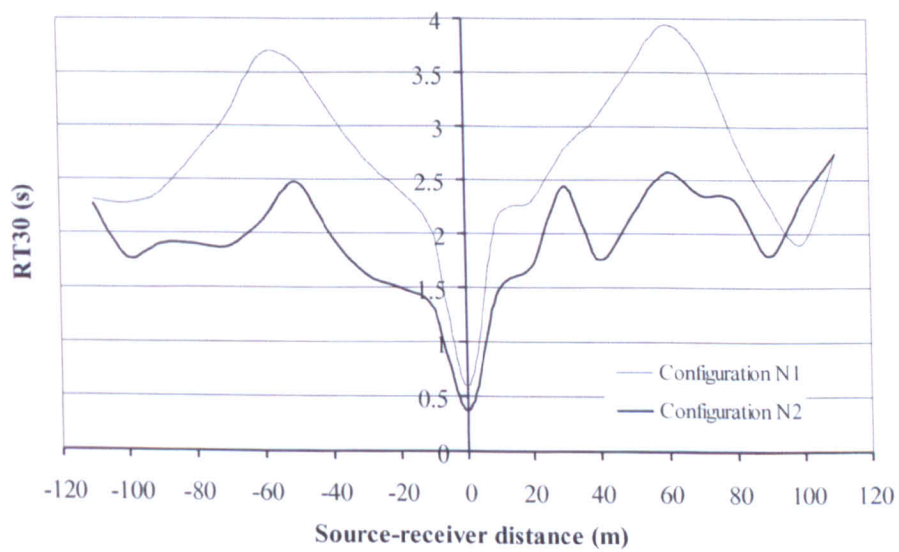
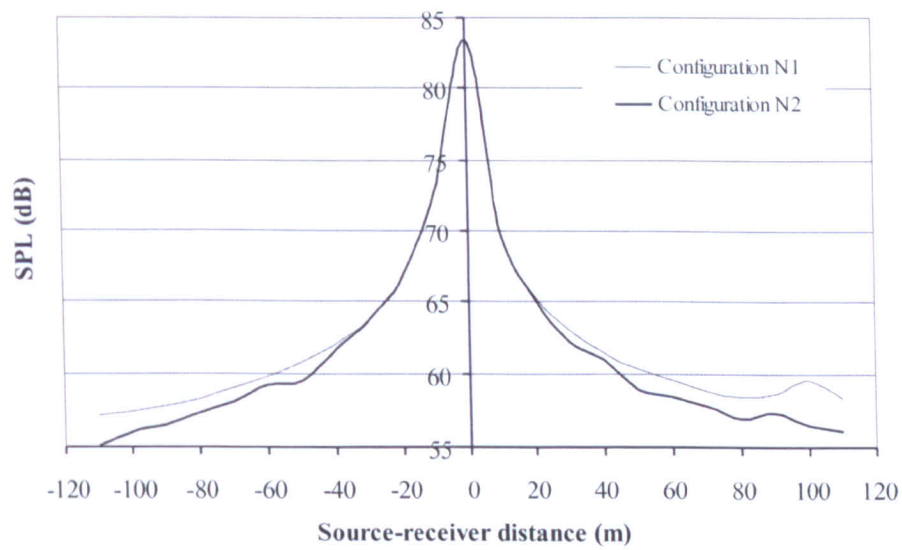
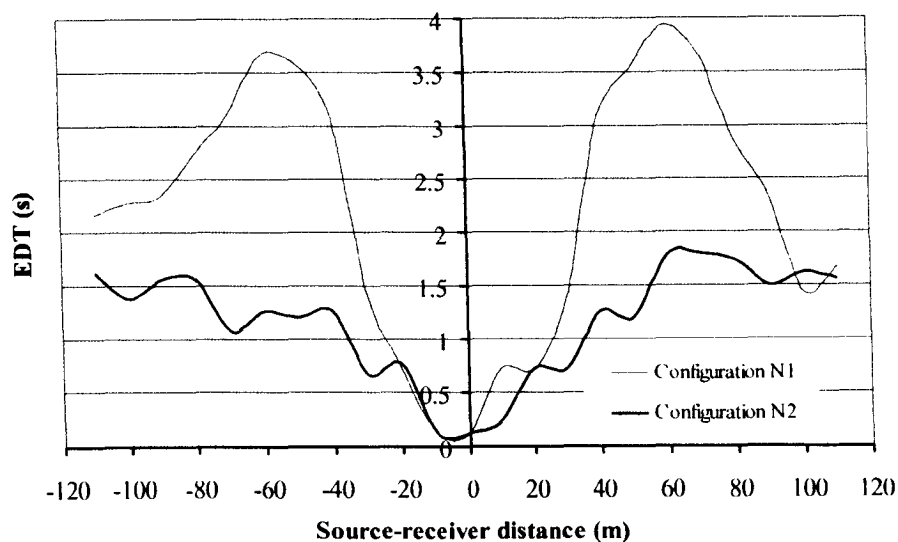


Figure 7.14 Sound indices comparisons of the two simplified models of Piazza Navona





(c) EDT

Figure 7.15 Sound indices comparisons of the two configurations along Y axis

7.4 CONTRAST SPACES - PIAZZA DELLA SIGNORIA

Piazza della Signoria in Florence is a great example of Renaissance ordering of space. As illustrated in Figure 7.16, the main square forms two distinct but interpenetrating spaces. Their boundary is defined by an optical barrier of sculpture. Maintaining a complete sense of enclosure, Piazza della Signoria is essentially medieval in shape with streets entering informally at different angles (Moughtin, 2003). The Palazzo Uffizi was designed to open off one side of Piazza della Signoria. Using this device, a formless medieval space was converted into two spaces with proportions corresponding more closely to Renaissance ideals. The shaft of space contained by the Uffizi walls and framed by the arch at the end provides a lens to look to the cathedral dome in the far distance. As can be seen in Figure 7.16(b), by adding this narrow shaft of space to the originally almost rectangular space, in one direction the contrasting forms of the palace tower and the great dome are dramatized. From a typological soundscape point of view, this contrast of spaces also provides a great opportunity for dramatic urban soundscape.

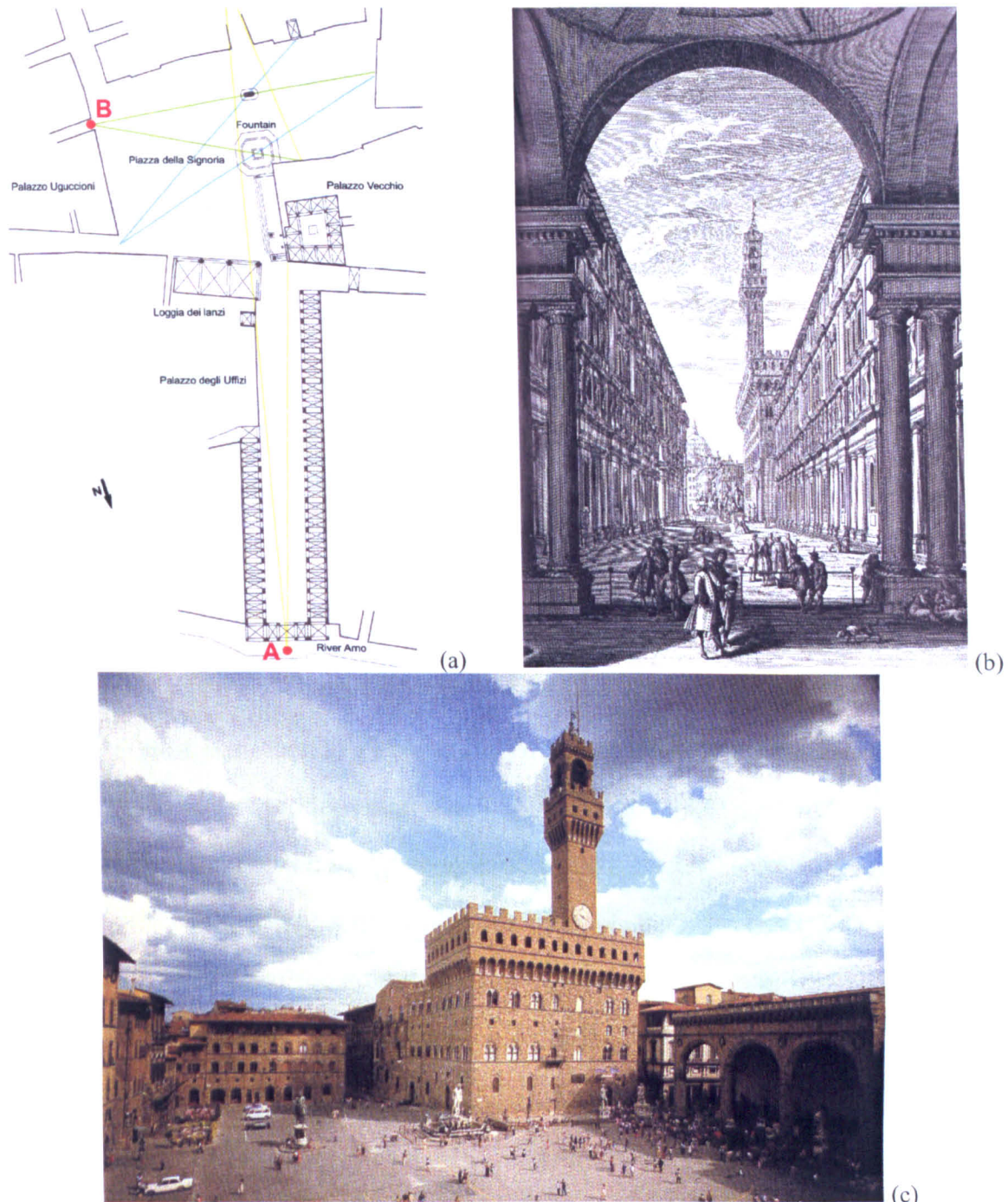


Figure 7.16 Site plan and perspective views of Piazza della Signoria, Florence

(a) site plan (source: Bacon, 1975)

(b) perspective view from point A (source: Bacon, 1975)

(c) perspective view from point B (source: Wirtz, 2000)

In order to compare the soundscape of the contrast spaces of Piazza della Signoria, a Raynoise model is designed, as shown in Figure 7.17. The building heights are assumed as 45m for the Palazzo Vecchio and an additional 40m for the tower; 25m for the Loggia dei Lanzi and Palazzo degli Uffizi. All the other surrounding building

heights are assumed as 25m. A single sound source of 100dB is positioned at Ammanati's Neptune fountain at 1.5m in height.

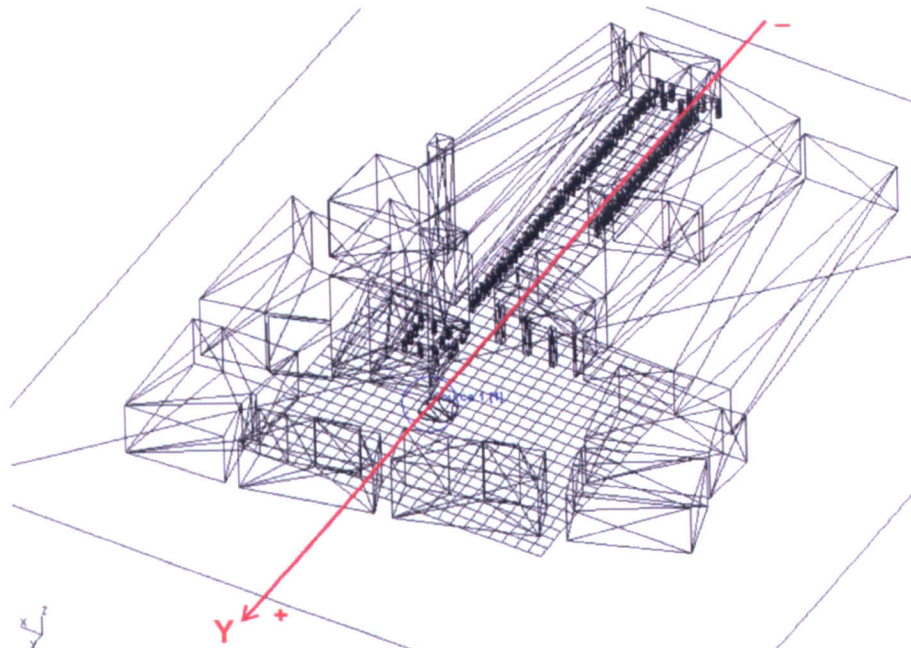
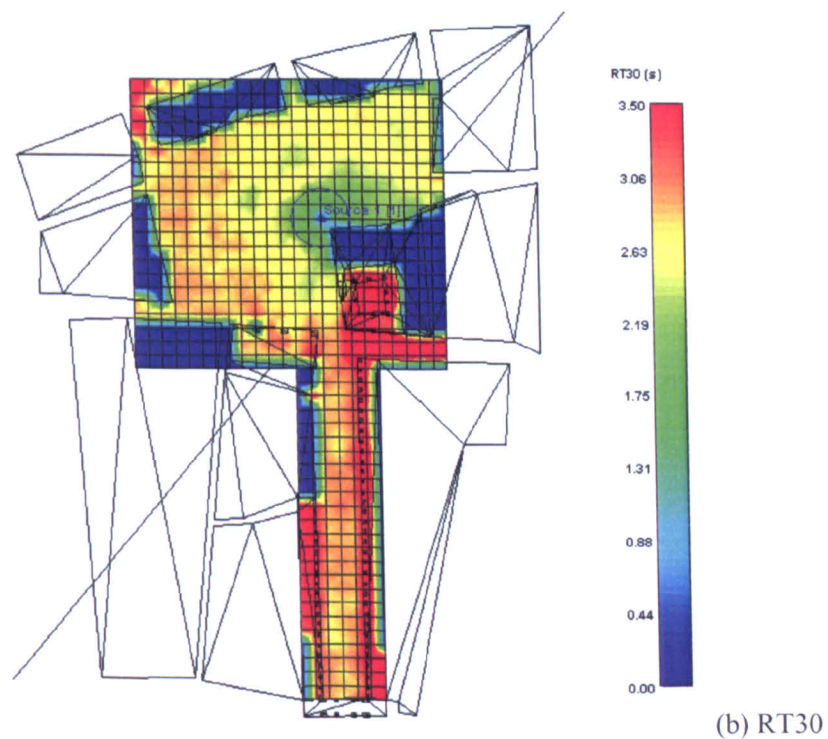
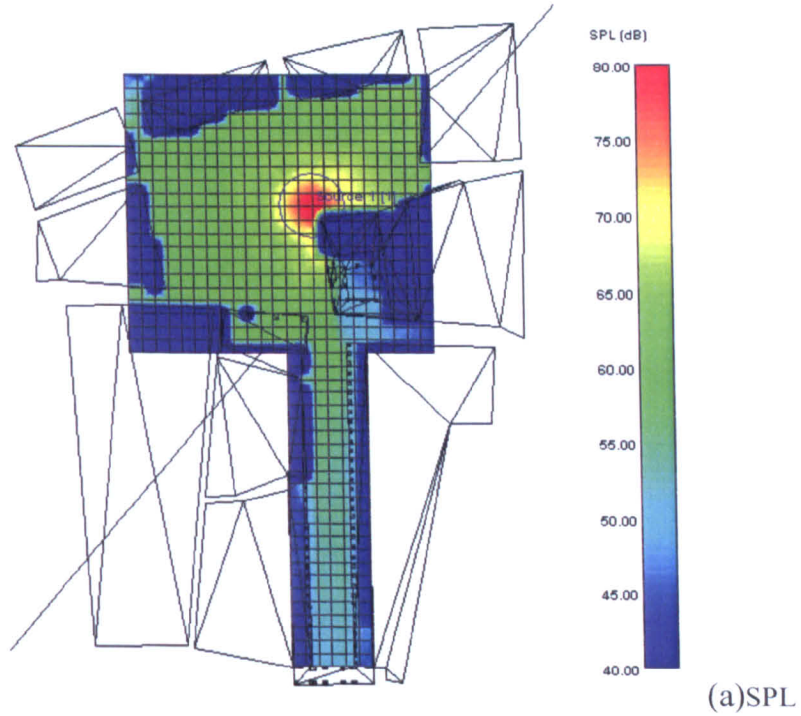


Figure 7.17 Simplified model of Piazza della Signoria in Raynoise

Figure 7.18 shows the sound distribution of Piazza della Signoria. Correspondingly, the detailed sound distribution along the Y axis is shown in Figure 7.19. In terms of the SPL, in the near field of the sound source, because of the dominant role of direct sound and early reflection, there is no difference between the two sides along the Y axis. Around 10m away from the sound source, Palazzo Vecchio reduces the width to the south part of the central square. It can be seen that in Figure 7.19(a), the attenuation curve becomes rather different between the two sides. With shorter reflecting distances, the SPL decreases slower with an increase of source-receiver distance to the south part of the square. However, it is interesting to note that in the far field, when the narrow shaft space joins the central square (approximately 60m from the sound source), the attenuation curve almost keeps the same tendency.

In terms of RT30 and EDT, it can be seen that in Figure 7.19(b) and (c), the introduction of the narrow shaft space significantly changes the sound field in the far field. As shown in Figure 7.19(c), EDT value has increased more than 60% when the narrow shaft space joins the central square. It is suggested that in different positions of

Piazza della Signoria, people may have rather different perceptions of a given sound source such as the fountain. It could be further derived that when people walk into this space, their footsteps or their voices can indicate the dramatic spatial changes. Piazza della Signoria shows a great example of organizing contrast spaces to create dramatic not only visual, but also aural effects.



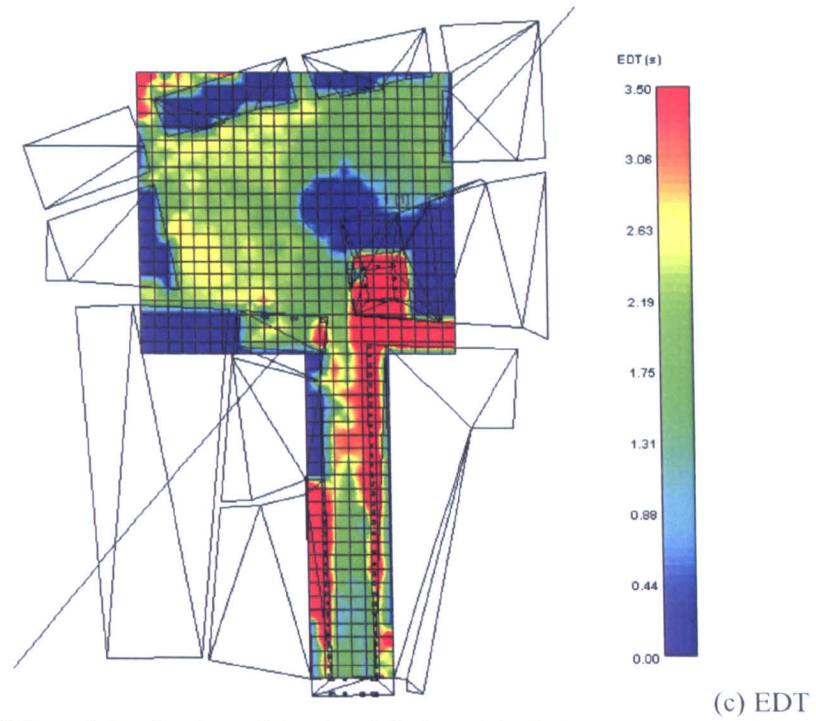
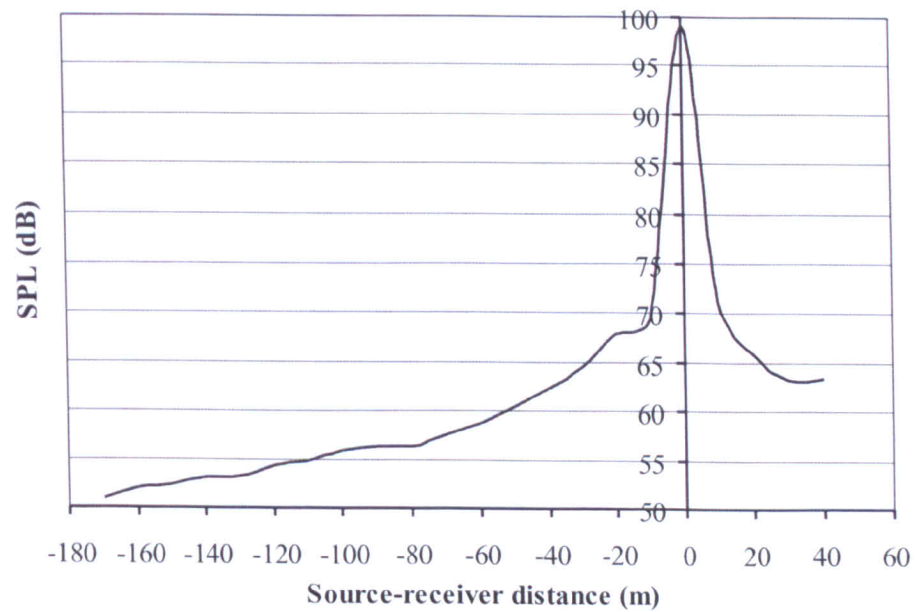
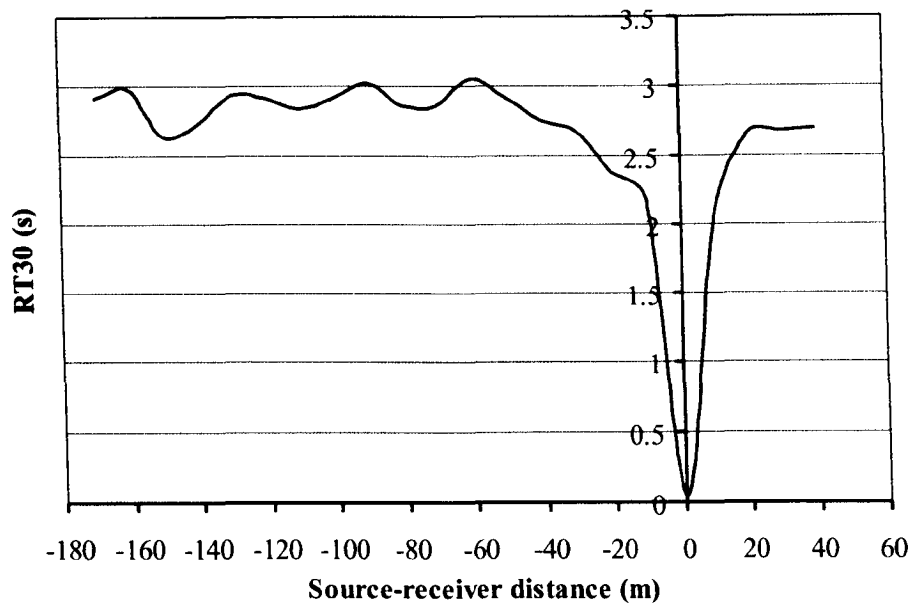
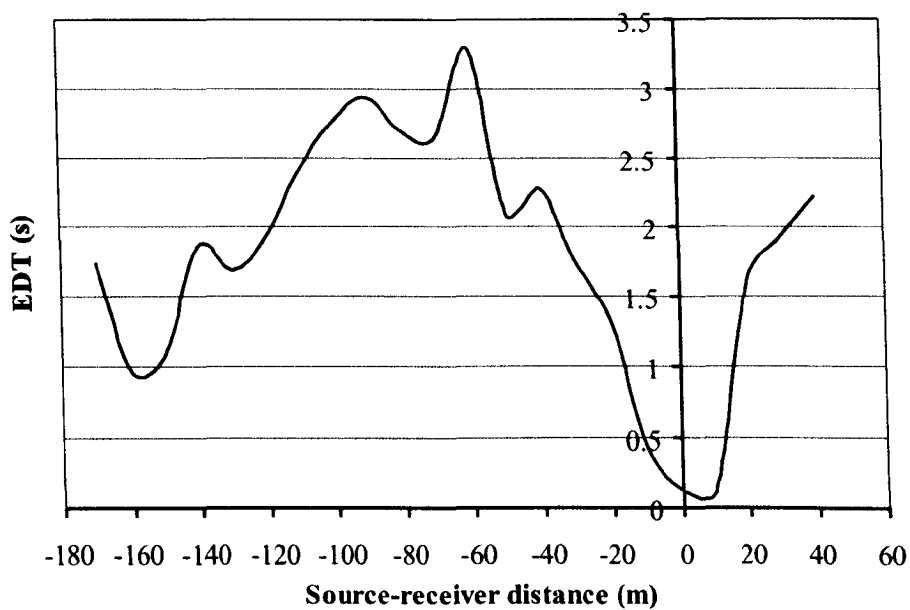


Figure 7.18 Sound distribution of the simplified model of Piazza della Signoria





(b) RT30



(c) EDT

Figure 7.19 Sound indices comparisons of the simplified model of Piazza della Signoria along Y axis

7.5 SUMMARY

In this chapter, three classic urban design principles, i.e. enclosure, continuity and contrast spaces, have been analysed from the typological soundscape point of view. Campidoglio, Piazza Navona, and Piazza della Signoria are selected as examples of the principles, respectively.

From the analysis, it can be seen that the sound field of a complex urban space is generally similar to that of the typologically classifiable forms. For example, the sound field of Campidoglio still keeps the essential characteristic of a rectangular space. By adding more details to the spatial forms, such as changing the shape of the end boundary, changing the orientation of surround walls, increasing the size of a opening within a certain proportion, etc., the SPL will only have a negligible change. However, these detailed spatial designs will have a significant influence on RT30 and EDT. It has been found from this study that EDT variation has approximately direct relationships with the spatial form change. Rather than responding to the overall shape and size of the space, the direction and distance of the closer facades have more influence on EDT. The analysis also suggests that by using unusual or contrast shaped spatial forms, dramatic sound field can be created specifically.

Therefore, from an urban design point of view, the sound level distribution of a space can be briefly predicted by its overall shape, size and material at an early stage. However, carefully designed spatial details can create more comfortable or dramatic sound fields.

Chapter 8

Sound Elements and Activities

Most of the sounds which can be heard within a city are artificial. The major generators of outdoor noise nowadays are transportation vehicles. Every time a street with automobile traffic is converted to a pedestrian street, there are renewed opportunities for hearing a different world. Effectively reducing unwanted noise and introducing wanted sounds are very important for providing a relatively comfortable or pleasant acoustic environment, as discussed in Section 4.2.

Therefore, in this chapter, the designable soundscape features are examined from a designer's viewpoint and water features, music and activities are selected for detailed analysis. The masking effect of water features, the rich spectrum characteristic, unlimited forms, function of entertainment, as well as contemporary design tendency are discussed in the first section. In the second section, the importance and the principles of providing a suitable place for people to generate active sounds are discussed. Additionally, the soundscape characteristics of music, as one of the most popular street activities, are studied.

8.1 SOUNDSCAPE ELEMENTS – WATER FEATURE AS AN EXAMPLE

Water is a prominent feature in many environments. Water related recreational behaviour inherently involves a transaction of people and environment (Ittelson, 1973). Water has a magnetic attraction that is unrivalled by other materials or elements (Pitt, 1990). Several hypotheses offer explanations for its near-universal appeal. As viewed from a “naturalness of human existence” perspective, humans have an innate desire to return to the natural environment of the phylogenetic past (Sitte, 1965). The naturalness of human existence hypothesis finds empirical support in several landscape

perception studies that repeatedly find preference for natural versus man-made landscapes (Ulrich, 1983), a preference within man-made settings for the presence of natural elements (Brush & Palmer, 1979). From this perspective, the presence of water, the quintessential element of nature, symbolizes the former existence of humans in a more natural environment.

Human responses to aquatic environments emanate from the sound, smell, taste, and feel of water, as well as from the sight of it. Cool, refreshing and thirst-quenching water is not only a life necessity, but one of life's great pleasures. All over the world, in countless urban public open spaces, drinking fountains have been designed to provide abundant fresh water, monumental fountains have been rife with symbolic connotations, and interactive fountains have been entertaining children and the young at heart (Symmes, 1998). A spraying fire hydrant can transform a sweltering city surface into an urban oasis. The sound of moving water – whether a roar or a whisper – breaks the stillness and provides aural refreshment to the general public.

In order to understand the magic power of the sound of water, a series of water features have been selected from the Peace Gardens in Sheffield, the Chatsworth Garden, Rome and Tivoli, etc. for the soundscape study.

8.1.1 Water as Sound Masker - Fountains in the Peace Gardens

As described in Section 3.2.4, the water features in the Peace Gardens provide the most attractive characteristic of this city centre square. As shown in Figure 8.1, the Goodwin Fountain, which can be noticed both aurally and visually, is the focus point. Water issues from 89 jets (the aerated water comes from nozzles recessed in small holes) which are flush with the well patterned Yorkshire stone pavement. There is no fountain pool or other barrier, so people have immediate access to the water. As a constantly changing three dimensional sculpture, the playful choreography of jets may rise and fall in different strengths, enthralling people with their unpredictable sequences.

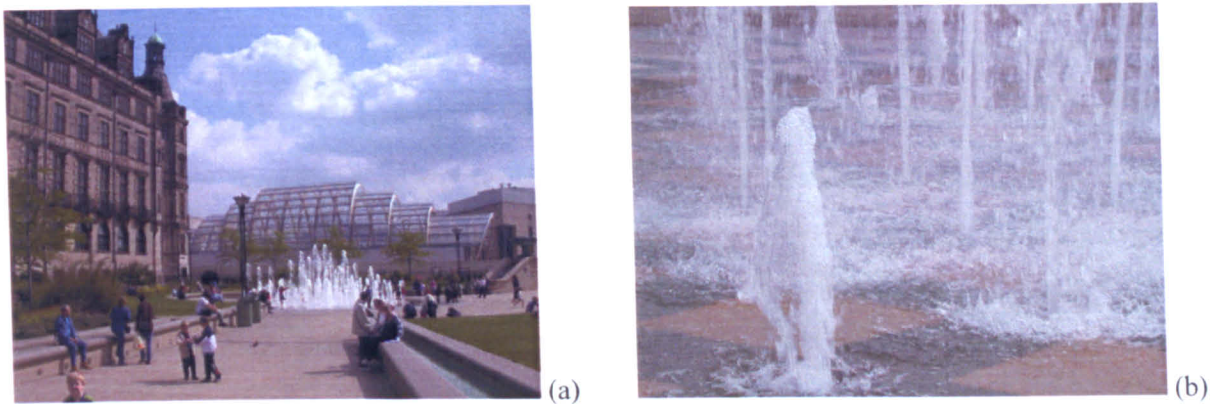


Figure 8.1 The Goodwin Fountain in the Peace Gardens

There is no need to look for the fountain because the splashing sound of water attracts people's attention. Although within the city centre and with busy traffic on one side of the square, there are times traffic noise is scarcely noticeable. Only the beautiful sound of water prevails, creating, in effect, an urban oasis.

In Chapter 4, from the analysis of subjective evaluation towards individual sound elements, it is shown that the acoustic comfort evaluation is greatly affected by the sound source type. When a pleasant sound such as water or music dominates the soundscape of an urban public open space, the relationship between the acoustic comfort evaluation and the sound level is considerably weaker than that of other sound sources such as traffic and demolition sounds. From the field survey of the Peace Gardens, it has been found that when the fountain sound is the main sound source, the increase in the noise level has almost no effect on the acoustic comfort evaluation. In other words, the introduction of a pleasant sound could considerably improve the acoustic comfort, even when its sound level is rather high. In order to find out the reason, the spectrum and dynamic range of the soundscape in the Peace Gardens are studied in this section.

A series of recordings were carried out using the 01dB Symphonie Measurement System (01dB-Stell, 2001) on the 29th of November 2002. During the recording a pre-polarised microphone connected to a two channel data acquisition unit, which transfers data in real-time to a notebook computer, via a PCcard interface. Combining the

functions of several instruments, Symphonie was used to record the raw audio signal (function as a DAT recorder) while measuring the sound level time history (function as a data-logging integrating sound level meter) and visualising a frequency spectrum in real time (function as a real time frequency analyser).

Three measurement points were positioned in the Peace Gardens, as shown in Figure 8.2. Point M1 was 1.5m away from the Pinstone Street, which was the direct source of traffic noise. Point M2 was 1.5m away from the Goodwin Fountain, which was the direct source of the water sound. Point M3 represented the typical sound in the Peace Gardens. The measurement method was in accordance with the specification, for noise surveys in the Noise Guidance (Environment Agency, 2000). All the measurements were taken at 1.2m above the ground level. During the measurement, the weather condition was good and the wind speed was less than 5m/s.

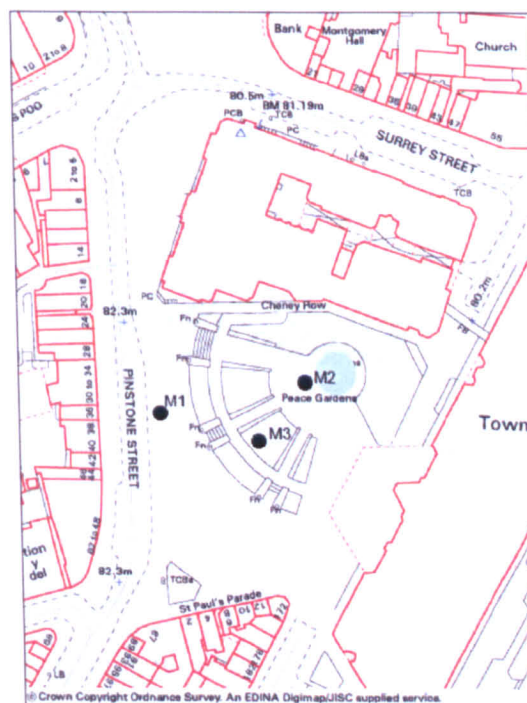
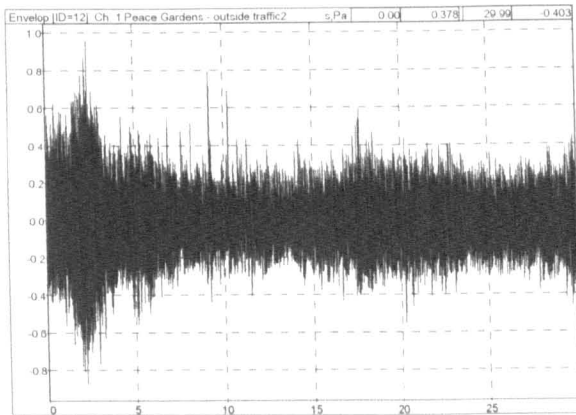
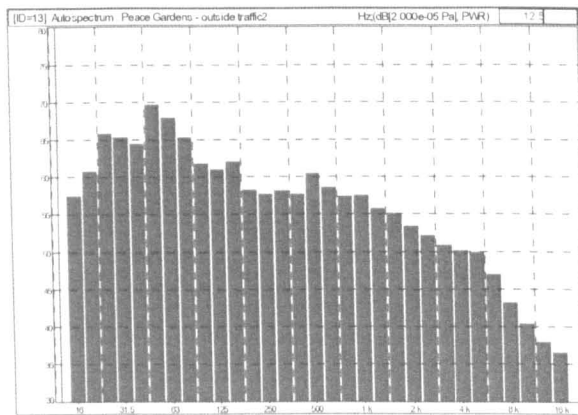


Figure 8.2 Plan of the Peace Gardens with measurement points

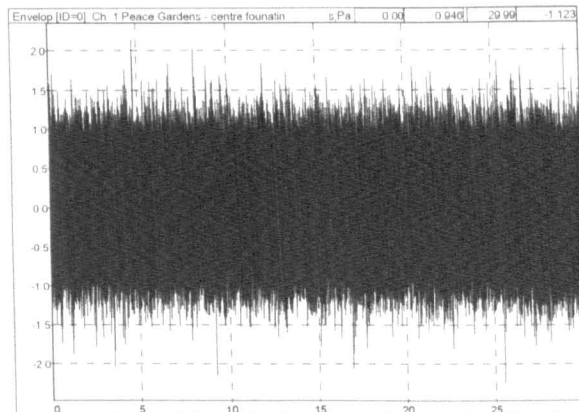
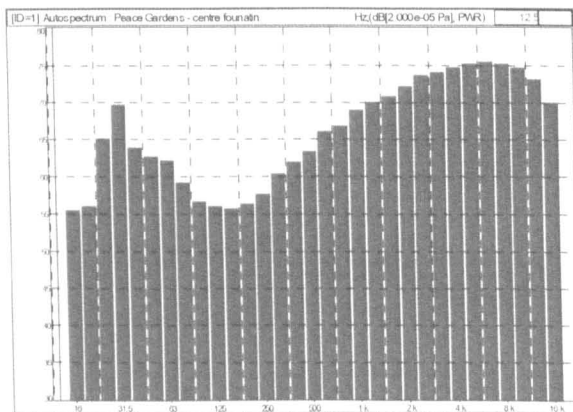
Figure 8.3 illustrates the spectra (1/3 octave) and dynamic range of the sounds in the Peace Gardens. In terms of spectrum, in comparison with the water sound from the Goodwin fountain in the Peace Gardens, the traffic noise from the road outside has notable low frequency components, as can be seen in Figure 8.3(a). In contrast, as

shown in Figure 8.3(b) and although it has some low frequency components, the water sound has many more high frequency components. It is important to note that the typical soundscape of the Peace Gardens combined the main characteristic of the two main sound sources. As shown in Figure 8.3(c), the overall soundscape of the Peace Gardens has more low frequency components, but the high frequency components are more than that of the traffic noise. In terms of dynamic range, traffic sound has variable dynamic range, whereas the water sound has large, but less variable dynamic range. As a result, the typical dynamic range of the Peace Gardens soundscape is at a relatively medium level, but less varied.

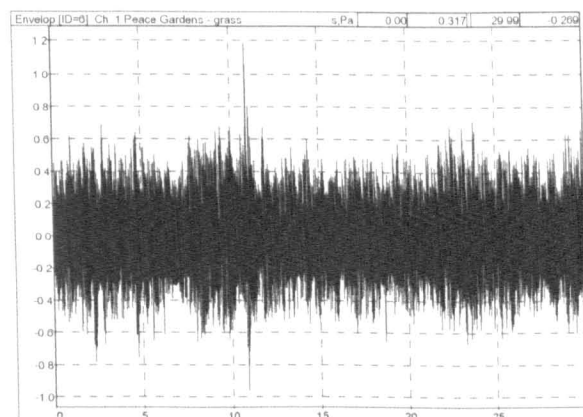
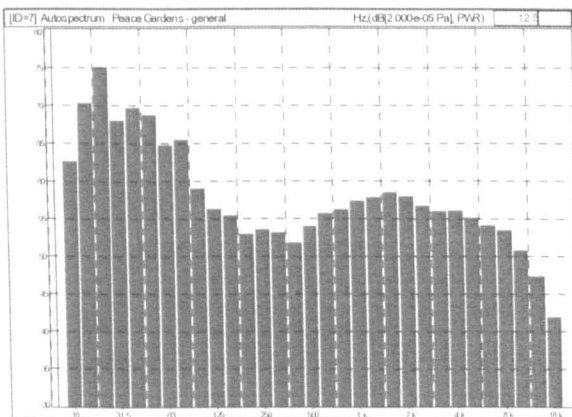
In Figure 8.4, the spectra of the three sounds are compared. The possibilities of masking can be seen in the figure. Generally speaking, the masking effect is highly dependent on the SPL of the masker. At low SPL, the masking effect tends to be similar for frequency above and below the frequency of the masker. As the SPL of the masker is raised the low masks high effect increases and the resulting masking level curve becomes increasingly asymmetric, which results in the masking effect being considerably greater for maskees which are above rather than those below the frequency of the masker (Howard & Angus, 2001). Therefore, it is easy for low frequency sound to mask the high frequency sound. The existence of low frequency components in the water sound has effectively masked the low frequency components in the traffic sounds. Although, it is very difficult for high frequency sound to totally mask the low frequency sound, the increase of high frequency components has improved the overall sound tone to be richer in the Peace Gardens. Also the water sound has improved the dynamic range of the overall soundscape to be smaller and more consistent, which is found to be more pleasant as a background sound (Kang & Du, 2003).



(a) traffic noise outside the Peace Gardens at Point M1



(b) the fountain sounds in the Peace Gardens at Point M2



(c) the soundscape in the Peace Gardens at Point M3

Figure 8.3 Spectra and dynamic range of the sounds in the Peace Gardens

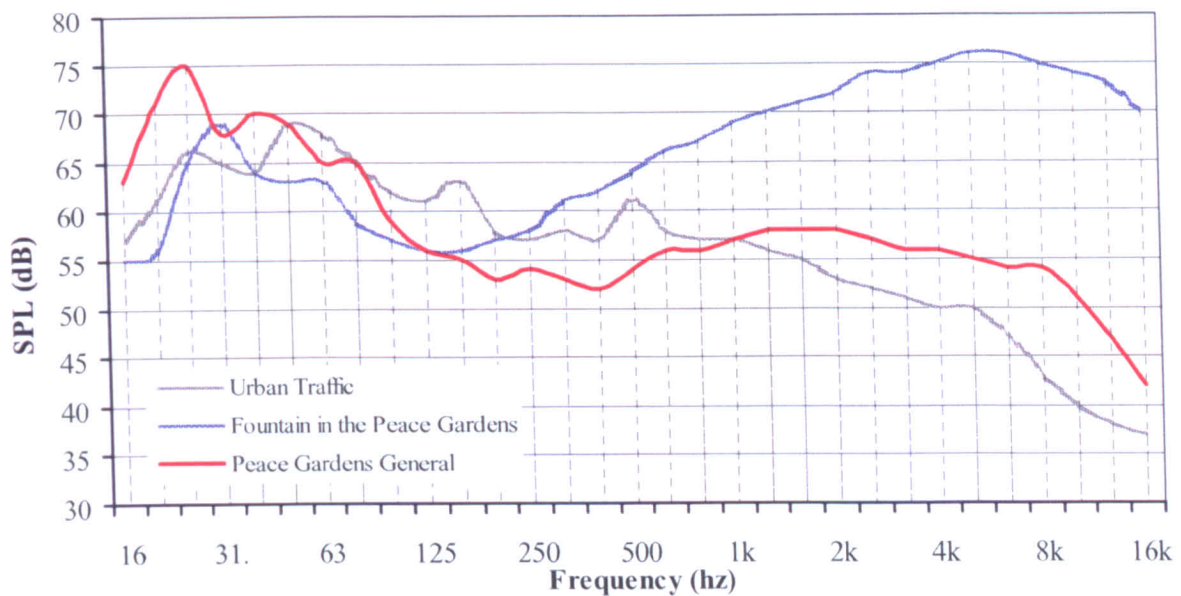


Figure 8.4 The comparison of the sound spectra in the Peace Gardens

8.1.2 Water as Spectrum Enricher – Water Features in the Chatsworth Garden

From the spectrum analysis of the Peace Gardens, it has been found that there are notable high frequency components in the fountains sound, as well as low frequency components. In order to compare the different frequency components of different fountain forms, more sound recordings have been carried out in the Chatsworth Garden.

The Chatsworth house and its garden is one of the most splendid estates in England. Famous for its waterworks and fountains, while not as lavish as those at Versailles or at other villa and palaces on the Continent, the Chatsworth Garden is in perfect harmony with the natural beauty of the Peak District. From 1687 to 1706, William Cavendish, the first Duke of Devonshire, created the original house and extensive formal gardens.

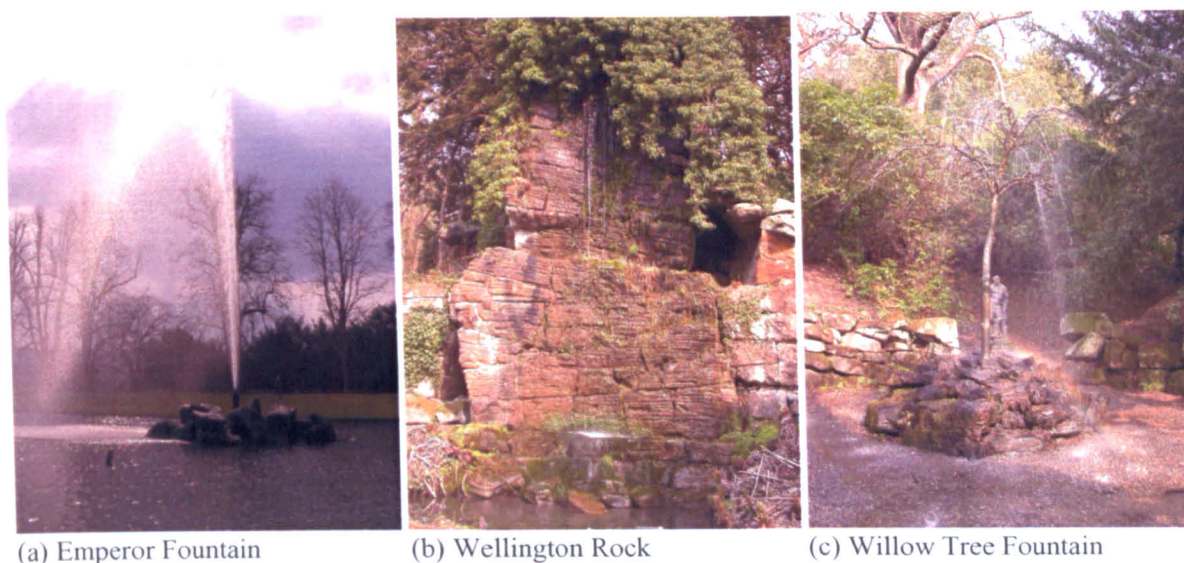
Constructed in 1844, the Emperor Fountain, shown in Figure 8.5(a), rises dramatically from the Canal Pond and is regarded as the most spectacular fountain at Chatsworth. Never before had water jets in England achieved such heights. As recorded by the Duchess of Devonshire in 1999, the nozzles of the jet were made of brass, and the normal jet would play 81m and is on record as having reached 90m. The Emperor

Fountain was powered by a system of hydraulic technology that was remarkable in its day (Astley, 1998). The lake could release almost four thousand gallons per minute at peak capacity to activate the gigantic jet.

Another dramatic man-made water feature in the Chatsworth Garden is the Wellington Rock, shown in Figure 8.5(b). Falling water drops from 13.7m in height to its pond. Like so much in the garden, the waterfall appears to be natural. The rock is made up of many big stones cemented together and the water is piped from a stream above (the Duchess of Devonshire, 1999).

As pictured in Figure 8.5(c), the Willow Tree Fountain, made in 1693, reflected the European taste for ingenious joke fountains that suddenly drenched unsuspecting visitors who had paused to admire its lifelike qualities (Astley, 1998). The Willow Tree Fountain was composed of eight thousand pieces of copper and brass and had eight hundred jets of water hidden in the branches and leaves. It has been placed in the middle of artfully arranged natural landscape. In the winter the willow tree looks so much like the other leafless trees that its trick of wetting the unwary is all the more successful.

The recording of the fountain sounds in the Chatsworth Garden was carried out on the 20th of April, 2003. A Solo data logging integrating sound level metre was used to record and analyse the sound signals (01dB-Stell, 2002). The recording point was taken at the closest positions to each water feature where accessible to the general public, generally within 0.5m distance. Therefore, the sound level recorded for each water feature is not the absolute SPL generated from the water, but the typical SPL that can be heard by the visitors of the garden. The spectra of the Emperor Fountain, Wellington Rock and the Willow Tree Fountain are shown in Figure 8.6. In order to understand the characteristic of the water sounds, an urban traffic sound spectrum, which was recorded by the Solo sound level metre at a point 1.5m away from a typical road in the Sheffield City Centre, is also shown in Figure 8.6.



(a) Emperor Fountain

(b) Wellington Rock

(c) Willow Tree Fountain

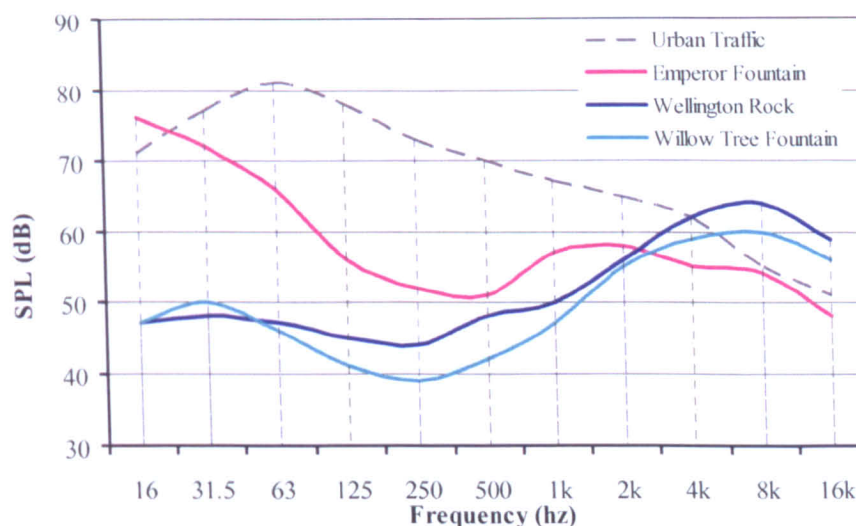
Figure 8.5 Fountains in the Chatsworth Garden**Figure 8.6** The comparison of the spectra of the sounds in the Chatsworth Garden and urban traffic noise

Figure 8.6 shows that in comparison with the urban traffic sound, the spectra of the water sounds are significantly different in terms of their frequency components. Raised to around 80m high and then falling to hit the water of the Canal Pond, the water from the Emperor Fountain generated a very high level of low frequency sound. The peak SPL is more than 66dB around 63Hz. Different from urban traffic noise, which has a peak SPL of 81dB appeared at 63Hz and lowest SPL of 52dB at 16kHz, the sound from the Emperor Fountain has the lowest SPL of about 50dB at both 500Hz and 16kHz. It is interesting to find that both have relatively low level of water flow and the water fell first on a hard surface. Sounds generated from the Wellington Rock and Willow Tree Fountain both have notable high frequency components and weak low

frequency components. For example, the sound from Wellington Rock has a SPL of 64dB at 8kHz, but only 47dB at 63Hz.

The frequency components differences above suggest that different fountain forms, in particular, different water flowing methods result in different sound frequencies. The most likely explanation is the high frequency components come from the water splash itself. Also by dropping on the hard surface, like the Wellington Rock, the high frequency components within the water sound are even more amplified. It is also found that when the large flow of water rises to a very high level and then drops to a water body or hard surface, like the Goodwin Fountain in the Peace Gardens and the Emperor Fountain in the Chatsworth Garden, notable low frequency components are contained in the sound generated.

Another fantastic water feature in the Chatsworth Garden, the Cascade as shown in Figure 8.7, is one of the most dramatic splashing and rushing water features in the world. It was originally designed in the 1690s by Grillet and redesigned by Paxton around 1830 (Astley, 1998). At the Cascade, a sheet of running water flows over 24 groups of elegant steps, down from the baroque pavilion to drop abruptly into a culvert at the bottom. The height of the paving stones, over which the water flows, the numbers and widths of the 24 groups of steps are all different. Therefore, the running water sounds are all different.



Figure 8.7 Cascade with Temple Pavilion in the Chatsworth Garden

In order to further investigate the water sound spectrum and its form, on the 20th of April 2003, the Solo sound level metre was used to record the water sound from the Cascade. As shown in Figure 8.8, four representative groups of steps were selected for the recording. The first two groups, shown in Figure 8.8(a) and (b) have a small number of steps, whereas the second two groups, shown in Figure 8.8(c) and (d) have up to 7 steps. In order to avoid recording sound from adjacent step groups, the recording point of each step group was positioned as close as possible to the water fall. As shown in Figure 8.9, the recorded sound levels of each step group are rather similar. According to the Inverse Square Law and the recording position used, the sound level from adjacent step groups will attenuate at least 12dB. This suggests that the sound generated from adjacent step groups had negligible effect to the accuracy of the sound recording of the 'target' step groups.

In Figure 8.9, comparison was made with spectra of the different steps. It is interesting to note that all the water forms in the Cascade have notably rather similar medium to high frequency components from 1k to 8kHz. The SPL of the medium to high frequency is ranging around 70 to 75dB. However, with the difference in step forms, the SPLs of low frequency components are significantly different. The group of 2 steps has the highest low frequency SPL. The sound is 65dB at 31.5Hz, which is even higher than the higher frequency of that sound. However, the group of 7 steps has the lowest SPL at low frequency, at 54dB at 31.5Hz. This is probably because the step height varies in each group, resulting in running water falling on both hard surface and sometimes on the spray water. Therefore, each group of steps is generating a different frequency sound.



Figure 8.8 Step forms of the Cascade in the Chatsworth Garden

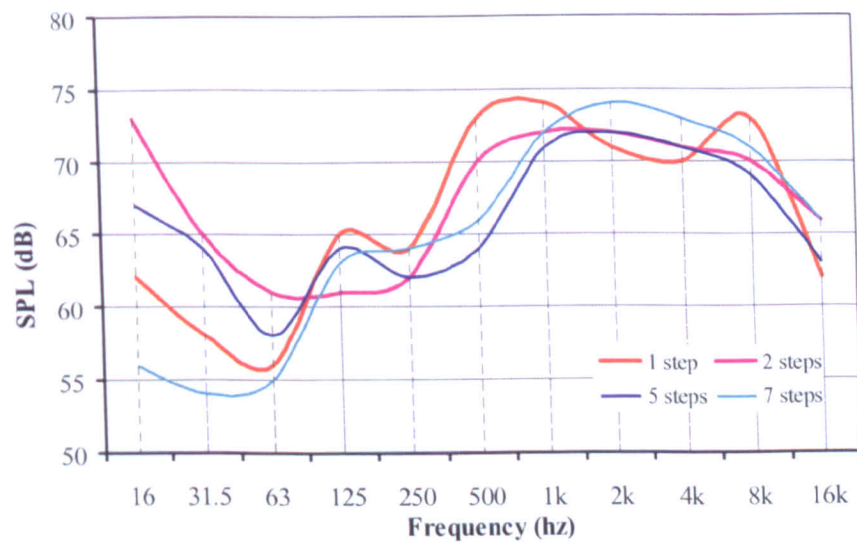


Figure 8.9 The comparison of sound spectra amongst different step forms of the Cascade

In terms of water feature design, in particular considering the soundscape characteristics, it is of great importance to understand the existing background soundscape. When the background sound is traffic noise, which has considerable low frequency components, in order to mask it, it would be necessary to design larger water features with considerable water fall from higher level. However, designing a small flow of water with hard surface may be the choice of generating pleasant high frequency sound in any soundscape background.

From the spectrum analysis for the fountains in the Chatsworth Garden (see Figure 8.6 and Figure 8.9) and the Goodwin Fountain in the Peace Gardens (see Figure 8.4), it is interesting to note that most of the water sounds have significant high frequency components at around 2k to 8kHz. According to the equal loudness contours (Egan, 1988, Croome, 1977), human ears are most sensitive to tones in the region between 2k and 5kHz where the threshold curve is at its lowest. This means that at the same sound level, the sound whose main frequency is 2k to 5kHz is perceived louder than other frequency sound. This result perhaps can explain why water sound is always distinctive from the background sound. Because of this characteristic of the water sound, it may not be able to mask the low frequency background sound (e.g. traffic sound) in terms of psycho-acoustic experiments. However, the high 2k to 5kHz frequency components contained in the water sound can act as sound spectrum enricher, which enriches the overall spectrum. Therefore, from a psychological point of view, people feel more positive about the overall soundscape, although they may still be able to hear the traffic sound.

8.1.3 Water as Legend - Fountains in Rome

There are no other cities in the world that have as many fountain masterpieces as Rome. Two thousand and eight hundred years of water infrastructure and continuous urban development have resulted in fountains being built all over the city. They are located in front of the cathedrals, in the centres of urban squares and at the corners of

the streets. Water is a living system that includes natural features (springs, the Tiber River, etc.) and hydraulic elements (aqueducts, bridges, fountains, etc.) that are linked through topography (Rinne, 1998). The revival of the fountains was vital to the reestablishment of Rome as the centre of spiritual and political life. The forms of fountains have been inconsistent and changing like the waters in the fountains themselves. In this section, several fountains in Rome are introduced because of their great connection of visual and aural forms. It is the running water that gives life to the sculpture, and it is the sculpture that gives spirit to the water.



(a)



(b)



(c)



(d)

Figure 8.10 Fountains in Rome
(a) the Trevi Fountain
(b) the Four Rivers Fountain in Piazza Navona
(c) the Fountain of the Bees,
(d) drinking Fountain in Villa Borghese

Ranked as one of the Rome's most-loved symbols, the Trevi Fountain, shown in Figure 8.10(a), has always been regarded as a glorious monument rather than just a great artwork. The fountain conjoins the organic and constructed worlds of stone in architectural form. Animated by gravity and a host of small nozzles, its water falls in sheets, spilling from basin to basin, spreading and gaining in volume with each inferior tier (Symmes, 1998). The arrangement of three basins of diminishing widths also forces the perspective and exaggerates the apparent depth of the cascade. Caught in the brilliance of sunlight, the sparkle and spectacle of the fountain's waters contrast markedly with the shaded periphery, augmenting their visual effect (Symmes, 1998). The impetuous mass of water composing the leit-motif of the entire fountain, and the non-stop performance from dawn to evening overwhelming the whole plaza, here the melody of waterworks transforms the tumultuous urban life into a delightful spectacle.

As illustrated in Figure 8.10(b), the Four Rivers Fountain is situated at the centre of the Piazza Navona, which has long been one of Rome's favourite gathering spaces for the upper classes and is arguably the city's most famous example of continuity in town planning. Designed by Bernini, it is a scenographic *tour de force* (Symmes, 1998), whose poetic conceit is based on the allegory of the greatest rivers then known. It features four marble river gods supporting a fifty-four feet high Egyptian obelisk, crowned by a cross bearing the arms of the Pamphili dove. The impetuous waters of cascades and jets here create a rich spectrum of soundscape, which enhances the magnificence of one of the liveliest places in Rome.

The Fountain of Bees, shown in Figure 8.10(c), was originally a drinking trough and was repositioned to its present location in 1917 (Venturi & Sanfilippo, 1996). Its current configuration comprises a large scallop, whose top half is open in a vertical position, exposing the contents. At the join, three giant bees are arranged symmetrically, seemingly zipping the fine jets of water that spout steadily into the lower valve of the shell.

Unlike above ornate cousins, this typical drinking fountain shown in Figure 8.10(d) serves the ordinary and brings a kind of plain beauty to urban life. Its graceful single jet creates clear, simple sound, breaking the silence and reflecting the essence of life.

8.1.4 Water as Music and Fun - Fountains in Villa d'Este, Tivoli

There is no such a place in the world which has as much fun with water as in Villa d'Este, one of the most spectacular country retreats in 16th century's Italy. Its promise of clean, cool air and refreshing water provides visitors with endless delights and surprises. Its fountains, ranging from small, gurgling spigots to roaring cascades, from water-propelled automata to drenching water jokes, entertain and revitalize visitors. Not only does water express a variety of visual forms, it also conveys a variety of sounds. In Villa d'Este, the water is manipulated to create sensual effects so that one will be continuously diverted from the garden's main axis throughout the ascent and urged to explore its paths by following the varying sounds of water.



(a)



(b)

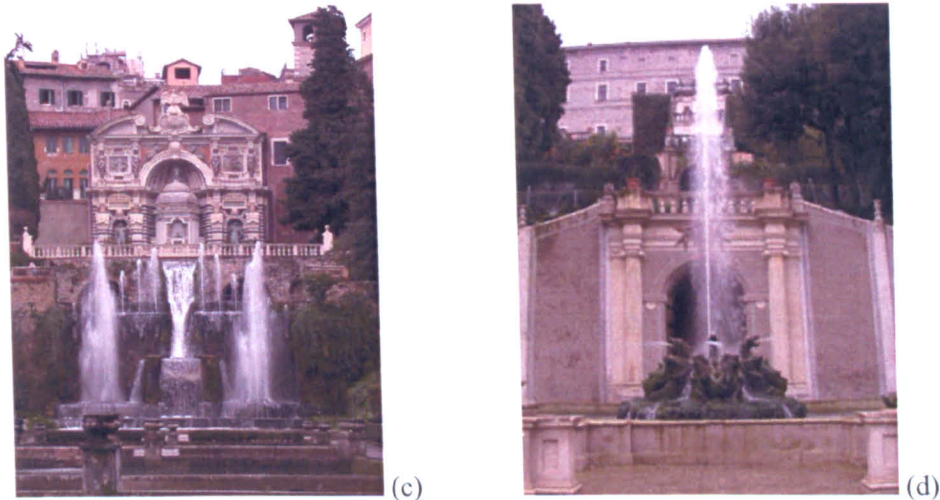


Figure 8.11 Fountains in Villa d'Este, Tivoli, Italy
 (a) the Hundred Fountains
 (b) the Fountain of Tivoli
 (c) the Fountain of the Organ & the Fountain of Neptune
 (d) the Fountains of Dragons

Illustrated in Figure 8.11(a), the Hundred Fountains border a 100-meter long, straight path leading from the 'Rometta' fountain to the Fontana dell'Ovato. Each small fountain here is adorned by carved relief such as lilies, obelisks and boats, and is capped by an Este eagle. Allegorically, the thin spurts of water, fed by the hundred jets, represent the Aniene River, which runs from Tivoli to Rome and joins the Tiber (Lozzi Roma, 2002). Operating in continuous succession, vigorous water falls into two parallel channels, setting a quick rhythm and forming one single play.

The Fountain of Tivoli, also known as the Ovato, is the most prominent of the water works and key to the garden's iconographic program. As shown in Figure 8.11(b), the baroque fountain takes its name from its oval shape basin, which is surrounded by a wall punctuated by arches and niches containing nymphs. The fountain is featured by a centre piece of an overwhelming cascade, whose semicircular form stretches the water, creating a mighty veil that drops down in a resonating dome (Symmes, 1998). Walking through the cave-like darkness behind this crystal-clear curtain, wet with its spray and deafened by its roar, visitors have the unique experience of becoming part of the fountain. The Ovato is admirable for not only its profusion of ornamental motifs, but also the harmony between people and the natural sounds.

Among the garden's greatest delights are the water-driven automata, exemplified by the Fountain of the Organ, or the Hydraulic Organ as its original name. Shown in Figure 8.11(c), it took its name because it was connected to a water-driven mechanism that intimated the sounds of an organ. The theory is: the water drops through a conduit into an underground cavity, forcing a strong draft of air through the organ pipes; then another heavy jet of water slowly rotates a toothed copper cylinder mounted on an iron frame which moves the keys of the organ, playing madrigals and motets (Lozzi Roma, 2002). As the water is regulated, the organ pipes play automatically so that unsuspecting visitors would not believe that such a vivid music come from a simple hydraulic mechanism.

Just below the Hydraulic Organ lies the Fountain of Neptune, which is the youngest in the garden. It is featured by boldly grafting several water displays onto Pirro Ligorio's original waterfall. The fountain grows smoothly out from its large base, gradually intensifying and becoming ever livelier as it climbs up to join the balustrade of the above Fountain of the Organ. The symmetrical jets hurl skyward in a fluid pyramidal pattern that brings to mind a vision of vibrating organ pipes. Although the compact and thundering mass of water composes the driving motif through the cascades and jets, it is eventually calmed down at the lowest basin to suit the tranquil Fish Ponds. Thus a series of tumultuous foaming torrents are gradually transformed into an emerald stretch of water (Lozzi Roma, 2002), mirroring the flowing clouds and the peaceful sky.

The Fountain of the Dragons is the dominant motif at the very heart of the garden, as shown in Figure 8.11(d). Designed by Pirro Ligorio, the fountain is featured by a group of horrid dragons in the centre, with open mouths and wings frightening those who look upon them. Previously, it was also called the Fountain of Girandola, which means rotating fireworks. The name came from its complicated waterworks, which produced a rapid succession of explosions, cannon shots and blasts that resembled fireworks in Rome. Recent years have seen several spouts restored, with fascinating water jets roaring skyward and filling the air with 'resounding pistol cracks'. Actually, by changing in form from single tall jets to umbrella-like sprays it can also mimic the

gentle patter of rain. This graceful, vivacious fountain is the perfect combination of architecture, sculpture, art and music.

8.1.5 Water as Urban Oases - Contemporary Fountains

Nowadays, with the development of modern technology, contemporary fountain design is more and more user orientated. Multimedia technology has been involved in the fountain design. As shown in Figure 8.12, sound, music, light, colour and people's activities can be brought together by a single interactive fountain. The great success of these fountains comes from people's involvement. "*Children play in it, seniors watch they play in it, and the middle-aged wonder if they are still young enough to play in it*" (Treib, 1998). Their water splashes, create a spectacle and their coolness draws great attention.



(a) a fountain in London



(b) a fountain in Venice

Figure 8.12 Interactive fountains in urban public open spaces

8.2 PEOPLE'S ACTIVITIES

The success of public open spaces relies on how people use them. A beautiful urban square, without any person using it, is a failed design. The designer cannot enforce people to use the space. However with a thoughtful design, a place can be attractive to the general public, for them to see and to be seen, to listen and to be listened to. People and their activities provide urban life with unlimited possibilities in terms of soundscape. Therefore, in this section, an 'undesignable' soundscape element, people's activities, is discussed. The section includes two parts. The first part is to discuss how

to design space to provide opportunities for street activities; and the second part is especially about music, which is one of the most popular street activities.

8.2.1 Providing Opportunities for Outdoor Activities

Providing a suitable place for people to generate active sounds is important. As analysed in Section 5.3, sounds generated by interesting activities may add dramatic elements to the soundscape, and thus increase the range of psychological adaptation. As shown in Figure 8.13, the unlimited activities can happen in any forms in any part of the world.



Figure 8.13 Outdoor activities

The generation of activities depends on suitable space forms and physical factors, since these characteristics of a place provide the possibility for certain types of activity. On the one hand, the form of the hard space in squares is very important for the generation of activities (Yang & Kang, 2001). On the other hand, green land affects the microclimate and noise levels in a square. Therefore, the arrangement of hard space, green land, as well as thoroughfares, is very important for public open space design. To analyse this, different arrangements are studied.

Figure 8.14 shows three types of urban square, according to the arrangement of these elements. For the first type, the square is sub-divided into discrete green land areas. No single large area of hard space can be used for people's activity. Thus this kind of square is mainly used as a pedestrian thoroughfare. As a consequence, it is difficult to generate active sounds.

For the second, several areas of hard space are positioned directly against the boundary. This form provides the possibility of different activities taking place together. Sometimes, even the pavement can be used for activities. More than one type of active sound can be generated there. Users have more flexibility to choose the activity place. But any user wanting to pass through the square unavoidably passes at least one activity area. Consequently, in passing through the square, impeded conditions will occur when the activities are taking place.

In the third type of square, hard space is located in the core of the space. The thoroughfare makes it easy to access the hard space, as well as the sub-divided green spaces around the whole square. The definite edge of the hard space also allows other activities to take place. If a user just wants to pass through the square, he/she can choose a way around the core activity area without being impeded.

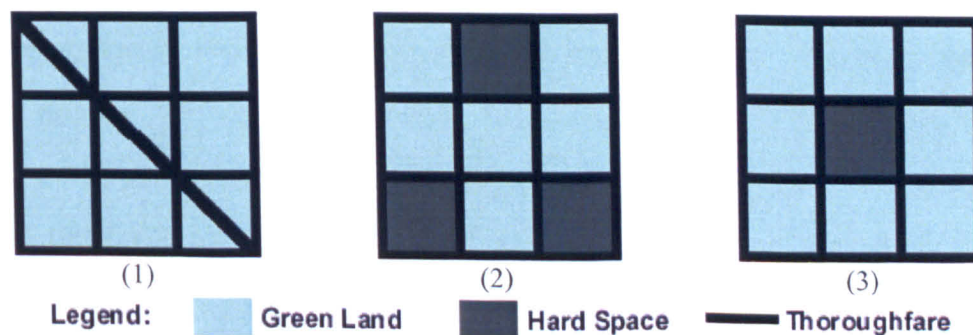


Figure 8.14 Three types of square form

8.2.2 Music

Of all the street/square activities, playing music is the most popular. Yalch and Spangenberg's (1990) research found that clothes shoppers reported they spent more unplanned time in-store when music was played. One possible explanation for these

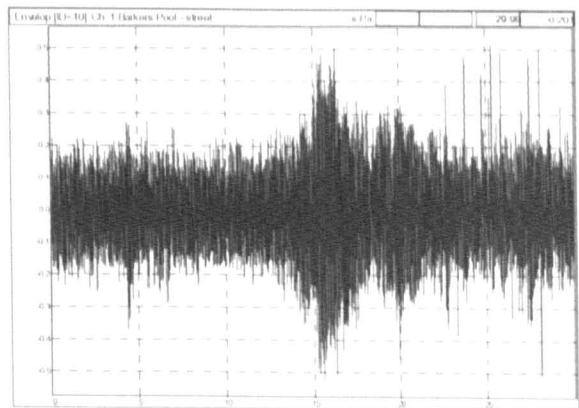
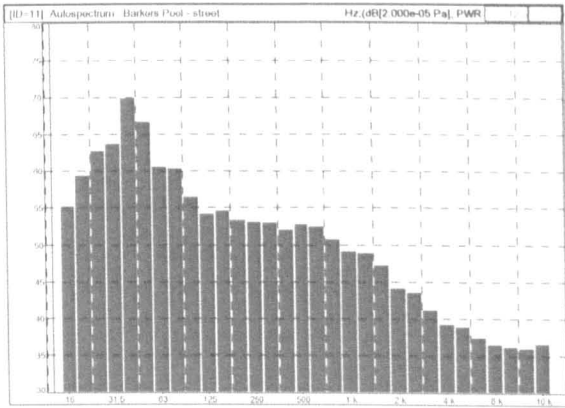
results is that waiting time should increase in the presence of liked music and decrease in the presence of disliked music. A considerable amount of research has supported Berlyne's (1971) theory that liking musical pieces can be predicted by their complexity: pieces of moderate complexity (unpredictable, erratic, and varied) generally are preferred to those of either low or high complexity, giving rise to a so-called inverted-U relation between liking and complexity (Finnas, 1989; Hargreaves, 1986; North & Hargreaves, 1997). This is because pieces of moderate complexity elicit maximum arousal in pleasure centres of the brain but without bringing about arousal in displeasure centres (Berlyne, 1971). In contrast, pieces of low complexity bring about little activity in either the pleasure or displeasure centres; pieces of high complexity bring about high levels of activity in displeasure centres, which override activity in pleasure centres. North and Hargreaves (1996) found that moderate-complexity pop music led to the greatest number of people visiting the source of that music, a student welfare advice stall set up in a university cafeteria; high- and low-complexity music and also no music led to fewer visitors. The further study of North and Hargreaves (1999) indicated that listening to music should lead to specifically longer subjective time estimations than no music, because music increases the amount of the information that participants are required to process. This increase in subjective time, in turn, should have meant that music led to shorter actual waiting times than no music. Their results are obviously disappointing in commercial implications; however, their results indicated another way in which background music can influence responses to the listening environment. They suggested that any attempt to explain music listening behaviour must also account for its effects on responses to the context in which this occurs.

From the previous analysis of the Barkers Pool in Section 4.4, it is found that, with a given Leq, people felt quieter when there was no music. However, when music was played in the background sound, the variation in acoustic comfort evaluation is negligible with an increase in sound level, suggesting that the existence of music can make people feel more acoustically comfortable.

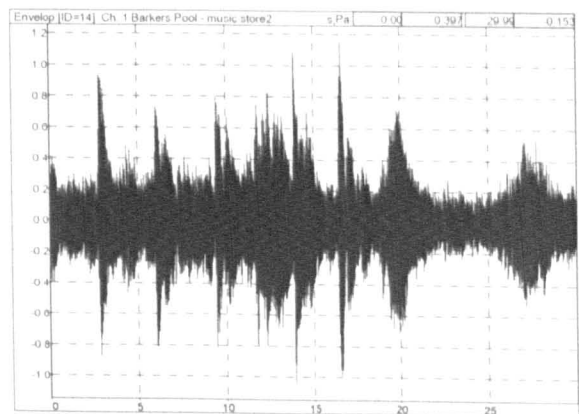
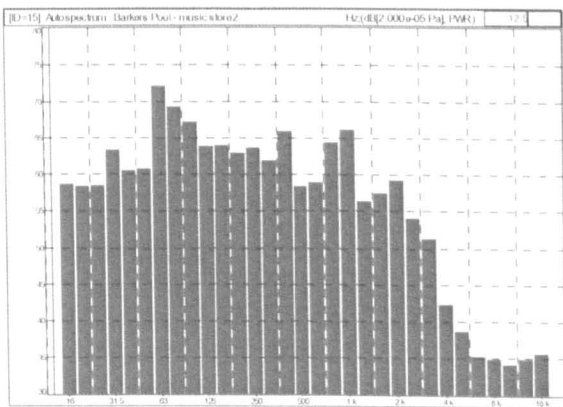
In order to further investigate the reason, a series recording was carried out using Symphonic measurement System on the 29th of November 2002 with good weather conditions (see Section 8.1.1 for more measurement details).

Figure 8.15 illustrates the spectra (1/3 octave) and dynamic range of the traffic noise outside of the Barkers Pool, the music played in the Sheffield City Hall, and the general soundscape of the Barkers Pool. The recording points were positioned at the paving next to the road, staircase of the Sheffield City Hall and the central of the Barkers Pool, respectively. In comparison to the traffic sound, shown in Figure 8.15(a), the music sound from the Sheffield City Hall not only had notable low frequency components, but also had much more medium frequency components. In terms of dynamic range, the music sound was more variable, but the variation had its rhythm. Therefore, the overall soundscape in the Barkers Pool combined the characteristic of both sound sources, with both notable low frequency and medium frequency components. The dynamic range of the overall soundscape in the Barkers Pool was larger, but less varied.

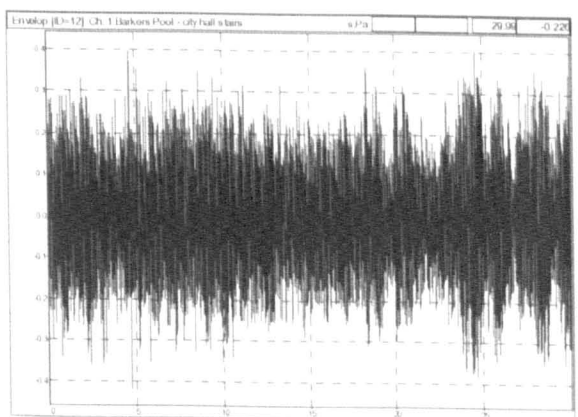
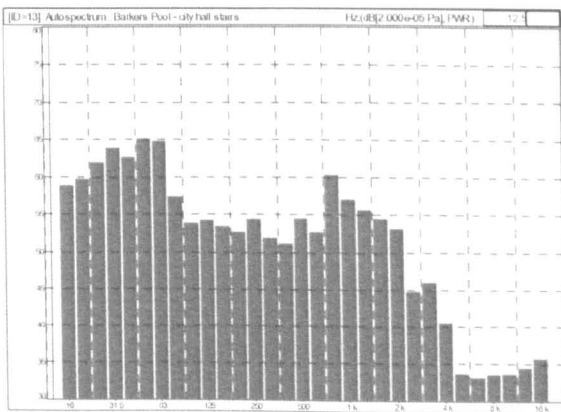
In Figure 8.16, the three sound spectra in the Barkers Pool are compared. It can be seen that the low frequency components in the music were not loud enough to mask the traffic sound. However, high frequency components contained in music bring it forward by comparison with other sounds and resulting in a more acceptable soundscape. Therefore, although people can still hear the background traffic sound, the existence of pleasant music sound makes the traffic sound less significant from psychological point of view. This is the reason why people estimate the sound level was rather high when music was played in the Barkers Pool. However, because of the preference to the music, the variation in acoustic comfort evaluation towards music was negligible with an increase in sound level.



(a) traffic outside of the Barkers Pool



(b) music in the Barkers Pool



(c) general soundscape of the Barkers Pool

Figure 8.15 Spectra and dynamic range of the sounds in the Barkers Pool

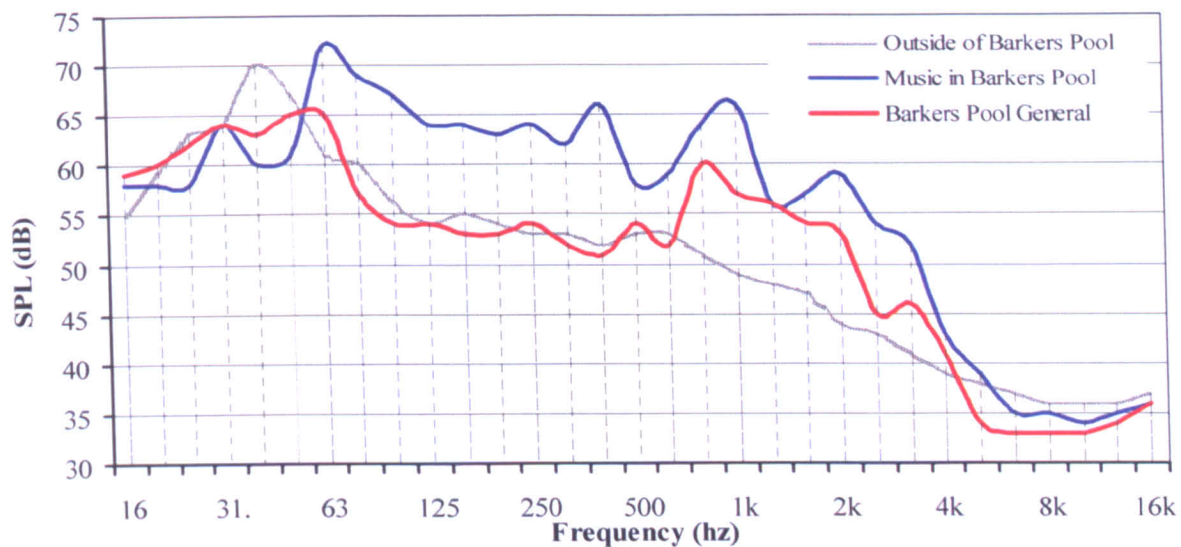


Figure 8.16 The comparison of sound spectra in the Barkers Pool

8.3 SUMMARY

In this chapter, discussions are concentrated on sound elements and activities. Firstly, as an example of soundscape elements, water features were analysed from their sound masking effect, spectrum enrichment function, spiritual life, fun making, as well as contemporary design tendencies. Water, in the form of fountains, is proved to have endless effect in colouring the soundscape in urban public open spaces.

From detailed spectrum and dynamic range analysis for water sounds, it is found that most of the water sounds have significant high frequency components around 2k to 8kHz and some of them also have notable low frequency components. This result probably can explain why water sound is always distinctive from the background sound. For the overall soundscape, the introduction of water sounds can effectively enrich the spectrum. Therefore, from psychological point of view, people show more acceptance of the overall soundscape, although they may still able to hear the background noise.

Furthermore, it is found that the spectrum of water features is designable. Different water flow methods result in different sound frequencies. Generally speaking, high frequency components come from the water splash itself. Also by dropping on the hard surface, the high frequency components within the water sound are even more amplified. When the large flow of water rises to a very high level and then drops to a water body or hard surface, notable low frequency components are contained in the sound generated.

In the chapter, discussion is also focused on how to provide opportunities for street activities. According to the different arrangements of hard space, green land and thoroughfares, three types of urban spaces have been analysed. It is suggested that the defined edge (e.g. by walls, colonnades, or shrub planting, etc.) encourages activities to take place.

Finally as one of the most popular street activities, music has been studied in terms of soundscape. Similar to water sounds, it has been found that the low frequency components in the music are not loud enough to mask the traffic sound. However, high frequency components contained in the music have brought the music sound out from the other background sounds and make it more pleasant.

Chapter 9

Conclusions and Future Work

The main aim of this thesis is to establish a systematic framework for soundscape design considerations in urban public open spaces. This thesis has considered and explored the key elements of a desirable soundscape in urban public open spaces. The discussions are focused on three questions: (1) why soundscape, broadly conceived, is an important aspect of urban public open space evaluation; (2) what kind of soundscape is more desirable in urban public open spaces; (3) how to achieve a more desirable soundscape in urban public open spaces. From an aesthetic approach, this thesis has focused on the essential characteristics of sound as well as its interaction with people – users of public open spaces, and spaces – containers of the soundscape.

This is not, of course, an argument for an ideology of the aural to replace the hegemony of the visual aspect. It is rather a plea for the more explicit incorporation of soundscape design in particular into the consideration of public open spaces.

9.1 CONTRIBUTIONS OF THE STUDY

9.1.1 Theoretical Framework

From the beginning of this thesis, soundscape of urban public open spaces has been examined from an aesthetic approach. It has been argued that soundscape in urban public open spaces should be an essential part of the urban imageability study, in which aesthetic quality has been identified as a major dimension in the public's perception. Innovating from previous studies, the aim of this research is to identify the key soundscape components in urban public open space and thus to benefit the understanding of soundscape design. This research has been focused on the actual users' point of view.

9.1.2 Systematic Methodology

By means of social survey, observation, and physical parameter measurement, a comprehensive on-site questionnaire survey was carried out across Europe. For the first time, soundscape has been put into the overall social, visual and micro-climate context. In total, 9,200 people were interviewed on site in the 14 case study sites. Among these, 1,009 users were interviewed by the author in Sheffield.

9.1.3 Identity of Soundscape

Throughout Part I of this thesis, solid evidences have been found that soundscape is an important factor in people's perception and evaluation of urban public open spaces. In perceiving the sound elements in a given soundscape, it is found that the first noticed sounds by users are not necessarily the loudest - people always mention the soundmarks as their first noticed sounds. People pay attention to the sounds they hear in public open spaces and they have the instinct to distinguish what experts define as soundmarks, keynote sounds and foreground sounds.

All aesthetic questions involve preference. This research further confirms that natural and culturally approved sounds as a group are generally preferred in urban public open spaces. Moreover, these preferences are proved to influence people's choice of using a public open space. It has been suggested that favourable sounds in a given place encourage people to select a place. In addition, a tendency is found that in a given place, people tend to sit close to their favoured sounds, thereby effectively masking other unwanted sounds. This evidence has shown that the general public is calling for more aesthetically appealing soundscape in urban public open spaces. Therefore, the soundscape identity is a vital character for a successfully designated place.

9.1.4 The Emotional Dimensions of Soundscape

The study has focused on the interaction between people and the soundscape. The information contained in the soundscape, sound levels, people's preferences and evaluations, their background and behaviours are the key factors involved in the study.

Considerable differences have been found between the subjective evaluation of sound level and the acoustic comfort evaluation. The latter is much more complicated and its correlation with a measured sound level is systematically less than that between the sound level evaluation and measured sound level. More importantly, people tend to show more tolerance in terms of acoustic comfort evaluation (Yang & Kang, 2005a).

The further findings from this thesis have explained the above difference. It has been proved that the overall soundscape perception and evaluation directly relates to three basic emotional response variables, i.e. arousal, pleasure, and dominance. Within which, the sound level has a direct relationship with the arousal level, preferable sound elements relate to the pleasure and the choice for people to choose their favourable sounds explains some form of dominance.

In terms of sound level, it is suggested that the subjective evaluation generally relates well with the mean L_{eq} , especially when the L_{eq} is lower than a certain value, which is 73dBA on the basis of this research. With an increase in the sound level, arousal level increases correspondingly. However, with a similar tendency, the degree of people's sound level evaluation varies in different sites.

An important finding of this study suggests that the background sound level (L_{eq90}), instead of L_{eq} , is a more important index in evaluating soundscape in urban public open spaces. A lower background sound level generally makes people feel quieter, even with a higher foreground sound level.

In terms of individual sound elements, it has been found that the pleasure of soundscape in an urban public open space is greatly affected by the information contained in the sound. When a pleasant sound such as music or water dominates the

soundscape of an urban public open space, the relationship between the acoustic comfort evaluation and the sound level is considerably weaker than that of other sound sources such as traffic and demolition type sounds. In other words, the introduction of a pleasant sound could considerably improve the acoustic comfort, even when its sound level is rather high.

In terms of the third emotional dimension, dominance, it is more related to the users' behaviour in the urban public open spaces. The finding suggests that psychological factors are influential in determining the soundscape evaluation of a space and the change occurring within it.

Through recognising the key emotional dimensions of the soundscape in urban public open spaces, the interactive relationship between the dimensions can be seen clearly. Therefore, in soundscape design, attentions have to be paid to all the three dimensions. A pleasant and comfortable soundscape would not be achievable if only one aspect, e.g. reducing noise level, was considered.

9.1.5 Personal Differences

The analysis results suggest that there are rather clear sound preference differences between interviewees. It has been found that the differences are at three levels. The first can be defined as basic preference. People generally share a common opinion in preferring nature- and culture-related sounds rather than artificial sounds. However, cultural background and long-term environmental experience play an important role in people's judgment of sound preference (Yang and Kang, 2003; Yang & Kang, 2005b). People from different backgrounds may show rather different tendencies in their sound preferences. Thus there is a second level sound preference, which can be defined as macro-preference. At the third level, within the same cultural background and long-term environmental experience, personal differences exist. This can be defined as micro-preference. In particular, the differences between age groups are more significant than other factors.

Young people and old people may have some essential differences in evaluating sounds. Generally speaking, with an increase in age, people are more favourable to, or tolerant towards sounds relating to nature, culture and human activities. By contrast, younger people are more favourable to, or tolerant towards, music and mechanical sounds. From the viewpoint of urban square design, it is important to understand that the different tendencies of age difference between soundscape and landscape preferences.

Between males and females there are only slight differences. Females tend to put more emotional colours into their sound preference. It is noted that differences between sounds exceed gender differences.

It is found that both cultural differences and long-term acoustic experience influence people's sensitivity towards the sound levels in urban public open spaces. However, cultural differences play a more important role than the acoustic experience. In terms of sound preferences, it is found that city-living people generally share a common opinion in preferring natural and culture-related sounds rather than artificial sounds. However, cultural background and long-term environmental experience play an important role in people's judgement of sound preferences. People from a similar cultural background and long-term environment may show a similar tendency on their sound preferences. In terms of demographic differences, it has been shown that except for a slight tendency shown towards older people it was felt more comfortable than teenagers, there was no correlation between noise sensitivity and other demographic characteristics.

In examining the temporary status, the following tendencies are found (1) users who were standing were most acoustically uncomfortable, while users who were sitting were most acoustically comfortable; (2) groups with two people were more likely to be annoyed by the surrounding noise, whereas groups with more than two people were more insensitive towards soundscape; (3) users who came to the sites daily were most annoyed by the sound levels and users who came yearly were most tolerant. However, these tendencies do not apply to all 14 case study sites; only certain sites when

relatively more activities. Psychological adaptation is probably more significant in such situations.

Overall it can be seen that beside the general roles of emotional variables, personal differences play an important role. Although normally people share common opinions on the sound level, preferable sounds and appropriate activities in urban public open spaces, different people may still react differently in terms of how quickly their arousal level increases, what are their favourable sounds, and how they use the place. Therefore, during design considerations, attention should be paid to the characteristics of the potential users.

9.1.6 Other Physical Factors

Based on the data of 9,200 interviews, three factors have been identified in evaluating comfort conditions of urban public open spaces. Factor 1 (22.8%) is mainly associated with thermal comfort. Factor 2 (17.5%) is associated with visual and auditory senses. Factor 3 (14.8%) is principally related to humidity. The above factors cover 55% of the total variance, which indicates the complexity in evaluating comfort conditions of urban public open spaces. In other words, other aspects, such as social/cultural factors, may also influence the evaluation.

More importantly, the above findings also suggest that aural and visual perceptions have never been separated by the users of urban public open spaces. The auditory and visual perceptions always appear as the same factor when people evaluate the overall comfort in urban public open spaces. As has been insisted throughout this thesis, the calling of soundscape design is not an argument for an ideology of the aural to replace the hegemony of the visual aspect. It is vital to understand that a pleasant soundscape setting can benefit the visual setting, or *vice versa*. This finding is especially important for the design consideration of urban public open space regeneration, when visual improvement is difficult to achieve.

9.1.7 Typological Soundscape Design

Inspired from typological urban design, to benefit urban designers' understanding of the relationship between the spatial forms and the soundscape, the concept of 'typological soundscape study' has been defined in this thesis. Through computer simulation, a series of typologically classified forms have been studied in terms of shape, scale and openings. SPL, RT30 and EDT are the three indices considered in this study. From the typological soundscape analysis in this research, it is proved that typological spatial forms as well as spaces with various sizes and openness play significant roles in contributing to the sound field characteristics.

Different shaped spaces result in different sound fields. The results suggest that the more reflection surfaces are included in the enclosure, the higher the value of the indices. With the same area, at a given source-receiver distance, the circle shape, which is represented by a multi-plane polygon in the simulation, it has the highest SPL and longest RT30 and EDT.

The further analysis for the boundary absorption and diffusion has suggested that, although for different reasons, the increase of boundary absorption and diffusion can both reduce the overall SPL, RT30 and EDT. In terms of SPL, for the size of the studied square, 2,500m², when the absorption coefficient increases from 0 to 1, the SPL decreases 11-13dB, whereas it is approximately 6dB when diffusion coefficient increases from 0 to 1. From the design point of view, in terms of reducing SPL, increasing the absorption coefficient is more effective than increasing diffusion coefficient. However, increasing the diffusion coefficient is more effective in making the RT30 and EDT distribution more even in the configurations. The difference ratio is about 10%. It is also found that increasing the absorption coefficient can reduce the SPL, RT30 and EDT differences between different shapes, whereas the reduction of the differences by increasing the diffusion coefficient is dependent on the location of a receiver. It has a lesser effect when the receiver point is in the far field.

In terms of the scale of the spaces, as expected, the SPL becomes systematically less with increasing square size. In the far field of the configurations, the SPL is

approximately 6-8dB lower when the square size is doubled. In terms of RT30 distribution, the configuration size has significant influence on the overall sound field. The RT30 increases systematically with increasing square size. The RT30 of the receivers in the far field increases more than that in the near field. However, in terms of EDT distribution, the variation of different sized configurations is not constant across the whole sound field. It is found that the position of the reflection surfaces around the receiver plays a more important role than the overall configuration size.

In terms of boundary openness, as expected, the overall SPL, RT30 and EDT values decrease with increasing opening size. However, it is found that the SPL decreases more when the openings appear at the mid-field, whereas the RT30 decreases more when the openings appear at the near field. It is also important to note that the opening has more influence in reducing the overall SPL and RT30 of the configuration rather than the vicinity of the opening. However, the EDT value at a certain receiver largely depends on the position and the size of the opening near the receiver.

In urban design processes, the combination of various shaped, scaled and opening positioned forms can create endless urban public open spaces. Based on the case study of three urban space precedents, which represents classic urban design principles, it has been found that the sound field of a complex urban space is generally similar to that of the typologically classifiable forms. Especially the SPL, it is mainly determined by the shape, size, opening and material of the typologically classifiable forms. When these factors are determined, some detailed spatial form changes only have negligible effects to the sound level distribution of the space. However, it is also found that detailed spatial form changes, such as changing the shape of the end boundary, changing the orientation of surround walls, increasing the size of openings within a certain proportion, etc., will have a significant influence on RT30 and EDT. In particular, EDT variation has an approximately direct relationship with the spatial form change. Of more relevance to soundscape design in urban public open spaces, it is important to consider the possible sound level distribution of the space at a master-planning stage. Overall, the findings from the typological soundscape study can be used as general guidelines for estimating the possible sound level distributions. However, carefully

designed spatial details at a later stage can help to create more comfortable or dramatic sound fields.

9.1.8 Passive and Active Soundmark Design

As have been proved in this research, soundscape is an emotive environment. Therefore, in terms of soundscape design in urban public open spaces, when the background sound level is not excessive, introducing soundmarks may have dramatic effects. According to the type of sounds, soundmarks can be classified as 'passive' and 'active'. The former are intentionally designed functional and/or aesthetical elements with pleasant sounds, such as fountains and sonic sculptures, whereas the latter are sounds generated by interesting activities.

A typical passive soundmark, water, in the form of fountains, springs or cascades, is often used as a landscape element in public open spaces. Water sound can be defined as a 'primary soundscape quality' (Yang & Kang, 2005b). In this research, the water sound was classified as favourite by 79.3% of the interviewees, and the introduction of water elements has dramatically improved the soundscape quality in the studied urban squares. From detailed spectrum and dynamic range analysis for water sounds, it is found that most of the water sounds have significant high frequency components around 2k to 8k Hz and some of them also have notable low frequency components. For the overall soundscape, water sounds can effectively enrich the soundscape spectrum. Therefore, from the psychological point of view, people show more acceptance of the overall soundscape, although they may still be able to hear the background noise.

It has also been found that the spectrum of water features is designable. Different water flow methods result in different sound frequencies. Generally speaking, high frequency components come from the water splash itself. Also by dropping on the hard surface, the high frequency components within the water sound are even more amplified. When the large flow of water rises to a very high level and then drops to a water body or hard

surface, notable low frequency components are contained in the sound generated. Special attention must be paid to the flow rate. Keeping it at a constant sound level may cause people to lose interest and consequently the effects on their psychological adaptation would diminish with time.

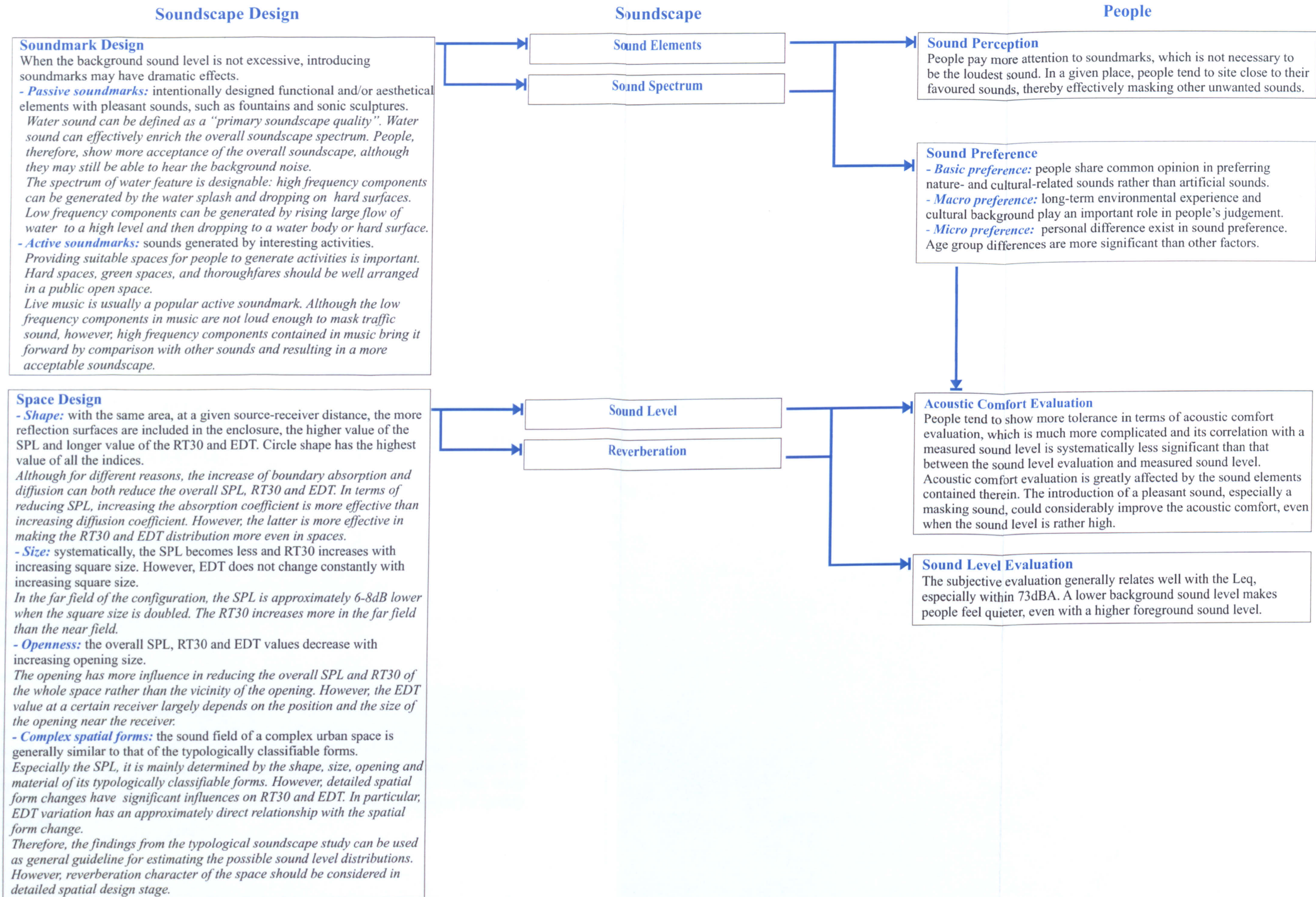
In terms of active soundmarks, providing suitable spaces for people to generate activities is very important. Hard spaces, green spaces, as well as thoroughfares should be well arranged in a public open space. A green space may enhance the natural appeal of a square, attract wild animals' activities such as birds singing, and improve the microclimate conditions and sound level distribution. Hard spaces are useful for generating many activities, especially for younger people, such as skateboarding. As well as designing space form and surface materials to generate exciting sound environments for such activities, it is important to reduce possible disturbance to other users, by introducing sound absorbent ground and noise barriers, for example.

Live music is usually very popular. As the water sound, it has been found that the low frequency components in music are not loud enough to mask traffic sound. However, high frequency components contained in music bring it forward by comparison with other sounds and resulting in a more acceptable soundscape. Additionally, people are attracted by the activities of the players as well as by the music itself. In this situation, the type of music (e.g. classic music, pop music, etc.) is relatively less important. However, when music is from a store or played through a public address system, the music type and its sound level need to be considered carefully.

9.1.9 Soundscape Design Considerations

To sum up, the soundscape design considerations concluded from this thesis are summarized in Figure 9.1.

Table 9.1 Soundscape design considerations in urban public open spaces



9.2 FUTURE WORK

Field Survey

In this research, field survey is one of the key methodologies employed. Based on the EU funded RUROS project, the field survey sites were selected within Europe. In the research findings, cultural and long-term acoustic experience has been identified as a factor influencing people's soundscape evaluations. However, the tendency found in this research is still not clear enough. It will be appropriate to extend the intensive field survey to more countries.

Psycho-acoustic Study

In this study, psycho-acoustic indices were not included, due to the complex source conditions. It would be useful to identify some typical sources and study the psycho-acoustic indices systematically, probably under laboratory conditions. In order to identify the acoustic characteristics of individual sounds, intensity measurements would be useful in such a study.

Reverberation

As mentioned in Chapter 3, due to complex source and openness situations of the field survey sites, in this research reverberation was not evaluated in the questionnaire survey. It would be useful to find a series of more enclosed squares to carry out the reverberation study. It is suggested that in the study simple sound source should be provided, and a jury may be more appropriate to be used as subjects. In such a study a systematic reverberation measurement can also be made. The measurement results would be valuable for validating the simulation model, as well as studying relationships between subjective and objective aspects.

Evaluation Tool

From analysing 9,200 interview questionnaires, this research has found several correlations between environment index and people's evaluations. The finding from this research formed a useful base for another current study, '*Acoustic comfort study using Neutral Network*'. The study is based on a modern computer technology, Neutral Network. By inputting a large amount of data, the programme can be trained to remember the relative tendency. Through this process, a Neutral Network model can be built up as an acoustic comfort evaluation tool.

Design Tool

From the typological soundscape study in this thesis, it has been found that the spatial forms have direct relationship with the sound field. Also, it has been found that the higher frequency components in the water sound and music make people feel more relaxed and enjoyed. The finding from this research formed a useful base for a current study, '*Acoustic simulation and auralisation in urban spaces*'. Computer software is being developed to simulate aural-visual animations. It is believed this further study will enhance the urban designer's ability for soundscape design and ensure the quality of such design.

REFERENCES

- 01dB-Stell. (2001). *Symphonie Measurement System - Getting Started Manual*. Limonest: 01dB-Stell.
- 01dB-Stell. (2002). *Solo – Data Logging Integrating Sound Level Meter - User Manual*. Limonest: 01dB-Stell.
- Anderson, L.M., Mulligan, B.E., Goodman, L.S., and Rezen, H.Z. (1983). Effects of sounds on preferences for outdoor settings. *Environment and Behavior*, 15, 539-566.
- Apfel, R.E. (1998). *Deaf Architects and Blind Acousticians, a Guide to the Principles of Sound Design*. New Haven: Apple Enterprises Press.
- ASA (the Acoustic Society of America). (2005). *Proceedings of the 149th Meeting of the Acoustical Society of America*. Vancouver: ASA.
- Astley, S. (1998). The fountains at Chatsworth. In *Fountains: Splash and Spectacle* (ed. M. Symmes). London: Thames and Hudson.
- Bacon, E.N. (1975). *Design of Cities* (revised edn.). London: Thames and Hudson.
- Baron, R.A. (1970). *The Tyranny of Noise*. New York: St. Martin's.
- Barrio, I.L. and Carles, J.L. (1995). Acoustic dimensions of inhabited areas: quality criteria. *The Soundscape Newsletter*, 10, 6-8.
- Berglund, B., Eriksen, C.A., and Nilsson, M.E. (2001). Perceptual characterization of perceived soundscape in residential area. In *Proceedings of the 17th International Conference on Acoustics*.
- Berlyne, D.E. (1960). *Conflict, Arousal and Curiosity*. New York: McGraw-Hill.
- Berlyne, D.E. (1971). *Aesthetics and Psychobiology*. New York: Appleton-Century-Crofts.
-

-
- Brush, R.O. and Palmer, J.F. (1979). Measuring the impact of urbanization on scenic quality: land use change in the northeast. In *Our Natural Landscape* (eds. G. Elsner and R.S. Smardon). Berkeley: Pacific Southwest Forest and Range Experiment Station.
- Bryan, M.E. and Tempest, W. (1973). Are our noise laws adequate? *Applied Acoustics*, 6, 219-232.
- Carles, J.L., Barrio, I.L., and de Lucio, J.V. (1999). Sound influence on landscape values. *Landscape and Urban Planning*, 43, 191-200.
- Couic, M.C. and Deletre, J.J. (1999). An intersensory approach to urban analysis and design. *Acoustica – acta acustica*, 85, Suppl.1: S355.
- Croome, D.J. (1977). *Noise, Building and People*. Oxford: Pergamon Press.
- DataKustik GmbH. (1998). *Cadna/A for Windows - User Manual*. Munich: DataKustik GmbH.
- De Ruiter, E. (2000). Noise control in the compact city. In *Proceedings of the 7th International Congress on Sound and Vibration*.
- DETR (Department of the Environment, Transport and the Regions). (2000). *Urban Regeneration White Paper: Our Towns and Cities – the Future: Delivering an Urban Renaissance*. London: Stationery Office.
- Department of the Environment. (1994). *Planning Policy Guidance (PPG) 24: Planning and Noise*. London: Welsh Office.
- The Duchess of Devonshire. (1999). *Chatsworth Garden*. Derby: Derbyshire Countryside Ltd.
- Dubois, D. and David, S. (1999). A cognitive approach of urban soundscapes. *Acoustica – acta acustica*, 85, Suppl.1: S355.
- Egan, M.D. (1988). *Architectural Acoustics*. London: McGraw-Hill.
-

-
- Ellermeier, W., Eigenstetter, M., and Zimmer, K. (2001). Psychoacoustic correlates of individual noise sensitivity. *Journal of Acoustic Society of America*, 109, 1464-1473.
- Environment Agency. (2000). *Noise Guidance - Internal Guidance for the Regulation of Noise at Waste Management Facilities under Waste Management Licensing Regulations*. Bristol: Environment Agency.
- Esposito, C.V. (1984). Methodological issues in assessment of environmental sound perception, a strategy for empirical research. In *EDRA 15: The Challenge of Diversity* (eds. D. Duerk and D. Campbell). Washington DC: Environmental Design Research Association.
- Field, A. (2000). *Discovering Statistics – Using SPSS for Windows*. London: SAGE Publications.
- Fields, J.M. et al. (1997). Guidelines for reporting core information from community noise reaction surveys. *Journal of Sound and Vibration*, 206, 685-695.
- Finnas, L. (1989). How can musical preferences be modified? a research review. *Bulletin of the Council for Research in Music Education*, 102, 1-58.
- Gifford, R. and Ng, C.F. (1982). The relative contribution of visual and auditory cues to environmental perception. *Journal of Environmental Psychology*, 2, 275-284.
- Gifford, R. (1996). *Environment Psychology*. Boston: Allyn and Bacon.
- Granö, J.G. (1929). Reine geographie. *Acta Geographica*, 2, 1-202.
- Hargreaves, D.J. (1986). *The Developmental Psychology of Music*. New York: Cambridge University Press.
- Harison, J.D. and Howard, W.A. (1972). The role of meaning in the urban image. *Environment and Behavior*, 4, 398-411.
- Hinton, J. and Bloomfield, A. (2000). Local noise mapping: the future? In *Proceedings of the Institute of Acoustics*, 2 (2), 431-436.
-

-
- Hintzen-Bohlen, B. (2001). *Rome and the Vatican City*. Cologne: Könemann.
- HMSO. (1988). *Calculation of Road Traffic Noise (CoRTN)*. London: Department of Transport, Welsh Office, Her majesty's Stationery Office.
- Howard, D. and Angus, J. (2001). *Acoustics and Psychoacoustics* (2nd edn.). Oxford: Focal Press.
- Howes, D. (ed.) (1991). *The Varieties of Sensory Experience*. Toronto: University of Toronto Press.
- Huang, J. (2003). *Accuracy and Efficiency in Noise Mapping* (MSc dissertation). Sheffield: the University of Sheffield.
- ICA (International Congress on Acoustics). (2001). *Proceedings of the 17th International Congress on Acoustics*. Rome: ICA.
- ICA (International Congress on Acoustics). (2004). *Proceedings of the 18th International Congress on Acoustics*. Kyoto: ICA.
- Inter-noise (the International institute of Noise Control Engineering). (2004). *Proceedings of the 33rd International Congress and Exposition on Noise Control Engineering*. Prague: Inter-noise.
- Ismail, M.R. and Oldham, D.J. (2003). Computer modeling of urban propagation. *Building Acoustics*, 10, 221-253.
- Ittelson, W.H. (1973). *Environment and Cognition*. New York: Seminar Press.
- Jopson, I. (2002). The accuracy of noise mapping. *Acoustics Bulletin*, 27 (5), 46-47.
- Kang, J. (2000). Sound propagation in street canyons: comparison between diffusely and geometrically reflecting boundaries. *Journal of the Acoustical Society of America*, 107, 1394-1404.
-

-
- Kang, J. (2001). Sound propagation in interconnected urban streets: a parametric study. *Environment and Planning B: Planning and Design*, 28, 281-294.
- Kang, J. (2002a). *Acoustics of Long Spaces: Theory and Design Practice*. London: Thomas Telford Ltd.
- Kang, J. (2002b). Computer simulation of the sound fields in urban squares: comparison between diffusely and geometrically reflecting boundaries. In *The 32nd International Acoustical Conference – EAA Symposium “Acoustics Banska Stiavnica 2002”*, Slovakia.
- Kang, J. (2002c). Numerical modeling of the sound field in urban streets with diffusely reflecting boundaries. *Journal of Sound and Vibration*, 258 (5), 793-813.
- Kang, J. (ed.) (2005). *Urban Acoustics – special issue of Applied Acoustics*, 66 (2).
- Kang, J. and Du, Z. (2003). Sound field and acoustic comfort in library reading rooms. In *Proceedings of the 10th International Congress on Sound and Vibration*.
- Kang, J. and Zhang, M. (2002). Semantic differential analysis on the soundscape of open urban public spaces. In *Proceedings of the First Pan-American/Iberian Meeting on Acoustics*.
- Kang, J. and Zhang, M. (2003). Acoustic simulation of urban squares. In *Proceedings of the 10th International Congress on Sound and Vibration*.
- Kaplan, S. (1987). Aesthetics, affect, and cognition - environmental preference from an evolutionary perspective. *Environment and Behavior*, 19, 3-32.
- Kariel, H.G. (1980). Mountaineers and the general public: a comparison of their evaluation of sounds in a recreational environment. *Leisure Sciences*, 3, 155-167.
- Krier, R. (1979). *Urban Space*. London: Academy Editions.
- Krier, L. (1984). *Houses, Palaces, Cities* (ed. D. Porphyrios). London: Academy Editions.
-

-
- Kuwano, S. and Namba, S. (2001). Dimension of sound quality and their measurement. In *Proceedings of the 17th International Congress on Acoustics*.
- Lang, J. (1988). Symbolic aesthetics in architecture: toward a research agenda. In *Environmental Aesthetics* (ed. J. L. Nasar). Cambridge: Cambridge University Press.
- Lewers, T. (1993). A combined beam tracing and radiant exchange computer model for room acoustics. *Applied Acoustics*, 38, 161-178.
- LMS Numerical Technologies N.V. (1997). *Raynoise Revision 3.0 Users Manual*. Leuven: LMS International.
- Lozzi Roma. (2002). *Villa d'Este*. Tivoli: Lozzi Roma Edizioni Turistiche.
- Lynch, K. (1960). *The Image of the City*. Cambridge: The MIT Press.
- Lynch, K. (1981). *A Theory of Good City Form*. Cambridge: The MIT Press.
- Lyons, E. (1983). Demographic correlations of landscape preference. *Environment and Behavior*, 15, 487-511.
- Mehrabian, A. and Russell, J.A. (1974). *An Approach to Environmental Psychology*. Cambridge: The MIT Press.
- Mehrabian, A. (1976). *Public Places and Private Spaces – The Psychology of Work, Play, and Living Environments*. New York: Basic Books Inc.
- Moreira, N. and Brya, M. (1972). Noise annoyance susceptibility. *Journal of Sound and Vibration*, 21, 449-462.
- Morris, A. (1994). *History of Urban Form - Before the Industrial Revolutions* (3rd edn.). London: Longman.
- Moughtin, C. (2003). *Urban Design: Street and Square* (3rd edn.). London: Architectural Press.
-

Nasar, J. L. (1990). Perception, cognition, and evaluation of urban places. In *Public Places and Spaces* (eds. I. Altman and E. H. Zube). New York: Plenum Press.

Nasar, J. L. (ed.) (1988). *Environmental Aesthetics – Theory, Research, and Applications*. Cambridge: Cambridge University Press.

Nikolopoulou, M. (ed.) (2004). *Designing Open Spaces in the Urban Environment: a Bioclimatic Approach*. Athens: Centre for Renewable Energy Sources.

Norberg-Schulz, C. (1979). *Genius Loci*. New York: Rizzoli International Publications, Inc.

North, A.C. and Hargreaves, D.J. (1996). The effects of music on responses to a dining area. *Journal of Environmental Psychology*, 16, 55-64.

North, A.C. and Hargreaves, D.J. (1997). Experimental aesthetics in everyday life. In *The Social Psychology of Music* (eds. D. J. Hargreaves and A.C. North). Oxford: Oxford University Press.

North, A.C. and Hargreaves, D.J. (1999). Can music move people? The effects of musical complexity and silence on waiting time. *Environment and Behavior*, 31, 136-169.

Ohlson, B. (1976). Sound fields and sonic landscapes in rural environments. *Fennia*, 148, 33-45.

Osgood, C.E., Suci, G.J., and Tannenbaum, P.H. (1957). *The Measurement of Meaning*. Urbana: University Press of Illinois.

Patsouras, C., Fastle, H., Patsouras, D., and Pfaffelhuber, K. (2001). Psychoacoustic sensation magnitudes and sound quality rating of upper middle class cars' idling noise. In *Proceedings of the 17th International Congress on Acoustics*.

Pease, J. (2000). Editor comment. *Noise Management*, 3 (4), 2000.

Peterson, S. (1979). Urban design tactics. *Architectural Design*, 49 (3), 76-81.

-
- Peterson, G. L. (1975). Recreational preferences of urban teenagers. In *Children, Nature and the Urban Environment, Proceedings of a Symposium at George Washington University*.
- Pitt, D.G. (1990). The attractiveness and use of aquatic environments as outdoor recreation places. In *Public Places and Spaces* (eds. I. Altman and E. H. Zube). New York: Plenum Press.
- Porteous, J.D. and Mastin, J.F. (1985). Soundscape. *Journal of Architectural and Planning Research*, 2 (3), 169-186.
- Porteous, J.D. (1996). *Environmental Aesthetics – Ideas, Politics and Planning*. London: Routledge Press.
- Prall, D. (1929). *Aesthetic Judgement*. New York: Crowell.
- Raimbault, M., Bérengier, M., and Dubois, D. (2001). Common factors in the identification of urban soundscapes pilot study in two French cities: Lyon and Nantes. In *Proceedings of the 17th International Congress on Acoustics*.
- Rapoport, A. (1977). *Human Aspects of Urban Form*. Oxford: Pergamon.
- Rinne, K.W. (1998). The fall and rise of the waters of Rome. In *Fountains: Splash and Spectacle* (ed. M. Symmes). London: Thames and Hudson.
- Rock, I. and Harris C.S. (1967). Vision and touch. *Scientific American*, 216, 96-104.
- Schachtel, E.G. (1959). *Metamorphosis*. New York: Basic Books Inc.
- Schafer, M.R. (1977a). *The Turning of the World*. Toronto: McClelland and Stewart.
- Schafer, M.R. (1977b). *Five Village Soundscapes*. Vancouver: A.R.C. Publications.
- Schulte-Fortkamp, B. (2001). The quality of acoustic environments and the meaning of soundscapes. In *Proceedings of the 17th International Conference on Acoustics*.
-

-
- Shaw, E.A.G. (1996). Noise environments outdoors and the effects of community noise exposure. *Noise Control Engineering Journal*, 44 (3), 109-119.
- Shield, B. (2002). How can we be sure noise maps are accurate? *Acoustics Bulletin*, 27 (4), 39.
- Siegel, S. and Castellan, N.J. (1988). *Nonparametric Statistics for the Behavioral Sciences* (2nd edn.). London: McGraw-Hill Book Company.
- Sitte, C. (1965). Greenery within the city. In *City Planning According to Artistic Principles* (ed. C. Sitte, trns. C.R. Collins and C.C. Collins). New York: Random House.
- Southworth, M. (1969). The sonic environment of cities. *Environment and Behavior*, 1, 49-70.
- Stansfeld, S. (1992). Noise, noise sensitivity and psychiatric disorder: epidemiological and psychophysiological studies. *Psychological Medicine, Monograph Supplement*, 22.
- Stedman, L. (2002). Brent maps the borough. *Noise Management*, 23, 5.
- Stocker, J. (2002). *Noise Mapping Cambridge City Centre*, <http://www.cerc.co.uk>.
- Symmes, M. (ed.) (1998). *Fountains: Splash and Spectacle*. London: Thames and Hudson.
- Tamura, A. (1998). An environmental index based on inhabitants' recognition of sounds. In *Noise Effects '98: Proceedings of the 7th International Congress on Noise as a Public Health Problem*.
- Taylor, S.M. (1984). A path model of aircraft noise annoyance. *Journal of Sound and Vibration*, 96, 243-260.
- Tompsett, R. (2002). Noise mapping-accuracy is our priority. *Acoustics Bulletin*, 27 (4), 9.
-

-
- Trancik, R. (1986). *Finding Lost Space: Theory of Urban Design*. New York: Van Nostrand Reinhold Company.
- Treib, M. (1998). Fountains as urban oases. In *Fountains: Splash and Spectacle* (ed. M. Symmes). London: Thames and Hudson.
- Truax, B. (ed.) (1978). *The World Soundscape Project's Handbook for Acoustic Ecology*. Vancouver: A.R.C. Publications.
- Truax, B. (1984). *Acoustic Communication*. New Jersey, Alex Publishing.
- Tsai, K.T. and Lai, R.P. (2001). The research of the interactions between the environmental sound and sight. In *Proceedings of the 17th International Conference on Acoustics*.
- Ulrich, R. S. (1983). Aesthetic and affective response to natural environments. In *Human Behavior and Environment* (eds. I. Altman and J.F. Wohlwill), Vol.6, *Behavior and the Natural Environment*. New York: Plenum Press.
- Urban Task Force. (1999). *Towards an Urban Renaissance: Final Report for the Urban Task Force*. London: Urban Task Force.
- Venture, F. and Sanfilippo, M. (1996). *Fountain of Rome*. New York: The Vendome Press.
- Venturi, R. (1966). *Complexity and Contradiction in Architecture*. New York: Museum of Modern Art.
- Viollon, S., Lavandiera, C., and Drakeb, C. (2002). Influence of visual setting on sound ratings in an urban environment. *Applied Acoustics*, 63, 493–511.
- Viollon, S. (2003). Two examples of audio-visual interactions in an urban context. In *Proceedings of the 5th European Conference on Noise Control – Euronoise 2003*.
-

-
- Ward, L.M. and Russell, J.A. (1981). The psychological representation of molar physical environments. In *Journal of Experimental Psychology: General*, 110, 121-152.
- Weinstein, N.D. (1978). Individual differences in reactions to noise: a longitudinal study in a college dormitory. *Journal of Applied Psychology*, 63, 458-466.
- Wirtz, R.C. (2000). *Florence*. Cologne: Könemann.
- Yalch, R. and Spangenberg, E. (1990). Effects of store music on shopping behavior. *Journal of Consumer Marketing*, 7, 55-63.
- Yang L.N. and Shield B.M. (1999). Two methods of modelling a curved surfaces in a ray tracing model. *Building Acoustics*, 5 (2), 69-78.
- Yang L.N. and Shield B.M. (2000). Development of a ray tracing computer model for the prediction of the sound field in long enclosures. *Journal of Sound and Vibration*, 229 (1), 133-146.
- Yang, W. (2000). *Soundscape Design in Urban Open Public Spaces* (MSc dissertation). Sheffield: the University of Sheffield.
- Yang, W. and Kang, J. (2001). Acoustic comfort and psychological adaptation as a guide for soundscape design in urban open public spaces. In *Proceedings of the 17th International Congress on Acoustics*.
- Yang, W. and Kang, J. (2003). A cross-cultural study of soundscape in urban open public spaces. In *Proceedings of the 10th International Congress on Sound and Vibration*.
- Yang, W. and Kang, J. (2005a). Acoustic comfort evaluation in urban open public spaces. *Applied Acoustics*, 66 (2), 211-229.
- Yang, W. and Kang, J. (2005b). Soundscape and sound preferences in urban squares: a case study in Sheffield. *Journal of Urban Design*, 10 (1), 69-88.
-

Zeitler, A. and Hellbrück, J. (2001). Semantic attributes of environmental sounds and their correlations with psychoacoustic magnitudes. In *Proceedings of the 17th International Congress on Acoustics*.

Zeitler, A. and Hellbrück, J. (1999). Sound quality assessment of everyday-noises by means of psychophysical scaling. In *Proceedings of Inter-noise 99*.

Zimmer, K. and Ellermeier, W. (1999). Psychometric properties of four measures of noise sensitivity: a comparison. *Journal of Environmental Psychology*, 19, 295-302.

Zube, E.H., Pitt, D.G., and Evans, G.W. (1983). A life span development study of landscape assessment. *Journal of Environmental Psychology*, 3, 115-128.

APPENDIX:**SHEFFIELD FIELD SURVEY QUESTIONNAIRES**

LOCATION: SHEFFIELD (THE PEACE GARDENS)

RECORD: _____

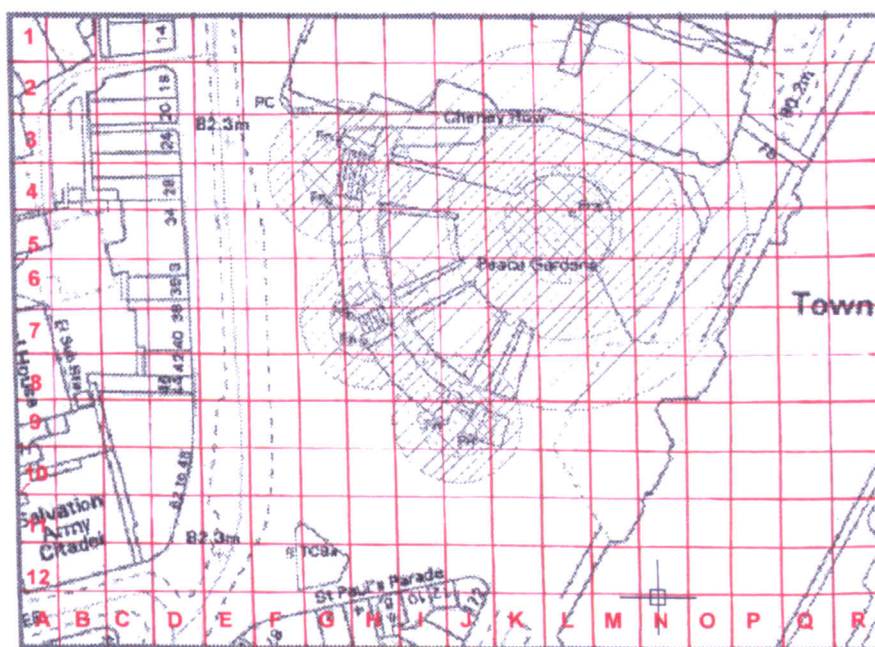
Name of observer: _____

Date: ___/___/___ (dd/mm/yy)

Monitoring Period: Morning Midday Afternoon Evening

Time: From _____ To _____
hh : mm : ss hh : mm : ss

Day of the week: Monday Tuesday Wednesday Thursday Friday Saturday Sunday Public Holiday

Sound Level (one-minute Leq) _____ dB(A)**Location in Site**

The Peace Gardens (10m x 10m each grid)

Fountain: A. Open B. Not open

Demolition: A. Yes B. No

Interviewee

- Sex: Male, Female
- Activity: sitting (consumer/free) standing walking sports playing with children
- Clothing:
 - T-shirt, (sleeveless/short/long) shirt, (cotton/woollen) jumper, sweatshirt
 - shorts, trousers, jeans, skirt (long, short), dress (short/long, no/short/long sleeves)
 - vest, cardigan, jacket (denim/cotton, wool), raincoat, overcoat, tie
 - umbrella
 - Cap/hat - Sunglasses

Food/drink Consumption: A. Cold drink B. Hot drink C. Food D. None

Status: 1. A. Alone B. With 1 person C. With more than 2 persons

- | | | |
|--|-----|----|
| 2. Wearing earphones/listening to music? | Yes | No |
| 3. Presently stay in sunlight | Yes | No |
| 4. Making movements to screen his/her eyes from excessive | Yes | No |
| 5. Performing a reading or writing task just before the interview | Yes | No |
| 6. Watching something distant (i.e. >10m away) just before the interview | Yes | No |
| 7. Which direction sector is the Interviewee presently looking at? | | |

LOCATION: SHEFFIELD (THE BARKERS POOL)

RECORD: _____

Name of observer: _____

Date: ____/____/____ (dd/mm/yy)

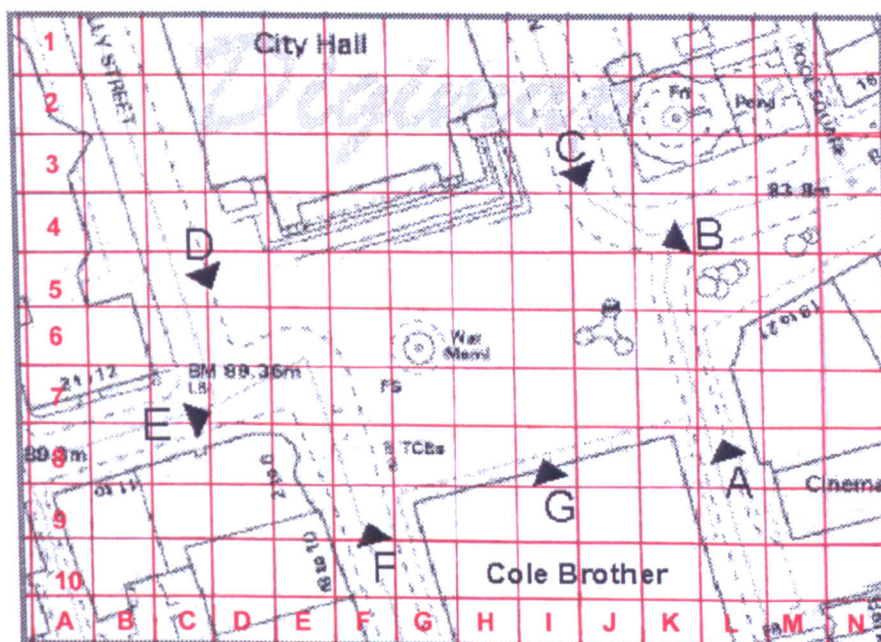
Monitoring Period: Morning Midday Afternoon Evening

Time: From _____ To _____
 hh : mm : ss hh : mm : ss

Day of the week: Monday Tuesday Wednesday Thursday Friday Saturday Sunday Public Holiday

Sound Level (one-minute Leq) _____ dB(A)

Location in Site



The Barkers Pool (10m x 10m each grid)

Music: 1. Yes 2. No

Interviewee

- Sex: Male, Female
- Activity: sitting (consumer/free) standing walking sports playing with children
- Clothing:
 - T-shirt, (sleeveless/short/long) shirt, (cotton/woollen) jumper, sweatshirt
 - shorts, trousers, jeans, skirt (long, short), dress (short/long, no/short/long sleeves)
 - vest, cardigan, jacket (denim/cotton, wool), raincoat, overcoat, tie
 - umbrella
 - Cap/hat - Sunglasses
- Food/drink Consumption: A. Cold drink B. Hot drink C. Food D. None
- Status:
 1. A. Alone B. With 1 person C. With more than 2 persons
 2. Wearing earphones/listening to music? Yes No
 3. Presently stay in sunlight: Yes No
 4. Making movements to screen his/her eyes from excessive Yes No
 5. Performing a reading or writing task just before the interview: Yes No
 6. Watching something distant (i.e. >10m away) just before the interview: Yes No
 7. Which direction sector is the Interviewee presently looking at?

RECORD: _____

Age Group: Child Teenager 18-24 25-34 35-44 45-54 55-64 >65

- At the moment do you find it
1 Very cold 2 Cold 3 Neither cold nor warm 4 Warm 5 Very hot
- What do you think of the **sun** at this moment? **(If it sunny)**
1 Prefer more 2 OK 3 Too much sun
- What do you think of the **wind** at this moment?
1 Stale 2 Little wind 3 OK 4 Windy 5 Too much wind
- What do you think of the **humidity** at this moment?
1 Damp 2 OK 3 Dry
- Are you feeling **comfortable**?
1 Yes 2 No
- What do you think of the **brightness** of this space?
1 Very dark 2 Dark 3 Neither dark nor bright 4 Bright 5 Very bright
- Do any surfaces appear noticeably **glaring** to you?
A No B Ground or pavement C Surrounding buildings D Vegetation
E Urban furniture F Canopy or sky G Vehicles
- Does the **view** from your position affect your appreciation of this site?
1. Negatively 2. not at all 3. Positively
- What is your general feeling towards the **sound level** in this space at this moment?
1. Very quiet 2. Quiet 3. Neither quiet nor noisy 4. Noisy 5. Very noisy
- Do you feel comfortable toward the **acoustic** environment at this moment? *
1. Very comfortable 2. Comfortable 3. Neither comfortable nor uncomfortable
4. Uncomfortable 5. Very uncomfortable
- How would you describe the **acoustics** in your **home**?
1. Very quiet 2. Quiet 3. Neither quiet nor noisy 4. Noisy 5. Very noisy
- What sound can you hear in this space at this moment? *
1....., 2....., 3.....
- Please classify the following sounds by '**annoyance**', '**neither favour nor annoyance**', '**favour**'

Bird songs (A, N, F)	Surrounding speech (A, N, F)	Children's shouting (A, N, F)
Bells of church (A, N, F)	Pedestrian crossing (A, N, F)	Passenger cars (A, N, F)
Water (A, N, F)	Clock chimes or music (A, N, F)	Passenger buses (A, N, F)
Music played on street (A, N, F)	Music from passenger cars (A, N, F)	Music from stores (A, N, F)
Insect sounds (A, N, F)	Vehicle parking (A, N, F)	Construction (A, N, F)

- Are you satisfied with the environment here? (Yes / No) _____
 - How frequently do you use this space? **A.** daily, **B.** weekly, **C.** monthly, **D.** yearly
 - Are you a local inhabitant? **A.** Yes **B.** No (If no, where are you from?
 - General speaking, when you want to relax for a short period outside, you prefer..... *
A. Quiet, natural sounds only **B.** Mainly natural sounds with artificial sounds in far distance
C. Natural and artificial sounds mix
- Could you briefly describe why?
.....

PERSONAL INFORMATION

Your personal information will help us to classify the different preferences for the square, but you could ignore any questions that you would not like to answer.

- Are you a? **A.** Pupil/student **B.** Working person **C.** Pensioner **D.** Housekeeper **E.** Other.....
- What is your educational level? **A.** Primary school **B.** Secondary school **C.** University

* Additional soundscape questions asked in Sheffield